

Title	Visualization of Hydrazine Decomposition in a Catalyst Bed by Using Neutron Radiography
Author(s)	Ito, Daisuke; Saito, Yasushi; Kagawa, Hideshi; Nagata, Taiichi; Masuoka, Tadashi; Ikeda, Hirohide; Kawabata, Yuji
Citation	Physics Procedia (2015), 69: 577-582
Issue Date	2015
URL	http://hdl.handle.net/2433/215125
Right	© 2015 The Authors. Published by Elsevier B.V. This is an open access article under the CC BY-NC-ND license(http://creativecommons.org/licenses/by-nc-nd/4.0/).
Type	Journal Article
Textversion	publisher



10 World Conference on Neutron Radiography 5-10 October 2014

Visualization of hydrazine decomposition in a catalyst bed by using neutron radiography

Daisuke Ito^{a*}, Yasushi Saito^a, Hideshi Kagawa^b, Taiichi Nagata^b,
Tadashi Masuoka^b, Hirohide Ikeda^b, Yuji Kawabata^a

^aResearch Reactor Institute, Kyoto University, 2-1010 Asashiro-nishi, Kumatori, Sennan, Osaka 590-0494, Japan

^bJapan Aerospace Exploration Agency, Japan

Abstract

Most mono-propellant thruster technologies were developed in the 1960s. Those basic principles and fundamental mechanisms, such as the catalyst and propellant, are still in use without major technical innovation. However, much remains to be clarified in terms of the mechanisms and quantitative limitations of the hydrazine decomposition phenomena inside the mono-propellant thruster. Therefore, in order to enhance the reliability of the propulsion systems, it should be promising to perform the direct observation of the physical and chemical phenomena occurring in the catalyst bed of the mono-propellant thruster. For that purpose, a visualization of the mono-propellant thruster was performed by using high frame-rate neutron radiography technique. The experiments were conducted at the Kyoto University Research Reactor and the hydrazine injection behavior to the catalyst bed was visualized clearly.

© 2015 The Authors. Published by Elsevier B.V. This is an open access article under the CC BY-NC-ND license (<http://creativecommons.org/licenses/by-nc-nd/4.0/>).

Selection and peer-review under responsibility of Paul Scherrer Institut

Keywords: Hydrazine decomposition, catalyst bed, mono-propellant thruster, high frame-rate neutron radiography

1. Introduction

Hydrazine catalyst thrusters have been used for wide variety of extended mission duty cycle. In such thruster operation, void might be formed in a catalyst bed of the reactor due to the breakup of the catalyst granules. Since the void might cause the operation instability of the thruster and the unexpected thrust decay, the catalyst behavior

* Corresponding author. Tel.: +81-72-451-2373; fax: +81-72-451-2431.
E-mail address: itod@rri.kyoto-u.ac.jp

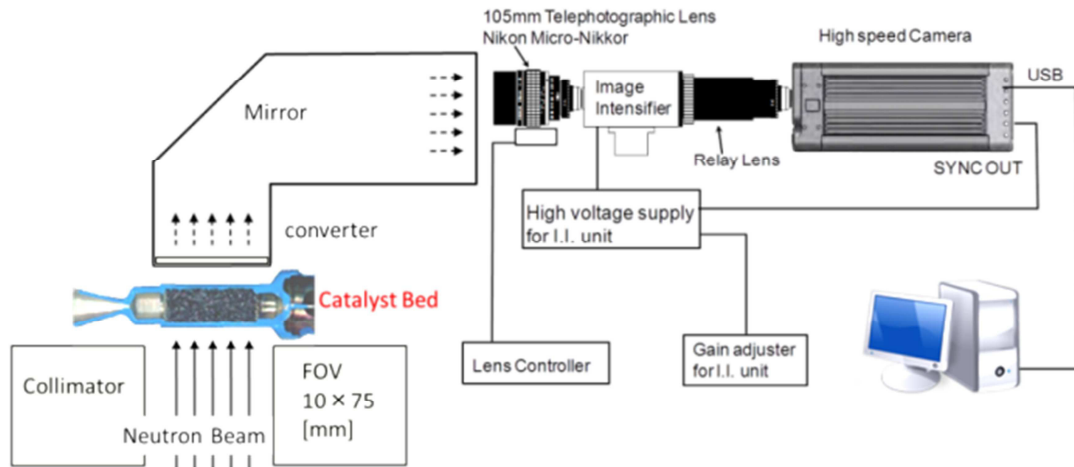

Fig. 1. High frame-rate neutron imaging system at B-4 experimental room in KURRI

in the thruster should be investigated. Visualization experiments have been carried out by using a transparent thruster simulator unit so far (Kagawa et al. 2004, Kagawa and Kushiki 2009, Yaroshenko and Podlevskikh 2014). The catalyst grain motion and catalyst bed temperature distribution were observed at the outer surface of the catalyst bed. However, the reaction of the hydrazine decomposition mainly occurs inside the catalyst bed. For that purpose, X-ray radiography has been applied (Goto et al. 2004). Although the behavior of the catalyst granules inside the catalyst bed could be observed clearly by using X-ray, the decomposition phenomena such as phase change should also be investigated.

Therefore, the neutron radiography technique was applied to visualize the hydrazine decomposition phenomena inside the thruster. Neutrons are characterized by higher cross-section for hydrogen. Thus it is suitable to observe the hydrazine flow which contains much hydrogen. In this study, dynamic information of the hydrazine injection was acquired by high frame-rate neutron radiography and the pulse injection behavior in the catalyst bed was investigated from the dynamic image sequence.

2. Experimental setup and method

2.1. Experimental facility and neutron radiography system

Experiments were conducted at the B-4 experimental room in the Research Reactor Institute, Kyoto University (KURRI). Hydrazine is designated as a toxic substance and the use is generally limited at nuclear reactor facility. However, the B-4 experimental room is placed outside of the reactor room by utilizing a supermirror neutron guide tube (Saito et al., 2011). Therefore, it is possible to perform the present experiments after safety review is passed properly. The schematic view of the neutron radiography experiment is illustrated in Fig. 1. The catalyst bed was placed on the neutron beam line and at the front of a converter (LiF:ZnS (Ag)). The optical light converted from neutrons at the converter was acquired by the imaging system consisting of a high-speed camera, an image intensifier and an optical lens. The image sequence acquired by the present system has some image noises due to the short exposure time. Therefore, a spatio-temporal filtering technique which extends conventional bilateral filter to three-dimensional region was applied to the obtained radiographs. As a result, the image noise could be reduced considerably to evaluate the hydrazine decomposition phenomena.

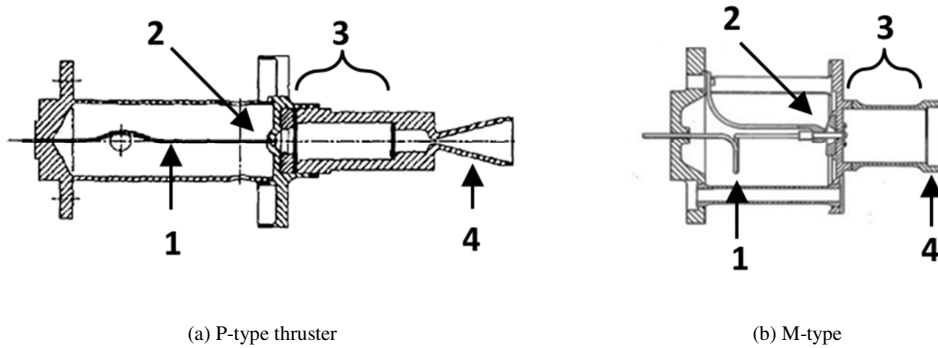

Fig. 2. Cross-sectional views of P-type and M-type injectors (1. feed tube, 2. injector, 3. catalyst bed, 4. nozzle)

2.2. Thruster simulators

Two types of 1N class thruster simulator unit were prepared for the neutron imaging experiments. One is a penetrate injector with head space (P-type) used for MBB's thruster (Kollen and Viertel, 1996), as shown in Fig. 2(a). Another is a mesh diffusion shower head injector (M-type) for which is used Olin cooperation designed to extend the mission life (Bruke et al., 1996), as shown in Fig. 2(b). These simulated thrusters were made of actual metallic material and the catalyst bed could not be seen from the outside of the thruster. They were prepared by IHI Aerospace Co., Ltd. under contract with JAXA. Two thrusters were installed to portable test equipment in parallel, as used in our previous paper (Kagawa, 2011, Kagawa, et al., 2014). The service life is known to differ considerably due to the difference in the two designs (Goto, et al., 2011). The P-type injector has a short service life due to the high load of the catalyst bed, while the M-type injector has a longer life due to soft hydrazine decomposition at the catalyst bed. In the present experiments, these injectors were operated in pulse injection mode. The period and number of the injections were varied.

2.3. Hydrazine thickness estimation

In the neutron radiography, the image gray levels of the thruster without the hydrazine (G_E) and with the hydrazine (G_H) can be expressed as follows,

$$G_E = C \cdot \phi_{th} \cdot \exp(-\Sigma_T \delta_T - \Sigma_C \delta_C) + G_0 \quad (1)$$

$$G_H = C \cdot \phi_{th} \cdot \exp(-\Sigma_T \delta_T - \Sigma_C \delta_C - \Sigma_H \delta_H) + G_0 \quad (2)$$

where G , C , ϕ_{th} , Σ and δ denote the image gray level, the gain, the thermal neutron flux, the total macroscopic cross section, and the thickness, respectively. The subscripts T , C and H show the thruster, the catalyst and the hydrazine, respectively. G_0 is the offset. From the Eq.(1) and Eq.(2), the thickness of the hydrazine in the thruster can be obtained by the following equation.

$$\delta_H = -\frac{1}{\Sigma_H} \ln \left(\frac{G_H - G_0}{G_E - G_0} \right) \quad (3)$$

Here, the total macroscopic cross-section of the hydrazine has to be given to calculate the hydrazine thickness by Eq. (3). Thus, it was evaluated experimentally using a stepped container filled by the liquid hydrazine in this study.

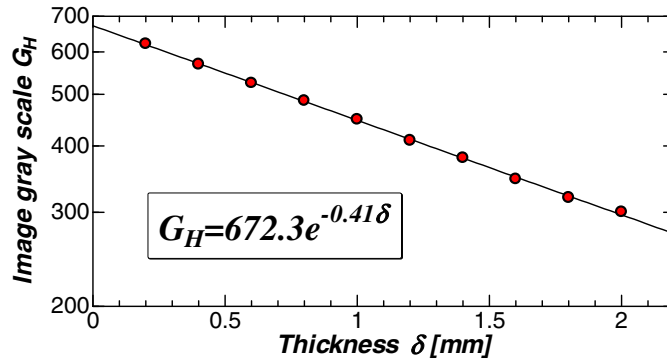

Fig. 3. Relation between thickness and image gray level for liquid hydrazine in the stepped sample.

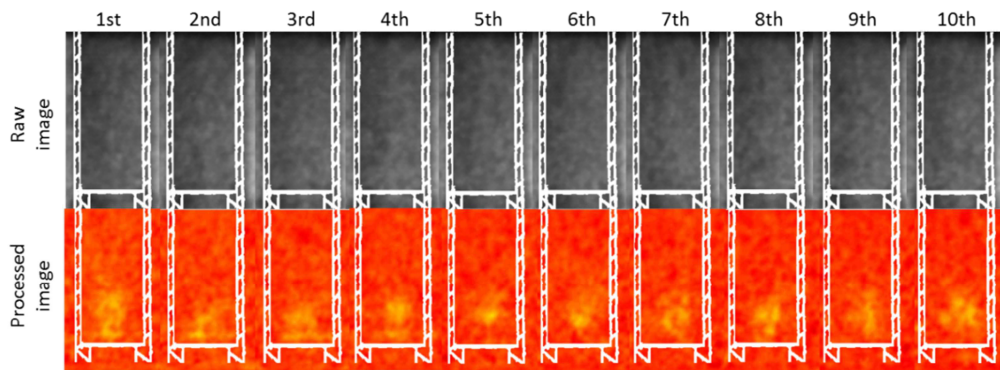

Fig. 4. Typical radiographs of hydrazine pulse injection using P-type injector (0.1sec ON/0.9sec OFF at 2.4MPa).

The neutron radiograph of the stepped sample was obtained by the imaging system shown above. The image gray scale is plotted against the hydrazine thickness, as shown in Fig. 3. The exponential fitting result is also represented in the graph. As a result, the macroscopic cross-section of the hydrazine used in this experiment is 0.41 mm^{-1} .

3. Results and discussion

3.1. Visualization results

Typical visualization result using the P-type injector is shown in Fig. 4. The frame rate of the image acquisition was 200 Hz and the neutron flux was $5 \times 10^7 \text{ n/cm}^2 \text{ s}$ at the beam exit. The upper row shows the raw images taken by the high speed camera and the lower one is images processed to accentuate the difference before and after the hydrazine injection. Liquid hydrazine absorbs more neutrons; however, it is difficult to recognize the presence of the hydrazine from the raw images. In contrast, it could be visualized clearly in the processed images. The bright area represents where much hydrazine exists. At first pulse, the liquid hydrazine penetrates to relatively wide region, while not many changes were found in the following pulses.

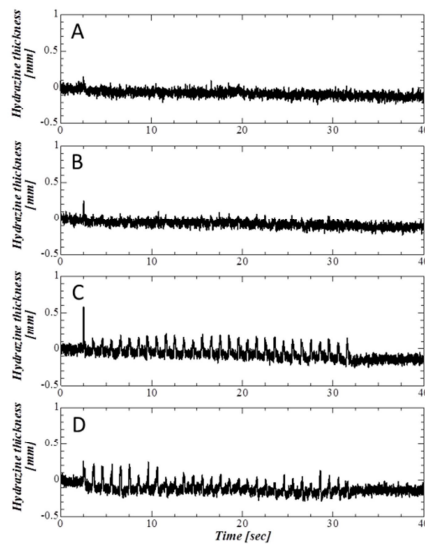
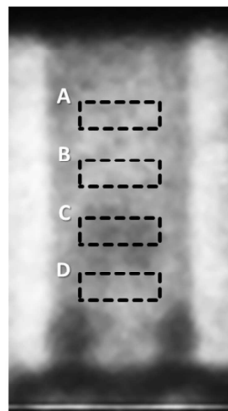

(a) P-type injector

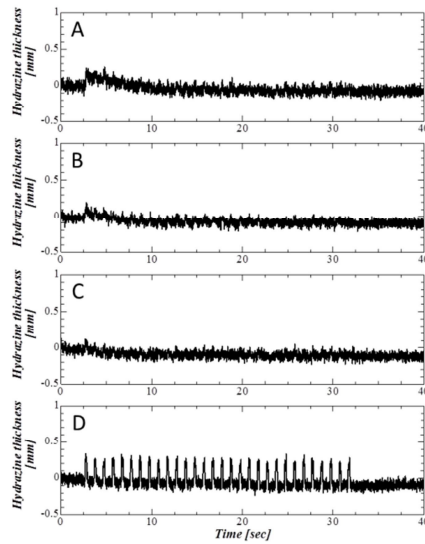
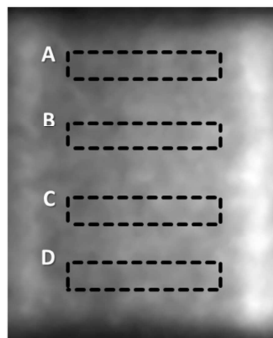

(b) M-type injector

Fig. 5. Pulse behaviors of injected hydrazine at different positions for P-type and M-type injectors.

3.2. Time-series pulse injection behavior

The simulated thrusters were operated in the pulse mode with 30 pulses (0.2sec ON/0.8sec OFF). The feed pressure was 2.4 MPa. The hydrazine injection behavior was visualized by the neutron radiography with a frame rate of 500 Hz. The thickness of the hydrazine in the catalyst bed was estimated from the brightness of the image and the macroscopic cross section which was obtained in the pre-experiment using the stepped test piece. The hydrazine pulsing behavior for both injectors is shown in Fig. 5. The hydrazine thickness was estimated by Eq.(3)

and it was averaged over the area illustrated in the left image of the figure. In Fig. 5 (a), the first pulse has large thickness and it reaches to the downstream of the catalyst bed. However, most of the hydrazine exists only near the inlet after the second pulse and they have small variation. On the other hand, the injection was uniformly at the upstream for M-type injector in Fig. 5 (b). In addition, the periodic pulses were observed even at the far side of the injector. As a result, the difference of the injection behaviors using two thrusters could be found by estimating the hydrazine thickness from the neutron radiographs. Thus, the stability and dispersibility of the thruster could be evaluated and a possibility of the performance assessment for the optimum hydrazine thruster was shown.

4. Conclusions and outlook

Hydrazine decomposition phenomena were investigated by high frame-rate neutron radiography technique which has been developed at the KURRI B-4 port. Two types of the mono-propellant thrusters were used to visualize the hydrazine injection behavior inside the catalyst bed. The presence of the liquid hydrazine in the catalyst bed was observed clearly from the neutron radiographs. The local hydrazine thickness in the thruster was estimated from the radiographs and the spatio-temporal characteristics were studied. The stability and dispersibility of the thruster could be evaluated by the radiographs and it has a possibility of the performance assessment to determine the extended catalyst bed life of the mono-propellant thruster.

References

- Burke et al., 1996. Long Life Catalytic Gas Generator for Space Propulsion Applications, United States Patent, No.5,568,723.
- Goto, D., et al., 2004. "Effects of Gravity on Voided Catalyst Bed of Hydrazine Monopropellant Thrusters", 4th International Spacecraft Propulsion Conference, Sardinia, Italy, 89.
- Goto, D., et al., 2011. "Endurance Firing Test Results of the Long Life 1N Hydrazine Thruster", 47th AIAA/ASME/SAE/ASEE Joint Propulsion Conference, San Diego, California, AIAA-2011-5772.
- Kagawa, H., et al., 2004. "Visualization for a Voided Catalyst Bed of Hydrazine Thruster in Microgravity", 40th AIAA/ASME/SAE/ASEE Joint Propulsion Conference, Fort Lauderdale, Florida, AIAA-2004-4153.
- Kagawa, H., Kushiki, K., 2009. "Measurement of Temperature Distribution at Mono-Propellant Catalyst Thruster", 49th Conference on Aerospace Propulsion and Power, B21.
- Kagawa, H., 2011. "Neutron Radiography used on a Mono-Propellant Thruster", 47th AIAA/ASME/SAE/ASEE Joint Propulsion Conference, San Diego, California, AIAA-2011-5841.
- Kagawa, H., et al., 2014. "Hydrazine Decomposition Phenomena Observed by Neutron Radiography at a Catalyst Bed", 10th International Symposium on Special Topics in Chemical Propulsion. Poitiers France, Paper #024.
- Kollen, O., Viertel, Y., 1996. "Development and Qualification of a Low-Cost, Long-Life 1-N Monopropellant Hydrazine Thruster", 32nd Joint Propulsion Conference and Exhibit, Lake Buena Vista, Florida, AIAA-96-2867.
- Kushiki, K., Kagawa, H., 2009. "Visualization of Propellant Behavior inside Catalyst Thruster Using Neutron Radiography", 45th AIAA/ASME/SAE/ASEE Joint Propulsion Conference, Denver, Colorado, AIAA-2009-4972.
- Saito, Y., et al., 2011. Development of Neutron Radiography Facility for Boiling Two-Phase Flow Experiment in Kyoto University Research Reactor. Nuclear Instruments and Methods in Physics Research Section A: Accelerators, Spectrometers, Detectors and Associated Equipment 651, 36-41.
- Yaroshenko, N.T., Podlevskikh, N.A., 2014. "Experimental Investigation of Decomposition of Liquid Monopropellant on High-Active High-Porous Catalyst by using High-Speed Filming", 10th International Symposium on Special Topics in Chemical Propulsion. Poitiers, France, Paper #125