

Online Research @ Cardiff

This is an Open Access document downloaded from ORCA, Cardiff University's institutional repository: <https://orca.cardiff.ac.uk/id/eprint/110408/>

This is the author's version of a work that was submitted to / accepted for publication.

Citation for final published version:

Muhssin, Mazin T. ORCID: <https://orcid.org/0000-0002-2780-3845>, Cipcigan, Liana M. ORCID: <https://orcid.org/0000-0002-5015-3334>, Sami, Saif Sabah and Obaid, Zeyad Assi 2018. Potential of demand side response aggregation for the stabilization of the grids frequency. Applied Energy 220 , pp. 643-656. 10.1016/j.apenergy.2018.03.115 file

Publishers page: <https://doi.org/10.1016/j.apenergy.2018.03.115>
<<https://doi.org/10.1016/j.apenergy.2018.03.115>>

Please note:

Changes made as a result of publishing processes such as copy-editing, formatting and page numbers may not be reflected in this version. For the definitive version of this publication, please refer to the published source. You are advised to consult the publisher's version if you wish to cite this paper.

This version is being made available in accordance with publisher policies.

See

<http://orca.cf.ac.uk/policies.html> for usage policies. Copyright and moral rights for publications made available in ORCA are retained by the copyright holders.



Potential of Demand Side Response Aggregation for the Stabilization of the Grid's Frequency

Mazin T. Muhssin^{a,b}, Liana M. Cipcigan^a, Saif Sabah Sami^a, Zeyad Assi Obaid^a

^aSchool of Engineering, Cardiff University, Cardiff, CF24 3AA, UK

^bCollege of Engineering, The University of Mustansiriyah, Baghdad, 10047, Iraq

Abstract The role of ancillary services related to the frequency control have become increasingly important in the smart grids. Demand Side Response is a competitive resource that can be used to regulate the grid frequency. This paper describes the use of heat pumps and fridges to provide ancillary services of frequency response so that to continuously balance the supply with demand. The power consumption of domestic units is usually small and, therefore, the aggregation of large numbers of small units should be able to provide sufficient capacity for frequency response. In this research, dynamic frequency control was developed to evaluate the capacity that can be gathered from the aggregation of domestic heat pumps and fridges for frequency response. The potential of frequency response was estimated at a particular time during winter and summer days. We also investigated the relationship between both loads (domestic heat pumps and fridges) to provide Firm Frequency Response service. A case study on the simplified Great Britain power system model was developed. Based on this case study, three scenarios of load combination were simulated according to the availability of the load and considering cost savings. It was demonstrated that the aggregation of heat pumps and fridges offered large power capacity and, therefore, an instantaneous frequency response service was achievable. Finally, the economic benefit of using an aggregated load for Firm Frequency Response service was estimated.

Keywords: Aggregated load control; Ancillary services; Dynamic frequency control; Fridge; Heat pump; Smart grid

1 Nomenclature and parameters

DSR	Demand side response
FFR	Firm frequency response
	Temperature of building
	Temperature of fridge's cooler
	Minimum temperature of a building/cooler
	Maximum temperature of a building/cooler
	Availability of low-frequency response from heat pumps
	Availability of high-frequency response from heat pumps
	Availability of low-frequency response from fridges
	Availability of high-frequency response from fridges
	Seasonal availability of low-frequency response in winter
	Seasonal availability of low-frequency response in summer
	Seasonal availability of high-frequency response in winter
	Seasonal availability of high-frequency response in summer
	Number of heat pumps
	Number of fridges
	Number of heat pumps that have ON states
	Number of heat pumps that have OFF states
	Number of fridges that have ON states

	Number of fridges that have OFF states
and	Upper and lower trigger Frequency of a heat pump unit
and	Upper and lower trigger Frequency of a fridge unit
and	Final switching signal of a heat pump and a fridge
	Temperature control signal of the building
	Temperature control signal of the cooler

2 Introduction

In a power system, frequency deviation is the main indicator of the momentary imbalance between supply and demand. The grid's frequency fluctuates continuously due to the practical difficulty of controlling generation to instantaneously track all changes in demand [1]. In real power systems, frequency response services are traditionally classified into the following three categories [2]:

- Primary service, which is provided by frequency-sensitive generators and a load that responds within a few seconds to a change of grid frequency.
- Secondary service, which is provided by generators and a load responding to the frequency signal within 5–10 minutes and which can be continued until the frequency is restored to the nominal value.
- Tertiary service, which is an emergency control action that is applied when there is a serious power mismatch between supply and demand. This service is typically provided by stand-alone generators.

In the Great Britain power system, uncertainty in demand forecasting is met by ensuring a sufficient amount of spinning reserve from large scale generating units driven by nuclear and fossil fuel sources. These generators alter their active power output in response to a frequency change. However, continuing to rely on fossil fuels to produce electricity has two main problems: the potential shortage of fossil fuels at reasonable prices and the emissions that come from burning the fuel. It is predicted that changes in environmental legislation and other government policies will result in a higher generation diversity. More electricity will be generated from renewable, low-carbon resources such as wind and solar. In the Great Britain (GB), it is projected that wind generation may contribute up to 30% of the total generation capacity by 2020 [3]. However, increasing the reliance on renewables causes two challenges:

- Increasingly intermittent sources provide a large proportion of variable and less flexible generation. Hence, maintaining an instantaneous balance between supply and demand is becoming a real challenge in the GB power system [4].
- System inertia is reduced when converter-connected generators displace the conventional generation sources.

Increasing demand is another challenge that is facing the power system. The level of electricity consumption will increase as a result of electrification of heat, such as electric heat pumps, and electrification of transport, such as electric vehicles [4, 5]. The electricity sector is becoming more diverse with a transition from a small number of large companies to a wide range of smaller aggregators and innovators [4]. To accommodate this level of variable generation and demand, additional conventional frequency response (acting in seconds) is required, which will significantly increase the operational cost [6]. However, a considerable portion of the frequency response required to balance the grid frequency could be obtained by the demand at low cost through demand side response (DSR) mechanism. DSR is a process that can deliberately change the users' natural pattern in response to a signal from other parties. Businesses and consumers can turn up, turn down, or shift their flexible demand in real-time to provide a frequency response service after receiving a frequency signal [7].

2.1 Brief description of frequency control strategies

This section aims to describe the latest strategies that use the demand to provide ancillary services of frequency response to continuously balance supply with demand. Recent studies have demonstrated the concept and benefits of DSR, although they have not directly referred to a specific load technology. For example, references [2, 8-11] summarize the technical features and economic benefits of using demand control algorithms. These studies use a stochastic control algorithm and they have applied it to the load to stabilize the system frequency. The responsive load in these studies has the potential to provide a considerable operating cost saving and they can reduce carbon emissions by replacing the spinning reserve service of generators with the frequency response service of demand. The authors in [12, 13] studied large battery applications for frequency response provision. Battery storage systems can be installed to store electricity when solar generation exceeds the demand or when electricity is cheap. This stored electricity can then be used when needed. However, the use of large batteries for frequency response provision requires a large investment cost. Electric vehicles (EVs) may be used for the same purpose with less investment cost. In [5, 14-17], a population of EVs were used a source of demand response to regulate the grid frequency and provide rapid frequency response with the presence of large scale of intermittent wind generation. A dynamic EV frequency control algorithm that considered the travelling behavior of the EV users was developed to drive the EVs charging/discharging in response to changes in the grid frequency [5]. The authors in [17] developed an estimation tool to estimate the 24- hour EV charging load for frequency control study based on statistical analysis and according to EV type.

Thermostatically Controlled Loads (TCLs), such as fridges, heat pumps, water heaters, bitumen tanks, and so on, are also flexible candidates for DSR [18-21]. The normal operation of these appliances can be temporarily interrupted without a noticeable effect on the temperature. Because there are a large number of thermal loads connected to the grid and their thermal storage characteristics, the TCLs could potentially provide a significant economic value throughout the provision of various forms of ancillary services [2, 22-24]. Two main dynamic TCLs frequency control algorithms have been used for the provision of a frequency response service, namely: centralised and decentralized control. For example, in [25] and [26], a comprehensive DSR strategy based on central load control was developed to regulate the system frequency by controlling the aggregation of electric water heating and air conditioning units. However, the centralised load control algorithm requires the support of a high- performance communication system between the load and the system operator. The system operator operates the central controller, which monitors the ON/OFF state conditions of all thermostats and decides to turn them ON or OFF to balance demand with supply and restore the grid frequency to the nominal limits. Ideally, the load controller should not use real-time communication between the system operator and millions of TCLs connected to the grid because of the expensive infrastructure requirements and the possibility of communication failures.

Decentralized control algorithms have also been used for frequency regulation and they are installed locally [27, 28]. Hence, they do not need two- way communication with the system operator. Decentralized control strategy uses triggering frequency signal with predefined frequency deviation ranges. The frequency controller only turns the TCLs ON or OFF when the grid frequency exceeds the trigger frequency ranges. However, the decentralized control algorithms presented in these studies may not limit the operation of the frequency controller dynamically with the temperature and, therefore, the temperature performance of TCLs might be undermined.

Another class of the decentralized control system aims to control the power consumption of TCLs dynamically with the temperature by using a dynamic frequency control (DFC) algorithm [20, 21, 29-32]. The dynamic decentralized controller in [30-32] controls the power consumption of domestic refrigerators and industrial melting pots linearly with

the frequency changes. The controller aims to maintain the primary thermal storage functions of each unit. In [20], the dynamic decentralized controller controls the power consumption of industrial bitumen tanks dynamically in response to frequency deviations by measuring the present and previous frequency samples. Field tests were undertaken on 76 bitumen tanks by Open Energi, the commercial aggregator who provides frequency services to the GB power operator, and each tank was equipped with a dynamic demand controller [20]. It was shown in that study that bitumen tanks can provide frequency response and decrease the spinning reserve of the generators. In [21], a DFC was developed to control the power consumption of domestic heat pumps to stabilize the grid frequency. The dynamic operation of DFC was improved by giving a parabolic shape to the relationship between the temperature and frequency variations. The parabolic shape expanded the region of the switching action, which caused more heat pumps to respond to the frequency event earlier. As the grid frequency recovered, the DFC ensured smooth reconnection. Thus, the substantial load payback that could result from a simultaneous reconnection of a substantial load after the frequency event was avoided.

2.2 Scope

The purpose of this paper is to develop a flexible demand scheme or the aggregation of heat pumps and fridges to provide ancillary services of frequency response to continuously balance demand with supply. The power consumption of domestic load is usually small and, therefore, requires an aggregation of substantial number of load to provide a noticeable response to a large system, such as the GB power system. In addition, the reliance on the aggregation of similar types of domestic load to provide the required frequency response will burden that type of load and, hence, the aggregation of diverse types of load is important to unlock the flexibility of domestic demand. The contribution of this study is summarized as follows:

1. Investigate the availability of heat pumps and fridges in the ON and OFF states, which are available to be switched OFF/ON in response to the frequency change over the time of day.
2. Develop an improved decentralized Dynamic Frequency Control (DFC) algorithm that can continuously control the power consumption of heat pumps and fridges in a non-disruptive way.
3. Exploit the presence of a population of heat pumps and fridges to be used as a source of flexible demand to regulate the grid frequency and provide rapid frequency response.
4. Develop a mathematical formula that describes the combination of heat pumps and fridges for the provision of frequency response service.
5. Examines the potential of the DFC algorithm by connecting the aggregated controlled load to the simplified GB power system.
6. Investigates the financial value of the aggregated load control to participate in the balancing service based on the present operational practice of the GB power system.

This paper aims to answer the following questions:

1. How to specify the number of heat pumps and fridges to be combined for the provision of frequency response?
2. Can the aggregated heat pumps and fridges participate in the Firm Frequency Response (FFR) service in GB?
3. What are the scenarios that the demand aggregator can adopt for the combination of heat pumps and fridges taking into account the number of units and cost saving?
4. What impact might the DFC-based aggregated heat pumps and fridges have on the grid frequency and rate of change of frequency (RoCoF) when the value of system inertia is low?

5. Does the aggregated controlled load in this study mimic the behavior of frequency-sensitive generators?
6. What is the economic and environmental value of the aggregated load control?

3 Availability of load

3.1 Availability of heat pumps at different times of the day

The availability of load is defined as the fraction of load that is available to provide a low and high-frequency response without undermining the internal load function. In real life, only part of the load has ON-state and is available to switch OFF, and only part of the load has OFF-state and is available to switch ON in response to system frequency. Therefore, the system operator needs to be notified about the amount of load that is available to respond to the grid frequency at each time of a day.

In this paper, the Availability of Low Response () is defined as the percentage of load that is available to be switched OFF to provide a low-frequency response. The Availability of High Response () is the percentage of load that is available to be switched ON to provide a high-frequency response. For heat pumps, data of average and are gathered and estimated considering the Element Energy’s medium uptake scenario for the year 2030 [33]. The and are half hourly data gathered over a day and they are averaged for the winter months in Great Britain [33, 34], as presented in Fig. 1. It is shown that the response is highest at 06:30 and lowest between 23:00 and 04:00.

The response from heat pumps is seasonal; that is, they use less power in summer than in the winter due to the lower heating demand. The seasonal effect on the energy consumption of heat pumps over the year is obtained from [33], as shown in Fig. 2. The seasonal availability of low-frequency response in winter and summer months are denoted and . For a high-frequency response, the seasonal availability is denoted and .

Based on the (winter), (winter) and the seasonal availability, the and over a summer day are calculated using equations (1) and (2). Fig. 3 shows the (summer) and (summer) that are averaged between April to September.

$$\text{_____} \tag{1}$$

$$\text{_____} \tag{2}$$

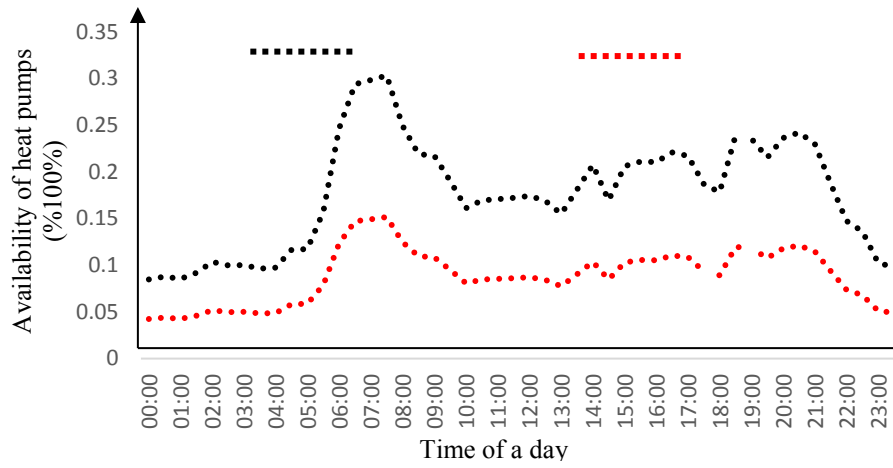

Fig. 1 Availability of heat pumps over a winter day

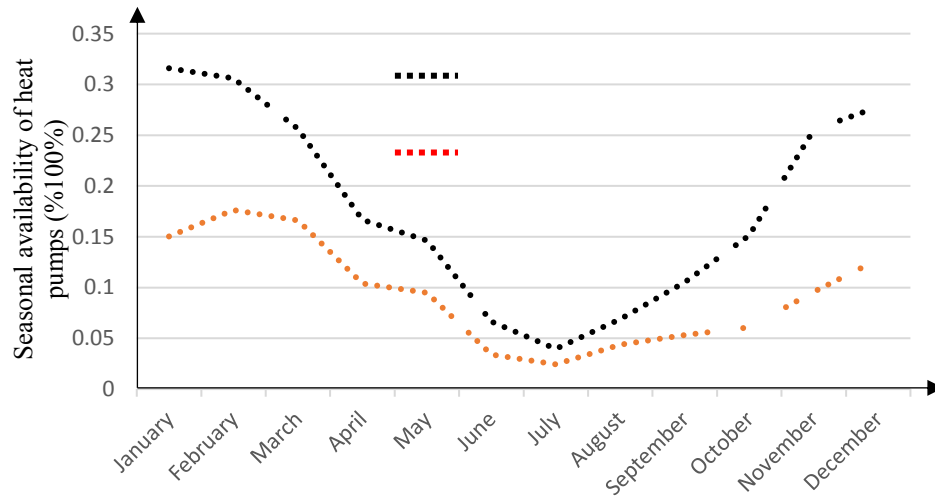

Fig. 2 Seasonal Availability (SA) of heat pumps [33]

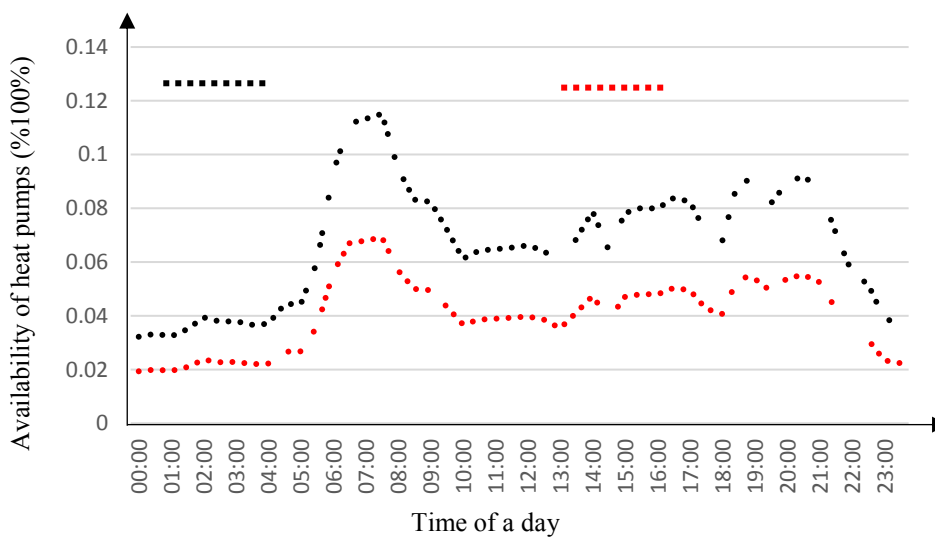

Fig. 3 Availability of heat pumps over a summer day

3.2 Availability of fridges at different times of the day

For fridges, field test to measure the α and β were undertaken for winter months in 2011/2012 [35]. The investigations were carried out on 1,000 fridges in Great Britain’s homes, including diverse types of coolers/freezers covering almost 80% of the fridge market. The average α and β in the summer and winter at each hour of a day are given in [35]. The availability of fridges is nearly constant over the day because most fridges are usually engaged in the consumers’ use.

3.3 Potential response from all heat pumps and fridges

According to the 2030 medium uptake scenario developed by Element Energy, as presented in [33], there are expected to be 3.8 million heat pumps in Great Britain’s dwellings by 2030. There will also be approximately 48 million fridges in GB by 2030 according to [36]. Each heat pump has a typical power consumption of 3kW [33], and each fridge has a typical power consumption of 0.1kW [35]. The total availability response from all the heat pumps and fridges over the whole day is calculated by using equations (3) and (4).

$$\alpha = \frac{N_{ON}}{N_{total}} \tag{3}$$

$$\beta = \frac{N_{OFF}}{N_{total}} \tag{4}$$

where N_{ON} and N_{OFF} are the numbers of heat pumps that have ON and OFF states, respectively. Similarly, N_{ON} and N_{OFF} are the numbers of fridges that have ON and OFF states respectively. N_{total} and N_{total} are the total numbers of heat pumps and fridges respectively.

Fig. 4 shows the entire availability of aggregated load at different times of the day. As shown in Fig. 4, the potential of frequency response from aggregated heat pumps and fridges is considerable, especially in the winter. At the GB’s peak demand time (17:00–20:00), the heat pumps and fridges are available to provide a minimum of 3,500MW load decrease in winter and drop to 2,450MW in summer. Meanwhile, at the lowest Great Britain system demand between (00:00–06:00), the load aggregation is able to provide a minimum of 3,640MW increase in winter and 2,320MW in summer. It can be observed that the availability of frequency response is always lower in the summer due to lower heat pump demand.

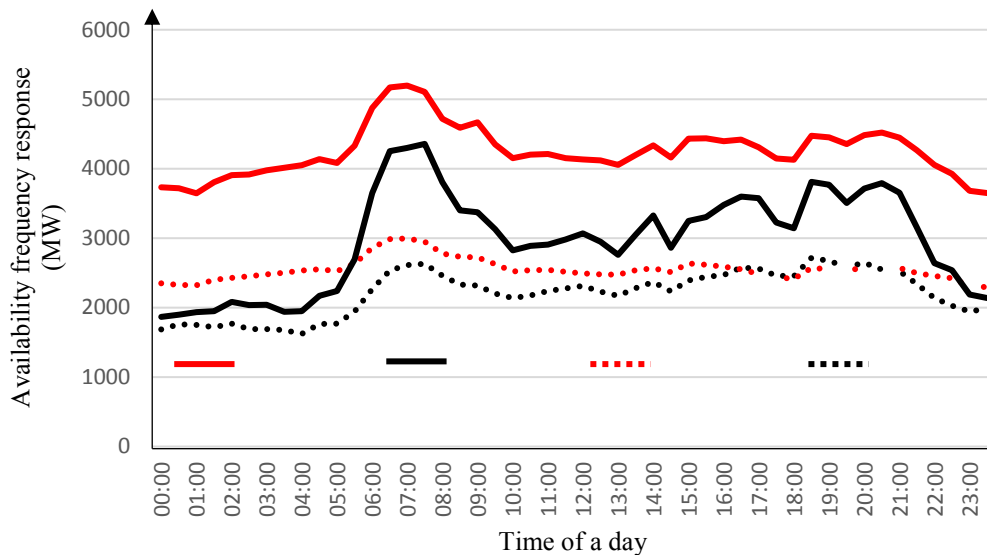

Fig. 4 Available frequency response from all heat pumps and fridges over a day

4 Load aggregation for the provision of frequency response

4.1 Concept

In Great Britain, the National Grid is obliged to maintain the grid frequency to within $\pm 1\%$ of 50Hz (i.e. $50\pm 0.5\text{Hz}$). The National Grid uses Balancing Mechanism (BM) tool to balance the electricity supply and demand in real-time [37]. The BM allows the frequency response providers to sell electricity to the system (i.e. National Grid or distribution networks) by either increasing generation or decreasing demand consumption. The FFR is one of the most valuable balancing services in GB that is open to BM and non-BM providers [38, 39]. The demand aggregators can secure a bridging contract with the network operator (or National Grid) to build their flexible demand scheme by aggregating different assets. In the FFR service, businesses and consumers can sell the demand consumption by turning up, turning down, or shifting their flexible demand in real-time to provide a frequency response service after receiving a frequency signal. To participate in the FFR service, demand aggregators must be capable of providing a minimum of 10MW of frequency response to the grid within 30 seconds of a frequency event.

4.2 Potential applications of demand side response aggregation

The DSR that is obtained from the aggregation of heat pumps and fridges can provide various applications, as follows:

- **Frequency control**, the aggregated heat pumps and fridges can be controlled through a DFC algorithm. Then, the controlled load will be connected to the power system to regulate the grid frequency (i.e. help to balancing the demand with supply second by second in real-time).
- **Ancillary services**, during system contingencies (such as a power station tripping out), the controlled load can support the grid frequency by temporarily reducing the demand consumption.
- **Spinning reserve**, the participation of DSR aggregation reduces the spinning reserve shared by the generators, especially during peak demand hours [4].
- **Carbon emission**, the integration of aggregated load control to the system minimizes the capacity of part load (i.e. fossil fuel) generators, and hence the carbon emission is reduced.

4.3 Identification method for the combination of heat pumps and fridges

The aggregation of certain numbers from both heat pumps and fridges to provide a minimum low frequency response of 10MW to the grid is calculated by using equation (5). The time of the day is divided into five periods according to the availability of the load, as shown in Fig. 5. The intersection point between the red and black slopes represents the aggregation of 8,000 heat pumps and 30,5396 fridges to provide 10 MW of low frequency response over the time 14:00-21:00 (the time that involves the peak demand). The values of α and β are the averaged value of the five periods given, as shown in Table 1.

(5)

Table 1 α and β at different times of day

Period	Time of day	α ($\times 100\%$)	β ($\times 100\%$)
1	10:00-13:30	0.17	0.167
2	14:00-17:00	0.2	0.165
3	17:30-18:00	0.18	0.184
4	18:30-21:00	0.23	0.175
5	22:00-04:00	0.12	0.15

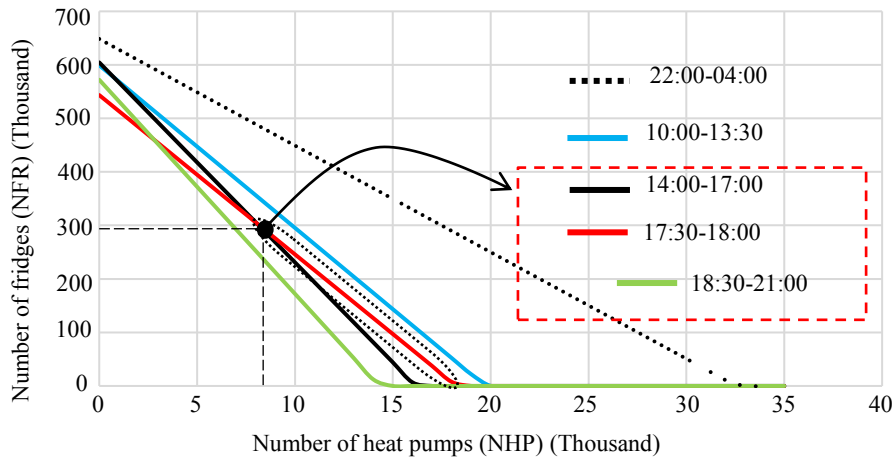

Fig. 5 Aggregation of heat pumps and fridges for the provision of 10MW threshold (low frequency response service)

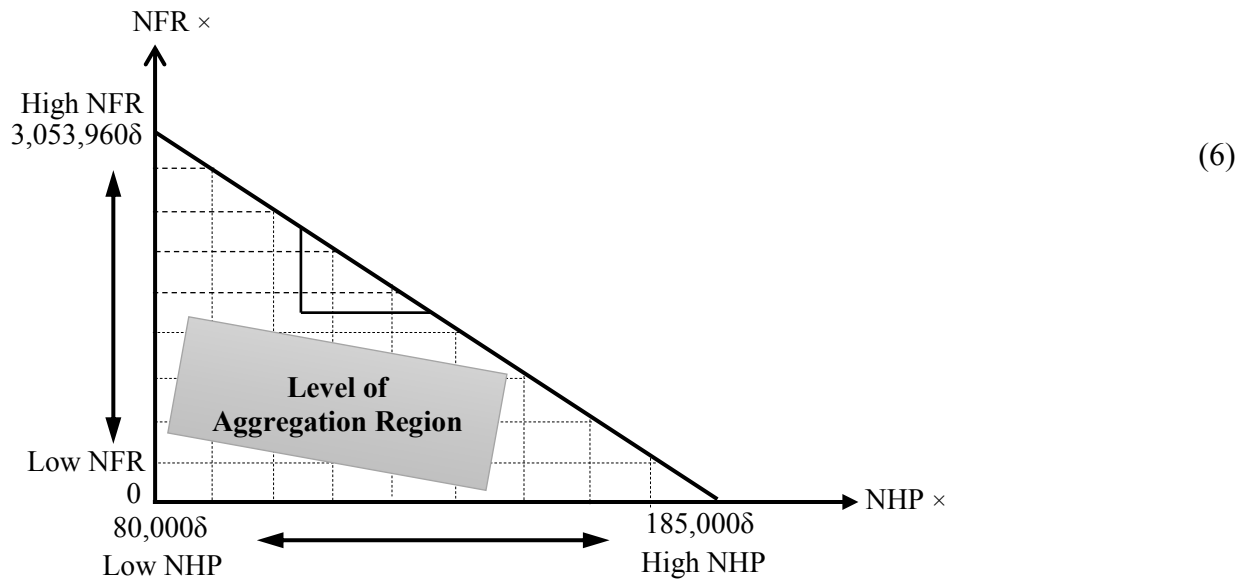

Fig. 6 Relationship of the combination of heat pumps and fridges for the provision of 100MW or more low frequency response service

The relationship between the NHPs and NFRs in equation (5) is linear. Hence, the red slope in Fig. 5 (shaded area) is used to calculate the combination number of heat pumps and fridges for a large power provision. This slope is scaled up to represent the provision of minimum 100MW. Then, the load scaling factor () is added to represent the power at any combination, as shown in Fig. 6. For example, when , the resulting combination numbers (and) are used to provide a low frequency response of 100 MW. When , the resulting combination numbers are used to offer a power of 200 MW.

The is used as an input to specify the level of aggregated load using equation (6). The frequency response provided by the heat pumps is higher than that for fridges because the power rate of the heat pump is typically higher. However, the availability of heat pumps is very seasonal and is not always available in large numbers. Therefore, the fridges can compensate for the lack of frequency response because they are available at every time of the day. In this paper, the following three scenarios are considered to provide the same amount of frequency response, where the aggregators can adopt a certain number of heat pumps and fridges according to the availability of the load and based on cost saving. For example, if the load aggregator needs to provide a certain amount of frequency response from any combination of heat pumps and fridges, then equation (6) ensures the provision of the same size of frequency response required by the load aggregator (i.e. if NFR is increased, then NHP is decreased to provide the same power output and vice versa):

- **Combination of Low NHP–High NFR:** This scenario is more suitable when heat pumps’ demand is low for summer days due to the low heat pump demand. The power rating of a heat pump is typically 30 times the power rating of a fridge. Therefore, an aggregation of a small number of heat pumps requires a vast number of fridges to compensate for the required frequency response (see Fig. 7(a)).
- **Combination of Average NHP–Average NFR:** This scenario is more economical than the previous one and it can be used when there is larger number of heat pumps (see Fig. 7(b)).
- **Combination of High NHP–Low NFR:** This scenario is more appropriate for use in winter months due to higher heat pump demand. Hence, the aggregator can adopt a large number of heat pumps and a small number

of fridges, as shown in Fig. 7(c). This is the more economical scenario because the entire number of responsive units is reduced.

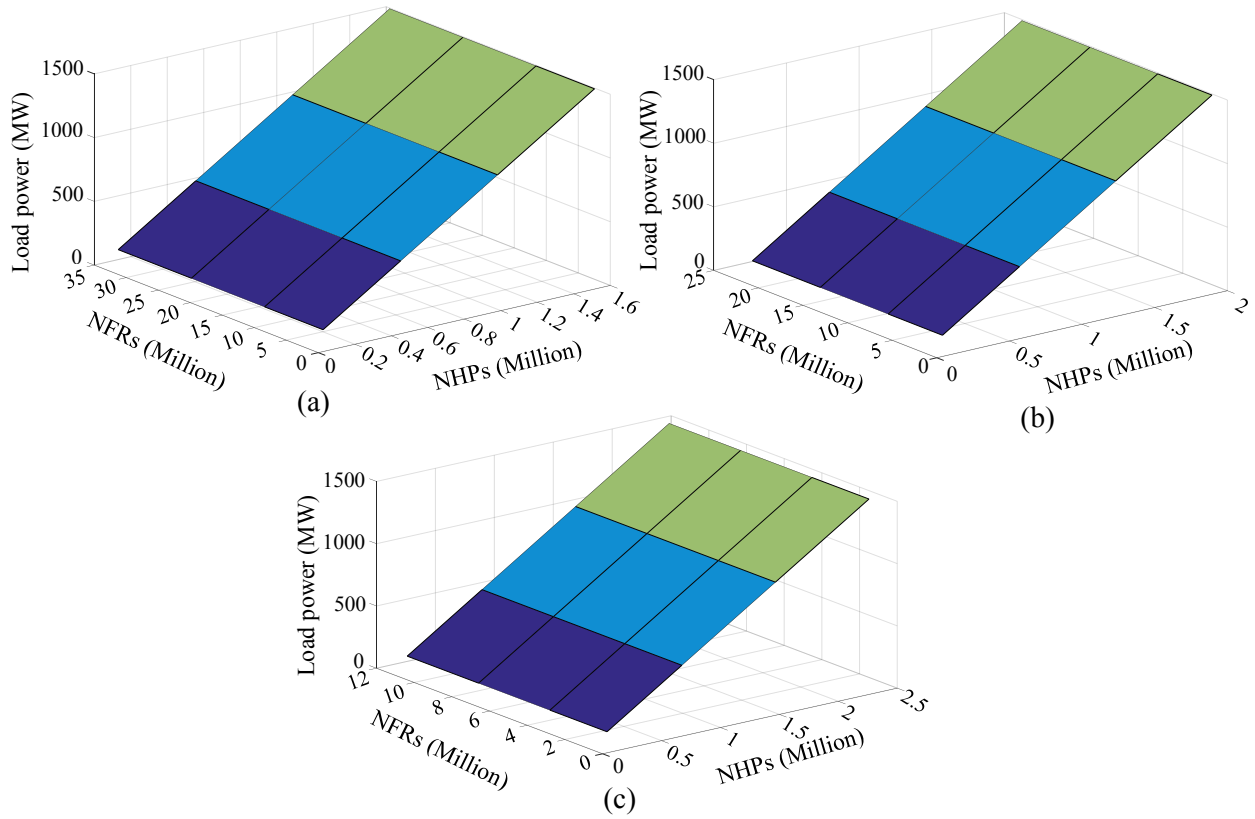

Fig. 7 The provision of low frequency response with different combinations of NHPs and NFRs (a) low NHP–high NFR (b) average NHP–average NFR (c) high NHP–low NFR

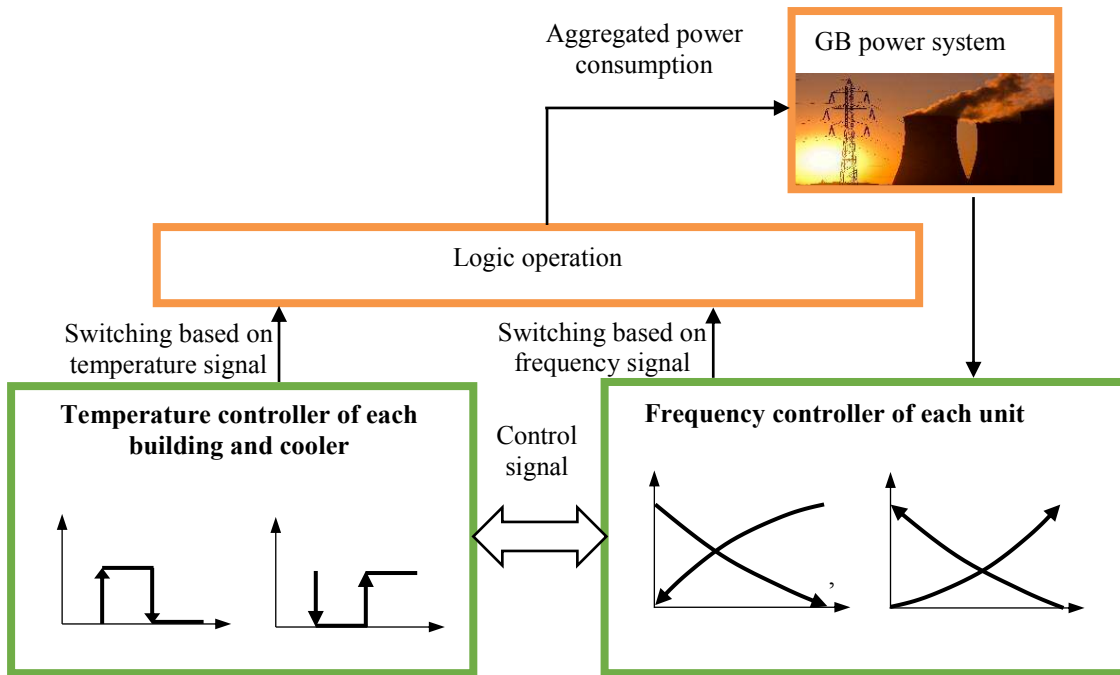

Fig. 8 Diagram of the DFC of each unit

5 Aggregated load control algorithm

This study considers the provision of frequency response based on dynamic FFR service [38, 40]. In this service, the power of several aggregated loads can be controlled to maintain the grid frequency stable (typically 50 Hz) at any time.

A control algorithm is developed to switch OFF or ON each unit in response to a regulation signal. In this paper, the grid frequency is used as the regulation signal. A decentralized controller that can be applied to both the heat pump and the fridge is developed as shown in Fig. 8.

The Temperature Controller measures the temperature of the fridges and buildings, and the Frequency Controller continuously monitors the frequency of GB grid. Each unit is assigned with two trigger frequencies and . The range of is 49.5–49.9 Hz and the range of is 50.1–50.5 Hz, which is consistent with the steady-state limits of grid frequency in the Great Britain power system. The control algorithm compares with the trigger frequencies simultaneously. The frequency controller should ensure a smooth switching behavior and it should avoid the high payback that could result from a large number of units recovering at the same time. Therefore, the following techniques are implemented:

- The trigger frequencies of a heat pump and vary dynamically with the building temperature , as shown in Fig. 9. For a frequency drop, the heat pumps are switched OFF in descending order starting from the warmest building. Similarly, for a frequency rise, the heat pumps are switched ON in ascending order starting from the coldest building.
- The trigger frequencies of a fridge and vary dynamically with the cooler temperature , as shown in Fig. 9. For a frequency drop, fridges are switched OFF in ascending order starting from the coldest fridge. Similarly, for a frequency rise, fridges are switched ON in descending order starting from the warmest fridge.

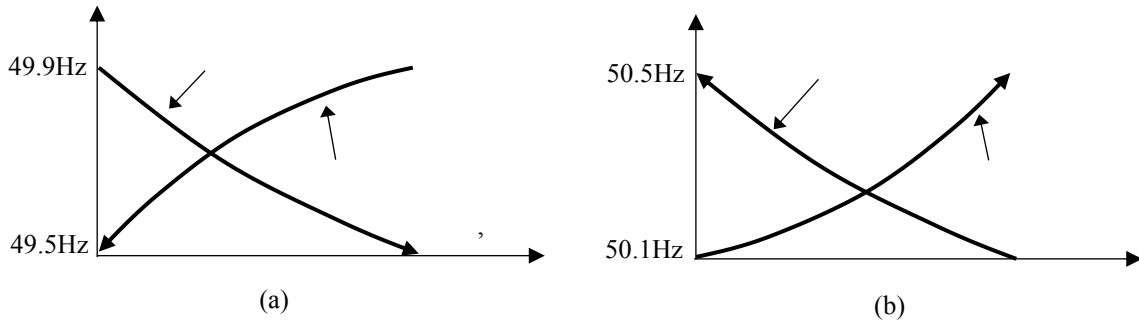

Fig. 9 Dynamic trigger frequencies vs. the temperature a) vs and vs b) vs and vs

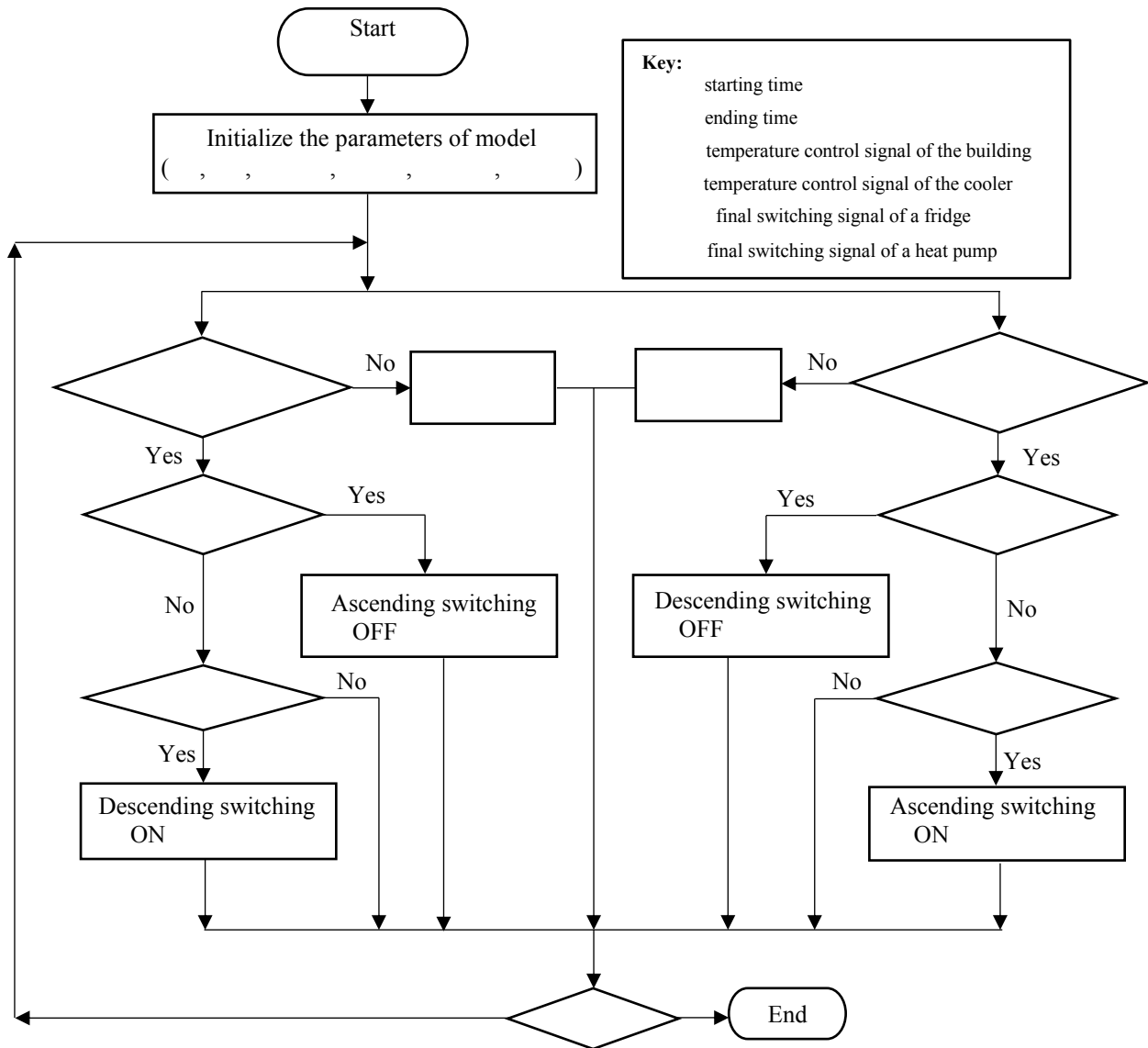

Fig. 10 Flow chart of the aggregated load control system

Fig. 10 shows the flowchart of the control system of the aggregated load. The initial temperature of a population of buildings and the initial temperature of a population of fridges are diversified by randomizing the starting time using a uniform distribution.

The frequency controller should not undermine the internal temperature (and). When the temperature exceeds

the predefined temperature set-points (typically for a building $T_{set} = 19^{\circ}\text{C}$ and $T_{set} = 23^{\circ}\text{C}$ [41] and for a cooler $T_{set} = 7.5^{\circ}\text{C}$ and $T_{set} = 8.5^{\circ}\text{C}$ [35]), the temperature controller is prioritized and follows T_{set} , while T_{set} follows T_{actual} . In other words, the final switching signal will respond to the temperature controller but will not to the frequency controller, even through the time of a frequency incident. However, when the temperature is within the acceptable limit, the frequency controller is prioritized; that is, T_{set} and T_{actual} respond to the frequency controller. If $T_{set} > T_{actual}$ and/or $T_{set} < T_{actual}$, this indicates that there is a frequency drop signal and hence each unit is switched OFF ($T_{set} > T_{actual}$ and $T_{set} < T_{actual}$) to decrease the power demand. If $T_{set} < T_{actual}$ and/or $T_{set} > T_{actual}$, this indicates that there is a frequency rise signal and hence the appliance is switched ON ($T_{set} < T_{actual}$ and $T_{set} > T_{actual}$) to increase the power demand.

6 Simplified Great Britain power system

To study the power system frequency response, a simplified model representing the governor, inertia and damping of the Great Britain power system is developed (Fig. 11) [42, 43]. The system inertia J is 6.5sec. It is measured according to the interconnector loss (loss of 1000 MW) that occurred on September 30, 2012 [20, 44]. The load frequency dependence was lumped into a damping constant D , which was set to 1 p.u. The GB's spinning reserve generators (i.e. frequency-sensitive generators) were represented by governor-turbine transfer functions as shown in Fig. 11 [20, 42]. For the provision of a primary response, all generators should have a governor droop setting between 3%–5% according to the GB grid code [45]. Some generators are required to provide secondary frequency control. Therefore, the simplified GB power system is represented by two lumped blocks: G1 and G2 [20]. Block G1 represents 20% of the generators that provide primary frequency response, while block G2 represents 80% of the generators that provide primary and secondary frequency response, as shown in Fig. 11. The provision of a secondary response was modelled by the supplement integral control loop with gain K_i . The speed governor deadband in blocks G1 and G2 should not be greater than 0.03Hz; however, to increase certainty, here it was selected to be $\pm 0.015\text{Hz}$ [45]. The governor droop is represented by the gain K_d and was set to 20 p.u. in all scenarios. The parameters used in Fig. 11 are given in Table 2, where T_g and T_t are generator-turbine time constants [42].

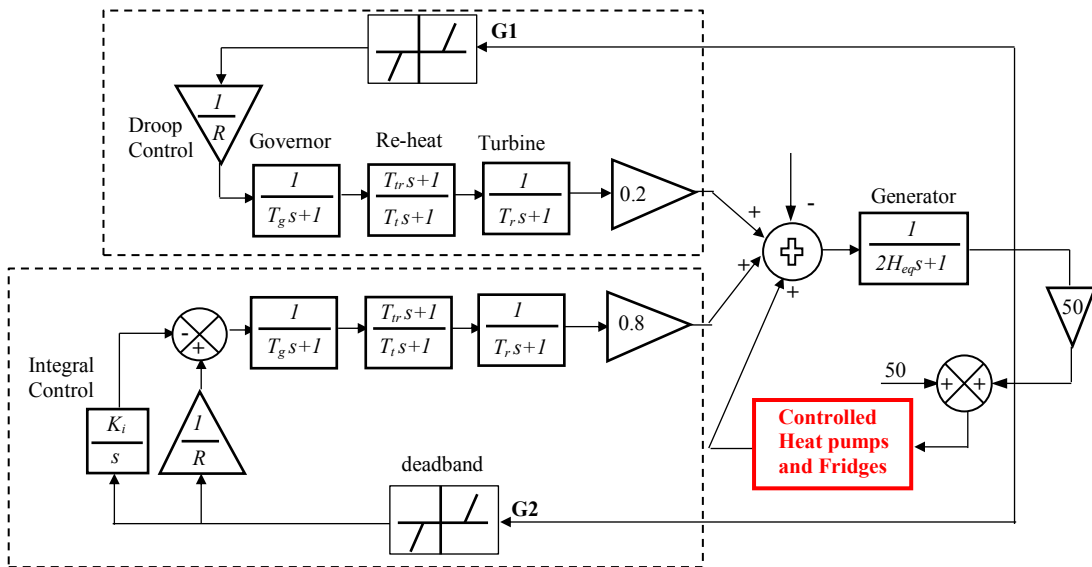

Fig. 11 Simplified Great Britain power system model

Table 2 Parameters of the Simplified Great Britain power system:
system demand =41 GW

$1/R$	T_g	T_{tr}	T_t	T_r	K_i
20	0.2	2	20	0.3	0.05

7 Results and discussions

7.1 Case study based on the FFR threshold

A case study was conducted to examine the capability of an aggregated load to provide 10MW, representing the minimum amount of low frequency response to participate in the FFR service [38]. An aggregation of 8,000 heat pumps and 30,5396 fridges was considered. This was estimated over the time interval (14:00-17:00) and (17:30-18:00), based on the intersection point in Fig. 5. Meanwhile, Fig. 12 shows the frequency profile that was injected to the system. The frequency drop at time 470 sec was considered to examine the capability of the aggregated controllable loads to reduce their power consumption offering a FFR service. Fig. 13 shows the behavior of the power consumption drawn by the controlled load during the frequency event. The heat pumps and fridges were switched OFF immediately, providing a reduction of 10MW from their power consumption proportional to the frequency drop.

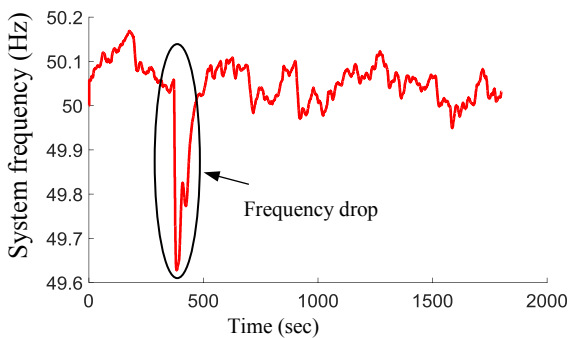

Fig. 12 Injected grid frequency profile

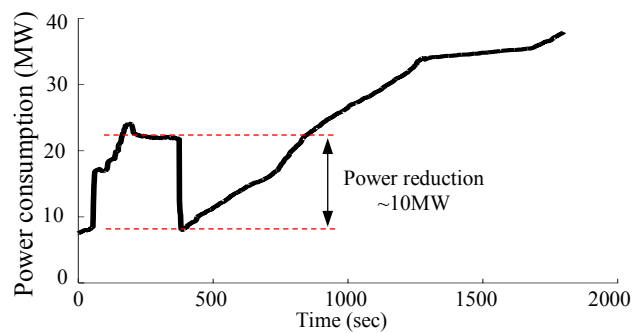

Fig. 13 Power reduction from aggregated heat pumps and fridges to provide 10MW

Table 3 Combination scenarios of heat pumps and fridges to provide 1,000 MW as a maximum low frequency response

Scenarios	Total NHP	Total NFR	Available NHP for frequency response	Available NFR for frequency response
Sc ₁	1,062,500	22,858,945	191,250	4,206,046
Sc ₂	1,325,000	15,220,195	238,500	2,800,516
Sc ₃	1,587,697	7,575,715	285,785	1,393,932

7.2 Case study based on continuous frequency regulation

The DFC algorithm is applied to a population of heat pumps and fridges to provide continuous frequency response in proportion to frequency changes. Dynamic response is automatically delivered for all variations in frequency outside of the deadband (50Hz \pm 0.015Hz) [37]. The aggregated load has a maximum of 500 MW when the grid frequency drops to 49.5 Hz (i.e. to represent the capacity of aggregated load in the summer). Simulation was implemented by injecting a profile recording the GB power system frequency into the dynamically controlled load, as shown in Fig. 14. As can be seen, the power output of aggregated load dynamically changes following the frequency variation. Therefore, the aggregated load control can be used to continuously regulate the grid frequency.

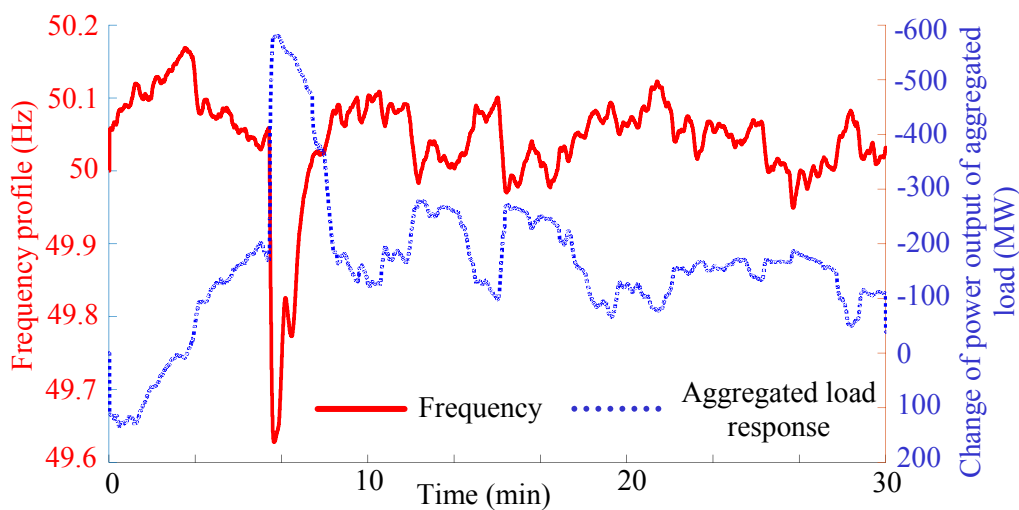

Fig. 14 Continuous behavior of aggregated load in response to frequency variations

7.3 Case study (based on three scenarios) on the simplified Great Britain power system

The heat pump and fridge models were connected to the simplified GB power system. The frequency control of each unit received a frequency signal from the GB grid (see Fig. 11), and it then triggered the appliance deliberately in response to the frequency variation. The output of each appliance represents the power consumption which was absorbed from the grid.

A loss of two individual generators was applied to the system based on [46]. The loss of the first generator has caused a loss of 345MW at time 11:34 (in the real event) equivalent with time 200 sec in this modelling study. Around two minutes later, the loss of the second generator caused additional loss of 1,237MW. The system demand was 41GW at the time of the frequency incidents.

Three combination scenarios for a number of heat pumps and fridges (listed in Table 3) are considered for the provision of low frequency response service (maximum 1000MW). It was assumed that each heat pump has a typical power consumption of 3kW and that each fridge has a typical power consumption of 0.1kW. These scenarios are based on Fig. 6 and are described below.

Scenario 1: Sc₁ (Low NHP–High NFR): this scenario assumed a low availability of heat pumps, for example in a summer day, and thus 191,250 heat pumps were considered. By using equation (6), and for the provision of 1000MW as a maximum low frequency response, the number of fridges was calculated to be 4,206,046. The frequency response in this scenario was very dependent on the fridges.

Scenario 2: Sc₂ (Average NHP–Average NFR): In this scenario, 238,500 responsive heat pumps and 2,800,516 responsive fridges were considered to provide power reduction of maximum 1000MW from the aggregated load. The number of fridges was reduced by 33% from Sc₁, while the number of heat pumps was increased by 20%.

Scenario 3: Sc₃ (High NHP–Low NFR): This is the more economical scenario as the number of responsive units was reduced to 1,679,717 (about 38.3% from Sc₁). In this scenario, 285,785 responsive heat pumps and 1,393,932 fridges were considered to provide power reduction of a maximum 1000MW from the aggregated load. The dependency on the fridges for the frequency response was reduced by 67% from Sc₁. The number of connected heat pumps was increased by 33% from Sc₁.

Two sets of results during the frequency incident were simulated: with and without the controllable loads. Fig. 15 shows the power consumption behavior of the heat pumps and fridges individually in the three defined scenarios before and after the frequency incidents. It can be seen that the load power has decreased immediately after the two frequency incidents.

Fig. 16 shows the power reduction drawn by the aggregated load (see the left axis) and the change of power output of generators (see the right axis), using the three defined scenarios. It can be seen that the entire power reduction from the aggregated load is almost equal in Sc₁ and Sc₂ (about 660MW), with a slightly different value in Sc₃ (about 600MW). The small difference in Sc₃ is due to the use of a high number of fridges where the coolers’ temperature is highly diversified causing some fridges not to respond to the frequency change. The use of controlled loads has significantly reduced the power output from synchronous generators (around 50%).

The impact of reducing the power consumption of the aggregated load on the grid frequency is shown in Fig. 17. The first frequency drop was reduced from 49.8Hz to 49.9Hz. Following the second incident, the frequency drop was reduced from 49.22Hz to around 49.58Hz. In the three scenarios, the frequency drop has reduced to almost the same value.

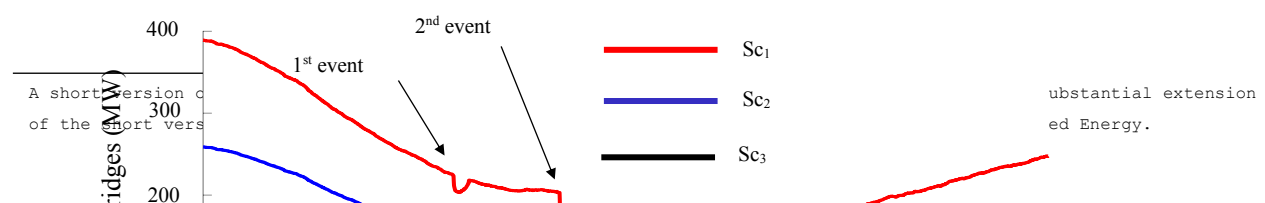

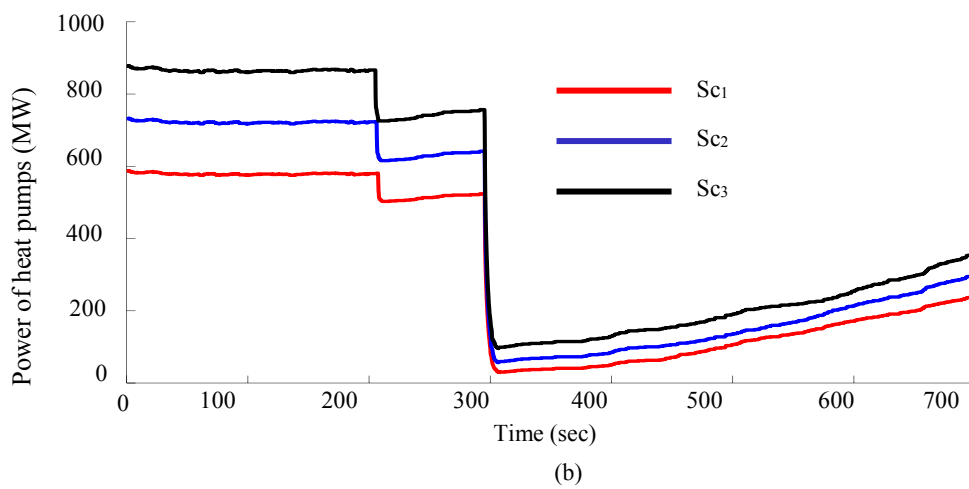

Fig. 15 Load power reduction a) fridges b) heat pumps

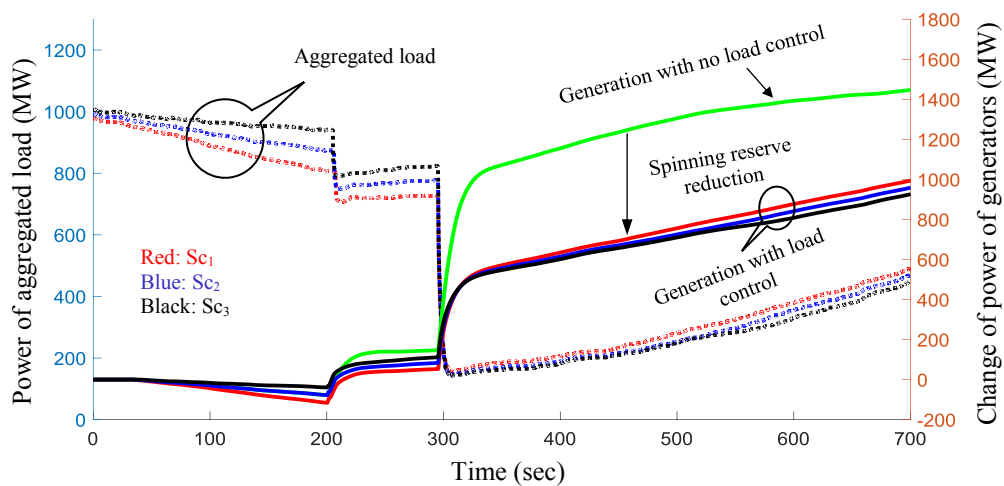

Fig. 16 Power reduction of aggregated load and change of power output of the synchronous generators

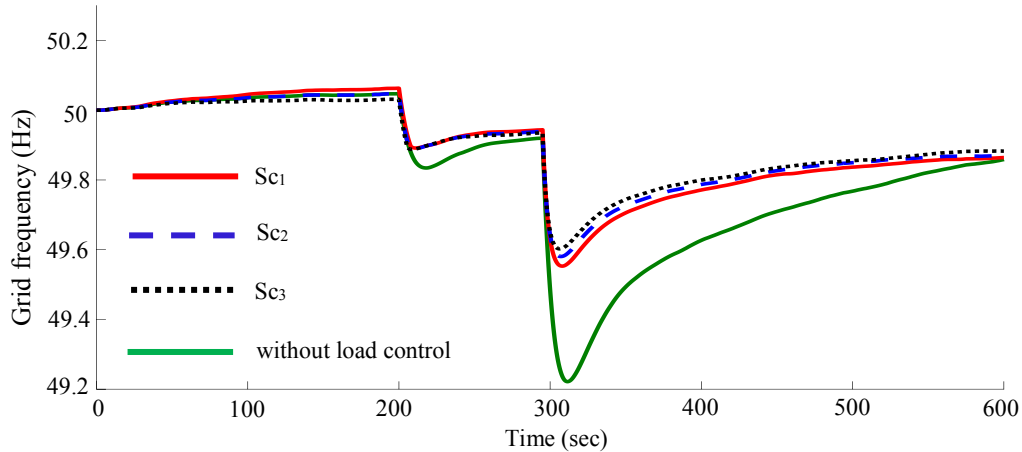

Fig. 17 Variation of grid frequency at each load combination scenario

7.4 Case study on the future GB power system with a reduced system inertia

This case study was conducted for low system inertia (i.e., 3.1 sec) to represent the future GB power system with much generation from converter-connected wind turbines [47]. The system base was assumed to be 28 GW, representing a summer evening.

A combination of heat pumps and fridges to provide FFR service during the summer season is considered. For simulation results, the aggregation of 87 thousand responsive heat pumps and 2.5 million responsive fridges was considered. This was estimated over the time interval 17:30–18:00, based on the estimation of a summer day. The heat pump and fridge models were connected to the simplified Great Britain power system that was presented in Section 6. The loss of 1800MW from the generation power, representing the infrequent infeed loss in the Great Britain power system, was applied to the simplified GB power system at time 100sec. Fig. 18 shows the behavior of aggregated heat pumps and fridges during and after the frequency event. When the grid frequency dropped lower than 49.5Hz, all of the responsive heat pumps were switched OFF and, hence, their power consumption has reduced to almost zero (i.e. reduction of 250MW has achieved). Consequently, a large number of fridges (about 2.5 million fridges) were switched OFF to compensate the required 500MW of frequency response. It can be seen that the reduction of aggregated load has impacted positively on reducing the frequency deviation.

Fig. 19 shows that frequency deviation with and without the use of aggregated load control. The frequency deviation has decreased from 49.13Hz to 49.35Hz. Fig. 19 also shows the behavior of power consumption driven by the aggregated load for 30min. It can be seen that the behavior of the heat pumps and the fridges is different because the diversity of heat pumps and fridges is different.

Fig. 20 shows the change of power output drawn by the frequency-sensitive generators with and without the aggregated load control. It can be seen that the generation power (spinning reserve) has reduced by 30% when the aggregated load control was used. The controlled load can provide similar response to the frequency-sensitive generators and this will reduce the frequency response from the generators.

Fig. 21 shows the values of the rate of change of frequency (RoCoF) between 0.6sec to 2sec after the frequency event. It can be seen that the provided frequency response from the aggregated load control has significantly reduced the RoCoF at the earlier sub-seconds following the incident. Therefore, the DFC algorithm is an effective method to halt the RoCoF, especially when there is a reduction in system inertia.

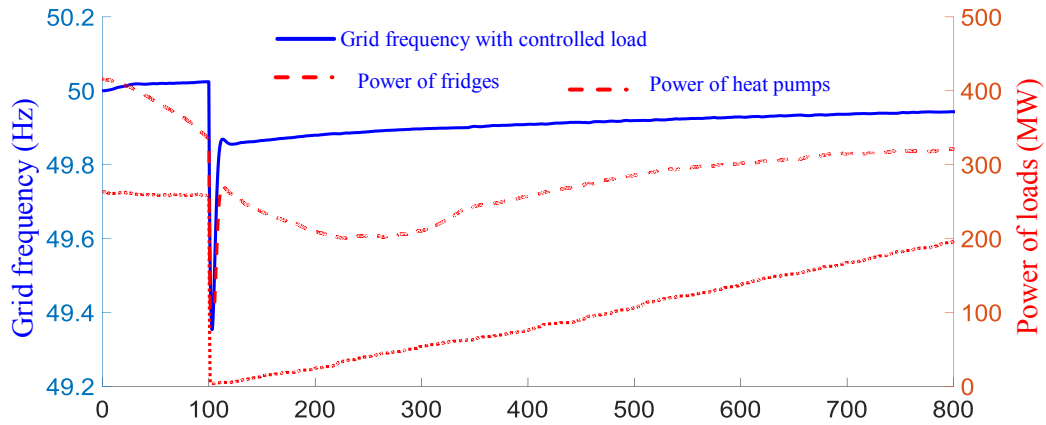

Fig. 18 Grid frequency and power of heat pumps and fridges

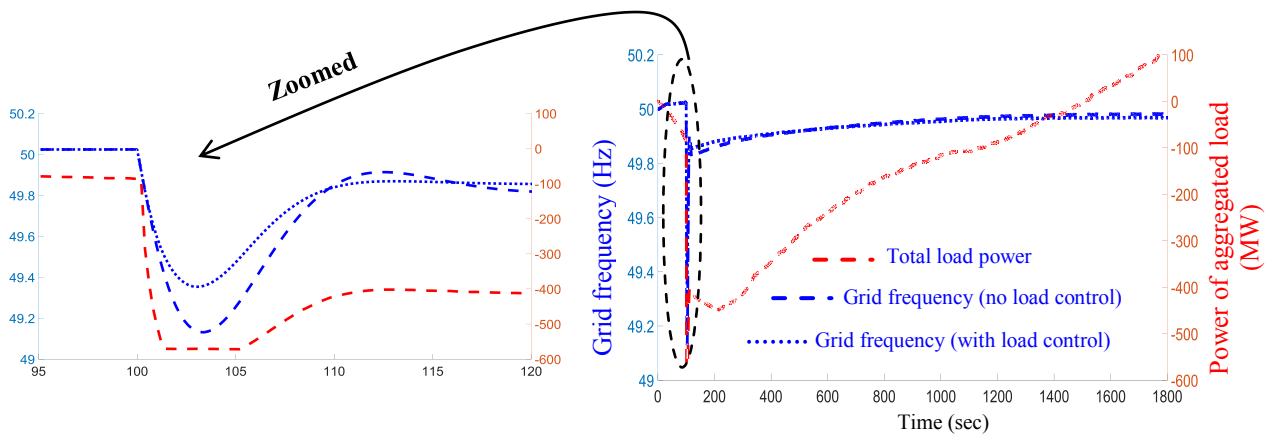

Fig. 19 Grid frequency with the behavior of load during and half hour following the incident

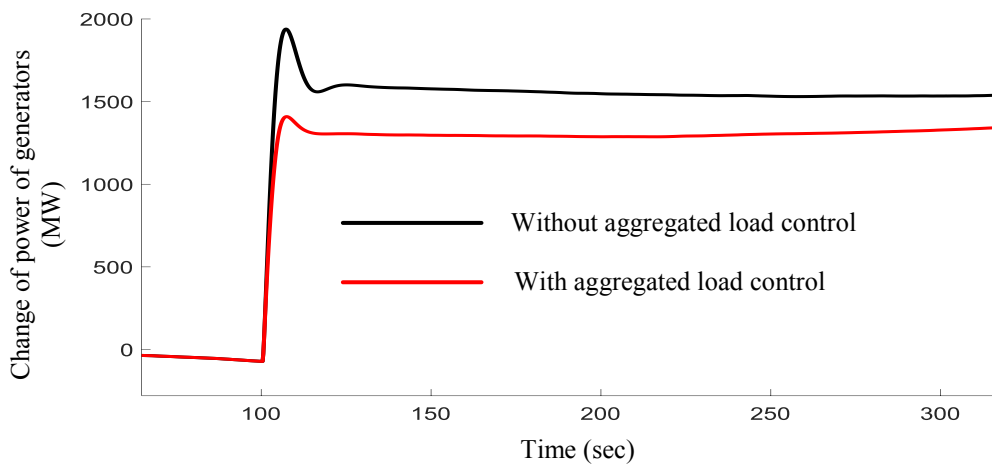

Fig. 20 Change of generation power in response to the frequency event

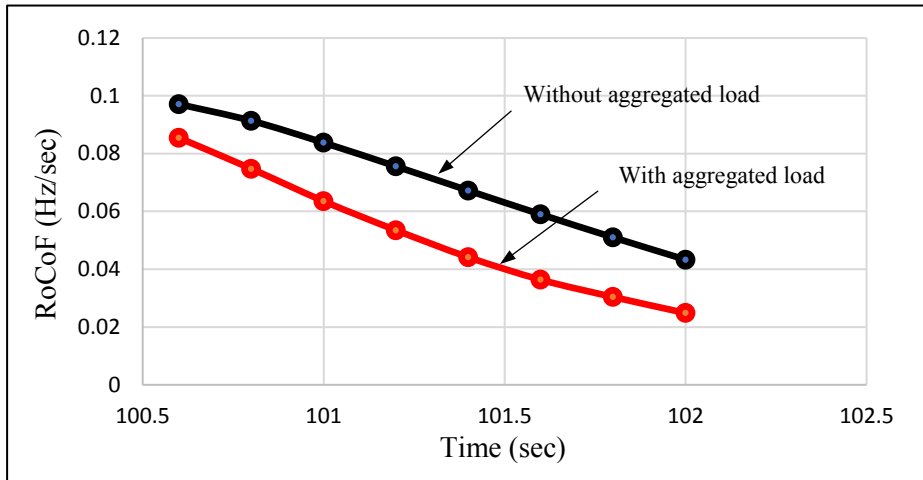

Fig. 21 Rate of change of frequency 0.4–2 sec following the frequency event

8 Conclusion

This paper investigated the potential of demand side response from the aggregation of heat pumps and fridges for the frequency control. The availability of heat pumps and fridges at the time of day was presented. Aggregation of the low and high-frequency response from all heat pumps and fridges was calculated for the Great Britain power system at different times of winter and summer days. In addition, the number of heat pumps and fridges to provide Firm Frequency Response service was estimated.

A decentralized DFC algorithm was developed for the provision of the frequency response service. The control algorithm was coordinated to provide an aggregated response from a population of heat pumps and fridges without undermining the temperature of the buildings and fridges.

The model was then integrated into a simplified Great Britain power system model. Three scenarios were presented to differentiate the combination of the load according to the load availability and considering cost saving. It has been shown that the dynamic control of aggregated load has the potential to offer considerable frequency response and a reduction of 50% in governor action of spinning reserve generators was achieved. In addition, the potential of aggregated load control was investigated on the reduced system inertia of the future Great Britain power system during a summer day. It has been shown that the aggregated load control is an efficient approach to reduce the rate of change of frequency during the first sub-seconds following the frequency event. However, the availability of heat pumps is low in the summer, which requires a substantial number of fridges (typically more than 2 million) to compensate for the provision of 500 MW of frequency response.

The frequency response depends significantly on the expensive frequency-sensitive generators. The use of the aggregated load control will reduce the use of these generators and will result in considerable cost saving. In addition, to meet the greenhouse emissions policy, the dynamic controlled load is, of course, a worthy cause. In this paper, the financial value of the aggregated load control to provide frequency, using three scenarios, is briefly estimated. According to the monthly report of National Grid for the year 2014 [48], the total frequency response of 1,236.4GWh was estimated

to cost the National Grid £5.2 million per month. Therefore, the cost of the total frequency response per 1MWh per month is £4.2. In this paper, the load aggregator is assumed to provide 1,000MW of the frequency response over the time 14:00-21:00 (240 hours in a month). Thus, the value of the aggregated load control is calculated as follows:

(8)

According to equation (8), the benefit for the load aggregator to provide frequency response service is £1.01m/month (~ £12.12m/year). However, the total value contribution from each appliance depends on the defined scenarios as shown in Table 4. The cost of each DFC is assumed to be equal to £3[30].

In Sc₁, the total number of 1,062,500 heat pumps and 22,858,945 fridges are connected to the grid to provide 1,000MW of frequency response and, therefore, the value contribution from each unit is approximately £7.13, assuming a lifetime of 20 years for each appliance (including the cost of the frequency controller). In Sc₂, there are 1,325,000 heat pumps and 15,220,195 fridges, the value contribution from each unit is increased to £11.65. In Sc₃, there are 1,587,697 heat pumps and 7,575,715 fridges, the value contribution from each unit is increased to £23.5.

In conclusion, the third scenario (Sn₃) is more economic for the provision of 1,000 MW of frequency response. The aggregation of a larger number of heat pumps and a lower number of fridges will provide cost savings to the system operator. However, the technical feasibility of each scenario is required.

It is worth mentioning that the rough estimation presented in Table 4 ignored any value that could be earned from the reduction of greenhouse emissions (due to reduced part-loading).

The simulation results that were accomplished in this paper have provided a scope of solution for real problems (i.e. fast RoCoF, reduction in system inertia, spinning reserve of generators, and greenhouse emissions). Future work will examine the role of aggregated load control to reduce the spinning reserve of generators by connecting the dynamic demand control models to the detailed transmission and generation master model of National Grid.

Table 4 Value contributed by each appliance to provide 1,000 MW of frequency response service

	Scenario (Sc ₁)	Scenario (Sc ₂)	Scenario (Sc ₃)
Value per appliance (£)	7.13	11.65	23.5

Acknowledgements

The authors would like to thank Element Energy for sharing the heat pumps data which was used in this study. The authors gratefully acknowledge the Higher Committee for Education Development in Iraq (HCED-Iraq) for providing grant funding for this project. The authors would also like to acknowledge the EPSRC project ‘‘Ebbs and Flows of Energy Systems’’ (EP/M507131/1) for supporting part of this work.

References

- [1] UK National Grid. *‘‘Frequency response, National Grid’’, 2015.* Available: <http://www2.nationalgrid.com/uk/services/balancing-services/frequency-response/>. [Accessed: 01-Oct-2016]
- [2] M. Aunedi, P. A. Kountouriotis, J. E. O. Calderon, D. Angeli, and G. Strbac, ‘‘Economic and Environmental Benefits of Dynamic Demand in Providing Frequency Regulation,’’ *IEEE Transactions on Smart Grid*, vol. 4,

- pp. 2036-2048, 2013.
- [3] UK National Grid. "2016 Future Energy Scenario," July, 2016 [Online]. Available: <http://fes.nationalgrid.com/>
- [4] UK National Grid. "2017 Future Energy Scenario," July, 2017 [Online]. Available: <http://fes.nationalgrid.com/media/1253/final-fes-2017-updated-interactive-pdf-44-amended.pdf>
- [5] J. Meng, Y. Mu, H. Jia, J. Wu, X. Yu, and B. Qu, "Dynamic frequency response from electric vehicles considering travelling behavior in the Great Britain power system," *Applied Energy*, vol. 162, pp. 966-979, 2016.
- [6] UK National Grid. "Enhanced Frequency Control Capability (EFCC)," Oct. 2014 [Online]. Available: <https://www.ofgem.gov.uk/ofgem-publications/87210/ispecfcnget.pdf>
- [7] Electricity Demand-Side Response. "The Parliamentary Office of Science and Technology London," Jan. 2014. Available: <http://researchbriefings.parliament.uk/ResearchBriefing/Summary/POST-PN-452#fullreport>
- [8] Z. Akhtar, B. Chaudhuri, and S. Y. R. Hui, "Primary Frequency Control Contribution From Smart Loads Using Reactive Compensation," *IEEE Transactions on Smart Grid*, vol. 6, pp. 2356-2365, 2015.
- [9] M. R. V. Moghadam, R. T. B. Ma, and R. Zhang, "Distributed Frequency Control in Smart Grids via Randomized Demand Response," *IEEE Transactions on Smart Grid*, vol. 5, pp. 2798-2809, 2014.
- [10] L. Jia and L. Tong, "Dynamic Pricing and Distributed Energy Management for Demand Response," *IEEE Transactions on Smart Grid*, vol. 7, pp. 1128-1136, 2016.
- [11] V. Trovato, I. Martinez-Sanz, B. Chaudhuri, and G. Strbac, "Advanced control of thermostatic loads for rapid frequency response in Great Britain," in *2017 IEEE Manchester PowerTech*, 2017, pp. 1-1.
- [12] L. Chun-Feng, L. Chun-Chang, and W. Chi-Jui, "Effect of battery energy storage system on load frequency control considering governor deadband and generation rate constraint," *IEEE Transactions on Energy Conversion*, vol. 10, pp. 555-561, 1995.
- [13] M. Avendano-Mora and E. H. Camm, "Financial assessment of battery energy storage systems for frequency regulation service," in *2015 IEEE Power & Energy Society General Meeting*, 2015, pp. 1-5.
- [14] P. M. R. Almeida, J. A. P. Lopes, F. J. Soares, and L. Seca, "Electric vehicles participating in frequency control: Operating islanded systems with large penetration of renewable power sources," in *2011 IEEE Trondheim PowerTech*, 2011, pp. 1-6.
- [15] S. Izadkhast, P. Garcia-Gonzalez, P. Frías, and P. Bauer, "Design of Plug-In Electric Vehicle's Frequency-Droop Controller for Primary Frequency Control and Performance Assessment," *IEEE Transactions on Power Systems*, vol. 32, pp. 4241-4254, 2017.
- [16] P. M. R. Almeida, F. J. Soares, and J. A. P. Lopes, "Electric vehicles contribution for frequency control with inertial emulation," *Electric Power Systems Research*, vol. 127, pp. 141-150, 2015.
- [17] Y. Mu, J. Wu, J. Ekanayake, N. Jenkins, and H. Jia, "Primary Frequency Response From Electric Vehicles in the Great Britain Power System," *IEEE Transactions on Smart Grid*, vol. 4, pp. 1142-1150, 2013.
- [18] V. Trovato, F. Teng, and G. Strbac, "Role and Benefits of Flexible Thermostatically Controlled Loads in Future Low-Carbon Systems," *IEEE Transactions on Smart Grid*, vol. PP, pp. 1-1, 2017.
- [19] Z. A. Obaid, L. M. Cipcigan, M. T. Muhssin, and S. S. Sami, "Development of a water heater population control for the demand-side frequency control," in *2017 IEEE PES Innovative Smart Grid Technologies Conference Europe (ISGT-Europe)*, 2017, pp. 1-6.
- [20] M. Cheng, J. Wu, S. J. Galsworthy, C. E. Ugalde-Loo, N. Gargov, W. W. Hung, et al., "Power System Frequency Response From the Control of Bitumen Tanks," *IEEE Transactions on Power Systems*, vol. 31, pp. 1769-1778, 2016.
- [21] M. T. Muhssin, L. Cipcigan, N. Jenkins, S. Slater, M. Cheng, and Z. Obaid, "Dynamic Frequency Response from Controlled Domestic Heat Pumps," *IEEE Transactions on Power Systems*, vol. PP, pp. 1-1, 2018.
- [22] D. Papadaskalopoulos, G. Strbac, P. Mancarella, M. Aunedi, and V. Stanojevic, "Decentralized Participation of Flexible Demand in Electricity Markets—Part II: Application With Electric Vehicles and Heat Pump Systems," *IEEE Transactions on Power Systems*, vol. 28, pp. 3667-3674, 2013.
- [23] The energyst. Demand Side Response: Bringing businesses into balancing. 2015, [Online]. Available: <http://www.openenergi.com/wp-content/uploads/2016/01/Demand-Side-Response-report-2015.pdf>
- [24] Open Energi. *Demand Response Market Overview: Glossary of Demand Response Services*. . Available: <http://www.openenergi.com/wp-content/uploads/2015/10/Demand-Response-Glossary-V7-.pdf>. [Accessed: 12-Feb-2018]
- [25] S. A. Pourmousavi and M. H. Nehrir, "Real-Time Central Demand Response for Primary Frequency Regulation in Microgrids," *IEEE Transactions on Smart Grid*, vol. 3, pp. 1988-1996, 2012.
- [26] J. Kondoh, N. Lu, and D. J. Hammerstrom, "An Evaluation of the Water Heater Load Potential for Providing Regulation Service," *IEEE Transactions on Power Systems*, vol. 26, pp. 1309-1316, 2011.
- [27] A. Molina-Garcia, F. Bouffard, and D. S. Kirschen, "Decentralized Demand-Side Contribution to Primary Frequency Control," *IEEE Transactions on Power Systems*, vol. 26, pp. 411-419, 2011.
- [28] S. Lu, N. Samaan, R. Diao, M. Elizondo, C. Jin, E. Mayhorn, et al., "Centralized and decentralized control for demand response," in *ISGT 2011*, 2011, pp. 1-8.
- [29] M. T. Muhssin, L. M. Cipcigan, N. Jenkins, M. Cheng, and Z. A. Obaid, "Potential of a Population of Domestic Heat Pumps to Provide Balancing Service," *Journal Tehnicki vjesnik/Technical Gazette*, vol. 25, pp. 709-717, 2018.

- [30] J. A. Short, D. G. Infield, and L. L. Freris, "Stabilization of Grid Frequency Through Dynamic Demand Control," *IEEE Transactions on Power Systems*, vol. 22, pp. 1284-1293, 2007.
- [31] M. Cheng, J. Wu, S. J. Galsworthy, N. Gargov, W. H. Hung, and Y. Zhou, "Performance of industrial melting pots in the provision of dynamic frequency response in the Great Britain power system," *Applied Energy*, vol. 201, pp. 245-256, 2017.
- [32] M. Cheng, S. S. Sami, and J. Wu, "Benefits of using virtual energy storage system for power system frequency response," *Applied Energy*, vol. 194, pp. 376-385, 2017.
- [33] Element Energy. "Frequency Sensitive Electric Vehicle and Heat Pump Power Consumption, final report for National Grid", July. 2015
- [34] M. Muhssin, L. Cipcigan, M. Cheng, and Z. Obaid, "Load Aggregation over a Time of Day to provide Frequency Response in the Great Britain Power System," *Energy Procedia*, vol. 142, pp. 2177-2182, 2017.
- [35] M. Cheng, J. Wu, S. Galsworthy, N. Jenkins, and W. Hung, "Availability of load to provide frequency response in the great Britain power system," in *2014 Power Systems Computation Conference*, 2014, pp. 1-7.
- [36] Department for Business and Energy and Industrial Strategy. Energy Consumption in the UK. Nov 2016, [Online]. Available: https://www.gov.uk/government/uploads/system/uploads/attachment_data/file/573269/ECUK_November_2016.pdf
- [37] National Grid. *Firm Frequency Response (FFR)*. Available: https://www.nationalgrid.com/sites/default/files/documents/Firm%20Frequency%20Response%20%28FFR%29%20Interactive%20Guidance%20v1%200_0.pdf. [Accessed: 10-Jan-2018]
- [38] National Grid. (2016). *Firm Frequency Response (FFR)*. Available: <http://www2.nationalgrid.com/UK/Services/Balancing-services/Frequency-response/Firm-Frequency-Response/>. [Accessed: 01-Jan-2016]
- [39] Energy UK. Ancillary services report 2017. April 2017, [Online]. Available: <https://www.energy-uk.org.uk/publication.html?task=file.download&id=6138>
- [40] Open Energi. *Demand Response Market Overview, Glossary of Demand Response Services*. . Available: <http://www.openenergi.com/wp-content/uploads/2015/10/Demand-Response-Glossary-V7-.pdf>. [Accessed: 01-Oct-2016]
- [41] M. T. Muhssin, L. M. Cipcigan, N. Jenkins, C. Meng, and Z. A. Obaid, "Modelling of a population of Heat Pumps as a Source of load in the Great Britain power system," in *2016 International Conference on Smart Systems and Technologies (SST)*, 2016, pp. 109-113.
- [42] P. Kundur, N. Balu, and M. Lauby, "*Power system stability and control*". New York: McGraw-Hill, 1994.
- [43] J. B. Ekanayake and N. Jenkins, "'Frequency Response from Wind Turbines'," *Wind Engineering*, vol. 32, no. 6, pp. 573-586, 2008.
- [44] National Grid. Frequency Changes during Large Disturbances and their Impact on the Total System. Aug. 2013 [Online] Available: <https://www.nationalgrid.com/sites/default/files/documents/16943-Industry%20Consultation.pdf>
- [45] National Grid plc. "*The Grid Code Issue 5 Revision 18*," Aug. 2016 [Online]. Available: <http://www2.nationalgrid.com/uk/industry-information/electricity-codes/grid-code/the-grid-code/>
- [46] UK National Grid. Report of the National Grid Investigation into the Frequency Deviation and Automatic Demand Disconnection that occurred on the 27th May 2008," Feb. 2009 [Online]. Available: <http://www.nationalgrid.com/NR/rdonlyres/E19B4740-C056-4795-A567-91725ECF799B/32165/PublicFrequencyDeviationReport.pdf>
- [47] National Grid, "Frequency changes during large disturbances and their Impact on the Total System," National Grid. Aug. 2013.
- [48] National Grid, "Firm Frequency Response Market Information, monthly report," National Grid. Feb. 2014.