



**DEVELOPMENT AND APPLICATION OF CLASSIFICATION
METHODOLOGIES FOR COMPARING REIMBURSEMENT
DECISION-MAKING PROCESSES FOR NEW MEDICINES**

A thesis submitted in accordance with the conditions governing candidates for the
degree of

DOCTOR OF PHILOSOPHY

in

CARDIFF UNIVERSITY


Presented by

NICOLA ALLEN

April 2015


DECLARATION

This work has not been submitted in substance for any other degree or award at this or any other university or place of learning, nor is being submitted concurrently in candidature for any degree or other award.

Signed  (candidate) Date ...6/8/2015.....

STATEMENT 1

This thesis is being submitted in partial fulfillment of the requirements for the degree of PhD

Signed  (candidate) Date ...6/8/2015.....

STATEMENT 2


This thesis is the result of my own independent work/investigation, except where otherwise stated.

Other sources are acknowledged by explicit references. The views expressed are my own.

Signed  (candidate) Date ...6/8/2015.....

STATEMENT 3: PREVIOUSLY APPROVED BAR ON ACCESS

I hereby give consent for my thesis, if accepted, to be available online in the University's Open Access repository and for inter-library loans **after expiry of a bar on access previously approved by the Academic Standards & Quality Committee.**

Signed  (candidate) Date ...6/8/2015.....

ACKNOWLEDGMENTS

I am greatly indebted and extremely grateful for the outstanding supervision and unwavering support from both my supervisors Professor Sam Salek and Professor Stuart Walker. Their encouragement and expertise has been the cornerstone of my research and I will be forever thankful that they have given me this opportunity.

I would also like to express my gratitude to all the staff at the Centre for Innovation in Regulatory Science (CIRS), especially to Lawrence Liberti for supporting my research and providing continued help and guidance that went beyond my expectations, Dr Neil McAuslane for his expert advice and Magda Bujar and Tina Wang for their help. I would also like to thank Dr Franz Pichler for his invaluable expertise and advice throughout the first year of this research.

To all the HTA agency and Pharmaceutical industry representatives, my sincere thanks for their help and provision of data. I am also considerably grateful to the Canadian Agency for Drugs and Technologies in Health for their cooperation in facilitating this research.

Furthermore, I would like to thank the staff at the School of Pharmacy and Pharmaceutical Sciences, particularly Ms Helen Harron, who have been helpful and supportive from the very beginning of this journey. I am also grateful for the help and guidance from Professor Robert Sewell, who has offered his support for the final year of this work.

I dedicate my thesis to my family and friends, especially to my parents (Den and Susan Allen) who have always been my greatest inspiration and a source of unconditional love and support. My sisters (Claire and Eleanor) also deserve my wholehearted appreciation. Finally, I also dedicate this thesis to Charles Delingpole for his years of understanding and endless encouragement that has given me the motivation to continue and complete this research.

ABSTRACT

Health Technology Assessment (HTA) considers the therapeutic effectiveness of a health technology and may also evaluate cost-effectiveness. The aim of this study was to evaluate HTA agencies, their relationship to regulatory authorities and other decision-makers and to identify common appraisal practices with respect to the economic and therapeutic evaluation of new medicines.

The national reimbursement pathways for 33 European jurisdictions were evaluated to identify two taxonomic sets that categorise HTA agencies by evaluating the relationship between the HTA, regulatory and decision-making functions within the reimbursement system (System taxonomy) and the processes for appraisal and conducting the clinical and economic evaluation (Process taxonomy). Ten distinct archetype groups were subsequently identified by comparing the two taxonomic sets.

National HTA recommendations were identified for nine European jurisdictions with varied health care systems and approaches for HTA, to enable comparisons using the classification tool to assess correlation. HTA decisions were also identified from four countries that have generally similar approaches for HTA (Australia, Canada, England and Scotland) to understand the rationale for discordant HTA recommendations. The Canadian HTA environment was evaluated in greater detail to understand the impact of the national non-mandatory HTA recommendations for coverage decisions from four provinces (Alberta, British Columbia, Ontario and Quebec). Senior representatives and final decision-makers from these four provinces completed the study questionnaire and participated in semi-structured interviews to provide further insights regarding the impact of the national Canadian HTA agency.

Comparisons of HTA recommendations from national HTA agencies with general similarities (Australia, Canada, England and Scotland) identified significant differences and a range of causes for discordant recommendations, such as: submission timing, comparator choice and willingness to accept risk. Results for comparing Canadian national HTA recommendations with coverage decisions from four provinces demonstrated much greater overall concordance (κ (kappa coefficient) =0.432 to κ =0.663) than comparing Canadian national HTA recommendations with Australia, England and Scotland (κ =0.129 to κ =0.336). Feedback from the semi-structured

interviews also indicated that participating provincial payers increasingly rely on the national HTA agency.

The development of a novel classification tool, comparisons of HTA recommendations from very different and also generally similar HTA agencies and the evaluation of the Canadian HTA environment have ultimately led to the proposal of a progressive alignment approach which supports on-going efforts to create a more efficient European HTA environment.

CONTENTS

Acknowledgements	iii
Abstract	iv
Contents	vi
List of Abbreviations	viii
Glossary of Terms	xiv
List of Figures	xviii
List of Tables	xxii
Chapter One: General Introduction	1
Background.....	2
Origins and development of technology assessment in the United States.....	5
Adoption of Health Technology Assessment in Australia and Canada.....	7
Adoption of Health Technology Assessment in Europe.....	8
Comparative studies.....	10
International HTA networks.....	15
Multi-stakeholder initiatives.....	18
Frameworks and best practices for HTA.....	20
Impact on stakeholders.....	21
Potential studies for moving forward.....	22
Aim and Objectives of the Study	24
Chapter Two: Study Rational and Methodological Framework	25
Study Rationale.....	26
Methodological Framework.....	26
Study plan.....	40
Summary.....	42
Chapter Three: Development of archetypes to facilitate comparative analysis of reimbursement and decision-making processes	44
Introduction.....	45
Objectives.....	48
Methodology.....	48
Results.....	54
Discussion.....	68
Summary.....	73
Chapter Four: Comparisons of HTA Processes and Reimbursement Recommendations for nine European Jurisdictions using the classification tool	75
Introduction.....	76
Objectives.....	76
Methodology.....	77
Results.....	78
Discussion.....	100
Summary.....	103

Chapter Five: A Comparison of HTA Processes and Reimbursement Recommendations in Australia, Canada and the UK.....	105
Introduction.....	106
Objectives.....	107
Methodology.....	107
Results.....	109
Discussion.....	154
Summary.....	159
Chapter Six: An Evaluation of the Impact of Canadian National HTA Recommendations for Provincial Payers.....	161
Introduction.....	162
Objectives.....	164
Methodology.....	165
Results.....	168
Discussion.....	186
Summary.....	194
Chapter Seven: Assessing the Value of HTA Process Maps and their Impact on the Pharmaceutical Industry and Health Technology Assessment Agencies.....	196
Introduction.....	197
Objectives.....	197
Methodology.....	198
Results.....	208
Discussion.....	227
Summary.....	231
Chapter Eight: General Discussion.....	232
Introduction.....	233
Lessons from Canada.....	238
Pan-European HTA.....	241
Study Limitations.....	246
Recommendations.....	247
Future Work.....	248
Conclusion.....	249
References.....	251
Publications.....	272
Publications.....	273
Oral Presentations.....	273
Poster Presentations.....	273
Appendices.....	274
Appendix A: Information sources for the production of HTA process.....	274
Appendix B: Compendium of HTA process maps.....	283

LIST OF ABBREVIATIONS

AB	: Alberta
ADHD	: Attention Deficit Hyperactivity Disorder
ADTC	: Area Drug and Therapeutic Committee
AETMIS	: Agence d'évaluation des technologies et des modes d'intervention en santé
AFMPS	: Agency for Medicines and Health Products
AHTAC	: Australian Health Technology Advisory Committee
AHTAPoI	: Agency for Health Technology Assessment in Poland
AIMS	: Atlantic Institute for Market Studies
AIFA	: Italian Medicines Agency
AMNOG	: Act for Restructuring the Pharmaceutical Market in Statutory Health Insurance
ASMR	: Improvement in Medical Benefit
AWMSG	: All Wales Medicines Strategy Group
BHIVA	: British HIV Association
BNF	: British National Formulary
BC	: British Columbia
BCOHTA	: British Columbia Office of Health Technology Assessment
BRVO	: Branch Retinal Vein Occlusion
CADTH	: Canadian Agency for Drugs and Technologies in Health
CCOHTA	: Canadian Coordinating Office of Health Technology Assessment
CDEC	: Canadian Drug Experts Committee
CDR:	: Common Drug Review

CEDIT	: Comité d'Evaluation et de Diffusion des Innovations Technologiques Assistance Publique Hôpitaux de Paris
CEPS	: Economic Committee on Health Care Products
CETS	: Conseil d'évaluation des Technologies de la Santé du Québec
CGB	: Medicines Evaluation Board
CI	: Confidence Interval
CMT	: Centre for Medical Technology Assessment
CPR	: Pricing and Reimbursement Committee
CRVO	: Central Retinal Vein Occlusion
CSEMI	: Comité Scientifique d'évaluation des Médicaments aux fins d'inscription
CTG	: Medicines Reimbursement Commission
DHS	: Department of Human Services
DMARD	: Disease-Modifying Antirheumatic Drug
DRRC	: Drug Review Resource Committee
DRRT	: Drug Review Resource Team
DUSC	: Drug Utilisation Sub-Committee
DVA	: Department of Veterans' Affairs
ECDET	: Expert Committee on Drug Evaluation and Therapeutics
ECOHTA	: European Co-ordinating office of Health Technology Assessment
EEA	: European Economic Area
EHTAC	: European Health Technology Assessment Collaborations
EMA	: European Medicines Agency
EPAR	: European Public Assessment Report
ERG	: Evidence Review Groups

EU	: European Union
EUnetHTA	: European Network of Health Technology Assessment
EUnetHTA JA2	: EUnetHTA Joint Action project 2
EV	: Economic Value
FAD	: Final Appraisal Determination
FPSE	: Federal Public Service Economy
FPSSS	: Federal Public Service Social Security
G-BA	: Federal Joint Committee
GDP	: Gross Domestic Product
GKV-Spitzenverband	: National Association of Statutory Health Insurance Funds
GVS	: Dutch Pharmaceutical Products Reimbursement System
HAS	: French National Authority for Health
HCIWG	: Health Care Innovation Working Group
HSE	: Health Service Executive
HTA	: Health Technology Assessment
HTAi	: Health Technology Assessment international
ICER	: Incremental Cost-effectiveness Ratio
IDRAC	: International Drug Regulatory Affairs Compendium
INAHTA	: International Network of Agencies for Health Technology Assessment
INAMI-RIZIV	: National Institute for Health and Disability Insurance
INESSS	: The Institut National d'Excellence en Santé et en Services Sociaux
IQWiG	: Institute for Quality and Efficiency in Healthcare
ISPOR	: International Society for Pharmacoeconomics and Outcomes Research

KCE	: Belgian Health Care Knowledge Centre
MHRA	: Medicines and Healthcare products Regulatory Agency
MPA	: Medicines Products Agency
MSAC	: Medicare Services Advisory Committee
NAS	: New Active Substance
NCCHTA	: National Coordinating Centre for Health Technology Assessment
NCPE	: National Centre for Pharmacoeconomics
NHS	: National Health Service
NHTAP	: National Health Technology Advisory Panel
NICE	: National Institute for Health and Care Excellence
NIHB	: Non-Insured Health Benefits
NOC	: Notice of Compliance
ODBP	: Ontario Drugs Benefit Program
OECD	: Organisation for Economic Co-operation and Development
ON	: Ontario
OTA	: Office of Technology Assessment
PAPIG	: Public and Patient Involvement Group
PASAG	: Patient Access Scheme Assessment Group
PBAC	: Pharmaceutical Benefits Advisory Committee
PCPA	: Pan-Canadian Pharmaceutical Alliance
pCODR	: pan-Canadian Oncology Drug Review
PEB	: Pharmaceutical Evaluation Branch
PEI	: Prince Edward Island
PLA	: Price Listing Agreement

PMPRB	: Patented Medicines Price Review Board
PPRS	: Pharmaceutical Price Regulation Scheme
PBS	: Pharmaceutical Benefits Scheme
PSD	: Public Summary Document
QALY	: Quality Adjusted Life Years
QB	: Quebec
R&R	: Regulatory and Reimbursement
RAMQ	: Régie de l'assurance maladie du Québec
REA	: Relative Effectiveness Assessment
RedETSA	: Health Technology Assessment Network for the Americas
RCT	: Randomised Controlled Trial
RHB	: Regional Health Boards
Rx&D	: Canada's Research-Based Pharmaceutical Companies
SA	: Scientific Advice
SBU	: Swedish Council on Technology Assessment in Health Care
SEED	: Shaping European Early Dialogues
SMC	: Scottish Medicines consortium
SMR	: Medical Benefit
STA	: Single Technology Appraisal
TA	: Technology Assessment
TC	: Transparency Committee
TGA	: Therapeutic Goods Administration
TV	: Therapeutic Value
VBP	: Value-Based Pricing
VEG-F	: Vascular Endothelial Growth Factor
VTE	: Venous Thromboembolic Events

WAR : Scientific Advisory Board
WHO : World Health Organisation
ZIN : National Health Care Institute

GLOSSARY OF TERMS

Approval: Refers to a New Active Substance achieving licensing approval from a regulatory authority of a HTA agency granting a positive recommendation for the reimbursement of a new medicine.

Company/Sponsor: The owner of the product that has initiated the submission.

Comparator: A medicinal product or placebo used as a reference in clinical trials and HTA appraisals.

Coverage: Refers to the extent to which medicines and/or healthcare costs rendered by a healthcare program are covered.

Decision-maker: Determines the final decision to reimburse the new medicine by the coverage scheme for the system in question.

Drug plans: Refers to multiple public Canadian drug plans that cover the cost for prescription medicines.

Economic Value (EV): Refers to the determination of the cost-effectiveness, cost-utility, cost-benefit, and/or budget impact of the new therapy.

European Economic Area (EEA): Austria, Belgium, Bulgaria, Croatia, Cyprus, Czech Republic, Denmark, Estonia, Finland, France, Germany, Greece, Hungary, Iceland, Ireland, Italy, Latvia, Liechtenstein, Lithuania, Luxembourg, Malta, Netherlands, Norway, Poland, Portugal, Romania, Slovakia, Slovenia, Spain, Sweden, Switzerland, UK.

European Union (EU): Austria, Belgium, Bulgaria, Croatia, Cyprus, Czech Republic, Denmark, Estonia, Finland, France, Germany, Greece, Hungary, Ireland, Italy, Latvia, Lithuania, Luxembourg, Malta, Netherlands, Poland, Portugal, Romania, Slovakia, Slovenia, Spain, Sweden and UK.

Health Technology: May refer to a range of treatments (pharmaceutical, medical devices), vaccines, surgical procedures and preventative measures.

Health Technology Assessment (HTA): Generally considers the clinical benefit and cost-effectiveness of a health technology in the appropriate context, but it also considers relevant social and ethical implications.

Indication: The specific indication for which the active substance for the medicine is intended to cure, alleviate, treat, prevent or diagnose disease in humans.

Payer: Refers to the entity that reimburses the costs for medicines and/or healthcare, other than the patient.

Pharmacoeconomics: A scientific discipline that compares the value of medicines.

Recommended: Refers to a positive recommendation issued by a Health Technology Assessment Agency. The recommendation may or may not include prescribing restrictions such as conditional clinical criteria.

Recommended with restrictions: Refers to a recommendation that has been issued by a Health Technology Assessment with conditional criteria. This may include restrictions in the form of clinical criteria for prescribing, administrative or specialist approval, maximum quantity or limited reimbursement rate.

Recommender: HTA appraisal results in a recommendation for reimbursement but the final decision is made elsewhere.

Reviewer: Refers to persons trained in the scientific assessment of data to provide a recommendation for the reimbursement of new medicines.

Risk: The possibility of harm or unfavourable effects caused by a medicine or treatment.

Marketing Authorisation: Refers to the legal approval granted to a company/sponsor by a national or regional authority to market a medicinal product in the appropriate market or region.

Medicine: Pharmacological product for human use with intended medical intervention.

Medicine-indication: Refers to medicine and the indication included in the submission to the Health Technology Assessment Agency. This may not reflect the full indication approved by the regulatory authority.

New Active Substance (NAS): A chemical, biological, biotechnology or radiopharmaceutical substance that has not been previously available for therapeutic use in humans and is destined to be made available as a prescription only medicine, to be used for the cure, alleviation, treatment, prevention or in vivo diagnosis of diseases in humans.

Not recommended: Refers to a negative reimbursement/coverage recommendation issued by a Health Technology Assessment agency.

Patients' Access: Refers to the new medicine being made available for patients by the public or private providers.

Price Authority: Determines or controls the list price for a new medicine. This could be achieved by a voluntary price agreement or by imposing a ceiling price.

Provider: Adopts the new medicine based on the outcome of the decision maker.

Reimbursement: Payment by a third party to repay costs of medicines or healthcare on behalf of the patient.

Scientific Advice (SA): Provision of scientific advice to the sponsor in relation to the drug development programme of the submission of evidence to that agency.

Submission: Is an application for review of a new medicine that has been submitted to the appropriate authority. This could refer to applications sent to a Health Technology Assessment agency for reimbursement of the proposed indications or an application submitted to a regulatory authority for market authorisation of the proposed indications.

Therapeutic value (TV): The evaluation of the clinical evidence in order to determine if there is added therapeutic value in the new medicine.

LIST OF FIGURES

Figure 1.1	Total expenditure on health as a percentage of gross domestic product in 2012.....	2
Figure 1.2	Factors driving health care expenditure.....	3
Figure 1.3	First Health Technology Assessment agency or unit per country in Australasia, Europe and North America.....	6
Figure 1.4	European Health technology assessment (HTA) agencies and units established from 1982 to 2007.....	9
Figure 1.5	Modification of the EUnetHTA Core Model	17
Figure 2.1	The Study flowchart	41
Figure 3.1	Mapping methodology information tier 1.....	50
Figure 3.2	Mapping methodology information tier 2.....	51
Figure 3.3	Mapping methodology information tier 3.....	52
Figure 3.4	Process map for Austria (January 2012).....	55
Figure 3.5	Process map for Denmark (June 2014)	55
Figure 3.6	Process map for Liechtenstein (February 2012)	56
Figure 3.7	Process map for Portugal (June 2014)	56
Figure 3.8	Process map for Spain (May 2014)	57
Figure 3.9	Process map for Switzerland (June 2014).....	57
Figure 3.10	System taxonomy.....	58
Figure 3.11	HTA process taxonomy	60
Figure 3.12	Archetype grid.....	61
Figure 3.13	Information sharing flow diagrams	62
Figure 3.14	Information sharing schematic for archetypes.....	64
Figure 3.15	System taxonomy geographical location map	66
Figure 3.16	16 HTA process taxonomy geographical location map	66
Figure 3.17	Archetype geographical location map.....	67
Figure 4.1	HTA recommendations and listing outcomes for 9 European jurisdictions classified according to three categories.	82
Figure 4.2	Process map for Belgium (May 2014).....	83
Figure 4.3	Process map for England (August 2014).....	84
Figure 4.4	Process map for France (July 2014).....	85
Figure 4.5	Process map for Germany (May 2014).....	86

Figure 4.6	Process map for Ireland (May 2014).....	87
Figure 4.7	Process map for Italy (May 2014)	88
Figure 4.8	Process map for the Netherlands (May 2014).....	89
Figure 4.9	Process map for Scotland (May 2014).....	90
Figure 4.10	Process map for Sweden (September 2014)	91
Figure 4.11	HTA recommendations for NASs for malignant disease.....	97
Figure 5.1	Process map for the Canadian Common Drug Review (March 2014)	113
Figure 5.2	Process map for Australia (December 2014).....	115
Figure 5.3	Process map for Scotland (May 2014).....	116
Figure 5.4	Process map for England (August 2014).....	118
Figure 5.5	Medicine-indication pairs HTA recommendations for Canada, Australia, England and Scotland.....	121
Figure 5.6	Positive HTA recommendations for medicine-indication pairs.....	126
Figure 5.7	Proportion of medicines were all issued a negative recommendations.....	127
Figure 5.8	Medicine and indication combinations classified by therapeutic area.....	128
Figure 5.9	Timeline for apixiban (Eliquis) for prevention of venous thromboembolic events (VTE)	130
Figure 5.10	Timeline for denosumab (Prolia) for Osteoporosis in postmenopausal women.....	132
Figure 5.11	Timeline for golimumab (Simponi) for rheumatoid arthritis.....	133
Figure 5.12	Timeline for golimumab (Simponi) for ankylosing spondylitis.....	135
Figure 5.13	Timeline for Telaprevir (Incivek) for Hepatitis C infection (genotype 1), Chronic (treatment naïve).....	136
Figure 5.14	Timeline for tocilizumab (Actemra) for rheumatoid arthritis.....	137
Figure 5.15	Timeline for ustekinumab (Stelera) for psoriasis.....	138
Figure 5.16	Timeline for dabigatran (Pradaxa) for prevention of venous thromboembolism.....	141
Figure 5.17	Timeline for fingolimod (Gilenya) for multiple sclerosis.....	143
Figure 5.18	Timeline for golimumab (Simponi) for psoriatic arthritis.....	144
Figure 5.19	Timeline for prasugrel (Effient) for acute coronary syndromes.....	146
Figure 5.20	Timeline for ranibizumab injection (Lucentis) for Macular oedema, secondary to retinal vein occlusion (Branch Retinal Vein Occlusion (BRVO)	148
Figure 5.21	Timeline for ranibizumab injection (Lucentis) for Macular oedema, secondary to Central Retinal Vein Occlusion (CRVO)	148

Figure 5.22	Timeline for telaprevir (Incivek) for Hepatitis C infection (genotype 1) in treatment experienced patients.....	151
Figure 5.23	Timeline for ticagrelor (Brilinta/Brillique) for acute coronary syndrome.....	153
Figure 6.1	Process map for the Common Drug Review (March 2014)	169
Figure 6.2	Process map for the regulatory to reimbursement pathway for new medicines in Alberta (September 2013)	171
Figure 6.3	Process map for the regulatory to reimbursement pathway for new medicines in British Columbia (March 2013)	172
Figure 6.4	Process map for the regulatory to reimbursement pathway for new medicines in Ontario (March 2013)	173
Figure 6.5	Process map for the regulatory to reimbursement pathway for new medicines in Quebec (September 2013)	175
Figure 6.6	Medicines approved by the CDR from January 2009 to May 2013 grouped by therapeutic area.....	178
Figure 6.7	Overview of medicine recommendations issued from January 2009 to May 2013 by the CDR with provincial payers and HTA recommendations.	179
Figure 6.8	Percentage agreement CDR recommendations with provincial payer and HTA recommendations using multinomial categories.....	181
Figure 6.9	Percentage agreement of provincial payer and HTA recommendations and CDR recommendations using binomial categories.....	181
Figure 6.10	Provincial listing decision agreement with CDR recommendations for 5 case studies with binomial categories.....	183
Figure 6.11	Manufacturer consultations during assessment period.....	185
Figure 6.12	Days taken for CDR process and provincial review.....	186
Figure 7.1	Agency questionnaire.....	200-203
Figure 7.2	Industry questionnaire.....	204-207
Figure 7.3	Sources used by HTA agencies to collect information for regulatory and reimbursement systems.....	209
Figure 7.4	Information source factors ranked by agencies (n=4)	210
Figure 7.5	Factors exhibited by information sources according to HTA agency respondents.....	211
Figure 7.6	Value of systematic HTA process mapping methodology according to agency respondents	212
Figure 7.7	Potential process map impact on HTA activities (n=5)	214
Figure 7.8	Importance of jurisdictions to HTA agency respondents (n=4)	215

Figure 7.9	Agency respondents preferred formats for the Regulatory and Reimbursement Atlas (n=5)	216
Figure 7.10	Sources used by pharmaceutical industry to collect information for regulatory and reimbursement systems (n=6)	218
Figure 7.11	Information source factors ranked by industry (n=6)	218
Figure 7.12	Factors exhibited by agency websites, ISPOR Roadmaps and Regulatory and Reimbursement Atlas according to industry respondents.....	219
Figure 7.13	Factors exhibited by Regulatory and Reimbursement Atlas, Consultants and Internal reference sources according to industry respondents.....	220
Figure 7.14	Value of systematic HTA process mapping methodology according to industry respondents (n=6)	221
Figure 7.15	Potential impact of HTA process maps on company strategy.....	223
Figure 7.16	Importance of countries by industry respondents.....	224
Figure 7.17	Process maps potential to inform company decision-making.....	226
Figure 7.18	Industry respondents preferred format for accessing Regulatory and Reimbursement Atlas (n=6)	227
Figure 7.19	Ten highest ranked countries by importance for HTA agency and pharmaceutical industry respondents.....	230
Figure 8.1	Progressive alignment phase 1.....	244
Figure 8.2	Progressive alignment phase 2.....	245

LIST OF TABLES

Table 3.1	Key Principles for the improved conduct of Health Technology Assessment.....	47
Table 3.2	Comparison of this research and resources available in the public domain.....	69
Table 4.1	Multinomial classification for HTA recommendations.....	80
Table 4.2	Congruence of HTA recommendations and listings allocated to three categories and colour-coded by System taxonomy.....	93
Table 4.3	Congruence of HTA recommendations and listings allocated to three categories and colour-coded by HTA Process taxonomy.....	95
Table 4.4	NASs classified by British National Formulary categories.....	96
Table 4.5	Congruence for HTA recommendations by jurisdictional pairs for NASs for malignant disease	99
Table 5.1	Comparison of Canadian, Australian, English and Scottish Healthcare Coverage.....	111- 112
Table 5.2	Comparison of HTA recommendations options for Canada Australia, England and Scotland.....	120
Table 5.3	Proportion of Medicine-indication pairs by multinomial categories of recommendations.....	122 .
Table 5.4	Proportion of Medicine-indication pairs by binomial categories of recommendations.....	122
Table 5.5	Percentage agreement of national HTA recommendations in Australia, Canada, England and Scotland (multinomial category classification).....	123
Table 5.6	Percentage agreement of national HTA recommendations for medicine–indication combinations in Australia, Canada, England and Scotland (binomial category classification)	123
Table 5.7	Kappa agreement of national HTA recommendations for medicine–indication combinations in Australia, Canada, England and Scotland (binomial category classification)	124
Table 5.8	Summary table of case studies that received positive recommendations from four agencies.....	131
Table 5.9	Summary table of case studies that received a negative recommendation from one of the four agencies.....	140
Table 6.1	General agency and survey specific discussion points for interview..	167
Table 6.2	Comparison of options for HTA recommendations and formulary listing outcomes.	176
Table 6.3	Proportion of medicine-indication pair recommendations by multinomial categories.....	180

Table 6.4	Proportion of medicine-indication pair recommendations by binomial categories	180
Table 6.5	Provincial expert committee composition.....	184
Table 6.6	Patient input opportunities at the national and regional HTA agencies and payers.....	184
Table 6.7	Comparison of percentage agreement and kappa coefficients with previous study.....	187

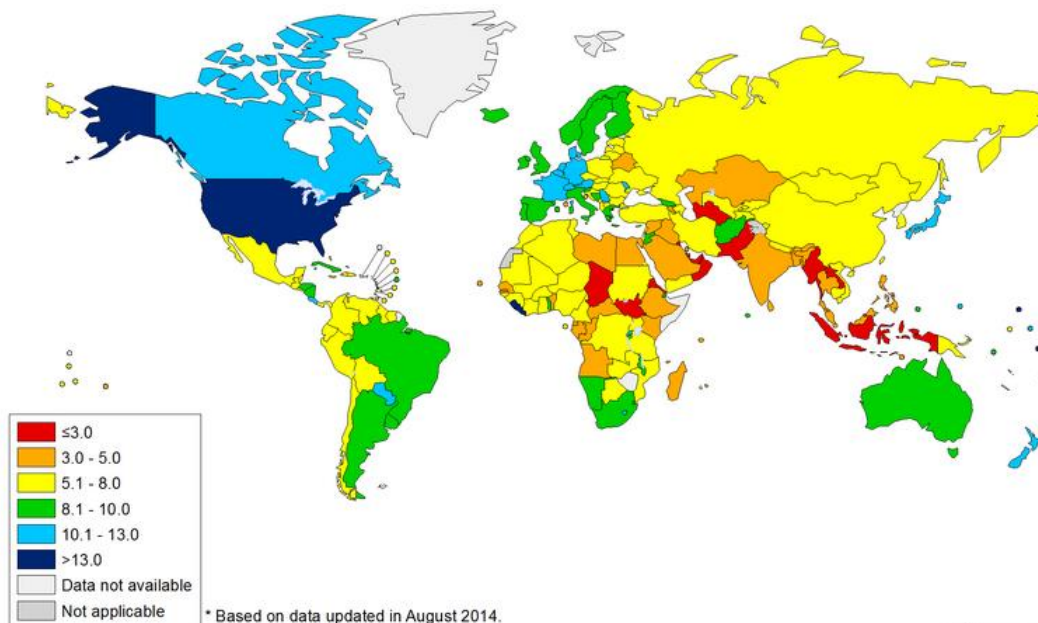
CHAPTER 1

General Introduction

BACKGROUND

Life expectancy from birth has improved throughout the world since the 1950's (Leon, 2011). Across the European member states, life expectancy increased by 5.1 years from 1990 to 2012 and continues to rise (Organisation for Economic Co-operation and Development (OECD), 2014a). Multiple factors can be attributed to these observed increases in life expectancy, such as: improved standards of living and increased access to quality healthcare. However, the costs for providing healthcare are also rising and often increasing faster than GDP. From 1990 to 2007 average healthcare expenditure increased by 80% in France, Germany, Italy, Spain, Switzerland and the United Kingdom while GDP only grew by 25% (Beyer *et al.*, 2007). Healthcare expenditure continues to increase and more countries throughout the world are spending a greater proportion of GDP on healthcare. In 2012, 58 countries spent more than 6.1% of GDP on healthcare (Figure 1.1). An increased expenditure on healthcare is to be expected as more countries strive to provide universal health coverage but demand for access to innovative new treatments and improved standards of care is continuous.

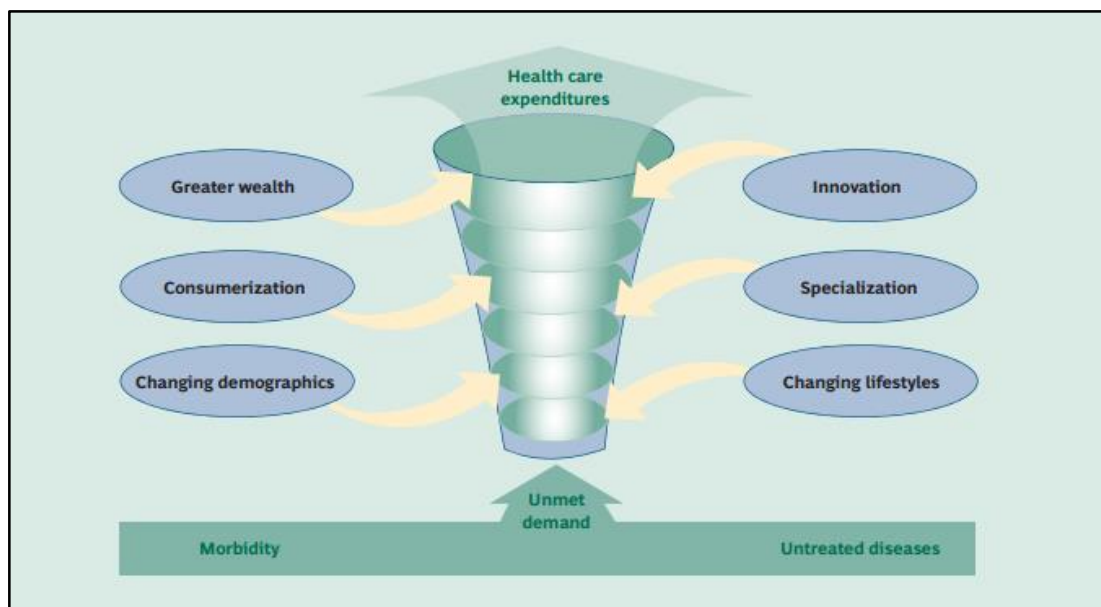
Figure 1.1: Total expenditure on health as a percentage of gross domestic product in 2012



Source: Figure adapted from World Health Organisation (WHO) (2014b)

Beyer *et al.* (2007) describes the ever increasing demand for healthcare as a vortex with six key factors encouraging greater expenditure: greater wealth; consumerisation; changing demographics; innovation; specialisation and changing lifestyles. As societies become wealthier, citizens are usually more educated and are less accepting of disease and are more informed of treatment options. This increases patient demand and also drives consumerism, which encourages development of new innovative and more specialised treatments (Figure 1.2).

Figure 1.2: Factors driving healthcare expenditure, figure reproduced from Beyer *et al.* (2007)



Increased access to quality healthcare is a contributing factor towards increased life expectancy which is also producing a change in demographics. By 2050, an estimated two billion people will be aged 60 or older (World Health Organisation (WHO) 2014a). A growing older population will further drive demand for new treatments as increased age is associated with chronic illness amongst other public health challenges. The sixth factor driving the healthcare vortex is changing lifestyles. Modern societies in many countries are experiencing greater prevalence of obesity in all age groups. Obesity is linked to many chronic diseases including type 2 diabetes which used to be known as adult-onset diabetes as it generally affected adults over 40 years of age (Diabetes UK, 2010). However, the increasing prevalence of childhood obesity

has resulted in more young people diagnosed with type 2 diabetes. In 2002, the first cases of juvenile type 2 diabetes in the UK were diagnosed in overweight girls aged 9 to 16 years old (Ehtisham *et al.*, 2000). The rising costs associated with diabetes will provide many challenges for healthcare providers. Diabetes alone is expected to account for 17% of the total UK National Health Service (NHS) expenditure by 2035/36 (Hex *et al.*, 2012). The continuously increasing costs of healthcare creates a challenging environment for policy makers and healthcare providers and emphasises the importance of using resources wisely. Yet, in 2010, the World Health Organisation (WHO) published a report that found 20 – 40% of health systems expenditure was wasted and concluded that every country could improve efficiency (World Health Organisation (WHO) 2010). The sixty-seventh World Health Assembly resolution noted the results of this report and urges member states “*to strengthen the link between health technology assessment and regulation and management, as appropriate*” (World Health Organisation (WHO) 2014c).

The definition for Health technology Assessment (HTA) can vary as the intended purpose and methodologies used to conduct HTA often differ, but a commonly used definition for HTA is:

“A multidisciplinary process that summarises information about the medical, social, economic and ethical issues related to the use of a health technology in a systematic, transparent, unbiased, robust manner. Its aim is to inform the formulation of safe, effective, health policies that are patient focused and seek to achieve best value” (European Network for Health Technology Assessment (EUnetHTA) 2015b).

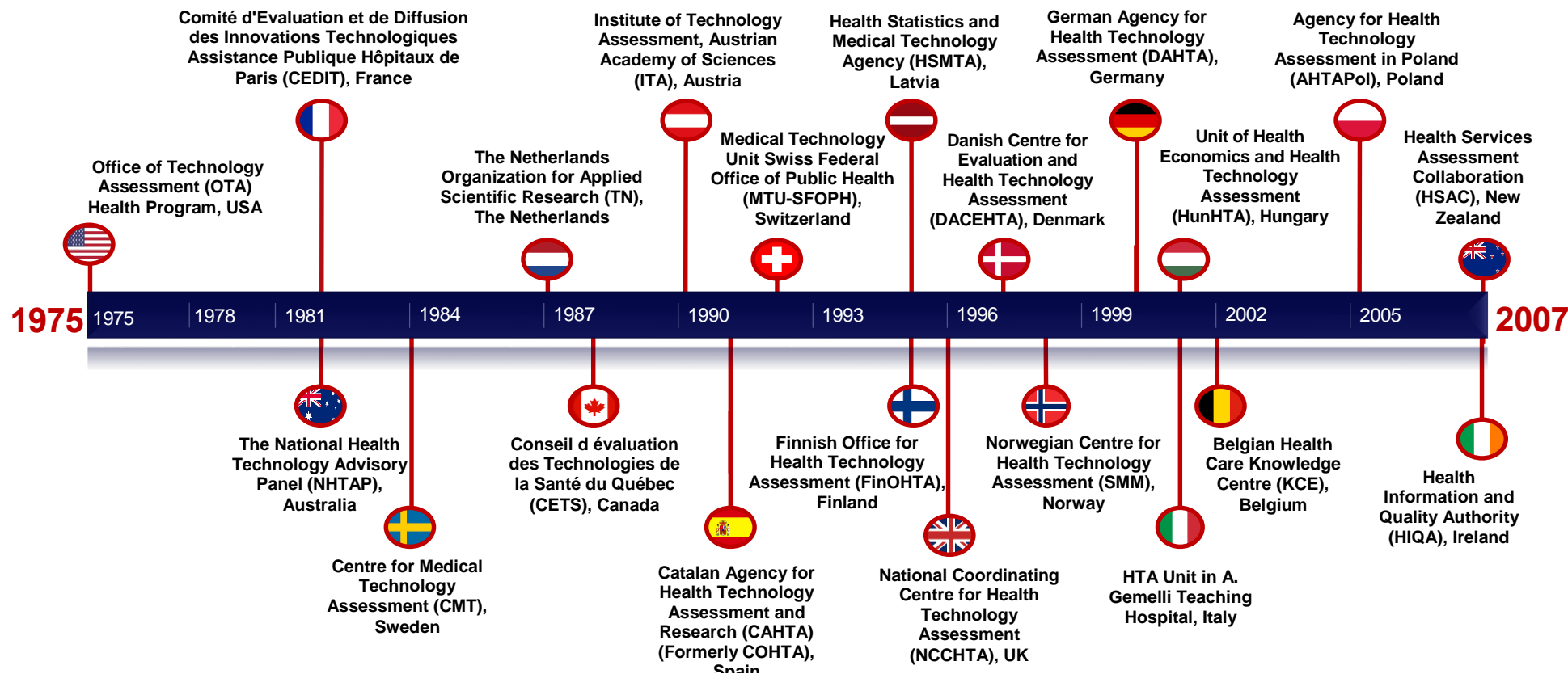
The health technology to be assessed can include a range of treatments (pharmaceutical, medical devices), vaccines, surgical procedures and preventative measures. A HTA may focus on a single technology or consider a range of treatment options and preventative measures. Ultimately the scope of HTA depends on the mandate of each HTA agency and generally considers the clinical benefit and cost effectiveness of a health technology in the appropriate context, but it also considers relevant social and ethical

implications. Therefore, HTA is primarily concerned with the effectiveness of the health technology, whereas regulatory authorities consider safety and efficacy but there can still be areas of over-lap. HTA is currently utilised by many payers to inform pricing and reimbursement decisions and this additional step is commonly known as the fourth hurdle following the three hurdles for marketing approval: safety, efficacy and quality. However, most healthcare systems already had some form of pricing controls prior to introduction of the fourth hurdle. For example, Australia and some Canadian provinces conducted comparative clinical assessments, the Netherlands grouped similar drugs and used therapeutic reference pricing and the UK routinely reimbursed new medicines but regulated prices through the Pharmaceutical Price Regulation Scheme (PPRS) which determined a maximum cap on profits for drugs sold to the UK National Health Service (Drummond, 2013).

ORIGINS AND DEVELOPMENT OF TECHNOLOGY ASSESSMENT IN THE UNITED STATES

Health Technology Assessment (HTA) is a relatively young field that was first introduced in the 1960's but has rapidly grown over the last 30 years. In 1965, the term Technology Assessment (TA) was first used in the United States Congress by the committee of Science and Astronautics (Goodman, 2014). TA was intended to support policy and was defined as *“a comprehensive form of policy research that examines the short- and long-term social consequences of the application or use of technology”* (Office of Technology Assessment 1976, cited in (Banta, 2002). In 1972, Congress authorised the Office of Technology Assessment (OTA) and the OTA health programme was introduced in 1975 (Figure 1.3) (Goodman, 2014). The OTA health programme released its first report in 1976 and activities included assessing health technologies and defining the methods for HTA such as cost effectiveness analysis and Randomised Controlled Trials (RCT) (Office of Technology Assessment, 1995).

Figure 1.3: First Health Technology Assessment agency or unit per country in Australasia, Europe and North America



Data sources: from Velasco-Garrido and Busse (2005); Garrido *et al.* (2008); Goodman (2014); International Network of Agencies for Health Technology Assessment (INAHTA). (2015)

Timeline is not intended to be exhaustive

After twenty three years, the OTA closed in 1995 due to budget cuts (Princeton University, 2015; Banta, 2002), but HTA was already becoming established in other countries facing similar challenges to the United States. The growth of HTA was also supported by developments in evidence-based medicine for supporting clinical practice and the establishment of the Cochrane Collaboration which generates evidence to inform clinical practice (Banta, 2002).

ADOPTION OF HEALTH TECHNOLOGY ASSESSMENT IN AUSTRALIA AND CANADA

In 1982, the Commonwealth of Australia established The National Health Technology Advisory Panel (NHTAP) (Figure 1.3). NHTAP was a panel of experts with representatives from manufacturing, insurance and health professionals and provided suggestions for the appropriate use of devices or procedures in Australia (Hailey, 2009). In 1990, NHTAP combined with a group for the development of guidelines for highly specialised procedures (Superspeciality Services Subcommittee) to become the Australian Health Technology Advisory Committee (AHTAC) and eventually AHTAC was replaced with the Medicare Services Advisory Committee (MSAC) (Hailey, 2009). MSAC is still active today and provides recommendations to the Minister for Health for the appropriate use and reimbursement of medical technologies or services (Australian Government Department of Health, 2014). HTA is also utilised by the Australian public health system to guide reimbursement for the decisions for new medicines. The Pharmaceutical Benefits Advisory Committee (PBAC) provides recommendations to the Minister of Health for the inclusion of new medicines in the Pharmaceutical Benefits Scheme (PBS) (Australian Government Department of Health, 2015). In 1990, the PBAC produced guidelines for the use of economic evaluation and from 1993 the submission of an economic evaluation became a mandatory requirement for manufacturers (Hailey, 2009).

In 1988, the first HTA body was established in Canada, the Conseil d'évaluation des Technologies de la Santé du Québec (CETS) to support the Minister of Health and Social Services in Québec (Office of Technology Assessment, 1995) (Figure 1.3). A pan-Canadian HTA body was subsequently created in 1989 (Canadian Coordinating Office of Health Technology Assessment (CCOHTA)) to provide clinical and economic

guidance for participating drug plans (Menon and Stafinski, 2009). The CCOHTA has since become the Canadian agency for Drugs and Technologies in Health (CADTH) which includes the Common Drug Review (CDR) that conducts HTA for new medicines (excluding oncology products) and provides non-mandatory listing recommendations for 18 participating public drug plans. CADTH also includes the pan-Canadian Oncology Drug Review (pCODR), a HTA programme solely for the review of oncology medicines. Quebec does not participate in the national Canadian HTA programmes because it has maintained its own HTA agency: The Institut national d'excellence en santé et en services sociaux (INESSS) (International Network of Agencies for Health Technology Assessment (INAHTA), 2014). In 2000, CETS became the Agence d'évaluation des technologies et des modes d'intervention en santé (AETMIS) which merged with the Conseil du médicament in 2011 to become INESSS.

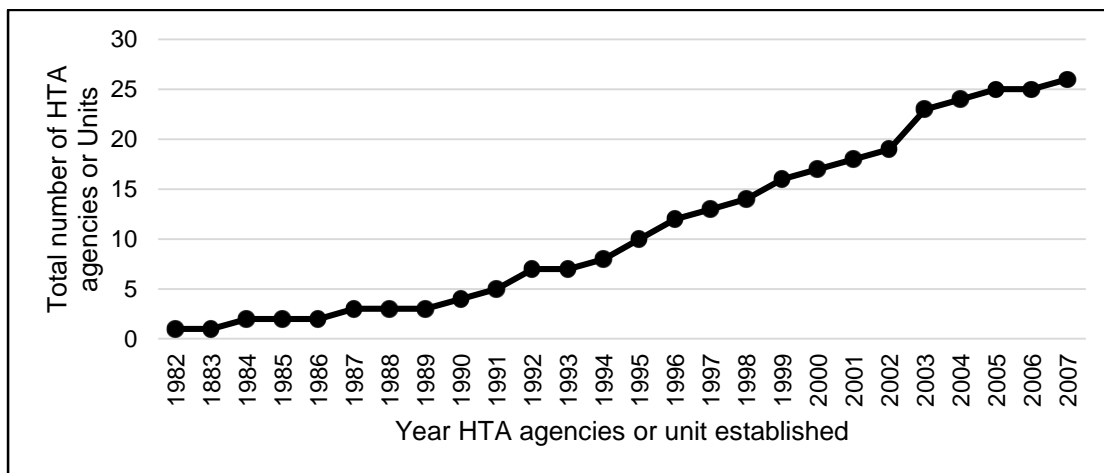
ADOPTION OF HEALTH TECHNOLOGY ASSESSMENT IN EUROPE

Banta (2002) explains how the early work of the Office of Technology Assessment (OTA) was transferred to many European countries throughout the 1990's and HTAs mainly focused on the clinical benefit and cost effectiveness of the health technology. The Comité d'Evaluation et de Diffusion des Innovations Technologiques Assistance Publique Hôpitaux de Paris (CEDIT) was established in 1982 to conduct HTA at the regional level and the Centre for Medical Technology Assessment (CMT) was formed in Sweden in 1984 to conduct ad hoc HTA (Garrido *et al.*, 2008) (Figure 1.3). In 1987, the first formal national European HTA agency was the Swedish Council on Technology Assessment in Health Care (SBU). The number of HTA agencies and organisations has grown rapidly since the mid-1990's (Figure 1.4).

Garrido *et al.* (2008) also observed that the organisations established to focus on conducting and disseminating were mostly established in the 1980's and 1990's and classified the HTA agencies into two difference groups: 1- organisations that primarily conduct and disseminate HTA reports (such as: CEMIT and SBU) and 2- organisations with broader mandates (Such as the Belgian Health Care Knowledge Centre (KCE) and the Agency for Health Technology Assessment in Poland (AHTAPol)). However,

these two categories are extremely broad and do not reflect the heterogeneity of the current European HTA environment. HTA agencies and units are established to assess health technologies within a specific context. This may be at the local level (e.g. Spain and Italy) or at the national level (e.g. UK and Germany). Healthcare systems also vary across Europe as they have originated from different welfare state ideologies and developed over time to meet different populations political and social needs (Bambra and Eikemo, 2008; Arts and Gelissen, 2002).

Figure 1.4: European Health technology assessment (HTA) agencies and units established from 1982 to 2007



Data source: Garrido 2008

The current processes used to guide the pricing and reimbursement recommendations also differ between European countries. For example, the UK require a formal health economic analysis unlike Germany and France. Within the UK there are also different routes for gaining reimbursement approval for NHS England, NHS Scotland and NHS Wales. NICE appraises medicines to provide a reimbursement recommendation for NHS England and Wales, but NICE does not appraise all medicines. Only new medicines that are identified by horizon scanning and are requested by the secretary of state ((National Institute for Health and Care Excellence (NICE), 2013b) are appraised by NICE. NICE and the All Wales Medicines Strategy Group (AWMSG) have a memorandum of understanding to prevent duplication of work and the AWMSG will not appraise a new medicine if a NICE appraisal is expected to produce guidance within 12 months (All Wales Medicines Strategy Group (AWMSG), 2014). NHS Scotland has its own HTA agency to conduct HTA for new medicines, the Scottish Medicines Consortium (SMC). Unlike NICE, the SMC appraises all new medicines

prior to reimbursement by NHS Scotland and if the manufacturer does not provide a submission to the SMC within an appropriate timeframe the SMC will issue a negative reimbursement recommendation due to non-submission (Scottish Medicines Consortium (SMC), 2012). Both NICE and SMC submissions require clinical and cost-effectiveness data and prefer cost-utility analysis using Quality Adjusted Life Years (QALY) (Scottish Medicines Consortium (SMC) 2014; National Institute for Health and Care Excellence (NICE), 2013a).

Prices for medicines sold in Germany have been considerably higher than the OECD average as a result of previous pricing mechanisms that enabled manufacturers to set their own prices (Organisation for Economic Co-operation and Development (OECD), 2008). In 2011, the Act for Restructuring the Pharmaceutical Market in Statutory Health Insurance (AMNOG) was introduced to control the prices of patented medicines and generate savings of up to 2 billion Euros (Henschke *et al.*, 2013). Since the introduction of AMNOG, manufacturers are required to submit evidence demonstrating a new medicine's therapeutic benefit over an existing comparator. Medicines that demonstrate a therapeutic benefit are eligible for price negotiations to determine a price to reflect the level of additional benefit. If no additional benefit is found the medicine will be subject to reference pricing. Cost effectiveness evaluations are not explicitly required by AMNOG and Henschke *et al.* (2013) argues that this may overlook an important factor for evaluation and should at least be considered for long-term policy. Similar to Germany, the French National Authority for Health (HAS) assesses the clinical effectiveness and added therapeutic benefit of a new medicine without cost-effectiveness data to determine a reimbursement price. However, from October 2013, economic evaluation is now a required part of the submission for new medicines with a high clinical benefit and a significant impact on expenditure (more than 20 million Euros) (Rumeau-Pichon *et al.*, 2014).

COMPARATIVE STUDIES

Previous work

Many comparative studies have been published to describe and evaluate the differences between HTA agencies and several of these include more than one European HTA agency (Franken *et al.*, 2012; Schwarzer and Siebert, 2009; Bending

et al., 2012; Kleijnen *et al.*, 2012; Moharra *et al.*, 2008; Sorenson and Chalkidou, 2012; Mathes *et al.*, 2013; Levy *et al.*, 2010; Nicod and Kanavos, 2012). However, projects such as the International Society for Pharmacoeconomics and Outcomes Research (ISPOR), Road Maps have compiled an online public database of descriptive profiles for the decision-making process of regulatory authorities, HTA agencies, healthcare providers for the reimbursement of pharmaceuticals and medical devices. The profiles are produced by local experts from each healthcare system which is particularly valuable for countries that are not transparent, but the profiles/road maps do not adhere to a uniform structure and many have not been updated since 2008 (International Society For Pharmacoeconomics and Outcomes Research (ISPOR), 2012). A report published by Charles River Associates has provided a descriptive overview of HTA agencies and the regulatory and reimbursement decision-making practices for pharmaceuticals at the national level for several countries (Wilsdon and Serota, 2011). These include uniform flow charts which are easier to compare but less detailed than the ISPOR Road Maps. This report has also produced a method for classifying HTA agencies but is limited to the timing of HTA. The WHO has also published country specific descriptive reports and posters for the pricing and reimbursement of pharmaceuticals (World Health Organisation Collaborating Centre for Pharmaceutical Pricing and Reimbursement Policies, 2015a; World Health Organisation Collaborating Centre for Pharmaceutical Pricing and Reimbursement Policies, 2015b). The WHO reports are comprehensive and produced by local experts but some countries only have reports produced in 2007. Similarly for the posters, they have been produced by local experts but once again they do not follow a uniform methodology so can be difficult to compare. Separate posters have been created to distinguish between the in-patient and out-patient pathways, but most of the posters were produced in 2010 and have not been directly updated, instead a separate document listing changes and future plans has been published to accompany the original poster. Straus and Jones (2004) noted that many studies from the previous 10 years had focused on developing an evidence base and recommended future studies in the decade following 2004 should focus on outcomes. Many studies from 2004 have compared HTA recommendations across a range of countries, some have focused on process, approaches for cost-effectiveness evaluations, the clinical evidence and differences between therapeutic groups.

A descriptive study by Sorenson and Chalkidou (2012) compares evolution of HTA in England, France, Germany and Sweden and discusses potential future developments such as using HTA for disinvestment, methods for applying HTA to a localised context and increased interest in Value-Based Pricing (VBP) in the UK, but VBP was not part of the new Pharmaceutical Pricing and Reimbursement Scheme (PPRS) launched in 2014. A comparative study conducted by Bending *et al.* (2012) compares HTA processes and agreement of reimbursement recommendations for SMC and HAS. These two agencies were chosen as examples of HTA agencies that include or exclude cost effectiveness analysis, respectively. Bending *et al.* (2012) identified cases where SMC and HAS exhibited differences in dealing with clinical data uncertainties and concluded that France determines the reimbursement status based on a judgement of the therapeutic value which results in price as the main variable to be adjusted in negotiations for France. Whereas, Scotland receives a price submitted by the manufacturer and must determine the value of the product in relation to the submitted price, therefore the quantity/patient population is the main adjustable variable in Scotland. The study provides an interesting comparison of two different systems to evaluate the contribution of formal health economic analysis. However, there are many variables between the two systems in addition to their processes regarding formal economic evaluation. For example, SMC provides a reimbursement recommendation for NHS Scotland which is funded by taxation and fully subsidises pharmaceuticals for all citizens. Whereas the HAS Transparency Committee (TC) determines the actual benefit of a new medicine which is used by the national health insurance to define the reimbursement rate (important-65%, moderate-30%, mild-15%, insufficient-not included on the positive list) (Haute Autorité de Santé (HAS), 2014) and the added therapeutic value is used to determine price. Therefore, there are many factors that could impact the reimbursement recommendation in addition to the utilisation of formal cost-effectiveness evaluations. A larger study could be conducted to see if the differences observed occur in between groups of agencies categorised by their utilisation of clinical and cost-effectiveness evaluation. A study with more countries will still be comparing systems with multiple differences due to the varied nature of HTA and healthcare systems, but it might be able to identify trends. Mathes *et al.* (2013) compared a broader range of economic methods and processes for 14 HTA agencies and identified strong variation of the quantity and content of recommendations for HTA agencies and argued in favour of harmonisation of

economic evaluation processes which would aid generalisability and transferability of data.

Comparative studies including Australia, Canada and the UK

Of the many published comparative studies there are several that include HTA agencies from Australia, Canada, and the UK (Nicod and Kanavos, 2012; Mathes *et al.*, 2013; Levy *et al.*, 2010; Lexchin and Mintzes, 2008; Spinner *et al.*, 2013; Clement *et al.*, 2009; Mauskopf *et al.*, 2011). This is not surprising as they are countries with an established history of HTA and although publications vary in detail, they are transparent enough to publish HTA recommendations online, in English and with a rationale for decisions. However, this should not imply that this area of research is saturated. The published studies compare various different country combinations and focus on a specific component of the HTA processes or recommendations. HTA agencies regularly adapt to meet the needs of the healthcare system and the patient population they serve, but are also subject to changes as a result of political reforms. Therefore, repeated evaluations are also needed throughout time to provide up-to-date comparisons and to observe the evolution of HTA in these countries.

Mauskopf *et al.* (2011) summarised evidence requirements for HTA agencies in 12 countries (including Australia, Canada, England and Scotland) to evaluate how the differences could impact HTA recommendations and recommended that the impact caused by these differences could be used to guide future harmonisation of HTA. Numerous studies have also compared similarities and differences between HTA recommendations issued by Australian, Canadian and British HTA agencies. All of these studies identified disparities between the HTA recommendations, but the authors' opinions regarding the primary reasons for discordant recommendations varied. Lexchin and Mintzes (2008) compared the Canadian CDR recommendations issued up to 2006 with HTA recommendations from Australia (PBAC) and Scotland (SMC) and concluded that the CDR is 'no different' from PBAC and SMC in regard to the proportion of recommendations issued by each agency using three categories (recommended, recommended with restrictions and not recommended), but when they compared recommendations directly they identified poor concordance and suggested divergent recommendations were due to pharmacoeconomic reasons. A later study by Nicod and Kanavos (2012) compared HTA recommendations from 2007

to 2009 in Australia, Canada, England, Scotland and Sweden to identify divergent recommendations and the rationale behind recommendations for different therapeutic groups. This study concluded that there were significant differences between the HTA recommendations within therapeutic groups, for example Canada was found to be less likely to accept medicines with a marginal benefit for Central Nervous System (CNS) treatments (Nicod and Kanavos, 2012). A study by Spinner *et al.* (2013) reviewed nine medicines that all received a HTA recommendation from Australia, Canada and England between 2007 and 2010. The medicines were reviewed in depth to assess whether different clinical evidence was a cause for divergent recommendations and the study did identify differences between the HTA agencies choice for comparator and inclusion of trials.

Comparisons to provide learnings for the United States

A few studies compared HTA agencies from Australia, Canada and the UK and used these countries as examples for including cost-effectiveness evaluation in the United States. Clement *et al.* (2009) compared HTA recommendations available up to 2008 for Australia, Canada and England and argued that differences in listing decisions are more likely to be due to differences in willingness to accept risk. Clement *et al.* (2009) also used the results to discuss an update of comparative effectiveness research in the United States. Levy *et al.* (2010) reviewed the processes in HTA systems in Australia, Canada, the Netherlands, Scotland and Sweden to compare different approaches for comparative effectiveness research and also to provide discussion points for the United States. Overall, Levy *et al.* (2010) found more similarities than differences for the processes across the five countries.

Comparative studies for HTA in Canada

Comparative studies evaluating medicines listed across Canadian provinces prior to the inception of the CDR generally identified low concordance across Canadian provincial listing decisions: (Anis *et al.*, 2001; Gregoire *et al.*, 2001; MacDonald and Potvin, 2004). The CDR was introduced to help standardise access to new medicines by maximising the use of resources, reducing duplication of assessments and providing timely and equal access to evidence (Allen *et al.*, 2014), but Morgan *et al.* (2006) argued that decentralising decision-making to multiple provincial payers

reduces the impact of the CDR and Hollis and Law (2004) predicted that provinces will only become slightly more standardised without implementing a Canadian national formulary. The predictions by Hollis and Law (2004) and Morgan *et al.* (2006) were potentially supported by a more recent study by Attaran *et al.* (2011), which identifies concordance of listing decisions by some provincial payers with the CDR to be “*no better than random chance*”. However, McMahon *et al.* (2006) compared provincial listings with 25 new medicines, issued a CDR recommendation from inception (2003) to June 2005 and concluded that there was general concordance, but further studies are required to determine whether the CDR will harmonise provincial listings for new medicines. Similarly, Tierney *et al.* (2008) commented on the consistency of agreement between provincial listing decisions with CDR recommendations and referred to a presentation from CADTH that found CDR recommendations issued within the first three years of inception and provincial listing agreements matched 90 per cent of the time (Canadian Agency for Drugs and Technologies in Health (CADTH), 2007). These studies only evaluated the early years of the CDR and cannot inform us of the current impact of the CDR for provincial listing decisions. A more recent study by Gamble *et al.* (2011) compared provincial listing-decisions and CDR recommendations for new medicines granted marketing approval for sale in Canada up to May 2009 and identified greater concordance than Attaran *et al.* (2011) despite the fact that both studies evaluated CDR recommendations issued over a similar period of time. Subsequent research has evaluated CDR recommendations but has not compared a more recent cohort of CDR recommendations with provincial listing decisions (Rocchi *et al.*, 2012; Iannazzo *et al.*, 2013; Nicod and Kanavos, 2012; Spinner *et al.*, 2013). Therefore, there is a need for further research comparing more recent CDR recommendations and provincial listing decisions to determine the impact of the non-mandatory CDR recommendations and to add more evidence to the existing body of research to help determine whether the CDR is increasing harmonisation of provincial listing decisions as recommended by McMahon *et al.* (2006).

INTERNATIONAL HTA NETWORKS

HTA has grown rapidly since the 1990's and the growing number of HTA organisations, professionals and researchers has led to the establishment of societies

and networks. Health Technology Assessment international (HTAi), a society for the promotion of Health Technology Assessment, has members from over 65 countries and activities including hosting annual conferences, regional meetings, policy forums for senior representatives from private and public organisations to engage in strategic discussions and special interest sub-groups for all HTAi members to share experiences (Health Technology Assessment International (HTAi), 2015). The International Society for Pharmacoeconomics and Outcomes Research (ISPOR) was founded in 1995 and currently has more than 9500 members from 114 countries and its activities include annual meetings in North America, an annual European meeting and regional meetings in Asia and Latin America (International society For Pharmacoeconomics and Outcomes Research (ISPOR), 2015). ISPOR also has an official journal (Value in Health) and has published a range of research online including the ISPOR Road Maps (International Society For Pharmacoeconomics and Outcomes Research (ISPOR), 2012). The International Network of Agencies for Health Technology Assessment (INAHTA) was founded in 1993 and currently has 55 member agencies from 32 countries (International Network of Agencies for Health Technology Assessment (INAHTA), 2015). INAHTA's mission is to provide a forum to identify and pursue member interests. Members meet each year adjunct to the HTAi annual meeting.

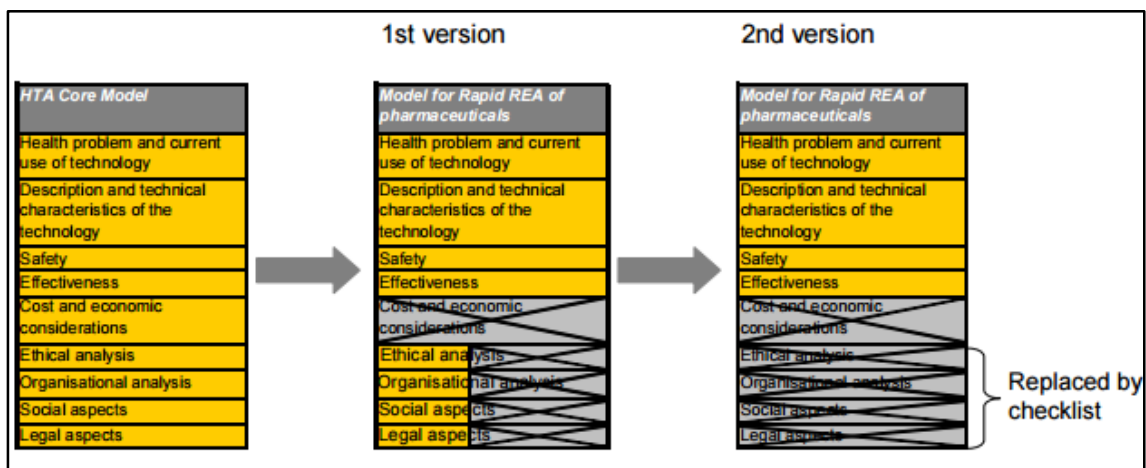
The European Network for Health Technology Assessment (EUnetHTA) was established in 2006 to create a sustainable European network for HTA and to develop and implement tools to transfer information between members. EUnetHTA was based on previous collaborative projects such as EUR-ASSESS, HTA-EUROPE and the OECD Health Project (Banta *et al.*, 1997; Jonsson, 2002; Organisation for Economic Co-operation and Development (OECD), 2005). EUnetHTA was initially granted three years funding from the European Commission, but continued to receive further funding and the European Commission has since supported the formation of a permanent European HTA network and the technical cooperation of the new network is expected to be conducted by EUnetHTA (Kristensen, 2012; European Network for Health Technology Assessment (EUnetHTA), 2014). EUnetHTA currently has over 80 participant member organisations from more than 30 countries. According to Kristensen (2012) the most innovative scientific and practical output of EUnetHTA has been the development of a HTA Core Model. The HTA Core Model contains 9 domains

and each provide a framework for analysis (National Institute for Health and Welfare, 2014):

- Description and technical characteristics of technology
- Health problem and current use of technology
- Safety
- Clinical Effectiveness
- Cost and economic evaluation
- Ethical aspects
- Organisational aspects
- Social aspects
- Legal aspects

The Core Model was designed to enable sharing of HTA information in a common format that can be transferred between members at the national and international level. However, Ascroft and Pichler (2014) question the practicalities of the quantity of information required for the Core Model as EUnetHTA members are unlikely to have the capacity to review all the medicines and technologies that were reviewed by the EMA. The EUnetHTA Core Model has also been modified for a rapid Relative Effectiveness Assessment (REA) process which only considers the effectiveness and safety data (European Network for Health Technology Assessment (EUnetHTA), 2013) (Figure 1.5). Ascroft and Pichler (2014) have proposed that the rapid REA could provide value by developing a REA report to supplement the current European Public Assessment Reports (EPARs).

Figure 1.5: Modification of the EUnetHTA Core Model, image reproduced from European Network for Health Technology Assessment (EUnetHTA), (2013)



HTA is also becoming more established in countries outside of Australasia, Europe and North America and regional networks have been created in Asia and the Americas that include members from countries with established HTA. The Pan-American Health Organisation (PAHO) recently established the HTA Network for the Americas (RedETSA) (Lemgruber, 2013). An agreement to create a regional network was determined at the regional 2010 HTAi meeting in Argentina. The network, chaired by PAHO currently has members from 25 institutions from 13 countries: Argentina, Bolivia, Brazil, Canada, Chile, Colombia, Costa Rica, Cuba, Ecuador, Mexico, Paraguay, Peru, and Uruguay. RedETSA activities include mapping HTA activities throughout the region and opportunities for capacity building.

HTA representatives from Thailand and South Korea met at the 2010 HTAi conference and identified the need for a regional collaboration network. In 2011 the first HTAsiaLink newsletter was produced and currently publishes three newsletters a year. A collaborative research project was also conducted for an Asian study on the value of the Quality Adjusted Life Year (QALY) (HTAsiaLink, 2015a). HTAsiaLink currently has 15 members including NICE International from the UK, HealthPact from Australia and the Australian Safety and Efficacy Register of New Interventional Procedures (HTAsiaLink, 2015b).

MULTI-STAKEHOLDER INITIATIVES

Regulatory authorities assess the quality, safety and efficacy of a new medicine to determine eligibility for marketing approval. Many countries now also require manufacturers to submit a dossier for a HTA reimbursement recommendation. The HTA will assess clinical effectiveness and usually will also consider the cost-effectiveness evidence to determine a new medicine's reimbursement status. Lumpkin *et al.* (2012) emphasised the need for regulatory authorities and reimbursement decision-makers to collaborate to reduce the duplication of work and generate data for both market access and reimbursement. Kendall *et al.* (2009) discussed the potential for including HTA with FDA to share information where they incorporate similar activities of HTA and regulatory to share data and reduce duplication. However, (Breckenridge *et al.*, 2010) notes that merging regulatory and HTA could cause a conflict of interests as most regulatory authorities are partially funded by industry fees.

Some HTA agencies and regulatory authorities have been collaborating at the national and international level to enhance dialogue and to help create a more collaborative regulatory and HTA environment. In 2010, the European Medicines Agency (EMA) and EUnetHTA collaborated on a project to improve the EMA's EPARs to be more supportive of the needs of HTA agencies (Berntgen *et al.*, 2014). In 2010, the EMA and HTA agencies from the Austria, France, Germany, Italy, the Netherlands, Spain, Sweden and the UK also launched a pilot for providing joint scientific advice for manufacturers during the development stages. About 25 procedures were assessed using the joint EMA-HTA scientific advice by November 2013, when a joint EMA-HTA workshop was held to draft best-practice guidance for EMA-HTA (European Medicines Agency (EMA), 2015b). In 2010, the EMA and HTA agencies from Austria, France, Germany, Italy, the Netherlands, Spain, Sweden and the UK launched a pilot for providing joint scientific advice for manufacturers during the development stages. The Shaping European Early Dialogues (SEED) consortium is a pilot for early dialogue between health technology developers and HTA agencies during the development phase. SEED is currently led by HAS (France) and includes 14 participant HTA members (Shaping European Early Dialogues for Health Technologies, 2015).

Joint regulatory and HTA scientific advice has also been piloted at the national level with varying success. In 2009, the Australian regulatory authority (Therapeutic Goods Administration (TGA)) and the PBAC conducted a pilot for offering joint scientific advice for manufacturers to identify the value and practicalities of the project (Wonder *et al.*, 2013). Wonder *et al.* (2013) noted that the pilots provided an opportunity to discuss opposing views and work more closely but Fronsdal *et al.* (2012) also noted challenges with resource implications and limited manufacturer feedback. NICE has been offering a scientific advice programme since 2009 and first piloted parallel scientific advice with the MHRA in 2010 to determine interest in parallel scientific advice (National Institute for Health and Care Excellence (NICE), 2014; Methven, 2010). MHRA and NICE have also recently announced a new collaboration. The Early Access to Medicines Scheme was launched in 2014 and provides manufacturers with the opportunity to participate in a voluntary scheme to collaborate with the MHRA and NICE to provide patients with life threatening or highly debilitating illnesses early access to medicines prior to marketing approval (Medicines and Healthcare Products Regulatory Agency (MHRA), 2014).

FRAMEWORKS AND BEST PRACTICES FOR HTA

Studies have been conducted to develop general frameworks for HTA such as the EUnetHTA HTA Core Model that contains nine domains which each provide a framework for the development of information for sharing between members. Frameworks have also been developed to describe reimbursement processes (Hutton *et al.*, 2006; Schwarzer and Siebert, 2009; Rogowski *et al.*, 2008). The descriptive framework developed by Hutton *et al.* (2006) used information from the public domain (mainly official organisation websites) and included Canada and 13 European countries. Hutton noted that a “*complete set of information on the systems in Europe, Canada and Australia would be a valuable resource for researchers and policy makers*”. Schwarzer and Siebert (2009) produced a descriptive framework for comparison but it was only applied to five organisations in four European countries. The descriptive framework developed by Rogowski *et al.* (2008) is for both new medicines and procedures, but they also noted that the process is more formalised for new medicines. Producing a general framework for the reimbursement of procedures and medical devices will be more challenging as there is no formal national procedure for many countries and manufacturers often communicate directly with hospitals or regional buyers.

Drummond *et al.* (2008) developed 15 key principles for the improved conduct of HTA for resource allocation decisions. The key principles cover a broad range of HTA activities and are organised into four categories: structure; methods; processes for conduct and use in decision-making. Drummond *et al.* (2008) emphasises the importance for unbiased and transparent HTA and argued that ‘*the HTA process is best conducted independently of the body that ultimately will be responsible for adopting, paying and implementing the HTA decisions.*’ The key principles were very well received and a study comparing the implementation of the key principles in 14 organisations from nine countries was subsequently published in 2010 (Neumann *et al.*, 2010). Neumann *et al.* (2010) identified great variation between the agencies and their uptake of the key principles and concluded that the HTA organisations have work to be done to meet the best practices for HTA outlined in the key principles and suggested using these for benchmarking, but a later publication that used these as a

benchmark received criticisms due to the ranking implications which may not provide fair comparisons when mandates vary greatly between HTA organisations (Drummond *et al.*, 2012; Henshall, 2012). In order to benchmark an agency or organisation to compare performance or learn from similar agencies or organisations, suitable comparators must first be identified. A classification tool could enable identification of agencies with similar processes and facilitate benchmarking. Plus, if classifications are recorded over a period of time, the evolution of HTA agencies can also be evaluated.

IMPACT ON STAKEHOLDERS

The benefits of HTA have been acknowledged by many policy and decision-makers and this is reflected in the increasing international growth of HTA research and established organisations. However, HTA has faced criticisms from patients and manufacturers. Patients need to understand why they are denied access to a new product and patient advocacy groups want to contribute towards the reimbursement decision-making process (Wyke, 2011; Canadian Diabetes Association, 2007). Baker (2011) also notes that patient groups may need guidance for preparing evidence and HTA should consider providing resources to enable patient input.

The increasing growth of HTA can also provide an increasingly challenging environment for manufacturers that are required to produce submissions for a range of payers each with their own submission requirements and value judgements.

POTENTIAL STUDIES FOR MOVING FORWARD

A range of comparative studies have already been conducted for comparing HTA processes and recommendations for countries with established HTA agencies. However, HTA is a rapidly growing field and agencies are constantly evolving to meet healthcare system needs and in response to political changes. An up-to-date systematic comparison of a large group including countries with established HTA agencies and younger HTA organisations would expand the existing body of knowledge, but a broad range of approaches for HTA could also be used to identify key similarities and differences to generate a classification tool. The European Economic Area (EEA) consists of a diverse range of reimbursement systems including

countries with established HTA agencies to countries that do not conduct any HTA. Such a classification tool could be applied to regions beyond Europe, where HTA is already established but also for countries or regions that have recently introduced HTA, such as Asia and Latin America which have recently established regional HTA networks (HTAsiaLink and RedETSA). Development of such a classification tool with a large selection of countries also increases the potential number of HTA agencies that could be included to compare the classification tool with HTA recommendations. Several studies have been conducted comparing HTA recommendations issued by European HTA agencies and have identified many potential factors as causes for discordant recommendations that range from clinical evidence to pharmacoeconomic analysis. Comparing the classification tool with HTA recommendations will expand on existing research by evaluating a more recent cohort of HTA recommendations and calculating agreement between country pairs but may also identify correlations between country classification groups and reimbursement recommendations.

Comparative studies for HTA recommendations issued by the national Canadian HTA agency (CDR) have produced conflicting conclusions regarding the impact of the non-mandatory CDR recommendations for provincial listing decisions. Therefore, further research evaluating the impact of the CDR by calculating concordance of a more recent cohort of new medicines would build on the existing body of evidence, but combining HTA recommendations with opinions from representatives and decision-makers across Canada would add more weight to the conclusions. A novel method for HTA comparisons would also include the cohort of medicines collected for the study to compare HTA recommendations and regional listing decisions within Canada to compare with HTA recommendations from similar international HTA agencies. This would provide three valuable outcomes:

- Assess the impact of the CDR by calculating the level of agreement between national HTA recommendations and regional listing decisions compared with the level of agreement between the CDR and international HTA agencies that conduct their own full HTA. This also would provide evidence to support or oppose reports criticising the CDR for being more restrictive than other OECD countries.

- Investigate case studies to identify factors for discordant recommendations to add to the existing body of knowledge for factors that impact HTA recommendations.
- Calculate the level of agreement for HTA recommendations between countries with existing similarities for which previously published studies have calculated the level of agreement, thus providing an opportunity for long-term comparisons to identify whether these countries are naturally becoming more harmonised as HTA evolves.

Each national and regional reimbursement system should be profiled prior to conducting comparative studies for developing a classification tool for evaluating HTA recommendations. A novel HTA process mapping methodology should be used to produce these profiles and the resulting process maps may also provide value for persons with an interest in reimbursement pathways. Opinions from a selection of stakeholders could also identify the potential value of the HTA process maps.

AIM AND OBJECTIVES OF STUDY

Aim

The aim of this research is to review Health Technology Assessment agencies and their relationship to regulatory authorities and other decision-makers and to identify common appraisal practices with respect to economic and therapeutic evaluation.

Objectives

For this research the objectives are to:

- Develop a classification tool to categorise systems and practices of Health Technology Assessment agencies in Europe.
- Evaluate and compare HTA processes and reimbursement recommendations for nine European jurisdictions using the classification tool.
- Identify similarities and differences with respect to national HTA recommendations in Canada, Australia, England and Scotland.
- Evaluate the impact of the common drug review listing recommendations for provincial payers (Alberta, British Columbia and Ontario) and Quebec.
- Assess the value of the HTA process maps for the pharmaceutical industry and Health Technology Assessment agency stakeholders.
- Discuss the feasibility of a pan-European Health Technology Assessment agency.

CHAPTER 2

Study Rationale and Methodological Framework

STUDY RATIONALE

Health technology assessment (HTA) is a relatively young field but also one that has been readily adopted to help guide reimbursement recommendations for new medicines at both the national and regional levels. HTA agencies and practices vary between countries and within regions due to differences in healthcare systems, budgets, politics and social expectations, which can result in discordant reimbursement recommendations for the same medicine. The European commission provides funding for the European Network of Health Technology Assessment (EUnetHTA) to harmonise scientific criteria to reduce patient access inequalities, reduce duplication of workload and shared learning. A comprehensive literature review identified the need for a non-ranking method of comparison for HTA agencies and reimbursement systems, greater understanding of the factors influencing reimbursement recommendations and the impact of non-mandatory HTA recommendations. Therefore, this research aims to assess the international HTA environment in Canada, Australia and Europe to develop a classification tool, review rationale for discordant recommendations and compare the non-mandatory recommendations of the Canadian common drug review with provincial listing decisions.

METHODOLOGICAL FRAMEWORK

Study Design

An appropriate study design must first be selected to facilitate data collection and analysis that will enable the research question to be answered. The purpose of research can be classified as exploratory, descriptive or explanatory (Yin, 2003). Exploratory studies generate new insights, are suitable when the problem or key variables are difficult to determine and often lead to further research (Zikmund *et al.*, 2009). Descriptive studies seek to provide an accurate profile and can follow exploratory studies or lead to explanatory or exploratory studies, but explanatory research investigates the cause and effect relationship and is suitable when variables and relationships are already defined (Saunders *et al.*, 2009).

Methodological approaches to research can broadly be classed as qualitative or quantitative. However, as Dabbs (1982) observed, “*Qualitative and quantitative are*

not distinct.” (as cited in Berg, 2009). Creswell (2003) argues that “*Mixed methods research has come of age*” and thus describes three categories for approaches to research: quantitative, qualitative and mixed methods.

- Quantitative approaches: these generate objective and quantifiable data using surveys or experimental methods. The data is usually statistically analysed to test hypotheses.
- Qualitative approaches: qualitative research seeks to generate hypotheses and methods include interviews and observations to generate text-based data, collect opinions or describe the complexity or range of events (Curry *et al.*, 2009).
- Mixed methods approaches: these combine quantitative and qualitative research approaches that can be conducted sequentially or in parallel. Combining quantitative and qualitative approaches can utilise the benefits of both methods, generate a more complete data set, confirm results and provide deeper insights (Curry *et al.*, 2009; Creswell, 2003).

The main purpose of this research will be exploratory and will also include supportive descriptive studies. To achieve the aims of this research a range of studies will be conducted utilising mostly qualitative and mixed methods approaches. Therefore, hypothesis testing will be discussed in individual chapters where appropriate.

Data Sources

Information will be sourced from official agency websites, peer-reviewed journals, HTA agency representatives and pharmaceutical industry representatives.

Literature search strategy

Published literature will be systematically searched to provide an overview of the development and current HTA environment in Europe, North America and Australia. Scopus and PubMed will be the primary repositories searched for peer-reviewed publications that should ideally have been published within the last five years to ensure information is up-to-date. However, older publications will also be included where these are expected to provide value to the study. The following key words and terms will be included in the search strings for the literature search:

- Health Technology Assessment
- HTA
- HTA recommendations
- HTA networks
- Reimbursement recommendations
- Reimbursement pharmaceuticals
- Coverage decisions
- Payers
- Fourth Hurdle
- Affordability

Official agency websites and public databases

Public databases will be used to construct databases of reimbursement recommendations for new medicines. The European Medicines Agency (EMA) online database for human medicines will be the initial source for identifying new medicines for sale in Europe and the list of medicines recorded from the EMA will be used to identify medicine reimbursement recommendations from various official European HTA websites. The Canadian Agency for Drugs and Technologies in Health (CADTH) and Common Drug Review (CDR) online database will be searched to identify new medicines granted a reimbursement recommendation from the CDR and this will generate a list of medicines that will be used to identify reimbursement recommendations and rationale from regional Canadian payers and from Australia and the UK. The inclusion criteria, exclusion criteria and date to be recorded are specific to each study and will be discussed in the appropriate chapters.

Advantages

- By collecting data from official agency websites public databases the data will be obtained directly from the primary source and is expected to be the most recently published data available for each agency
- The information sources are published online which enables instant access to the most recently published data
- Data is already published in the public domain and therefore will not require any confidentiality considerations

- The information available should be standardised for each medicine within each agency website or database.

Disadvantages

- The official agency websites or databases may not all be regularly updated.
- The information available may not be standardised between the different agency websites and public databases and is restricted to the data published.
- The published information may not be a true representation of practices.
- Confidentiality agreements may require information to be omitted prior to publication.

HTA agency, pharmaceutical industry and payer representatives

Representatives from HTA agencies, the pharmaceutical industry and payer agencies will be contacted to provide opinions, insights and validate information obtained from the public domain. For example, process maps are developed using information primarily sourced from the public domain (official agency websites and peer reviewed publications) and agency or pharmaceutical representatives that have working experience or expert knowledge of the agencies included in the process map will be asked to review and provide feedback.

Advantages

- Information available in the public domain may not be the most up-to-date and different sources can provide conflicting information. Therefore, it is very valuable to have direct feedback.
- Provides opportunity to obtain information not available in the public domain.

Disadvantages

- Opinions are subjective by nature.
- The representative may not have knowledge or experience in all the areas investigated.

Data Collection Techniques

Several studies will be conducted in order to answer the research questions and these will require various data collection techniques. This will include the primary researcher collecting information from the public domain to be recorded in a database using Microsoft Excel and subsequently validated and analysed. Data will also be collected directly from HTA agencies and pharmaceutical industry representatives using a questionnaire technique. There are generally two approaches for administering a questionnaire: a self-administered questionnaire to be completed by the study participants or the questionnaire is administered by an interviewer (a semi-structured interview).

Questionnaires

The questionnaire provides a structured method for collecting primary data using carefully designed questions. A self-administered questionnaire with no interviewer present is the most common and reliable form but its advantages and disadvantages must be considered to determine whether it is appropriate for the study (Allsop, 2006; Evans, 1995; Dillman, 2013; Trochim, 2006b):

Advantages

- Inexpensive as a questionnaire can be distributed electronically by email/website to a large sample or can be posted for a small cost if a paper version is required. There are also no travel or time costs as an interviewer does not need to be present
- Less time consuming as a self-administered questionnaire does not require an interviewer to be present for completing it and therefore information can be collected from a large sample in a shorter period of time
- Convenient as respondent can complete at any chosen time, stop and start
- Greater consistency as all recipients respond to exactly the same set of questions
- It can be anonymised if required
- Versatile as questionnaires can be sent to the study sample electronically or by post

Disadvantages

- No opportunity for respondents to ask interviewer to clarify questions or terminology for e-mail or postal versions. If required this can be remedied by employing an interviewer delivered self-administered questionnaire where an interviewer delivers the questionnaire with short verbal instruction to the study participants and is present during the completion of the questionnaire to answer any queries from the study participants
- Response rates can be low and recipients may not be willing to e-mail or post their completed questionnaire
- Open ended or long free text questions are not usually practical
- Closed questions could be too restrictive and not provide an option that accurately reflects the respondents' answer
- Difficult to judge the quality of the response or to be certain who has completed the questionnaire
- Require follow-ups to improve the response rate

Questionnaire data collection methods

There is range of options for collecting data using both the self-administered and interviewer-administered questionnaire approaches. The most appropriate method is the one that would facilitate collection of the desired data, which is relevant to the study population and achieved with the available resources (Evans, 1995).

Paper-based questionnaire delivered by Post - the simplest form of questionnaire technique is paper-based as it only requires the respondent to have access to a pen or pencil to complete. There are no software or internet access barriers to completion but the respondent is required to return the completed questionnaire by post. This would require additional time for postal delivery. There is also usually only one copy which could get lost or damaged in transit.

Electronic questionnaire delivered by email - data only needs to be entered once for electronic questionnaires and can be saved in multiple locations to reduce risk of losing data. The electronic questionnaire can also be easily duplicated in cases where a respondent needing to send a section of the questionnaire to another colleague or

department for completion. This method requires access to the internet for retrieving and completing the questionnaire. There is, however, a risk that emails may get lost in spam folders. There may also be software limitations depending on the format of the questionnaire.

Web-based electronic questionnaire - as with the electronic questionnaires sent by email, data only needs to be entered once for a web based questionnaires and will require internet access. Depending on the software used to create the questionnaire, it can potentially be accessed from any computer and optimised for completion by smart phone or tablet. A web-based questionnaire can also enable access by more than one person if the questions cannot all be answered by a single respondent. The completed questionnaire can be saved to a location chosen during the design stage of the web-based questionnaire which enables instant response.

Interviewer administered questionnaire by telephone or conference call - administering the questionnaire remotely reduces expenses and saves time by removing need for interviewer to travel to meet respondents but time-zones may need to be considered. Telephone interviews can be conducted spontaneously or arranged in advance. However, conference or video calls will require a pre-arranged time slot and access to the appropriate software and internet. The interviewer records the respondents answers in real-time therefore, there is a spontaneous response but the respondent also has a limited time to prepare their answer. The interviewer may record their conversation with the respondents, but would require their consent and additional time and resources to transcribe and analyse the recorded interviews.

Interviewer questionnaire administered in person - interviews conducted face-to-face are the most personable option and this can enhance the interviewers rapport with the respondent, help the respondent feel more at ease and provides opportunity for the interviewer to consider the respondents facial expressions and body language. Interviewer time and travel costs can be lengthy and expensive depending on the location of the respondents in relation to the interviewer. Similar to the questionnaires administered by an interviewer remotely, the respondents will have a limited time to formulate their response to questions but answers would be of spontaneous nature. If

the respondent gives permission for the interview to be recorded, additional time and resources will be needed to transcribe and analyse the audio data.

Interviewer questionnaire administered to groups - an interviewer may administer a questionnaire to an individual or to a group. Group interviews can be conducted remotely using conference and video calls and may also be conducted face-to-face. In addition to the previously discussed strengths and limitations associated with interviewer administered questionnaires, a group interview can save time as a single interviewer can collect responses from more than one respondent. Time and expenses associated with travel may also be reduced, but additional planning is likely to be required to organise an appropriate time that satisfies all the respondents and interviewer needs.

Semi-structured interviews

Semi-structured interviews are similar to self-administered questionnaires as they both utilise predefined list of structured questions. However, semi-structured interviews are administered by an interviewer and the respondents provide their answers verbally for the interviewer to record. The interview format is more flexible and can be conducted face-to-face, by telephone, video conferencing etc. However, the interviewer is also considered to be part of the method instrument (Trochim, 2006b). The interview technique provides additional advantages to that of the questionnaires which must be carefully considered (Evans, 1995; Trochim, 2006b; Weinberg, 2013):

Advantages

- Interviewer has opportunity to ask probing or follow-up questions.
- Respondent can ask the interviewer clarifying questions.
- Often easier for the respondent as they can talk freely and particularly beneficial for questionnaires that require opinions or more open ended questions.
- The more personal nature of the interview makes it easier to judge the quality of the response.
- Higher response rate.

Disadvantages

- Travel and time costs for the interviewer may need to be considered.
- More resource intensive and time consuming to conduct and analyse.
- Greater variance as the interviewer becomes part of the method instrument and the interviewer's style for delivery of questions and interactions with the respondent will vary to a certain degree, which can cause difficulties for comparison (e.g. Variability between different interviewers).
- Risk of the interviewer asking leading questions resulting in biased answers.

Both self-administered questionnaires and semi-structured interview techniques will be used to collect data. The self-administered electronic questionnaire delivered by email is more appropriate for collecting HTA agency and pharmaceutical industry representative's opinions regarding the value of the process map methodology as the target respondents are located in various European and American cities. A combination of self-administered electronic questionnaires and semi-structured interviews will be conducted for the study of regional Canadian payers. The self-administered questionnaires are more appropriate for collecting factual data which is likely to require the respondent to conduct some research. The chosen payer representatives are based in four Canadian provinces which would be resource intensive requiring additional time and travel expenses for the interviewer. However, face-to-face semi-structured interviews enable the interviewer to ask more open ended questions and provide opportunities for the Canadian payers to ask clarifying questions for the questions in both the interview and self-administered questionnaire.

Questionnaire Development

The self-administered questionnaires for the Canadian payers study and the study evaluating the value of the process maps will be designed with consultations with experts and piloted prior to the full studies. Evans (1995) advises piloting questionnaires with a small sample to identify issues such as misleading instructions, vague or leading questions, limited or incomplete response options and choice of terminology. The questionnaire for the Canadian payers study will be created in consultation with representatives from CADTH and Alberta services. The questionnaire will initially be piloted with a regional payer prior to full distribution. The

questionnaire for evaluating the value of the process maps will be created in consultation with experts to design the questionnaire structure and content prior to piloting the survey with representatives from both the HTA agencies and pharmaceutical industry.

Questionnaire validation

It is important to determine the validity of a questionnaire. Use of a valid questionnaire will improve the quality and comparability of the data and confidence in the conclusions (Kazi and Khalid, 2012). According to Jary and Jary (1995) validity is “*the extent to which a measure, indicator or method of data collection possesses the quality of being sound or true as far as can be judged*” (as cited in Pierce, 2008), in other words ‘measuring what it purports to measure’. There are multiple types of validity to be measured in questionnaire development (Block, 2006; Phelan and Wren, 2006; Trochim, 2006a).

Face validity

For a questionnaire to have face validity, the meaning of the questions should be clear and obvious (Block, 2006). This is a simple measure and can be easily determined by stakeholders (Phelan and Wren, 2006).

Content validity

Content validity assesses whether the questions in the questionnaire, in terms of their emphasis and focus, are relevant and suitable for their intended purpose/population (Block, 2006). This can be measured by checking the content of the questionnaire against a defined list of criteria that should be met (Trochim, 2006a). A panel of experts and a panel selected from the intended population can be brought together to determine the content validity by assessing emphasis and focus of each question against the objectives (Phelan and Wren, 2006).

Criterion validity

Criterion validity checks the performance of the questionnaire by determining whether it will generate results that will correlate with existing criterion if available (i.e. gold standard) (Block, 2006; Phelan and Wren, 2006).

Construct validity

The construct validity determines the questionnaires ability to assess its intended purpose or support hypotheses (Block, 2006). It should exhibit strong correlation with closely related measures (i.e. convergent construct validity) and exhibit poor correlation with distantly related measures (i.e. divergent construct validity).

These concepts for questionnaire development will be examined in relation to the questionnaire that will be developed for Chapter 7 to assess the impact of HTA process maps for pharmaceutical industry and HTA agency stakeholders.

Data validation

Various methods will also be employed to validate the data collected from the range of studies to be conducted:

- Data will be retrieved from primary sources and reputable published material.
- Draft process maps and the information sources used to produce the process maps will be audited by a second researcher to clarify that the map is an appropriate representation of the available sources. The two researchers will discuss any discrepancies and if a consensus cannot be reached a third researcher or expert in the field will be consulted.
- The final process maps will be sent to HTA representatives or experts for review. This will be particularly useful when sources are conflicting or do not accurately reflect current practices.
- Data collected from the public domain will be sourced and recorded by the primary researcher. A second researcher will then audit the completed database against the public domain sources for accuracy or the primary researcher will conduct the audit after a reasonable period of time has passed from completion of the initial database. The audit technique will include checking data points at defined intervals and if errors are found the audit will include every data point.
- The face-to-face interviews provide opportunity to the respondents in the Canadian payers study to ask clarifying questions for the self-administered questionnaire.

Data Processing and Analysis

The information to be collected will include a combination of quantitative and qualitative data. The quantitative data will be analysed using Microsoft Excel, SPSS and EpiTools (Sergeant, 2015) to conduct descriptive statistics and test hypotheses. The qualitative data will include responses from the questionnaire, semi-structured interview recordings and descriptive data to produce HTA process maps.

HTA recommendation categories

To facilitate analysis, the HTA recommendation categories must be compared across the agencies to find comparable categories. Both binomial and multinomial classification methods have been published and offer different strengths and weaknesses. The binomial classification is the simplest option as medicines are either positively recommended or receive a negative recommendation (not recommended). This classification approach is more appropriate when the available information is unclear or not available for restrictions. In addition, the two category classification approach is also more appropriate for conducting descriptive statistics that require two categories. However, as stated by Fischer (2012), omitting the restrictions may oversimplify the effects of the recommendations. Multinomial classifications of varying complexity have also been published (Clement *et al.*, 2009; Gamble *et al.*, 2011; Nicod and Kanavos, 2012). These commonly include three recommendation categories (recommended, recommended with restrictions and not recommended). More detailed classifications include categories for different types of restrictions but these usually focus on a single HTA agency rather than comparing across agencies (Raftery, 2006; Mason and Drummond, 2009; O'Neill and Devlin, 2010).

Three different databases of HTA recommendations will be conducted for this research. The first will collect HTA recommendations from 9 European HTA agencies for new medicines approved in Europe, the second will collect HTA recommendations for national HTA recommendations for new medicines in Australia, Canada and the UK and the third will collect national and regional HTA recommendations for new medicines in Canada. HTA recommendations will be collected directly from the primary source. However, the level of transparency varies between agencies and a language translation tool will be required for information that is not available in English. The reimbursement recommendation will be recorded as categorised by the HTA

agency that issued the decision. The types of HTA recommendations recorded in each database will be compared across the included agencies (or payers) to determine comparable groups. Both multinomial and binomial classifications will be used in these studies where appropriate.

Percentage agreement

Using Microsoft Excel, HTA recommendations classified in binomial or multinomial categories can be numerically coded to calculate the quantity of concordant recommendations for each medicine between jurisdictional pairs. Not all HTA agencies will have reviewed the same medicines. Thus, reporting the total number of concordant recommendations alone could be misleading and, therefore the percentage agreement will be calculated between jurisdiction pairs to report the proportion of concordant recommendations.

Inter-rater reliability

Statistical methods are available for calculating the degree of reliability between raters. Cohen's Kappa is a method for calculating reliability (degree of error) between two raters that can be considered to be more reliable than percentage agreement alone as it considers the proportion of agreements expected due to chance (Feinstein and Cicchetti, 1990). Fleiss's kappa is similar to Cohen's kappa but enables comparison of more than two raters. However, according to Hallgren (2012) Fleiss's Kappa is not suitable for studies where data is fully-crossed (rated by the same raters/coders).

Cohen's kappa will be used to calculate inter-rater reliability for HTA recommendations but according to Gwet (2014) *"If categories can be ordered (or ranked) from the "Low" to the "High" ends, then the Kappa coefficient could dramatically understate the extent of agreement among raters."* Therefore, the kappa coefficient can be calculated for HTA recommendations using the binomial classification (nominal groupings) but a weighted kappa is required for the multinomial classification (ordinal groupings). Cohen (1968) emphasises the importance of these weightings and recommends consulting a committee of *"substantive experts"* to reach a consensus.

Limitations of the kappa coefficient include two paradoxes that must be considered when interpreting the results (Feinstein and Cicchetti, 1990; Cicchetti and Feinstein,

1990; Viera and Garrett, 2005). These paradoxes occur as kappa is affected by the prevalence of results and the distribution of marginal proportions. The effect of prevalence can result in a low kappa value for rare findings (Viera and Garrett, 2005). (Feinstein and Cicchetti, 1990) also state that the kappa paradox can result in a low kappa value for two observers that appear to have a high level of agreement. Various methods have been published to account for these paradoxes and support the interpretation of results and these include reporting the proportion of both positive and negative agreements and calculating confidence intervals (Feinstein and Cicchetti, 1990; Cicchetti and Feinstein, 1990; Sim and Wright, 2005; Viera and Garrett, 2005).

Confidence intervals

Understanding uncertainty is important for inferential statistics and, therefore calculating confidence interval (CI) can quantify the level of uncertainty. The CI can be defined as *“a range of values for a variable of interest constructed so that this range has a specified probability of including the true value of the variable.”* (Gillam *et al.*, 2012). A 95% confidence interval is commonly stated and will be used for this study (Porta, 2014).

Methods for calculating a confidence interval for binomial proportions include the standard Wald, adjusted Wald, Wilson Score, Clopper-Pearson and Jeffrey's (Brown *et al.*, 2001). The standard Wald method is commonly used but also has important limitations to consider. If the proportion has a value close to 0 or 1 the standard Wald may produce an interval with a percentages that are negative or larger than 100% and is also not suitable for small n values and (Brown *et al.*, 2001) recommends either the Wilson score and equal-tailed Jeffrey's for dataset with an $n < 40$. This study has chosen to use the Wilson score method because it is suitable for small n values and will not produce confidence intervals with negative or larger than 100% value.

Semi-structured interviews

The semi-structured interviews will be conducted with a predefined checklist of questions to be used during all interviews for consistency. The interviewer will request permission to record the interview and the resulting audio files will be transcribed to facilitate identification of themes.

STUDY PLAN

A systematic literature review for the production of HTA process maps will provide an overview of the current regulatory to reimbursement systems included in this research and form the basis of the studies to be conducted (Figure 2.1). The uniform methodology of the HTA process maps facilitate comparison for the development of a classification tool and to help understand the process for determining the reimbursement recommendations to be collected and compared. Finally, a study will be conducted to identify how the HTA process maps can provide value to stakeholders.

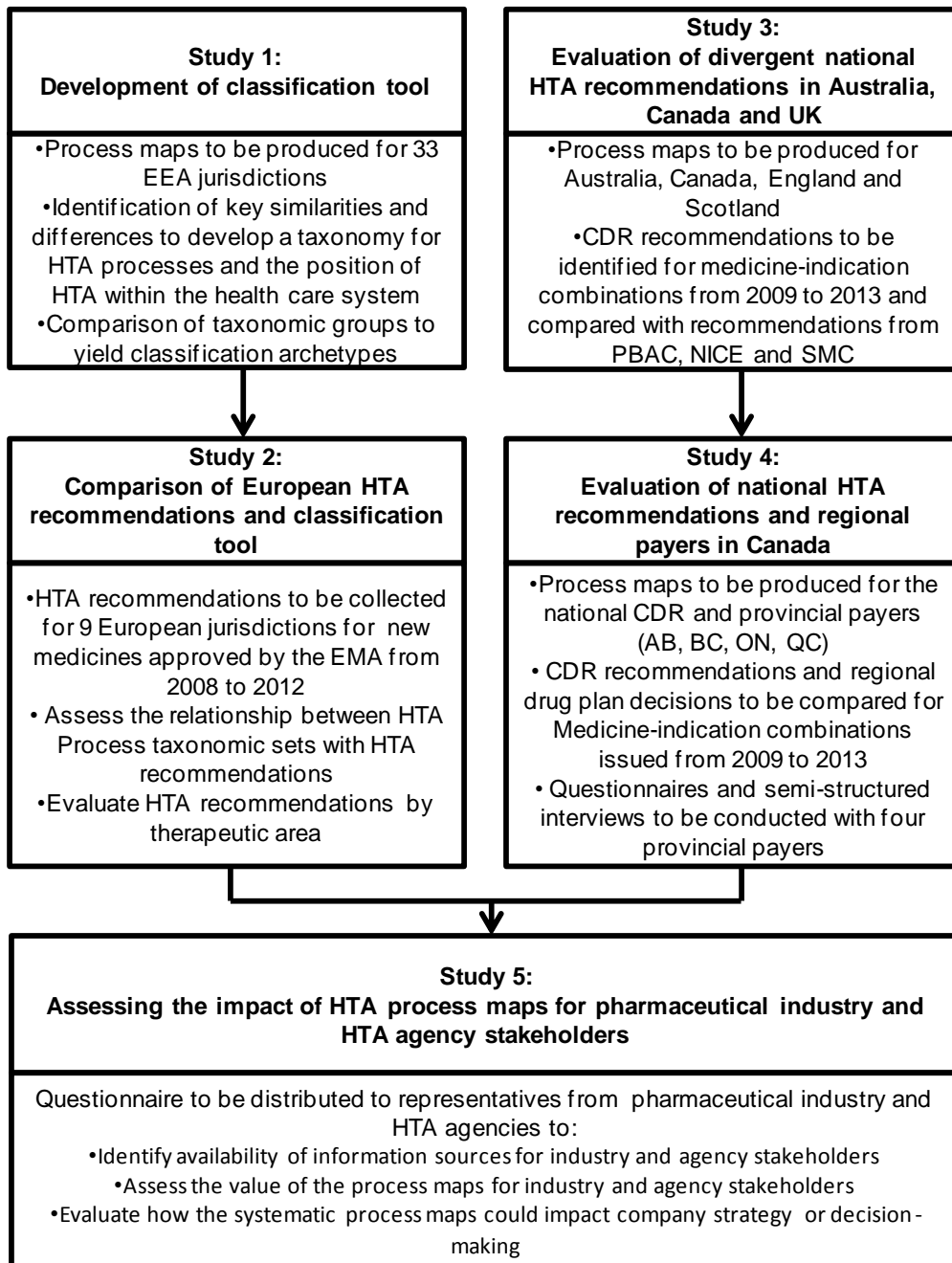
Study 1 (Chapter 3): Development of a classification tool

The initial research to be conducted for this study will be the production of HTA process maps using a novel mapping methodology (see chapter 3) to provide an overview of 33 European national reimbursement systems. Therefore, the research for the HTA process maps will have a descriptive purpose but this will then lead to exploratory research through the identification of key variables between the HTA processes and reimbursement systems. The uniform aspect of the mapping methodology provides comparable profiles that will be used to develop a classification tool.

Study 2 (Chapter 4): Comparison of European HTA recommendations and classification tool

The second study will compare HTA recommendations from nine European national agencies for comparison with the classification tool to identify potential relationships between the classification categories and reimbursement recommendations. This study will include the collection of HTA recommendations that will be coded to enable basic descriptive analysis for hypotheses testing.

Figure 2.1: The Study flowchart



Key: AB- Alberta; BC- British Columbia; CDR: Common Drug Review; EEA- European Economic Area; EMA- European Medicines agency; HTA; Health Technology Assessment; ON- Ontario; QC- Quebec; PBAC- Pharmaceutical Benefits Assessment Committee; NICE- National Institute for Health and Care Excellence; SMC- Scottish Medicines Consortium

Study 3 (Chapter 5): Evaluation of divergent national HTA recommendations in Australia, Canada and UK

Study 3 will begin with descriptive research through the production of HTA process maps for the national regulatory to reimbursement systems for new medicines in Australia, Canada, England and Scotland. The study will then include exploratory

research through the collection of HTA recommendations from the national HTA agencies for each jurisdiction for comparison with descriptive statistics. The distribution of positive and negative recommendations will be compared across jurisdictions to identify case studies to compare rationale for medicines reimbursement recommendations.

Study 4 (Chapter 6): Evaluation of national HTA recommendations and regional payers in Canada

Study 4 will expand on the research conducted for study 3 by using the same initial cohort of new medicines but these will be used to compare CDR recommendations against local payer decisions rather than comparing CDR recommendations internationally (study 3). This study will be exploratory using a mixed methods approach through the construction of a database of reimbursement recommendations and the utilisation of a questionnaire followed by semi-structured interviews.

Study 5 (Chapter 7): Assessing the impact of process maps for pharmaceutical industry and HTA agency stakeholders

The electronic questionnaire approach will be used to source feedback and comments for the HTA process mapping methodology from HTA agency and pharmaceutical industry stakeholders. This study will also be exploratory as it seeks to identify how the HTA process maps can provide value for stakeholders and could formulate suggestions for future improvements and developments of the methodology.

SUMMARY

- This chapter provides the rationale for the studies to be conducted on the Australian, Canadian and European HTA environment.
- The advantages and disadvantages for the different methods for administering and delivering a questionnaire have been described and methods for analysing the information obtained has been discussed.
- The chosen approaches for data validation, data processing and data analysis have been described

- A study plan has been developed to describe the various studies to be conducted for this research and demonstrate how the studies are connected and ordered.

CHAPTER 3

Development of archetypes to facilitate comparative analysis of reimbursement and decision-making processes

INTRODUCTION

Healthcare expenditure in Europe, as with much of the world, is rising faster than national gross domestic product (GDP) (Beyer *et al.*, 2007). Healthcare resources face an increasing demand from consumers resulting in a greater gap between public expectations and affordability (Pammolli *et al.*, 2012). With limited options for additional healthcare funding, policy/coverage decision-makers are turning to Health Technology Assessment (HTA) in order to ensure healthcare resources are used efficiently. In general, HTA for coverage decision-making evaluates the added therapeutic benefits, the risks and the uncertainties of applying the new technology to the coverage population in the context of the local standard of care. In addition, HTA may also include economic assessment of the new technology. A typical output from HTA is a recommendation as to the use and/or relative value of the technology to the decision-maker and payer (Henshall *et al.*, 2011; Drummond *et al.*, 2008; Facey, 2006).

One particularly impactful aspect of decision-making with regard to healthcare resource allocation occurs when HTA recommendations result in highly publicised negative decisions for non-coverage of new pharmaceuticals (Littlejohns *et al.*, 2009). Pharmaceuticals only form about a fifth of most total healthcare budgets (Organisation for Economic Co-operation and Development (OECD), 2011). However, they can have an immediate budget impact and are a component of healthcare expenditure that, from a political perspective, are measurable and relatively easy to regulate in comparison to, for example, salaries of healthcare professionals, costs incurred from clinical errors or finding a consensus for general expenditure cuts in healthcare services (British Medical Association (BMA), 2010; Reynard *et al.*, 2009; Myllykangas *et al.*, 1997). The impact of HTA on new pharmaceutical coverage decision-making in Europe has caused concern amongst patient groups over access to medicines and rationing by the pharmaceutical industry in relation to curbing innovation and the impact on pricing of new pharmaceuticals (Baker, 2011; Wyke, 2011; Pammolli *et al.*, 2011). A key concern shared by these and other healthcare stakeholders is the degree of variation by which HTA is conducted and applied across Europe (European Network for Health Technology Assessment (EUnetHTA), 2007).

The variation in philosophies and techniques across national and regional HTA bodies in Europe is a product of political, social and financial differences. European healthcare systems can be classified according to many different typologies of varying indicators (Eikemo and Bambra, 2008; Arts and Gelissen, 2002). However, they are generally based upon 3 different ideologies of social welfare (Arts and Gelissen, 2002):

- **Liberal/ Beveridge**

A model that provides modest benefits according to strict eligibility criteria and means testing

- **Conservative/ Bismark**

Regime of social insurance coverage that provides benefits proportional to earnings

- **Social Democratic/ Scandinavian**

A model of high universalism for the distribution of benefits

Within the context of these different healthcare ideologies, HTA has developed as standalone agencies or as units within existing healthcare agencies and their remit and context varies considerably by country or region. The different systems have spawned different approaches to HTA, resulting in a diversity of organisational architectures and processes for HTA assessment (Hutton *et al.*, 2006). Key aspects of the variation between European HTA systems are (i) the extent of information that is applied to the assessment of the new technology, especially the use of economic information (ii) the level of independence between the processes for assessment, appraisal and decision-making and (iii) the variation in methodologies used in the evaluations (Sculpher and Drummond, 2006).

Although some factors are unique to each nation and therefore cannot be aligned, such as the political milieu and a country's ability to fund national healthcare schemes, the fundamental scientific criteria used for the HTA evaluation should have their basis in consistently applied, scientifically rigorous methodologies that encourage transparency of quality decision-making. The European Commission has recognised the need for a more efficient European HTA environment to help overcome inequalities in patient access to therapies (European Network for Health Technology Assessment (EUnetHTA), 2008). Accordingly, this organisation has recently amended the

Transparency Directive to ensure timely coverage decision-making and provided grants to support the European Network of Health Technology Assessment (EUnetHTA), which recently implemented the EUnetHTA Joint Action project 2 (EUnetHTA JA2) to establish sustainable cross-border HTA collaboration in Europe with the development of a core HTA model (European Commission, 2012; European Network for Health Technology Assessment (EUnetHTA), 2012).

Table 3.1: Key Principles for the improved conduct of Health Technology Assessment

Key Principles
Structure of HTA programmes
1. The goal and scope of the HTA should be explicit and relevant to its use
2. HTA should be an unbiased and transparent exercise
3. HTA should include all relevant technologies
Methods of HTA
5. HTA should incorporate appropriate methods for assessing costs and benefits
6. HTAs should consider a wide range of evidence and outcomes
7. A full societal perspective should be considered when undertaking HTAs
8. HTAs should explicitly characterize uncertainty surrounding estimates
9. HTAs should consider and address issues of generalisability and transferability
Processes for conducting HTA
10. Those conducting HTAs should actively engage all key stakeholder groups
11. Those undertaking HTAs should actively seek all available data
12. The implementation of HTA findings needs to be monitored
Use of HTA in decision-making
13. HTA should be timely
14. HTA findings need to be communicated appropriately to different decision makers
15. The link between HTA findings and decision-making processes needs to be transparent and clearly defined

Source: Drummond *et al.*, (2008)

Drummond *et al.* (2008) proposed 15 Key Principles to be used as a measure to benchmark HTA agencies by applying a score to each principle (Table 3.1). The 15

Key Principles cover a range of HTA practices, but not all of the Key Principles may be relevant to the mandates of individual agencies. Therefore, scoring HTA agencies according to a criterion that is not applicable to their practices will result in these agencies unfairly achieving a lower overall score. Henshall (2012) responded to this publication by expressing a need for an “*objective approach to describing health system decision-making systems*”. Resources are currently available that offer flow diagrams and pictorial representations of coverage systems (International Society For Pharmacoeconomics and Outcomes Research (ISPOR), 2012; Eldessouki and Dix Smith, 2012; World Health Organisation Collaborating Centre for Pharmaceutical Pricing and Reimbursement Policies.). However, this study aims to provide additional value to the currently available resources through the application of a novel mapping process that ensures all maps conform to a uniform methodology, a common graphical representation and standardised descriptors focused on reimbursement.

OBJECTIVES

The main objectives of this study are to:

1. Characterise the review and decision-making systems for new pharmaceuticals for 33 European jurisdictions and to categorise these according to a standard taxonomy.
2. Categorise the diversity of the different HTA systems by identifying sub-groups with common elements of process (ie, archetypes) that could be used to describe general characteristics common to the different systems within each archetype, and provide a method of non-ranking classification.
3. Examine the relationship of the subgroups to determine how these archetypes could be useful in practice, for example by the identification of groups of countries where work sharing could be adopted.

METHODOLOGY

The scope of this research was limited to the national pathway and processes for regulatory, HTA and coverage decisions for New Active Substances. For the purpose of this research a New Active Substance (NAS) was defined as a chemical, biological, biotechnology or radiopharmaceutical substance that has not been previously

available for therapeutic use in humans and is destined to be made available as a prescription only medicine, to be used for the cure, alleviation, treatment, prevention or in vivo diagnosis of diseases in humans. This research was also limited to the creation of process maps, using a systematic mapping methodology, for the following 33 European jurisdictions from the European Economic Area (EEA):

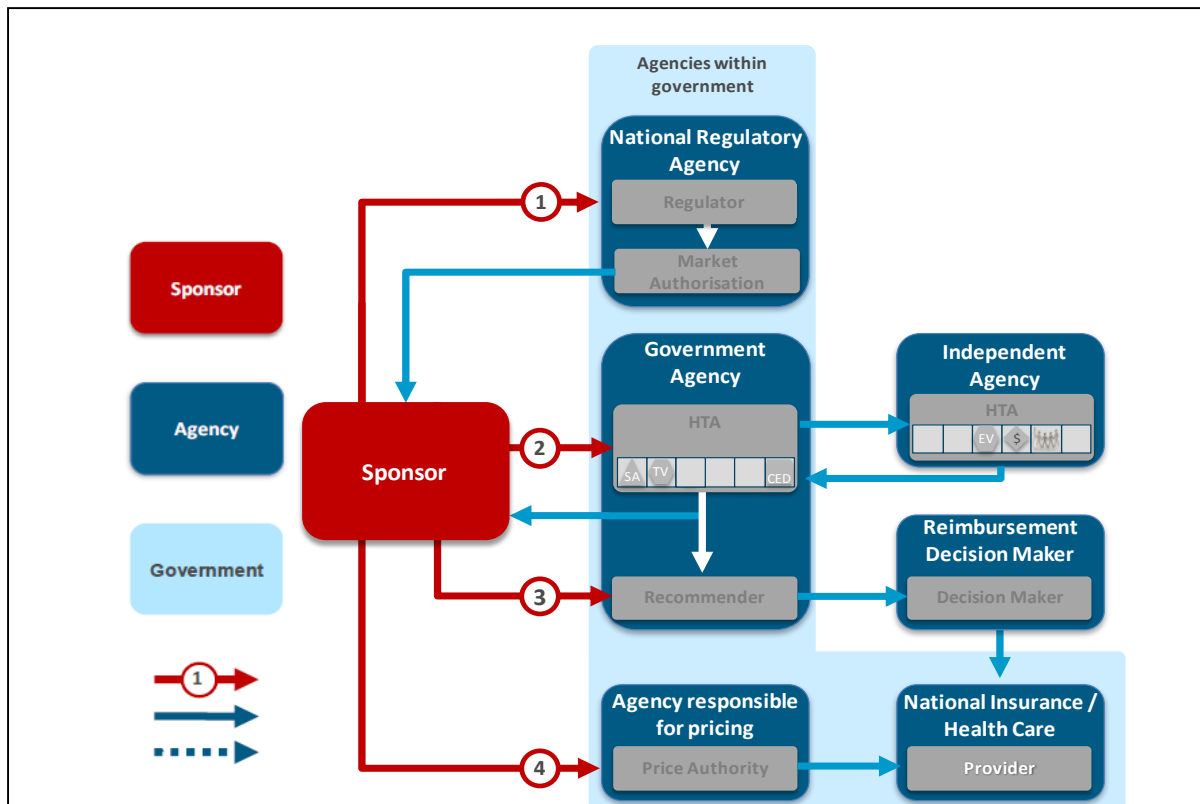
- Austria
- Belgium
- Bulgaria
- Cyprus
- Czech Republic
- Denmark
- England
- Estonia
- Finland
- France
- Germany
- Greece
- Hungary
- Iceland
- Ireland
- Italy
- Latvia
- Liechtenstein
- Lithuania
- Luxembourg
- Malta
- Netherlands
- Norway
- Poland
- Portugal
- Romania
- Scotland
- Slovakia
- Slovenia
- Spain
- Sweden
- Switzerland
- Wales

Some European nations have decentralised decision-making to the regional level and, in such cases, the presence of multiple regional decision-makers are indicated within the map for the overall national pathway. Information used to create the process maps was primarily sourced from the most up to date information in the public domain. This included the official agency or Ministry of Health websites (Appendix A) International Drug Regulatory Affairs Compendium (IDRAC[®]) expert reports (Thomson Reuters, 2015), ISPOR Roadmaps and the WHO Collaboration Centre Country Reports. This information was applied to a refined systematic mapping methodology (Allen *et al.*, 2010a; Allen *et al.*, 2010b; Patel *et al.*, 2011; Pichler *et al.*, 2010).

The novel mapping methodology used to create the process maps displays information in three tiers. The first information tier identifies the interaction between the NASs sponsor and agencies involved in the national process (Figure 3.1). The interactions are indicated by coloured arrows; red arrows for sponsor and agency interactions, and blue arrows for agency to agency interaction. Dashed arrows are used to show interactions that are not mandatory but often occur. The Sponsor (red)

arrows are also numbered to help indicate the order of these interactions. A pale blue shaded area is added to highlight which agencies operate within government.

Figure 3.1: Mapping methodology information tier 1

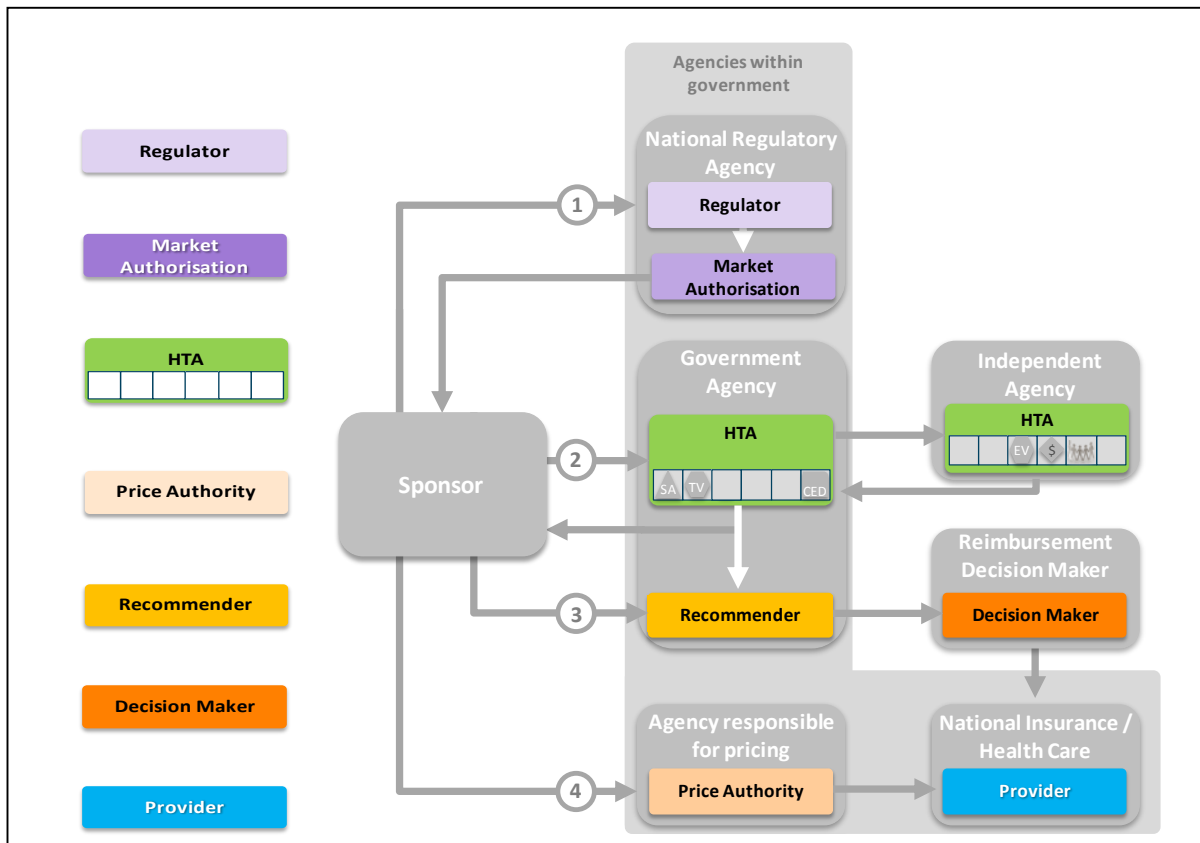


Interactions between the NASs sponsor (red box) and key agencies (dark blue box) are visually represented for the first information tier. Sponsor to agency interactions are numbered and indicate the order of steps involved in the system. Dashed lines have also been included to represent non-mandatory interactions. A pale blue shaded area highlights agencies that are within government.

The second information tier examines the roles performed by the agencies within the system. The most significant components of the system are chosen and defined to create seven core functions. A colour-coded tab is produced for each of these seven core functions and is added to the agency, or agencies, that perform the defined function (figure 3.2) (Pichler and Wang, 2012):

- **Regulator**
Scientific evaluation based on safety, quality and efficacy is conducted to determine if market authorisation should be recommended.
- **Market Authorisation**
Decision to grant market authorisation to the new medicine is made.
- **HTA**
The assessment of the new medicine is conducted in relation to the therapeutic value and/or economic value of the new medicine to the healthcare system.

Figure 3.2: Mapping methodology information tier 2



Seven agency core functions are identified for the second information tier: Regulator, Market Access, HTA, Price Authority, Recommender, Decision Maker and Provider. Each core function is allocated a colour-coded label and added to agency that performs the function.

- **Price Authority**

Determines or controls the list price for a new medicine. This could be achieved by a voluntary price agreement or by imposing a ceiling price.

- **Recommender**

HTA appraisal results in a recommendation for reimbursement but the final decision is made elsewhere.

- **Decision Maker**

Decision to reimburse the new medicine is made in relation to the coverage scheme for the system in question.

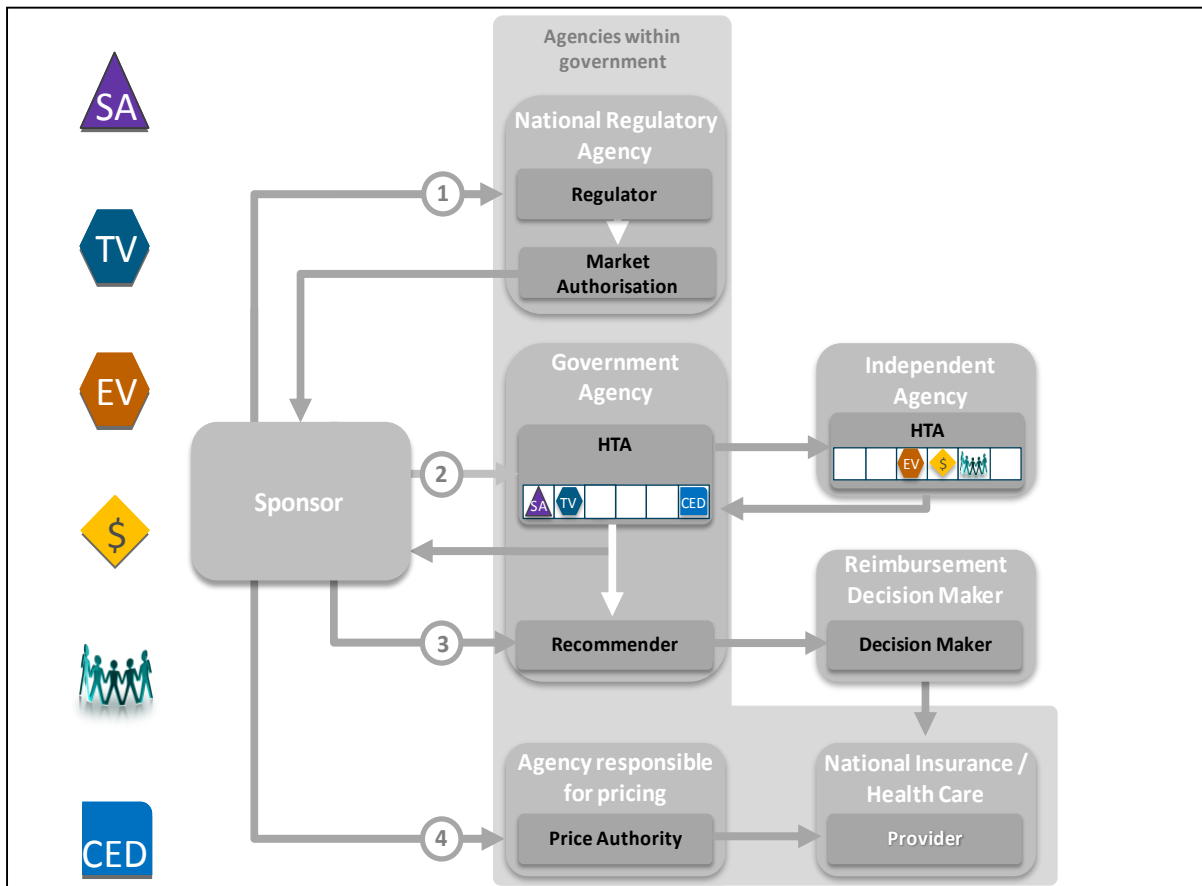
- **Provider**

The new medicine is adopted based on the outcome of the decision maker.

The HTA core function tab includes a task bar to display additional information about the agencies HTA processes. Six key activities are chosen as the defining elements to characterise the agency. A colour-coded icon is produced for each key activity, and

added to the HTA task bar for agencies that routinely partake in a particular activity (Figure 3.3):

Figure 3.3: Mapping methodology information tier 3



The core function label for 'HTA' includes a toolbar to display the key functions performed by the HTA agency. The mapping methodology pilot identifies 6 key HTA activities: Scientific Advice (SA), Therapeutic Value (TV), Economic Value (EV), Reimbursement Rate Setting (\$), Public Consultation and Coverage with Evidence Development (CED).

- Scientific Advice (SA)**
 Provision of scientific advice to the sponsor in relation to the drug development programme of the submission of evidence to that agency.
- Therapeutic value (TV)**
 Evaluation of the clinical evidence in order to determine if there is added therapeutic value in the new medicine.
- Economic value (EV)**
 Determination of the cost-effectiveness, cost-utility, cost-benefit, and/or budget impact of the new therapy.

- **Reimbursement rate (\$)**

Determination of the rate of reimbursement for the new medicine, usually into pre-defined categories.

- **Public consultation**

Involvement of patients, patient advocates and/or public representatives, to include both formal and informal forms of consultation.

- **Coverage with Evidence Development (CED)**

Provision of release of the new medicine where data is limited with the condition of further evidence development.

All three information tiers are consolidated to produce the final process map. The different system processes were determined by interpreting sources available from official HTA agency or Ministry of Health websites (Appendix A), journal publications and the International Drug Regulatory Affairs Compendium (IDRAC[®]; Thomson Reuters) expert reports. An Internet translation tool (Google Translate) was used to translate online information sources unavailable in English. This included all official HTA agency or Ministry of health websites for jurisdictions except where English is the primary language (England, Ireland, Scotland and Wales). Several agency websites do provide some information in English (e.g. G-BA (Germany), HAS (France) and TLV (Sweden)), but more detailed information is often included in the primary language and was therefore translated for completeness. Each process map was reviewed by a second in-house researcher to confirm the primary researcher's interpretation of the information sources. If consensus could not be agreed, a third opinion from a researcher with previous experience as director of a European HTA agency was consulted. Where possible, the process maps were reviewed by a country expert. Usually this included a representative from the national HTA agency (AHTAPol; HAS; INAMI; IQWIG; NICE; SMC; TLV; ZIN (formerly CVZ), but feedback from presentations provided at meetings of a not-for-profit organisation to members of the pharmaceutical industry were also incorporated as the process maps provide an overview of the reimbursement system from regulatory approval to the healthcare provider from the perspective of the sponsor. The sourced information is used to generate an information hierarchy displayed within 3 tiers in the resulting process maps. These information tiers allow all stakeholders, including those with no prior knowledge of

HTA, to understand the reimbursement process. All process maps also conform to a specification of defined colour-coded functions and icons to enable efficient intersystem comparison. Following the completion of all 33 process maps, common similarities and differences were identified and used to create 2 groups of taxonomies for the healthcare systems.

RESULTS

The results for this chapter will be presented in six parts:

- **Part I-** Process maps for 33 European jurisdictions
- **Part II-** Categorising the ‘System taxonomy’
- **PART III-** Categorising the ‘HTA Process taxonomy’
- **Part IV-** Convergence of taxonomies to establish archetypes
- **Part V-** Relationships between taxonomies and archetype groups
- **Part VI-** Geographical locations of classifications

PART I- Process maps for 33 European jurisdictions

Process maps were developed for each of the 33 European nations to illustrate the steps involved in regulatory, HTA, and coverage processes for NASs. Process maps for Austria, Denmark, Liechtenstein, Portugal, Spain and Switzerland are provided in Figures 3.4 – 3.9 to demonstrate the variation in processes included in this study. For example, the process map for Spain represents a system with greater decentralised decision-making compared to the majority of European reimbursement systems (Figure 3.8). The system shown in the process map for Liechtenstein is even more unique because Liechtenstein will accept drugs that have been granted marketing authorisation in Austria and Switzerland and may also choose to adopt the prices set by the Swiss Federal Office of Public Health.

The full set of process maps for the 33 European jurisdictions included in this study is available in Appendix B. The maps identified notable differences in the extent to which agencies conducted a defined set of core functions, the number of decision-making bodies, their sequence within the overall process and the key HTA tasks that they undertake.

Figure 3.4: Process map for Austria (January 2012)

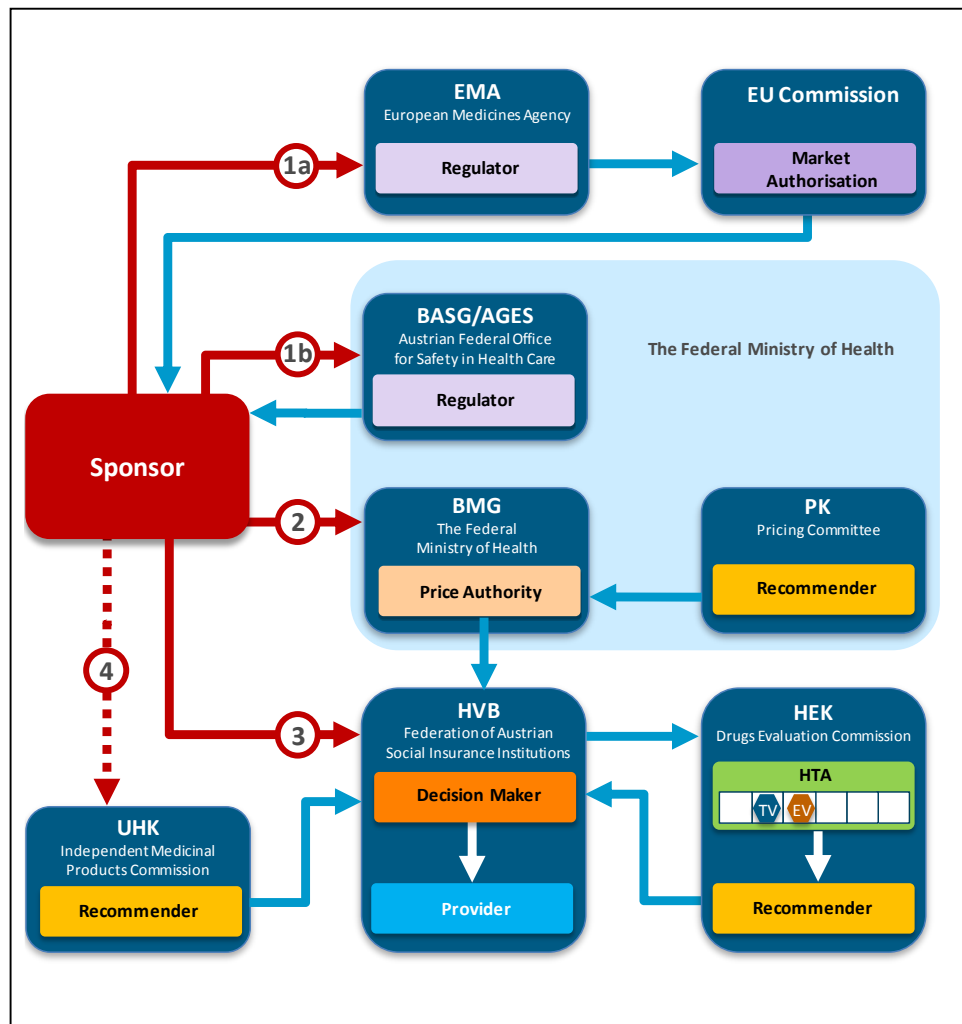


Figure 3.5: Process map for Denmark (June 2014)

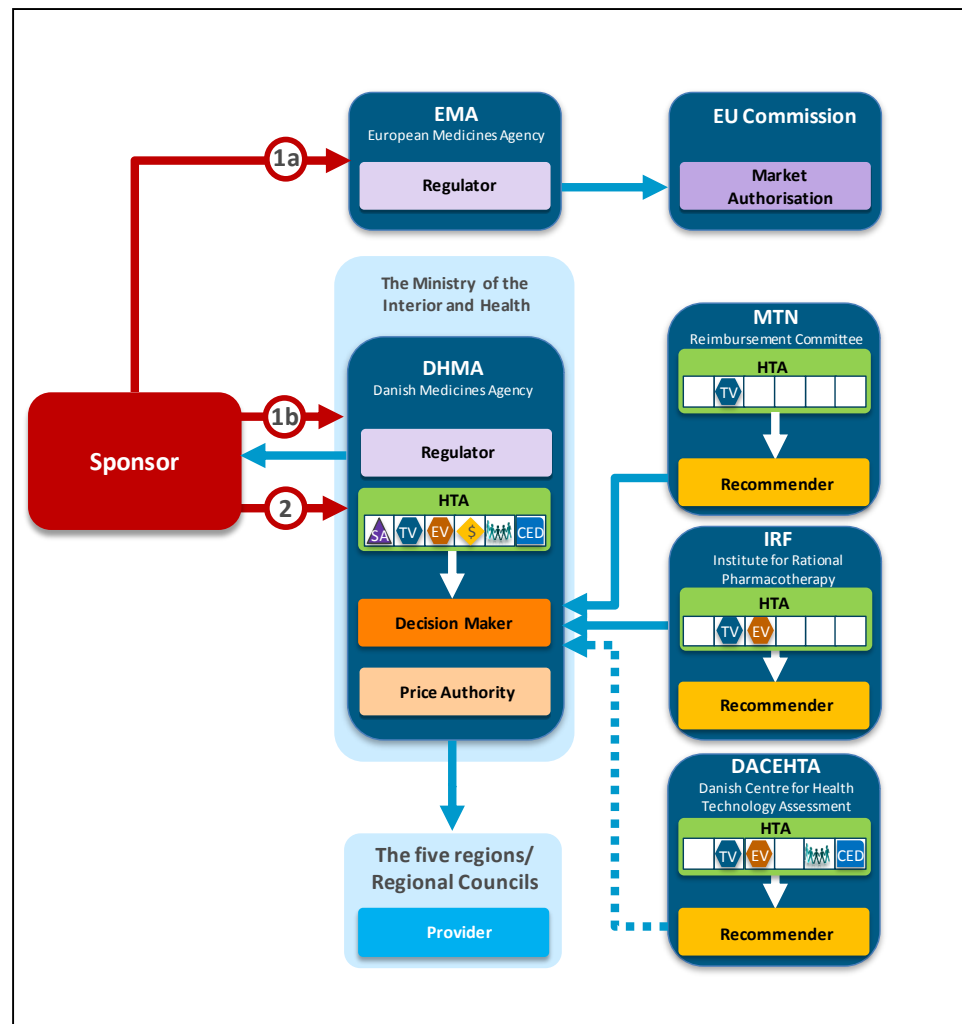


Figure 3.6: Process map for Liechtenstein (February 2012)

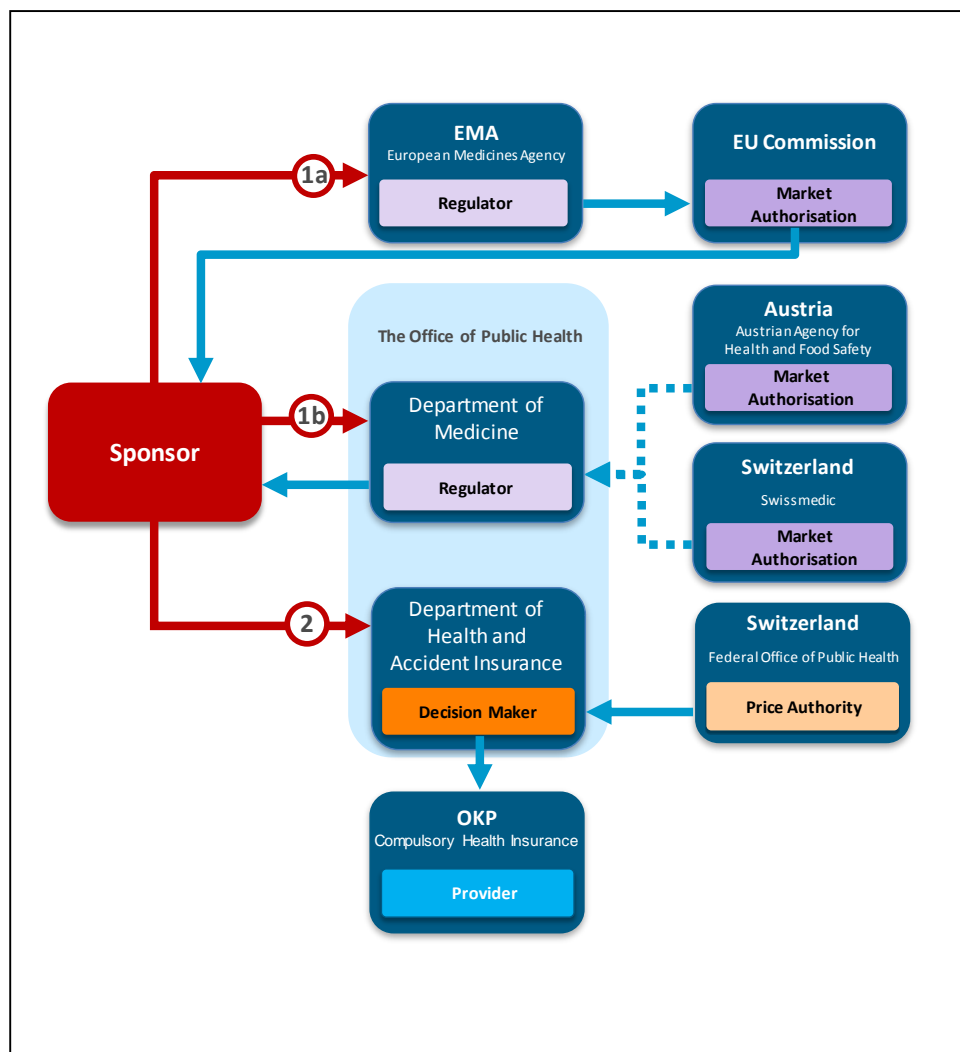


Figure 3.7: Process map for Portugal (June 2014)

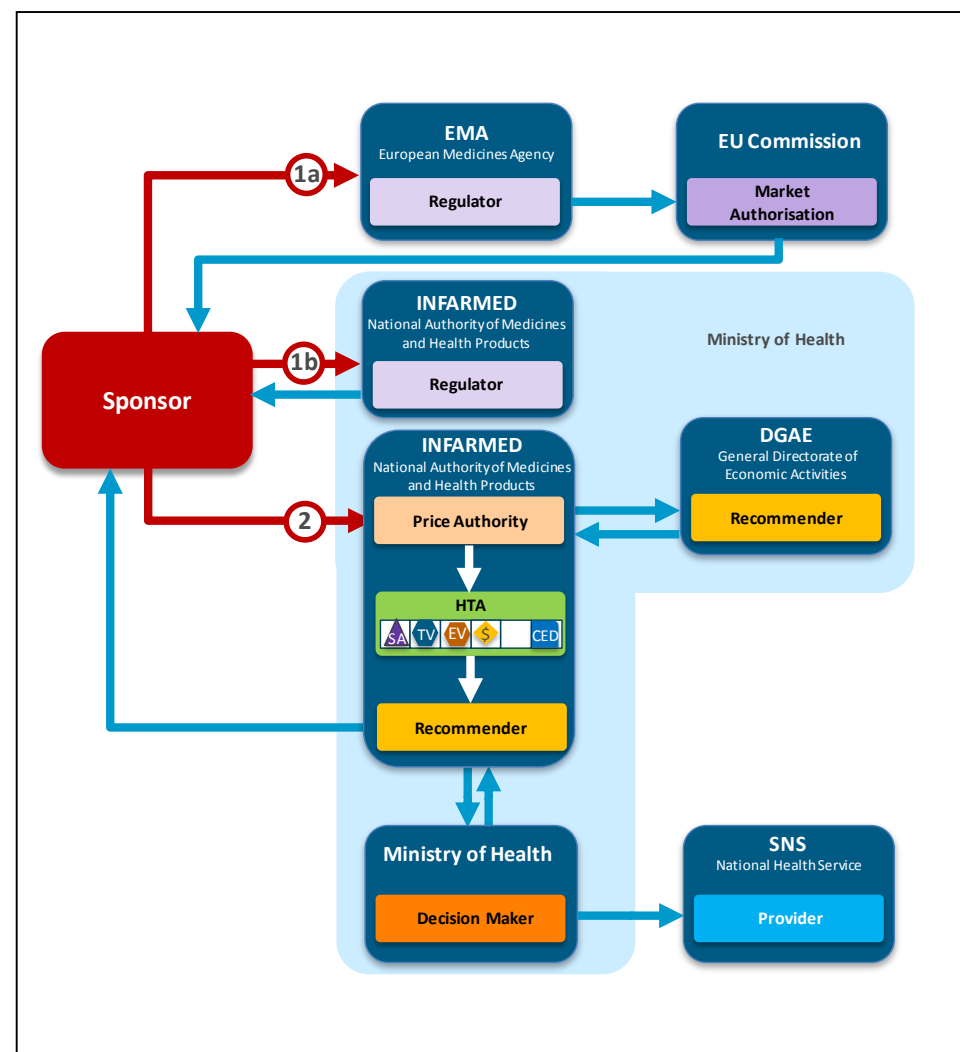


Figure 3.8: Process map for Spain (May 2014)

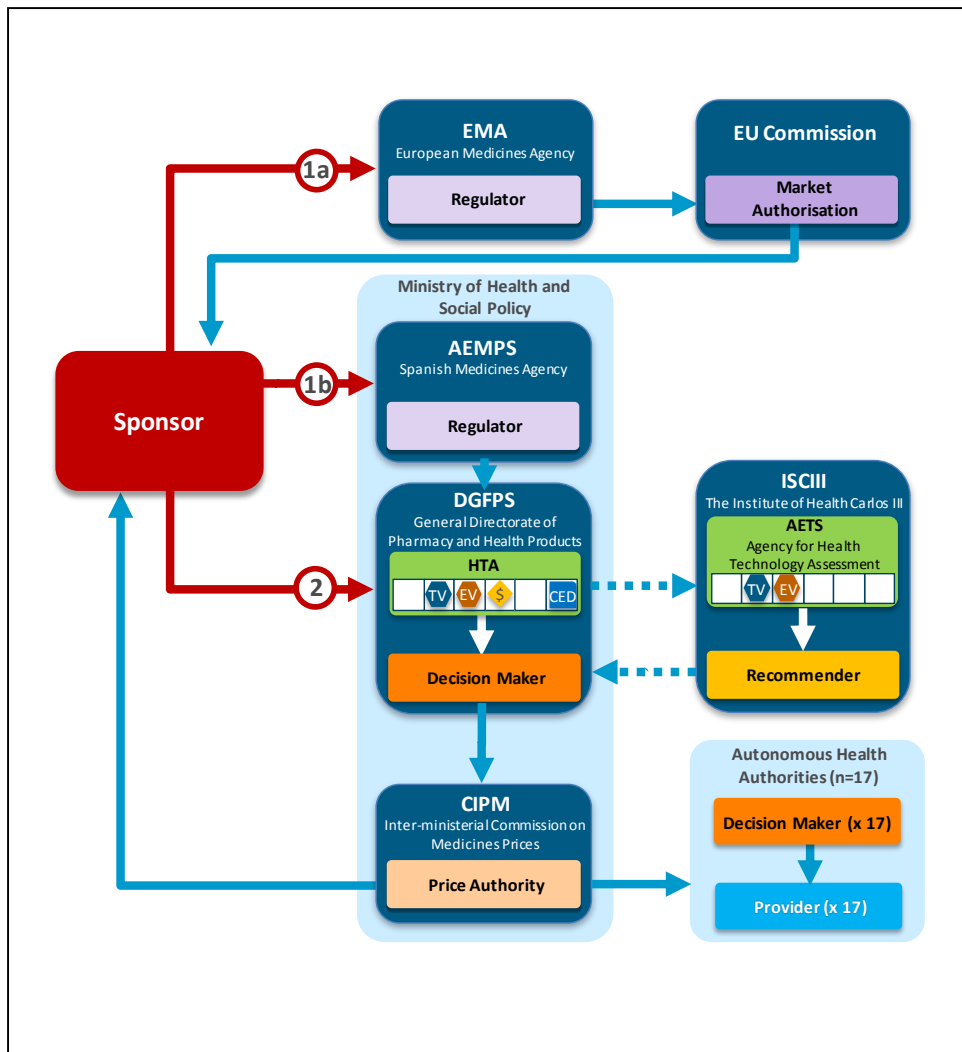
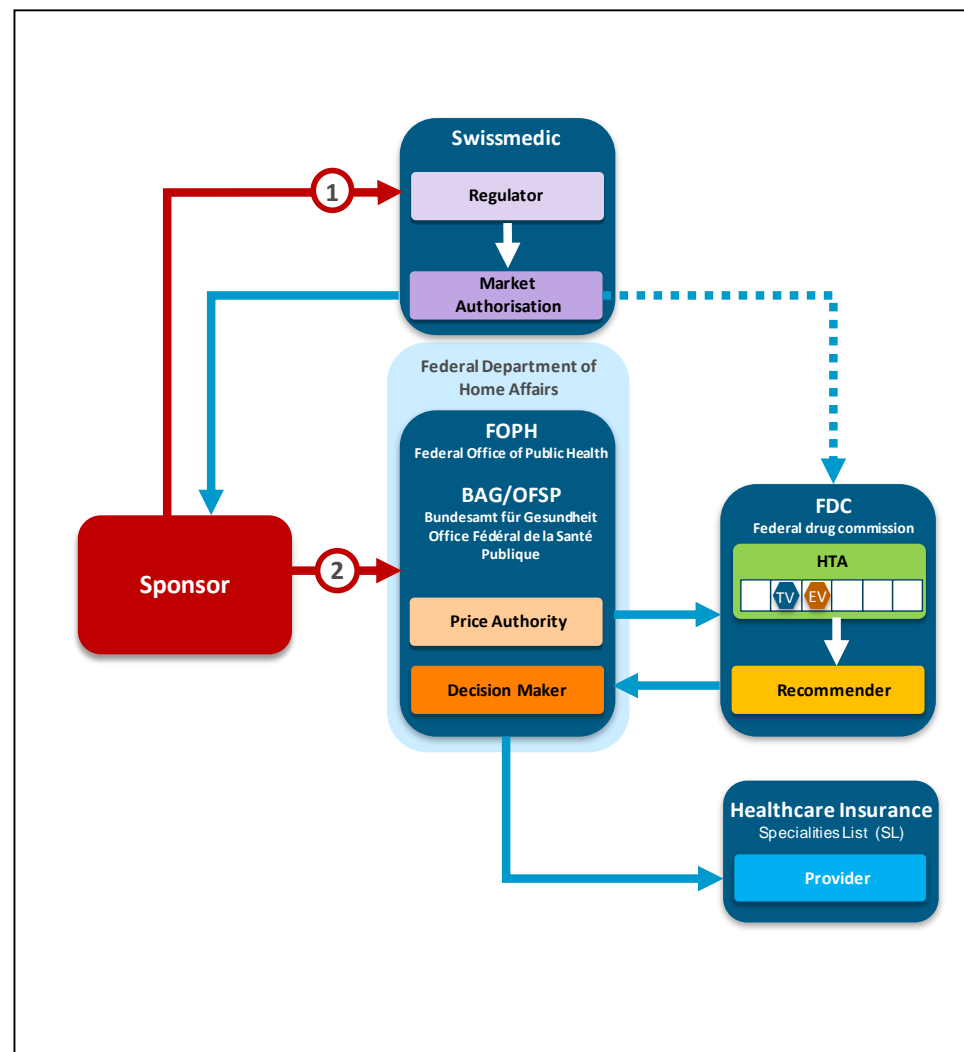


Figure 3.9: Process map for Switzerland (June 2014)

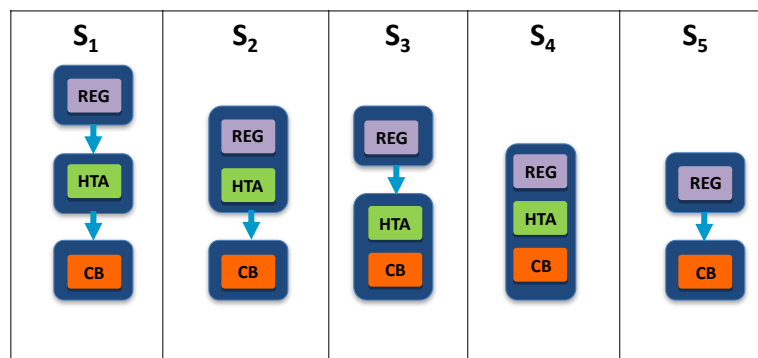


PART II- Categorising the ‘System taxonomy’

The 33 European process maps were compared to identify similarities and differences between the regulatory to reimbursement systems. The comparisons focused on high-level similarities and differences to ensure that the observed diversity could be represented by a small number of categories that could each be assigned to multiple systems.

The first taxonomy produced by this research is the ‘System taxonomy’. This shows the position of the national HTA agency with regards to the regulatory and decision-making coverage body (Figure 3.10). This ‘System taxonomy’ set contains 4 groups including HTA and an additional fifth group for systems that use external HTA:

Figure 3.10: System taxonomy



The System taxonomic set is based on the position of a national HTA agency, if present, in relation to the position of the regulatory (REG) and the decision-making coverage body (CB).

- **S₁** - Regulatory, HTA and decision-making coverage body functions are performed by separate agencies. This is the most fragmented category of the ‘System taxonomy’ and could be perceived to offer the most independent option for HTA and decision-making. More independent systems could be perceived to be less susceptible to bias. However, sustaining multiple agencies could be more costly than a single agency performing multiple functions.
- **S₂** - Regulatory and HTA functions are performed by a single agency and the decision-making coverage body functions are independent. A single agency performing HTA and regulatory functions could enable resource sharing and therefore require fewer resources than two independent agencies. A single agency may also offer greater opportunities for HTA and regulatory to share

learnings and expertise. There may also be improved communication and therefore more timely processes between HTA and regulatory.

- **S₃** - HTA and decision-making coverage body functions are performed by a single agency with the regulatory function performed independently. The combined HTA and decision-making function may provide more opportunities for communication and more timely decisions. However, HTA may be perceived to be susceptible to bias if conducted by the same agency responsible for the final funding decision.
- **S₄** - Regulatory, HTA and decision-making coverage body functions are all performed within a single agency. This is the most integrated of the four HTA containing categories. This integrated approach could provide the best opportunities for shared learnings and increase cost-effectiveness due to more opportunities for resource sharing. However, HTA may be perceived to be susceptible to bias if conducted by the same agency responsible for the final funding decision.
- **S₅**- No HTA is performed within the national regulatory to reimbursement system. This group has been created to enable the categorisation of systems that do not conduct their own HTA.

PART III- Categorising the HTA ‘Process taxonomy’

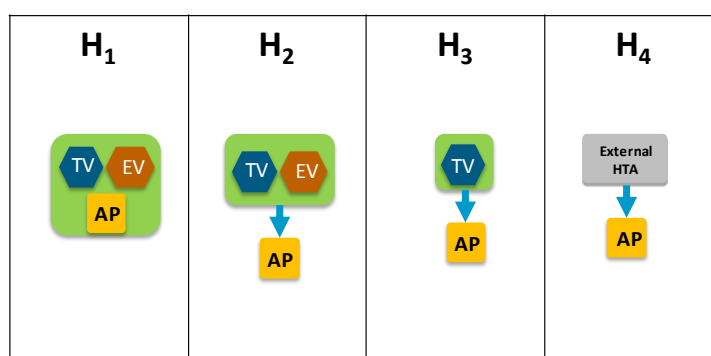
The second categorisation outcome of this research is the ‘HTA process taxonomy’ (Figure 3.11). This focuses on the relationship between the HTA appraisal, therapeutic assessment and the economic evaluation if present. The HTA process taxonomic set also includes a group for systems that utilise external HTA:

- **H₁** - Therapeutic value assessment, economic evaluation and appraisal are performed within the same agency. Combining multiple aspects of the HTA process could be more susceptible to bias.
- **H₂** - Therapeutic value assessment is conducted within the same agency as economic evaluation but the appraisal is performed independently, usually by healthcare professionals rather than civil servants. It could be perceived that including an independent appraisal is less susceptible to bias.
- **H₃** - Therapeutic value is assessed prior to independent appraisal. This is the most fragmented of the three HTA containing categories of the ‘HTA process

taxonomy'. Conducting an independent assessment of therapeutic value could be perceived to be less susceptible to bias, especially for high cost drugs.

- **H₄** - Appraisal is conducted using information from an external HTA report or by considering the coverage decisions of reference countries. This group has been created to enable the categorisation of systems that do not conduct their own HTA.

Figure 3.11: HTA process taxonomy



The HTA process taxonomic set, focuses on the key tasks performed by the HTA agency. Each group shows the relative positions of 3 key tasks, if performed, within the HTA agency: therapeutic value (TV); economic value (EV); and appraisal (AP).

PART IV- Convergence of taxonomies to establish archetypes

Each of the national HTA agencies were categorised by the convergence of their two taxonomic sets (this excluded the external HTA options), which were determined by the primary researchers interpretation of the system structure and HTA activities presented in the 33 EU HTA process maps (Figure 3.12). The nations with HTA-performing agencies or committees were classified using this grid; the two nations that do not conduct HTA were listed by the name of their jurisdiction only. By comparing the confluence of the two taxonomies, the 33 national agencies were classified into different archetype groups. For example, the National Centre for Pharmacoeconomics (NCPE) is part of the Irish public healthcare system and has been assigned to group H₁S₁ because the regulator, HTA agency and the coverage decision-making body are positioned independently within the system (System taxonomy S₁) and the NCPE review considers both cost effectiveness and clinical evidence and conducts the appraisal ('HTA process taxonomy' H₁).

The archetype group S₅H₄ is derived from the System taxonomic set S₅ that does not include HTA in the national healthcare system and HTA Process taxonomic set H₄

which utilises evidence from external HTA. The inclusion of this group enables this research to classify national healthcare systems that do not conduct their own HTA. Overall, this study has yielded ten distinct HTA archetype groups which enables representation of all 33 European nations assessed in this study (Figure 3.12).

Figure 3.12: Archetype grid
System Process taxonomy

	S ₁ 	S ₂ 	S ₃ 	S ₄ 	S ₅
H ₁ 	DC (CYP) NCPE (IRE) DGFPS (SPA) MOH DTC (MAL)	INFARMED (POR)	AWMG (WAL) PDL (BUL) IMPRC (ICE) CHE (LAT) LRC (LIT) MSS (LUX) SCC (SVK) SMC (SCO) TLV (SWE)	SUKL (CZE) DHMA (DEN) NOMA (NOR) AIFA (ITA)	
H ₂ 	HEK (AUS) INAMI (BEL) IQWIG (GER) OHTA (HUN) AHTAPol (POL)		NICE (ENG) HILA (FIN)		
H ₃ 	HAS (FRA) WAR (NET) FDC (SWZ)	SAM (EST)	TSC (ROM) RC (SVN)		
H ₄ 					GREECE LIECHTENSTEIN

Archetype key				
S ₁ H ₁	S ₃ H ₁	S ₃ H ₂	S ₂ H ₃	S ₄ H ₁
S ₂ H ₁	S ₁ H ₂	S ₁ H ₃	S ₃ H ₃	S ₅ H ₄

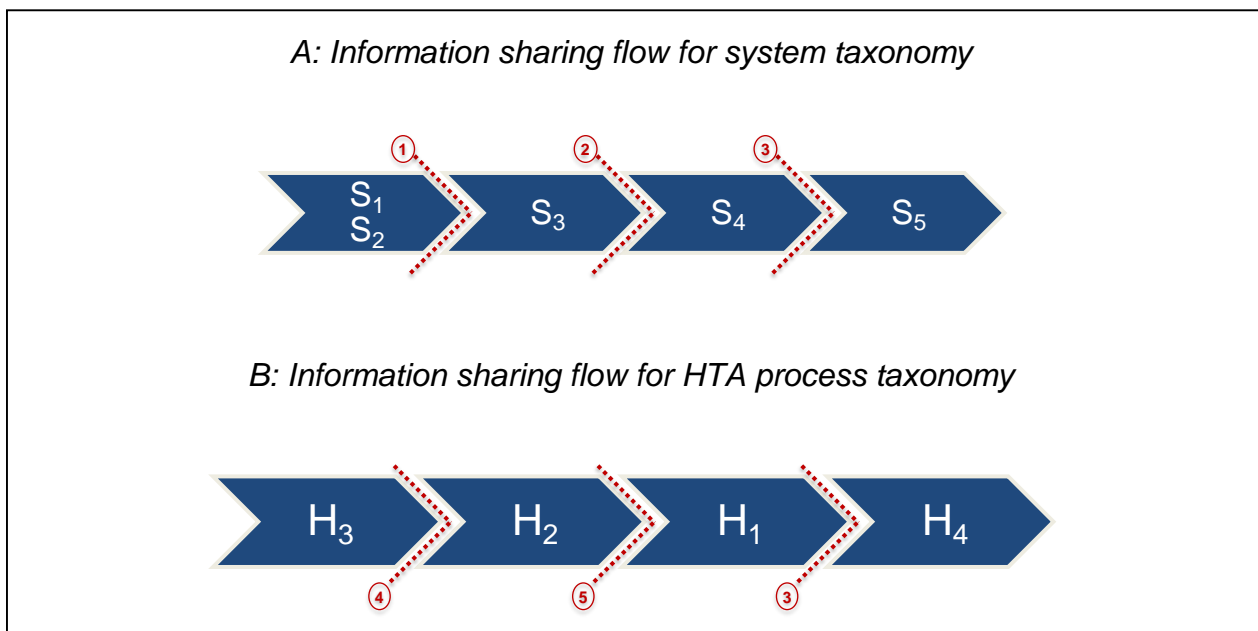
This cross-reference grid shows to which system and HTA process taxonomy group each HTA agency, and its respective national system, have been allocated. The ten archetype groups are listed by their abbreviations in the archetype key and each group's position is represented on the grid by colour. Boxes with no agencies have been left blank.

Nine jurisdictions were allocated to the largest archetype grouping S₃H₁: Bulgaria; Iceland; Latvia; Lithuania; Luxembourg; Slovakia; Scotland; Sweden and Wales (Figure 3.12). The S₃H₁ group includes systems with an agency that performs both HTA and decision-making with an independent regulatory authority and for the HTA process, the therapeutic value assessment, economic evaluation and appraisal are performed within a single agency. The second most common archetype observed in Europe was S₁H₂ and includes five jurisdictions: Austria; Belgium; Germany; Hungary and Poland. Unlike group S₃H₁, the systems allocated to group S₁H₂ have separated agencies or bodies to perform the HTA and decision-making. The S₁H₂ jurisdictions also include an independent appraisal within their HTA process.

PART V- Relationships between taxonomies and archetype groups

The relationships between the subgroups of the two taxonomic sets and archetype groups were examined to evaluate whether the differences could theoretically impact utilisation of the groups for information sharing. The potential for collaboration between different archetype groups was considered by initially evaluating the possible obstacles for HTA information flow between the two taxonomic sets (Figure 3.13).

Figure 3.13: Information sharing flow diagrams



This pictorial diagram shows the optimal direction for information flow. The numerically labelled dashed arrows indicate different opportunities for conflicts of interests.

Five key obstacles were identified for the HTA process and System taxonomies and their positions are indicated by numbered arrows in Figure 3.13:

- 1- Potential conflict of interests when information provided by a system containing an agency with combined HTA and coverage body (S₃ and S₄) to a system that conducts HTA separately from the decision-making coverage body (S₁ and S₂).
- 2- Need to consider the potential impact of agencies collaborating with agencies from less integrated systems (S₁, S₂ and S₃) as this may affect timeliness. More integrated systems (S₄) that include multiple functions performed by a single agency could have increased opportunity for communication and pooling resources.
- 3- The countries allocated to groups S₅ and H₄ use information from external HTA. Therefore they could receive information provided by any of the other groups within their taxonomies but they are unable to provide HTA.
- 4- Agencies allocated to group H₃ perform an exclusively clinical HTA. Therefore collaborating with agencies that combine their therapeutic and economical assessments (H₁ and H₂) is unlikely to provide optimal results due to a potentially perceived conflict of interest.
- 5- The potential conflict of interests (or additional workload) when the recipient group (H₂ and H₃) that routinely conducts external appraisal receives information from a group that does not conduct an external appraisal (H₁).

The key difference between the System taxonomic sets S₁ and S₂ is whether the Regulator and HTA functions are performed in a single agency or independently. These have been combined in Figure 3.13 because the differences in positioning these two core functions are not considered to be a potential conflict of interest. In fact, the combination of these two core functions in a single agency could provide increased opportunities for communicating, sharing resources and learnings. These potential conflicts were then applied to the archetype groups and added to a grid to show potential for sharing HTA assessment information between different archetype groups and where conflicts of interest may need consideration (Figure 3.14).

Figure 3.14: Information sharing schematic for archetypes

		Provider									
		S ₁ H ₃	S ₂ H ₃	S ₃ H ₃	S ₁ H ₂	S ₃ H ₂	S ₁ H ₁	S ₂ H ₁	S ₃ H ₁	S ₄ H ₁	S ₅ H ₄
Recipient	S ₁ H ₃	✓	✓	?	X	X	X	X	X	X	X
	S ₂ H ₃	✓	✓	?	X	X	X	X	X	X	X
	S ₃ H ₃	✓	✓	✓	X	X	X	X	X	X	X
	S ₁ H ₂	✓	✓	?	✓	?	??	??	??	??	X
	S ₃ H ₂	✓	✓	✓	✓	✓	??	??	??	??	X
	S ₁ H ₁	✓	✓	?	✓	?	✓	✓	?	?	X
	S ₂ H ₁	✓	✓	?	✓	?	✓	✓	?	?	X
	S ₃ H ₁	✓	✓	✓	✓	✓	✓	✓	✓	✓	X
	S ₄ H ₁	✓	✓	✓	✓	✓	✓	✓	✓	✓	X
	S ₅ H ₄	✓	✓	✓	✓	✓	✓	✓	✓	✓	X

Symbol	Description
✓	Information generated by provider group should be suitable for recipients needs.
?	Consider potential conflict of interests. Information provided by an agency with combined HTA and coverage body.
??	Consider potential conflict of interests. Recipient group may need an additional external appraisal.
X	Information from provider is unlikely to be appropriate for the requirements of agencies within this group.

This pictorial representation shows how agencies allocated to archetype groups could provide and receive information from HTA assessments for optimal value. The ‘?’ symbol is used to highlight sharing scenarios which have potential but may have potential conflicts of interest.

Potential for sharing HTA assessment information between archetype groups are categorised as one of the following:

✓- Information generated by provider group should be suitable for recipients needs. For example agencies within the same archetype group should be ideal candidates for information sharing as they should not be subject to the conflict of interests proposed for agencies sharing between different archetype groups. Sharing between different archetype groups could also be more preferable between certain pairs of archetype groups. For example, information generated by agencies allocated to group S₁H₃ (France (HAS), Netherlands (WAR) and Switzerland (FDC)) has the potential to share information with all other archetype groups because S₁H₃ is derived from the most independent System and HTA Process taxonomic groups and its processes could be perceived to be less subject to bias.

?- Consider potential conflict of interests. Information provided by an agency with combined HTA and coverage body. For example an agency allocated to archetype group S₃H₁, such as the Dental and Pharmaceutical Benefits agency (TLV) in Sweden, will perform both HTA and coverage decision-making. This could be a perceived conflict of interest for agencies allocated to groups S₁H₁ or S₂H₁ as their coverage decision-making body is independent.

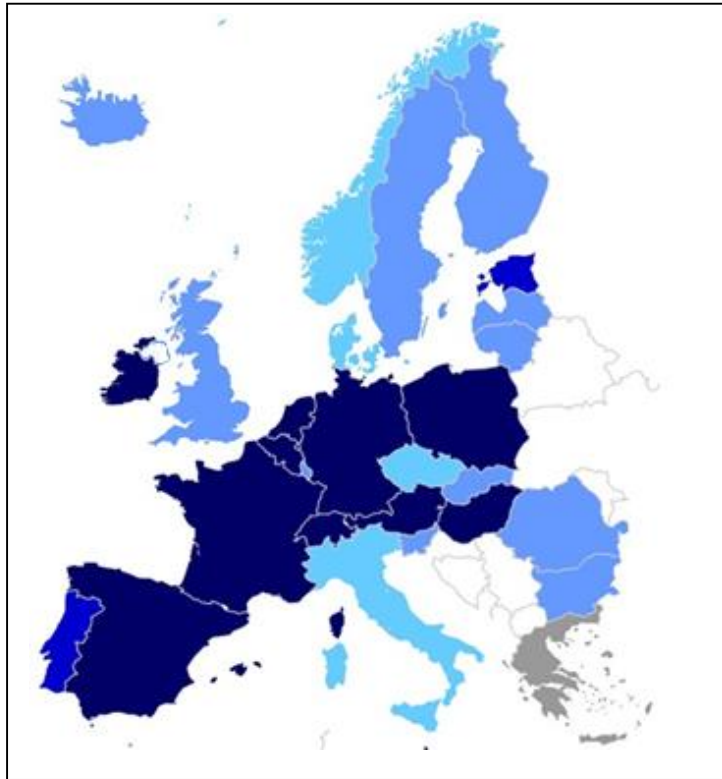
?? - Consider potential conflict of interests. Recipient group may need an additional external appraisal. For example, agencies allocated to groups S₁H₁ (e.g. Spain (DGFPS)), S₂H₁ (e.g. Portugal (INFARMED)), S₃H₁ (e.g. Wales (AWMG)) and S₄H₁ (e.g. Italy) could provide information that may not have been externally appraised.

X - Information from provider is unlikely to be appropriate for the requirements of agencies within this group. For example, healthcare systems allocated to group S₅H₄ (Greece and Lichtenstein) are not recommended for sharing information with any other archetype group and S₅H₄ members do not conduct their own HTA.

PART VI- Geographical locations of classifications

Colour-coded maps were created to display the geographical locations of the two taxonomic groups (Figures 3.15 – 3.17).

Figure 3.15: System taxonomy geographical location map



System taxonomy Key				
S1	S2	S3	S4	S5

Figure 3.16: HTA process taxonomy geographical location map



HTA process taxonomy Key			
H1	H2	H3	S3

The 'System taxonomy' demonstrates some clustering of the S₁ across central Europe with more variation for the 'System taxonomy' allocations for the peripheral jurisdictions. However, the reverse is observed for the HTA process taxonomy that demonstrates more variation for the HTA processes adopted in central Europe and preference for a single 'HTA process taxonomy' subset (H₁) for peripheral jurisdictions. A colour-coded map was also produced for the HTA archetype groupings (Figure 3.17). The 33 jurisdictions are not distributed evenly to the 10 distinct archetype groups and the largest group (S₃H₁) is the most dispersed. However, the second largest group (S₁H₂) exhibits the greatest amount of clustering of all the archetypes.

Figure 3.17: Archetype geographical location map



Archetype key				
S ₁ H ₁	S ₃ H ₁	S ₃ H ₂	S ₂ H ₃	S ₄ H ₁
S ₂ H ₁	S ₁ H ₂	S ₁ H ₃	S ₃ H ₃	S ₅ H ₄

DISCUSSION

The European Medicines Agency (EMA) has provided a centralised regulatory review process for European member states since 1995 (European Medicines Agency (EMA), 2015c). However, post-marketing authorisation pathways for reimbursement remain unique to each member state. Most European jurisdictions utilise HTA methodologies to guide reimbursement decision-making but similarities between HTA practices can result in duplication of workload and inefficient use of resources when multiple jurisdictions assess the same health technology. There are also many differences between European HTA agency mandates, HTA processes, existing formularies, best care pathways, budget limitations and national political and social expectations. This can result in duplication of effect, different reimbursement decisions for the same health technology and cause patient access inequalities throughout Europe. These inefficiencies are recognised and the European Network of HTA (EUnetHTA) has already begun initiatives for European HTA collaboration (European network for Health Technology Assessment (EUnetHTA), 2015a).

Various efforts have also been conducted to explain the many different reimbursement pathways across Europe (Table 3.2)

The International Society For Pharmacoeconomics and Outcomes Research (ISPOR), (2012) Roadmaps are produced by local experts or agency representatives and many have not been updated for several years. Local experts and agency representatives provide the data in a format of their choosing resulting in mostly text-base descriptions accompanied by diagrams produced by various different methodologies. The reimbursement systems can also change quickly and the most current practices may no longer be represented by some of the ISPOR Roadmap profiles.

The WHO Collaborating Centre for Pharmaceutical Pricing and Reimbursement Policies has published a collection of posters that provide flow diagrams of the reimbursement process for in-patient and out-patient pathways. These posters provide a more visual representation of the systems compared to the ISPOR Roadmaps but they do not follow a uniform methodology and many were produced more than five years ago.

Table 3.2: Comparison of this research and resources available in the public domain

Resource	Similarities to process maps	Differences to process maps
International Society For Pharmacoeconomics and Outcomes Research (ISPOR), (2012)	<ul style="list-style-type: none"> • The published Roadmaps including a visual representation of the national reimbursement pathways • Roadmaps available for 15 European countries included in this study 	<ul style="list-style-type: none"> • Process maps are created using a uniform methodology unlike the Roadmaps which are created by local experts who use a format of their choice • Process maps are accompanied by a table of information that is more concise than the more detailed text description included in the Roadmaps • Process maps produced for an additional 18 European jurisdictions than ISPOR • The Roadmaps are created by local experts and the process maps are sent for validation by local experts • Developed a method to categorise the reimbursement systems • Many of the Roadmaps have not been updated since 2008.
World Health Organisation Collaborating Centre for Pharmaceutical Pricing and Reimbursement Policies. (2015a)	<ul style="list-style-type: none"> • Published posters of the reimbursement pathways for 27 European jurisdictions included in this study • The process maps and WHO posters both provide visual representations of the systems with supportive text to explain the roles of the agencies or committees 	<ul style="list-style-type: none"> • The WHO have produces separate flow diagrams for the in-patient and out-patient pathways • The explanatory text is included in the flow charts of the WHO posters but is provided as an accompanying table for the process maps • Process maps are created using a uniform colour-coded methodology unlike the WHO Roadmaps • The individual WHO in-patient and outpatient pathway posters were mostly created in 2010 and have not been updated. However a separate poster has been produced to list more recent changes to the systems
Charles River Associates (Wilsdon and Serota, 2011; Wilsdon <i>et al.</i> , 2014)	<ul style="list-style-type: none"> • The Charles River Associates (CRA) reports provide an overview of the national pathway for 8 European jurisdictions included in this research 	<ul style="list-style-type: none"> • The CRA flow diagrams are uniform but very basic and do not include colour-coded tabs or icons to enable quick identification of agency roles or the HTA processes conducted

Charles River Associates have published reports to compare international HTA practices including eight European jurisdictions included in this study. The reports also included basic flow diagrams of the reimbursement systems and other analyses (Wilsdon and Serota, 2011; Wilsdon *et al.*, 2014).

However, none of these sources have utilised a systematic mapping methodology to produce uniform visual representations of the regulatory to reimbursement systems

for all member states of the European Union (EU) in 2012. A total of 33 process maps were created according to predetermined specifications to ensure uniformity. The diversity of these 33 systems was evaluated to produce two taxonomic sets to classify agencies according to their positions within the national system and also by the HTA processes the agency performs.

The similarities and differences of the 33 European national regulatory and reimbursement systems have been reviewed to produce a taxonomy that focuses on the external environment of the HTA agency by classifying organisational architecture of each system according to the interactions between 3 core functions, namely regulator, HTA, and the coverage body that contribute to the final decision. The interactions between these 3 core functions can ultimately affect overall system performance and Drummond et al. (2008) has also stressed the importance of conducting HTA independently of the decision-making body to reduce bias.

The 'System taxonomy' could be used to suggest potential collaborations to develop core HTA tools and methodologies. The 'System taxonomy' indicates which agencies may have more similar opportunities for communication and resource sharing due to multiple functions being performed by the same agency. However, it could also be perceived that a less integrated system is less susceptible to bias due to the greater level of independence of the decision-making coverage body from the agency responsible for conducting HTA.

The second resulting classification group is the 'HTA process taxonomy'. The subgroups of the 'HTA process taxonomy' distinguish between the HTA agency's approach for conducting the therapeutic value and economic value assessments and their relationship to the overall appraisal. The process maps display six different key HTA activity icons, but only therapeutic value and economic value were chosen for the HTA process taxonomic set as these are the most frequently utilised to assist reimbursement decisions (Henshall *et al.*, 1997). The position of the HTA appraisal has also been added to the HTA process taxonomic set as this indicates a key difference between the different agencies approaches for conducting HTA. The incorporation of an independent appraisal can reduce the perception of bias (Drummond *et al.* 2008) and is therefore an important factor that should be considered for classification. Each taxonomic set also contains a subgroup for nations that adopt

external HTA to ensure the taxonomies were representative of all 33 national systems. Although many European nations still do not have a formal HTA system (e.g. Bulgaria and Cyprus), 31 of the 33 systems profiled for this study required therapeutic assessment as a minimum requirement for coverage decision-making (Moharra *et al.*, 2008). Greece and Liechtenstein were the only two national systems that did not perform their own HTA at the time of this study. However, this does not imply that medicines are reimbursed by these two nations without any additional considerations following market access approval, as the coverage decisions of these countries are formed using information from external HTA reports.

The 'HTA process taxonomy' could suggest appropriate working collaborations by distinguishing how different HTA agencies utilise the therapeutic evaluation in relation to the economic assessment and appraisal. This would enable HTA agencies to collaborate and share information that would be of optimal value to the agencies within each archetype group and between appropriate groups. Group H₃ agencies, that perform their therapeutic evaluation independent of economic data such as the French National Authority for Health (HAS), and The Scientific Advisory Board (WAR) of the National Health Care Institute (ZIN; Netherlands), would be more natural partners for collaboration as compared to agencies from the highly integrated set H₁ which perform the therapeutic and economic evaluation together (Italian Medicines Agency (AIFA) and Norwegian Medicines Agency (NOMA)).

This study has subsequently achieved its second objective: to categorise the diversity of the different HTA systems by identifying sub-groups with common elements of process (ie, archetypes) that could be used to describe general characteristics common to the different systems within each archetype and provide a method of non-ranking classification. Ten distinct HTA archetype groups were created by evaluating the confluence of the 'HTA process taxonomy' and the 'System taxonomy'. The archetypes and the two taxonomies provide a non-ranking method of categorising the diversity of HTA systems. This addresses a need for an "objective approach to describing healthcare decision-making systems" (Henshall, 2012). Henshall (2012) raised this need in response to a suggested methodology for benchmarking agencies using Drummonds Key Principles (Drummond *et al.*, 2008; Drummond *et al.*, 2012). Charles River Associates have suggested a simpler method to categorise HTA by the timing of the assessment (Wilsdon and Serota, 2011).

A geographical colour-coded set of maps was produced to identify trends between geographical location and a jurisdiction's allocated taxonomic subsets or archetype group. These maps demonstrated a preference for one 'System taxonomy' subset for some countries across central Europe but overall the maps did not demonstrate any strong correlation. This could be due to the various different welfare state ideologies that developed throughout Europe (Bambra and Eikemo, 2008; Arts and Gelissen, 2002). The effects of these ideologies can help explain why some welfare states such as Germany and France are funded by compulsory health insurance (Bismark) rather than through taxation as in the UK (Beveridge). However, even neighbouring countries with the same underpinning welfare state origins do not necessarily fall within the same groupings. It was concluded from the results that classifications based primarily on geographical location, ability to pay, or welfare state design may not be the optimum solution for determining groups for collaborations that require agencies with similar processes. Instead, identifying factors more closely related to the current HTA processes and their position within the reimbursement system could produce a more productive collaboration. Identifying groups with similar processes in Europe could be used to create collaborative groups as a stepping-stone for greater alignment. This progressive alignment approach would deliver the benefits of collaboration: reduced duplication of work, more efficient use of resources, more timely HTA and potentially less patient access inequalities. HTA is also a young field and it may be premature to suggest a one-size-fits-all approach for conducting HTA. A non-ranking classification can also help to characterise HTA agencies objectively without implying a particular HTA model as gold standard. A universally accepted classification method that implies rank could encourage an unnatural convergence of HTA practices towards the more positively ranked model. Therefore, an objective method of classification that does not suggest a gold standard could help maintain key differences in HTA practices. This approach could also be used as a basis for progressive alignment that would also provide an environment in which the key differences observed in the present HTA can be maintained while encouraging the development of more efficient HTA practices in the future.

Assessing the national pathways for NASs in order to test this conceptual approach was the main focus of this research. The taxonomies, and therefore archetypes, were developed to identify the main common and high-level factors that can be directly compared to produce a limited number of groups with a sizeable subset.

The process maps can provide an overview of the regulatory and reimbursement systems to help explain the complexity of the reimbursement process and provide value for a variety of stakeholders. This can be a useful tool to assist healthcare professionals explain to patients why they may have to wait to gain access to medicines following marketing approval, or why a patient in another European jurisdiction has access to different medicines. The process maps and subsequent archetypes can provide value to HTA agencies who wish to explain their role and processes to external parties and to gain increased knowledge of other systems and HTA processes to facilitate comparison with their peers. The process maps may also help regulators to compare the multiple HTA processes and will be increasingly useful as HTA and regulatory agencies continue to work more closely to provide shared scientific advice (European Medicines Agency (EMA), 2015b). Finally, this approach can provide value to the pharmaceutical industry by enabling a comparison of multiple regulatory and reimbursement systems and identifying groupings with key similarities and differences that could assist market access strategies.

Future research should investigate more detailed HTA activities and comparisons with HTA recommendations to identify whether HTA processes correlate with HTA outcomes. It is acknowledged that information sharing in practice would require a more detailed comparison of HTA methodologies. The taxonomic sets and archetype groups that have been created are deliberately high-level to enable the exploration of new concepts.

SUMMARY

- A novel mapping methodology has produced process maps of the regulatory, HTA and reimbursement systems for New Active Substances in 33 European jurisdictions. These process maps can provide value for patients who wish to understand how their health service provider decides which drugs to reimburse.

- The diversity observed in the 33 process maps was summarised to form two taxonomic sets. The 'System taxonomy' represents the variation of the regulatory, HTA and reimbursement systems organisational architecture. The 'HTA process taxonomy' displays the relationship between the three key elements of the HTA process: therapeutic value assessment, economic value assessment and the appraisal.
- The confluence of the System and HTA process taxonomies identified 10 individual archetype groups to classify all 33 jurisdictions.
- The taxonomic sets and archetype groups provide value to agencies by enabling a comparison of processes with their peers and to industry by enabling a comparison of multiple regulatory and reimbursement systems and identifying groupings with key similarities and differences that could assist market access strategies.
- Colour-coded maps of the 33 European jurisdictions were created for the 'System taxonomy', 'HTA process taxonomy' and the 10 archetype groups. Some regional clustering was observed, but overall the colour-coded maps suggest other factors, such as political and social, may impact the diversity observed in the current European HTA environment.
- The archetypes are labeled by combining the alpha-numeric code given to the taxonomic subgroups from which they are derived. This coding provides an objective form of characterising HTA agencies and the regulatory to reimbursement system. An objective form of classification is desirable as it enables comparison of systems that often have vastly different mandates and avoids scoring on aspects that may be irrelevant for a particular system.
- The differences between the taxonomic groups were evaluated to examine how these archetypes could be useful in practice. The potential impact these differences could have upon information exchange was used to investigate alternative methods for choosing work sharing groups for HTA.

CHAPTER 4

Comparisons of HTA Processes and Reimbursement Recommendations for nine European Jurisdictions using the classification tool

INTRODUCTION

Patients in the developed world are becoming increasingly involved in many stages of their healthcare system from actively engaging in the treatment decision-making process with their physician, to joining patient advocacy groups and providing the patients' perspective for funding decisions. The advent of the internet has provided patients with a wealth of knowledge and increased opportunities for communication and collaboration. However, increased knowledge of treatment options drives consumerism and feeds into the healthcare vortex that drives expectations and demands of the healthcare system (Beyer *et al.*, 2007).

More informed patients are aware of patient access inequalities. Patients living within one jurisdiction may experience delays, or be denied access to the same medicine that was approved for reimbursement in another jurisdiction due to different processes and requirements of the reimbursement system. The need to reduce inefficiencies for access to new medicines in Europe is recognised and the European Commission funded permanent network for HTA will expand on the work conducted by the European Network for Health Technology Assessment (EUnetHTA), (2014) to produce a more collaborative and efficient European HTA environment.

As a result of the research described in Chapter 3 it is proposed that there should be a progressive approach to support moving towards a more aligned HTA environment in Europe. Therefore, two taxonomic sets were developed to classify agencies according to the organisation of the system and the relationship between key HTA processes. The confluence of these two taxonomies produced 10 archetype groups that were developed as a theoretical exercise for categorising HTA processes. This theoretical method of categorisation by the two taxonomic sets will be compared with real world HTA recommendations to identify potential congruence and to highlight areas for refinement.

OBJECTIVES

The main objectives of this study are to:

- 1- Assess the relationship between System taxonomic sets with HTA recommendations for New Active Substances granted EMA approval from 2008 to 2012

- 2- Assess the relationship between HTA Process taxonomic sets with HTA recommendations for NASs granted EMA approval from 2008 to 2012
- 3- Evaluate HTA recommendations for NASs granted EMA approval from 2008 to 2012 by therapeutic area groups

METHODOLOGY

The European Medicines Agency (EMA) online database was searched for New Active Substances granted EMA marketing approval from January 1st 2008 to December 31st 2012. A NAS was defined as:

A chemical, biological, biotechnology or radiopharmaceutical substance that has not been previously available for therapeutic use in humans and is destined to be made available as a prescription only medicine, to be used for the cure, alleviation, treatment, prevention or in vivo diagnosis of diseases in humans.

Generics, vaccines and products previously licensed for sale in any European jurisdiction were excluded from this study.

Health Technology Assessment recommendations were subsequently identified for each NAS and approved indication(s) from the official national agency websites for the following agencies (Appendix A): The Belgium Health Insurance Agency (INAMI); National Centre for Health and Care Excellence (NICE) in England; French National Authority for Health (HAS); Federal Joint Committee (G-BA) in Germany; National Centre for Pharmacoeconomics (NCPE) in Ireland; Italian Medicines Agency (AIFA); Dutch National Health Care Institute (ZIN); Scottish Medicines Agency (SMC) and The Dental and Pharmaceutical Benefits Agency (TLV) in Sweden. The nine agencies were chosen on the basis of the availability of published recommendations in English or because the agency allows data for HTA recommendations to be available in the public domain. The final selection of agencies also required a selection of jurisdictions that could be allocated to a range of taxonomic sets for comparison. An online translation tool (Google Translate) was also used to aid data collection when agency recommendations were not available in English, such as: AIFA; INAMI; TLV and ZIN.

When more than one review was published, the first HTA recommendation or listing was recorded and the completed dataset was also validated. Each HTA

recommendation or listing was then allocated to one of the following three categories: recommended; recommended with restrictions or not recommended.

The three HTA recommendation categories were subsequently numerically coded for direct comparison between agency pairs to enable the identification of the total number of recommendations with congruent outcomes. The percentage of total congruent outcomes were calculated for each pair of agencies and presented in two colour-coded cross-tabulation tables. The two tables grouped each jurisdiction according to the two taxonomies ('System taxonomy' and 'HTA process taxonomy') developed in chapter 3. These tables facilitated testing of the following hypotheses:

- 1- There is a correlation between HTA recommendations and System taxonomic sets
- 2- There is a correlation between HTA recommendations and HTA Process taxonomic sets

The NASs identified for this study were also classified according to the British National Formulary categories to enable a comparison of HTA recommendations by therapeutic areas.

RESULTS

Results are presented in three parts:

PART I- reimbursement recommendations by nine EU jurisdictions for NASs approved by EMA

PART II- a comparison of nine HTA agencies for congruence with respect to taxonomic groupings following EMA regulatory approvals

PART III- a comparison of nine HTA agencies reimbursement recommendation with respect to therapeutic area

PART I- Reimbursement recommendations by nine EU jurisdictions for NASs approved by EMA

A total of 102 NASs were approved by the EMA from January 1st 2008 to December 31st 2012. The online databases for the nine European jurisdictions were

subsequently searched for reimbursement recommendations for each of the NASs and their approved indication(s). The quantity of information available varied between jurisdictions, as the only data obtained was that in the public domain. Published reimbursement recommendations were recorded and classified into three categories: recommended, recommended with restrictions and not recommended (Table 4.1).

The INAMI (Belgium) online database reported the reimbursement status of 69% of the total 102 NASs approved by the EMA. NASs approved for reimbursement by INAMI are categorised into one of three classes: “Class 1” are NASs of added therapeutic value; “Class 2” is for NASs with comparable therapeutic value and “Class 3” is for Generics. (Belgium Health care Knowledge Centre (KCE), 2013) Class 3 has been excluded from table 4.1 as only recommendations for NASs have been recorded.

Reimbursement recommendations for NICE (England) were only available for 39% of the NASs because NICE only conduct an appraisal for NASs expected to have a ‘significant impact’ and excludes generics, biosimilars, antibiotics, vaccines and HIV drugs (National Institute for Health and Care Excellence (NICE), 2015a).

HAS (France) reviewed the largest proportion of the 102 EMA NASs (91%). NASs recommended for reimbursement by HAS include an Improvement in Medical Benefit (ASMR) score of I to V.

Recommendations from the G-BA (Germany) early benefit assessment are published online as a requirement of the Act on the Reform of the Market for Medicinal Products (AMNOG). However, AMNOG only came into effect from January 1st 2011 so older NASs would not have been reviewed by the AMNOG process. Therefore, the G-BA produced the lowest number of recommendations (30%) as G-BA early benefit assessment recommendations are only available for products approved by the EMA from 2010 onwards. All recommendations issued by the G-BA have been allocated to the universal reimbursed category because the G-BA recommendation gives a score for the added therapeutic benefit.

Table 4.1: Multinomial classification for HTA recommendations

Jurisdiction (Agency)	Reimbursed	Reimbursed with restrictions	Not reimbursed	Total recommendations for 102 NASS approved by EMA
Belgium (Belgium Health Insurance Agency (INAMI))	Insured (Class 1)	Orphan drugs	Not Reimbursed	69%
	Insured (Class 2)			
England (National Institute for Health and Care Excellence (NICE))	Recommended	Optimised	Not recommended	39%
France (French National Authority for Health (HAS))	Approved	Approved with restriction	Not recommended	91%
Germany (Federal Joint Committee (G-BA))	Indication of a considerable additional benefit	N/A	N/A	30%
	Hint of considerable additional benefit			
	Proof of a significant additional benefit			
	Minor additional benefit			
	Additional benefit has not been proved			
Ireland (National Centre for Pharmacoeconomics (NCPE))	Reimbursement Recommended	N/A	Reimbursement not recommended	56%
			Reimbursement not recommended at submitted price	
Italy (Italian Medicines Agency (AIFA)**)	Reimbursed Class A	Not available	Not available	67%
	Reimbursed class H			
Netherlands (National Health Care Institute (ZIN))	Insured (Annex 1A)	Insured with restrictions	Not recommended	75%
	Insured (Annex 1B)	Expensive drugs policy		
		Orphan drugs		
Scotland (Scottish Medicines Consortium (SMC))	Accepted	Restricted	Not recommended	77%
Sweden (Dental and Pharmaceutical Benefits Agency (TLV))	General	Limitations	Not recommended	61%

The NCPE (Ireland) publishes the recommendations from the initial Rapid Review and the Full Pharmacoeconomic Review. No recommendation is recorded when there is only a recommendation to conduct a Full Pharmacoeconomic review, but the outcome of the Full Pharmacoeconomic Review recommendation is not available.

New Active Substances are reviewed by AIFA for inclusion in the national formulary that consists of three lists: 'list A' for products fully reimbursed by the NHS; 'list H' for products only reimbursed in hospitals and 'list C' for products not reimbursed (Italian

Medicines Agency (AIFA), 2015). Only lists A and H are published online and neither list includes approved indications of criteria for prescribing. Therefore, the negative recommendations are unknown and it is unclear whether the recommended drugs are reimbursed with any restrictions. Due to the ambiguity of these recommendations, Italy has been excluded from the final comparisons.

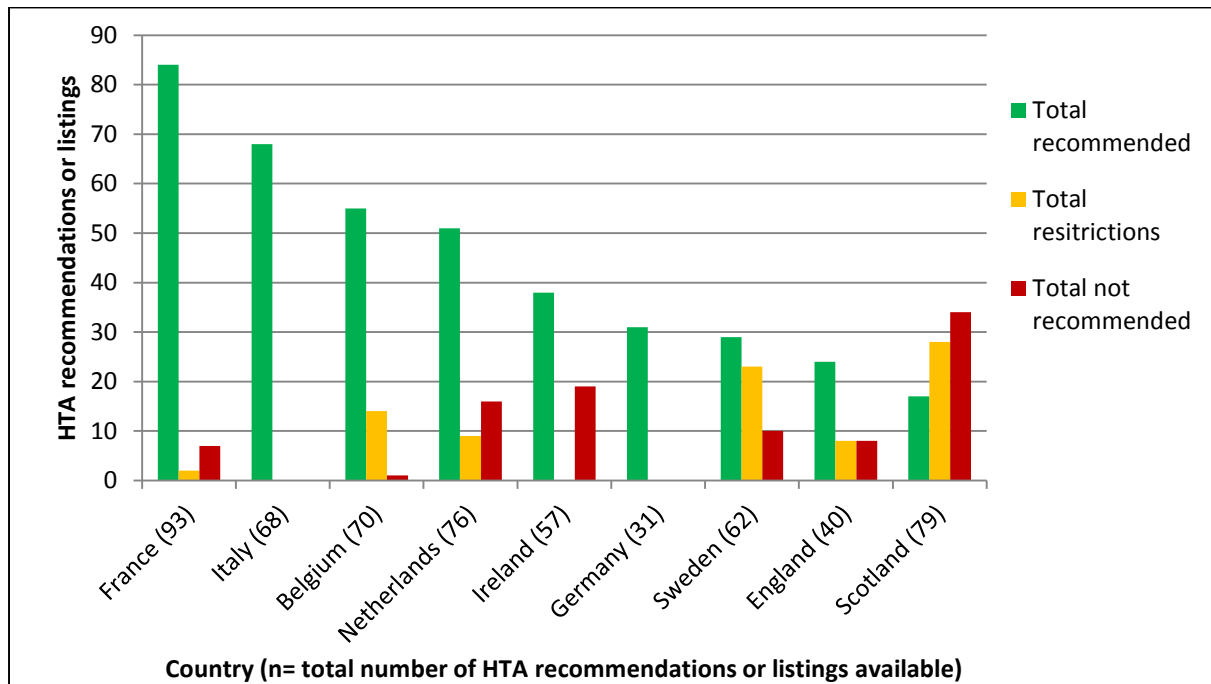
Positive recommendations for reimbursement by ZIN (Netherlands) can be categorised into two groups: 'Annex 1a' for NASs that have a similar therapeutic value and are interchangeable and 'Annex 1b' for NASs that have added therapeutic value.

The SMC (Scotland) reviewed the second highest number of EMA approved NASs (77%) during the study period. The SMC is the only agency that issued a negative recommendation when sponsors of a NAS had failed to submit a dossier for review. These recommendations are not a true negative and have been excluded from this study. Therefore only the first recommendation issued following a complete submission has been recorded.

The TLV (Sweden) published recommendations for 61% of the EMA approved NASs and the online database categorised recommendations under three categories: general, limitations and not recommended.

The HTA recommendations and outcomes for nine European jurisdictions classified according to three categories are presented in Figure 4.1. HAS (France) reviewed the largest number of NASs (n=93) and also had the largest proportion of positive recommendations (n=82). AIFA (Italy) issued the second largest quantity of positive recommendations but AIFA is also the only agency that did not publish information for indications and restrictions. INAMI (Belgium) issued the third largest number of positive recommendations (n=55) and also recommended 15 NASs for reimbursement with restriction. ZIN (Netherlands) reviewed more NASs than Belgium but issued a larger proportion of negative recommendations (n=16). The outcomes of the NCPE (Ireland) assessment did not include a category that could be classified as restricted. Therefore there are no NASs allocated a restricted recommendations by the NCPE

Figure 4.1: HTA recommendations and listing outcomes for 9 European jurisdictions classified according to three categories.



The G-BA (Germany) early benefit assessment recommendations are only available for 31 of the NASs reviewed by the EMA. The G-BA only issues a recommendation for the level of added therapeutic benefit to be used in price negotiations. Therefore, there are no recommendations classified as ‘restricted’ or ‘not recommended’. The TLV (Sweden) reviewed more than half (n=62) of the NASs approved by the EMA but only 10 of the reviewed NASs were not recommended for reimbursement. The SMC (Scotland) issued the largest number of negative reimbursement recommendations (n=17) and the fewest positive recommendations (n=34).

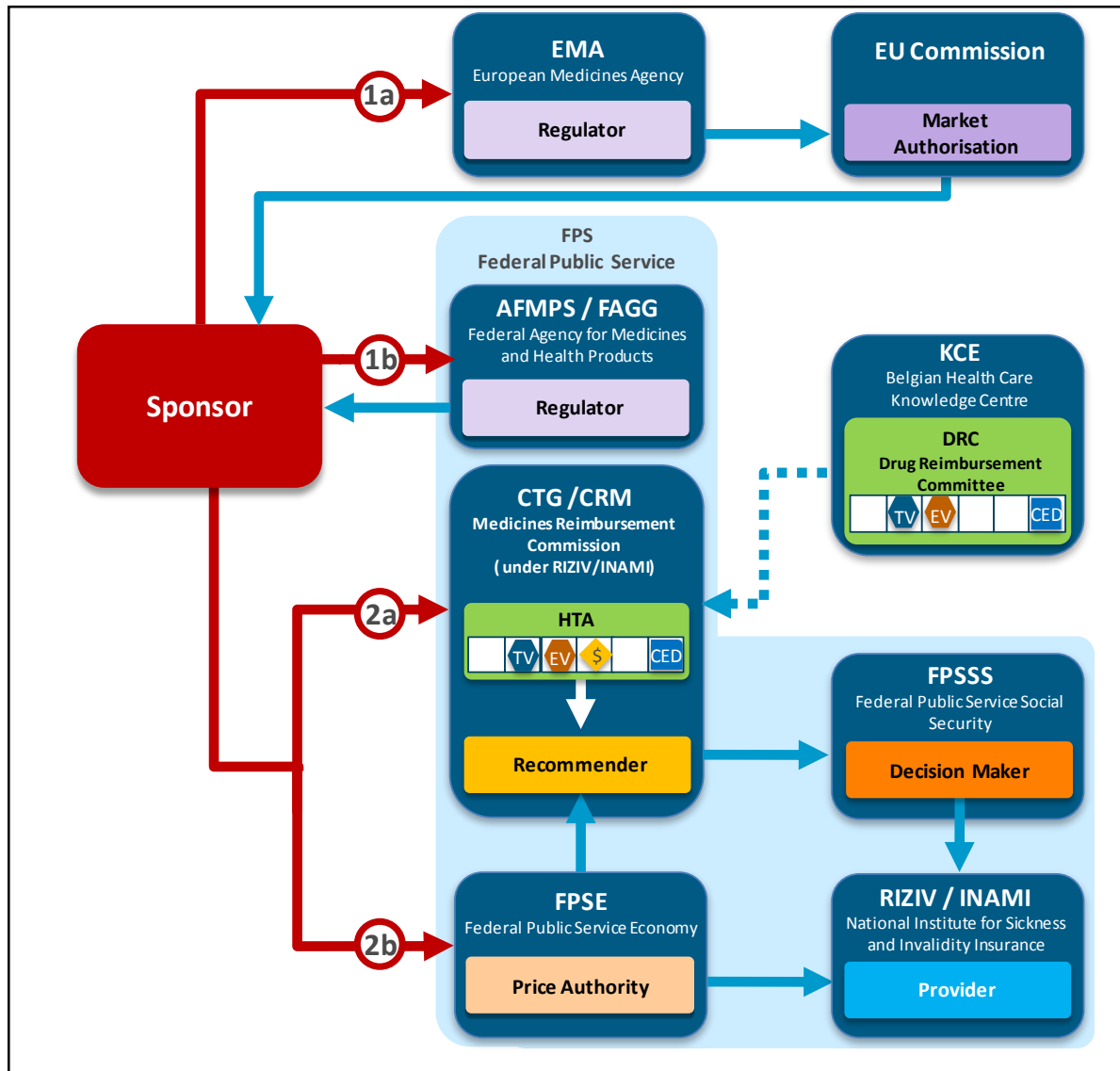
The reimbursement pathway for NASs is outlined for all nine European jurisdictions in figures 4.2 to 4.10.

Belgium

Once a NAS has been granted marketing approval by the EMA or the Federal Agency for Medicines and Health Products (AFMPS), the sponsor (manufacturer) can apply for reimbursement by INAMI (Figure 4.2). The cost-effectiveness and added therapeutic value of the NAS is evaluated by the Medicines Reimbursement Commission (CTG) and the maximum price is then determined by the Federal Public Service Economy (FPSE). Finally, the reimbursement level is decided by the Federal

Public Service Social Security (FPSSS). NASs allocated to Class 1 are fully reimbursed and can be priced according to the level of added therapeutic value, but NASs allocated to Class 2 have a comparable therapeutic value and the maximum reimbursement price is set according to the price of other drugs in the same category (Belgium Health care Knowledge Centre (KCE), 2013).

Figure 4.2: Process map for Belgium (May 2014)

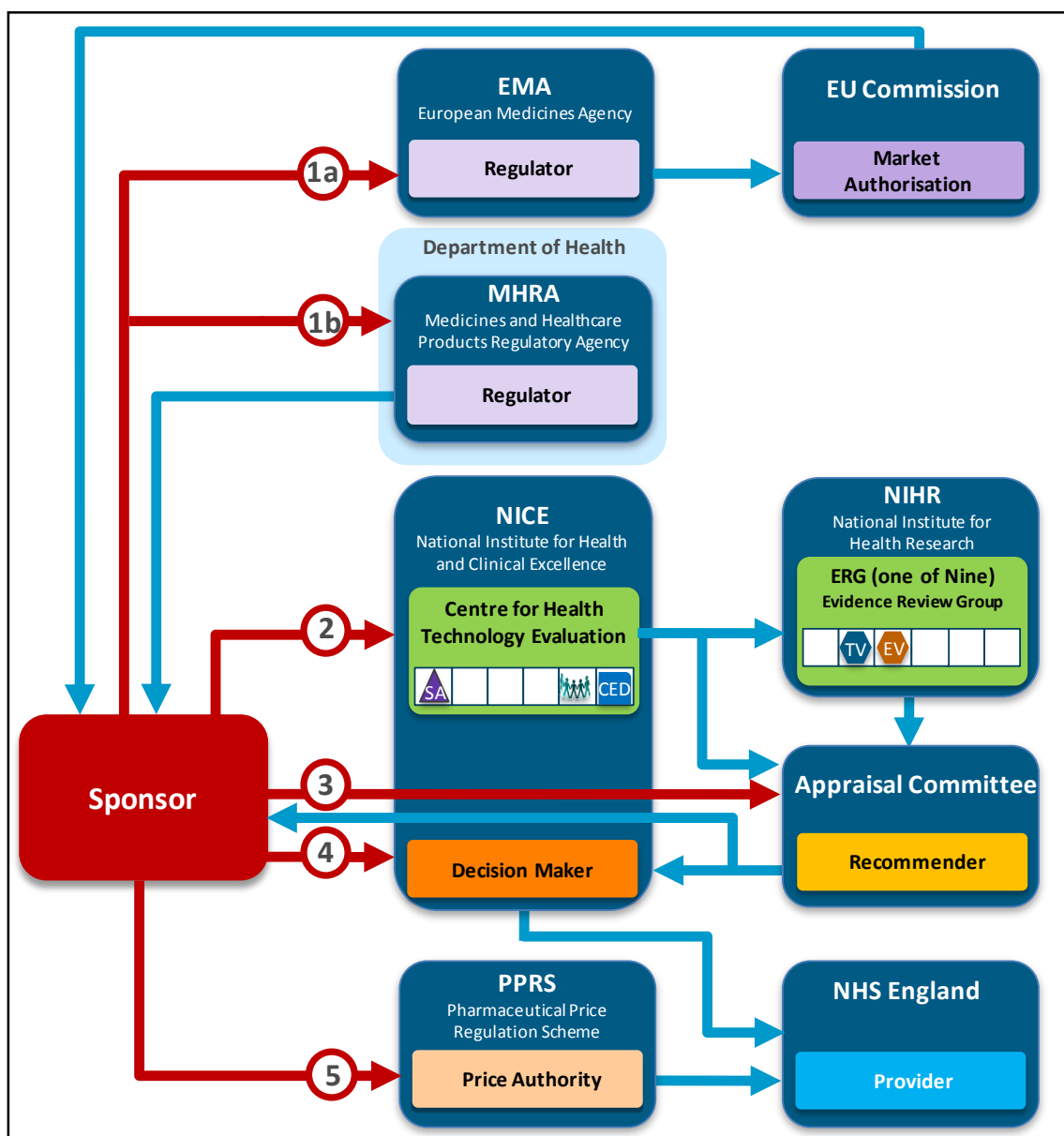


England

The English national HTA agency (NICE) only review NASs that are expected to have a 'significant impact' and excludes generics, biosimilars, antibiotics, vaccines and HIV drugs (National Institute for Health and Care Excellence (NICE). 2015a). NICE conducts horizon scanning and receives requests from the Department of Health to

identify potential NASs for review. Manufacturers can submit information about their upcoming products to be included in NHS horizon scanning via UK PharmaScan online. Once a NAS receives a positive recommendation by NICE, it is legally required to be made available to all eligible NHS England patients (Figure 4.3). Therefore, antibiotics are excluded from NICE appraisals due to regional differences in antibiotic resistance. NICE does not review HIV drugs or prepare treatment guidelines for HIV because these are prepared by the British HIV Association (BHIVA) and clinicians prescribe HIV treatment inline with the BHIVA guidance (British HIV Association (BHIVA), 2015).

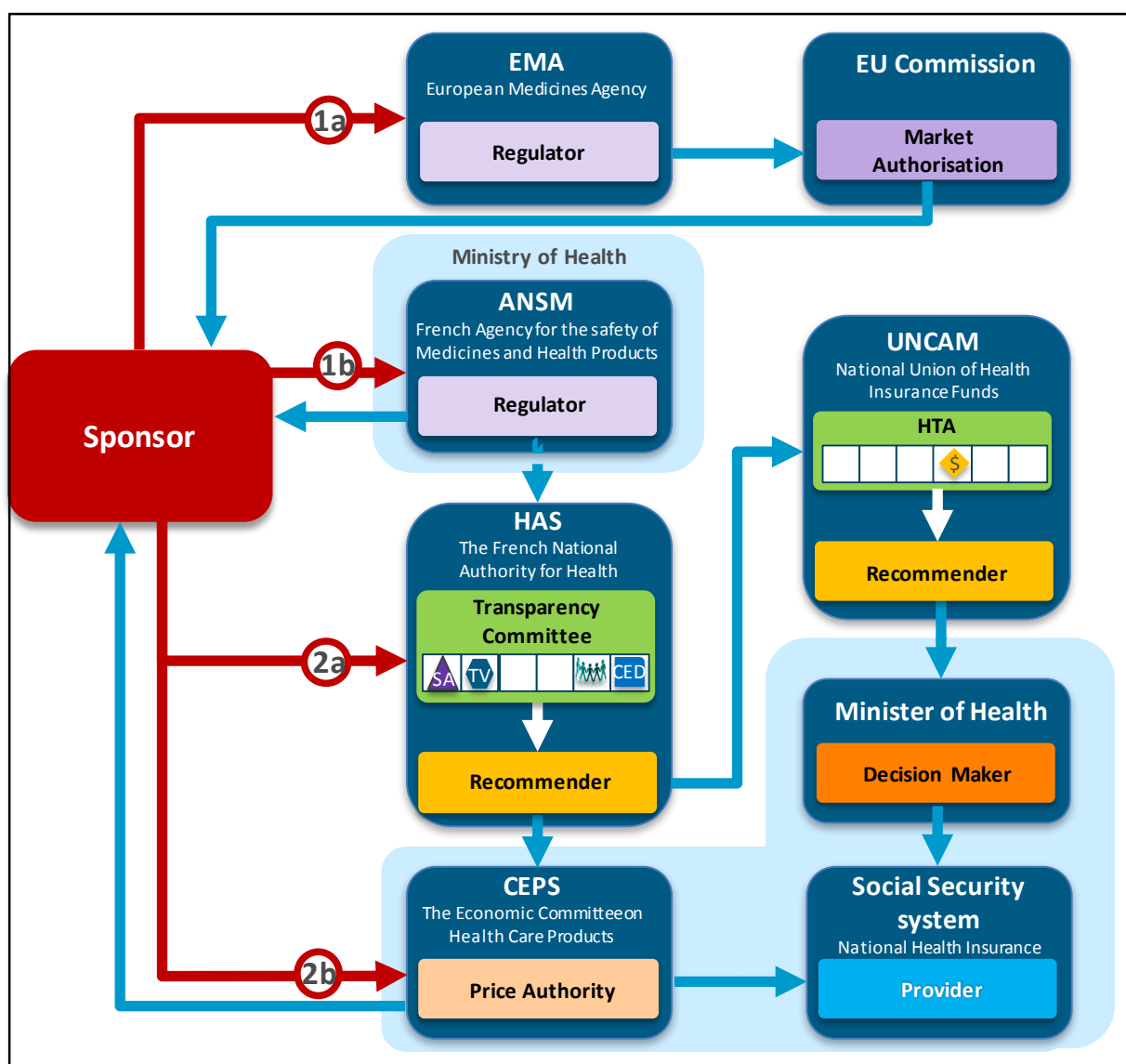
Figure 4.3: Process map for England (August 2014)



France

The French national HTA agency (HAS) accepts applications to review NASs granted marketing approval by the EMA for reimbursement by the French Social Security System (Figure 4.4). The Transparency Committee reviews the medical benefit (SMR) and improvement in medical benefit (ASMR) and forwards the recommendation to the Economic Committee on Health Care Products (CEPS) to determine price and to the National Union of Health Insurance Funds (UNCAM) to decide on the reimbursement rate.

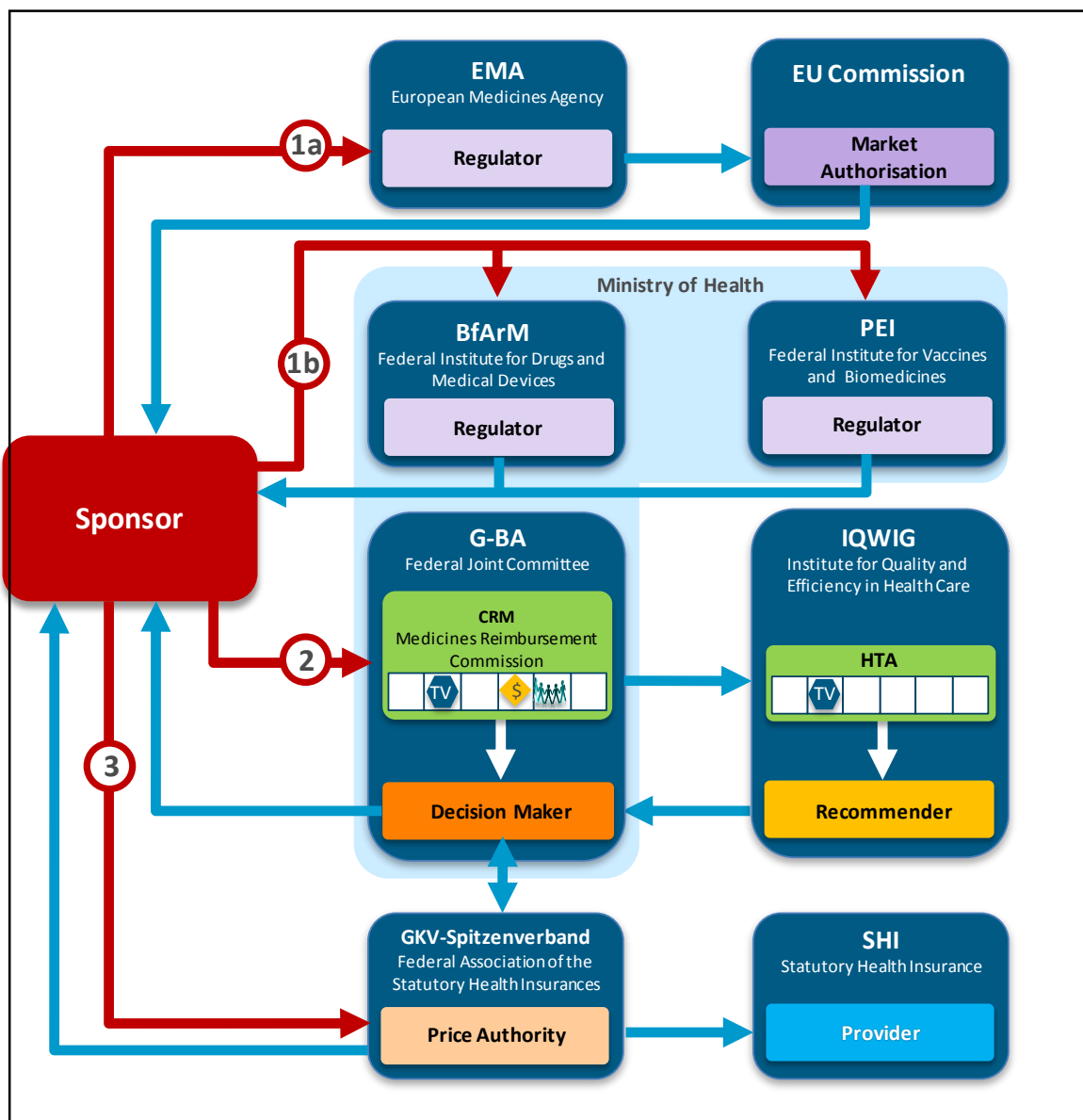
Figure 4.4: Process map for France (July 2014)



Germany

When a NAS is granted marketing approval in Germany the sponsor (manufacturer) is free to set the initial price (valid for 12 months) but also required to submit a dossier to the Federal Joint Committee (G-BA) (Figure 4.5). The added therapeutic benefit of the NAS is assessed either by the G-BA or the Institute for Quality and Efficiency in Healthcare (IQWiG) on behalf of the G-BA.

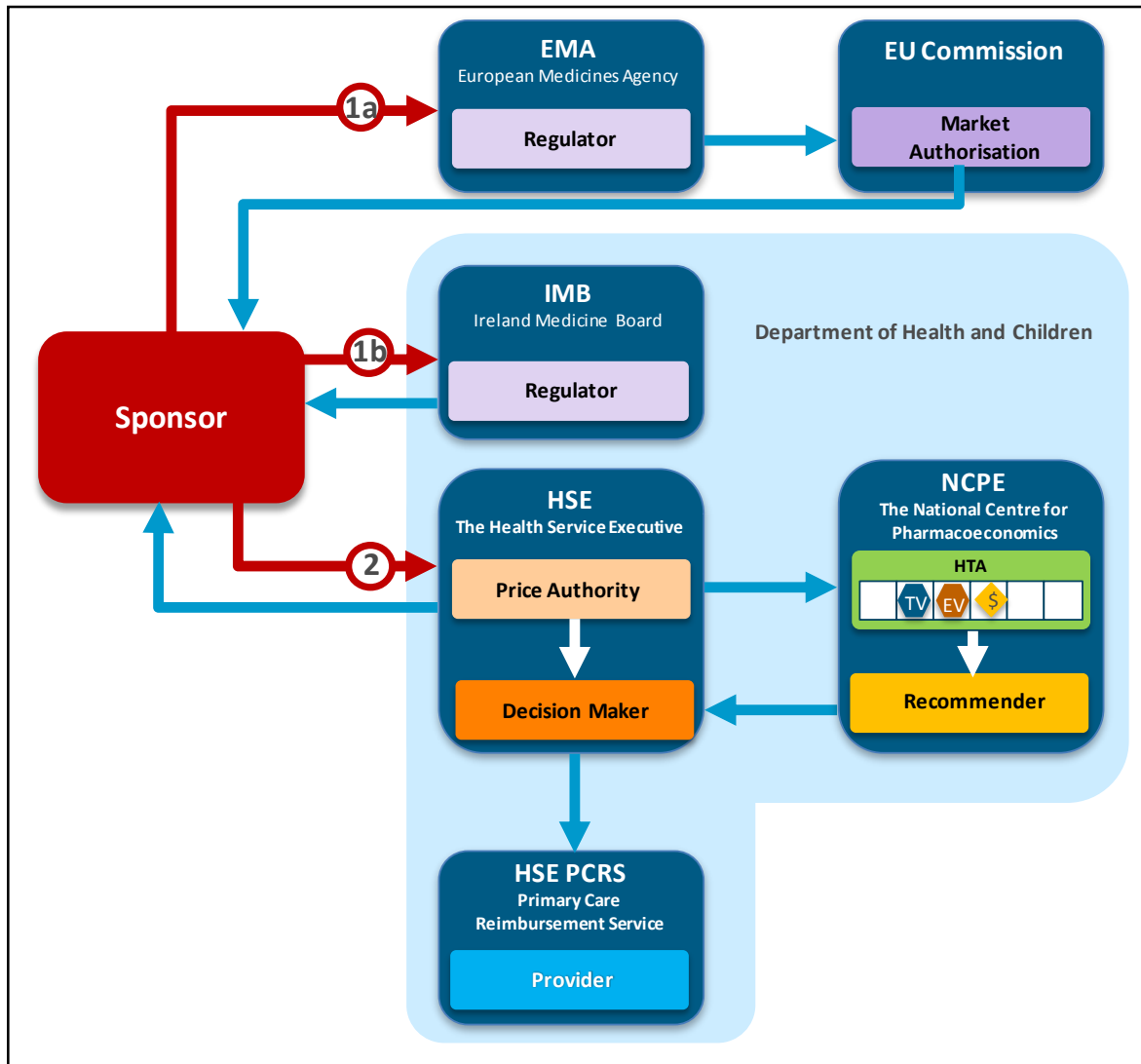
Figure 4.5: Process map for Germany (May 2014)



The final added therapeutic benefit score is determined by the G-BA and used to influence price negotiations between the Federal Association of the Statutory Health Insurance (GKV-Spitzenband) and the sponsor (manufacturer) to set the

reimbursement price. NASs that score one of the four levels of added therapeutic benefit will be priced according to the comparators and the level of added therapeutic benefit. NASs deemed to have no added therapeutic benefit will be priced inline with comparators. The final reimbursement price will be effective after the first year of launch (Federal Joint Committee (G-BA), 2015b).

Figure 4.6: Process map for Ireland (May 2014)



Ireland

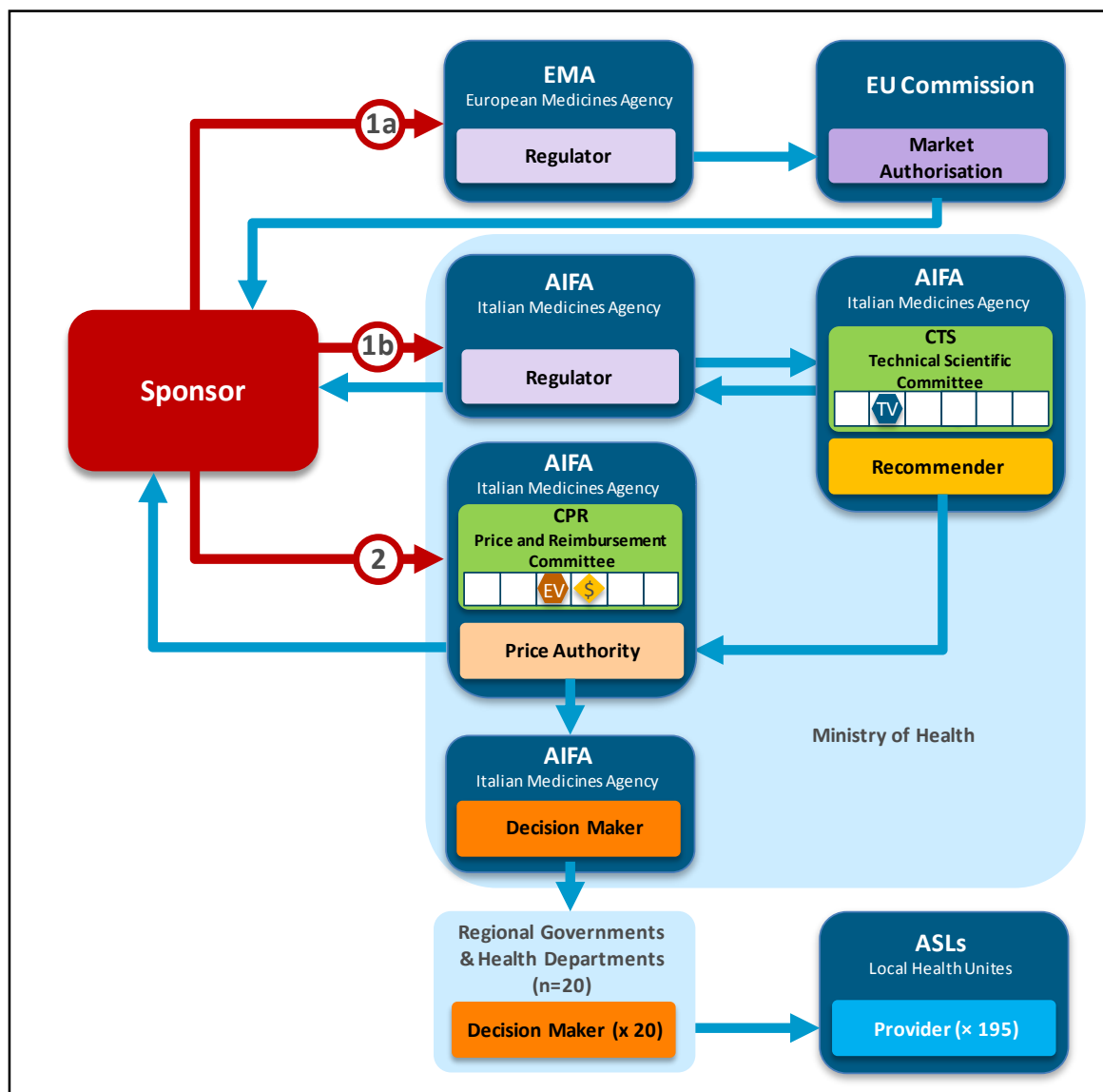
The National Centre for Pharmacoeconomics (NCPE) conducts a review of all NASs granted marketing approval for sale in Ireland. The sponsor (manufacturer) must submit a dossier to the NCPE for a Rapid Review (Figure 4.6). NASs that are 'high-cost products or those with a significant budget impact' are submitted for a full pharmacoeconomic assessment (National Centre for Pharmacoeconomics (NCPE),

2014). The NCPE recommendation is then sent to the Health Service Executive (HSE) to determine the final reimbursement decision.

Italy

Once a NAS has been granted marketing approval by the EMA or the Italian Medicines Agency (AIFA), the sponsor (manufacturer) can apply for the NAS to be included in the national pharmaceutical formulary (Figure 4.7).

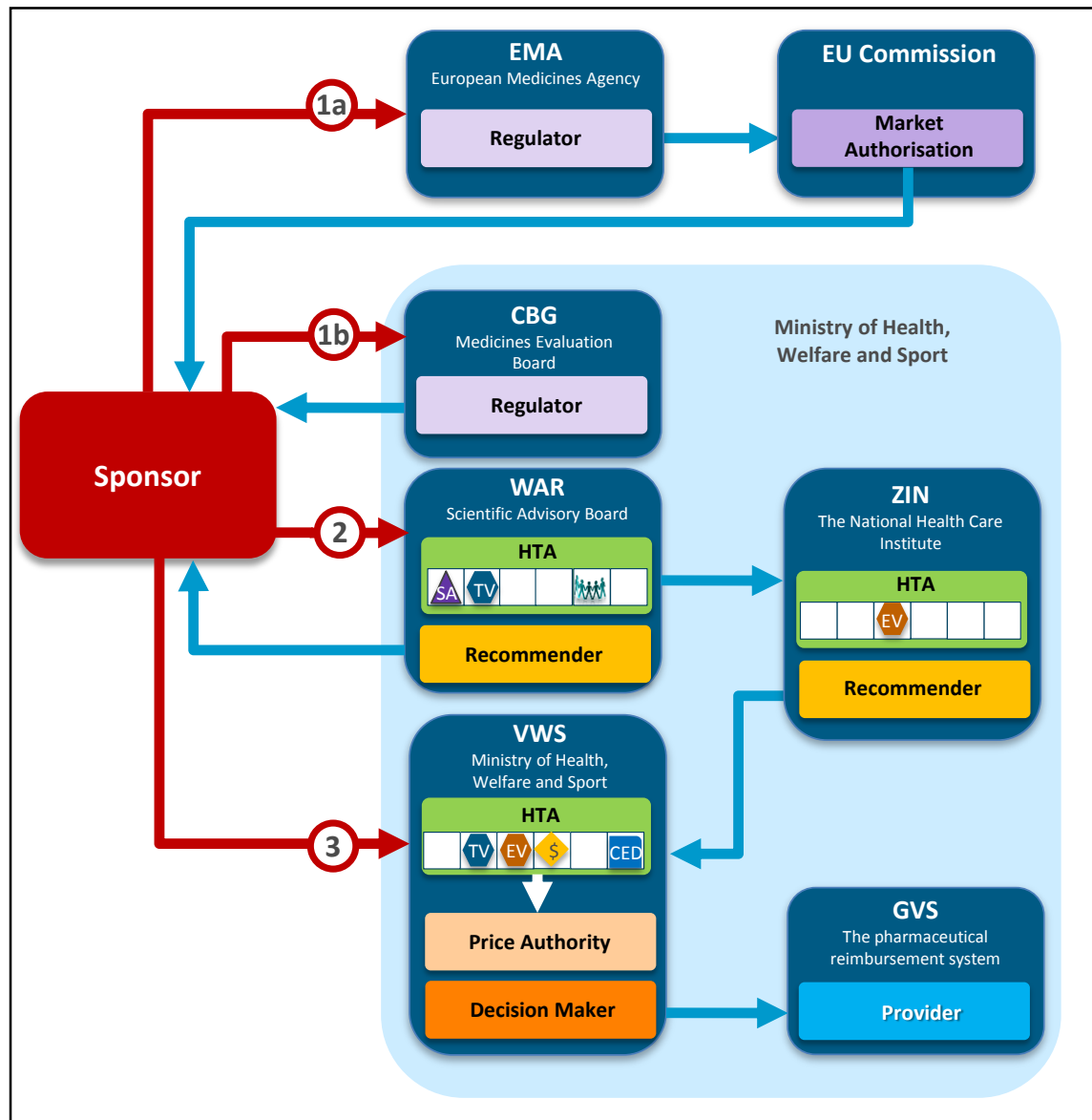
Figure 4.7: Process map for Italy (May 2014)



First, AIFA will classify the NAS according to the severity of disease and then determine the level of innovation compared to existing treatments. The Pricing and

Reimbursement Committee (CPR) will negotiate the final reimbursement price with the manufacturer. However, the level of co-payment is determined at the regional level.

Figure 4.8: Process map for the Netherlands (May 2014)



The Netherlands

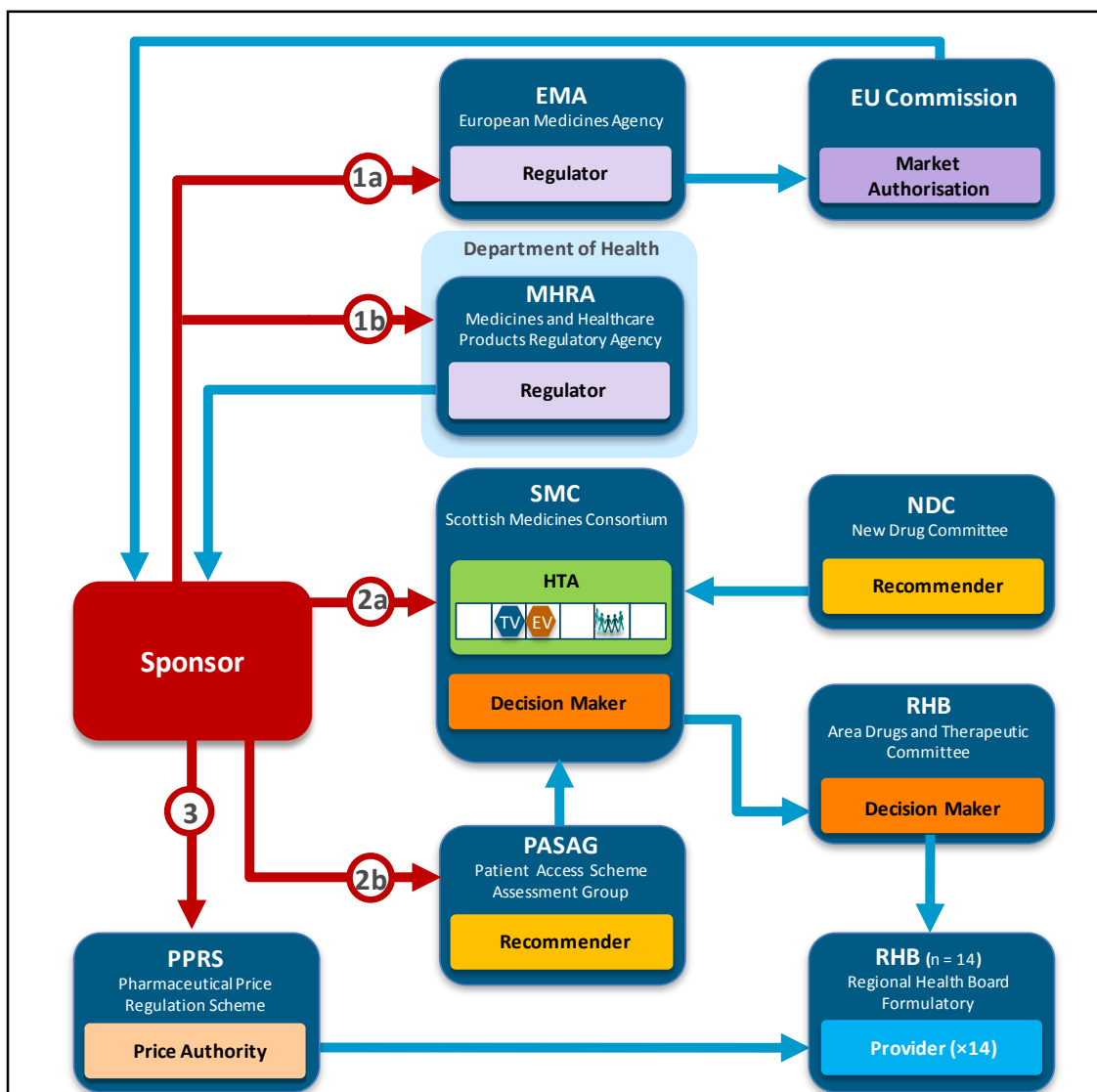
New Active Substances granted marketing approval by the EMA or the Medicines Evaluation Board (CGB) must be reviewed by ZIN (Dutch National Health Care Institute) to determine reimbursement eligibility by the Pharmaceutical Reimbursement System (GVS) (Figure 4.8). NASs are reviewed by the Scientific Advisory Board (WAR) to determine whether they have a therapeutic value ('Annex 1a') that is interchangeable with comparators or an added therapeutic benefit ('Annex

1b'). The NASs allocated to 'Annex 1b' are priced in relation to other drugs in the same group.

Scotland

Sponsors (manufacturers) of NASs granted marketing approval by the EMA or the MHRA, are required to submit a dossier to the SMC at the time of launch (Figure 4.9). The SMC will review the data submitted by the sponsor to determine the added therapeutic benefit and cost-effectiveness of the NAS.

Figure 4.9: Process map for Scotland (May 2014)



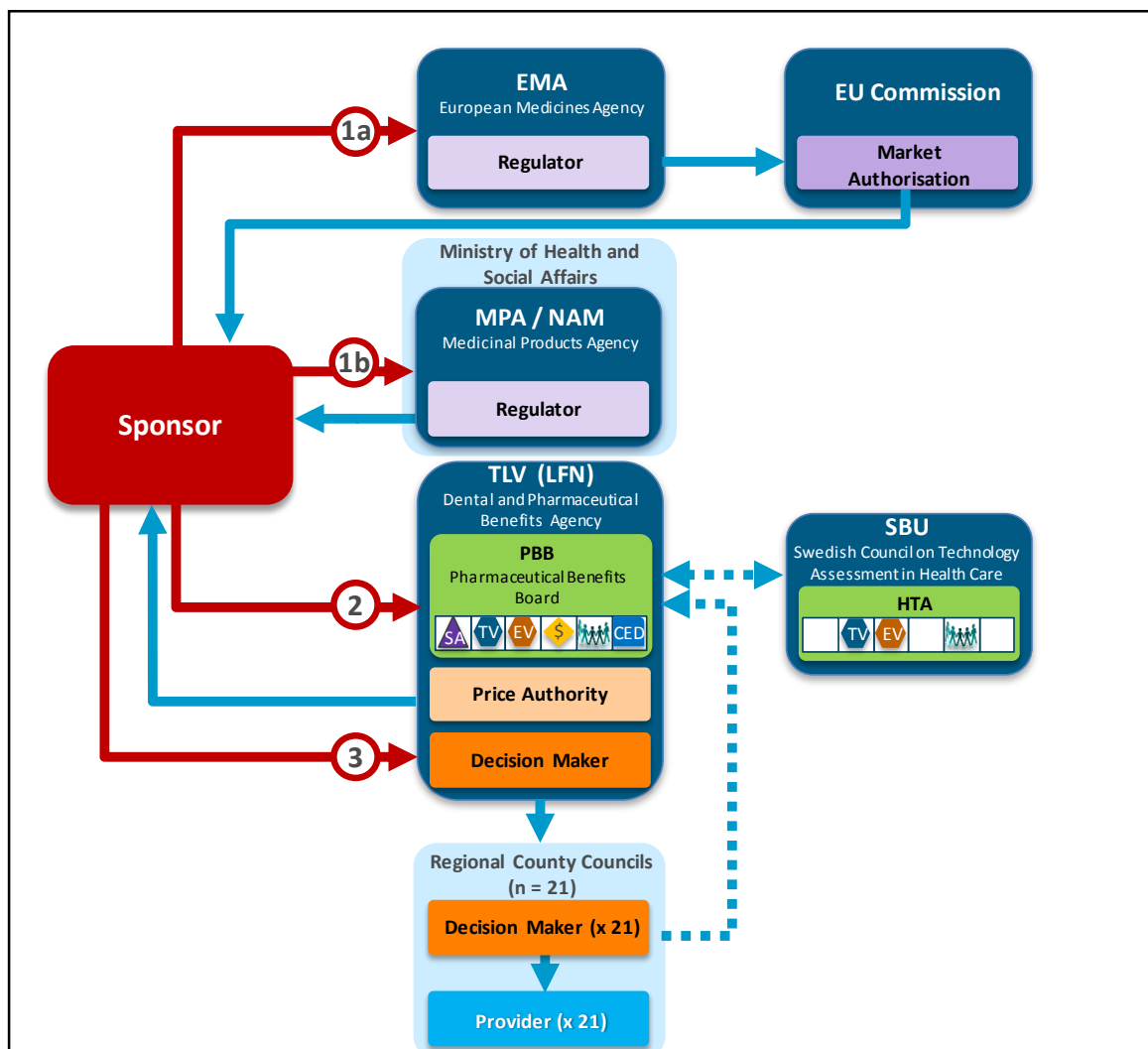
The Patient Access Scheme Assessment Group (PASAG) conducts an assessment of the feasibility of any sponsor proposed patient access schemes and provides a recommendation to NHS Scotland. If the SMC recommends a new medicine based on

a PASAG approved patient access scheme the SMC will disseminate details of the scheme to the NHS boards (Scottish Medicines Consortium (SMC), 2015a). Positive recommendations of the SMC are included in the regional formularies and reimbursed by NHS Scotland.

Sweden

When a NAS has been granted marketing approval in Sweden by the EMA or the Medicines Products Agency (MPA) the sponsor (manufacturer) can apply to the national HTA agency (TLV) for a decision for reimbursement by the Pharmaceutical Benefits Scheme (Figure 4.10).

Figure 4.10: Process map for Sweden (September 2014)



The TLV is required to review all NASs but the sponsor may also apply to the individual Regional County Councils for reimbursement. The reimbursement recommendations by the TLV are mandatory and will be adopted by the Regional County Councils, but

the speed and contextualisation of the recommendation will vary between regions. The TLV will not negotiate price, and will therefore base the final reimbursement decision on the price submitted by the manufacturer.

PART II- A comparison of nine HTA agencies for congruence with respect to taxonomic groupings following EMA regulatory approvals

Each national agency was directly compared with the other eight national agencies to determine the percentage of congruent HTA recommendations. A total of 36 unique pair combinations and their congruence percentage were evaluated and displayed in a cross tabulation format (Table 4.2). The congruence percentages have been classified into three grades: high congruence ($\geq 75\%$); medium congruence ($\geq 50\%$) and low congruence ($<50\%$). An official consensus for acceptable level of agreement using percentage agreement could not be identified, but ranges from 75% or higher have been considered acceptable (Graham *et al.* 20012). The lowest end of this range was used to identify high correlation as this enabled two pair wise agreements to be considered as 'high' agreement compared to the majority of results. Each jurisdiction has also been colour coded and grouped according to its allocated System taxonomic set (Figure 3.10).

The largest taxonomic set is S_1 (Germany, Ireland, France, Netherlands and Belgium) that represents a system that has separate agencies or organisations to perform the regulatory, HTA and decision-making functions. The second group is S_3 (England, Scotland and Sweden) and includes systems that have an independent regulatory agency or an agency that performs both the HTA and decision-making functions. Jurisdictional pairs grouped in the same taxonomic set have been highlighted by yellow boxes to aid comparison (Table 4.2). Out of all the countries compared, there were only two pairs that displayed high level congruence (Belgium, France and Germany) and both pairs are located within a single taxonomic group and have been circled in red (Table 4.2). All pairs within the S_1 taxonomic group had a 50% or higher agreement for HTA recommendations and therefore scored either high or medium congruence with the implication that these classifications could provide a basis for collaboration and work sharing.

Table 4.2: Congruence of HTA recommendations and listings allocated to three categories and colour-coded by System taxonomy

Congruent outcomes by 3 categories (total number of products reviewed)	Germany	Ireland	France	Netherlands	Belgium	England	Scotland	Sweden
Germany	N/A	54% (24)	93% (30)	68% (25)	79% (24)	60% (15)	33% (21)	31% (16)
Ireland	N/A	N/A	54% (50)	51% (47)	64% (42)	55% (29)	51% (49)	33% (42)
France	N/A	N/A	N/A	71% (72)	68% (68)	58% (38)	26% (74)	46% (57)
Netherlands	N/A	N/A	N/A	N/A	60% (57)	60% (35)	44% (63)	52% (54)
Belgium	N/A	N/A	N/A	N/A	N/A	65% (31)	27% (60)	54% (46)
England	N/A	N/A	N/A	N/A	N/A	N/A	45% (38)	53% (30)
Scotland	N/A	N/A	N/A	N/A	N/A	N/A	N/A	50% (56)
Sweden	N/A	N/A	N/A	N/A	N/A	N/A	N/A	N/A

System taxonomy Key				
S ₁	S ₂	S ₃	S ₄	S ₅

Congruence Key		
High congruence ≥ 75%	Medium congruence < 75% to ≥ 50%	Low congruence < 50%

N/A- Not Applicable

Taxonomic set S_3 (England, Scotland and Sweden) did not include any high congruence pairs and only included two medium and one low congruence pair. Overall, this has demonstrated that there were two pairs with high congruence ($\geq 75\%$), 18 pairs scored medium congruence ($\geq 50\%$), and 8 pairs scored low congruence ($<50\%$).

The same 36 congruence percentage pairs have been arranged in a second cross tabulation to compare with the HTA Process taxonomic sets (Table 4.3) (Figure 3.11). The nine European jurisdictions have been arranged into three HTA process taxonomic sets. The taxonomic group H_1 (Scotland, Ireland and Sweden) includes HTA agencies that perform the economic evaluations, therapeutic value and appraisal together. The second taxonomic group H_2 (Germany, Belgium and England) perform the therapeutic value and economic value assessment with an independent appraisal and taxonomic set H_3 (France and Netherlands) includes agencies that perform a separate therapeutic value with an independent appraisal. The jurisdictions have also been colour-coded by taxonomic group and jurisdictional pairs grouped in the same taxonomic set have been highlighted with yellow boxes to aid comparison (Table 4.3).

The jurisdictional pairs for countries in HTA process taxonomic group H_2 (Germany, England and Belgium) scored one high congruent pair (Belgium and Germany) and two medium congruent pairs. Group H_1 (Scotland, Ireland and Sweden) scored two medium congruent pairs and one low congruent pair (Sweden and Ireland). Taxonomic group H_3 only included France and Netherlands, with a percentage agreement of 71%.

The distribution of high, medium and low congruence pairs does not suggest any clustering around HTA process taxonomic groupings. The two high congruence pairs have been circled in red but only one appears in a pair allocated to the same taxonomic set (Table 4.3). Equally, only five of the 18 pairs displaying medium congruence are located in the same taxonomic set: England and Germany; England and Belgium; Ireland and Scotland; Sweden and Scotland; France and Netherlands.

Table 4.3: Congruence of HTA recommendations and listings allocated to three categories and colour-coded by HTA Process taxonomy

Congruent outcomes by 3 categories (total number of products reviewed)	Germany	England	Belgium	Scotland	Ireland	Sweden	France	Netherlands
Germany	N/A	60% (15)	79% (24)	33% (21)	54% (24)	31% (16)	93% (30)	68% (25)
England	N/A	N/A	65% (31)	45% (38)	55% (29)	53% (30)	58% (38)	60% (35)
Belgium	N/A	N/A	N/A	27% (60)	64% (42)	54% (46)	68% (68)	60% (57)
Scotland	N/A	N/A	N/A	N/A	51% (49)	50% (56)	26% (74)	44% (63)
Ireland	N/A	N/A	N/A	N/A	N/A	33% (42)	54% (50)	51% (47)
Sweden	N/A	N/A	N/A	N/A	N/A	N/A	46% (57)	52% (54)
France	N/A	N/A	N/A	N/A	N/A	N/A	N/A	71% (72)
Netherlands	N/A	N/A	N/A	N/A	N/A	N/A	N/A	N/A

HTA process taxonomy Key			
H ₁	H ₂	H ₃	H ₄

Congruence Key		
High congruence ≥ 75%	Medium congruence 75% to ≥ 50%	Low congruence <50%

N/A- Not Applicable

The first taxonomic group ('System taxonomy') is more likely to be useful in practice as the HTA recommendations for NAS approved by the EMA demonstrate greater correlation with the 'System taxonomy' than the HTA process taxonomy.

PART III- A comparison of nine HTA agencies reimbursement recommendation with respect to therapeutic area

HTA recommendations by therapeutic area were compared by allocating the 102 NASs to BNF categories (Table 4.4). The category for malignant disease contains the largest group of NASs (n=28) but the second largest category (Cardiovascular system) only contained 11 NASs. Only five of the Cardiovascular NASs had been reviewed by eight or more agencies and three of the NASs had been reviewed by less than half of the nine national agencies in this study. Therefore, only the NASs for malignant disease will be compared as the other categories do not contain enough NASs for a meaningful comparison.

Table 4.4: NASs classified by British National Formulary categories

BNF Category	Total NASs
1- Gastro-intestinal system	3
2-Cardiovascular system	11
3- Respiratory system	7
4- Central nervous system	7
5- Infection	10
6- Endocrine system	9
7- Obstetrics, gynaecology, and urinary-tract disorders	2
8- Malignant disease and immunosuppression	28
9- Nutrition and blood	6
10- Musculoskeletal and joint diseases	10
11- Eye	1
12- Ear, nose, and oropharynx	1
13- Skin	1
14- Immunological products and vaccines	0
15- Anaesthesia	1
Unclassified	5

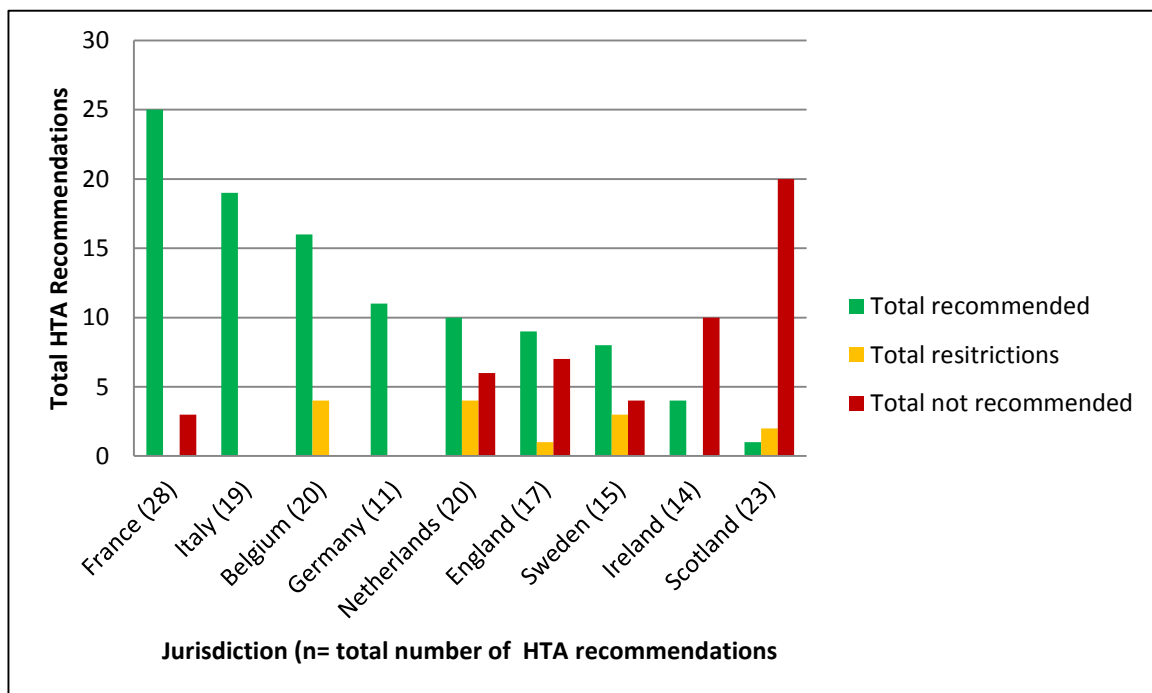
The HTA recommendations for NASs for malignant disease from nine jurisdictions are compared in Figure 4.11.

The French national agency (HAS) was the only agency to review all 28 of the NASs for malignant disease. The 28 recommendations from HAS included 25 positive and three negative decisions.

AIFA (Italy) issued the second largest number of positive recommendations but this may not be a true representation as information for restrictions and negative recommendations was not publicly available.

INAMI (Belgium) recommended positive reimbursement for 20 NASs for malignant disease and of these restricted reimbursement for four NASs.

Figure 4.11: HTA recommendations for NASs for malignant disease



The German G-BA reviewed the fewest number of NASs for malignant disease (n=11) but the G-BA early benefit assessment recommendations only became a legal requirement since 2011 (Figure 4.11).

ZIN (Netherlands) reviewed 20 of the NASs for malignant disease and issued positive recommendations for 10 NASs, four were recommended with restrictions and six were issued a negative reimbursement recommendation.

NICE (England) did not recommend reimbursement for seven of the NASs for malignant disease, recommended one drug with restrictions and recommended nine drugs for full reimbursement.

The TLV only reviewed 15 of the 28 NASs for malignant disease approved by the EMA, of which eight were granted full recommendation for reimbursement, three were recommended with restrictions and four were not recommended.

The SMC (Scotland) and NCPE (Ireland) issued the two highest quantities of negative recommendations for NASs for malignant disease with 20 and 10 negative recommendations respectively (Figure 4.11). A possible explanation for these results could be a higher weighting on cost-effectiveness but the implications of these decisions are that patients in Scotland and Ireland are denied access to treatments approved in other European jurisdictions.

Overall, the percentage congruence of jurisdictional pair recommendations for NASs to treat malignant disease (Table 4.5) was much lower compared to the percentage agreements for all other therapeutic areas (Tables 4.2 and 4.3). The Belgian (INAMI), French (HAS) and German (G-BA) national agencies were the only three to have high congruence for their issued recommendations (Table 4.5). These three national agencies also issued the greatest number of positive recommendations (excluding Italy). This is inline with the previous tables for all therapeutic area congruence pairs (Table 4.2 and 4.3) and the highest observed percentage agreement was 100% for the 11 NASs reviewed by Germany and France. However, the majority of jurisdictional pairings (n=19) had a congruence of less than 50% for recommendations for NASs for malignant disease. The two national agencies with the highest number of negative recommendations (Scotland and Ireland) both had 0% agreement with the German national agency (G-BA). This is likely to be due to the recommendations from the G-BA not including an option for no reimbursement. Instead, the G-BA issues a recommendation of unproven or minimal added therapeutic benefit to guide price negotiations.

Table 4.5: Congruence for HTA recommendations by jurisdictional pairs for NASs for malignant disease

BNF 8	Germany	England	Scotland	Ireland	France	Netherlands	Sweden	Belgium
Germany	N/A	38% (8)	0% (6)	0% (7)	100% (11)	63% (8)	0% (4)	78% (9)
England	N/A	N/A	47% (15)	44% (9)	41% (17)	46% (13)	44% (9)	54% (13)
Scotland	N/A	N/A	N/A	69% (13)	9% (23)	24% (17)	29% (14)	6% (17)
Ireland	N/A	N/A	N/A	N/A	21% (14)	17% (12)	30% (10)	31% (13)
France	N/A	N/A	N/A	N/A	N/A	55% (20)	33% (15)	70% (20)
Netherlands	N/A	N/A	N/A	N/A	N/A	N/A	42% (12)	56% (16)
Sweden	N/A	N/A	N/A	N/A	N/A	N/A	N/A	50% (12)
Belgium	N/A	N/A	N/A	N/A	N/A	N/A	N/A	N/A

Congruence Key		
High congruence ≥ 75%	Medium congruence < 75% to ≥ 50%	Low congruence <50%

N/A- Not Applicable

DISCUSSION

Healthcare systems vary greatly between European jurisdictions. However, the processes and requirements for approving new medicines for reimbursement have been established to meet unique population needs and budget limitations. Two taxonomic sets and archetype groups for characterising the diversity of processes observed in 33 national European healthcare systems have been developed (Chapter 3) and these have been compared with HTA recommendations from nine European national agencies that have been included based on transparency and language limitations.

The depth of information published varied between agency websites, as does the rationale for the HTA recommendation and this provides some difficulties for the comparisons carried out. For example, SMC (Scotland) publishes recommendations for the reimbursement and criteria for use of NASs, but the G-BA (Germany) publishes a recommendation with a score for the level of added therapeutic benefit compared to existing treatment options, which will be used to guide pricing. Therefore, the SMC recommendations can be easily allocated into all three of the reimbursement recommendation categories used in this study: recommended, recommended with restrictions and not recommended (Federal Joint Committee (G-BA), 2015a; Scottish Medicines Consortium (SMC), 2015b). Conversely, the German G-BA recommendation only provides a score for the level of added therapeutic benefit and can only be categorised into a single category: 'recommended'. Both the G-BA and SMC publish recommendations including the indications under review and it is clear when the SMC has issued any negative recommendations or recommendations with restrictions.

Despite the difficulties for comparing G-BA recommendations, Germany has been included in this study because it is a very important market. Germany has the largest pharmaceutical sector in Europe with the highest value and greatest number of employees (European Commission. 2013). Additionally, the AMNOG law only came into effect from 2011 and has been met with resistance since (Research-Based Pharmaceutical Companies, 2012). Therefore, it was of

interest to include the G-BA early benefit assessment recommendations in this comparative study of European HTA recommendations and processes.

HTA recommendations were compared with the two taxonomic sets rather than the archetype groups as the archetype groups were developed from the confluence of the two taxonomies. Therefore, if HTA recommendations were congruent with both the taxonomic sets, this should also be evident in the archetype groupings. It would not be possible to have a range of jurisdictional pairs for the majority of the ten archetype groups as HTA recommendations were only collected for nine European jurisdictions. The HTA process archetype contains jurisdictional pairs for all three HTA performing taxonomic sets. However, the 'System taxonomy' does not contain pairs for two of the four taxonomic sets: S₂ and S₄. The S₂ taxonomic set is unusual as only two agencies were allocated to this set for the full European study. The S₄ taxonomic group included more jurisdictions in the full study (Chapter 3) than the S₂ set but is only represented by Italy in this study.

The congruence between HTA recommendations and taxonomic sets was calculated by percentage agreement for all 36 possible combinations of jurisdictional pairs. The percentage agreement results support the first hypothesis that there is a correlation between HTA recommendations and System taxonomic sets. This could imply that there is a relationship between the regulatory, HTA and decision-making functions in the healthcare system and the final HTA recommendations. A relationship between the process and HTA recommendations could support the conclusions of chapter three that suggests identifying working groups based on process could be useful for a progressive alignment approach. However, the lack of correlation between the 'HTA process taxonomy' and HTA recommendations does imply that further research is required to refine the archetypes for real life application.

The second hypothesis, that there are correlations between HTA recommendations and HTA process taxonomic sets is not supported by the results of this study. It is more difficult to allocate agencies to HTA process taxonomic sets because it is not always clear how independent the clinical evaluation will be from the economic evaluation. For example, HAS (France)

now requires a submission of an economic dossier in parallel with the clinical submission but only for NASs that have a high rating for improvement in medical benefit (ASMR I, II or III) and a estimated annual cost of more than €20 million (Rumeau-Pichon *et al.*, 2014). Therefore, the HAS evaluation could be allocated to a different HTA process taxonomic set depending on the NAS evaluated.

One hundred and two NASs were allocated to therapeutic areas using the BNF categories. However, only the category for NASs for malignant disease contained a large enough group for comparison (n=28). Only one of the 28 NASs was reviewed by all nine jurisdictions. Vemurafenib, was granted marketing approval by the EMA in 2012 as ‘monotherapy for the treatment of adult patients with BRAF-V600-mutation-positive unresectable or metastatic melanoma.’ (European Medicines Agency (EMA), 2014). Six jurisdictions approved vemurafenib for reimbursement (Belgium, England, Germany, France, Italy and Netherlands) but three jurisdictions did not recommend vemurafenib due to cost (Ireland, Scotland and Sweden). Five NASs were reviewed by eight of the nine jurisdictions: ipilimumab, fingolimod hydrochloride, gefitinib, abiraterone acetate and cabazitaxel. Notably, all five of these NASs were not recommended for reimbursement by the NCPE (Ireland) or the SMC (Scotland).

The G-BA early benefit assessment does not issue negative reimbursement recommendations but it does classify NASs according to the added therapeutic benefit. Two NASs for malignant disease (pixantrone dimaleate and vandetanib) were allocated to the G-BA’s lowest classification group for NASs that have not proven any therapeutic benefit. Pixantrone dimaleate was also reviewed by HAS (France) and NICE (England). HAS also assigned pixantrone dimaleate to the lowest classification for added therapeutic value (V-absence) but has approved pixantrone dimaleate for as third or fourth-line treatment for multiply relapsed or refractory aggressive non-Hodgkin B-cell lymphomas. NICE granted optimised reimbursement status for pixantrone dimaleate as a third or fourth-line treatment at the discounted price agreed with the manufacturer for the patient access scheme. Vandetanib was classified as no proven benefit as the G-BA did not receive full documentation for review.

Belgium, France, Italy and Netherlands approved vandetanib for reimbursement but HAS (France) only found a minor therapeutic benefit and Netherlands recommended vandetanib for reimbursement with only a comparative therapeutic benefit ('Annex 1a').

Overall, the comparison of the 28 NASs for malignant disease revealed a larger proportion of low congruent percentage agreements (n=19) compared to the comparison of 102 NASs for all therapeutic areas (n=8). Both comparisons produced only two jurisdictional pairs with a high congruence percentage. Therefore, the larger quantity of jurisdictional pairs with a medium congruence agreement for the comparison with all therapeutic areas would suggest that NASs in therapeutic areas other than malignant disease could have much greater agreement for HTA recommendations and should be investigated further.

Overall, the comparison of HTA recommendations for EMA approved NASs with the two taxonomic groups has provided value by identifying a correlation between the organisation of the healthcare reimbursement system ('System taxonomy') and HTA recommendations. The case study comparison of 28 EMA approved NAS for malignant disease between nine European jurisdictions also provides value by demonstrating potential variation between HTA recommendations and therapeutic area.

SUMMARY

- HTA recommendations for nine national agencies were obtained from the public domain for 102 NASs approved by the EMA from January 1st 2008 to December 31st 2012.
- HTA recommendations were included from nine national agencies: The Belgium Health Insurance Agency (INAMI); National Centre for Health and Care Excellence (NICE) in England; French National Authority for Health (HAS); Federal Joint Committee (G-BA) in Germany; National Centre for Pharmacoeconomics (NCPE) in Ireland; Italian Medicines

Agency (AIFA); Dutch National Health Care Institute (ZIN); Scottish Medicines Agency (SMC) and The Dental and Pharmaceutical Benefits Agency (TLV) in Sweden.

- Potential congruence between the 'System taxonomy' and HTA recommendations was identified. A relationship between system organisation and HTA recommendations supported the conclusion (Chapter 3) that suggest identifying working groups based on system organisation.
- Agreement between the 'HTA process taxonomy' and HTA recommendations was not identified. This does imply that further research is required to refine 'HTA process taxonomy' and this would subsequently influence the archetype groups derived from the confluence of the two taxonomies.
- HTA recommendations for malignant disease demonstrated a larger number of jurisdictional pairs with low congruence compared to the comparisons that included NASs from all therapeutic areas. Further research should evaluate more therapeutic areas to identify whether certain therapeutic areas impact HTA recommendations.

CHAPTER 5

A Comparison of HTA Processes and Reimbursement Recommendations in Australia, Canada and the UK

INTRODUCTION

An estimated \$103 billion was lost in global pharmaceutical sales following patent expiry during the period of 2009 to 2012 (Deloitte, 2012), with the result that generics rapidly replaced multiple top blockbuster branded medicines (Jimenez, 2012; Thakur and Ramacha, 2012). Competition from generics is increasing, and the global generics market is predicted to reach over \$400 billion by 2016 (IMS Institute for Healthcare Informatics, 2012; Vernaz *et al.*, 2013). The growing availability of less expensive generics plus the rising costs for new medicines and limited healthcare budgets increases the need for the rationalised allocation of public resources (Pammolli *et al.*, 2011; Stuckler *et al.*, 2010). As a result, most public health providers require manufacturers to demonstrate the benefits of their new drug technology over existing treatments prior to reimbursement approval. The evaluations of treatments to guide health policy and reimbursement decisions is usually performed by Health Technology Assessment (HTA) agencies. HTA can minimise patient access inequalities, support evidence-based medicine and promote the efficient use of resources (European Network for Health Technology Assessment (EUnetHTA), 2008). However, HTA can require additional time following post-marketing authorisation and may deny reimbursement for licensed treatments that fail to display sufficient added benefit or that are deemed too costly. Thus, HTA is often cited as the fourth hurdle to patients' access to medicines (Jackson, 2007; Packer *et al.*, 2006; Hutton *et al.*, 2006). Generally, HTA will evaluate the therapeutic value and cost effectiveness of a health technology. However, the scope and methodologies utilised to conduct HTA can vary greatly between agencies, as affordability, and social and political factors are unique to each coverage population (Allen *et al.*, 2013).

Reimbursement recommendations from HTA have to meet a variety of stakeholder needs: manufacturers require their product to be reimbursed to cover the costs of research and development and fund future research for innovative treatments; healthcare providers and payers seek to maximise utilisation of limited resources to provide the best possible healthcare for the population; patients and physicians need access to the most efficacious and innovative treatments.

The methodologies informing the final HTA recommendation vary between agencies. For example, to determine the value of a new pharmaceutical product, France and Germany consider an added therapeutic value assessment (Drummond *et al.*, 2014). Alternatively, Australia, Canada, England and Scotland consider the value of a new pharmaceutical product in terms of health gains expressed in Quality-Adjusted Life-Years (QALY) (Cleemput *et al.*, 2011; Drummond *et al.*, 2014). An Incremental Cost-effectiveness Ratio (ICER) can also be calculated to determine the additional cost per QALY and agencies may have an implicit (e.g., Canada and Australia) or explicit (e.g., England and Scotland) ICER thresholds for determining reasonable cost-effectiveness (Cleemput *et al.*, 2011).

This study focuses on the HTA environment in Australia, Canada, England and Scotland as these 4 nations have an entwined history and are often classified as sharing a common liberal/ basic security welfare state ideology (Eikemo and Bamba, 2008; Arts and Gelissen, 2002). The classification of the welfare state can help explain why these jurisdictions all provide a basic universal healthcare coverage that is funded through taxation and often means tested.

OBJECTIVES

- Evaluate the national regulatory, HTA and reimbursement pathways for public healthcare in Australia, Canada, England and Scotland
- Compare initial Canadian national HTA recommendations from January 2009 to May 2013 with the initial HTA decisions by Australian, English and Scottish HTA agencies
- Identify factors for differing national HTA recommendations between Australian, Canadian, English and Scottish HTA agencies

METHODOLOGY

Information from the public domain was evaluated to identify the key agencies involved in the national regulatory, HTA and reimbursement process for Australia, Canada, England and Scotland. This information enables the

development of a process map for each jurisdiction using a previously developed mapping methodology (Allen *et al.*, 2010a). The process maps display the regulatory, HTA and reimbursement pathways through a uniform methodology for visual comparison. These maps enable the identification and relationships between the agencies conducting HTA and the body responsible for the final reimbursement decision.

The reimbursement outcomes for Australia, Canada, England and Scotland have also been chosen for comparison due to several common factors: recommendations and rationale are publicly available online, regularly updated, published in English and are transparent (Neumann *et al.*, 2010). Data for the reimbursement recommendations, although not the final coverage decision, were identified for the responsible agency. The Canadian Agency for Drugs and Technologies in Health (CADTH) Common Drug Review (CDR) programme was selected as the primary agency for this study as the intention is to compare the national non-mandatory recommendations with Canadian provincial payer listing decisions (chapter 6). For this study, the list of drug products that meet the following inclusion criteria were identified, namely: initial submission to the CDR with a listing recommendation issued from January 2009 to May 2013. New indication submissions were also included if the initial submission meets the inclusion criteria. The proprietary name, generic name, indication and recommendation were recorded from the online CDR database (Canadian Agency for Drugs and Technologies in Health (CADTH), 2015b).

The published HTA agency recommendations for the Pharmaceutical Benefits Advisory Committee (PBAC) of the Pharmaceutical Benefits Scheme (PBS), (2015) (Australia), the National Institute for Health and Care Excellence (NICE), (2015b) (England) and the Scottish Medicines Consortium (SMC), (2015b) (Scotland) were also obtained for the medicine-indication pairs recorded from the CDR database. The HTA recommendations for Australia, England and Scotland were identified by generic name and indication and included medicines if marketed under a different brand name for the Australian or European market provided they were listed for the same indications as the initial CDR recommendation. Where an agency has reviewed indications separately

or issued different recommendations per indication within a single review, this was recorded as a medicine-indication pair for all four agencies.

The data for HTA recommendations included a range of different outcomes that were specific for each jurisdiction. All potential outcomes were reviewed to enable a cross comparison of the recommendations according to multinomial categories (recommended, recommended with restrictions or not recommended). The proportion of medicines allocated to each category was identified for each jurisdiction. Using these multinomial categories, the recommendations for each medicine were then compared with the drug product listing from each of the other three jurisdictions and coded accordingly.

The rationale for the HTA recommendations for the medicine case studies were collected from the four HTA agency websites (Canadian Agency for Drugs and Technologies in Health (CADTH), 2015b; Pharmaceutical Benefits Scheme (PBS), 2015; National Institute for Health and Care Excellence (NICE), 2015b; Scottish Medicines Consortium (SMC), 2015b). The dates for regulatory approval were also identified from the Australian, Canadian and European regulatory authorities' online databases (Therapeutic Goods Administration (TGA), 2015; Health Canada, 2015; European Medicines Agency (EMA), 2015a).

RESULTS

For the purpose of clarity the results will be presented in four parts

PART I- a review of HTA agencies and their characteristics and role in the healthcare systems for Australia, Canada, England and Scotland

PART II- identification of HTA recommendations for new medicines-indication combinations for Australia, Canada England and Scotland

PART III- an evaluation of the factors influencing concordant HTA recommendations for Australia, Canada, England and Scotland

PART IV- an evaluation of factors influencing discordant HTA recommendations for Australia, Canada, England and Scotland

PART I- a review of HTA agencies and their characteristics and role in the healthcare systems for Australia, Canada, England and Scotland

Characteristics of the healthcare system and HTA agencies of the four chosen countries were recorded for comparison (Table 5.1). Australia, Canada, England and Scotland all provide universal healthcare funded by taxation and share a long history of HTA. The first HTA organisations were established in the eighties in Australia and Canada followed by the UK in 1996. Currently all four countries have a national HTA agency and they all consider clinical effectiveness and cost effectiveness to guide reimbursement recommendations, but their activities vary due to different mandates and their unique political, social and population needs. For example, NICE does not routinely evaluate every medicine for reimbursement by NHS England and Wales. Only medicines that are expected to meet an unmet need or a high cost are considered for a NICE evaluation and some medications are exempt (antibiotics and HIV therapies). However, the SMC conducts a review of all new medicines, formulations and indications to provide a reimbursement recommendation to NHS Scotland. The PBAC also reviews all new medicines to be reimbursed by the PBS. No medicines can be accepted for reimbursement by the PBS without a positive recommendation from the PBAC.

The CDR also reviews all new medicines (excluding oncology products) to provide a listing recommendation to guide the final listing decisions of the participating drug plans. Stakeholder involvement also varies between the four HTA agencies. For example, NICE is currently the only HTA agency that offers scientific advice, but the CDR has recently started to accept applications for its new scientific advice programme.

Table 5.1: Comparison of Canadian, Australian, English and Scottish Healthcare Coverage

Characteristics	Jurisdictions			
	Canada	Australia	England	Scotland
Population 2012	34,880,500*	22,684,000*	53,500,000	5,300,000
Year of first HTA organisation	1988 (Conseil d'Évaluation des Technologies de la Santé du Québec (CETS))***	1982 (The National Health Technology Advisory Panel (NHTAP))+	1996 (National Coordinating Centre for Health Technology Assessment (NCCHA)) **	
Current HTA agency	Canadian Agency for Drugs and Technologies in Health (CADTH) Common Drug Review (CDR)	Pharmaceutical Benefits Advisory Committee (PBAC) of the Pharmaceutical Benefits Scheme (PBS)	National Institute for Care and Health Excellence (NICE)	Scottish Medicines Consortium (SMC)
Products reviewed	The CDR process assesses out patient pharmaceuticals excluding all oncology products as these are reviewed by the pan-Canadian Oncology Drug Review	The PBAC provides a listing recommendation for reimbursement of outpatient pharmaceuticals by the PBS	NICE only assesses pharmaceuticals that are expected to have a high impact or address an unmet need. NICE does not review antibiotics or HIV medication	SMC assesses all new outpatient and inpatient pharmaceuticals
Scientific Advice (SA) programme	Not currently: in 2014 CADTH announced plans for a SA programme and is accepting applications from January 2015	Yes: Manufacturers can submit a request for advice from the Pharmaceutical Evaluation Branch (PEB)	Yes: SA is offered independently and NICE also offers parallel SA with the Medicines and Healthcare Products Regulatory Agency (MHRA) and the European Medicines Agency (EMA)	No
Cost per QALY Threshold (USD+++)	CAD \$20,000 to \$100,000 (USD \$17,214 to \$86,072)	AUD \$69,900 (USD \$57,095)	GBP £20,000 to £30,000 (USD \$ 31,156 to £46,735)	GBP £20,000 to £30,000 (USD \$ 31,156 to £46,735)
Implicit or explicit QALY threshold	Implicit	Implicit	Explicit	Explicit

Data Sources: *Organisation for Economic Co-operation and Development (OECD), (2014b), **Office for National Statistics (2013), ***Menon and Stafinski (2009), + Office of Technology Assessment (1995), ** Drummond and Sorenson (2009), +++ historical conversion rate from January 1st 2015 (XE, 2015)

Table 5.1 (continued): Comparison of Canadian, Australian, English and Scottish Healthcare Coverage

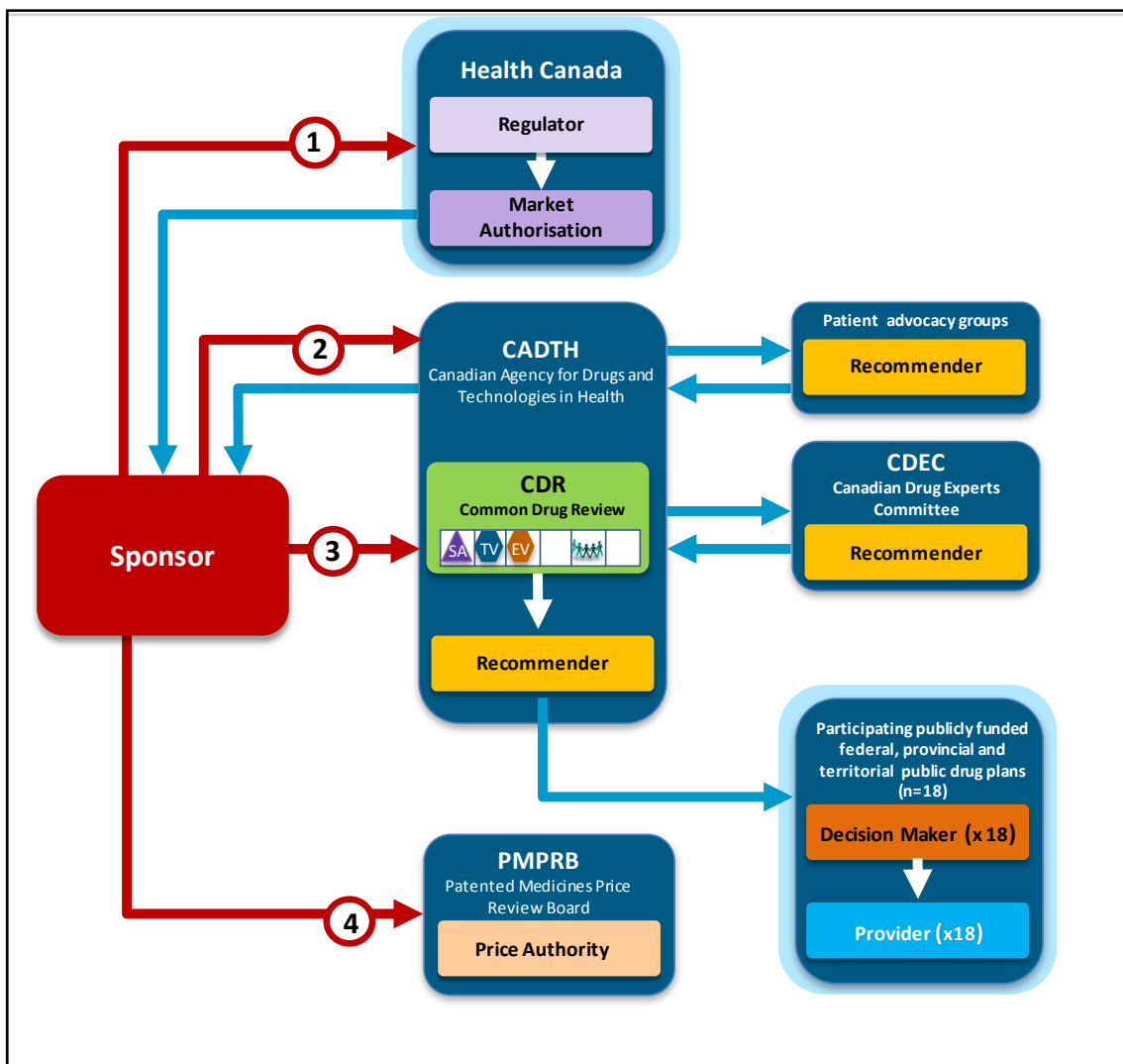
Characteristics	Jurisdictions			
	Canada	Australia	England	Scotland
Impact of recommendations	Recommendations are sent to the decision-maker of 18 participating public drug plans to guide listing decisions in the local context	Recommendations are sent to the government to determine the final listing decision for inclusion in the PBS. Pharmaceuticals cannot be included in the PBS without a PBAC recommendation	Pharmaceuticals recommended by NICE should be available within 3-months to eligible patients	Scottish NHS Boards should ensure that pharmaceuticals recommended by the SMC are available
Transparency	Submission progress report and rationale for final recommendation published on CADTH website	Public summary documents published online include recommendations and rationale	A summary of the NICE appraisal committee conclusions published online	Summary of SMC recommendations published online
Formal patient input	The CDR sends a formal request to patient input groups and allows 15 working days for response	The agenda for PBAC meetings are published 6 weeks in advance. Patients and citizens can submit comments online	Patient access scheme expert panel includes two patients/ lay persons	Bimonthly Public and Patient Involvement Group (PAPIG) meetings
Universal healthcare coverage	A government-funded national healthcare system for permanent residents. Each province and territory is responsible for its own healthcare plan and provides cover for all necessary medical services. Coverage for prescription drugs is highly subsidised and varies by region.	Medicare provides free hospital treatment and highly subsidised prescription medicines through the PBS for all Australian permanent residents	The National Health Service (NHS) provides free healthcare for permanent residents of the UK and EU nationals. NHS prescriptions incur a highly subsidised flat-rate charge in England, but about 90% of prescriptions are dispensed for free due to various exemption criteria.	The National Health Service provides free healthcare for permanent residents of the UK and EU nationals. All NHS prescriptions in Scotland and dispensed free of charge.
Funding source	Taxation	Taxation	Taxation	
Total health expenditure as percentage of GDP 2012 (World Bank, 2015)	10.9% GDP	9.1% GDP	9.4% GDP	

All four HTA agencies have a system to formally include patient input to guide their HTA recommendations. These systems vary from accepting online comments from patients and citizens (PBAC), sending a formal request to patient input groups for comments (CDR), including patients and lay persons at meetings (NICE) and hosting bimonthly Public and Patient Involvement Group (PAPIG) meetings (SMC). Process maps were produced to show the regulatory, HTA and reimbursement pathways for: Canada (CDR), Australia (PBAC), England (NICE) and Scotland (SMC) (Table 5.1) (Figures 5.1 – 5.4).

Common Drug Review (CDR)

The CDR is the centralised Canadian HTA agency recognized by all federal, provincial and territorial public drug plans except that of Quebec.

Figure 5.1: Process map for the Canadian Common Drug Review (March 2014)



The Canadian Agency for Drugs and Technologies in Health (CADTH) established the CDR to standardise the Canadian HTA environment, reduce the duplication of HTA and ultimately to decrease the time taken for patients to access new and innovative medicines (Spitz, 2013). For a new medicine or indication to be eligible for review the following steps are required (Figure 5.1):

Step 1: The manufacturer (sponsor) must first apply for marketing approval from Health Canada. Medicines approved by Health Canada (or expecting approval within 90 days) can be submitted to CADTH for review by the CDR.

Step 2: Once a submission is received, the CDR notifies patient advocacy groups of the upcoming review and provides for patient input. The CDR evaluates the therapeutic benefit and cost-effectiveness of the submitted medicine and prepares a report to send to the Canadian Drug Experts Committee (CDEC) with any received patient input. The CDEC is an independent advisory committee that reviews the CDR reports and determines a listing decision for participating provincial, territorial and federal plans.

Step 3: The CDR sends the CDEC recommendation to the manufacturer for comments prior to notifying the participating drug plans of the final listing recommendation.

Step 4: Manufacturers are required to submit prices to the Patented Medicines Price Review Board (PMPRB) from introduction to the Canadian market and then twice a year until patent expiry.

Pharmaceutical Benefits Scheme (PBS)

The PBS provides subsidised prescription drugs for all Australian citizens. For a new drug to be eligible for inclusion in the PBS schedule the following steps are required:

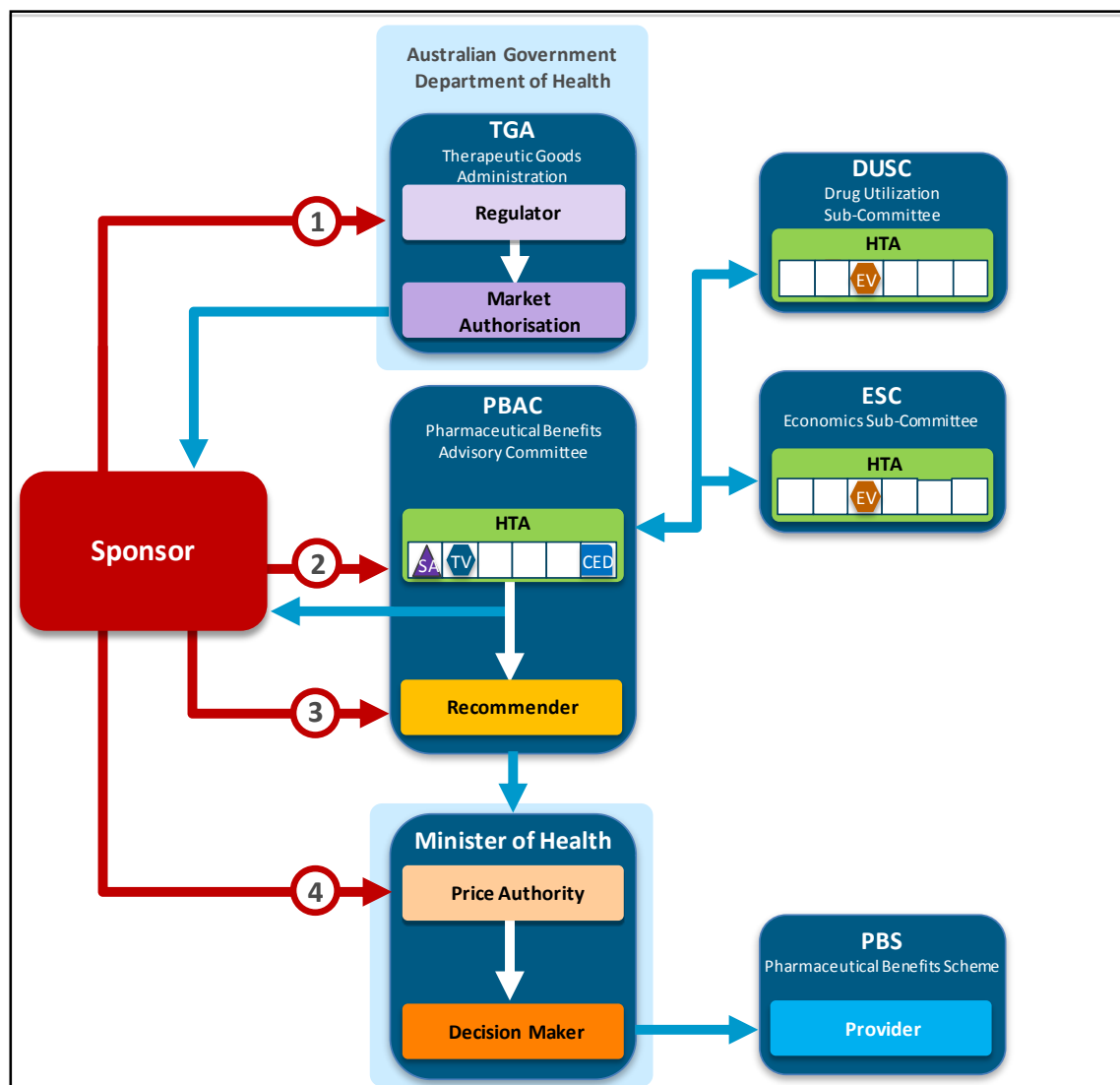
Step 1: The manufacturer (Sponsor) must first apply for the new medicine to be registered in the Australian Register of Therapeutic Goods (Figure 5.2).

Step 2: The manufacturer can then submit an application for review by the Pharmaceutical Benefits Advisory Committee (PBAC). The Drug Utilisation Sub-Committee (DUSC) estimates usage and expected costs of the new medicine and the Economics Sub-Committee reviews the pharmacoeconomic data in the manufacturer's submission to advise the PBAC.

Step 3: The PBAC provides written advice to the manufacturer following the PBAC decision and provides an opportunity for the manufacturer to comment on the Public Summary Document (PSD) prior to publication.

Step 4: The PBAC provides a listing recommendation for the Minister of Health who is responsible for the final listing decision following consultation with the manufacturer (Sponsor) and the PBAC. The Minister of Health can only approve medicines if they have first received a listing recommendation from the PBAC, but any medicine with an expected annual cost greater than AUD\$10 million must be determined at Cabinet level.

Figure 5.2: Process map for Australia (December 2014)

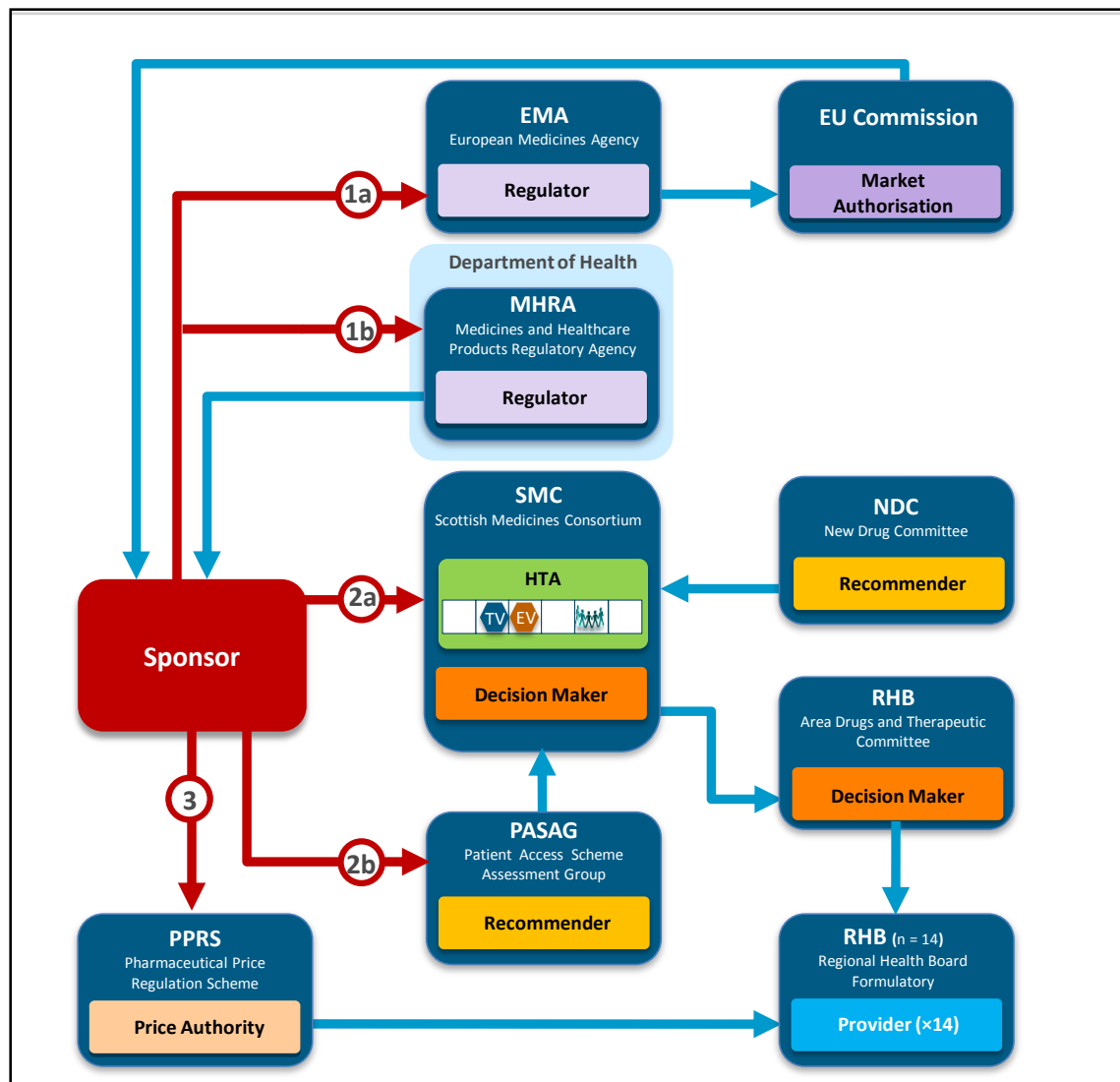


The Scottish Medicines Consortium (SMC)

The SMC was established to review all new medicines for sale in Scotland to provide a recommendation for reimbursement by NHS Scotland. The following steps are required for a new medicine to be considered for reimbursement (Figure 5.3):

Step 1a or 1b: The manufacturer (sponsor) can apply for marketing authorisation for new medicines to be sold in Scotland from either the European Medicines Agency (EMA) (Step 1a) or the Medicines and Healthcare Products Regulatory Agency (MHRA) (Step 1b).

Figure 5.3: Process map for Scotland (May 2014)



Step 2a: The manufacturer (Sponsor) must provide a submission to the SMC for review otherwise the SMC will be unable to review the medicine and a negative non-submission status will be assigned until a full submission is received. Submissions to the SMC will first be reviewed by the New Drug Committee who will prepare a draft for manufacturer comments prior to submission to the SMC for the final decision.

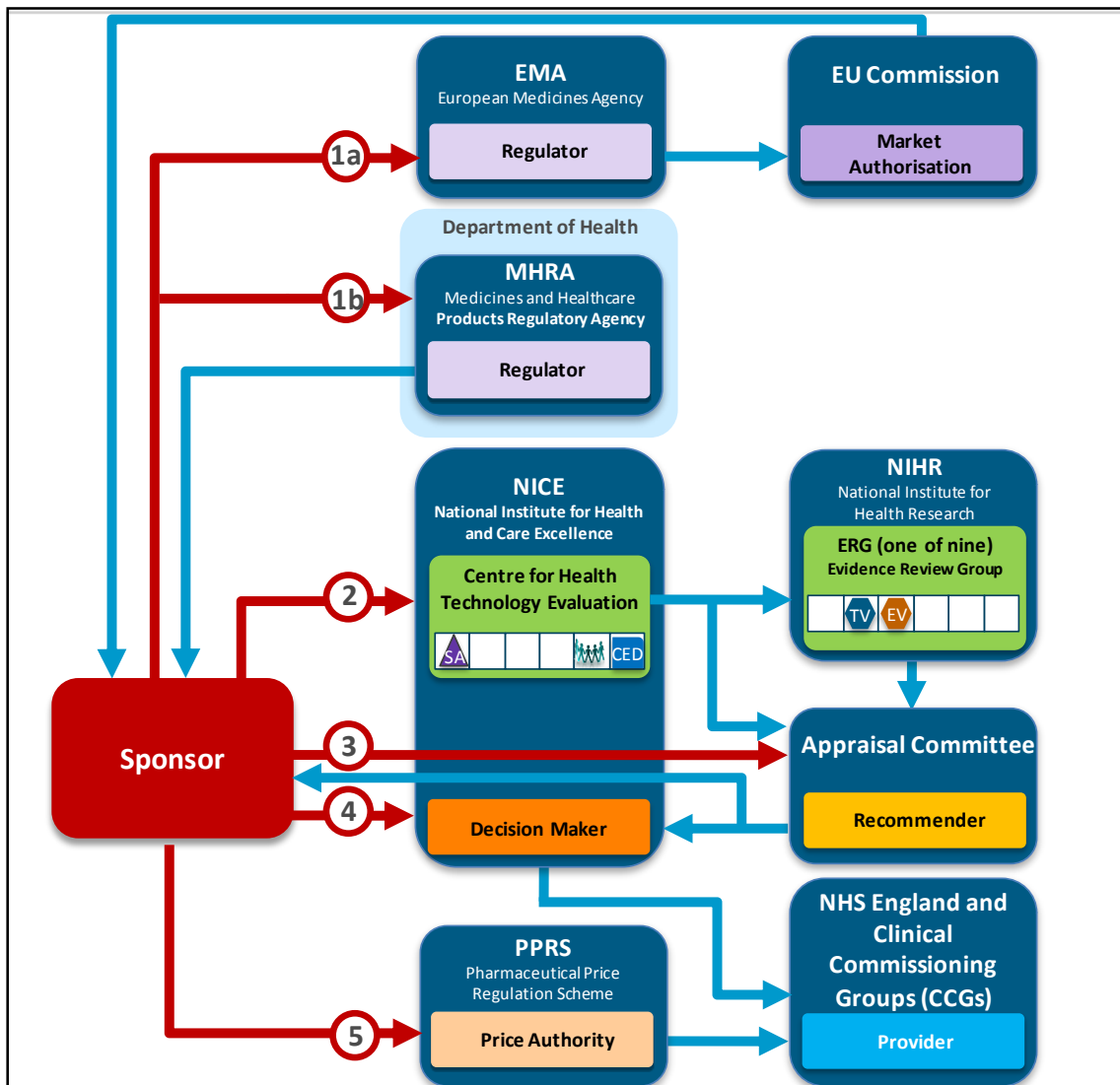
Step 2b: The manufacturer may also submit an application for a patient access scheme to the Patient Access Scheme Assessment Group (PASAG) for review. A Public and Patient Involvement Group (PAPIG) also meets bimonthly to promote the patient/carer view and to present a summary of patient advocacy group submissions prior to SMC meetings (Scottish medicines Consortium, 2013a). Once the SMC has determined a final reimbursement recommendation, the Scottish National Health Service (NHS) Regional Health Boards (RHB) and Area Drug and Therapeutic Committees (ADTCs) are notified of the recommendation and prescribing advice. (Scottish Medicines Consortium, 2013b).

Step 3: The Pharmaceutical Price Regulation Scheme (PPRS) regulates pharmaceutical prices indirectly by controlling the profit of member pharmaceutical companies. The PPRS is a voluntary scheme that is generally renewed every five years and the current PPRS scheme started January 2014.

National Institute for Health and Care Excellence (NICE)

Unlike the public healthcare systems in Canada, Australia and Scotland, not all new medicines are required to be reviewed for reimbursement in England. The national HTA agency in England is NICE which conducts a Single Technology Appraisal (STA) for medical products that are formally requested by the Secretary of State for Health. Each request is considered against a list of elimination criteria to ensure technology appraisals are not conducted if NICE has already published guidance or considered a similar or identical product for review (National Institute for Health and Care Excellence, 2013). The following steps are required for new medicines to be reviewed by NICE (Figure 5.4):

Figure 5.4: Process map for England



Step 1a or 1b: Medicines to be sold in England require marketing approval from the EMA (step 1a) or MHRA (step 1b). If marketing authorisation has not been granted prior to the NICE appraisal, the manufacturer is required to include details of the expected market authorisation in the NICE submission.

Step 2: Following a formal request from the Secretary of State for Health, the manufacturer is contacted and provided an opportunity to discuss the submission requirements. NICE will then assign a project team and one of nine Evidence Review Groups (ERG) to review the manufacturers submission and request input from patients, physicians and commissioners.

Step 3: The ERG considers submitted evidence and prepares a report on the

clinical and cost effectiveness of the medicine and sends the report to the manufacturers to confirm accuracy.

Step 4: The ERG sends the final report to the NICE appraisal Committee for the Final Appraisal Determination (FAD). The NHS in England and Wales is required to provide funding for drug products recommended by NICE within three months of a positive recommendation. SMC guidance is also recommended for use by NHS England and Wales when a NICE appraisal has not been conducted.

Step 5: Manufacturers are invited to participate in a voluntary government scheme to regulate prices for the NHS.

PART II- identification of HTA recommendations for new medicine-indication combinations for Australia, Canada England and Scotland

Eighty-nine initial submissions were identified for medicine-indication pairs that met the inclusion criteria for an initial submission to the CDR that issued a listing recommendation from January 2009 to May 2013. New indication submissions were also included if the initial submission met the inclusion criteria. Sixteen different HTA recommendation outcomes were recorded from across the four HTA agencies (Table 5.2). These HTA recommendations have been classified into three multinomial categories for comparison (recommended, recommended with restrictions and not recommended). Five of the sixteen different HTA recommendations types were identified from the CDR recommendations. The 'list' and 'list in a similar manner' were categorised according to the universal 'recommended' category.

The 'list in a similar manner' recommendation advises participating drug plans to list the product in the same manner as other drugs in its class. The 'list with criteria/condition' recommendation includes CDR recommended restrictions and is therefore allocated to the multinomial 'recommend with restrictions' category. The CDR issues two distinct negative recommendation categories 'Do not list' and 'Do not list at the submitted price'. The latter was introduced by the CDR to indicate, to participating drug plans, where a negotiated price could have produced a positive recommendation.

Table 5.2: Comparison of HTA recommendations options for Canada Australia, England and Scotland

HTA Agency	Binomial classification:		
	Positive recommendation		Negative recommendation
	Multinomial classification:		
	Recommended	Recommended with restrictions	Not Recommended
CDR (Canada)	list	list with criteria/condition	do not list
	list in a similar manner		do not list at the submitted price
PBAC (Australia)	unrestricted benefit	restricted benefit	rejected
		authority required (streamlined)	
		authority required	
NICE (England)	recommended	optimised	not recommended
SMC (Scotland)	accepted	restricted use	not recommended

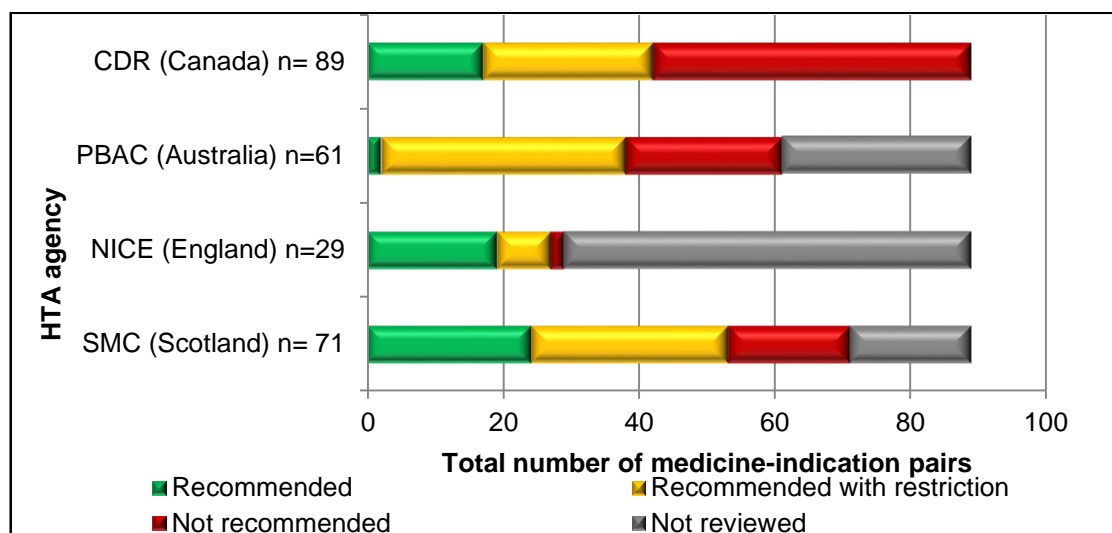
Five different recommendations were identified from the PBAC published summary documents. The ‘unrestricted benefit’ recommendation was allocated to the universal recommended category and the ‘rejected’ recommendation was included in the universal ‘Not recommended’ category. The ‘authority required’ and ‘authority required (streamlined)’ ‘authority required (streamlined)’ recommendations were both allocated to the universal recommended with restrictions category as these both include barriers to access. The ‘authority required’ recommendation requires written or telephone approval from Department of Human Services (DHS) or the Department of Veterans’ Affairs (DVA) prior to prescribing (Pharmaceutical Benefits Scheme (PBS), 2014). The ‘authority required (streamlined)’ recommendation is less restrictive as physicians are only required to include a streamlined authority code on the prescription. However, any prescriptions for quantity or repeats greater than approved PBS listing will be treated as an ‘authority required’ item and will need written or telephone approval from the DHS or DVA.

NICE and the SMC both issued reimbursement recommendations under three main categories. NICE recommendations are categorised as either

‘recommended’, ‘optimised’ or ‘not recommended’ and these were allocated to the universal recommended, recommended with restrictions and not recommended categories respectively. NICE ‘optimised’ recommendations include criteria to restrict reimbursement. Similarly, the three different SMC recommendations were ‘accepted’, ‘restricted use’ and ‘not recommended’ and these three recommendation types were allocated to the universal recommended, recommended with restrictions and not recommended categories respectively. Binomial categories for comparison were created by combining the recommended and recommended with restrictions categories to produce a group for positive recommendations to enable comparisons between positive or negative listings (Table 5.2). The not recommended category for the multinomial classification has been relabeled negative recommendations to distinguish between the two classification systems.

All of the 89 medicine-indication pairs were reviewed by the CDR because the CDR recommendations were the initial source for identifying drug products for inclusion in this comparative study. The SMC reviewed the largest proportion of the CDR drug product and indication combinations (n=71), followed by Australia (n=61) and England (n=29) (Figure 5.5).

Figure 5.5: Medicine-indication pairs HTA recommendations for Canada, Australia, England and Scotland



The proportion of recommendation types issued by each HTA agency for the 89 medicine-indication pairs was calculated for the multinomial category and binomial category classifications (Table 5.3 - 5.4). The multinomial categories enables inclusion of the restricted criteria, but restrictions can vary by each drug and agency remit and this variation is difficult to capture with a single restriction category. Therefore, the binomial categories are also included to compare recommendations as either positive or negative. The 95% confidence interval was also calculated for each recommendation type using the Wilson score method (Brown *et al.*, 2001).

Table 5.3: Proportion of Medicine-indication pairs by multinomial categories of recommendations

Agency	Recommended (±95% CI)	Recommended with restriction (±95% CI)	Not recommended (±95% CI)
CADTH CDR (Canada) n= 89	19.1% (12.3%; 28.5%)	28.1% (19.8%; 38.2%)	52.8% (42.5%; 62.8%)
PBS PBAC (Australia) n=61	3.3% (0.9%; 11.2%)	59% (46.5%; 70.5%)	37.7% (26.6%; 50.3%)
NICE (England) n=29	65.5% (47.3%; 80.1%)	27.6% (14.7%; 45.7%)	6.9% (1.9%; 22%)
SMC (Scotland) n= 71	33.8% (23.9%; 45.4%)	40.8% (30.2%; 52.5%)	25.4% (16.7%; 36.6%)

Table 5.4: Proportion of Medicine-indication pairs by binomial categories of recommendations

Agency	Positive recommendation (±95% CI)	Negative recommendation (±95% CI)
CADTH CDR (Canada) n= 89	47.2% (37.2%; 57.5%)	52.8% (42.5%; 62.8%)
PBS PBAC (Australia) n=61	62.3% (49.7%; 73.4%)	37.7% (26.6%; 50.3%)
NICE (England) n=29	93.1% (78%; 98.1%)	6.9% (1.9%; 22%)
SMC (Scotland) n= 71	74.6% (63.4%; 83.3%)	25.4% (16.7%; 36.6%)

The PBAC issued the greatest number of ‘recommendations with restrictions’ (59%) however, when calculated using the binomial category classification, which combines the ‘recommended’ and ‘recommended with restrictions’ groups, the PBAC issued the third most positive recommendations (62.3%) followed by the CDR (47.2%). NICE issued the greatest proportion of positive recommendations (93.1%), but also issued the lowest number of total

recommendations (n=29) as NICE does not review all new medicines and indications. The SMC issued the second highest proportion of positive recommendations (74.6%) and also reviewed the second largest number of medicine-indication pairs (n=71).

The three HTA recommendation classification categories (recommended, recommended with restriction and not recommended) were coded for direct comparison between each of the four HTA agencies. The percentage agreement was calculated for each agency pair and all scored lower than 50% (Table 5.5). The percentage agreement was also calculated for the binomial category classification and all agency pairs scored greater than 50%, but none higher than 80% (Table 5.6). Greater concordance is expected for the binomial classification as there are fewer categories for comparison. However, the percentage agreement for the binomial categories still suggests a sizeable proportion of discordant recommendations have been issued.

Table 5.5: Percentage agreement of national HTA recommendations in Australia, Canada, England and Scotland (multinomial category classification)

Percentage agreement	CADTH CDR	PBS PBAC	NICE	SMC
CADTH CDR	N/A	49%	24%	38%
PBS PBAC	N/A	N/A	21%	32%
NICE	N/A	N/A	N/A	45%
SMC	N/A	N/A	N/A	N/A

N/A = Not Applicable

Table 5.6: Percentage agreement of national HTA recommendations for medicine–indication combinations in Australia, Canada, England and Scotland (binomial category classification)

Percentage agreement (n= total reviewed)	CDR	PBAC	NICE	SMC
CDR	N/A	67% (n=61)	55% (n=29)	61% (n=71)
PBAC	N/A	N/A	63% (n=24)	62% (n=53)
NICE	N/A	N/A	N/A	72% (n=29)
SMC	N/A	N/A	N/A	N/A

N/A = Not Applicable

Table 5.7: Kappa agreement of national HTA recommendations for medicine–indication combinations in Australia, Canada, England and Scotland (binomial category classification)

Kappa agreement (n= total reviewed)	CDR	PBAC	NICE	SMC
CDR	N/A	$\kappa=0.336$ (n=61)	$\kappa=0.129$ (n=29)	$\kappa=0.194$ (n=71)
PBAC	N/A	N/A	$\kappa=0.115$ (n=24)	$\kappa=0.156$ (n=53)
NICE	N/A	N/A	N/A	$\kappa=0.101$ (n=29)
SMC	N/A	N/A	N/A	N/A

N/A = Not Applicable

The level of agreement between HTA agency recommendations using the binomial category classification was calculated for jurisdictional pairs using kappa scores. The CDR and PBAC achieved the greatest kappa score ($\kappa=0.336$), but this is only considered to be a fair level of agreement (Viera and Garrett, 2005). All other jurisdictional pairs achieved kappa scores within the slight agreement range despite the overall percentage agreement for one of these jurisdictional pairs being greater than the percentage agreement for the CDR and PBAC. However, this is likely to be due to a documented kappa paradox that has been discussed in chapter 2. Clement *et al.* (2009) and Nicod and Kanavos (2012) both published kappa scores for comparing agreement between HTA recommendations issued by the CDR, NICE and PBAC, but only Nicod and Kanavos (2012) also included recommendations from the SMC. However, both of these studies included oncology medicines which are excluded from this study due to the inclusion criteria for drugs reviewed by the CDR. Nicod and Kanavos (2012) reviewed drug indication pairs appraised between 2007 to 2009 and identified the largest kappa score for recommendations issued by NICE and PBAC ($\kappa=0.287$), followed by the CDR and PBAC ($\kappa=0.250$). Clement *et al.* (2009) identified HTA recommendations for the CDR, NICE and PBAC that were publicly available from December 2008 which included varying start dates for datasets (2001 for NICE, 2004 for the CDR and 2005 for PBAC). The largest kappa coefficient identified by Clement *et al.* (2009) was for recommendations issued by the CDR and NICE of $\kappa=0.55$

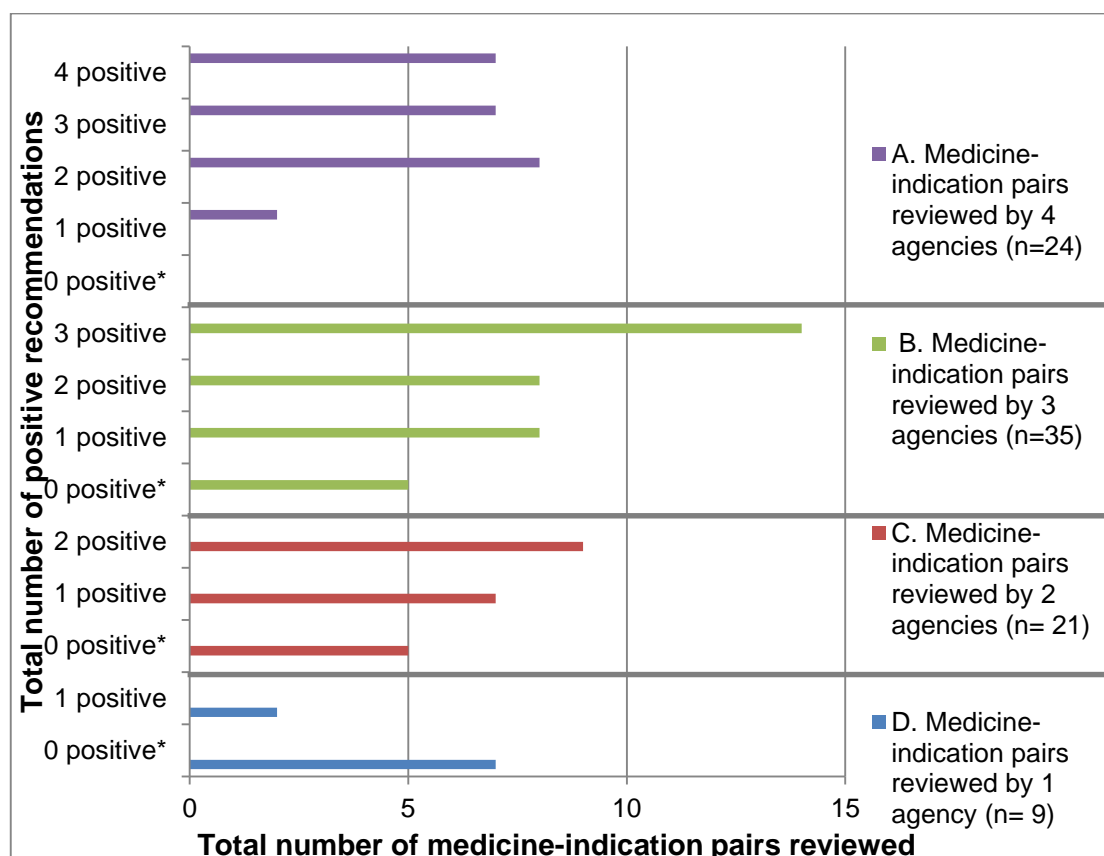
followed by the CDR and PBAC $\kappa=0.27$. Therefore, comparing the results of this study with the larger kappa scores identified in previous studies could imply that HTA recommendations are becoming more divergent. However, these differences may also be explained by the varying agency criteria that include oncology medicines and resubmissions.

Eighty-nine medicine-indications were evaluated in this study and these were categorised by the number of agencies that reviewed each medicine-indication pair (Figure 5.6):

- Twenty-four medicine-indications were reviewed by all four HTA agencies and seven of these were granted a positive recommendation from all four HTA agencies (Figure 5.6A). No medicines were issued a negative recommendation from all four agencies.
- Thirty-five medicines were reviewed by three of the four HTA agencies and 14 of these were granted a positive listing recommendation by all three HTA agencies (Figure 5.6B). Eight medicines received a positive recommendation from 2 agencies and another eight medicines received a positive recommendation from only one of the three agencies. Five medicines were issued a negative recommendation by all three agencies.
- Five medicine-indication pairs were also issued all negative recommendations for the group reviewed by only two HTA agencies. However, this group only included 21 medicine-indication pairs (Figure 5.6C). Nine of the medicine-indication pairs were issued positive recommendations by both reviewing agencies and seven medicine-indication pairs were granted a single positive recommendation.
- The smallest group includes medicines reviewed by only one agency (n=9) (Figure 5.6D). All of these medicines were reviewed by the CDR as the inclusion criteria for the list of medicine-indication pairs required a CDR review. Only two of the nine medicine-indication pairs reviewed by a single agency (CDR) were granted a positive recommendation.

The group of medicines reviewed by all four HTA agencies was evaluated to select medicine-indication pairs for case studies. The seven medicines to receive all positive recommendations were chosen as examples for positive recommendation case studies.

Figure 5.6: Positive HTA recommendations for medicine-indication pairs

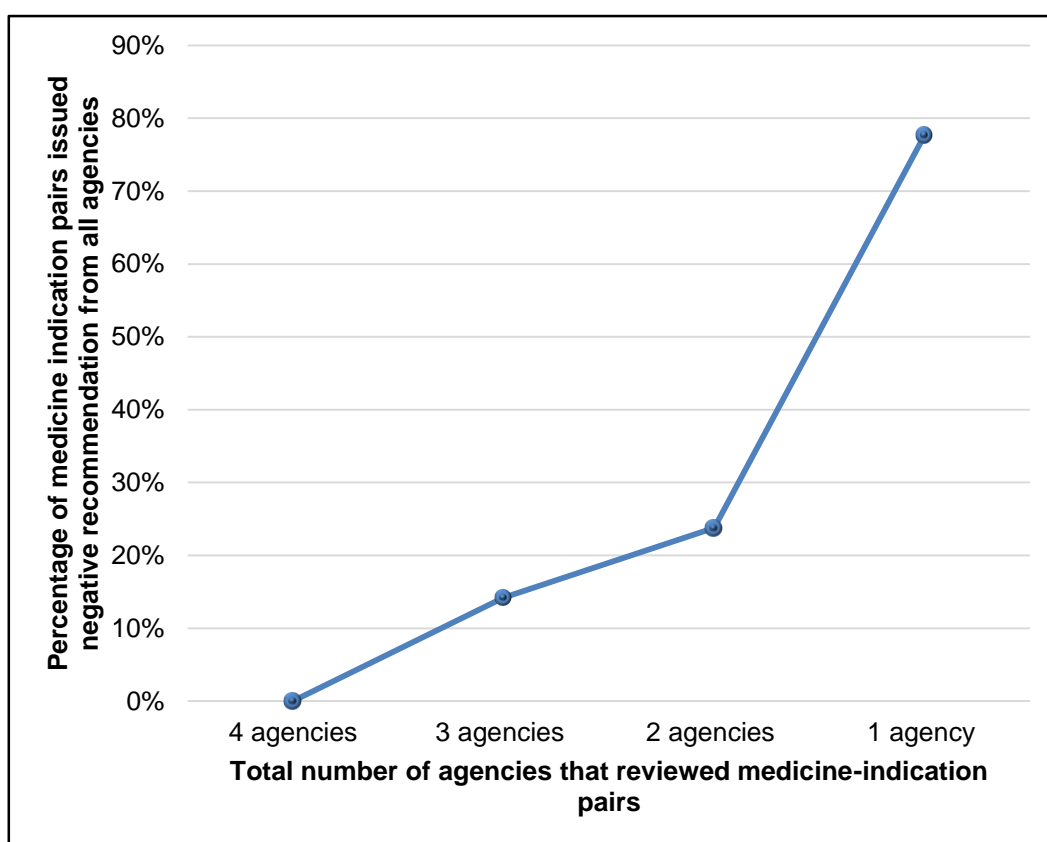


**0 positive recommendations represents the proportion of medicines that received all negative recommendations*

Seven other medicine-indication pairs achieved a negative initial recommendation from one agency and positive recommendations (with or without restrictions) from the other three agencies and these were chosen as case studies to identify causes for the discordant HTA recommendations. Interestingly, the proportion of medicines to receive all negative recommendations from all reviewing agencies increases as the total number of agencies to review decreases (Figure 5.7). This suggests that the more negative HTA recommendations a medicine receives, fewer markets will

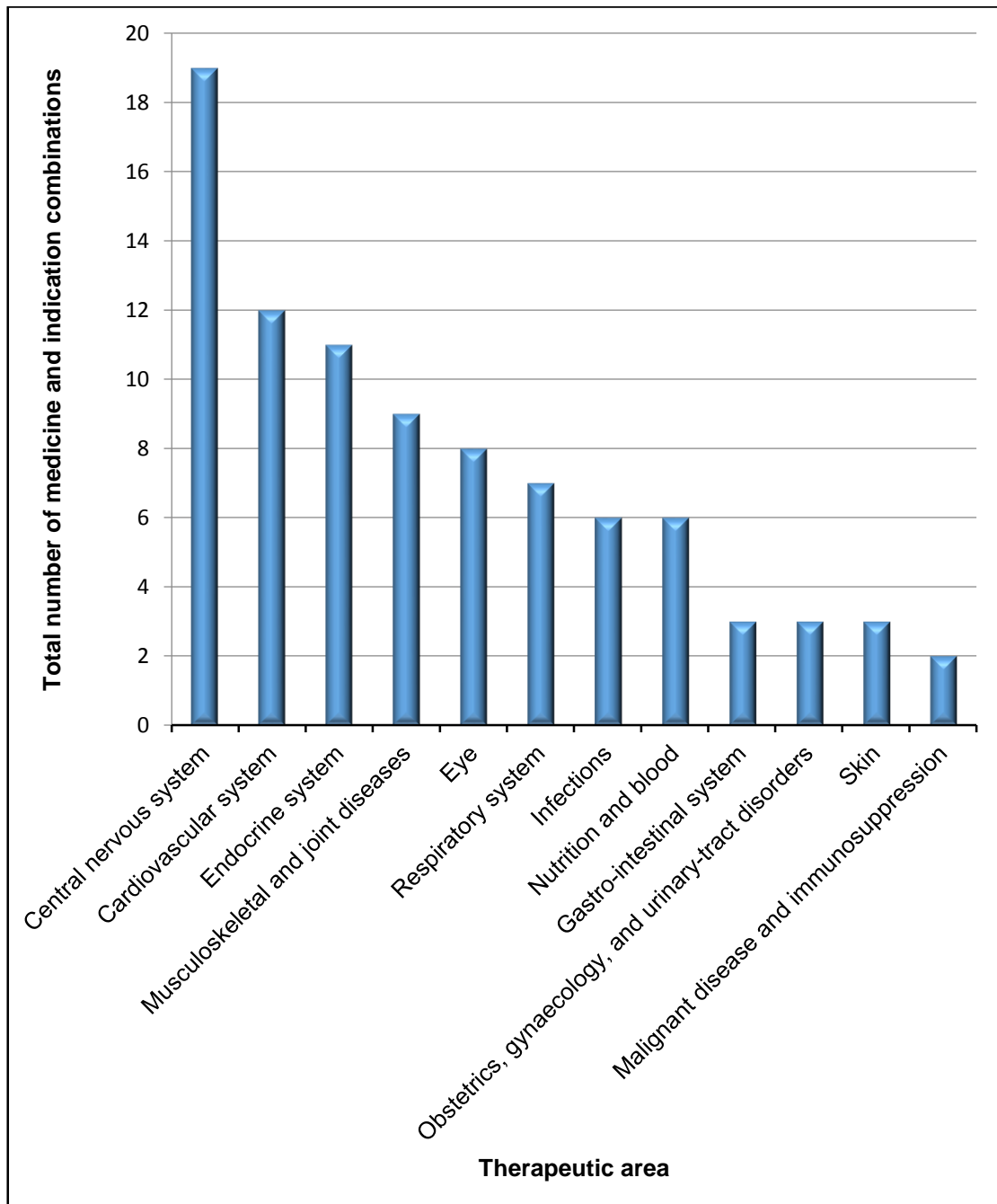
receive a submission for reimbursement. This can have negative implications for patient access as fewer submissions reduces potential opportunities for a positive reimbursement recommendations for patients to access the new medicine. However, if the manufacturer has anticipated that the medicine is unlikely to be reimbursed by HTA agencies with similar criteria then the decision to not submit saves time and resources for the manufacturer and HTA agencies.

Figure 5.7: Proportion of medicines were all issued a negative recommendations



The 89 medicine and indication combinations included in this study were also grouped by therapeutic area using British National Formulary categories. No oncology products were included in this study as these are not eligible for review by the CDR. The most popular therapeutic areas were the central nervous system (19) followed by the cardiovascular system (12) and endocrine system (11) (Figure 5.8).

Figure 5.8: Medicine and indication combinations classified by therapeutic area



PART III- an evaluation of the factors influencing concordant HTA recommendations for Australia, Canada, England and Scotland

The seven medicine-indication combinations that received positive initial recommendations from all four HTA agencies were chosen as case studies to identify the key reasons underpinning the recommendations. Information for

regulatory approval and HTA recommendations was collected from the public domain directly from the following regulatory authorities or HTA agency websites:

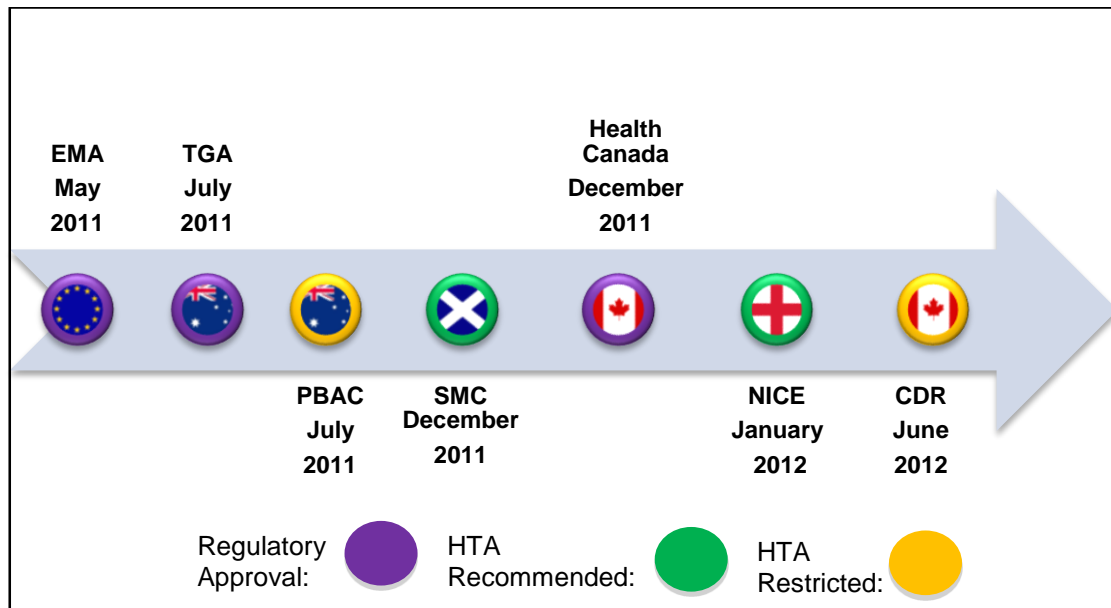
- European Medicines Agency (www.ema.europa.eu)
- Canadian Agency for Drugs and Technologies in Health Common Drug Review (www.cadth.ca)
- Health Canada (www.hc-sc.gc.ca)
- National Institute for Care and Health Excellence (www.nice.org.uk)
- Pharmaceutical Benefits Scheme Pharmaceutical Benefits Advisory Committee (www.pbs.gov.au)
- Scottish Medicines Consortium (www.scottishmedicines.org.uk)
- Therapeutic Goods Administration (www.tga.gov.au)

The dates of regulatory approval from the EMA, Health Canada and the TGA were recorded with the publication dates for each initial HTA recommendation to produce a timeline of events for each case study. The time from first HTA recommendation to the fourth HTA recommendation varied greatly across the seven positive case studies from 5 months to 20 months (Table 5.8).

Case study 1: Apixaban (Eliquis) for prevention of venous thromboembolic events (VTE)

Apixaban (Eliquis) was granted marketing approval by the EMA (May 2011), the TGA (July 2011) and Health Canada (December 2011) for the prevention of Venous Thromboembolic Events (VTE) in patients that have undergone elective knee or hip replacement surgery. The first HTA approval was for an 'authority required' recommendation issued by the PBAC in July 2011, shortly after marketing authorisation was granted by the TGA (Figure 5.9). Apixaban was subsequently recommended as 'accepted' for reimbursement by the SMC in December 2011 and NICE 'recommended' apixaban in January 2012. The CDR subsequently issued a 'list with criteria/condition' recommendation in June 2012. The final HTA recommendation from the CDR was issued eleven months after the first HTA recommendation from the PBAC.

Figure 5.9: Timeline for apixaban (Eliquis) for prevention of venous thromboembolic events (VTE)



All four HTA agencies considered subcutaneous enoxaparin as a comparator for the orally administered apixaban. Enoxaparin was considered the appropriate comparator by NICE as it is the most widely used low molecular weight heparin in the UK. The PBAC noted that they accepted the manufacturer's submission with rivaroxaban as the primary comparator and enoxaparin as the secondary comparator. However, the trials submitted for rivaroxaban were indirect comparisons using enoxaparin as the common comparator.

The PBAC and SMC both accepted that apixaban is non-inferior/similar to enoxaparin, but NICE concluded that there was insufficient clinical evidence to determine the efficacy of apixaban and rivaroxaban. The CDR, NICE and SMC all concluded that apixaban was clinically superior to enoxaparin and more cost-effective. The final PBAC recommendation was also based on a cost minimisation basis of apixaban compared with rivaroxaban.

Table 5.8: Summary table of case studies that received positive recommendations from four agencies

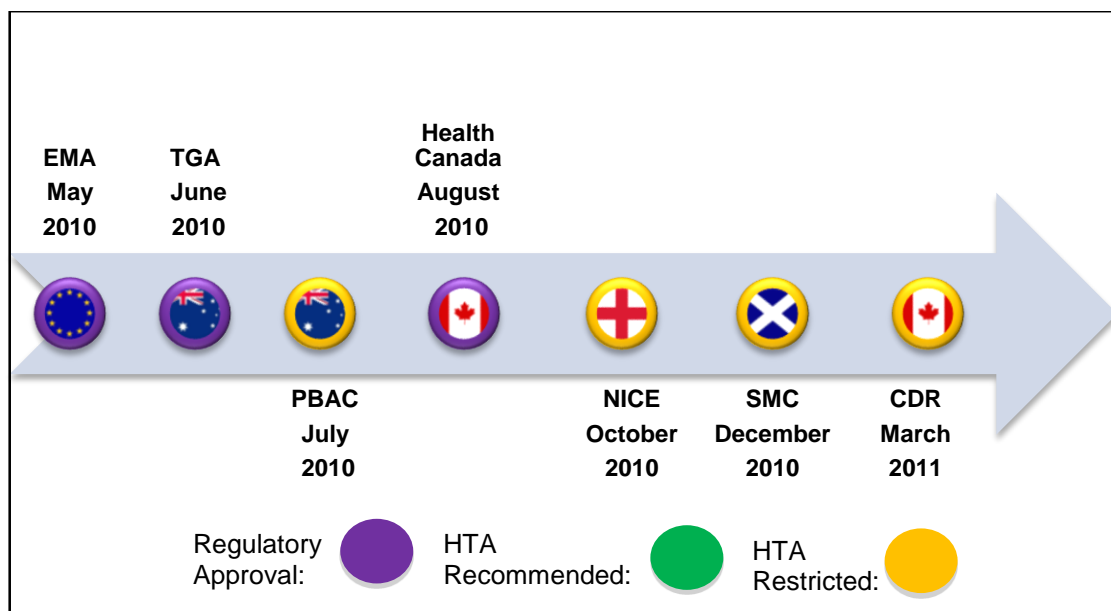
Case Study	Generic Name	Proprietary name	Indication	CDR (Canada)	PBAC (Australia)	NICE (England)	SMC (Scotland)	Time from H1 to H4 (Months)
Case study 1	Apixaban	Eliquis	Prevention of venous thromboembolic events (VTE)	RR	RR	R	R	11
Case study 2	Denosumab	Prolia	Osteoporosis in postmenopausal women	RR	RR	RR	RR	9
Case study 3	Golimumab	Simponi	Rheumatoid Arthritis	R	RR	RR	RR	18
Case study 4	Golimumab	Simponi	Ankylosing spondylitis	R	RR	R	RR	20
Case study 5	Telaprevir	Incivek	Hepatitis C infection (genotype 1), Chronic (treatment naïve)	RR	RR	R	R	5
Case study 6	Tocilizumab	Actemra	Rheumatoid Arthritis	RR	RR	RR	RR	16
Case study 7	Ustekinumab	Stelara	Psoriasis	RR	RR	R	RR	19

Key: H1- first HTA recommendation, H4- fourth HTA recommendation, R- Recommended, RR- Recommended with restrictions

Case study 2: Denosumab (Prolia) for Osteoporosis in postmenopausal women

In May 2010 the EMA was the first regulatory authority to grant marketing approval for denosumab (Prolia) for the treatment of osteoporosis in postmenopausal women. The TGA and the CDR also granted marketing approval for the treatment of osteoporosis in postmenopausal women in June 2010 and August 2010, respectively (Figure 5.10).

Figure 5.10: Timeline for denosumab (Prolia) for Osteoporosis in postmenopausal women



The PBAC issued the first HTA recommendation for denosumab on a price minimisation basis with zoledronic acid, which was considered to be of similar effectiveness. This recommendation approved denosumab for the patient population suggested in the manufacturers submission. However, The manufacturer had originally requested denosumab to be listed under the 'Authority required (streamlined)', but the PBAC decided to recommend denosumab for the more restricted 'Authority required' option due to the medicine's novel method of action and limited safety data that would require ongoing surveillance.

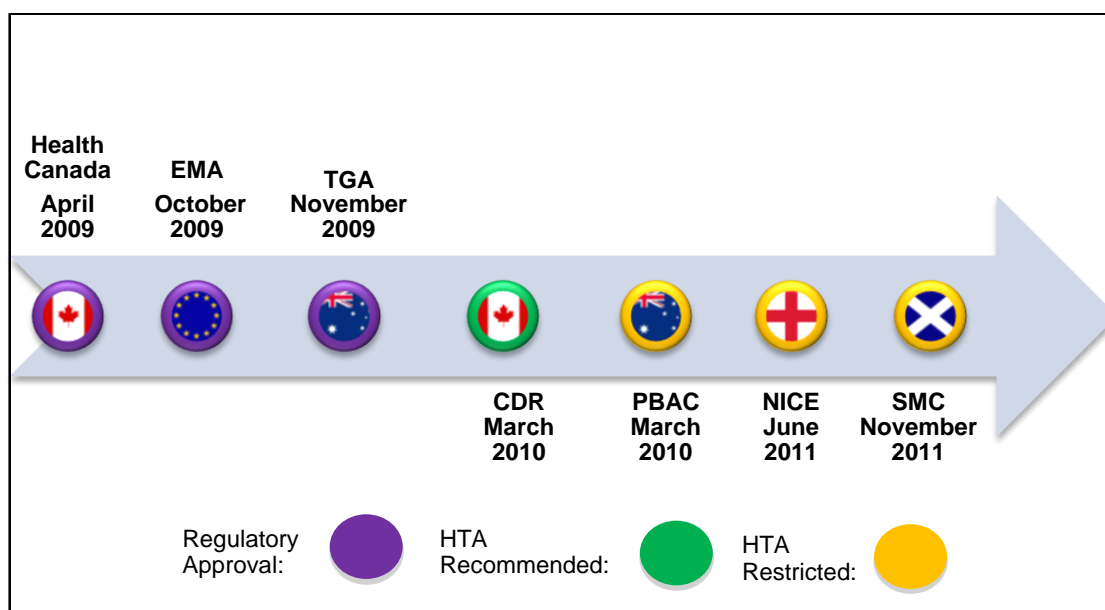
NICE issued the second HTA recommendation (October 2010), shortly followed by SMC (December 2010) and the CDR (March 2011).

The manufacturer's submission to NICE and SMC requested review of denosumab for patients that were contraindicated or intolerant to oral bisphosphonates and this is reflected in the restrictions included in the NICE and SMC recommendation. The CDR listing recommendation also included these restrictions. The CDR, NICE and SMC all accepted that trials demonstrate denosumab to be clinically superior to placebo and could be considered more cost effective for patients that are contraindicated or intolerant to oral bisphosphonates.

Case study 3: Golimumab (Simponi) for rheumatoid arthritis

In April 2009, Health Canada granted marketing authorisation for golimumab (Simponi) as combination therapy with methotrexate for the treatment of moderate to severe active rheumatoid arthritis, including eligible patients that had not been treated previously with methotrexate (Figure 5.11).

Figure 5.11: Timeline for golimumab (Simponi) for rheumatoid arthritis



Golimumab was also approved for the same indication by the EMA (October 2009). In November 2009, the TGA subsequently approved golimumab as a combination therapy with methotrexate for the treatment of moderate to severe

active rheumatoid arthritis, but only for patients that had not responded to treatment with Disease-Modifying Antirheumatic Drugs (DMARDs) including methotrexate. The CDR and PBAC both provided a listing recommendation for golimumab (50mg monthly dose) for the treatment of rheumatoid arthritis in March 2010. The PBAC recommended an 'authority required' listing and cost minimisation with comparators (adalimumab and etanercept), which were deemed to be of a comparable efficacy. Golimumab would also be listed with the same restrictions and price reductions the PBAC has applied to comparators.

The CDR determined golimumab as clinically superior to placebo and issued a 'list in similar manner to other drugs in class' recommendation. The CDR recommendation was also restricted to a maximum of 50mg monthly dose, as the annual cost was expected to be more cost-effective than other TNF-alpha inhibitors if administered once a month and only a limited benefit for identified doses higher than 50mg. NICE issued an 'optimised' recommended golimumab as combination therapy with methotrexate when previous treatments have failed. NICE was the only HTA agency to recommend the higher 100mg dose, but only if the manufacturer provided it at the same price as the 50mg option. SMC agreed that golimumab is superior to methotrexate alone and also cost effective at the 50mg dose. The SMC 'restricted' recommendation requires golimumab to be used in line with the existing British Society for Rheumatology prescribing guidelines for TNF-alpha inhibitors and only recommends the monthly 50mg dose.

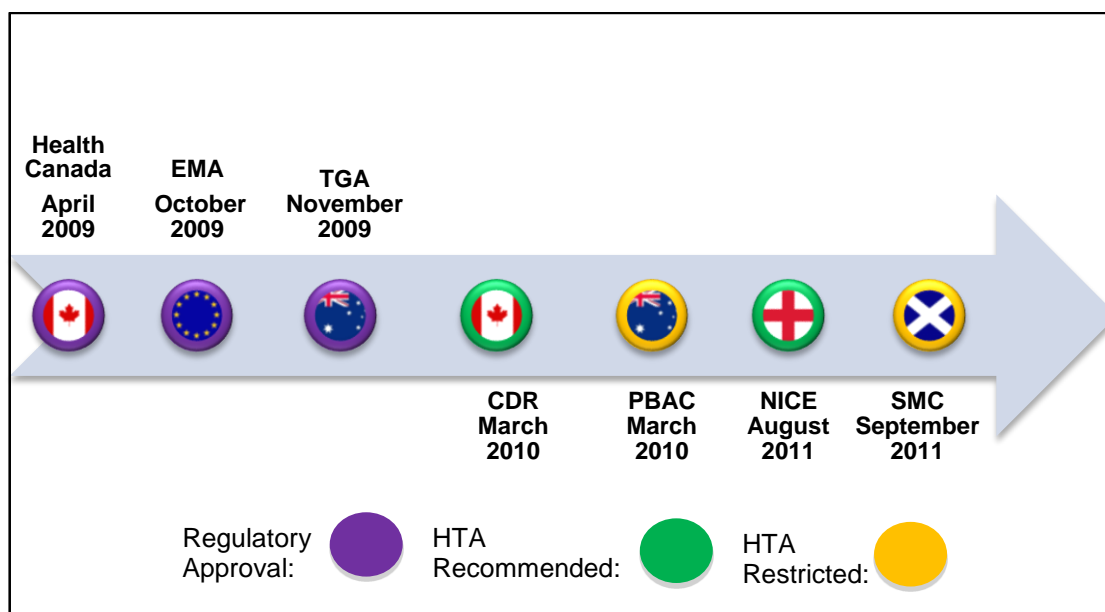
Four HTA agencies recommended the 50mg dose as the cost effective option, unless the manufacturer provided the 100mg dose at the same cost (NICE). The four HTA agencies also noted the absence of direct trial comparisons with other TNF-alpha inhibitors.

Case study 4: Golimumab (Simponi) for ankylosing spondylitis

In April 2009, Health Canada approved golimumab (Simponi) for the treatment of active Ankylosing Spondylitis (AS) for patients who had not responded to conventional therapy and the EMA approved golimumab for the same indication

in October 2009 (Figure 5.12). The marketing authorisation granted by the TGA approved golimumab for the treatment of active AS.

Figure 5.12: Timeline for golimumab (Simponi) for ankylosing spondylitis



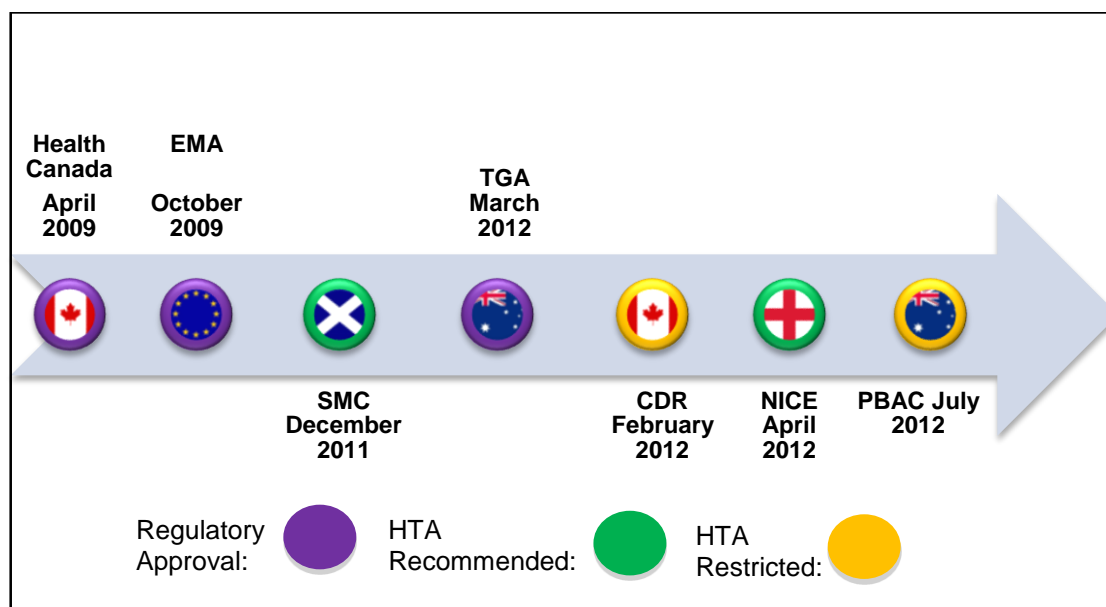
The PBAC and the CDR both issued recommendations for golimumab for the treatment of AS in March 2010, the same time as the recommendations issued for golimumab for the treatment of rheumatoid arthritis. The PBAC, CDR and SMC all issued the same HTA recommendation classification for both of the reviewed indications: ‘authority required’ and ‘list in a similar manner’ and ‘restricted’ respectively. NICE issued a ‘recommended’ recommendation for golimumab for the treatment of AS in line with clinical practice, which is less restrictive than the NICE ‘optimised’ recommendation for golimumab for the treatment of rheumatoid arthritis.

Once again, all four HTA agency recommendations were for the 50mg dose as the cost effective option, unless the manufacturer provided the 100mg dose at the same cost (NICE). All HTA agencies noted the absence of direct trial comparisons with other TNF-alpha inhibitors.

Case study 5: Telaprevir (Incivek) for Hepatitis C infection (genotype 1), Chronic (treatment naïve)

Telaprevir for the treatment of Hepatitis C infections in treatment naïve and treatment experienced patients were included in a single submission to all HTA agencies except for the initial submission to the PBAC. The initial submission received a negative recommendation and is reviewed in more detail in case study 13. The resubmission to the PBAC also included the indication for treatment naïve patients and was recorded as the first PBAC recommendation for telaprevir for hepatitis C infection and therefore meets the inclusion criteria for the positive case studies (Figure 5.13).

Figure 5.13: Timeline for Telaprevir (Incivek) for Hepatitis C infection (genotype 1), Chronic (treatment naïve)

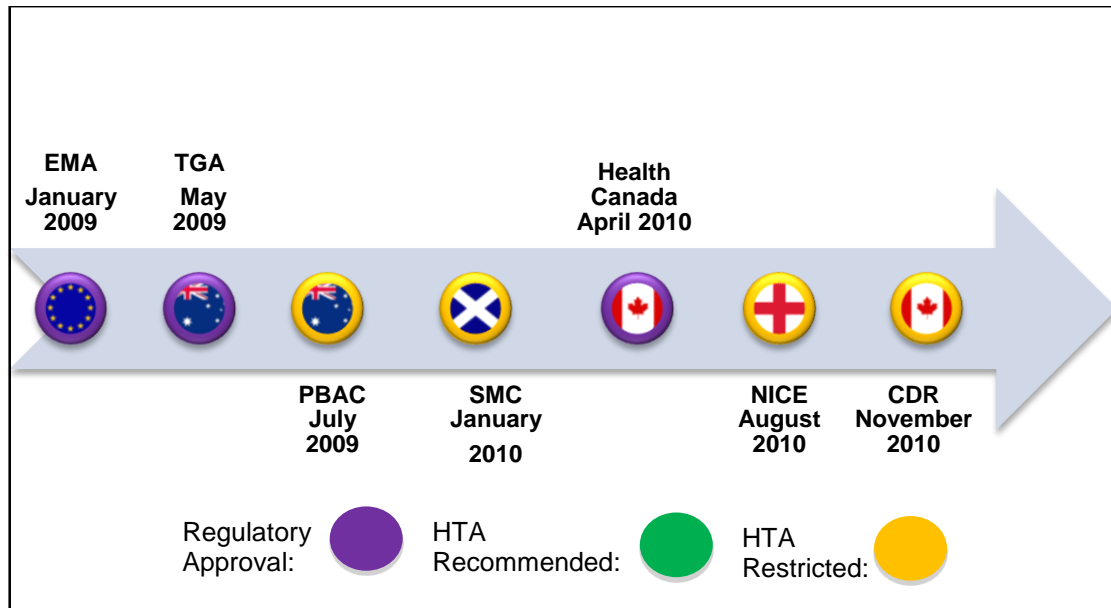


Case study 6: Tocilizumab (Actemra) for rheumatoid arthritis

Tocilizumab (Actemra/RoActemra) was granted market authorisation for the treatment of moderate to severe active rheumatoid arthritis in combination with methotrexate, or as monotherapy if methotrexate is inappropriate, by the EMA (January 2009), the TGA (May 2009) and Health Canada (April 2010) within a 15-month period. The market authorisation from the TGA and Health Canada also approved tocilizumab for the treatment of rheumatoid arthritis in combination with other Disease-Modifying Antirheumatic Drugs (DMARDs) and

this treatment combination is also considered for the HTA recommendations issued by the PBAC and the CDR (Figure 5.14).

Figure 5.14: Timeline for tocilizumab (Actemra) for rheumatoid arthritis



The PBAC issued the first HTA listing recommendation for tocilizumab (July 2009) and recommended the PBS provide tocilizumab with the ‘authority required’ restriction as part of the Highly Specialised Drugs Program. The indications approved include tocilizumab in combination with methotrexate in eligible patients that have not responded to TNF-alpha treatment on a cost-minimisation basis with abatacept, which was considered to be of comparative efficacy. The PBAC did not approve tocilizumab for combination therapy with other DMARDs due to uncertain efficacy and cost.

In January 2010, the SMC determined tocilizumab to be clinically superior compared to placebo and cost-effectiveness analysis indicated that tocilizumab was unlikely to exceed the threshold of £30,000/QALY. The SMC issued a ‘restricted use’ recommendation for tocilizumab, which only recommended tocilizumab for combination therapy with methotrexate, when one or more previous treatments (TNF-alpha inhibitors and DMARDs) had failed, as the economic case for monotherapy was not proven. NICE issued an ‘optimised’ recommendation (August 2010) which approved the use of tocilizumab as

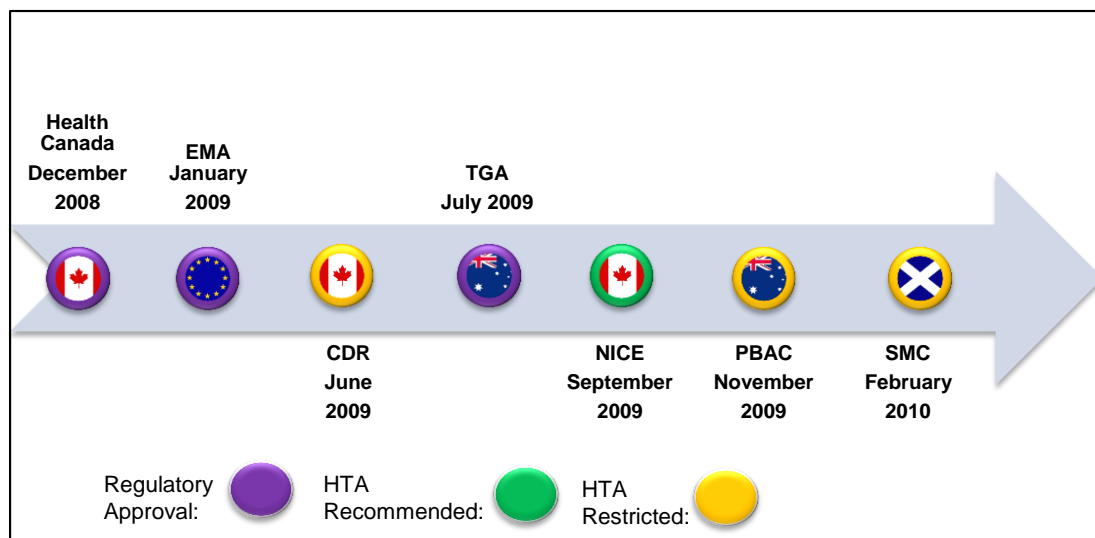
combination therapy, but this did not include a recommendation for monotherapy due to lack of data, similar to the SMC recommendation.

The CDR issued a HTA recommendation 16months after the first HTA recommendation from the PBAC. The CDR recommended tocolizumab should be 'listed with criteria/condition' as combination therapy with methotrexate or other DMARDs for eligible patients that have not responded to previous treatment (TNF-alpha inhibitors and DMARDs). The CDR recommendation noted that tocolizumab was not licensed for general use for patients that had failed to respond to DMARDs alone and this is therefore reflected in the listing recommendation.

Case study 7: Ustekinumab (Stelara) for psoriasis

Ustekinumab (Stelera) was granted marketing approval for the treatment of moderate to severe plaque psoriasis in adult patients who are eligible for phototherapy or systemic therapy by Health Canada in December 2008 and the TGA in July 2009 (Figure 5.15).

Figure 5.15: Timeline for ustekinumab (Stelera) for psoriasis



Ustekinumab was also granted marketing approval by the EMA in January 2009 for the treatment of moderate to severe plaque psoriasis in adult patients. However, the EMA restricted the indication to only patients that are

contraindicated, intolerant or failed to respond to phototherapy or other systemic therapy as the benefit/risk ratio was positive for the restricted population (EMA, 2009).

All four HTA agencies reviewed ustekinumab within seven months of the first HTA assessment. The CDR granted the first HTA approval for ustekinumab in June 2009 as 'list with criteria/conditions', followed by a 'recommended' recommendation from NICE (September 2009), an 'authority required' recommendation from PBAC (November 2009) and an approval for 'restricted use' from the SMC (February 2010). All four HTA agencies used etanercept as a comparator and noted a significant therapeutic benefit for ustekinumab. All four HTA agencies determined the cost effectiveness of ustekinumab to be comparable to competitors (etanercept and adalimumab). Cost effectiveness was determined by comparing the equivalent annual cost of treatments (CDR) or by incremental cost per QALY (PBAC, NICE and SMC). NICE and SMC both noted that an acceptable level of cost-effectiveness was achieved with the inclusion of a patient access scheme.

The Canadian CDR and Australian PBAC recommendation both included criteria/conditions that include the EMA marketing restriction to patients that had failed to respond, contraindicated or intolerant to phototherapy and other systemic therapies. The published CDEC reasons for the recommendation noted that the committee had concerns over the associated risks of ustekinumab and needed to balance the benefits and harms.

PART IV- an evaluation of factors influencing discordant HTA recommendations for Australia, Canada, England and Scotland

The final results section will focus on case studies of medicine-indication pairs reviewed by all four HTA agencies that include a negative recommendation from only one HTA agency (Table 5.9).

Table 5.9: Summary table of case studies that received a negative recommendation from one of the four agencies

Case Study	Generic Name	Proprietary name	Indication	CDR (Canada)	PBAC (Australia)	NICE (England)	SMC (Scotland)	Time from H1 to H4 (Months)
Case study 8	Dabigatran etexilate	Pradaxa	Thromboembolism (venous), prevention	DR	RR	R	R	14
Case study 9	Fingolimod	Gilenya	Multiple Sclerosis	RR	RR	R	DR	13
Case study 10	Golimumab	Simponi	Arthritis, psoriatic	R	RR	R	DR	13
Case study 11	Prasugrel hydrochloride	Effient	Acute Coronary Syndrome	DR	RR	R	RR	18
Case study 12a	Ranibizumab injection	Lucentis	Macular oedema, secondary to retinal vein occlusion, (branch retinal vein occlusion)	RR	DR	RR	DR	19
Case study 12b	Ranibizumab injection	Lucentis	Macular oedema, secondary to retinal vein occlusion, (central retinal vein occlusion)	RR	DR	R	RR	19
Case study 13	Telaprevir	Incivek	Hepatitis C infection (genotype 1), Chronic (treatment experienced)	RR	DR	R	R	5
Case study 14	Ticagrelor	Brilinta	Thrombotic events in Acute Coronary Syndromes, Prevention	DR	RR	R	R	19

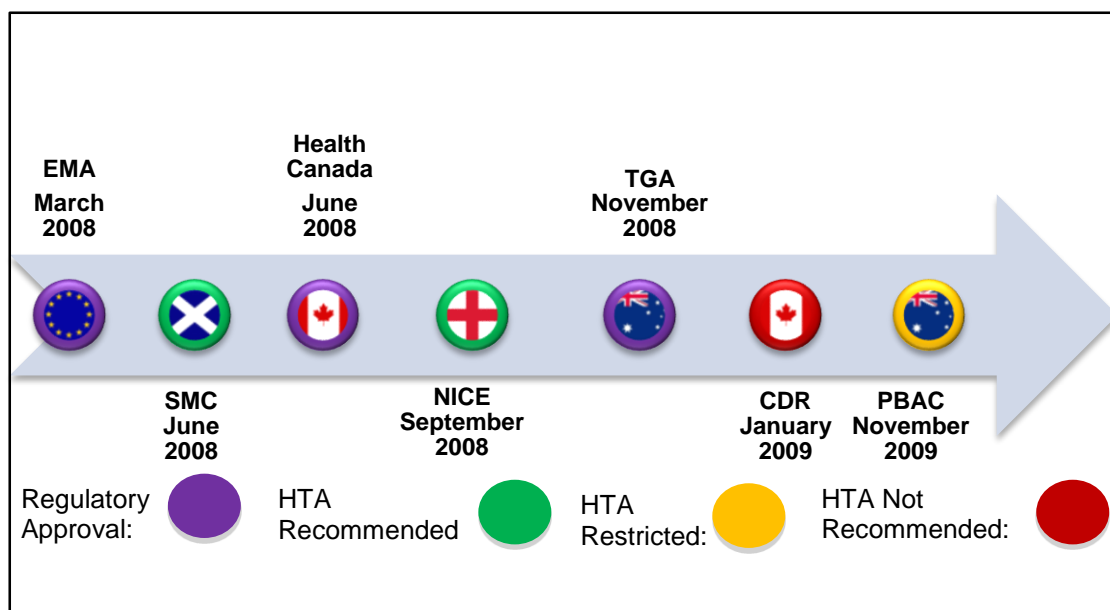
Key: H1- first HTA recommendation, H4- fourth HTA recommendation, R- Recommended, RR- Recommended with restrictions, DR- Not recommended

Seven medicine-indication pairs met this inclusion criteria, but the case study for ranibizumab also discusses two indications (cast 12a and 12b) despite only one indication meeting the inclusion criteria as both indications were reviewed in the same submissions on most occasions. Each case study is accompanied by a timeline that outlines the sequence of regulatory approvals and HTA recommendations using multinomial categories.

Case study 8: Dabigatran (Pradaxa) for prevention of venous thromboembolism following a total hip replacement or total knee replacement surgery

Dabigatran was first granted marketing authorisation by the EMA (March 2008) for the prevention of venous thromboembolism (figure 5.16) and was positively approved by the SMC (June 2008) and NICE (September 2008) within six months. The PBAC was the third HTA agency to issue a positive recommendation in November 2009. The CDR was the only HTA agency to issue a negative recommendation (January 2009) as the CDEC committee found the evidence submitted for dabigatran was not sufficient to prove non-inferiority to enoxaparin.

Figure 5.16: Timeline for dabigatran (Pradaxa) for prevention of venous thromboembolism



The CDEC committee also noted concerns that dabigatran could be used for indications outside of the marketing authorisation. The SMC, NICE and PBAC all included enoxaparin as a comparator and the SMC agreed that dabigatran was non-inferior to enoxaparin and NICE determined dabigatran was likely to have an equivalent clinical and cost effectiveness. The SMC, NICE and PBAC all noted cost-saving benefits of orally administering dabigatran compared to sub-cutaneous comparators as part of their recommendation rationale.

For this cases study, the CDR was the only agency to issue a negative recommendation despite other HTA agencies also expressing concerns over evidence supporting non-inferiority with comparator (Figure 5.16). The CDR was also the only HTA agency that did not explicitly refer to the cost-saving benefits of dabigatran's oral route of administration.

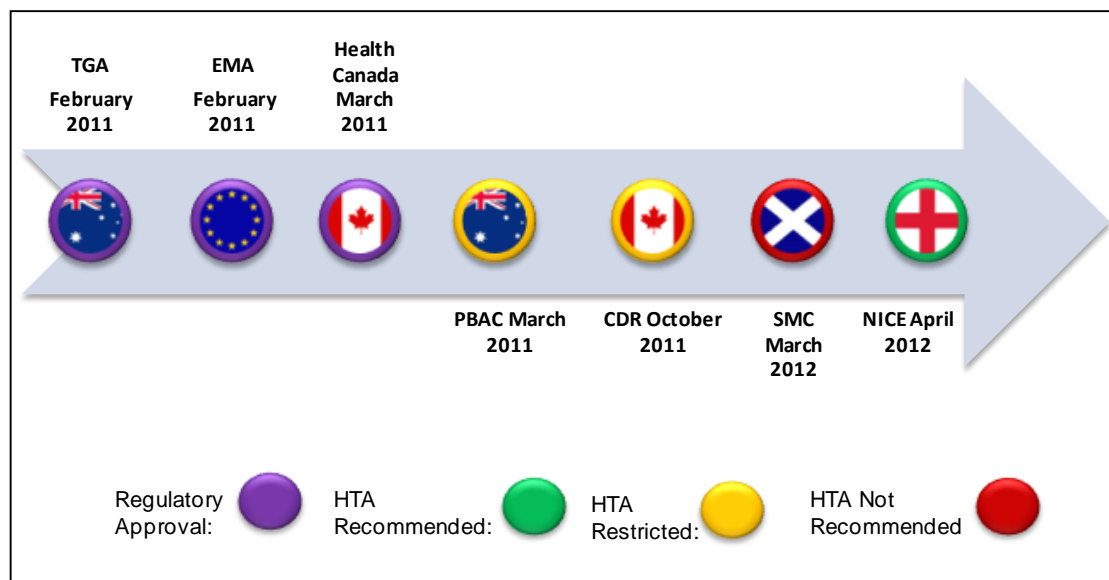
Case study 9: Fingolimod (Gilenya) for multiple sclerosis

Fingolimod (Gilenya) was granted marketing authorisation for the treatment of active, relapsing multiple sclerosis by the TGA (February 2011), the EMA (February 2011) and Health Canada (March 2011) within a two-month period (Figure 5.17). Fingolimod is the first oral medicine available for the treatment of multiple sclerosis and this provides benefits for patients by removing the need for injections. All four HTA agencies concluded that fingolimod treatment produced a significant reduction in annualised relapsed rates, but generally accepted that its efficacy was comparable to Interferon beta-1a.

All of the HTA submissions included Interferon beta-1a as the main comparator, which received a varied response from the agencies. The PBAC accepted Interferon beta-1a as the main comparator and considered the additional comparator (natalizumab) as informative. However, NICE and SMC both noted concerns regarding the manufacturers choice of Interferon beta-1a as the only comparator as the marketing authorisation from the EMA specifies fingolimod is to be used by patients with high disease activity despite treatment with at least one disease modifying therapy. Health Canada also recommended that

fingolimod is generally recommended for patients that have had an inadequate response or are intolerant to one of more therapies for multiple sclerosis.

Figure 5.17: Timeline for fingolimod (Gilenya) for multiple sclerosis



The PBAC issued the first HTA recommendation in March 2011, which was a restricted ‘authority required’ recommendation. However, the published public summary document states that the PBAC initially refused to recommend fingolimod due to uncertain cost effectiveness and an exceptionally high price, but the manufacturer submitted a lower price prior to the meeting and this was then considered to be cost-effective. The restricted recommendation from the PBAC requires a diagnosis confirmed by MRI, at least two relapses in 2 years and specifies criteria to discontinue treatment if patients demonstrate continuing disability progression.

The CDR ‘list with criteria/condition’ recommendation also specifies criteria for identifying patients where fingolimod treatment should be stopped as the reasons for recommendation state that the use of a high-cost agent is unwarranted without substantial and sustained clinical benefit.

SMC was the only HTA agency to issue a negative listing recommendation and this was due to uncertainties regarding comparator choice for the initial

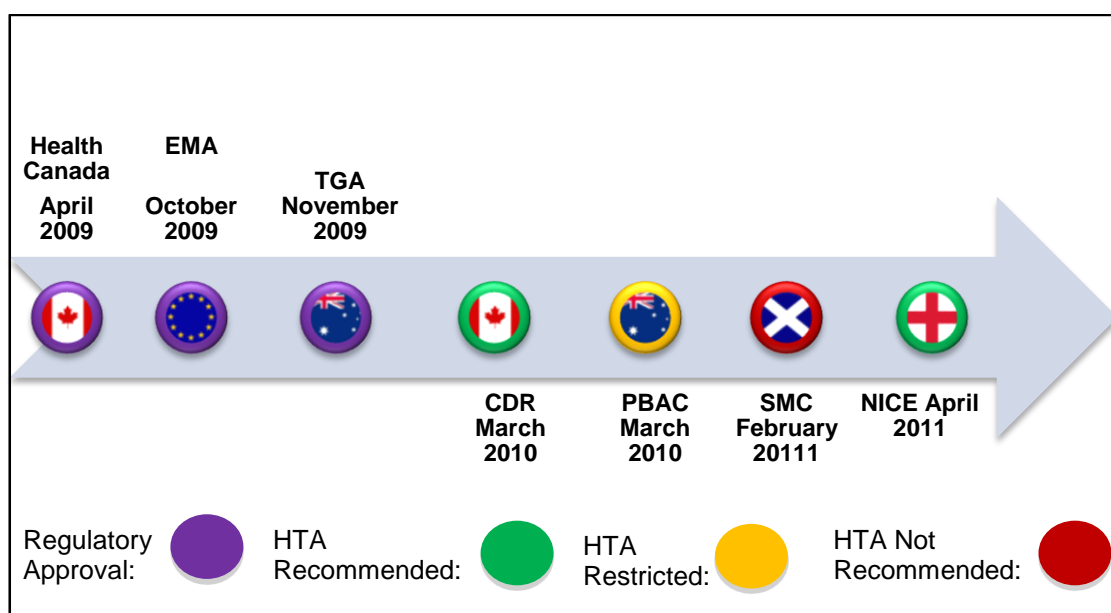
submission in March 2012. The resubmission contained an additional comparator (natalizumab) and fingolimod was subsequently granted 'restricted use' in September 2012.

Fingolimod was eventually issued a positive listing recommendation by all four HTA agencies within 14 months of first regulatory approval, but received an initial negative recommendation from the SMC due to comparator choice. This case-study is an example of a high cost medicine that achieved positive listing recommendations from HTA agencies that consider cost-effectiveness because the agencies recognised the innovative value.

Case study 10: Golimumab (Simponi) for psoriatic arthritis

Golimumab (Simponi) was granted market authorisation for the treatment of moderate to severe psoriatic arthritis, alone or in combination with methotrexate for patients that have not responded adequately to disease-modifying anti-rheumatic drugs (DMARDs) by Health Canada (April 2009), the EMA (October 2009) and the TGA (November 2009). A HTA recommendation for the treatment of psoriatic arthritis was issued by all four agencies within 12 months of the first recommendation by the CDR (March 2010) (Figure 5.18).

Figure 5.18: Timeline for golimumab (Simponi) for psoriatic arthritis



All four HTA recommendations noted a lack of trials with direct comparisons, but accepted that golimumab was clinically superior to placebo (CDR, NICE and SMC) and/or suggests similar efficacy to other TNF-alpha inhibitors (PBAC, NICE). The CDR, NICE and SMC accepted adalimumab, infliximab and etanercept as comparators and the PBAC also used adalimumab and etanercept.

The CDR accepted the cost of golimumab to be less than comparators when administered 12 times a year. NICE also noted that the ICER for golimumab compared with infliximab would result in a savings per QALY lost due to the lower price and less QALYs gained. The CDR, NICE and PBAC all recommended golimumab for reimbursement, but the SMC issued a negative recommendation due to an insufficiently robust economic analysis. However, following a resubmission in June 2012, golimumab was granted a recommendation for 'restricted' use as the economic case was demonstrated. The SMC restricted golimumab to only the 50mg dose as the 100mg was not considered cost-effective. The recommendations from the CDR and PBAC were also only for the 50mg dose, but NICE accepted the 100mg dose for use only with a patient access scheme that acquires the 100mg dose at the same cost as the 50mg dose.

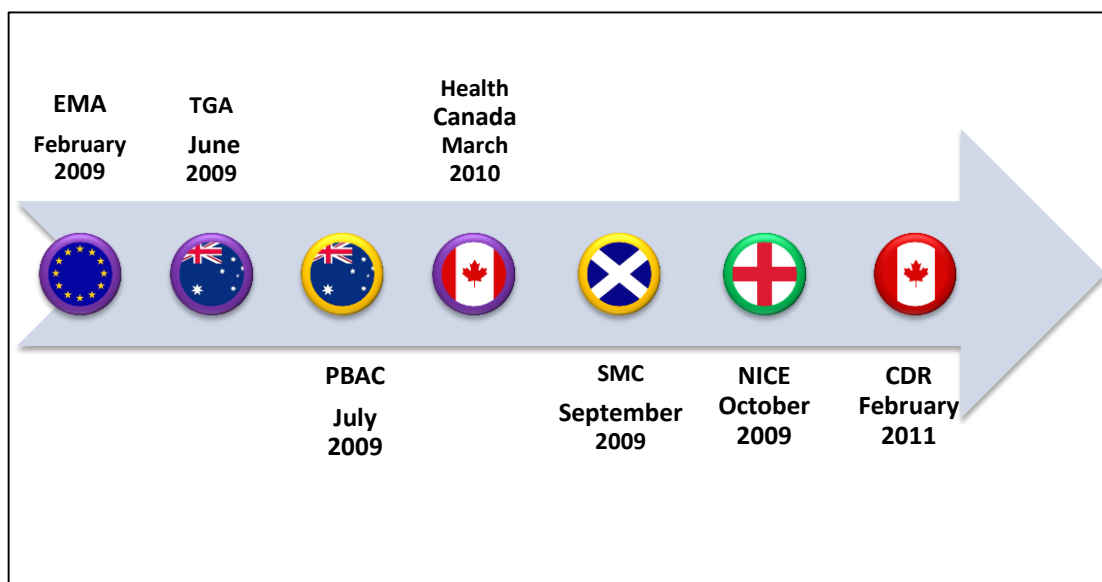
Following the successful resubmission to the SMC, golimumab was eventually granted a positive listing recommendation by all four HTA agencies. Golimumab has also been reviewed in case study 3 for rheumatoid arthritis and case study 4 for ankylosing spondylitis and both indication submissions received positive initial recommendations from the SMC and were submitted after the initial golimumab submission to the SMC for psoriatic arthritis. It could be concluded that the manufacturers' experience from this case study provided useful insights for future submissions.

Case study 11: Prasugrel (Effient) for acute coronary syndrome

Case study 11 identified for medicines issued a negative recommendation by a single agency is for prasugrel (Effient) for the treatment of acute coronary

syndromes. Prasugrel was initially granted marketing authorisation by the EMA (February 2009), shortly followed by the TGA (June 2009) and finally approved by Health Canada a year later. The PBAC issued the first HTA recommendation for a restricted (authority required (streamlined)) listing, followed by a restricted listing from the SMC in September 2009 and a 'recommended' recommendation from NICE in October 2009. The CDR issued the last HTA recommendation in February 2011 with a negative 'do not list' recommendation (Figure 5.19).

Figure 5.19: Timeline for prasugrel (Effient) for acute coronary syndromes



The incremental cost per QALY considered by all four HTA agencies were all within the explicit or implicit QALY thresholds (Table 5.1). All four HTA agencies accepted clopidogrel as the main comparator and either accepted the superior clinical benefit of prasugrel (PBAC and SMC) or raised concerns over the transferability of the clinical trials for national clinical practice (CDR and NICE). NICE was uncertain about the comparative efficacy, but believed prasugrel could be beneficial for certain patient populations. Both the NICE 'recommended' and SMC 'restricted' recommendations only recommended the 10mg dose of prasugrel.

The negative recommendation from the CDR cited uncertainty over the applicability of the trial design to Canadian clinical practice and also raised concerns over safety due to trial results indicating a statistically significant increase of major bleeding events for prasugrel over clopidogrel. The CDR also noted that they expect prasugrel could offer benefits for some patients, but did not have data to support these assumptions. In June 2012, the CDR issued another 'do not list' recommendation in response to the manufacturer's resubmission. The resubmission included a lower price, but the comparator (clopidogrel) was then available as a generic. Additional data were also included, but no new randomised controlled trials met CDR requirements and the CDR still expressed concerns over the generalisability of trial data in the Canadian context. However, the resubmission recommendation also stated that a positive listing could be achieved at a lower price for prasugrel.

The CDR does not negotiate price as the final listing decision and price negotiations are determined by participating drug plans but the CDR states that a positive listing recommendation could be achieved at a lower price. The CDR has indicated to participating plans that prasugrel could be a viable option and demonstrated that the CDR recommendation is partially similar to the other three HTA agencies but differences in agency remit have resulted in a different recommendation classification.

Case studies 12a and 12b: Ranibizumab injection (Lucentis) for Macular oedema, secondary to retinal vein occlusion (Branch Retinal Vein Occlusion (BRVO) (case study 12a) and Central Retinal Vein Occlusion (CRVO) (case study 12b)

Case studies 12a and 12b are for medicines issued a negative recommendation by a single HTA agency and are both for ranibizumab (Lucentis) for the treatment of macular oedema, secondary Branch Retinal Vein Occlusion (BRVO) (case study 12a) (figure 5.20) or to Central Retinal Vein Occlusion (CRVO) (case study 12b) (Figure 5.21).

The EMA issued the first marketing authorisation for ranibizumab (March 2011) followed by Health Canada (July 2011) and the TGA (December 2011). The SMC issued the first HTA assessment recommendation for ranibizumab

(November 2011) a year before the next HTA recommendation was issued by the CDR (October 2012) and the PBAC (November 2012) and 18 months prior to a HTA recommendation from NICE (May 2013).

Figure 5.20: Timeline for ranibizumab injection (Lucentis) for Macular oedema, secondary to retinal vein occlusion (Branch Retinal Vein Occlusion (BRVO))

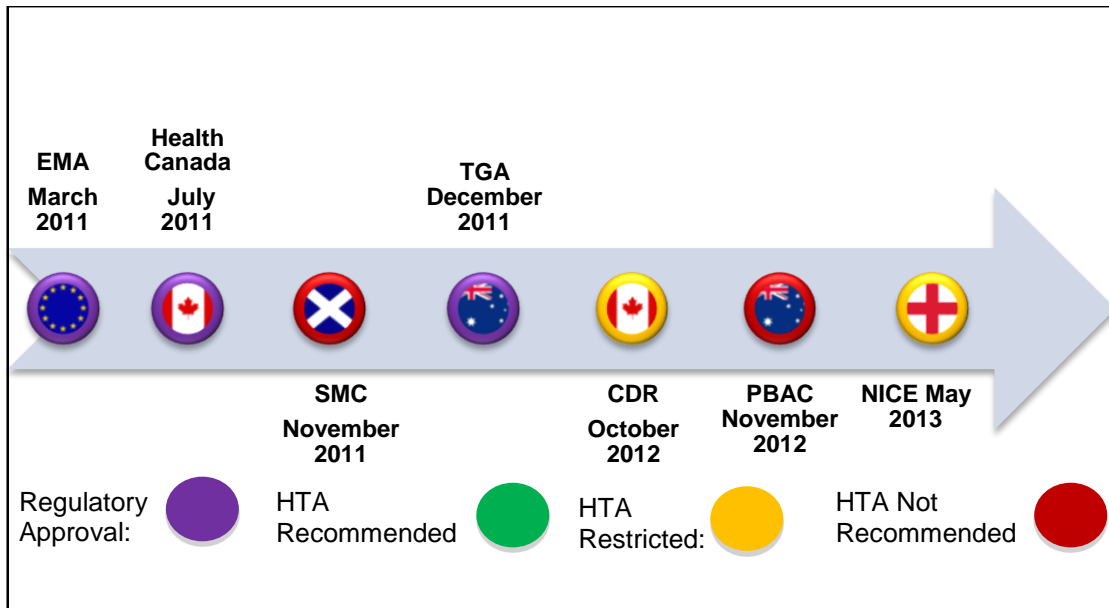
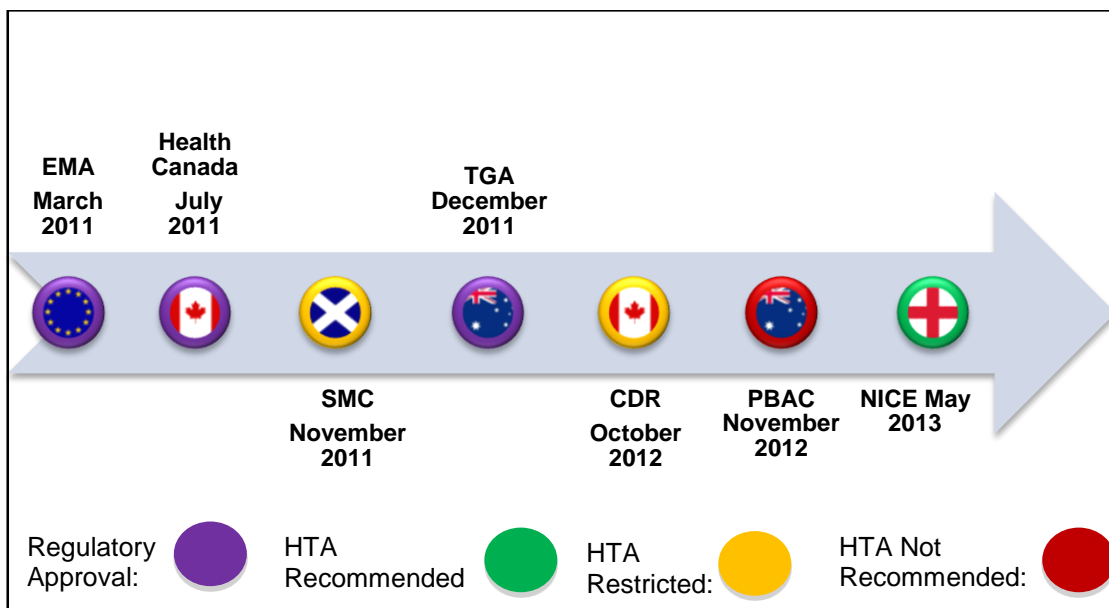


Figure 5.21: Timeline for ranibizumab injection (Lucentis) for Macular oedema, secondary to Central Retinal Vein Occlusion (CRVO)



All four HTA agencies accepted laser photocoagulation as the comparator for macular oedema, secondary to BRVO (Figure 5.20). However, macular oedema, secondary to CRVO does not respond to laser photocoagulation and therefore three HTA agencies (CDR, PBAC and SMC) accepted 'observation' as the main comparator and one agency used 'best supportive care' for comparison. Patients with macular oedema, secondary to BRVO may experience spontaneous improvement in their condition, but spontaneous improvement is not expected for patients with macular oedema, secondary to CRVO. Therefore, there is a greater need for treatment options for patients with macular oedema, secondary to CRVO and HTA agencies issued different recommendations for the different indications.

The PBAC was the only HTA agency to issue a negative recommendation for ranibizumab for the treatment of macular oedema, secondary to CRVO and BRVO due to its high cost and uncertain cost-effectiveness (Figure 5.21 and 5.20). The ICERs across BRVO and CRVO were considered to be between AUS\$45,000 to \$75,000 and likely to be even higher as the PBAC found the benefits to be overestimated in the manufacturers submission. Therefore the ICERS are expected to exceed the implicit QALY threshold of AUD \$69,900. The PBAC also expressed concerns over laser photocoagulation as a comparator and noted that bevacizumab is widely used to treat macular oedema secondary to BRVO and CRVO despite not being TGA approved for these indications or formulated for intravitreal use. The manufacturer resubmitted ranibizumab for consideration by the PBAC. However, the first resubmission (November 2013) was deferred due to ongoing concerns over comparator and another resubmission (March 2014) was also deferred as the price reduction was still not low enough to outweigh the uncertainties around cost effectiveness.

The SMC issued a 'restricted' recommendation for ranibizumab, which only recommends ranibizumab for the treatment of macular oedema, secondary to CRVO as ranibizumab can provide benefits to patients that lack alternative treatment options and the manufacturer agreed to a patient access scheme. The SMC did not recommend ranibizumab for the treatment of BRVO due to

uncertainties over cost effectiveness and a high ICER. However, the manufacturer submitted a resubmission for ranibizumab to treat BRVO and the SMC issued a positive recommendation in May 2013 as a result of a patient access scheme.

The CDR issued a 'list with criteria/condition' recommendation for ranibizumab for the treatment of macular oedema, secondary to CRVO and BRVO. The BRVO recommendation is to offer ranibizumab to patients not previously treated with a Vascular Endothelial Growth Factor (VEG-F) inhibitor and coverage limited to 24 months.

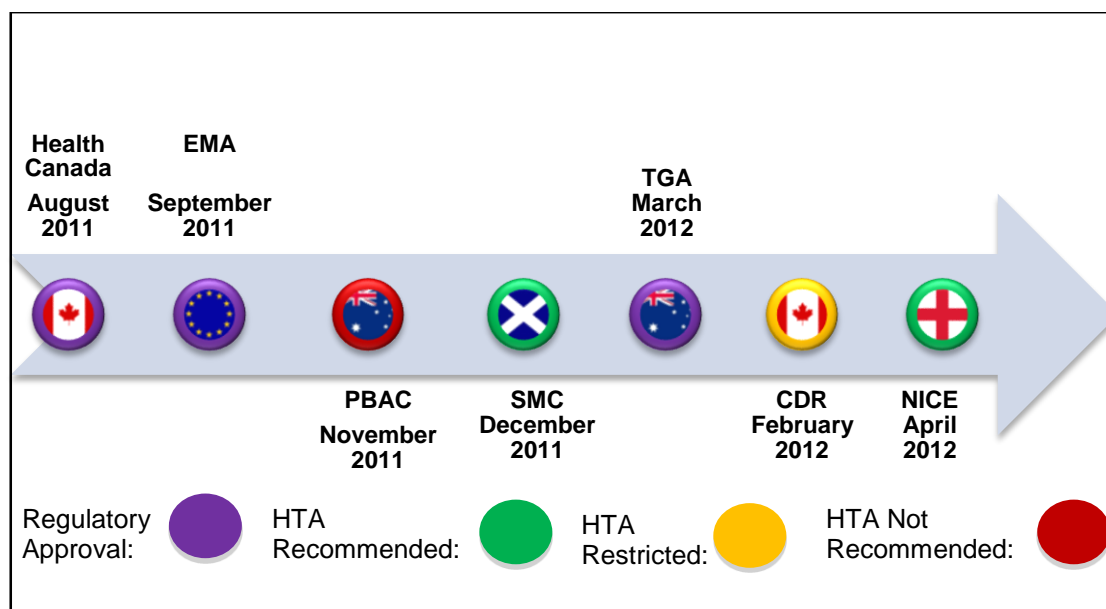
In May 2013 NICE issued two different recommendations for ranibizumab to treat retinal vein occlusion. NICE issued a 'recommended' recommendation for the treatment of macular oedema, secondary to CRVO in line with market authorisation and a patient access scheme with a price reduction from the manufacturer. However, an 'optimised' recommendation was issued for ranibizumab with a patient access scheme for the treatment of macular oedema, secondary to BRVO only when laser photocoagulation therapy was unsuccessful or not appropriate.

Ranibizumab received positive recommendations from the CDR, SMC and NICE for both BRVO and CRVO indications. The SMC recommendation for ranibizumab to treat CRVO was initially negative but a resubmission with a patient access scheme has since resulted in a positive recommendation. All three of these HTA agencies issued more restrictive positive recommendations for ranibizumab to treat BRVO as this indication has potential treatment options and patients can spontaneously improve unlike CRVO. The manufacturer's submission to the PBAC has been deferred due to ongoing concerns for comparator choice. PBAC and NICE both considered bevacizumab to be an appropriate comparator choice despite no marketing authorisation to treat CRVO or available intravitreal formulation. However, the varying willingness to accept alternative comparators has resulted in different reimbursement recommendations.

Case study 13: Telaprevir (Incivek) for Hepatitis C infection (genotype 1) in treatment experienced patients

Telaprevir (Incivek) for the treatment of Hepatitis C infection (genotype 1) with compensated liver disease was given two different initial reimbursement recommendations by the PBAC due to the initial manufacturers submission (November 2011) only requesting a review of telaprevir for patients that are treatment experienced. This initial submission was rejected by the PBAC because final product information from the TGA was not available at the time of the review (Figure 5.22).

Figure 5.22: Timeline for telaprevir (Incivek) for Hepatitis C infection (genotype 1) in treatment experienced patients



In March 2012, the TGA approved marketing authorisation for telaprevir for the treatment of chronic Hepatitis C infection (genotype 1) with compensated liver disease in patients who are either treatment naïve or are treatment experienced (interferon alpha with or without ribavirin). The manufacturer’s resubmission to the PBAC (March 2012) also included a request to review telaprevir for the treatment of naïve patients.

The PBAC approved both indications (treatment naïve and treatment experienced), with separate restrictions, for ‘authority required (streamlined)’

listing to be only available in specialised treatment centres. The recommendation was based on acceptable cost-effectiveness when the price of the telaprevir treatment course was equal to the cost of boceprevir. The PBAC also recommended the manufacturer provides a 100% rebate for treatment costs above the provided estimates. However, sponsor comments stated that they did not believe in a 100% rebate for a risk share agreement. The resubmission for treatment of experienced patients was also the initial PBAC consideration for the treatment naïve indication. All four HTA agencies provided a positive initial recommendation for telaprevir for this indication. Therefore, telaprevir also meets the inclusion criteria for the positive case studies.

The SMC was the second HTA agency to review telaprevir for patients with chronic hepatitis C and published two separate recommendations for treatment naïve and treatment experienced patients in December 2011. Both indications were determined to have a statistically significant clinical benefit and cost effectiveness compared to peginterferon alpha and ribavirin. However, the ICER for telaprevir/peginterferon alpha and ribavirin for treatment experienced patients that were null responders was calculated to be as high as £73,600 per QALY, but this was sensitive to many variables (e.g. age) and overall, cost effectiveness was accepted.

In February 2012, the CDR issued a final recommendation for telaprevir for the treatment of hepatitis C, including both treatment naïve and treatment experienced patients. A recommendation for 'list with criteria/condition' at a reduced price with clinical criteria that eligible patients are not co-infected with HIV. The CDR published recommendation noted that patients with HIV were excluded from the trial and the benefits are unclear for this subgroup of patients. The SMC and NICE published recommendations also noted that HIV patients were excluded from the trial, but no restrictions for HIV patients were included in the recommendations from NICE, SMC or the accepted PBAC resubmission.

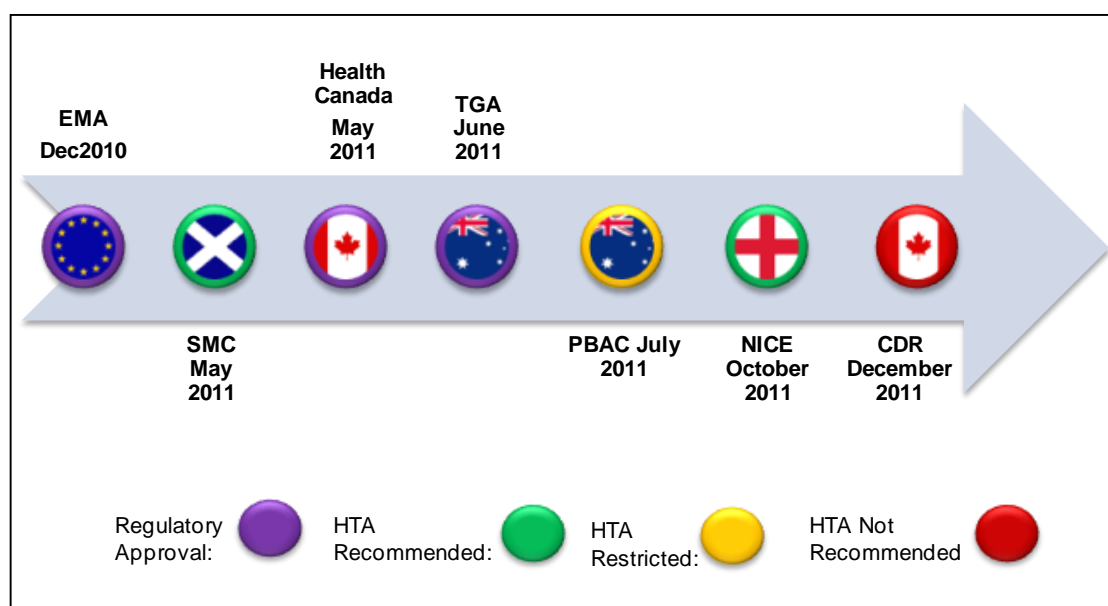
Ultimately, telaprevir for hepatitis C infection in treatment experience patients achieved positive recommendations from the four HTA agencies. The initial negative recommendation from the PBAC was due to the timing of the

submission as the TGA final product information was not available at the time of the meeting.

Case Study 14: Ticagrelor (Brilinta/Brillique) for acute coronary syndrome

The final case study for medicines issued a negative recommendation by a single HTA agency is for ticagrelor, sold as Brillique in Europe and Brilinta in Canada and Australia. In December 2010 the EMA issued the first marketing approval for ticagrelor for the treatment of acute coronary syndromes. Marketing authorisation for ticagrelor was issued more than a year later in Canada (May 2011) and Australia (June 2011) (Figure 5.23).

Figure 5.23: Timeline for ticagrelor (Brilinta/Brillique) for acute coronary syndrome



The SMC issued the first HTA recommendation in May 2011 as 'accepted' followed by an 'authority required (streamlined)' recommendation from the TGA in July 2011 and a 'recommended' recommendation from NICE in October 2011. All three HTA reviews accepted ticagrelor as clinically superior to clopidogrel, but uncertainties were raised over comparative safety (PBAC).

However NICE decided the potential benefits outweighed the risks and the SMC found the increase in adverse events were not significant. The PBAC,

NICE and SMC review all accepted the increased cost per QALY to clopidogrel to be below the implicit or explicit thresholds.

The CDR issued a 'Do not list' recommendation in December 2011 as a regional analysis did not provide evidence that ticagrelor would provide significant benefits over clopidogrel for the North American population and the CDR could therefore not justify the increased cost of ticagrelor. However, the CDR recommendation summary also stated that a positive recommendation would be more likely if the price was reduced. The CDR issued a similar recommendation for prasugrel (case study 1) which also noted that a reduced price could result in a positive recommendation. Once again, this is a divergent recommendation issued by the CDR as negotiating price is not part of the CDR's remit.

DISCUSSION

This chapter describes a comparison of HTA in Canada, Australia, England and Scotland. These four jurisdictions were selected due to transparency and availability of data in English, as these all provide online summaries with rationale for reimbursement recommendations. The comparisons of the full HTA recommendations dataset provides a useful overview of recommendations for non-cancer medicines issued over a period greater than three years and has demonstrated that the more negative HTA recommendations a medicine receives, the fewer markets will receive a submission for reimbursement (Figure 5.7). The four HTA agencies selected for inclusion in this study share common factors, such as: considering clinical and cost-effectiveness of new medicines and have an implicit or explicit QALY threshold. When one or more of these HTA agencies issue a negative recommendation it is possible that the manufacturer may decide against further submissions to similar agencies. This could be perceived negatively for patients as they will be unable to access medicines that have not been reviewed and recommended for their jurisdiction. This is also negative for the manufacturer as it reduces the opportunity to achieve a return on the initial research and development expenditure. However, it may also require the time and costs

spent on rejected submissions for the manufacturer and HTA agencies. This could produce a more innovative and efficient environment if manufacturers are deterred from allocated resources for the research and development of products that are unlikely to satisfy HTA requirements and therefore have reduced chances of reimbursement.

The case studies provide further insights into the rationale behind the HTA recommendations. The fourteen case studies were selected from the 25 medicine-indication pairs that were reviewed by all four HTA agencies. No medicine-indication pairs received all 'recommended' using the multinomial classification, but seven medicine-indication pairs were all positive recommendations using the binomial classification (Figure 5.6) (Table 5.4). These were selected to provide further insights into the similarities and differences behind positive recommendations. Another seven medicine-indication pairs were issued a negative recommendation by only one of the four agencies. These seven medicine-indication pairs were chosen as case studies to identify reasons for the divergent recommendations as the other three agencies were in general agreement and issued a positive recommendation. These were of value for identifying similarities and differences between the four agencies.

The most common factor associated with the divergent case studies was uncertainties around cost-effectiveness and the justification for a high cost product. For example, golimumab for psoriatic arthritis (case study 10) was initially rejected by the SMC due to submission of an insufficient economic analysis. The initial submission to SMC included a cost-utility analysis that demonstrated that a comparator (etanercept) had a lower cost per incremental QALY so that SMC concluded that the comparator would be preferred by decision-makers. The resubmission included a cost-minimisation comparison of the drug costs over a year with the same three comparators and demonstrated etanercept to be more cost-effective than two comparators (etancercept and infliximab) and cost-neutral with adalimumab. Interestingly, a cost minimization analysis was also included in the initial submissions to the CDR and PBAC which were submitted up to a year before the initial submission

to the SMC. This might imply that the cost-minimisation analysis was a key factor for positive recommendations. Therefore, if the manufacturer's submission to the SMC had originally included this, then golimumab may have had a positive recommendation for the initial submission and patients in Scotland would have had earlier access to golimumab.

Case studies eleven and twelve for ranibizumab for the treatment of macular oedema secondary to Branch Retinal Vein Occlusion (BRVO) (case study 12a) and CRVO (case study 12b) also included divergent recommendations due to uncertainties for cost-effectiveness of the product. The PBAC was the only HTA agency to issue a negative recommendation for both indications due to these uncertainties. Ranibizumab is a high cost product and the calculated Incremental Cost Effectiveness Ratios (ICERs) exceeded the implicit QALY threshold for the PBAC. However, the PBAC also expressed concerns surrounding the choice of comparator. The same comparators were included in the submissions to the four agencies and all agencies generally accepted observation or best supportive care as a comparator for CRVO and laser photocoagulation for BRVO. However, the PBAC noted that in clinical practice bevacizumab was often used to treat both CRVO and BRVO despite bevacizumab not having TGA approval for these indications and not formulated for intravitreal use. The NICE appraisal also concluded bevacizumab to be an appropriate comparator despite having no marketing authorisation from the EMA, as this is not a prerequisite to be considered as a comparator. NICE considered the safety and efficacy of bevacizumab for the treatment of CRVO and BRVO, but ultimately did not include bevacizumab in the cost-effectiveness analysis due to a lack of evidence.

Fingolimod for the treatment of MS (case study 9) also resulted in a divergent recommendation due to concerns regarding the cost-effectiveness of the product as a result of comparator choice. The SMC rejected the initial submission in March 2012 due to the economic case not being demonstrated, but subsequently approved fingolimod for restricted use in September 2012 when the manufacturer resubmitted with a new comparator (natalizumab). Natalizumab was also submitted as a secondary comparator in the PBAC

submission a year earlier (March 2011). Fingolimod is also an example of a high cost product that exceeds implicit QALY thresholds, but still gains approval: CDR calculated that the cost per QALY could be as high as CAN\$337,381 and PBAC calculated the incremental cost per QALY up to AUD\$200,000. The four agencies all acknowledged the therapeutic benefits of fingolimod and its innovative value as the first oral treatment for MS and the need for new treatment option in this area.

The CDR issued negative recommendations for two medicines for the treatment of acute coronary syndromes. The CDR first rejected prasugrel in February 2011 due to concerns surrounding the trial design which they believed may not be generalisable to Canadian clinical practice and also expressed safety concerns for the product. NICE also noted that the trial submitted may not be generalisable to English clinical practice and PBAC, NICE and SMC all noted concerns over safety. The CDR also rejected ticagrelor in December 2011 (case study 14) due to uncertain therapeutic benefit for the North American patient population, but recommendations for both ticagrelor and prasugrel noted that a reduced price could result in a positive decision. These are examples where a divergent recommendation from the CDR is likely to be due to the remit of the CDR as the CDR does not negotiate price. The participating drug plans are responsible for price negotiations and therefore the CDR has acknowledged in its recommendation that this medicine may be a viable option and manufacturers are granted the opportunity to resubmit at a reduced price during the embargo period if the CDEC recommendation states that a reduced price will be considered. However, the manufacturer can only submit a reduced price once and the CDR does not consider price listing agreements, price caps, rebates or changes to the indication population (CDR, 2014). The results of these case studies support the results of Clement et al. (2009) who also concluded that recommendations from the CDR, NICE and PBAC can vary due to agencies ability to negotiate price.

The rationale for the divergent decision issued by the PBAC for incivek for the treatment of hepatitis C (case study 13) was very different to the other 6 case studies. This case study provides an example where the timing of the process was the cause of uncertainties that led to a negative recommendation. The four

agencies all accepted that incivek demonstrated a clinical benefit, but the submission to the PBAC (November 2011) was prior to TGA approval (March 2012) and therefore the PBAC did not have the final TGA product information at the time of the appraisal and the submission was rejected. The resubmission was subsequently approved in July 2012 after TGA approval.

The seven divergent case studies demonstrate examples where new medicine-indication pairs have been rejected due to uncertainties surrounding a range of factors such as: cost-effectiveness, comparator choice, clinical benefit, safety, trial design, and submission timing. In several of the case studies with divergent recommendations, the rationale for the negative recommendation was also considered by the other three agencies yet they issued a positive recommendation. Therefore, the differences in recommendations could be considered to be due to agencies approaches to risk perception. This supports an observation by Clement *et al.* (2009) where observed differences in listing decisions from the CDR, PBAC and NICE were more likely due to agency processes and different attitudes to risk than the interpretation of clinical and economic evidence. Two case studies provide examples where the SMC initially rejected a submission, but later accepted a resubmission that contained a cost-minimisation comparison or a comparator choice that was not included in the original submission, but was included in submissions to other agencies a year prior to the initial SMC submission. This could suggest that manufacturers may require more specific guidance for submissions and more transparency regarding how the agency considers different types of evidence to determine a listing decision. Increasing consistency of the HTA process and evidence requirements could reduce discordant recommendations that are a result of initial submissions that misjudged the evidence requirements. Discordant recommendations that are due to differences in agency risk perception or agency mandate to negotiate price are more difficult to overcome.

This study expands upon prior work by Clement *et al.* (2009), Nicod and Kanavos (2012) and Spinner *et al.* (2013) that reviewed similarities and differences between HTA recommendations from all, or three, of the four jurisdictions examined in this study. The HTA recommendations reviewed in

this study are for a more recent selection of medicine-indication pairs and have a unique inclusion criteria by requiring all medicines to be reviewed by the CDR. This enables this study to draw comparisons with the Canadian regional payers reviewed in chapter 6 in addition to this international comparison. The HTA recommendations for the 89 medicine-indication pairs has identified substantial variation between recommendations issued by the CDR, PBAC, NICE and SMC and, unlike the comparative studies by Clement *et al.* (2009) and Nicod and Kanavos (2012), this study excluded resubmissions. This focused on the first recommendation issued by agencies and provided insights into how successful the manufacturers initial submissions are for these four established and transparent HTA agencies (Neumann *et al.*, 2010). The case studies have included resubmissions as this can help identify the impact of the updates for the resubmissions. The results of this research includes case studies where submissions were for trials that did not appropriately follow clinical practice for the country of submission (case study 11) and uncertainties surrounding comparator choice (case studies 9, 12a and 12b). This supports the findings by Spinner *et al.* (2013), which included comparator choice and agency reasons for rejecting trials as a result of varying clinical evidence. Unlike the study by Skinner *et al.* this did not focus on clinical evidence and also identified other factors for divergent decisions, such as an agency's ability to negotiate price or product listing agreements (case studies 11 and 14) which supports the findings of Clement *et al.* (2009) and Nicod and Kanavos (2012). The prevalence and impact of the factors identified in the full set of divergent case studies could be investigated in further work with a larger dataset and more detailed insights could be obtained if data can be sourced directly from agencies where information is not available in detail in the public domain.

SUMMARY

- Process maps for the regulatory to reimbursement pathways of new medicines and indications were produced for the CDR (Canada), PBAC (Australia), NICE (England) and SMC (Scotland).

- The comparison of HTA recommendations for new medicine-indication pairs issued from January 2009 to May 2013 builds on previous work comparing recommendations from the CDR, PBAC and NICE (Clement *et al.* 2009; Nicod and Kanavos 2012; Spinner *et al.* 2013).
- Percentage agreement using a binomial category classification enabled the calculation of percentage agreement and kappa coefficients. NICE and SMC had the greatest percentage agreement for recommendations, but the CDR and PBAC demonstrated the greatest interrater reliability with a kappa coefficient of 0.336.
- Using the CDR recommendations as inclusion criteria produces a unique dataset that enables comparisons to be drawn with a study evaluating the impact of CDR recommendations on regional payer decision-making (Chapter 6).
- Seven case studies compared the rationale for medicine-indication pairs that received a positive recommendation from four agencies and seven case studies investigated the rationale for divergent negative HTA recommendations by a single agency for medicine-indication pairs that received a positive recommendation by the other three agencies.
- Overall, the four HTA agencies reviewed for this study are all established agencies with expertise, experience and generally similar approaches for conducting HTA, but their recommendations still have substantial differences.

CHAPTER 6

An Evaluation of the Impact of Canadian National HTA Recommendations for Provincial Payers

INTRODUCTION

Canada's publicly funded national healthcare system has been providing medical care for residents for nearly half a century. In accordance with the Canada Health Act of 1984, provinces are required to provide all medically necessary hospital and physician services, although this mandate only included prescription medicines when administered within hospital. Multiple payers provide coverage for outpatient medicines, including 19 publicly funded federal, provincial and territorial drug plans, each with varying eligible groups and formularies. In 2013, the total annual expenditure for prescription medications in Canada was an estimated \$29.3 billion, of which \$12.2 billion was funded through the public sector (Canadian Institute for Health Information (CIHI), 2014) which is similar to many European publicly funded healthcare systems. Canada's public drug plans utilise health technology assessment (HTA) to inform reimbursement decision-making. Canada has a long history of HTA and created its first HTA body in 1988 with the establishment of Conseil d'Évaluation des Technologies de la Santé du Québec (CETS) to promote, support and produce assessments of health technologies to advise the Ministère de la Santé et des Services sociaux (Minister of Health and Social Services) (Office of Technology Assessment, 1995). In 1989, the Canadian Coordinating Office of Health Technology Assessment (CCOHTA) was created as a pan-Canadian HTA body to provide clinical and economic guidance for the reimbursement of health technologies to 18 public drug plans (Menon and Stafinski, 2009). In 1991, the British Columbia Office of Health Technology Assessment (BCOHTA) was created within the University of British Columbia as HTA was also becoming established within Alberta and Saskatchewan (Office of Technology Assessment, 1995).

Health Technology Assessment has evolved in Canada and throughout the world as healthcare policy and decision-makers are increasingly utilising HTA to ensure healthcare resources are used efficiently (Allen *et al.*, 2013). The Canadian Agency for Drugs and Technologies in Health (CADTH) provides the Common Drug Review (CDR) programme to conduct a centralised national HTA review recognised by all federal, provincial and territorial public drug plans

except that of Quebec. Prior to the inception of the CDR in 2002, multiple provincial, territorial and federal drug plans performed their own HTAs to determine coverage for a new drug product. CADTH established the CDR to standardise the Canadian HTA environment, reduce the duplication of HTA and ultimately to decrease the time taken for patients to access innovative medicines (Spitz, 2013). The more recently established European Network of HTA (EUnetHTA) was also created to develop a more timely and efficient use of HTA resources for participating members (European Network for Health Technology Assessment (EUnetHTA), 2008). However, EUnetHTA aims to create a sustainable network of European HTA agencies that share information and methodologies, rather than creating a single European HTA agency to provide reimbursement recommendations. EUnetHTA participants will ultimately need to provide a reimbursement recommendation that considers their unique population needs, budget and existing treatment options. The patient populations, healthcare systems, budgets, political and cultural differences of EUnetHTA members are more heterogeneous than the participating plans of the CDR, but the Canadian HTA environment is an example of a working model for sharing HTA information that is contextualized at the local level and this can provide useful insights for the European HTA environment.

The CDR has been subjected to criticism from various stakeholders. In 2007, the Canadian Diabetes Association prepared a written submission to the House of Commons Standing Committee on Health that questions whether the CDR has created duplication of work and delays for patient access to new medicines (Canadian Diabetes Association, 2007). The written submission states that participating drug plans were to dismantle their existing drug review processes and focus on budget impact and regional health priorities, but refers to the expansion of Ontario's expert committee for reviewing medicines to now include patient representatives and British Columbia's review of its provincial drug review. In 2011 the Atlantic Institute for Market Studies (AIMS) published a report evaluating the alignment of a sample of provincial listing decisions and CDR recommendations (Attaran *et al.*, 2011). Attaran *et al.* (2011) calculated percentage agreement between the CDR and three provinces (Ontario, Prince

Edward Island and Newfoundland and Labrador) to be as low as 50% which is described as 'no better than random chance'. However the findings of Attaran *et al.* (2011) conflict with a study that also compared CDR recommendations from inception to 2009 with provincial listing decisions and identified greater agreement between the CDR and provincial listing decisions (Gamble *et al.*, 2011).

No studies have subsequently been published comparing post-2009 CDR recommendations with provincial listing decisions. Therefore, there is a gap in the existing body of knowledge and a more recent comparison of CDR recommendations and with provincial listing decisions will provide data that is more up-to-date and relevant for the current HTA environment. Building upon existing studies is also recommended by McMahon *et al.* (2006) to identify whether the CDR is creating more standardised coverage for medicines across Canada. This will also provide more evidence to either support or oppose Morgan *et al.* (2006) who argues that multiple provincial decision-makers reduces the impact of the CDR and similarly, Hollis and Law (2004) who predict that, without a national Canadian formulary, the CDR will only slightly improve standardization of medicines coverage across provinces. Therefore, this research focuses on the Canadian HTA environment to compare the non-mandatory HTA recommendations from the national CDR and the final listing decisions from provincial drug plans and HTA. For this study, the 4 largest provinces have been chosen for comparison with the CDR: Alberta, British Columbia, Ontario and Quebec. Quebec has its own HTA agency and, therefore, does not officially use the CDR report as a guide for their final reimbursement decision.

OBJECTIVES

This study aims to evaluate the impact of the CDR recommendations for participating payers. This will be achieved by:

- Comparing CDR recommendations issued from January 2009 to May 2013 with listing decisions from three participating provincial public payers (Alberta, British Columbia and Ontario) and Quebec

- Identifying HTA resources for Alberta, British Columbia, Ontario and Quebec
- Understanding how these four decisions-makers use CDR assessments
- Identifying additional assessments that are not considered for the CDR recommendation, but are required by the three provincial payers
- Comparing how the patient-voice is included in the listing decision-making process in Alberta, British Columbia, Ontario and Quebec

METHODOLOGY

Information from the public domain was evaluated to identify the key agencies involved in the regulatory, HTA and reimbursement process for the CDR and new medicines in 4 jurisdictions: Alberta, British Columbia, Ontario and Quebec. This information was collected to produce a process map for each jurisdiction using the novel mapping methodology described in chapter 3 (Allen *et al.*, 2010a). The process maps display the regulatory, HTA and reimbursement pathways through a uniform methodology for visual comparison. Data for the reimbursement recommendations and final listing decisions were identified for the responsible agency or organisation. The first agency to be reviewed was CADTH, to identify the list of drug products that meet the following inclusion criteria: initial submission to the CDR and issued a recommendation from January 2009 to May 2013. Data collected from the CDR section of the CADTH website included the following for each medicine-indication pair: Generic name; proprietary name; indication; date final CDR recommendation issued (dd/mm/yyyy) and final recommendation. The online websites for Alberta, British Columbia, Ontario and Quebec were subsequently searched for the initial listing decision of the same medicine-indication combinations identified from the CDR. The listing decisions for each province were also sent to each provincial drug plan for verification. The data collected for HTA recommendations and payer listing decisions included a range of different reimbursement outcomes for each jurisdiction. All potential outcomes were reviewed to enable an appropriate cross comparison of the recommendations and listings to create multinomial categories for comparison, namely: recommended, recommended with restrictions and not recommended.

These multinomial categories were reviewed with the CDR and provincial payers/agencies to ensure comparability.

Using the multinomial categories, the CDR recommendation for each drug product was then compared with the medicine listing from each of the four provincial payers/agencies and numerically coded for comparison and to identify where there were divergent outcomes. The percentage of listings that agreed with the CDR recommendations was subsequently calculated. From this list five case studies were selected on the basis of at least one agency/payer issuing a listing decision that differs from the CDR recommendations and each case study was further investigated by questionnaire and interview. Alberta Health, INESSS and CADTH reviewed the questionnaire during its development to ensure the scope was feasible and the lexicon was not misleading. This was particularly important for the Quebec agency where French is the predominantly spoken language. The questionnaire contained two parts: the first part includes agency/payer profile information, and the second part was drug-specific data. The agency profile section included: year HTA activities began; total annual spend; total number of full time employees; review committee membership composition; and budget impact considerations. Each questionnaire was prefilled with the chosen medicine and indication. When possible, additional sections were completed with information from the public domain and this was verified by the regional payers. The data requested in the drug specific section of the questionnaire included: consultation with patient advocacy groups; consultation with manufacturer; date of final HTA recommendation and date of final listing decision. Following distribution of the questionnaire, semi-structured interviews were conducted by the primary researcher with representatives from the provincial drug plans or HTA agency in Alberta, British Columbia, Ontario and Quebec.

Table 6.1: General agency and survey specific discussion points for interview

Main question	Additional questions
<ul style="list-style-type: none"> Can you tell me about the resources available to your agency? 	<ul style="list-style-type: none"> How many staff? How many staff are allocated to HTA/assessment of pharmaceuticals? Annual Budget? Proportion of budget allocated to HTA?
<ul style="list-style-type: none"> Can you provide an overview of the process for reviewing a new drug for reimbursement? 	<ul style="list-style-type: none"> Target time for drug review? Average time for drug review? How do you communicate with the manufacturer during the review process? How is the final recommendation deliberated? What happens if you can't reach consensus? How is the final result disseminated? What initiatives does your agency undertake to promote transparency? What is the key driver for transparency? Can your agency negotiate price with the manufacturer?
<ul style="list-style-type: none"> Can you tell me how patient input is included in the decision-making process? 	<ul style="list-style-type: none"> Can you tell me if your agency provides guidance or financial support for patient input? How does your agency view input from patient groups sponsored by industry? Can you think of an example when patient input has been the primary reason for a positive reimbursement decision?
<ul style="list-style-type: none"> Can you tell me how your agency uses the CDR recommendation and report? 	<ul style="list-style-type: none"> How does your agency receive applications for a new drug to be reimbursed? Can you tell me if your agency conducts any assessments in addition from the common drug review? How useful is the common drug review report for reimbursement decision-making at your agency? How often do you think your agency complies with the CDR recommendation?
<ul style="list-style-type: none"> In your experience, which factors often have the most impact on the final reimbursement decision? 	<ul style="list-style-type: none"> What are the most common reasons for a change in reimbursement status? What are the most common causes for a drug to be reassessed?
<ul style="list-style-type: none"> Can you tell me how your agency reviews medical devices? 	<ul style="list-style-type: none"> How do you communicate with stakeholders during the review process? How is the final recommendation deliberated? What happens if you can't reach consensus?
<ul style="list-style-type: none"> Can you review the classification table and tell me if you think the listing recommendations from your agency are appropriately classified? 	<ul style="list-style-type: none"> Show table of drug recommendation classifications
<ul style="list-style-type: none"> Can you tell me about your experience completing the questionnaire? 	<ul style="list-style-type: none"> Were there any questions in the questionnaires that need clarification? Was any of the prefilled information incorrect?
<p>Drug specific questions (personalized for agency)</p>	<ul style="list-style-type: none"> Were any of the drugs subject to a pricing agreement? Was patient input provided? How was patient input requested? Can you tell me which group provided the patient input?

Representatives were chosen from a very small population of Canadian provincial payers, based on relationships established from previous research and introductions by senior staff at the Canadian Common Drug Review. The interviews were supported by a list of core and additional questions to ensure each interview covered all the required topics (Table 6.1). The primary researcher also transcribed and manually coded the individual transcripts to compare and identify common themes.

RESULTS

The results are presented in the following three parts:

PART I- Process maps for the regulatory to reimbursement pathways for the Canadian national HTA review and four provincial pathways

PART II- Comparison of CDR recommendations and provincial reimbursement decisions

PART III- A description of provincial payers and HTA structure, resources and medicine case studies

PART I- Process maps for the regulatory to reimbursement pathways for the Canadian national HTA review and four provincial pathways

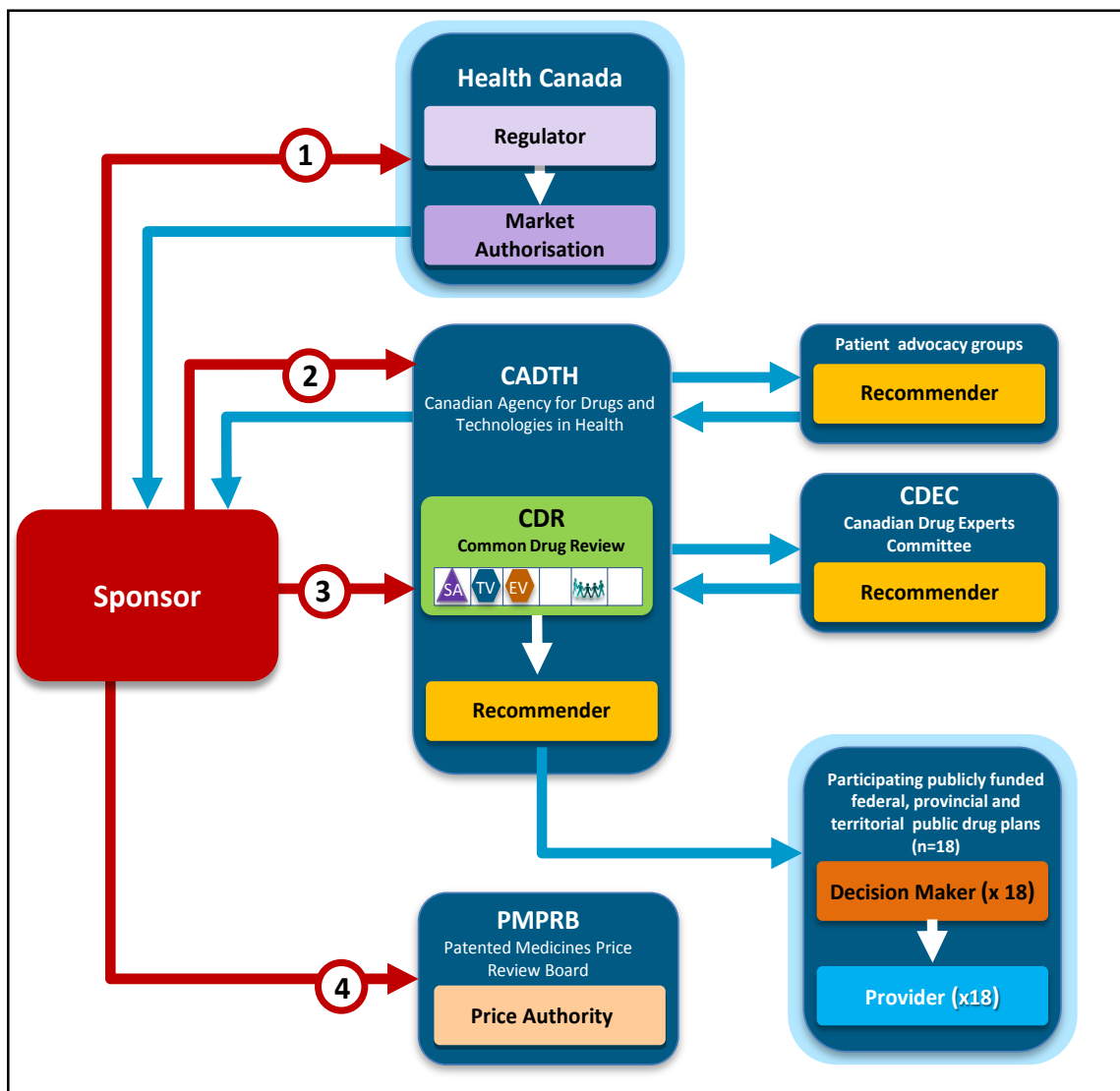
HTA process maps were produced for the CDR and the four provinces using information primarily sourced from the public domain (Appendix A), and from the semi-structured interviews.

Common Drug Review (CDR)

Although outlined previously, this chapter will include a more detailed description of the CDR as it is pivotal for this study, which is solely focused on Canada. The CDR process is driven by manufacturer submissions, but applications for new medicines, medicines with new indications and new combination products are required to have obtained a Notice of Compliance (NOC) from Health Canada or are expected to obtain an NOC from Health Canada within 90 days of submission (pre-NOC submission) (figure 6.1, Step 1) (Canadian Agency for Drugs and Technologies in Health (CADTH), 2013).

Generally, submissions are reviewed as they are received on a first-come, first-served basis. Once an application has been received, the name of the medicine under review is posted on the CADTH patient input website with a 15-day deadline for response (Figure 6.1 Step 2). Patient input is then forwarded to the review team, which includes clinical experts, clinical and economic reviewers and information specialists. The review team conducts an independent literature search to be reviewed with the manufacturer’s submission and patient input to produce a CDR Clinical Review Report. The review team then uses the information in the CDR Clinical Review Report to assess the manufacturer-submitted pharmacoeconomic data to produce the CDR Pharmacoeconomic Review Report.

Figure 6.1: Process map for the Common Drug Review (March 2014)



The final reviewers' reports are sent to the manufacturer for comment and reviewers' responses to manufacturers' comments are included in the brief prepared for use by the Canadian Drug Expert Committee (CDEC) (Canadian Agency for Drugs and Technologies in Health (CADTH), 2015a) (Figure 6.1, step 3). CDEC is an advisory body composed of healthcare professionals and public members which reviews the information in the reviewers' reports and a reimbursement recommendation is decided by a majority vote at the scheduled CDEC meeting after a period of deliberation (Canadian Agency for Drugs and Technologies in Health (CADTH), 2014). Manufacturers are given ten business days from receipt of the CDEC recommendation to file a request for reconsideration. In accordance with Canada's decentralised healthcare system, the final notice of CDEC recommendation is sent to the federal, provincial and territorial drug plans, where each plan will review the submission and the CDEC recommendation in their own local context. The Patented Medicines Price Review Board (PMPRB) regulates the prices of patented medicines sold in Canada and manufacturers are required to submit prices from inception to patent expiry (Figure 6.1, step 4).

CDR Participating provincial payers

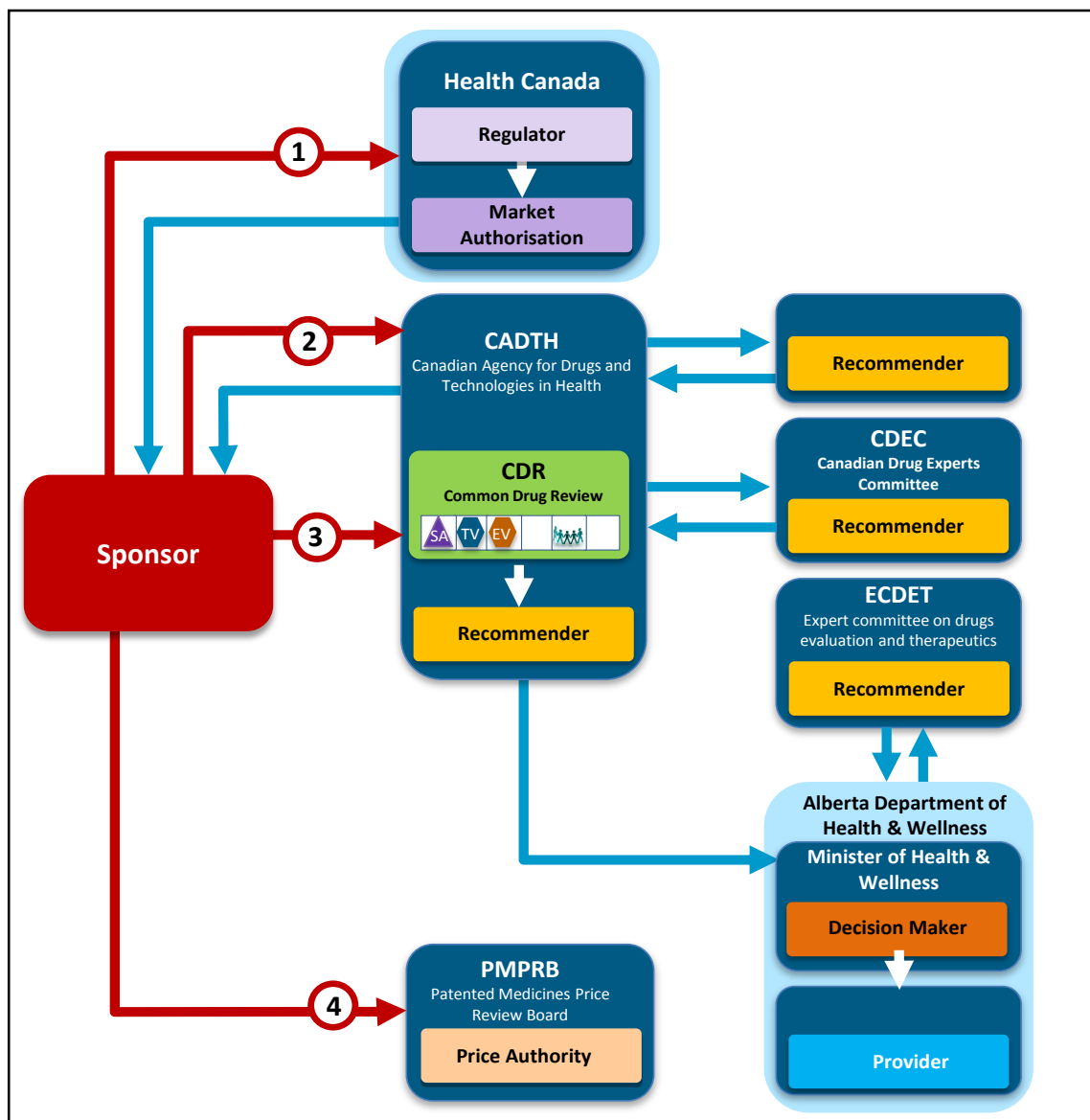
Alberta, British Columbia and Ontario are three of the eighteen CDR participating provincial, territorial and federal public payers and have been evaluated for this study. These three provincial payers have been reviewed to produce three process maps to show the relationship between the CDR and the provincial specific process. The HTA process maps for provinces that are participants of the CDR, initially follows the process for submission to the CDR outlined in chapter 5. The process following the final CDR review recommendation are province specific and are outlined below.

Alberta

The Alberta Minister of Health and Wellness determines the final listing decision for new medicines and indications (Figure 6.2). The CEDEC recommendation and CDR clinical and economic dossiers are considered with additional regional specific data to form a listing decision that accounts for the local context.

Alberta's Expert Committee on Drug Evaluation and Therapeutics (ECDET) is required to review all new medicines and indications that do not meet the CDR requirements (Figure 6.2). Alberta also offers a Price Listing Agreement (PLA) option for medicines that have not been listed through the CDR or the ECDET process (Alberta Health, 2015).

Figure 6.2: Process map for the regulatory to reimbursement pathway for new medicines in Alberta (September 2013)

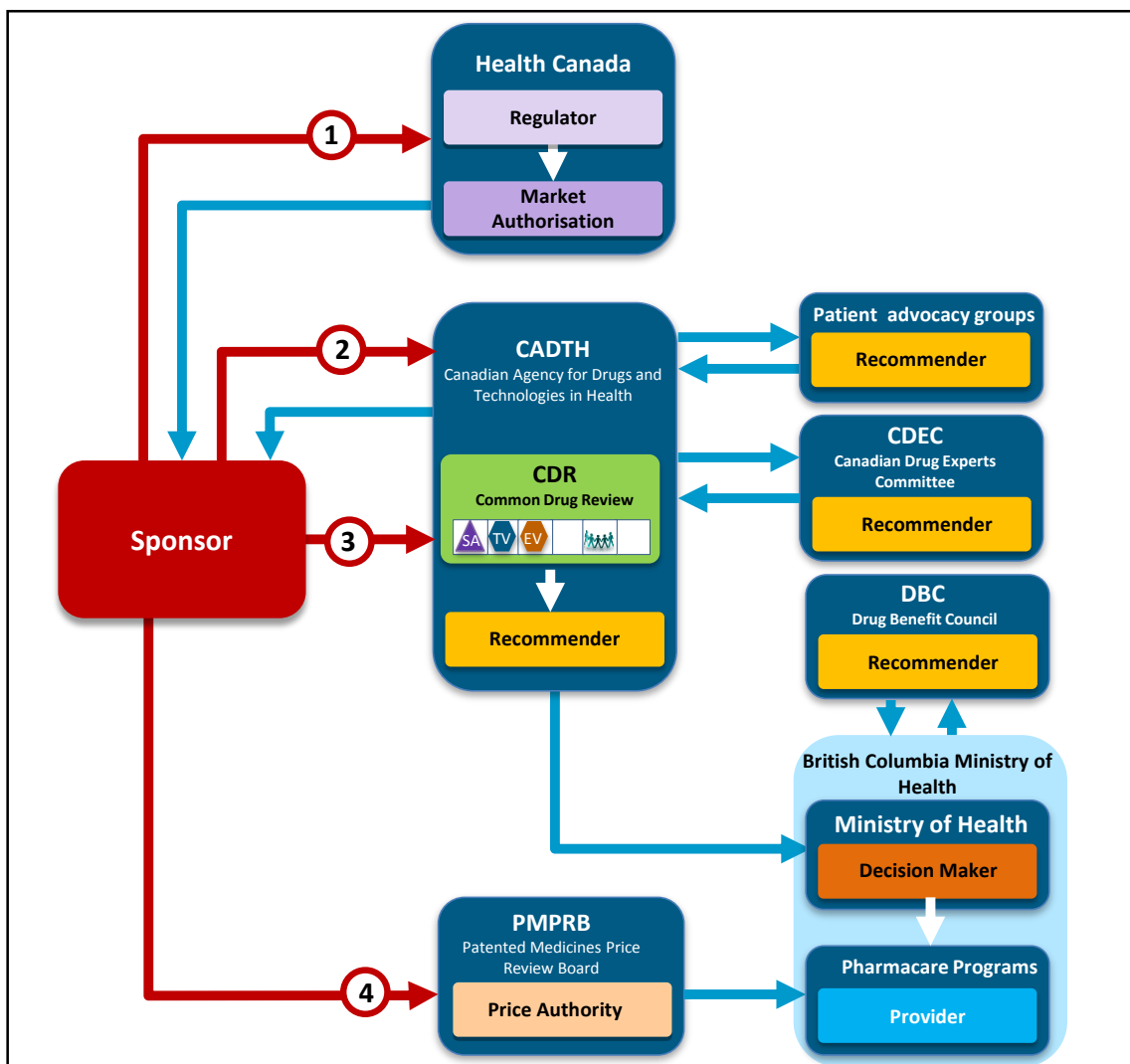


British Columbia

The British Columbia Ministry of Health initiates the provincial review of new medicines and new indications following the completion of the CDR (Figure

6.3). The CDR dossiers are sent to the Drug Review Resource Committee (DRRC) to determine the review requirements and assemble a Drug Review Resource Team (DRRT) that will prepare a report of the medicine to be reviewed for the manufacturer to comment (British Columbia Ministry of Health, 2015a). The Ministry of Health also publishes a list of medicines under review online on 'Your Voice' website which enables patients and carers to submit their comments for consideration by an independent committee of 12 professional and public members (Drug Benefit Council (DBC)) (British Columbia Ministry of Health, 2015b). Patient input from 'Your Voice' website is sent with the DRRT report and manufacturer's comments for the DBC to review and provide a listing recommendation for the Minister of Health.

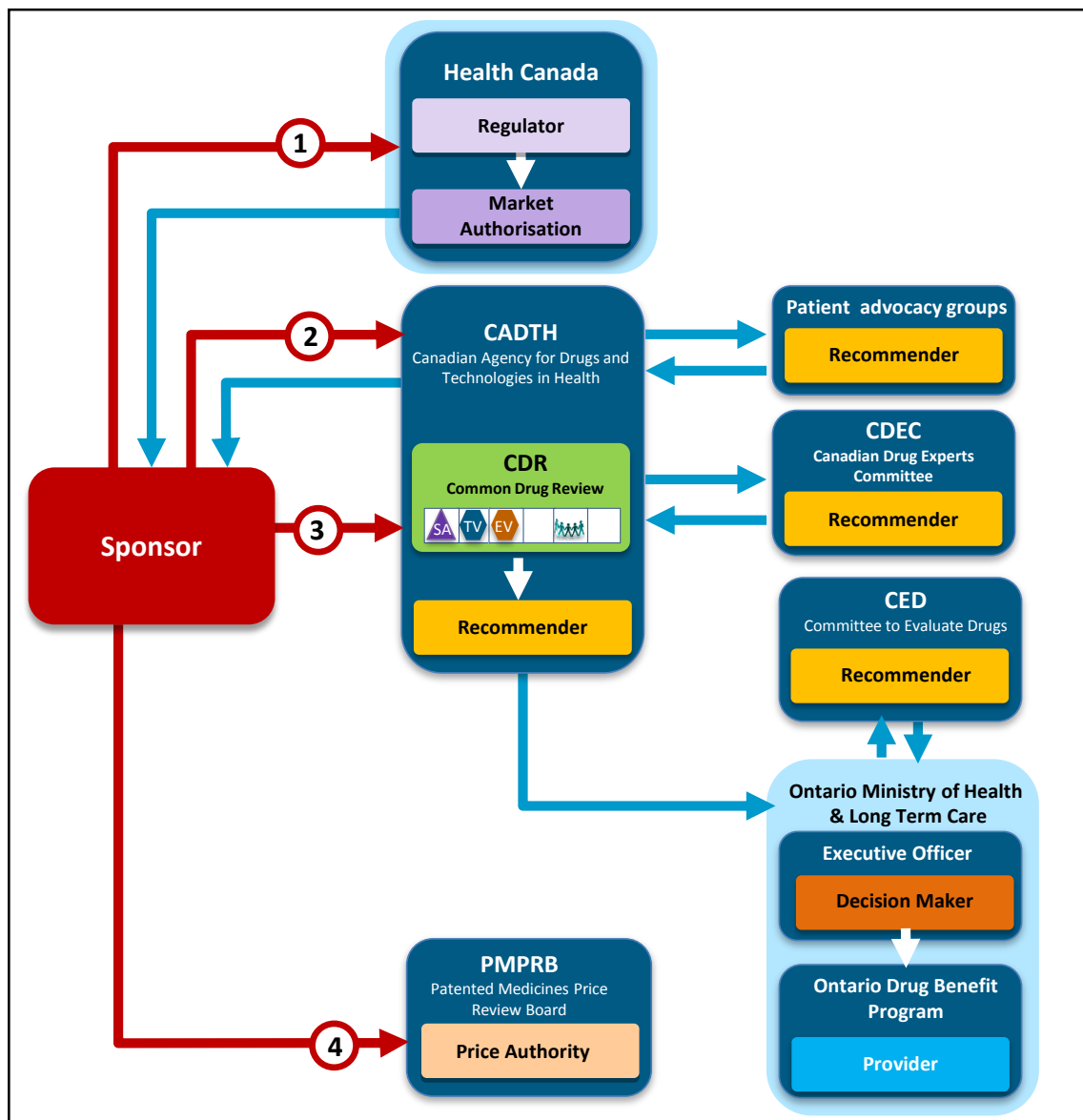
Figure 6.3: Process map for the regulatory to reimbursement pathway for new medicines in British Columbia (March 2013)



Ontario

Manufacturers seeking listing approval for the Ontario Drugs Benefit Program (ODBP) for new medicines and indications can submit an application to the ODBP following completion of the CDR process (Figure 6.4). The submission is reviewed by the Committee to Evaluate Drugs (CED), which consists of 16 members including two patient representatives (Ministry of Health and long-term care, 2013) (Figure 6.4). The CED provides a listing recommendation to the executive officer of the ODBP and they determine the final listing decision.

Figure 6.4: Process map for the regulatory to reimbursement pathway for new medicines in Ontario (March 2013)



Québec: Institut national d'excellence en santé et en services sociaux (INESSS)

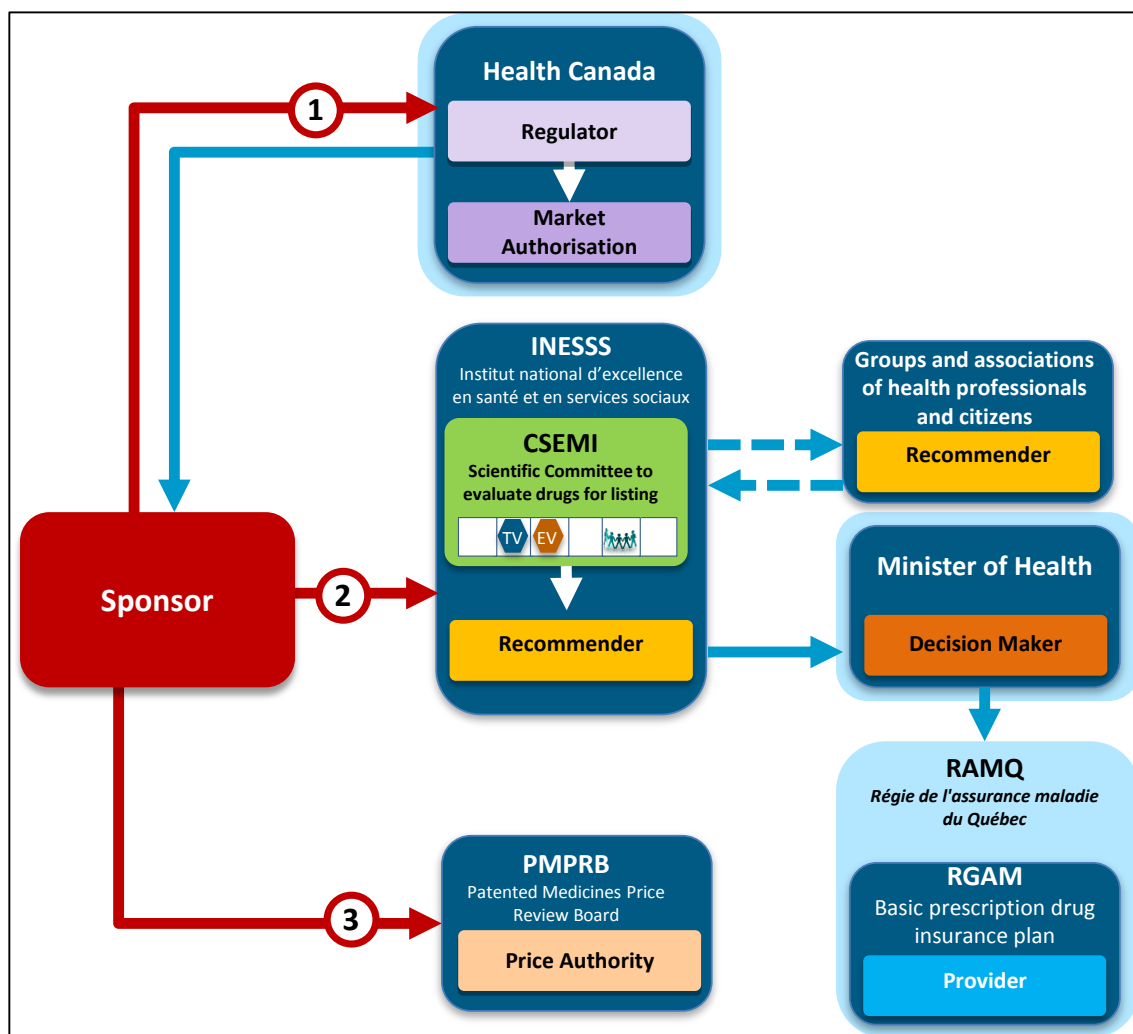
In 2000, CETS became the Agence d'évaluation des technologies et des modes d'intervention en santé (AETMIS) (Battista *et al.*, 2009). Eleven years later, AETMIS merged with the Conseil du médicament and was renamed INESSS. Amongst other roles, INESSS is responsible for assessing the clinical advantages and cost effectiveness for drugs, devices and interventions to provide a recommendation for their use and coverage by the Québec public insurance plan, the Régie de l'assurance maladie du Québec (RAMQ).

The INESSS review process for medicines takes about 6 months from submission to completion and the public announcement of the decision by the Minister (Institut national d'excellence en santé et en services sociaux (INESSS), 2013). INESSS considers applications from the manufacturer/sponsor for medicines that have been granted a NOC from Health Canada and the reviews concern medicines to be added to Québec's drug insurance plan (Liste des médicaments) as well as for medicines to be dispensed in hospitals (Liste des médicaments-Établissements), including innovative medicines, as well as generics (Figure 6.5, Step 1). When a completed submission is received, the medicines are added to a work schedule and are posted online once the deadline for applications has passed (figure 6.5, Step 2).

As soon as the work plan is published online, patient advocacy groups and professional bodies are invited to provide feedback. INESSS also accepts patients' comments from individuals that are not part of a patient group organisation. The manufacturer's submission and any feedback from stakeholders is reviewed by professionals at INESSS and the Comité scientifique de l'évaluation des médicaments aux fins d'inscription (CSEMI) (Institut national d'excellence en santé et en services sociaux (INESSS), 2014). CSEMI consists of healthcare professionals, economists, ethicists, managers, experts and public members. The submitted medicine first undergoes a clinical review to assess effectiveness in terms of the therapeutic benefit compared to current reimbursed treatment options. If the therapeutic benefit cannot be

established, the review goes no further and the Ministère de la Santé et des Services sociaux (Minister of Health and Social Services) is notified. If a satisfactory therapeutic benefit is determined, the value of the medicine product is considered in the dimensions of price, cost effectiveness, the advisability of adding the medicine to the list and its impact on the health and social services system. After the review is complete, CSEMI produces a report to be sent to the INESSS Board of Directors, who ratify the CSEMI recommendation to be passed to the Ministère de la Santé et des Services sociaux (Minister of Health and Social Services), who determines the final reimbursement decision for the Québec public insurance plan.

Figure 6.5: Process map for the regulatory to reimbursement pathway for new medicines in Quebec (September 2013)



The assessment report is available to the public on INESSS website when the announcement is made (Institut national d'excellence en santé et en services sociaux (INESSS), 2013). The manufacturer is also required to provide pricing details of all patented medicines sold in Canada from initial sale to patent expiry (Figure 6.5, step 3).

PART II- Comparison of CDR recommendations and provincial reimbursement decisions

Two methods have been used to classify the HTA and payer recommendation in this study. The binomial classification contains two categories: positive and negative recommendations. The positive recommendation category combines the multinomial recommended and recommended with restriction categories and the negative recommendation category is the equivalent of the 'do not recommend' category (Table 6.2).

Table 6.2: Comparison of options for HTA recommendations and formulary listing outcomes.

Payer or HTA agency	Binomial classification:		
	Positive recommendation		Negative recommendation
	Multinomial classification:		
	Recommended	Recommended with restrictions	Not recommended
CDR	List	List with criteria/condition	Do not list
	List in a similar manner		Do not list at the submitted price
Alberta Health	Regular benefit	Rare disease drug program	Not a benefit
	Regular benefit/restricted benefit	Multiple Sclerosis (MS) Drug	
		Step Therapy/Special Authorisation	
		Restricted benefit	
British Columbia Pharmacare	General benefit	Special Authority	Non-benefit
Ontario Drug Benefit Program	Regular benefit	Limited use	Funding not available
		Exceptional access program	Funding not considered
INESSS (Quebec)	Ajout aux listes de médicaments	Medicament d'Exception	Avis de refus

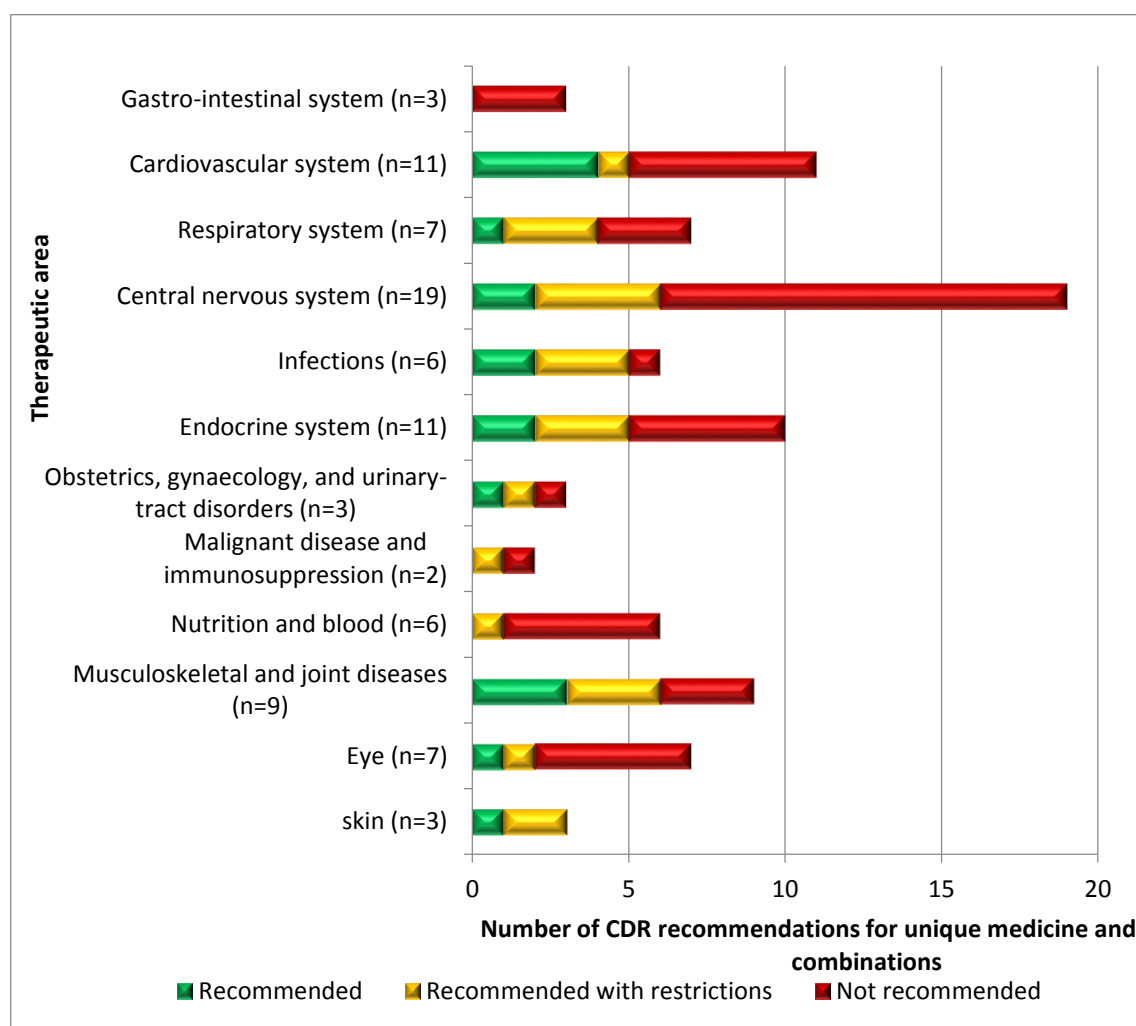
Recommendations recorded from the CDR were one of five different outcomes: 'list'; 'list in a similar manner'; 'list with criteria/condition'; 'do not list' and 'do not list at the submitted price'. For the multinomial classification with three universal categories, the 'list' and 'list in a similar manner' recommendations were categorised as 'recommended'.

The 'list with criteria/condition' recommendations were allocated to the 'recommended with restrictions' category and the 'do not list' and 'do not list at the submitted price' were categorised as 'not recommended'. Medicines issued a 'regular benefit' or 'regular benefit/restricted benefit' were grouped in the universal 'recommended' category. Medicines issued a 'restricted benefit', 'Step Therapy/ Special Authorisation' or allocated to the 'rare disease program' or 'Multiple Sclerosis Drug' were grouped in the recommended with restrictions category and medicines that were deemed 'not a benefit' were allocated to the not recommended category. For British Columbia, 'General benefit' medicines were grouped in the recommended category and the 'special authority' and 'not a benefit' medicines were allocated to the recommended with restrictions and not recommended categories respectively. Similarly, the 'regular benefit' medicines for Ontario were grouped in the recommended category, 'limited use' and 'Exceptional access' medicines were grouped in the recommended with restrictions category and medicines that were granted a 'funding not available' or 'funding not considered' recommendation were grouped in the not recommended category. Medicines with an 'Ajout aux listes de médicaments' recommendation from INESSS were grouped in the recommendation category, 'Medicament d'Exception' medicines were added to the recommended with restrictions group and medicines with an 'Avis de refus' recommendation were allocated to the do not recommend category.

The original 86 medicine-indication pairs that were identified for CDR recommendations issued from January 2009 to May 2013 (chapter 5) were also used in this study. However, the total number of medicine-indications evaluated in chapter 5 was 89 because other national HTA agencies included in the study had split some indications to issue multiple recommendations. To ensure the study was a like-for-like comparison, the indications were subsequently split

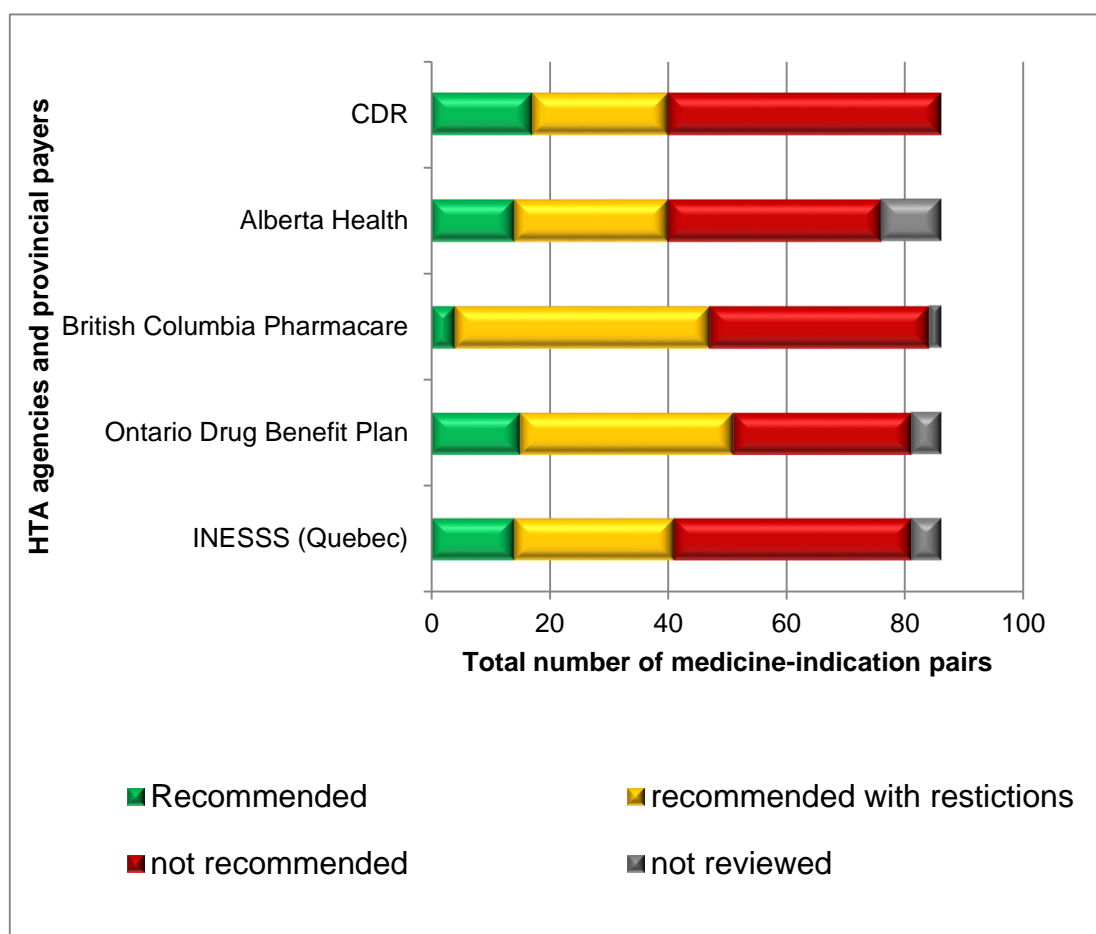
and the total number of medicine-indications reviewed in chapter 5 was 89. The 86 medicine-indication pairs evaluated in this study were grouped according to the BNF therapeutic categories to provide an overview of the therapeutic areas and the proportion of recommendations using the multinomial categories (Figure 6.6). The largest therapeutic area is the central nervous system (n=19) followed by the cardiovascular system (n=12) and the Endocrine system (n=11). The least common therapeutic areas were the gastro-intestinal system (n=3), skin (n=3) and malignant disease and immunosuppression (n=2). The latter is a direct result of the inclusion criteria because the CDR does not review oncology medicines.

Figure 6.6: Medicines approved by the CDR from January 2009 to May 2013 grouped by therapeutic area



An overview of the total number of medicine-indication pairs reviewed by the CDR and the four provincial payers/ agencies and their allocation to the multinomial categories is provided in Figure 6.7. Alberta health reviewed the smallest number of medicine-indication pairs (n=76), Ontario and Quebec both reviewed 81 and British Columbia reviewed 84 medicine-indication pairs.

Figure 6.7: Overview of medicine recommendations issued from January 2009 to May 2013 by the CDR with provincial payers and HTA recommendations



The largest proportion of negative/not recommended medicine-indication pairs was issued by the CDR (53.5%) followed by Quebec (49.4%), Alberta (47.7%), British Columbia (44.0%) and Ontario (37.9%) (Table 6.3). Therefore, Ontario also issued the largest proportion of positive recommendations (63%) (Table 6.4).

Table 6.3: Proportion of medicine-indication pair recommendations by multinomial categories

HTA agencies and payers	Recommended (±95% CI)	Recommended with restrictions (±95% CI)	Not recommended (±95% CI)
CDR (n=86)	19.8% (12.7%; 29.4%)	26.7% (18.5%; 36.9%)	53.5% (43.0%; 63.7%)
Alberta (n=76)	18.4% (11.3%; 28.6%)	34.2% (24.5%; 45.4%)	47.4% (36.5%; 58.4%)
British Columbia (n=84)	4.8% (1.9%; 11.6%)	51.2% (40.7%; 61.6%)	44.0% (33.9%; 54.7%)
Ontario (n=81)	18.5% (11.6%; 28.3%)	44.4% (34.1%; 55.3%)	37.0% (27.3%; 47.9%)
Quebec (n=81)	17.3% (10.6%; 26.9%)	33.3% (24.0%; 44.1%)	49.4% (38.8%; 60.0%)

Table 6.4: Proportion of medicine-indication pair recommendations by binomial categories

HTA agencies and payers	Positive recommendation (±95% CI)	Negative recommendation (±95% CI)
CDR (n=86)	46.5% (36.3%; 57.0%)	53.5% (43.0%; 63.7%)
Alberta (n=76)	52.6% (41.6%; 63.5%)	47.4% (36.5%; 58.4%)
British Columbia (n=84)	56.0% (45.3%; 66.1%)	44.0% (33.9%; 54.7%)
Ontario (n=81)	63.0% (52.1%; 72.7%)	37.0% (27.3%; 47.9%)
Quebec (n=81)	50.6% (40.0%; 61.2%)	49.4% (38.8%; 60.0%)

The binomial and multinomial categories were also used to calculate the percentage agreement between the CDR recommendations and regional payer decisions or regional HTA (INESSS). For the multinomial categories the percentage agreements ranges from 63% (Ontario) to 74% (Alberta) (Figure 6.8). The binomial categories increased the percentage agreements to 72% agreement with Quebec, 78% with Ontario, 82% with British Columbia and 83% with Alberta (Figure 6.9).

Figure 6.8: Percentage agreement CDR recommendations with provincial payer and HTA recommendations using multinomial categories

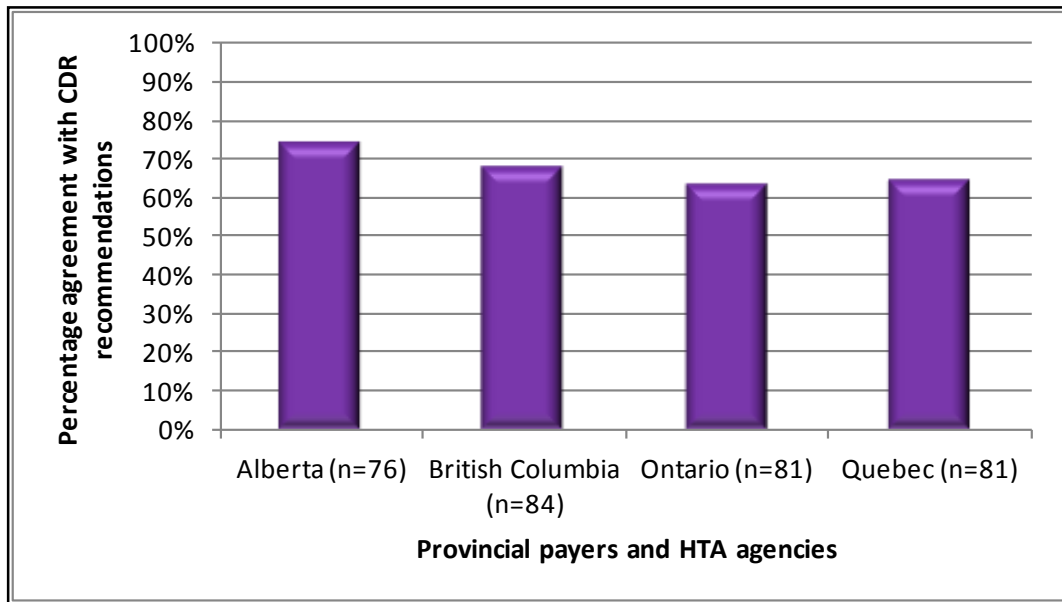
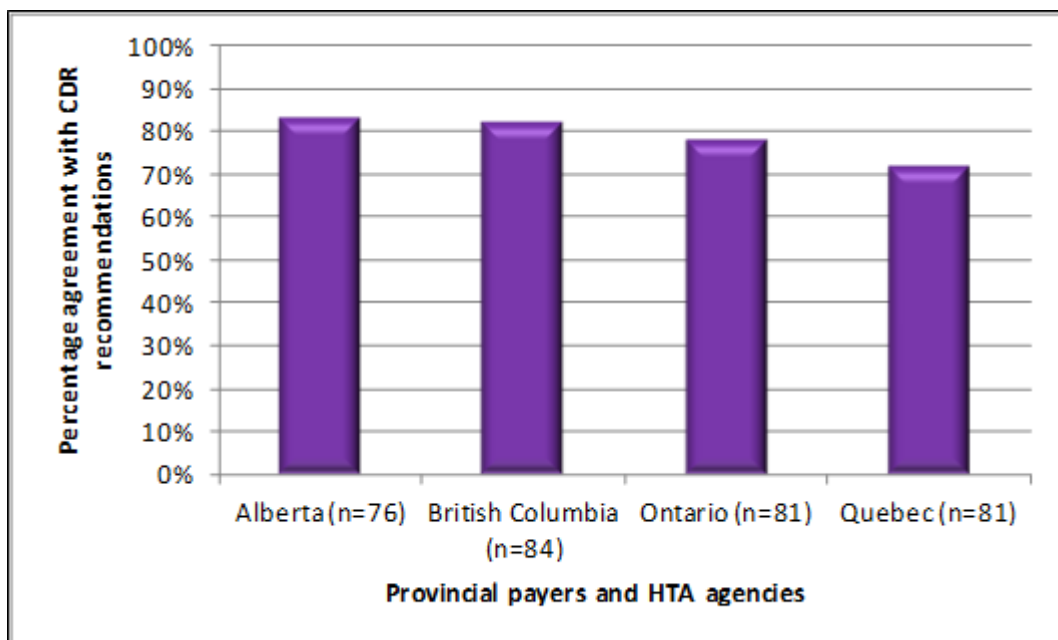


Figure 6.9: Percentage agreement of provincial payer and HTA recommendations and CDR recommendations using binomial categories



Kappa coefficients were calculated for inter-rater reliability between the CDR and the four provincial payers/agencies. Alberta (0.663) and British Columbia

(0.647) demonstrated substantial levels of agreement with the CDR and Ontario (0.560) and Quebec (0.432) scored moderate agreement with the CDR recommendations (Viera and Garrett, 2005).

PART III- A description of provincial payers and HTA structure, resources and medicine case studies

The four provincial payers/agencies were surveyed using a combination of questionnaires and semi-structured interviews. Invitations to interview were sent to the four provinces and interviews were scheduled with seven representatives (Alberta n=1, British Columbia n=1, Ontario n=2 and Quebec n=3) with decision-making or advisory roles. The semi-structured interviews were conducted, transcribed and analysed by the primary researcher. Answers were manually coded for each transcript and then compared to identify the following common themes for discussion:

- Payer/agency resources
- Provincial review processes for new medicines
- Utilisation of the CDR recommendation and report
- Manufacturers role in the provincial review
- Opportunities for patient input
- Factors that impact listing decisions
- Opportunities for price negotiations

The first part of the survey and semi-structured interviews requested information about the payer organisation/HTA agency and the results indicated a very varied payer environment. For example, the total number of full time employees ranged from twenty (Alberta) to one hundred and thirty (Quebec) and total number of full time employees allocated to HTA or reimbursement review activities ranged from four (Ontario) to twenty-five (Quebec). All four provincial payers/agencies include a review committee to provide a listing decision. The majority of members on these review committees were physicians for all provinces except for British Columbia, which had a marginally greater number of pharmacists (Table 6.5). Alberta was the only province that did not include a health economist whereas other member professions included

ethicists, bioethicists and statisticians. Only two provincial expert committees included patient members (Quebec and Ontario) but British Columbia included three public members. The CDR, British Columbia, Ontario and Quebec provided an opportunity for patient input online and all accepted submissions from patient advocacy groups but only British Columbia and Quebec accepted an input from individuals (Table 6.6). Alberta, British Columbia and Ontario also use patient input from the CDR process.

The second part of the survey and semi-structured interviews requested information about five specific case studies. These were identified for medicine-indication pairs that received discordant provincial listing decisions. Only one of the case studies (Olmesartan) received an initial positive recommendation (binomial categories) from all four provinces (Figure 6.10). Three case studies (aztreonam, calcitriol and golimumab) received an initial positive recommendation from three provinces and one case study (Saxagliptin) received a single positive recommendation.

Figure 6.10: Provincial listing decision agreement with CDR recommendations for 5 case studies with binomial categories

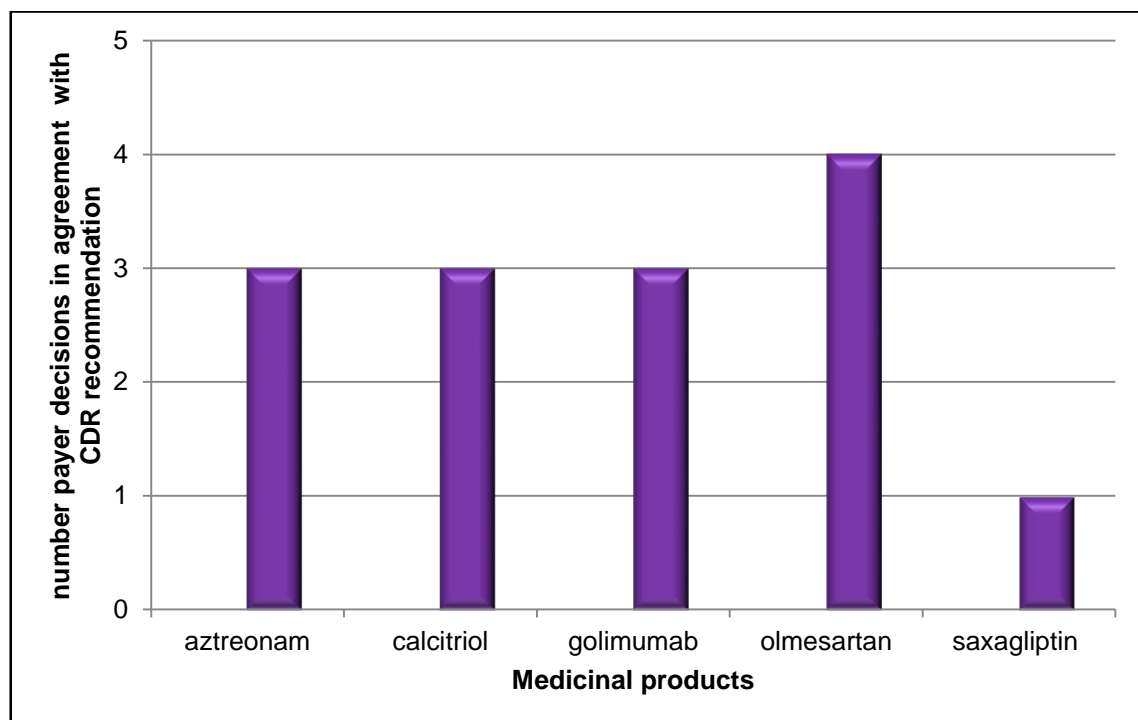


Table 6.5: Provincial expert committee composition

Payer or HTA Agency	Committee Composition					
	Physicians	Pharmacists	Health Economists	Patient representatives	Other	total
Alberta Health	4	4	0	0	0	8
British Columbia Ministry of Health	3	4	1	0	3 public, 1 bioethicist	12
INESSS	7	4	1	2	2 ethicists, 1 statistician expert	17
Ontario Drug Benefit Program	12	2	1	2	1 Chair	17

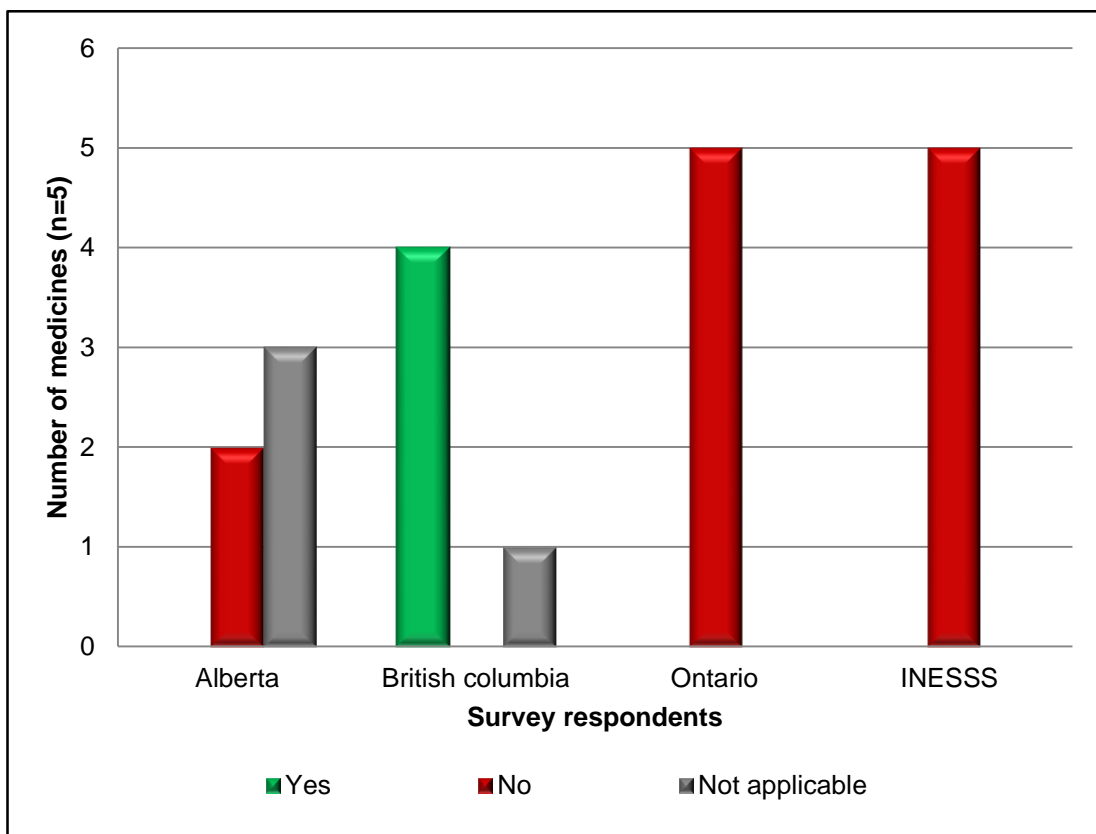
Table 6.6: Patient input opportunities at the national and regional HTA agencies and payers

Payer or HTA Agency	Patient members on expert committee	Public members on expert committee	Call for patient input online	Input accepted from patient groups	Input accepted from individuals	preferred template for input provided	Uses patient input from centralised review
Alberta Health	–	–	–	–	–	–	+
British Columbia Pharmacare	–	+	+	+	+	+	+
CADTH	–	+	+	+	–	+	N/A
INESSS	+	–	+	+	+	–	N/A
Ontario Drug Benefit Program	+	–	+	+	–	+	+

N/A – Not Applicable

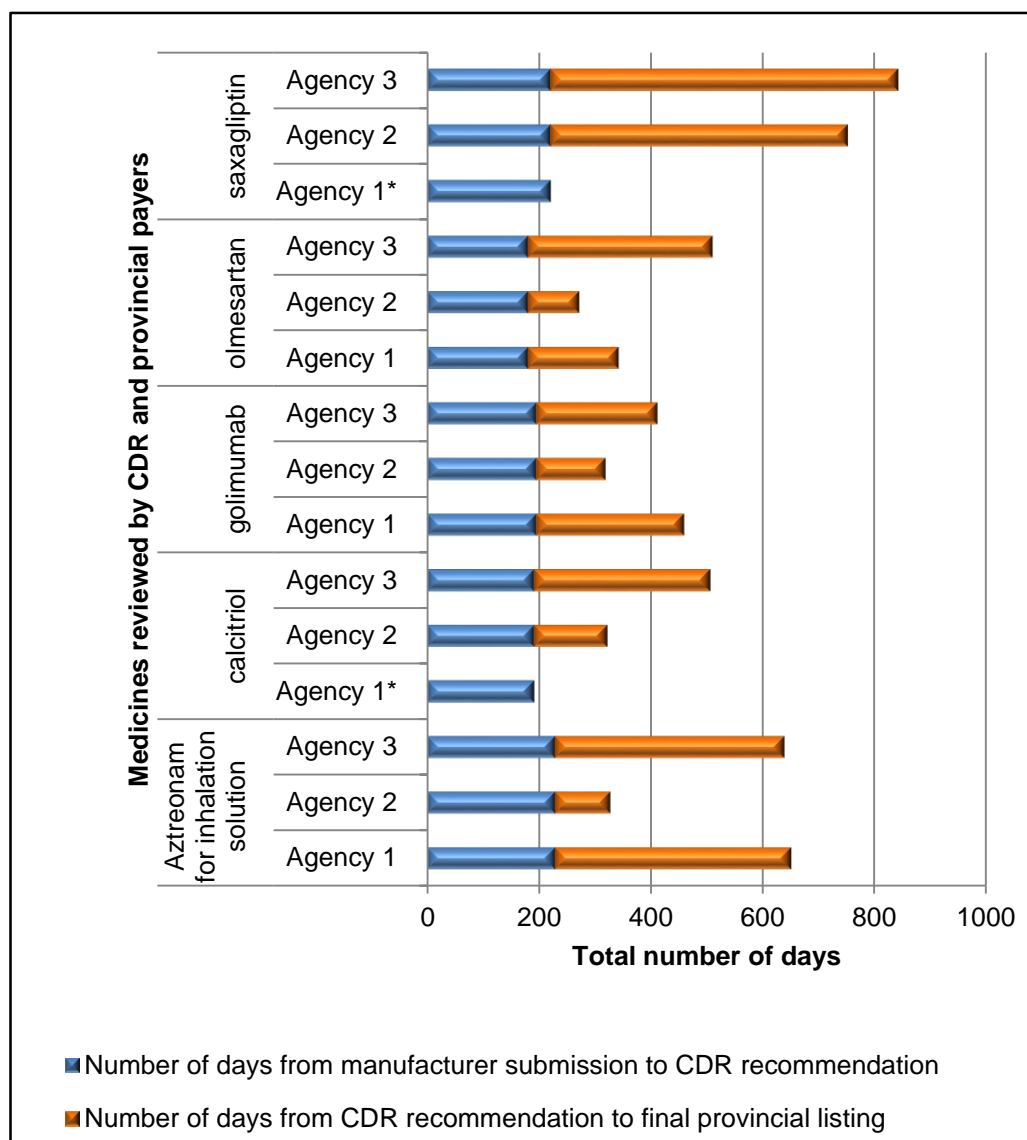
Only one province consulted the manufacturer during the assessment period (British Columbia) (Figure 6.11). However, other provinces indicated that they communicated with the manufacturer at different stages of their review process, usually prior to the review to confirm submission meets requirements or post review to clarify questions for the expert committee.

Fig 6.11: Manufacturer consultations during assessment period



The time taken from submission to the CDR to date of final CDR recommendation to participating plans was consistent ranging from 180 days to 228 days (Figure 6.12). The time taken for consideration by the regional payers was more varied and ranged from as quickly as 92 days to 423 days. The review process for INESSS works in a continuous cycle rather than a queue. INESSS requires all submissions to be reviewed within a set period of time when submitted by the deadline for each cycle.

Figure 6.12: Days taken for CDR process and provincial review



**Data not provided for provincial listing date*

DISCUSSION

Prior to the inception of the common drug review, each provincial payer/agency conducted their own HTA to guide provincial listing decisions. Quebec is the only province that does not participate in the CDR and therefore still conducts a full HTA. The public payers for the other three provinces included in this study (Alberta, British Columbia and Ontario) are members of the CDR and use the CDR dossiers to inform their decision-making processes. Reimbursement recommendations issued by the CDR for 86 medicine-indication pairs from January 2009 to May 2013 were compared with

listing decisions in Alberta, British Columbia, Ontario and Quebec. Multinomial and binomial category classification were used to group the recommendations for comparison and calculate the percentage agreement and kappa coefficients for each province and the CDR. These results expand on previous work and provide interesting insights when compared with results of previous studies. Gamble et al. (2011) calculated agreement between the CDR and 11 public drug plans for all CDR recommendations issued from CDR inception to May 2009. The data set included in this study has a slight overlap with the data set for Gamble et al. as data was collected from January 2009, but the majority of this data set is for more recent recommendations. A comparison of the percentage agreements and kappa coefficients that were calculated using binomial classifications (listed or not listed) suggests that provincial payers are increasingly aligning with CDR recommendations. The study by Gamble et al. (2011) identified Ontario as the province with the lowest percentage agreement (64.2%) and kappa coefficient ($k=0.28$) with the CDR. However, the more recent data set used in this study calculated the CDR and Ontario percentage agreement to be 77.8% and the kappa coefficient doubled to $k=0.56$ (Table 6.7).

Table 6.7: Comparison of percentage agreement and kappa coefficients with previous study

	Alberta	British Columbia	Ontario	Quebec
Percentage agreement from Gamble et al. (2011)	86.8%	67.9%	64.2%	71.7%
Percentage agreement from this study	82.1%	82.9%	77.8%	71.6%
Kappa coefficients from Gamble et al. (2011)	$K=0.73$	$K=0.33$	$K=0.28$	$K=0.45$
Kappa coefficients from this study	$K=0.663$	$K=0.647$	$K=0.560$	$K=0.432$

The kappa coefficient is arguably a more robust measurement of agreement as it considers the proportion of agreement that could be due to chance (chapter 2). Therefore, these results suggest a substantial increase in alignment between Ontario's more recent listing decisions and the CDR recommendations. The results of this study also produced an increase in percentage agreement for the CDR and British Columbia from 67.9% to 82.1% and an increase in kappa score from $k=0.33$ to $k=0.647$ (Table 6.7). The percentage agreement and kappa coefficients calculated for Quebec and the

CDR are consistent with the results previously published by Gamble *et al.* (2011), but the percentage agreement and kappa coefficients for Alberta and the CDR decreased slightly. However, this still demonstrates a substantial level of agreement (Viera and Garrett, 2005). Overall the percentage agreements and kappa coefficients from this study show greater alignment between the CDR and recent provincial listing decisions. Seven public drug plans were reviewed by Gamble *et al.* (2011), but were not included in this study. Five of these public drug plans (Saskatchewan, New Brunswick, Nova Scotia, Newfoundland and Labrador and the Non-insured Health Benefits (NIHB)) all scored percentage agreement values from 83% to 96.2% and the remaining two plans had percentage agreement values of 73.6% (Manitoba) and 67.9% (Prince Edward Island) (Gamble *et al.*, 2011). In addition, all seven have high percentage agreements and kappa coefficients from $k=0.31$ to 0.88 (Gamble *et al.*, 2011). Therefore, if we assume that the listing decisions for these seven public plans have increased or decreased in alignment with the CDR in proportion to the changes observed for the four provincial plans in this study, then there will still be substantial alignment.

The kappa coefficients from this study can also suggest that there is greater provincial alignment for listing decisions by comparing with the results of a study conducted prior to inception of the CDR. Anis *et al.* (2001) also calculated kappa coefficients for provincial listing decisions using binomial categories (positive and negative) and for the 10 provinces the results ranged from $k=-0.11$ to $k=0.64$. For the four provinces included in this study (Alberta, British Columbia, Ontario and Quebec), Anis *et al.* (2001) calculated the pair wise kappa coefficients ranging from $k=0.06$ to $k=0.39$. The results from this study calculated kappa coefficients for the four provinces (Alberta, British Columbia, Ontario and Quebec) compared with recommendations from the CDR and results ranged from $k=0.432$ to $k=0.663$. Anis *et al.* (2001) directly compared provincial pairs as there was no CDR at the time of the study. However, comparing the provinces with the CDR to indirectly compare between provinces, these values suggest provincial listing decisions are becoming more aligned. The results from MacDonald and Potvin (2004) are more difficult to compare as they used 'full' and 'restricted' as the two categories for comparison, unlike this study which used positive and negative listing recommendations for binomial comparisons which enables comparison with previous studies such as Gamble *et al.* (2011) and (Anis *et al.*, 2001).

The questionnaires and semi-structured interviews provided insights into the provincial review and decision-making process, but the interviews were also conducted with senior representatives and decision-makers and these provide valuable insights, especially regarding the use of CDR reports and recommendations. The responses from the three CDR participating provinces (Alberta, British Columbia and Ontario) indicated that they only conduct a partial-HTA on an ad hoc basis. This is consistent with the information provided for total number of full time employees and full time employees allocated to HTA or reimbursement activities. For example, the number of full time employees allocated to HTA or reimbursement activities for all three CDR participating provinces was much smaller compared to Quebec which conducts a full HTA.

The CDR participating provinces also indicated that there are occasions when they may conduct a local review, but these are generally the exception. Alberta, British Columbia and Ontario have all maintained expert committees post inception of the CDR to provide a provincial listing recommendation that considers the CDR recommendation and evidence for providing local context. Alberta outlined three key components that are generally used to evaluate new medicines in the Alberta context: Alberta specific budget impact; alternative treatments available through the Alberta Drug Benefit List and the position in therapy. These three components are broadly similar to additional criteria used to contextualise the CDR recommendation for British Columbia and Ontario, but these two provincial payers also have opportunities for patient input to be submitted for consideration in the provincial review. The 2008 Alberta pharmaceutical strategy proposed the creation of a public committee for a more accountable and transparent provincial review process (Alberta Health and Wellness, 2009). However, a public committee had not been implemented at the time of the interview but was still under consideration.

The three CDR participating provinces will receive patient input provided to the CDR with the CDR reports and final recommendation. British Columbia have the 'Your Voice' website for patients to subscribe and receive alerts for upcoming reviews. Any patient input is summarised by the public members of the Drug Benefit Council and presented to all members of the Drug Benefit Council. Ontario also has an online submission process for patient groups to register interest and provide patient input submissions. Neither British Columbia nor Ontario provide formal training, but they do provide a

template of key questions for guidance and generally allow about 30 days for submissions. Both agencies accept patient input that received support from the pharmaceutical industry, but payers noted that they do not want a repeat of the manufacturer's submission and conflicts of interest should be disclosed. One provincial payer also noted that manufacturer supported patient input can help facilitate and speed up the patient input process. Quebec does not participate in the CDR so does not receive the patient input from the CDR, but has its own process for including patient input. A list of drugs to be evaluated is published on the INESSS (Quebec) website and patients' are generally given 30 days to provide submissions. Patient input is accepted from individuals and organisations and no formal structure is required, so submissions will be accepted in any format including those using templates from other agencies.

The semi-structured interviews also discussed the impact of patient input and the general consensus was that patient input was a main consideration but not a driving factor for the final listing decision. Ontario provided an example where a patient group for Attention Deficit Hyperactivity Disorder (ADHD) produced a very detailed submission to outline concerns regarding short-acting treatments for ADHD and eventually this led to broader access to long-acting treatments for ADHD in Ontario. Quebec also provided examples where patient input had been an important factor for determining listing decisions for the treatment of rare diseases in children. In two of these cases an additional meeting was organised for a family member to meet with a sub-group of the committee so they can provide their experiences in a less intimidating environment.

Therapeutic benefit was generally considered the most important factor for influencing a listing-decision. Ontario and Quebec both stated that if a product cannot demonstrate a therapeutic benefit then the review will not proceed to discuss other factors. Quebec requires a benefit over existing treatments otherwise a negative listing-decision is issued. Safety and the absence of alternative treatments were also discussed as secondary considerations if therapeutic benefit had first been determined. British Columbia also referred to the CDR evidence report as a driving factor for the Drug Benefit Council recommendation.

Comments and opinions regarding the CDR were unanimously positive from all provinces. The participating drug plans receive two dossiers from the CDR (one clinical

and once economic) to guide their recommendations. Quebec does not receive the CDR dossiers, but they noted that they conduct a systematic review as part of the HTA process and if a review from the CDR was published they would consider it along with other published HTA reports. However, due to the CDR first-come-first-serve queuing system for submissions, INESSS often issues a listing recommendation and final decision prior to the CDR recommendation. Ontario emphasised the value of the CDR by stating that without the CDR evidence they would be reanalysing exactly the same information. Alberta expressed similar views by noting that they are very supported by the CDR and they do their best to align with the CDR recommendations. British Columbia also said that they rely a great deal on the CDR and described it as ‘a cornerstone in our review process’. British Columbia also discussed upcoming changes to their review process that demonstrate an increasing reliance on the CDR and upcoming medicines issued a ‘do not list’ recommendation from the CDR will no longer be considered for provincial review in British Columbia.

The three CDR participating drug plans all agreed that their recommendations are generally congruent with the CDR, but price negotiations often impact the final decision. British Columbia explained that they may negotiate on the following three CDR recommendations: ‘list’; ‘list with condition/criteria’ and ‘do not list at the submitted price’. However, they rarely negotiate for ‘do not list’ recommendations. The review process in Alberta only allows price negotiation with manufacturers after the formal review decision is determined, so price negotiations can occur following irrespective of positive or negative listing decisions. Quebec was the only province in this study that does not negotiate on price because it is not within the INESSS mandate.

Two provincial payers also discussed the more recently established Pan-Canadian Pharmaceutical Alliance (PCPA) (formerly the Pan-Canadian Pricing Alliance) that is part of The Council of the Federation’s Health Care Innovation Working Group (HCIWG) (Council of the Federation, 2015). The PCPA aims to combine the purchasing power of participating provinces (excluding Quebec and Nunavut) to benefit price negotiations and all medicines reviewed by the CDR and the pan-Canadian Oncology Drug Review (pCODR) are eligible. The PCPA could lead to more consistent reimbursement decisions across Canada. However, the participating provinces will still have varying

budgets and the prices negotiated by the PCPA may still be more affordable for wealthier provinces.

Overall, this study has demonstrated increasing alignment between provincial payers and the CDR by expanding upon previous work by Gamble *et al.*, (2011). This study also suggests greater alignment between recent provincial listing decisions compared to provincial listing decisions issued prior to the inception of the CDR by drawing comparisons with Anis *et al.*, (2001). The results of this study disagreed with the conclusions drawn in the report published by AIMS (Attaran *et al.*, 2011). The data set in this study is more recent than the AIMS dataset, which selected the first 25 and last 25 drug reviews published on the Common Drug Review in February 2009. The AIMS study calculated percentage agreements using a multinomial classification category that the authors acknowledged was 'not necessarily accurate' and grouped recommendations as: 'province agrees with CDR'; 'province disagrees with CDR and has a drug benefit less than CDR's recommendation' or 'Province disagrees with CDR and has a drug benefit exceeding CDR's recommendation'. The use of multinomial categories has been criticised due to the difficulty of accurately comparing restrictions (Fischer, 2012). Binomial categories provide mutually exclusive categories for comparison but it is also argued that these can also be too simplistic. Therefore, this study used both multinomial and binomial classifications for comparison. The AIMS study has also only published percentage agreement values, which, unlike kappa coefficients, do not take into consideration the proportion of agreement which is likely to be due to chance (chapter 2).

This study also evaluated the impact of the CDR on three participating plans and has drawn comparisons with the listing decisions and review processes of the Quebec HTA agency, INESSS. A written submission from the Canadian Diabetes Association regarded the provinces decisions to maintain their provincial review processes post inception of the CDR as an indication that the CDR and provinces are duplicating work. However, the results of this study comparing the resources of CDR participating drug plans demonstrate fewer employees compared to Quebec's INESSS which conducts a full HTA. The three participating drug plans have also described how their expert committees review the CDR reports with province specific information (budget impact,

existing treatment options and position in therapy) to formulate a listing decision in the local context.

The report from Canada's Research-Based Pharmaceutical Companies (Rx&D), (2011) found the listing rate from the CDR to be below the average for OECD countries, but this listing rate is close to the listing rate for Austria (<60%) and Finland (60%) and New Zealand (60%). The report also compares the listing rate of CDR recommendations (54%) with public drug plan listing average (46%) from 2004 to 2010. These results indicate that the public drug plans are generally more restrictive than the CDR, but the results from this study show the four listing rates for the four provinces to either be equivalent (Alberta) or higher (British Columbia, Ontario and Quebec) than the CDR. A more recent report from Canada's Research-Based Pharmaceutical Companies (Rx&D), (2012) also found the total number of positive listings for new medicines to be below average (23rd) for the 32 jurisdictions included in the study.

In conclusion, this study has evaluated the impact of the CDR on provincial listing decisions by comparing the CDR recommendations for 86 medicine-indication pairs with the listing decisions of four provincial public plans. Surveys and semi-structured interviews with payer/agency representatives and decision-makers provide unique insights into the processes and opinions of experts. A review of published literature identified criticisms of the CDR process, but these were not supported by the results of this study. The provincial listing decisions and CDR recommendations demonstrate moderate to substantial agreement, which, combined with the results of the survey and semi-structured interviews, shows the CDR does influence provincial listing decisions and therefore provides value for participating plans. These observed increases in alignment could be a result of provinces becoming more reliant on the CDR over time, but may also indicate that the CDR continues to improve and develop to meet payers' needs. However, a proportion of divergent outcomes can also demonstrate the flexibility of the CDR process. The ability for provincial payers to incorporate local context, and issue recommendations accordingly, is a valuable characteristic of the CDR process, which supports public plans with varying budgets and patient populations. European countries are much more heterogeneous than Canadian provinces, but CDR does provide an example of a centralised review process that provides evidence to support

the common requirements of participating plans with the added flexibility of incorporating evidence and budget impact that is context specific.

SUMMARY

- This study adds to the existing body of knowledge by providing novel research to fill an identified gap in previously published research. No studies have been published comparing the impact of post-2009 CDR recommendations on provincial listing decisions and previously published studies reached conflicting conclusions for the concordance of provincial listing decisions with CDR recommendations.
- The evaluation of the concordance of CDR recommendations with provincial listing decisions builds on previous studies (Gamble *et al.*, 2011; Anis *et al.*, 2001; Gregoire *et al.*, 2001; MacDonald and Potvin, 2004), which also meets a need for additional research to identify whether the CDR is helping to standardise coverage decisions across provinces (McMahon *et al.*, 2006).
- The reimbursement processes have been described and represented using a novel, uniform HTA process mapping methodology for the Canadian centralised HTA process (CDR), three CDR participating provincial payers (Alberta, British Columbia and Ontario) and for provincial HTA agency (Quebec).
- Reimbursement recommendations issued by the CDR for 86 medicine-indication pairs from January 2009 to May 2013 were compared and demonstrated moderate to substantial alignment with listing decisions in Alberta, British Columbia, Ontario and Quebec.
- Comparing the results of this study with previously published studies demonstrates that participating provinces are generally becoming increasingly aligned with CDR recommendations (Gamble *et al.*, 2011; Anis *et al.*, 2001; Gregoire *et al.*, 2001; MacDonald and Potvin, 2004).

- The results of the data generated from the questionnaires and semi-structured interviews demonstrated strong support for the CDR from provincial payers and describes how they utilise the CDR evidence and listing recommendations.
- Canada has established various mechanisms to include patient input at the national and regional levels. The CDR, British Columbia, Ontario and Quebec have all established their own approaches for including patient input, and Alberta currently uses patient input provided to the CDR but is considering establishing its own public committee.

CHAPTER 7

Assessing the Value of HTA Process Maps and their Impact on the Pharmaceutical Industry and Health Technology Assessment Agencies

INTRODUCTION

Health Technology Assessment (HTA) and reimbursement decision-making processes can vary greatly between jurisdictions at both the national and regional level. HTA activities and their role within the regulatory and reimbursement (R&R) system can evolve quickly in response to political, social and economic developments. This can create a challenging environment for stakeholders as HTA is increasingly utilised to guide reimbursement decisions. For example, patients may wish to understand why they are unable to access funding for a new medicine that is has already been approved for reimbursement in a different jurisdiction. A systematic mapping methodology (Chapter 3) was previously created to provide a uniform visual representation of the regulatory, HTA and reimbursement systems. The uniform methodology facilitates comparisons between multiple jurisdictions and a visual format can enable quick identification of key aspects and improve usability. The process mapping methodology has also been applied to produce more than 70 process maps for New Active Substances (NASs), oncology products and medical devices at the national and regional level. The process maps have also facilitated the development of a tool for non-ranking classification of HTA agencies and reimbursement systems (Chapter 4). Industry and agency representatives have been consulted to help understand how the compilation of process maps (Regulatory and Reimbursement Atlas) can provide value to stakeholders and guide future research.

The aim of this study was to assess the value of HTA process maps and their impact on the pharmaceutical industry and HTA agencies with the following objectives:

OBJECTIVES

- Identify general availability of HTA process maps for HTA agencies and pharmaceutical companies
- Assess the value of the systematic process mapping methodology for HTA agencies and pharmaceutical companies
- Evaluate how the process maps could impact agency activities
- Determine how the process maps could impact pharmaceutical company strategy

- Assess how the process maps may inform decision-making for pharmaceutical companies

METHODOLOGY

Two study questionnaires were designed to collect information from pharmaceutical industry and HTA agency representatives, which were primarily selected due to membership of the Centre for Innovation in Regulatory Science (CIRS) HTA program. CIRS is a not-for-profit organisation that provides a neutral, professional forum to facilitate dialogue and productive discussions between members from the pharmaceutical industry, regulatory authorities and HTA agencies. The G-BA (Germany) is not a member of CIRS but was included in the scope of this study as Germany is the largest pharmaceutical market in Europe. CIRS membership was chosen as the primary selection criteria because this potentially provided access to a range of senior industry and agency representatives. The HTA process maps have also been presented at previous CIRS workshops and this increased the likelihood that more responders will be familiar with the process maps and may be able to draw upon previous experiences to determine their value. However, this selection criteria may also introduce bias which should be considered when interpreting the results.

The HTA agency questionnaire contained multiple tick box response options and free text questions within three distinct sections:

Part I – Identify availability of HTA process maps for HTA agencies

Part II – Assess the value of the systematic HTA process mapping methodology for HTA agencies

Part III – Evaluate how the systematic process maps could impact HTA agency activities

The pharmaceutical industry study was divided in four sections and also included two additional industry specific items:

Part I – Identify availability of the HTA process maps for pharmaceutical companies

Part II – Assess the value of the systematic HTA process mapping methodology for pharmaceutical companies

Part III – Evaluate how the systematic process maps could impact company strategy

PART IV – Assess how the systematic process maps may inform decision-making for pharmaceutical companies

The two study questionnaires were reviewed by an expert panel of senior staff members from CIRS with experience developing and questionnaires for conducting research with agency and industry representatives. The expert panel reviewed the study questionnaires to determine their content validity using four criteria: clarity of instructions; language clarity; sentence structure completeness and relevance. Feedback from the expert panel was incorporated prior to the pilot study. Two pharmaceutical industry representatives and two HTA agency representatives were subsequently contacted to complete the study questionnaire and participate in a discussion to review the study questionnaire and to provide feedback. The pilot study identified areas for improvement, such as the inclusion of an additional free-text question to enable respondents to specify why they might decide to use the consolidated collection of process maps (Regulatory and Reimbursement Atlas) over other sources and to include an additional response option ('Sometimes') to describe respondents experiences using a range of information resources.

The agency questionnaire was updated in line with the pilot recommendations and distributed to ten agencies (Figure 7.1):

- AIFA (Italy)
- HAS (France)
- NICE (England)
- CADTH (Canada)
- INAMI (Belgium)
- SMC (Scotland)
- GBA (Germany)
- INESSS (Canada)
- TLV (Sweden)
- ZIN (Netherlands)

The final version of the industry questionnaire was distributed to eight pharmaceutical companies (Figure 7.2):

- Bayer
- GlaxoSmithKline
- Roche
- Daiichi-Sankyo
- Johnson & Johnson
- Sanofi
- Eli Lilly
- Pfizer

Respondents provided electronic and hand completed versions of the questionnaire or completed the study via telephone.

Figure 7.1: Agency questionnaire

1. Identifying availability of process maps

1.1) Have you seen the HTA process maps prior to completing this survey? Please put a cross in one box.

Yes No

1.2) Have you used any of the following sources to find information on regulatory and reimbursement (R&R) systems? Please put a cross in all relevant boxes

Other agency websites ISPOR Roadmaps R&R Atlas Internal reference source

Thomson Reuters Cortellis™ Consultants Other*

*Please provide name of 'other' source(s).

1.3) Please put a number in the boxes to rank the following factors of an R&R source in order of importance according to your opinion (from 1 being most important to 4 as least important):

up-to-date information user-friendly standardised format

link to sources

For questions 1.4 to 1.10, please put a cross either the Yes, Sometimes (SO), No or Don't Know (DK) box to indicate if, in your opinion, the source complies with each of the following factors:

	Up-to-date information				User-friendly				Standardised format				Link to sources			
	Yes	SO	No	DK	Yes	SO	No	DK	Yes	SO	No	DK	Yes	SO	No	DK
1.4) Agency Websites	<input type="checkbox"/>	<input type="checkbox"/>	<input type="checkbox"/>	<input type="checkbox"/>	<input type="checkbox"/>	<input type="checkbox"/>	<input type="checkbox"/>	<input type="checkbox"/>	<input type="checkbox"/>	<input type="checkbox"/>	<input type="checkbox"/>	<input type="checkbox"/>	<input type="checkbox"/>	<input type="checkbox"/>	<input type="checkbox"/>	<input type="checkbox"/>
1.5) ISPOR Roadmaps	<input type="checkbox"/>	<input type="checkbox"/>	<input type="checkbox"/>	<input type="checkbox"/>	<input type="checkbox"/>	<input type="checkbox"/>	<input type="checkbox"/>	<input type="checkbox"/>	<input type="checkbox"/>	<input type="checkbox"/>	<input type="checkbox"/>	<input type="checkbox"/>	<input type="checkbox"/>	<input type="checkbox"/>	<input type="checkbox"/>	<input type="checkbox"/>
1.6) R&R Atlas	<input type="checkbox"/>	<input type="checkbox"/>	<input type="checkbox"/>	<input type="checkbox"/>	<input type="checkbox"/>	<input type="checkbox"/>	<input type="checkbox"/>	<input type="checkbox"/>	<input type="checkbox"/>	<input type="checkbox"/>	<input type="checkbox"/>	<input type="checkbox"/>	<input type="checkbox"/>	<input type="checkbox"/>	<input type="checkbox"/>	<input type="checkbox"/>
1.7) Internal reference source	<input type="checkbox"/>	<input type="checkbox"/>	<input type="checkbox"/>	<input type="checkbox"/>	<input type="checkbox"/>	<input type="checkbox"/>	<input type="checkbox"/>	<input type="checkbox"/>	<input type="checkbox"/>	<input type="checkbox"/>	<input type="checkbox"/>	<input type="checkbox"/>	<input type="checkbox"/>	<input type="checkbox"/>	<input type="checkbox"/>	<input type="checkbox"/>
1.8) Cortellis	<input type="checkbox"/>	<input type="checkbox"/>	<input type="checkbox"/>	<input type="checkbox"/>	<input type="checkbox"/>	<input type="checkbox"/>	<input type="checkbox"/>	<input type="checkbox"/>	<input type="checkbox"/>	<input type="checkbox"/>	<input type="checkbox"/>	<input type="checkbox"/>	<input type="checkbox"/>	<input type="checkbox"/>	<input type="checkbox"/>	<input type="checkbox"/>
1.9) Consultants	<input type="checkbox"/>	<input type="checkbox"/>	<input type="checkbox"/>	<input type="checkbox"/>	<input type="checkbox"/>	<input type="checkbox"/>	<input type="checkbox"/>	<input type="checkbox"/>	<input type="checkbox"/>	<input type="checkbox"/>	<input type="checkbox"/>	<input type="checkbox"/>	<input type="checkbox"/>	<input type="checkbox"/>	<input type="checkbox"/>	<input type="checkbox"/>
1.10) Other (please name)	<input type="checkbox"/>	<input type="checkbox"/>	<input type="checkbox"/>	<input type="checkbox"/>	<input type="checkbox"/>	<input type="checkbox"/>	<input type="checkbox"/>	<input type="checkbox"/>	<input type="checkbox"/>	<input type="checkbox"/>	<input type="checkbox"/>	<input type="checkbox"/>	<input type="checkbox"/>	<input type="checkbox"/>	<input type="checkbox"/>	<input type="checkbox"/>

* SO- Sometimes, DK- Don't Know

Figure 7.1 (continued): Agency questionnaire

2. Assessing the value of systematic process mapping methodology

Please review the systematic process map methodology (pages 3-4), then for each statement 2.1) to 2.11) please put a cross in one box that describes how far you agree with each statement.

	Strongly Agree	Agree	Disagree	Strongly disagree	No opinion
2.1) It is of value to know how the sponsor interacts with agencies within the R&R system	<input type="checkbox"/>	<input type="checkbox"/>	<input type="checkbox"/>	<input type="checkbox"/>	<input type="checkbox"/>
2.2) It is of value to know how agencies interact with each other within the R&R system	<input type="checkbox"/>	<input type="checkbox"/>	<input type="checkbox"/>	<input type="checkbox"/>	<input type="checkbox"/>
2.3) Process maps are easy to understand for a person with NO prior knowledge of R&R systems	<input type="checkbox"/>	<input type="checkbox"/>	<input type="checkbox"/>	<input type="checkbox"/>	<input type="checkbox"/>
2.4) Process maps are easy to understand for a person with some prior knowledge of R&R systems	<input type="checkbox"/>	<input type="checkbox"/>	<input type="checkbox"/>	<input type="checkbox"/>	<input type="checkbox"/>
2.5) Process maps are valuable for a person who wishes to expand their knowledge of R&R systems to include new jurisdictions	<input type="checkbox"/>	<input type="checkbox"/>	<input type="checkbox"/>	<input type="checkbox"/>	<input type="checkbox"/>
2.6) The 7 core functions identify important roles within the R&R system	<input type="checkbox"/>	<input type="checkbox"/>	<input type="checkbox"/>	<input type="checkbox"/>	<input type="checkbox"/>
2.7) The 7 core functions aid comparability between R&R systems	<input type="checkbox"/>	<input type="checkbox"/>	<input type="checkbox"/>	<input type="checkbox"/>	<input type="checkbox"/>
2.8) The 6 HTA key icons identify valuable aspects of HTA activities	<input type="checkbox"/>	<input type="checkbox"/>	<input type="checkbox"/>	<input type="checkbox"/>	<input type="checkbox"/>
2.9) The 6 HTA key icons aid comparability between R&R systems	<input type="checkbox"/>	<input type="checkbox"/>	<input type="checkbox"/>	<input type="checkbox"/>	<input type="checkbox"/>
2.10) The uniform methodology enables quick visual comparison between R&R systems	<input type="checkbox"/>	<input type="checkbox"/>	<input type="checkbox"/>	<input type="checkbox"/>	<input type="checkbox"/>

2.11) Please provide reasons or examples to explain, in your opinion, why you would choose to use the R&R Atlas instead of other sources:

Figure 7.1(continued): Agency questionnaire

3. Evaluate how the HTA process maps could impact agency activities

Please review the systematic process map methodology (pages 3-4), then for each statement 3.1) to 3.7), please put a cross in one box that describes how far you agree with each statement.

I see the value of the HTA process maps as a...	Strongly Agree	Agree	Disagree	Strongly disagree	No opinion
3.1) Presentation aid	<input type="checkbox"/>	<input type="checkbox"/>	<input type="checkbox"/>	<input type="checkbox"/>	<input type="checkbox"/>
3.2) Training tool to introduce employees to new R&R systems	<input type="checkbox"/>	<input type="checkbox"/>	<input type="checkbox"/>	<input type="checkbox"/>	<input type="checkbox"/>
3.3) Reference source to understand new R&R systems	<input type="checkbox"/>	<input type="checkbox"/>	<input type="checkbox"/>	<input type="checkbox"/>	<input type="checkbox"/>
3.4) Reference source to update knowledge of R&R systems	<input type="checkbox"/>	<input type="checkbox"/>	<input type="checkbox"/>	<input type="checkbox"/>	<input type="checkbox"/>
3.5) Source to identify how other R&R systems and HTA processes compare	<input type="checkbox"/>	<input type="checkbox"/>	<input type="checkbox"/>	<input type="checkbox"/>	<input type="checkbox"/>
3.6) Source to identify how other R&R systems and HTA processes compare to your own practices	<input type="checkbox"/>	<input type="checkbox"/>	<input type="checkbox"/>	<input type="checkbox"/>	<input type="checkbox"/>
3.7) Demonstrating your agencies role in the R&R system to stakeholders	<input type="checkbox"/>	<input type="checkbox"/>	<input type="checkbox"/>	<input type="checkbox"/>	<input type="checkbox"/>

3.8) Please provide comments for any additional factors _____

3.9) How important is it for your agency to obtain up-to-date information for reimbursement systems in the following countries?

Please put a cross in one box (high, medium or low) for each country

Country	Level of importance			Country	Level of importance		
	High	Medium	Low		High	Medium	Low
Brazil	<input type="checkbox"/>	<input type="checkbox"/>	<input type="checkbox"/>	Luxembourg	<input type="checkbox"/>	<input type="checkbox"/>	<input type="checkbox"/>
Canada	<input type="checkbox"/>	<input type="checkbox"/>	<input type="checkbox"/>	Netherlands	<input type="checkbox"/>	<input type="checkbox"/>	<input type="checkbox"/>
China	<input type="checkbox"/>	<input type="checkbox"/>	<input type="checkbox"/>	Poland	<input type="checkbox"/>	<input type="checkbox"/>	<input type="checkbox"/>
Denmark	<input type="checkbox"/>	<input type="checkbox"/>	<input type="checkbox"/>	Portugal	<input type="checkbox"/>	<input type="checkbox"/>	<input type="checkbox"/>
France	<input type="checkbox"/>	<input type="checkbox"/>	<input type="checkbox"/>	Russia	<input type="checkbox"/>	<input type="checkbox"/>	<input type="checkbox"/>
Germany	<input type="checkbox"/>	<input type="checkbox"/>	<input type="checkbox"/>	Spain	<input type="checkbox"/>	<input type="checkbox"/>	<input type="checkbox"/>
Greece	<input type="checkbox"/>	<input type="checkbox"/>	<input type="checkbox"/>	Switzerland	<input type="checkbox"/>	<input type="checkbox"/>	<input type="checkbox"/>
Italy	<input type="checkbox"/>	<input type="checkbox"/>	<input type="checkbox"/>	South Korea	<input type="checkbox"/>	<input type="checkbox"/>	<input type="checkbox"/>
Japan	<input type="checkbox"/>	<input type="checkbox"/>	<input type="checkbox"/>	UK	<input type="checkbox"/>	<input type="checkbox"/>	<input type="checkbox"/>
Latvia	<input type="checkbox"/>	<input type="checkbox"/>	<input type="checkbox"/>	USA	<input type="checkbox"/>	<input type="checkbox"/>	<input type="checkbox"/>

Figure 7.1(continued): Agency questionnaire

3.10) Please provide details of any high-importance countries not included in the above tables:

3.11) The R&R Atlas is available in multiple formats. Which of the following formats would you or team be likely to use? Please put a cross in all relevant boxes

Website interactive PDF iPad® application Android® application

To be completed by the respondent:

Name:

Position:

Agency:

Signature: _____

Date: _____

Please provide any comments regarding this survey and the R&R Atlas below:

Figure 7.2: Industry questionnaire

1. Identifying availability of process maps

1.1) Have you seen the HTA process maps prior to completing this survey? Please put a cross in one box.

Yes No

1.2) Have you used any of the following sources to collect information on regulatory and reimbursement (R&R) systems? Please put a cross in all relevant boxes

Agency Websites ISPOR Roadmaps R&R Atlas Internal reference source
 Thomson Reuters Cortellis™ Consultants Other*

*Please provide name of 'other' source(s).

1.3) Please put a number in the boxes to rank the following factors of an R&R source in order of importance according to your opinion (from 1 being most important to 4 as least important):

up-to-date information user-friendly standardised format
 link to sources

For questions 1.4 to 1.10, please put a cross either the Yes, Sometimes (SO), No or Don't Know (DK) box to indicate if, in your opinion, the following information source complies with each of the following factors:

Information source	Up-to-date information				User-friendly				Standardised format				Link to sources			
	Yes	SO	No	DK	Yes	SO	No	DK	Yes	SO	No	DK	Yes	SO	No	DK
1.4) Agency Websites	<input type="checkbox"/>	<input type="checkbox"/>	<input type="checkbox"/>	<input type="checkbox"/>	<input type="checkbox"/>	<input type="checkbox"/>	<input type="checkbox"/>	<input type="checkbox"/>	<input type="checkbox"/>	<input type="checkbox"/>	<input type="checkbox"/>	<input type="checkbox"/>	<input type="checkbox"/>	<input type="checkbox"/>	<input type="checkbox"/>	<input type="checkbox"/>
1.5) ISPOR Roadmaps	<input type="checkbox"/>	<input type="checkbox"/>	<input type="checkbox"/>	<input type="checkbox"/>	<input type="checkbox"/>	<input type="checkbox"/>	<input type="checkbox"/>	<input type="checkbox"/>	<input type="checkbox"/>	<input type="checkbox"/>	<input type="checkbox"/>	<input type="checkbox"/>	<input type="checkbox"/>	<input type="checkbox"/>	<input type="checkbox"/>	<input type="checkbox"/>
1.6) R&R Atlas	<input type="checkbox"/>	<input type="checkbox"/>	<input type="checkbox"/>	<input type="checkbox"/>	<input type="checkbox"/>	<input type="checkbox"/>	<input type="checkbox"/>	<input type="checkbox"/>	<input type="checkbox"/>	<input type="checkbox"/>	<input type="checkbox"/>	<input type="checkbox"/>	<input type="checkbox"/>	<input type="checkbox"/>	<input type="checkbox"/>	<input type="checkbox"/>
1.7) Internal reference source	<input type="checkbox"/>	<input type="checkbox"/>	<input type="checkbox"/>	<input type="checkbox"/>	<input type="checkbox"/>	<input type="checkbox"/>	<input type="checkbox"/>	<input type="checkbox"/>	<input type="checkbox"/>	<input type="checkbox"/>	<input type="checkbox"/>	<input type="checkbox"/>	<input type="checkbox"/>	<input type="checkbox"/>	<input type="checkbox"/>	<input type="checkbox"/>
1.8) Thomson Reuters Cortellis™	<input type="checkbox"/>	<input type="checkbox"/>	<input type="checkbox"/>	<input type="checkbox"/>	<input type="checkbox"/>	<input type="checkbox"/>	<input type="checkbox"/>	<input type="checkbox"/>	<input type="checkbox"/>	<input type="checkbox"/>	<input type="checkbox"/>	<input type="checkbox"/>	<input type="checkbox"/>	<input type="checkbox"/>	<input type="checkbox"/>	<input type="checkbox"/>
1.9) Consultants	<input type="checkbox"/>	<input type="checkbox"/>	<input type="checkbox"/>	<input type="checkbox"/>	<input type="checkbox"/>	<input type="checkbox"/>	<input type="checkbox"/>	<input type="checkbox"/>	<input type="checkbox"/>	<input type="checkbox"/>	<input type="checkbox"/>	<input type="checkbox"/>	<input type="checkbox"/>	<input type="checkbox"/>	<input type="checkbox"/>	<input type="checkbox"/>
1.10) Other (please name)	<input type="checkbox"/>	<input type="checkbox"/>	<input type="checkbox"/>	<input type="checkbox"/>	<input type="checkbox"/>	<input type="checkbox"/>	<input type="checkbox"/>	<input type="checkbox"/>	<input type="checkbox"/>	<input type="checkbox"/>	<input type="checkbox"/>	<input type="checkbox"/>	<input type="checkbox"/>	<input type="checkbox"/>	<input type="checkbox"/>	<input type="checkbox"/>

* SO- Sometimes, DK- Don't Know

Figure 7.2 (continued): Industry questionnaire

2. Assessing the value of systematic process mapping methodology

Please review the systematic process map methodology (pages 3-4), then for each statement 2.1) to 2.11) please put a cross in one box that describes how far you agree with each statement.

	Strongly Agree	Agree	Disagree	Strongly disagree	No opinion
2.1) It is of value to know how the sponsor interacts with agencies within the R&R system	<input type="checkbox"/>	<input type="checkbox"/>	<input type="checkbox"/>	<input type="checkbox"/>	<input type="checkbox"/>
2.2) It is of value to know how agencies interact with each other within the R&R system	<input type="checkbox"/>	<input type="checkbox"/>	<input type="checkbox"/>	<input type="checkbox"/>	<input type="checkbox"/>
2.3) Process maps are easy to understand for a person with NO prior knowledge of R&R systems	<input type="checkbox"/>	<input type="checkbox"/>	<input type="checkbox"/>	<input type="checkbox"/>	<input type="checkbox"/>
2.4) Process maps are easy to understand for a person with some prior knowledge of R&R systems	<input type="checkbox"/>	<input type="checkbox"/>	<input type="checkbox"/>	<input type="checkbox"/>	<input type="checkbox"/>
2.5) Process maps are valuable for a person who wishes to expand their knowledge of R&R systems to include new markets	<input type="checkbox"/>	<input type="checkbox"/>	<input type="checkbox"/>	<input type="checkbox"/>	<input type="checkbox"/>
2.6) The 7 core functions identify important roles within the R&R system	<input type="checkbox"/>	<input type="checkbox"/>	<input type="checkbox"/>	<input type="checkbox"/>	<input type="checkbox"/>
2.7) The 7 core functions aid comparability between R&R systems	<input type="checkbox"/>	<input type="checkbox"/>	<input type="checkbox"/>	<input type="checkbox"/>	<input type="checkbox"/>
2.8) The 6 HTA key icons identify valuable aspects of HTA activities	<input type="checkbox"/>	<input type="checkbox"/>	<input type="checkbox"/>	<input type="checkbox"/>	<input type="checkbox"/>
2.9) The 6 HTA key icons aid comparability between R&R systems	<input type="checkbox"/>	<input type="checkbox"/>	<input type="checkbox"/>	<input type="checkbox"/>	<input type="checkbox"/>
2.10) The uniform methodology enables quick visual comparison between R&R systems	<input type="checkbox"/>	<input type="checkbox"/>	<input type="checkbox"/>	<input type="checkbox"/>	<input type="checkbox"/>

2.11) Please provide comments to explain why you would chose to use the R&R Atlas instead of other sources:

Figure 7.2 (continued): Industry questionnaire

3. Evaluate how the HTA process maps could impact company strategy

Please review the systematic process map methodology (pages 3-4), then for each statement 3.1) to 3.7), please put a cross in one box that describes how far you agree with each statement.

I see the value of the HTA process maps as a...	Strongly Agree	Agree	Disagree	Strongly disagree	No opinion
3.1) Presentation aid	<input type="checkbox"/>	<input type="checkbox"/>	<input type="checkbox"/>	<input type="checkbox"/>	<input type="checkbox"/>
3.2) Training tool to introduce employees to new R&R systems	<input type="checkbox"/>	<input type="checkbox"/>	<input type="checkbox"/>	<input type="checkbox"/>	<input type="checkbox"/>
3.3) Reference source to understand new R&R systems	<input type="checkbox"/>	<input type="checkbox"/>	<input type="checkbox"/>	<input type="checkbox"/>	<input type="checkbox"/>
3.4) Reference source to update knowledge of R&R systems	<input type="checkbox"/>	<input type="checkbox"/>	<input type="checkbox"/>	<input type="checkbox"/>	<input type="checkbox"/>
3.5) Source to identify which agencies to engage with	<input type="checkbox"/>	<input type="checkbox"/>	<input type="checkbox"/>	<input type="checkbox"/>	<input type="checkbox"/>
3.6) Tool to support research projects to aid market access strategies	<input type="checkbox"/>	<input type="checkbox"/>	<input type="checkbox"/>	<input type="checkbox"/>	<input type="checkbox"/>
3.7) Tool to aid planning of market access strategies	<input type="checkbox"/>	<input type="checkbox"/>	<input type="checkbox"/>	<input type="checkbox"/>	<input type="checkbox"/>

3.8) Please provide comments for any additional factors

3.9) How important are the following markets for your company's market access teams?

Please put a cross in one box (high, medium or low) for each country

Market	Level of importance			Market	Level of importance		
	High	Medium	Low		High	Medium	Low
Brazil	<input type="checkbox"/>	<input type="checkbox"/>	<input type="checkbox"/>	Luxembourg	<input type="checkbox"/>	<input type="checkbox"/>	<input type="checkbox"/>
Canada	<input type="checkbox"/>	<input type="checkbox"/>	<input type="checkbox"/>	Netherlands	<input type="checkbox"/>	<input type="checkbox"/>	<input type="checkbox"/>
China	<input type="checkbox"/>	<input type="checkbox"/>	<input type="checkbox"/>	Poland	<input type="checkbox"/>	<input type="checkbox"/>	<input type="checkbox"/>
Denmark	<input type="checkbox"/>	<input type="checkbox"/>	<input type="checkbox"/>	Portugal	<input type="checkbox"/>	<input type="checkbox"/>	<input type="checkbox"/>
France	<input type="checkbox"/>	<input type="checkbox"/>	<input type="checkbox"/>	Russia	<input type="checkbox"/>	<input type="checkbox"/>	<input type="checkbox"/>
Germany	<input type="checkbox"/>	<input type="checkbox"/>	<input type="checkbox"/>	Spain	<input type="checkbox"/>	<input type="checkbox"/>	<input type="checkbox"/>
Greece	<input type="checkbox"/>	<input type="checkbox"/>	<input type="checkbox"/>	Switzerland	<input type="checkbox"/>	<input type="checkbox"/>	<input type="checkbox"/>
Italy	<input type="checkbox"/>	<input type="checkbox"/>	<input type="checkbox"/>	South Korea	<input type="checkbox"/>	<input type="checkbox"/>	<input type="checkbox"/>
Japan	<input type="checkbox"/>	<input type="checkbox"/>	<input type="checkbox"/>	UK	<input type="checkbox"/>	<input type="checkbox"/>	<input type="checkbox"/>
Latvia	<input type="checkbox"/>	<input type="checkbox"/>	<input type="checkbox"/>	USA	<input type="checkbox"/>	<input type="checkbox"/>	<input type="checkbox"/>

3.10) Please provide details of any high-importance markets not included in the above tables:

Figure 7.2 (continued): Industry questionnaire

4. Assessing how the HTA process maps may inform decision-making

Please review the systematic process map methodology (pages 3-4), then for each statement 4.1) to 4.7), put a cross in one box that describes how far you agree with each statement.

I see the value of the HTA process maps influencing decision-making for...	Strongly Agree	Agree	Disagree	Strongly disagree	No opinion
4.1) Determining which parts of your organisation should be involved	<input type="checkbox"/>	<input type="checkbox"/>	<input type="checkbox"/>	<input type="checkbox"/>	<input type="checkbox"/>
4.2) Identifying which agencies to approach	<input type="checkbox"/>	<input type="checkbox"/>	<input type="checkbox"/>	<input type="checkbox"/>	<input type="checkbox"/>
4.3) Determining order of agencies to approach	<input type="checkbox"/>	<input type="checkbox"/>	<input type="checkbox"/>	<input type="checkbox"/>	<input type="checkbox"/>
4.4) Acquiring better knowledge of R&R system market access requirements	<input type="checkbox"/>	<input type="checkbox"/>	<input type="checkbox"/>	<input type="checkbox"/>	<input type="checkbox"/>
4.5) Identifying which R&R systems are similar/dissimilar	<input type="checkbox"/>	<input type="checkbox"/>	<input type="checkbox"/>	<input type="checkbox"/>	<input type="checkbox"/>
4.6) Determining which agencies drive access	<input type="checkbox"/>	<input type="checkbox"/>	<input type="checkbox"/>	<input type="checkbox"/>	<input type="checkbox"/>
4.7) Determining which agencies drive price	<input type="checkbox"/>	<input type="checkbox"/>	<input type="checkbox"/>	<input type="checkbox"/>	<input type="checkbox"/>

4.8) Please provide comments for any additional factors

4.9) The R&R Atlas is available in multiple formats. Which of the following formats would you or team be likely to use? Please put a cross in all relevant boxes

- Website
 interactive PDF
 iPad® application
 Android® application

Name: _____

Position: _____ Company: _____

Signature: _____ Date: _____

Please provide any comments regarding this survey and the R&R Atlas below:

RESULTS

For the purpose of clarity the results are presented in the following seven parts:

PART I - Availability of the HTA process maps for HTA agencies

PART II - Value of the systematic HTA process mapping methodology for HTA agencies

PART III - How the systematic process maps could impact HTA agency activities

PART IV - Availability of the HTA process maps for pharmaceutical companies

PART V- Value of the systematic HTA process mapping methodology for pharmaceutical companies

PART VI - How the process maps could impact company strategy

PART VII - How the process maps may inform decision-making for pharmaceutical companies

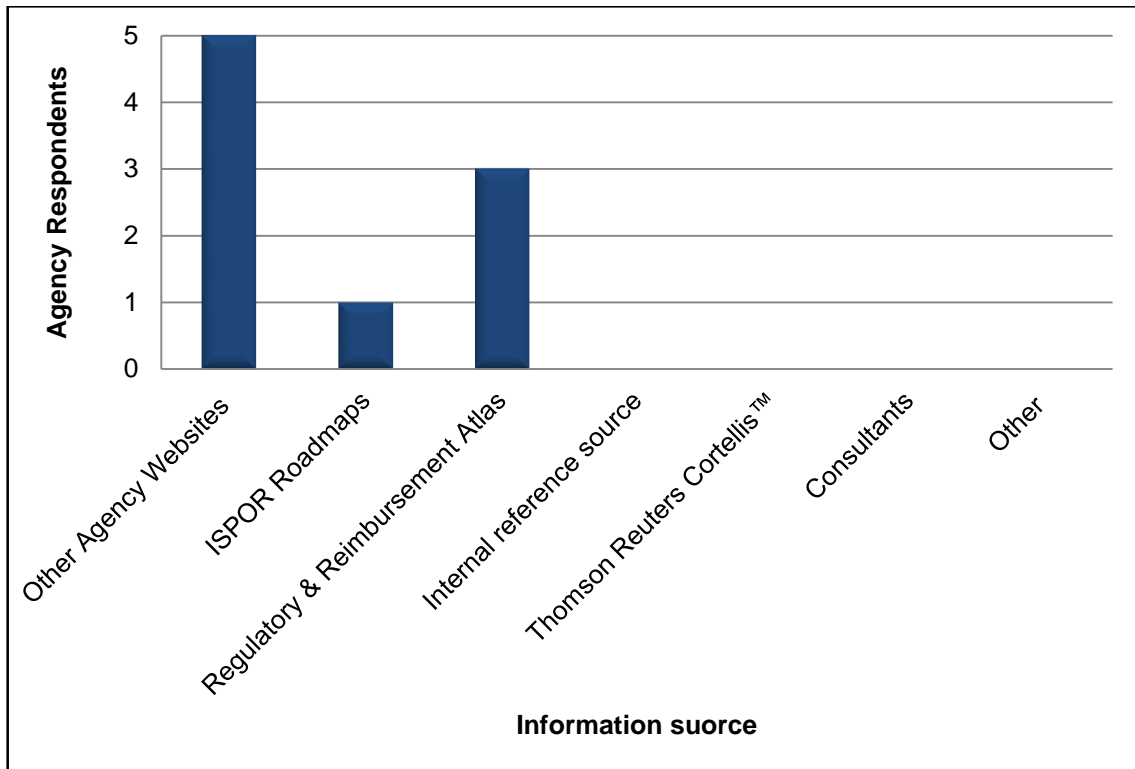
HTA Agency

PART I – Availability of the HTA Process Maps for HTA agencies

The agency study questionnaire was distributed to ten HTA agencies and five of these HTA agencies provided a completed questionnaire (50% response rate) following either one or two reminders for completion. Four of the agencies did not respond and one explained that they were too busy to take part in the study. The five HTA responders that completed the questionnaire held senior positions (Director, Chief pharmacist, or advisor). Three of the five agency respondents had seen the process maps prior to completion of the questionnaire.

Agency representatives used only three of the six regulatory and reimbursement information sources included in the questionnaire and did not provide any information for 'Other' information sources (Figure 7.3). This would suggest that no other information sources are utilised to collect information for reimbursement systems by the responding HTA agency representatives. The most commonly used source was other agency websites (n=5) and the second most common source was the Regulatory and Reimbursement Atlas (n=3). Only one agency representative selected the option for the ISPOR Roadmaps (Figure 7.3).

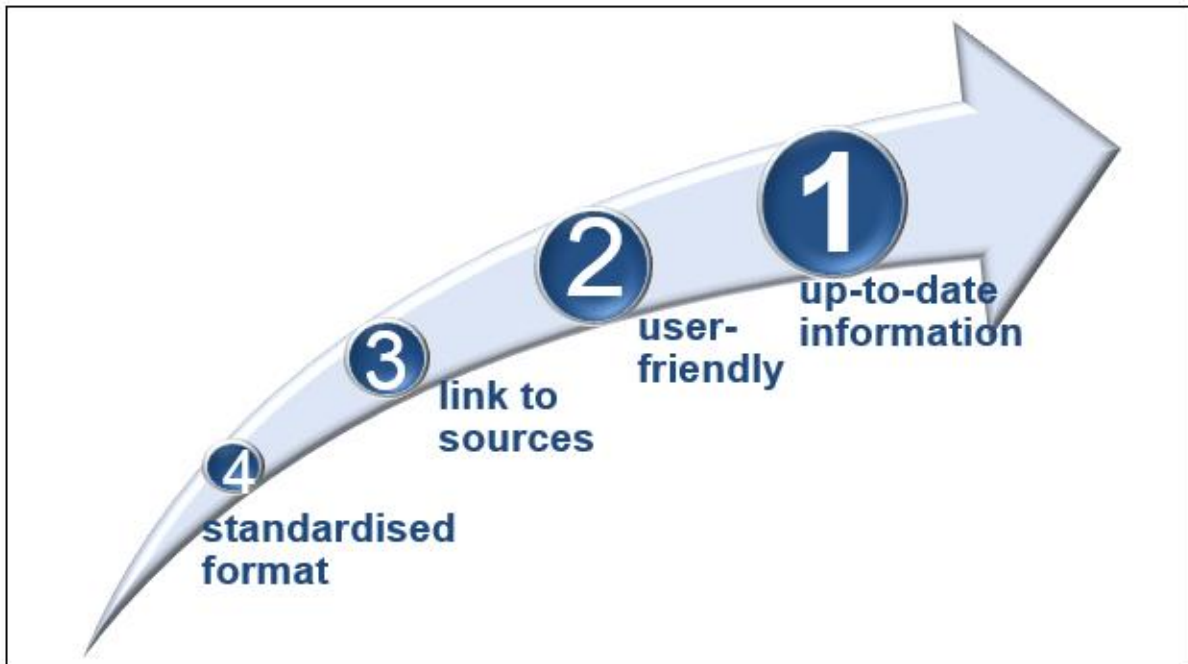
Figure 7.3: Sources used by HTA agencies to collect information for regulatory and reimbursement systems



The study required respondents to rank regulatory and reimbursement factors by order of importance (Figure 7.4). This question was answered by four agency respondents and three of the four agency respondents ranked ‘up-to-date information’ as the most important factor. Overall, ‘user-friendly’ was the second most important factor by rank and one of the four HTA agency respondents ranked ‘user-friendly’ as the most important factor.

Agency respondents completed the study questionnaire to indicate whether, in their opinion, sources they have used to collect information for reimbursement systems have up-to-date information, are user friendly, link to sources and have a standardised format (Figure 7.5). The most commonly used information source was other agency website but the most positively scored information resource was the Regulatory and Reimbursement Atlas (Figure 7.5). The Regulatory and Reimbursement Atlas was the only information resource that had at least one responder agree that it provided up-to-date information, is user friendly, links to sources and has a standardised format

**Figure 7.4: Information source factors ranked by agencies (n=4)
(from 1 being most important to 4 as least important)**

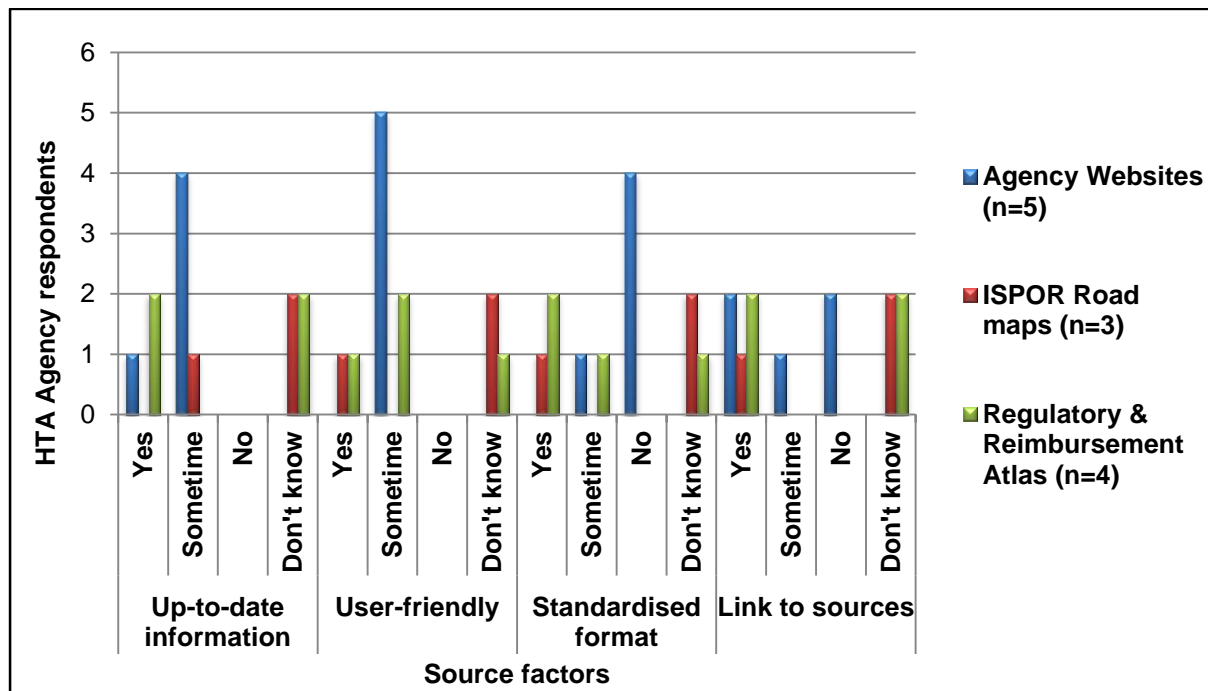


The HTA agency respondents all answered 'sometimes' for whether other agency websites were user-friendly and only one respondent selected 'yes' for providing up-to-date information. Some HTA respondents indicated that they mostly selected the 'sometimes' option due to the large diversity of content demonstrated across different HTA agency websites. Only one agency respondent indicated that they use the ISPOR Roadmaps as an information resource and this responder agreed that the ISPOR Roadmaps complied with three of the four ranked factors: (Figure 7.5).

PART II -Value of the systematic HTA process mapping methodology for HTA agencies

Respondents were asked to indicate whether they agreed with 10 statements as to how the process mapping methodology and information provided by the systematic process maps could provide value as an educational or comparative tool. Respondents were given a five point Likert scale to indicate the degree they agreed with each statement (strongly agree, agree, no opinion, disagree and strongly disagree). Overall, respondents agreed with the ten statements. All of the statements were scored 'agree' or 'strongly agree' by the agency respondents.

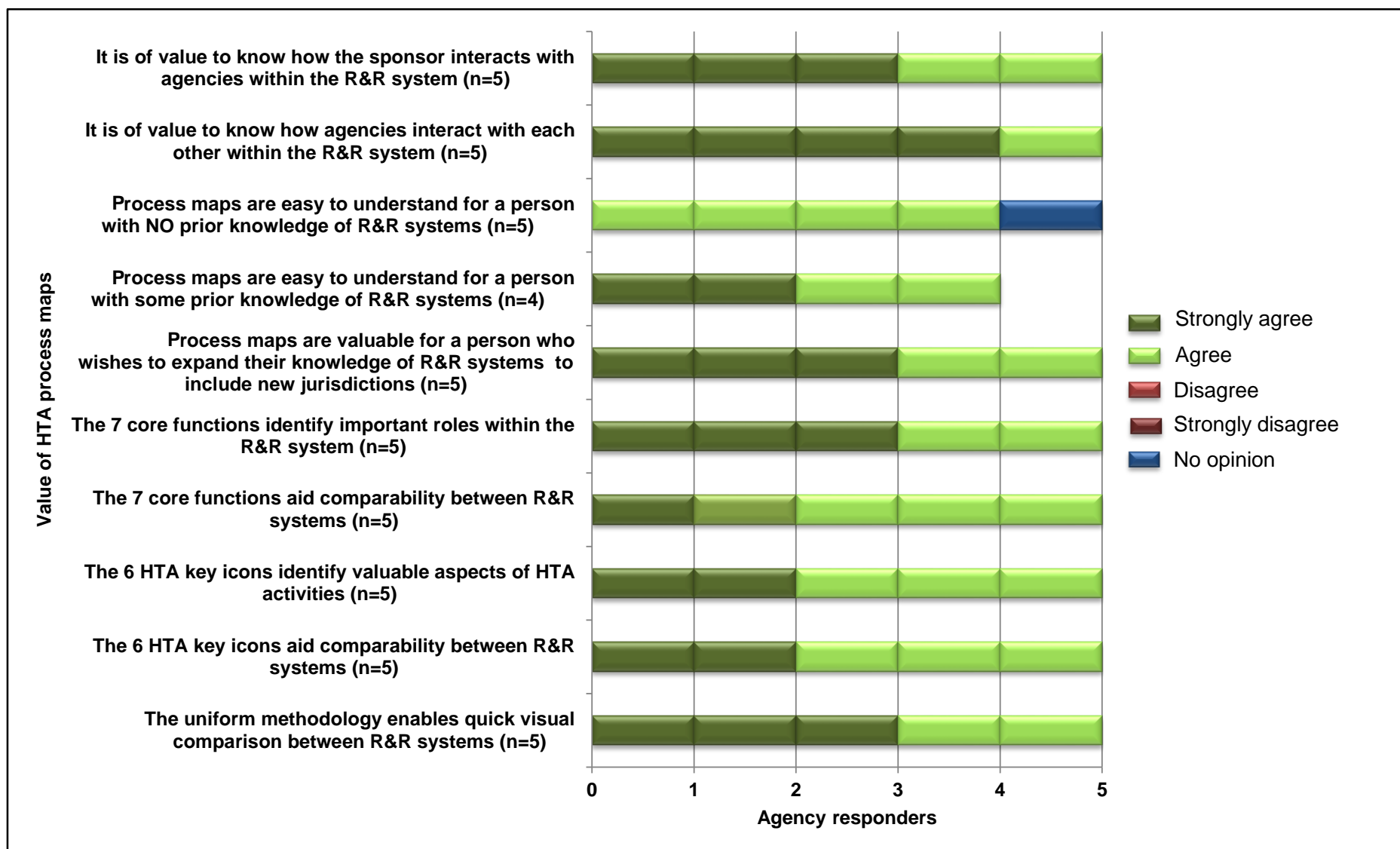
Figure 7.5: Factors exhibited by information sources according to HTA agency respondents



Only one of the nine questions did not receive any ‘strongly agree’ scores from the agency respondents: ‘process maps are easy to understand for a person with NO prior knowledge of R&R systems’ (Figure 7.6). However, respondents also reviewed a similar statement ‘process maps are easy to understand for a person with some prior knowledge of R&R systems’ which was assigned two ‘strongly agree’ scores. This could imply that additional support materials might be needed to enable individuals with no knowledge of reimbursement systems to gain maximum benefit from the systematic process maps included in the Regulatory and Reimbursement Atlas.

Agency respondents also provided scores for statements about the systematic mapping methodology. Each HTA process map is created in a three-step process to display three tiers of information (Chapter 3). The second tier of information identifies core functions (Regulatory, Market Access, HTA, pricing, recommender, decision-maker and provider) performed by the agencies in the system and the third information tier focuses on the HTA component of the system by including six icons for key HTA activities (Scientific advice, Therapeutic value, Economic value, Reimbursement rate, Public consultation and Coverage with evidence development).

Figure 7.6: Value of systematic HTA process mapping methodology according to agency respondents



The agency respondents scored mostly agreed or strongly agreed that the core functions and key HTA activity icons represented important aspects of the system and aided comparability (Figure 7.6). A free text question was included in part II of the agency study to enable agency respondents the opportunity to suggest reasons why they would chose to use the systematic process maps (Regulatory and Reimbursement Atlas). Two of the five respondents (holding a director or advisor position) provided comments for this question. Both comments referred favourably to the usability of the process maps:

- *“One-stop shop, easy to use, comparability”*
- *“The flow chart kind of illustration is most helpful in terms of user friendliness etc. I guess you might come to a point where the flow chart will get too complicated but so far it works for these purposes”*

PART III - How the systematic process maps could impact HTA agency activities

HTA agency respondents were also asked to indicate whether they agreed with statements that suggest how the systematic process maps could be used to support agency activities (Figure 7.7). The overall HTA agency respondent scores for these statements were all positive with no statements were scored negatively. The most popular statement was scored ‘strongly agree’ by four of the five agency respondents and one respondent scored ‘agree’:

- ‘Demonstrating your agencies role in the R&R System to stakeholders’.

The second most popular option was allocated three ‘strongly agree’ and two ‘agree’ scores:

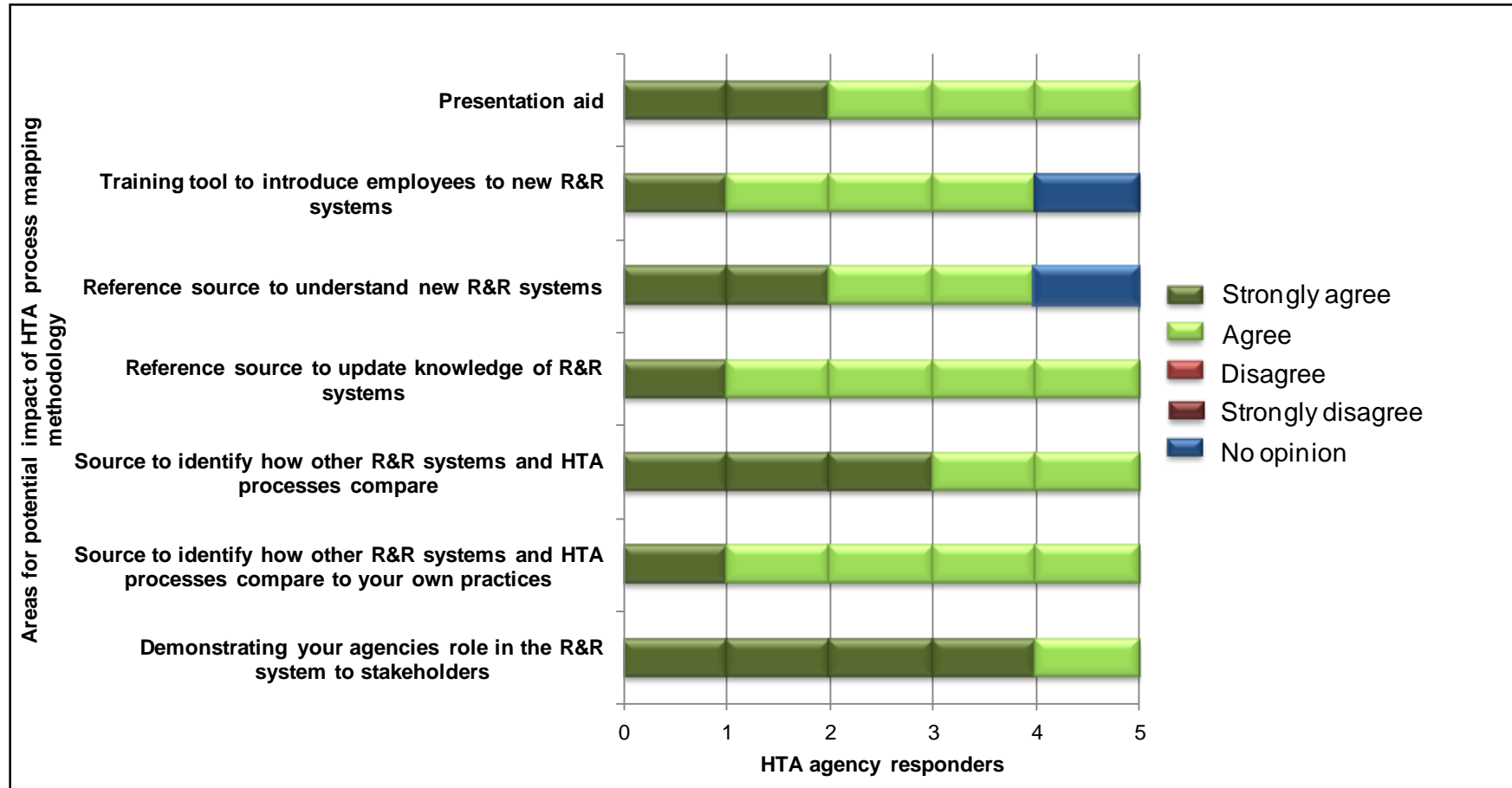
- ‘Source to identify how other Regulatory & Reimbursement (R&R) systems compare’.

Only two statements received a ‘no opinion’ score from an agency respondent:

- ‘Training tool to introduce employees to new R&R systems’
- ‘Reference source to understand new R&S systems’

Agency respondents were also asked to rank 20 countries as ‘high’, ‘medium’ or ‘low’ importance to their organisation (Figure 7.8). Five jurisdictions with established and active HTA agencies were ranked high by all five agency respondents (Canada, France, Germany, Netherlands and UK).

Figure 7.7: Potential process map impact on HTA activities (n=5)



Switzerland was the only jurisdiction to achieve rankings of ‘High’, ‘Medium’ and ‘Low’. Poland was the only jurisdiction ranked ‘Medium’ by all agency responders and no jurisdictions were assigned all ‘Low’ rankings. The low scoring jurisdictions included those without HTA agencies such as China and Japan.

Figure 7.8: Importance of jurisdictions to HTA agency respondents (n=4)

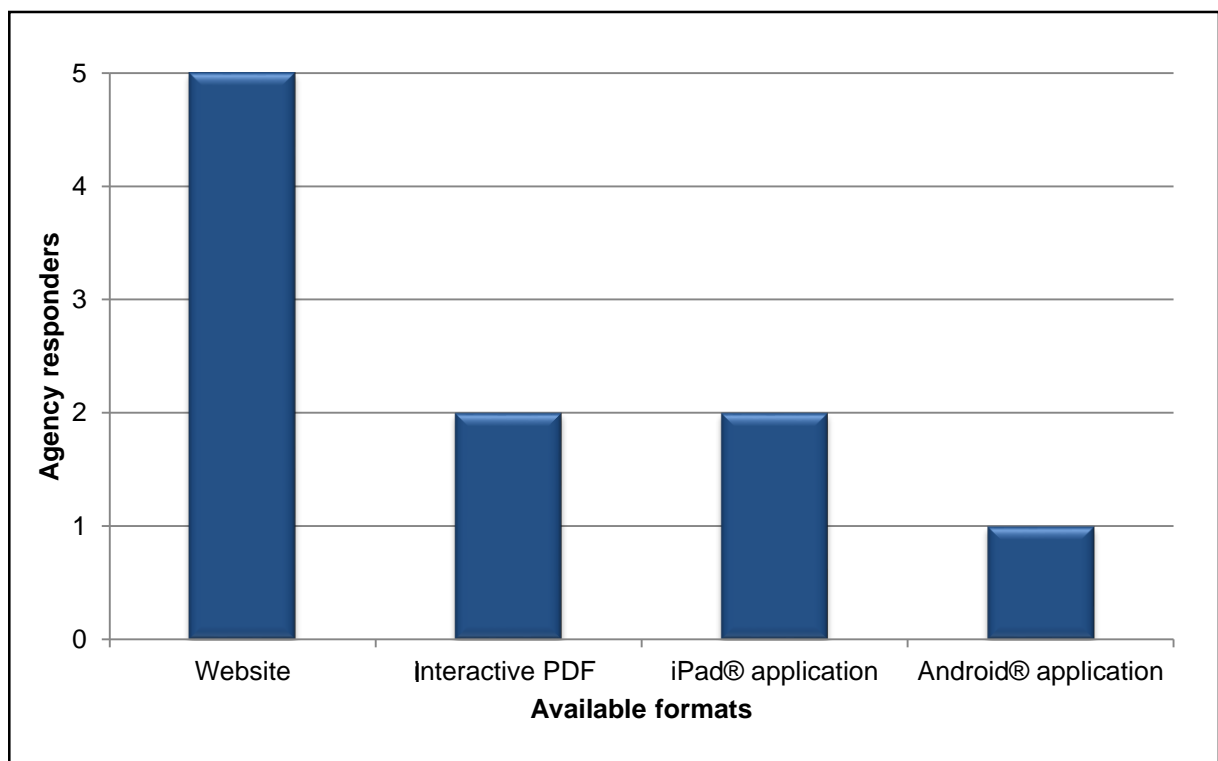


Finally, the agency study included a question to identify how HTA agencies would access the compilation of process maps. Four format options were provided (Website, Interactive PDF, iPad® application and Android® application) and all were selected by at least one responder (Figure 7.9). The website option was the most favoured with all agency respondents selecting this option. Two agencies indicated that they would use the Interactive PDF and iPad© application and only one respondent indicated that they would use the Android© format.

A box for general comments was included in the study and captured very supportive statements from agency representatives:

- *“Great job. I think this work fills an important gap in the resources and tools available for industry, HTA bodies, payers and academics. This is a fast growing field and getting increasingly complex with time and this tool (Atlas) provides a one stop experience for people who are keen to understand the Regulatory-HTA-Payer landscape, different interaction points and similarities and differences across different systems. Finally, the methodology and standardised format is quite sophisticated yet simple and user-friendly.”*
- *“Great tool. The HTA Key Activity value would benefit from 2 additional icons: - One that relates to other factors like for instance for INESSS organizational and ethical considerations or for NICE end of life criteria etc., - One icon that lists the availability or not of risk sharing agreements. These 2 elements are essential if we want to compare R&R accurately”*

Figure 7.9: Agency respondents preferred formats for the Regulatory and Reimbursement Atlas (n=5)



Pharmaceutical industry

PART IV - Availability of the HTA Process Maps for Pharmaceutical companies

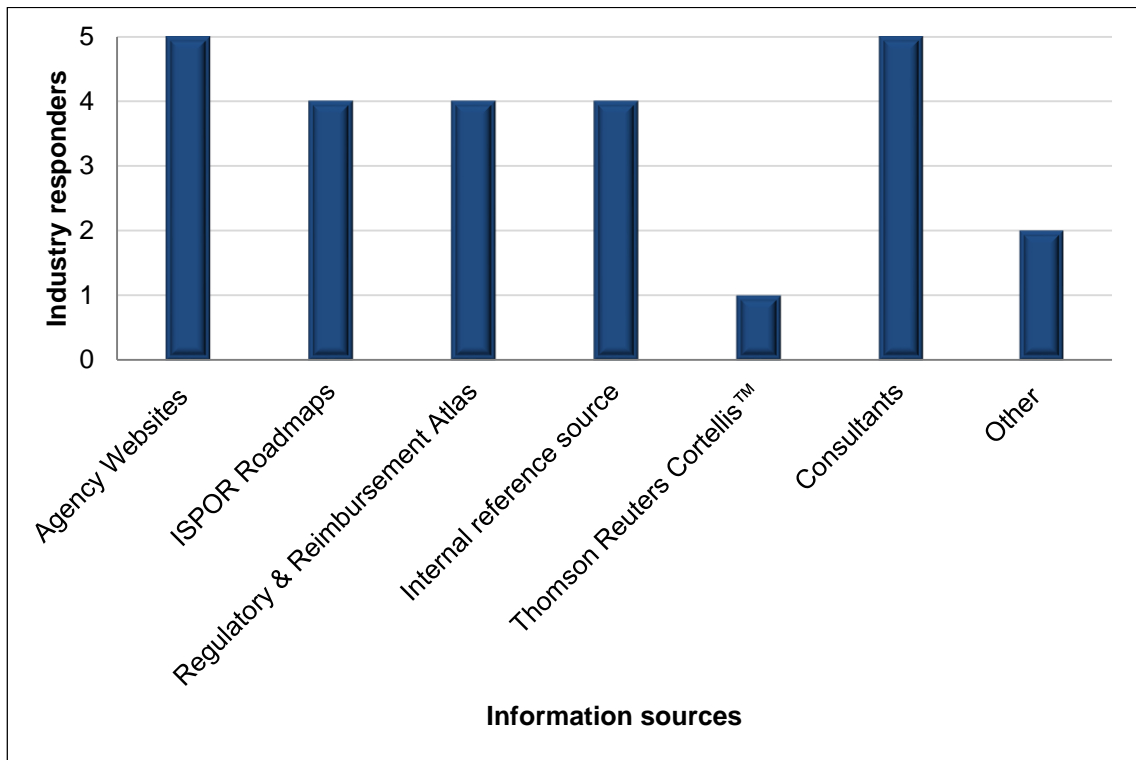
The industry study questionnaire was distributed to eight pharmaceutical companies and six completed questionnaires were received (75% response rate) from responders based in the USA (n=4) and Europe (n=2). The roles of the responders varied from senior Executive Director to Research Associate. The companies were selected due to their membership of the Centre for Innovation in Regulatory Science's (CIRS) HTA program where the process maps have been previously presented. Therefore, only one of the six respondents had not seen the process maps prior to completion of the questionnaire.

Pharmaceutical industry respondents were also asked if they had used six named information sources to collect information for R&R systems:

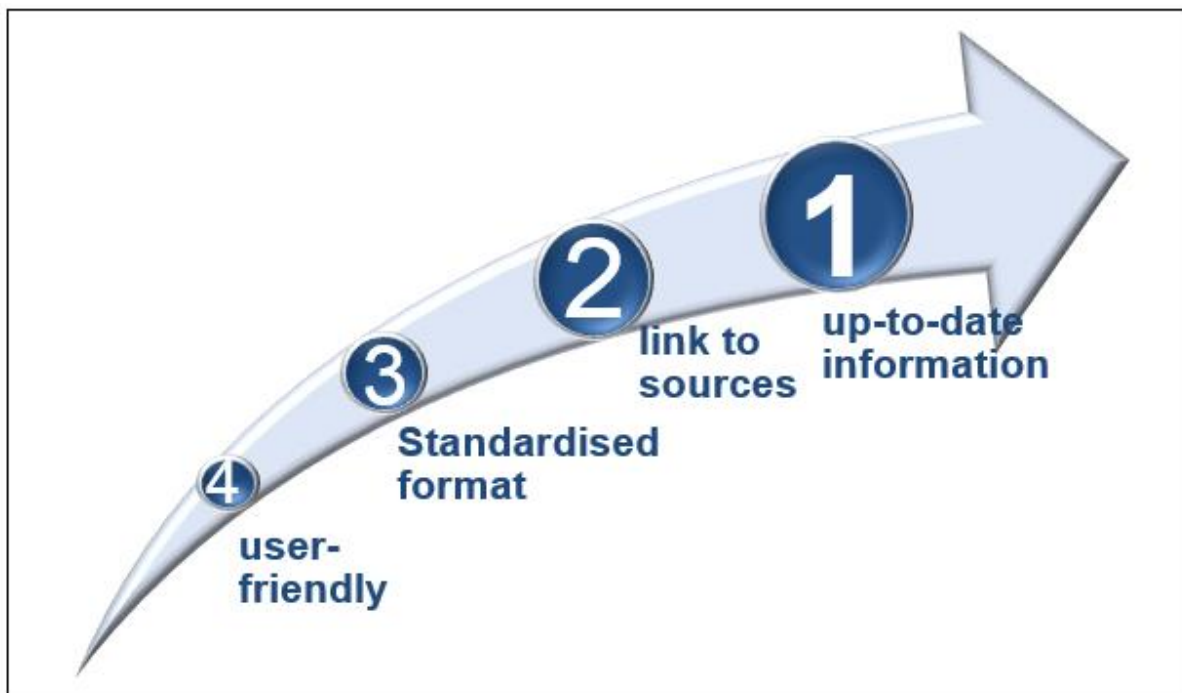
- Agency websites
- ISPOR Roadmaps
- Regulatory and Reimbursement Atlas
- Internal reference source
- Thomson Reuters Cortellis™
- Consultants

The most popular information sources utilised by industry respondents was agency websites and consultants with five of the six respondents indicating that they have used both. Four respondents indicated that they have used ISPOR Roadmaps, Regulatory and Reimbursement Atlas and an internal reference source. The least used was Thomson Reuters Cortellis™, which was only used by one industry respondent (Figure 7.10). Industry respondents were also asked to rank four factors of regulatory and reimbursement information sources. The most important factor for industry was up-to-date information and was ranked first by all six of the industry respondents. User-friendly, Standardised format and Link to sources were all ranked either second, third or fourth by at least one respondent and thus scored very closely for second, third and fourth position. Overall, the second most important ranked factor was link to sources, the third most important factor was standardised format and the least important was user-friendly (Figure 7.11).

Figure 7.10: Sources used by pharmaceutical industry to collect information for regulatory and reimbursement systems (n=6)

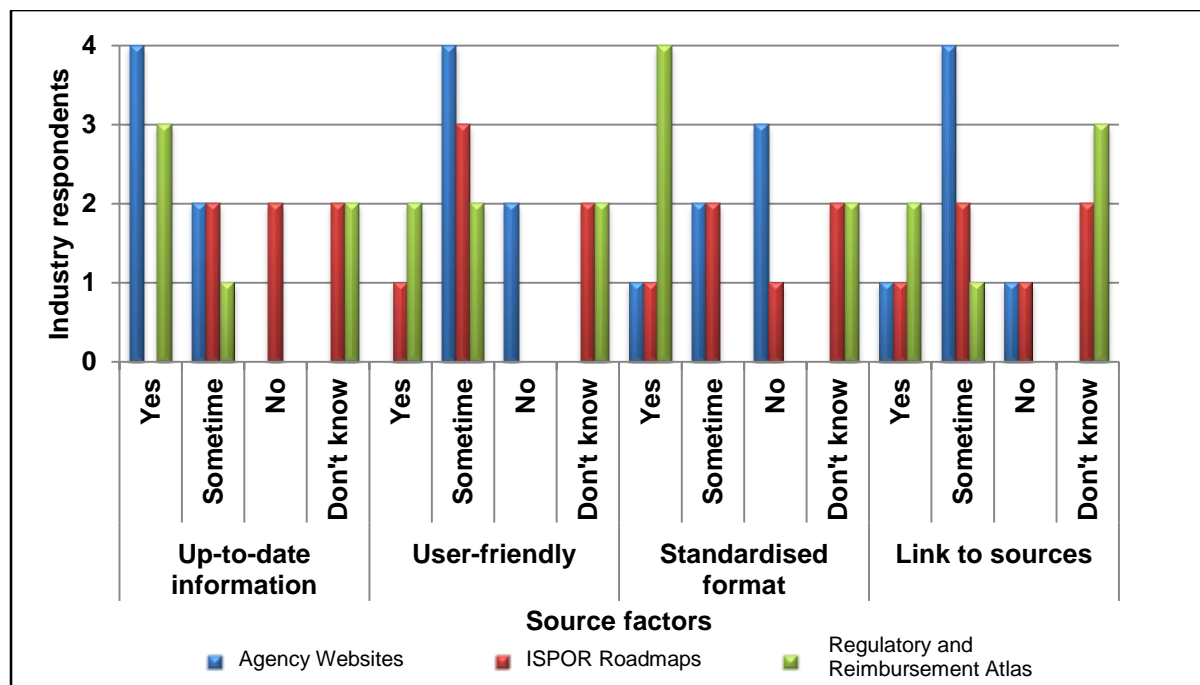


**Figure 7.11: Information source factors ranked by industry (n=6)
(From 1 being most important to 4 as least important)**



Industry respondents also indicated how, in their personal experience, they believed the six named information sources complied with the four previously ranked factors (Figure 7.12 to 7.13). Agency websites were one of the most used information sources, but industry respondents also assigned the most negative scores to agency websites (Figures 7.10 and 7.12). However, agency websites also scored highest for the number of industry respondents at the top ranked factor (up-to-date information) (Figure 7.11). The Regulatory and Reimbursement Atlas received the greatest quantity of 'yes' scores of all named information sources for up-to-date information, link to sources, user friendly and standardised format (Figure 7.12). ISPOR Road maps were assigned two 'no' scores for providing up-to-date information, which was also the information source factor ranked top priority by all six industry respondents (Figure 7.12 and 7.13).

Figure 7.12: Factors exhibited by agency websites, ISPOR Roadmaps and Regulatory and Reimbursement Atlas according to industry respondents

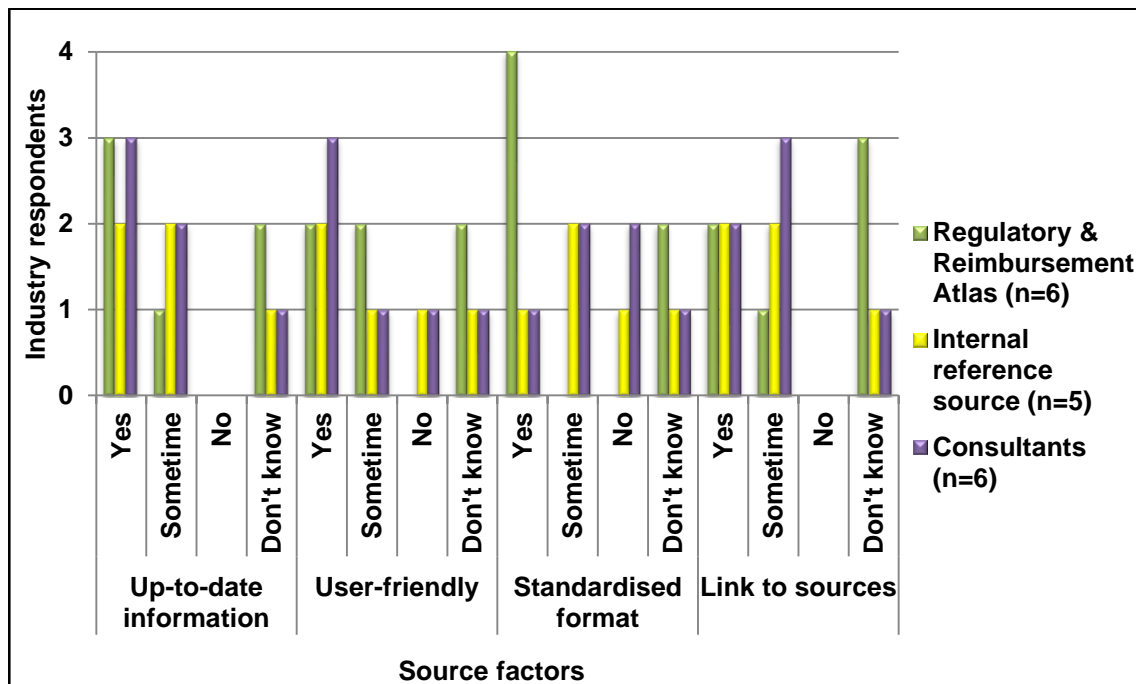


PART V - Availability of the HTA process maps for pharmaceutical companies

The industry respondents indicated how much they agreed or disagreed with ten statements for how the systematic process maps can provide value as an educational

and comparative tool (Figure 7.14). These ten statements are the same statements included in the first section of the agency study questionnaire.

Figure 7.13: Factors exhibited by Regulatory and Reimbursement Atlas, Consultants and Internal reference sources according to industry respondents



Nine of the ten statements were assigned ‘Strongly agree’ or ‘Agree’ by all industry respondents. The two most positively scored statements refer to information provided by the systematic mapping methodology:

- It is of value to know how the sponsor interacts with agencies within the R&R system
- It is of value to know how agencies interact with each other within the R&R system

The next most popular statement was scored three ‘Strongly agree’ and three ‘Agree’:

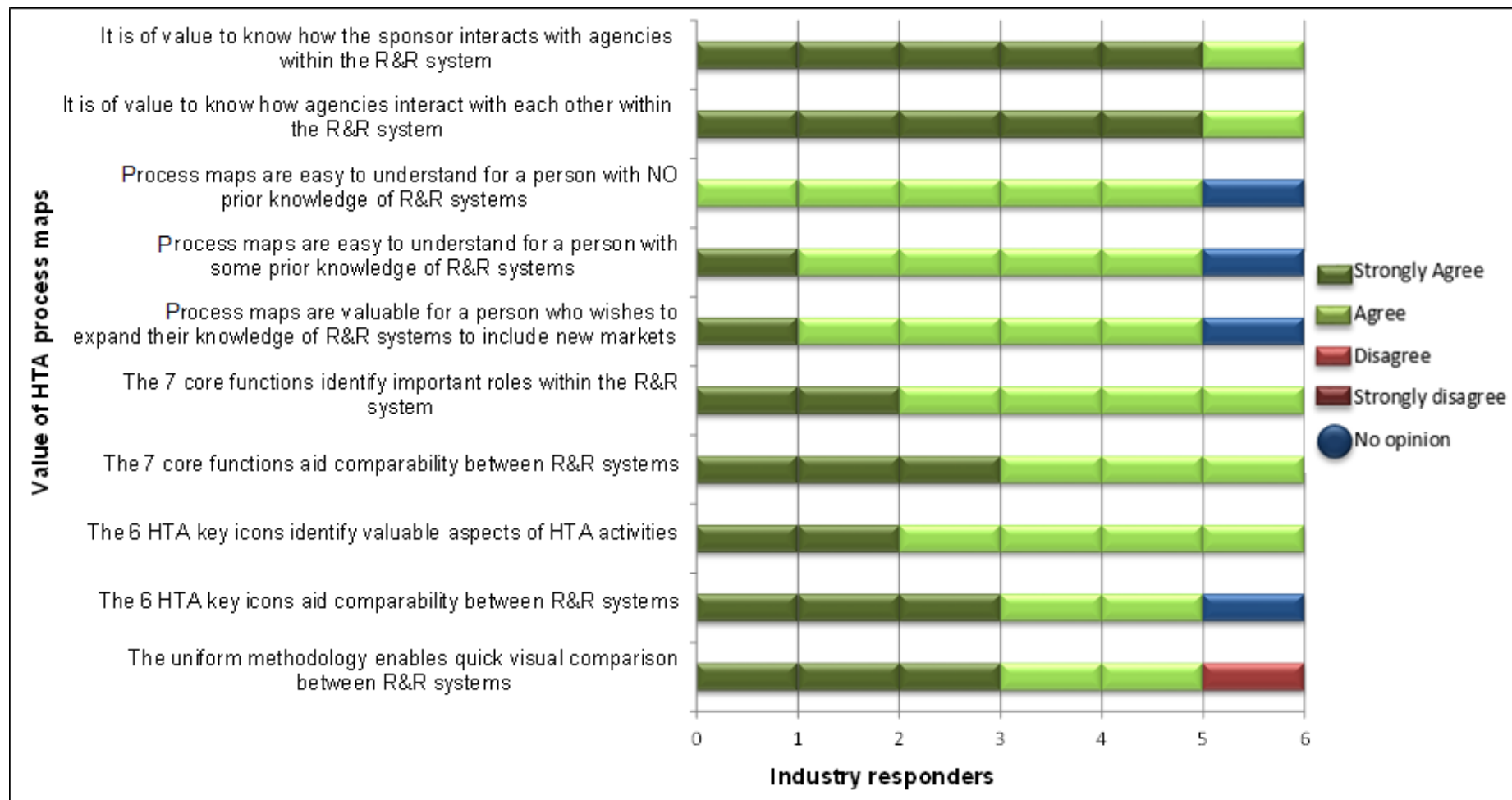
- The 7 core functions aid comparability between R&R systems

Only one industry responder scored one of the ten statements negatively:

- The uniform methodology enables quick visual comparison between R&R systems

However, three other industry respondents also selected ‘Strongly agree’ and two selected ‘Agree’ for this statement.

Figure 7.14: Value of systematic HTA process mapping methodology according to industry respondents (n=6)



In response to a question asking why companies would choose to use the process maps (Regulatory and Reimbursement Atlas) over other information sources, three of the six respondents provided comments that were all positive attributes of the process maps:

- *“Uniform methodology”*
- *“Clarity and ease of use”*
- *“The graphical representation of the Atlas would be a good choice for discussions with internal colleagues and external audiences to provide a common point of discussion”*

PART VI - How the process maps could impact company strategy

The industry representatives scored seven statements for how the process maps (Regulatory and Reimbursement Atlas) could impact company strategy (Figure 7.15). Two of the seven statements were all scored as ‘Strongly agree’ or ‘Agree’ with only one responder indicating ‘no opinion’:

- I see the value of the process maps as a reference source to understand new R&R systems
- I see the value of the process maps as a reference source to update knowledge of R&R systems

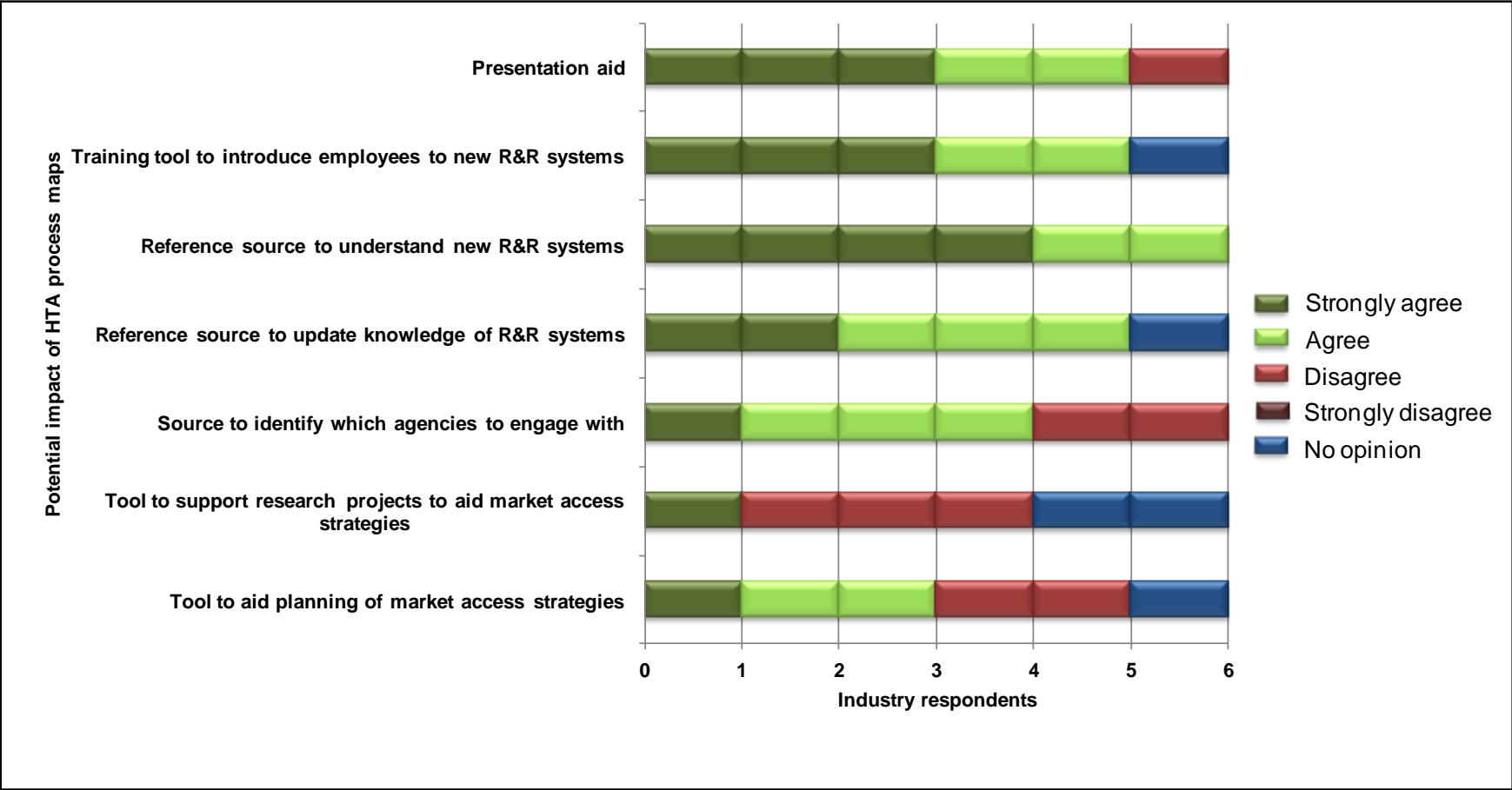
All industry respondents, except one, also answered ‘Strongly agree’ or ‘Agree’ for the following two real-life applications of the Regulatory and Reimbursement Atlas:

- I see the value of the process maps as a presentation aid
- I see the value of the process maps as a training tool to introduce employees to new R&R systems

The most negatively scored statement with only one positive score was:

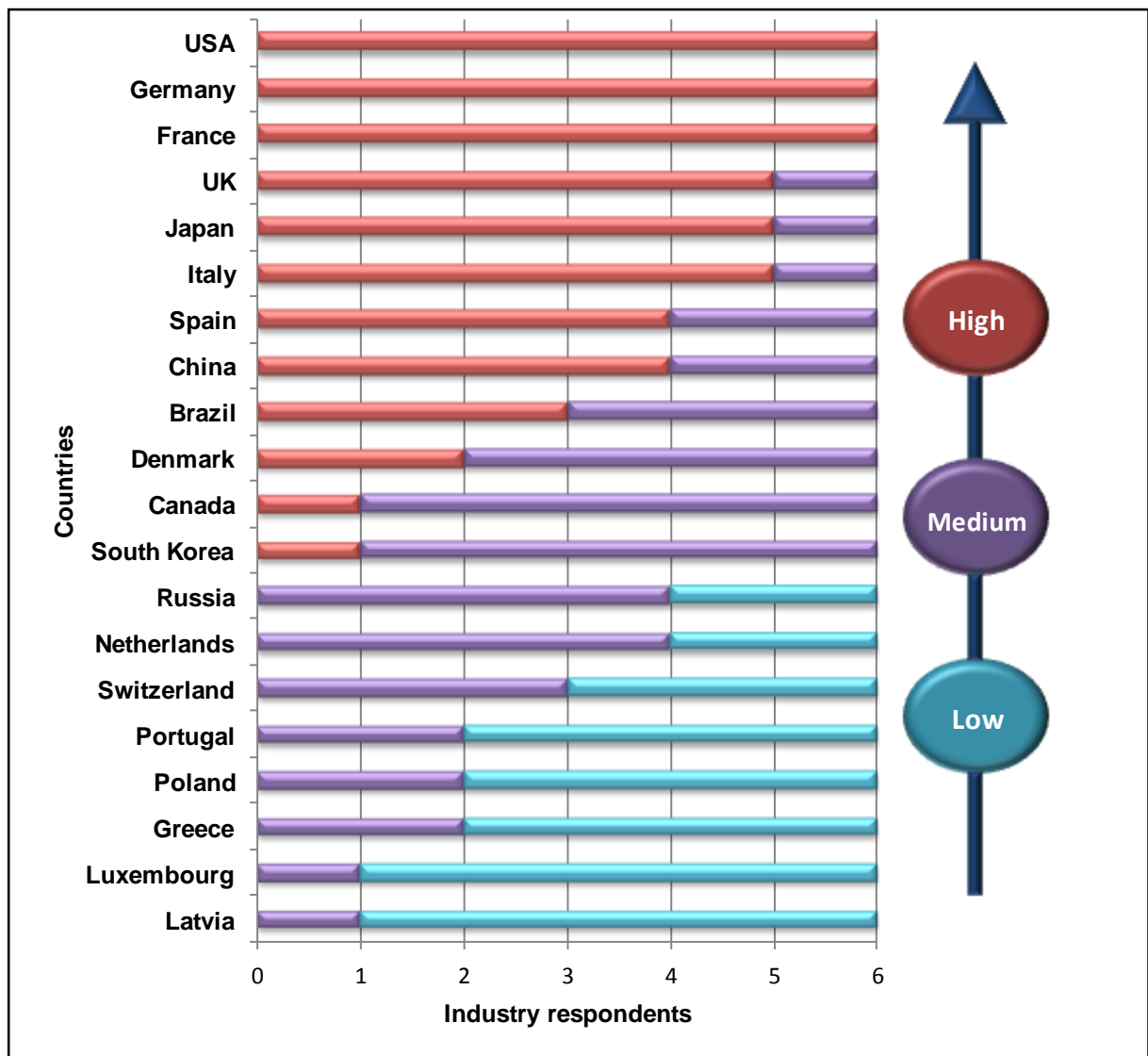
- Tool to support research projects to aid market access strategies

Figure 7.15: Potential impact of HTA process maps on company strategy



The industry questionnaire included the same list of 20 countries to be ranked (high, medium or low) as the agency questionnaire. Unlike the agency results, only three countries scored 'high' from all respondents: Germany, France and the USA. The majority of industry responders were also mainly based in the USA (n=4) and two responders from Europe (Switzerland and the UK). However, most of the responders (n=4) also held very senior positions (Director or higher) with a global role, one responder had a global management role and another was a research associate. Industry respondents also scored countries without HTA agencies higher than the agency responses (e.g. Japan and China) (Figure 7.16). The two lowest priority countries were Latvia and Luxembourg with one 'Medium' and five 'Low' scores.

Figure 7.16: Importance of countries by industry respondents



PART VII – How the process maps may inform decision-making for pharmaceutical companies

Seven statements for ways the process maps could influence company decision-making were included in the industry study. Industry scored the answers using a five point Likert scale (Figure 7.17). The two most positively answered statements were all scored 'Strongly agree' or 'Agree' by respondents:

- *I see the value of the process maps influencing decision-making for Acquiring better knowledge of R&R system market access requirements*
- *I see the value of the process maps influencing decision-making for Identifying which R&R systems are similar/dissimilar*

The following statements were assigned four positive scores by industry respondents:

- *I see the value of the process maps influencing decision-making for determining which agencies drive access*
- *I see the value of the process maps influencing decision-making for determining which agencies drive price*

Overall, the scores were mostly positive for all statements except one:

- *I see the value of the process maps influencing decision-making for determining which parts of your organisation should be involved*

This statement was negatively scored by three industry respondents but two other industry respondents scored the statement positively.

Industry respondents also selected the website format as their preferred method of accessing the process maps from four different formats: website, interactive PDF, iPad application® and Android® application. The second most popular method was by interactive PDF (Figure 7.18).

Industry respondents provided the following comments in response to the industry study questionnaire:

- *“As probably every large pharma company we have dedicated market access teams in the countries which I would approach on specific questions. Thus, I see most value in the comparison of systems and the training component.”*

Figure 7.17: Process maps potential to inform company decision-making

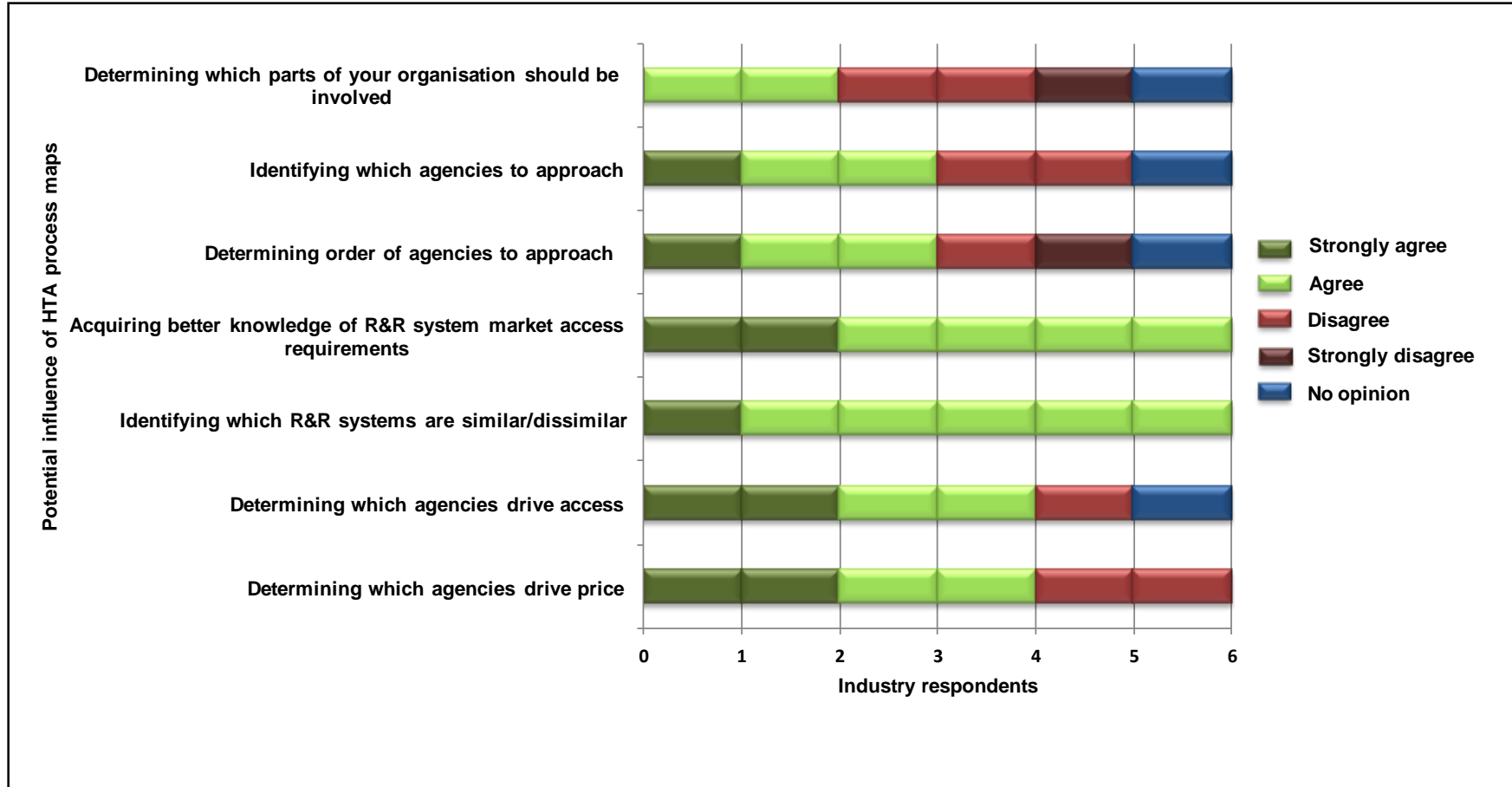
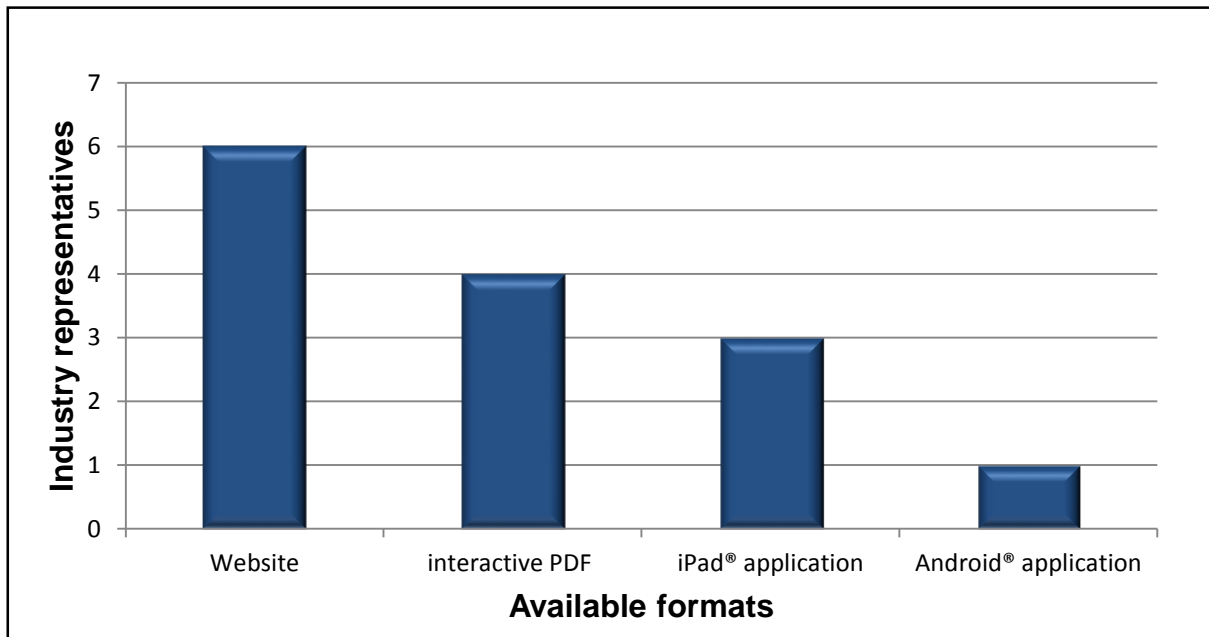


Figure 7.18: Industry respondents preferred format for accessing Regulatory and Reimbursement Atlas (n=6)



- *“The Atlas is a helpful tool to gain first insights into a P&R system and its actors”*

The comments from industry respondents support the use of the systematic process maps as an educational and training tool for providing insights into reimbursement systems and also as a comparative tool.

DISCUSSION

This study has reviewed both HTA agency and pharmaceutical industry opinions regarding the value of the HTA process maps for their organisation. Overall, the study response from agency representatives was largely positive despite that 2 of the 5 agency respondents had not seen the process maps prior to completing the questionnaire. One of the most encouraging results is the agency representatives score for the Regulatory and Reimbursement Atlas (compilation of systematic process maps) for how well, in their opinion, they believe the Regulatory and Reimbursement Atlas provides up-to-date information, links to sources, has a standardised format and is user-friendly. Agency websites were the most selected source to be utilised by agency representatives, but the Regulatory and Reimbursement Atlas had the greatest quantity of respondents that believed it complied with these four factors.

Part II of the agency questionnaire provided more encouraging results for the process maps. Ten positive statements that related to the value of the process maps did not receive a single disagree or strongly disagree answer. The questionnaire results strongly support the use of the process maps as an educational tool with the following statements achieving all positive opinion scores:

- Process maps are easy to understand for a person with no prior knowledge of R&R systems
- Process maps are easy to understand for a person with some prior knowledge of R&R systems
- The process maps are valuable for a person who wishes to expand their knowledge of R&R systems to include new jurisdictions
- The 7 core functions (Regulatory, Market Access, HTA, pricing, recommender, decision-maker and provider) identify important roles within the R&R system
- The 6 HTA key icons (Scientific advice, Therapeutic value, Economic value, Reimbursement rate, Public consultation and Coverage with evidence development) identify valuable aspects of HTA activities
- The 7 core functions aid comparability between R&R systems
- The 6 HTA key icons aid comparability between R&R systems
- The uniform methodology enables quick visual comparison between R&R systems
- I see the value of the process maps as a training tool to introduce employees to new R&R systems
- I see the value of the process maps as a reference source to understand new R&R systems
- I see the value of the process maps as a source to identify how other R&R systems and HTA processes compare

The following statements all received positive opinion scores to support the utilisation of the process maps as a communication tool:

- I see the value of the process maps as a presentation aid
- I see the value of the process maps as a source to identify how other R&R systems and HTA processes compare to your own practices

- I see the value of the process maps as demonstrating your agencies role in the R&R system to stakeholders

The visual representation of the system could aid communication from HTA agencies to patients, citizens and other stakeholders. Using the comparability functions of the process maps to compare how roles between different regulatory and reimbursement systems compare to internal practices could be useful to support comparisons with peers and internal audits.

The Industry study also provides support for the Regulatory and Reimbursement Atlas. Similarly to the HTA agency responses, the agency websites were the most utilised source but the Regulatory and Reimbursement Atlas (process maps) received the highest scores for compliance across all four information source factors. The responses support the utilisation of the process maps as an educational tool. A comment from an industry representative supports the application of the tool as an educational support for introducing and obtaining an overview of regulatory and reimbursement systems:

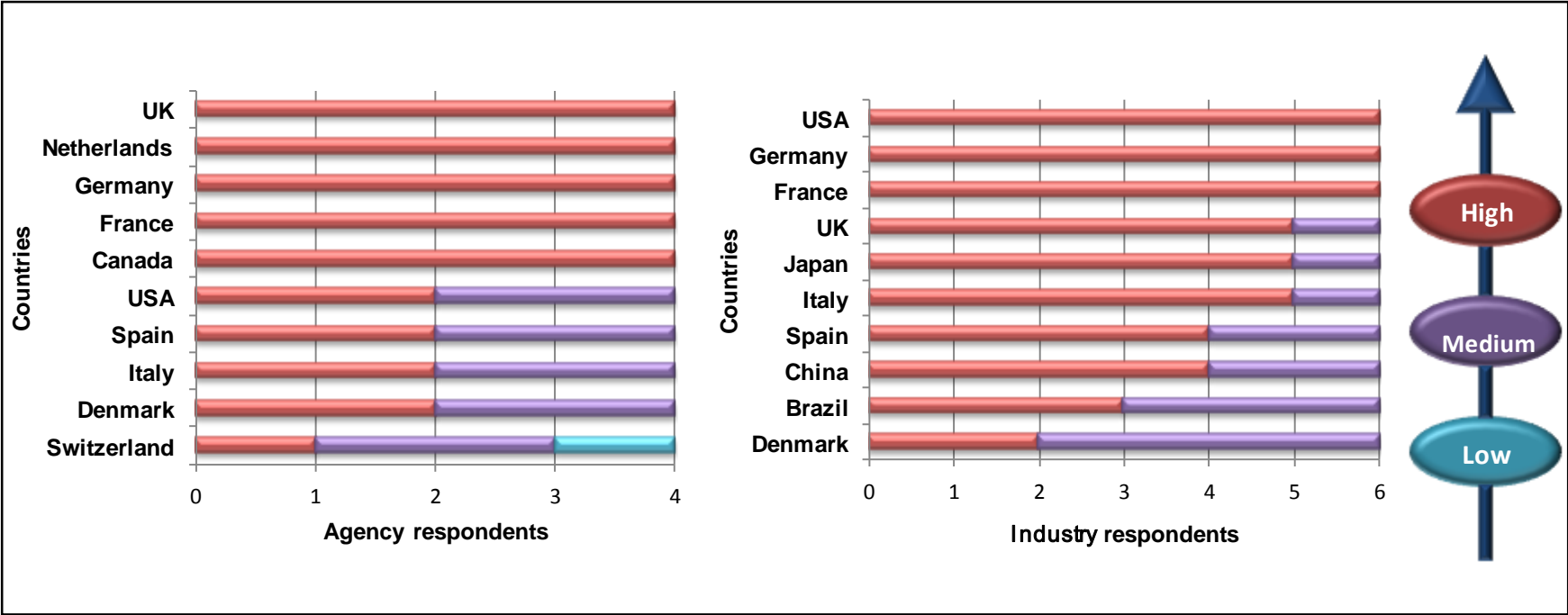
“The Regulatory and Reimbursement Atlas is a helpful tool to gain first insights into a P&R system and its actors”

Another free text answer from an industry representative acknowledges the value of utilising the process maps as a communication tool:

“The graphical representation of the Atlas would be a good choice for discussions with internal colleagues and external audiences to provide a common point of discussion”

The main questions that received different answers from industry and agency respondents were the ranking of jurisdictions by level of importance (Figure 7.19). However, this is to be expected as industry and agencies have different priorities and will view jurisdictions from different perspectives. Important jurisdictions to most pharmaceutical industry representatives will be the larger or rapidly growing markets.

Figure 7.19: Ten highest ranked countries by importance for HTA agency and pharmaceutical industry respondents



However, a HTA agency is more likely to view jurisdictions with an established HTA organisation that is internationally active as these countries can provide opportunities for shared learning or comparison. Overall the agency and industry study questionnaires have both yielded a majority of positive responses from both the multiple-choice questions and free text answers, for example:

“Great job. I think this work fills an important gap in the resources and tools available for industry, HTA bodies, payers and academics... the methodology and standardised format is quite sophisticated yet simple and user-friendly.”

SUMMARY

- This study achieved a response rate of 75% for the industry and 50% for the HTA agencies. The industry received a better response rate, but five of the five respondents were based in English speaking nations. Language may have been a barrier for lower agency response rate.
- Overall, agency and industry responses were positive.
- Both Industry and agency responses support the utilisation of the HTA process maps as an educational tool.
- Industry and agency respondents both agreed with statements to support the use of the Regulatory and Reimbursement Atlas (Process maps) as a communication tool.
- The main disparities between the agency and industry responses were from ranking of jurisdictions/markets by importance. As industry and agencies have different priorities, they would therefore view jurisdictions from different perspectives.
- Both industry and agency respondents favoured the website format for accessing the systematic process maps (Regulatory and Reimbursement Atlas).

CHAPTER 8

General Discussion

INTRODUCTION

Background

The process required for providing patients' access to new medicines has become more complex with the increased uptake of Health Technology Assessment (HTA) to inform coverage decisions. HTA is commonly referred to as the 'fourth hurdle' as it assesses the clinical effectiveness of a new health technology following the regulatory assessment for safety, efficacy and quality with the fifth hurdle as affordability. The establishment of the European Medicines Agency (EMA) in 1995 standardised the procedure for gaining market access for new medicines across Europe, but now the pharmaceutical industry is required to submit multiple applications to individual European countries for reimbursement. The methodologies and processes used to conduct HTA can vary from country to country and also between regions when decision-making is decentralised. Thus, the pharmaceutical industry must learn to navigate a market that resembles an ever changing patchwork of HTA agencies as HTA methodologies and processes continue to evolve. Manufacturers often submit applications first to markets where they are likely to achieve a higher price, as many European countries will review prices achieved in other European markets to guide pricing. This can result in patient access inequalities throughout Europe, as patients in countries that tend to pay higher prices are more likely to have earlier access and patients in countries that are unable or not willing to provide coverage at a price obtained in other European countries may be denied access. The time taken to prepare multiple submissions is also detrimental to the pharmaceutical industry as it reduces the time left on the patent to recover research and development costs and generate a profit. In order to move forward to a more harmonised HTA environment within Europe, it is first necessary to understand the current varying HTA practices and how these may impact coverage decisions.

This study was designed to evaluate a range of HTA agencies with different processes and positions within both national and regional healthcare systems. The relationship between HTA agencies, regulatory authorities and coverage decision-making bodies was also considered to be important to enable an understanding of current healthcare pathways, identify areas of potential overlap and evaluate the impact of HTA recommendations. Different methods for HTA were also compared to understand the prevalence and impact for the varying approaches for considering clinical and cost-

effectiveness. Several objectives were met to achieve the study aim namely, to review Health Technology Assessment agencies and their relationship to regulatory authorities and other decision-makers and to identify common appraisal practices with respect to economic and therapeutic evaluation.

First, a novel classification tool was developed to enable groupings of HTA agencies that share certain characteristics, but without implying any indication of rank between groupings. Being objective is an important feature of the classification tool because the mandates of HTA agencies can vary greatly. The relationship between the classification tool groupings and HTA recommendations for nine European national HTA agencies (Belgium, England, France, Germany, Ireland, Italy, the Netherlands, Scotland and Sweden) were subsequently evaluated to identify trends to meet the second objective. Thirdly, HTA recommendations and rationale were also compared for four HTA agencies (Australia, Canada, England and Scotland) with broadly similar approaches to identify causes for discordant HTA recommendations. The Canadian HTA environment was further evaluated as a case study to investigate the impact of non-mandatory coverage recommendations from a centralised HTA agency for multiple payers. Finally, representatives from HTA agencies and the pharmaceutical industry were studied to identify how the regulatory, HTA and reimbursement process maps can provide value in practice. Achieving these objectives provides evidence to debate the potential development of a pan-European HTA agency and whether lessons can be learned from current HTA agencies that have sought to provide HTA evidence and/or coverage recommendations for multiple heterogeneous regions.

Comparative studies

HTA recommendations from HTA agencies across Australasia, Europe and North America have been compared to evaluate agreement, identify trends and understand the rationale behind discordant HTA recommendations. This adds to the existing body of knowledge by expanding on previous work and supports the identification of trends over an extended period of time. This study has also investigated the rationale underpinning discordant HTA recommendations issued by national HTA agencies from Australia, Canada, England and Scotland, which all share a common welfare state origin, similar approaches for cost-effectiveness evaluations, similar GDP and

inclusion of an independent expert committee. This expands upon previous studies that have evaluated HTA recommendations to determine agreement between country pairs and compared rationale for discordant recommendations. However, even when reviewing the proportion of recommendation types issued by the four countries there are considerable disparities, which does not support the conclusion by Lexchin and Mintzes (2008) that there is no difference between the proportions of recommendations. A study by Spinner *et al.* (2013) evaluated the clinical evidence reviewed for nine case studies and concluded that differences in recommendations can be attributed to differences in clinical evidence. However, the results from this study indicate that the situation is much more complex and that even where similar evidence has been considered, different HTA recommendations were issued. For example, the concerns that led to negative recommendations by one agency were often considered by another agency which issued a positive recommendation. For example, ranibizumab injection (Lucentis) to treat macular oedema, secondary to retinal vein occlusion secondary to Branch Retinal Vein Occlusion (BRVO) and Central Retinal Vein Occlusion (CRVO), was issued a negative recommendation by the Australian HTA agency due to high cost and uncertainties regarding its cost-effectiveness. The same comparators were submitted to all four agencies, but the PBAC believed that a more appropriate comparator which reflected clinical practice (bevacizumab) should have been included in the submission, despite not having marketing authorisation for the indication under review. NICE also noted that they believed bevacizumab was an appropriate comparator, but accepted that data were not available for bevacizumab and issued a positive recommendation. These results are supportive of the conclusions by Clement *et al.* (2009) who argued that differences in listing decisions were more likely to be due to differences in willingness to accept risk. Interestingly, the case studies also provided examples where all four agencies have expressed concerns over safety for new medicines which had already been granted regulatory approval. Therefore the regulatory authorities for Australia, Canada and Europe had already assessed the safety, efficacy and quality of the new medicine and deemed the benefits to be acceptable in regards to the relative risks. In one example, prasugrel to treat coronary syndromes, achieved positive recommendations from Australia, England and Scotland. However, the Canadian national HTA agency issued a negative listing recommendation primarily due to concerns over the transferability of the clinical trials to the Canadian context, but also as a result of

concerns over increased adverse events. Therefore, the consideration of safety by both regulatory authorities and HTA agencies indicates an area of overlap and potential duplication of work. This could point towards the value of a closer collaboration and work-sharing between regulatory authorities and HTA agencies as provided in the joint scientific advice piloted by the EMA and European HTA agencies.

The comparisons of nine European HTA agencies (Belgium, England, France, Germany, Ireland, Italy, the Netherlands, Scotland and Sweden) build upon previous studies such as Nicod and Kanavos (2012) and Bending *et al.* (2012). Nicod and Kanavos (2012) evaluated HTA recommendations from Australia, Canada, England, Scotland and Sweden with a particular focus on therapeutic areas and concluded that these can result in significant differences. The results from this study also grouped HTA recommendations by therapeutic area, but only the group of medicines to treat malignant disease contained a reasonable number of products for comparison. The agreement calculated between HTA recommendations for medicines to treat malignant disease issued by country pairs was considerably lower than the level of agreement calculated for all therapeutic areas combined. Therefore, these results support the findings of Nicod and Kanavos (2012) as they also suggest that there are differences between therapeutic areas, but this study has included a cohort of more recent medicines that were evaluated across a larger selection of European HTA agencies. Bending *et al.* (2012) compared the processes and recommendations of two national HTA agencies (France and Scotland) to identify differences between agencies that include or exclude cost-effectiveness evaluations for reimbursement recommendations for new medicines. However, there are many factors that can cause discordant HTA recommendations and comparing only two agencies has limited value. Therefore the comparisons of HTA recommendations from nine European HTA agencies is more likely to identify potential correlation of factors that impact reimbursement recommendations. The calculations for agreement between country pairs indicated that HTA agencies, classified by the System process taxonomy, may correlate with concordant HTA recommendations. This is a novel result and a valuable outcome of the development of the classification tool. Interestingly, the results produced from using the classification tool to group HTA agencies/organisations from 33 European jurisdictions by archetypes did not demonstrate any correlation with geographical location or welfare state design. Therefore, this indicates that using

location to select groups of countries for collaborations which require similar processes may not provide optimum results. A more practical approach would be to identify factors more closely related to current HTA processes for work sharing collaborations, but this should not suggest that they will also issue concordant recommendations. No correlation was identified between the HTA process taxonomic set and the HTA recommendations issued by nine European national HTA agencies. It is also often said that *“if you have seen one HTA system, you have seen one HTA system”* (O’Donnell *et al.*, 2009). Even countries with generally similar aspects to their healthcare system, their ability to pay, and approaches for cost-effectiveness evaluations can issue discordant HTA recommendations.

The archetype groups from the classification tool cover a broad range of approaches for HTA and reimbursement systems, including countries that do not conduct their own HTA. Therefore, it is likely that these archetypes could categorise approaches for HTA that have been established in countries outside Europe. This could provide value for the recently established regional networks such as: HTAsiaLink and RedETSA (HTAsiaLink, 2015b; Lemgruber, 2013). One of the initial goals of RedETSA is to map out the current HTA environment across member countries. The classification tool and HTA process maps could potentially support the initial mapping stages and provide an educational tool for increasing awareness of newly established HTA agencies. The HTA process maps could also update knowledge of various reimbursement systems for professionals, academics and provide value as a communication tool for patients, citizens and students to support initiatives for transparency and awareness. This could be particularly useful for patient groups to educate new members. The process maps could also accompany more in-depth profiles when more detail is required such as guidelines for manufacturer’s submissions. The classification tools can also be used by HTA agencies to identify other agencies that share similarities, which could be valuable for identifying potential collaborators, but also for choosing appropriate comparators if an agency wishes to undertake benchmarking activities. As the HTA agency, and/or the healthcare system evolves it is possible it will change its archetype and taxonomic groupings. If the changes in classification are recorded over time, this could enable the trajectory of HTA agencies to be tracked and also identify potential trends, which may indicate that the global HTA environment is naturally converging towards an optimal approach for HTA. However, it should also be noted that these

HTA archetypes and taxonomic groups have been developed as an academic research project and the potential obstacles for collaboration are likely to be more complex in the real world.

LESSONS FROM CANADA

The Canadian HTA environment was evaluated by comparing HTA recommendations (excluding oncology medicines) from the national centralised Canadian HTA agency, the Common Drug Review (CDR) with listing decisions from four provinces (Alberta, British Columbia, Ontario and Quebec). The Canadian HTA environment is of particular interest because it has the potential to provide learnings for future HTA harmonisation in Europe. The CDR is not the only HTA agency that was established to standardise multiple regions. The National Institute for Health and Care Excellence (NICE) was created to reduce patient access inequalities to new medicines across England and Wales. Increased standardisation is achieved by NICE through mandatory positive recommendations, in addition to other roles such as the generation of clinical guidance. The Canadian HTA environment is unique, as it includes a centralised HTA agency that provides non-mandatory listing recommendations accompanied with comprehensive clinical and economic dossiers that are sent to 18 participating provincial, territorial and federal drug plans. Each drug plan is responsible for determining the final listing decision and utilises the CDR dossiers by considering the evidence in the local context. Manufacturers are still required to submit an application to the regional drug plans, which also provides an opportunity to provide local context specific data within the submission. These factors indicate the CDR as a potential model for future harmonisation of the European HTA environment as the CDR participating drug plans are heterogeneous and could represent European countries.

Evidence was generated in this study through surveys, semi-structured interviews and data collected from the public domain to provide insights into the CDR, the impact of non-mandatory HTA recommendations on regional decision-makers and to expand on existing research. Comparisons of CDR HTA recommendations and provincial listing decisions from four provinces (Alberta, British Columbia, Ontario and Quebec) enabled the calculation of concordance between the CDR and the four provinces. This

provided valuable information to the existing body of knowledge, as the most recently published comparative studies had conflicting conclusions regarding the impact of the CDR. Attaran *et al.* (2011) concluded that for some provinces the impact of the CDR was no better than random chance, yet Gamble *et al.* (2011) reviewed new medicines from a similar period and the results demonstrated moderate to substantial correlation. The study conducted by Attaran *et al.* (2011) did not review all medicines from inception of the CDR, instead they selected the first 25 and last 25 recommendations from 2003 to late 2008. The results from this study supported the results from Gamble *et al.* (2011), which reviewed the full set of CDR recommendations from inception up to 2009 and indicated greater alignment. This suggests the impact of the CDR is leading to more harmonised provincial recommendations across Canada.

The results from the semi-structured interviews with payer/HTA agency representatives and decision-makers added weight to the results as these opinions strongly supported the work of the CDR and described upcoming measures that demonstrated increasing reliance on the CDR process. For example, British Columbia will no longer consider medicines for regional review if issued a 'do not recommend' by the CDR, but will still consider all other CDR recommendation types (including 'do not list at the submitted price') for the regional review for considering the manufacturers submission and CDR evidence in the local context. Therefore, the results of this study provide evidence to indicate that the non-mandatory CDR recommendations impact regional decision-making and that the CDR is increasing harmonisation across participating plans. This could be due to the CDR continuing to develop the evidence dossiers and HTA recommendations to become increasingly suited to participating payers' needs, but could also be a result of payers' becoming more reliant on the CDR. Ultimately, the CDR provides an example of a working model for a centralised HTA agency that could improve harmonisation for a range of heterogeneous regions while maintaining the flexibility for each region to determine the final coverage decision.

Previous studies have also discussed the potential for a pan-European HTA agency and a few of these have drawn comparisons with the Canadian HTA environment and the potential harmonisation of European HTA. However, these were published more than a decade ago and do not reflect current developments in Canada and Europe

(McDaid, 2003; Lehoux *et al.*, 2004). McDaid (2003) suggested the establishment of a European equivalent for the Canadian Co-ordinating office of Health Technology Assessment (CCOHTA) the European Co-ordinating office of Health Technology Assessment (ECOHTA) could either prepare assessments and disseminate evidence to participating agencies or analyse reports generated by individual European HTA agencies. Twelve years have passed since the publication of the study by McDaid (2003) and CCOHTA has now evolved into the Canadian Agency for Drugs and Technologies in Health (CADTH) and now operates the CDR and the pan-Canadian Oncology Drug Review (pCODR). The CDR and pCODR both provide listing recommendations for participating drug plans. Therefore, the introduction of ECOHTA could be controversial in Europe if it was expected to develop into a European Agency for Drugs and Technologies in Health that would provide pan-European HTA recommendations. Initially the national Canadian HTA agency CCOHTA (now CADTH) could not agree whether to issue a listing recommendation with the nationally conducted HTA's as it is the responsibility of provincial governments to determine reimbursement (Lehoux *et al.*, 2004). The proposal for EUnetHTA explicitly states that EUnetHTA is not intended to be a European HTA agency and should never issue reimbursement recommendations. While there are similarities between the challenges faced by heterogeneous Canadian provincial payers and great variation between European countries, there are more similarities to the Canadian HTA environment and this study agrees with the EUnetHTA proposal in regards to a European HTA agency not to issue HTA reimbursement recommendation (European Network for Health Technology Assessment (EUnetHTA), 2008).

Lehoux *et al.* (2004) reviewed six Canadian HTA agencies (one national and five regional) and discussed challenges with streamlining manufacturer's submissions. The results from this study indicate that this is less of an issue now for provincial payers as the CDR has helped to streamline the submission process. Manufacturers are still required to submit applications at the provincial level, but the feedback from the semi-structured interviews indicated that the CDR submission is very similar to previous provincial submission requirements and that the additional information required for the provincial submission is specific for reviewing the medicine in the local context. Lehoux *et al.* (2004) also discussed a paradox between the importance of contextualising findings for increased impact and the argument that if HTA agencies

consider the same evidence with the same methodology then they should reach a similar conclusion. The development of the CDR provides a compromise for this paradox as all participating public drug plans now receive the same evidence dossiers and therefore do not need to conduct a full HTA assessment across multiple provinces that could choose to utilise multiple methodologies. However, the provincial payers retain their positions as decision-makers and that enables the final decision to also consider the local context. Other issues for consideration raised by Lehoux *et al.* (2004) included the need to improve awareness of HTA to increase impact for informing policy and practice. Ultimately Lehoux *et al.* (2004) recommended the establishment of collectives of HTA agencies, which would enable shared resources and research. The establishment of the CDR in Canada has demonstrated a successful working model for sharing HTA evidence as a result of a centralised review, which provides a more efficient use of resources. The rationale underpinning the establishment of EUnetHTA has similarities with the rationale for the creation of the CDR as both aim to reduce duplication of work, use HTA resources more efficiently and provide access to robust scientific evidence. The disparities between medicines coverage across Canadian provinces was a key concern that led to the development of the CDR. Similarly, patient access to new medicines varies across Europe and EUnetHTA aims to support cross-border application of tools and methodologies for HTA.

PAN-EUROPEAN HTA

Drummond (2003) argued that the creation of a European HTA agency is a possibility but three key challenges will need to be harmonised first: economic evaluation guidelines; decision-making processes and societal willingness-to-pay for health technologies. He suggested that the harmonisation of economic guidelines would be the easiest of the three challenges, but even with common European guidelines the differences between country policies may require tailored reports to enable inclusion or exclusion of data, such as productivity costs. Harmonising societal willingness-to-pay is arguably the most challenging factor. Even if there was a single price for Europe, there would still be differences in the local costs for healthcare that may be required to deliver or monitor the medicine, which would affect the cost-effectiveness of the product. Overall, Drummond (2003) suggests the likelihood of all three achieving harmonisation in the near future is very low.

An abridged European HTA agency could be a feasible compromise in the near future, rather than waiting for the European Healthcare environment to align HTA methodologies and societal willingness-to-pay to be standardised. The abridged European agency would actually be a collection of European HTA agencies working in collaboration. This could be called the European Health Technology Assessment Collaborations (EHTAC) and would work in collaboration with the EMA to provide parallel scientific advice and generate evidence for the rapid REA report to supplement the EMA's EPARs (Figure 8.1, step 1). It is proposed that European agencies with existing similarities could form collaborative groups to share HTA assessment evidence that is suitable to meet their common needs (Figure 8.1, step 2). For example, rather than having a single European guideline for economic evaluation, there could be several guidelines that are each accepted by a group of HTA agencies and these groups would collaborate to generate the evidence. This would enable HTA agencies to acquire the benefits of shared resources and the pharmaceutical industry would also benefit if they had significantly fewer economic-evaluation guidelines to meet. In addition to coordinating multiple collaborations, EHTAC could also have a central role in generating Relative Effectiveness Assessment (REA) using the EUNETHTA adapted and piloted core model for rapid REA process. The rapid REA process only requires safety and effectiveness data available at the time of launch. Ascroft and Pichler (2014) have argued in favour of the rapid REA process over the full core model as, at least for the pilot stage, the former would be more realistic for industry and HTA agencies resources to conduct for every medicine evaluated by the EMA.

Eventually, it is feasible that a truly pan-European HTA agency could evolve from EHTAC as multiple HTA agencies with varying practices will have already aligned within their collaborative groups. The pan-European HTA agency would then be established to complete the second and final phase of the progressive alignment approach by harmonising the HTA processes and methodologies utilised by the collaborative groups. This would enable a pan-European HTA agency to generate evidence at the European level, which could be provided in dossiers to participating countries to be considered in the local context. The pan-European agency could be independent from the regulatory authority, similar to the Canadian HTA environment, or it could be established as part of the EMA (Figure 8.2). There are already examples

of agencies that conduct regulatory and HTA functions at the national level in Europe such as the Italian Medicines Agency (AIFA). The EMA has already collaborated with EUnetHTA to improve the EPARs to become more supportive of HTA needs (Berntgen *et al.*, 2014) and conducted pilots for joint EMA and HTA scientific advice (European Medicines Agency (EMA), 2015b). The EMA-HTA would utilise the EUnetHTA Core Model to produce evidence dossiers for participants and would also implement the 15 Key Principles as proposed by Drummond *et al.* (2008). These would provide the backbone of the EMA-HTA as the EUnetHTA Core Model and Key Principles are already generally well respected in the field. Overall, the EMA-HTA would provide many practical benefits such as the sharing of resources, reducing duplication of work and sharing data. Kendall *et al.* (2009) has proposed the establishment of NICE in the USA by incorporating the HTA body within the Food and Drug Administration (FDA) which would enable the HTA body to share resources with the regulatory authority.

A pan-European HTA agency is a controversial topic and it could be argued that it is not possible to harmonise HTA across Europe as countries are too different and the political, social and economic aspects of HTA cannot be aligned. However, the Canadian HTA environment provides a working model for a centralised HTA agency that enables regions to include evidence generated at the national level that has been considered in the local context. It should also be noted that prior to the establishment of the EMA there were many that doubted the possibility of a single European regulatory authority due to varying approaches across Europe. However, the EMA was established in 1995 and has now been successfully providing marketing authorisation for medicines across Europe for more than twenty years.

Figure 8.1: Progressive alignment phase 1

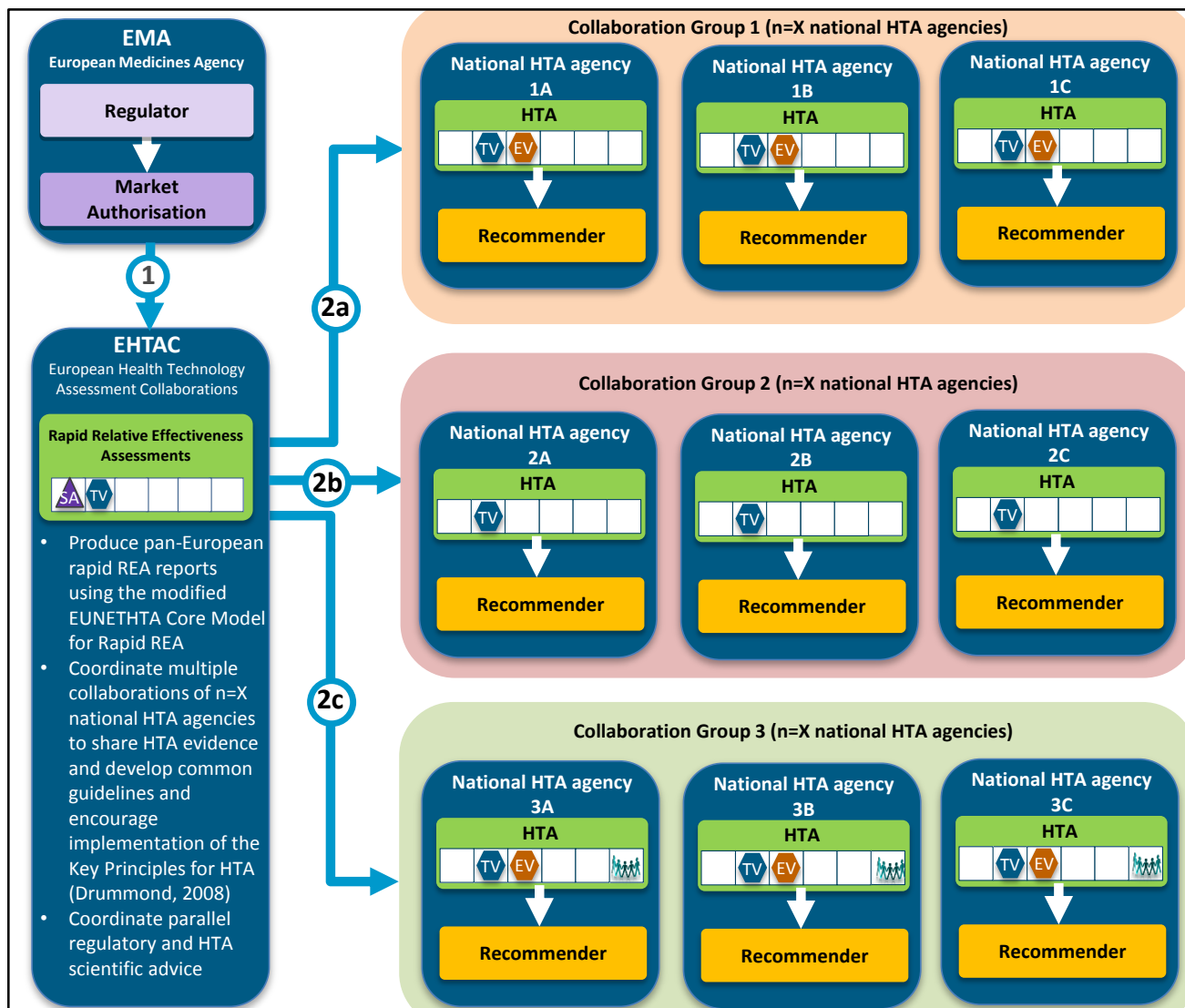
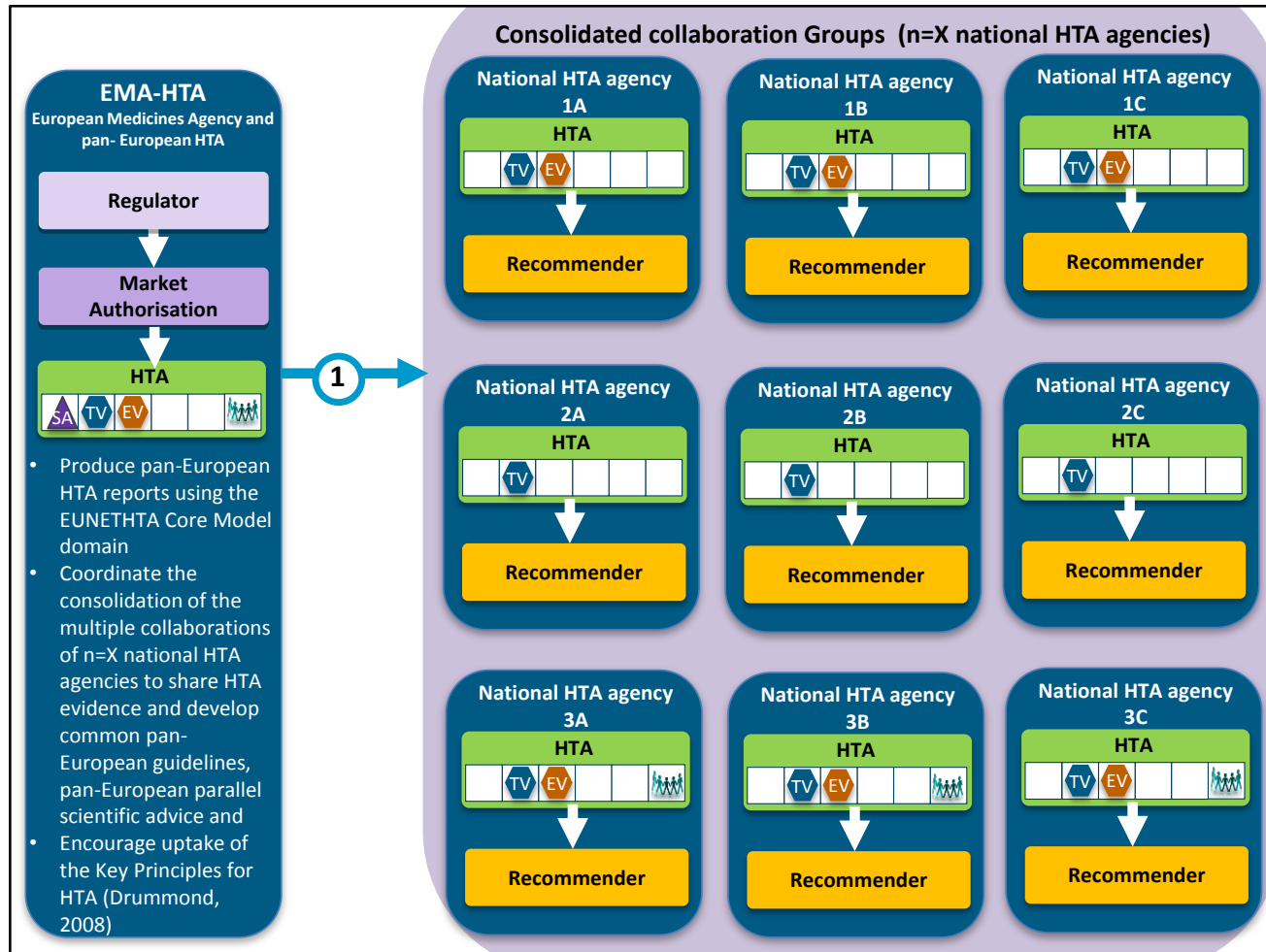


Figure 8.2: Progressive alignment phase 2



STUDY LIMITATIONS

- The data collection for most of this research was limited to the public domain and grey literature searches, such as government, academic or industry literature that is not formally published. Where possible, HTA agencies were contacted directly to confirm the information collected in the public domain and to complete surveys and semi-structured interviews to provide further insights and opinions. However, not all of the HTA agencies/organisations were able to provide feedback for the process maps.
- The HTA agencies and organisations within the healthcare systems evaluated in this study produced websites with varying degrees of transparency. This emphasised the need for additional steps to validate data collected from the public domain but also provided insights for how different agencies comply with one of the 15 Key Principles for HTA (Drummond *et al.*, 2008).
- Some agency websites only published information in their national language, which was a limitation for the primary researcher when no English version was available. To reduce this limitation, an online translation tool was utilised and, when possible, a second researcher with the relevant language skills conducted an audit of the translated data.
- A small sample of provincial payer and agency representatives (n=7) were interviewed to evaluate the impact of the national Canadian HTA agency recommendations (chapter 6). This sample was limited due to the very small population size of Canadian provincial payers, the number of provinces with potential contacts identified to invite to interview,, interviewer time and travel costs. These seven interviewees were sought from the four largest provinces, which also represented the provinces with the most divergent decisions. However, it would have been preferable to have at least one representative interviewed from all 18 participating plans of the Common Drug Review and Quebec.

- The primary researcher conducted all semi-structured interviews for this study for consistency (Chapter 6). However the primary researcher only had limited interviewing experience prior to this study which can affect the quality and depth of the answers provided by the interviewees. To reduce this limitation, the interview guide was reviewed by researchers with experience conducting interviews and two pilot interviews were conducted prior to the commencement of the full study.
- The selection criteria for identifying participants for the questionnaire to understand value of the HTA process maps (chapter 7), was primarily determined by membership of a not-for-profit organisation that provides a neutral, professional forum. This selection criteria provided contact with representatives from HTA agencies and the pharmaceutical industry, but also increased the likelihood that responders would be familiar with the HTA process maps and would therefore be able to provide more informed answers. However, this could also introduce bias into the study as the research had been presented at previous meetings of the not-for-profit organisation that was attended by some of the responders. This study has successfully piloted the questionnaire with a range of senior stakeholder representatives and has indicated an overall positive response for the process maps. However, a larger study could be conducted with a broader selection criteria and inclusion of a wider range of stakeholders (e.g. academics, clinicians, patients and researchers) to reduce bias and understand the potential value of the process maps for a more diverse audience.

RECOMMENDATIONS

- It is recommended that HTA agencies regularly update their websites to ensure they clearly outline current practices. Publishing information in English would also support international studies.
- The maps generated from this research could be used by agencies to support patient and public engagement as well as being an educational and reference tool for pharmaceutical industry employees, researchers and professionals working within the field of HTA.

- HTA agencies should consider using the objective classification tool and record the archetype group that reflects their current practices and re-evaluate and record their archetype groupings when their processes change. This would enable comparisons over time that could track the trajectory of HTA agencies as they evolve.

FUTURE WORK

- Results produced from this research suggests that provincial payers are becoming more aligned with CDR recommendations. Combining these results with feedback from interviews with payer representatives and decision-makers, strongly suggests that the CDR recommendations increasingly impact regional decisions despite being non-mandatory. Future research could build on this study by asking provincial payers if and why they think the results demonstrate an increase in agreement.
- Future adaptations to the HTA classification tool would benefit from input from a range of stakeholders that are part of the process for new medicines obtaining reimbursement such as: regulatory authorities, HTA agencies, manufacturers and patient groups.
- The research conducted for comparing CDR recommendations with regional coverage decisions should be repeated when a sizeable cohort of new CDR recommendations have been issued and compared with all provincial payers. This will enable comparisons to be drawn before and after implementation of the pan-Canadian Pharmaceutical Alliance (PCPA). The introduction of the PCPA may produce greater harmonisation between the CDR provinces and a comparative study of provincial HTA recommendations prior and post introduction of the PCPA could provide some interesting insights for the impact of the PCPA.
- The archetype groups and two taxonomic sets (System process taxonomy and 'HTA process taxonomy') were developed and tested on 33 European jurisdictions with a

wide range of processes and healthcare systems. Therefore, it would be of value to determine whether this tool can be applied to a range of reimbursement systems and HTA agencies beyond Europe.

- The archetype groups could be refined to include an option for pricing controls. This would enable the classification tool to capture the variations in countries that do not use HTA, but use a form of pricing controls to regulate the reimbursement of new medicines.
- This study has focused on HTA for new medicines, but the HTA process mapping methodology and classification tool could be applied to HTA processes for the reimbursement of medical devices.
- The malignant disease case study has highlighted areas where further research could provide interesting insights. Due to the small number of medicines allocated to other therapeutic area categories, this study was unable to fully evaluate the impact of therapeutic areas on HTA recommendations. A larger study that collected data over a longer period of time could produce a sufficient dataset to evaluate more therapeutic areas.

CONCLUSION

The establishment of a pan-European regulatory authority was initially controversial but the EMA has since transformed the European regulatory environment from a patchwork of multiple regulatory authorities with individual submission requirements for marketing authorisation to a single streamlined process. Overall, this has produced a more harmonised and efficient European regulatory environment while also maintaining national regulatory authorities in order to conduct activities that are specific for each member nation. However, the uptake of formal HTA processes has now created an additional level of complexity that essentially undermines the harmonisation and efficiencies achieved by the establishment of the EMA as multiple submissions with different evidence requirements are now necessary to gain access to individual European markets. Projects such as EUnetHTA have produced vital research that will

support the creation of a more harmonised and efficient European HTA environment. The publication of the 15 Key Principles for HTA support the implementation of more robust and accountable approaches to HTA throughout the world (Drummond *et al.*, 2008).

The progressive alignment approach that has been developed throughout this research builds on the important work by EUnetHTA funded by the European Commission and various multi-stakeholder initiatives such as parallel regulatory authority and HTA scientific advice, to suggest a model for achieving a more harmonised HTA environment. This progressive alignment approach is novel as it enables the benefits of harmonisation to be achieved prior to the establishment of a single pan-European HTA agency which may not happen in the near future. Instead, collaborations can be achieved by grouping HTA agencies that already have similar approaches to HTA so harmonisation can be achieved within various groups first. Sharing evidence would reduce duplication of work and be particularly beneficial for HTA agencies or organisations with fewer resources, but would also increase the efficiency for all collaborating agencies. The collaborations could eventually result in the European HTA environment only requiring a few different guidelines for economic evaluation in the near future. This would reduce the resources required by industry for completing submissions and could also speed up the time to submission. Therefore, the development of a novel classification tool, comparisons of HTA recommendations from very different and also generally similar HTA agencies and the evaluation of the Canadian HTA environment have ultimately led to the development of the ground-breaking progressive alignment approach which supports the ongoing efforts to create a more efficient European HTA environment.

REFERENCES

- Alberta Health. (2015). *Prescription drug program – Reviews and approvals* [Online]. Available: <http://www.health.alberta.ca/services/drugs-review.html> [Accessed 3rd March 2015]
- Alberta Health and Wellness (2009) Alberta Pharmaceutical Strategy [Online]. Available: <http://www.health.alberta.ca/documents/Pharmaceutical-Strategy-2008.pdf> [10th April 2015]
- All Wales Medicines Strategy Group (AWMSG). (2014). *AWMSG in relation to NICE* [Online]. Available: http://www.awmsg.org/healthcare_nice.html [Accessed 3rd March 2015]
- Allen, N., Pichler, F., Salek, M. & McAuslane, N. (2010a). *Assessing performance & decision making by comparing key milestones from approval to reimbursement in eleven countries*. MPharm, Cardiff University.
- Allen, N., Pichler, F. & Salek, M. S. (2010b). Assessing performance and decision making by comparing key milestones from approval to reimbursement in 10 leading countries. *The 46th Annual Meeting of the Drug Information Association (DIA)*. Washington, D.C.
- Allen, N., Pichler, F., Wang, T., Patel, S. & Salek, S. (2013). Development of archetypes for non-ranking classification and comparison of European National Health Technology Assessment systems. *Health Policy*, **113**:305-312.
- Allen, N., Wang, T. & Liberti, L. (2014). Health technology assessment processes in Canada. *Regulatory Rapporteur*, **11**: 11-15.
- Allsop, L. (2006). *Creating effective questionnaires and surveys and analysing the data* [Online]. Available: <http://www.lse.ac.uk/library/versions/Creating%20effective%20questionnaires%20and%20surveys.pdf> [Accessed 3rd February 2015]
- Anis, A. H., Guh, D. & Wang, X. H. (2001). A dog's breakfast: Prescription drug coverage varies widely across Canada. *Medical Care*, **39**: 315-326.
- Arts, W. & Gelissen, J. (2002). Three worlds of welfare capitalism or more? A state-of-the-art report. *Journal of European Social Policy*, **12**:137-158.
- Ascroft, R. C. & Pichler, F. (2014). *The case for HTA cooperation* [Online]. Available: <https://lillypad.eu/WP/wp-content/uploads/Ascroft-and-Pichler-2014-MedNous.pdf> [Accessed 20th March 2015]
- Attaran, A., Cartagena, R. & Taylor, A. (2011). The Effectiveness of the Common Drug Review in Canada's National Drug Strategy. Atlantic Institute for Market Studies.

- Australian Government Department of Health. (2014). *Welcome to the Medical Services Advisory Committee* [Online]. Available: <http://www.msac.gov.au/> [Accessed 18th March 2015]
- Australian Government Department of Health. (2015). *Role of the Pharmaceutical Benefits Advisory Committee* [Online]. Available: <http://www.pbac.pbs.gov.au/information/role-of-pbac.html> [Accessed 18th March 2015]
- Baker, M. (2011). Health technology assessment: Why it matters to patient groups. *Regulatory Rapporteur*, **8**: 12-13.
- Bambra, C. & Eikemo, T. A. (2008). Welfare state regimes, unemployment and health: a comparative study of the relationship between unemployment and self-reported health in 23 European countries. *J Epidemiol Community Health*, **63**: 92-8.
- Banta, D. (2002). The development of health technology assessment. *Health Policy*, **63**: 121-132.
- Banta, D. H., Werko, L., Cranovsky, A., Henshall, C., Jonsson, E., Liberati, A., Matillion, Y. & Sheldon, T. (1997). Introduction to the Eur-Assess Report. *International Journal of Technology Assessment in Health Care*, **13**: 133-143.
- Battista, R. N., Cote, B., Hodge, M. J. & Husereau, D. (2009). Health technology assessment in Canada. *International Journal of Technology Assessment in Health Care*, **25**: 53-60.
- Belgium Health care Knowledge Centre (KCE). (2013). *Barriers and Opportunities for the Uptake of Biosimilar Medicines in Belgium- Synthesis* [Online]. Available: https://kce.fgov.be/sites/default/files/page_documents/KCE_199Cs_Biosimilars_synthese%20ENG_0.pdf [Accessed 3rd August 2014]
- Bending, M., Hutton, J. & McGrath, C. (2012). A Comparison of Pharmaceutical Reimbursement Agencies' Processes and Methods in France and Scotland. *International Journal of Technology Assessment in Health Care*, **28**: 187-194.
- Berg, B. L. (2009). *Qualitative Research Methods for the Social Sciences*, Needham Heights, MA: Allyn & Bacon
- Berntgen, M., Gourvil, A., Pavlovic, M., Goettsch, W., Eichler, H. G. & Kristensen, F. B. (2014). Improving the Contribution of Regulatory Assessment Reports to Health Technology Assessments-A Collaboration between the European Medicines Agency and the European network for Health Technology Assessment. *Value Health*, **17**: 634-41.

- Beyer, D., Flanagan, A., Heinemann, A. & Poensgen, A. (2007). *Health Care Regulation Across Europe From Funding Crisis to Productivity Imperative* [Online]. BCG perspectives: The Boston Consulting Group. Available: https://www.bcgperspectives.com/content/articles/health_care_regulation_across_europe [Accessed 10th July 2012]
- Block, D. J. (2006). *Healthcare Outcomes Management: Strategies for Planning and Evaluation*, Sudbury, MA: Jones and Bartlett
- Breckenridge, A., Woods, K. & Walley, T. (2010). Medicines Regulation and Health Technology Assessment. *Clinical Pharmacology & Therapeutics*, **87**: 152-154.
- British Columbia Ministry of Health. (2015a). *Sponsor Engagement in the Drug Review Process* [Online]. Available: <http://www2.gov.bc.ca/gov/topic.page?id=E7A57815F6D946A39E975A0C1F55BBDB> [Accessed 3rd April 2015]
- British Columbia Ministry of Health. (2015b). *Your Voice* [Online]. Available: <http://www2.gov.bc.ca/gov/topic.page?id=33F183B514AD488ABCB1F712FD1E695E> [Accessed 3rd April 2015]
- British HIV Association (BHIVA). (2015). *Summary* [Online]. Available: <http://www.bhiva.org/ClinicalGuidelines.aspx> [Accessed 10th March 2015]
- British Medical Association (BMA). (2010). *Doctors' pay and tackling the financial pressures in the NHS* [Online]. Available: <http://www.bma.org.uk/employmentandcontracts/pay/paybriefing13dec2010.jsp> [Accessed 14th May 2012]
- Brown, L. D., Cai, T. T., DasGupta, A., Agresti, A., Coull, B. A., Casella, G., Corcoran, C., Mehta, C., Ghosh, M., Santner, T. J., Brown, L. D., Cai, T. T. & DasGupta, A. (2001). Interval estimation for a binomial proportion - Comment - Rejoinder. *Statistical Science*, **16**: 101-133.
- Canada's Research-Based Pharmaceutical Companies (Rx&D). (2011) 2010- 2011 The Rx&D International Report on Access to Medicines [Online]. Available: http://www.patientscomefirst.ca/inc/pdfs/RxD_InternationalReport_2011_en.pdf [Accessed 15th February 2015]
- Canada's Research-Based Pharmaceutical Companies (Rx&D). (2012) 2011- 2012 The Rx&D International Report on Access to Medicines [Online]. Available: <http://www.wyathhealth.com/wp-content/uploads/IRAM/iram-2011-2012-English.pdf> [Accessed 15th February 2015]

- Canadian Agency for Drugs and Technologies in Health (CADTH). (2007). *Canadian Agency for Drugs and Technologies in Health Submission Brief to House of Commons Standing Committee on Health* [Online]. Ottawa, ON. Available: http://www.cadth.ca/media/media/CADTH_Submission_to_Standing_Committee_on_Health_070409.pdf [Accessed 23rd March 2015]
- Canadian Agency for Drugs and Technologies in Health (CADTH). (2013). *Common Drug Review Submission Guidelines for Manufacturers* [Online]. Available: http://www.cadth.ca/media/cdr/process/CDR_Submission_Guidelines_e.pdf [Accessed 5th March 2014]
- Canadian Agency for Drugs and Technologies in Health (CADTH). (2014). *Procedure for the CADTH Common Drug Review* [Online]. Available: https://www.cadth.ca/media/cdr/process/CDR_Procedure.pdf [Accessed 11th December 2014]
- Canadian Agency for Drugs and Technologies in Health (CADTH). (2015a). *Canadian Drug Expert Committee (CDEC)* [Online]. Available: <https://www.cadth.ca/canadian-drug-expert-committee-cdec> [Accessed 1st April 2015]
- Canadian Agency for Drugs and Technologies in Health (CADTH). (2015b). *Reports* [Online]. Available: <https://www.cadth.ca/cdr/reports> [Accessed 10th April 2015]
- Canadian Diabetes Association. (2007). Written Submission to the House of Commons Standing Committee on Health: The Common Drug Review Isn't Working for Canadian With Diabetes.
- Canadian Institute for Health Information (CIHI). (2014). Prescribed Drug Spending in Canada, 2012: A Focus on Public Drug Programs. Ottawa, ON: CIHI.
- Cicchetti, D. V. & Feinstein, A. R. (1990). HIGH AGREEMENT BUT LOW KAPPA .2. RESOLVING THE PARADOXES. *Journal of Clinical Epidemiology*, **43**: 551-558.
- Cleemput, I., Neyt, M., Thiry, N., De Laet, C. & Leys, M. (2011). Using threshold values for cost per quality-adjusted life-year gained in healthcare decisions. *International Journal of Technology Assessment in Health Care*, **27**: 71-76.
- Clement, F. M., Harris, A., Li, J. J., Yong, K., Lee, K. M. & Manns, B. J. (2009). Using Effectiveness and Cost-effectiveness to Make Drug Coverage Decisions A Comparison of Britain, Australia, and Canada. *Jama-Journal of the American Medical Association*, **302**: 1437-1443.
- Cohen, J. (1968). Weighted Kappa: Nominal Scale Agreement with Provision for Scaled Disagreement or Partial Credit. *Psychological Bulletin*, **70**: 213-220.

- Council of the Federation. (2015). The pan-Canadian Pharmaceutical Alliance *Characteristics* [Online]. Available: <http://www.pmprovinceterritoires.ca/en/initiatives/358-pan-canadian-pricing-alliance> [Accessed 6th March 2015]
- Creswell, J. W. (2003). *Research Design: Qualitative, Quantitative and Mixed Methods Approaches*, Thousand Oaks, USA: Sage
- Curry, L. A., Nembhard, I. M. & Bradley, E. H. (2009). Qualitative and Mixed Methods Provide Unique Contributions to Outcomes Research. *Circulation*, **119**: 1442-1452.
- Deloitte. (2012). 2013 Global life sciences outlook. Available: <http://www.deloitte.com/assets/Dcom-Ireland/Local%20Assets/Documents/Life%20sciences/2013%20Global%20Life%20Sciences%20Sector%20Report.pdf> [Accessed 4th September 2013]
- Diabetes UK. (2010). *Diabetes in the UK 2010: Key statistics on diabetes* [Online]. Available: http://www.diabetes.org.uk/documents/reports/diabetes_in_the_uk_2010.pdf [Accessed 22nd March 2015]
- Dillman, D. A. (2013). Mail and Other Self-Administered Questionnaires. In: ROSSI, P. H., VRIGHT, J. D. & ANDERSON, A. B. (eds.) *Handbook of Survey Research*. New York, USA: Academic Press.
- Drummond, M. (2013). Twenty Years of Using Economic Evaluations for Drug Reimbursement Decisions: What Has Been Achieved? *Journal of Health Politics, Policy & Law*, **38**: 1081-1102.
- Drummond, M., de Pouvourville, G., Jones, E., Haig, J., Saba, G. & Cawston, H. (2014). A Comparative Analysis of Two Contrasting European Approaches for Rewarding the Value Added by Drugs for Cancer: England Versus France. *Pharmacoeconomics*, **32**: 509-520.
- Drummond, M., Neumann, P., Jonsson, B., Luce, B., Schwartz, J. S., Siebert, U., Sullivan, S. D. & Adv, I. G. H. T. A. (2012). Can We Reliably Benchmark Health Technology Assessment Organizations? *International Journal of Technology Assessment in Health Care*, **28**: 159-165.
- Drummond, M. & Sorenson, C. (2009). Nasty or Nice? A Perspective on the Use of Health Technology Assessment in the United Kingdom. *Value in Health*, **12**: S8-S13.
- Drummond, M. F. (2003). Will there ever be a European drug pricing and reimbursement agency? *The European Journal of Health Economics*, **4**: 67-69.

- Drummond, M. F., Schwartz, J. S., Jonsson, B., Luce, B. R., Neumann, P. J., Siebert, U. & Sullivan, S. D. (2008). Key principles for the improved conduct of health technology assessments for resource allocation decisions. *International Journal of Technology Assessment in Health Care*, **24**: 244-258.
- Ehtisham, S., Barrett, T. G. & Shaw, N. J. (2000). Type 2 diabetes mellitus in UK children – an emerging problem. *Diabetic Medicine*, **17**: 867–871.
- Eikemo, T. A. & Bambra, C. (2008). The welfare state: a glossary for public health. *J Epidemiol Community Health*, **62**: 3-6.
- Eldessouki, R. & Dix Smith, M. (2012). Health Care System Information Sharing: A Step Toward Better Health Globally. *Value in Health Regional Issues*, **1**: 118-120.
- European Commission. (2012). *Commission proposes faster access to medicines for patients* [Online]. Available: <http://europa.eu/rapid/pressReleasesAction.do?reference=IP/12/205&format=HTML&aged=0&language=EN&guiLanguage=en> [Accessed 6th March 2012]
- European Commission. (2013). *Pharmaceuticals in Europe: Facts and Figures* [Online]. Available: http://ec.europa.eu/enterprise/sectors/healthcare/competitiveness/importance/facts-figures_en.htm [Accessed 8th September 2014]
- European Medicines Agency (EMA). (2014). *Annex 1: Summary of Product Characteristics* [Online]. Available: http://www.ema.europa.eu/docs/en_GB/document_library/EPAR_-_Product_Information/human/002409/WC500124317.pdf [Accessed 6th November 2014]
- European Medicines Agency (EMA). (2015a). *European public assessment reports* [Online]. Available: http://www.ema.europa.eu/ema/index.jsp?curl=pages/medicines/landing/epar_search.jsp&mid=WC0b01ac058001d124 [Accessed 2nd March 2015]
- European Medicines Agency (EMA). (2015b). *Health-technology-assessment bodies* [Online]. Available: http://www.ema.europa.eu/ema/index.jsp?curl=pages/partners_and_networks/general/general_content_000476.jsp& [Accessed 13th April 2015]
- European Medicines Agency (EMA). (2015c). *Legal Foundation* [Online]. Available: http://www.ema.europa.eu/ema/index.jsp?curl=pages/about_us/general/general_content_000127.jsp [Accessed 3rd March 2015]

- European Network for Health Technology Assessment (EUnetHTA). (2007). *Comments to EUnetHTA Proposal Nov 2007* [Online]. Available: http://www.EUnetHTA.eu/Stakeholder_Forum/Activities_for_Stakeholders/Comments_to_EUnetHTA_Proposal_Nov_2007/ [Accessed 10th July 2012]
- European Network for Health Technology Assessment (EUnetHTA). (2008). *Proposal for the EUnetHTA Collaboration* [Online]. Available: <http://www.EUnetHTA.eu/sites/5026.fedimbo.belgium.be/files/EUnetHTA%20Collaboration%20Proposal%20June%202008.pdf> [Accessed 24th March 2015]
- European Network for Health Technology Assessment (EUnetHTA). (2012). *EUnetHTA Joint Action 2, 2012-15* [Online]. Available: http://www.EUnetHTA.eu/Public/Work_Packages/EUnetHTA-Joint-Action-2/ [Accessed 11 July 2012]
- European Network for Health Technology Assessment (EUnetHTA). (2013). *HTA Core Model® for Rapid Relative Effectiveness Assessment of Pharmaceuticals* [Online]. Available: http://www.EUnetHTA.eu/sites/5026.fedimbo.belgium.be/files/Model%20for%20Rapid%20REA%20of%20pharmaceuticals_final_20130311_reduced.pdf [Accessed 4th April 2015]
- European Network for Health Technology Assessment (EUnetHTA). (2014). *EUnetHTA and the HTA Network* [Online]. Available: <http://www.EUnetHTA.eu/EUnetHTA-and-hta-network> [Accessed 01 July 2014]
- European network for Health Technology Assessment (EUnetHTA). (2015a). *About Us* [Online]. Available: <http://www.EUnetHTA.eu/about-us> [Accessed 23rd January 2015]
- European Network for Health Technology Assessment (EUnetHTA). (2015b). *Common questions - Health Technology Assessment (HTA)* [Online]. Available: <http://www.EUnetHTA.eu/faq/Category%201-0#t287n73> [Accessed 17th April 2015]
- Evans, N. (1995). *Using Questionnaires and Surveys to Boost Your Business*, London, UK: Pitman Publishing.
- Facey, K. (2006). *Health Technology Assessment (HTA) Glossary* [Online]. Available: http://inahta.episerverhotell.net/upload/HTA_resources/Edu_INAHTA_glossary_July_2006_final.pdf [Accessed 10th July 2012]
- Federal Joint Committee (G-BA). (2015a). *The benefit assessment of pharmaceuticals in accordance with the German Social Code, Book Five (SGB V), section 35a* [Online]. Available: <http://www.english.g-ba.de/benefitassessment/information/#3> [Accessed 8th February 2015]

- Federal Joint Committee (G-BA). (2015b). *Questions and Answers about the Procedure* [Online]. Available: <http://www.english.g-ba.de/benefitassessment/information/faq/#12> [Accessed 8th February 2015]
- Feinstein, A. R. & Cicchetti, D. V. (1990). HIGH AGREEMENT BUT LOW KAPPA .1. THE PROBLEMS OF 2 PARADOXES. *Journal of Clinical Epidemiology*, **43**: 543-549.
- Fischer, K. E. (2012). A systematic review of coverage decision-making on health technologies-Evidence from the real world. *Health Policy*, **107**: 218-230.
- Franken, M., le Polain, M., Cleemput, I. & Koopmanschap, M. (2012). SIMILARITIES AND DIFFERENCES BETWEEN FIVE EUROPEAN DRUG REIMBURSEMENT SYSTEMS. *International Journal of Technology Assessment in Health Care*, **28**: 349-357.
- Fronsdal, K., Pichler, F., Mardhani-Bayne, L., Henshall, C., Rottingen, J.-A., Morland, B. & Klemp, M. (2012). INTERACTIONS INITIATIVES BETWEEN REGULATORY, HEALTH TECHNOLOGY ASSESSMENT AND COVERAGE BODIES, AND INDUSTRY. *International Journal of Technology Assessment in Health Care*, **28**: 374-381.
- Gamble, J. M., Weir, D. L., Johnson, J. A. & Eurich, D. T. (2011). Analysis of drug coverage before and after the implementation of Canada's Common Drug Review. *Canadian Medical Association Journal*, **183**: E1259-E1266.
- Garrido, M. V., Kristensen, F. B., Nielsen, C. P. & Busse, R. (2008). *Health Technology Assessment and Health Policy-Making in Europe: Current status, challenges and potential* [Online]. Available: http://www.euro.who.int/__data/assets/pdf_file/0003/90426/E91922.pdf [Accessed 1st March 2015]
- Gillam, S., Yates, J. & Badrinath, P. (2012). *Essential Public Health: Theory and Practice*, Cambridge, UK: Cambridge University.
- Goodman, C. S. (2014). *HTA 101: Introduction to Health Technology Assessment*. Bethesda, MD, USA: National Library of Medicine.
- Graham, M., Milanowski, A. & Miller, J. (2012). *Measuring and Promoting Inter-Rater Agreement of Teacher and Principal Performance Ratings*. The Center for Educator Compensation and Reform (CECR), United States.
- Gregoire, J. P., MacNeil, P., Skilton, K., Moisan, J., Menon, D., Jacobs, P., McKenzie, E. & Ferguson, B. (2001). Inter-provincial variation in government drug formularies. *Canadian Journal of Public Health-Revue Canadienne De Sante Publique*, **92**: 307-312.

- Gwet, K. L. (2014). *Handbook of Inter-Rater Reliability: The Definitive Guide to Measuring the Extent of Agreement Among Raters*, Gaithersburg, MD, USA: Advanced Analytics.
- Hailey, D. (2009). The history of health technology assessment in Australia. *International Journal of Technology Assessment in Health Care*, **25**: 61-67.
- Hallgren, K. A. (2012). Computing Inter-Rater Reliability for Observational Data: An Overview and Tutorial. *Tutorials in quantitative methods for psychology*, **8**: 23-34.
- Haute Autorité de Santé (HAS). (2014). *Pricing & Reimbursement of drugs and HTA policies in France* [Online]. Available: http://www.has-sante.fr/portail/upload/docs/application/pdf/2014-03/pricing_reimbursement_of_drugs_and_hta_policies_in_france.pdf [Accessed 3rd March 2015]
- Health Canada. (2015). *Notice of Compliance (NOC) Database* [Online]. Available: <http://www.hc-sc.gc.ca/dhp-mps/prodpharma/notices-avis/noc-acc/index-eng.php> [Accessed 2nd March 2015]
- Health Technology Assessment International (HTAi). (2015). *About HTAi* [Online]. Available: <http://www.htai.org/htai/about-htai.html> [Accessed 1st February 2015]
- Henschke, C., Sundmacher, L. & Busse, R. (2013). Structural changes in the German pharmaceutical market: Price setting mechanisms based on the early benefit evaluation. *Health Policy*, **109**: 263-269.
- Henshall, C. (2012). Describe decision-making systems, assess health technology assessment reports. *Int J Technol Assess Health Care*, **28**: 168.
- Henshall, C., Mardhani-Bayne, L., Fronsdal, K. B. & Klemp, M. (2011). Interactions between health technology assessment, coverage, and regulatory processes: Emerging issues, goals, and opportunities. *International Journal of Technology Assessment in Health Care*, **27**: 253-260.
- Henshall, C., Oortwijn, W., Stevens, A., Granados, A. & Banta, D. (1997). Priority setting for health technology assessment - Theoretical considerations and practical approaches - A paper produced by the priority setting subgroup of the EUR ASSESS project. *International Journal of Technology Assessment in Health Care*, **13**: 144-185.
- Hex, N., Bartlett, C., Wright, D., Taylor, M. & Varley, D. (2012). Estimating the current and future costs of Type 1 and Type 2 diabetes in the UK, including direct health costs and indirect societal and productivity costs. *Diabetic Medicine*, **29**: 855–862.

- Hollis, A. & Law, S. (2004). A national formulary for Canada. *Canadian Public Policy-Analyse De Politiques*, **30**: 445-452.
- HTAsiaLink. (2015a). *Asian study on value of a QALY* [Online]. Available: <http://www.htasialink.org/about/product.php> [Accessed 24th March 2015]
- HTAsiaLink. (2015b). *HTAsiaLink Members* [Online]. Available: <http://www.htasialink.org/member/member.php> [Accessed 24th March 2015]
- Hutton, J., McGrath, C., Frybourg, J. M., Tremblay, M., Bramley-Harker, E. & Henshall, C. (2006). Framework for describing and classifying decision-making systems using technology assessment to determine the reimbursement of health technologies (fourth hurdle systems). *International Journal of Technology Assessment in Health Care*, **22**: 10-18.
- Iannazzo, S., De Francesco, M., Gomez-Ulloa, D. & Benucci, M. (2013). A review of cost-effectiveness evaluations as part of national health technology assessments of biologic DMARDs in the treatment of rheumatoid arthritis. *Expert Review of Pharmacoeconomics & Outcomes Research*, **13**: 455-468.
- IMS Institute for Healthcare Informatics. (2012). *The Global Use of Medicines: Outlook Through 2016*. Available: http://www.imshealth.com/deployedfiles/ims/Global/Content/Insights/IMS%20Institute%20for%20Healthcare%20Informatics/Global%20Use%20of%20Meds%202011/Medicines_Outlook_Through_2016_Report.pdf [Accessed 8th August 2013]
- Institut national d'excellence en santé et en services sociaux (INESSS). (2013). *Drug plan evaluation process* [Online]. Available: http://www.inesss.qc.ca/fileadmin/doc/INESSS/Inscription_medicaments/Processus/Evaluation-medic_EN_28082013.pdf. [Accessed 20th November 2014]
- Institut national d'excellence en santé et en services sociaux (INESSS). (2014). *Evaluation process and criteria* [Online]. Available: <http://www.inesss.qc.ca/en/activites/drug-products/evaluation-process-and-criteria.html> [Accessed 29th March 2014]
- International Network of Agencies for Health Technology Assessment (INAHTA). (2014). *INESSS - Institut national d'excellence en santé et en services* [Online]. Available: <http://inahta.episerverhotell.net/Members/INESSS/> [Accessed 29th March 2014]
- International Network of Agencies for Health Technology Assessment (INAHTA). (2015). *INAHTA Members* [Online]. Available: <http://www.inahta.org/our-members/> [Accessed 10th March 2015]

- International Society For Pharmacoeconomics and Outcomes Research (ISPOR). (2012). *ISPOR Global Health Systems Road Map* [Online]. Available: <http://www.ispor.org/htaroadmaps/default.asp> [Accessed 16th May 2012]
- International society For Pharmacoeconomics and Outcomes Research (ISPOR). (2015). *About ISPOR* [Online]. Available: <http://www.ispor.org/about-ispor.asp> [Accessed 1st March 2015]
- Italian Medicines Agency (AIFA). (2015). *Elenco Medicinali di fascia A e H* [Online]. Available: <http://www.agenziafarmaco.gov.it/it/content/elenco-medicinali-di-fascia-e-h> [Accessed 1st August 2014]
- Jackson, T. J. (2007). Health technology assessment in Australia: challenges ahead. *Medical Journal of Australia*, **187**: 262-264.
- Jimenez, J. (2012). The CEO of Novartis On Growing After A Patent Cliff. *Harvard Business Review*, **90**: 39-42.
- Jonsson, E. (2002). DEVELOPMENT OF HEALTH TECHNOLOGY ASSESSMENT IN EUROPE. *International Journal of Technology Assessment in Health Care*, **18**: 171-183.
- Kazi, A. & Khalid, W. (2012). Questionnaire designing and validation. *Journal of the Pakistan Medical Association*, **62**: 514-516.
- Kendall, T., McGoey, L. & Jackson, E. (2009). If NICE was in the USA. *The Lancet*, **374**: 272-273.
- Kleijnen, S., George, E., Goulden, S., d'Andon, A., Vitre, P., Osinska, B., Rdzany, R., Thistrup, S., Corbacho, B., Nagy, B. Z., Leufkens, H. G., de Boer, A. & Goettsch, W. G. (2012). Relative Effectiveness Assessment of Pharmaceuticals: Similarities and Differences in 29 Jurisdictions. *Value in Health*, **15**: 954-960.
- Kristensen, F. B. (2012). Development of European HTA: from Vision to EUnetHTA. *Michael*, **9**: 147-156.
- Lehoux, P., Tailliez, S., Denis, J. L. & Hivon, M. (2004). Redefining health technology assessment in Canada: Diversification of products and contextualization of findings. *International Journal of Technology Assessment in Health Care*, **20**: 325-336.
- Lemgruber, A. (2013). *HTA Network of the Americas (RedETSA)* [Online]. Available: http://www.who.int/medical_devices/Sat_am_HTA_4_LEMGRUBER.pdf [Accessed 6th June 2014]
- Leon, D. A. (2011). Trends in European life expectancy: a salutary view. *International Journal of Epidemiology*, **40**: 271-277.

- Levy, A. R., Mitton, C., Johnston, K. M., Harrigan, B. & Briggs, A. H. (2010). International Comparison of Comparative Effectiveness Research in Five Jurisdictions Insights for the US. *Pharmacoeconomics*, **28**: 813-830.
- Lexchin, J. & Mintzes, B. (2008). Medicine reimbursement recommendations in Canada, Australia, and Scotland. *American Journal of Managed Care*, **14**: 581-588.
- Littlejohns, P., Garner, S., Doyle, N., Macbeth, F., Barnett, D. & Longson, C. (2009). 10 years of NICE: still growing and still controversial. *Lancet Oncology*, **10**: 417-424.
- Lumpkin, M. M., Eichler, H. G., Breckenridge, A., Hamburg, M. A., Loenggren, T. & Woods, K. (2012). Advancing the Science of Medicines Regulation: The Role of the 21st-Century Medicines Regulator. *Clinical Pharmacology & Therapeutics*, **92**: 486-493.
- MacDonald, K. & Potvin, K. (2004). Interprovincial variation in access to publicly funded pharmaceuticals: A review based on the WHO Anatomical Therapeutic Chemical classification system. *Canadian Pharmacists Journal / Revue des Pharmaciens du Canada*, **137**: 29-34.
- Mason, A. R. & Drummond, M. F. (2009). Public funding of new cancer drugs: Is NICE getting nastier? *European Journal of Cancer*, **45**: 1188-1192.
- Mathes, T., Jacobs, E., Morfeld, J. C. & Pieper, D. (2013). Methods of international health technology assessment agencies for economic evaluations- a comparative analysis. *BMC Health Services Research*, **13**: 371.
- Mauskopf, J., Walter, J., Birt, J., Bowman, L., Copley-Merriman, C. & Drummond, M. (2011). Differences among formulary submission guidelines: Implications for health technology assessment. *International Journal of Technology Assessment in Health Care*, **27**: 261-270.
- McDaid, D. (2003). Co-ordinating health technology assessment in Canada: a European perspective. *Health Policy*, **63**: 205-213.
- McMahon, M., Morgan, S. & Mitton, C. (2006). The Common Drug Review: a NICE start for Canada? *Health Policy*, **77**: 339-51.
- Medicines and Healthcare Products Regulatory Agency (MHRA). (2014). *Apply for the early access to medicines scheme (EAMS)* [Online]. Available: <https://www.gov.uk/apply-for-the-early-access-to-medicines-scheme-eams> [Accessed 3rd March 2015]
- Menon, D. & Stafinski, T. (2009). Health Technology Assessment in Canada: 20 Years Strong? *Value in Health*, **12**: S14-S19

- Methven, K. (2010). Regulatory affairs expands its horizons – Integrating regulatory affairs and health technology. *Regulatory Rapporteur*, **7**: 25-27.
- Moharra, M., Kubesch, N., Estrada, M. D., Parada, A., Cortés, M. & Espallargues, M. (2008). Survey report on HTA organisations. Barcelona (Spain): Catalan Agency for Health Technology Assessment and Research. Catalan Health Service. Department of Health. Autonomous Government of Catalonia.
- Morgan, S. G., McMahon, M., Mitton, C., Roughead, E., Kirk, R., Kanavos, P. & Menon, D. (2006). Centralized drug review processes in Australia, Canada, New Zealand, and the United Kingdom. *Health Affairs*, **25**: 337-347.
- Myllykangas, M., Ryyanen, O. P., Kinnunen, J. & Takala, J. (1997). Attitudes to cuts in expenditure and increased fees in health care. *Public Health*, **111**: 71-5.
- National Centre for Pharmacoeconomics (NCPE). (2014). *Pharmacoeconomic Evaluations* [Online]. Available: <http://www.ncpe.ie/pharmacoeconomic-evaluations/> [Accessed 17th August 2014]
- National Institute for Health and Care Excellence. (2013). *Technology appraisals topic selection* [Online]. Available: <http://www.nice.org.uk/getinvolved/topicselection/TechnologyAppraisalTopicSelection.jsp> [Accessed 3rd July 2013]
- National Institute for Health and Care Excellence (NICE). (2013a). *Guide to the methods of technology appraisal 2013* [Online]. Available: <https://www.nice.org.uk/article/pmg9/chapter/5-the-reference-case> [Accessed 3rd March 2015]
- National Institute for Health and Care Excellence (NICE). (2013b). *Technology appraisals topic selection* [Online]. Available: <http://www.nice.org.uk/getinvolved/topicselection/TechnologyAppraisalTopicSelection.jsp> [Accessed 3rd July 2013]
- National Institute for Health and Care Excellence (NICE). (2014). *Advice on generating relevant evidence* [Online]. Available: http://review2013-2014.nice.org.uk/support/Scientific_Advice/ [Accessed 24th March 2015].
- National Institute for Health and Care Excellence (NICE). (2015a). *Frequently asked questions* [Online]. Available: <https://www.nice.org.uk/about/what-we-do/scientific-advice/frequently-asked-questions> [Accessed 6th January 2015]
- National Institute for Health and Care Excellence (NICE). (2015b). *Guidance List* [Online]. Available: <https://www.nice.org.uk/guidance/published?type=ta> [Accessed 3rd February 2015]

- National Institute for Health and Welfare. (2014). *HTA Core Model Handbook* [Online]. Available: http://mekka.thl.fi/htacore/HTACoreModel_Handbook_2014-04-08.pdf [Accessed 2nd February 2015]
- Neumann, P. J., Drummond, M. F., Jonsson, B., Luce, B. R., Schwartz, J. S., Siebert, U. & Sullivan, S. D. (2010). Are Key Principles for improved health technology assessment supported and used by health technology assessment organizations? *International Journal of Technology Assessment in Health Care*, **26**: 71-78.
- Nicod, E. & Kanavos, P. (2012). Commonalities and differences in HTA outcomes: A comparative analysis of five countries and implications for coverage decisions. *Health Policy*, **108**: 167-177.
- O'Donnell, J. C., Pham, S. V., Pashos, CL., Miller, D. W., Dix Smith, M., (2009). Health Technology Assessment: Lessons Learned from Around the World—An Overview. *Value in Health*, **12**: S1-S5
- O'Neill, P. & Devlin, N. J. (2010). An Analysis of NICE's 'Restricted' (or 'Optimized') Decisions. *Pharmacoeconomics*, **28**, 987-993.
- Office for National Statistics. (2013). *Population Estimates for UK, England and Wales, Scotland and Northern Ireland, Mid-2011 and Mid-2012* [Online]. Available: <http://www.ons.gov.uk/ons/rel/pop-estimate/population-estimates-for-uk--england-and-wales--scotland-and-northern-ireland/mid-2011-and-mid-2012/index.html> [Accessed 6th August 2013]
- Office of Technology Assessment. (1995). *Health care technology and its assessment in eight countries*, Washington DC: US Government Printing Office
- Organisation for Economic Co-operation and Development (OECD). (2005). *Health Technologies and Decision Making, The OECD Health Project*, Paris: OECD Publishing
- Organisation for Economic Co-operation and Development (OECD). (2008). *Pharmaceutical Pricing Policies in a Global Market* [Online]. Available: <http://www.oecd.org/els/pharmaceuticalpricingpoliciesinaglobalmarket.htm> [Accessed 3rd March 2015]
- Organisation for Economic Co-operation and Development (OECD). (2011). *Health at a Glance 2011: OECD Indicators* [Online]. OECD Publishing. Available: http://dx.doi.org/10.1787/health_glance-2011-en [Accessed 10th July 2012]
- Organisation for Economic Co-operation and Development (OECD). (2014a). *Life expectancy and healthy life expectancy at birth*, Health at a Glance: Europe 2014, Paris: OECD Publishing

- Organisation for Economic Co-operation and Development (OECD). (2014b). *OECD Stat Extracts* [Online]. Available: <http://stats.oecd.org/> [Accessed 8th August 2014]
- Packer, C., Simpson, S. & Stevens, A. (2006). International diffusion of new health technologies: A ten-country analysis of six health technologies. *International Journal of Technology Assessment in Health Care*, **22**: 419-428.
- Pammolli, F., Magazzini, L. & Riccaboni, M. (2011). The productivity crisis in pharmaceutical R&D. *Nat Rev Drug Discov*, **10**: 428-38.
- Pammolli, F., Riccaboni, M. & Magazzini, L. (2012) The sustainability of European health care systems: beyond income and aging. *European Journal of Health Economics*, **13**:623-634.
- Patel, S., Pichler, F. & Salek, M. S. (2011). *Comparisons of Pharmaceutical Registration to Reimbursement in the 30 European Economic Area Countries*. MPharm, Cardiff University.
- Pharmaceutical Benefits Scheme (PBS). (2014). *Fact Sheet: Streamlined Authorities* [Online]. Available: <http://www.pbs.gov.au/info/publication/factsheets/shared/fact-sheet-streamlined-authorities> [Accessed 5th December 2014]
- Pharmaceutical Benefits Scheme (PBS). (2015). *Public Summary Documents by Product* [Online]. Available: <http://www.pbs.gov.au/info/industry/listing/elements/pbac-meetings/psd/public-summary-documents-by-product> [Accessed 3rd March 2015]
- Phelan, C. & Wren, J. (2006). *Exploring Reliability in Academic Assessment* [Online]. Available: <https://www.uni.edu/chfasoa/reliabilityandvalidity.htm> [Accessed 10th January 2015]
- Pichler, F., Allen, N., Salek, M. S. & Liberti, L. (2010). Development of systematic process maps to enable comparison between different HTA and decision making systems: the first step to benchmarking. *ISPOR Thirteenth Annual European Congress November 2010*. Prague, Czech Republic.
- Pichler, F. & Wang, T. (2012). *Process Map Report: A systematic comparison of healthcare systems of 31 European Countries*. Centre for Innovation in Regulatory Science, London, UK.
- Pierce, R. (2008). *Research Methods in Politics*, London, UK: Sage.
- Porta, A. (2014). *A Dictionary of Epidemiology* [Online]. Oxford University Press. Available: <http://www.oxfordreference.com/view/10.1093/acref/9780195314496.001.0001/acref-9780195314496> [Accessed 2nd February 2015]

- Princeton University. (2015). *The OTA legacy* [Online]. Available: <https://www.princeton.edu/~ota/> [Accessed 20th March 2015]
- Raftery, J. (2006). Review of NICE's recommendations, 1999-2005. *British Medical Journal*, **332**: 1266-1268.
- Research-Based Pharmaceutical Companies. (2012). *General Political Situation* [Online]. Available: <https://www.vfa.de/en/latest-topics/country-report-germany-general-political-setting-february-2012.html> [Accessed 8th September 2014]
- Reynard, J., Reynolds, J. & Stevenson, P. (2009). *Practical Patient Safety*, Oxford, UK :Oxford University Press.
- Rocchi, A., Miller, E., Hopkins, R. B. & Goeree, R. (2012). Common Drug Review Recommendations An Evidence Base for Expectations? *Pharmacoeconomics*, **30**: 229-246.
- Rogowski, W. H., Hartz, S. C. & John, J. H. (2008). Clearing up the hazy road from bench to bedside: A framework for integrating the fourth hurdle into translational medicine. *BMC Health Services Research*, **8**: 194
- Rumeau-Pichon, C., Rochaix, L. & Harousseau, J. L. (2014). *Production of economic opinion on drugs and medical devices in France: challenges and issues* [Online]. Available: <http://www.htai2014.org/temp/20147477224/OR153.pdf> [Accessed 3rd March 2015]
- Saunders, M., Thornhill, A. & Lewis, P. (2009). *Research Methods for Business Students* Essex, England, UK: Pearson Education.
- Schwarzer, R. & Siebert, U. (2009). Methods, procedures, and contextual characteristics of health technology assessment and health policy decision making: Comparison of health technology assessment agencies in Germany, United Kingdom, France, and Sweden. *International Journal of Technology Assessment in Health Care*, **25**: 305-314.
- Scottish medicines Consortium. (2013a). *PAPIG* [Online]. Available: http://www.scottishmedicines.org.uk/Public_Involvement/PAPIG/PAPIG [Accessed 3rd July 2013]
- Scottish Medicines Consortium. (2013b). *What we do* [Online]. Available: http://www.scottishmedicines.org.uk/About_SMC/What_we_do/index [Accessed 3rd July 2013]

- Scottish Medicines Consortium (SMC). (2012). *SMC process for issuing 'not recommended' advice due to non-submission by a pharmaceutical company* [Online]. Available: https://www.scottishmedicines.org.uk/About_SMC/Policy_statements/SMC_process_for_issuing_not_recommended_advice_due_to_non-submission_by_a_pharmaceutical_company [Accessed 3rd March 2015]
- Scottish Medicines Consortium (SMC). (2014). *Working with SMC- A Guide for Manufacturers* [Online]. Available: https://www.scottishmedicines.org.uk/files/submissionprocess/Working_with_SMC_July_2014.pdf [Accessed 3rd March 2015]
- Scottish Medicines Consortium (SMC). (2015a). *Patient Access Schemes* [Online]. Available: https://www.scottishmedicines.org.uk/Submission_Process/Submission_guidance_and_forms/Patient-Access-Schemes [Accessed 18th February 2015]
- Scottish Medicines Consortium (SMC). (2015b). *SMC Advice Directory* [Online]. Available: https://www.scottishmedicines.org.uk/SMC_Advice/Advice_Directory/SMC_Advice_Directory [Accessed 3rd February 2015]
- Sculpher, M. J. & Drummond, M. F. (2006). Analysis sans frontieres - Can we ever make economic evaluations generalisable across jurisdictions? *Pharmacoeconomics*, **24**: 1087-1099.
- Sergeant, E. S. G. (2015). *Epitools epidemiological calculators* [Online]. AusVet Animal Health Services and Australian Biosecurity Cooperative Research Centre for Emerging Infectious Disease. Available: <http://epitools.ausvet.com.au> [Accessed 3rd March 2015]
- Shaping European Early Dialogues for Health Technologies. (2015). *What is SEED?* [Online]. Available: http://www.earlydialogues.eu/has/?page_id=10 [Accessed 24/03/2015].
- Sim, J. & Wright, C. C. (2005). The kappa statistic in reliability studies: Use, interpretation, and sample size requirements. *Physical Therapy*, **85**: 257-268.
- Sorenson, C. & Chalkidou, K. (2012). Reflections on the evolution of health technology assessment in Europe. *Health Economics Policy and Law*, **7**: 25-45.
- Spinner, D. S., Birt, J., Walter, J. W., Bowman, L., Mauskopf, J., Drummond, M. F. & Copley-Merriman, C. (2013). Do different clinical evidence bases lead to discordant health-technology assessment decisions? An in-depth case series across three jurisdictions. *ClinicoEconomics and outcomes research : CEOR*, **5**: 69-85.

- Spitz, S. (2013b). A decade of the Common Drug Review. *Canadian Medical Association Journal*, **185**: E277-E278.
- Straus, S. E. & Jones, G. (2004). What has evidence based medicine done for us? It has given us a good start, but much remains to be done. *British Medical Journal*, **329**: 987-988.
- Stuckler, D., Basu, S. & McKee, M. (2010). Budget crises, health, and social welfare programmes. *British Medical Journal*, **340**: C3311
- Thakur, V. P. S. & Ramacha, S. (2012). Pharmaceutical Business Strategy: A Generics Perspective. *Journal of Intellectual Property Rights*, **17**: 484-496.
- Therapeutic Goods Administration (TGA). (2015). *Australian Register of Therapeutic Goods* [Online]. Available: <https://www.tga.gov.au/australian-register-therapeutic-goods> [Accessed 02nd March 2015]
- Thomson Reuters. (2015). *Cortellis* [Online]. Available: <http://lifesciences.thomsonreuters.com/products/cortellis> [Accessed 3rd April 2015]
- Tierney, M., Manns, B. & Comm, C. E. D. A. (2008). Optimizing the use of prescription drugs in Canada through the Common Drug Review. *Canadian Medical Association Journal*, **178**: 432-435.
- Trochim, W. M. K. (2006a). *Measurement Validity Types* [Online]. Available: <http://www.socialresearchmethods.net/kb/measval.php> [Accessed 3rd February 2015]
- Trochim, W. M. K. (2006b). *Types of Surveys* [Online]. Available: <http://socialresearchmethods.net/kb/survtype.php> [Accessed 3rd February 2015]
- Velasco-Garrido, M. & Busse, R. (2005). *Health technology assessment: An introduction to objectives, role of evidence, and structure in Europe* [Online]. Available: http://www.euro.who.int/__data/assets/pdf_file/0018/90432/E87866.pdf [Accessed 10th February 2015]
- Vernaz, N., Haller, G., Girardin, F., Huttner, B., Combescure, C., Dayer, P., Muscionico, D., Salomon, J. L. & Bonnabry, P. (2013). Patented drug extension strategies on healthcare spending: a cost-evaluation analysis. *PLoS Med*, **10**: e1001460.
- Viera, A. J. & Garrett, J. M. (2005). Understanding interobserver agreement: the kappa statistic. *Family Medicine*, **37**: 360-363.
- Weinberg, E. (2013). Data Collection: Planning and Management. In: ROSSI, P. H., VRIGHT, J. D. & ANDERSON, A. B. (eds.) *Handbook of Survey Research*. New York, USA: Academic Press.

- Wilsdon, T., Fiz, E. & Haderi, A. (2014). *A comparative analysis of the role and impact of Health Technology Assessment: 2013* [Online]. Available: <http://www.efpia.eu/uploads/documents/cra-comparative-analysis.pdf> [Accessed 3rd April 2015]
- Wilsdon, T. & Serota, A. (2011). *A comparative analysis of the role and impact of Health Technology Assessment* [Online]. Charles River Associates. Available: http://www.phrma.org/sites/default/files/pdf/hta_final_comparison_report_13_may_2011_stc1.pdf [Accessed 3rd April 2015]
- Wonder, M., Backhouse, M. E. & Hornby, E. (2013). Early Scientific Advice Obtained Simultaneously from Regulators and Payers: Findings from a Pilot Study in Australia. *Value in Health*, **16**: 1067-1073.
- World Bank. (2015). *Health expenditure, total (% of GDP)* [Online]. Available: <http://data.worldbank.org/indicator/SH.XPD.TOTL.ZS> [Accessed 2nd March 2015]
- World Health Organisation (WHO). (2010). *The world health report: health systems financing: the path to universal coverage*. Geneva, Switzerland: World Health Organization
- World Health Organisation (WHO). (2014a). *Ageing and life course* [Online]. Available: <http://www.who.int/ageing/en/> [Accessed 20th March 2014]
- World Health Organisation (WHO). (2014b). *Total expenditure on health as a percentage of the gross domestic product, 2012* [Online]. Available: http://gamapserver.who.int/mapLibrary/Files/Maps/TotPercentGDP_2012.png [Accessed 21st March 2015]
- World Health Organisation (WHO). (2014c). *WHA67.23 - Health Intervention and Technology Assessment in Support of Universal Health Coverage. WHA Resolution; Sixty-seventh World Health Assembly* [Online]. Available: <http://apps.who.int/medicinedocs/documents/s21463en/s21463en.pdf> [Accessed 20th March 2015]
- World Health Organisation Collaborating Centre for Pharmaceutical Pricing and Reimbursement Policies. (2015a). *At a glance/ posters* [Online]. Available: <http://whocc.goeg.at/Publications/CountryPosters> [Accessed 20th March 2015]
- World Health Organisation Collaborating Centre for Pharmaceutical Pricing and Reimbursement Policies. (2015b). *Reports* [Online]. Available: <http://whocc.goeg.at/Publications/CountryReports> [Accessed 20th March 2015]

- Wyke, A. (2011). *Feedback from Patient Rapporteurs* [Online]. Biotherapy Development Association. Available: <http://www.bdaoncology.org/docs/2011htaaw.pdf> [Accessed 14th May 2012]
- XE. (2015). *Current and Historical Rate Tables* [Online]. Available: <http://www.xe.com/currencytables/?from=USD&date=2015-01-01> [Accessed 2nd January 2015]
- Yin, R. K. (2003). *Case Study Research: Design and methods*, Thousand Oaks, USA : Sage
- Zikmund, W. G., Babin, B. J., Carr, J. C. & Griffin, M. (2009). *Business Research Methods*, Canada: South-Western Cengage Learning

PUBLICATIONS

Publications

Allen N, Wang T, Liberti L (2014). Health Technology Assessment Processes in Canada. *TOPRA Regulatory Rapporteur*, **11**: 11-15.

Allen N, Pichler F, Wang T, Liberti L, Patel S, Salek MS (2013). Development of archetypes for non-ranking classification and comparison of European National Health Technology Assessment systems. *Health Policy* **113**: 305–312.

Oral Presentations

Allen N. (2014) Comparison of reimbursement and decision-making processes. CIRS Seminar: Measuring the impact of HTA on new medicines development and coverage decision making. Beijing, China

Allen. N. (2014) Development and application of comparative methodologies for reimbursement decision-making processes for new medicines. School of Pharmacy and Pharmaceutical Sciences Research Day. Cardiff University, UK

Allen N. The Canadian HTA Process Project. (2013) CIRS workshop on building quality into HTA and Coverage Decision-Making Processes: What are the features of good practice in HTA? London, UK

Poster Presentations

Allen N, Walker S, Liberti L. (2014) Do HTA processes correlate with reimbursement recommendations following EMA approvals? ISPOR 6th Asia-Pacific Conference. Beijing, China

Allen N, Liberti L, Salek MS. (2014) Benchmarking Canadian HTA agency and provincial payer decision-making. 2014 CADTH Symposium. Quebec, Canada

Allen N, Pichler F, Wang T, Liberti L, Salek MS. (2013) A comparison of 33 European national HTA and decision making systems using archetypes and taxonomies: a model for progressive alignment? 10th Annual meeting of HTAi. Seoul, Korea

Allen N, Pichler F, Wang T, Liberti L, Salek MS. (2013) Development and application of comparative methodologies for reimbursement decision making processes for new medicines and devices. School of Pharmacy and Pharmaceutical Sciences Research Day. Cardiff University, UK

APPENDIX A

Information sources for the production of HTA process maps: table of agency websites

Information sources for agencies included in the HTA Process Maps

Country	Acronym	Full name	Link
Australia	TGA	Therapeutic Goods Administration	http://www.tga.gov.au
	DUSC	Drug Utilisation Sub-committee	http://www.pbs.gov.au/info/industry/listing/participants/drug-utilisation-subcommittee
	PBAC	Pharmaceutical Benefits Advisory Committee	http://www.health.gov.au/internet/main/publishing.nsf/Content/Pharmaceutical+Benefits+Advisory+Committee-1
	ESC	Economics Sub-Committee	http://www.pbs.gov.au/info/industry/listing/participants/economics-subcommittee-esc
		Minister for Health and Ageing	http://www.health.gov.au/
	PBS	Pharmaceutical Benefits Scheme	http://www.pbs.gov.au
Austria	BASG/AGES	Austrian Federal Office for Safety in Health Care	http://www.basg.at
	BMG	The Federal Ministry of Health	http://www.bmg.gv.at/
	HVB	Federation of Austrian Social Insurance Institutions	www.hauptverband.at
	PK	Price Committee	http://bmg.gv.at/home/Schwerpunkte/Medizin/Arzneimittel/Arzneimittelpreise/EU-Durchschnittspreise_laut_ASVG
	HEK	Drugs Evaluation Commission	http://www.hauptverband.at/portal27/portal/hvbportal/channel_content/cmsWindow?action=2&p_menuid=65987&p_tabid=5
	UHK	Independent Medicinal Products Commission	http://bmg.gv.at/home/Schwerpunkte/Medizin/Arzneimittel/Beiraete_und_Kommissionen/Unabhaengige_Heilmittelkommission
Belgium	AFMPS/FAGG	Federal Agency for Medicines and Health Products	http://www.fagg-afmps.be
	CTG/CRM	Medicine reimbursement commission	http://www.inami.fgov.be/fr/inami/organes/Pages/commission-remboursement-medicaments.aspx

	KCE	Belgian Health Care Knowledge Centre	https://kce.fgov.be/
	FPSE	Federal Public Service Economy	http://economie.fgov.be/en/
	FPSSS	Federal Public Service Social Security	http://socialsecurity.fgov.be/
	RIZIV/INAMI	National Institute for Sickness and Invalidity Insurance	http://www.inami.be
Bulgaria	BDA	Bulgarian Drug Agency	http://en.bda.bg/
	MOH	Ministry of Health	http://www.mh.government.bg
	PC	Price Committee	http://www.mh.government.bg/Articles.aspx?lang=bg-BG&pageid=383
	PDL	Positive drug list committee	http://www.mh.government.bg/Articles.aspx?lang=bg-BG&pageid=384
	TC	Transparency committee	http://www.mh.government.bg/Articles.aspx?lang=bg-BG&pageid=413
	NHIF	National Health Insurance Fund	http://www.en.nhif.bg/
Canada		Health Canada	http://www.hc-sc.gc.ca/index-eng.php
	CADTH	Canadian Agency for Drugs and Technologies in Health	http://www.cadth.ca/
	CDR	Common Drug Review	https://www.cadth.ca/cdr
	CDEC	Canadian Drug Expert Committee	https://www.cadth.ca/canadian-drug-expert-committee-cdec
	PMPRB	Patented Medicine Price Review Board	http://www.pmprb-cepmb.gc.ca/home
	ECDET	Expert committee on Drugs Evaluation and Therapeutics	http://www.health.alberta.ca/about/advisory-bodies.html
		Alberta Health	http://www.health.alberta.ca
		British Columbia Ministry of Health	http://www.gov.bc.ca/health/
	INESSS	National Institute for Excellence in Health and Social Services	www.inesss.qc.ca

	CSEMI	Scientific Committee to evaluate drugs for registration	http://www.inesss.qc.ca/index.php?id=27&L=1
	RGAM	Basic prescription drug insurance plan	http://www.ramq.gouv.qc.ca/fr/citoyens/assurance-medicaments/Pages/description.aspx
	RAMQ	Quebec Health Insurance Plan	http://www.ramq.gouv.qc.ca
Cyprus		Drug Council	http://www.moh.gov.cy/moh/phs/phs.nsf/dmlcouncilmed_gr/dmlcouncilmed_gr?OpenDocument
		Drug Price Control Committee	http://www.moh.gov.cy/moh/phs/phs.nsf/dmlcomminspect_gr/dmlcomminspect_gr?OpenDocument
		Drug committee	http://www.moh.gov.cy/moh/phs/phs.nsf/dmlphcomm_gr/dmlphcomm_gr?OpenDocument
	HIO	Health Insurance Organization	http://www.hio.org.cy/en/index_en.htm
	MOH	Ministry of Health	http://www.moh.gov.cy
Czech Republic	SUKL	The State Institute for Drug Control	http://www.sukl.eu/
		General Health Insurance	http://www.vzp.cz
	MOH	Ministry of Health	http://www.mzcr.cz
Denmark	DHMA	The Danish Medicines Agency	http://laegemiddelstyrelsen.dk
	MTN	The Reimbursement committee	http://laegemiddelstyrelsen.dk/en/topics/statistics,-prices-and-reimbursement/reimbursement-of-medicines/the-reimbursement-committee.aspx
	IRF	Institute for Rational Pharmacotherapy	http://laegemiddelstyrelsen.dk/en/service-menu/about-us/institute-for-rational-pharmacotherapy
	DACEHTA	The Danish Centre for Health Technology Assessment	http://www.sst.dk/English/DACEHTA.aspx
Estonia	SAM	State Agency of Medicines	http://www.sam.ee
	EHIF	Estonia Health Insurance Fund	http://www.haigekassa.ee/eng
	SM	Ministry of Social Affairs	http://www.sm.ee/eng/pages/index.html

Finland	FIMEA	Finnish Medicines Agency	http://www.sam.ee
	KELA	Social Insurance Institution of Finland	http://www.fimea.fi
	HILA	The Finnish Pharmaceuticals Pricing Board	http://www.stm.fi/en/ministry/boards/pharmaboard/frontpage/
	STM	Ministry of Social Affairs and Health	http://www.stm.fi/
France	ANSM	French Agency for the Safety of Medicines and Health Products	http://www.ansm.sante.fr/
	HAS	French National Authority for Health	http://www.has-sante.fr
	UNCAM	National Union of Health Insurance Funds	http://www.ameli.fr
	CEPS	The Economic Committee on Health Care Products	http://www.sante.gouv.fr/comite-economique-des-produits-de-sante-ceps.html
	N/A	Social Security System	http://www.securite-sociale.fr/
Germany	BfArM	Federal Institute for Drugs and Medical Devices	http://www.bfarm.de
	PEI	Federal Institute for Vaccines and Biomedicines	http://www.pei.de
	G-BA	Federal Joint Committee	http://www.g-ba.de
	IQWiG	Institute for Quality and Efficiency in Health Care	https://http://www.iqwig.de
	GKV	Federal Association of the Statutory Health Insurances	https://http://www.gkv-spitzenverband.de
Greece	EOF	National Organisation for Medicines	http://www.eof.gr
	YYKA	Ministry of Health and Social Solidarity	http://www.yyka.gov.gr/
	GGKA	General Secretariat of Social Security	http://ggka.citron.gr
Hungary	OGYI	National Institute of Pharmacy	http://www.ogyi.hu

	ESKI	National Institute for Strategic Health Research	http://www.eski.hu
	OEP	The National Health Fund	http://www.oep.hu
Iceland	IMA	Iceland Medicine Agency	http://www.imca.is/
	IMPRC	Icelandic Medicine Pricing and Reimbursement Committee	http://www.lgn.is/?pageid=62
	TR	The Social Insurance Administration	http://www.tr.is
Ireland	IMB	Irish Medicines Board.	http://www.imb.ie/
	NCPE	The National Centre for Pharmacoeconomics	http://www.ncpe.ie
	HSE	The Health Service Executive	http://www.hse.ie/eng/
	HSE PCRS	Primary Care Reimbursement Service	http://www.hse.ie/eng/staff/PCRS/About_PCRS/
Italy	AIFA	Italian Medicines Agency	http://www.agenziafarmaco.gov.it
	CPR	Price and Reimbursement Committee	http://www.agenziafarmaco.gov.it/en/content/committees
	CTS	Technical Scientific Committee	http://www.agenziafarmaco.gov.it/en/content/committees
	ASLs	Local Health Unites	http://www.salute.gov.it/infoSalute/atlanteHome.jsp?menu=atlante
Latvia	VZA	State Agency for Medicine	http://www.vza.gov.lv
	CHE	The Centre of Health Economics	http://vec.gov.lv/
	VNC	Health Payment Centre	http://www.vnc.gov.lv
Liechtenstein		Department of Medicine	http://www.llv.li/amtstellen/llv-ag-heilmittel-2/llv-ag-arzneimittel-2/llv-ag-arzneimittel-kontrollstelle_fuer_arzneimittel.htm
		Department of Health and Accident Insurance	http://www.llv.li/amtstellen/llv-ag-versicherung/llv-ag-versicherung-krankenversicherung_neu/llv-ag-versicherung-krankenversicherung-krankenstellen.htm

	OKP	Compulsory Health Insurance	http://www.liv.li/amtsstellen/llv-avw-krankenversicherung-kurzvorstellung.htm?nav=teaser&imainpos=46728&lpid=3789
Lithuania	VVKT	State Medicine Control Agency	http://www.vvkt.lt
	VLK	State Patient Fund	http://www.vlk.lt
	MOH	Ministry of Health	http://www.sam.lt/
Luxembourg	MOH	Ministry of Health	http://www.ms.public.lu
		Ministry of Social Security	http://www.mss.public.lu
	CNS	National Health Fund	http://www.cns.lu/
Malta	MA	Medicine Authority	http://medicinesauthority.gov.mt/aboutus.htm
	MOH	Ministry of Health, the Elderly and Community care	https://ehealth.gov.mt
	HPSS	Healthcare Procurement and Supplies Services	http://sahha.gov.mt/pages.aspx?page=200
Netherland	CBG/MEB	Medicines Evaluation Board	http://www.cbg-meb.nl/
	CFH	Board for Pharmaceutical Aid	http://www.cvz.nl/zorgpakket/cfhagenda/commissie/commissie.html
	ZIN	The National Health Institute	http://www.zorginstituutnederland.nl/
	VWS	Ministry of Health, Welfare and Sport	http://www.minvws.nl
	GVS	The pharmaceutical reimbursement system	http://www.farmatec.nl/geneesmiddelen/prijzenenlimieten/vergoedingssysteem/
Norway	NoMA	Norwegian Medicines Agency	http://www.legemiddelverket.no
	HOD	Ministry of Health and Care Service	http://www.regjeringen.no/en/dep/hod.html
Poland	URPL	Office for Registration of Medicinal Products, Medical Devices and Biocidal Products	http://en.urpl.gov.pl/

	AHTAPol	Health Technology Assessment Agency in Poland	http://www.aotm.gov.pl
	MZ	Ministry of Health	http://www.mz.gov.pl
	NFZ	National Health Fund	http://www.nfz.gov.pl
Portugal	INFARMED	National Authority of Medicines and Health Products	http://www.infarmed.pt/portal/page/portal/INFARMED
	DGAE	General Directorate of Economic Activities	http://www.dgae.min-economia.pt/
	MOH	Ministry of Health	http://www.min-saude.pt
Romania	ANMDM	National Medicines and Medical Devices Agency	http://www.anm.ro
		Transparency Commission	http://www.ms.gov.ro/?pag=10&id=2870
	MOH	Ministry of Health	http://www.ms.gov.ro
Slovakia	SUKL	State Institute for Drug Control	http://www.sukl.sk
	N/A	Categorisation committee	http://www.health.gov.sk/?statuty-6
	SLOVAHTA	Slovak Agency for Health Technology Assessment	http://www.farmako-ekonomika.sk/images/stories/slovahta/vizia/Slovahta-vizia.pdf
	VsZP	General Health Insurance	http://www.vszp.sk
	MOH	Ministry of Health	http://www.health.gov.sk
Slovenia	JAZMP	Agency for Medicinal Products and Medical Devices of the Republic of Slovenia	www.jazmp.si
	ZZZS	Slovenia Health Insurance Institute	http://www.zzzs.si
Spain	AEMPS	Spanish Medicines Agency	http://www.aemps.gob.es
	ISCIII	The Institute of Health Carlos III	http://www.isciii.es

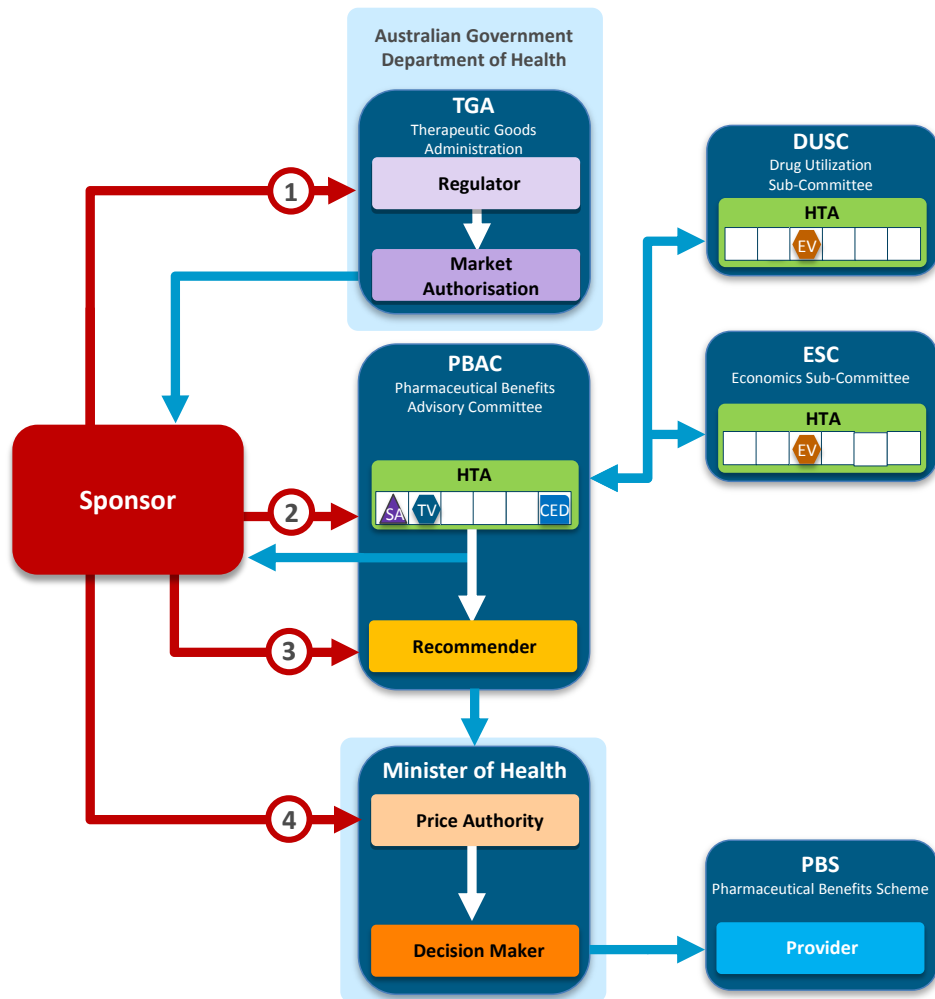
	CIPM	Inter-ministerial Commission on Medicines Prices	http://www.msc.es/profesionales/farmacia/financiacion/home.htm
	DGFPS	General Directorate of Pharmacy and Health Products	http://www.msc.es/profesionales/farmacia/organizacion.htm
Sweden	MPA	Medical Products Agency	http://www.lakemedelsverket.se/english/
	SBU	Swedish Council on Technology Assessment in Health Care	http://www.sbu.se
	TLV/LFN	Pharmaceutical Benefits Board	http://www.tlv.se/
Switzerland		Swissmedic	http://www.swissmedic.ch
	BAG/ FOPH	Federal Office of Public Health	http://www.bag.admin.ch
UK	MHRA	Medicines and Healthcare products Regulatory Agency	http://www.mhra.gov.uk
	NICE	National Institute for Health and Clinical Excellence	http://www.nice.org.uk/
	NIHR	National Institute for Health Research	http://www.nihr.ac.uk
	PPRS	Pharmaceutical Price Regulation Scheme	https://www.gov.uk/government/publications/pharmaceutical-price-regulation-scheme-2014
	SMC	Scottish Medicines Consortium	http://www.scottishmedicines.org.uk/Home
	PASAG	Patient Access Scheme Assessment Group	https://www.scottishmedicines.org.uk/Submission_Process/Submission_guidance_and_forms/Patient-Access-Schemes
	AWMSG	Scotland Regional Health Board	http://www.gov.scot/Topics/Health/NHS-Workforce/NHS-Boards
		All Wales Medicines Strategy Group	http://www.wales.nhs.uk/sites3/home.cfm?orgid=371
	LHB	New Medicine Group	http://www.wales.nhs.uk/sites3/page.cfm?orgid=371&pid=25692

APPENDIX B

HTA Process maps for 39 Jurisdictions

Process map for Australia

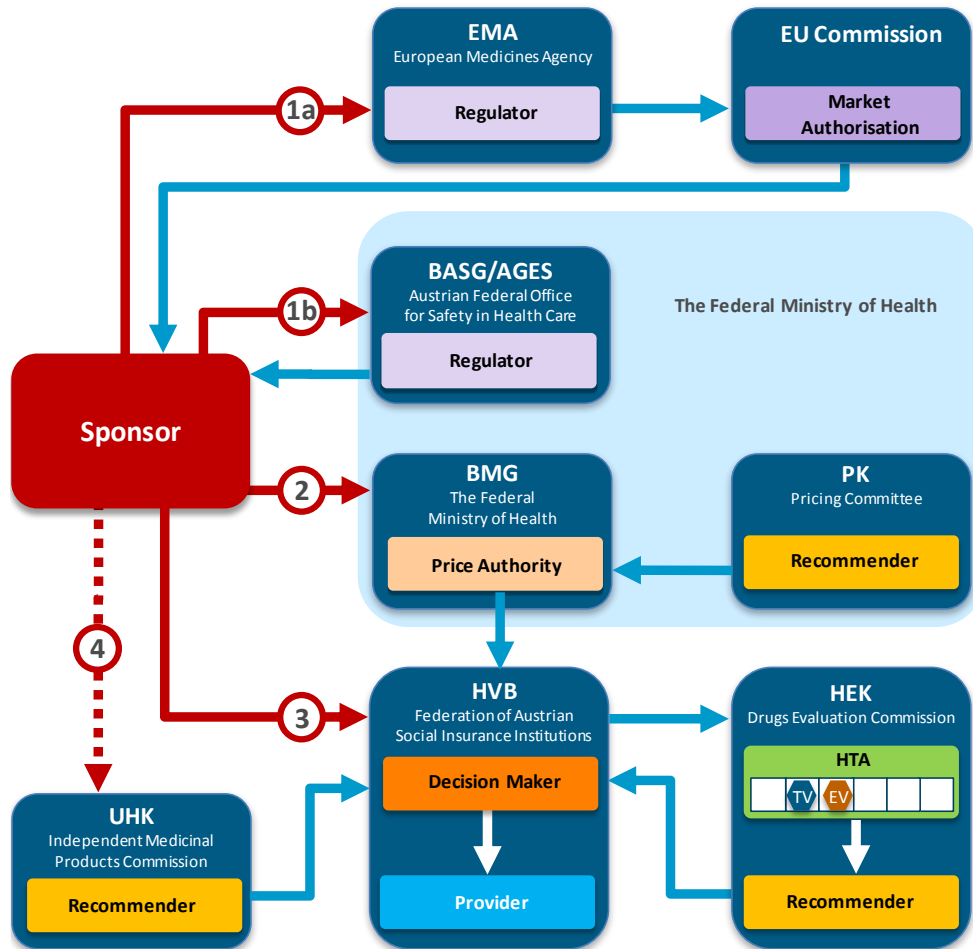
Version: December 2014



Agency (Committee)	Function	Key activity
TGA The Therapeutic Goods Administration	Regulator	The regulatory agency for medical drugs and devices. The key activities of the TGA include pre-market evaluation, licensing of manufacture and post-marketing monitoring.
	Market Authorisation	While the TGA recommends registration, the final decision is made by the delegate of the Minister of Health.
PBAC Pharmaceutical Benefits Advisory Committee	HTA	PBAC assesses the comparable clinical and cost effectiveness of pharmaceuticals and vaccines for the purpose of determining eligibility for public subsidy.
	Recommender	PBAC makes recommendations for listing on the PBS that are non-binding and require Ministerial approval. However recommendations not to list are binding.
DUSC Drug Utilisation Sub-Committee	HTA	The DUSC is a sub-committee of that estimates projected usage and forecasts the financial cost of new medicines (i.e. budget impact).
ESC Economics Sub-Committee	HTA	The ESC is a sub-committee of PBAC. The ESC reviews and interprets economic analyses in submissions to PBAC and advises PBAC on cost-effectiveness.
Minister of Health	Price Authority	As currently, the Minister (or delegate) considers pricing matters subsequent to PBAC meetings, following the introduction of a new streamlined process for listing medicines on the PBS in 1 April 2014. A key component of this measure was the cessation of the operations of the Pharmaceutical Benefits Pricing Authority (PBPA). The Minister's decision must be based on consultation with the sponsor and advice from the PBAC.
	Decision Maker	For pharmaceuticals with a projected annual cost of less than AUD\$10 million, the Minister of Health (or a delegate) is the decision maker for listing new drugs onto the PBS. For pharmaceuticals with an estimated value of greater than AUD\$10 million, the decision is required to be made at Cabinet level.
PBS Pharmaceutical Benefits Scheme	Provider	The national government subsidises the cost of medicines listed under the PBS. An exception is vaccines which are subsidised under the National Immunisation Programme (NIP).

Process map for Austria

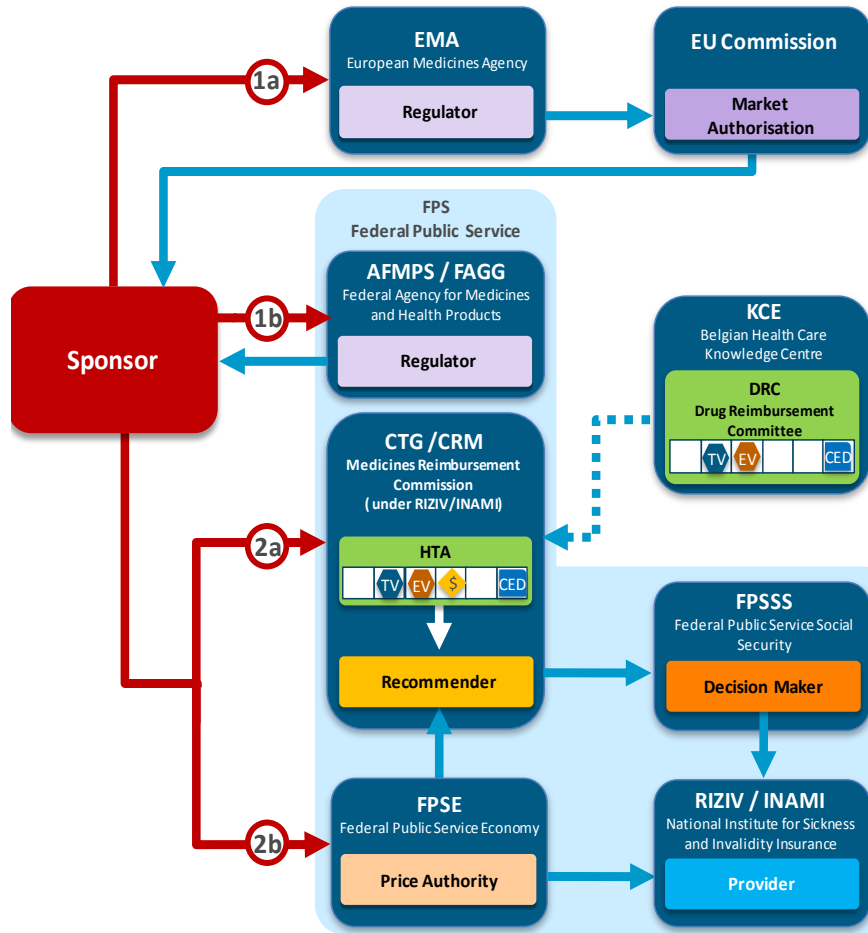
Version: January 2012



Agency (Committee)	Function	Key activity
BASG/AGES Austrian Federal Office for Safety in Health Care	Regulator	BASG is the regulatory authority for medicinal products and medical devices. The key activities of BASG include providing scientific advice, admission of clinical trial, inspections, market authorisation of medicinal products and market surveillance for medicinal products and medical devices.
	Market Authorisation	BASG is responsible for granting marketing authorisations for pharmaceuticals.
PK Pricing Committee	Recommender	The Committee collects price notifications from companies to calculate the EU average price. The result of assessment is sent to BMG to support price setting.
BMG The Federal Ministry of Health	Price Authority	The manufacture price of pharmaceuticals is set at the level of EU Average Price. The Ministry sets the EU Average Price for reimbursable drugs under the advice from Pricing Committee.
HEK Pharmaceutical Evaluation Board	HTA	HEK studies the therapeutic benefits of the products with respect to pharmacological, medical therapeutic, and health economic value.
	Recommender	HEK is a group of 20 experts nominated by several Austrian public bodies, including social health insurance representatives to provide advice on the reimbursement decision.
HVB Federation of Austrian Social Insurance Institutions	Decision Maker	Decisions on reimbursement status are made by HVB on the basis of recommendations of the Pharmaceutical Evaluation Board.
	Provider	HVB is the umbrella organization for 21 sick funds in Austria. The HVB is responsible for reimbursement of pharmaceuticals
UHK Independent Medicinal Products Commission	Decision Maker	An appeal against the negative decision made by HVB can be made to UHK, the Independent Medicinal Products Commission. The UHK has the function of an appeal court. All committee members are independent experts nominated by public bodies in Austria. The UHK is responsible for monitoring HEK and HVB.

Process map for Belgium

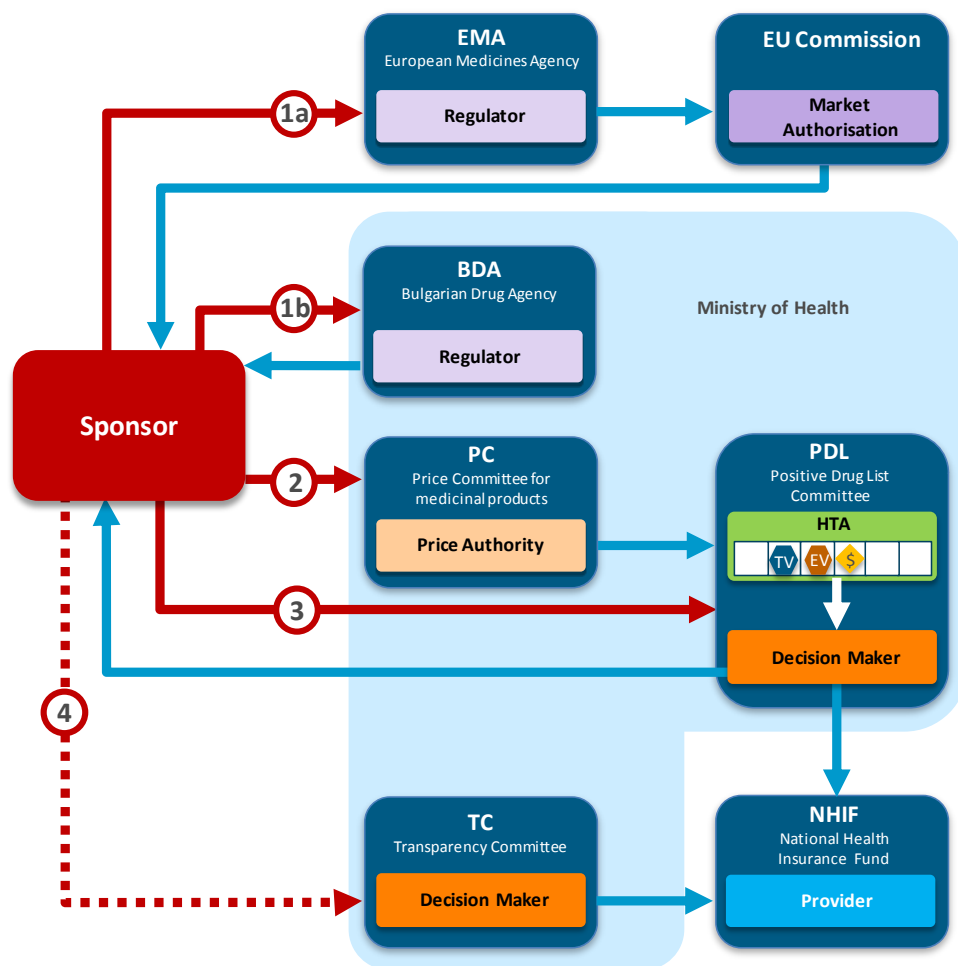
Version: May 2014



Agency (Committee)	Function	Key activity
AFMPS / FAGG Federal Agency for Medicines and Health Products	Regulator	The regulatory agency for medical drugs and devices. The key activities of AFMPS include evaluation, approval and control of requests for clinical trials for medicines, market authorisation and post-market surveillance.
	Market Authorisation	AFMPS/FAGG grants market authorisation based on efficacy, safety and quality. The market authorisation holder of medicines approved by EMA must inform the AFMPS/FAGG about the date the medicine will be marketed.
CTG / CRM (hosted under INAMI) Medicines Reimbursement Commission	Recommender	CRM provides recommendation on reimbursement status and reimbursement price to the FPSS.
	HTA	The sponsor submits the reimbursement application to CTG/CRM at the same time as the pricing application is made to FPSE. Legal criteria affecting the drug reimbursement decisions include: (Added) therapeutic value, medical and social need, budget impact, price and efficacy.
KCE Belgian Health Care Knowledge Centre	HTA	The KCE is an independent organization that provides studies and reports to advise policy-makers on health care decisions. KCE conducts studies that support the political decision making on healthcare. The KCE is not itself involved in making decisions and not in their implementation.
FPSS Federal Public Service Social Security	Decision maker	FPSS Social Security (FPSS) is responsible for assigning reimbursement to pharmaceuticals. Reimbursable drugs are classified into seven reimbursement categories on the basis of its therapeutic value.
FPSE Federal Public Service Economy	Price Authority	The FPSE is responsible for pricing. The FPSE sets maximum price of reimbursable prescription-only drugs. For non-reimbursed medicines, the pricing is free but the FPSE must be notified.
RIZIV / INAMI National Institute for Sickness and Invalidity Insurance	Provider	RIZIV /INAMI is the public social security institution that organises and financially manages healthcare insurance in Belgium.

Process map for Bulgaria

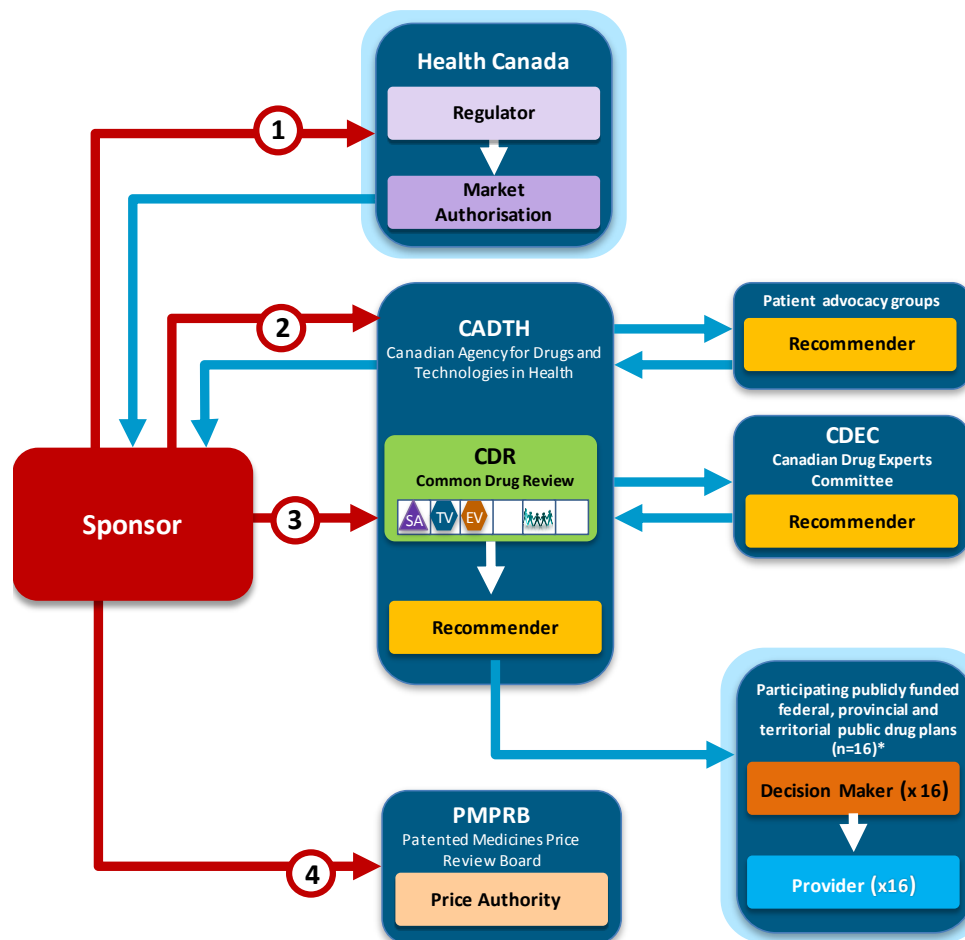
Version: October 2011



Agency (Committee)	Function	Key activity
BDA Bulgarian Drug Agency	Regulator	The BDA is the regulatory authority under administrative supervision of the Ministry of Health. The BDA coordinates its activity with the regional inspectorates for the prevention and control of public health.
	Market Authorisation	The BDA issues authorisations for medicinal products and carries out assessment of the quality, efficacy, and safety of medicinal products in relation with their marketing authorisations.
PC Price Committee for medicinal products	Price Authority	The Price Committee is established at the Ministry of Health to regulate the prices of medicinal products dispensed on medical prescription and registers the prices of medicinal products dispensed without medical prescription.
PDL Positive Drug List Committee	Decision Maker	The Positive Drug List Committee reviews and makes decisions on applications for inclusion, change, or exclusion of medicinal products from the Positive Drug List of the Republic of Bulgaria.
	HTA	The committee evaluates the therapeutic benefit of medicinal products, conducts economic evaluation for additional therapeutic benefits, and the social and economic burden.
Transparency Committee	Decision Maker	The Transparency Committee is a body which may appeal the decisions of the Pricing Commission and Positive List Committee.
NHIF National Health Insurance Fund	Provider	The funding of healthcare for insured citizens is provided by the National Health Insurance Fund (NHIF). The NHIF is an independent public institution separated from the structure of the social healthcare system and has its own bodies of management.

Process map for Canada (National Common Drug Review)

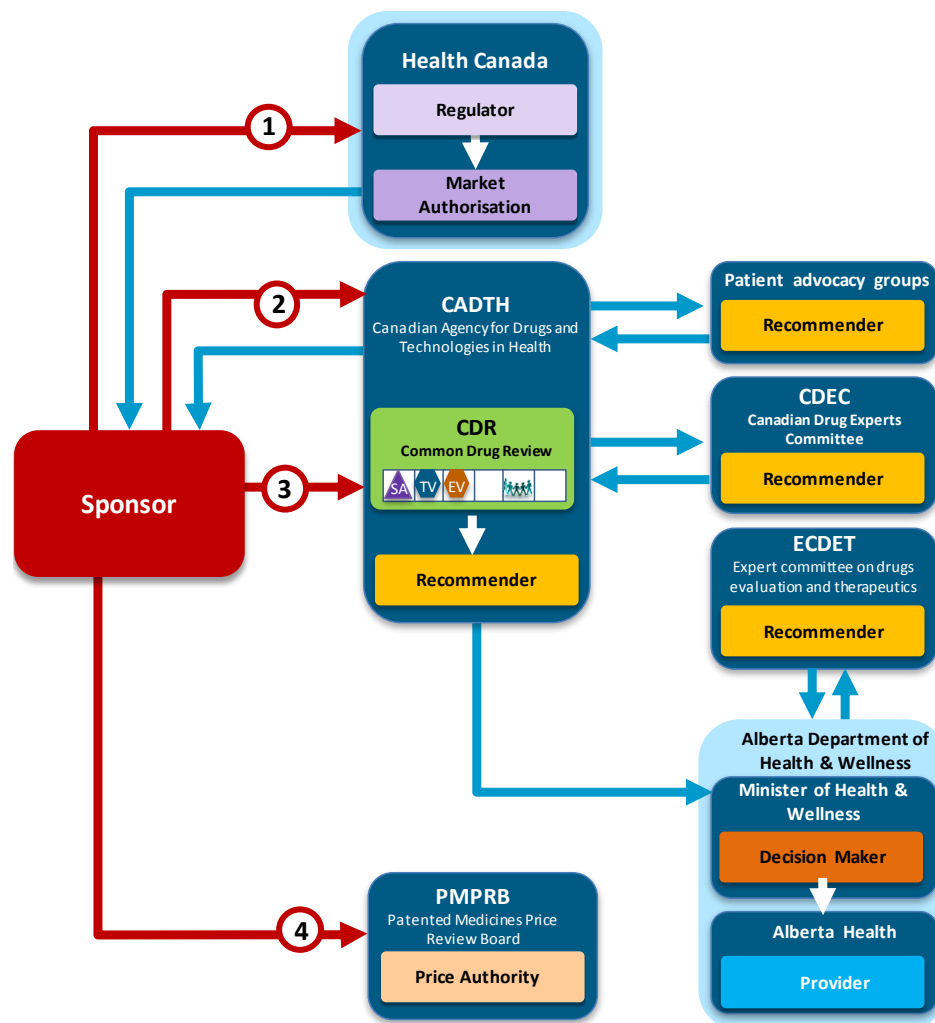
Version: March 2014



Agency (Committee)	Function	Key activity
Health Canada	Regulator	Therapeutic Products Directorate (TPD) regulates drugs and medical devices for human use. Biologics and Genetic Therapies Directorate (BGTD) regulate biologics and radiopharmaceuticals.
	Market Authorisation	The Notice of Compliance is signed by the Director General in TPD/BGTD as the approval documents for market authorisation. The NOC and a Drug Notification Form is sent to manufacture.
CADTH Canadian Agency for Drugs and Technologies in Health	HTA	The Common Drug Review (CDR) is part CADTH, an independent agency that assesses drugs and health technologies. The sponsor's initial submission is sent, with information from an independent literature search and patient input, to the CDR for clinical and pharmacoeconomic review.
	Recommender	The Common Drug Review evaluates the efficacy and pharmacoeconomic data of drug, and considers comments from the CDEC and the participating provincial and territorial public drug programs to provide recommendations for reimbursement to the provincial and territorial public plans.
CDEC Canadian Drug Experts Committee	Recommender	The CDEC is an appointed independent body comprised of physicians, pharmacists and professionals that makes recommendations on drug reimbursement as part of common drug review process for participating provincial and territorial public drug plans.
Patient Advocacy groups	Recommender	CADTH notifies and receives patient input from advocacy groups to send to the CDR clinical and pharmacoeconomic reviewers.
PMPRB Patented Medicines Price Review Board	Price Authority	The PMPRB regulates the price of patented drug products.
Participating public drug plans	Decision maker	The participating federal, provincial and territorial public drug plans receive a final reimbursement recommendation from CDEC to help guide their final reimbursement decision within the terms of their mandate.
	Provider	The participating federal, provincial and territorial public drug plans provide access to the health technology, according to their respective provincial or territorial final reimbursement decision, to patients who meet their defined eligibility criteria.

Process map for Canada (Alberta)

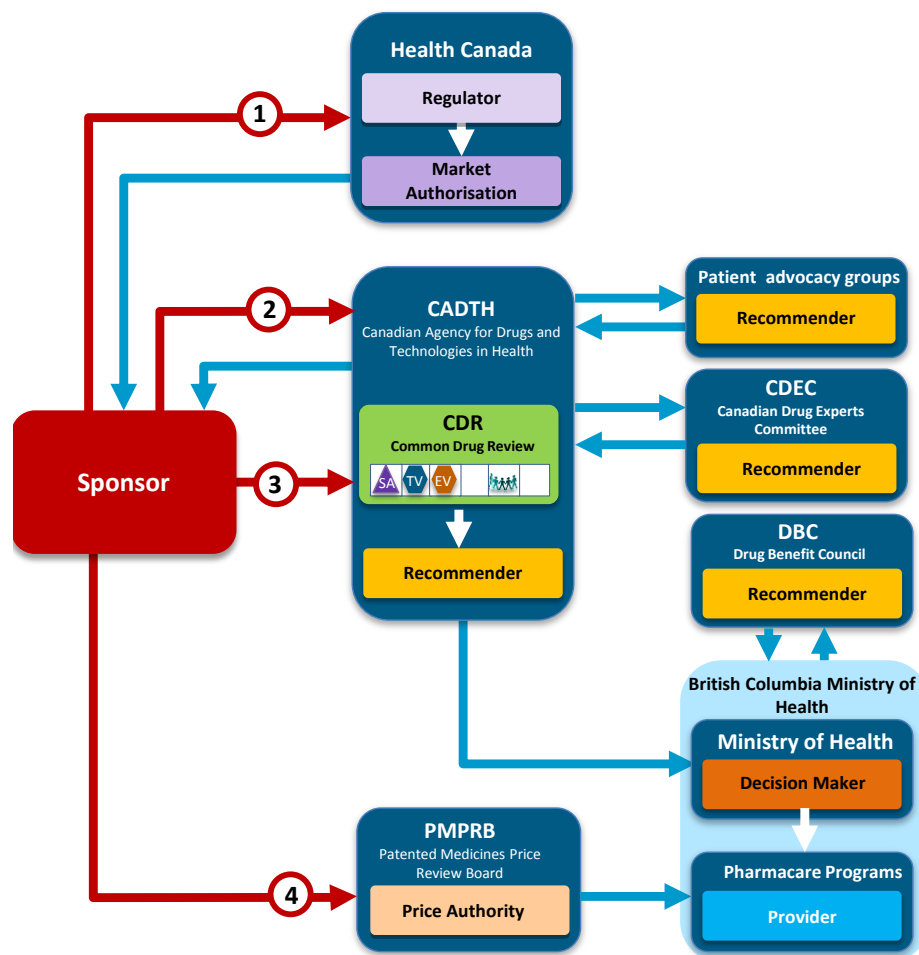
Version: September 2013



Agency (Committee)	Function	Key activity
Health Canada	Regulator	Therapeutic Products Directorate (TPD) regulates drugs and medical devices for human use. Biologics and Genetic Therapies Directorate (BGTD) regulate biologics and radiopharmaceuticals.
	Market Authorisation	The Notice of Compliance is signed by the Director General in TPD/BGTD as the approval documents for market authorisation. The NOC and a Drug Notification Form is sent to manufacture.
CADTH Canadian Agency for Drugs and Technologies in Health	HTA	The Canadian Agency for Drugs and Technologies in Health (CADTH) is an independent agency that assesses drugs and health technologies.
	Recommender	The Common Drug Review (CDR), which is run through the CADTH, evaluates the efficacy and pharmacoeconomic data of drug, and makes recommendations on reimbursement to the provinces.
CDEC Canadian Drug Experts Committee	Recommender	The CDEC is an appointed independent body comprised of physicians, pharmacists and professionals that makes recommendations on drug reimbursement as part of common drug review process for participating provincial and territorial public drug plans.
Patient Advocacy groups	Recommender	The common drug review retrieves patient input to send to clinical and pharmacoeconomic reviewers.
PMPRB Patented Medicines Price Review Board	Price Authority	The PMPRB is an independent quasi-judicial body with a mandate to regulate the prices charged for patented drug products and report pharmaceuticals trends for sales of drugs and R&D spending by patentees.
Alberta Health	Decision maker	Minister of Health for Alberta reviews the recommendations from ECDET to determine eligibility for reimbursement
	Provider	Alberta Health provides financial assistance to eligible residents to purchase approved prescription pharmaceuticals.
ECDET Expert Committee on Drug Evaluation and Therapeutics	Recommender	The ECDET evaluates the clinical and economic value of pharmaceuticals that do not fall within the Common Drug Review Mandate, and provides formulary listing recommendations.

Process map for Canada (British Columbia)

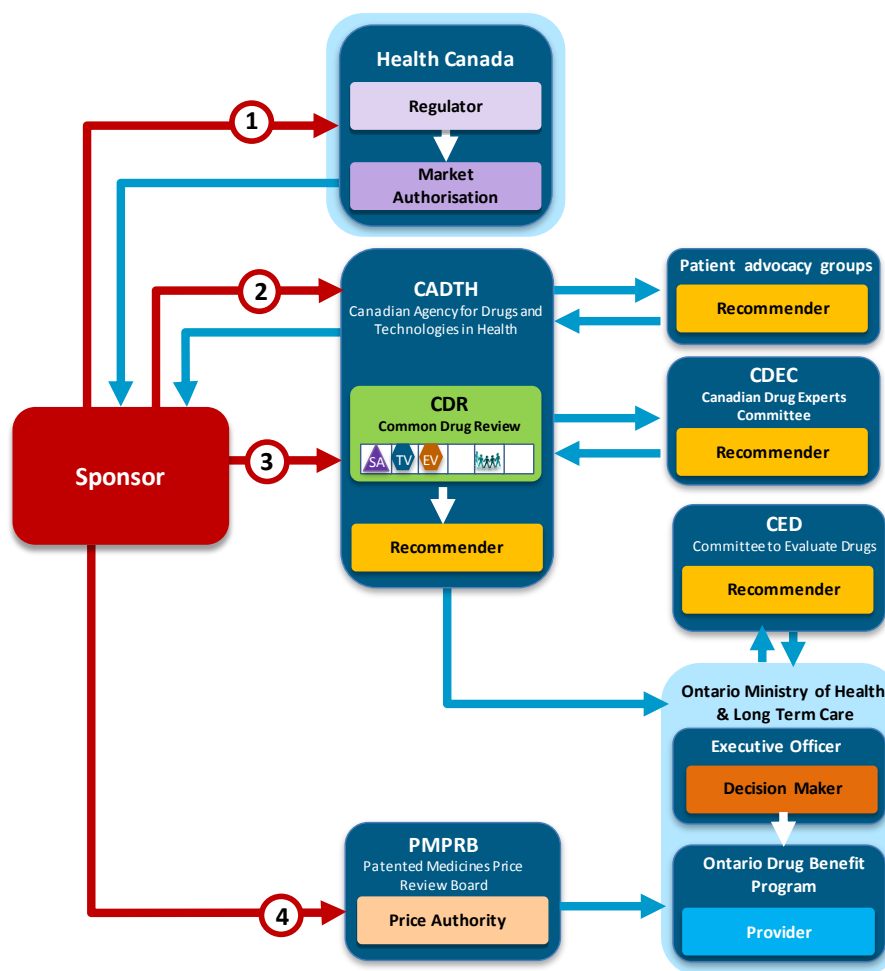
Version: March 2013



Agency (Committee)	Function	Key activity
Health Canada	Regulator	Therapeutic Products Directorate (TPD) regulates drugs and medical devices for human use. Biologics and Genetic Therapies Directorate (BGTD) regulate biologics and radiopharmaceuticals.
	Market Authorisation	The Notice of Compliance is signed by the Director General in TPD/BGTD as the approval documents for market authorisation. The NOC and a Drug Notification Form is sent to manufacture.
CADTH Canadian Agency for Drugs and Technologies in Health	HTA	The Canadian Agency for Drugs and Technologies in Health (CADTH) is an independent agency that assesses drugs and health technologies.
	Recommender	The Common Drug Review (CDR), which is run through the CADTH, evaluates the efficacy and pharmacoeconomic data of drug, and makes recommendations on reimbursement to the provinces.
CDEC Canadian Drug Experts Committee	Recommender	The CDEC is an appointed independent body comprised of physicians, pharmacists and professionals that makes recommendations on drug reimbursement as part of common drug review process for participating provincial and territorial public drug plans.
Patient Advocacy groups	Recommender	The common drug review retrieves patient input to send to clinical and pharmacoeconomic reviewers.
British Columbia Ministry of Health	Decision maker	The British Columbia Ministry of Health considers the recommendations from the Drug Benefit Council to determine eligibility for reimbursement by the British Columbia Pharmacare plans,
	Provider	British Columbia Pharmacare provides financial assistance to eligible residents to purchase recommended medicines.
DBC Drug Benefit Council	Recommender	The DBC reviews the CDR evidence, final recommendation and patient input from the 'Your Voice' website to determine a listing recommendation.
PMPRB Patented Medicines Price Review Board	Price Authority	The PMPRB is an independent quasi-judicial body with a mandate to regulate the prices charged for patented drug products and report pharmaceuticals trends for sales of drugs and R&D spending by patentees.

Process map for Canada (Ontario)

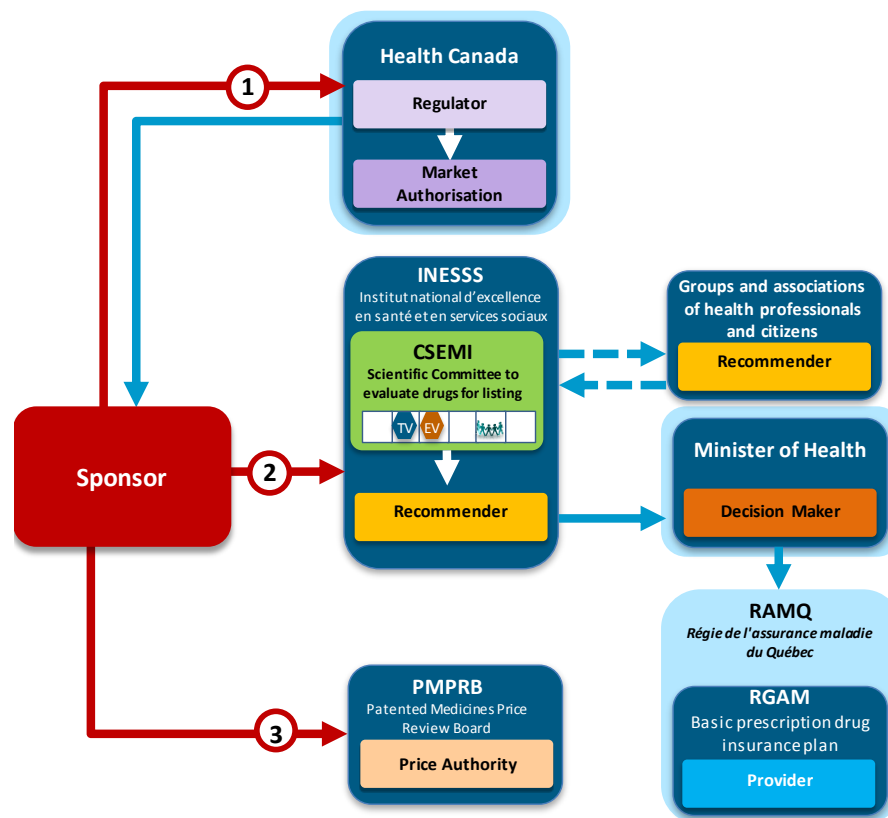
Version: March 2013



Agency (Committee)	Function	Key activity
Health Canada	Regulator	Therapeutic Products Directorate (TPD) regulates drugs and medical devices for human use. Biologics and Genetic Therapies Directorate (BGTD) regulate biologics and radiopharmaceuticals.
	Market Authorisation	The Notice of Compliance is signed by the Director General in TPD/BGTD as the approval documents for market authorisation. The NOC and a Drug Notification Form is sent to manufacture.
CADTH Canadian Agency for Drugs and Technologies in Health	HTA	The Canadian Agency for Drugs and Technologies in Health (CADTH) is an independent agency that assesses drugs and health technologies.
	Recommender	The Common Drug Review (CDR), which is run through the CADTH, evaluates the efficacy and pharmacoeconomic data of drug, and makes recommendations on reimbursement to the provinces.
CDEC Canadian Drug Experts Committee	Recommender	The CDEC is an appointed independent body comprised of physicians, pharmacists and professionals that makes recommendations on drug reimbursement as part of common drug review process for participating provincial and territorial public drug plans.
Patient Advocacy groups	Recommender	The common drug review retrieves patient input to send to clinical and pharmacoeconomic reviewers.
PMPRB Patented Medicines Price Review Board	Price Authority	The PMPRB is an independent quasi-judicial body with a mandate to regulate the prices charged for patented drug products and report pharmaceutical trends for sales of drugs and R&D spending by patentees.
CEC Committee to evaluate Drugs	Recommender	The CED is an independent advisory group of healthcare professionals with experience in drug therapy and drug use evaluation. The CED provides listing recommendations to the Executive Officer for the Ontario Ministry of Health and Long Term Care.
Ontario Ministry of Health and Long Term Care	Decision maker	The Executive officer for Ontario Ministry of Health and Long Term Care reviews the recommendations from the CDR and CED to determine eligibility for reimbursement
	Provider	Ontario Drug Benefit programs provide financial assistance to eligible residents to purchase approved prescription pharmaceuticals.

Process map for Canada (Quebec)

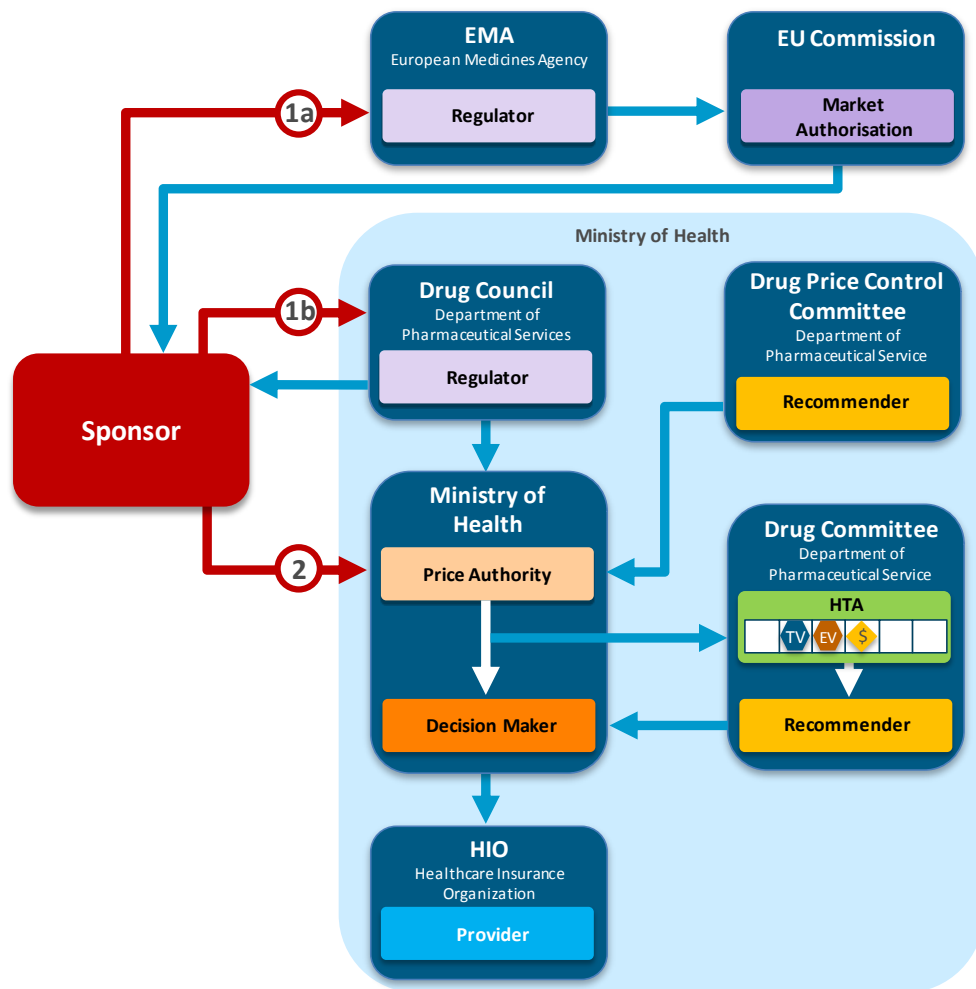
Version: September 2013



Agency (Committee)	Function	Key activity
Health Canada	Regulator	Therapeutic Products Directorate (TPD) regulates drugs and medical devices for human use. Biologics and Genetic Therapies Directorate (BGTD) regulate biologics and radiopharmaceuticals.
	Market Authorisation	The Notice of Compliance is signed by the Director General in TPD/BGTD as the approval documents for market authorisation. The NOC and a Drug Notification Form is sent to manufacture.
INESSS Institut national d'excellence en santé et en services sociaux	HTA	From January 2011 the INESSS succeeded the Council of the drug and the Agency for Health Technology Assessment and Intervention Methods in Health (AETMIS). INESSS will evaluate the therapeutic and economic value of pharmaceuticals, technologies and health interventions.
	Recommender	The institute provides a clinical and economical evaluation of a pharmaceutical, technology or health intervention to help aid the reimbursement decision.
CSEMI Scientific Committee to Evaluate Drugs for Registration	Recommender	The CSEMI is usually formed of external experts (Physicians, pharmacists and health economists) who provide a reimbursement recommendation by voting according to the criteria in the INESSS Act.
Groups and associations of health professionals and citizens	Recommender	INESSS invites groups and associations of health professionals and citizens to provide comments and observations of the evaluation plan to CSEMI
MOH Quebec Minister of Health	Decision maker	The Quebec Minister of Health will decided whether the health technology is eligible for coverage by the regional health insurance plan / Régie de l'assurance maladie du Québec (RAMQ).
RGAM le régime général d'assurance médicaments	Payer	The RGAM is a list of medicines covered by the basic prescription drug insurance plan. Drug Formulary for Institutions lists medications eligible for use in Quebec health institutions to be covered by the RAMQ
PMPRB Patented Medicines Price Review Board	Price Authority	The PMPRB regulates the price of patented drug products. Non-patented medicines do not need to have the price reviewed by PMPRB.

Process map for Cyprus

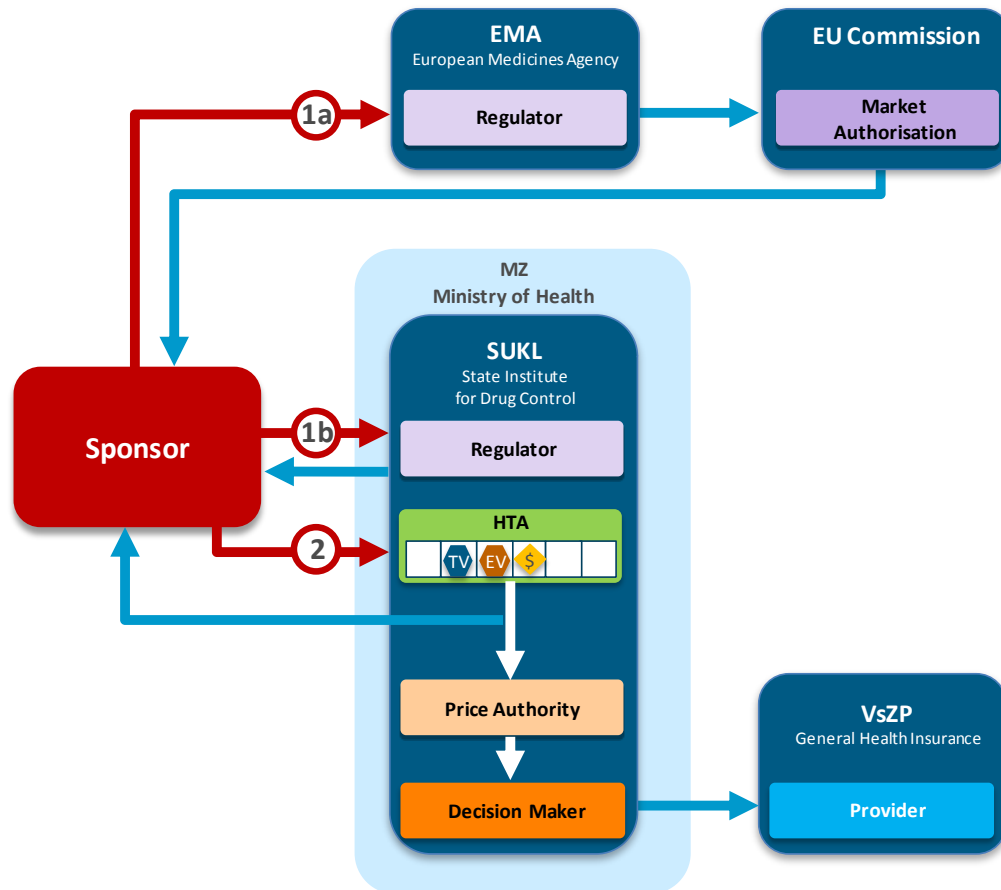
Version: February 2012



Agency (Committee)	Function	Key activity
Drug Council Department of Pharmaceutical Services of the MoH	Regulator	The regulatory body for medical drugs and devices. The key activities of the Department of Pharmaceutical Service include licensing of medicines, licensing of manufacture and wholesales, pharmacovigilance, and the pricing of medicines.
	Market Authorisation	The Department of Pharmaceutical Services of the MoH is in charge of issuing market authorisation to new medicines based on their quality, safety and efficacy. The result of evaluation will also be used to support the coverage decision-making.
Drug Committee Department of Pharmaceutical Service of the MoH	HTA	The assessment conducted by drug committee is based on the Evidence Based Medicine method. An economic evaluation is also conducted in relation to the financial capabilities required by the annual growth rate of the budget for medicines.
	Recommender	The Drug Committee is responsible for evaluating submissions for new drug to be listed on the national formulary. The result of assessment is sent to the MOH to facilitate decision-making.
Drug Price Control Committee Department of Pharmaceutical Service of the MoH	Recommender	The Price committee is responsible for advising the MOH on all matters relating to drug price.
MoH Ministry of Health	Price Authority	In the public system pharmaceuticals are purchased through tendering operated by the Department of Pharmaceutical Services of the MoH. The MoH makes decision on purchase of substances from different tenders.
MoH Minister of Health	Decision Maker	The MoH makes decisions on drug reimbursement based on the advice from Drug Council and Drug Committee.
HIO Health Insurance Organization	Provider	Healthcare service is covered by health insurance, which is managed by Health Insurance Organisation. The HIO is operated by representatives of the government. Pharmaceuticals listed on the National Formulary can be reimbursed under the public system at 100% or 50%.

Process map for Czech Republic

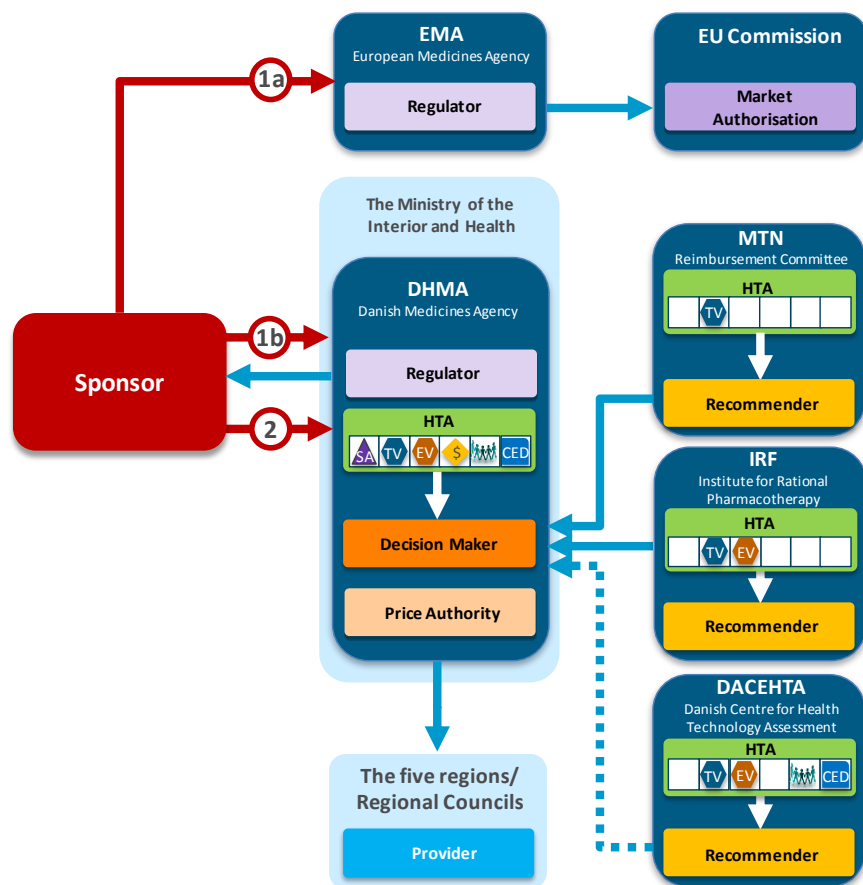
Version: October 2011



Agency (Committee)	Function	Key activity
SUKL The State Institute for Drug Control	Regulator	The SUKL is an administration body established under direct control of the Ministry of Health to ensure high-quality, effective and safe human pharmaceuticals are available in the Czech Republic.
	Market Authorisation	The SUKL assesses the drug applications with regards to their quality, efficacy, and safety and grants the market authorisations.
	HTA	The SUKL conducts assessment of new medicines for the assignment of reimbursement. The principles for evaluation include: efficacy and safety, cost-effectiveness, budget impact and therapeutic assessment.
	Price Authority	SUKL decides on the maximum prices of pharmaceuticals. Separate pricing application and reimbursement application are made to SUKL.
	Decision Maker	The SUKL is responsible for the regulation of drug prices and reimbursement. The decision-making process involves individual administrative proceedings.
VsZP General Health Insurance	Provider	There are nine sick funds that are responsible for the reimbursement of pharmaceuticals. The VsZP is the biggest sick fund and is one of the basic pillars of the Czech health care system.

Process map for Denmark

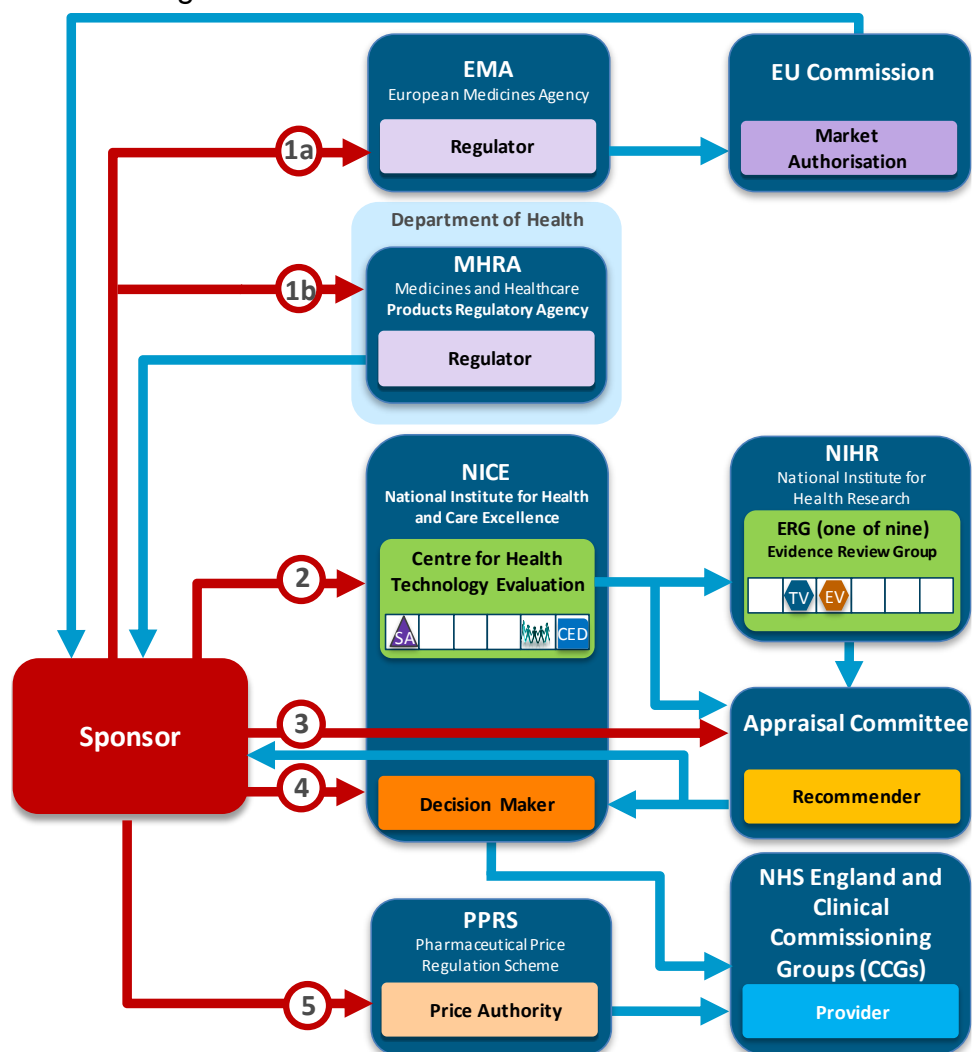
Version: June 2014



Agency (Committee)	Function	Key activity
DHMA The Danish Health and Medicines Authority	Regulator	The DHMA is a government agency that operates under the Ministry of the Interior and Health to ensure effective and safe healthcare products use in Denmark.
	Market Authorisation	The Licensing Division in DHMA is responsible for granting market authorisation to human and veterinary medicinal products based on their efficacy, safety and quality.
	HTA	The DHMA assesses the therapeutic value and cost-effectiveness of reimbursable drugs.
	Price authority	The DHMA fixes the reimbursement prices based on a co-payment rate for pharmaceuticals. There is free pricing for all pharmaceuticals at the manufacturer and wholesale price level.
	Decision maker	The DHMA decides if a drug will be included on the positive list for general reimbursement. Applications for individual reimbursement can also be made directly to the DHMA.
MTN The Reimbursement committee	HTA	The MTN is an independent committee, comprised of a maximum seven people, that assesses the safety and added therapeutic value of pharmaceuticals.
	Recommender	The MTN advises the DHMA on both general reimbursement and individual reimbursement of new drugs.
IRF Institute for Rational Pharmacotherapy	HTA	The IRF is responsible for promoting the most rational use of medicinal products with respect to both pharmacological and economics aspects.
	Recommender	The IRF conducts its own pharmacoeconomic evaluation and provides advice and guidance to the DHMA.
DACEHTA the Danish Centre for Health Technology Assessment	HTA	DACEHTA is an HTA body within the National Board of Health that aims to improve quality, standards and value for money in the Danish health service.
	Recommender	DACEHTA collaborates with health authorities at regional level to evaluate pharmaceutical products.
Five regional councils	Provider	Five regions act as a third-party payer for the coverage of reimbursable drugs at regional level. At local level the municipalities have supplementary reimbursement system based on social indications.

Process map for England

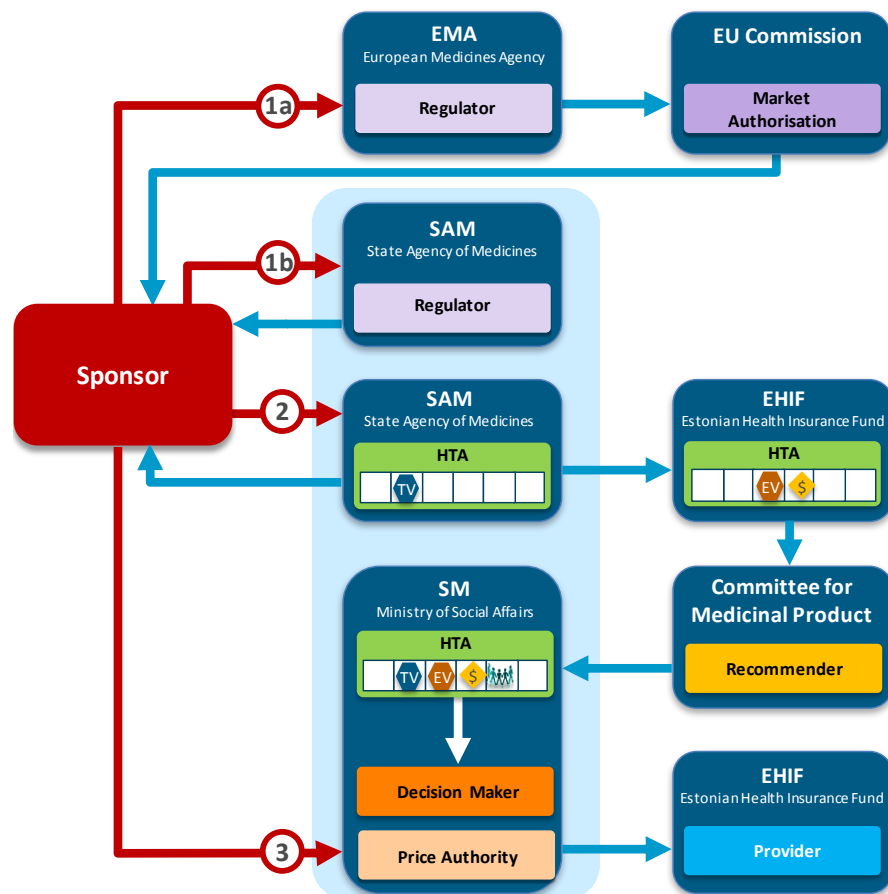
Version: August 2014



Agency (Committee)	Function	Key activity
MHRA Medicines and Healthcare products Regulatory Agency	Regulator	The MHRA is a government agency that regulates medicines on the basis of safety, quality and efficacy.
	Market Authorisation	The MHRA authorises marketing licence for new drugs.
NICE National Institute for Health and Care Excellence	HTA	NICE provides pharmacoeconomic guidance, sets quality standards and manages a national medicinal products database. The recent change of NICE's name represents the broadening of its remit to improve social care guidelines.
	Decision maker	NICE carries out cost-effectiveness evaluations for new pharmaceuticals that are submitted for inclusion in national formulary. In June 2013, the scope of NICE assessment was broadened to include a medicine's value to patients and society.
NIHR National Institute for Health Research	HTA	The NIHR is a government body that coordinates and funds research for the National Health Service (England). The NIHR supports individuals, facilities and research projects.
NHS England and Clinical Commissioning Groups (CCGs)	Provider	NHS is a government independent body whose main role is to improve health outcomes in England. From April 2013, Strategic Health Authorities (SHAs) and Primary Care Trusts (PCTs) were replaced by NHS England and Clinical commissioning Groups (CCGs). NHS England provides leadership for the NHS, authorises 211 CCGs and devolves responsibility to 27 Local Area Teams (LATs) to commission primary care. Ten of the LATs are leads for specialised commissioning. CCG's are responsible for the allocation of the drug budget and managing prescribing for their jurisdiction.
PPRS Pharmaceutical Price Regulation Scheme	Price Authority	The PPRS regulates the price indirectly by controlling the profit of the pharmaceutical companies. From 2014, the new PPRS scheme will ensure the NHS bill for branded medicines will remain flat over the following two years and will increase by less than 2% in each of the subsequent three years.
Appraisal Committee	Recommender	The Appraisal Committee is an independent standing advisory committee of NICE. It makes a judgement on whether or not the technology should be recommended for use within the NHS.

Process map for Estonia

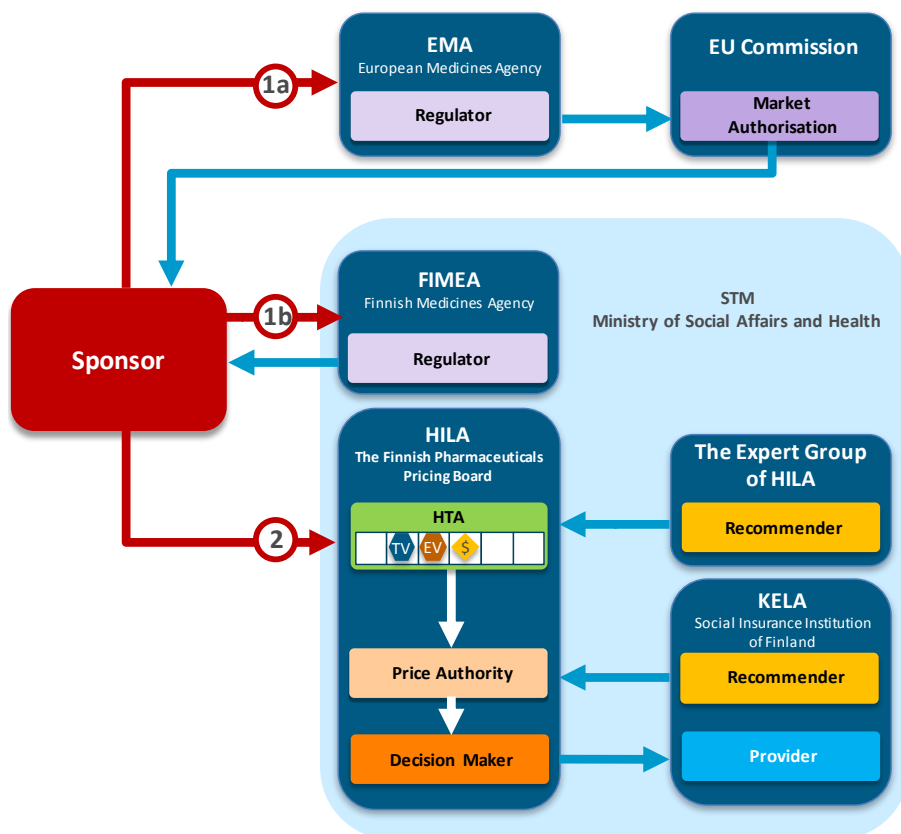
Version: June 2012



Agency (Committee)	Function	Key activity
SAM State Agency of Medicines	Regulator	The main responsibility of SAM is the protection and promotion of public and animal health, through the supervision of medicines for human and veterinary use.
	Market Authorisation	SAM is established under the Ministry of Social Affairs which is responsible for issuing market authorisations.
	HTA	The application for drug reimbursement is submitted to SAM. The criteria of evaluation by SAM include safety, effectiveness and alternative treatment.
EHIF Estonian Health Insurance Fund	HTA	The EHIF evaluates the applications from financial and budgetary standpoints.
	Provider	The EHIF is responsible for the reimbursement of pharmaceuticals.
Committee for Medicinal Product	Recommender	After applications evaluated by SAM and EHIF, the opinions are forwarded to the Committee for Medicinal Product. The SM makes decisions based on recommendations from the Committee for Medicinal Product.
SM Ministry of Social Affairs	HTA	The SM evaluates the applications based on the criteria of pharmacoeconomic analysis, comparative treatment, price development and budgetary restrictions.
	Decision Maker	The SM is responsible for making decision on reimbursement, based on the advice from the Committee for Medicinal Products.
	Price Authority	The SM makes decision on the manufacturer price base the decision on reimbursement, sometimes the pricing procedure is incorporated into the reimbursement procedure.

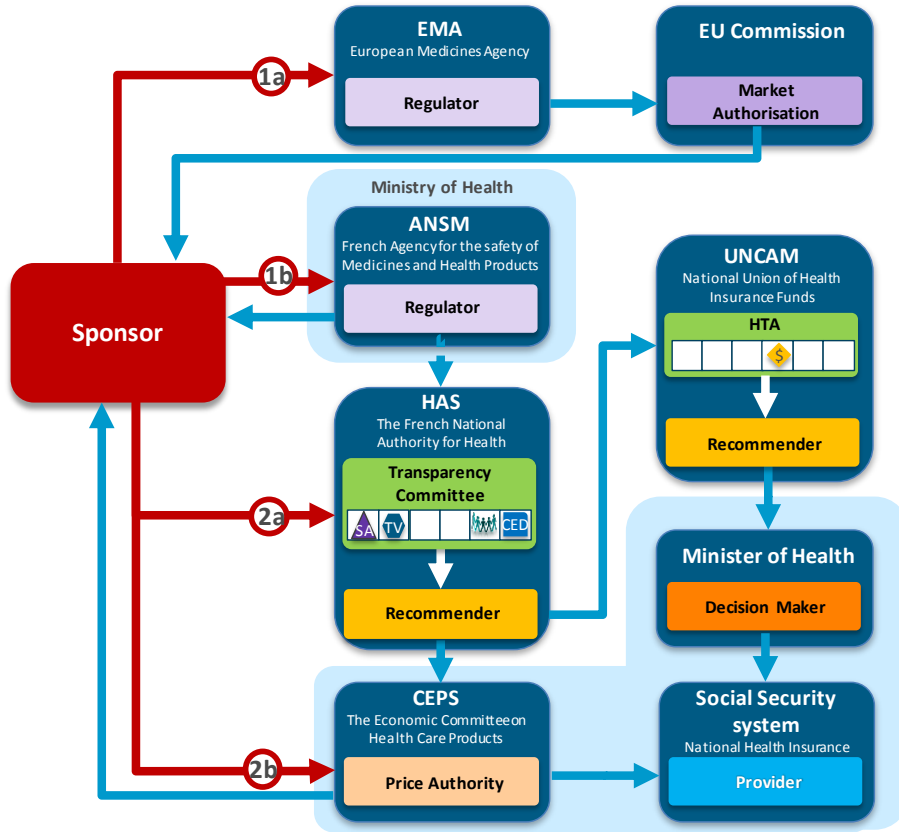
Process map for Finland

Version: June 2012



Agency (Committee)	Function	Key activity
FIMEA Finnish Medicines Agency	Regulator	The FIMEA is the national authority operated under the Ministry of Social Affairs and Health. The FIMEA promotes the health and safety of the population by regulating pharmaceuticals.
	Market Authorisation	The FIMEA assesses the quality, safety and efficacy of drug applications and grants market authorisation to new medicines.
The Expert Group of HILA	Recommender	This expert group represents medical, pharmacological, health economics and social insurance expertise. The expert group provides advice to the HILA for drug reimbursement.
HILA The Finnish Pharmaceuticals Pricing Board	HTA	The criteria of the HILA evaluation include therapeutic value, cost-effectiveness, benefits gained and costs of special reimbursement status.
	Price Authority	The HILA decides the wholesale prices of medicinal products based on the opinions from the Social Insurance Institution (KELA) and from the expert group if necessary.
	Decision Maker	The HILA acquires an opinion from its expert group and makes the final decision on drug reimbursement.
KELA Social Insurance Institution of Finland	Recommender	The HILA will consult with the opinion from KELA during coverage decision-making process.
	Provider	The KELA provides a National Health Insurance scheme that covers part of the cost of a range of health services

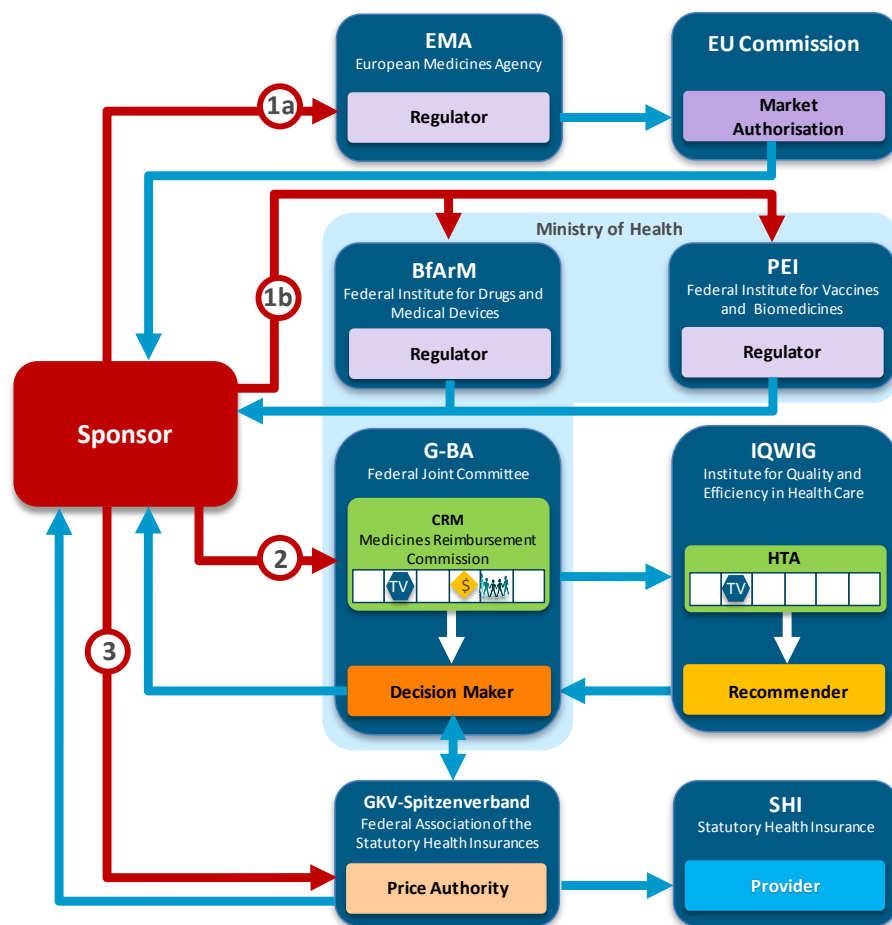
Process map for France
Version: July 2014



Agency (Committee)	Function	Key activity
ANSM French Agency for the Safety of Medicines and Health Products	Regulator	The ANSM has replaced AFSSAPS as the government agency responsible for regulating health products intended for human consumption. The key activities of ANSM also include implementation of regulations for trials, manufacturing, import, export, wholesale distribution, storage, marketing and advertising.
	Market Authorisation	The ANSM is responsible for granting market authorisation as well as post-market surveillance.
HAS French National Authority for Health	HTA	The Transparency Committee evaluates pharmaceuticals with regards to their medical benefit (SMR) and their innovation rate (ASMR).
	Recommender	The Transparency Committee forwards its recommendation simultaneously to both CEPS for pricing decision and to UNCAM for fixing reimbursement rate. The HAS may also provide its own advice.
UNCAM National Union of Health Insurance Funds	HTA	The UNCAM evaluate the medical benefit of pharmaceuticals under recommendations from the Transparency Committee.
	Decision maker	The UNCAM makes decision on reimbursement rate based on the evaluation made by the Transparency Committee and the pricing decision of the CEPS. The UNCAM fixes the reimbursement rate of pharmaceuticals within the rate limit defined by decree.
CEPS The Economic Committee on Health Care Products	Price Authority	The CEPS is a regulatory body that fix prices of drugs and rates of single-use medical devices that are covered by compulsory health insurance. CEPS fixes price after negotiation pharmaceutical companies, the price will relate to the ASMR rating provided by HAS.
Social Security system National Health Insurance Adoption committee	Provider	The Social Security system manages and controls the national health insurance.

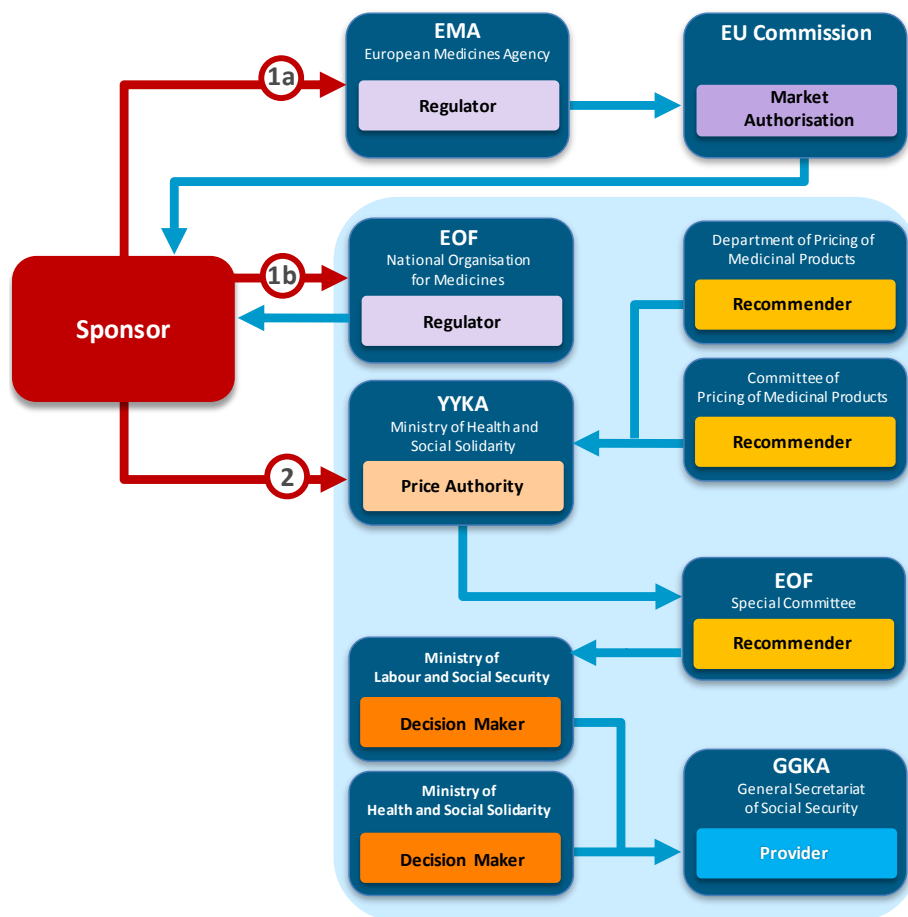
Process map for Germany

Version: May 2014



Agency (Committee)	Function	Key activity
BfArM Federal Institute for Drugs and Medical Devices	Regulator	The BfArM is the federal agency operated under the Ministry of Health that regulates drugs and medical devices for human use.
	Market Authorisation	The BfArM is responsible for market authorisation of pharmaceuticals, registration of medical devices and post-marketing surveillance.
PEI Federal Institute for Vaccines and Biomedicines	Regulator	The PEI is the federal agency operated under the Ministry of Health that is responsible for regulating biological products, including vaccines, antibodies, blood/blood products, tissues and medicines for gene therapy.
	Market Authorisation	The PEI is responsible for market authorisation of vaccines and biomedicines.
G-BA Federal Joint Committee	HTA	The G-BA is responsible for evaluating and then categorising reimbursable pharmaceuticals. The G-BA performs a rapid assessment to evaluate the additional benefit in relation to an appropriate comparator for new drugs; the appropriate comparator is set by G-BA. The outcome of the assessment will be used to determine the final price.
	Decision maker	The G-BA makes decisions on reimbursement eligibility of new pharmaceuticals based on their additional medical benefit compared to designated comparator
IQWiG Institute for Quality and Efficiency in Health Care	HTA	The IQWiG is an independent federal organization for evaluation of the medical benefit of new pharmaceuticals. IQWiG conducts benefit assessment commissioned by G-BA.
	Recommender	The IQWiG will recommend new pharmaceuticals depending on its assessments of their benefits.

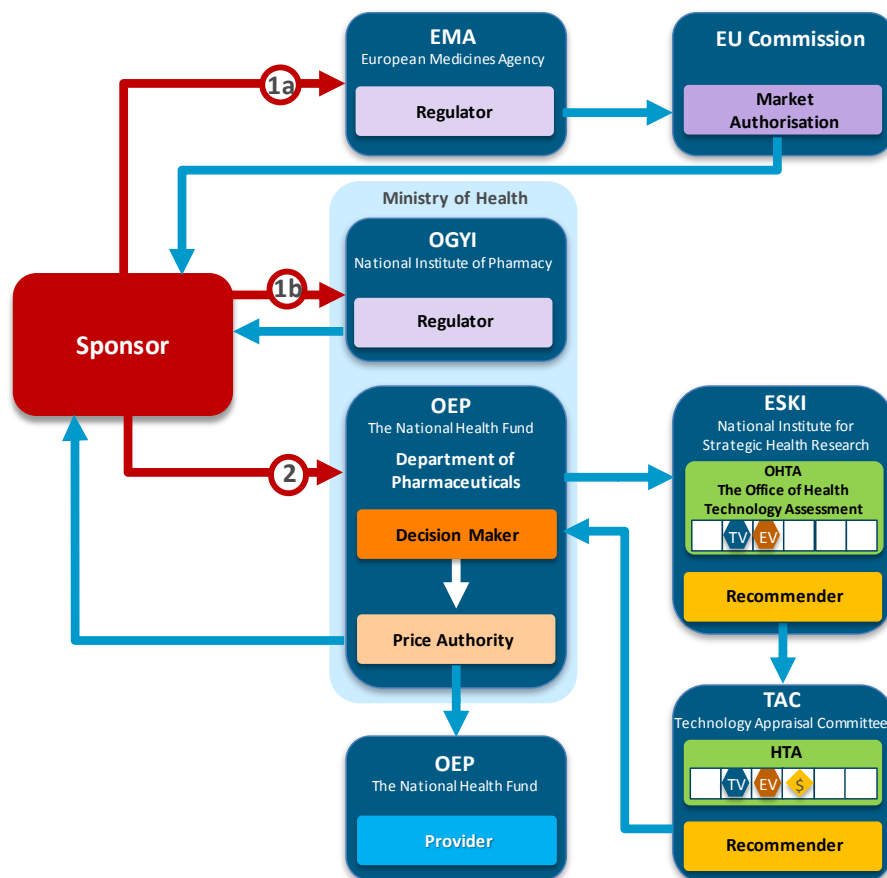
Process map for Greece
Version: February 2012



Agency (Committee)	Function	Key activity
EOF National Organisation for Medicines	Regulator	The EOF is the national agency responsible for regulation of pharmaceuticals. The EOF is operated under the Ministry of Health and Social Solidarity.
	Market Authorisation	The EOF is responsible for evaluation and approval of safe, effective medicinal products.
Department of Pricing of Medicinal Products Committee of Pricing of Medicinal Products	Recommender	The Department of Pricing of Medicinal Products and the Committee of Pricing of Medicinal Products will review the pricing application and provide advice to the Ministry of Health and Social Solidarity for pricing.
YYKA Ministry of Health and Social Solidarity	Price Authority	The Ministry of Health and Social Solidarity is the competent authority for drug pricing. The Ministry sets the wholesale, hospital and retail prices of medicines.
EOF Special Committee	Recommender	The special committee is appointed by EOF to set up a list of reimbursable medicinal products. The recommendation is sent to Minister for decision-making.
Minister of Labour and Social Security Minister of Health and Social Solidarity	Decision Maker	The Minister of Labour and Social Security and Minister of Health and Social Solidarity make a common decision to approve the list of reimbursable medicinal products suggested by the special committee.
GGKA General Secretariat of Social Security	Provider	The GGKA is the umbrella organization for 40 occupation-based sickness funds in Greece. The GGKA is responsible for the reimbursement of pharmaceuticals.

Process map for Hungary

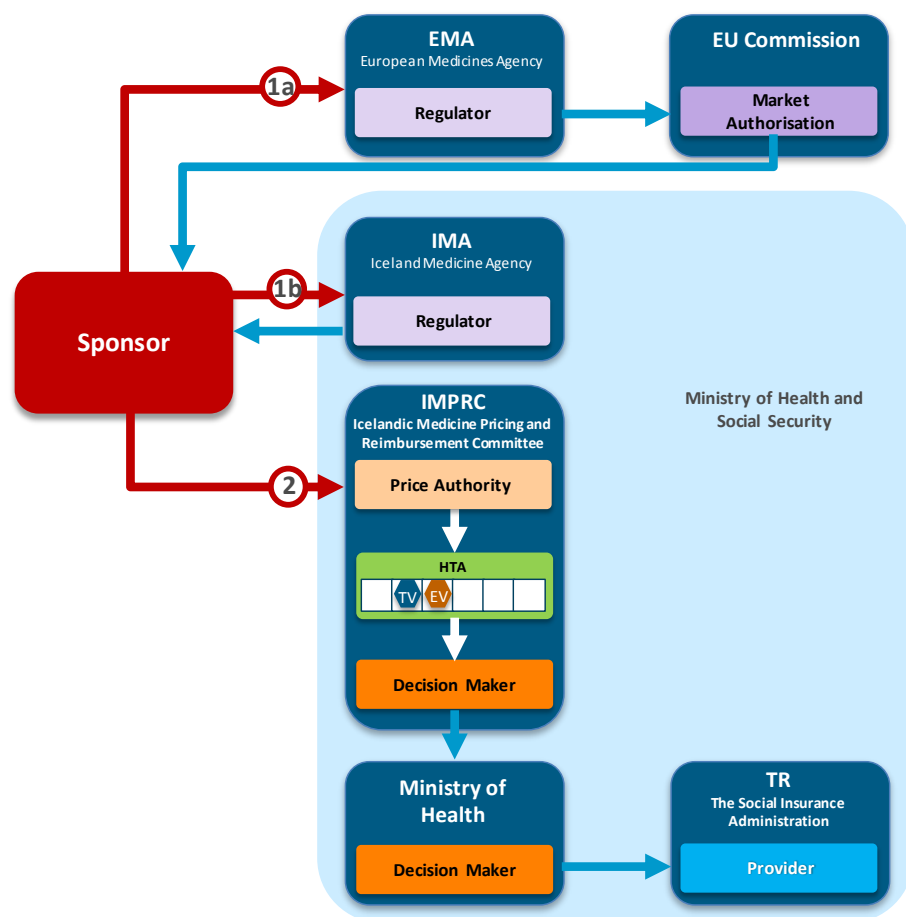
Version: November 2011



Agency (Committee)	Function	Key activity
OGYI National Institute of Pharmacy	Regulator	The OGYI is the regulatory agency responsible for marketing authorization and supervision of manufacturing, wholesale trade and retail trade of medicinal products and devices in Hungary.
	Market Authorisation	The OGYI grants market authorisation to medicinal products based on their efficacy, safety and quality.
OHTA (under ESKI) The Office of Health Technology Assessment	HTA	The Office of Health Technology Assessment (OHTA) is an independent institute within ESKI. The OHTA conducts pharmacoeconomic analysis and evaluates the efficacy and effectiveness of medicinal products.
	Recommender	The drug reimbursement application is submitted to the Department of Pharmaceutical in the OEP for registration. Afterwards, the OHTA makes critical appraisal based on the submitted dossier, the outcome is then forwarded to the TAC.
TAC Technology Appraisal Committee	HTA	The TAC assesses the reimbursement application regarding the efficacy and cost-effectiveness information, burden of the disease and budget impact.
	Recommender	The TAC conducts drug evaluation based on the appraisal from OHTA. The TAC provides recommendation to the OEP for reimbursement decision.
OEP The National Health Fund	Decision Maker	The Department of Pharmaceuticals in OEP makes decision on the drug reimbursement under advice from TAC.
	Price Authority	The market authorisation holder negotiates the price with the OEP for reimbursable drugs. The pricing process is integrated in the reimbursement procedure.

Process map for Iceland

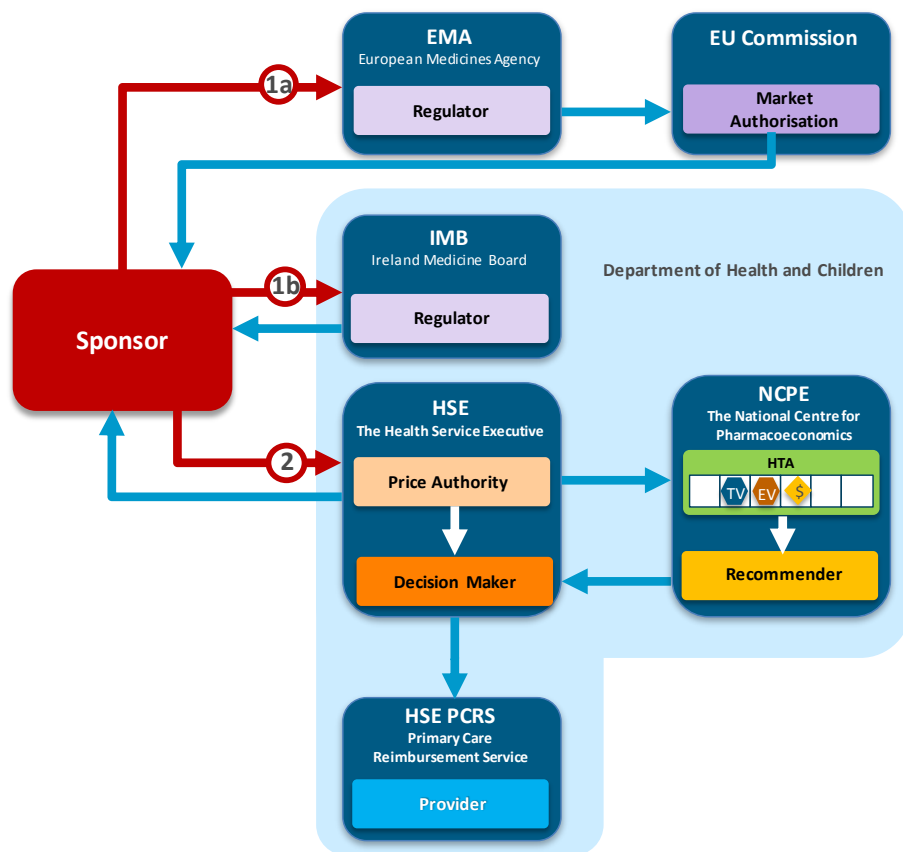
Version: November 2011



Agency (Committee)	Function	Key activity
IMA Iceland Medicine Agency	Regulator	The IMA is the regulatory agency under the Ministry of Health and Social Securities. The main responsibilities of IMA are assessment, inspection and market authorisation of medicinal products.
	Market Authorisation	The IMA grants market authorisation to medicinal products based on their quality, safety and efficacy.
IMPRC Icelandic Medicine Pricing and Reimbursement Committee	Price Authority	The IMPRC makes decision on the wholesale price of pharmaceuticals.
	HTA	The IMPRC assesses drugs regarding their safety, therapeutic value and evaluates pharmacoeconomic data and budget impact.
	Decision Maker	The IMPRC grants reimbursement approvals to pharmaceuticals. The reimbursement rate will be set by the Ministry of Health.
Minister of Health	Decision Maker	The Ministry of Health sets the National Reimbursement Code for reimbursable drugs based on the ATC code. The reimbursement rate of drugs is dependent on the category of the Reimbursement Code.
TR The Social Insurance Administration	Provider	The Social Insurance Administration is a governmental service institution that manages the Icelandic Health Insurance.
IMA Iceland Medicine Agency	Regulator	The IMA is the regulatory agency under the Ministry of Health and Social Securities. The main responsibilities of IMA are assessment, inspection and market authorisation of medicinal products.

Process map for Ireland

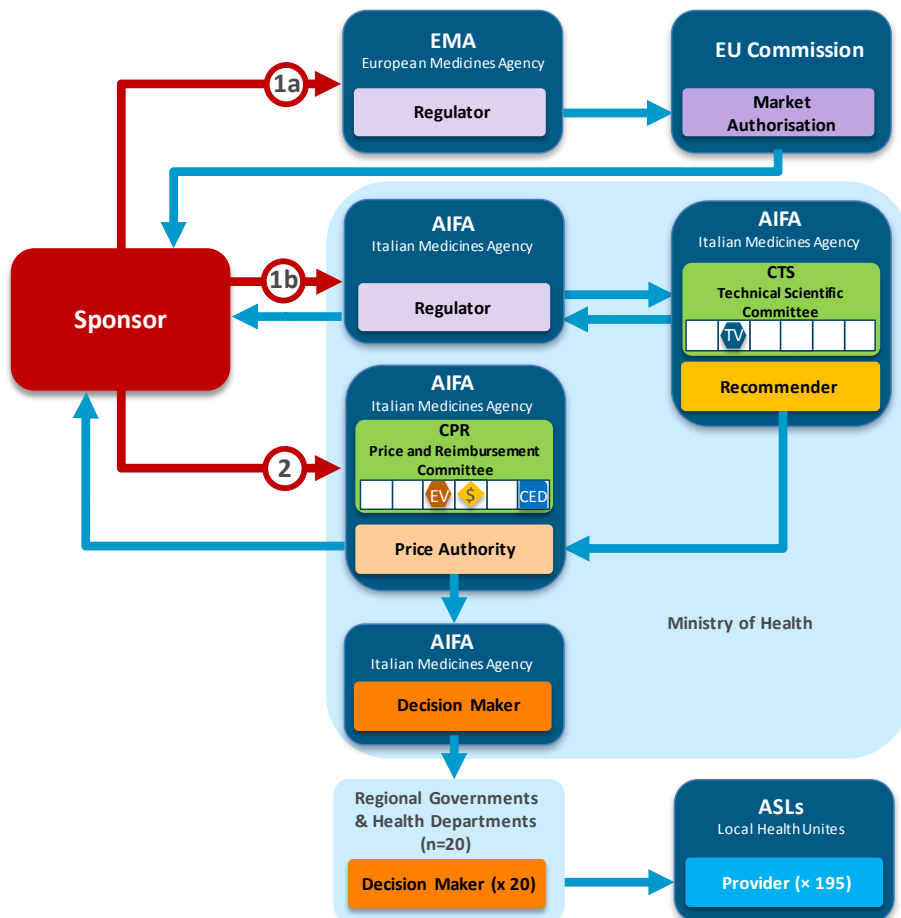
Version: May 2014



Agency (Committee)	Function	Key activity
IMB Irish Medicine Board	Regulator	The IMB is the regulatory agency under the Department of Health and Children responsible for the regulation of medicine, medical devices and healthcare products.
	Market Authorisation	The IMB evaluates and grants market authorisation to new medicines to ensure the quality, safety and efficacy of medicines available in Ireland.
NCPE The National Centre for Pharmacoeconomics	HTA	The reimbursement application is sent to the Health Service Executive (HSE). The NCPE reviews the cost-effectiveness and budget impact of the new medicines for the HSE.
HSE The Health Service Executive	Price Authority	The HSE sets the wholesale price of new medicines.
	Decision Maker	The HSE makes decisions on the reimbursement of pharmaceuticals based on the pharmacoeconomic evaluations by NCPE.
HSE PCRS Primary Care Reimbursement Service	Provider	The Primary Care Reimbursement Service makes payment for healthcare service and provides the reimbursement of pharmaceutical products on behalf of HSE.

Process map for Italy

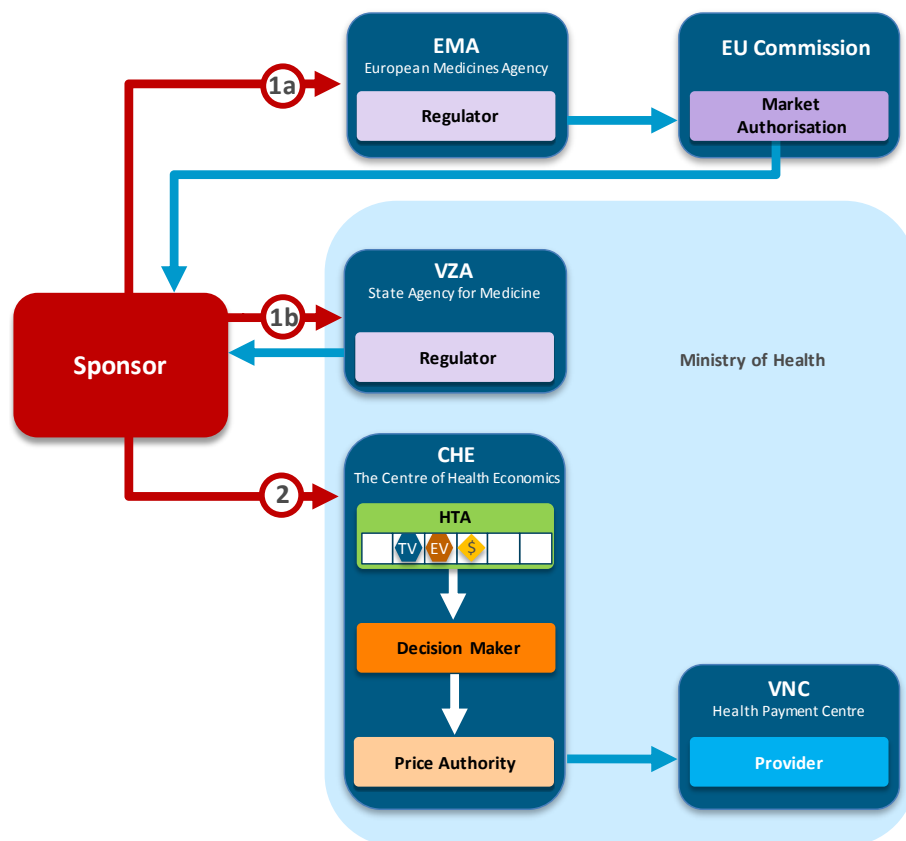
Version: May 2014



Agency (Committee)	Function	Key activity
AIFA Italian Medicine Agency	Regulator	The AIFA is the national authority responsible for the drug regulation in Italy. The key activities of AIFA include registration of medicinal products, post-marketing surveillance, pricing and reimbursement of medicines.
AIFA Italian Medicine Agency	Market Authorisation	The technical scientific committee (CTS) of the AIFA evaluates pharmaceuticals regarding their quality, safety and efficacy, the AIFA grants the market authorisation to the new drugs based on the assessment by CTS.
CTS (within AIFA) Technical Scientific Committee	HTA	The CTS assess the therapeutic benefit and the level of innovation of new medicinal products.
CTS (within AIFA) Technical Scientific Committee	Recommender	The CTS provide classification of the new medicinal products for reimbursement according to homogeneous therapeutic category.
CPR (within AIFA) Price and Reimbursement Committee	Price Authority	The CPR negotiates price of reimbursable drugs with manufacture. The criteria for pricing include therapeutic value assessment by CTS, innovation level, cost-effectiveness, budget impact, price and consumption data in other European countries.
AIFA Italian Medicine Agency	Decision Maker	The AIFA makes decision on the price and reimbursement status of new medicinal products. The decision is officially published in a decree.
Regional Governments & Health Department (x20)	Decision Maker	Twenty regions implement the coverage decision by the AIFA according to their own resources. The regionalisation results in variance in level of co-payment across the country.
ASLs Local Health Unites (x195)	Provider	The healthcare provision is organized and managed by ASL at local level.

Process map for Latvia

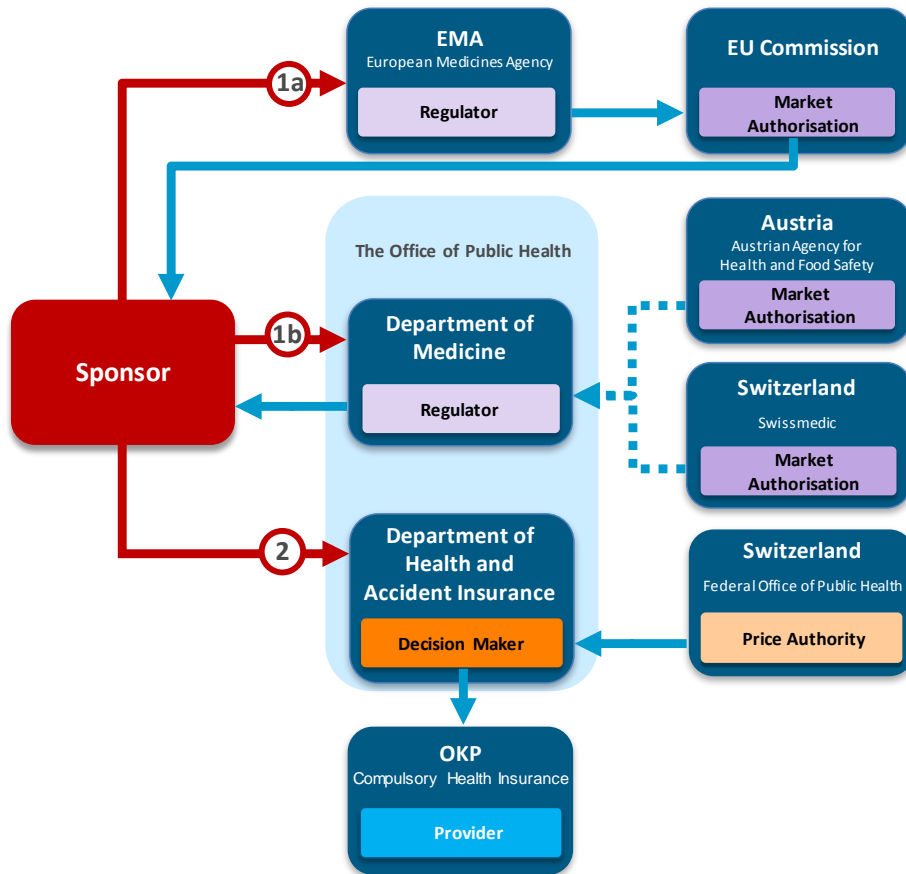
Version: December 2011



Agency (Committee)	Function	Key activity
VZA State Agency for Medicine	Regulator	The VZA is the Regulatory Authority under the Ministry of Health to ensure availability of efficient, safe and qualitative medicines for the Latvian population.
	Market Authorisation	The VZA grants market authorisations for new medicines based on their efficacy, safety and quality.
CHE Centre of Health Economics	HTA	The CHE is the state institution operated under the Ministry of Health to ensure the most effective use of the state budget in providing health care services. The CHE evaluates pharmaceuticals regarding the therapeutic value, the cost-effectiveness data, the burden of the disease and the budget impact.
	Decision Maker	The CHE makes decisions on the reimbursement of pharmaceuticals based on the therapeutic and financial assessment.
	Price Authority	The CHE makes decision on the price for reimbursable pharmaceuticals.
VNC Health Payment Centre	Provider	The VNC is operated under the Ministry of Health to administrate the state budgetary funds for health care and provide health care services.

Process map for Liechtenstein

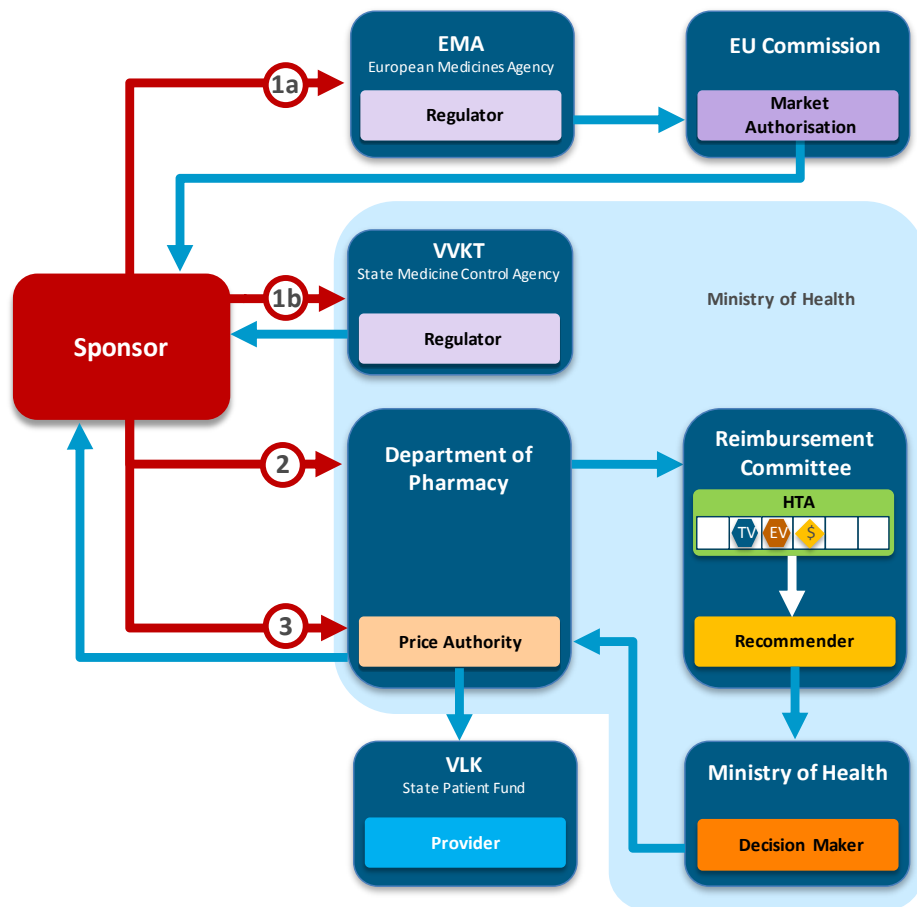
Version: February 2012



Agency (Committee)	Function	Key activity
Department of Medicine	Regulator	The Department of medicine is a regulatory body operated under the Office of Public Health. The main responsibility of the Department includes inspections, market authorisations and market surveillance of pharmaceutical products
	Market Authorisation	The Department is responsible for granting market authorisation to new medicines based on their quality, safety and efficacy. Based on the Agreement between the Governments of Austria and Liechtenstein, medicines approved in Austria will be recognized automatically in Liechtenstein. Medicines approved by Swissmedic (in Switzerland) that contain new active substances will be recognized in Liechtenstein after 12 months.
Switzerland Federal Office of Public Health	Price Authority	The pricing for medicines in Liechtenstein is proposed according to the price set by the Federal Office of Public Health in Switzerland.
Department of Health and Accident Insurance	Decision Maker	The Department of Health and Accident Insurance decides whether to adopt the drug price set in Switzerland and the reimbursement status of the medicines.
OKP Compulsory Health Insurance	Provider	OKP provides the payment and coverage for healthcare service in Liechtenstein.

Process map for Lithuania

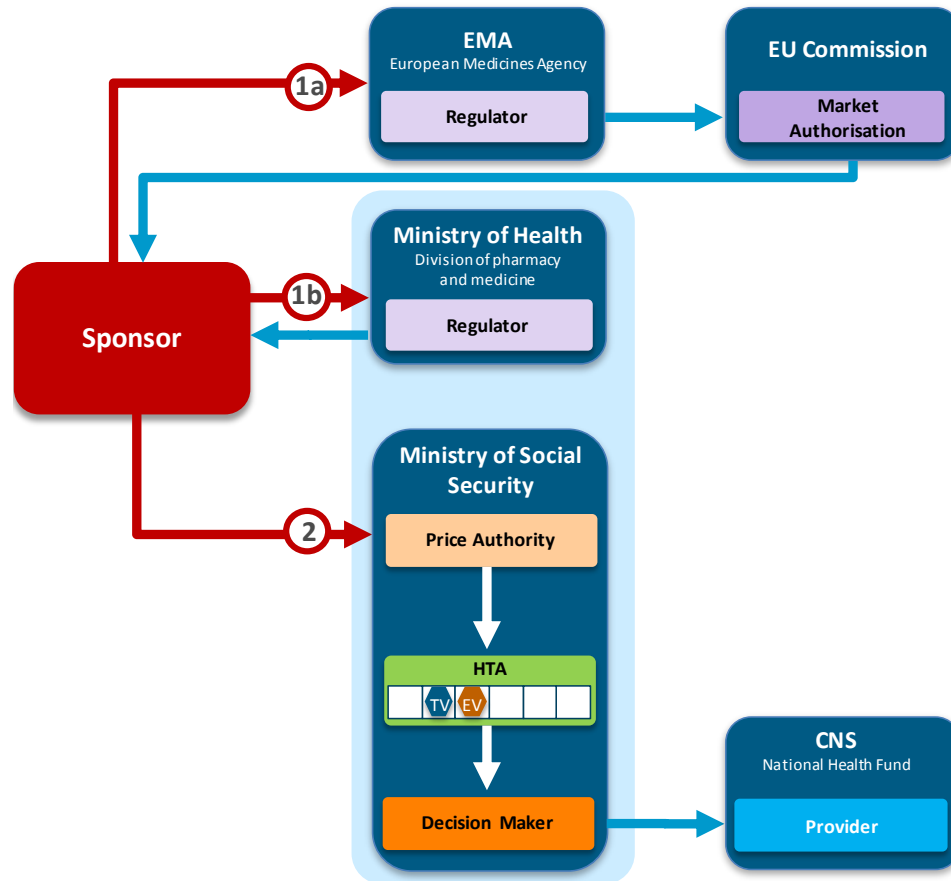
Version: December 2011



Agency (Committee)	Function	Key activity
VVKT State Medicine Control Agency	Regulator	The VVKT is operated under the Ministry of Health, its responsibilities include granting marketing authorisation, classifying pharmaceuticals, pharmacovigilance, inspections and distribution of pharmaceuticals.
	Market Authorisation	The VVKT protects public health through the evaluation and supervision of medicines for human use. The market authorisation is issued based on the assessment of efficacy, safety and quality of medicinal products.
Reimbursement Committee	HTA	The drug reimbursement application is sent to the Department of Pharmacy, after registration the application is forwarded to the Reimbursement Committee for assessment. The Committee evaluates the therapeutic value, cost-effectiveness, safety and budget impact.
	Recommender	The Reimbursement Committee makes recommendations on the drug reimbursement based on its evaluation; the result is sent to the Ministry of Health.
Ministry of Health	Decision Maker	The Ministry of Health is responsible for organizing the Reimbursement Committee to evaluate the reimbursement application. The Ministry of Health makes the final decision based on the assessment from the Committee.
	Price Authority	The Department of Pharmacy under the Ministry of Health sets the price for reimbursable medicines. The pricing application is made separately to the department after the reimbursement approval.
VLK State Patient Fund	Provider	The VLK provides coverage for health care under the supervision of the Ministry of Health.

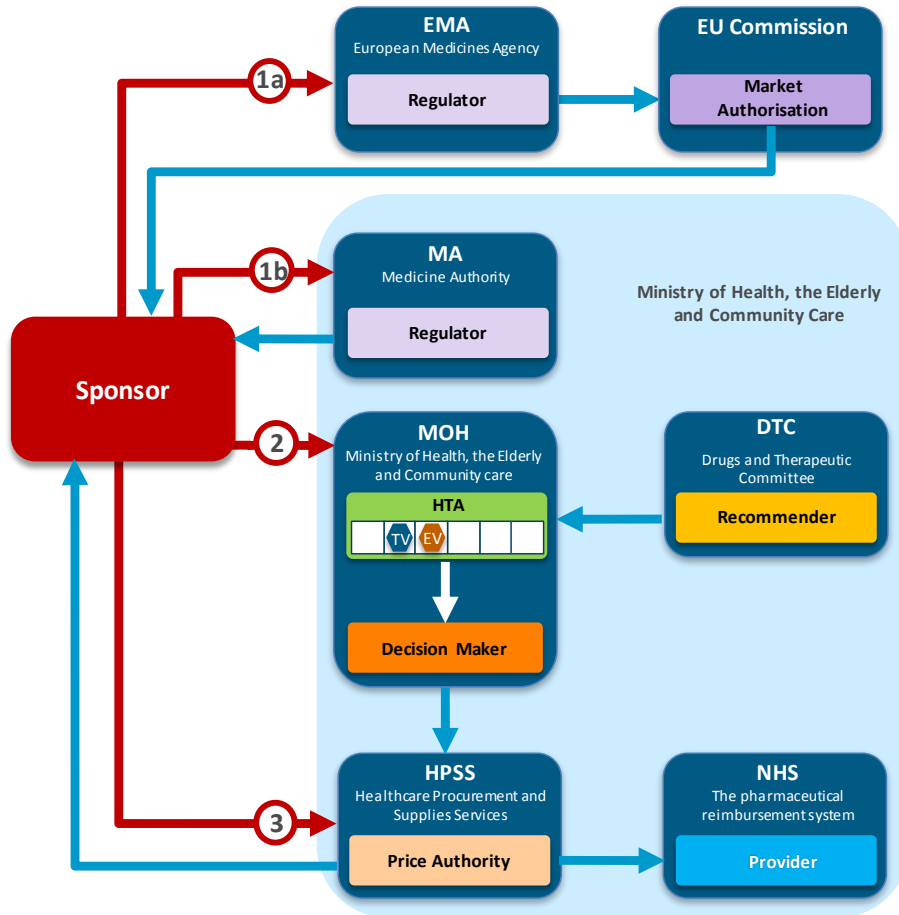
Process map for Luxembourg

Version: November 2011



Agency (Committee)	Function	Key activity
Ministry of Health Division of Pharmacy and Medicines	Regulator	The Ministry of Health is in charge of health policy and legislation, the Division of Pharmacy and Medicines within the Ministry of Health is responsible for the authorisation of pharmaceuticals, post-marketing surveillance and the supervision of the practice of professional pharmacists.
	Market Authorisation	The Division of Pharmacy and Medicines assesses drug applications regarding their efficacy, safety and quality. Based on the positive outcome of the assessment, the Ministry of Health issues market authorisation for medicinal products.
Ministry of Social Security	Price Authority	The Ministry of Social Security fixes the pharmacy retail price of pharmaceuticals.
	HTA	The market authorisation holder submits drug applications to Ministry of Social Security for inclusion on the positive list. The key criteria of assessment are the therapeutic value of the medicine, cost-effectiveness and patient need.
	Decision Maker	The Ministry of Social Security makes decision on the inclusion of medicinal products on the positive list.
CNS National Health Fund	Provider	Reimbursement provided by the CNS is calculated based on the cheapest price of generic drugs containing the same active ingredients. Patients are eligible to accept the branded or generic formulations. However, they will be responsible for any extra medication costs that are not covered by the CNS.

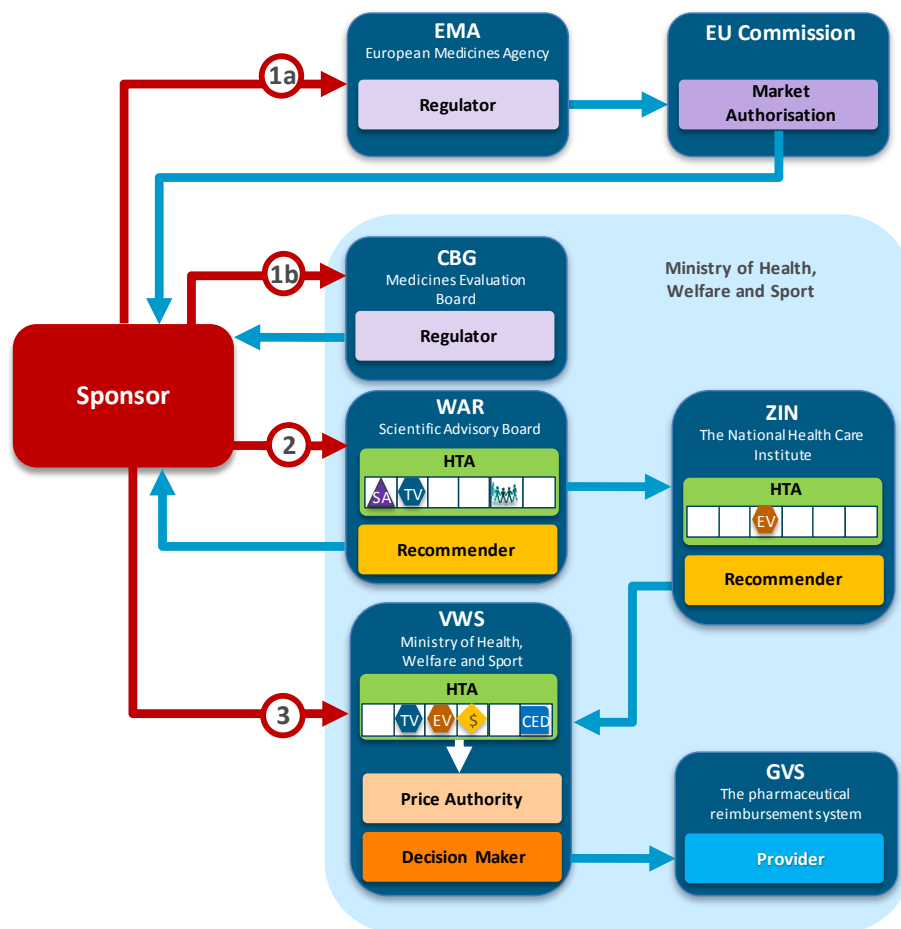
Process map for Malta
Version: November 2011



Agency (Committee)	Function	Key activity
MA Medicine Authority	Regulator	The MA is the regulatory agency for national public health. The main activities of the MA include the regulation of the safety, quality and efficacy of medicinal products in the Maltese market, post market surveillance and monitoring of advertisements for medicinal products.
	Market Authorisation	The MA is responsible for issuing market authorisation and classification of pharmaceuticals.
DTC Drug and Therapeutic Committee	Recommender	The DTC provides recommendations to the MOH for the inclusion of medicinal products in the national formulary.
MOH Ministry of Health, the Elderly and Community Care	HTA	The MOH assesses medicinal products regarding their efficacy, safety, cost and cost-effectiveness and their allocation of resources.
	Decision Maker	The MOH makes decisions on the inclusion of medicinal products in the national formulary with advice from the DTC.
HPSS Healthcare Procurement and Supplies Services	Price Authority	The HPSS is set up within the MOH for the procurement of pharmaceuticals. The HPSS makes decisions on the price of pharmaceuticals in the NHS system via tendering.
NHS National Health Insurance	Provider	The NHS provides full reimbursements for pharmaceuticals listed on the national formulary.

Process map for the Netherlands

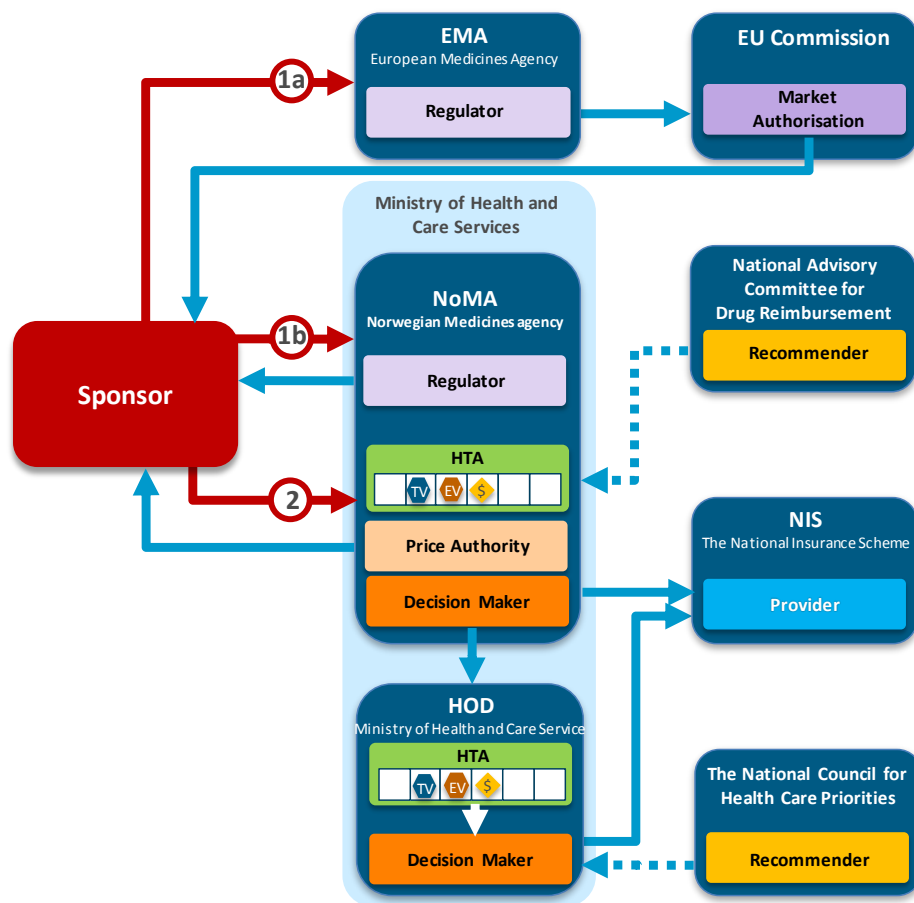
Version: May 2014



Agency (Committee)	Function	Key activity
CBG/MEB Medicines Evaluation Board	Regulator	The CBG/MEB is part of Ministry of Health, Welfare and Sport that regulates medicinal products for human use.
	Market Authorisation	The CBG/MEB is responsible for market authorisation of pharmaceuticals, registration of medical devices and monitoring the safety of medicines.
WAR Scientific Advisory Board	HTA	The WAR assesses the therapeutic value for new pharmaceuticals based on efficacy, effectiveness and their applicability.
	Recommender	The WAR performs assessment on pharmaceuticals to advise ZIN. The WAR decides whether the new drugs are therapeutically interchangeable (to be included in the reference price system) or not interchangeable (no reimbursement limit) based on its assessment.
ZIN The National Health Care Institute	HTA	On 1 April 2014, the CVZ, as a result of a task expansion in the areas of Quality and Innovation, changed its name to National Health Care Institute (ZIN). The National Health Care Institute performs pharmacoeconomic assessment for new pharmaceuticals and provides advice on reimbursement to VWS.
	Recommender	The National Health Care Institute provides recommendations to the VWS for reimbursement decisions.
VWS Ministry of Health, Welfare and Sport	HTA	The VWS assesses the reimbursement applications based on recommendations from CFH. The reimbursement decision will be based on an assessment of cost-effectiveness and budget impact.
	Decision maker	The VWS makes decisions on the reimbursement category and reference reimbursement price.
GVS The pharmaceutical reimbursement system	Provider	The GVS a system for claiming the drug reimbursement. The coverage by the drug reimbursement system is based on the classification of drugs into groups of interchangeable drugs

Process map for Norway

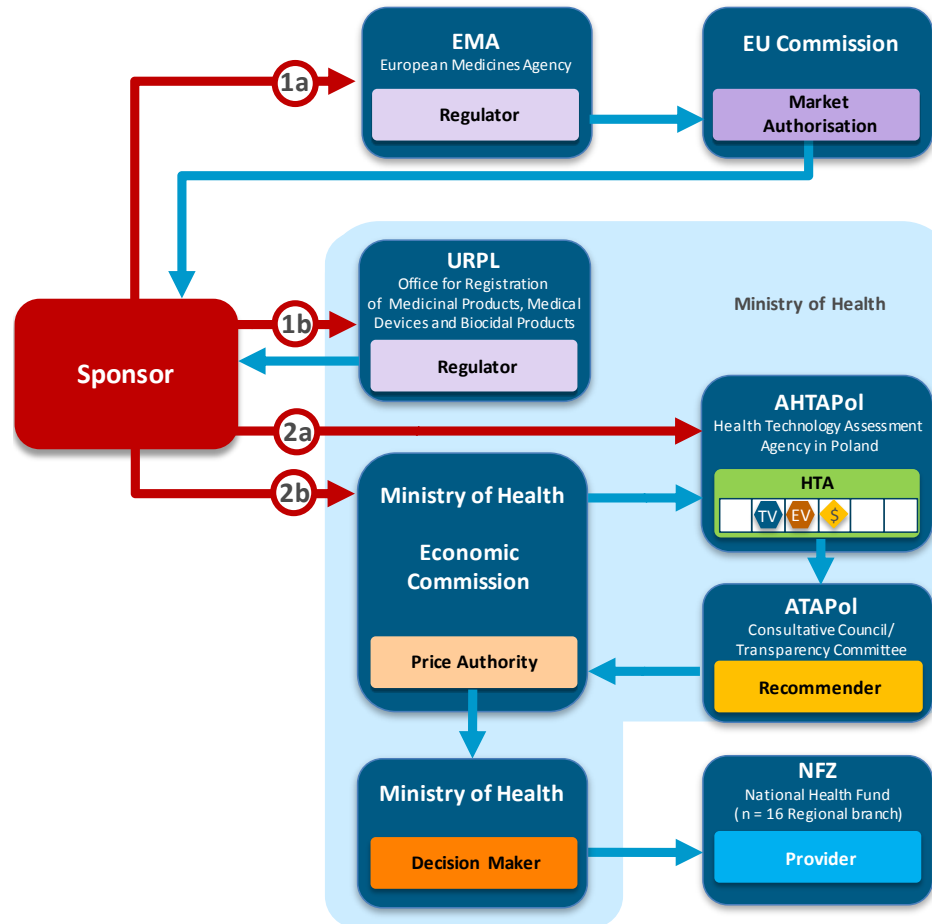
Version: April 2012



Agency (Committee)	Function	Key activity
NoMA Norwegian Medicines Agency	Regulator	The NoMA is the national agency that regulates drugs and medical devices. The key activities of NoMA include: supervision of clinical trials, supervision of manufacture and distribution of pharmaceuticals, authorisation and post marketing control of pharmaceuticals.
	Market Authorisation	The NoMA is responsible for granting market authorisations for pharmaceuticals and the registration of medical devices. It ensures cost-efficient, effective and rational use of medicines.
	HTA	The NoMA assesses both the therapeutic value and the cost-effectiveness of drugs.
	Price Authority	The NoMA makes decisions on the maximum price based on international price comparisons and determines the reimbursement price of drugs that are covered by the National Insurance Scheme (NIS).
	Decision maker	The NoMA makes decisions on reimbursement if the annual budget impact is less than 5 million Norwegian Krone (NOK) by the fifth year of approval.
HOD Ministry of Health and Care Service	HTA	The HOD evaluates the drug reimbursement application. It acts under advice from The National Council for Health Care Priorities.
	Decision maker	The HOD makes decision on reimbursement if the annual budget impact is more than five million Norwegian Krone (NOK) by the fifth year of approval.
National Advisory Committee for Drug Reimbursement	Recommender	The National Advisory Committee for Drug Reimbursement is an external committee that advises the NoMA on the decision of drug reimbursement. It provides advice regarding verification of documentation, severity of disease and clinical criteria.
The National Council for Health Care Priorities	Recommender	The National Council for Health Care Priorities provides recommendations to the HOD on decisions of drug reimbursement.
NIS The national insurance scheme	Provider	The NIS reimburses the cost of drugs.

Process map for Poland

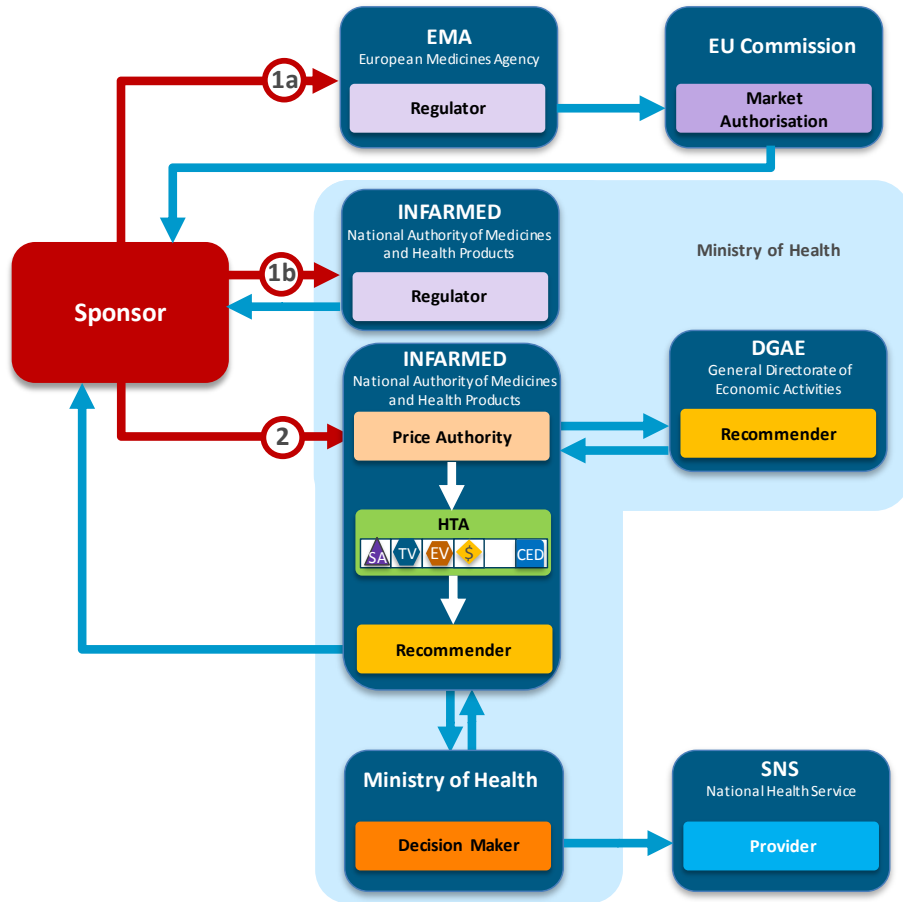
Version: January 2012



Agency (Committee)	Function	Key activity
URPL Office for Registration of Medicinal Products, Medical Devices and Biocidal Products	Regulator	The URPL is a government administrative authority under the Ministry of Health (MZ). The URPL is responsible for authorisation, classification and pharmacovigilance of pharmaceutical products.
	Market Authorisation	The URPL grants market authorisations for medicinal products, medical devices and biocidal products.
AHTAPol Health Technology Assessment Agency in Poland	HTA	AHTAPol assesses drug applications based on the therapeutic value, pharmacoeconomics studies and financial consequences to the healthcare system.
	Recommender	AHTAPol serves as an advisory body to support the MZ in the decision making process.
Consultative Council	Recommender	The Consultative Council is an advisory, independent body with 10 highly qualified members appointed by the Minister of Health. The HTA appraisal is prepared by the Consultative Council and the President of AHTAPol.
MZ Ministry of Health	Price Authority	The MZ decides on the price for reimbursed drugs. The price is set through a negotiation with the Drug Management Team.
	Decision Maker	The Minister of Health makes the final decision for drug pricing and reimbursement. The Minister is not obliged to follow the recommendation from AHTAPol.
NFZ National Health Fund (16 regional branches)	Provider	The NFZ was set up under the control of MZ and organized in 16 regional branches. The NFZ provides coverage for the healthcare service.

Process map for Portugal

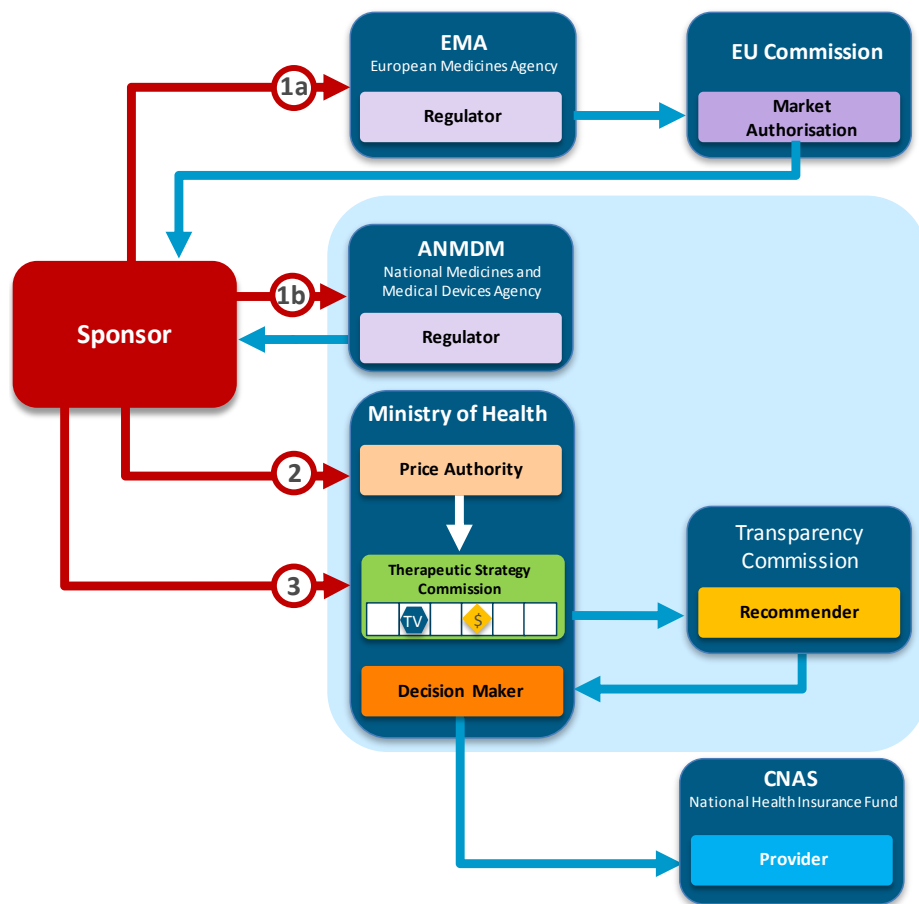
Version: June 2014



Agency (Committee)	Function	Key activity
INFARMED National Authority of Medicines and Health Products	Regulator	The INFARMED is the regulatory agency in Portugal. The key activities of INFARMED include evaluation, market authorisation, regulation and control of medicinal products, medical devices and cosmetics.
	Price Authority	The INFARMED is the authority responsible for price approval of medicinal products, having replaced DGAE in August 2012. INFARMED establishes the maximum price for the medicinal product and the application is then forwarded to the DGAE for auditing.
	Market Authorisation	The INFARMED issues market authorisation to new drugs based on its quality, efficacy and safety.
	HTA	The INFARMED assesses medicinal products regarding its therapeutic value and economic advantages.
	Recommender	The INFARMED provides its recommendation to the Minister of Health for a formal decision. Upon the positive decision from the Minister of Health, the INFARMED issues an official approval letter for reimbursement to the manufacturer.
DGAE General Directorate of Economic Activities	Recommender	The DGAE is the former public entity responsible for pricing. The DGAE will continue to be consulted, by issuing non-binding secondary opinion to INFARMED.
Minister of Health	Decision Maker	Based on a positive outcome of assessment by INFARMED, the Minister of Health makes the decision on reimbursement approval.
SNS National Health Insurance	Provider	The costs of reimbursable drugs are covered by the SNS. There are four reimbursement levels (90%, 69%, 37%, 15%) based on the therapeutic value of the medicinal products.

Process map for Romania

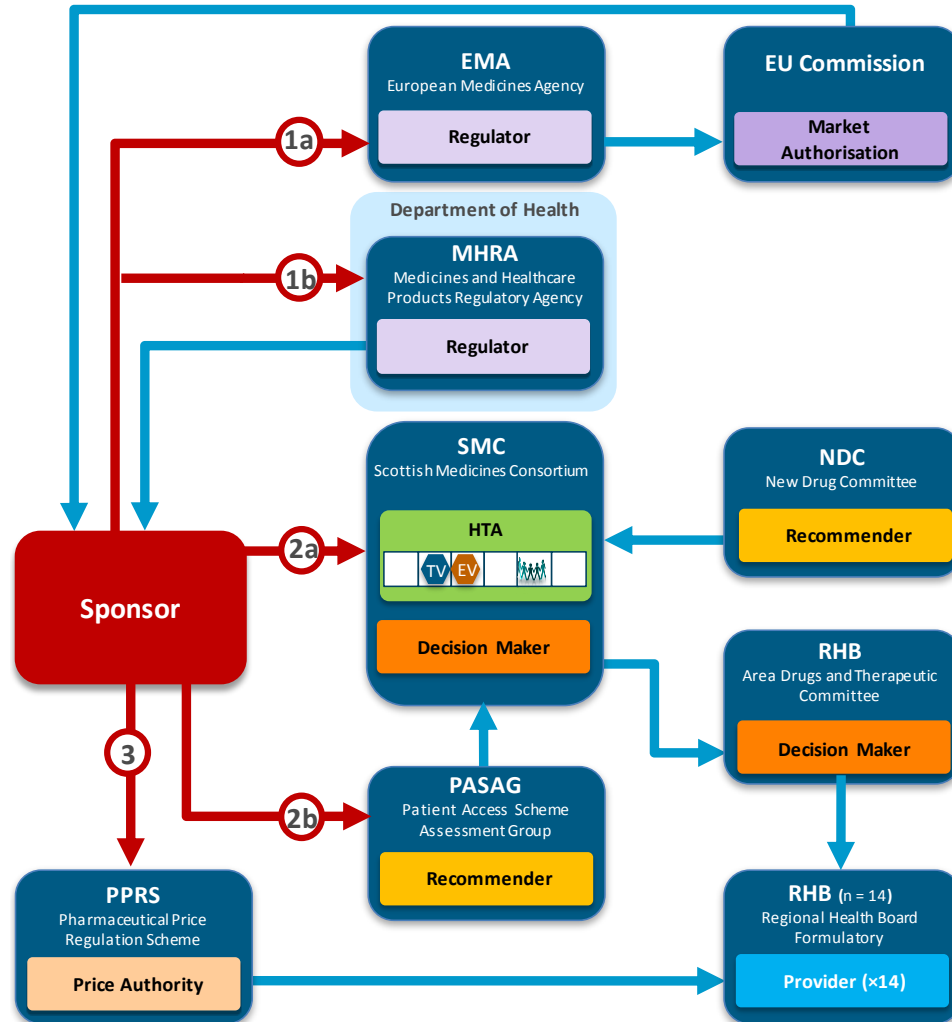
Version: December 2011



Agency (Committee)	Function	Key activity
ANMDM National Medicines and Medical Devices Agency	Regulator	The ANMDM is the regulatory agency operated under the Ministry of Health. The key activities of the ANMDM include the evaluation, authorisation and surveillance of medicinal products.
	Market Authorisation	The ANMDM grants market authorisation to high quality, safe and effective medicinal products for human use.
Ministry of Health	Price Authority	The Directorate for Strategies and Medicine Policy under the Ministry of Health sets price for prescription only medicines.
	HTA	The reimbursement procedure is set by the Ministry of Health. The Therapeutic Strategy Commission assesses product applications for inclusion in the reimbursement list. The effectiveness, efficacy and safety of products are evaluated; no pharmacoeconomic analysis is required.
	Recommender	The reimbursement list proposed by the Therapeutic Strategy Commission is sent to the Transparency Commission. The Transparency Commission endorses the list and forwards it to the Minister of Health.
	Decision Maker	The Minister of Health signs the final list of reimbursement products. The Ministry is the decision maker that sets the reimbursement rate and reimbursement price for pharmaceuticals.
CNAS National Health Insurance Fund	Provider	The CNAS is the umbrella organisation of regional and nationwide sickness funds. The CNAS provides coverage for reimbursable medicines.

Process map for Scotland

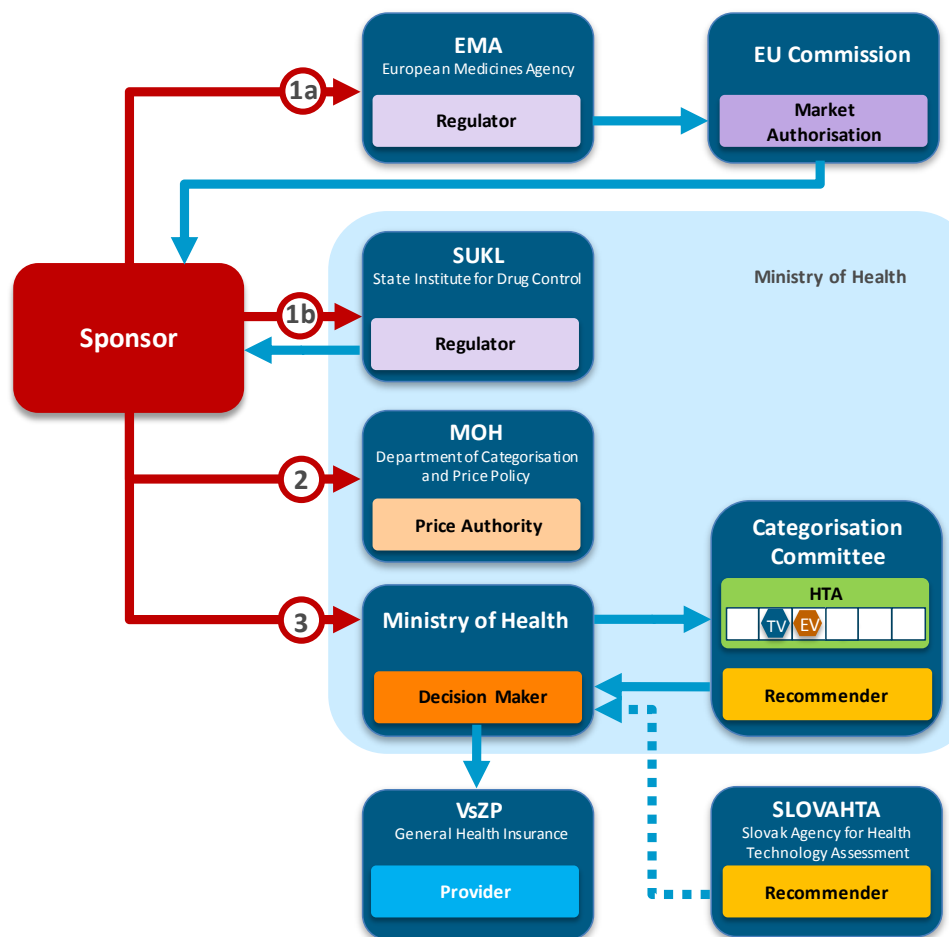
Version: May 2014



Agency (Committee)	Function	Key activity
MHRA Medicines and Healthcare products Regulatory Agency	Regulator	The MHRA is a government agency that regulates medicines on the basis of safety, quality and efficacy.
	Market Authorisation	The MHRA authorises marketing licences for new drugs.
SMC Scottish Medicines Consortium	HTA	The Scottish Medicines Consortium was established to assess all new medicines for use in Scotland. The SMC assess the efficacy, comparative safety and cost-effectiveness of new drugs.
	Decision maker	The Scottish Medicines Consortium (SMC) makes final decision to advise to NHS Boards and their Area Drug and Therapeutics Committees (ADTCs) across Scotland whether they are cost effective for use in Scotland.
NDC New Drug Committee	Recommender	Applications submitted to SMC will be reviewed by the New Drug Committee (NDC) first; the NDC will provide a draft advice to companies. Companies will have a chance to respond to the advice before submit the application to the SMC for final decision.
PASAG Patient Access Scheme Assessment Group	Recommender	The Patient Access Scheme (PAS) is a scheme proposed by a pharmaceutical company in order to improve the cost-effectiveness of a medicine. The application for PAS will be reviewed by the Patient Access Scheme Assessment Group.
PPRS Pharmaceutical Price Regulation Scheme	Price Authority	The PPRS regulates the price indirectly by controlling the profit of the pharmaceutical companies.
RHB (x14) Regional Health Board	Decision maker	Each Health Board has an Area Drugs and Therapeutic Committee (AD&TC) which advise on the use of medicines within their geographical location. The ADTC and Health Board provide decisions for the provision of drug based on the SMC recommendation.
	Provider	The 14 Health Boards in Scotland are responsible for the provision of health care to their area.

Process map for Slovakia

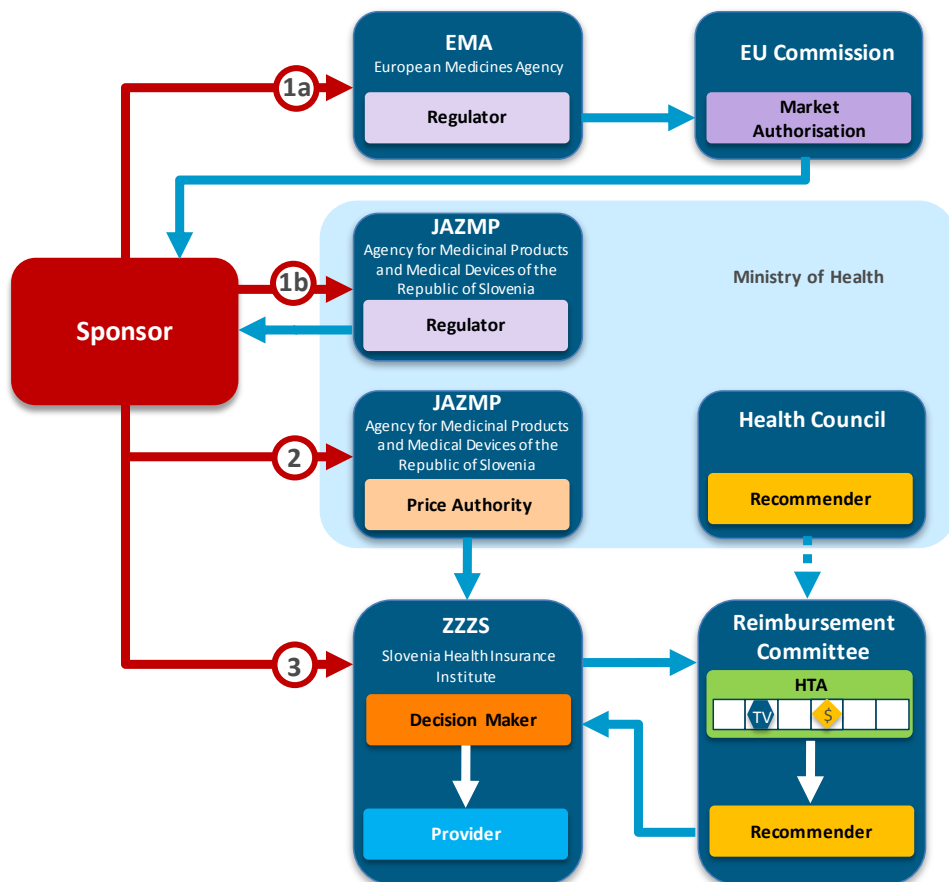
Version: December 2011



Agency (Committee)	Function	Key activity
SUKL State Institute for Drug Control	Regulator	The SUKL is operated under the Ministry of Health. The SUKL is responsible for the authorisation and classification of pharmaceuticals, as well as for the vigilance and the examination of market players in the pharmaceutical system.
	Market Authorisation	The SUKL issues market authorisation to new medicines based on their efficacy, safety and quality.
MOH Department of Categorisation and Price Policy	Price Authority	The MOH sets the retail price for reimbursable drugs.
MOH Categorisation Committee	HTA	The Categorisation Committee is set up under the Ministry of Health to assess drug applications for reimbursement. The Committee evaluates the therapeutic benefit and economic data of products.
	Recommender	The Committee provides recommendation to the Minister of Health based on its medical and economical assessment.
Minister of Health	Decision Maker	The Minister of Health makes decisions on the inclusion of drugs in the reimbursement list and on reimbursement rates.
SLOVAHTA Slovak Agency for Health Technology Assessment	HTA	The SLOVAHTA is a not-for-profit organization that carries out activities to provide information on health technologies. It is not involved in official procedure of pricing and reimbursement.
VsZP General Health Insurance	Provider	The VsZP provides coverage of the cost for reimbursable pharmaceuticals.

Process map for Slovenia

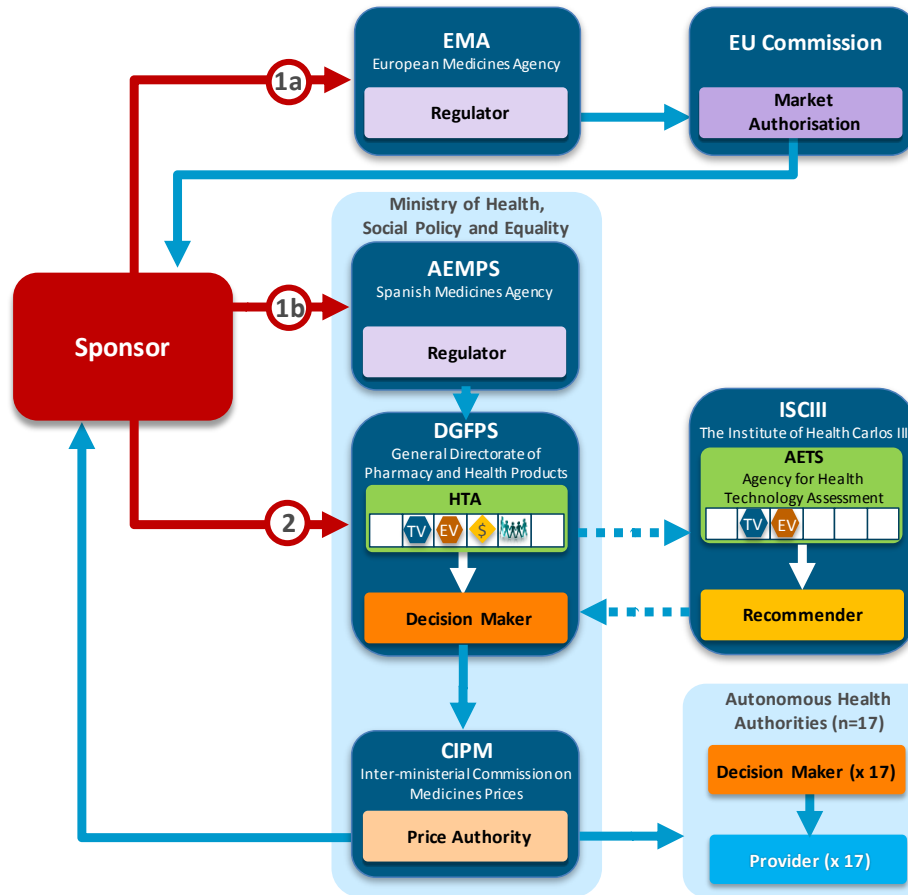
Version: December 2011



Agency (Committee)	Function	Key activity
JAZMP Agency for Medicinal Products and Medical Devices of the Republic of Slovenia	Regulator	The JAZMP is operated under the Ministry of Health to implement national policies and legislation for medicines, medical devices, blood, tissues and cells with the aim of protecting public health.
	Market Authorisation	The JAZMP is responsible for marketing authorisation, registration and classification of pharmaceuticals based on the assessment of their efficacy, safety and quality.
JAZMP Agency for Medicinal Products and Medical Devices of the Republic of Slovenia	Price Authority	The JAZMP sets up statutory pricing at the wholesale level for pharmaceuticals. The pricing decision is sent to Slovenia Health Insurance Institute (ZZS) for reimbursement evaluation. If the price exceeds the limit set by the Slovenia Health Insurance Institute, the drug cannot be reimbursed.
ZZS Slovenia Health Insurance Institute Reimbursement Committee	HTA	The Reimbursement Committee is set up under the ZZS to evaluate the drugs applications for reimbursement. The Committee assesses the efficacy and indications of each drug.
	Recommender	The Committee advises the ZZS on drug reimbursement.
Health Council	Recommender	The Health Council is the highest coordination expert body that advises the Ministry of Health on important health issues. The Health Council may provide advice to the Reimbursement Committee on drug reimbursement.
ZZS Slovenia Health Insurance Institute	Decision Maker	The ZZS makes decision on the reimbursement of pharmaceuticals regarding the reimbursement category, the reimbursement rates and the reimbursement price.
	Provider	The ZZS aims to provide efficient distribution of public funds for national health care.

Process map for Spain

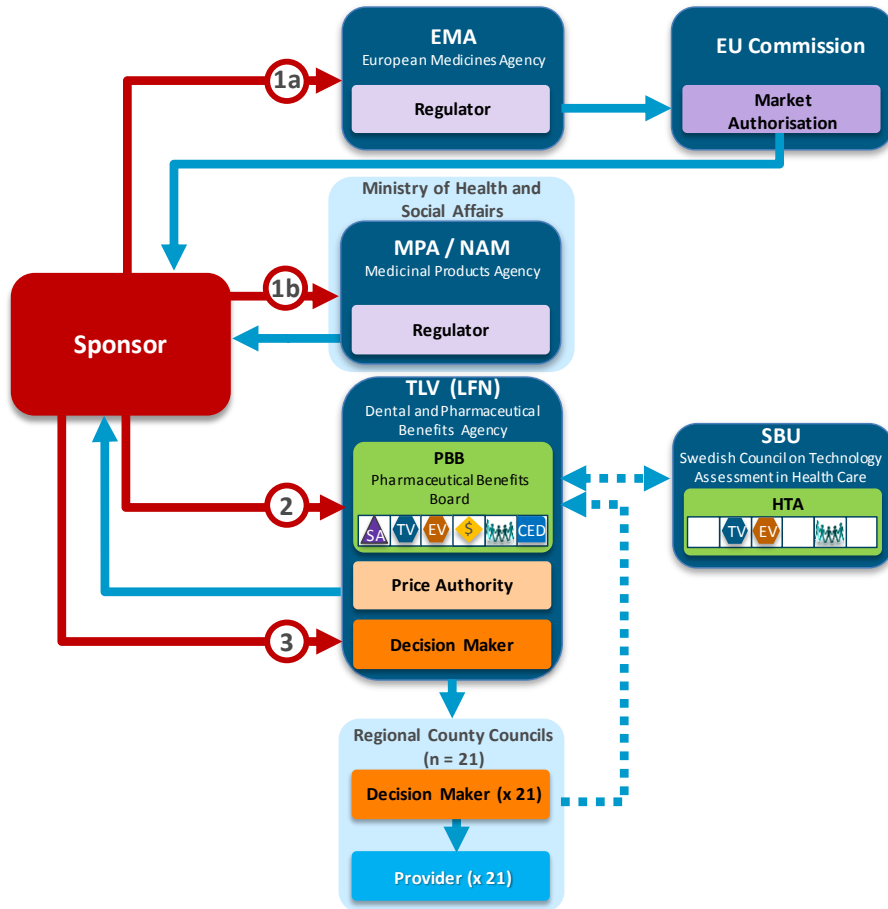
Version: May 2014



Agency (Committee)	Function	Key activity
AEMPS Spanish Medicines Agency	Regulator	The AEMPS, as the regulatory agency under the Ministry of Health, Social Policy and Equality, is responsible for the evaluation, market authorisation, inspection and post-market surveillance of pharmaceuticals. Within AEMPS, GCPT (Therapeutic Positioning Coordination Group), in coordination with DGFPS and the Autonomous Health Authorities, prepares a national therapeutic positioning report (IPT), in which the comparative efficacy and safety of a drug are evaluated. The report is used as the basis of reimbursement decisions.
	Market Authorisation	The AEMPS issues market authorisations for medicinal products and assigns the national code.
DGFPS General Directorate of Pharmacy and Health Products	HTA	The DGFPS initiates the pricing and reimbursement procedure with the manufacturer. The DGFPS evaluates the drugs regarding their therapeutic value and efficacy, the degree of innovation of the drug and severity of the disease. The likely price of the drug and budget impact is also considered during the assessment.
	Decision Maker	The DGFPS makes decisions on the inclusion of medicinal products into the national health care reimbursement system.
AETS Agency of Health Technology Assessment	HTA	The AETS is set up within the Institute of Health Carlos III to provide guidance and facilitate the decision making process for reimbursement. The assessment of AETS is initiated by requests from government.
CIPM Inter-ministerial Commission on Medicines Prices	Price Authority	The CIPM sets the price for reimbursable pharmaceuticals.
Autonomous Health Authorities (n=17)	Decision Maker	The regional governments implement the coverage and reimbursement decisions at local level based on their health care budgets. The regional governments compile local formularies.
	Provider	The provision of medicinal products is controlled by local formularies and reimbursement is covered by the national health care system.

Process map for Sweden

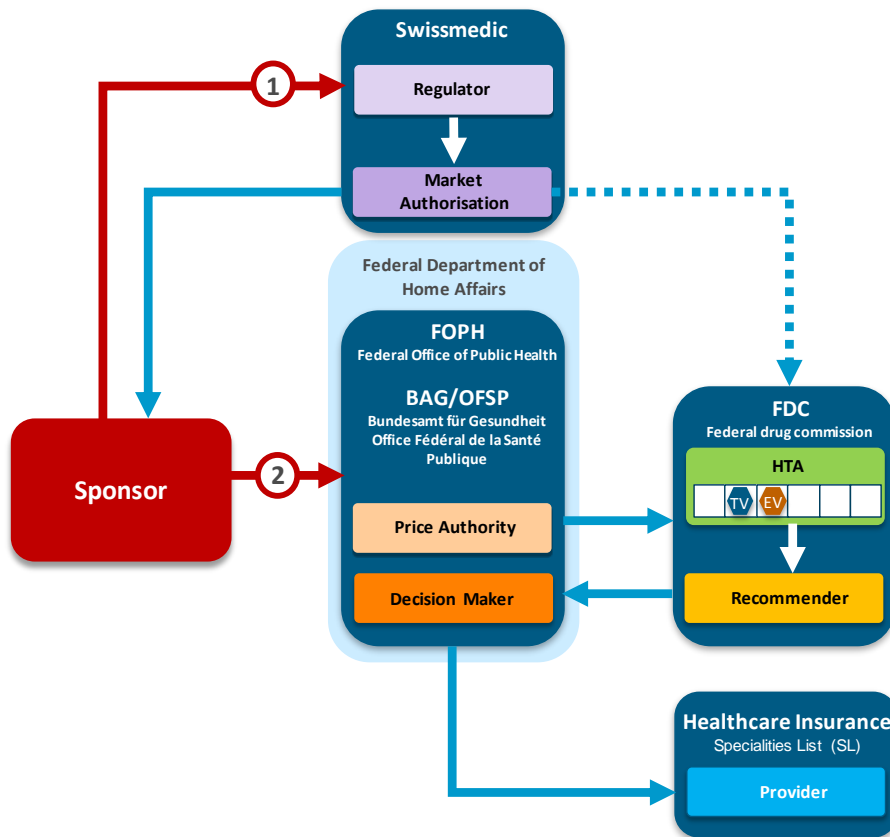
Version: September 2014



Agency (Committee)	Function	Key activity
MPA/NAM Medical Products Agency	Regulator	The MPA/NAM is the Swedish national authority responsible for regulation and surveillance of the development, manufacture and marketing of drugs and other medicinal products. The MPA/NAM is responsible for granting market authorisation for medicines and the registration of medical devices. Marketing authorisation of medicines is granted or rejected by the General Director of the MPA/NAM based on their quality, safety and efficacy.
SBU Swedish Council on Technology Assessment in Health Care	HTA	The SBU is a national institute responsible for conducting pharmaco-economic appraisals. The SBU provides support for the scientific assessment report and decision making in health care. However, the SBU is not officially involved in the pricing and reimbursement decision.
TLV/LFN Dental and Pharmaceutical Benefits Agency	HTA	The TLV/LFN assesses the therapeutic value and cost effectiveness of new pharmaceuticals. The TLV/LFN may consult the MPA/NAM for advice.
	Decision maker	The TLV/LFN is a government agency that makes decision on drug price and reimbursement. Reimbursement decisions made by the TLV/LFN are at national level and are adopted at the local level by the county councils.
	Price Authority	The TLV/LFN approves the wholesale price for drugs requiring reimbursement.
21 County Councils	Provider	The provision of health care is determined by the 21 county councils. The cost of drugs is reimbursed through each single county council with a fixed state subsidy.

Process map for Switzerland

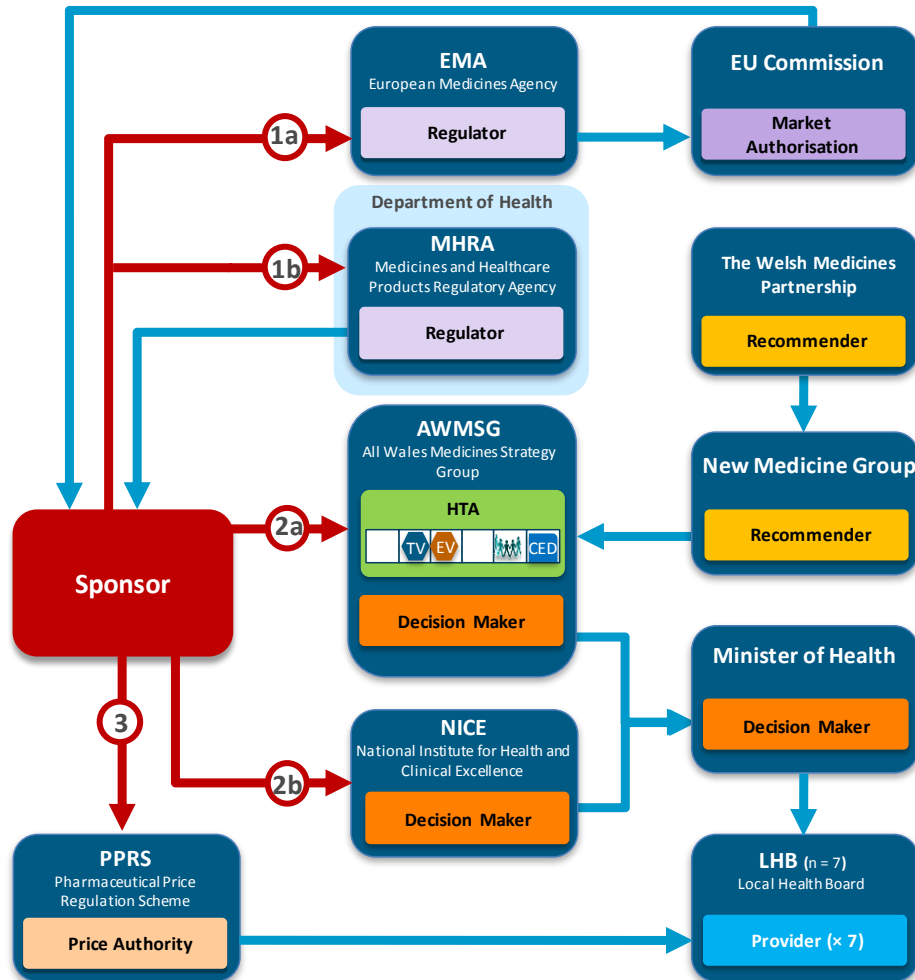
Version: January 2012



Agency (Committee)	Function	Key activity
Swissmedic	Regulator	Swissmedic is affiliated with the Federal Department of Home Affairs to regulate medicine and medical devices and is independent in its organisation and management. The key activities of Swissmedic include: licensing medicines, granting authorizations to manufacture and distribute wholesale, inspecting facilities and monitoring medicines and medical devices already on the market.
	Market Authorisation	Swissmedic is responsible for pre-market evaluation, granting market authorisation and post-market monitoring.
FDC Federal Drug Commission	HTA	THE FOPH has commissioned the FDC to evaluate new drugs. The FDC evaluates the effectiveness of drugs based on Swissmedic's assessment. The FDC classifies new drugs within 5 categories according to their level of innovation.
	Recommender	The FDC advises the Federal Office of Public Health on the inclusion of pharmaceuticals in the Specialities List (SL).
BAG/OFSP FOPH Federal Office of Public Health	Decision maker	The OFSP regulates both the inclusion of pharmaceuticals in the Specialities List (SL) and the pricing of reimbursed pharmaceuticals. The criteria of reimbursable drugs are efficacy and cost-effectiveness.
	Price Authority	The OFSP sets the maximum price for all drugs in the Specialities List (SL).

Process map for Wales

Version: April 2012



Agency (Committee)	Function	Key activity
MHRA Medicines and Healthcare products Regulatory Agency	Regulator	The MHRA is a government agency that regulates medicines on the basis of safety, quality and efficacy.
	Market Authorisation	The MHRA authorises marketing licences for new drugs.
AWMSG All Wales Medicines Strategy Group	HTA	The AWMSG appraises new medicines for which no NICE guidance is expected for at least 12 months from the date of submission.
	Decision maker	The AWMSG meets in public to assess the evidence for a new drug application and considers the advice from the New Medicine Group, considering the broader health context of Wales and the broader budgetary impact of the treatment, to provide a recommendation to the Minister.
The Welsh Medicines Partnership	Recommender	Evidence for evaluation is collected from medicines companies and public sources, clinical experts and patient organisations. The evidence is collated and evaluated by an expert secretariat at the Welsh Medicines Partnership.
The Welsh Medicines Partnership	Recommender	Evidence for evaluation is collected from medicines companies and public sources, clinical experts and patient organisations. The evidence is collated and evaluated by an expert secretariat at the Welsh Medicines Partnership.
New Medicine Group	Recommender	The NMG makes an initial recommendation to the AWMSG on the use of the medicine, based on its cost-effectiveness and potential benefits in the Welsh context.
Minister of Health	Decision maker	The Minister for Health and Social Services makes decision on the coverage of medicines by NHS Wales following advice from two sources: the National Institute for Health and Clinical Excellence (NICE) and the All Wales Medicines Strategy Group (AWMSG).
PPRS Pharmaceutical Price Regulation Scheme	Price Authority	The PPRS ensures the NHS has access to good quality branded medicines at reasonable prices. The PPRS regulates the price indirectly by controlling the profit of the pharmaceutical companies. The scheme will be replaced by value-based pricing for branded drugs in 2014.
LHB (x7) Local Health Board	Provider	The 7 Local Health Boards in Wales are responsible for the provision of health care to their area.