



EASA.2010/FC10 SC.02

Description:	SAMPLE III SC.02 - Studying, sAmpling and Measuring of aircraft ParticuLate Emission III â€œ Final Report
Language:	English
Project Area:	Environmental Protection
Project Date:	09/12/2011
Project reference:	EASA.2010/FC10 SC.02
Project Status:	Final



EUROPEAN AVIATION SAFETY AGENCY
AGENCE EUROPÉENNE DE LA SÉCURITÉ AÉRIENNE
EUROPÄISCHE AGENTUR FÜR FLUGSICHERHEIT

Research project EASA.2010.FC10 – SC.02

Studying , sAmpling and Measuring of aircraft ParticuLate Emissions III – Specific Contract 02 SAMPLE III – SC.02

27 November 2012



EASA.2010.FC.10
Specific Contract N^o: SC02

SAMPLE III: Contribution to aircraft engine PM certification requirement and standard Second Specific Contract– Final Report

27th November 2012

Lead Authors:

A Crayford² & M Johnson¹

Report Authors:

R Marsh², Y Sevcenco², D Walters², P Williams³, A Petzold⁴, P Bowen², J Wang⁵, D Lister⁶



GTRC
GAS TURBINE RESEARCH CENTRE



EMPA



1. Rolls-Royce plc, Derby DE24 8BJ, UK
2. GTRC, Cardiff University, School of Engineering, Cardiff, CF24 3AA, UK
3. Centre for Atmospheric Science, University of Manchester, M13 NPL, UK
4. Institute of Atmospheric Physics, DLR Oberpfaffenhofen, 82234 Wessling, Germany
5. Analytical Chemistry, EMPA, CH-8600 Dübendorf, Switzerland / Institute of Environmental Engineering, ETH Zurich, CH-8093 Zurich, Switzerland
6. Dr David Hugh Lister, Camberley, UK



Table of Contents

Table of Contents.....	2
Disclaimer.....	4
Acknowledgements.....	5
Executive Summary.....	6
1. Structure of the Report.....	9
2. Introduction.....	10
3. Objectives of the study.....	12
4. Task 1: Drafting documents for the development of the ARP.....	13
4.1 Introduction.....	13
4.2 Task 1a: Co-edit draft non-volatile PM Mass and Number ARP.....	13
4.3 Task 1b: Team lead of SAE E31 PM sampling section.....	15
4.4 Lower Cut-off selection for Number measurement analysers.....	16
4.4.1 CPC Operational Principles and lower Cut off Point.....	16
4.4.2 Gas Turbine exhaust PM characterisation.....	19
4.5 Conclusions of Task 1.....	24
5. Task 2: Testing at SR Technics facility in Zürich, Switzerland.....	25
5.1 Introduction.....	25
5.2 Sampling system design, manufacture and specifications.....	26
5.2.1 Sampling Probe (1PTS).....	27
5.2.2 Primary Sampling Line (2PTS).....	28
5.2.3 Additional sampling to allow simultaneous sampling (2PTSa).....	28
5.2.4 Primary splitter, dilution and spill box (3PTS).....	28
5.2.5 Sampling line, (4PTS).....	37
5.2.6 Cyclone & Secondary splitter (5PTS).....	37
5.2.7 CO ₂ Gaseous transport system (GTS).....	41
5.2.8 Splitters required for sampling lines.....	42
5.2.9 SAE E31 recommended PM measurement section overview.....	43
5.3 Additional Equipment required for experimentation.....	46
5.3.1 Volatile particle removal.....	46
5.3.2 Number analyser's.....	48
5.3.3 Mass analyser's.....	49
5.3.4 Size analyser's.....	50
5.3.5 Volatile analyser's.....	55
5.3.6 Diluent gas.....	55
5.4 Sampling system installation.....	56
5.4.1 Overview of SR Technics sampling probe.....	57
5.4.2 Installation of SAMPLE III sampling system.....	60
5.5 SAMPLE III and FOCA Sample line design overview.....	64
5.6 Experimental design.....	66
5.6.1 Line inter-comparison experiment.....	68
5.6.2 Line Penetration experiments.....	69
5.6.3 Size methodology inter-comparison experiment.....	71



5.6.4	CPC lower cut point sensitivity.....	72
5.6.5	Catalytic Stripper efficiency experiment.....	73
5.7	Engine types and operating conditions.....	74
5.7.1	Engines serviced and passed off in SR Technics test cell.....	74
5.7.2	Dedicated engine test.....	79
5.8	Conclusions of Task 2.....	88
6.	Task 4: Data analysis.....	89
6.1	Introduction.....	89
6.2	Pre-test analyser inter-comparison (calibration check).....	89
6.2.1	CPC Inter-comparison.....	89
6.2.2	LII laboratory inter-comparison.....	92
6.2.3	Size Instrument laboratory inter-comparison.....	94
6.3	Line inter-comparison experiment.....	95
6.3.1	Non Volatile PM Mass.....	95
6.3.1	Non Volatile PM Number.....	97
6.3.1	Dilution ratio sensitivity.....	101
6.4	Size methodology inter-comparison experiment.....	108
6.4.1	CPC lower cut point sensitivity.....	108
6.4.2	Non-volatile PM Size SMPS.....	108
6.4.3	SMPS, DMS & FAPES Inter-comparison.....	110
6.5	Catalytic Stripper efficiency experiment.....	113
6.6	PM sampling system impact on organic PM.....	115
6.7	Line Penetration experiments.....	117
6.7.1	Line length influence (12m versus 25m).....	117
6.7.2	Line Temperature (60 °C vs 160 °C).....	119
6.7.3	Real time penetration measurement (gantry vs downstream).....	122
6.8	Conclusions of Task 4.....	124
7.	Task 3: Probe sampling capabilities assessment for R-R engine pass off testing.....	126
7.1	Introduction.....	126
7.2	Design Concept.....	126
7.3	Probe Manufacture and Installation.....	129
8.	Conclusions.....	129
9.	Appendices.....	131
A.	Development of mass analyser performance calibration technique.....	132
B.	Assessment of size-dependent PM density (UA & UBC).....	137
C.	Comparison of non-volatile mass instrumentation (NRC, MS&T).....	139
D.	Volatile PM characterisation (ETH).....	140



Disclaimer

This study has been carried out for the European Aviation Safety Agency by an external organisation and expresses the opinion of the organisation undertaking the study. It is provided for information purposes only and the views expressed in the study have not been adopted, endorsed or in any way approved by the European Aviation Safety Agency. Consequently it should not be relied upon as a statement, as any form of warranty, representation, undertaking, contractual, or other commitment binding in law upon the European Aviation Safety Agency.

Ownership of all copyright and other intellectual property rights in this material including any documentation, data and technical information, remains vested to the European Aviation Safety Agency. None of the materials provided may be used, reproduced or transmitted, in any form or by any means, electronic or mechanical, including recording or the use of any information storage and retrieval system, without express written consent from the European Aviation Safety Agency. All logo, copyrights, trademarks, and registered trademarks that may be contained within are the property of their respective owners.

Persons wishing to reproduce in whole or in part the contents of this study are invited to submit a written request to the following address:

**European Aviation Safety Agency
Postfach 101253
D-50452 Köln
Germany**



Acknowledgements

The consortium wish to express their gratitude to a number of people, without their valued input this study would not have been as comprehensive. Particular note should be given to Theo Rindlisbacher on behalf of the Federal Office of Civil Aviation, Switzerland (FOCA) without the intellectual and collaborative financial support of whom this test campaign would not have been possible. Also special thanks should be made to SR Technics in particular the test bed staff and Frithjof Siegerist for his management and liaison efforts in running the engines and enabling fitting of the consortium sampling lines to the test facility.

Dr Jacob Swanson and Dr Adam Boies of Cambridge University along with several instrument manufacturers namely, AVL, Cambustion, Grimm & TSI also deserve special mention for supplying both instruments and expertise for the SR Technics test campaign which enabled a more rigorous comparison and appraisal of the sampling systems to be made.

Other research groups also attended the EASA funded SAMPLE III SC02 test campaign in order to address other outstanding SAE E-31 Non Volatile PM Measurement issues, however, their valued input to both experimental design and measurement have made for a more complete evaluation of the sampling systems. Special appreciation is made to Dr Greg Smallwood and Dr Kevin Thomson of National Research Council Canada, whose expertise was invaluable in providing, running and analysing the mass instruments enabling a better appraisal of line penetration to be assessed. Dr Jason Olfert and Tyler Johnson of the University of Alberta, also provided expertise in the analysis of the PM density which enables a more thorough appraisal of the Size instruments applicability to be made. Dr Steve Rogak from the University of British Columbia also provided support for the measurement of PM through microscopy enabling a better understanding of primary particle size and agglomerate shape to be made, this in turn will aid in appraising line loss uncertainties in the future. Dr Amewu Mensah and Joel Corbin from ETH Zurich also should be thanked for providing much needed volatile species data which has allowed a much needed appraisal of catalytic stripper technology to be made. In addition, Jelena Buha and Yeon Kyoung Bahk of EMPA provided assistance in operating the FOCA system and calibration of the gas analysers.



Figure 1 SAMPLE III experimental team



Executive Summary

This report details the methods, results and conclusions of the project entitled “SAMPLE III: Contribution to aircraft engine PM certification requirement and standard”. This project was funded via the European Aviation Safety Agency (EASA) under the Specific Contract N^o: **SC02** Implementing Framework Contract N^o: **EASA.2010.FC10**. The objective of this specific contract is to appraise the SAE E31 concept sampling system for measurement of particulate matter at the exhaust of large-scale gas turbine aircraft engines in support of the development of a robust ‘ballotable’ ARP which will subsequently enable a non-volatile particulate matter (PM) certification requirement.

In order to deliver the aforementioned objective it was necessary to perform the following tasks namely;

- Provide support in drafting the “draft working document” that will lead to the ARP for ballot, with the support of participating Consortium members
- Coordinate the collection of knowledge and data, as well as supporting the work on the draft working document as required, in particular the Sampling section
- Subcontract aircraft engine running hours at SR Technics, Zurich which may be used to help support the Swiss Kerosene Tax proposal
- Assess the operating parameters and perform an inter-comparison of two SAE E31 concept sampling systems at the SR Technics engine testing facility.
- Assess the probe sampling capabilities in conditions similar to engine certification tests at the exhaust of engines, during production pass off testing at Rolls-Royce.
- Analysis of data obtained and recorded during the execution of the above Tasks, as well as relevant data recorded during SAMPLE I, SAMPLE II and SC01 of SAMPLE III, in an effort to address remaining gaps in technical knowledge to draft the ARP.

To deliver the above tasks numerous design, experimental and desk based studies were performed which are detailed below.

- Attend and manage SAE E31 meetings and telecon’s to advise on PM sampling and measurement issues
- Design and manufacture SAMPLE III sampling system to allow remote operation and monitoring within SR Technics test cell.
- Design, build and implement modification of SR Technics sampling system to allow multiple sampling systems to sample simultaneously
- Install new SAMPLE III sampling system and two identical PM instrument suites at SR Technics, Zurich.
- Conduct numerous piggy back and dedicated engine test campaigns at SR Technics
- Co-edit the Draft Working Document on non-volatile PM sampling ready to be used in order to develop the draft ARP for ballot.

Key Results from this study include:

1. The SAE E31 nvPM Draft Working Document is currently on schedule for early 2013 but will need further line verification and operational comparisons with engine manufacturer systems to ensure the ARP is ballotable in 2014
2. Two sampling systems built to be compliant with the E31 draft working document (as drafted beginning of 2012) were installed at SR Technics maintenance facility, and operated simultaneously behind a FOCA installed single point traversable probe.



3. Installation of primary dilution system (3PTS) in SR Technics test cell was difficult and labour-intensive. In addition the installation of the dual instrument suites in a non air conditioned confined space meant that area was at a premium and there was a risk of instrumentation overheating
4. Dedicated engine testing was performed using SR Technics owned CFM56-5B4-2P. €50k was spent via EMPA for the engine testing which was also successfully used in support of the Swiss Kerosene Tax proposal.
5. Due to staged combustion, the CFM56-5B4-2P engine emits a wide range of Smoke Number, non-volatile particle mass and number concentrations at relatively low power conditions. This provided both particle systems with a good variety of aircraft gas turbine aerosol with minimal fuel flow usage.
6. Long dedicated steady-state test points of 20 minutes indicated particle concentration drift at certain conditions. Mass and number concentrations mutually drifted together.
7. It was witnessed that repeatability of setting similar engine conditions was difficult to obtain and therefore affected PM repeatability tests. Variability could be due to ambient or engine variability. Further engine data is required across various engine/combustor types in order to ascertain the source and expected magnitude of nvPM mass and number variability.
8. It was perceived that performing PM measurements on a decreasing power curve seemed to indicate slightly reduced PM emissions compared to an increasing power curve.
9. Both the DMS and LII instruments coped well with the hostile conditions inside the engine test cell, however, there were some mechanical issues that had to be overcome during the test campaign on both instruments.
10. Both systems (sampling and instrument suites) operated correctly and properly under a range of sampling and concentration conditions. Though operation of the control spill valves was initially difficult at low probe pressures.
11. It is important to ensure analysers are fully calibrated and within calibration time limits. Detailed and calibration timeframe procedures are required to minimise measurement uncertainty.
12. When both the SAMPLE III and FOCA line were operated under similar conditions (specifically primary dilutor inlet pressure associated to equivalent dilution ratios), the systems measured both mass and number concentrations to within 10%. This is within expected measurement uncertainties and implies the PM system design is robust (for similar sampling inlet conditions).
13. Particle non-volatile number concentration appears to be sensitive to dilution ratio
14. Particle non-volatile mass concentration appears to be marginally or insensitive to dilution ratio. However, this conclusion is based upon mass concentrations close to the instrument LDL (low detection limit) reducing the confidence of this statement.
15. Over the repeated dedicated engine conditions the SAMPLE III line appeared to show higher (20%) particle penetration for number concentration than the FOCA line. Even though it was theoretically expected that the FOCA line would have slightly better penetration due to slight line geometry differences.
16. Over the repeated dedicated engine conditions the SAMPLE III line appeared to show higher (15%) particle penetration for mass concentration than the FOCA line.
17. Excellent comparison repeatability (<3%) was observed between the two PM measurement systems

18. The automotive PMP-type CPC lower size cut point ($d_{50} = 23\text{nm}$, $d_{90} = 41\text{nm}$) is not sufficient to quantify non-volatile PM number concentrations from current fleet aircraft engine exhaust.
19. Based on SMPS size distributions downstream of the CS-VPR, no particles are observed $<10\text{nm}$ diameter at the end of the sampling system. Thus there is no rationale to measure particles $<10\text{nm}$. However, the d_{90} lower cut point should not be $>15\text{nm}$ diameter to minimise the effect of variable particle size distribution on the measurement.
20. Two commercially available CPCs that meet the lower cut-point ($d_{90} < 15\text{nm}$), agreed to within 7%.
21. Smoke Number filter measurements must not be taken simultaneously with nvPM measurement. A constant sample flow should be maintained (including no switching of valves) in the raw sample system at all times during PM measurement on the diluted line, in order to prevent primary dilutor sample inlet pressure fluctuations. The impact of valve switching is more evident at sub-ambient primary dilutor inlet pressure conditions.
22. Data analysis has shown that theoretical differences in losses between line lengths (12 versus 25m) compared to measured differences are within 20% for a specific particle size.
23. Utilising the OC/EC filter EUSAAR methodology has shown catalytic stripper methodology to be extremely efficient (within the bounds of the filter measurement uncertainty) at removing organic mass.
24. Data analysis has shown inconclusive volatile/organic aerosol results for filter versus AMS methodology
25. The size methodology inter-comparison provided better than expected results with good size agreement. However differences were observed in absolute number concentration between SMPS (Condensation particle counter) and fast measurement techniques (electrometer counting). There are still issues over bi-modality in the DMS data inversion between 15 to 30nm.
26. Measurement of real-time line penetration curves proved line efficiency consistency over all power conditions indicating that there was no effect of the line getting 'dirty' over the dedicated engine test period.
27. Data obtained whilst operating the FOCA line at 60°C and SAMPLE III line at 160°C showed contrary conclusions compared to previous line temperature comparison work performed on the HES combustor and large scale modern engine in SAMPLE II. Zurich data indicated better penetration for the lower sampling temperature. Explanation of this contradiction is challenging, however, the experimental dataset obtained under SAMPLE II was substantial (multiple temperatures) and repeatable, whereas the dataset obtained under this contract was a single one-off test.
28. A piccolo-type probe has been successfully designed, and is being manufactured, to be installed on a Rolls-Royce production pass-off pylon. Enabling the possibility of performing PM measurements on a number of same-type engines at R-R Derby.



1. Structure of the Report

This report draws on a number of experimental tests, reviews and studies, each designed to broaden knowledge in a specific topic area concerned with building a new methodology for the measurement of aircraft Particulate Matter (PM) emissions. Although the report does not provide a finalised methodology, it is intended that the information contained herein will be used to aid EASA and other regulatory bodies towards the development of future practices and procedures for non-volatile PM measurement in terms of mass and number.

Key themes in this report are:

- Appraise a representative lower 'cut off' value for CPCs applicable for the measurement of non-volatile number behind a modern large scale civil aviation jet engine.
- Demonstrate applicability of SAE E31 concept PM Sampling system behind a 'full scale' large civil aviation jet engine over broad operating thrust settings at representative sampling periods.
- Determine comparative performance of two SAE E31 concept Sampling systems running simultaneously behind a 'full scale' large civil aviation jet engine over broad operating thrust settings at representative sampling periods.
- Assess ability of catalytic stripper technology in removing 'real full-scale' large civil aviation jet engine exhaust volatile fraction
- Provide experimental data to assess real time penetration efficiencies of the SAE E31 concept PM sampling system
- Assess feasibility in adding a size measurement analyser to the concept PM sampling system.



2. Introduction

The global effects of aircraft PM emissions are a key concern from the point of human health and climate change. Controls on aircraft emissions and maintaining compliance for local air quality standards on European airports is expected to be a significant issue in some cases. Whilst significant effort is being made to identify, quantify, model and predict these effects there is still a sizeable amount of development work required to produce a working specification for the absolute measurement of emissions of PM. Both mass and number emission concentration will need to be measured in a format that can act as a standardised test under engine certification conditions. Other known aircraft emission challenges include accurate, traceable quantification of volatile emissions, especially aerosol precursors.

Control of PM emissions is one of the top priorities of the ICAO/CAEP (Committee on Aviation Environmental Protection). As a first step towards establishing a non-volatile PM Standard, CAEP, in 2010, remitted its Working Group 3 (WG3) to:

“Evaluate and document sampling and measurement methodologies for aircraft engine non-volatile PM emissions. Note input from SAE-E31.” [Remit E18.01]

“Develop an aircraft engine based metric and methodology for application as a non-volatile PM emissions certification requirement for new engine types.” [Remit E18.02]

With a target date of February 2013.

Furthermore there is an expectation that CAEP will have developed an International Standard for PM by the end of its next 3 yearly cycle [2016].

WG3, with support of EASA and other Regulatory Agencies (Swiss FOCA, UK CAA, US FAA, Transport Canada & US EPA) requested the SAE E-31 to provide a non-volatile PM mass and number Aerospace Recommended Practice (ARP) document ready for formal approval by ballot of E31 members (a ‘ballot-ready document’) by February 2013. The SAE E-31 PM sub-committee has been working on developing appropriate sampling and measurement methods for aircraft non-volatile PM emissions, but has expressed severe reservation about meeting the time scale requested by CAEP for a fully developed document.

EASA funded a 1 year study (known as the SAMPLE project), commencing in October 2008, which was one of the first collaborative programmes designed to evaluate the applicability of a number of modern measurement techniques whilst assessing the nature of PM. Conclusions from the original SAMPLE programme (EASA.2008.OP.13, 2009) suggested that calibration of the measurement techniques is critical. EASA then funded another year’s study (SAMPLE II), which commenced December 2009. This collaborative effort was to determine the effect of the sampling line, in terms of its construction and operation on the exhaust sample being presented to the analysers compared with the exhaust sample at the engine exhaust plane. Conclusions from the SAMPLE II study (EASA.2009.OP.18, 2010) noted that sample line residence time appears to be a key parameter to PM losses and that VPR efficiency is difficult to analyse and hence a specific lower size PM cut-off may be required to reduce uncertainty. EASA then funded Specific Contract 01 (SC01) within SAMPLE III, a 4 year frame-work contract



(EASA.2010.FC.10) commencing December 2010. This work developed a concept sampling system in terms of components, manufacture and operability.

Whilst previous studies during SAMPLE & SAMPLE II have quantified the nature of PM and the interaction between PM and the transport process used to convey it from the point of generation to the point of measurement, and SAMPLE III (SC01) developed a robust well defined sampling system which has been adopted as the SAE E31 concept for PM sampling, this has yet to be manufactured in a manner ready for certification type testing and tested behind numerous 'full-scale' large civil aviation jet engines at representative thrust levels. Also at present there have been no comparisons made of two nominally identical SAE E31 concept compliant systems which is needed to provide confidence that such systems can give repeatable and comparative data sets.



3. Objectives of the study

The work detailed in this report is only determined with the implementing framework contract **EASA.2010.FC10 (SAMPLE III)** specific contract **SC02**.

The main purpose of this specific contract **SC02** is to apply the knowledge gained from the previous few years of study (SAMPLE, SAMPLE II & SAMPLE III SC01) along with that shared within the SAE E31Committee gained from full-scale engine testing in order to check the practicability and representativeness of the SAE E31 concept sampling system whilst developing a ballot ready SAE ARP for the measurement of non- volatile PM mass and number.

EASA required the SAMPLE III consortium to conduct the following tasks in order to support the above objective:

Task 1: Drafting documents for the development of the ARP

Task 2: Testing at SR Technics facility in Zürich, Switzerland

Task 3: Data analysis

Task 4: Probe sampling capabilities assessment for Rolls Royce engine pass off testing



4. Task 1: Drafting documents for the development of the ARP

4.1 Introduction

As discussed earlier, Working Group 3 (WG3) with the support of EASA and other Regulatory agencies (Swiss FOCA, Transport Canada, UK CAA, US EPA & US FAA) requested the SAE E31 to provide a Draft Working Document (DWD) that will lead to a ballot-ready non-volatile PM mass and number ARP by 2014.

In order to assist in the development of the DWD, the consortium have been tasked with two specific objectives namely: Task 1a - co-editing the DWD in conjunction with Dr Rick Miake-Lye who is funded by the US FAA and Task 1b - leading the development of the sampling section of the ARP.

4.2 Task 1a: Co-edit draft non-volatile PM Mass and Number ARP

To facilitate this task the consortium has sub-contracted Dr David Lister who has worked in the field of exhaust emission measurements and standard development for numerous bodies (MOD/DERA and its forerunners, QinetiQ and CAA) for the previous 30+ years and has been a key member of the SAE E31 for 25 years, during which time he has been active in the writing and editing of numerous ARP's and AIR's in the various roles of contributor, reviewer and sponsor. He has been a long term member of WG3, as a technical contributor and leader and also has been a specialist technical advisor to the UK government in the policy discussions and decision making at ICAO/CAEP. He thus has extensive experience and insight into what will be expected from the ARP and its applicability within the broad international regulatory and standard setting context.

Prior to the start of SAMPLE III-SC02, SAE E31 had already been developing proposals for sampling and measurement systems through a number of focussed Technical Teams (Sampling, Mass measurement, Number measurement and Calculation methodology). Additionally, members of E31 who work for a Regulatory Agency formed a further team (RAT^a) to advise on regulatory aspects. These groups are overseen by a Co-ordination Group.

By the end of 2011, Dr Rick Miake-Lye had already prepared a first draft of a 'Working Document' (Draft Working Document version 1), albeit with many gaps and technical issues unresolved, as a starting point for review at the PM Sub-committee meeting in January 2012.

Dr Lister has, as a member of the RAT, considered and agreed several initial 'concessions' from a regulatory perspective i.e. use of existing OEM engine sampling probes, requirement for the PM sample transfer system to be independent of the standard ICAO Annex 16, Vol. II system, standardisation of the PM sample transfer system irrespective of engine application, thus enabling activity to focus on the core aspects of designing and testing a fundamentally different measurement system, whilst limiting variability and uncertainties from lack of standardisation at this time.

^a RAT: Regulatory Agencies Team. A group of SAE E31 members drawn from the National Regulatory Agencies of EASA, Swiss FOCA, Transport Canada, UK CAA, US EPA & US FAA. They are not acting in an official role of a regulator, but as experts who are members of SAE E31.



The outcomes of Task 1a have aided in proposing, initiating and development of a performance specification approach to defining analyser requirements, breaking what had been a seemingly irresolvable impasse of trying to 'down-select' a specific analyser type for PM mass measurement from potentially competing concepts, with this way forward now being adopted in the most current draft working document.

Through the attendance of the Sampling and Mass measurement Teams, primarily through the bi-weekly telecons, technical requirements along with text and diagrams have been added to the relevant sections of the DWD. Numerous members of the SAMPLE III consortium (including Dr Dave Lister) and other observers (Dr Rick Miake-Lye) attended the SAMPLE III.02 test campaign in Zurich which ensured a sound understanding and validating of the requirements of the draft working document in a real engine test environment.

Dr. Mark Johnson and Dr. Dave Lister are members of the SAE E31 PM ARP Co-ordination group, which has aided in ensuring a co-ordinated technical, regulatory and policy perspective to the decisions taken in the development of the current working document. This enabled qualified co-editing of the second version of the DWD by Dr Dave Lister, which was presented, discussed, and edited at the Annual meeting of SAE E31 (San Diego 2012). Subsequently the Sampling and Mass measurements sections were intensively reviewed by the OEMs, including input by Dr Mark Johnson on behalf of Rolls Royce. Dr Lister (and others) are assessing the OEM comments and proposals with the aim of providing a third draft version for further review in September (2012); with the key aim to resolve any queries to ensure OEM confidence in making sound business purchase and engine test opportunity decisions this year, prior to performing validation testing of the proposed test and measurement procedures starting in 2013.

Dr Dave Lister has participated in the WG3/PMTG meetings (as a member) and latterly as part of a small formal Liaison Group^a ensuring appropriate and timely information exchange between the SAE E31 and WG3. This has required development and presentation of papers on behalf of SAE E31 and technical discussions with WG3/PMTG relating to potential applicability of the sampling and measurement methodologies to the variety of engine type that might be considered for regulation, for example, Turbofan, turboprop, APU, etc, as well as the need / desirability of correcting for PM losses in the sampling system. This 'cross-over' activity has been possible because of previous and on-going activity and relationships within the ICAO/CAEP programmes and additional funding provided by UK DfT, which has benefited both the technical development of the SAE E31 documentation and its anticipated subsequent incorporation into the ICAO/CAEP standard setting process that WG3 will undertake.

Significant progress has been made in development of the DWD, but there are a few immediate technical issues that need to be resolved - one needing input from WG3/PMTG - and substantial real engine testing before SAE E31 is in the position of having a 'ballot-ready' document available.

A 'technology readiness level' (TRL) time line highlighting the route forward for the development of a 'ballotable' ARP as was presented by the SAMPLE III consortium and

^a E31-WG3 PM Liaison Group consisting of Dr Lister, Dr Randy McKinney (P&W) and Dr Rick Miake-Lye (Aerodyne Research) – formally appointed and approved by both E31 and WG3 [May 2012]

developed further during the SAE E31 annual meeting (San Diego 2012) is presented below (Figure 2).

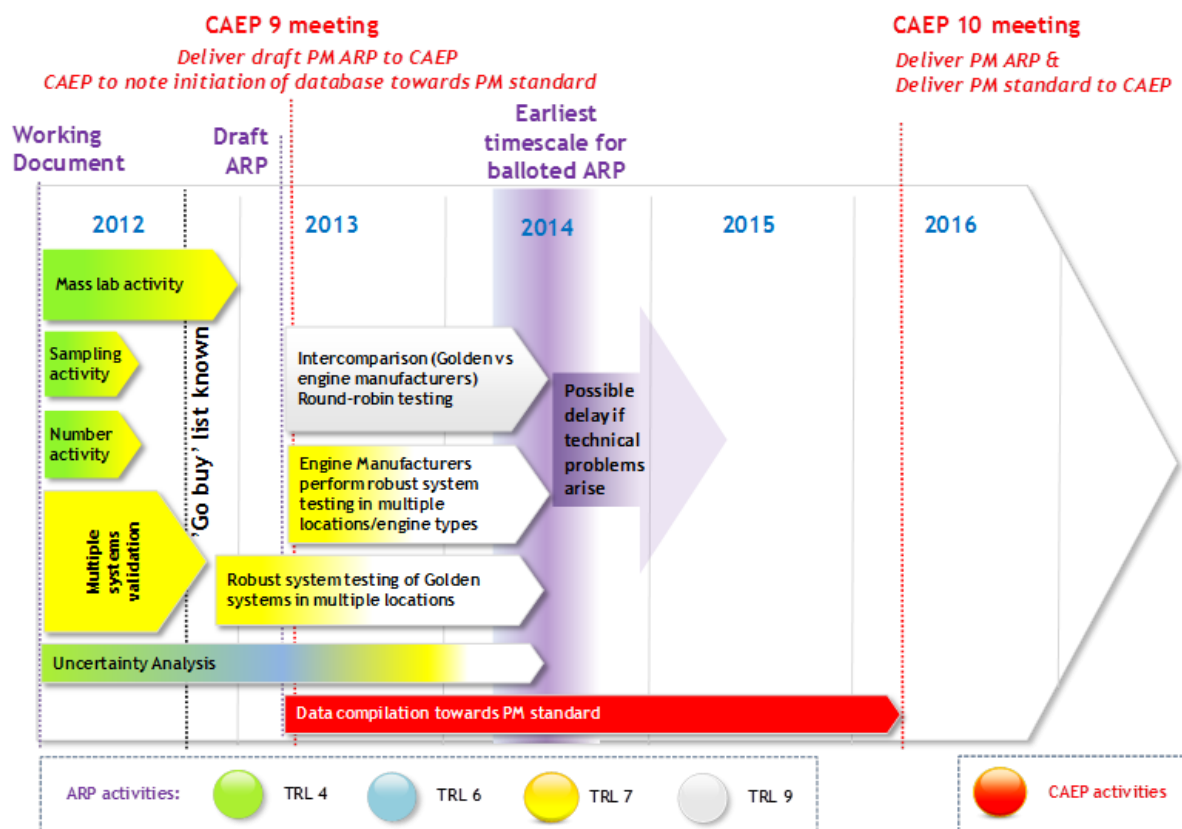

Figure 2 Proposed TRL PM standard Road map

It can be seen that if there is sufficient funding available, the balloted ARP is predicted to be ready between the second and third quarter of 2014, with a caveat that this date is prone to slippage if there are unforeseen technical problems to overcome.

4.3 Task 1b: Team lead of SAE E31 PM sampling section

Dr Mark Johnson is team lead of the sampling section of the current draft ARP, as such he has been responsible for guiding the sampling team discussions in bi-weekly tele-conferences along with leading discussion at SAE E31 Committee and PM sub-committee meetings. Knowledge gained during these meetings has facilitated the sampling section of the working document to be drafted by Dr Mark Johnson, whilst he has kept the SAE E31 committee aware of uncertainties in the sampling system via a specific 'tracking spreadsheet' which highlights areas of research required to achieve a ballot ready ARP.

As sampling team lead, Dr Mark Johnson has been responsible for drafting the sampling section of the PM ARP as discussed above in 4.2. Apart from utilising personal knowledge and building upon group SAE E31 discussions, many liaisons were required with individual SAE E31 members and external sources of information (for example Dr Jon Andersson, PMP Golden engineer, Dr Paul Quincey, NPL to keep pace with ongoing automotive and ambient PM sampling regulations and research). All of which has helped to feed in information to continually building the DWD towards 'ballotable' status.



In order to ensure that the appropriate technical issues were being addressed, Dr Mark Johnson was test co-ordinator of the SAMPLE III SR Technics test campaign (SAMPLE III.2 campaign). This role not only involved campaign planning and system building (along with Dr Andrew Crayford) and co-ordinating the actual test, but also liaising with many other parties involved in the testing. These included EMPA (subcontracting SR Technics for the engine lease, test-bed and running costs; and Swiss kerosene tax proposal interaction), FOCA (operation of FOCA PM sampling system), CU (Catalytic stripper and EC OC filter measurements), Grimm, TSI, AVL & Cambustion (instrument loans), NRC, ETH, UA, UBC (externally supported collaborations providing mass, volatile and density instrumentation and knowledge).

4.4 Lower Cut-off selection for Number measurement analysers

At the time of the SAE E31 annual committee meeting held in Ottawa 2011, the number team recommended that in order to enable a ballot ready ARP to be ready for January 2013 it would be prudent to base the number measurement system on that prescribed by the European Automotive PMP procedures. However, for numerous reasons, highlighted by Jon Andersson (PMP's 'Golden' engineer) at the Ottawa meeting, Jon advised that the CPC & VPR technology designed for non-volatile number concentration measurement of automotive diesel reciprocating engines resulted in a lower cut-off size at a $d_{50} = 23\text{nm}$ which due to the available CPC technology left a $D_{90} = 41\text{nm}$. However, based on previous test campaign results (Partemis, SAMPLE I, AAFEX, etc) and on recent size distribution and number measurements taken utilising SAE-E31 concept sampling systems (SAMPLE II, SAMPLE III.01, AAFEX II, MS&T/FOCA Zurich etc), it is evident that there is a potential scientific issue of adopting the lower cut-off diameter for condensation particle counters deemed suitable for the measurement of automotive exhaust PM. Owing to this it is suggested that a CPC with a lower cut off is adopted (e.g $d_{50} = 10\text{nm}$, $d_{90} = 15\text{nm}$). However, all these previous campaigns (except SAMPLE III.01) only employed evaporation type volatile removal thus the influence of volatile PM introduces doubt and uncertainty on the lower cut point.

4.4.1 CPC Operational Principles and lower Cut off Point

A more thorough explanation of CPC functionality has been presented previously (SAMPLE). Therefore only the key properties of the applied particle number measurement methodology will be discussed here. The technology is based on the principle, that nanometer-sized particles are grown by forced condensation of alcohol vapour onto their surface. After an increase in size to micron sized droplets, the particles are sufficiently large to be counted by light scattering techniques. The minimum particle diameter which activates sufficient droplet growth depends on the degree of super-saturation of the alcohol vapour in the aerosol sample. A schematic of a standard CPC of type TSI 3010 is shown below (Figure 3).

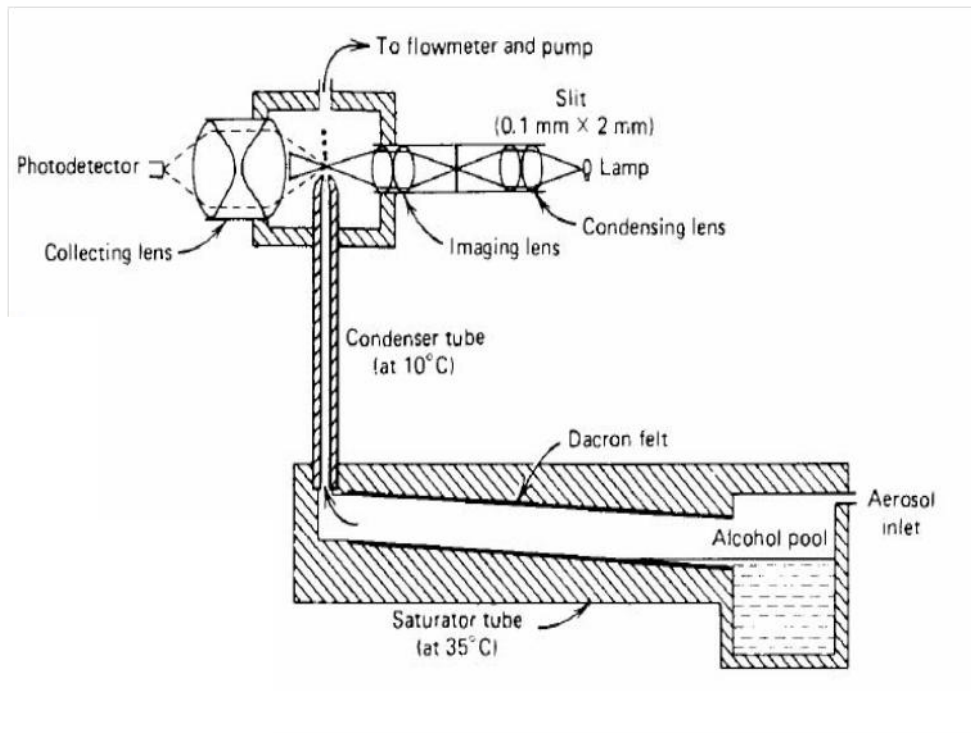

Figure 3 Schematic representation of operational principle of CPC

Super-saturation of the alcohol vapour is generated by creating a temperature difference between the heated saturator and the cooled condenser. The minimum detectable diameter at 50% counting efficiency (d_{50}), can be adjusted by changing the temperature difference (ΔT) between Saturator and Condenser. Dr Andreas Petzold at DLR has previously performed intense laboratory tests to ascertain the link between saturation loading, ΔT and measurable droplet diameters, a summary of the findings is given below (Figure 4).

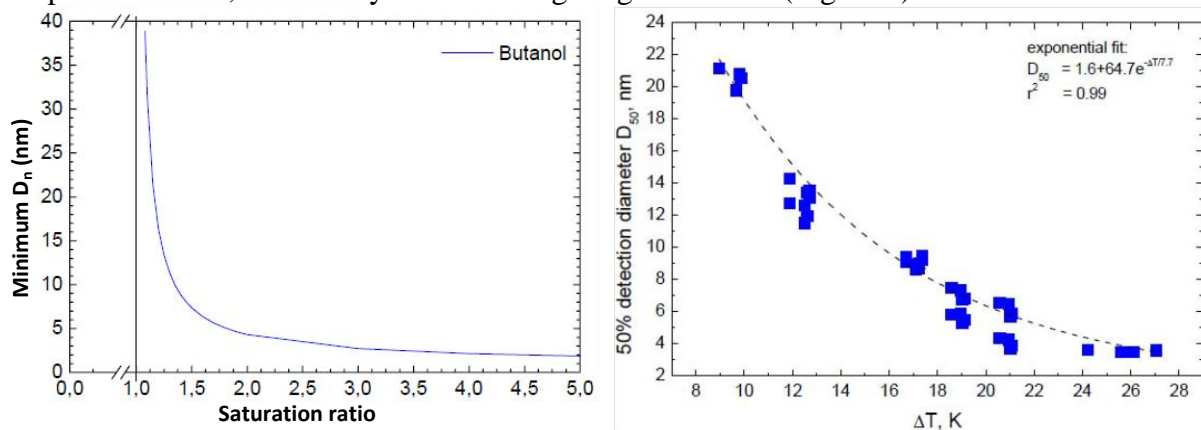

Figure 4 (a&b) Theoretical and experimental effects of saturation ratio and temperature on the diameter of particulates that can be measured respectively

It can be seen above (Figure 4a) that Kelvin theory predicts that for growth of 5nm particles a super-saturation of 200% is required compared with <150% for the growth of 15nm particles. As the saturation ratio is controlled by the ΔT between the heated saturator, where the PM sample is saturated with the butanol vapour and the cooled condenser, where the grown particles are counted then it can be shown (Figure 4b) that increasing ΔT increases the active

super-saturation ratio and hence decreases the minimum detectable particle diameter. As can be seen a change in ΔT from 6-30°C brings about a change in detectable diameter of 5-25nm.

However, even at a fixed super-saturation ratio for a given particle diameter not all of the particles entering the measurement cell will significantly grow and be measured. As such for a particular ΔT there will be an associated response to a particular sized particle. The instrument response function can be represented by an S-shaped curve (Figure 5).

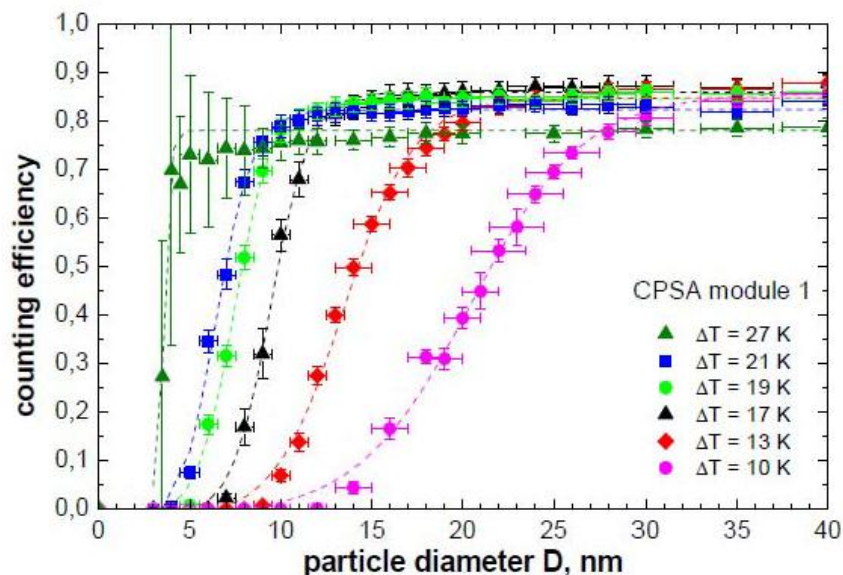

Figure 5 Counting efficiency as a function of particle diameter for different levels of ΔT

What is of highest relevance for this application is the fact that the slope of the transfer function is dependent on the temperature difference. Operating a CPC at a cut-off diameter (d_{50}) of 23nm as prescribed by PMP requires a low ΔT ($\sim 10^\circ\text{C}$). The associated instrument response function is characterized by a soft slope at 50% detection efficiency. Furthermore the response function reaches its maximum detection efficiency for particles with diameters of 40nm and above.

As discussed the link between CPC counting efficiency and particle diameter depends on the temperature difference ΔT between saturator and condenser of the instrument. A detailed analysis of the CPC response curve to particle size, particle material etc. is given in other studies conducted outside of the SAMPLE III consortium (Giechaskiel et al., 2011).

Again it is seen that the drop of counting efficiency for a PMP CPC starts at around 40nm, which as discussed is within the size range for peak non-volatile number concentration in gas turbines at high thrust conditions.

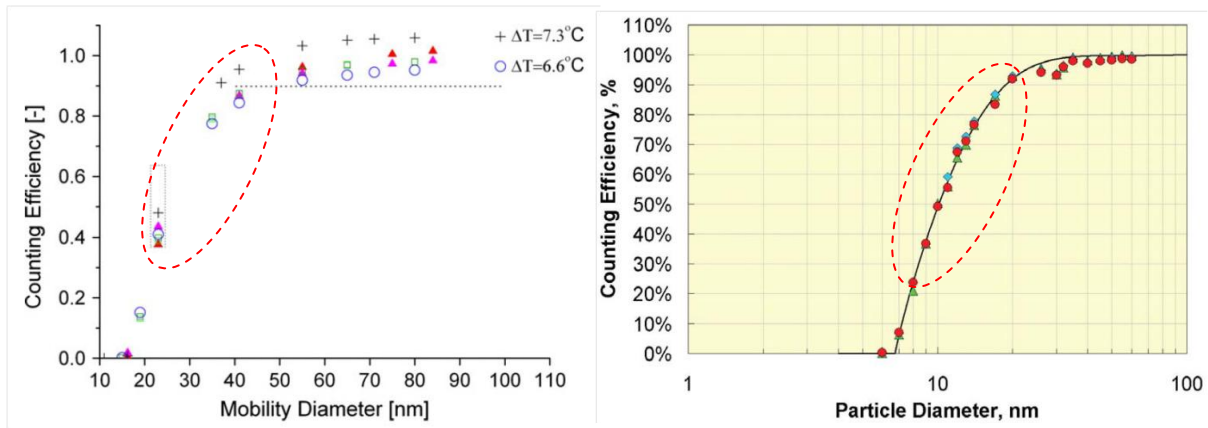

Figure 6 (a&b) Cut-off curves for PMP (TSI3790) counter set at 23nm and a 10nm (TSI 3722) respectively

Both the weak slope at 50% detection efficiency and the fact that 100% counting efficiency is only reached for particles > 40nm in diameter make the application of a CPC tuned to high cut-off diameters, similar to those prescribed by PMP may not be appropriate for the measurement of gas turbine exhaust particles, as discussed later.

4.4.2 Gas Turbine exhaust PM characterisation

Previous data taken from representative gas turbine exhaust assessing the size distributions of the PM aerosol emitted from a representative gas turbine exhaust (Figure 7) have displayed mean diameters in the 20-40nm range, therefore if a PMP type CPC was to be employed a significant fraction of particles in terms of number would not be counted due to the counting efficiency in this range. However, if a $d_{50} = 10\text{nm}$ was adopted then >90% of the particles would be counted.

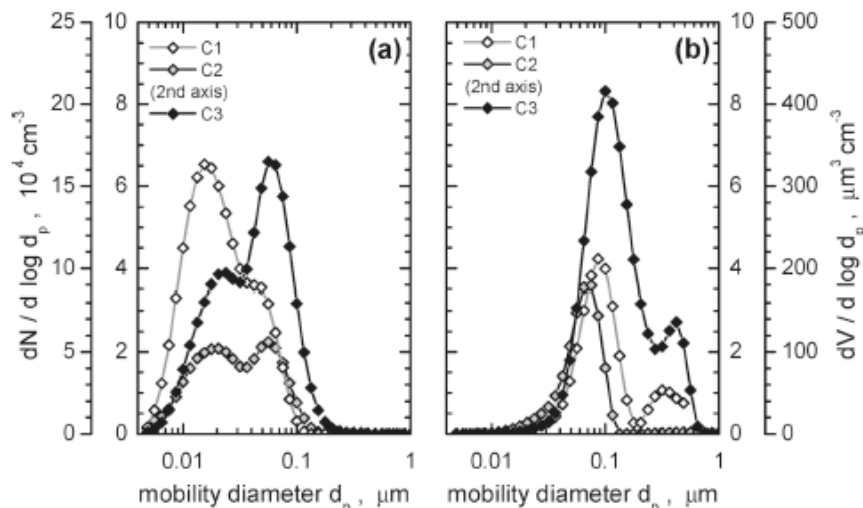

Figure 7 (a&b) Particle size spectra for all investigated conditions measured with a DMS500 in terms of number and volume respectively (Petzold et al. , 2011)

DMS and SMPS data taken during SAMPLE III.01 behind a Rolls Royce Artouste APU engine is also shown to display similarly small size distributions with mean diameters of approximately 30-40nm (Figure 8). As can be seen there is a discrepancy in the distribution

recorded as bimodal by the DMS and mono-modal by the SMPS. However, when observing the proposed CPC cut points of $d_{50}=10\text{nm}$ and PMP's $d_{50}=23\text{nm}$ in black dashed and black solid lines respectively and their associated $d_{90}=15\text{nm}$ and PMP's $d_{90}=41\text{nm}$ in red dashed and red solid lines, it becomes apparent that if a PMP approach is adopted then the majority of particles making it down the sampling lines would not be counted.

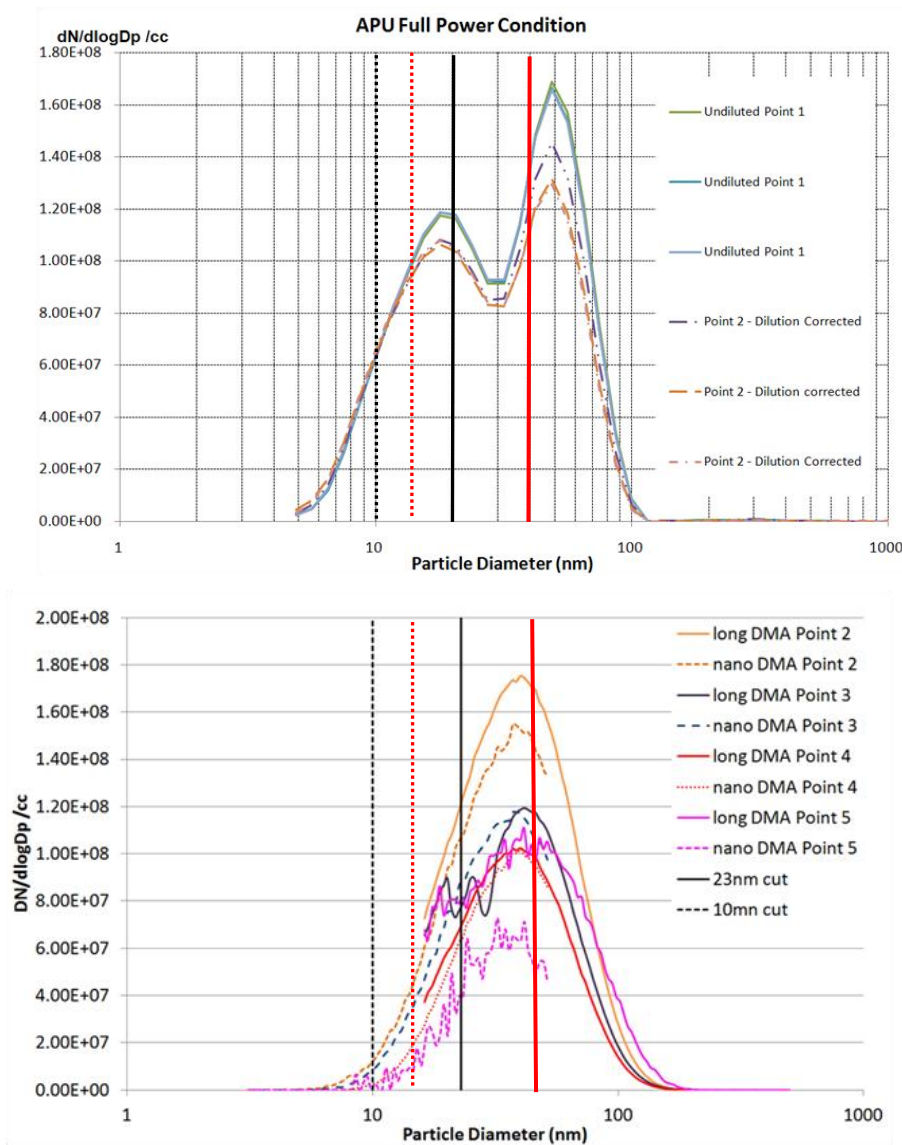

Figure 8 DMS & SMPS size distributions of Rolls Royce Artouse APU at numerous locations along the sample line, (proposed CPC black dashed line, $d_{50}=10\text{nm}$, red dashed line, $d_{90}=15\text{nm}$, PMP CPC black solid line $d_{50}=23\text{nm}$, red solid line $d_{90}=41\text{nm}$)

However, one issue in choosing a lower cut-point CPC is that of volatile removal efficiency, it has been shown previously by numerous studies (SAMPLE II, Kittelson & Swanson presentation SAE E31 Ottawa 2011), that the PMP type VPR may not be capable of removing all volatile PM but simply reduces it to a size range smaller than can be detected by the PMP adopted CPC (e.g. $<23\text{nm}$). However, there are concerns that if a lower cut point is to be adopted then a more robust VPR system will be required. As such the SAE E31 have adopted a method based on the PMP VPR with the inclusion of a catalytic stripper which

actually converts the volatile fraction into gaseous CO₂ hence ensuring it does not re-condense as small PM prior to counting in the CPC.

Previous work performed under SAMPLE II observed relatively small differences between utilising CPCs with d₅₀ cut-points at 10 and 23nm. Particle size distribution data obtained in SAMPLE II from a large modern aircraft gas turbine engine with representative rotating rake sampling is shown in Figure 9. The data was obtained on a diluted sampling line with a design within the existing draft working document specifications. It should be noted however, that the DMS instrument was not located behind a volatile removal device, hence volatile PM may be present.

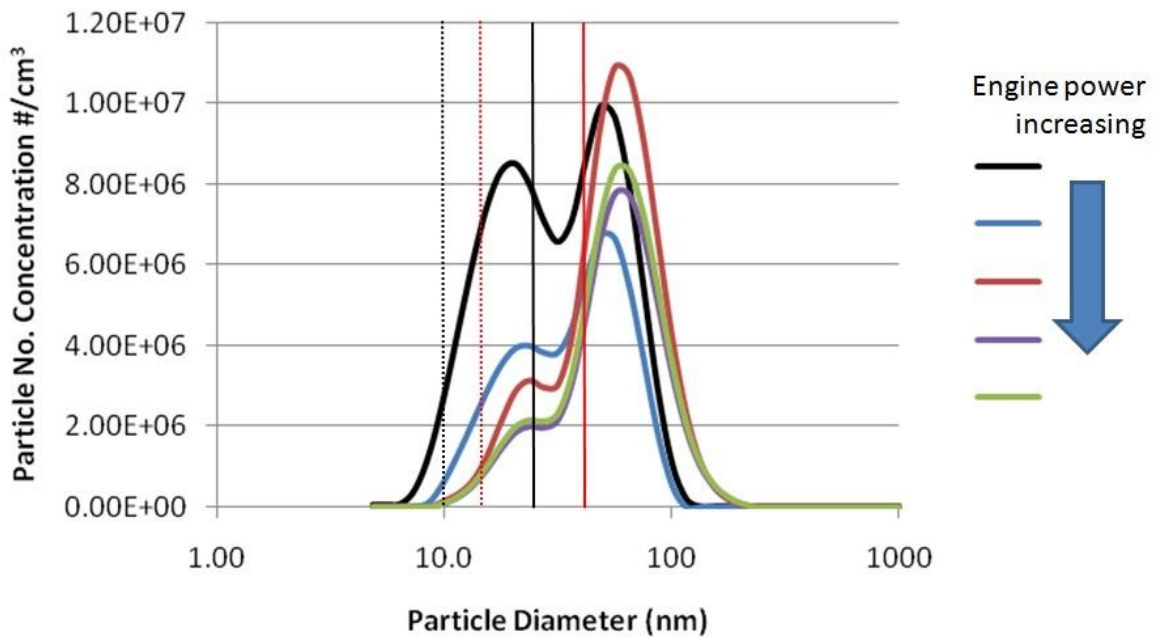

Figure 9 SAMPLEII engine test particle size distributions

Two CPCs (with d₅₀'s of 10 and 23nm) were located after an evaporation (PMP) type AVL VPR and the results are shown below in Figure 10. Only 3 data points are shown due to an instrument malfunction part way through the power curve. As can be seen, the CPC with the lower cut-size measured a higher number concentration of between 10 to 15%. With an uncertainty on the number measurement of around 20% this difference was not seen to be statistically significant. In addition due to the use of an evaporation/dilution volatile removal device, volatiles could have accounted for some of the observed difference in the <23nm size range.

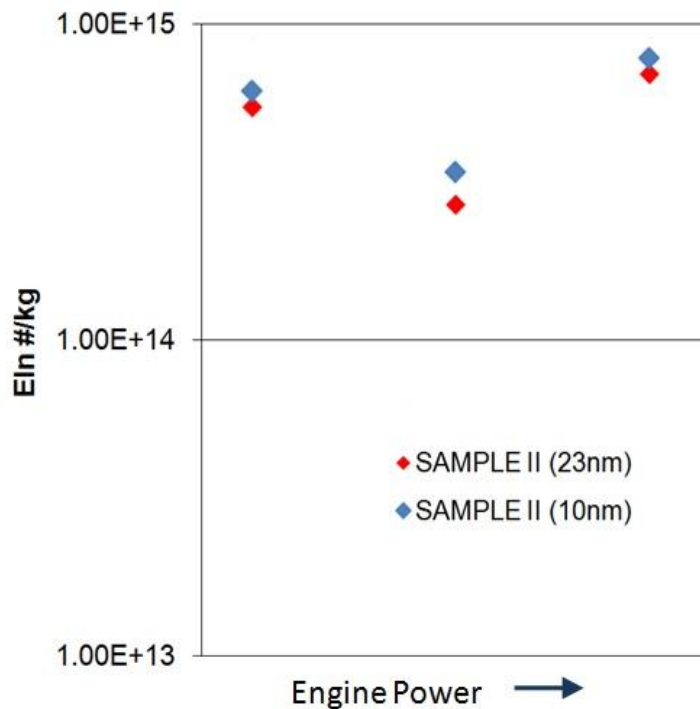

Figure 10 Particle number emission indices obtained with two CPCs with different d_{50} lower size cut-points (10 and 23nm).

In August 2011, FOCA performed an experiment at SR Technics to obtain data to help assess the lower cut point on in-service engines. In this experimental setup the majority of data was obtained with three different CPCs each with a different lower cut point (TSI 3788, $d_{50}=2.5\text{nm}$, TSI 3772, $d_{50}=10\text{nm}$ & Grimm PMP, $d_{50}=23\text{nm}$) were employed behind an AVL PMP VPR, that did not include a catalytic stripper hence it is not known if volatile PM is present. For one mixed flow engine (where the hot combustion exhaust is diluted prior to probe tip), the PMP VPR was replaced with a CS-type and CPC results indicated that at steady state conditions (not transient), number concentrations were similar to previously obtained with a PMP VPR.

The raw data taken from the different CPC over a range of power levels were normalised against each other (a value of 1.0 shows agreement between readings) and the data is given below (Figure 11).

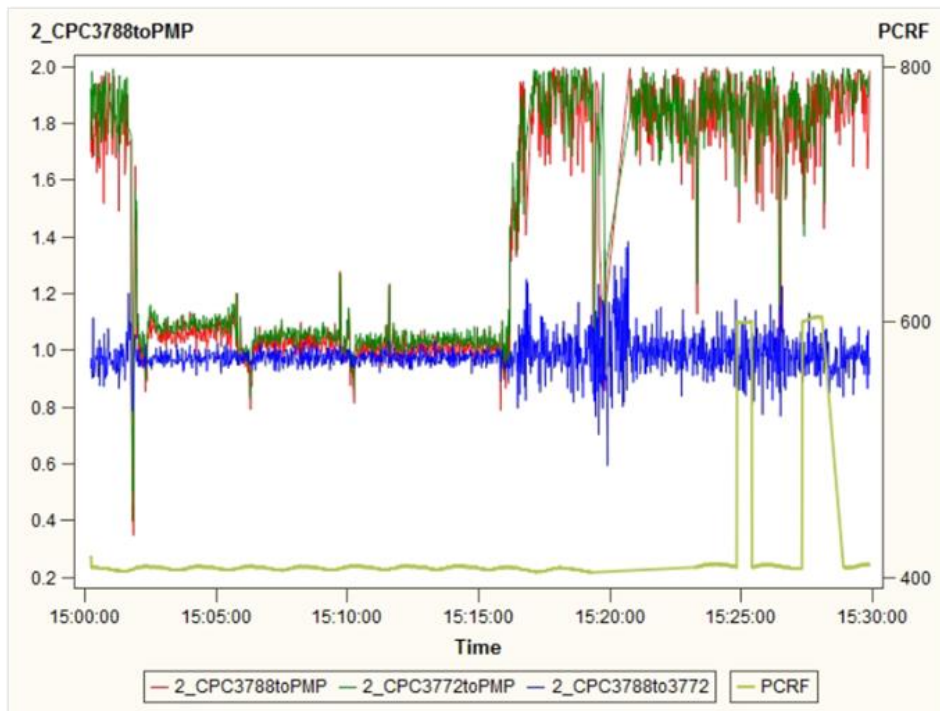

Figure 11 Normalised CPC inter comparison between $d_{50}=2.5, 10 \text{ \& } 23\text{nm}$ analysers, (red line 2.5nm versus 10nm, green line 10nm versus 23nm and blue line 2.5nm versus 10nm)

It should be noted that the red line is a ratio between the 2.5nm to the 23nm analysers, the green line is the 10nm to the 23nm analyser and the blue line is the 2.5nm versus 10nm analyser.

It can be seen that both the 2.5 & 10nm analysers show a discrepancy compared to the 23nm analysers and this offset is power dependant it is noticed at a flight idle condition (15:00-15:02) this offset is high at (80% increase in number) then this drops to approximately 5-10% at the three high thrust conditions (15:02-15:07). As the engine is then driven to further lower power conditions (15:17-15:30) again a large 80% disagreement is observed. This variable offset proves that subtle changes in the size distribution massively affect the number concentration measured with a 23nm CPC as for the lower size distributions (at idle conditions) a large portion ($\approx 40\%$) of the PM are smaller than the $D_{90}=41\text{nm}$ accurately counted on this analyser.

In contrast the CPC comparison between the $d_{50}=2.5 \text{ \& } 10\text{nm}$ (blue line) measure almost identical number concentrations across all power profiles, this supports the observation discussed earlier (Petzold et al., 2011) that a counter operated at $d_{50} = 10\text{nm}$ samples more than 90% of all particles emitted from the gas turbine, and displays the fact that there is no requirement to pick a CPC with a lower cut point than a $d_{50} = 10\text{nm}$

As can be seen by adopting a lower cut-point CPC ($d_{50}=10\text{nm}$, $d_{90}=15\text{nm}$) it is observed that in all of the above cases the majority ($>90\%$) of solid PM transferred through the sampling system are measured. Compared with, at times, less than 50% of particles when measured using a PMP type counter ($d_{50}=23\text{nm}$, $d_{90}=41\text{nm}$).

This data seems to validate the SAMPLE III consortium recommendation of a lower ($d_{50}=10\text{nm}$, $d_{90}=15\text{nm}$) cut point CPC. However, to ensure the conclusion of cut off points are



not an artefact of the instruments tested and/or the presence volatile PM, specific data (both number count and size distribution behind catalytic strippers) was obtained at the SR Technics test facility in Zurich as part of the SAMPLE III.02 test campaign which will be discussed in further detail later (6.4.1).

4.5 Conclusions of Task 1

1. The SAE E31 nvPM draft working document is currently on schedule for early 2013 but will need further line verification and operational comparisons with engine manufacturer systems to ensure the ARP is 'ballotable' in 2014

5. Task 2: Testing at SR Technics facility in Zürich, Switzerland

5.1 Introduction

To enable the testing phase at SR Technics in Zurich to be conducted, a new sampling system that could be fitted within the engine test cell at the test facility and remotely operated needed to be designed, manufactured and installed.

The sampling system used in SAMPLE III.01 formed the basis for the SAMPLE III.02 test campaign at SR Technics. However, a new remotely controllable 3PTS ‘box’ with specific geometry was required to permit an installation and simplify the building of the 2PTS interface to try and ensure that the best possible line comparison experiment could be performed.

It was ensured that the design of the sampling system complied with the current version of the SAE E31 concept sampling system (as taken from the SAE E31 tracking spreadsheet) was consulted (Figure 12) along with sampling text (from the latest SAE E31 Draft working document at the date of the campaign preparation, January 2012).

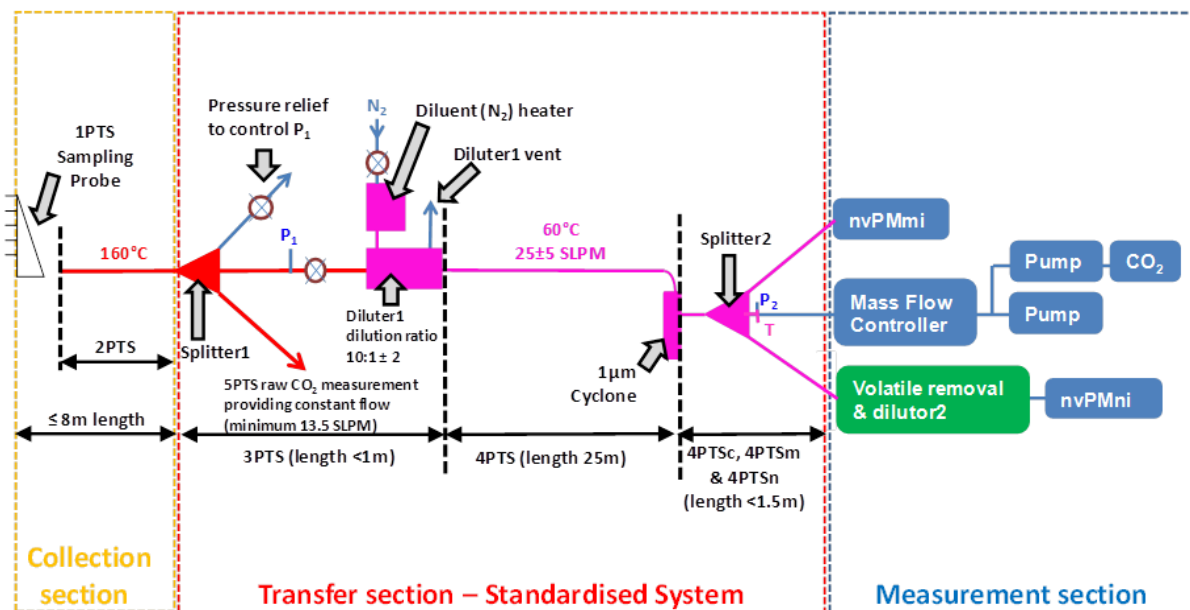

Figure 12 SAE E31 Concept Sampling system, as defined in current tracking spreadsheet

From the above, it was possible to develop a sampling system that complied to current SAE E31 recommendations in order that two ‘compliant’ systems may be tested simultaneously, behind a full scale ‘large’ civil aviation gas turbine.

5.2 Sampling system design, manufacture and specifications

To allow both the FOCA and SAMPLE III PM sampling systems to be tested simultaneously it was necessary to develop a concept by which they could be installed in parallel into the SR Technics test bed.

A schematic of the final concept is given below (Figure 13). As can be seen the two systems sample through a common sampling probe (1PTS) and primary sample line (2PTS). To enable simultaneous sampling of both lines through a common sampling probe, an additional section (2PTSa) comprising a three way splitter was required to allow both sampling systems. To ensure that the flow to each system was as uniform as possible the two 30° splits were used to supply the PM sampling lines, with the central line being used to supply the existing Annex 16 sample line. Generally the Annex 16 line would be fed from the PM diluter box splitter. However, it was perceived that to try and link the Annex 16 lines after the diluter boxes may lead to preferential flow through one of the specific sampling lines in 2PTSa which may lead to a different loss in this section. Therefore, the Annex 16 leg within the primary dilution section (3PTS) of both the SAMPLE III and FOCA sample lines were blocked.

On looking at the current SAE E31concept sampling system the authors felt some of the terminology was confusing therefore it is proposed that sections 4PTS_n, 4PTS_m & 4PTS_c are simply renamed 5PTS as this section is not part of the standardised 25m PTFE line prescribed in 4PTS, unfortunately 5PTS was already prescribed in the current concept as the CO₂ measurement line (Annex 16), however, the authors feel to give this the terminology PTS (particle transfer system) is not suitable for a gaseous transfer line therefore this line within this report will be termed the GTS (gaseous transfer system).

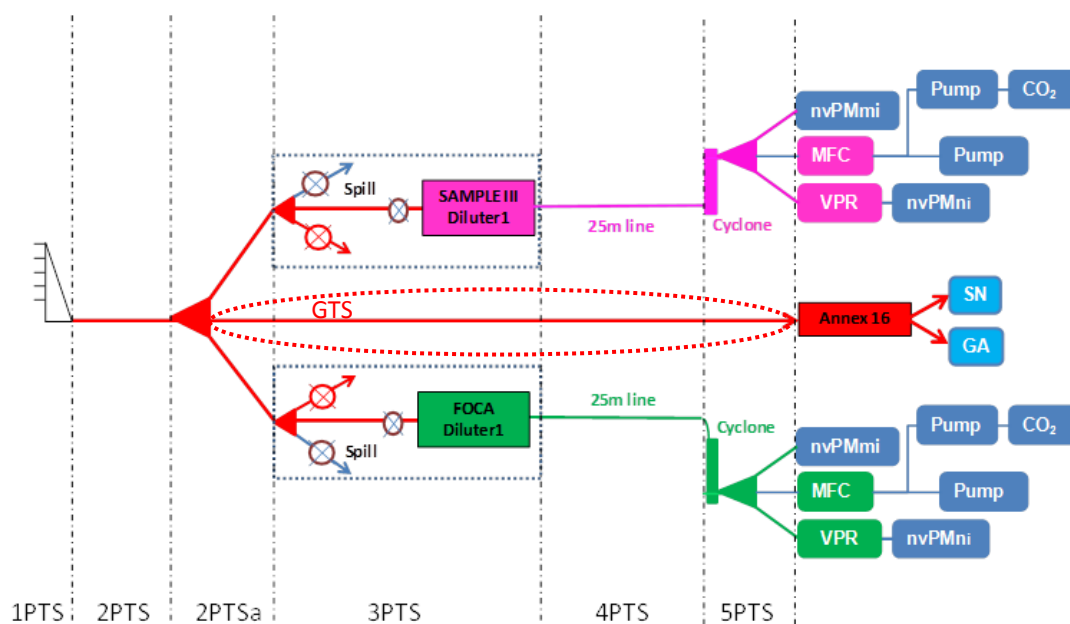

Figure 13 Conceptual design of the Zurich test sample line set up

Within the current SAE E31working document there are numerous options available within each of the different sampling sections which meet the specifications currently laid out in the

document, therefore the exact specification of each particle transfer section for both the SAMPLE III and FOCA PM sampling systems is given below.

5.2.1 Sampling Probe (1PTS)

This section is common for both systems and utilises the currently installed single point 1D traversable probe. A photograph of the probe inlet and the traversable probe support are given below (Figure 14).

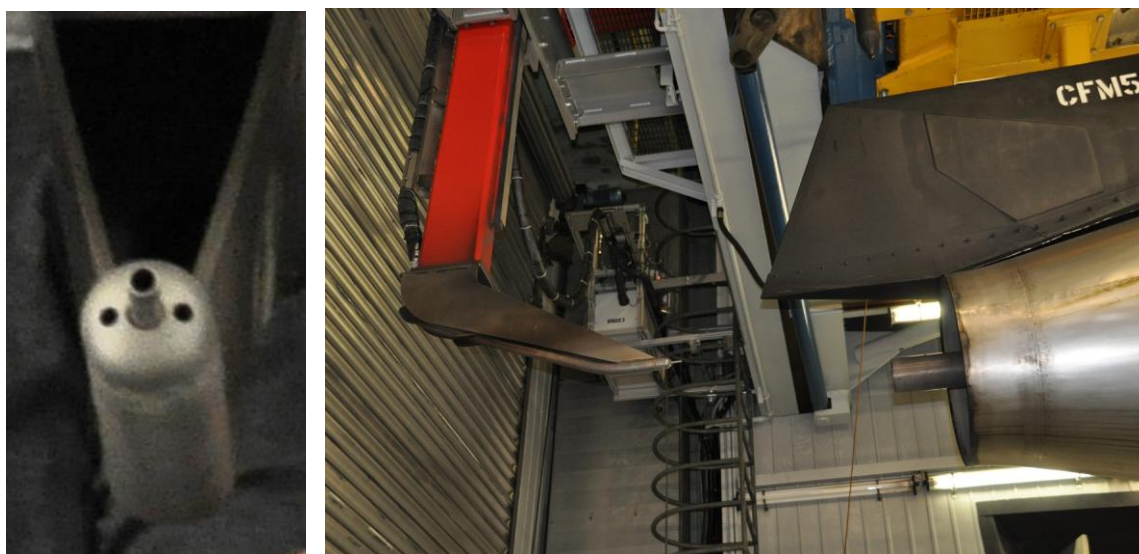

Figure 14 (a&b) SR Technics 8mm single point probe front and side views respectively

The probe is as discussed a 8mm ID stainless steel single point sampling probe, which is sheathed with a 25mm sleeve with 2 inlet holes which allow hot exhaust gases to flow past the probe sample line ensuring it does not cool below 160°C, the probe sample line is made from 10mm OD (8mm ID) stainless steel line and is approximately 1m in length before coupling with the primary sampling line (2PTS). As explained previously, the probe can be traversed in the vertical plane on the centre line of the engine generally from below the centre line of the engine through the exhaust and out of the top of the exhaust stream.

It should be noted that this section of the sampling transfer section does not meet with the specifications of the SAE E31 PM working document as it does not meet with some of the specifications laid out in Annex 16 for a sampling probe. To ensure that the sample is representative of the engine exhaust an Annex 16 probe is specified as having a minimum of 12 sampling points, positioned across the exit plane of the engine exhaust, each of which must sample iso-kinetically and thus have a 80% pressure drop across the probe. As such the probe at SR Technics which as discussed is an 8mm single point probe does not meet this criteria. Though the probe could be traversed across 12 points on a single plane.

Annex 16 also states the probe must be within $\frac{1}{2}$ a nozzle diameter of the engine exhaust exit plane. Unfortunately the probe in its current configuration depending on engine type being investigated sometimes does not meet this specification either. For the above reasons it should be noted that all subsequent data published in this report can and should only be used

to assess the performance of the sampling systems under investigation and is in no way representative of the engines being sampled.

5.2.2 Primary Sampling Line (2PTS)

Again this section of the sampling system is common to both sampling systems. This section is 6m in length, and constructed from 10mm OD (8mm ID) bendable stainless steel pipe. The line is electrically trace heated and insulated to ensure the sample does not drop below 160°C.

5.2.3 Additional sampling to allow simultaneous sampling (2PTSa)

To accommodate the two sampling systems a modification to the primary sampling line was required. As can be seen above (Figure 13) an additional splitter is required compared to the SAE E31 approved system (Figure 12). A photograph of this section during installation and fully installed is given below (Figure 15)

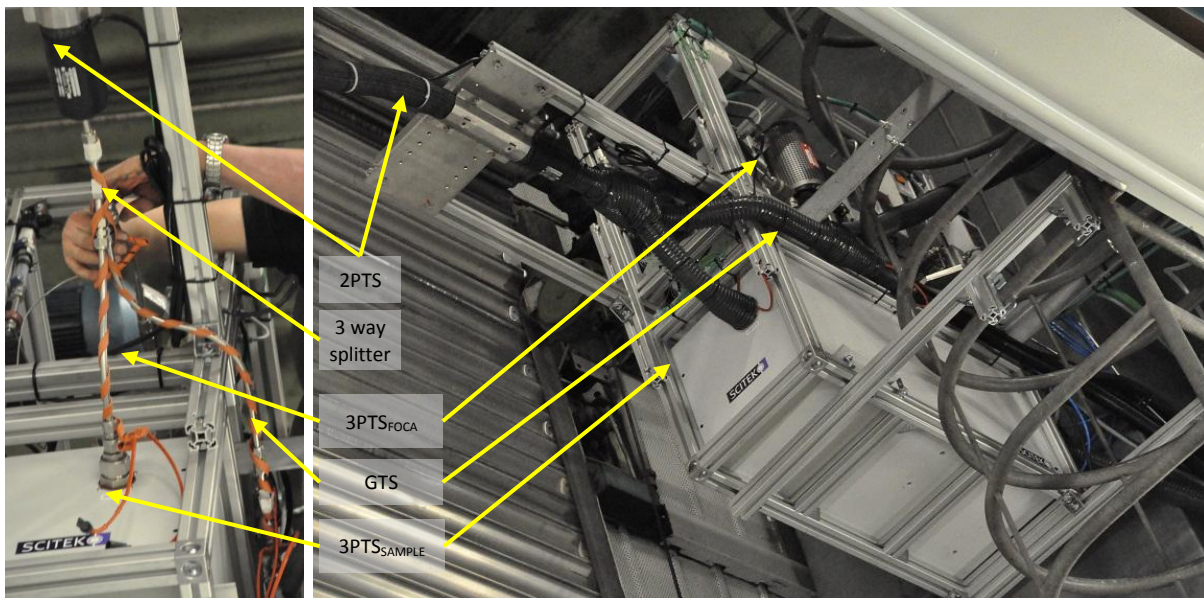

Figure 15 (a&b) Photograph of section 2PTSa during setup and when commissioned within SR Technics engine test cell

It can be seen that after the three way splitter, two nominally identical (including bend geometry) 10mm sample lines 340mm in length were fitted to connect 2PTS to each of sample lines primary splitters. Also a third branch for the GTS line was taken off at this point. As can be seen (Figure 15a) each of the three lines were then electrically trace heated, and insulated (Figure 15b) ensuring the lines could be maintained at 160°C.

5.2.4 Primary splitter, dilution and spill box (3PTS)

Two compliant primary splitter, dilution and spill boxes (3PTS) based on the schematic of the particle measurement system taken from SAE E31 draft working document version 1 installed in parallel within the SR Technics test cell behind the overhead gantry.

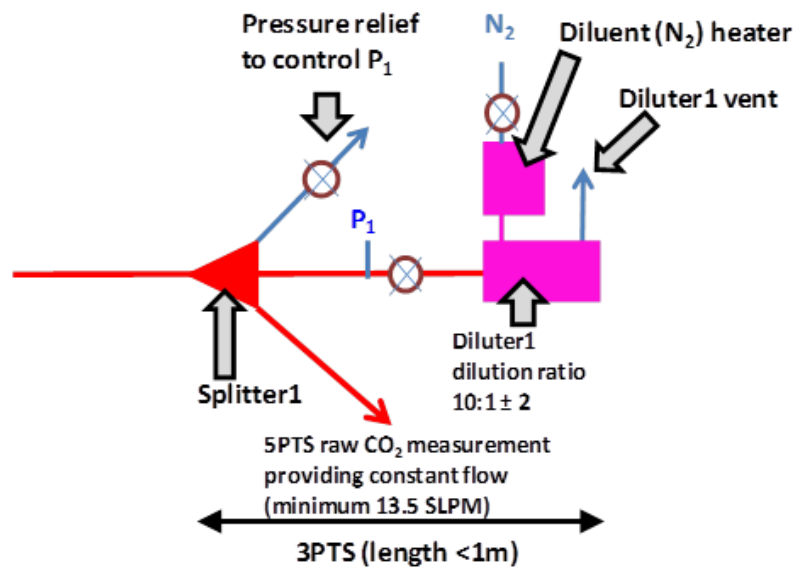

Figure 16 Zoomed in section of 3PTS from schematic of particle measurement system from current draft working document

As can be seen, section 3PTS is defined as a three way splitter, splitting to exhaust spill which is required to have a controlled valve in order that pressure at the inlet of the other 2 lines (P_1) namely the CO_2 measurement line GTS (which can be used for existing Annex 16 specification measurements) and the PM sample line can be regulated independent of engine thrust level. The colour of the diagram illustrates that the lines carrying sample to both the PM line and GTS are to be maintained at $160^\circ C$.

As can be seen the next section of 3PTS requires an isolation valve for the PM sampling line, this is required for a number of reasons including to facilitate a leak check on the GTS line up to the probe as is prescribed by Annex 16. Also this valve is required to allow a cleanliness check of the line to be performed by shutting the valve and running only nitrogen through the line recent discussions within the SAE E31 (San Diego 2012) also highlighted that this valve could be used to allow a background PM measurement to be made from within the test cell by sampling backwards through the eductor diluter vent prior to a measurement campaign.

The last component of 3PTS is the eductor diluter which has been shown to be able to provide a dilution ratio of $10:1 \pm 2$ (in the previous SAMPLE III.01 test campaign). The document specifies that the diluter should be used to drop the temperature of the PM gas stream from $160^\circ C$ to $60^\circ C$ as it is thought that if this temperature drop is conducted in the diluter then thermophoretic losses are minimised, however, at this time the authors have seen no evidence to quantify this theory. The last component is the nitrogen heater which is required to ensure the exhaust gas of the diluter is at the $60^\circ C$ and is not cooled too low.

The last specification is that the overall length of 3PTS from the splitter to sample line (4PTS) input must be less than 1 meter in length.

5.2.4.1 SAMPLE III primary splitter, dilution and spill box

The SAMPLE III primary splitter, dilution and spill box (3PTS) was custom designed by the consortium and built ‘bespoke’ utilising some consortium members owned hardware components. A schematic & photographs of the SAMPLE III.02 3PTS design and built unit are presented below (Figure 17-Figure 19).

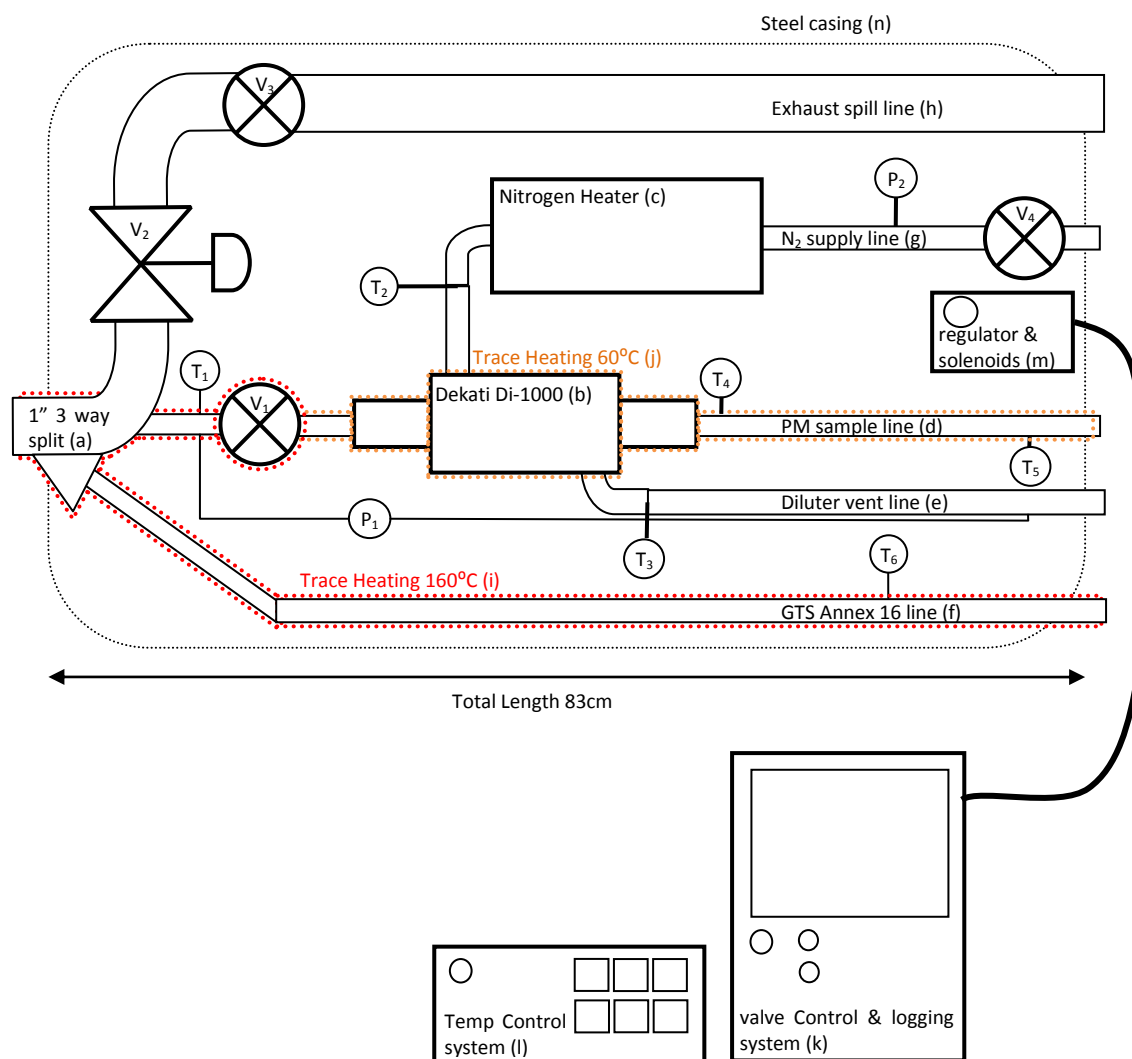

Figure 17 Schematic representation of SAMPLE III Primary splitter, dilution and spill box (3PTS)

As can be seen the design of the SAMPLE III 3PTS primary splitter, dilution and spill box contains numerous components including pipe-work, valves, splitters, pressure sensors, temperature sensors and trace heating. A summary of each individual component with specific details given later (Table 1).

It should be noted that in order to reduce the complexity of the schematic representation of the SAMPLE III 3PTS section (Figure 17) the control circuit diagram has not been included. However, a description of the controlling mechanism is given here. The temperature of the internally heated lines, splitters and valves was controlled using a remote PID control



temperature controller (l) (Figure 19b), with a mineral insulated ‘k’ type thermocouple, physically attached to relevant metal-work under the trace heating being used to control the PID. In the case of the PM sampling train, including both the eductor diluter (b) and PM sample line (d) (after isolation valve V_1) this was controlled at 60°C , and monitored using temperature sensor T_5 . For the sample three way splitter (a), PM isolation valve (V_1) and GTS (raw gas/Annex 16) line (f), temperature sensor T_6 was used to control the PID system with temperature sensor T_1 being continually monitored to ensure the PM sample temperature was always within the specified temperature range of $160^{\circ}\text{C} \pm 10^{\circ}\text{C}$.

The diluter outlet temperature, which the E31 committee currently recommend at 60°C , is controlled by PID control of the nitrogen heater (c), the temperature sensor T_4 which in this case has been housed in a specially designed and manufactured fitting so the thermocouple is mounted flush with the wall internally thus does not impact on the PM path. However, it was recommended at the SAE E31 committee meeting by the SAMPLE III consortium that this temperature could probably be more accurately measured by the thermocouple T_3 placed within the eductor diluter vent line (e) as this thermocouple can be positioned within the gas flow giving a better reading of gas temperature. As such this method is now recommended by the sampling team. To ensure the heater does not fail and damage the unit an alarm thermocouple T_2 is positioned at the nitrogen inlet to the eductor diluter, this limit can be set to a safe level and is used to trigger a high temperature cut out if this figure is exceeded.

The dilution ratio of the eductor diluter (b) is controlled by a proportional valve positioned on the exhaust spill line (V_2), the ‘bespoke’ control and logging system (k), monitored the pressure differential observed across the inlet of the eductor diluter (b) and the test cell ambient pressure, measured in the vent line of the eductor diluter (e). A pressure differential of 10mbar was shown in commissioning experiments to equate to a dilution ratio of approximately 10, therefore this input was placed into the controller settings as the desired set point and the exhaust spill valve (V_2) driven via a 4-20mA electrical current. To ensure the supply pressure of the dilution nitrogen was at the correct pressure to facilitate the required dilution ratio (2bar), a further alarm pressure sensor (P_2) was installed on the nitrogen supply line (g) after the nitrogen isolation valve (V_4).

Isolation valves (V_1 , V_3 & V_4) were controlled via pneumatic actuators which are remotely operated by the control & data logging system (k) via an electrical signal. The isolation valve for the exhaust spill line was not included in the original design, however, on commissioning the unit at Zurich it was observed that the proportional control valve (V_2) was unable to completely seal the line (under vacuum) making it impossible to conduct leak checks of both the Annex 16 and PM lines, therefore this recommendation is now adopted by the SAE E31 sampling team.

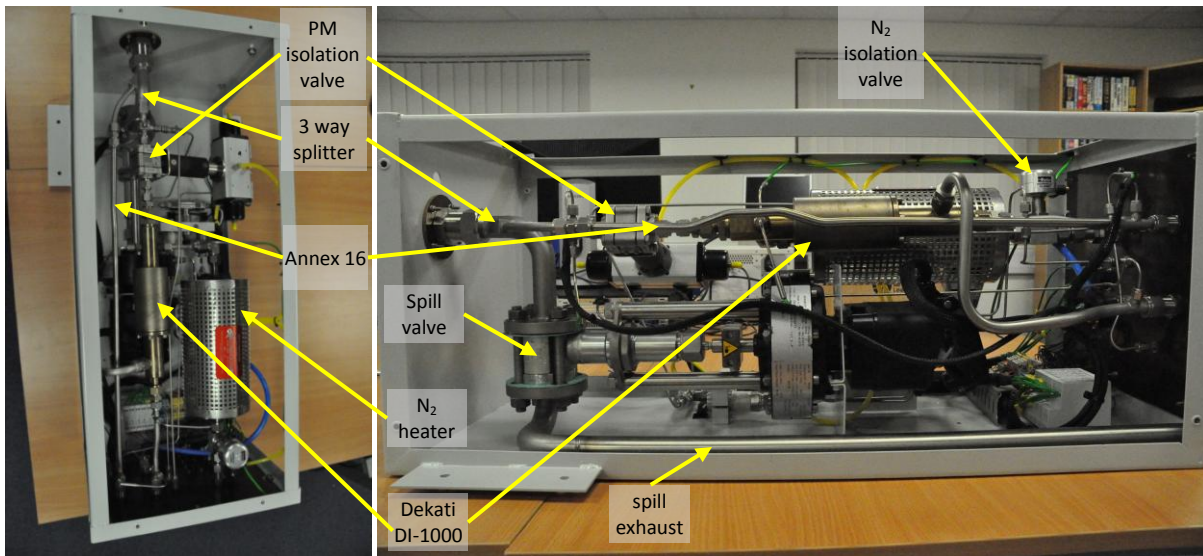

Figure 18 Photograph of internals of SAMPLE III splitter, diluter and spill box, prior to heat tracing installation

It is observed that remote control systems are required to operate the box, these units were installed with the PM measurement analysers outside of the test cell which facilitated any amendments to control settings to be performed during engine operation.

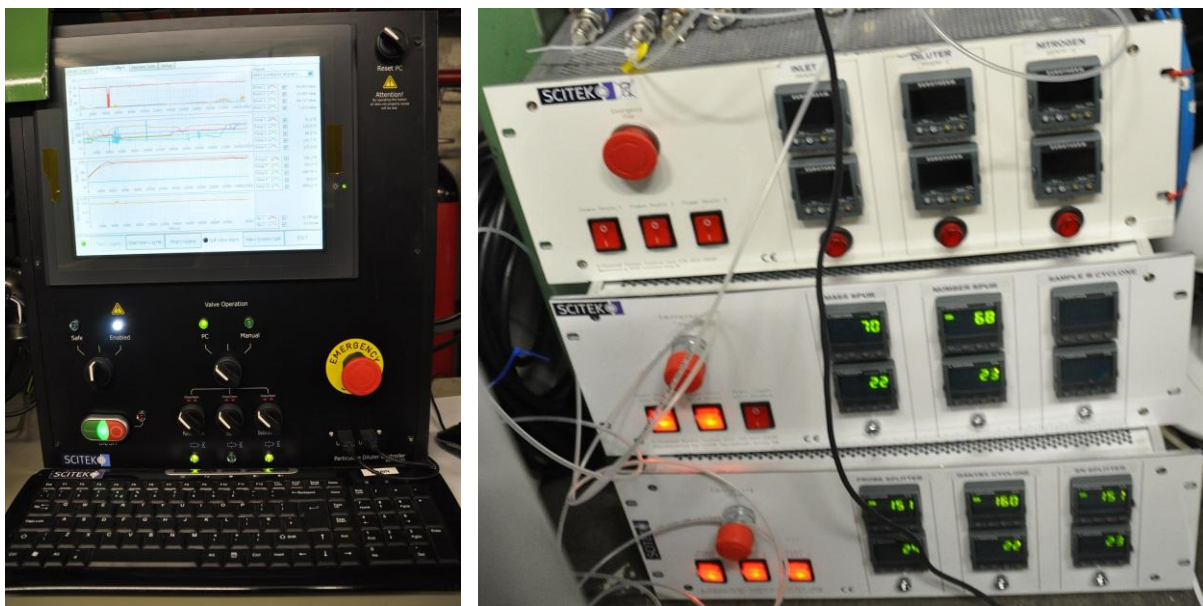

Figure 19 (a&b) Photographs of SAMPLE III control and data logging system and temperature control modules respectively

To enable the SAMPLE III 3PTS unit to be utilised with Rolls Royce’s certified emissions rake as well as FOCA’s single probe, it was necessary to manufacture a ‘bespoke’ primary splitter, allowing for the required 1” inlet from the cruciform sampling rake, which also has the requirement for a large spill line to ensure all of the exhaust from the 24 ganged sampling probes can be spilled at high thrust condition. If an inlet of 10mm (i.e. FOCA probe outlet size) was utilised, then the SAMPLE III system would be non-compliant to DWD specifications due to the inclusion of a large reduction step at the 3PTS inlet if attached to the certified emissions rake.

As can be seen from the schematic representation (Figure 17) and from photographs of the splitter before trace heating and insulation have been installed (Figure 20), that the splitter is constructed from 1" pipes with bosses externally welded and counter bored to allow an Annex 16 compliant (GTS) sample to be taken off at an angle of 30° and a PM sample line to be taken straight through on the centre line of the 1" pipe, which runs to the exhaust spill control valves. It can also be observed that the inlet 1" bulkhead fitting is thermally isolated from the steel enclosure casing (n), by using a round piece of low thermal conductivity material.

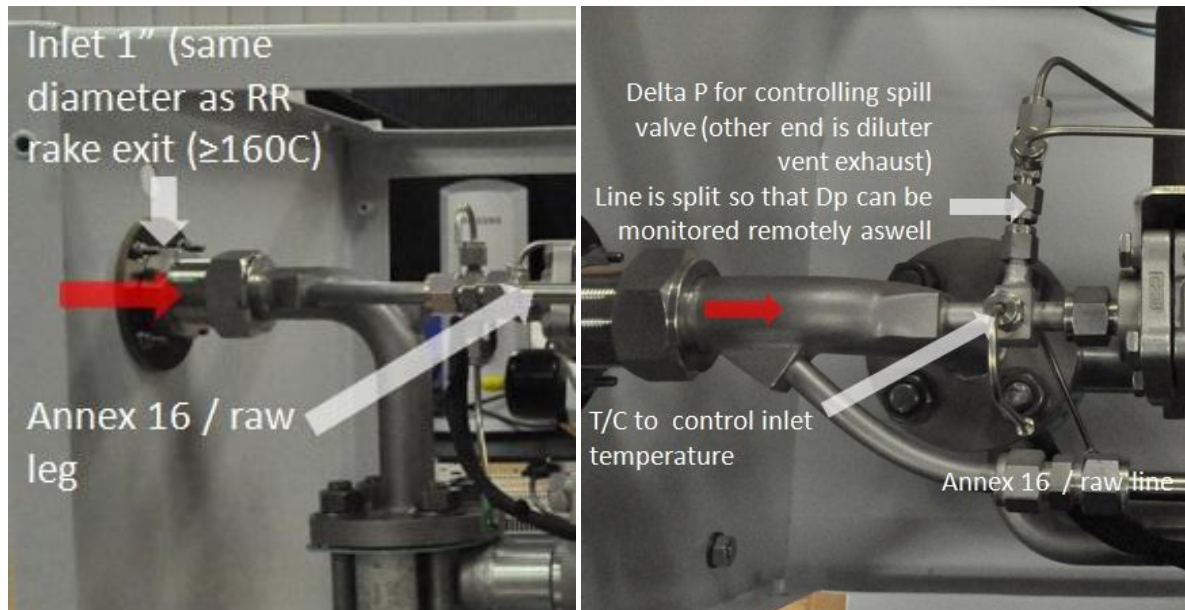

Figure 20 Photograph of side and top profiles of 'bespoke' primary splitter used within SAMPLE III 3PTS unit prior to heat tracing installation

The SAMPLE III system was successfully demonstrated at the SR Technics Zurich facility, however, at low thrust levels due to there being two systems operating simultaneously it was found that there was not enough flow being taken into the sampling probe (1PTS) to facilitate the use of the SAMPLE III proportional control valve V_2 , as such the isolation valve V_3 had to be operated which meant that the dilution ratio was unable to be controlled by the SAMPLE III control system, as such at times of low flow the SAMPLE III dilution ratios were outside of the currently, in the draft working document, specified dilution ratio of 10 ± 2 . However, at higher thrust level conditions there was sufficient flow to allow the independent control of valve V_2 and during these periods the dilution ratio was controlled to within the required specification. The reasons for this control problem will be discussed further in the data analysis section (chapter 0).



Table 1 Parts list of SAMPLE III Primary splitter, dilution and spill box (3PTS)

Part Id.	Description	Manufacturer	Approximate Cost
a.	3 way splitter, 1" inlet, 2 off 3/8" outlets PM straight through, 5PTS 35° offtake, 1" 90° exhaust spill	Bespoke (SCITEK)	€375
b.	DI-1000 eductor diluter (R-R owned)	Dekati	€7,500
c.	DH-1723 Nitrogen Heater (R-R owned)	Dekati	€2,500
d.	PM line- 3/8" Stainless steel tube & fittings	Swagelok	€65
e.	Diluter Vent Line- 1/2" Stainless steel tube	Swagelok	€125
f.	PM line- 3/8" Stainless steel tube & fittings	Swagelok	€65
g.	Nitrogen supply line- 3/8" Stainless steel tube & fittings	Swagelok	€65
h.	Exhaust spill line- 1" steel tube and fittings	Swagelok	€200
i.	160°C spiral wound silicon trace heating	Watlow	€125
j.	60°C spiral wound silicon trace heating	Watlow	€125
k.	Control & data logging system, computer, touch screen, national instruments compact rio,	Bespoke, (SCITEK)	€25,000
l.	Temperature control unit, 3 channel PID temperature controller	SCITEK	€2000
m.	Pneumatic solenoids and regulator set for valve control	Norgren	€500
n.	Steel enclosure box, 83cm x 35cm x 35cm	Bespoke, (SCITEK)	€1250
V ₁	PM Sample line isolation valve- T63m 3/8" high temperature ball valve and Pneumatic controller	Swagelok	€400
V ₂	Exhaust spill control valve- 1/2" 8021 series high temperature control valve and 8049 series positioner	Schubert & Saltzer	€4500
V ₃	Exhaust spill isolation valve- 1" high temperature ball valve (added during test)	Swagelok	€500
V ₄	Nitrogen isolation valve- 3/8" ball valve and Pneumatic controller	Parker	€125
T ₁	PM inlet thermocouple, logging 'k' type in bespoke flush mount housing	TC Direct	€100
T ₂	Nitrogen high temperature Alarm, 'k' type	TC Direct	€25
T ₃	Eductor Diluter vent line temperature, logging, 'k' type	TC Direct	€25
T ₄	PM sample temperature, 'k' type in bespoke flush mount housing	TC Direct/ SCITEK	€100
T ₅	PM Sample line control temperature, 'k' type 60°C control thermocouple	TC Direct	€25
T ₆	PM Sample line control temperature, 'k' type 160°C control thermocouple	TC Direct	€25
P ₁	Pressure differential pressure transducer (200mbar) controls exhaust spill valve (V ₂) to maintain constant dilution ratio	Druck	€250
P ₂	Absolute pressure transducer for nitrogen inlet pressure monitoring (2500mbarG)	Druck	€250

As can be seen there are a number of separate sections and components within section 3PTS which require constant monitoring, control and data logging as such to design and build the SAMPLE III primary splitter, dilution and spill box would currently cost in the order of

€47,000 (excluding design costs) and requires the detailed knowledge of the SAE E31 draft working document for the measurement of non volatile PM to design and operate.

5.2.4.2 FOCA primary splitter, dilution and spill box

The primary splitter, diluter and spill system installed at SR Technics is that designed and installed and owned by FOCA at the time of the sample probe installation which has been successfully demonstrated at a number of previous test campaigns (AVL-TSI test Aug 2011, MS&T test Dec 2011). A schematic and photograph of the FOCA primary splitter, diluter and spill system is given in (Figure 21&Figure 22)

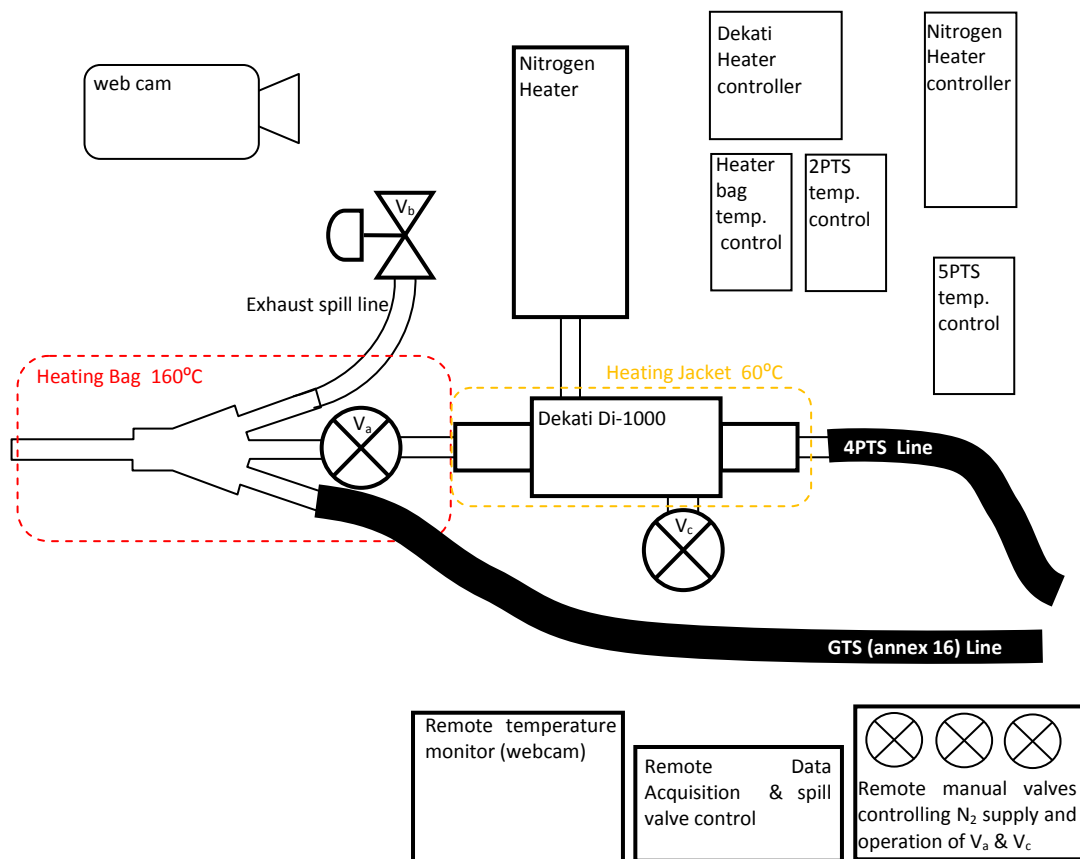

Figure 21 Schematic representation of SR Technics (FOCA) primary splitter, diluter and spill

As would be expected the SR Technics 3PTS unit is similar in design to that of the SAMPLE III system as both are made to the same SAE E31 recommendations, with both systems employing a Dekati DI-1000 diluter and DH-1723 Nitrogen Heater as their dilution system. However, there are some subtle differences in design with the primary splitter, in this case being a three way 15° angle, 8mm ID splitter as shown a technical drawing below (Figure 23). The heating of this splitter section is done employing the use of a ‘bespoke’ heating bag regulated to 160°C, which encases the whole splitter and PM isolation valve assembly. The DI-1000 diluter is heated by Dekati’s DH-1523 Insulated Diluter heater.

Because this system was designed to use in conjunction with the single 8mm probe installed at SR Technics the spill line and valve is also smaller than the SAMPLE III counterpart with a 8mm ID. The control of this valve is performed remotely using inlet pressure to the diluter as the variable to control and stabilise the dilution ratio.

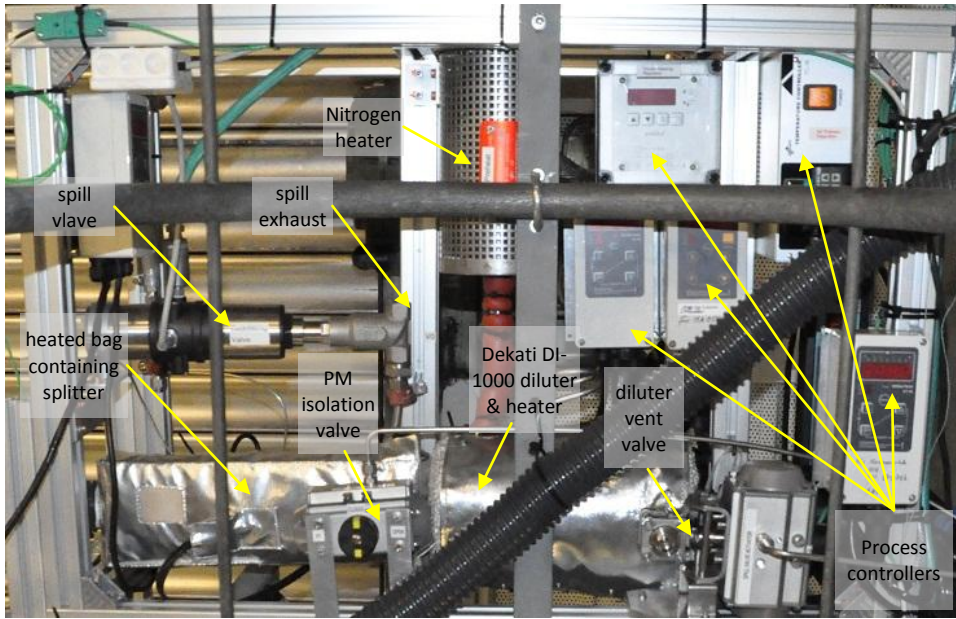

Figure 22 Photograph of SR Technics installed primary splitter, diluter & spill system (3PTS)

It is observed that the control methodology employed is mostly automated locally for the temperature control, with the PID readouts being remotely observed using a webcam. The valve control is conversely remotely controlled manually by an operator using a series of valves to actuate the isolation valves for nitrogen flow, PM line and diluter vent.

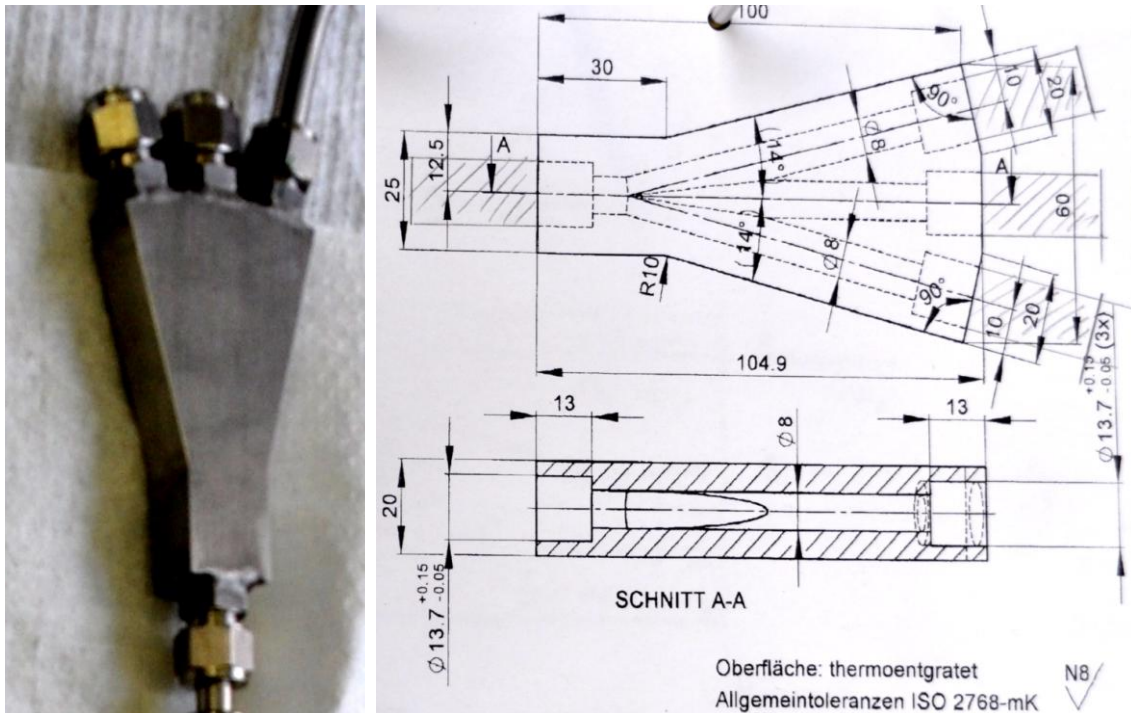

Figure 23 Photograph and technical drawing of FOCA primary splitter.



5.2.5 Sampling line, (4PTS)

As discussed earlier, current SAE E31 recommendations are that this section of line should be as standardised as possible thus current specifications dictate that 4PTS which is defined as from 3PTS outlet to instrument measurement inlet, as described in the SAE E31 recommended PM line schematic (Figure 12). To conform with the above, this section should be built as a 25m heated sampling line made of conductive PTFE with an internal diameter of between 7.7-8.05mm and heated to 60°C with as few connections as feasible.

5.2.5.1 *SAMPLE III Sampling line (4PTS)*

The SAMPLE III sampling line was the one built in SAMPLE III.01. It was designed and manufactured 'bespoke'. The sampling line is constructed from carbon loaded "conductive" PTFE which was made to order with the same outer diameter and wall thickness as standard Swagelok 3/8" stainless steel line. The line is constructed as one continual length of 25m and heated via electrical resistance through a stainless steel braid that was bound onto the outer surface of the PTFE tube. The temperature can therefore be controlled uniformly around the entire sample line by supplying a voltage potential down the braid. Numerous (4) thermocouples were then positioned along the lines length and the assembly insulated using silicon sponge pipe lagging and protected using high spiral wound flexible ducting.

5.2.5.2 *FOCA Sampling line (4PTS)*

Unfortunately FOCA had already installed its sampling line (4PTS) prior to the SAE E31 reaching agreement that as this section was where the majority of losses were encountered that this section should be a standardised and prescriptive as possible, hence the initial line that was installed was made only as sufficiently long as required to get from FOCA's primary splitter, diluter and spill box (3PTS) to the cyclone and secondary splitter (5PTS) which is mounted in a room outside of the test cell. As such the initial line was a spiral wound trace heated 8mm inner diameter conductive PTFE line was made at a length of 12m. To accommodate the new SAE E31 recommendation FOCA have added another nominally identical 12m section with a heated junction connecting the two lines. As such when setup for line inter-comparison the FOCA sampling line was ≈24.5m in length.

However, there was a great advantage in this setup namely that it enabled a direct comparison of two different lines (25m versus 12m) to be conducted real time behind a large scale commercial aviation gas turbine as is discussed further in section 5.6.2.1.

5.2.6 Cyclone & Secondary splitter (5PTS)

This section is defined as the section between the standardised sample line (4PTS) and the non-volatile PM mass and number instruments and mass flow controller. As the SAE E31 community currently believe the size distribution of a modern large scale commercial aviation gas turbine to be significantly lower than 1 micron it was thought that particles larger than this which are measured at the end of the sampling system are created as a product of 'shedding' from the sample lines. Previous mass studies (SAMPLE) have shown that if these very large (>1 micron) particles are included in the mass measurement then they can significantly alter the time weighted mass average. As these 'shedding' events are random in nature it was thought prudent by the SAE E31 committee to include a PM1.0 ($d_{50} = 1\mu\text{m}$)



cyclone at the end of the sampling line (4PTS) upstream of the mass analyser. After much debate to standardise the sample entering the mass and number analysers whilst protecting the number instrument and mass flow controllers from unwanted ‘fouling’ and blockage it was decided that this cyclone should sit before both the mass, number, CO₂ and mass flow control systems.

For the above reasons it was necessary to add a secondary splitter after the cyclone to carry sample to the mass, number and CO₂ and mass flow systems.

5.2.6.1 *SAMPLE III Cyclone & secondary splitter (5PTS)*

The cyclone utilised in the SAMPLE III design is a ‘made to order’ commercially available sharp cut cyclone designed and specially made to order by BGI Incorporated (US) this design (with a higher than normal flow-rate) was first specified by Greg Smallwood at NRC Canada and BGI has allocated the part number BGI 3800 NRC Canada 25 LPM PM1.0 . A schematic representation of the cyclone is given below (Figure 24). The cyclone was designed with $\frac{3}{8}$ ” inlets and outlets thus ensuring no shoulders are witnessed when connecting to imperial sample lines before or after the cyclone. As highlighted in the part number the d_{50} cut point is set at 1micron (PM1.0) and is designed to achieve this at a flow rate of 25sLPM. The design of these cyclones ensures current ‘state of the art’ technology giving a very sharp cut point profile and are used by the US EPA for ambient PM2.5 micron measurement.

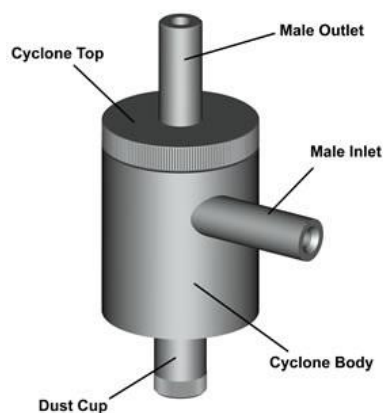

Figure 24 Schematic representation of BGI specially made to order PM1.0 sharp cut cyclone

The splitter employed for this section was a three way 30° $\frac{3}{8}$ ” inlet to 2 off $\frac{3}{8}$ ” outlets and 1 off $\frac{1}{4}$ ” outlet as described in section 5.2.6. A schematic of 5PTS as was used in both the SAMPLE III and FOCA systems is given below (Figure 25).

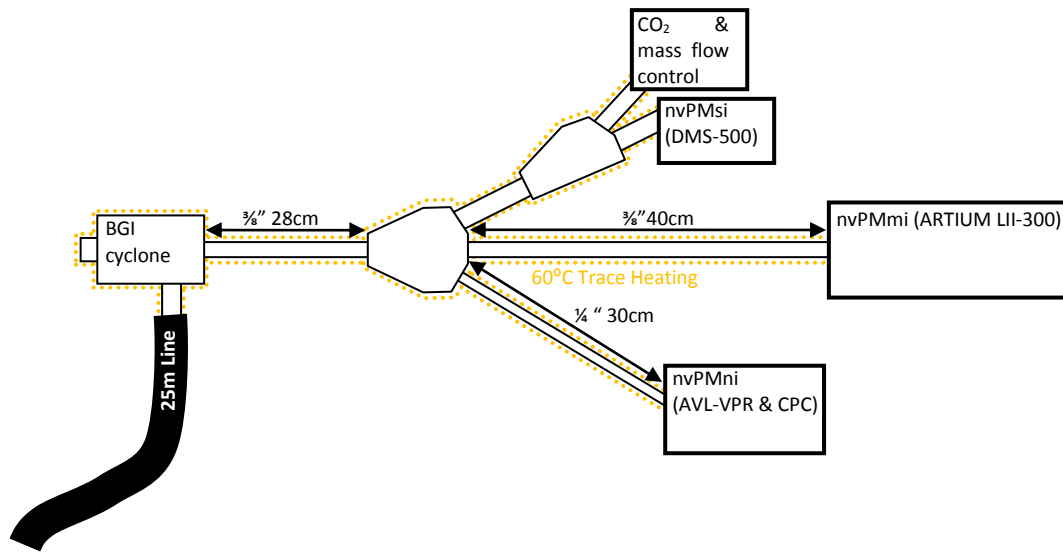

Figure 25 Schematic representation of 5PTS Cyclone and splitter assembly utilised in the SAMPLE III measurement system

As can be seen the splitter section was built ‘bespoke’ for this experiment utilising a three way splitter positioned 28cm from the outlet of the cyclone. Two $\frac{3}{8}$ ” splits were then used to supply sample via a 40cm line to the non-volatile PM mass instrument and via another 2 way $\frac{3}{8}$ ” splitter to the mass flow controller, CO₂ analyser and an additional non-volatile size instrument (which is not recommended in the current SAE E31 draft working document). A $\frac{1}{4}$ ” branch of the splitter was then used to carry sample along a 30cm length of line to the non-volatile PM number instrument. As per the recommendation of the current SAE E31 draft working document the change in line diameter required to feed the number instrument occurred within the splitter.

It is also noted that the whole assembly is trace heated and insulated to maintain the recommended 60°C temperature. Also it is observed that the maximum length from cyclone to PM instrument is approximately 70cm which is in compliance with the <1.5m recommended for 5PTS.

5.2.6.2 FOCA Cyclone & secondary splitter (5PTS)

The cyclone used in the FOCA system is a Stairmand UTC PM2.5 (10sLPM) which can be used for atmospheric PM2.5 measurement. A photograph of the cyclone before installation into the FOCA line is given below (Figure 26).

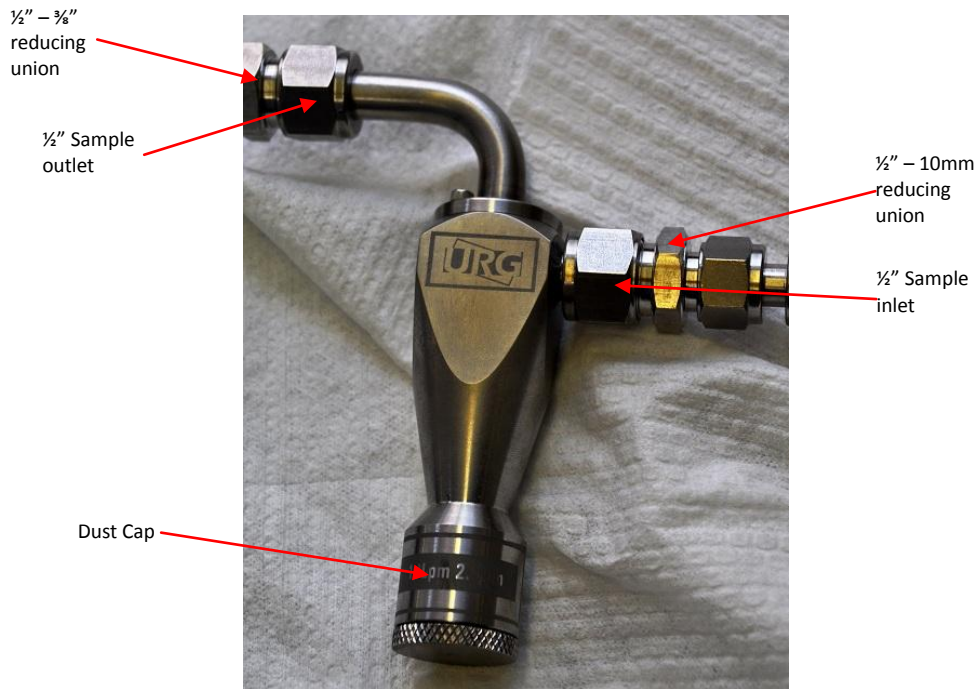

Figure 26 Photograph of cyclone used in FOCA PM sampling system

In order to ensure the lower required cut point of $1\mu\text{m}$ is achieved it is necessary to run this cyclone at a higher flow rate of approximately 25sLPM, which is what is required to satisfy the flow condition specified for section 4PTS.

As this cyclone is made for a different application the inlet and outlets are $\frac{1}{2}$ " OD hence there is a requirement for a $\frac{1}{2}$ " to 10mm reducing union which unfortunately means that there is an extra shoulder introduced into the system.

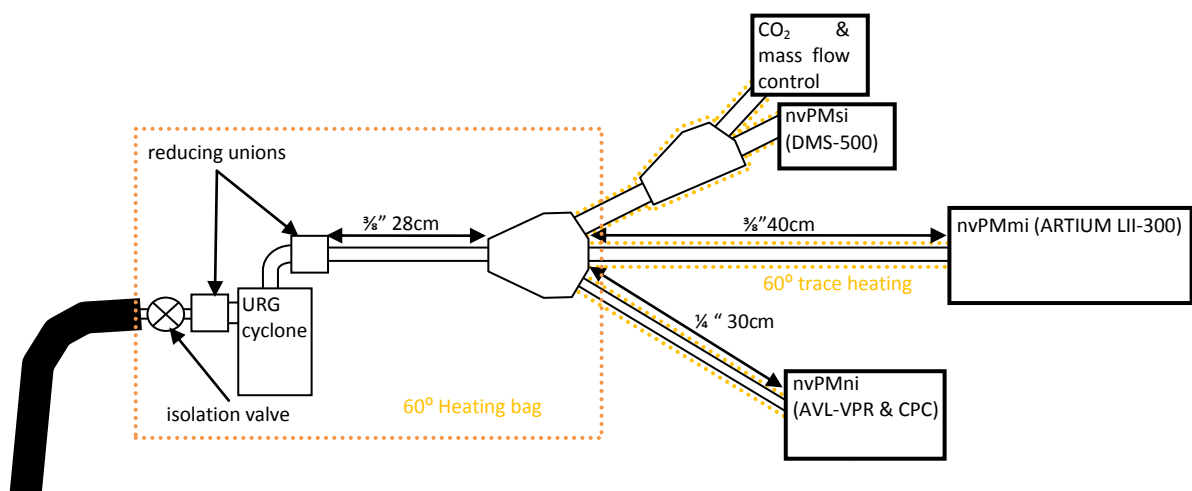

Figure 27 Schematic representation of 5PTS Cyclone and splitter assembly utilised in the FOCA - measurement system

As can be seen the basic structure of the 5PTS splitter is nominally identical for both the FOCA and SAMPLE III set ups, with other than the cyclones employed only the addition of reducing unions and an isolation ball valve along with a slightly different heating strategy utilising a heated bag for the cyclone up to the secondary splitter.

5.2.7 CO₂ Gaseous transport system (GTS)

As explained earlier to ensure a more uniform flow in section 2PTSa and as there was only one set of gas analysers available for the test campaign both the FOCA and SAMPLE III GTS outlets were blocked, and one common GTS used for both lines. As shown (Figure 13) a separate line was run from the extra splitter required in 2PTSa. To allow real time line penetration experiments to be conducted, which are discussed later (section 5.6.2.2) a length of trace heated $\frac{3}{8}$ " stainless line (34cm in length, equal to the lines supplying both 3PTS systems) was fitted to a splitter which fed a sample to a DMS and LII mounted on the gantry within the test cell, and also straight through to the FOCA GTS line previously fitted to the SR Technics test cell which is constructed using a 12m trace heated (160°C) 8mm OD (6mm ID) carbon loaded PTFE line. Along with the gas analysis suite the SAMPLE III consortium also installed an SAE ARP 1179 approved Richard Oliver smoke meter onto the line.

Due to the additional split for the extra PM analysers on the gantry and due to the traceability of the gas analyser's audit, unfortunately this line did not meet the requirements necessary to comply fully with Annex 16 specifications, however, as the line was common to both and only necessary to determine the exhaust CO₂ levels in order that EI corrections and primary dilution ratios could be applied to the data set this requirement in no way compromised the remit of the study designed to compare two compliant PM transport systems. A schematic of the GTS is given schematically below (Figure 28).

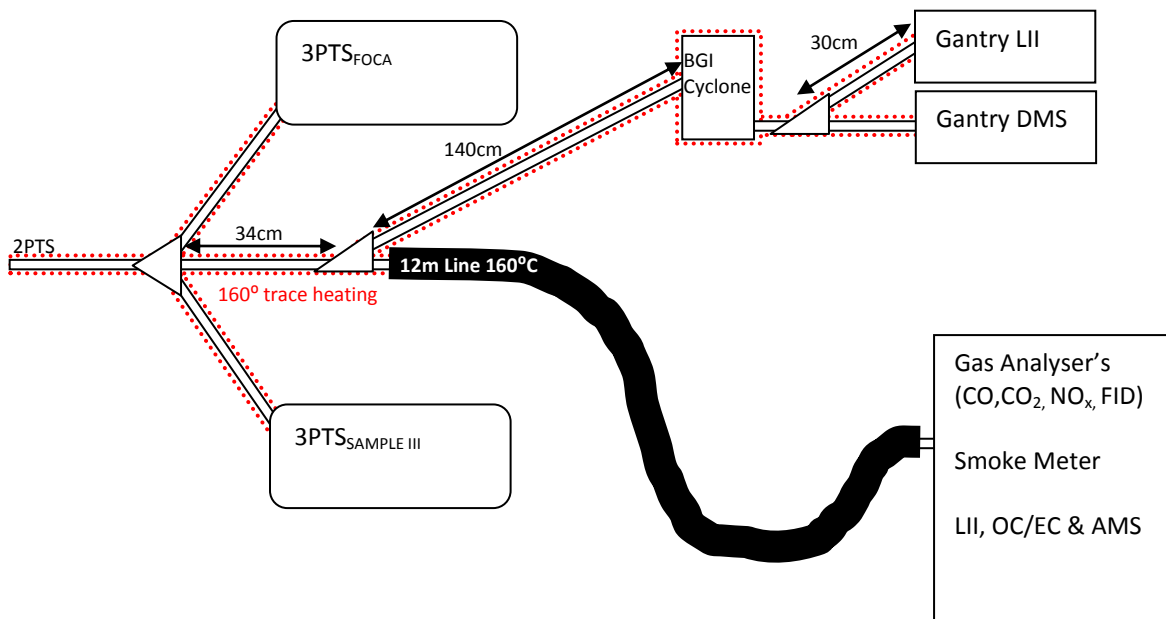

Figure 28 Schematic of common GTS as operated for FOCA to SAMPLE III line inter comparison study at SR Technics

5.2.8 Splitters required for sampling lines

As discussed in the previous sections numerous splitters were required to take the PM sample through the two ‘SAE E31 compliant’ sampling systems to their respective PM measurement suites. As this sampling system was a new bespoke design numerous two and three way splitters were designed and manufactured at Cardiff School of Engineering for this experiment by the SAMPLE III consortium. A sample design drawing along with a photograph of some of the splitters manufactured prior to installation into the sampling lines is given below (Figure 29).

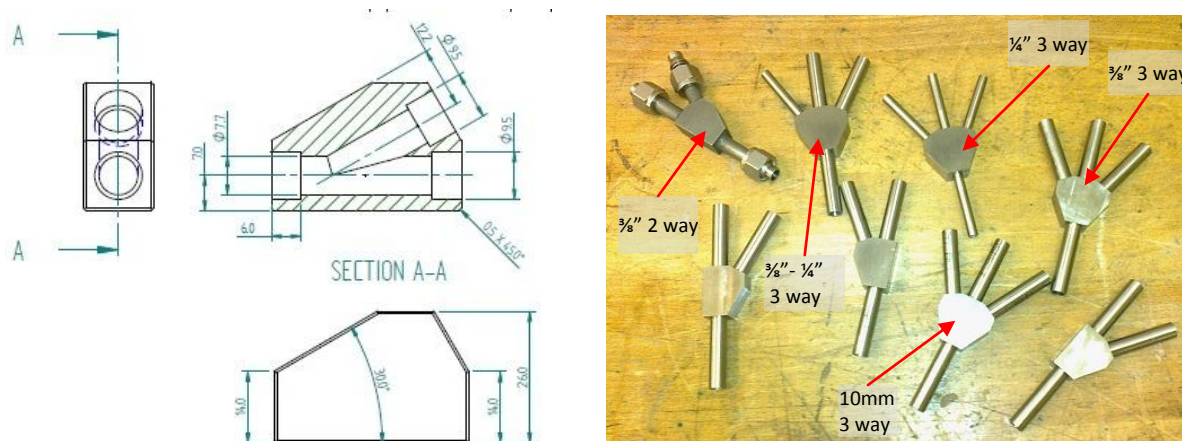

Figure 29 (a&b) example design drawing of 3/8" 2 way splitter and manufactured splitters prior to installation at SR Technics facility

In order to adhere to the SAE E31 sampling teams current recommendations the splitters were manufactured from stainless steel, ensuring there were no internal shoulders, and that splits were at the recommended angle of $<30^\circ \pm 5^\circ$. They also ensured that the recommendation of line diameter reductions being achieved within the splitter.

To manufacture the splitters to ensure minimal particle loss was observed the stainless block was bored to the desired internal diameter for the number of desired splits. The entry to the block was then counter bored with a flat bottomed end mill to the size of the outer diameter of the tube being used, leaving a shoulder to which the tube may be press-fitted to. By heating the block and cooling the tube it is possible to fit the tube down onto the shoulder, to ensure the ‘squareness’ of the tube end each tube was ‘turned off’ to length in a high precision lathe. When the tube was observed to be correctly positioned against the shoulder they were silver soldered into position to ensure their gas tightness.

To ensure a good internal finish and reduction of any minimal steps internal electro-polishing was then conducted within each splitter using specially manufactured electrodes.



5.2.9 SAE E31 recommended PM measurement section overview

Recently, the SAE E31 committee discussed at length which components should be included in the measurement section of the draft working document. After much debate it was decided that as the volatile particle removal system is integral to the non-volatile number measurement so that this component should be moved out of the sampling team section and incorporated into the number measurement team. As such the volatile particle remover (VPR) is now included as part of the measurement system, not the sampling system.

5.2.9.1 Non Volatile PM Number Instrument

5.2.9.1.1 Volatile Particle Remover (VPR)

Originally the SAE E31 looked at simply following the example of Europe's Automotive Particle Measurement Programme (PMP) in the measurement of non-volatile PM number. However, for reasons highlighted earlier in section 4.4, EASA on the recommendation of members of the SAMPLE III consortium stated due to scientific reasoning that they wished any subsequent ARP to have a lower cut size than the $d_{50}=23\text{nm}$ $D_{90}=41\text{nm}$ employed by the PMP protocols, due to the typically observed size distributions witnessed in the exhaust of modern large scale commercial aviation gas turbines.

Previous studies (Kittelson et al. SAE E31 meeting Ottawa 2011) have shown that the PMP methodology for a VPR is only suitable if particles of $>23\text{nm}$ are to be measured as the dilution, evaporation tube dilution system does not totally remove volatile PM it simply shrinks the diameter size to lower than 23nm . Therefore if a new lower cut point is sought it was suggested that a different approach to volatile removal may need to be sought.

As such, catalytic strippers were investigated as a suitable tool by the SAMPLE III consortium (SAMPLE III.01) and demonstrated on both challenge aerosols, and behind an Artouste APU gas turbine to offer additional benefit in the removal of volatile fractions from an exhaust stream. Partly due to this work the SAE E31 are now suggesting that catalytic stripper technology should be considered for utilisation in a VPR capable of delivering suitable exhaust void of volatile PM in the $>10\text{nm}$ size range.

As the SAE E31 is keen to only prescribe techniques and instruments that are commercially available. It has meant that currently the only PMP type VPR that can be bought 'off the shelf' employing a catalytic stripper is the AVL APC489-CS. This unit is based largely on the PMP AVL APC with the exception of an added catalytic stripper after the evaporation tube. Due to this being commercially available EASA purchased a unit which was loaned to the SAMPLE III consortium for the SAMPLE III.02 test campaign, so that a comparable unit could be added to the FOCA line AVL were approached and kindly loaned an additional unit to the test. A Photograph of an AVL APC is given in Figure 30. As a full description of this unit has been given previously (SAMPLE III.01) it will not be discussed further at this time.



Figure 30 Photograph of commercially available VPR incorporating a catalytic stripper

The current performance specifications from the SAE E31 PM measurement section of the draft working document are given as follows (Table 2).

Table 2 Current E31 performance specifications for penetration and volatile removal efficiency of different sized aerosols through VPR

Particle Size (nm)	15* nm	30 nm	50 nm	100 nm
Inlet Aerosol Concentration Required (#/cm ³)	> 1 x 10 ⁴	> 1 x 10 ⁵	> 1 x 10 ⁵	> 1 x 10 ⁵
Transmission Efficiency Required	> 0.5	> 0.7	> 0.7	> 0.7
Volatile Removal Efficiency	> 99.5%	> 99.5%	> 99.5%	> 99.5%

At present previous studies conducted in SAMPLE III.01 running an AVL APC with the addition of a bespoke catalytic stripper, suggested that the volatile removal efficiency of >99.5% could easily be achieved, therefore it is surmised that the newly commercially available model would have a similar removal efficiency. However, at present it is not to the authors knowledge proven that the current transmission efficiency criteria can be met. The SAMPLE III consortium have through their positions on the SAE E31 committee requested from AVL confirmation of this transmission efficiency by publishing both the transmission factor and dilution factor separately along with the particle correction reduction factor (PCRF) which is a combination of both dilution ratio and particle losses.

At the time of writing, however, the authors have not seen any individual transmission efficiencies quoted by the manufacturer but have heard on subsequent SAE E31 teleconferences that AVL have suggested amending these specifications to lower values of



>0.43 for the 15nm case and >0.65nm for the 30nm case, which suggests that if SAE E31 wish to adopt this methodology then there may be a necessity to slacken these performance specifications.

5.2.9.1.2 Non Volatile PM number counter

Current SAE E31 specifications state that this device must be a CPC instrument that has a working fluid of butanol and be counting in single count mode. As such the VPR is not only required to remove the volatile fraction but also to reduce the particle concentrations to levels to within the single count range (typically $<1e^{05}$ particles/cm³). On the recommendation of EASA and discussion points presented by SAMPLE III consortium members in the previous SAE E31 PM sub-committee meeting (Zurich 2012) along with subsequent discussions in the annual meeting (San Diego 2012), the size specification of the CPC is now given in the latest draft working document as the following (Table 3).

Table 3 Current SAE E31 size specifications for CPC to be used for measurement of non-volatile PM number

% Particle Counting Efficiency	Particle Size (nm)
d ₅₀	≤10
d ₉₀	≤15

However, at the time of planning this experiment this specification had not been fully agreed therefore it was decided prudent to still include numerous different cut point CPC's for measurement behind the AVL APC. As such numerous CPC's are included in this study details of which are given in detail later in the report (section 5.3.2.2).

5.2.9.2 Non Volatile PM Mass Instrument

At present the non-volatile PM mass instrument was poorly defined in the current E31 working draft document with the performance specification still being drafted by the mass 'Tiger Team'. However, within the committee three suitable instruments have been put forward, namely the Thermoelectron MAAP, Artium LII-300 & AVL MSS. On reviewing the specifications of these three analysers and relying on previous experiences in using the analysers the SAMPLE III consortium decided to use the Artium LII-300 analyser as the non-volatile mass instrument for both the SAMPLE III and FOCA Lines.

After a successful demonstration by NRC Canada in January 2012 at the SR Technics test cell it was also decided that an LII analyser should be positioned within the test cell on the gantry as highlighted earlier in section 5.2.7. As such this meant that there were three Artium LII instruments required for the test campaign the details of which are given below (Table 4).

Table 4 details of non-volatile PM mass instruments used

nvPMmi ID.	PM System	model	Owner
L_S_RR	SAMPLE III	Artium LII-300	Rolls Royce
L_F_HW	FOCA	Artium LII-300	Honeywell
L_G_RC	Gantry	Artium LII-300	NRC Canada



To ensure that mass concentrations from the three units could be compared to one another a laboratory study was conducted to normalise their outputs, details of which are discussed in more detail elsewhere (section 0).

5.3 Additional Equipment required for experimentation

As this experiment was not aimed at representatively measuring the PM concentrations of different engines passing through the SR Technics facility but designed as a scientific programme to investigate the uncertainties in PM measurements using SAE E31 approved sampling systems, it was necessary to employ additional analysers in addition to those required to measure non-volatile PM mass and number, in order that a deeper understanding in differences, particle transfer and volatile removal efficiency could be ascertained.

5.3.1 Volatile particle removal

To understand the concentrations of volatiles that are present in the exhaust and the effectiveness of different methodologies in removing them it was necessary to further study catalytic stripper (CS) technologies, as such Dr. Jacob Swanson (Cambridge University formerly University of Minnesota) was contacted to utilise a 'bespoke' CS similar to that successfully demonstrated in SAMPLE III.01 to add to volatile removal understanding in gas turbine exhaust measurement.

5.3.1.1 *Bespoke Catalytic Stripper*

The catalytic stripper prototype provided by Dr. Jacob Swanson for use in the Sample III.02 tests conducted at SR Technics contain 2 geometrically dissimilar catalysed ceramic substrates: an oxidizing catalyst and a sulphur trap. These elements are depicted schematically below (Figure 31). The oxidation catalyst is heavily coated with a proprietary mixture of precious metals, including platinum and palladium. The purpose of the oxidation catalyst is to remove the semi-volatile hydrocarbon particles and vapours in the gas turbine exhaust gas stream, which typically consists mainly of unburned fuel and some lubrication oil. The sulphur trap is a ceramic substrate that has been wash-coated with an alkaline earth metal oxide attached to a γ -alumina support. It is designed to capture and store sulphur compounds, like sulphuric acid, that would otherwise contribute to semi-volatile particle formation. In normal operation, both catalysts are heated to a temperature of 300 to 350°C.

For the EC/OC analysis required for these specific tests, it was desirable to collect samples at 60°C. Therefore, a metal cooling coil was installed after the catalytic elements. A coil length of approximately 0.2 m was required to meet the outlet temperature requirements.

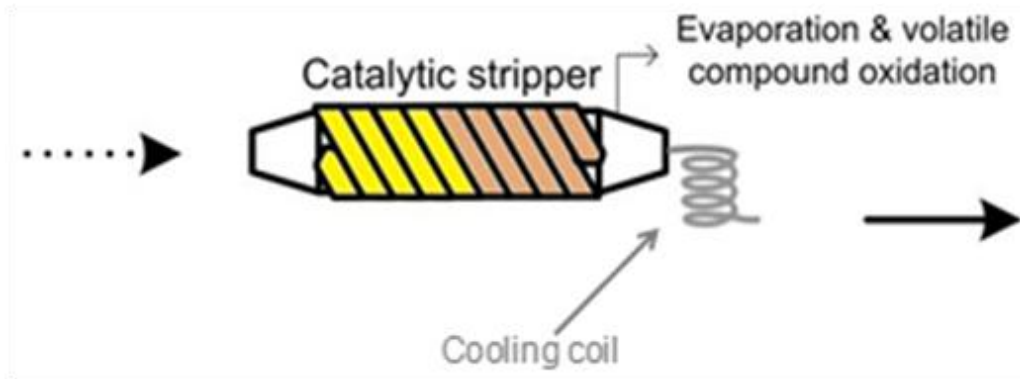

Figure 31 Simplified schematic of ‘bespoke’ catalytic stripper used in line inter-comparison studies conducted at SR Technics

The principal mechanisms by which particles are lost in the CS are thermophoresis (in the cooling coil) and diffusion (in the catalyst channels). Theoretical calculations of these losses for a CS internal temperature of 350°C, outlet temperature of 60°C, and a flow-rate of 8sLPM are shown below (Figure 32). Thermophoretic loss is independent of particle size and is responsible for ~20% of all loss. Diffusion losses depend on particle size with smaller particles lost more readily. Approximately 50% of 10 nm particles penetrate the device.

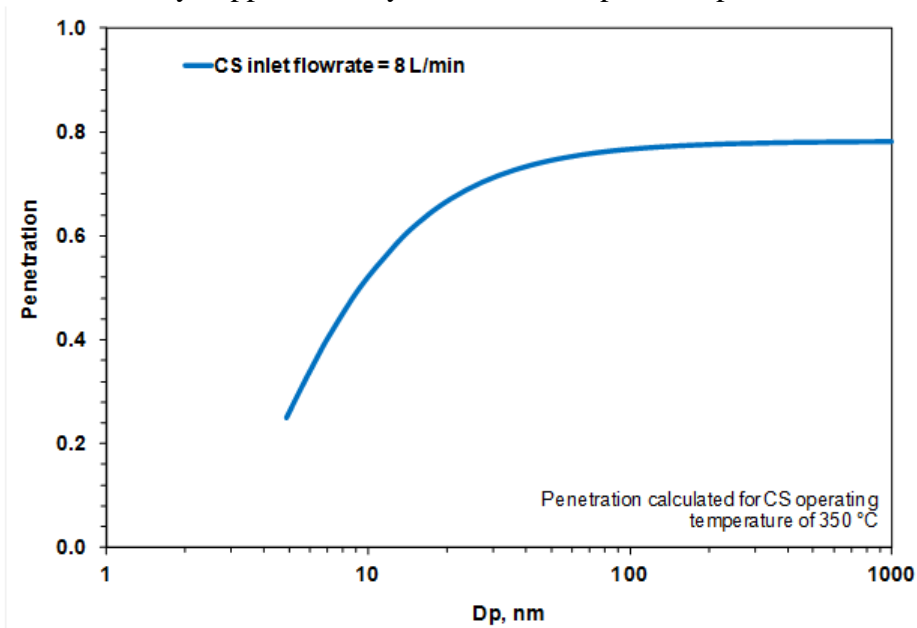

Figure 32 Predicted CS particle penetration (1- penetration = loss).

5.3.2 Number analyser's

As the SAE E31 has defined that butanol based CPC's are to be the method by which non-volatile PM number is to be measured then these are the instruments that were chosen for inclusion in this study. As discussed earlier (section 4.4) the lower cut point of the CPC chosen will massively effect the number concentration measured from a gas turbine exhaust and as such the consortium have decided to add further support to the findings discussed in section 4.4 by including numerous models of CPC within the test. A summary of the analysers used is presented in the following sections

5.3.2.1 CPC overview

A detailed description of CPC technology was given earlier (section 4.4) and in previous reports (SAMPLE I) therefore this will not be discussed further at this time.

5.3.2.2 Table of CPC's used

As there are two sampling lines being simultaneously compared to one and other during this test campaign it was necessary to develop two nominally identical instrument suites carrying matched pairs of analysers so that a true inter-comparison of the lines could be conducted. To allow for a low cut point study along with a size measurement analysis to be made with an SMPS two sets of 4 CPC's were required offering 3 different low cut points and an SMPS on each line. A summary of each of the 8 analysers utilised in this study is given below in Table 5.

Table 5 CPC instrument list as required for testing

CPC ID.	PM System	model	d_{50}/d_{90} (nm)	Owner
2.5_S_UM	SAMPLE III (SMPS)	TSI 3776	2.5/ 3.0	University of Manchester
2.5_F_EM	FOCA (SMPS)	TSI 3776	2.5/ 3.0	EMPA
5.0_S_TS	SAMPLE III	TSI 3775	5.0/ 9.0	TSI
5.0_F_EM	FOCA	TSI 3775	5.0/ 9.0	EMPA
10_S_GR	SAMPLE III	Grimm 5435	10/ 15	Grimm
10_F_GR	FOCA	Grimm 5435	10/ 15	Grimm
23_S_UM	SAMPLE III	TSI 3010 ^a	23/ 41	University of Manchester
23_F_UM	FOCA	TSI 3010 ^a	23/ 41	University of Manchester

To ensure confident comparisons could be made of the two lines a CPC inter-comparison was conducted in the laboratory and is discussed in detail later in this report (section 6.2.1).

1 The temperature gradient of the TSI3010 condenser was altered to achieve the PMP-type cut points

5.3.3 Mass analyser's

5.3.3.1 OC/EC

To accurately look at the true total mass (combustion emitted) loading of PM at the end of the sample line it is necessary to measure both the volatile fraction and the solid black carbon components. As such the most traceable method to date for doing this is a filter based methodology. OC/EC methods have been discussed in detail in earlier reports (SAMPLE I) hence are not discussed further at this time. However, this method was largely employed in this test campaign to try and assess the efficiency ability of the bespoke catalytic stripper in removing the volatile fraction from the exhaust.

Two pre-fired Tissuquartz filters were sampled simultaneously with and without a catalytic stripper and repeated three times at each power condition. The Smoke Number instrument was utilised as the non-stripped filter holder (Figure 33), whilst a separate stainless steel filter holder with 27mm diameter stain and internal angles adhering to ARP1179 specifications (as used in SAMPLE II), was used downstream of the catalytic stripper. Both filters were subjected to a flow rate of 8sLPM at a sample temperature of 60°C. The filters were then kept refrigerated at SR Technics and were transported back to the UK in a cool bag with ice packs to a traceable national measurement institute for analysis.



Figure 33 OCEC filter paper being removed from Smoke Number filter holder

The filters were analysed using the EUSAAR_2 protocol with optical transmittance correction. The procedures utilised in this study were covered by UKAS accreditation. To ensure reliability of results they were corrected for dynamic blank concentrations which in this study ranged from 0.8-1.98 $\mu\text{g}/\text{cm}^2$ which is well within the “typical field blank values are up to 4 $\mu\text{g OC}/\text{cm}^2$ ” stated in the European guidance document CEN/TR 16243:2011.



5.3.4 Size analyser's

5.3.4.1 Combustion DMS-500

The DMS-500 is a fast differential mobility sizing instrument which is capable of measuring PM aerosols in the range of 5-1000nm. A detailed description of this analyser has been given in previous reports (SAMPLE I) therefore a full description will not be given here.

In total 3 DMS-500 instruments were employed during the SR Technics test campaign, with a DMS being positioned after the splitter in section 5PTS (Figure 25& Figure 27) on both the FOCA and SAMPLE III sampling systems. The third DMS was positioned on the gantry (Figure 28) to allow real time penetration studies to be conducted on the sample lines.

A summary of the DMS-500's used for the study is given below (Table 6), as can be seen the analysers are nominally identical DMS-500 MKII's with the exception of D_S_CU which is a MKI that has been subsequently upgraded to MKII.

All three analysers were sent back to the instrument manufacturer, Cambustion and calibrated with a week of each other before shipping to Zurich. However, the consortium performed another inter-comparison at SR Technics to ensure comparability as discussed later (section 6.2.3).

Table 6 Summary of DMS used in test campaign

DMS ID.	PM System	Serial No	model	Owner
D_S_CU	SAMPLE III	M44	DMS-500 MkII (upgrade)	Cardiff University
D_F_RC	FOCA	M125	DMS-500 MKII	NRC Canada
D_G_CA	Gantry	M77	DMS-500 MKII	Cambustion

The DMS-500 has previously measured bimodal & trimodal distributions of soot behind a gas turbine source. Within the SAE E31 committee there has been much debate on whether these profiles are a result of the actual distribution or as a function of the algorithms used to derive the distribution within the DMS methodology. To investigate whether the latter is true the SAMPLE III consortium have had numerous discussions with Cambustion over the matter which have led to suggestions that there is the possibility that an inversion of the data could happen at the 30nm size range for the following reasons.

In the 20-50 nm region, particles tend to go from a region where all have 1 charge, to where some have 2 charges. This manifests itself as two distinct peaks on the ring current (electrical mobility) response as shown in Figure 34.

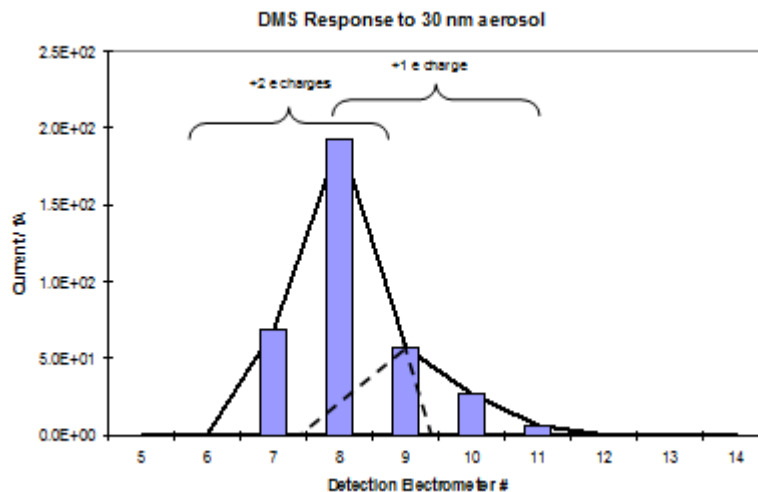

Figure 34 DMS response to a 30nm particle

The data inversion is usually sophisticated enough to correctly interpret these two peaks in the mobility spectrum as originating from just one peak in the size spectrum. However, an empirical calibration is applied to all DMS-500's before dispatch to adjust the size and concentration accuracy to be within acceptable bounds. If a sufficiently large correction needs to be applied, this can, in some circumstances, introduce artefacts into the spectral shape such as inflections, especially in the size region described above (above this region, charging produces a pseudo-continuous charge distribution, so this artefact tends not to happen). The solution is to add extra points to the empirical calibration, in this troublesome region.

However, often the bimodal and trimodal peaks are well away from the 30nm band therefore there is still the possibility that truly bi-modal distributions are witnessed behind certain gas turbines, as such a size inter-comparison of numerous different sizing techniques is included in this experiment programme as discussed later (section 0).

5.3.4.2 SMPS

A Scanning Mobility Particle Sizer (SMPS) is used to size and count submicron particles. The instrument performs the size classification and counting in separate stages. The technique for size classification is the same as that used in the DMS system, namely separating charged particles in an electric field. The size classifier is called a Differential Mobility Analyser (DMA) and consists of a central rod and outer column, separated by a known distance. A schematic of a TSI Nano 3085 DMA (the type used during the majority of the SAMPLE III.02 campaign) is shown in Figure 35.

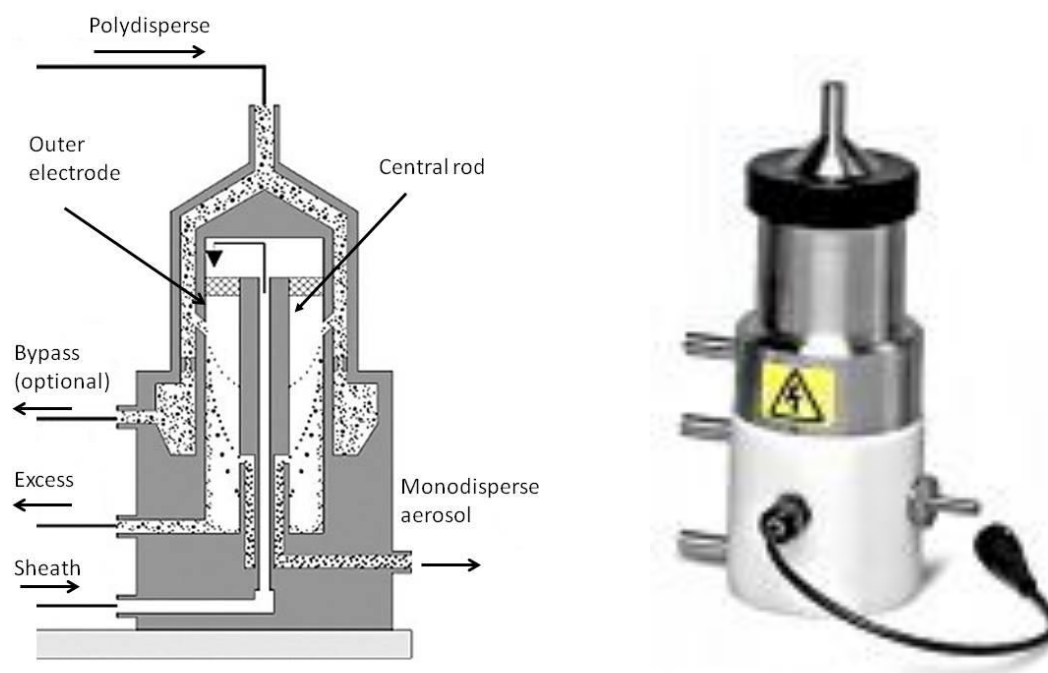

Figure 35 Schematic and Photograph of TSI Nano 3085 DMA

Polydisperse aerosol enter at the top of the DMA and are carried down the column by the sheath flow. A ramping voltage is placed between the central rod and outer electrode to generate a ramping electric field. At any given time, only a particle of a given electrical mobility can pass down the DMA and out of the exit slit. The remainder either impact on the central rod or exit via the excess flow. Those aerosol that are classified are then passed to a particle counter to be counted. This is one of the fundamental differences between the SMPS and DMS. The DMS is effectively a large DMA, but instead of ramping the voltage, it has a fixed voltage and a series of electrometer rings on one of the electrodes to count all sizes simultaneously.

By knowing the geometry of the DMA, the flow rate and the voltage ramp function, the electrical mobility can be converted to a diameter. The charging of the aerosol is also different between the DMS and SMPS. The DMS relies on corona discharge, whilst the SMPS uses a Kr-85 radioactive source. The advantage of this method is that the charge distribution (i.e. the percentage of particles charged as a function of size) is very well defined. However, the majority of the particles carry zero charge; therefore the SMPS requires times from 1-5 minutes to perform a scan to ensure there are adequate counting statistics.

A schematic of the SMPS system is shown in Figure 36 with the nano DMA attached. There are several models of DMA available, and the choice of DMA depends on the size range of interest. For particles in the range 2- 150nm, the TSI 3085 nano DMA should be used. For particles in the range 10-1000nm, the TSI 3081 should be used, although in practise there are large losses within the TSI 3081 at 10nm, so a lower detection limit of 20nm is more appropriate.

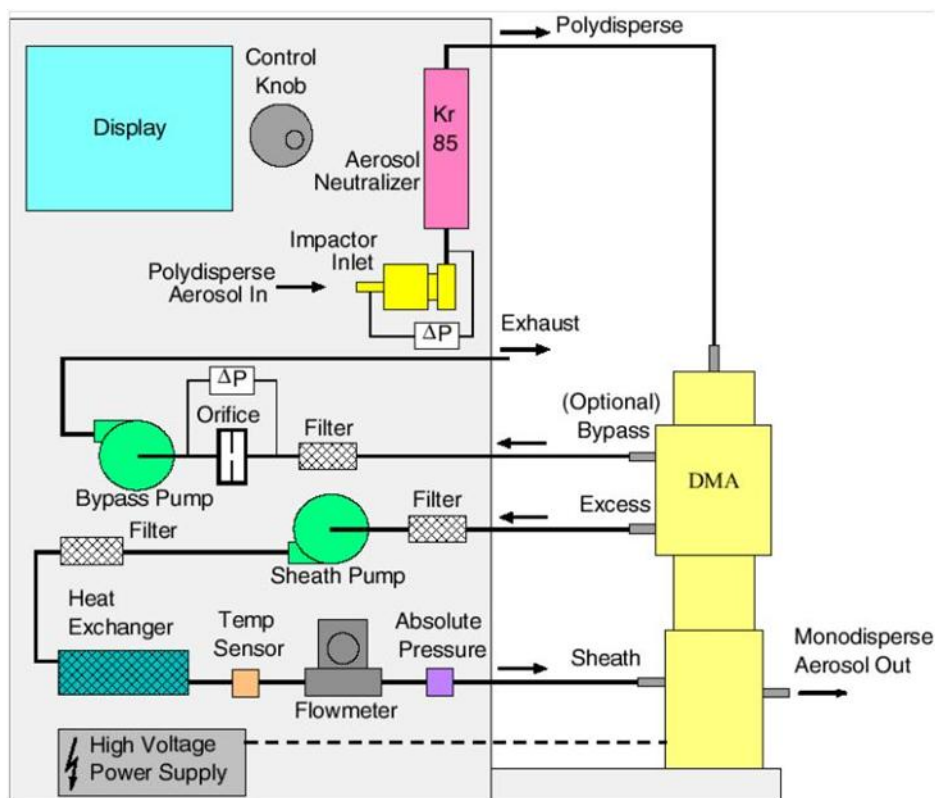

Figure 36 schematic of the SMPS system

5.3.4.3 Grimm Fast Aerosol Particle Emission Spectrometer (FAPES)

The FAPES is a recently developed instrument (manufactured by Grimm) that uses the electrostatic mobility technique to size particulates. The instrument operates on the same principle as an SMPS but data is obtained in real-time similar to a Cambustion DMS or a TSI EEPS.

The instrument includes an integrated heated dilution system at the sample inlet. The diluter uses recycled sample air to achieve a variable dilution ratio between 5.7:1 and 40:1. The recycled sample air is filtered, dried and purified using active carbon.

The FAPES system uses a bipolar charger (18.5 MBq²⁴¹Am α -emitter) for establishing a well-defined Fuchs-Wiedensohler equilibrium charge distribution on the particles. This type of charging results in a high portion of single charged particles in the size range of $> \sim 200$ nm. Thus, unlike uni-polar chargers, different size fractions feature well distinguished mobilities, even for larger particles. These charging probabilities form the basis for a reliable reconstruction of the particle size distribution.

The charged particles are classified with twelve Differential Mobility Analysers (DMAs) operated in parallel as shown below (

Figure 37). These classifiers feature an active length of 350 mm. Unlike for SMPS systems, each DMA voltage is kept constant and thus the sampling frequency is no longer limited by the scan-time for the DMA voltage. The 12 DMA voltages cover the range of 4.9 – 10000 V and the voltages of adjacent DMAs differ by a factor of two to ease the correction of remaining multiple charged particles. The DMAs are operated with a sample flow of

1.6sLPM and a sheath air flow of 8sLPM. This enables simultaneous concentration measurements for 12 size channels in the range of 6.3 – 474 nm. The signal of each size channel originates from an individual DMA and corresponds to a well-defined and narrow size range.

Theoretically each mobility fraction is measured with an absolute instrument and therefore not subject to any kind of calibration. Thus the measured size distributions have low uncertainty and the FAPES can be considered as a reference for fast particle sizers. However, the measurement resolution of 12 sizes compared to 32 on the DMS and 64 on the SMPS could lead to the FAPES omitting close or overlapping size modes.

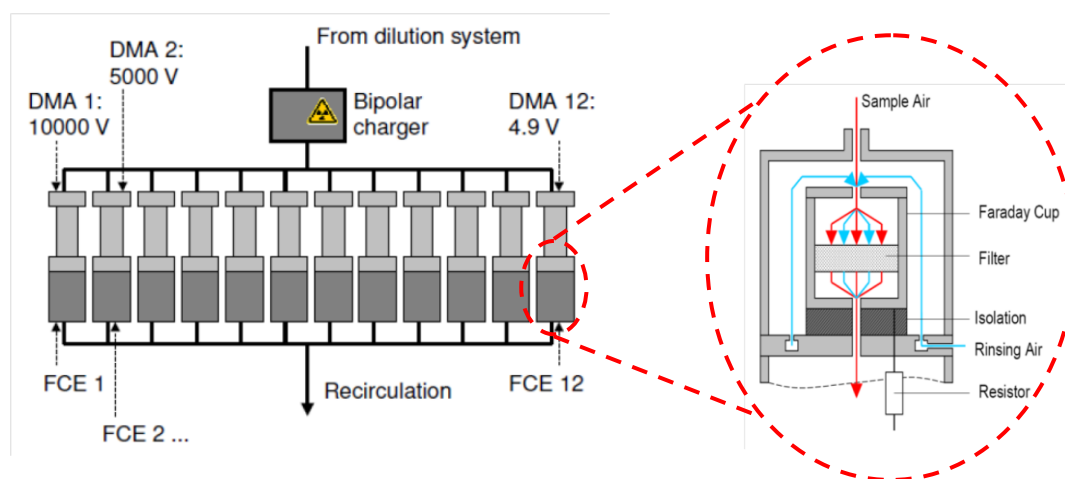

Figure 37 Schematic representation of Grimm FAPES instrument and

The detection of particles is accomplished with twelve Faraday Cup Electrometers (FCEs), one FCE for each DMA. These FCEs feature low noise level (~ 0.35 fA) and, due to the rinse air, a response time of $T_{10} - T_{90} = 200$ ms is achieved. The short response time of the FCE helps to create a fast overall response time (FAPES) $T_{10} - T_{90} = 0.7$ s. The use of rinsing air in the FCE has a second big advantage, to isolate and prevent contamination of the detection electrodes and thus leakage currents. Moreover, the detection of particle charges in the FCE is completely spatially separated from the strong electric fields in the aerosol classifier. Therefore the detected signals are unaffected from any variations of the high voltage, and the FCE signals are insensitive to mechanical shocks and vibration.

The FAPES was used in the size instrument inter-comparison but was also tested on the Gantry within the test cell to investigate the effect of penetration on size distribution along a sample line.



5.3.5 Volatile analyser's

5.3.5.1 Aerosol Mass Spectrometer (AMS)

The Aerosol Mass Spectrometer (AMS) is an instrument designed for measuring directly the volatile loadings within an exhaust stream. This instrument was discussed in detail in previous reports (SAMPLE I & SAMPLE II) therefore will not be discussed further at this time.

The AMS was utilised to examine the volatile loadings in the exhaust stream. Unfortunately the lower size limit of detection is 40nm for PM therefore it is difficult to fully assess the actual volatile PM loadings just using this method.

5.3.6 Diluent gas

Nitrogen gas (99.99% purity) was required to supply the diluent for the diluters in 3PTS and also for performing zero checks of the sampling system. Previous experience during previous SAMPLE projects had shown that using a manifold of gas cylinders allowed for simple operation without the complexity of constant checking of gas quantity.

Each 'bank' contained 12x50L cylinders at 200bar. One bank was entirely consumed during the 18 hours of dedicated engine testing, noting however, that two sampling systems were being operated. Another cylinder bank was two thirds consumed during the piggyback testing prior to and after the dedicated engine tests.

In addition, a bank of synthetic air was used to provide the diluent for both AVL VPR's. Due to the use of catalytic stripper technology it is advisable to use a diluent with an oxygen content i.e. air not nitrogen.

All gas banks were fitted with HEPA filters to ensure particle-free diluent. The bottles (Figure 38) were placed outside allowing easy transport access and improved health and safety practices.

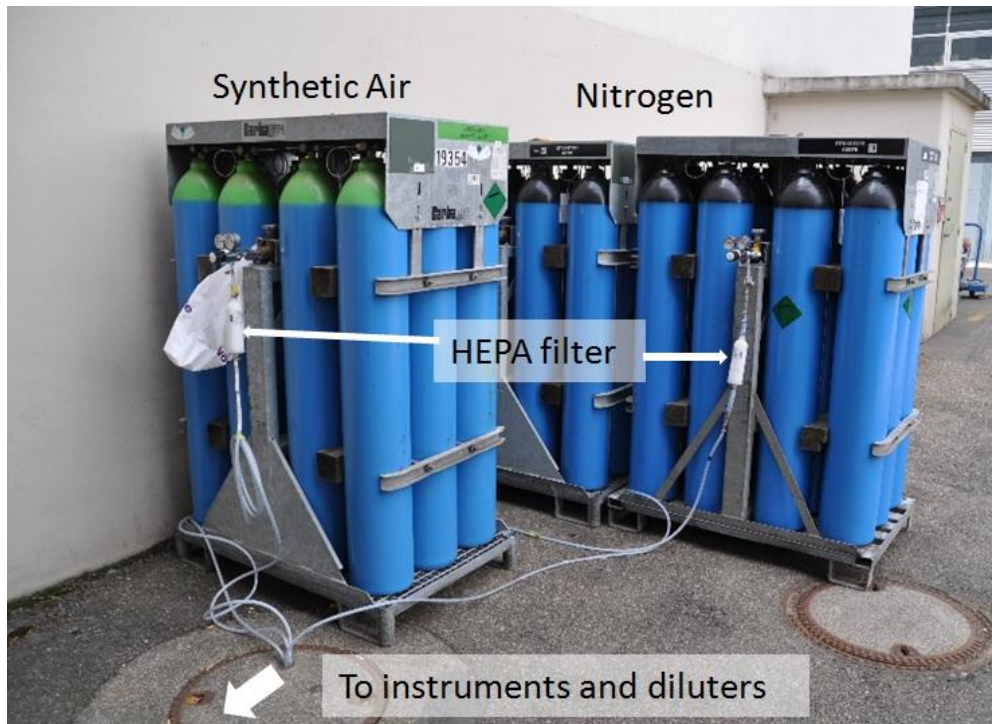

Figure 38 Diluent gas bottles installed outside test bed

5.4 Sampling system installation

A large portion of the experimental planning went into the design of the SAMPLE III sampling system to ensure when shipped to SR Technics that the installation would run as smoothly as possible. As such the entire system was first assembled at the GTRC in Port Talbot, South Wales to ensure its functionality before being broken down into its component parts and packed into a van, which consortium members drove to Switzerland.

It was hoped that by shipping the whole system at once would ensure the entire system arrived together, undamaged at the SR Technics facility in time for the installation. However, as stated as a concern in earlier feasibility studies (SAMPLE III.01) the managing of the documentation required to transport goods into Switzerland from the EU, proved problematic. Rolls-Royce shipping department filed the relevant paperwork to allow the transportation of the kit as one shipment but when the consignment arrived at the French Swiss border it was found that the paperwork was not correct for temporarily importing goods into Switzerland as such it took over a day for the consortium using the expertise of Rolls-Royce's shipping and their local shipping contractors (Kuehne & Nagel) to raise the relevant temporary import paperwork (T1 transit document) in place to allow the shipment to enter Switzerland. Unfortunately there are also discrepancies in the maximum load a van is allow to carry in Switzerland and the EU which meant that an additional van had to be chartered to ship half of the consignment from the border to Zurich.

Even though every effort had been made to ready the kit for installation at Zurich, it took 2 consortium members 11 days (25th March – 4th April 2012) to transport and install the kit into the test facility totalling approximately 220 man hours, excluding the extra man hours contributed by FOCA for an additional 2 people. This time was lengthened slightly owing to

the shipping issues discussed along with the fact that entry into the test cell is often restricted due to the natural through put of engines for test during the working week. Unfortunately at the time of this initial installation not all of the analysers had been received for installation therefore an additional installation of the remaining analysers was required for an extra 4 days of setup with numerous consortium staff totalling an additional 120 man hours.

5.4.1 Overview of SR Technics sampling probe

5.4.1.1 Representativeness of sample from SR Technics single point probe

As has been discussed previously here and in previous reports (SAMPLE III.01) the single point 1-D traversable probe does not meet Annex 16 recommendations to ensure representativeness of the exhaust sample. However, as this data set is not designed to examine the actual PM being emitted from the engines tested this is not an issue. Due to the unique opportunity of testing with a traversable probe behind a modern large scale commercial aviation gas turbine it was decided to observe the representativeness of the PM compared with the measured CO₂ value.

As such an experiment was undertaken to traverse through the exhaust and simultaneously measure non-volatile mass, and number along with CO₂. From this data set it was hypothesised that by correcting both number and mass to an Emission Index (EI) utilising the CO₂ data it would be possible to determine how representative the PM levels were compared with the measured CO₂.

The number and mass data were taken utilising the DMS-500 and Artium LII-300 positioned as discussed (Figure 28) on the gantry feeding off the GTS section of the measurement line. Raw data from the number and mass analysers during a traverse through an engine core at minimal idle condition are presented in Figure 39 and Figure 40 respectively.

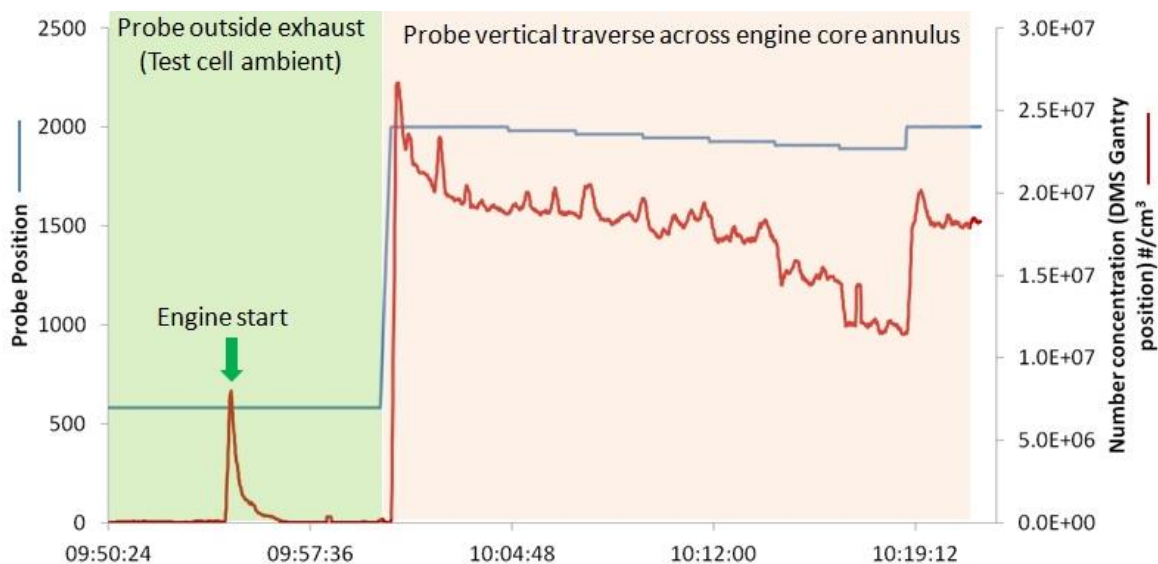

Figure 39 Number concentrations measured using gantry DMS during traverse of SR Technics probe through exhaust at Minimum Idle thrust

As can be seen even with the probe well out of the exhaust plume on engine start-up there is a huge surge in particle number within the test cell which then drops back to ambient as the

engine spools up. As the probe traverses into the engine core the number concentrations increase however, it is observed that as the traverse steps through the core the number concentration also appears to step down with each subsequent movement. To ensure this wasn't a trend of the engine with time the probe was then re-traversed back to its original position and the number concentrations again climbed but not back to original levels.

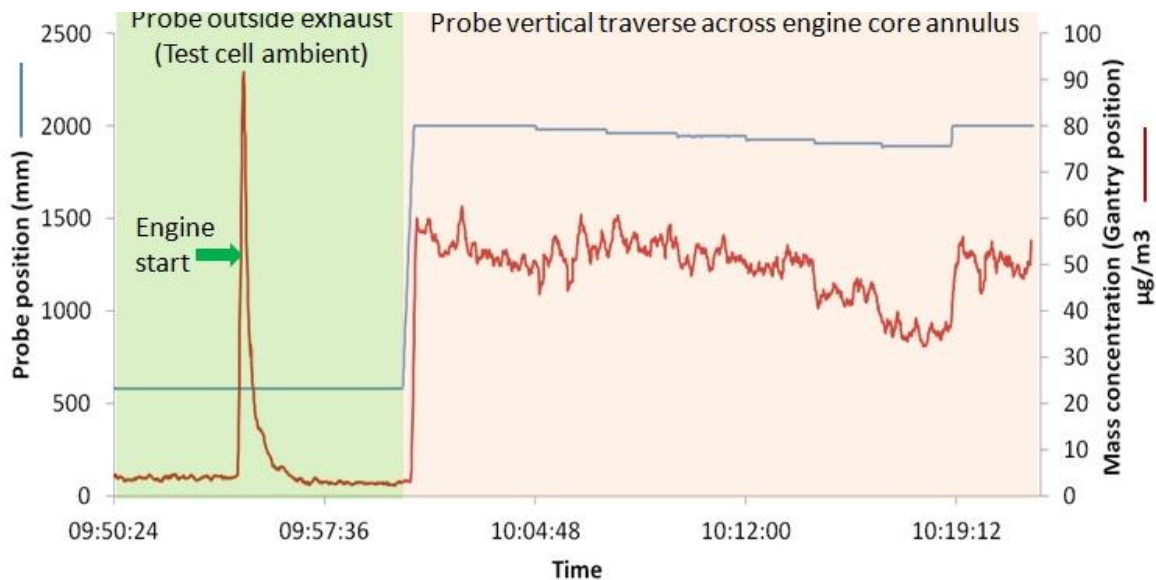

Figure 40 Mass concentrations measured using gantry LII during traverse of SR Technics probe through exhaust at Minimum Idle thrust

When comparing the mass data a similar observation is witnessed with the mass concentration also dropping with traverse position movement and recovering when the probe is repositioned back to its original measurement plane. These trends appear to show how variable in terms of PM mass and number the exhaust plume is across just one plane, hence how non representative any one measurement is when conducted with a single point probe. However when these values are normalised to EI to it can be ascertained how representative the PM is to the measured CO₂.

Figure 41 shows EI number for different probe positions. It can be seen that during the first four movements of the probe it appears that the EI number are within error bars of each other indicating that the CO₂ level is indicative of the expected PM number. However, when the probe moves further still there is suddenly a dramatic rise in PM number EI which displays that PM in terms of number may not be representative of the CO₂ measured in the same exhaust parcel. It is seen that when the probe is repositioned back to its original point the EI number again reduces down to similar values as were originally recorded.

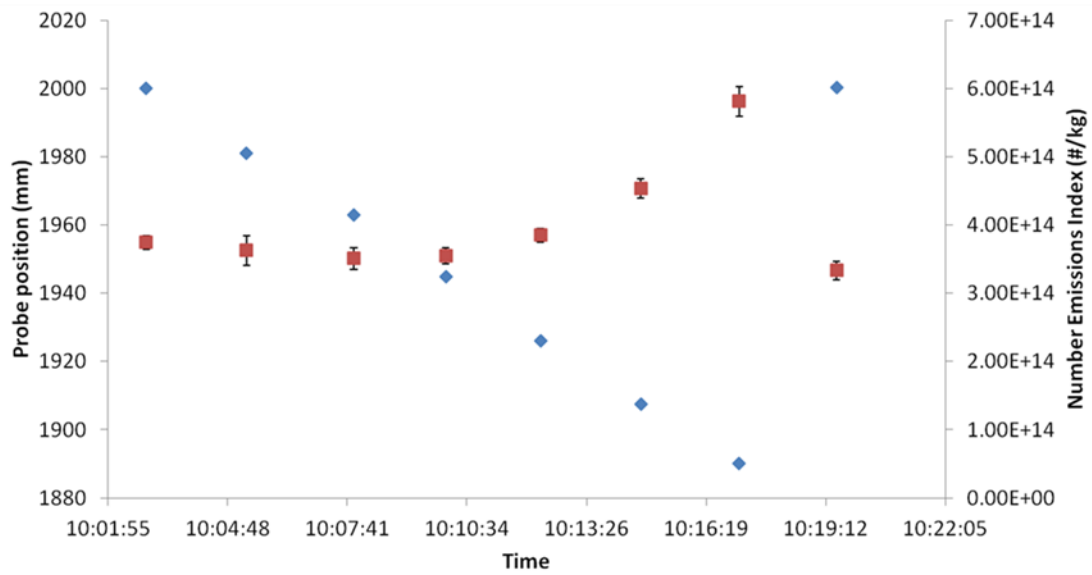

Figure 41 EI Number (red squares) with error bars (2 standard deviations) against probe position (blue diamonds) at Minimum Idle

When a similar EI plot is given for mass (Figure 42) a discrepancy in EI mass is not observed with probe position, with all error bars over lapping irrespective of probe position, this trend implies that in terms of non-volatile PM mass CO₂ representativeness is indicative of the mass observed.

These finding highlight the complex nature of PM measurement particularly when measuring number. The authors highlight the fact that this was a one off test therefore these observations should be treated with a sensible level of care before drawing firm conclusions and remind the reader that the PM size measurement was taken before any form of volatile suppressant or removal therefore the discrepancies observed in EI number with probe position could easily be attributed to higher localised volatile loadings which could condense in the sample line and lead to the higher EI number counts witnessed at certain probe positions.

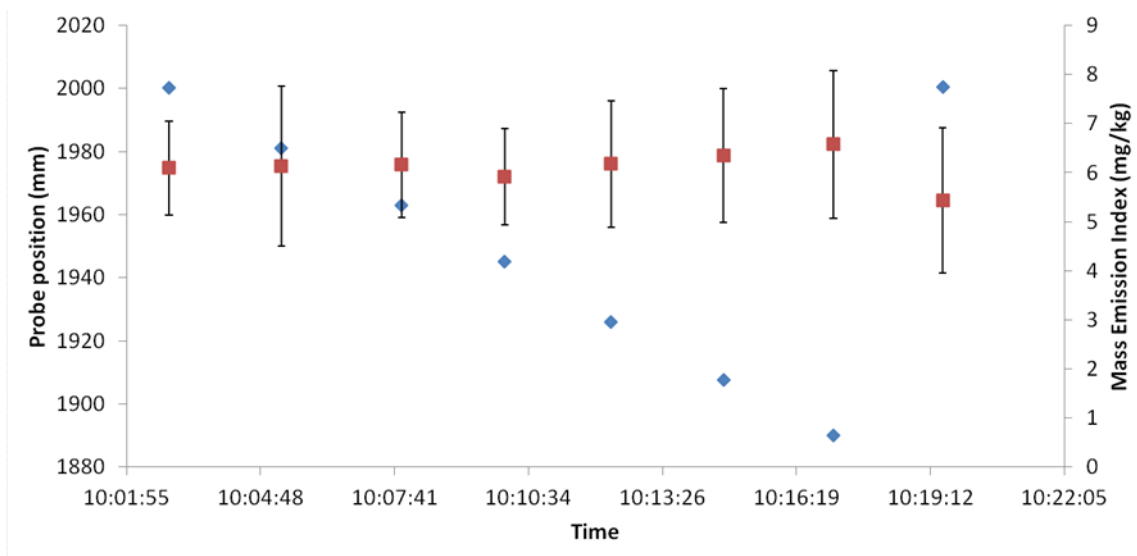

Figure 42 EI Mass (red squares) with error bars (2 standard deviations) against probe position (blue diamonds) at Minimum Idle

5.4.2 Installation of SAMPLE III sampling system

As discussed above, the installation of the SAMPLE III PM line into the facility and amendment of the FOCA system to accommodate running two systems simultaneously took hundreds of man hours, due to the natural engine through put at the facility along with the cramped conditions available for installing a measurement suite with in a fully operational engine test cell. However, the outcome was two, distinct, compliant sampling lines sampling from a common probe utilising exactly matched sampling lengths in sections 2PTSa and 5PTS with common sections 1PTS, 2PTS, GTS & measurement suites. As already explained, where possible all sections of the line that were outside of sections 3PTS, 4PTS and after the cyclone in 5PTS were made as nominally identical as possible by employing nominally identical custom designed and made matched splitters, and ensuring all pipe work was manufactured and fitted on- site to the same diameters, material, bends and heating.

Also the instrument suites installed were exactly the same types and utilised laboratory matched analysers and bespoke cut and matched piping. As such it was planned that any differences noted in the two PM systems being inter-compared are as a function of slight variations permissible within the primary splitter, diluter and spill section (3PTS), ‘standardised’ sampling line (4PTS) or cyclone choice (5PTS) as specified in the SAE E31 compliance protocols documented in the current PM working draft.

As 1PTS was already installed and functioning this section did not have to be amended by the SAMPLE III consortium however photographs and descriptions of the installation of the remaining sections are given as follows.

5.4.2.1 First sampling section and additional splitter (2PTS & 2PTSa)

As explained earlier to facilitate an extra sampling line an extra splitter was required compared with the SAE E31 recommended PM system (section 5.2.3). As the currently installed FOCA 3PTS section is already installed behind the gantry (approximately 10m off the test cell floor) it was necessary to install this section supported off the currently

installed stations. To accommodate this extra section the output of 2PTS had to be moved away and down from its original location, thus new support mounts had to be added to the structure and fitted working off a ladder and using a high level ‘cherry picker’ as shown in Figure 43.



Figure 43 Installation of section 2PTSa into test cell

5.4.2.2 Primary splitter, dilution and spill section (3PTS)

As the FOCA system was already in place it was necessary to build the SAMPLE III 3PTS section to be a similar size so it could be mounted as close as possible to ensure section 2PTSa could be identical to both lines. To facilitate this inclusion the FOCA 3PTSa section had to be moved up approximately (40cm) to give room for the SAMPLE III system to sit out of the air flow and behind the gantry structure.

A bespoke cage was constructed around the SAMPLE III 3PTS section and lifted via a crane up to a new support structure that was fastened to the gantry access ladder. Where it was securely fastened into place and physically tied to the FOCA 3PTS section as shown in Figure 44.



Figure 44 Installation of 3PTS section into SR Technics test cell

5.4.2.3 25m Carbon Loaded PTFE Sample line (4PTS)

The 25m line (4PTS) was then connected to the outlet of the 3PTS unit and had to be run in line with the FOCA lines down the test cell wall and through an underground gully that

channelled out of the test cell under the sound-proof walls and into the adjacent room where the measurement suites were housed, images of the sample lines after installation are given below (Figure 45).



Figure 45 Installation of SAMPLE III 25m PTFE sample line (4PTS)

5.4.2.4 Cyclones and secondary splitters (5PTS)

The FOCA cyclone was already fitted into a support cage within the adjacent measurement suite room therefore the secondary splitter section and SAMPLE III cyclone and identical secondary splitter assembly were fitted within the modified frame then trace heated in situ. Photographs of the installed 5PTS section are given below (Figure 46).

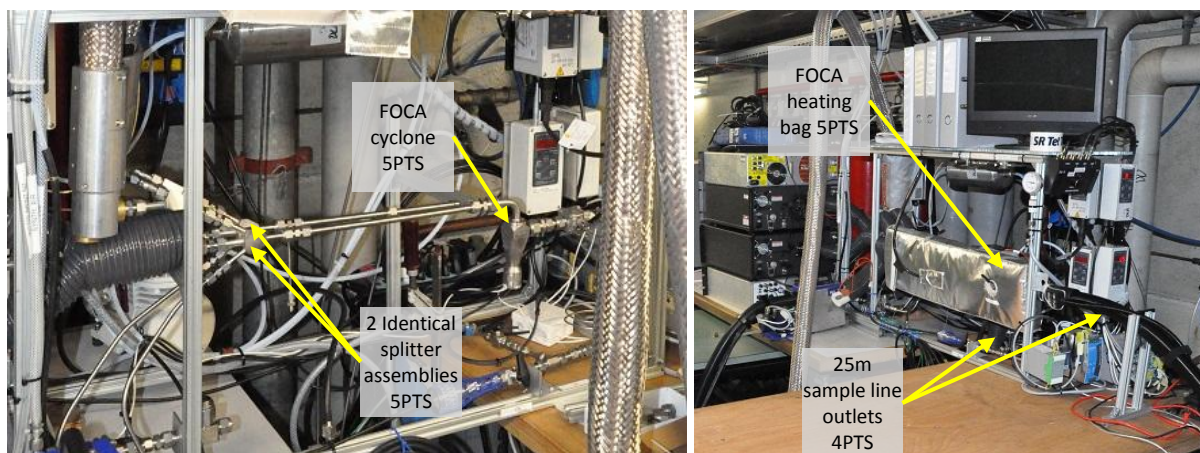

Figure 46 Installed cyclone and identical splitter sections (5PTS)

5.4.2.5 Gas Sample Transfer System (GTS)

To ensure a uniform flow the GTS was made common to both sampling systems by blocking the individual GTS outputs within the 3PTS section and building a common GTS section attached to section 2PTSa. This section facilitated additional analysers to be fitted to the gantry by adding a splitter to an additional length of pipe nominally identical to the legs of 2PTSa used to connect to the 3PTS sections. This facilitated real time penetration studies to be conducted. The GTS then utilised the current FOCA GTS sample line and was run via the same route as the PM sampling lines 4PTS to a rearranged gas analyser suite in the measurement room. A photograph highlighting the position of the start of the GTS and the FOCA gas analysers fitted on a specifically manufactured framework and SAMPLE III SAE smoke meter is given in Figure 47.

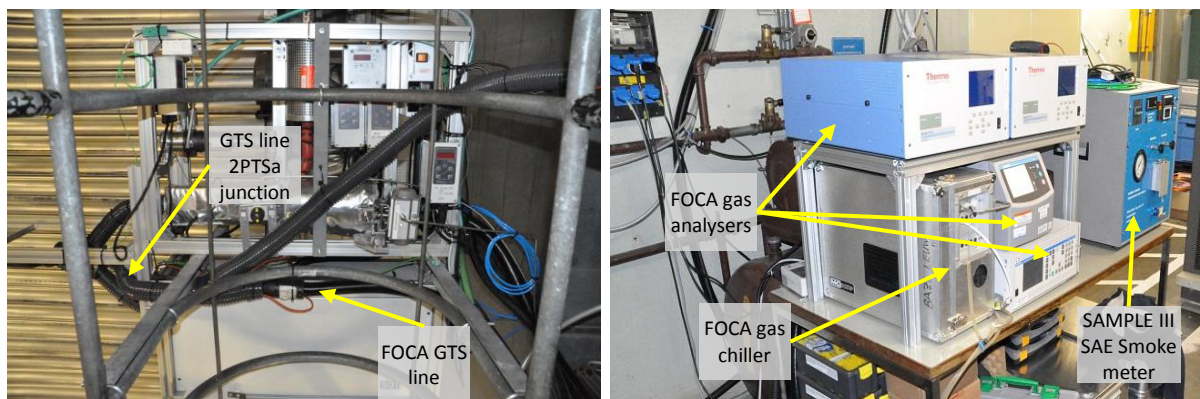

Figure 47 GTS Installation and Annex 16 equivalent emission analysers

5.4.2.6 PM measurement Suite

Two nominally identical instrument suites containing a non-volatile mass instrument (LII), non-volatile number instrument (VPR & 3xCPC), size instruments (DMS & SMPS) connected using identical pipe-work were installed into the measurement room, photographs of the installation are given (Figure 48)

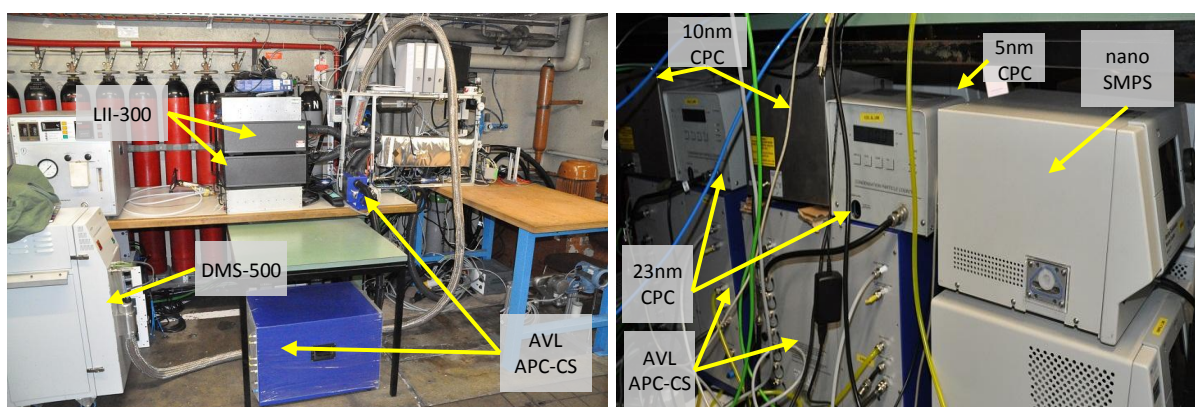

Figure 48 Non-volatile mass, Number and sizing analyser measurement suite

5.4.2.7 Gantry Instruments

To permit real-time line penetration measurement, mass and size instruments were mounted within the test cell and connected to the front end of the GTS sampling line. In order to get the instruments onto the Gantry they had to be lifted with a crane up onto the gantry and fastened down in bespoke made anti-vibration units. The LII instrument was mounted into a 19" rack mount cabinet and then the entire cabinet was isolated from the gantry floor via a mixture of stainless steel braid springs and foam. The DMS unit already contains internal springs supporting the delicate column inside, therefore on the recommendation of the manufacturer no additional damping was added which may have led to multiple modes of vibration. In fact the DMS was bolted onto a heavy (70kg) stainless steel base-plate and attached to the gantry in an attempt to prevent any mechanical vibration being an issue.

A DMS-500, LII-300 and FAPES were tested on the gantry, and on the whole performed well. However, there were some issues namely vibration affected internal hard drives, which

were replaced with solid memory versions, a blown high voltage power unit and a snapped critical fitting (both of which were successfully replaced during the campaign).

As can be seen the analysers were wrapped in plastic as a precaution as it has been known for rain and snow to be drawn into the test cell and wet the gantry. Images of the installation of the gantry analysers are given below (Figure 49).



Figure 49 Installation of the Gantry instruments

5.5 SAMPLE III and FOCA Sample line design overview

Although both sampling systems were both predominantly built to the most recent SAE E31 recommendations there are some subtle differences in the systems which are highlighted below (Table 7), thus if after the data analysis is conducted and there is not suitable agreement then these differences may be scrutinised in order to understand where these different losses may have occurred.



Table 7 Comparison of the two sampling systems employed for comparison testing

Sample Line Section	SAMPLE III	FOCA	Comments
1PTS	Identical	Identical	Common to both
2PTS	Identical	Identical	Common to both
2PTSa	Identical geometry	Identical geometry	As the flow in each branch is a function of both the spill flow and eductor inlet flow, the flow and hence residence time in each leg of this section may not have been equal for all experiments. However the length of this section is approximately 34cm which equates to less than 1% of the total sampling line length
3PTS Inlet/ Outlet tube diameter Splitter PM Isolation Valve Eductor Dilutor Internal Heating Spill Line Temperature Control system Valve Control system	1" inlet- 3/8" outlet 1" to - 3/8" straight Swagelok 3/8" (7.1mm bore) Identical Trace Heating 1" tube with 1/2" control valve Remote Automated system Remote Automated system	10mm throughout 10mm -10mm straight Swagelok10mm" (7.1mm bore) Identical Heating bags/Jackets 10mm tube and control valve Local Individual automated Remote manual control	The major differences noted in this section is the primary splitter size, tube size, heating method and control methodology. The same PM isolation valve is specified meaning a step of 11.25% in FOCA line compared with 8.4% in SAMPLE III from tube to bore. Also the FOCA unit is open to atmosphere increasing chances of a 'cold spot' forming in moving airstream
4PTS 25m PTFE Sample Line	1 length 3/8" line (7.75mmID)	2x12m 10mm (8mmID)	There is discrepancy of line diameter and length in the PTFE sample line. The trace heating methodology is also slightly different with the FOCA line employing trace heating compared with an induction braid used in the SAMPLE III line
5PTS Cyclone Splitter	Sharp Cut (3/8" in & out) Nominally identical	Stairmand (1/2" inlet & outlet) Nominally Identical	Different cyclone employed. Unfortunately the stairmand cyclone is supplied with 1/2" fittings thus requiring a step change to incorporate. There is also a slightly different heating methodology with the FOCA system employing a heating bag. There is also an extra isolation valve used upstream of the cyclone in the FOCA set up.
GTS	Identical	Identical	It is noted that this line was common to both sample lines, however it is noted that this line was not run in complete conformance of an Annex 16 sampling line
Analyser Suite	Nominally Identical	Nominally Identical	Two nominally identical sampling suites were constructed and normalised against each other in laboratory studies. To ensure any discrepancy was eliminated the DMS were switched from one line to the other for limited experiments



5.6 Experimental design

All the experiments were based upon a derivative of the line inter-comparison experiment design. Operational procedures were also similarly followed across all experiments. Roles and responsibilities were shared out and assigned to the various campaign personnel as follows (Table 8):

Table 8 Roles and responsibilities

Responsibility	Who
Test Co-ordinator	Mark Johnson (Rolls-Royce)
Test communication	Frithjof Siegerist (SR Technics) / Jacob Swanson (University of Cambridge)
SAMPLE III PM System	Mark Johnson
FOCA PM System	Theo Rindlisbacher (FOCA)
Annex 16 system	Theo Rindlisbacher / Mark Johnson
Gas Analysis including diluted CO ₂	Theo Rindlisbacher
DMS (Gantry / FOCA / SAMPLE III)	Yura Sevenco / David Walters (Cardiff University)
LII (Gantry / FOCA / SAMPLE III)	Greg Smallwood / Kevin Thomson (NRC)
MSS	AVL engineers (Michael Arndt, Richard Frazee)
VPR (FOCA / SAMPLE III)	AVL engineers (Michael Arndt, Richard Frazee)
CPC (2 x 3010, 2 x 3775)	Paul Williams (Manchester University)
CPC (2 x 5.435)	Grimm engineer (Hans-Joachim Schulz)
SMPS (2 x nano)	Paul Williams
FAPES	Grimm engineer (Lothar Keck)
Smoke Number	David Lister (SAMPLE III sub-contractor)
AMS	Paul Williams
OC / EC filters	Jacob Swanson
CPMA	Jason Olfert (University of Alberta)
Time synchronisation	David Walters
Master file format	Paul Williams
Data Storage	Yura Sevenco / Alice Suri (FOCA)

During engine running all the analysers operated continuously and data was automatically logged onto computers (nominally one computer per instrument type).

The operation test protocol was as follows (Table 9):



Table 9 Operational test protocol

Countdown	Location	Operation
-2 hours	Control room & Corridor	Synchronise all clocks
-1.5 hours	Gantry	Switch on DMS
	Gantry	Switch on FOCA heaters
	Gantry	Switch on LII
	Corridor	Switch on FOCA PM line heater
	Corridor	Switch on GTS line heater
	Corridor	Switch on SAMPLE III PM line heaters (9)
	Corridor	Switch on compressed air feed
	Corridor	Switch on both PM line pumps (4)
	Corridor	Switch on LII's (2)
	Corridor	Switch on Gas Analysis and Smoke Meter
	Corridor	Switch on CPC's & SMPS' (6 + 2)
	Corridor	Switch on DMS (2)
	Corridor	Switch on APC (2)
	Corridor	Switch on system control computer
	Corridor	Switch on mfc (2)
-1.25 hours	Corridor	Set flow rates on mfc's
	Corridor	Check CPC / DMS / LII / APC operating ok (e.g. green lights)
-1 hour	Corridor	Check manual / pneumatic valves are in correct positions (PM lines isolated, Nitrogen closed)
	Outside	Turn on and set Nitrogen (2.5 bar) and Synthetic air (2.5 bar) gas bottle pressure
	Corridor	Perform zero & span gas analysis Perform Smoke leak and zero check
-30 minutes	Corridor	Start data logging
	Corridor	Perform 5 minutes zero check (PM isolation valves CLOSED, Nitrogen valves OPEN)
	Corridor	Perform 5 minutes ambient check (PM isolation valves OPEN, Nitrogen OPEN)
	Corridor	Check line temperatures and pressures
-5 minutes	Corridor	Test ready status
ENGINE TEST Start	Corridor	Probe lowered into exhaust flow
Measurements obtained		
In between power curves (at MI)	Corridor	Perform 5 minutes zero check (PM isolation valves CLOSED, Nitrogen valves OPEN)
	Corridor	Perform zero & span gas analysis calibration
End of engine test	Corridor	Probe raised out of exhaust flow
	Corridor	Perform 5 minutes zero check (PM isolation valves CLOSED, Nitrogen valves OPEN)
	Corridor	Isolate all instruments
	Outside	Switch off Nitrogen and synthetic air gas bottle banks

5.6.1 Line inter-comparison experiment

This was the most essential experiment of the campaign. An inter-comparison experiment between two ARP working draft document systems (FOCA and SAMPLE III) was needed to understand the uncertainties associated between such systems. The instrument suite for the SAMPLE III system was sourced from within the consortium and EASA. The instrument suite for the FOCA system was sourced via collaboration with NRC, EMPA, ETH, and instrument manufacturer loans.

The setup on each line was designed to be as identical as possible. The 4PTS systems were both run with a 25 sLPM flow-rate controlled by mass flow controllers. To act as a ‘policeman’ and also obtain real-time size distributions, a DMS was located after the cyclone. Non-volatile particle mass and number measurements were obtained in line with the working draft document.

A schematic of the experiment setup can be seen below (Figure 50).

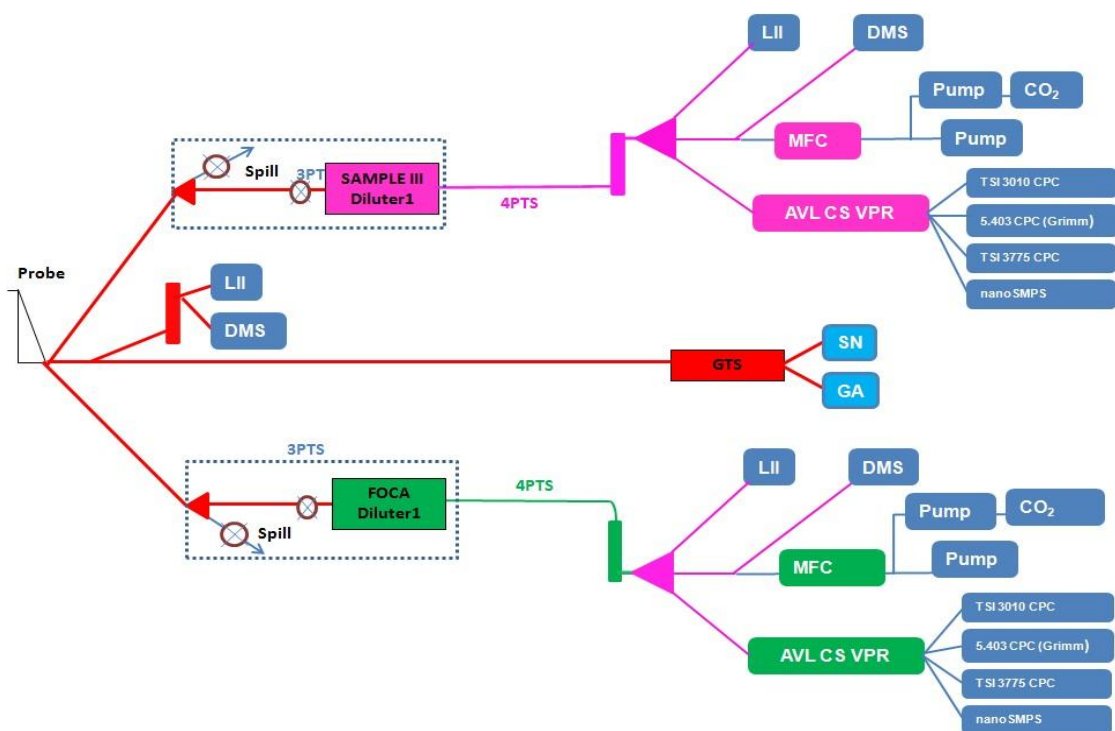

Figure 50 Schematic of line inter-comparison experiment

To ensure that there was no instrument suite bias, the policeman DMS instruments were physically switched between the two lines halfway through the test schedule.

5.6.2 Line Penetration experiments

5.6.2.1 Line length influence (12m versus 25m)

This experiment was included in this campaign to provide evidence to SAE E31 committee on the impact of a 25m line length and provide further evidence (in support of evidence already collected during the APU test campaign, SAMPLE III.01) that theoretical line loss corrections could correctly predict any additional loss observed.

The experiment was originally planned to be performed on a piggyback engine test. However, due to delays with instrument installation, system leak checking and importantly system operation, the experiment was moved onto the last (fourth) power curve of the dedicated engine test.

Whilst the engine was at MI, between the 3rd and 4th repeat power curves (as described later in Figure 59), the (2 x 12m) FOCA line was dismantled and re-attached to the PM system with only one length of 12m in place. This allowed a comparison to be made between the 25m SAMPLE III line and 12m FOCA line. The schematic for this experiment is shown below (Figure 51):

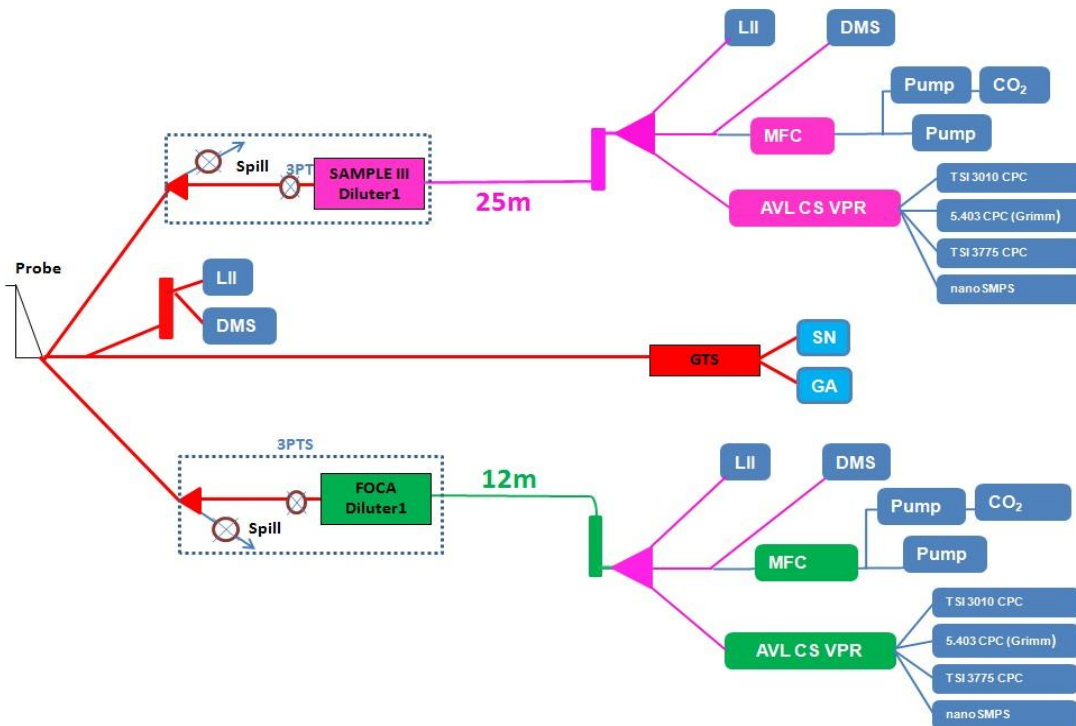

Figure 51 Schematic of line length experiment

5.6.2.2 Line Temperature (60°C versus 160°C)

This experiment was only included in this campaign as a piggyback experiment to gather more evidence on the effect of line temperature. Existing datasets have offered conflicting conclusions, so any additional data is helpful to further understand the science behind such differences. At the SAE E31 PM sub-committee in January 2012 a vote was taken to establish the line temperature for an ARP system, the outcome being 60°C, but with the committee split on the decision. The schematic for the line temperature comparison is shown in (Figure

52). The entire SAMPLE III system was heated to 160°C, whereas the FOCA system was kept at 60°C.

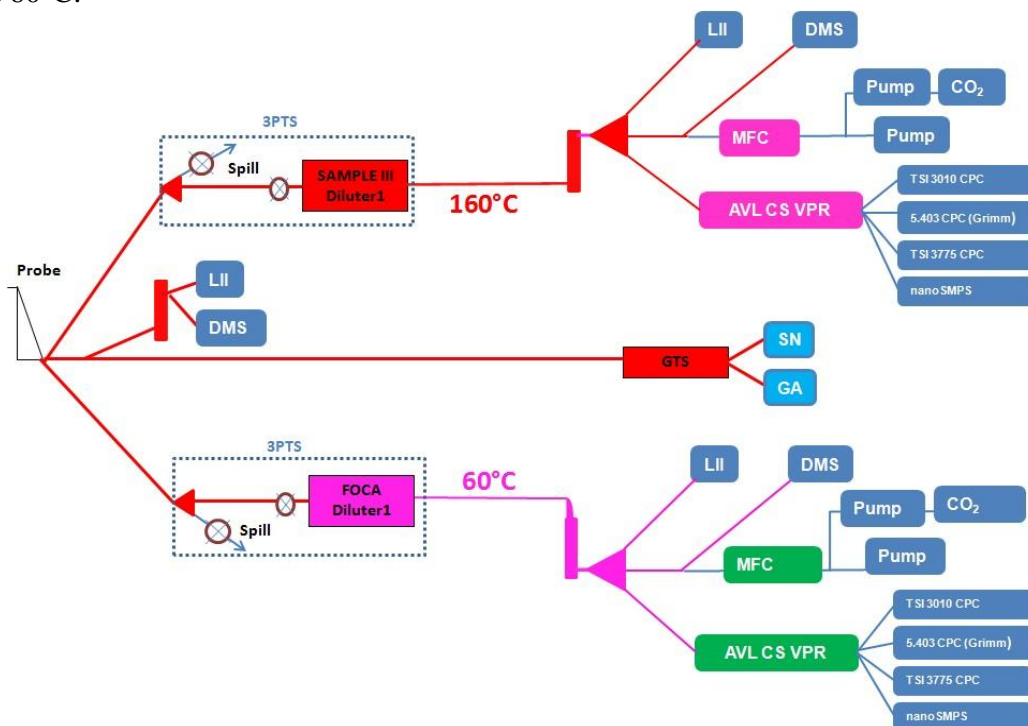

Figure 52 Schematic of line temperature comparison experiment

5.6.2.3 Real time penetration measurement (upstream vs downstream)

This experiment was planned in order to observe real-time PM penetration efficiency throughout the standardised sections of PM sampling system utilising large in-service gas turbine exhaust (rather than lab-based aerosol). Note that this experiment was also performed during SAMPLE III.01 using a small gas turbine engine (R-R Artouste APU). Due to the engine size it was possible to install the 3PTS section outside the test cell wall which allowed much easier installation.

This experiment was only possible to perform, once it had been proven that there was a high likelihood that the instruments would survive inside the SR Technics test cell. Dr Greg Smallwood (NRC Canada) was able to prove that a slightly modified LII instrument should be able to endure the ‘harsh’ testing environment by performing an instrument check test on the gantry at SR Technics in January 2012.

Penetration data was obtained on all dedicated and piggyback engine tests. And as such, the schematic of the experiment can be seen in each of the experiment figures (Figure 50-Figure 54)

5.6.3 Size methodology inter-comparison experiment

At the end of 2011, there were discussions within SAE E31 about the possibility of not only using the existing performance penetration methodology to describe the losses in the sampling system, but to actually attempt to correct for these losses. Though the general consensus within SAE E31 was that sizing instruments were not mature enough for engine certification, due to recent advances in sizing instrumentation, further evidence was required to inform CAEP WG3 that this view was still valid.

Dedicated engine test time was used to compare different size measurement methodologies at the end of the diluted PM sampling system.

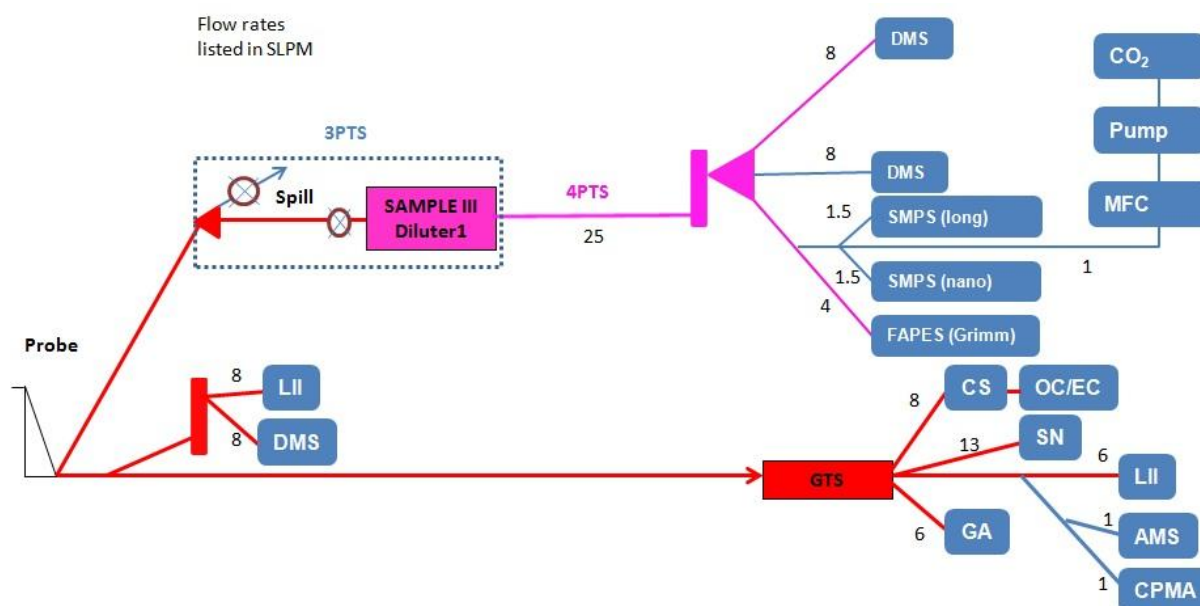

Figure 53 Schematic of dedicated size instrument comparison

Care was taken to try and ensure that wherever a flow splitter was installed, that the flow rates were balanced in each branch so each instrument would ‘see’ equal particle losses.

Fortunately the SR Technics engine schedule allowed the consortium to extend the size methodology experiment during piggyback engine tests that occurred after the dedicated running. For these further experiments, the size inter-comparison setup was designed to minimise the impact of volatiles. Instruments placed on the gantry were located behind a catalytic stripper. Instruments located at the end of the PM sampling system were located behind either a catalytic stripper or a VPR (which included a catalytic stripper).

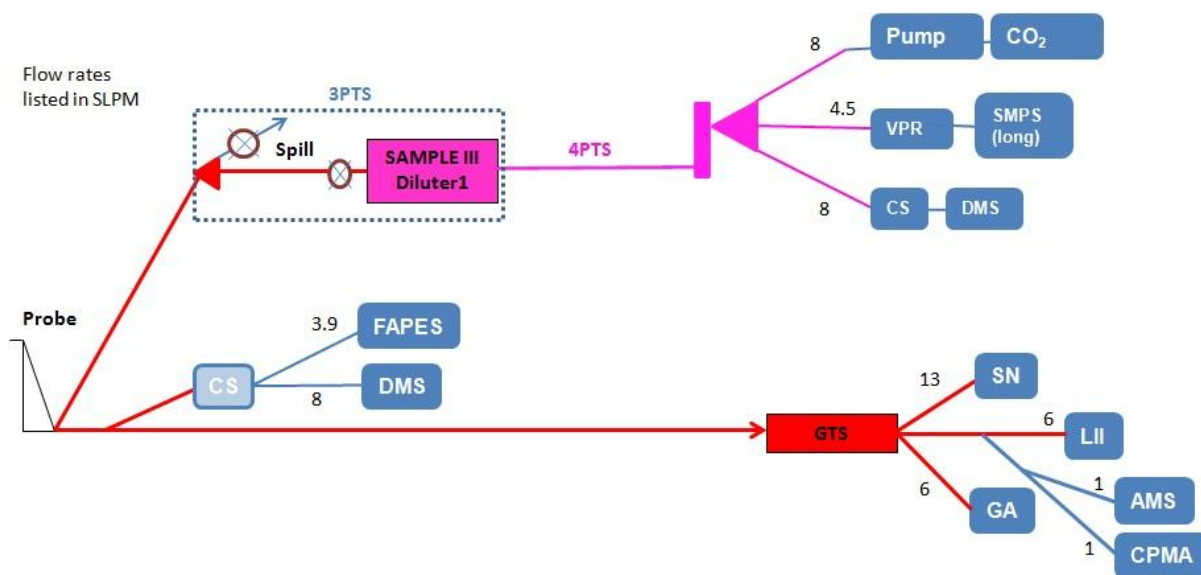

Figure 54 Schematic of Size instrument comparison on ‘piggy back’ engine test

5.6.4 CPC lower cut point sensitivity

As described in section 4.4, further experiments to determine the sensitivity of the CPC lower cut point were required to finalise the values to be used for the draft ARP.

The AVL VPR instrument outputs 8 sLPM which can be utilised for particle measurement. Thus it was possible to measure downstream of the VPR with a number of CPC’s with different lower size cut-points during the dedicated engine testing for the line inter-comparison. In addition, nano-SMPS’ were also utilised and set to measure in a size range of 2.5 to 60nm, providing detailed size measurements across the region of interest (Note: it was possible to utilise SMPS measurements due to the long steady-state sampling periods of 20 minutes) which allowed at least 5 SMPS scans to be performed to get a good statistical average.

Two commercially available CPC’s (Grimm 5.435 & TSI 3775) that meet the existing ARP draft working document standard lower size cut-off’s were tested and compared with TSI 3010’s which had their saturation temperature gradients altered such that they had PMP equivalent cut points (d_{50} 23nm, d_{90} 41nm).

Due to the installation location the CPC’s and SMPS were coupled to the exhaust of a VPR via flexible conductive silicon tubing as seen in Figure 55. This type of tubing is commonly used by research aerosol scientists. However, as the flow rates varied between the instruments, in order to keep the particle losses as near-identical as possible for each instrument, the lines were cut to specific lengths. In addition the lines were setup so that in the first 3-way splitter the flows were equally balanced in each leg, though it was not possible to repeat this in the second 2-way splitter (0.6 versus 1 sLPM). The short piece of tubing between the DMA column and CPC is part of the SMPS calculation measurement. The SMPS data was analysed using the residence time for the specific length.

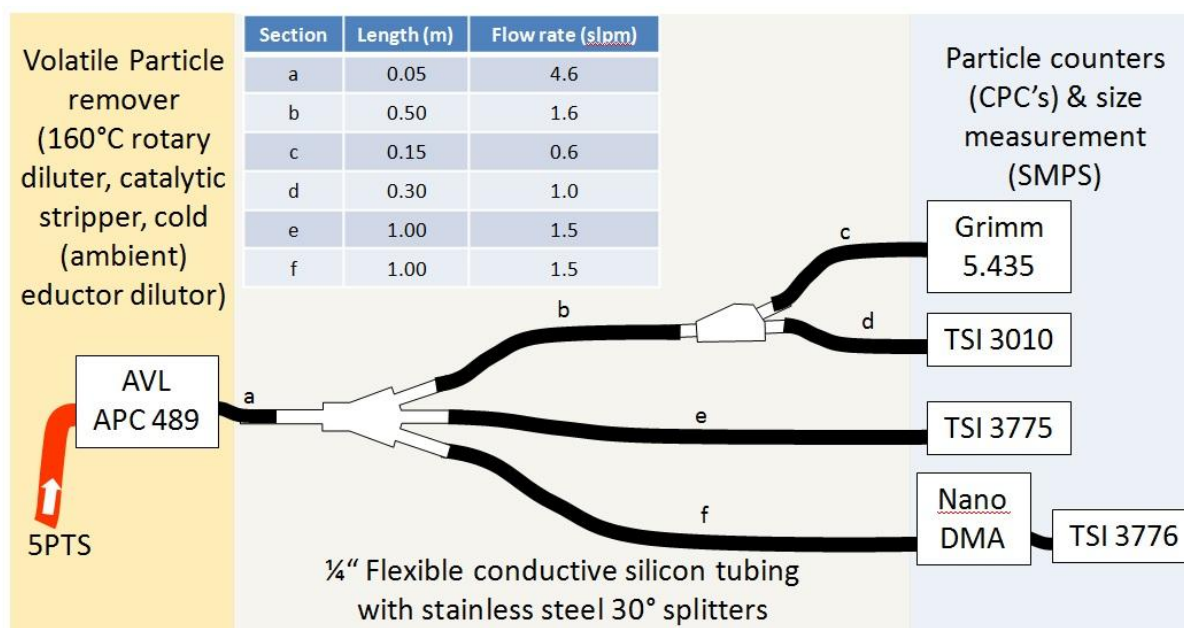

Figure 55 Multiple CPC and SMPS line configuration

It should be noted that there were CPC's installed inside both AVL APC units, the data was logged but has not been analysed as the internal line lengths and flows would create different particle losses for this data and the d_{50} and d_{90} size cut-off's were not compliant with the draft working document specifications.

5.6.5 Catalytic Stripper efficiency experiment

With SAE E31 agreeing to pursuing a lower CPC cut point size ($<15\text{nm}$), questions remain on the absolute efficiency of catalytic stripper technology volatile PM removal efficiency. AMS measurements obtained during the MS&T testing at SR Technics in Dec 2011 were inconclusive. The AMS technique only measures particle sizes down to 40nm therefore cannot quantify volatile PM below this size. OC/EC filter analysis allows quantification of volatile material within the size range of interest ($>10\text{nm}$).

Dedicated engine test time was used to obtain catalytic stripper efficiency measurements using OC/EC filter analysis. Due to the lower limit of detection of the filter analysis method ($0.5\ \mu\text{g}/\text{cm}^2$), this experiment was performed on the raw sample line (GTS) rather than the diluted PM line. To perform measurements on the PM line would have meant steady state engine conditions of up to 10 hours per filter, which is not realistic.

An LII was located on the GTS line so that the EC particle concentration could be measured in real-time, allowing a calculation to be performed to flow the sample (set at $8\ \text{sLPM}$ using a mass flow controller) for the correct amount of time to obtain the ideal surface area concentration (between 5 to $20\ \mu\text{g}/\text{cm}^2$). Three filters were obtained at each condition to ensure statistical repeatability.

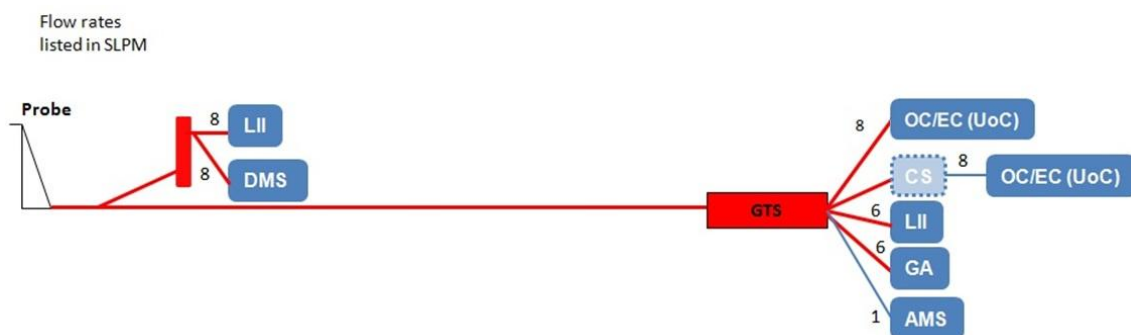

Figure 56 Schematic of CS efficiency experiment

5.7 Engine types and operating conditions

SR Technics made available several engines from the CFM56 and the Pratt & Whitney PW4000 engine families for particulate matter sampling and measurement in the Zurich test facility. Most of these were provided as ‘piggy-back’ opportunities during engine pass-off testing – with a limited number of power conditions (typically 4-5) from idle up to max continuous power. However one engine was selected and used for an intensive series of tests over 3 days dedicated to the requirements of the SAMPLE III project. Further details are given in the next sections.

5.7.1 Engines serviced and passed off in SR Technics test cell

As discussed earlier SR Technics service and pass off numerous variants of different engines from two of the major gas turbine manufacturers namely GE and Pratt and Whitney. A summary of the types of engines serviced and passed off within SR Technics Zurich engine test cell is given below.

5.7.1.1 GE CFM56 engine family

The CFM56 engine series is a family of engine models spanning a thrust range of 18,500 to 34,000 pounds that are installed on many short haul aircraft. Current models include:

- CFM56-5B, used on Airbus A318, A319, A320 and A321
- CFM56-7B, which has a slightly smaller fan than the -5B, used on Boeing 737-600/700/800/900

Several emissions, performance and durability improvements have been incorporated in these engine models since entry into service. NO_x emissions reduction features that have been offered included the staged lean-burn double annular combustor option (DAC) used in the CFM56-5B/2, -5B/2P, and -7B/2 engines, and the “technology insertion” combustor introduced in the CFM56-5B/3, -7B/3 and -7BE engine models in 2007. The DAC combustor is unique with respect to particulate matter emissions because it burns in a rich mode similar to the baseline combustor at low power, but switches to a lean combustion strategy at high power. Use of lean combustion should produce very low levels of smoke (soot) particles.



The first CFM56 engine entered service in 1982, and several previous models are still in service on the Boeing 737-300/400/500, Airbus A340-200/300, and civil and military variants of the DC8 and Boeing 707 aircraft.

A summary of the different engines within this family is given below (Table 10)

Table 10 Summary of different GE CFM56 engine family variants passed off at SR Technics Zurich test cell

Series	Take-off thrust range	Engine models	Aircraft application	Initial entry into service	Combustor options
2	22000 - 24000 lb	CFM56-2A, 2B and 2C	Boeing E3 Sentry, E8 Mercury and KC-135; McDonnell Douglas DC8-70	1982	
3	20000 - 23500 lb	CFM56-3B1, 3B2 and 3C1	Boeing 737-300/400/500	1984	
5	22000 - 26500 lb	CFM56-5A [4 thrust variants];	Airbus A320	1988	
	22000 - 33000 lb	-5B [9 thrust variants]	A318, A319, A320, A321	1994	Double Annular
	31200 - 34000 lb	-5C [3 thrust variants]	A340-200/300	1993	
7	19500 - 27300 lb	CFM56-7B [6 thrust variants]	Boeing 737-600/700/800/900	1998	Double Annular



5.7.1.2 P&W 4000 engine family

The PW4000 engine series is a family of high thrust turbofan engines, with thrust ratings from 52000 to 98000 lb, installed on long range aircraft i.e. Airbus A300-600, A310-300, A330-200/300, Boeing 777-200/300 and McDonnell Douglas MD-11.

The original annular combustor has had a continuous upgrade program including Phase 3, Floatwall and Talon aiming at improving durability and reducing NOx emissions. A summary of the different engines within this family is given below (Table 11).

Table 11 Summary of different P&W 4000 engine family variants passed off at SR Technics Zurich test cell

Fan Diameter	Take-off thrust range	Engine models (See Note 1)	Aircraft application	Initial entry into service	Combustor options
94” (2.4m)	230-275 kN (52000-62000 lb)	PW4052, 4056, 4060, 4062, 4062A, 4152, 4156, 4156A 4158, 4460 & 4462	Airbus A310-300, A300-600, Boeing 747-400, 767-200/300 & McDonnell Douglas MD11	June 1987	Phase 3
100” (2.5m)	287-311 kN (64500-70000 lb)	PW4164, 4168, 4168A and 4170	Airbus A330-200 & 300	Dec 1994	Floatwall, Talon
112” (2.8m)	329-441 kN (74000-98000 lb)	PW4074, 4077, 4077D, 4084, 4084D, 4090 & 4098	Boeing 777-200, 777-200ER & 777-300	June 1995	Floatwall

Note 1: last two digits of engine model designation indicate take-off thrust rating in lb

5.7.1.3 Piggy back engines tested

For any given period it is unknown which engines will actually be passing through the test cell therefore to a certain extent it is a random selection of engines that will be available for testing in any given testing period. During the SAMPLE III.02 testing window the following engines were tested (Table 12).

Table 12 Piggyback engines tested during SAMPLE III.02 testing period

Engine	Thrust	Combustor	other
PW4462-3	62000 lb (276 kN)	Phase 3	
PW4168	68000 lb (302 kN)	standard	
CFM56-5B3P	33000 lb (147 kN)	standard	
CFM56 -5C4	34000 lb (151 kN)	standard	mixed exhaust nozzle
CFM56-7B26	26300 lb (117 kN)	standard	
CFM56-7B26/3	26300 lb (117 kN)	Tech Insertion	

5.7.1.4 Piggy back engines power profiles

The piggyback engine tests at SR Technics consisted of maintenance seal break-in runs. The exact power curve profile is dependent on engine type and sometimes specific engine customer. However, they all contain a similar profile section consisting of stepped power increases from idle to high power (Max Continuous) with stable time period steps of between 2 and 10 mins. Once this ‘break-in’ schedule has been completed an engine performance curve is performed. As this data is critical evidence of good engine maintenance/performance, it is currently forbidden during this part of the schedule to obtain probe measurements.

To prevent unwanted additional stress on the traverse arm and probe, the probe was only lowered into the engine exhaust after engine start-up. After the break-in test the probe was then raised out of the exhaust flow to allow SR Technics to perform the performance curve. An example of a piggyback power curve and where emissions data was obtained (pink shaded section) is shown below in Figure 57.

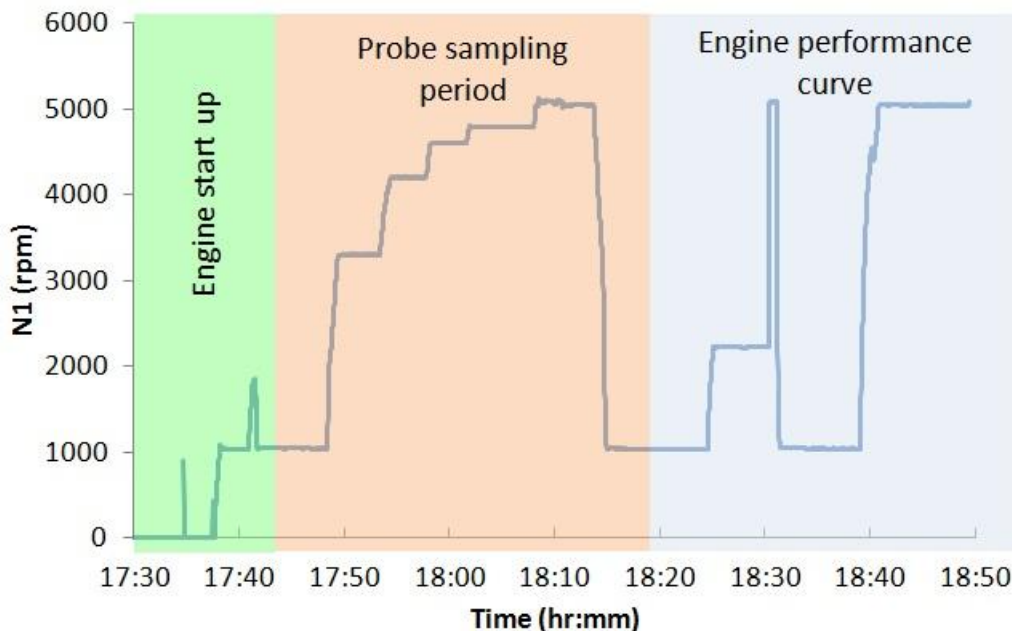

Figure 57 Example of a piggyback power curve during SAMPLE III.02 test campaign (CFM56-7B26-3) with labels indicating where probe sampling occurred

5.7.1.5 Piggy back engines particle size distributions

The range of piggyback engines tested provided a variety of aircraft engine particle sources. Even though all measurements from the SR Technics campaign are not representative of a specific engine source, the measurements do show some of the diversity of particle size distributions in current fleet engines. Figure 58 shows particle size distributions at low and high power conditions for several piggybacked engines. It can be seen that the size distributions tend to grow, and increase in number concentration at higher power conditions (resulting in increased particle mass concentrations at the higher power conditions). This is not unexpected as Smoke Number can typically increase with engine power which would correlate with expected higher mass concentrations.

It should be noted that as these size distributions were obtained at the gantry location (prior to 3PTS) , there will possibly be volatile contributions included and also due to additional particle losses in 3PTS, 4PTS, 5PTS and VPR the vast majority of the particles between 10 and 20nm will not penetrate through the line to the particle counter.

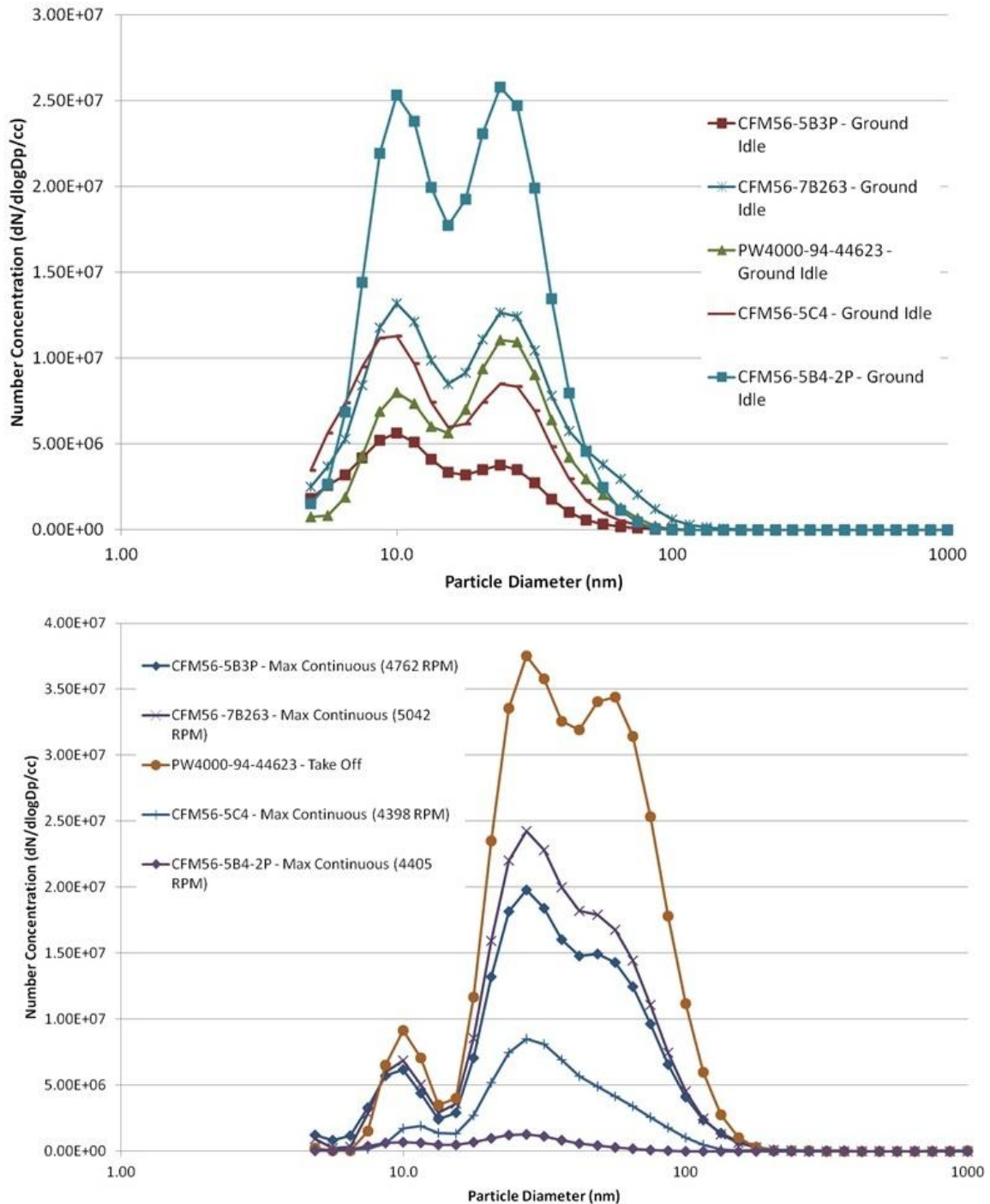

Figure 58 Piggyback engine particle size distributions for Idle and Max Continuous (Take-off for PW4000) power conditions. DMS located on Gantry.



5.7.2 Dedicated engine test

SR Technics are the owners of a limited number of different engines which were available to the consortium to rent for dedicated engine testing, and a description of the engine used is given as follows. A GE CFM56-5B4-2P engine was leased for five days (1 day preparation, 3 days testing & 1 day decommissioning) the dual annular combustor (DAC) is designed to minimise emissions, especially NO_x reduction, by optimising combustion for the different engine power modes and flight phases. It does this by utilising two concentric combustors; an outer ring that is the pilot zone and an inner ring that is the main combustor and fuelling them according to the power requirements. At low powers, only the pilot zone is fuelled - with a relatively rich fuel mix to ensure combustion stability; at high powers both are fuelled to provide a lean combustor mix that minimises NO_x production; at intermediate power variable fuelling occurs under the control of the engine management system. Smoke levels from this engine combustor are known to increase up to the point when the main combustor starts to be fuelled, then drop virtually to zero at higher powers.

This engine fitted with a double annular combustor was selected for the extended series of dedicated tests as it offered the opportunity of selecting test points that provide combinations of different levels of volatile material and smoke at modest power levels, thus minimising fuel consumption and allowing for more extensive testing [within the test budget]. A summary of the engine is given below (Table 13).

Table 13 Summary of dedicated engine

Engine	Thrust	Combustor	other
CFM56-5B4-2P	27000 lb (120 kN)	Double Annular	Staged combustion

5.7.2.1 Power curve profile and PM characterisation

As the dedicated engine was a double annular staged combustor it was necessary to perform a detailed ramp through the power curve so that the Particle matter concentrations could be ascertained for this engine at different points on the power curve.

The data collected from T₃ the combustor inlet temperature and fuel flow rate at different power conditions are plotted in Figure 59. Three typical power conditions of Minimum idle (MI), Max Continuous (MC) and Take off (TO) are plotted on the curve to show the range of power conditions that were considered during this power ramp. It is also shown where the final four PM concentration levels were selected on the power curve.

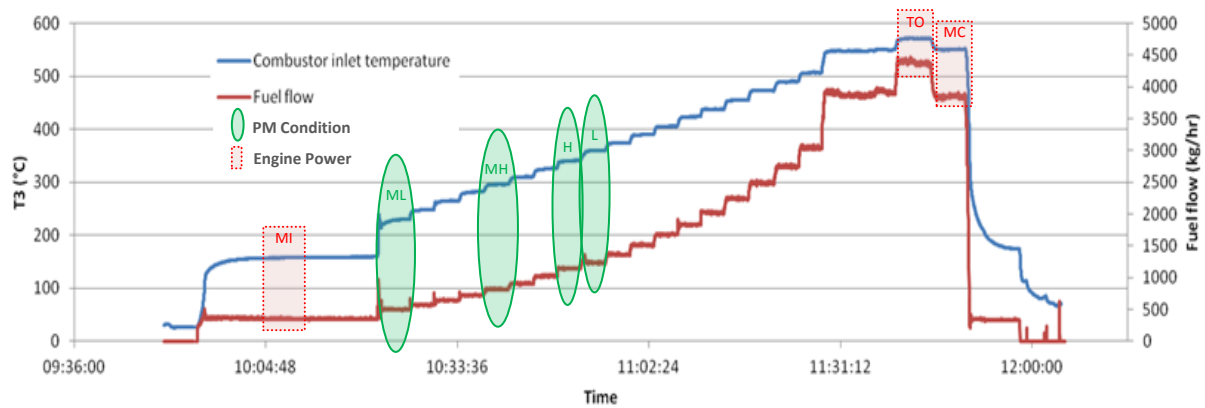

Figure 59 Engine ramp through power conditions for GE CFM56-5B4-2P DAC dedicated engine, showing different engine powers – Minimum Idle (MI), Max Continuous (MC) & Take-off (TO) and different PM Concentrations- Low (L), Medium Low (ML), Medium High (MH) & High (H)

Non-volatile number and mass measurements along with SAE Smoke number measurements were also conducted through this ramp to try and ascertain when the staging point occurred and give insight into where on the power curve suitable soot concentrations are witnessed, to enable the selection of four distinct PM concentrations. A graph of the smoke number data taken during the engine ramp displayed in Figure 59 with the same time stamp is presented below in Figure 60. As can be seen it is witnessed that there is a rise in smoke levels with increasing power up to a point where there is a step reduction in smoke. This step reduction occurs at the staging point, after which it is observed that there is a slight reduction in smoke (within the error of SN measurement $\pm 3SN$).

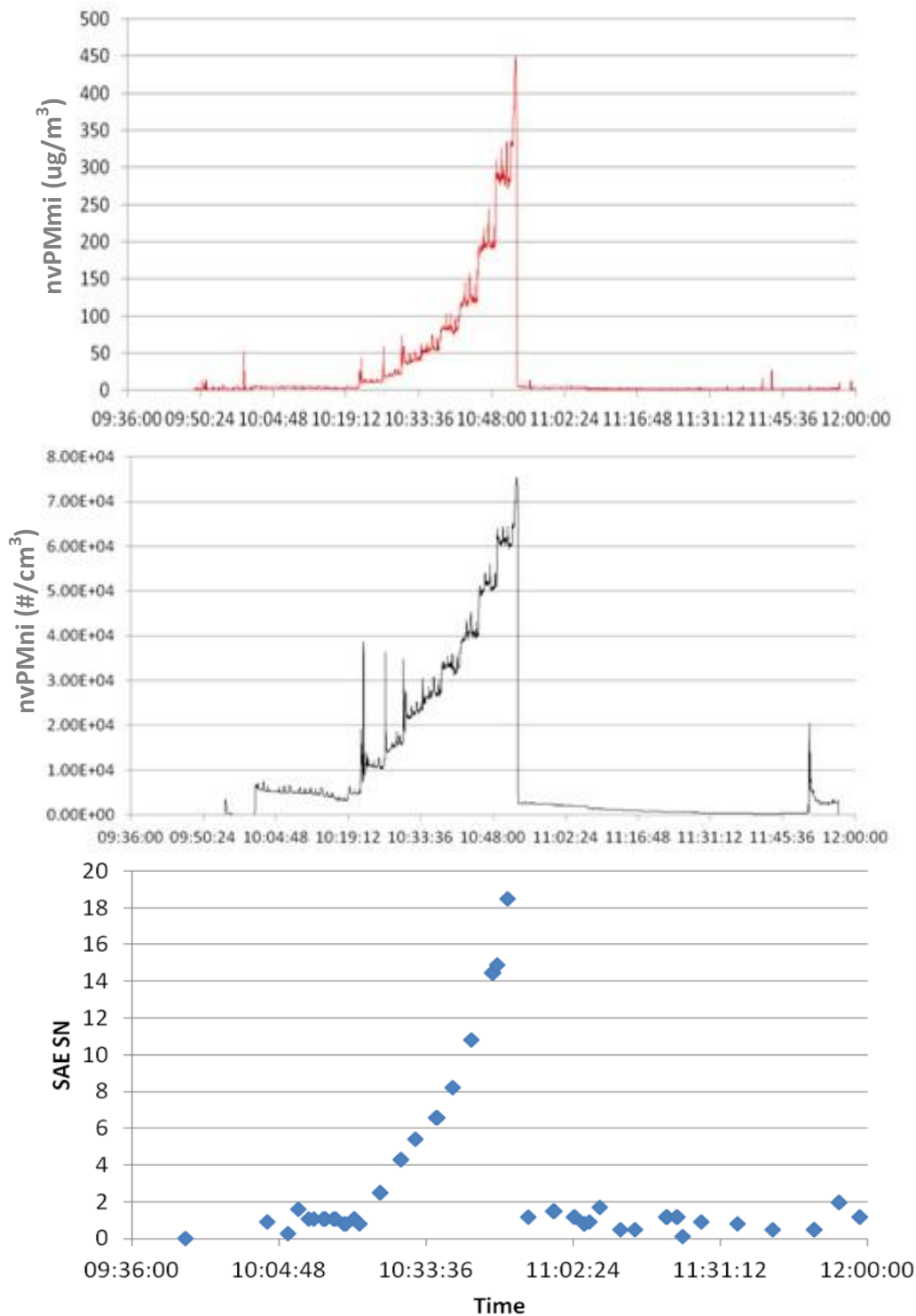

Figure 60 Non-volatile (raw uncorrected) PM mass & number and SAE smoke number values at different thrust conditions during dedicated engine up, down, up, up power curve

During the running of the power curves a fast sizing DMS instrument, located on the gantry within the test cell was also used to monitor the size and number concentrations at each of the 2 minute ramp power conditions. By processing the data real time during operation it was possible to ascertain four distinct different particle loadings Low, Medium Low, Medium High & High. Due to the double annular staged combustor process of the selected dedicated

engine it meant that up to staging particle concentrations increased with power, however on the staging point particle numbers dropped in concentration then continued to reduce with increasing power, as is shown from the raw DMS data taken during the ramp test (Figure 61).

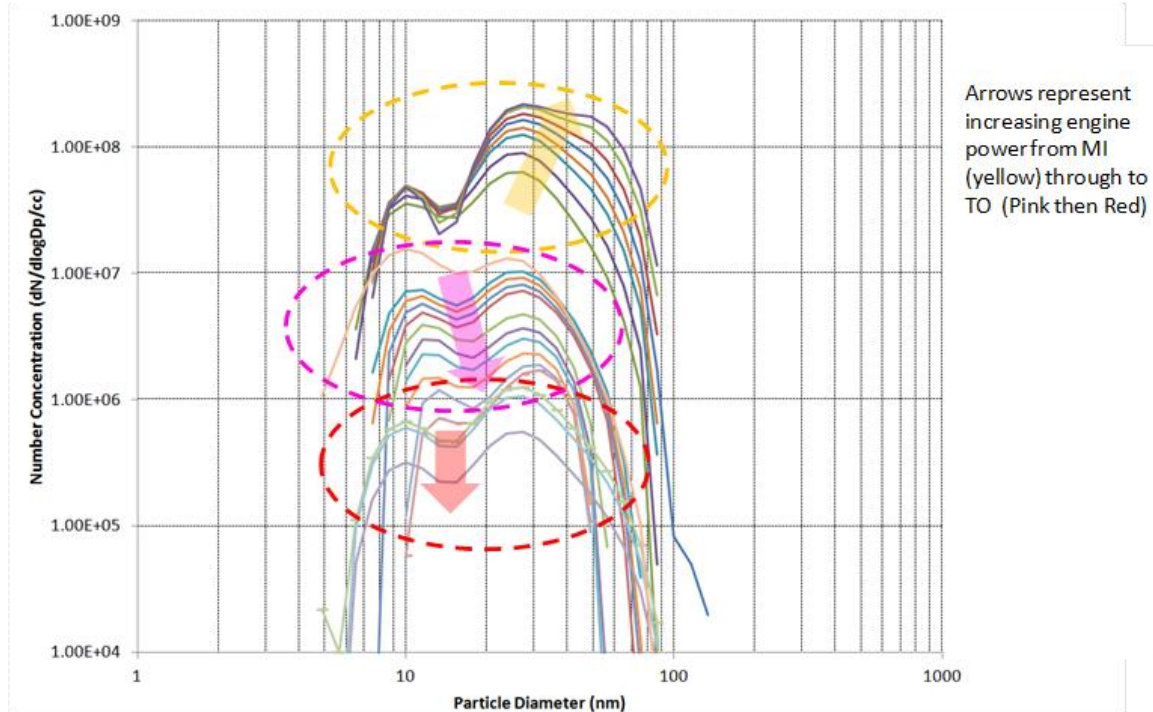

Figure 61 Raw DMS data taken on the Gantry within the SR Technics test cell during ramp power test of dedicated engine

As discussed earlier the PM concentrations increasing with power before staging is highlighted by the yellow boundary with the yellow arrow representing increasing power levels up to the stage point. This is the condition that the PM High concentration was selected. At the staging point, (area between the yellow and pink boundaries) the PM concentrations reduced as a step change then decreased with increasing power which is depicted by the pink arrow. Finally the maximum thrust conditions of Take-off and Max Continuous were tested as highlighted by the red boundary with the lowest concentrations measured at highest fuel flow rates (Take-off condition). It is also noted that these size/number concentrations are raw, thus are not EI corrected with CO₂ so if this was also factored into the calculation then there would be significantly lower EI number at higher power conditions after staging due to the increasing CO₂ concentrations across the full engine power range. The geometric mean values of the particle size distribution across the power curve are shown in Figure 62. It can be observed that the increasing size distributions matches that observed in Figure 61. Interestingly there appears to be another staging point towards the higher power conditions which is indicated by the sudden drop in particle size and number concentration.

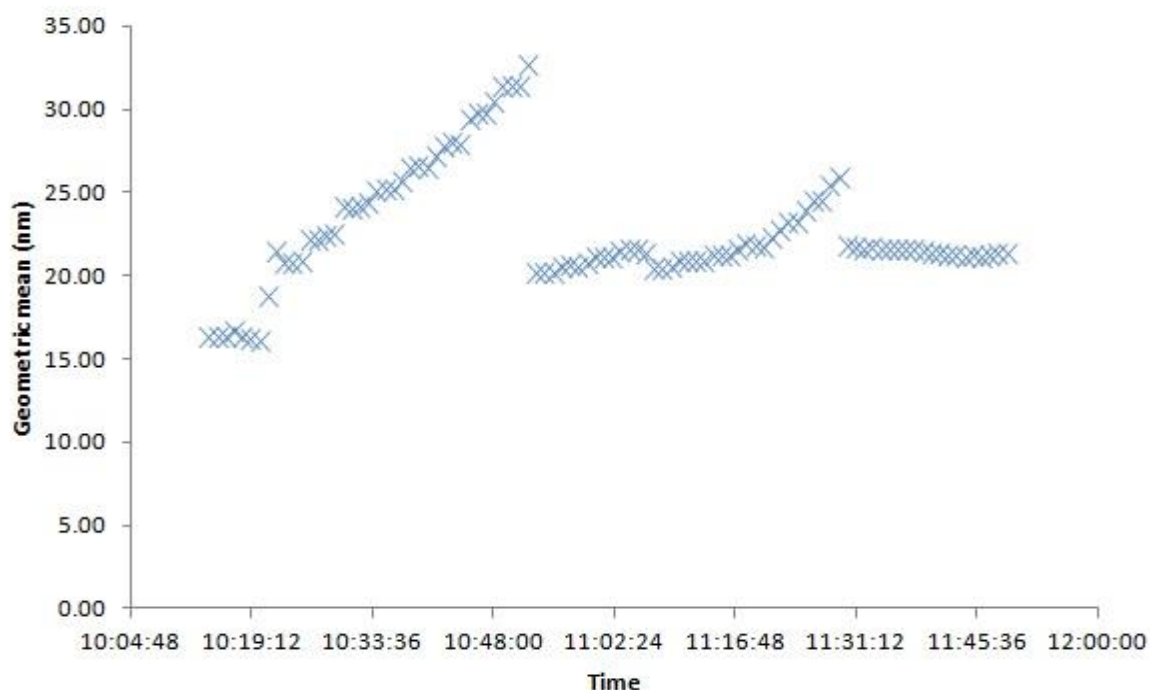

Figure 62 Power curve profile of Particle geometric mean sizes

As this study was to characterise the sampling systems not the engine PM concentration, PM levels were selected within the lower power conditions, with 3 from the power conditions before staging (yellow boundary) covering a range of PM distributions from low concentrations of small size, to high concentrations of large sized particles. An additional Low PM condition was chosen immediately after staging to give a different size distribution to those witnessed before staging. By picking the low PM condition at this point on the power curve meant that there were considerable fuel savings to be made compared to if a point at Take-off or Maximum continuous had been chosen (from within red boundary), which meant the consortium had more testing time available to conduct its experiments. Picking the Low condition at a point higher than the minimum smoke witnessed also ensured the mass loadings were slightly higher than the lower detection limit of the non-volatile PM mass instrument ($4\mu\text{g}/\text{m}^3$), and would reduce the time required to collect a suitable OC/EC filter if required.

The size distributions chosen to act as the four different PM levels for comparing the two compliant sampling systems are given in Figure 63.

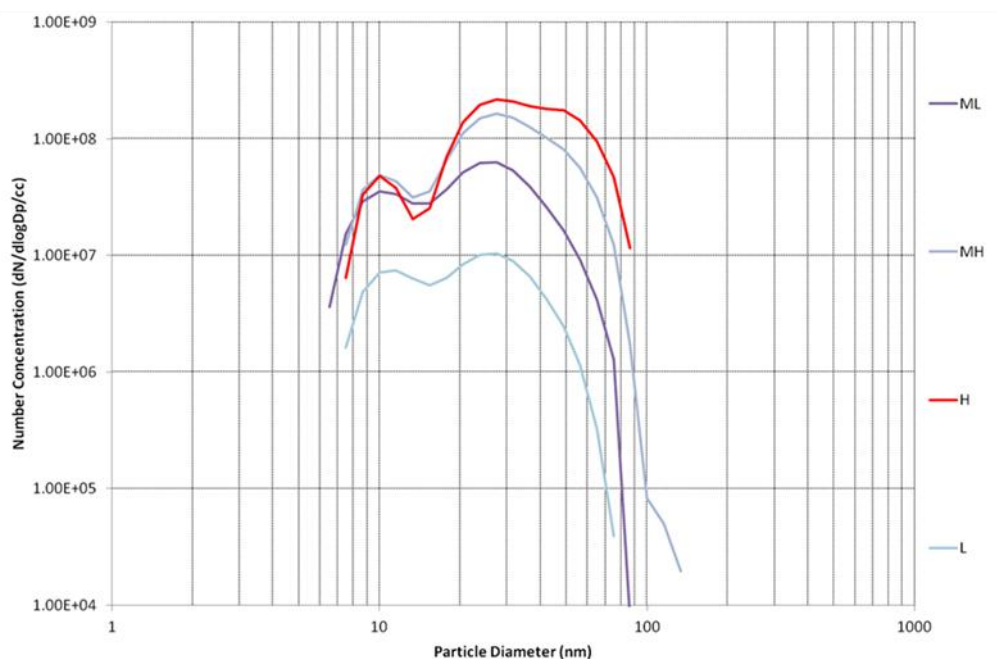

Figure 63 Size distributions of PM at the four power conditions chosen

It can be seen that the size distributions appear to be bimodal across the range which it is thought is due to there being a volatile peak at 10nm, as at this sampling location, measurements were performed on the raw exhaust with no volatile removal. As can be seen the four PM conditions chosen are High which has the largest size distribution and highest number concentration, then a reduction in size distribution and concentration is observed through Medium High, Medium Low and Low.

By picking four different distributions it was hoped that if there was good agreement between the lines at all condition then it offers support that the PM sample line methodology would be robust across a number of different engines at various power conditions, however if differences in the penetration efficiency of the two lines were observed then the varying size distributions entering the sample line may help determine what is causing these differences, using the fact that diffusion losses are size dependant whereas thermophoretic losses are size independent.

A summary of the engine conditions, gaseous measurements and PM measurements for each of the four chosen PM conditions is given below (Table 14). It should be noted that the CO and UHC concentrations unexpectedly do not follow the same trend across the engine conditions. This is most likely due to the single point non-representative sampling probe. This indicates that caution should be applied in attempting to quantify engine emissions data when utilising a non-representative probe sampling system.

Table 14 Corrected downstream measured values for Engine, PM & gaseous measurements at the four PM conditions chosen

PM Condition	T ₃ (°C)	N ₁ (rpm)	Fuel Flow (kg/hr)	nvPMmi (mg/m ³)	SAE SN	nvPMni (#/cm ³)	GMD (nm)	CO ₂ (%)	CO (ppm)	UHC (ppm)	NO _x (ppm)
L	375	2720	1235	0.019	1	1.4e6	20	2.49	218	63	71
ML	230	1400	460	0.090	2	0.9e7	20	2.01	370	16	32
MH	296	1950	720	0.410	7	1.8e7	27	2.29	357	4	56
H	340	2410	1020	1.200	13	3.1e7	33	2.60	391	2	84

5.7.2.2 Engine stability and repeatability

Emissions generated by engines are known to be dependent on ambient conditions of temperature, pressure and humidity and corrections for CO, HC and NO_x (derived from extensive parametric testing) are included in the existing Annex 16, Vol. II calculations. Corrections for ambient temperature and pressure are based on combustor inlet temperature and combustor inlet pressure. Using the recommended curve fitting procedure (plots of EI against combustor inlet temperature) effectively removes the temperature term. For CO, HC and NO_x, pressure exponents of 1.0, 1.0 and 0.5 are defined. NO_x emissions are also corrected for deviations of ambient humidity from a reference value by an exponential term ($\exp(19(H-H_{ref}))$).

However, while there may be ambient factor dependences for Smoke, no corrections are included in the Annex 16, Vol. II as it was not possible to determine reliable factors from parametric testing, not least because of the very large measurement uncertainties associated with the Smoke Number filter measurement procedure.

Determination of ambient condition variation effects on PM mass and number emissions from engines will require similar extensive parametric testing – not yet undertaken. However, it is possible that if during this testing the measurement uncertainty issues for SN and for PM mass and number measurements are the same. In that case the effect of ambient conditions would be negligible.

To examine the effects of engine stability and repeatability of the dedicated engine an up, down up, up power curve was conducted on the engine, which allowed some of the required experiments required to be conducted at various power conditions.

A graph of the power curve is given below (Figure 64) highlighting the points at which certain experiments were conducted coupled with a graph showing the comparative ambient conditions.

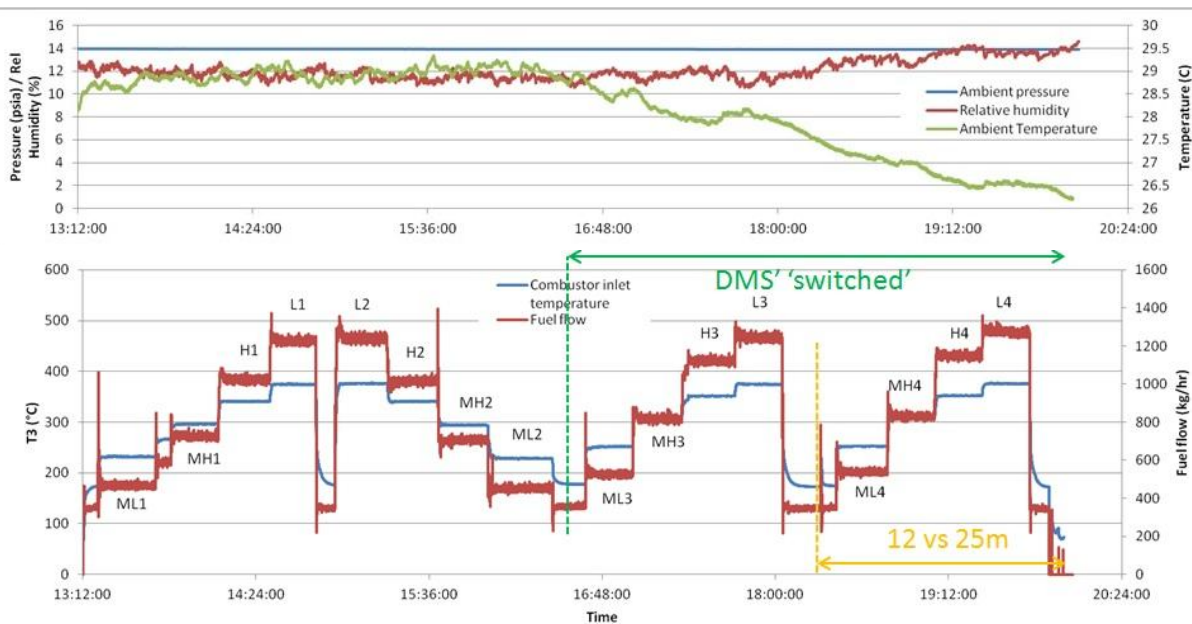

Figure 64 Ambient and engine conditions through up, down, up, up power curve of dedicated engine



As can be seen the four PM concentration points were met four times throughout the test day. It is also noted that the ambient conditions remained constant till approximately 16:30 at which time the temperature started to drop off and relative humidity climbed. It is also observed how dry the ambient air was for the test period. As can be seen there are discrepancies between repeated test points with H1 & H2 having T_3 temperatures of 380-350°C compared with H3 & H4 T_3 temperatures of 360°C this discrepancy is also noted in the comparative fuel flows with an increase of approximately 100kg/hr more fuel being consumed.

Non-volatile mass and number data is also presented for the power curve (Figure 65). It should be noted that these values are raw so have not been corrected for dilution ratio or in the case of the number counters the inter-analyser offsets, making it difficult to make quick comparisons between lines or conditions (Note that corrected data analysis is presented in (Task 4: Data analysis)). However, what is also observed is that even over the 20 minutes set conditions it appears that steady state condition of both mass and number is not observed. It should be noted that it was possible during all the test points to maintain a single dilution ratio on the volatile particle remover. Number concentrations were measured between $1e^3$ to $6e^4$ (For both the Grimm and TSI lower cut point CPC's the single particle count range is up to $1e^5$)

Large fluctuations are also observed on the number mid-way through each test point, on thorough examination of the data it was noted that these occur at the time the smoke number measurement is conducted and are symptomatic of changes in the dilution ratio of the primary diluter brought about by subtle changes in the pressure observed in 2PTS.

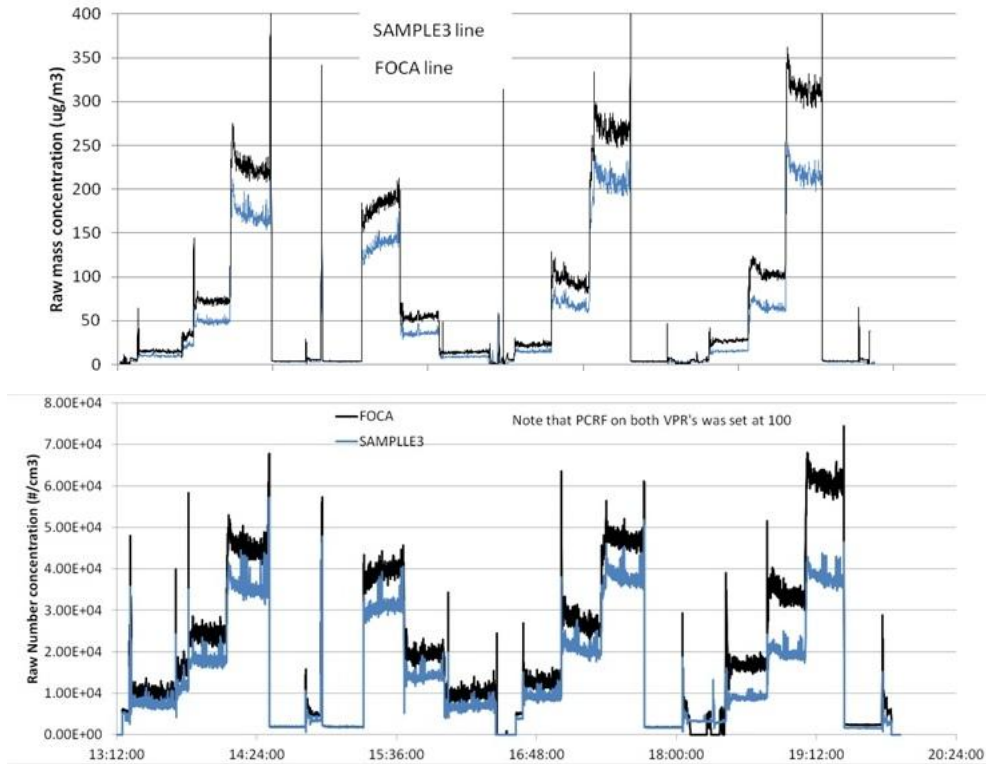

Figure 65 Raw non-volatile mass and number concentrations through up, down, up, up power curve of dedicated engine

The repeatability of size measurements for different PM concentration conditions was also examined by looking at the SMPS data for the four separate repeat points. The Low and Medium High conditions are presented below in Figure 66 (a & b) respectively.

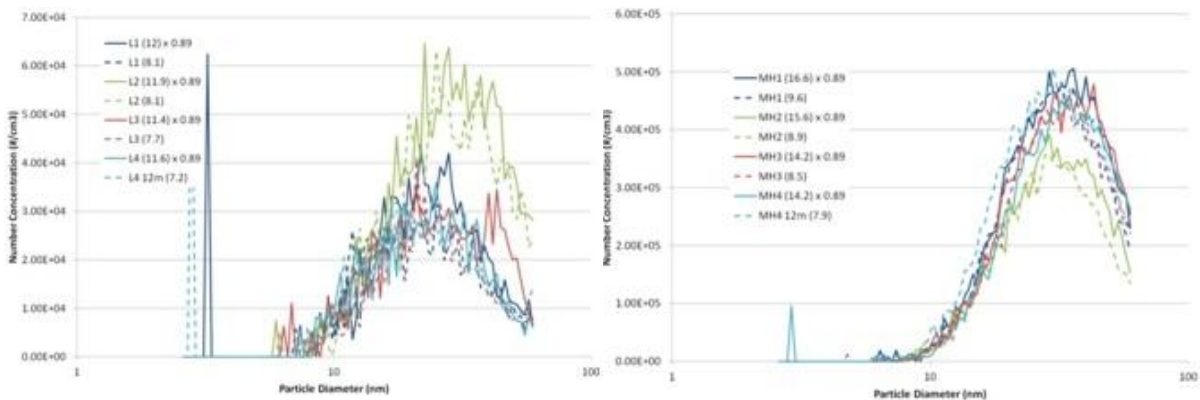

Figure 66 (a&b) SMPS size distributions corrected for dilution ratio and CPC offset for FOCA (dotted) and SAMPLE III (solid) sample lines for repeated PM loading points of Low and Medium high respectively

Good agreement can be observed (same colours, solid versus dashed lines) during the repeated power curves and at different PM load conditions.

However, large variations were witnessed during the repeated test points with the L₂ condition, on both sample lines. This data also appears to show the largest offset from the



other repeated (same power condition) points. This is interesting as this L_2 data was the only data measured on the 'down' (decreasing) power curve. Thus this may indicate that even though long stabilisation times of 20 minutes were observed, that the previous engine load may still affect the PM loading witnessed at a particular engine condition.

5.8 Conclusions of Task 2

1. Two sampling systems built to be compliant with the SAE E31 draft working document (that will lead to the ARP) were installed at SR Technics maintenance facility, and operated simultaneously behind a FOCA installed single point traversable probe.
2. Installation of primary dilution system (3PTS) in SR Technics test cell was difficult and labour-intensive. In addition, the installation of the dual instrument suites in a non-air conditioned confined space meant that space was at a premium and there was a risk of instrumentation overheating
3. Due to staged combustion, the CFM56-5B4-2P engine emits a wide range of Smoke Number, non-volatile particle mass and number concentrations at relatively low power conditions. This provided both particle systems with a good variety of aircraft gas turbine aerosol with minimal fuel flow usage.
4. Long dedicated steady-state test points of 20 minutes indicated particle concentration drift at certain conditions. Mass and number concentrations mutually drifted together.
5. It was witnessed that repeated setting of similar engine conditions was difficult to obtain and therefore affected PM repeatability tests. Variability could be due to ambient or engine variability. Further engine data is required across various engine/combustor types in order to ascertain the source and expected magnitude of nvPM mass and number variability.
6. It was perceived that performing PM measurements on a decreasing power curve seemed to indicate slightly reduced PM emissions compared to an increasing power curve.
7. Both the DMS and LII instruments coped well with the hostile conditions inside the engine test cell, however, there were some mechanical issues that had to be overcome during the test campaign on both instruments.
8. Both systems (sampling and instrument suites) operated correctly and properly under a range of sampling and concentration conditions. Though operation of the control spill valves was initially difficult to operate at low pressures.



6. Task 4: Data analysis

6.1 Introduction

All the engine data presented in this chapter has been corrected for dilution ratio and analyser offset, the off sets of the different analysers was determined in a laboratory based inter comparison study the details of which is presented below.

6.2 Pre-test analyser inter-comparison (calibration check)

To ensure the data from the two separate instrumentation suites and instrument inter-comparisons could be accurately compared it was first necessary to conduct a series of laboratory based studies to ensure that each analyser was calibrated against the others so data could be corrected for analyser to analyser variation. In an ideal world all these calibrations would be done independently by a certified test house conforming to regulated standards.

However, at this time the SAE E31 has still not fully approved the methodology required for calibrating the mass or number analysers, as such a laboratory test was conducted by the SAMPLE III consortium at the SR Technics facility prior to running engine tests. This methodology ensured that even if a traceable measurement could not be made that an accurate comparative measurement could be deduced by normalising against the laboratory measured offsets.

6.2.1 CPC Inter-comparison

As numerous CPC analysers were required to investigate the lower cut point sensitivity as discussed in detail earlier (section 4.4) along with CPC's required for running the SMPS. It was necessary to check that they all gave similar readings to a common aerosol so that any differences observed on each of the sampling lines could be attributed to line effects rather than instrument variation.

In total there were 8 CPC's required to run the experiments on the two separate sample lines. Two of the CPC's were supplied from Grimm Instruments and were setup to the recommended lower cut-point ($d_{50} = 10\text{nm}$, $d_{90} = 15\text{nm}$) as defined in section 4.4. As such Grimm conducted a rigorous calibration of the analysers 'in house' before shipping them to Zurich for testing. A photographic and schematic representation of the setup, similar to that used by the SAMPLE III consortium within the laboratory is given below in Figure 67.

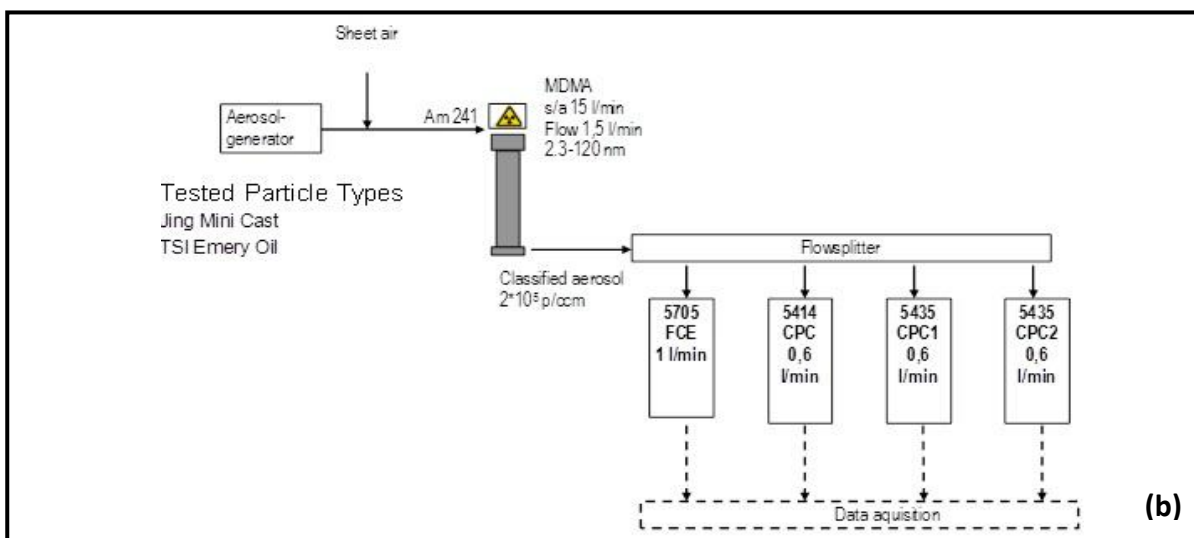

Figure 67 (a&b) Photograph and schematic of setup required for CPC calibration/ inter-comparison conducted at Grimm instruments

As can be seen to perform a CPC inter comparison you require four basic components namely:

1. Aerosol Generator
2. DMA column
3. Flow Splitter
4. CPC's to be tests (electrometer for calibration)

When calibrating the two CPC's for use as the SAE E31 approved CPC ($d_{50}=10\text{nm}$, $D_{90}=15\text{nm}$) Grimm used both emery oil and a Jing Mini Cast aerosol generator to determine their agreement. However, as a mini-cast was not available at SR Technics the aerosol generator used was a Palas Spark Generator in line with a TSI nano DMA column.

The data obtained across a range of sizes for the CPC inter-comparison conducted by the SAMPLE III consortium is presented graphically in Figure 68. The data is normalised against a recently calibrated TSI 3776 ($d_{50}=2.5\text{nm}$) analyser so one factor can be applied to allow comparisons between all of the 8 analysers.

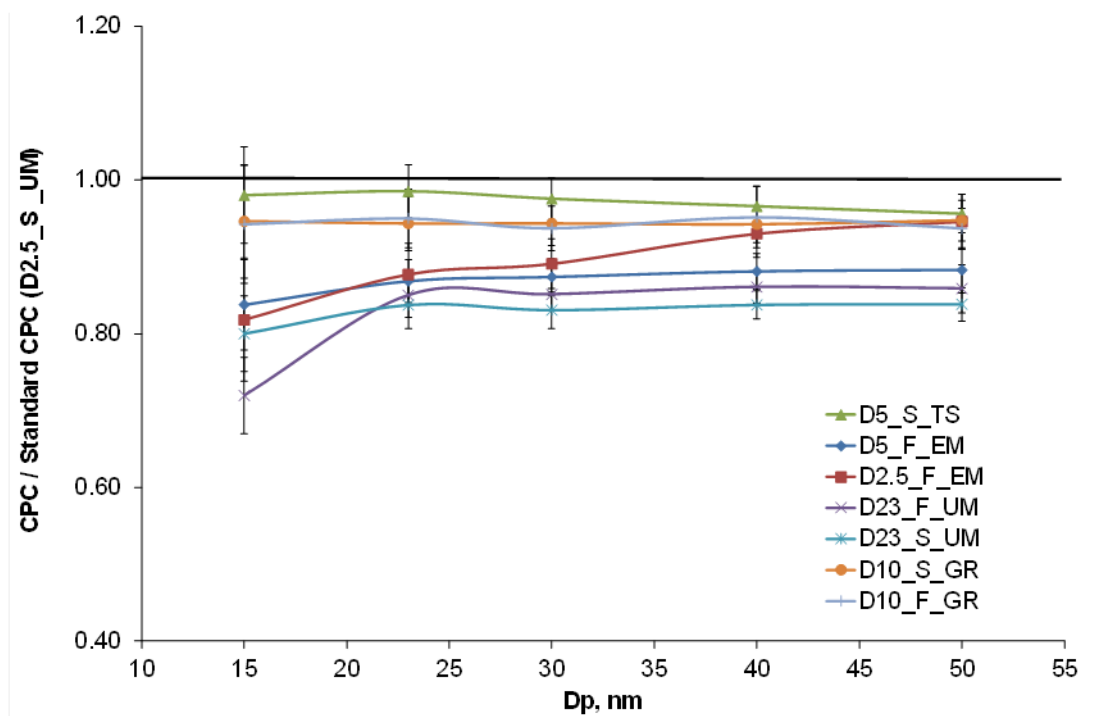

Figure 68 Comparative CPC data against size, normalised against calibrated TSI 3776 ($d_{50}=2.5\text{nm}$)

As can be seen there is a wide drift in data collected for the range of 8 analysers required to conduct the SR Technics test campaign. As would be expected due to the higher cut point the Grimm ($d_{50}=10\text{nm}$) analysers show a 5% lower counting efficiency across the entire size range, however the two Grimm analysers show excellent agreement with each other. It is also observed that the TSI 3775 ($d_{50}=5\text{nm}$) supplied by TSI showed excellent agreement across the size range also. The TSI 3010 (operated with altered temperature gradient to give a $d_{50}=23\text{nm}$) as expected witness the lowest counted values owing to their reduced counting efficiency brought about due to their higher cut point. Most surprisingly was the offset of EMPA's TSI 3776 ($d_{50}=2.5\text{nm}$) which should have give excellent agreement with the normalised CPC, however, on further investigation it was noted that this CPC had not been calibrated for 18 months hence the drift.

Due to this study being conducted it was now possible to use all of the CPC's and by correcting for the offset against the normalisation CPC, give real comparative data for the different sampling lines.

6.2.2 LII laboratory inter-comparison

There were three Artium LII-300 analysers used during the test campaign at SR Technics owned by NRC, Rolls-Royce and Honeywell. To ensure these analysers could be compared to one and other at different locations on a sampling line or on separate sampling lines they were normalised against each other in the laboratory. A schematic of the setup used to compare the LII instruments is given below (Figure 69).

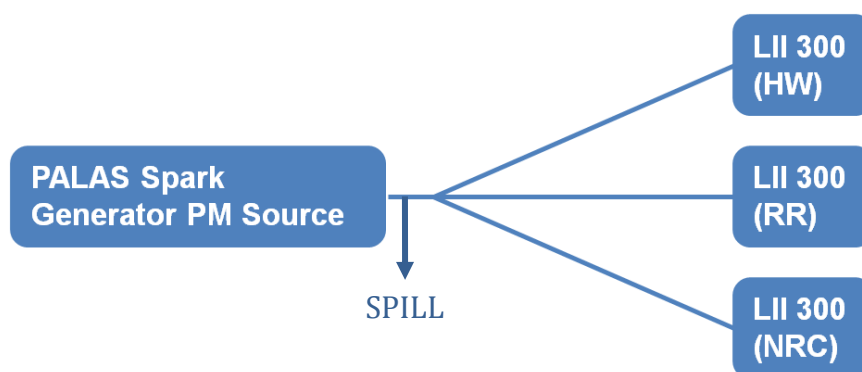

Figure 69 Schematic representation of setup used to compare non-volatile mass instruments

As can be seen a Palas Spark Generator was used to generate the black carbon PM source and by running this at various spark rates and gas flow rates different concentrations of PM mass could be distributed to the three analysers so they were each measuring from the same source simultaneously. A three way splitter was used for this study the design of which is described earlier, (section 5.2.8) and the analysers moved to different arms to ensure any offset was not as a function of the splitter.

To conduct the comparison five experiments were conducted at two different flow rates. This data is given below in Table 15. As can be seen there are large discrepancies between the 3 analysers with the largest offset being to the NRC LII-300. Unfortunately it was determined that the NPL approved blackbody used for the initial calibration of the Rolls Royce and Honeywell LII instruments had an incorrect factor applied hence the large discrepancy to the newly calibrated NRC LII instrument which had been calibrated on a traceable blackbody.

As such both the Rolls Royce and Honeywell analysers were normalised against the NRC LII to allow inter comparison to be conducted



Table 15 Laboratory normalisation data study for 3 LII instruments

Test Number	Flow rate (LPM)	LII (Rolls Royce)	LII (Honeywell)	LII (NRC)	Norm. to NRC LII (Rolls Royce)	Norm. to NRC LII (Honeywell)
1	4.5	364	331	187	1.947	1.770
2	4.5	393	348	200	1.965	1.740
3	10	278	245	139	2.000	1.763
4	10	277	248	143	1.937	1.734
5	10	293	259	146	2.007	1.774
Average normalisation factor					1.971	1.756

To ensure these normalisation factors were correct, a further experimental series of 3 experiments was investigated with the analysers being moved to different splitter arms for each repeat to remove splitter variation from the study. A table showing the offsets between the three analysers with the predetermined correction factors added is given below in Table 16.

Table 16 LII Laboratory comparison study data

Test Number	LII 300 (RR) ($\mu\text{g}/\text{m}^3$)	LII 300 (HW) ($\mu\text{g}/\text{m}^3$)	LII 300 (NRC) ($\mu\text{g}/\text{m}^3$)	
6	375	378	380	
7	380	374	379	
8	373	366	376	Mean value (9 points)
Average reading for three repeats	376	373	378	375.66
Difference from Mean value	0.1%	-0.7%	0.6%	

As can be seen that with the correction factors added from the preliminary laboratory study the analysers each read within 1% of the mean of the data taken from all of the analysers showing that the uncertainty in comparative data taken with these analysers is within 1% of the mean, which gives confidence that data taken between these analysers can be compared with a good degree of confidence.

Unfortunately during large scale engine testing the NRC LII positioned on the gantry sustained a catastrophic failure of the high voltage circuit board. As such this component had to be replaced mid test leading to there being a question over this analysers calibration. As such after the test campaign a new factor was determined for this analyser so comparative data from the gantry and raw sample lines should be treated with caution. However, as this failure did not affect either the Rolls Royce or Honeywell instruments then comparisons between these analysers during the test campaign are still valid.

6.2.3 Size Instrument laboratory inter-comparison

To allow comparisons to be made between the size analysers, particularly the 3 DMS-500 units used for the test campaign a laboratory study was conducted on the 3 types of size analysers to be inter-compared on the engine exhaust.

A schematic of one of the setups employed for laboratory size comparison is given below (Figure 70).

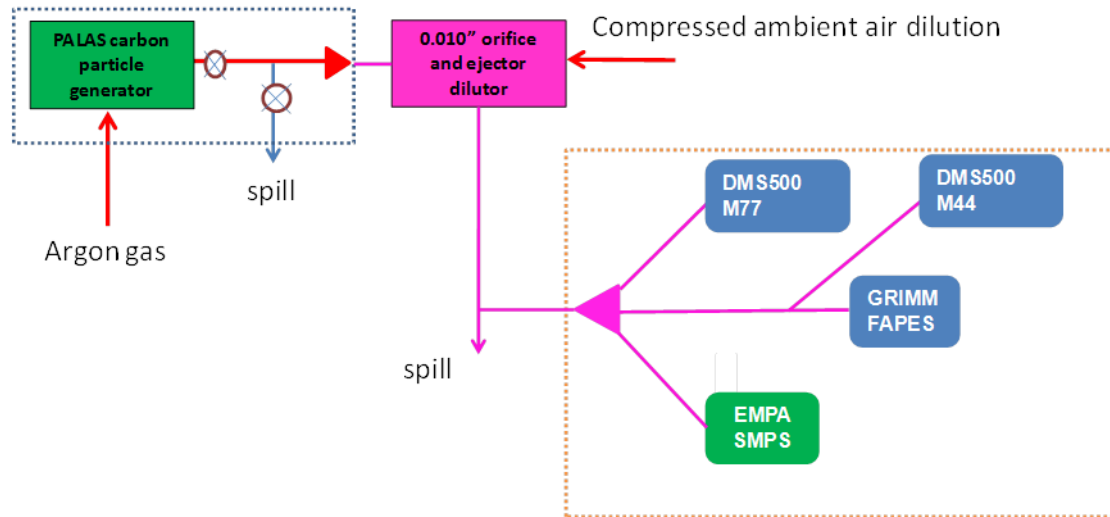

Figure 70 Schematic representation of laboratory setup for comparative data of size instruments

A typical plot of the comparative size distribution is given below in Figure 71. As can be seen there appears to be best agreement between the two DMS instruments which show a higher concentration but similar mean diameter to SMPS. The FAPES is closer to the DMS in terms of concentrations but shows a higher mean diameter than both the DMS and SMPS.

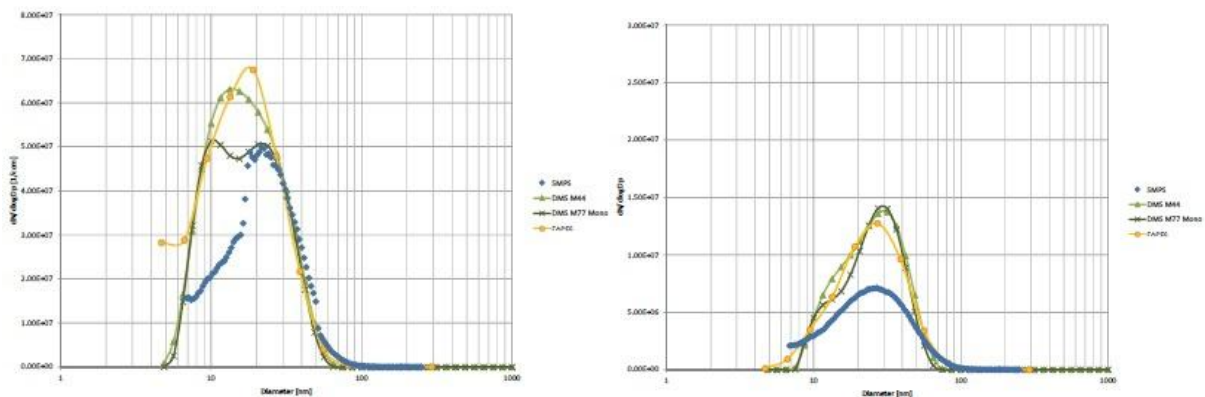

Figure 71 Comparative size distributions at two PM concentrations in laboratory testing

As can be seen, there appears to be good agreement between the 3 instruments with excellent agreement shown between the DMS-500 (MKII modified M44) and the FAPES, the SMPS also gives a similar mono-modal peak however, probably due to an inversion fitting issue the M77 DMS always displays a bi-modal structure. Due to the relatively high number concentrations, the SMPS was operating in the vicinity of the single to photometric measurement mode change. This mode switch can clearly be observed in the left chart of Figure 71 where the SMPS distribution concentration dramatically increases at 17nm as the



CPC measurement mode switches from single to photometric mode. However, it can be seen in the right chart of Figure 71, that there is poor agreement between the SMPS and other analysers when investigating a lower concentration condition even when the SMPS mode is continuously in single count mode. Any size inter-comparison between analysers is difficult and should be treated with caution, due to unknown traceable uncertainties.

6.3 Line inter-comparison experiment

6.3.1 Non Volatile PM Mass

Data showing non-volatile mass concentrations obtained using the LII instrumentation on both the SAMPLE III and FOCA sampling lines for the four dedicated power curves (with engine conditions corresponding to Low, Medium-Low, Medium-High and High PM) is shown in Figure 72. Data has been corrected for dilution. Columns represent averaged 1Hz data points from time periods selected between SN filter acquired data. This was due to the filter solenoid bypass valve switching causing concentration fluctuations in both lines. Each column corresponds to approximately 5 minutes at a particular engine condition. Data obtained on a single engine condition is reasonably repeatable with drift (up or down) within 10%. Except for the High PM condition where the drift increased up to 21%. In all cases the SAMPLE III columns (red) have higher non-volatile mass concentrations indicating better penetration for the SAMPLE III system compared to the FOCA system.

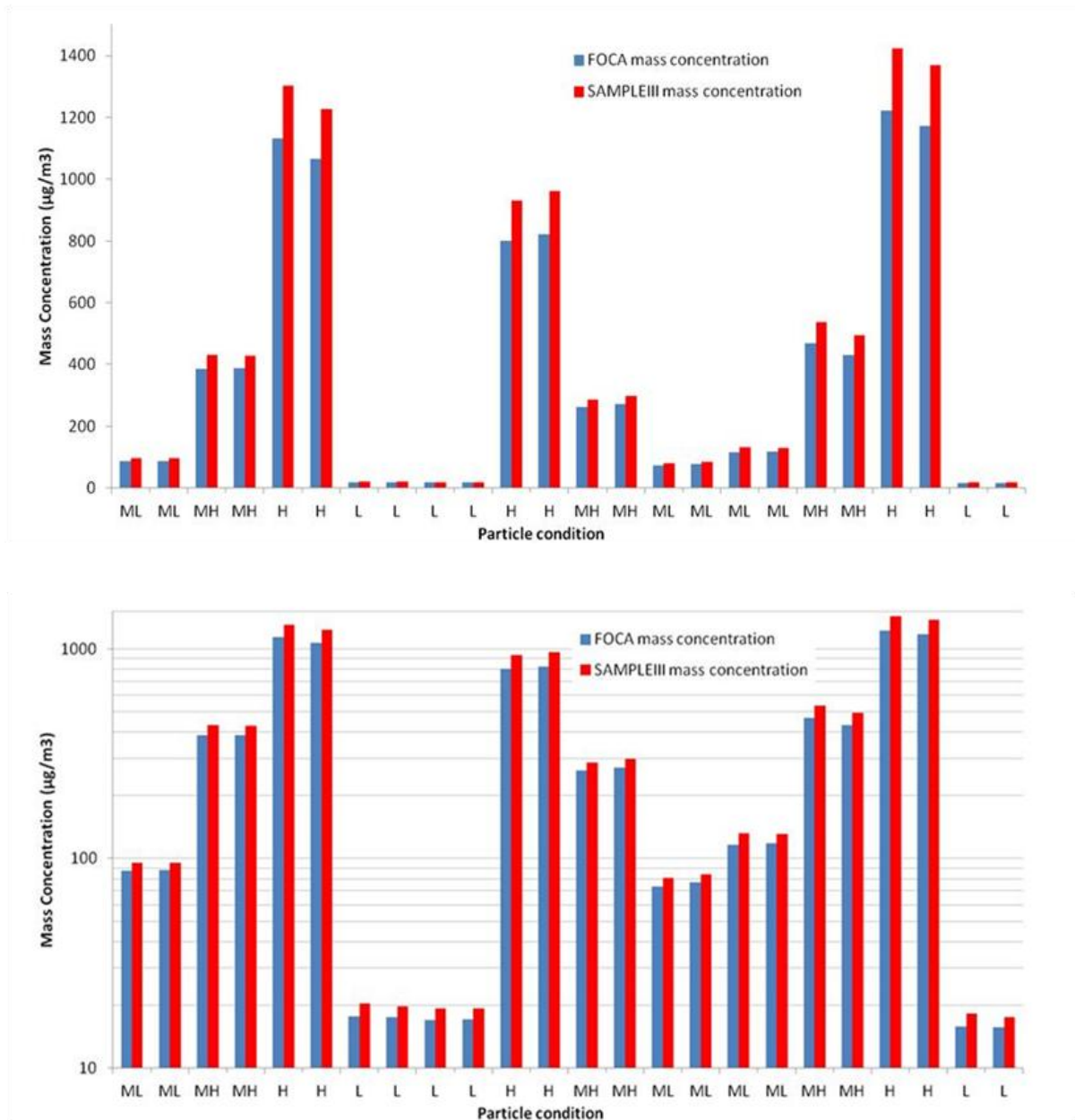

Figure 72 Linear and Log scale graphs of Non-volatile PM mass data from LII comparing SAMPLE III and FOCA sampling lines at different PM loading conditions on dedicated engine test

The increased penetration in the SAMPLE III system is clearly illustrated in Figure 73. The line comparison data reduces to a linear-fit with significant correlation (all data is <3% from line of best fit). The increased penetration for non-volatile PM mass is 15% for the SAMPLE III line compared to the FOCA line.

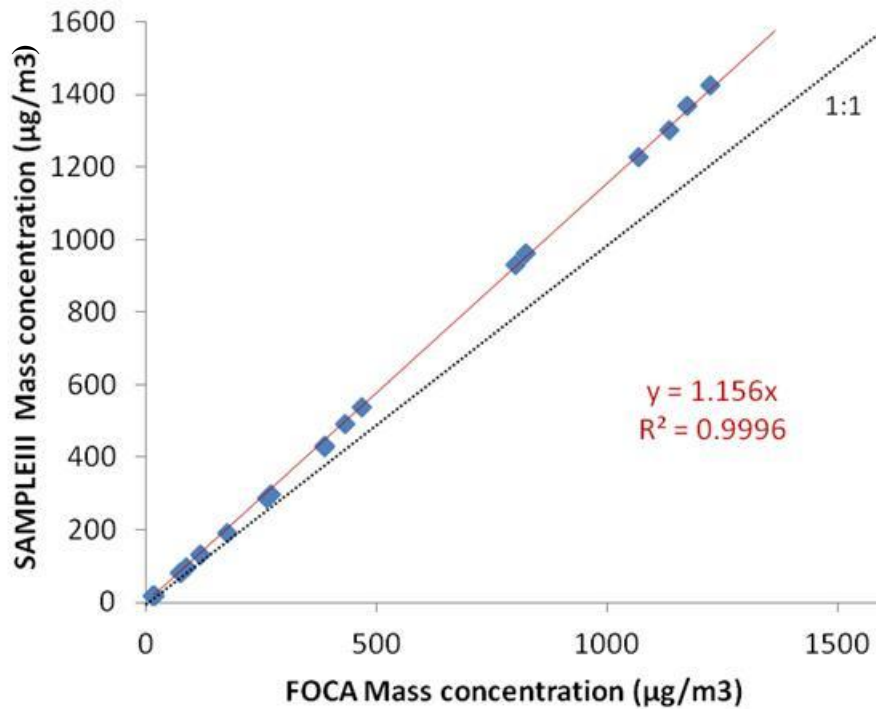

Figure 73 Comparison graph of non-volatile PM mass data from LII showing relative penetration of SAMPLE III and FOCA PM sampling lines for all PM loading concentrations

6.3.1 Non Volatile PM Number

Data showing non-volatile number concentrations obtained using the three CPC instrumentation on both the SAMPLE III and FOCA sampling lines for the four dedicated power curves (with engine conditions corresponding to Low, Medium-Low, Medium-High and High PM) is shown in Figure 74. Data has been corrected for dilution. Columns represent averaged 1Hz data points from time periods selected between SN filter acquired data. This was due to the filter solenoid bypass valve switching causing concentration fluctuations in both lines. Each column corresponds to approximately 5 minutes at a particular engine condition. Data obtained on a single engine condition is reasonably repeatable with drift (up or down) within 10%. Except for the High PM condition where the drift increased up to 16%. In all cases the SAMPLE III columns (red, pink and grey) have higher non-volatile number concentrations indicating better penetration for the SAMPLE III system compared to the FOCA system (blue, pale blue and black). Further discussion is provided later (section 6.4.1) on the lower CPC cut point. However, the data shown here clearly shows the inadequacy of utilising a PMP type ($d_{50} = 23\text{nm}$ $d_{90} = 41\text{nm}$) cut point for this particular engine type. With this type of CPC significantly under reading the other lower cut point CPC's.

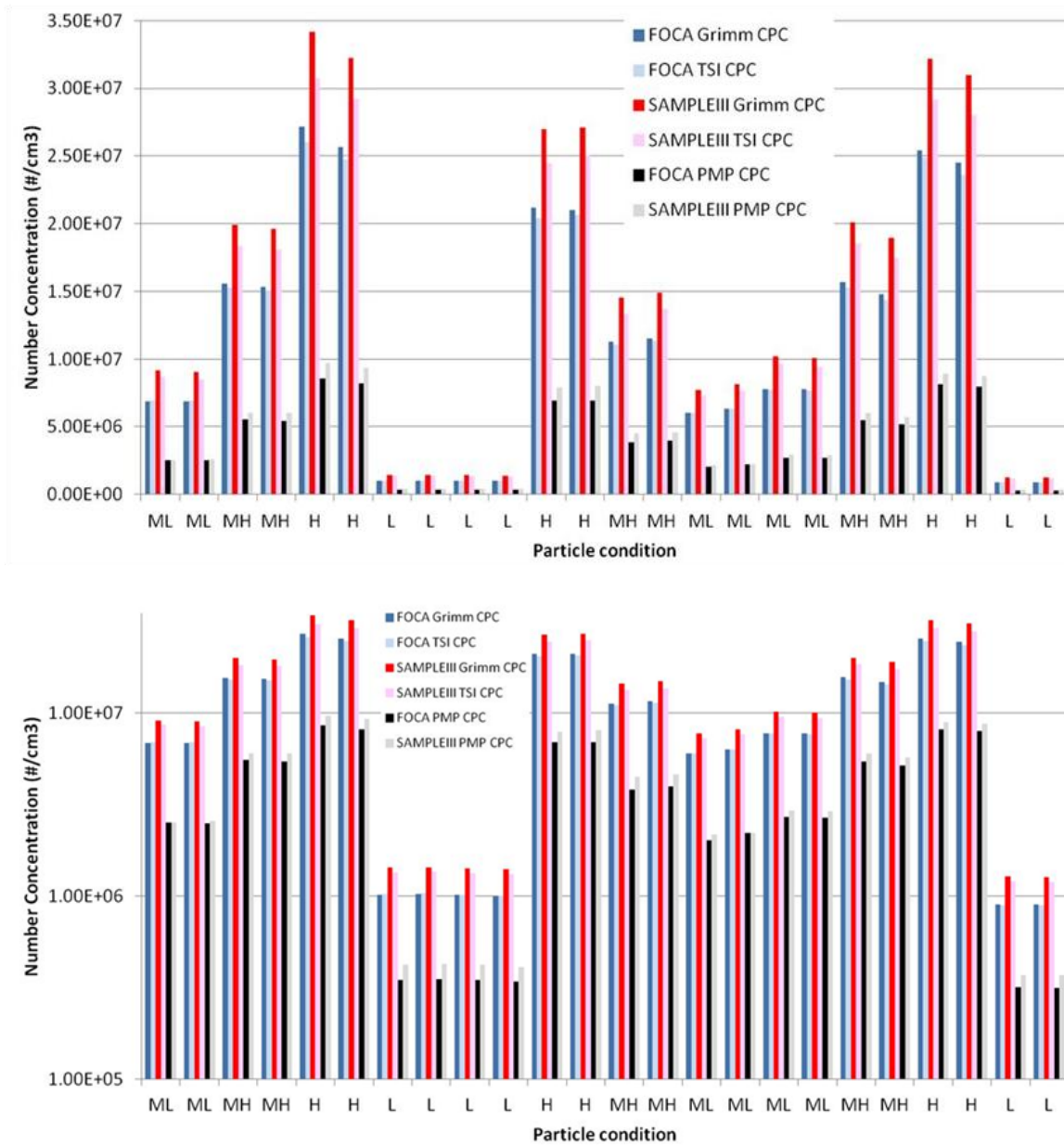

Figure 74 Linear and Log scale graphs of Non-volatile PM number data from various cut-point CPC's (d_{50} : Grimm 10nm, TSI 5nm, PMP 23nm) comparing SAMPLE III and FOCA sampling lines at different PM loading conditions on dedicated engine test

The increased penetration in the SAMPLE III system is clearly illustrated in Figure 74. In all CPC cases, the line comparison data reduces to a linear-fit with significant correlation (all data is <3% from fit for the lower cut point CPC's and <6% from fit for PMP type CPC). For the pair of Grimm CPC's the increased penetration for non-volatile PM number is 19.5% for the SAMPLE III line compared to the FOCA line. For the pair of Grimm 4.385 CPC's the increased penetration for non-volatile PM number is 19.5%. For the pair of TSI 3775 CPC's the increased penetration for non-volatile PM number is 27%. For the pair of PMP type CPC's the increased penetration for non-volatile PM number is 12%. This lower increase in penetration for the PMP type CPC indicates that a significant proportion of the difference in line penetrations appears to be due to diffusion rather than thermophoretic loss.

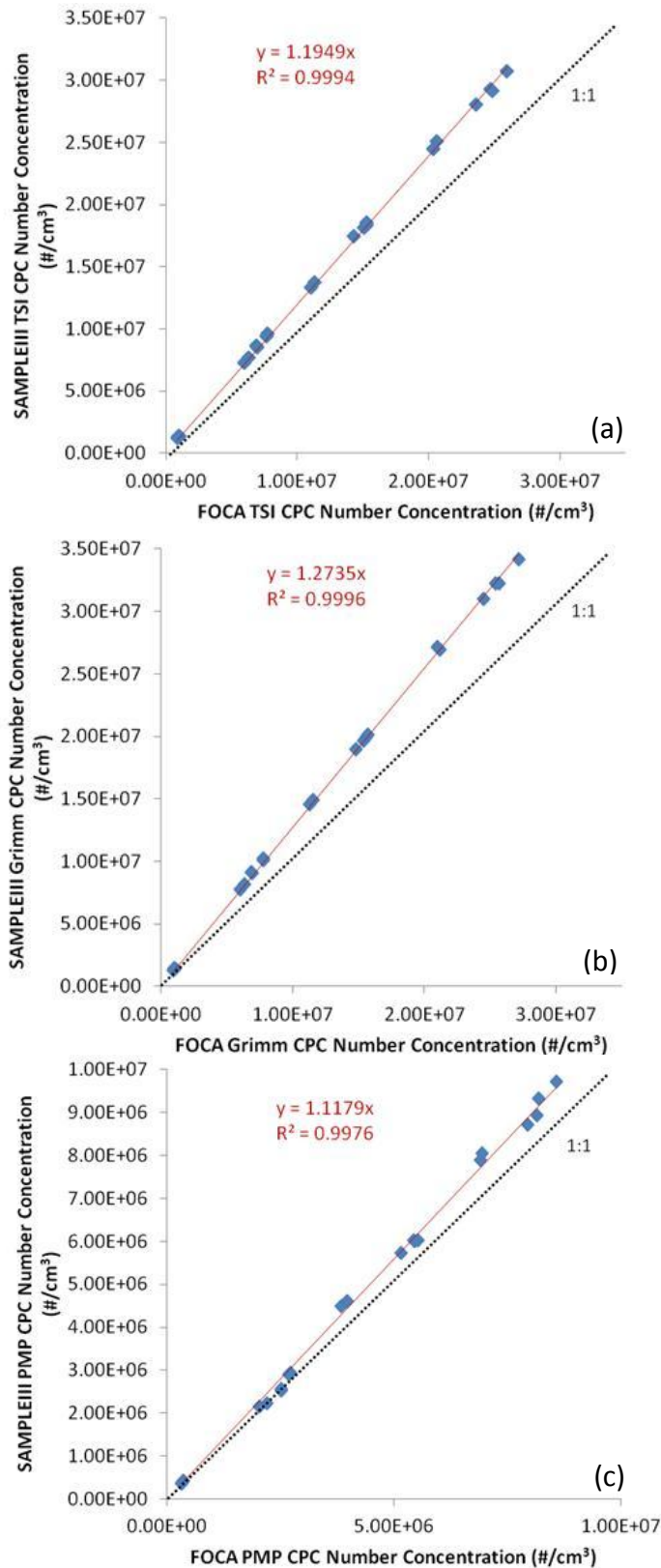

Figure 75 (a,b&c) Comparison graph of non volatile PM number data from TSI ($d_{50}=5\text{nm}$), Grimm ($d_{50}=10\text{nm}$) & PMP ($d_{50}=23\text{nm}$) CPC's showing relative penetration of SAMPLE III and FOCA PM sampling lines for all PM loading conditions



The total number concentrations from the size distributions measured on both sampling lines from the two DMS' upstream of the volatile particle remover are shown below in Figure 76.

It should be noted that number concentrations are significantly higher (almost double) than the lower cut point CPC's even though the DMS range starts at 5nm. This is because of the additional particle losses within the volatile particle remover (and conductive silicon tubing) plus there may be some volatile content in the DMS measurement. The red linear fit correlates the data taken on the first two power curves (Up, Down), and shows a similar trend to the CPC comparisons above. The increased penetration for non-volatile PM number on the SAMPLE III line is 18%. In order to eradicate any instrument bias, the DMS' were switched lines for the final two power curves (Down, down). The data for the same instrument is shown on the same figure axes, thus the green line shows the penetration shift on the opposite side of the 1:1 line. The switched penetration is 11%, thus indicating a DMS instrument bias of 7% but still the SAMPLE III line has a higher penetration of 10% according to the DMS instrumentation.

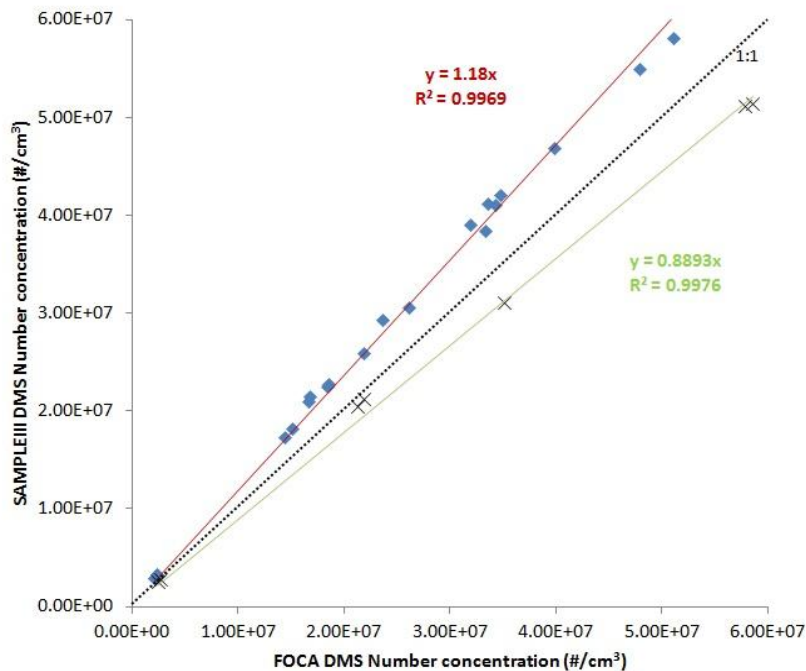

Figure 76 DMS number concentration showing relative penetration of SAMPLE III and FOCA PM sampling lines for all PM loading conditions. The red line (diamonds) signifies the Up, Down power curves, the green line (crosses) the Down, Down curves with the DMSs' switching sampling lines.

All the above number concentration data shows excellent repeatability for averaged data. Figure 77 shows all the 1Hz 'ramp' data for the pair of Grimm CPC's. Though the scatter is much higher than previous graphs, it can be observed that the linear fit still has a similar slope (22 versus 19.5) to that of averaged data. This indicates why the above measurement data is so repeatable. And that lower averaged periods (for example 30 seconds or 1 minute) of raw data ought to provide high quality repeatable datasets.

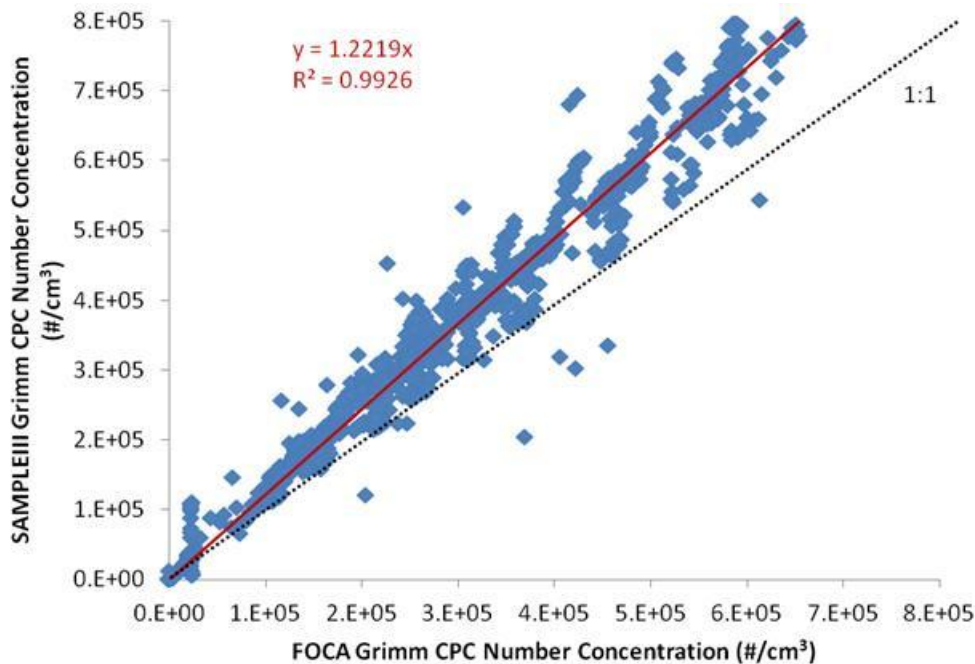

Figure 77 Comparison graph of non-volatile PM number data from Grimm ($d_{50}=10\text{nmCPC}$'s showing relative penetration of SAMPLE III and FOCA PM sampling lines for all data during the original power ramp corrected for primary dilution ratio only

6.3.1 Dilution ratio sensitivity

The inlet pressure measurements for both sampling systems for the 'ramp' power curve (Figure 59) are shown below in Figure 78. The SAMPLE III system utilises a differential pressure transducer across the diluter inlet and vent. Whereas the FOCA system utilises an absolute pressure transducer to measure the pressure at the diluter inlet. It can be observed that unsurprisingly the two curves shapes match up very well, with pressure fluctuations occurring at the same time and of similar magnitude. The overall pressure ranges are slightly different with the SAMPLE III system encountering $\sim 35\text{mbar}$ across the engine conditions, whereas the FOCA system encountered $\sim 75\text{mbar}$. The reason behind this is because the absolute pressure drops in the test cell as engine conditions increase, thus the FOCA pressure transducer measures a larger range. However, the FOCA diluter will still behave according to a 35mbar range as the FOCA diluter vent absolute pressure will also change with engine condition. It can be observed at approximately 10:55 the curves become flatter. Prior to this point there is a vacuum observed at the sample systems inlet, however, after this point both spill valves are open on the two systems with control valves operating to ensure the inlet pressure is as stable as possible.

Beneath the inlet pressure graph it is observed that the dilution ratio (predictably) varies with inlet pressure. As the inlet pressure increases the dilution ratio decreases. However, it can be observed that there is a discrepancy between the systems with the SAMPLE III system having a higher dilution ratio than the FOCA system. However, the difference narrows halfway through the power curve and they gradually approach each other until they are



virtually identical at Take-off conditions. The large spike observed on the SAMPLE III is a 15s transition as the control valve spill is opened.

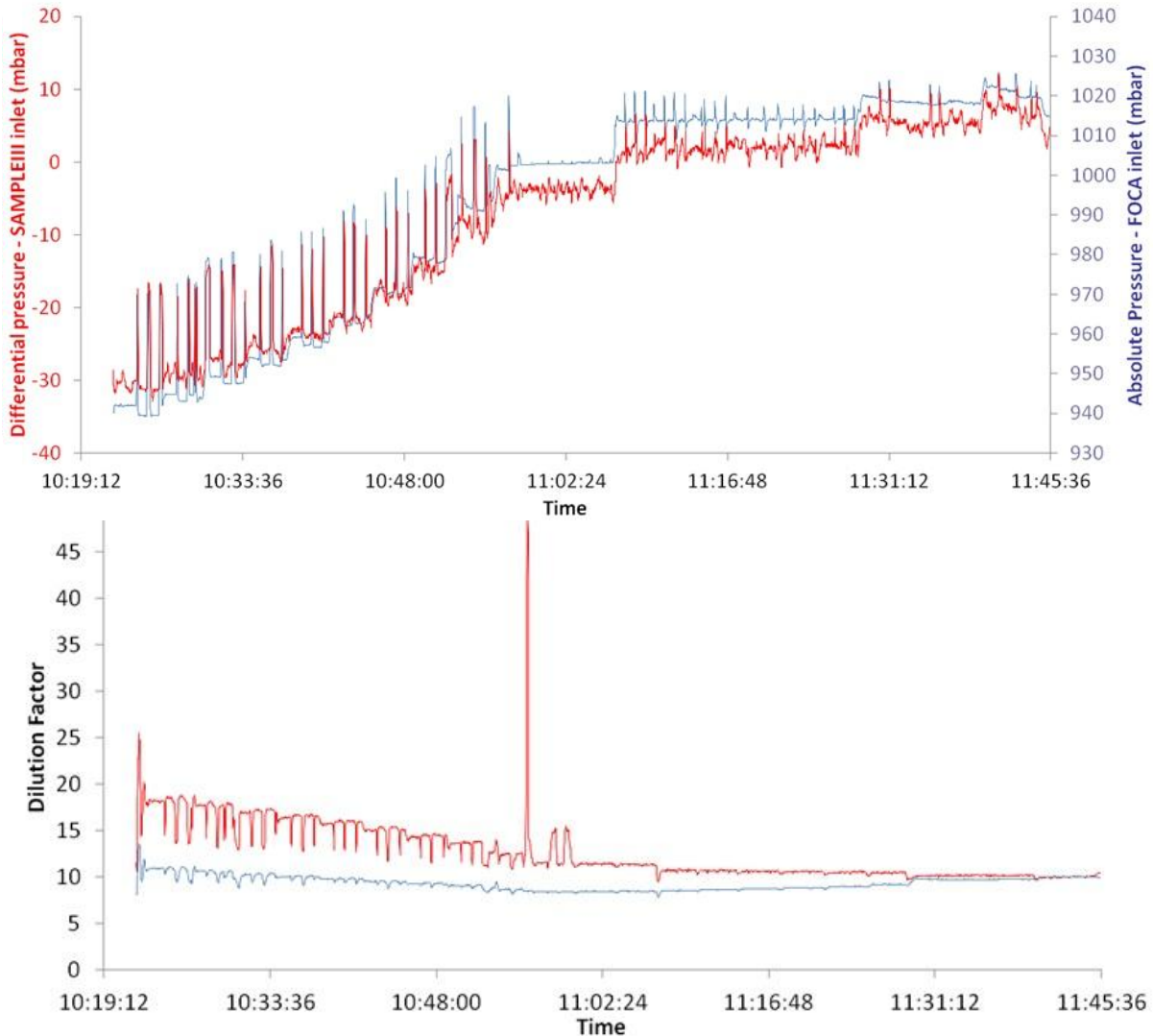

Figure 78 Graphs showing how the inlet pressures (top) and dilution factors (bottom) of both sampling systems varied across the ‘ramp’ power curve. Engine power increases with time (as shown in Figure 59)

Figure 79 shows the effect the control system possessed on attempting to maintain a constant dilution factor. It can be observed that at the beginning of the power curve the SAMPLE III spill valve is closed (so is the FOCA spill valve). The orange section notes the combustor staging in the engine curve where both mass and number reduce dramatically. A few minutes after this staging point the SAMPLE III spill valve opens and the dilution ratio becomes flatter (i.e. under control). In addition, the same figure shows the impact of these system changes on the non-volatile mass concentrations. The ratio of the mass concentrations between both sampling systems resides at around 1:1 across all power conditions indicating no relationship between dilution ratio and mass concentration. However, it should be noted that the mass concentrations post the combustor staging point are very low and close to the limit of detection for the instrumentation. The seemingly regular spikes observed in both datasets relate directly to the Smoke Number filter measurement on the raw sampling system. When a measurement is obtained using the Smoke Number device, a solenoid ball valve switches and the flow is momentarily stopped (<1s) before either diverting through the filter

or through a bypass route. However, the pressure wave caused by this fluctuation impacts the inlet pressure on both dilutors especially when the inlet pressure is at vacuum conditions.

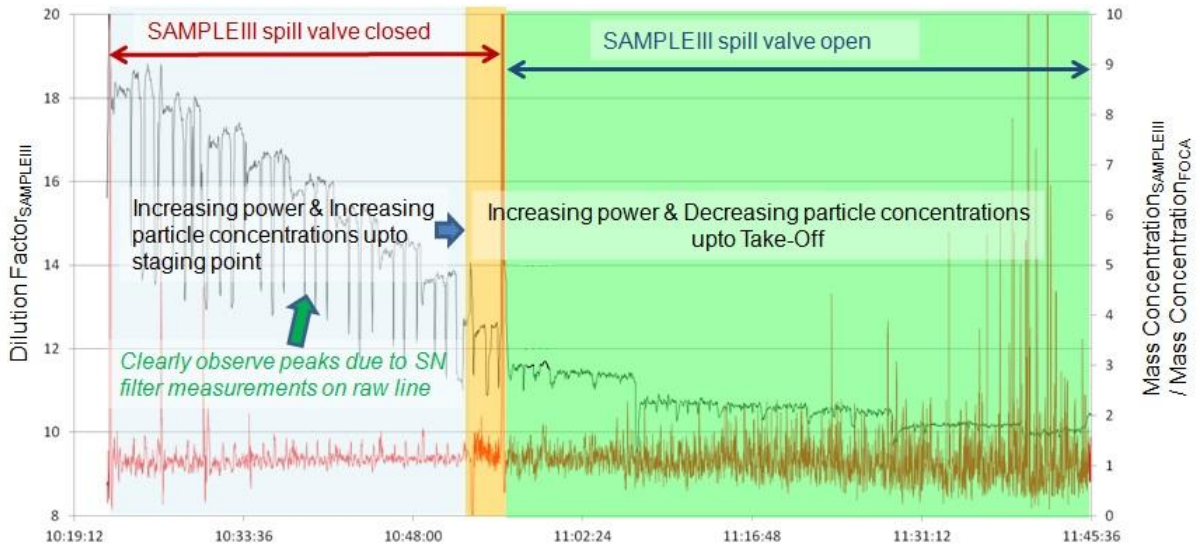

Figure 79 Diagram indicating SAMPLE III system control and engine power changes with Dilution Factor_{SAMPLE III} (black line). The red line shows the ratio between mass concentrations on the two systems.

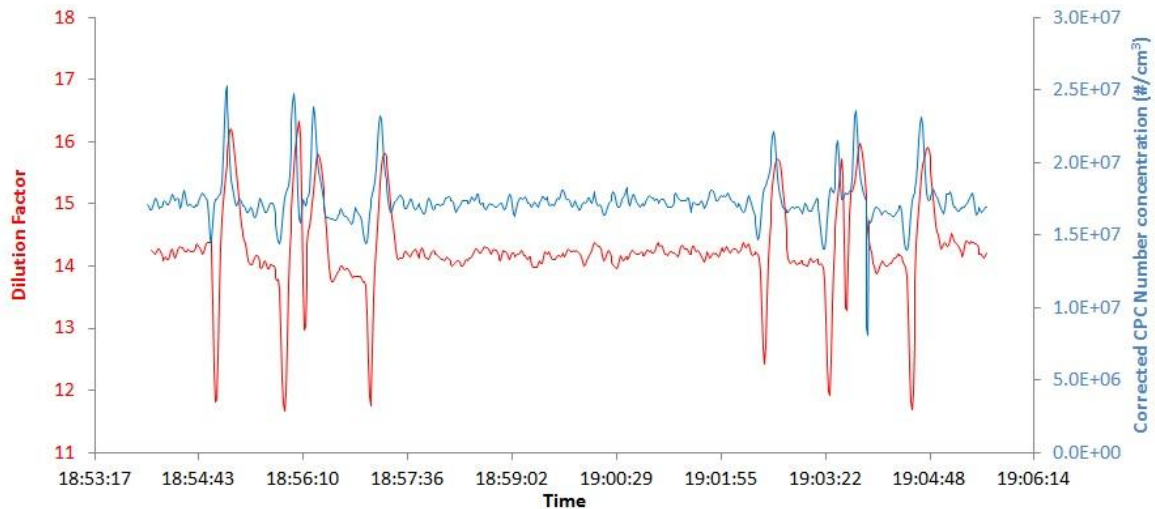

Figure 80 Dilution Ratio dependence on sample line penetration for non-volatile number

Focussing in on these pressure fluctuation spikes due to the SN filter, it can be observed in Figure 80 that predictably the dilution ratio is directly related and this also impacts the number concentration. The slight offset between the datasets is due to the longer sampling time to the CO₂ analysers and also slower response of the CO₂ analysers.

Plotting number concentration ratio between both sampling systems (using Grimm CPCs), versus dilution ratio is shown in Figure 81 for the whole power curve ramp. It can be observed that a potential relationship exists between the two variables. The majority of data is grouped together showing a small trend, however, during the large dilution spike described earlier that occurred during the switch between SAMPLE III spill valve opening, the data shows a clear relationship and is shown at the bottom of Figure 81. Analysis shows excellent



statistical agreement and a linear correlation. However, this analysis is performed on a small dataset and during a flow/pressure transition, causing it difficult to come towards a conclusion.

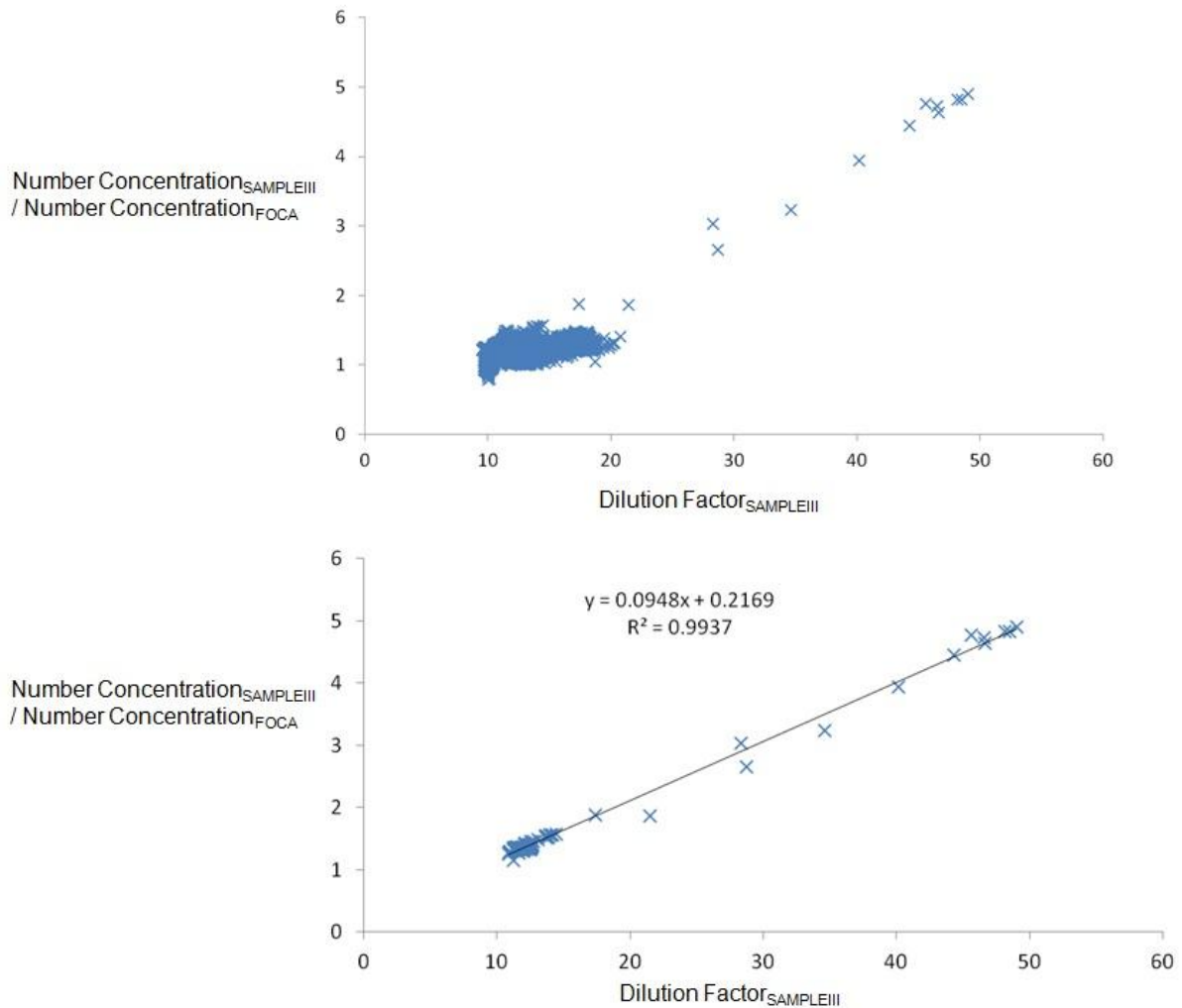

Figure 81 Observation of potential relationship between Dilution Factor and Number Concentration ratio between the SAMPLE III and FOCA systems. Top - All 'ramp' data is shown at the top, Bottom - dilution spike data (as seen in (Figure 78 bottom))

However, further evidence of this trend is observed when data analysis is restricted to when both systems are operating with their own spills and the dilution ratios are fairly flat (green shade in Figure 79). In Figure 82 the ratio of the non-volatile number concentration is clearly related to the dilution ratio. As dilution ratio increases the penetration on the SAMPLE III system also increase. Importantly when both systems are operating under the same conditions (spills open, same dilution ratios) then both systems agree within 10%.

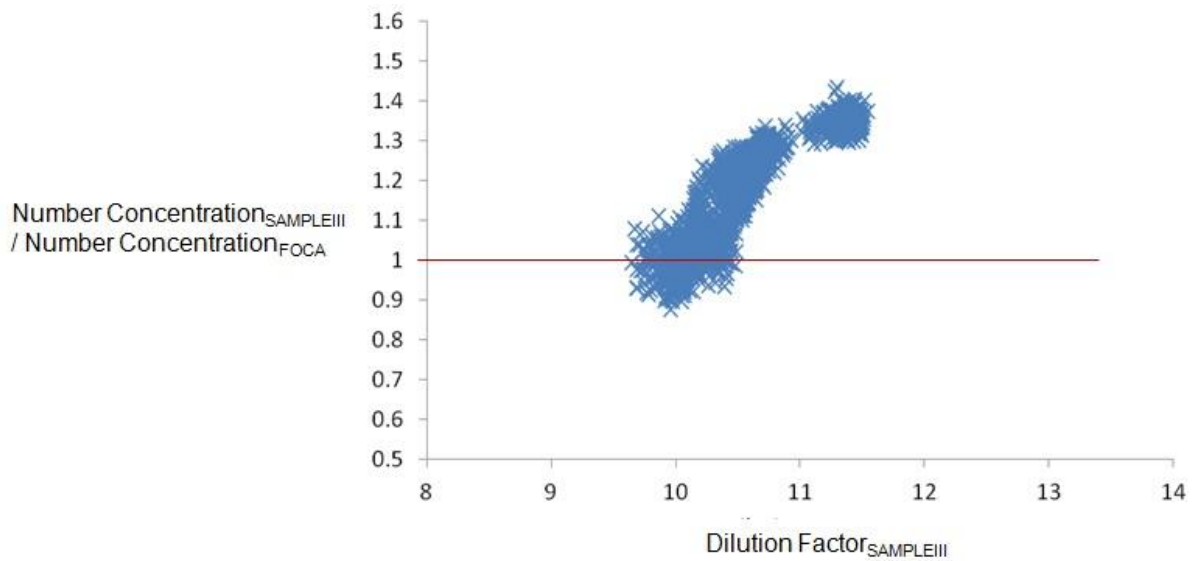

Figure 82 Plot of relationship between Dilution Factor_{SAMPLEIII} and Number concentration ratio between the two systems for data obtained when the SAMPLE III spill valve was OPEN (green shade Figure 79)

Following on the data analysis and relating the ratio of number concentrations to the ratio of dilutions ratios for the restricted dataset (green shade in Figure 79), a very obvious statistically linear correlation is observed and shown in Figure 83.

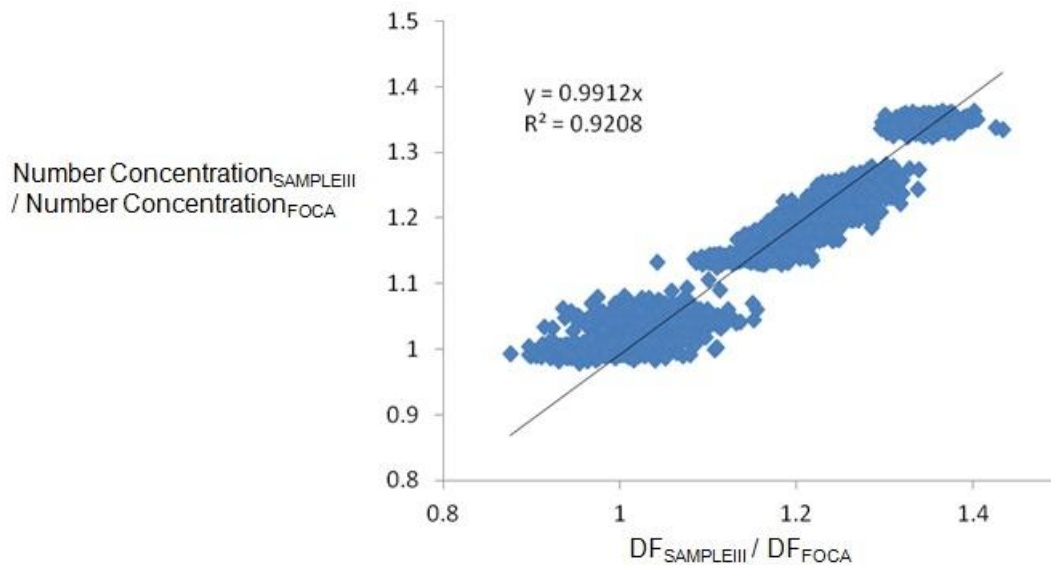

Figure 83 Plot showing clear linear relationship between Dilution Factor ratio and Number Concentration ratio.

Relating the same variables for mass concentration for same restricted dataset is shown in Figure 84. Here a relationship is not observed. However, the data is noisy, as previously described the mass concentrations for this period of the power curve are extremely low (<3ug/m³) and close limit of detection.

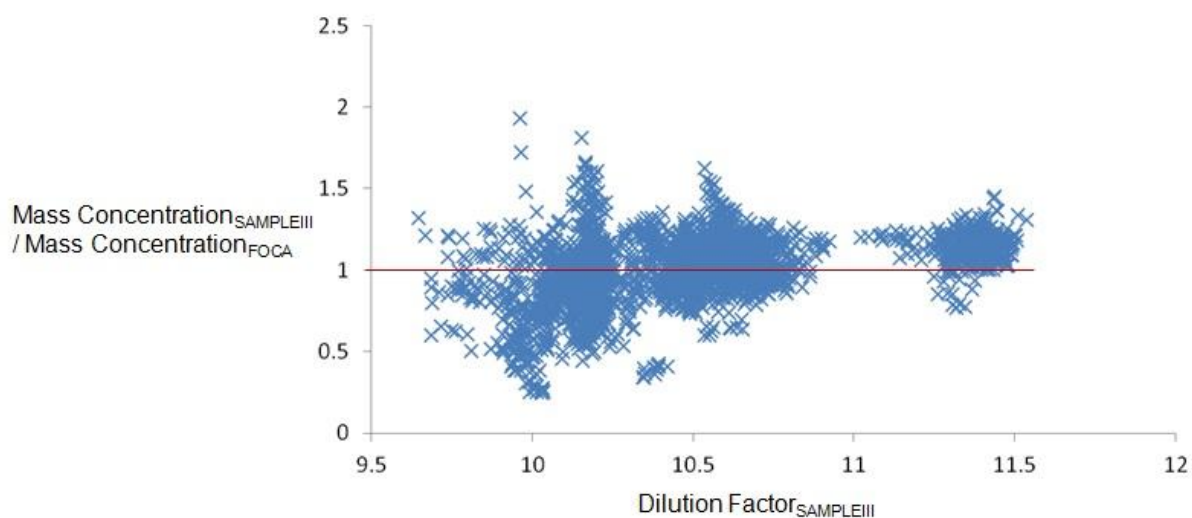

Figure 84 Plot showing constant mass concentration ratio versus Dilution Factor_{SAMPLE III}

The authors give possible reasons for this interdependence: (Note: that the cause may be due to multiple effects, or another currently unidentified effect)

1) *Different system geometry in 3PTS*

The flowrate and pressures show consistency across both lines for 4PTS and 5PTS. The only location where different pressures/flowrates are observed at 3PTS inlet. The only significant difference in geometry is at the inlet to 3PTS (splitter) and the cyclone inlet in 5PTS. But expectation is that the SAMPLE III splitter has a worse penetration than the FOCA splitter so the difference is in the wrong direction (i.e. the FOCA splitter should have better penetration). If geometry was having an impact it would be likely to have an impact on mass concentration as well as number. The dataset for mass concentration is, however, contestable due the very low concentrations measured at the higher engine powers. This is a fairly likely reason for the interdependence.

2) *System cleanliness*

Neither the diluter nor sample lines were cleaned prior to the test campaign (apart from gas purging). It is unlikely that cleanliness is having an effect as the penetration data was repeatable across a long testing period (several days).

3) *Non-linearity of CPCs*

A non-linearity of CPCs could be having an impact. However, both Grimm CPC's were traceably calibrated using the electrometer technique directly prior to the campaign and showed excellent comparison in the laboratory testing performed. So it is unlikely that this is the reason.

4) *Non-linearity of CO₂ analysers*

Both diluted CO₂ analysers were not quantitatively multi-point linearised prior to the test campaign and the NDIR technique is known to be non-linear. However, any impact on number would also be mirrored in the mass measurements however, as stated in (1) the mass dataset is contestable during the period of analysis. Therefore this is a likely reason.



5) *Eductor dilutor 'smashing' effect*

As the dilution ratio increases, the velocity gradient between the diluent and the sample also increases. This increased gradient could be causing the agglomerate particles to be 'smashed' apart creating more non-volatiles than are entering the diluter. Manufacturer datasets (PALAS) show that this is not the case when operating the dilutor at its specific operating point. However, data has not been published showing agreement or disagreement for dilution of high number concentrations of soot particles ($>1e^6$) in an eductor. This is a possible reason.

6) *Volatile condensation*

If volatile or organic material has a chance to condense on the non-volatile particles during the transition between 160°C and 60°C, then this could have an effect of scavenging particles. The variation in dilution ratio will change the residence time of the sample through the inlet of 3PTS to the tip of the dilutor venturi. If this effect is occurring, then it will vary with residence time and hence dilution ratio. However, in both systems the diluter interface geometry with the active 160°C heating (which is up to within 5 cm of the venturi inlet) are virtually identical indicating that this is an unlikely reason.

7) *Coagulation*

The existing theory of coagulation indicates that much higher (2 orders of magnitude) number concentrations and much longer residence times are required (days) before coagulation is encountered. It is unlikely that this is the reason.

6.4 Size methodology inter-comparison experiment

6.4.1 CPC lower cut point sensitivity

Data analysis was performed on the CPC's to investigate the impact of utilising the automotive PMP lower size cut point ($d_{50} = 23\text{nm}$ $d_{90} = 41\text{nm}$) and the proposed ARP draft working document ($d_{50} = 10\text{nm}$ $d_{90} = 15\text{nm}$). Figure 85 shows the inter-comparison between the two cut points for both sampling systems and for all four dedicated PM conditions. It can clearly be observed that the PMP type cut point under counts the proposed lower cut point by around 30% consistently on both sampling systems and across all PM conditions.

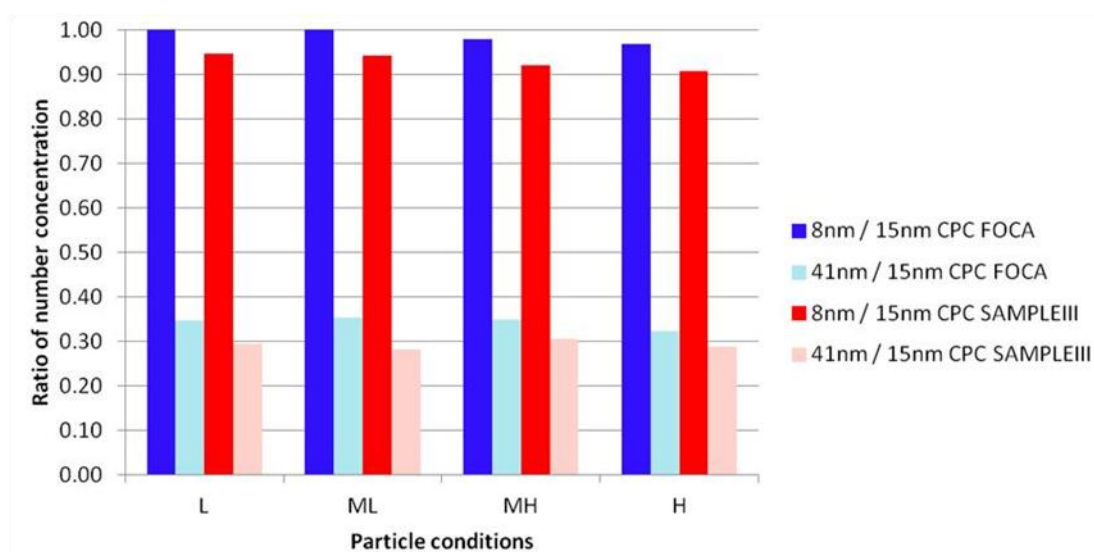

Figure 85 CPC inter comparison for different PM loadings normalised against the SAMPLE III TSI 3775 CPC ($d_{50}=5\text{nm}$ $d_{90}=8\text{nm}$) Other CPC's tested Grimm ($d_{50}=10\text{nm}$ $d_{90}=15\text{nm}$) & PMP ($d_{50}=23\text{nm}$ $d_{90}=41\text{nm}$)

This data is in contrast to data obtained during SAMPLE II for the large modern engine test campaign. Thus indicating that the engine/combustor type has an impact on the lower cut-point sensitivity and is not constant. SAMPLE II data was obtained utilising a PMP type cut point and TSI 3772 ($d_{50} = 10\text{nm}$ $d_{90} = 20\text{nm}$) CPCs (Figure 10). That dataset indicated only around 10 to 15% difference which is close to the measurement uncertainty.

6.4.2 Non-volatile PM Size SMPS

Particle size distributions were obtained for the first time behind a commercial catalytic stripper VPR on a gas turbine engine source. Nano-SMPS' were utilised in order to assess the penetration efficiency of non-volatile particulates through the entire sampling system (including VPR). The SMPS scanning range was set to 2.5- 60 nm. Particle size distributions for each of the dedicated engine curve power conditions are shown below for the FOCA system (Figure 86) and SAMPLE III system (Figure 87). The red and black lines equate to the d_{90} and d_{50} cut points for the PMP type CPC (solid) and proposed draft working document (dotted). It can be observed that the data between both systems is very similar. A significant proportion of the size distribution is below the PMP type cut points which explains why in

the CPC comparison a large difference was observed between the two types of cut point CPCs. However, on the other hand it can be seen that the proposed d_{90} lower cut point includes the vast majority (>98%) of the particles penetrating through the system to the CPC, and virtually all the particles penetrating the system are measured by the d_{50} lower cut point (10nm).

The particle size distributions concur with both the mass and number data, with mean particle sizes growing as the concentrations increase and then drops to a very low level after combustor staging (the black lines show $L_{1,2\&3}$ with very low distributions). It is also observed that even though the data at each power condition has averaged at least 4 size distribution samples, the data is still noisy and indicates the limitation of this technique for even relatively fast (several minutes) particle measurement.

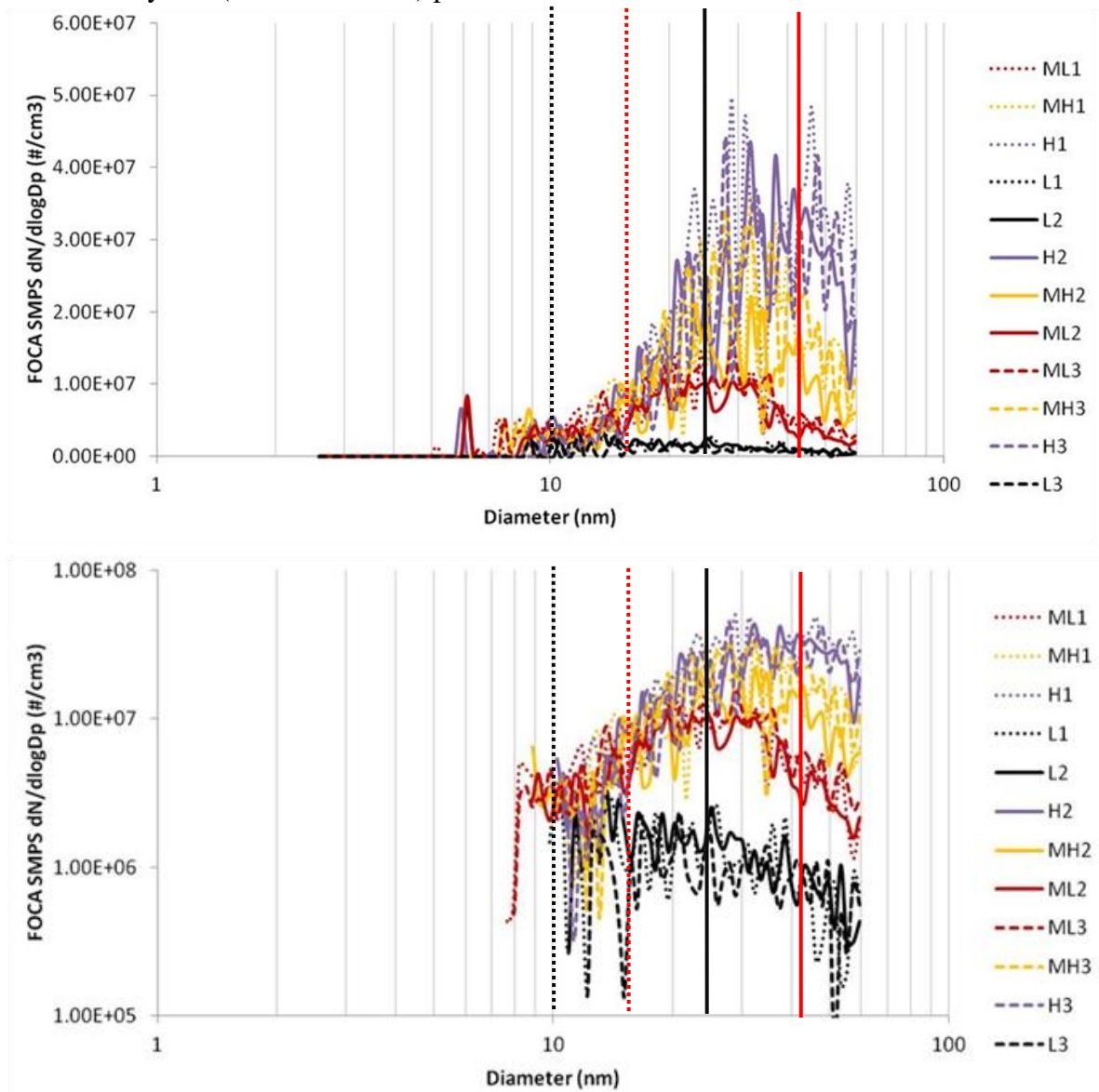

Figure 86 Linear and Log scale graphs of Non-volatile PM size distribution data from FOCA sampling line at different PM loading conditions on dedicated engine test with (proposed CPC black dashed line, $d_{50}= 10nm$, red dashed line, $d_{90}=15nm$, PMP CPC black solid line $d_{50}=23nm$, red solid line $d_{90}=41nm$)

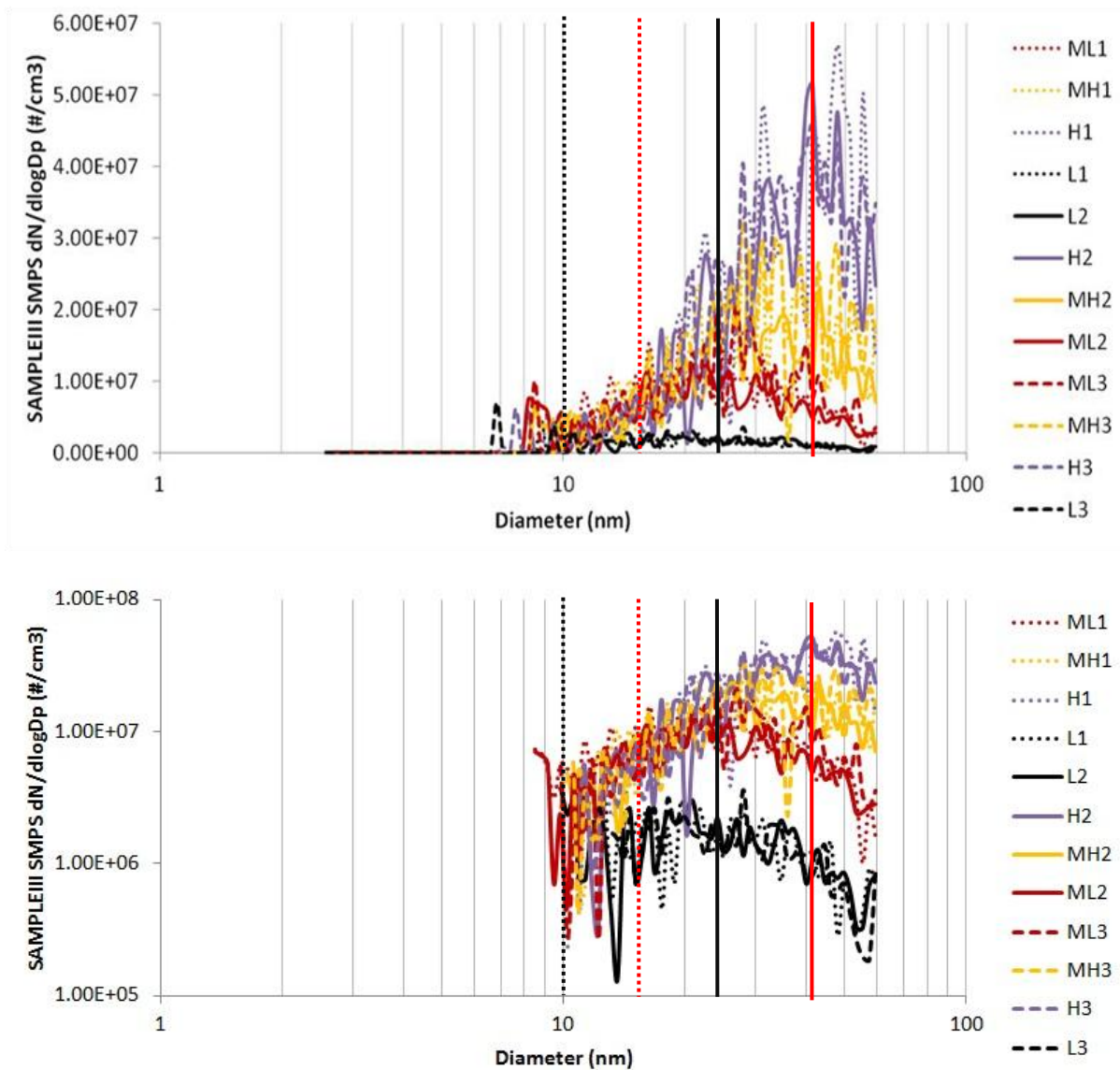

Figure 87 Linear and Log scale graphs of Non volatile PM size distribution data from SAMPLE III sampling line at different PM loading conditions on dedicated engine test (*proposed CPC black dashed line, $d_{50}=10\text{nm}$, red dashed line, $d_{90}=15\text{nm}$, PMP CPC black solid line $d_{50}=23\text{nm}$, red solid line $d_{90}=41\text{nm}$*)

6.4.3 SMPS, DMS & FAPES Inter-comparison

An inter-comparison of different particle size distribution techniques is shown below in Figure 88 for each dedicated engine power condition. Unfortunately data was only obtained with the DMS and SMPS-long for the L and MH power conditions due to an instrument malfunction. In all cases the geometric mean peak diameters agreed exceptionally well (<4nm difference) for all instrumentation. The absolute number concentration comparison agreed fairly well for the FAPES, DMS and nano-SMPS), however, the SMPS-long significantly under read the particle counts even though the CPC was normalised according to lab comparison experiment. It is unknown why this difference was observed especially with comparison to the same technique but different column (nano-SMPS).

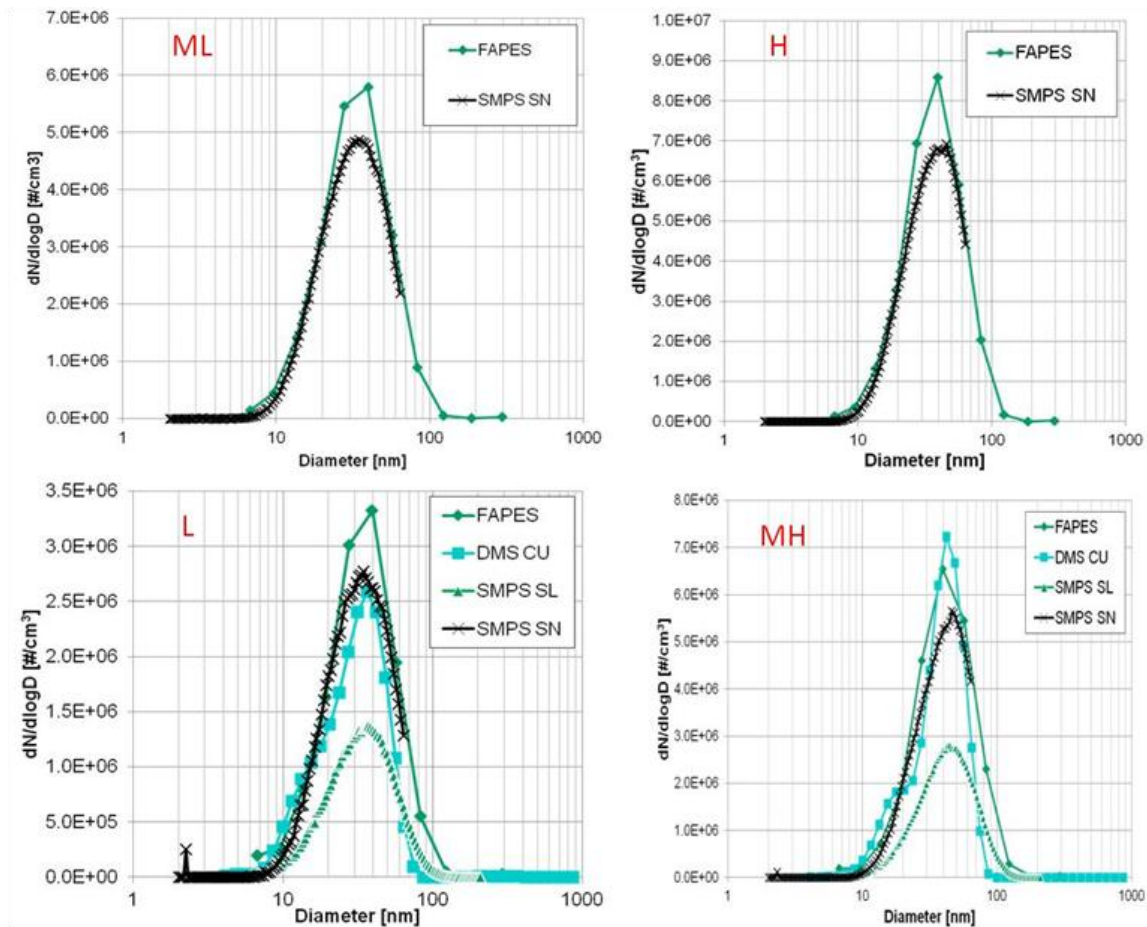

Figure 88 Size inter-comparison of SMPS (nano & long), DMS & FAPES conducted on dedicated engine on the SAMPLE III PM line

Further size methodology comparison experiments were carried out utilising piggyback engine testing. Figure 89 shows the data obtained for the size inter-comparison on the PW4000 engine. Data was gathered at a range of conditions from minimum idle through to take-off. With short steady-state periods (few minutes) the fast size analysers were suited for this type of analysis. It can be observed that at the engine conditions with higher particle concentrations, the FAPES and DMS agreed well in terms of peak concentration and geometric means (as seen Table 17). This replicated the conclusions obtained from the dedicated CFM56 engine testing. However, at lower number concentrations the FAPES had difficulty measuring the particle size distribution due to being close to its lower detection limit. The FAPES instrument has an in-built dilution of 40:1 to cool the sample for measurement, whereas the DMS is capable of measuring the sample hot through the measurement interior with zero dilution, thus has a wider operating range.

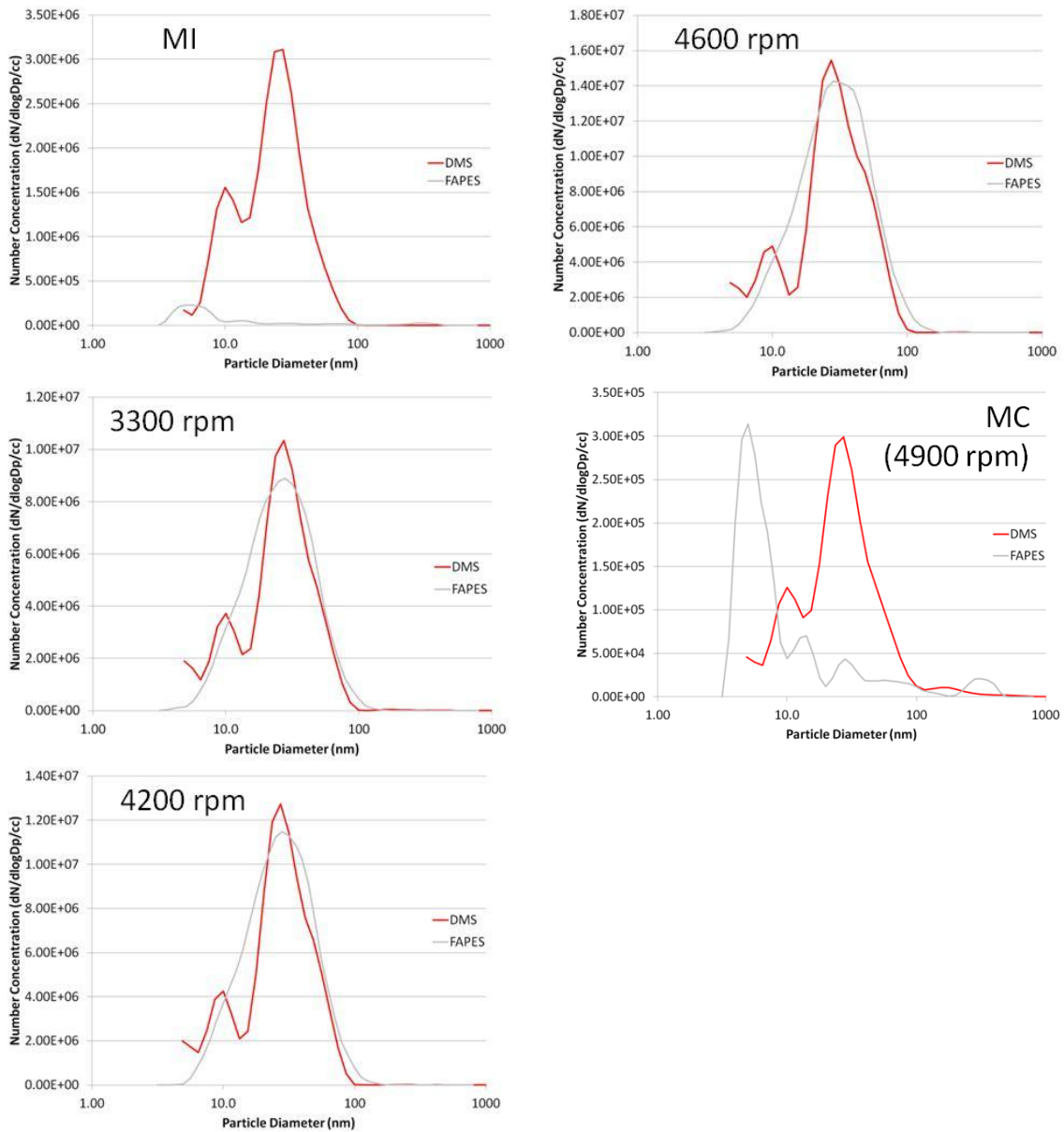

Figure 89 Fast Size analyser distributions FAPES and DMS at numerous power levels on ‘piggyback’ engine test

Table 17 Fast Size analyser inter-comparison FAPES and DMS at numerous power levels on ‘piggyback’ engine test

Engine condition (N1 RPM)	DMS Geometric mean (nm)	FAPES Geometric mean (nm)
MI	21.7	-
3300	24.0	27.5
4200	25.0	28.3
4600	26.0	31.0
MC (4900)	24.9	-

6.5 Catalytic Stripper efficiency experiment

The results of the catalytic stripper efficiency experiment are shown below in Figure 90 and Figure 91. The simultaneous filters taken upstream and downstream of the catalytic stripper are indicated by the red and blue bars respectively (schematic shown in Figure 56). The absolute elemental carbon concentrations are similar (within 2 standard deviations of the three filters) for each of the dedicated engine conditions. It should be noted that the downstream filters have been corrected for thermophoretic losses due to the drop in sample temperature from 350°C to 60°C. Analysis of the organic fraction in Figure 91 shows that within the uncertainty of the measurement (taking account of the filter blank) that zero organic carbon mass penetrates through the catalytic stripper.

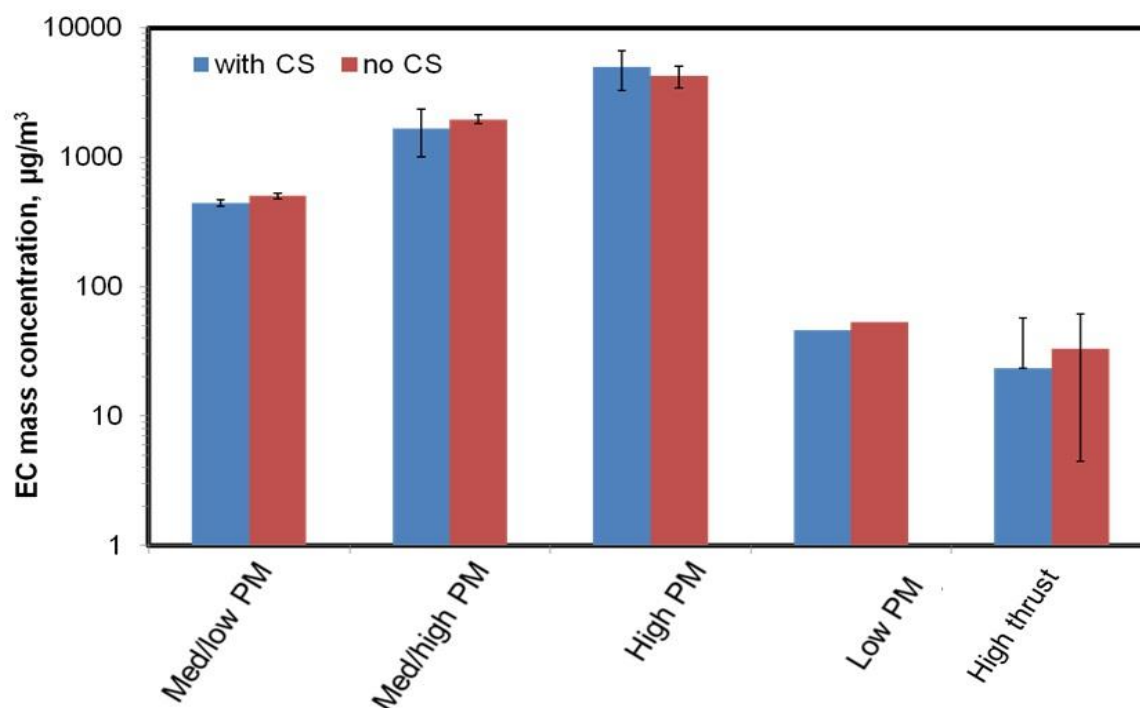

Figure 90 Elemental Carbon (EC) mass concentrations obtained simultaneously up and downstream of a catalytic stripper (CS). The error bars represent 1 standard deviation in relation to the 3 filters obtained at a single power condition

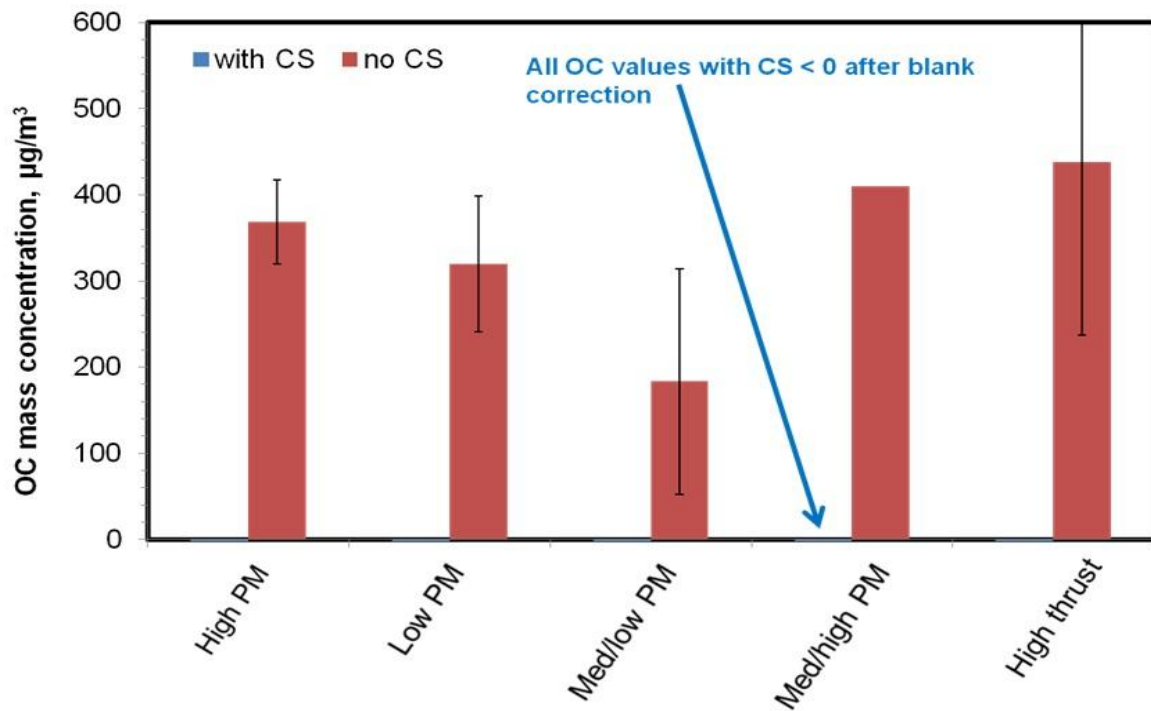

Figure 91 Organic Carbon (OC) mass concentrations obtained simultaneously up and downstream of a catalytic stripper (CS). The error bars represent 1 standard deviation in relation to the 3 filters obtained at a single power condition

Comparing the elemental to the organic mass fractions as shown below in Figure 92. It is observed that a wide range of EC to OC ratios is seen across the engine conditions. However, it should be noted that gaseous organic compounds are also likely to have been absorbed into the upstream quartz filter thus over reading the OC fraction. However, the gaseous unburned hydrocarbon data (Table 14) indicates relatively low concentrations (63ppm) at Low PM condition. But quantifying the difference in OC is difficult. Comparisons could be made with AMS data, however, as discussed earlier the AMS has a lower size limit of 40nm and is likely missing a proportion of OC mass from the small (20nm geometric mean) size distributions observed for this particular engine type.

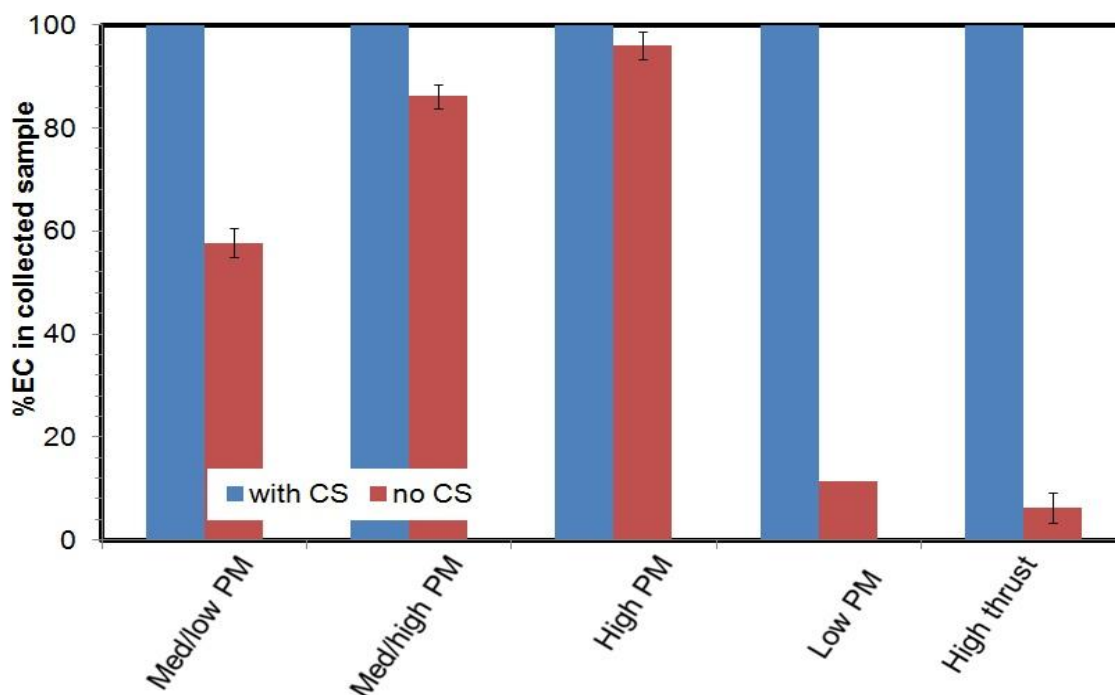

Figure 92 Ratio of Elemental to Organic carbon up and downstream of catalytic stripper. The error bars represent 1 standard deviation in relation to the 3 filters obtained at a single power condition

6.6 PM sampling system impact on organic PM

AMS data was obtained during the dedicated engine test at the four PM conditions. The instrument was switched between measuring on the raw (GTS) line and diluted FOCA sampling system.

Analysis shown below in Figure 93 shows the AMS measured organic PM data on both lines and in comparison to the LII measurement (elemental carbon) on the raw line. It is observed that the organic PM content on the diluted line is not insignificant and remain fairly constant across the engine conditions until dropping to limit-of-detection levels at the low PM staged condition. The organic PM content in the raw line is initially relatively equal at the ML condition and then increases with engine power until again dropping to limit-of-detection levels at the staged condition. This indicates that volatile PM material is penetrating through the diluted PM system. As the AMS only measures PM >40nm diameter then the organic mass contribution is likely to be higher.

The ratio of organic PM to elemental PM on the raw line remains fairly constant at 10% organic PM. This is in contrast to the OC/EC filter samples taken upstream of the catalytic stripper which showed a wide range of organic content and much higher contributions to total carbon mass. As explained above the filters will absorb gaseous hydrocarbons and with the lower size limit of the AMS it makes it extremely difficult to make any substantial conclusions over the quantity of organic/volatile material in the sampling lines, except to say they are not zero.

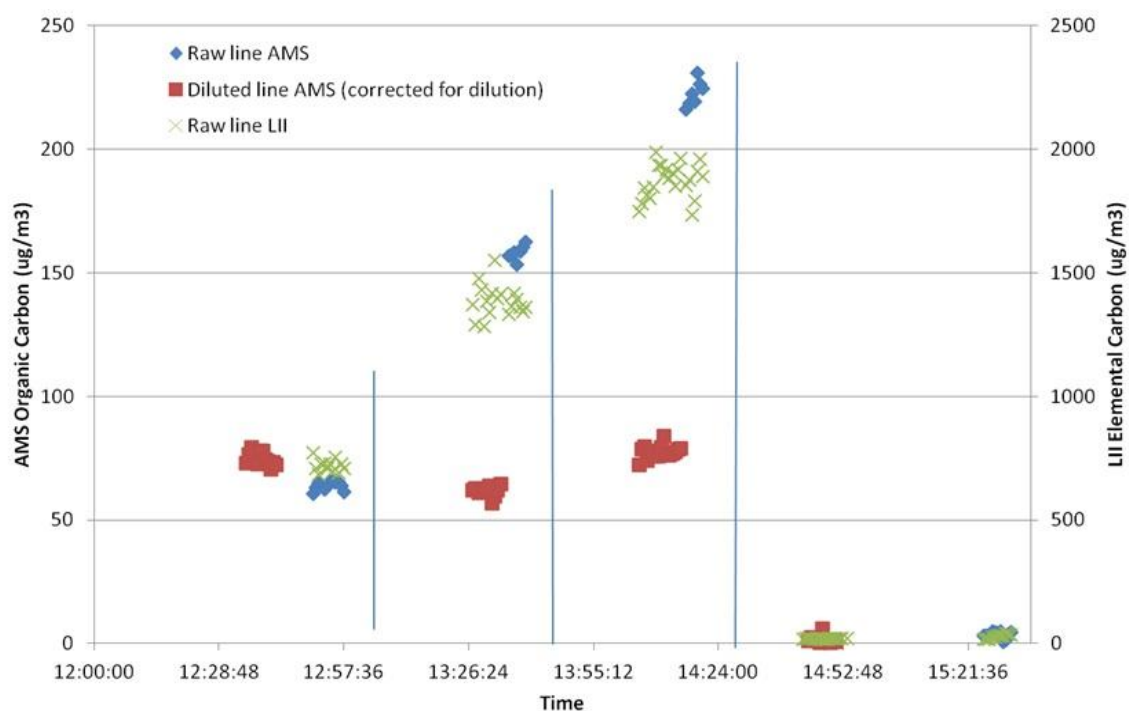

Figure 93 Raw versus diluted sampling system impact on organic PM compared with raw elemental carbon measurements

Care is needed when reporting and interpreting volatile mass or emission indices (EI). It has been shown that the organic mass increases beyond the exit plane^a. As the exhaust plume cools, organic vapours in the gas phase continue to condense to the particle phase thereby increasing the volatile particulate mass. This is in contrast to the gas phase CO₂ and non-volatile particles (soot), which once they have exited the engine, undergo no further processing i.e. the total mass of CO₂ and soot is conserved.

If a diluted sample is taken from the exhaust plane of an engine, then the mass per unit volume of CO₂ and soot can be calculated by applying the dilution factor to the measured values. Knowing the engine exhaust flow then allows the total mass of each to be determined. For the volatile fraction, this is not the case. Applying a correction factor to a measured diluted sample (and assuming no particle processing occurs in the sample lines), only yields the mass or EI at that sampling location (i.e. at a specific sample temperature and pressure).

A sample taken 10 metres away with the same dilution would probably produce a higher mass and EI. In conclusion, measurements of volatile material measured at the exhaust plane may not be representative of the total mass of volatile material emitted into the atmosphere, which impact on local air quality^b

^a Onasch, T. B.; Jayne, J. T.; Herndon, S.; Worsnop, D. R.; Miake-Lye, R. C.; Mortimer, P.; Anderson, B. E. Chemical Properties of Aircraft Engine Particulate Exhaust Emissions. *J. Propul. Power* 2009, 25 (No. 5), 1121–1137, DOI: 10.2514/1.36371

^b Paul I. Williams, James D. Allan, Prem Lobo, Hugh Coe, Simon Christie, Christopher Wilson, Donald Hagen, Philip Whitefield, David Raper, and Lucas Rye. Impact of Alternative Fuels on Emissions Characteristics of a Gas Turbine Engine – Part 2: Volatile and Semivolatile Particulate Matter Emissions. *ES&T*, Just accepted, 2012. DOI: 10.1021/es301899s



6.7 Line Penetration experiments

6.7.1 Line length influence (12m versus 25m)

6.7.1.1 Non Volatile PM Mass

LII instruments measuring non-volatile mass concentration data during the last ‘Up’ dedicated power curve were inter-compared to understand the magnitude of impact of line length on mass concentrations. In Figure 94 the data is normalised to the mass concentration in the SAMPLE III system. As described earlier the SAMPLE III system showed higher penetration than the FOCA system, this explains why the blue bars are ~10% lower than the green SAMPLE III bars. Halving the line length from 25 to 12m increased the mass concentrations measured by around 5 to 7%. This is not unexpected as diffusion loss for the larger mass-based size distribution is fairly flat. The FOCA system, with only half the line length of the SAMPLE III (25m) system, was still unable to achieve the higher mass concentrations measured after the SAMPLE III system.

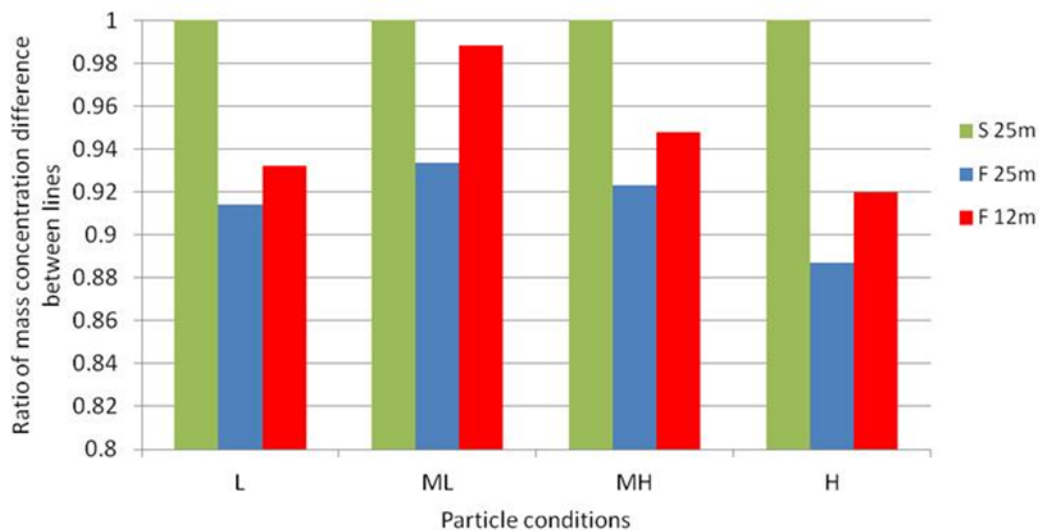

Figure 94 Non-volatile PM mass comparison of 12m versus 25m FOCA sample line normalised against 25m SAMPLE III line

6.7.1.2 Non-Volatile PM Number

The inter-comparison for line length for non-volatile number (Grimm CPCs) showed larger differences (Figure 95). Again the blue FOCA bars showed worse penetration compared to the SAMPLE III system (green) and the shorter 12m line increased the FOCA system number penetration by around 20 to 25%. This larger difference was expected as the diffusion loss will have a more significant impact on the smaller particles. However, yet again (as shown for mass, above) the increase in number concentration due to halving the line length, was still unable to achieve the higher penetration of the SAMPLE III system with twice the line length.

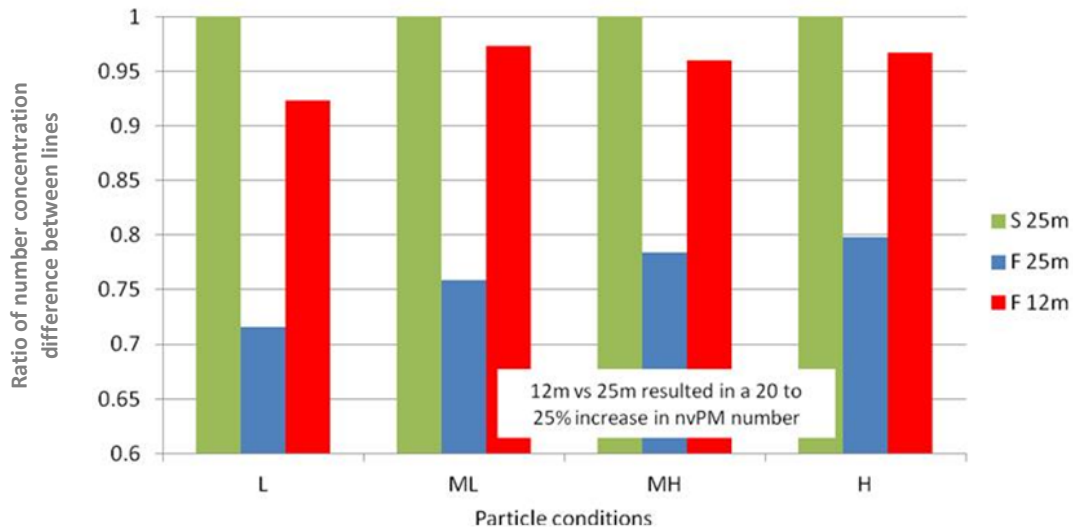

Figure 95 Non-volatile PM number comparison of 12m versus 25m FOCA sample line normalised against 25m SAMPLE III line

6.7.1.3 Penetration comparisons from Size analyser (DMS) and UTRC Model

Comparisons were made between measured and theoretical predictions for the penetration difference between a 25 and 12m sampling line length. The UTRC model contains conventional aerosol theory diffusion, thermophoretic and inertial losses and was developed with NASA finance. The size distributions were obtained using the DMS in order to limit the additional particle loss impact of the volatile particle remover. This does, however, mean that there may be some volatile particle impact on the measured data. Figure 96 shows the ratio of size distributions measured on the 12 versus 25m systems and the theoretical ratio, with linear and logarithmic axes. Theoretically the ratio should not change with actual size distribution, thus there is only one ‘model’ dataset, the error bars indicate 10% error. Data from all four dedicated engine power conditions show similar agreement with each other and realistic agreement with theoretical modelled data (within 25% at a specific particle size). This comparison provides more evidence that theoretical loss calculations can provide high-quality predictions (similar evidence was also obtained during SAMPLE III.01 using the APU gas turbine source).

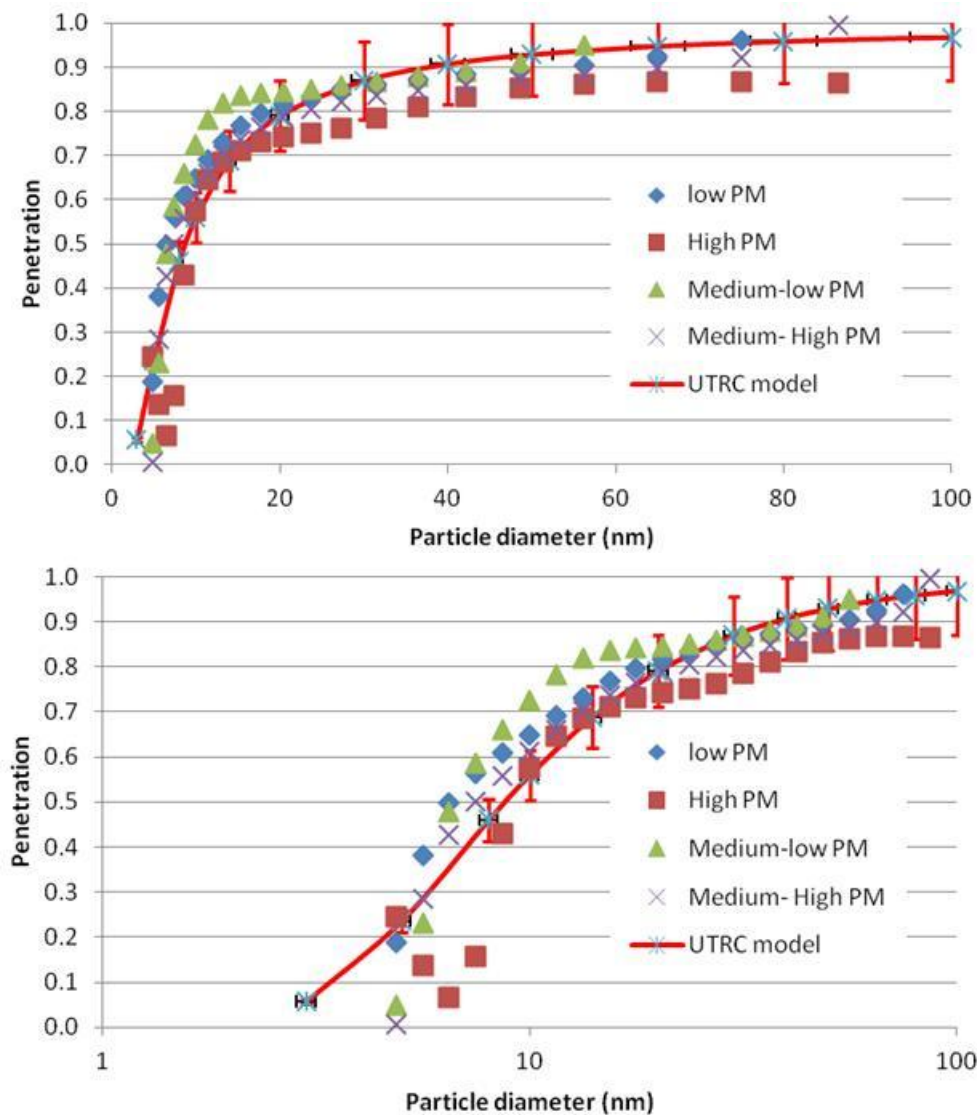

Figure 96 Linear and Log Measured Size penetration efficiency ratios for 12m versus 25m lines using DMS compared to UTRC model

6.7.2 Line Temperature (60°C vs 160°C)

6.7.2.1 Non Volatile PM Mass

Using engine piggyback data the sampling system temperature was compared. Comparing the LII non-volatile mass concentrations on the SAMPLE III and FOCA systems is shown below in Figure 97. The comparison shows an excellent almost 1:1 linear correlation between the two systems. This is in contrast to the results shown in Figure 73 where the SAMPLE III system had a slightly better penetration (where both sampling systems were operated at the same temperature of 60°C). Thus this data shows a worse penetration for the SAMPLE III system when maintained at a higher line temperature. It should be noted that this finding (that a higher line temperature shows worse penetration) contradicts the two separate methodical rig and engine specific line temperature effect experiments performed in SAMPLE II. However, conversely it should be noted that a previous DLR Stuttgart/FOCA study using a



diffusion flame as a gas turbine combustor exhaust surrogate did indicate better particulate penetration at lower line temperature.

These contradicting results indicate that in the future, if the particle measurement methodology is aimed to be improved, then more work is required in this area.

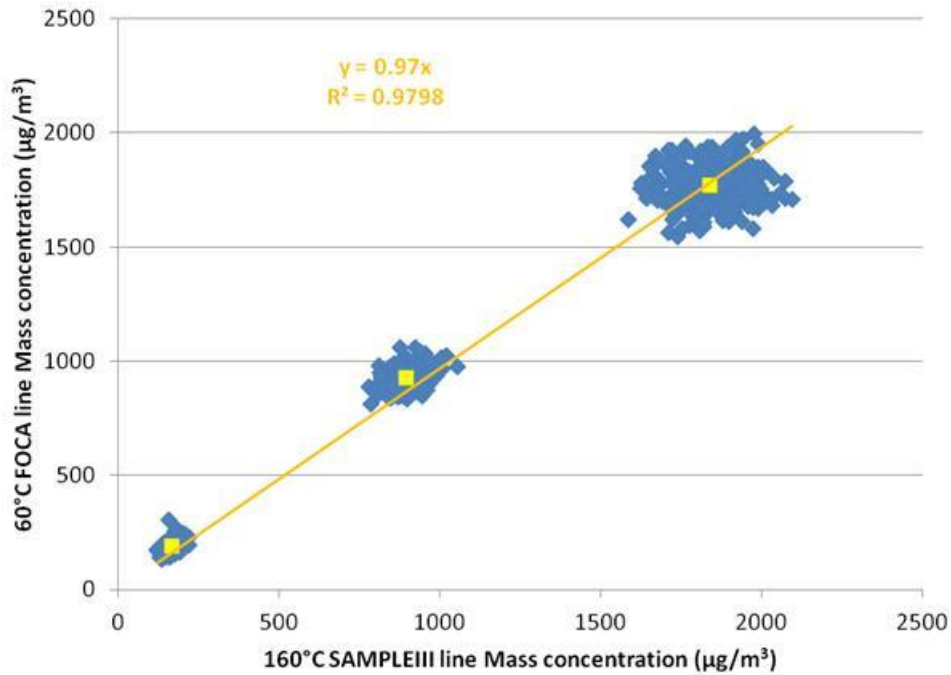

Figure 97 Non-volatile PM mass comparison using LII of FOCA & SAMPLE III lines at different temperatures (60°C versus 160°C), yellow squares indicate averaged data

6.7.2.2 Non-Volatile PM Number

Comparison of the Grimm non-volatile number concentrations on the SAMPLE III and FOCA systems is shown below in Figure 98. The comparison also shows an excellent almost 1:1 linear correlation between the two systems. This is again in contrast to the results shown in Figure 75 where the SAMPLE III system had a better penetration (when both systems were operated at the same line temperature of 60°C). Thus this data shows a worse penetration for the SAMPLE III system when maintained at a higher line temperature. Again as was discussed in the mass inter-comparison it should be noted that this finding (that a higher line temperature shows worse penetration) contradicts the two separate methodical rig and engine specific line temperature effect experiments performed in SAMPLE II. However, again it should be noted that a previous DLR Stuttgart/FOCA study using a diffusion flame as a gas turbine combustor exhaust surrogate did indicate better particulate penetration at lower line temperature.

Again these contradicting results indicate that in the future, if the particle measurement methodology is aimed to be improved, then more work is required in this area.

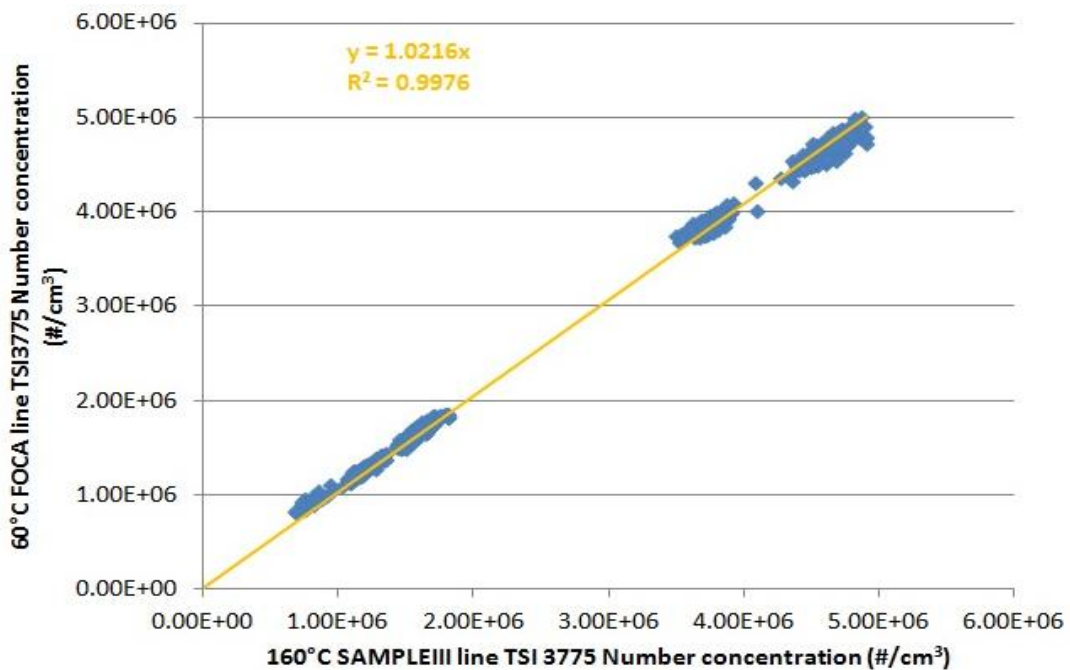

Figure 98 Non-volatile PM number comparison using TSI ($d_{50}=5\text{nm}$) CPC of FOCA & SAMPLE III lines at different temperatures (60°C versus 160°C)

6.7.2.3 Number data from Size analyser (DMS)

Comparing the DMS number concentrations on the SAMPLE III and FOCA systems is shown below in Figure 99. The comparison shows again an excellent almost 1:1 linear correlation between the two systems. This is in contrast to the results shown in Figure 76 where the SAMPLE III system had a better penetration (where both systems were operated at the same line temperature of 60°C).

Additionally, it should be noted that for the Maximum Continuous condition (highest particle mass and number concentrations), the DMS data seems to be offset from the linear correlation. The DMS instrument could be including a volatile contribution, which could be skewing the dataset (it is expected that due to higher volatile content towards low power conditions, that data is more likely to be skewed at these engine conditions).

Overall this data shows a slightly worse penetration for the SAMPLE III system when maintained at a higher line temperature. It is however, again noted that this finding (that a higher line temperature shows worse penetration) contradicts the two separate methodical rig and engine specific line temperature effect experiments performed in SAMPLEII. But again supports previous DLR Stuttgart/FOCA studies using a diffusion flame as a gas turbine combustor exhaust surrogate did indicate better particulate penetration at lower line temperature.

Again in terms of size measurement these contradicting results indicate that in the future, if the particle measurement methodology is aimed to be improved, then more work is required in this area.

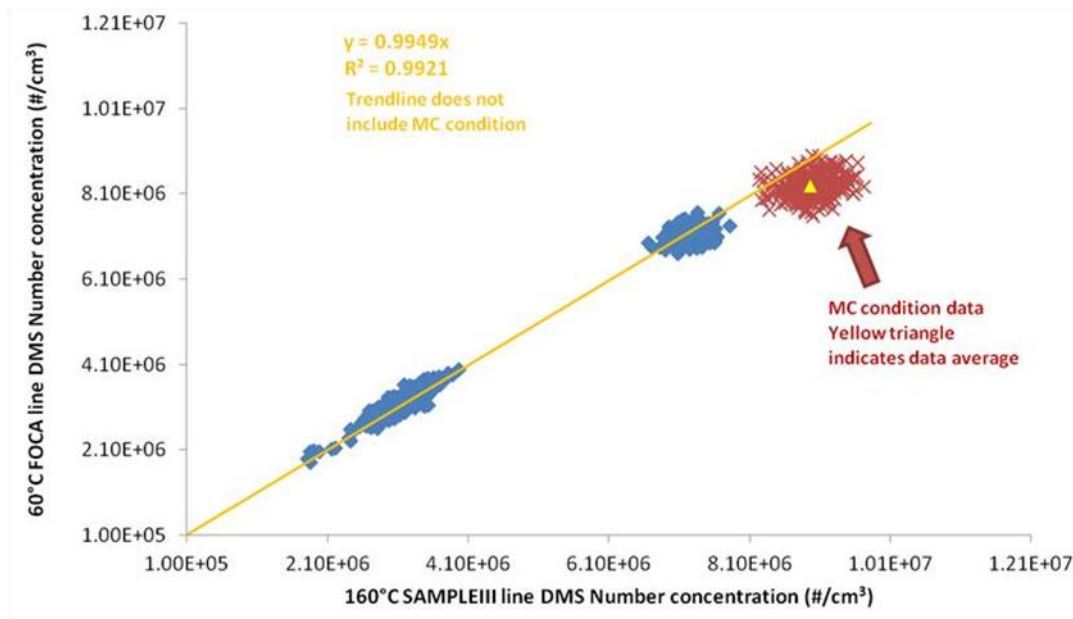

Figure 99 PM number comparison using DMS (volatiles included) of FOCA & SAMPLE III lines at different temperatures (60°C vs 160°C)

6.7.3 Real time penetration measurement (gantry vs downstream)

6.7.3.1 Non Volatile PM Mass

Utilising the LII instrumentation on the gantry and at end of both the PM sampling systems, simultaneous penetration of non-volatile mass concentration data was measured. This data is shown in Figure 100. The difference between the FOCA and SAMPLE III data is consistent across all PM conditions and with the comparisons made earlier (Figure 73). There is some variability of non-volatile mass concentration penetration data across the PM conditions with an average penetration loss of approximately 30%. It should be noted that this quantification of penetration is specific to the particle size distribution observed on this precise engine type. Different particle size distributions will have an impact on the particle penetration, and this is consistent with the variability observed. As the PM size distributions grow from ML to MH to H the penetration gets better. The Low PM condition measurement had extremely low mass, thus making it difficult to quantify the penetration at this specific data point. It should also be noted that care needs to be taken with the analysis of the gantry LII data due to the exchanging of the high voltage board part way through the test which may have impacted the calibration.

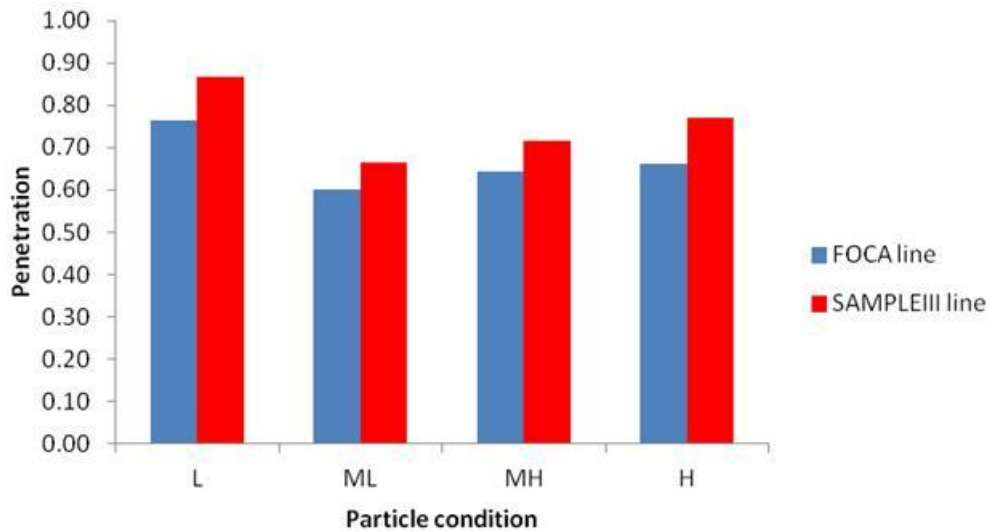

Figure 100 Real time non-volatile PM Mass penetrations measured with Gantry and downstream LII analysers

6.7.3.2 PM Number measured with DMS

Utilising the DMS instrumentation on the gantry and at end of both the PM sampling systems, simultaneous penetration of non-volatile mass concentration data was measured. This data is shown in Figure 101. The difference between the FOCA and SAMPLE III data is consistent across all PM conditions and with the comparisons made earlier (Figure 76). There is some variability of non-volatile number concentration penetration data across the PM conditions with an average penetration loss of approximately 40%. It should be noted that this quantification of penetration is specific to the particle size distribution observed on this precise engine type. Different particle size distributions will have an impact on the particle penetration. The data appears to be more consistent than the mass measurement data, however, there is likely a higher volatile contribution effect especially at the gantry measurement location, thus making it complicated to extricate the precise impact of this effect.

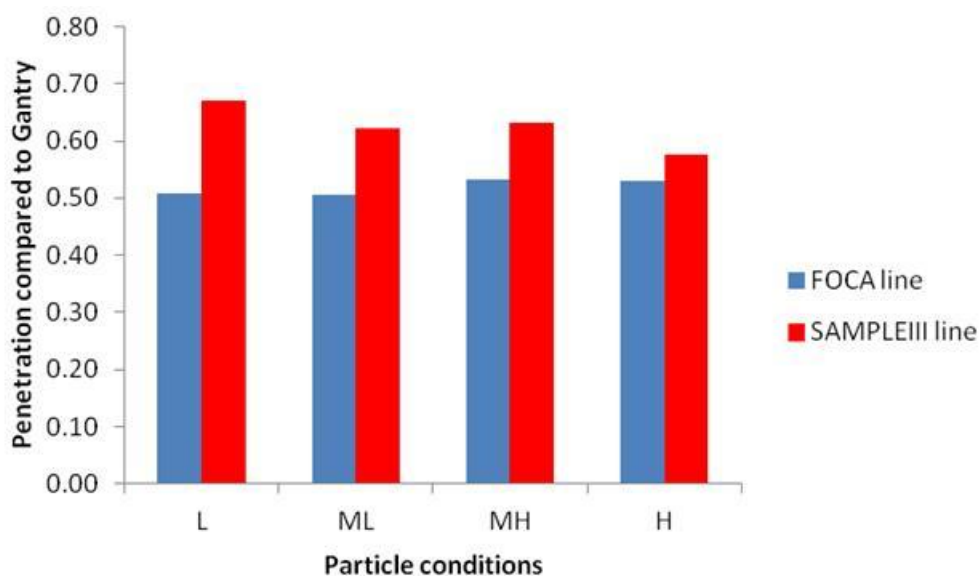

Figure 101 Real time Number penetrations measured with Gantry and downstream DMS-500 analysers

6.8 Conclusions of Task 4

1. It is important to ensure analysers are fully calibrated and within calibration time limits. Detailed quality checks and calibration timeframe procedures are required to minimise measurement uncertainty.
2. When both the SAMPLE III and FOCA line were operated under similar conditions (specifically primary dilutor inlet pressure associated to equivalent dilution ratios), the systems measured both mass and number concentrations to within 10%. This is within expected measurement uncertainties and implies the PM system design is robust (for similar sampling inlet conditions).
3. Particle non-volatile number concentration appears to be sensitive to dilution ratio
4. Particle non-volatile mass concentration appears to be marginally or insensitive to dilution ratio. However, this conclusion is based upon mass concentrations close to the instrument LDL (low detection limit) reducing the confidence of this statement.
5. Over the repeated dedicated engine conditions the SAMPLE III line appeared to show higher (20%) particle penetration for number concentration than the FOCA line. Even though it was theoretically expected that the FOCA line would have slightly better penetration due to slight line geometry differences (the FOCA cyclone step-inlet and additional isolation valve theoretically should have negligible impact).
6. Over the repeated dedicated engine conditions the SAMPLE III line appeared to show higher (15%) particle penetration for mass concentration than the FOCA line.
7. Excellent comparison repeatability (<3%) was observed between the two PM measurement systems
8. The automotive PMP-type CPC lower size cut point ($d_{50} = 23\text{nm}$, $d_{90} = 41\text{nm}$) is not sufficient to quantify non-volatile PM number concentrations from current fleet aircraft engine exhaust.
9. Based on SMPS size distributions downstream of the CS-VPR, no particles are observed <10nm diameter at the end of the sampling system. Thus there is no rationale to measure particles <10nm. However, the d_{90} lower cut point should not be



- >15nm diameter to minimise the effect of variable particle size distribution on the measurement.
10. Two commercially available CPC's that meet the lower cut-point ($d_{90} < 15\text{nm}$), agreed to within 7%.
 11. Smoke Number filter measurements must not be taken simultaneously with nvPM measurement. The flow must be constant (including no switching of valves) in the raw sample system at all times during PM measurement on the diluted line.
 12. Data analysis has shown that theoretical differences in losses between line lengths (12 versus 25m) compared to measured differences are within 20% for a specific particle size.
 13. Utilising the OC/EC filter EUSAAR methodology has shown catalytic stripper methodology to be extremely efficient (within the bounds of the filter measurement uncertainty) at removing organic mass material.
 14. Data analysis has shown inconclusive volatile/organic aerosol results for filter versus AMS methodology
 15. The size methodology inter-comparison provided better than expected results with good size agreement but differences in absolute concentration between SMPS (Condensation particle counter) and fast measurement techniques (electrometer counting). There are still issues over bi-modality in the DMS data inversion between 15 to 30nm.
 16. Measurement of real-time line penetration curves proved line efficiency consistency over all power conditions indicating that there was no effect of the line getting 'dirty' over the dedicated engine test period.
 17. Data obtained whilst operating the FOCA line at 60°C and SAMPLE III line at 160°C showed contrary conclusions compared to previous line temperature comparison work performed on the HES combustor and large scale modern engine in SAMPLE II. Zurich data indicated better penetration for the lower sampling temperature.



7. Task 3: Probe sampling capabilities assessment for Rolls Royce engine pass off testing

7.1 Introduction

In SAMPLE III.01 a concept was proposed whereby a permanently fixed emissions probe may be fixed to an engine mount pylon used to secure engines during their engine pass off running at Rolls Royce Derby. In the original proposal it was thought that the most suitable engine to mount the pylon concept on would be the Trent-900, however, on re-investigation of the Derby engine production schedule for the upcoming time period this view was modified and as such this concept has now been applied to the Trent-1000 engine.

This methodology of a permanent probe will give the benefit of potentially measuring gaseous and Particulate Matter emissions from each Trent-1000 engine that is passed off at Rolls Royce Derby using the pylon to which this probe will be fitted, which is estimated to be at a minimum of 50 engine per annum for the upcoming year. Unfortunately the likelihood is that not all these engines will be available for full emissions testing due to the complex testing schedule which means that engines can be moved from one test bed to another for pass off, however it is still envisaged numerous tests per month would be available utilising such a testing methodology.

7.2 Design Concept

The design of the new pylon mounted emissions probe has been completed by Rolls Royce, and is due to be added to one of the two pylons used to pass off new Trent-1000 manufactured and tested at Rolls Royce Derby. The design concept is based on one of the four single arms used on Rolls Royce's rotating cruciform certification rakes. The single arm is to be positioned at the same horizontal distance from the nozzle outlet as the certification cruciform, thus will sample exactly as one of the arms on the cruciform if the rotation is switched off. Due to the position of the probe in the hot exhaust where gas temperatures of up to 600°C are witnessed the probe will be manufactured from a single billet of Inconel stainless steel which has excellent corrosion properties at elevated temperature and pressures along with retaining its structural strength across a wide temperature range.

The 'piccolo' type probe shown in the technical drawing below (Figure 102) will be constructed to sample from 6 orifices each positioned to offer equal centre of areas across the nozzle of the Trent-1000 exhaust plane.

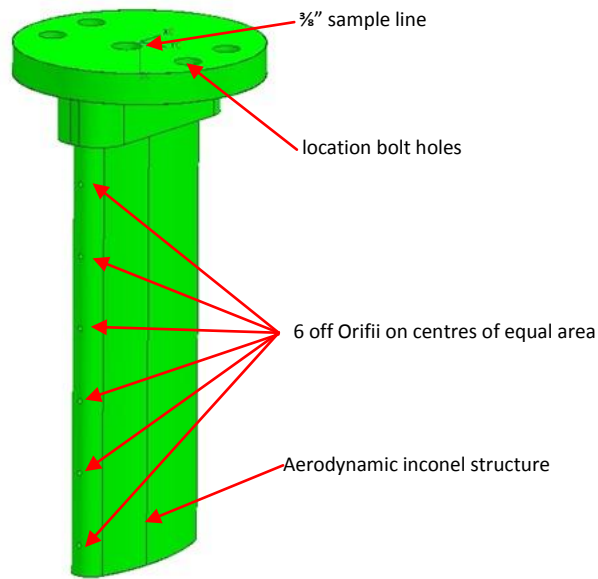

Figure 102 Engineering drawing of concept emissions probe to be fitted to Rolls Royce Trent-1000 engine pass off pylon

To fit the probe at the same location as the comparative certification probe, it was necessary to fit the probe in the tail fairing which is mounted off the pylon. At first due to the internal structure of the tail fairing it was not thought that this concept would be possible, however extensive design reviews have meant that by placing the probe off vertical from the tail fairing it is possible to incorporate the probe at the front end of the tail fairing and hence very close to the exhaust nozzle of the engine as shown (Figure 103).

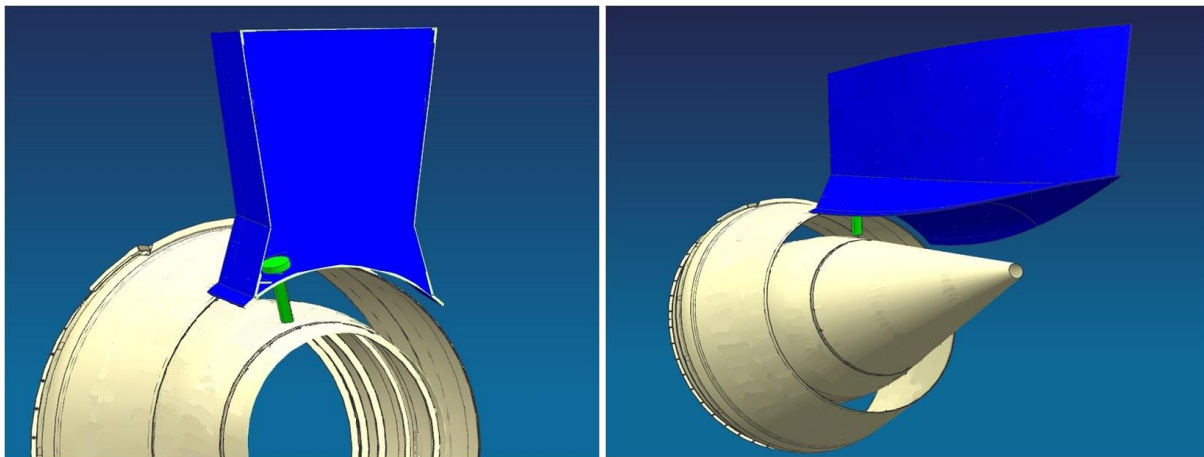

Figure 103 (a&b) Engineering concept drawing of design location of emissions probe within tail fairing of Trent engine pass off pylon

As explained in the original proposed concept (SAMPLE III.01) it would not be possible (due to engine exhaust variable geometry and cost) to build a permanent emissions probe fully compliant with the rigorous regulations specified in Annex 16, which are specifically written to ensure the representativeness of the sample compared to the entire engine exhaust. As such, Annex 16 specifies numerous recommendations for the sampling probe that should be met to ensure representativeness which are given below (Table 18), as can be seen, comments



are made to show how well a pylon based methodology could adhere to the Annex 16 specifications, with full conformity being written in green text, non-conformity being in red text and possible conformity being in orange text.

Table 18 Annex 16 specifications of emissions probe (1PTS) to ensure representativeness with comments on conformity of proposed pylon mounted probe

Detail	Specification	Comments on pylon concept
Probe Material	The probe material with which the exhaust sample is in contact shall be stainless steel or any other non-reactive material	In this case the design is utilising High Temperature grade stainless steel therefore the probe conforms
Probe Orifice	If a probe with multiple sampling orificii is used, all sampling orifices shall be of equal diameter. The probe design shall be such that at least 80 per cent of the pressure drop through the probe assembly is taken at the orifices.	The probe in this concept utilises 6 off equal diameter orifices, which are the same diameter as those used in the retrospective certification rake, which are designed to ensure a 80% pressure drop.
Number of Orifices	The number of locations sampled shall not be less than 12.	In this first concept a single rake utilising 6 orifices (similar to one arm of the certification cruciform rake) will be used therefore this specification is not met. However if this probe is observed to be close to representative then the addition of another identical probe on the other side of the tail fairing could be investigated to increase this number to 12.
Probe Location	The sampling plane shall be as close to the engine exhaust nozzle exit plane as permitted by considerations of engine performance but in any case shall be within 0.5 nozzle diameters of the exit plane.	The probe is now designed to be housed within the front section of the tail fairing ensuring the probe is in the same position, relative to the exhaust nozzle as the arms of the Rolls Royce certification cruciform rake
Representativeness	Probe placement and configuration shall be determined by representative gaseous and smoke demonstrations as defined by ARP 1256 and ARP 1179.	The representativeness of the sample will not be known until the probe is manufactured and installed onto the pylon and the gaseous data is compared with that obtained for the Trent-1000 engine under certification conditions, it is planned that this study will occur in the first quarter 2013.



7.3 Probe Manufacture and Installation

At the time of writing the fully approved design of the probe described above has been submitted to a Rolls Royce approved manufacturing centre. Unfortunately there is a significant lead time period required to obtain the correct material for the probe (Inconel). The SAMPLE III consortium has been advised there is currently a 2 months lead-time on the delivery of the inconel billet and then the manufacturers have estimated the manufacture will take approximately 1 week.

If these time-scales are correct it is hoped installation into the boat tail fairing will be planned to coincide with the quietest engine testing period in the year which occurs in January. This would allow possible operation of the probe from February/March 2013 onwards.

8. Conclusions

A summary of all of the conclusions made in Tasks 1-4 is presented below:

1. The SAE E31 nvPM draft working document is currently on schedule for early 2013 but will need further line verification and operational comparisons with engine manufacturer systems to ensure the ARP is ballotable in 2014
2. Two sampling systems built to the draft working document were installed at SR Technics maintenance facility, and operated simultaneously behind a FOCA installed single point traversable probe.
3. Installation of primary dilution system (3PTS) in SR Technics test cell was difficult and labour-intensive. In addition the installation of the dual instrument suites in a non-air conditioned confined space meant that area was at a premium and there was a risk of instrumentation overheating
4. Due to staged combustion, the CFM56-5B4-2P engine emits a wide range of Smoke Number, non-volatile particle mass and number concentrations at relatively low power conditions. This provided both particle systems with a good variety of aircraft gas turbine aerosol with minimal fuel flow usage.
5. Long dedicated steady-state test points of 20 minutes indicated particle concentration drift. Mass and number concentrations mutually drifted together.
6. It was witnessed that repeating of setting similar engine conditions was difficult to obtain and therefore affected PM repeatability tests.
7. It was perceived that performing PM measurements on a decreasing power curve seems to indicate slightly reduced PM emissions compared to an increasing power curve.
8. Both the DMS and LII instruments coped well with the hostile conditions inside the engine test cell, however, there were some mechanical issues that had to be overcome during the test campaign on both instruments.
9. Both systems (sampling and instrument suites) operated correctly and properly. Although it was observed that operation of the control spill valves was initially difficult to operate at low sample line pressures.
10. It is important to ensure analysers are fully calibrated and within calibration time limits. Detailed quality check and calibration timeframe procedures are required to minimise measurement uncertainty.



11. The SAMPLE III line appeared to show higher (20%) particle penetration for number concentration than the FOCA line. Even though it was theoretically expected that the FOCA line would have slightly better penetration due to slight line geometry differences.
12. The SAMPLE III line appears to show higher (10%) particle penetration for mass concentration than the FOCA line.
13. Excellent comparison repeatability (<3%) was observed between the two PM measurement systems
14. Particle number concentration appears to be sensitive to dilution ratio
15. The automotive PMP-type CPC lower size cut point ($d_{50} = 23\text{nm}$, $d_{90} = 41\text{nm}$) is not sufficient to quantify non-volatile PM number concentrations from current fleet aircraft engine exhaust.
16. Based on SMPS size distributions downstream of the CS-VPR, no particles are observed <10nm diameter at the end of the sampling system. Thus there is no rationale to measure particles <10nm. But the d_{90} lower cut point should not be >15nm diameter to minimise the effect of variable particle size distribution on the measurement.
17. Two commercially available CPC's that meet the lower cut-point ($d_{90} < 15\text{nm}$), agreed to within 7%.
18. Smoke Number filter measurements must not be taken simultaneously with nvPM measurement. The flow must be constant in the raw sample system at all times during PM measurement on the diluted line.
19. Data analysis has shown that theoretical differences in losses between line lengths (12 versus 25m) compared to measured differences are within 20% for a specific particle size.
20. Utilising the OC/EC filter EUSAAR methodology has shown catalytic stripper methodology to be extremely efficient (within the bounds of the filter measurement uncertainty).
21. Data analysis has shown inconclusive volatile/organic aerosol results for filter versus AMS methodology.
22. The size methodology inter-comparison provided better than expected results with good size agreement but differences in absolute concentration between SMPS (Condensation particle counter) and fast measurement techniques (electrometer counting). There are still issues over bi-modality in the DMS data inversion between 15 to 30nm.
23. Measurement of real-time line penetration curves proved line efficiency consistency over all power conditions indicating that there was no effect of the line getting 'dirty' over the dedicated engine test period.
24. Data obtained whilst operating the FOCA line at 60°C and SAMPLE III line at 160°C showed contrary conclusions compared to line temperature comparison work performed on the HES combustor and large scale modern engine in SAMPLE II. Zurich data indicated better penetration for the lower sampling temperature.
25. A piccolo-type probe has been successfully designed, and is being manufactured, to be installed on a Rolls-Royce production pass-off pylon. Enabling the possibility of performing PM measurements on a number of same-type engines at R-R Derby.



9. Appendices

Overviews of external collaboration work that was performed during the SAMPLE III.02 measurement campaign are presented here. The experiments described below were made possible due to the SAMPLE III.02 dedicated and piggyback test campaign. If and when results from these experiments are presented or published externally they will acknowledge both the SAMPLE III consortium and EASA. And the authors will send prior to publishing, copies of such documents to EASA for review.

A. Development of mass analyser performance calibration technique (UBC, NRC, Cambustion)

Drift performance calibration check requires a source of soot particles with minimal stability uncertainty. Typically the calibration source stability uncertainty < drift uncertainty.

Soot particle generation is unstable even for a miniCAST. Figure A1. below shows fluctuations (order of many seconds) purported to be due to internal mass flow controllers fighting each other, but also additional ‘random’ drift over longer periods (i.e hours). Both sources of fluctuation are ~10%

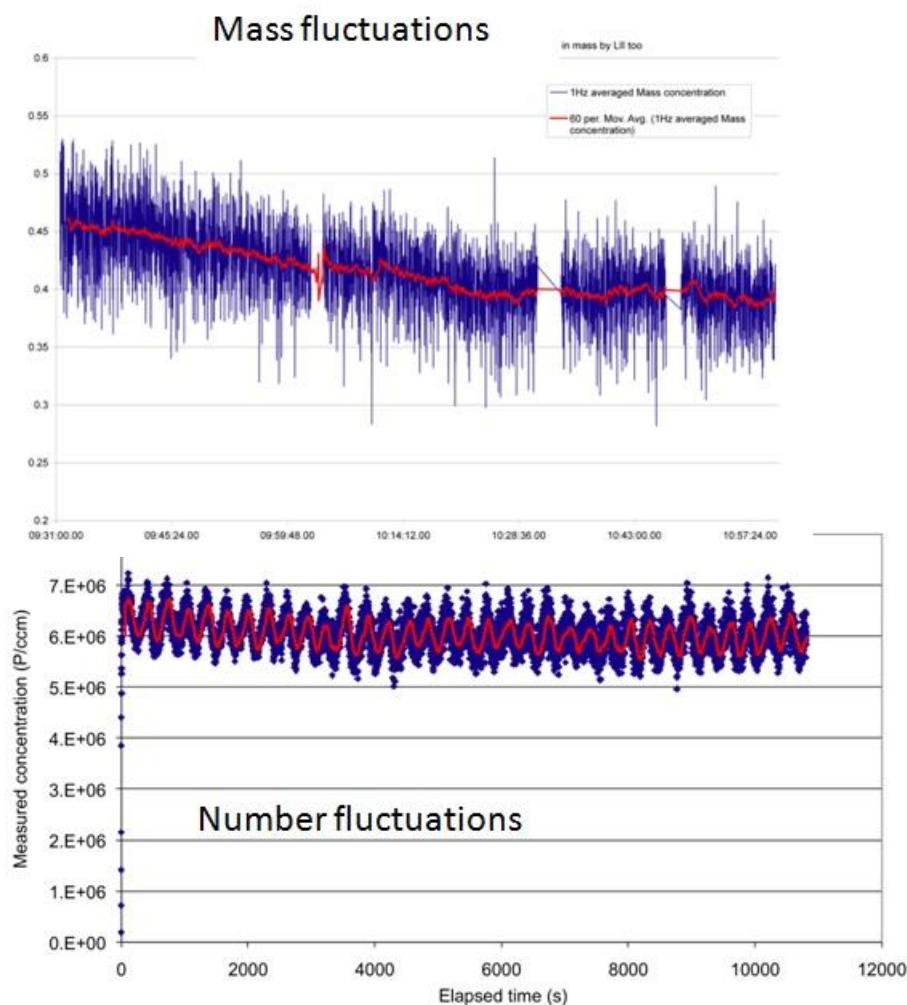

Figure A1 MiniCast “steady state” particle fluctuations

Possible solution:

Use a mass classifier device (with counter) on an unstable PM source, which delivers a traceable mass concentration output (<1%) to the mass instrument under calibration.

The CPMA (or Couette CPMA) is an instrument that classifies particles by their mass ^{1,2}. The CPMA consists of two rotating coaxial cylindrical electrodes rotating at different angular



velocities (see Figure A2). Electrically charged particles pass between the electrodes where they experience electrostatic and centrifugal forces (F_e and F_c , respectively) acting in opposite directions. Particles also experience a drag force which opposes the direction of motion. Particles of a particular mass-to-charge ratio will pass through the CPMA, depending on the rotational speed and voltage difference between the electrodes. Other particles will either be forced to the outer electrode if the centrifugal force is stronger than the electrostatic force or they will be forced to the inner electrode if the electrostatic force is dominant. Particles that impact the inner or outer electrode adhere to the surface and will not pass through the CPMA. Since the charge on the particles is known then the mass of the classified particles is known. The voltage and rotational speed can be stepped to classify particles of different mass-to-charge ratios.

The CPMA design represents a significant improvement over the aerosol particle mass (APM) analyzer. The APM, developed by Ehara et al. ³, operates in a similar manner to that of the CPMA; however, unlike the CPMA, the APM's inner and outer electrodes rotate at the same angular velocity. One major problem with the APM is that the instrument suffers from particle losses in the classifier due to unstable forces. The external forces in the APM are the centrifugal force, which is proportional to r and the electrostatic force, which is proportional to $1/r$ (where r is the distance from the centre of rotation). A particle of the correct mass-to-charge ratio will be balanced at the 'equilibrium radius', r^* . If the particle is positioned so that $r > r^*$ the centrifugal force will be greater than the electrostatic force and the particle will move toward the outer electrode. Depending on the force imbalance, the axial flow velocity, length of classifier, and drag on the particle, the particle may impact on the outer electrode.

Similarly, particles may impact on the inner electrode if they are positioned at $r < r^*$. This unstable system of forces in the APM causes many particles to be lost in the instrument, which greatly reduces the transfer function of the instrument. In the CPMA the inner electrode rotates slightly faster than the outer electrode. This creates a concave velocity profile between the electrodes (known as Couette flow; see Figure A2) such that the centrifugal force on the particle will decrease as the radius increases. With this system, particles of the correct mass-to-charge ratio move toward the equilibrium radius^a and the transfer function of the CPMA is greatly improved compared to the APM. Figure A3 (a) and (b) show the trajectory of particles of the same mass-to-charge ratio in the APM and CPMA (from the model described in ¹), where the equilibrium radius is centred between the two cylinders (r_c). The figure shows that the particles move toward the equilibrium radius in the CPMA, but they move away from the equilibrium radius in the APM, resulting in particle losses. This improvement in transfer function in the CPMA allows for higher resolution measurements and increased measurement range.

^aA stable system of forces can also be created in this type of instrument by manipulating the electrostatic field by changing the instrument geometry

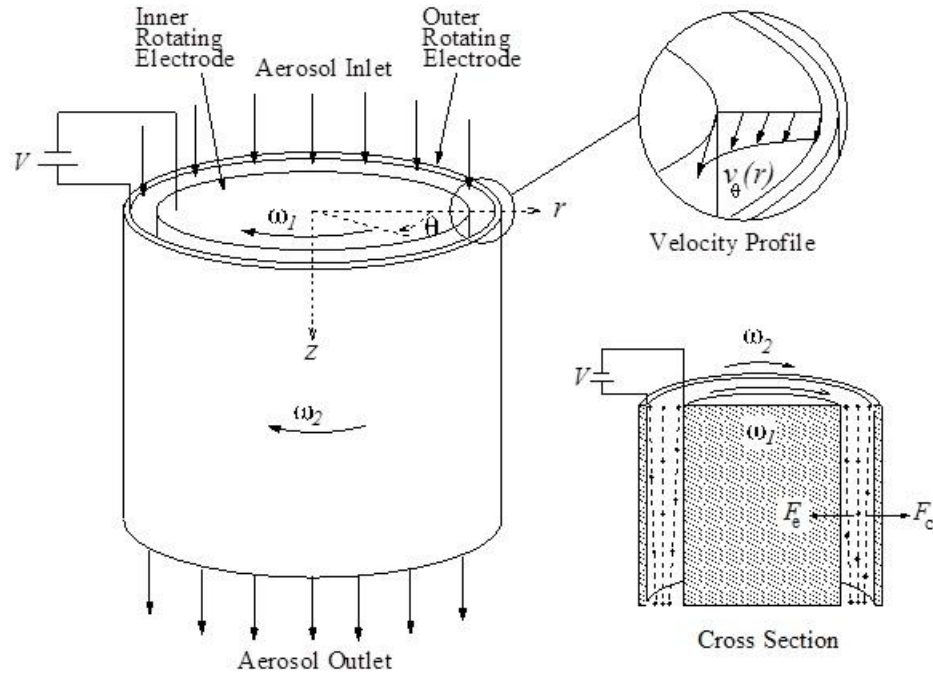

Figure A2 Schematic of the Couette centrifugal particle mass analyzer

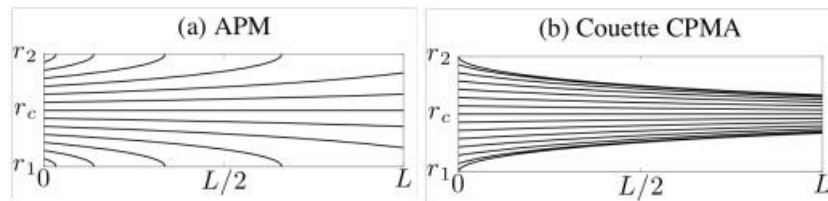

Figure A3. Trajectory of particles of the same mass-to-charge ratio in the (a) APM and (b) Couette CPMA. The x -axis represents the distance the particles travelled down the length, L , of the instruments. The y -axis represents the radial distance, r , from the centre of rotation, where r_1 and r_2 are the radius of the inner and outer cylinders, respectively. The electrostatic and centrifugal forces are balanced at the centre between the two cylinders (i.e. $r = r_c^*$).

The CPMA has direct traceability. The dependent variables of voltage, rotation speed and radii of cylinders are all known in the below equation. No empirical correlations are required.

$$\frac{m}{N_q} = \frac{eV}{r^2 \omega^2 \ln \left\{ \frac{r_o}{r_i} \right\}}$$

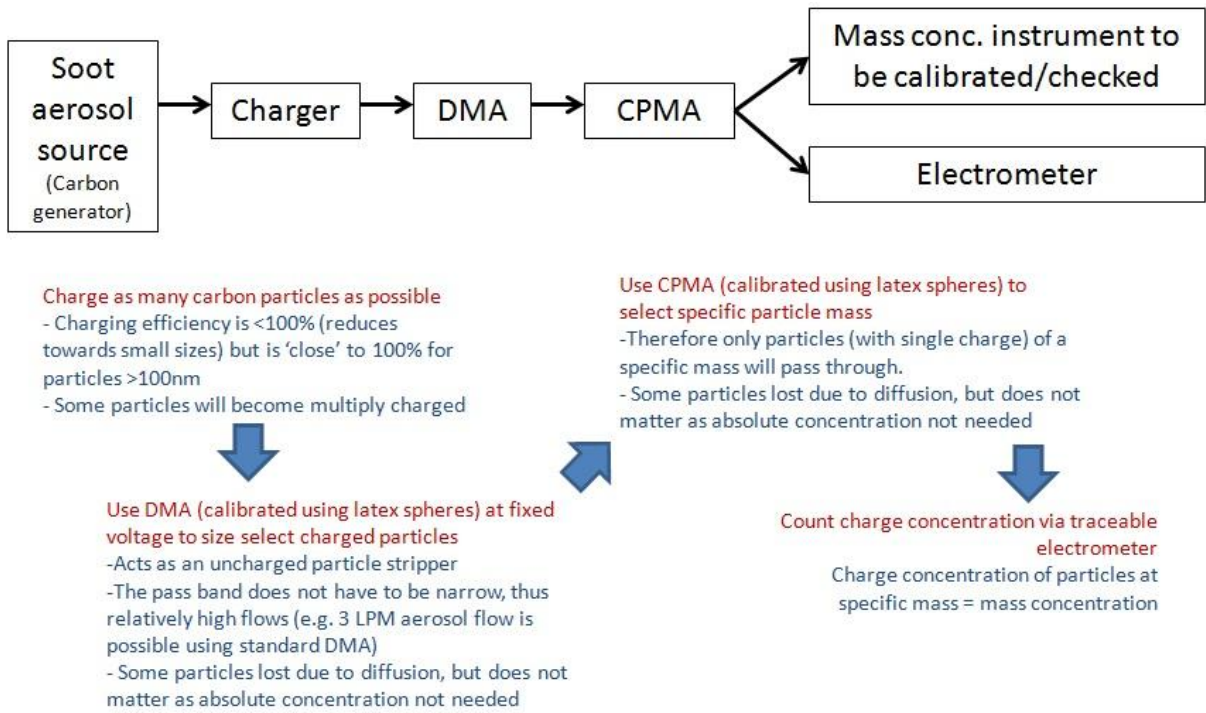

Figure A4 A possible solution for non-volatile (soot) mass instrument performance calibration/checks (note NIOSH 5040 with miniCAST still to be used for the absolute traceable calibration)

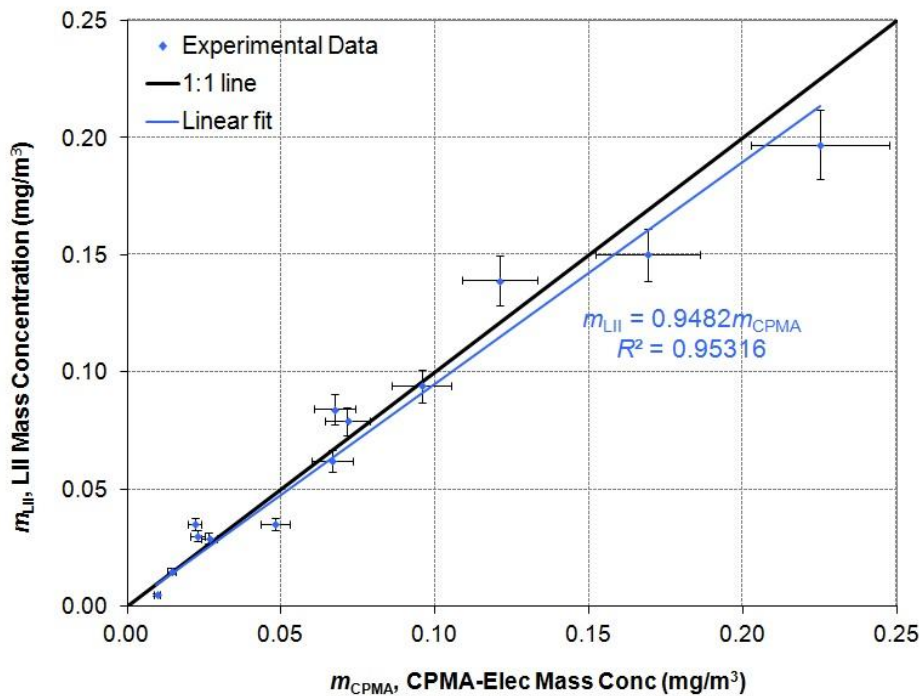

Figure A5 Preliminary results of calibration solution



References

- [1] J. Olfert and N. Collings, “New method for particle mass classification — The Couette centrifugal particle mass analyzer,” *Journal of Aerosol Science*, vol. 36, pp. 1338–1352, 2005.
- [2] J. S. Olfert, K. S. J. Reavell, M. Rushton, and N. Collings, “The experimental transfer function of the Couette centrifugal particle mass analyzer,” *Journal of Aerosol Science*, vol. 37, pp. 1840–1852, 2006.
- [3] K. Ehara, C. Hagwood, and K. J. Coakley, “Novel method to classify aerosol particles according to their mass-to-charge ratio - aerosol particle mass analyser,” *Journal of Aerosol Science*, vol. 27, no. 2, pp. 217–234, 1996.
- [4] J. Olfert, “A numerical calculation of the transfer function of the Fluted centrifugal particle mass analyzer,” *Aerosol Science and Technology*, vol. 39, pp. 1002–1009, 2005.

B. Assessment of size-dependent PM density (UA & UBC)

Figure B1 shows the effective density distribution measured at a constant engine test point using the CPMA-DMS system behind a catalytic stripper. Similar to other soot sources, such as diesel engines, the effective density ranges from 650-950 kg/m³ and decreases as the particle size increases. The mass mobility exponent for this engine load point was determined to be 2.69 by fitting the effective density distribution with a power law. This result is supported by the small fractal aggregates observed in the TEM image shown in Figure B2.

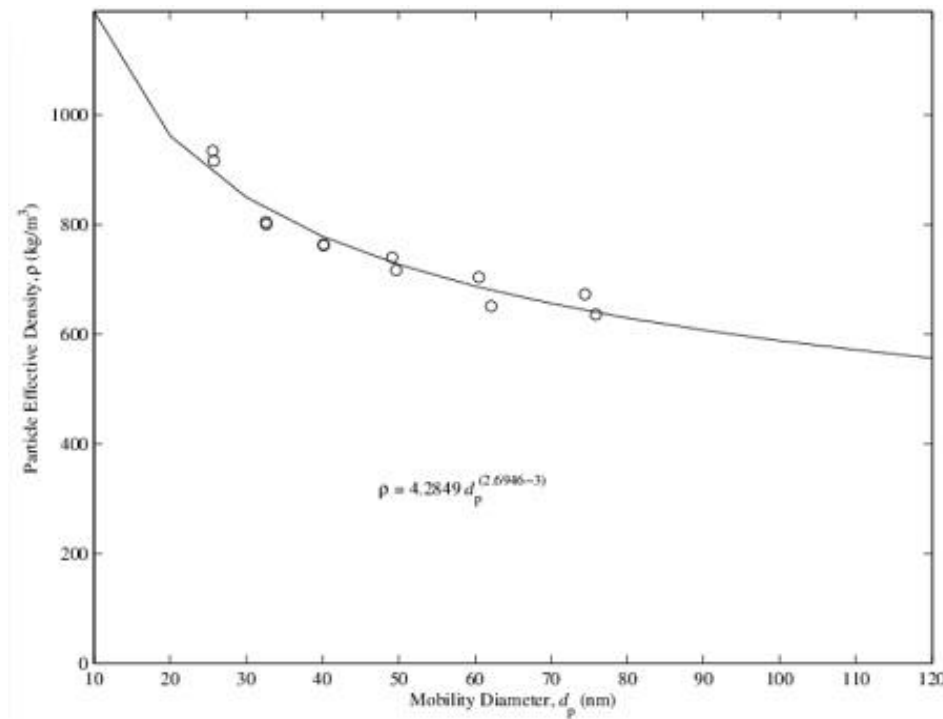

Figure B1 Size dependent effective particle density measured on CFM56-5B engine

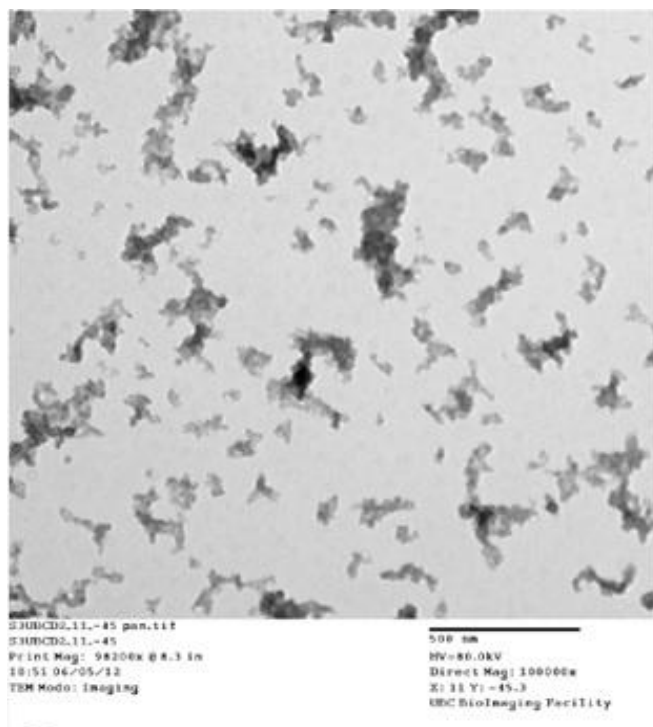

Figure B2 Transmission Electron Microscopy image of sample from CFM56-5B engine



C. Comparison of non-volatile mass instrumentation (NRC, MS&T)

At this current time NRC/MS&T are not in a position to provide precise data into this report. Analysis of the mass data taken during the SAMPLE III.02 engine test campaign will be presented internally during SAE E31 PM ARP Mass team meetings.



D. Volatile PM characterisation (ETH)

At this current time ETH are not in a position to provide data into this report. Analysis of ETH AMS data (specifically catalytic stripper efficiency assessment) taken during the SAMPLE III.02 engine test campaign will hopefully be presented or published externally in the future.