

**Novel Roles for RANK, ERK and Akt in Sensory
and Sympathetic Neuronal Populations**

**A Thesis Submitted to Cardiff University
for the Degree of PhD
2010**

Matthew James Smithen

**Cardiff School of Biosciences
Cardiff University**

UMI Number: U585424

All rights reserved

INFORMATION TO ALL USERS

The quality of this reproduction is dependent upon the quality of the copy submitted.

In the unlikely event that the author did not send a complete manuscript and there are missing pages, these will be noted. Also, if material had to be removed, a note will indicate the deletion.



UMI U585424

Published by ProQuest LLC 2013. Copyright in the Dissertation held by the Author.
Microform Edition © ProQuest LLC.


All rights reserved. This work is protected against
unauthorized copying under Title 17, United States Code.



ProQuest LLC
789 East Eisenhower Parkway
P.O. Box 1346
Ann Arbor, MI 48106-1346

Declaration

This work has not previously been accepted in substance for any degree and is not being concurrently submitted for any candidature for any degree

Signed.......... Matthew James Smithen
Date.....14/05/2010.....

Statement 1

This thesis is a result of my own investigations, except where otherwise stated. Other sources are acknowledged by explicit references.

Signed..........Matthew James Smithen
Date.....14/05/2010.....

Statement 2

I hereby give consent for my thesis, if accepted, to be available for photocopying and for inter-library loan, and for the title and summary to be made available to outside organizations.

Signed.......... Matthew James Smithen
Date.....14/05/2010.....

Abstract

A PCR screen, conducted in a previous study, to identify novel candidates involved in regulating the survival and growth of developing neurons, identified transcripts for the tumor necrosis factor receptor (TNFR) superfamily member receptor activator of NF- κ B (RANK) in the experimentally tractable sensory neurons of the mouse nodose, trigeminal and superior cervical ganglia. Immunohistochemistry revealed coexpression of RANK, together with its ligand, RANKL, and osteoprotegerin (OPG), a decoy receptor, in all nodose, trigeminal and superior cervical ganglia neurons in neonates. Over-expressing RANK inhibited BDNF- and CNTF-promoted neurite growth in nodose neurons, and NGF-promoted neurite growth in SCG and trigeminal neurons, without affecting neuronal survival. This effect was seen across a range of developmental ages, from embryonic timepoints, to postnatal ages, suggesting a fundamental role for this receptor in regulating neurotrophin-mediated neurite growth.

Investigations revealed the requirement of TRAF2, NIK, IKK β and NF- κ B, but not TRAF6 or IKK α , for RANK-mediated inhibition of BDNF-mediated neuritic outgrowth from nodose neurons at a time when neurons are extending axons and ramifying in their targets.

Exploration of other possible RANK signalling mediators revealed a role for the important intracellular kinases, MEK and Akt, in the regulation of BDNF-mediated neuritic outgrowth from early postnatal nodose neurons. Akt was found to positively regulate BDNF-mediated neuritic outgrowth, while MEK negatively regulates the outgrowth mediated by this neurotrophin.

Index

	Page number
Declaration	ii
Abstract	iii
Index	iv
Detailed Index	v
Figure Index	viii
List of abbreviations	x
Acknowledgements	xiii
Chapter 1: General Introduction	1
Hypothesis	68
Chapter 2: Materials and Methods	69
Chapter 3: RANK is a novel regulator of neurite growth in the developing peripheral nervous system	83
Chapter 4: RANK signalling regulating neurite outgrowth from P0 nodose neurons	116
Chapter 5: Roles of MEK/ERK and PI3K Signalling in neurite growth from developing nodose neurons	148
General Discussion	176
References	180

Detailed Index

	Page number
Declaration	ii
Abstract	iii
Index	iv
Detailed Index	v
Figure Index	viii
List of abbreviations	x
Acknowledgements	xiii
1 General Introduction	1
1.1 Brief Overview of neuronal development	2
1.1.1 Introduction	2
1.1.2 Neural Induction	3
1.1.3 Formation of the neural tube	6
1.1.4 Neuronal Migration	8
1.1.5 Axonal Growth and PCD	9
1.2 Organisation of the Peripheral Nervous System	12
1.2.1 Introduction	12
1.2.2 Organisation of the Somatic PNS	12
1.2.3 Organisation of the autonomic nervous system	15
1.2.4 Development of the peripheral nervous system	19
1.3 Regulation of neuronal survival in the PNS	21
1.3.1 Introduction	21
1.3.2 The neurotrophic theory	24
1.3.3 Neurotrophic requirements of selected peripheral ganglia	28
1.3.4 NGF	30
1.3.5 BDNF	31
1.3.6 CNTF	32
1.3.7 Trk receptors	32
1.3.8 p75	33
1.4 Regulation of neurite outgrowth	36
1.4.1 Axon extension and guidance	36
1.4.2 The role of neurotrophic factors in regulating neurite outgrowth from PNS neurons	36
1.4.3 Intracellular signalling pathways downstream of neurotrophic factors regulating neuronal survival and neurite outgrowth	38
1.5 The receptor activator of NF- κ B	40
1.5.1 The tumor necrosis factor superfamily	40
1.5.2 TNF family members and the regulation of neuronal Development	43
1.5.3 NF- κ B	45
1.5.4 RANK, RANKL and OPG	48
1.5.5 RANK, RANKL and OPG knockout mice	53
1.5.6 RANK signalling	54
1.6 ERK	60
1.7 Akt	64

Hypothesis	68
2 Materials and Methods	69
2.1 Introduction	70
2.2 Maintenance of CD1 mice	70
2.3 Isolation of mouse embryos	70
2.4 Dissection of peripheral ganglia	71
2.5 Preparation of tungsten needles	72
2.6 Dissociated neuronal cultures	72
2.6.1 Preparation of dishes	72
2.6.2 Culture media	73
2.6.3 Dissociation of ganglia	73
2.6.4 Seeding of neurons	73
2.7 Estimation of neuronal survival	74
2.8 Quantification of neurite outgrowth	75
2.9 Ballistic transfection	77
2.9.1 Plasmid preparation	77
2.9.2 Preparation of gold microcarriers for ballistic transfection	77
2.9.3 Ballistic transfection	78
2.10 Pharmacological inhibitors	80
2.11 Immunohistochemistry	80
2.12 Western Blots	80
2.13 Statistical analyses	82
3 RANK is a novel regulator of neurite growth in the developing peripheral nervous system	83
3.1 Introduction	84
3.2 RANK, RANKL and OPG are expressed in nodose, SCG and trigeminal neurons	87
3.3 Over-expression of RANK reduces the extent of neurite growth from P0 nodose neurons cultured with either BDNF or CNTF	92
3.4 Over-expression of RANK reduces neurite growth from P0 SCG and trigeminal neurons cultured with NGF	94
3.5 Over-expression of RANK in nodose, SCG and trigeminal neurons reduces the growth of these neuronal populations across a range of developmental timepoints	102
3.6 Discussion	111
4 RANK signalling regulating neurite outgrowth from P0 nodose neurons	116
4.1 Introduction	117
4.2 RANK signals via a distinct C-terminal domain to reduce neurite outgrowth from neonatal neurons	121
4.3 RANK signals via specific TRAF family member in nodose neurons	126
4.4 RANK signals via NIK to inhibit neurite outgrowth from nodose Neurons	131

4.5 IKK β plays a role in mediating RANK induced inhibition of neurite growth	134
4.6 RANK signals via NF- κ B in nodose neurons cultured with BDNF	137
4.7 Discussion	142
5 Roles of MEK/ERK and PI3K signalling in neurite growth from developing nodose neurons	148
5.1 Introduction	149
5.2 U0126 and PD98059 increase BDNF-promoted neurite growth from nodose neurons	152
5.3 BDNF exposure does not alter the levels of phosphorylated ERK1/2 in nodose neurons	153
5.4 MEK/ERK is not crucial for the effect of over-expressing RANK	154
5.5 Wortmannin and LY294002 decrease the growth of BDNF supplemented nodose neurons	163
5.6 BDNF increases the levels of phosphorylated Akt	164
5.7 Discussion	170
General Discussion	176
References	180

Figure Index

Figure 1:	Formation of the neural tube and early vesicle formation.....	4
Figure 2:	Molecular mechanisms of axonal growth and guidance.....	11
Figure 3:	Organisation of the cranial nerves.....	14
Figure 4:	Anatomical organisation of the DRG.....	17
Figure 5:	Sympathetic and parasympathetic divisions of the ANS.....	18
Figure 6:	Extrinsic and intrinsic control of apoptosis.....	23
Figure 7:	The neurotrophic theory.....	26
Figure 8:	The neurotrophins and their receptors.....	35
Figure 9:	The TNF and TNF receptor superfamilies.....	42
Figure 10:	RANK is a 616 a.a. receptor with a 383 a.a. cytoplasmic domain.....	51
Figure 11:	Mechanisms of action of OPG, RANKL and RANK in osteoclastogenesis.....	52
Figure 12:	RANK signalling pathways important in the regulation of osteoclastogenesis and survival.....	55
Figure 13:	MAPK signalling pathways.....	63
Figure 14:	Activation of PKB signalling pathways.....	65
Figure 15:	Graphic illustration of Sholl analysis.....	76
Figure 16:	Experimental outline.....	79
Figure 17:	RANK, RANKL and OPG are expressed in developing sensory nodose neurons.....	89
Figure 18:	RANK, RANKL and OPG expression in developing SCG neurons.....	90
Figure 19:	RANK, RANKL and OPG expression in developing trigeminal neurons.....	91
Figure 20:	Effect of over-expressing RANK on BDNF-dependent growth from P0 nodose neurons.....	97
Figure 21:	Effect of over-expressing RANK on CNTF-dependent growth from P0 nodose neurons.....	98
Figure 22:	Effect of over-expressing RANK on NGF-dependent growth from P0 SCG neurons.....	99
Figure 23:	Effect of over-expressing RANK on NGF-dependent growth from P0 trigeminal neurons.....	100
Figure 24:	Effect of over-expressing RANK in different neuronal Populations.....	101
Figure 25:	Over-expressing RANK reduces neurite growth from nodose neurons at different developmental stages.....	104
Figure 26:	Over-expressing RANK reduces neurite growth from nodose neurons at different developmental stages without affecting survival.....	105
Figure 27:	Over-expressing RANK reduces neurite growth from SCG neurons at different developmental stages.....	106
Figure 28:	Over-expressing RANK reduces neurite growth from SCG neurons at different developmental stages without affecting	

	survival.....	107
Figure 29:	Over-expressing RANK reduces neurite growth from trigeminal neurons at different developmental stages.....	108
Figure 30:	Over-expressing RANK reduces neurite growth from trigeminal neurons at different developmental stages without affecting survival.....	109
Figure 31:	Summary of results.....	110
Figure 32:	Aims of Chapter 4.....	120
Figure 33:	A RANK receptor deficient in two important signalling domains does not effect BDNF-dependent neurite growth.....	124
Figure 34:	The C-terminal tail of RANK mediates its ability to inhibit neurite outgrowth from neonatal nodose neurons.....	125
Figure 35:	Blocking the function of TRAF2 reduces the survival of nodose neurons cultured with BDNF.....	129
Figure 36:	TRAF2 mediates RANK's ability to inhibit BDNF-promoted neurite outgrowth from P0 nodose neurons.....	130
Figure 37:	NIK plays a role in transducing RANK activation into reduced neurite outgrowth from neonatal nodose neurons....	133
Figure 38:	RANK signals via IKK β in to reduce neurite outgrowth from neonatal nodose neurons.....	136
Figure 39:	RANK signals via NF- κ B in neonatal nodose neurons.....	140
Figure 40:	Proposed pathway of RANK signal transduction in nodose neurons.....	141
Figure 41:	Effect of U0126 on BDNF-dependent growth from sensory neurons.....	157
Figure 42:	Effect of PD98059 on BDNF-dependent growth from sensory neurons.....	158
Figure 43:	BDNF does not promote ERK1/2 phosphorylation in sensory neurons.....	159
Figure 44:	Effect of MEK inhibitors on BDNF dependent-growth in sensory neurons.....	160
Figure 45:	Adding BDNF at the same time or before the addition of U0126 abrogates its effect on neurite growth in sensory neurons.....	161
Figure 46:	Blocking ERK1/2 does not prevent the effect of over-expressing RANK in sensory neurons.....	162
Figure 47:	Effect of wortmannin on BDNF-dependent growth in sensory neurons.....	166
Figure 48:	Effect of LY294002 on BDNF-dependent growth in sensory neurons.....	167
Figure 49:	BDNF increases the phosphorylation of Akt in sensory neurons.....	168
Figure 50:	Effect of PI3K inhibitors on BDNF dependent-growth in sensory neurons.....	169
Figure 51	Summary of results.....	179

List of Abbreviations

Ach – Acetylcholine

ANOVA – Analysis of variance

ANS – Autonomic nervous system

APAF1 – Apoptosis protease-activating factor 1

BH-3 – Bcl-2 homology domain-only

BDNF – Brain derived neurotrophic factor

BMP – Bone morphogenetic protein

CG – Cranial Ganglia

CNS – Central Nervous System

CNTF – Ciliary neurotrophic factor

DRG – Dorsal root ganglion

E – Embryonic

ERK - Extracellular signal-regulated kinase

FGF – Fibroblast growth factor

GITR - Glucocorticoid-induced tumor necrosis factor receptor-related protein

HBSS – Hank's balanced salt solution

HGF – Hepatocyte growth factor

HVEM – Herpesvirus entry mediator

IKK – I κ B kinase

Jnk - c-Jun N-terminal kinase

LIF- Leukemia inhibitory factor

LIGHT - Lymphotoxin-related inducible ligand that competes for glycoprotein D

binding to herpesvirus entry mediator on T cells

MAPK – Mitogen activated protein kinase

MAPKK - MAPK kinase

MAPKKK or MAP3K - MAPKK kinase

MEK - MAPK extracellular signalling-regulated kinase (ERK) kinase

NF- κ B – Nuclear factor kappa B

NG – Nodose ganglion

NGF – Nerve growth factor

NIK- NF- κ B inducing kinase

NTDs – Neural tube defects

NT-3 – Neurotrophin-3

NT-4 – Neurotrophin-4

OCIF - Osteoclastogenesis inhibitory factor

ODF - Osteoclast differentiation factor

OPG – Osteoprotegerin

OSM – Oncostatin M

P – Postnatal

p75 – Low affinity neurotrophin receptor

PCD – Programmed cell death

PI3K – Phosphatidylinositol 3-kinase

PKB - Protein kinase B

PKC – Protein kinase C

PLC γ – Phospho lipase C gamma
PNS – Peripheral nervous system
RANK – Receptor activator of NF- κ B
RANKL – Receptor activator of NF- κ B ligand
SCG – Superior cervical ganglion
siRNA – Small, interfering RNA
TGFs – Transforming growth factors
TNF – Tumor necrosis factor
TNF α – Tumor necrosis factor α
TNFR – Tumor necrosis factor receptor
TRAF - Tumor necrosis factor receptor associated factor
TRANCE – TNF-related apoptosis-inducing cytokine
Trk - Tropomyosin-related kinase
YFP – Yellow fluorescent protein

Acknowledgements

My thanks go to Prof Alun Davies for the opportunity to study under his supervision, and for his support over the many years this has taken. Also to Dr Gerard O'Keeffe and Dr Humberto Gutierrez for the hours spent discussing my experiments and always helping me to master the techniques required. I'd also like to thank Prof Vic Duance and the Postgrad board for finding the funding to allow me to continue my studies, when I needed it most. I couldn't have finished this without the help of all of the above.

My thanks to all the other members of the Davies group who've helped me over the years, especially Laura, to get through this difficult time. To Anna and Sam, friends for many years, and members of other labs in Biosi, always willing to lend an ear and enjoy a pint of black lager with me.

To my fiancé for her unconditional love and perpetual encouragement, and for never giving up on me. For knowing when to kick me into gear and when to let me rest. Your support has gotten me through.

And finally, to my family, for their support and love. My parents and my siblings, I love you all and am forever grateful.

Chapter 1

General Introduction

1.1 Brief overview of neuronal development

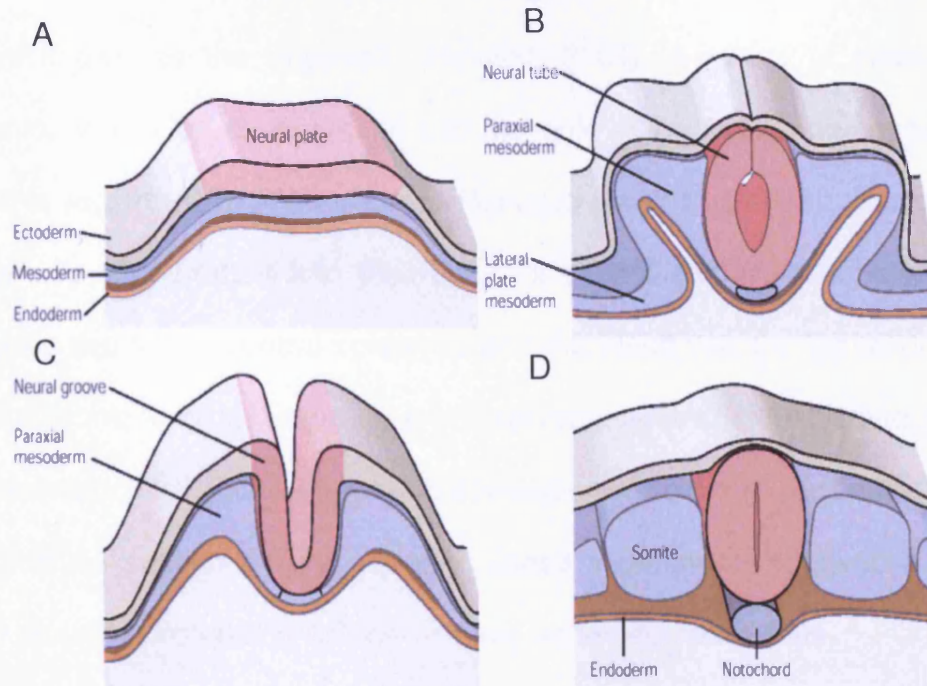
1.1.1 Introduction

The development of the mammalian brain and nervous systems is one of the most complex processes in nature requiring the formation, growth and refinement of an astonishing number of cells, around 10^{11} , and many more times that number of connections. The entire process requires an intricately controlled series of events to occur in sequence: the birth of neurons from progenitors, subsequent migration and the extension of processes to establish functional connections with target tissues. Firstly, I will provide an overview, in brief, of the events that occur during the stages of neuronal development, then I will detail the key players in the regulation of neuronal survival and neuritic outgrowth from these populations. Finally, I will discuss several families of extracellular and intracellular signalling molecules that are directly relevant for the research reported in this thesis, namely, the tumor necrosis factor (TNF) and TNF receptor (TNFR) superfamilies, the nuclear factor- κ B (NF- κ B) transcription factor family, the receptor activator of NF- κ B (RANK) signalling trio, the ERK1/ERK2 members of the MAPK family, and an important protein kinase, Akt, involved in intracellular signalling. The role of these proteins in the regulation of neuritic growth and neuronal survival are the focus of this research.

1.1.2 Neural induction

Following many rounds of division, the fertilized vertebrate embryo forms three layers: an internal endoderm, an intermediate mesoderm and an external ectoderm, in a process known as gastrulation. The vertebrate nervous system arises from a sheet of ectoderm cells, which lie along the dorsal midline, at the gastrula stage. These cells form the neural plate, which become the neural tube through the process of neurulation (Jessell & Sanes, 2000a). During neurulation, the neural plate buckles at the midline forming the neural fold. The dorsal tips of the neural folds then fuse, creating the tubular structure of the neural tube. Fig. 1A displays a schematic overview of this process, which will be reviewed in more detail in a subsequent section.

The neural tube forms the vertebrate central nervous system (CNS), the caudal region becoming the spinal cord and the rostral end becoming the brain (Jessell & Sanes, 2000a). The early stages of neural development are characterized by a rapid increase in cell numbers, and an uneven expansion of the different segments of the neural tube. Initially the rostral part of the neural tube forms three vesicles: the forebrain, midbrain and hindbrain vesicles, otherwise known as the prosencephalon, mesencephalon and rhombencephalon (Fig. 1B). The prosencephalon subsequently subdivides into the right and left telencephalic vesicles and the centrally located diencephalon and the rhombencephalon subdivides into the rhombencephalon and myelencephalon (Eagleson & Harris, 1990).



Three-vesicle stage

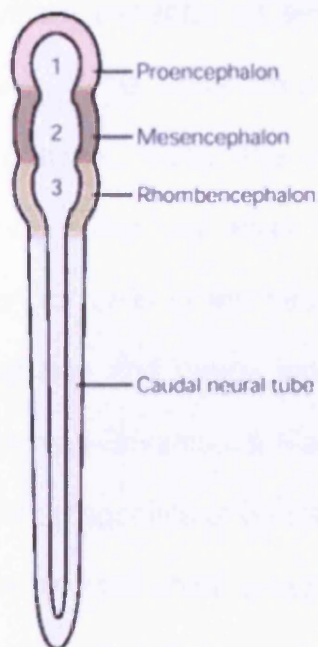


Figure 1: Formation of the neural tube and early vesicle formation. A. The neural plate (A) forms as a flat epithelial sheet that then rises (B) and folds towards the midline joining in the middle to form the neural tube (C). **B.** Three vesicle stage of early brain development. From Jessell & Sanes, 2000a.

The formation of the nervous systems is regulated by a region of the axial mesoderm known as the organizer (Harland, 2000). A series of pioneering experiments, conducted by Spemann and Mangold in the 1920s, demonstrated the role this region plays (Weinstein & Hemmati-Brivanlou, 1999). The dorsal blastophore lip was grafted into the region of a host amphibian embryo that usually gives rise to the ventral epidermis and the result was the formation of a second embryonic axis, including an entire nervous system. Transplanted tissue became the notochord, following normal development, however, host ectodermal cells formed the second embryonic axis. These experiments suggest that the organizer recruits surrounding ectoderm into a patterned neural tube.

The patterning of the nervous system depends on several inductive signals, which block the action of members of the Bone Morphogenic Protein (BMP) family such as BMP2 and BMP4 (Chitnis, 1999). The ectoderm is divided into three dorsoventral zones by BMP signalling from which the neural plate, neural crest and epidermis form. In order for cells in the neuroectoderm to become neurons they must adopt a neural fate and neural inducers such as chordin (Sasai et al., 1994), follistatin (Hemmati-Brivanlou & Melton, 1994) and noggin (Lamb et al., 1993) act as functional antagonists of BMPs. Other neural inducers include members of the Xnr3 family and the nodal antagonists Lefty and Antivin (Hansen et al., 1997; Meno et al., 1999) The ectoderm responds to BMP activation in a dose-dependent manner and a higher level of BMP activity correlates with an ectodermal fate, while a lower correlates with neuronal. BMP

signalling is constitutively active and neural inducers suppress BMP signalling inducing the expression of a number of transcription factors including Sox and Zic genes (Chitnis, 1999). These factors then promote the expression of genes required for neural and neuronal differentiation in the dorsal ectoderm. Other factors, such as fibroblast growth factors (FGFs) and Wnts are also necessary for patterning of the nervous system (Chitnis, 1999).

1.1.3 Formation of the neural tube

Neurulation occurs in four phases: formation of the neural plate or neural induction, shaping of the neural plate, bending of the neural plate and closure of the neural groove (Colas & Schoenwolf, 2001). The neural tube arises from dorsal midline ectodermal cells which thicken to become an initially pseudostratified epithelial area. Shaping of the neural plate involves apicobasal thickening of the ectoderm and extension so that it narrows mediolaterally and elongates rostrocaudally. Neural folds then form at the lateral extremes of the plate and begin to elevate and converge at the midline, establishing the neural groove. In humans, bending of the neural tube completes at the upper cervical region first. Bending occurs in two stages: furrowing and folding. Furrowing creates hinge points, three localized regions lying at the prechordal plate and paired dorsolateral hinge points, and folding occurs around these points. Folding around the median hinge point is referred to as elevation, and folding around the dorsolateral points, convergence.

Bending of the neural plate is driven by changes in neuroepithelial cells and changes in the adjacent cells of the epidermis. Furrowing at the median hinge point requires an inductive signal from the underlying notochord, in the form of Sonic Hedgehog, which is also involved in the formation of the floor plate of the neural tube (Jessell & Sanes, 2000). Ultimately, the neural folds are brought into contact resulting in fusing of the folds and the cells adhering to one another. This establishes the roof of the neural tube and neural crest cells form as the neural folds are elevating (Colas & Schoenwolf, 2001).

The failure of closure of the neural tube results in birth defects known as neural tube defects (NTDs) the most common of which are anencephaly, a failure of the rostral neural tube to close, and myelomeningocele, failure of fusion of the vertebral neural tube. Null mice have been generated that display NTDs implicating a range of factors in the regulation of closure of the neural tube (Copp, 2005).

It is clear that the position of cells in the neural tube is vital to their fate and that dorsoventral and anteroposterior positioning determines regional identity (Jessell & Sanes, 2000). Exposure to signalling molecules that are regionally restricted, and operate over these two axes, determine the fate of the cells. Important molecules include transforming growth factors (TGFs) (such as BMPs), hedgehogs, FGFs, Wnts and retinoids are all vital for the specification of cell fate (Lumsden & Krumlauf, 1996; Lee & Jessell, 1999).

1.1.4 Neuronal migration

The migration of neuronal and non-neuronal cells during development is a key process in the development of the CNS. Most central neurons arise in the ventricular zone and migrate to their final location before differentiating (Jessell & Sanes, 2000). These neurons then migrate along the surfaces of radial glial cells, using these cells as migratory guides, from ventricle to pia (Hatten, 1999). Once neurons reach the cortex, they organise themselves into layers with newer cortical neurons forming the outer zone, in an “inside-out” order (Angevine & Sidman, 1961).

There are two types of neuronal migration: the aforementioned radial migration along radial glial cells, in a direction perpendicular to the surface of the brain and tangential migration in line with the surface of the brain. The vast majority of neurons migrate via radial migration including cells of the cerebellar cortex, spinal cord, striatum and thalamus (Hatten, 1999). Populations that migrate via tangential migration include connections established between the median ganglionic eminence and the neocortex and hippocampus, and between the lateral ganglionic eminence and the olfactory bulb.

Several mouse models have facilitated our understanding of the process of neuronal migration. *Reeler*, a naturally occurring mouse mutant, displays an inversion of the normal “inside out” order of cortical neurons, along with a severe

cerebellar phenotype (Marin-Padilla, 1978). Another mouse model that has provided insights into neuronal migration is *weaver*, a model in which granule cell precursors die in ectopic positions due to an inability to migrate along glial fibres (Gao et al., 1993). In humans, the disorder periventricular heterotopia is caused by the failure of postmitotic neurons to leave the ventricular zone (Ekssioglu et al., 1996). Another disorder of neuronal migration in humans is lissencephaly, a condition that causes smoothing of the cortex and the presence of a four-layered cortex, in contrast with the usual six layers (Gleeson & Walsh, 2000).

1.1.5 Axonal growth and guidance

The establishment of functional connections requires the guidance of axons from neurons to their targets, over tremendous relative distances. Axons are guided by molecular cues encountered in their environments and there are four different mechanisms that guide growth cones: contact mediated attraction, chemoattraction, contact-mediated repulsion and chemorepulsion (Goodman, 1996). Guidance cues can be divided into four categories: long and short range attractive and long and short range repulsive cues. Long range attractive cues include netrins and short range attractive cues include laminins. Semaphorins and their receptors are an example of long range repulsive cues, while short range repulsive cues include ephrins and their receptors the Eph kinases. Other cues include DCC/neogenin, and the Unc5s, the slits and their receptors, the robos and the integrins (Jessell & Sanes, 2000).

Two of the most important regulators of axon guidance are the ephrins and their receptors, the Eph kinases, and G-protein-coupled receptors. Ephrins act in a gradient along the anteroposterior axis of the tectum, along with Eph kinases, along the anteroposterior axis of the retina, to help guide axons to their targets. G-protein-coupled receptors play critical roles in the guidance of olfactory receptors to specific targets within the brain, though in a very different way than the molecular gradients of other chemoattractants and the exact mechanism of action remains a mystery. Figure 2 shows a simplified diagram of some of the key regulators of axonal attraction and repulsion. The intracellular mechanisms that control neuronal growth will be discussed in a subsequent section.

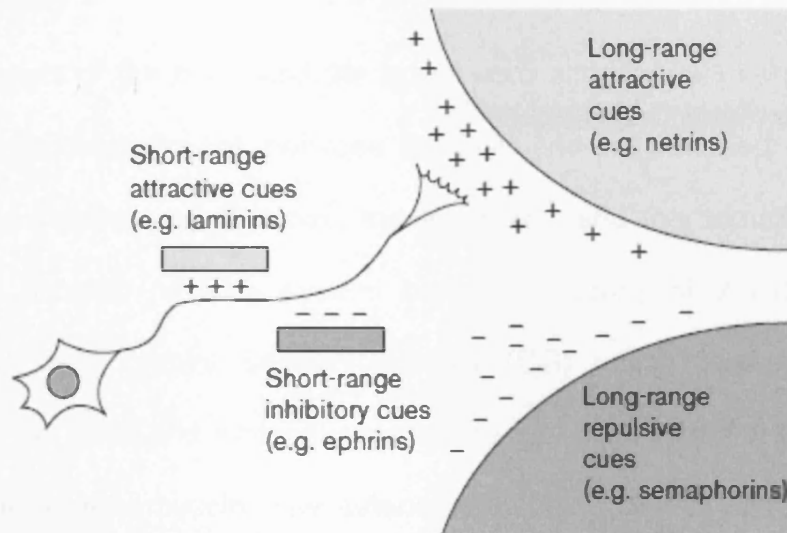


Fig 2: Molecular mechanisms of axonal growth and guidance. Four major classes of signals contribute to axon guidance: short and long range attractors and repulsors. An example is listed for each class. Adapted from Jessell & Sanes, 2000.

1.2 Organisation and development of the peripheral nervous system

1.2.1 Introduction

The CNS consists of the brain and the spinal cord and the peripheral nervous system (PNS) provides the link between the CNS and the periphery. The PNS can be divided into two subdivisions: the autonomic and the somatic nervous systems. The somatic nervous system contains neurons of the dorsal root ganglia (DRG) and cranial sensory ganglia (CG) which convey sensory information to the CNS and motoneurons whose cell bodies reside in the CNS and innervate skeletal muscle. The autonomic nervous system consists of the sympathetic, parasympathetic, and enteric nervous systems and regulates motor control of the viscera, smooth muscles and exocrine glands. The work contained in this thesis focuses on the role of the RANK receptor, and its associated ligands, in the regulation of neuritic growth from discrete populations of sensory and sympathetic neurons during development. The role of a MAPK family member, ERK, and the Akt family will also be explored. In this section I shall provide an overview of the organisation of the PNS and of the embryonic development of this nervous system.

1.2.2 Organisation of the somatic PNS

The somatic PNS is organized into twelve pairs of cranial nerves and thirty-one pairs of spinal nerves and these provide the CNS with sensory information from a range of inputs and innervate skeletal muscle throughout the body. There are

eight pairs of cranial sensory ganglia and the axons of these nerves form part of five of the twelve cranial nerves. The trigeminal ganglion is located on cranial nerve V and innervates mechanoreceptors, thermoreceptors and nociceptors of the face, nasal and oral cavities. The geniculate ganglion is located on cranial nerve VII and this nerve cluster innervates taste buds on the anterior two thirds of the tongue. Cranial nerve VIII contains fibres of the vestibular and spiral ganglia, which innervate inner ear hair cells. The petrosal ganglion, located on cranial nerve IX, innervates sensory receptors of the carotid body, as well as the taste buds in the posterior one third of the tongue. The superior glossopharyngeal ganglion is part of cranial nerve IX and innervates the skin of the pinna and tympanic membrane. Finally, the jugular and nodose ganglia form part of cranial nerve X and innervate various sensory targets in the pharynx, thorax and abdomen. Figure 3 illustrates the organization of the cranial nerves.

Each spinal nerve connects to the spinal cord via a dorsal root and a ventral root. The dorsal root consists of sensory fibres and their cell bodies, which are located in the dorsal root ganglia. The ventral root contains motor fibres with cell bodies located in the ventral grey matter. Just before the nerve leaves the vertebral column, via an intervertebral foramen, the roots join to form the spinal nerve and each spinal nerve then splits in dorsal and ventral rami, which consist of mixed sensory and motor fibres.

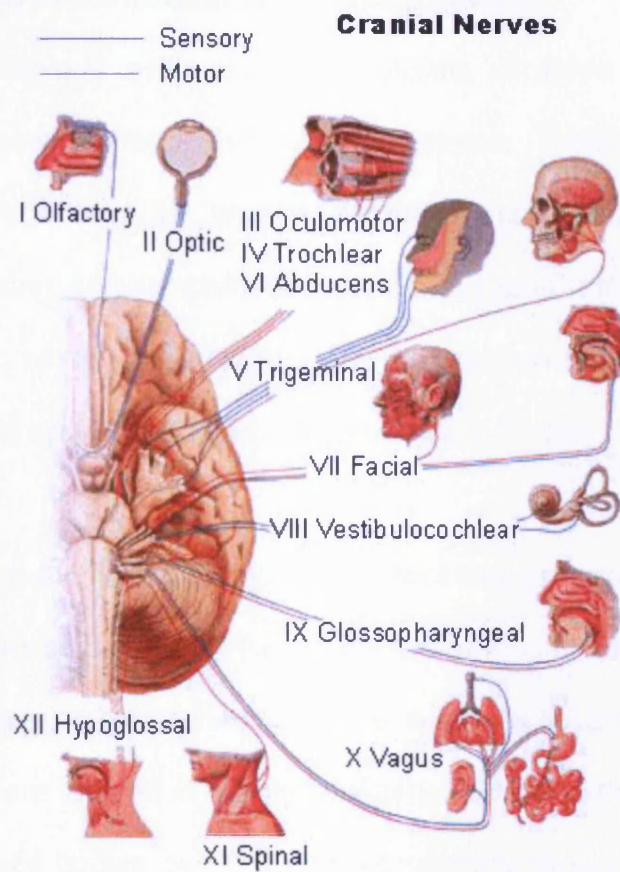


Fig 3: Organisation of the cranial nerves. An illustration depicting the cranial nerves and the tissues they innervate (www.web-books.com).

1.2.3 Organisation of the autonomic nervous system

The autonomic nervous system (ANS) consists of three subdivisions: the sympathetic, parasympathetic and enteric systems. These regulate visceral sensation, motor control of the viscera, smooth muscles and exocrine glands. The sympathetic and parasympathetic nervous systems maintain a balance in the body between energy consumption and the conservation of resources and the enteric nervous system regulates smooth muscle function in the gut.

The divisions of the ANS are organised in distinct anatomical ways. Unlike motor neurons of the somatic nervous system, whose neurons project directly from the CNS to their targets, motor neurons of the sympathetic and parasympathetic nervous systems are located in autonomic ganglia outside the CNS (Iverson et al., 2000). The cell bodies of preganglionic neurons are located in the spinal cord or brain stem, and their axons synapse with postganglionic neurons whose cell bodies are located in autonomic ganglia. Preganglionic sympathetic fibers emerge from thoracic and upper three lumbar segments and synapse with neurons in the paravertebral sympathetic chain ganglia and prevertebral ganglia. The preganglionic synapses release the neurotransmitter acetylcholine (ACh), while most postganglionic synapses utilise noradrenaline.

Preganglionic parasympathetic nerves originate from the brainstem and sacral spinal cord and travel in sacral spinal nerves or cranial nerves III, VII, IX and X.

Parasympathetic preganglionic neurons lie within the Sacral 2-4 segments of the spinal cord and within the brain stem, and synapse on postganglionic neurons near the organs they innervate. Cranial nerve X innervates the heart, lungs, stomach, upper intestine and ureter, while the remaining cranial nerves innervate the iris and salivary glands. As with the sympathetic nervous system, preganglionic neurons liberate Ach onto their postganglionic partners. However, unlike sympathetic neurons, postganglionic neurons of the parasympathetic nervous system release Ach (Nolte, 1999). Figure 4 shows an illustration of the organization of the DRG and Figure 5 shows a schematic illustration of the anatomical organisation of the sympathetic and parasympathetic divisions of the PNS.

The enteric nervous system consists of a mostly autonomous network that regulates the function of the gastrointestinal tract, pancreas and gallbladder. It contains local sensory neurons and interneurons, along with motor neurons, that extend along the entire length of the gastrointestinal tract in two plexuses: the myenteric plexus and the submucous plexus and these regulate the secretory functions of the gut and gut motility, respectively.

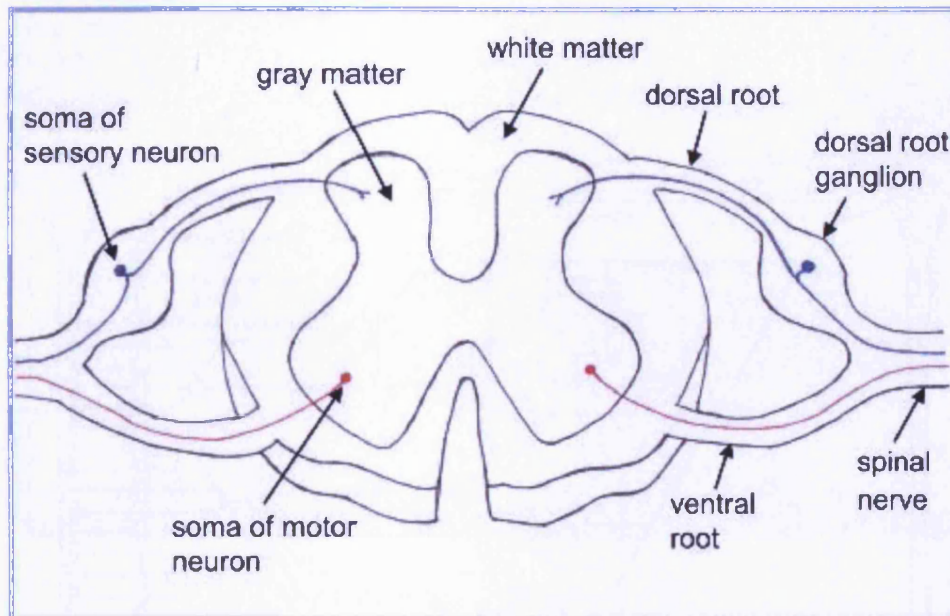


Fig 4. Anatomical organisation of the DRG.
(www.acceleratedcure.org/msersources/neuroanatomy).

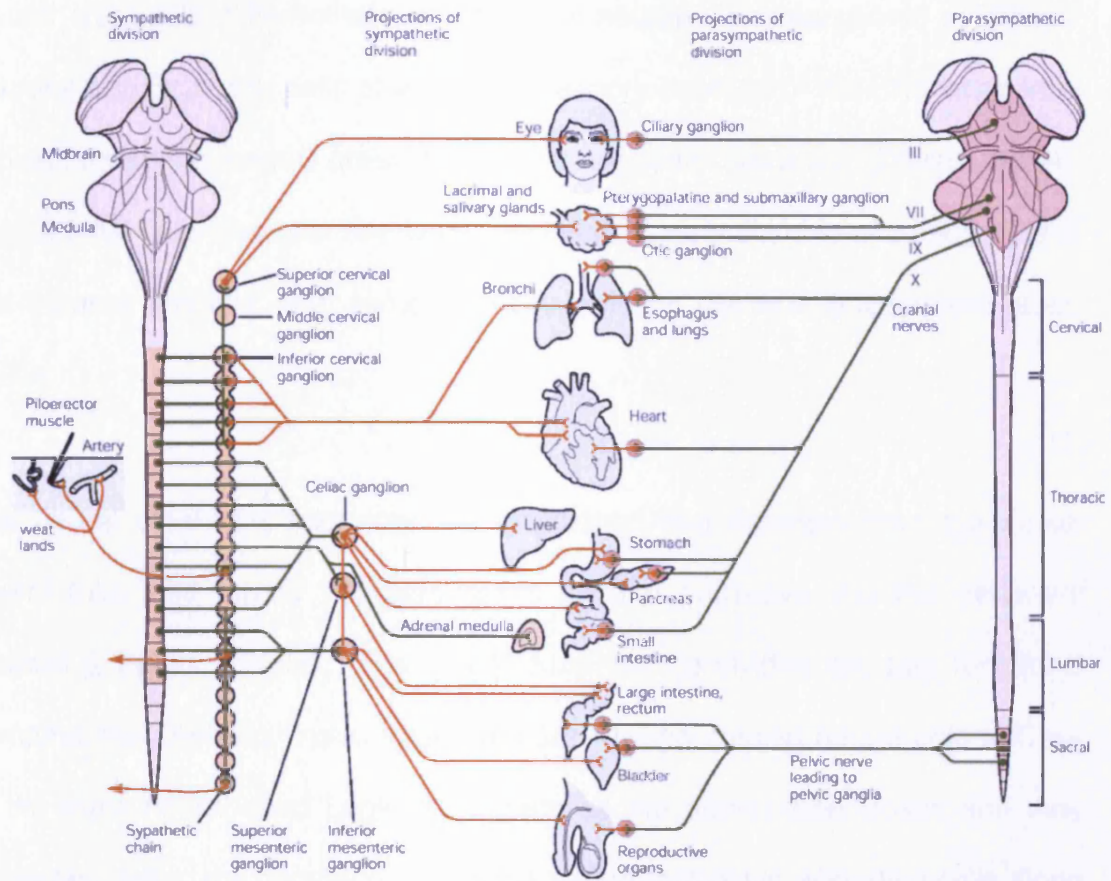


Fig 5: Sympathetic and parasympathetic divisions of the ANS. Diagram showing the organisational structure of the sympathetic (left) and parasympathetic (right) nervous systems and some of the targets they innervate. From Iverson et al., 2000.

1.2.4 Development of the peripheral nervous system

Neural crest cells differentiate into sensory neurons, postganglionic autonomic neurons and Schwann cells of the PNS. Sensory neurons of the PNS arise from two sources: the neural crest and the neurogenic placodes (Davies, 1994). Neural crest cells also give rise to pigment cells, catecholamine-secreting cells of the adrenal medulla and some cranial cartilage (Selleck & Bronner-Fraser, 1995).

The neural crest is a migratory cell population that emerges from the dorsal neural tube and rapidly migrates along several pathways into the periphery (Jessell & Sanes, 2000a). The neural crest can be divided into four functional domains: the cephalic, trunk, vagal and sacral, and cardiac neural crests. Cells of the trunk neural crest begin to migrate as the neural tube closes and they follow two paths: the dorsolateral and the ventral pathways. Migrating cells along the dorsolateral pathway produce melanocytes and travel into the epidermis. Cells that follow the ventral pathway become the DRG, sympathetic ganglia, and the adrenal medulla. Cranial neurons are derived from the cephalic neural crest, along with the dorsomedial part of the trigeminal ganglion, the trigeminal mesocephalic nucleus and the jugular ganglion. Parasympathetic ganglia of the gut are derived from the vagal and sacral neural crests. The molecular basis of neural crest formation is incompletely understood, although BMP and FGF signalling have both been implicated in neural crest induction, as has Wnt

signalling (Selleck & Bronner-Fraser, 1995; LeBonne & Bronner-Fraser, 1998; Brault et al., 2001).

Cranial sensory neurons are derived from two sources: neurogenic placodes, thickenings of ectodermal tissue induced by signals from the surrounding tissues, and neural crest cells. Neurogenic placodes can be divided into two groups: dorsolateral and epibranchial, based on their position in the developing cranium (Ayer-Le Lievre & Le Douarin, 1982). Dorsolateral placodes give rise to the vestibular and ventrolateral trigeminal ganglia and epibranchial to nodose, petrosal and geniculate ganglia.

1.3 Regulation of neuronal survival in the PNS

1.3.1 Introduction

Key factors in the regulation of apoptosis have been identified and include members of the Bcl-2, apoptotic protease activating factor (APAF) and caspase families (Jessell & Sanes, 2000; Cory et al., 2003). Caspases are final common agents for programmed cell death (PCD) in cells and Bcl-2 regulates the activity of this family. Neurotrophic factors promote the survival of neurons by suppressing the action of this apoptotic program. There are two distinct pathways crucial for PCD: the intrinsic pathway and the extrinsic pathway. The intrinsic pathway is activated by developmental cues and cytotoxic insults and is tightly controlled by Bcl-2 family member proteins. The extrinsic pathway is triggered by death receptor activation and leads to the activation of caspases independently of Bcl-2. Figure 6 shows a schematic illustration of the way apoptosis and members of the Bcl-2 family are modulated by neurotrophins.

The Bcl-2 family can be divided into three sections: pro-apoptotic, anti-apoptotic and Bcl-2 homology domain-only (BH-3) proteins (Cory et al., 2003). Proapoptotic members include BAX, BAK and BOK; anti-apoptotic include Bcl-2, Bcl-XL, Bcl-W and Bcl-B; and BH-3 only proteins include members such as BAD, BIK, BID, HRK, BIM, NOXA and PUMA (Reed, 2008). The method of action of pro-apoptotic members, such as BAX, is an interesting one. BAX permeabilises the membrane of the mitochondria, leading to the release of apoptogenic

molecules including cytochrome c and DIABLO. Cytochrome c then binds to APAF to form the apoptosome, which binds to caspase 9 and promotes apoptosis (Youle & Strasser, 2008). In neurons a balance is maintained between survival promoting signals such as neurotrophins, and death signals. NGF promotes survival by activation of pro-survival pathways including Akt and MAPK pathways. These support survival by inhibiting pro-apoptotic pathways such as Bad and Forkhead and promoting pro-survival pathways including CREB (Yuan & Yankner, 2000).

The exact reason why so many neurons are born that then undergo PCD is still a matter for debate. It has been suggested that this allows flexibility within neuronal systems and recovery from insult during development (Pettman & Henderson, 1998). In the nematode *C. Elegans* the number of cells apoptosing is surprisingly specific, with 105 out of 1090 neurons undergoing cell death. This function is thought to allow the generation of subtly different structures from initially similar lineages and the generation of sexually dimorphic structures (Bottjer & Arnold, 1997). Knockout mice have been generated for some of the key regulators of PCD. Bax knockout mice are relatively normal, as are transgenic mice over-expressing Bcl-2 (Knudson et al, 1995; Martinou et al., 1994) and both mice display increased numbers of neurons but normal life spans.

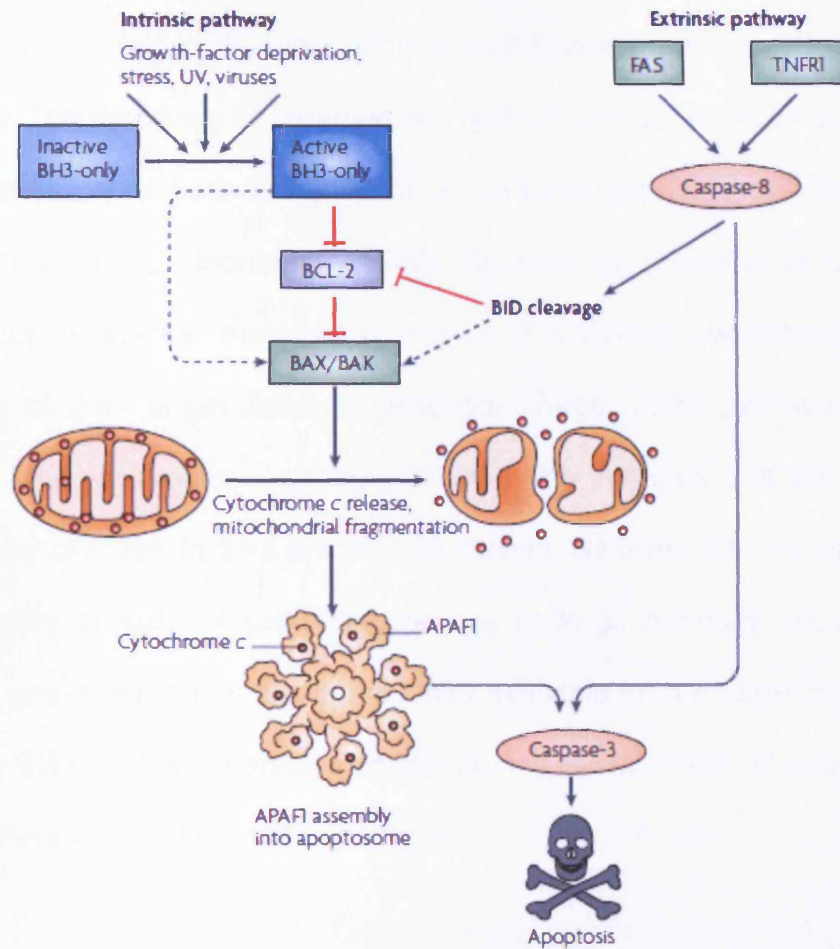


Fig 6: Extrinsic and intrinsic control of apoptosis. The extrinsic pathway of apoptosis can be activated by cell surface receptors such as Fas and TNFR1. The intrinsic pathway begins with induction of BH3 and the inactivation of various BCL-2 family members, activation of BAX and/or BAK. This leads to cytochrome C release, APAF-1 and caspase-3 activation. From Youle & Strasser, 2008.

1.3.2 The neurotrophic theory

The neurotrophic theory is one of the fundamental tenets of modern neuroscience. The discovery of nerve growth factor (NGF) provided an answer to the central question of how the survival of neuronal populations is regulated during development (Levi-Montalcini, 1987). Neurons are produced in far larger quantities than necessary; therefore a means of matching populations to the requirements of their target fields is essential. Target fields produce limiting quantities of NGF and other neurotrophins and only neurons that are able to obtain a supply of these factors are able to survive. Neurons that are unable to secure a supply of survival promoting factors undergo naturally occurring or PCD. In this way, the amount of trophic factor available from a target influences the resultant size of the innervating population (Davies, 1988; Barde, 1989). Figure 7 displays an illustration of this theory.

Since the discovery of NGF a plethora of evidence has increased our understanding of the way in which neuronal survival is regulated. Administration of anti-NGF antibodies *in vivo* eliminates sensory and sympathetic neurons dependent on NGF, while administration of NGF prevents naturally-occurring neuronal death (Levi-Montalcini & Booker, 1960; Yip, et al., 1984; Davies et al., 2003). Knockout mice lacking NGF or its receptor tyrosine kinase (TrkA) decreases sensory and sympathetic NGF-dependent populations (Crowley et al., 1994; Smeyne et al., 1994). Since the initial publicationn of the neurotrophic

theory, evidence has arisen that complicates the theory. Neurons require trophic support before and after synaptogenesis and from sources other than their target fields (Davies, 2003); many neuronal populations switch their neurotrophic requirements during development (Buchman & Davies, 1993; Wyatt et al., 1997; Kuruvilla et al., 2004) and PNS neurons survive independently of neurotrophic factors *in vitro* at the age when axons are beginning to sprout (Davies, 1994). The period of neurotrophin independence correlates precisely with the distance required for axons to reach their targets (Davies, 1989; Vogel & Davies, 1994).

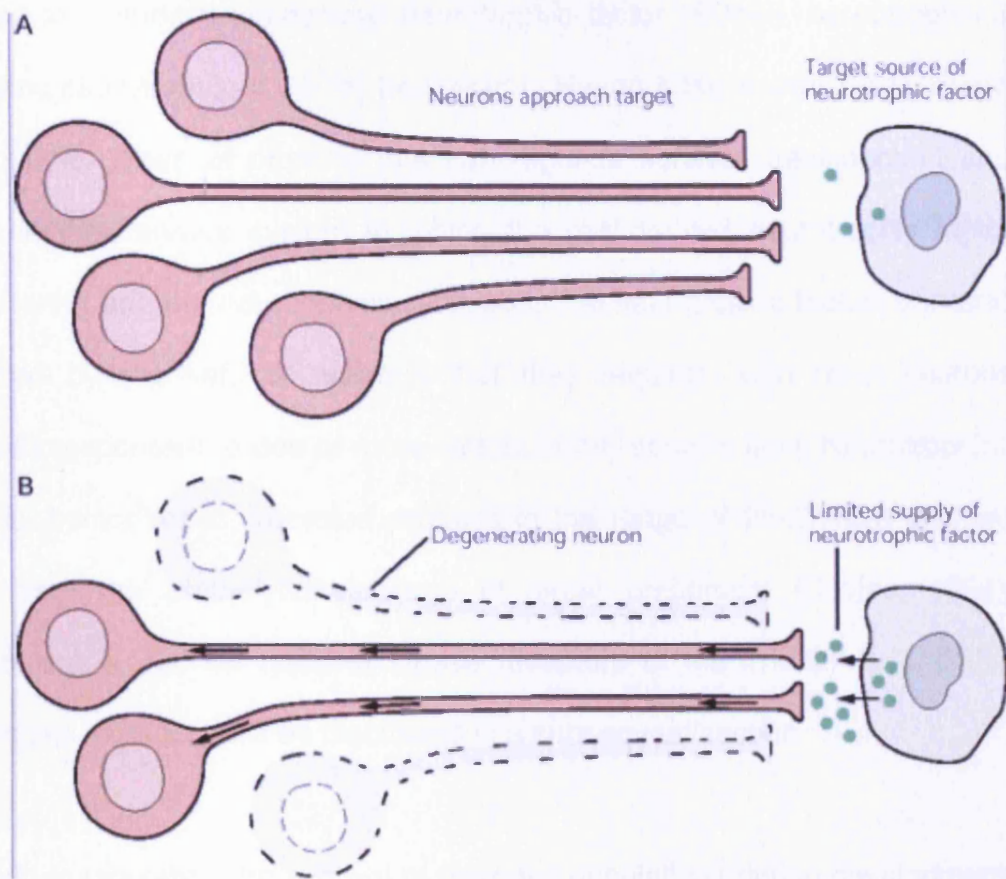


Fig 7: The neurotrophic theory. As neurons extend axons towards targets (A) a limited amount of survival promoting factor is secreted by the target. Neurons able to acquire the factor survive (B), those unable apoptose and neuronal population size is matched to target requirements.

Since the initial discovery of NGF, the neurotrophin family in mammals has been expanded to include brain-derived neurotrophic factor (BDNF), neurotrophin-3 (NT-3), and neurotrophin-4 (NT-4) (reviewed in Huang & Reichardt, 2001). There are also other types of proteins that can regulate survival, development and function in the nervous system including the glial-derived neurotrophic factor (GDNF) family and the neurotrophic cytokines. The neurotrophic factors can also be divided by the sets of neurons that they regulate, with most neurons specifically responsive to one or more factors at any specific time. Neurotrophins are basic, homodimeric, secreted proteins in the range of 25-27 kDa and are derived from the proteolytic cleavage of larger precursors (Davies, 1994). Neurotrophins signal via tyrosine kinase receptors of the Trk family and this family and its members will be discussed in a subsequent section.

In addition to regulating the survival of neuronal populations during development, the neurotrophin family has a range of other functions including the regulation of cellular proliferation, process outgrowth, and synaptic plasticity (Davies, 2000; Bidel & Barde, 2000; Thoenen, 2000). The original work contained in this thesis explores the role of specific receptors and intracellular mediators in the regulation of neuronal survival and outgrowth by neurotrophins. The neurotrophic requirements of specific ganglia have been well documented. In the following section, I will describe the neurotrophic requirements of ganglia that are relevant for the work of this thesis. I will then describe the biology of selected neurotrophins and their receptors that are relevant for this work.

1.3.3 Neurotrophic requirements of selected peripheral ganglia

The studies described in this thesis were performed on sensory neurons of the mouse nodose ganglion (NG), trigeminal ganglia (TG) and the sympathetic neurons of the superior cervical ganglion (SCG).

Nodose neurons are placode derived general visceral sensory neurons that innervate most of the thoracic and abdominal viscera. The majority of neurons of the mouse nodose ganglion survive and extend neurites when cultured in media containing BDNF, at embryonic and postnatal stages (Lindsay & Rohrer, 1985; Davies & Lindsay, 1986; Davies et al., 1986; Davies et al., 1993) and administration of BDNF *in vivo* rescues neurons that would otherwise die (Hofer & Barde, 1988). The survival of nodose neurons has also been shown to be regulated by NT-3 and NT-4 (Hohn et al., 1990; Davies et al., 1993b). Null mice have been generated for each of these factors and show increased cell death in the nodose population (Ernfors et al., 1994a; Liu et al., 1995; Erickson et al., 1996; Elshamy et al., 1997; Forgie et al., 2000). A small subpopulation of nodose neurons are also supported by NGF, early in development, and NGF knockout mice show a small decrease in the size of the nodose population (Forgie et al., 2000). Other factors have also been shown to support subpopulations of nodose neurons including the neurotrophic cytokines, CNTF, LIF, OSM and CT-1 (Horton et al., 1993; Davies et al., 1993; Horton et al., 1998). *In vitro* nodose neurons can be supported by BDNF and these neurotrophic cytokines.

The neurons of the TG are a discrete population of cutaneous sensory neurons that innervate the anterior part of the head (Davies, 2003). During early embryonic development trigeminal neurons are dependent upon a supply of BDNF and NT-3, but switch their dependence to NGF later in development (Buchman & Davies, 1993). These changes in neurotrophin responsiveness are mirrored by changes in expression of the Trk receptors in the neurons. Early in development TrkB and TrkC are highly expressed but later on the expression of these two receptors decreases, and the expression of TrkA mRNA increases (Ernfors et al., 1992; Arumae et al., 1993; Wyatt & Davies, 1993).

Neurons of the sympathetic SCG are supported by a variety of factors throughout their development. Both artemin and hepatocyte growth factor play roles in the development of this neuronal population (Maina et al., 1998; Andres et al., 2001; Baloh et al., 1998). SCG neurons respond to NGF at E14 and are dependent on this neurotrophin for survival during their development (Wyatt & Davies, 1995). Later in the development of this neuronal population SCG neurons respond to both NGF and NT-3 and this period corresponds to the expression of TrkA (Wyatt et al., 1997; Kuruvilla et al., 2004). Postnatal SCG neurons have also been shown to respond to LIF, CNTF and HGF (Kotzbauer et al., 1994; Thompson et al., 2004).

1.3.4 NGF

This neurotrophin was first discovered was by Rita Levi-Montalcini & Viktor Hamburger during studies of sensory and sympathetic ganglia of eight-day chick embryos (Levi-Montalcini, 1953). When embryonic day 8 (E8) ganglia were cultured close to fragments of mouse sarcoma 180 or 37, a dense halo of nerve fibres was seen in 12-24 hours. This was found to be due to the presence of a protein later dubbed “the” nerve growth factor. This factor was later isolated and purified so that biochemical and other studies could be performed (Cohen et al., 1954). Injection of NGF-specific antibodies into newborn mammals resulted in a marked loss of sympathetic neurons confirming the *in vivo* relevance of NGF (Levi-Montalcini & Booker, 1960).

Additional experiments clarified the role of NGF in the development of neuronal populations. Administration of NGF during the period of naturally occurring neuronal cell death prevents the death of these neurons (Davies, 2003). Mice lacking the NGF or the receptor tyrosine kinase (TrkA) genes show decreased numbers of sensory neurons and sympathetic neurons (Crowley et al., 1994; Smeyne et al., 1994). NGF is crucial for the development of the nervous system, especially for the survival of small nociceptive sensory neurons and sympathetic neurons (Farinas, 1999). As with other neurotrophins, NGF is synthesized in a precursor form and then cleaved to the mature form. NGF has been found to be

expressed in many regions of the CNS including neocortex, basal forebrain and hippocampus (Johnston, 1987).

1.3.5 BDNF

BDNF was first isolated from mammalian brain and was subsequently found to prevent the death of sensory neurons *in vivo* (Barde et al., 1982; Hofer & Barde, 1988). BDNF supports the survival of neuronal populations including trigeminal neurons, which respond to BDNF for a restricted period in their development, and neurons of the nodose, petrosal, geniculate and vestibular ganglia (Lindsay et al., 1985a; Davies et al., 1986b; Horton et al., 2001; Hofer & Barde, 1988; Tucker et al., 2001). BDNF also promotes neurite growth from neurons of the nodose, DRG, sympathetic and vestibular ganglia (Paves et al., 1997; Lentz et al., 1999; Tucker et al., 2001).

As with NGF, BDNF is synthesised as a precursor and then cleaved to form the mature, biologically active form (Lee et al., 2001), and BDNF shares 50% homology with NGF (Barde et al., 1982). BDNF is widely expressed in CNS regions, including the cerebral cortex, cerebellum, hippocampus, basal forebrain, hypothalamus striatum, and brainstem (Kawamoto, et al., 1996). BDNF knockout mice display severe defects in sensory neuronal populations essential for survival (Jones et al., 1994; Ernfors et al., 1994a). BDNF has also been implicated in a variety of developmental processes including proliferation,

learning and memory, long term potentiation, and synaptic plasticity (Tapia-Arancibia et al., 2004; Kaftiz et al., 1999; Bramham et al., 2005).

1.3.6 CNTF

Ciliary neurotrophic factor (CNTF) is a neurotrophic cytokine that supports the survival a variety of neuronal populations *in vitro* including nodose neurons and neurons of the parasympathetic ciliary ganglion, and promotes the survival of a subset of trigeminal neurons during the late fetal period (Barbin et al., 1984; Horton et al., 2001). CNTF has also been implicated in the regulation of neurite growth and axon regeneration in the developing and mature nervous systems (Siegel et al., 2000). CNTF was purified from embryonic chick eye (Barbin et al., 1984) and bears similarity to other neuropoietic cytokines including LIF, IL-6, OSM and G-CSF (Taga & Kishimoto, 1992). CNTF binds to a receptor complex consisting of gp130, leukaemia inhibitory factor receptor β , and CNTF receptor α (Stahl & Yancopoulos, 1994).

1.3.7 Trk receptors

Neurotrophins signal via a family of receptors known as the tropomyosin-related kinase (Trk) receptors as well as the common neurotrophin receptor p75, which is a member of the TNFR superfamily. The Trk family consists of 3 receptors: TrkA, TrkB and TrkC. Trk A was the first of these receptors to be discovered, as an oncogene product in a human colon carcinoma (Martin-Zanca et al, 1986; Kuruvilla et al., 2004). NGF binds to and activates TrkA (Kaplan et al., 1991;

Klein et al., 1991). TrkB and TrkC were identified by homology cloning to and were found to be receptors for BDNF (TrkB) and NT4 (TrkB), and NT3 (TrkC) respectively (Huang & Reichardt, 2001; Bibel & Barde, 2000). Figure 8 shows an illustration of the neurotrophins and the respective Trks they bind.

Activation of the Trk receptors leads to phosphorylation of tyrosine residues on the cytoplasmic domains of the receptors. This in turn leads to recruitment of adaptor proteins and coupling to intracellular signalling cascades including the Ras/ERK (extracellular signal-regulated kinase) protein kinase pathway, the phosphatidylinositol-3-kinase (PI3k)/Akt pathway and phospholipase C (PLC)- γ 1 (Huang & Reichardt, 2003). Akt and ERK have been shown to play a role in the regulation of survival and neuritic outgrowth mediated by neurotrophins and other factors in a variety of neurons (Huang & Reichardt, 2003). NGF was shown to be internalized by a receptor-dependent process, which was energy and microtubule dependent, and transported along axons for long distances in signalling endosomes to the cell soma (Shooter, 2001; Reichardt, 2006). Local signalling was shown to regulate the motility of growth cones, while cell survival and gene expression is regulated by signalling in the cell soma.

1.3.8 p75

The p75 common, low-affinity receptor binds all neurotrophins with equal effectiveness (Davies, 1994; Davies, 2003). p75 was cloned in the mid-eighties as a receptor for NGF (Chao et al., 1986; Radeke et al., 1987) and has since

been shown to enhance the survival response of embryonic sensory and postnatal sympathetic neurons to NGF (Lee et al., 1992; Lee et al., 1994; Davies, 1994; Lee et al., 1994a). However, there is also evidence that p75 promotes neuronal death in the absence of Trk signalling (Rabizadeh et al., 1993; Barrett et al., 1994; Domeniconi et al., 2007).

A Neurotrophin receptor interactions

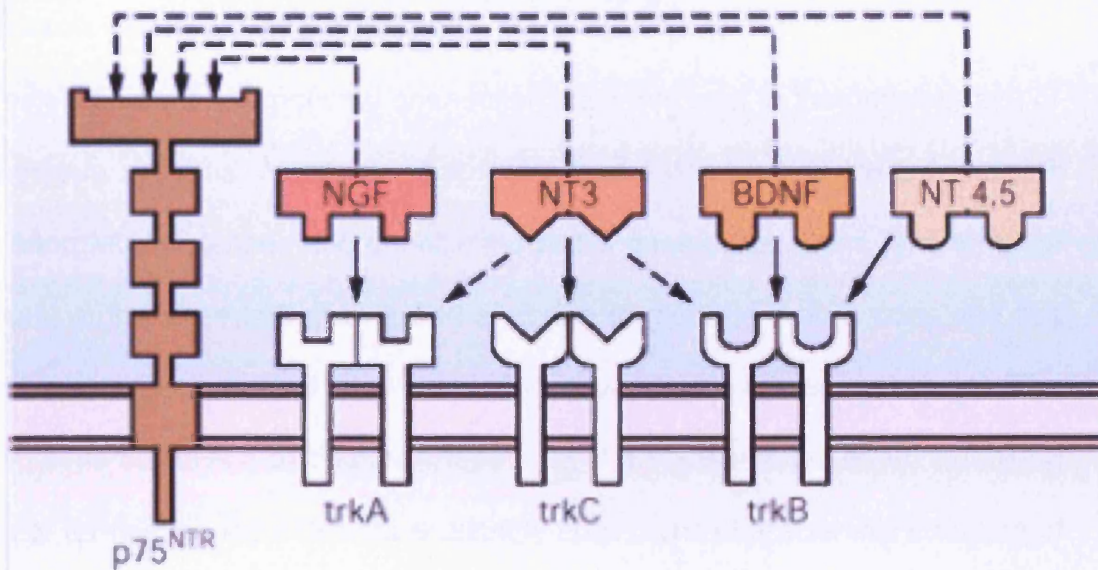


Fig 8: The neurotrophins and their receptors. Schematic illustration of the neurotrophins and the receptors they bind to. NGF binds TrkA, BDNF and NT-4 bind TrkB and NT-3 binds all 3 Trk receptors, but TrkC with more specificity. Adapted from Jessell & Sanes, 2000c.

1.4 Regulation of neurite outgrowth

1.4.1 Axon extension and guidance

The establishment of functional connections is a key step in the development of the nervous systems. Neurons must locate and extend axons towards targets over enormous distances and specific molecular cues guide axons. The terminal segment of the axon is a specialised structure termed the growth cone and this structure navigates through the embryonic environment towards its target. The growth cone displays a distinctive shape; that of an outstretched hand, extending “fingers” termed filopodia (Sanes & Jessell, 2000). The characteristic structure of the growth cone is shaped by fibrillar structures including microfilamentous actin and microtubules and contains receptors for guidance cues. The filopodia reach into the external environment and detect these extrinsic cues, some of which attract and others repel (Gallo & Letourneau, 1998). These cues include semaphorins, netrins, slits, which are almost all secreted molecules, ephrins, which are tethered to the plasma membrane, and morphogens and their associated receptor systems (Goodman, 1996; Grunwald & Klein, 2002).

1.4.2 The role of neurotrophic factors in regulating neurite outgrowth from PNS neurons

The role of neurotrophic factors in promoting neurite outgrowth *in vitro* is well established (Tucker et al., 2001; Davies, 2000; Kuruvilla et al., 2004). Due to the regulation of neuronal survival by these factors, their role in neurite growth *in*

vivo is more complex. The ability of neurons to initially extend axons in the absence of neurotrophin/Trk signalling also further complicates matters (Davies, 1994). Evidence that neurotrophins promote growth *in vivo*, as well as survival, was finally provided by the generation of mice deficient in NGF or TrkA, which were then crossed with BAX deleted mice (Patel et al., 2000; Glebova & Ginty, 2004). BAX deletion prevents the death of peripheral neurons (Deckwerth et al., 1996), facilitating study of the growth promoting effects of NGF/TrkA independently of their effects on neuronal survival. In these mice, DRG neurons extend axons through the dorsal roots and into the dorsal horn; however, superficial cutaneous innervation is absent suggesting a role for NGF in the regulation of peripheral target field innervation.

The use of ectopic sources of neurotrophins, combined with function blocking antibodies, has also clarified the role of these factors in the regulation of neurite growth (Tucker et al., 2001). *In vivo* gain-of-function experiments have also demonstrated the role of NGF in promoting neurite outgrowth from neuronal populations (Albers et al., 1994). A more recent study has reported the regulation of sympathetic development by NGF and NT-3 through TrkA, in a sequential and complementary manner (Kuruville et al., 2004). NT-3 was found to promote outgrowth but not survival, while NGF regulates both survival and outgrowth.

1.4.3 Intracellular signalling pathways downstream of neurotrophic factors regulating neuronal survival and neurite outgrowth

The activation of Trk receptors, through interaction with neurotrophins, leads to the phosphorylation of several conserved cytoplasmic tyrosine residues and the subsequent recruitment of various intracellular signalling mediators (Huang & Reichardt, 2003). Phosphorylation of additional residues creates docking sites for adaptor proteins containing phosphotyrosine-binding domains or src-homology-2 motifs (Huang & Reichardt, 2001). The Shc adaptor protein family, SchA, SchB and SchC, bind specific sites in Trk receptors, activating signalling pathways involving the small GTPase Ras and the serine/threonine kinase Raf. Downstream targets include PI3K, PLC- γ and MAPK family members and these signalling members regulate neuronal survival and growth (Patapoutian & Reichardt, 2001; Huang & Reichardt, 2003; Chao, 2003).

Neurotrophin signalling in the cell soma and nucleus is vital for neuronal survival (Atwal et al., 2000). Therefore investigations into the method of transport of neurotrophins from the periphery to the cell soma were conducted. NGF was shown to be internalised by a receptor-dependent process, which was energy and microtubule dependent, and transported along axons for long distances in small, membraneous vesicles to the cell soma (Shooter, 2001; Reichardt, 2006). Neurotrophins are localised within endosomes with the Trk receptors and activated signalling intermediates, such as PLC γ (Teng et al., 2005). Internalisation of NGF-TrkA and retrograde transport to the soma is necessary

for neurotrophin survival signal transmission (Rabizadeh et al., 1993; Barrett & Bartlett, 1994).

Two important signalling mediators, Akt and ERK, have been shown to act downstream of neurotrophins. Both ERK and Akt regulate the survival of neuronal populations (Vailliant et al., 1999). Akt promotes cell survival by blocking the action of pro-apoptotic proteins, such as BH3 only proteins, preventing binding to Bcl-2 protein members. Akt also blocks transcription factors FOXO and p53 thereby preventing the expression of BH-3 only proteins. Akt activation then prevents apoptosis by blocking the processing of pro-caspase-9, by the previously mentioned routes (Manning & Cantley, 2007). ERK and Akt have also been shown to contribute to the regulation of neurite growth in several neuronal populations including striatal and SCG neurons, cerebellar and sympathetic neurons (Gavalda et al., 2004; O'Keeffe et al., 2008; Dudek et al. 1997; Philpott et al., 1997; Crowder & Freeman, 1998). The role of ERK in the regulation of NGF-induced neurite outgrowth in PC12 cells has been well established (Cowley et al., 1994; Markus et al., 2002) and the role of Akt and ERK in the regulation of neuronal survival and outgrowth will be discussed further in subsequent sections.

1.5 The receptor activator of NF- κ B

1.5.1 The tumor necrosis factor superfamily

The receptor activator of NF- κ B ligand (RANKL), and its associated receptor, RANK, are the focus of this research. These proteins are members of the tumor necrosis factor (TNF) superfamily and receptor superfamily, respectively. These families consist of over 40 members that are vital in the regulation of the immune system (Hehlgans & Pfeffer, 2005). TNF α , after which the family was named, was initially discovered as an endotoxin-induced serum factor that was able to cause necrosis of specific tumor cell types (Bessis et al., 2005). TNF α is now known as a prototypic inflammatory cytokine and has been found to be involved in a range of cellular processes including apoptosis, necrosis, inflammation, proliferation and hematopoiesis. Most TNF family members are expressed as type II transmembrane glycoproteins that may be cleaved by specific metalloproteinases to become soluble ligands, or may remain active as membrane bound ligands (Grivennikov et al., 2006).

TNF α was found to bind to a receptor, named TNF receptor (TNFR). A complementary TNFR superfamily has since been characterised and Figure 9 shows an overview of this important family, along with their associated ligands. The TNF-like receptors are type I transmembrane proteins that are characterised by cysteine-rich domains and can be divided into three groups: those containing a proapoptotic domain, those lacking such a domain and decoy receptors

(Grivennikov et al., 2006). Members of the TNF superfamily include key regulators of bone function such as RANKL and OPG; important regulators of immune function including TNF α itself, CD40L, FASL, LIGHT and many others (for review see Locksley et al., 2001; Hehlhans & Pfeffer, 2005).

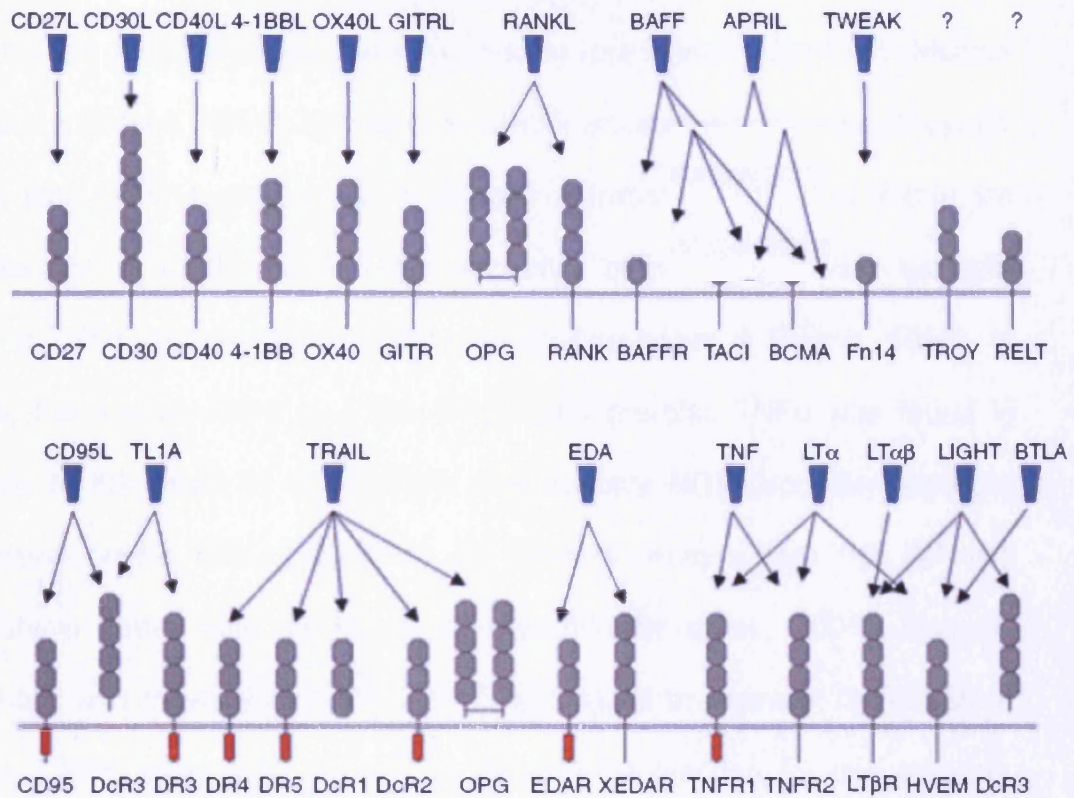


Fig 9: The TNF (shown in blue) and TNFR superfamilies. Arrows represent interactions with receptors. Ectodomains of TNFSFR members are shown in grey, with internal death domains as red cylinders. Adapted from Hehlhans & Pfeffer, 2005.

1.5.2 TNF family members and the regulation of neuronal development

The role of TNF α in the regulation of neuronal populations is complicated. TNF α is upregulated during immune and inflammatory responses in the CNS (Munoz-Fernandez & Fresno, 1998), as well in a number of neurodegenerative diseases. TNF α is also found to play a role in normal neuronal development and in the CNS glia are a source of this cytokine with both microglia and astroglia producing TNF α (Mizuno et al., 2005; Munoz-Fernandez & Fresno, 1998). In neurons, the role of TNF α is a little more controversial. TNF α was found to contribute to the death of sympathetic and sensory NGF-dependent neurons during development, and sympathetic and sensory neurons from TNF deficient mice survive better than wild-type neurons (Barker et al., 2001). Cultured sympathetic and trigeminal neurons were also found to express TNF α and its receptor, TNFR, suggesting an autocrine/paracrine function for this cytokine. Other studies using TNF α knockout mice also suggest a function for this cytokine in normal, late neuronal development in neurons of the hippocampus (Golan et al., 2004).

The function of other TNF superfamily members in neuronal populations is also under investigation and recent discoveries include a role for glucocorticoid-induced tumor necrosis factor receptor-related protein (GITR), and its ligand, GITRL, in the regulation of NGF-dependent growth in neurons of the SCG (O'Keeffe Et al., 2008) and a role for the TNF super-family member, LIGHT (lymphotoxin-related inducible ligand that competes for glycoprotein D binding to

herpesvirus entry mediator on T cells), and its receptor, herpesvirus entry mediator (HVEM), in the negative regulation of the growth of nodose neurons (Gavalda et al., 2009). To date there is no known role for the RANK, its ligand or decoy receptor in neuronal populations.

1.5.3 NF- κ B

One of the key downstream targets of RANK activation is NF- κ B. This transcription factor is an important regulator of a wide variety of cellular processes including cell survival and proliferation, regulation of the immune system and responses to stress (Baldwin Jr, 1996; Karin, 1999). This ubiquitously expressed family of transcription factors classically consists of five members: p65 (RelA), RelB, c-Rel, p50 and p52 in various combinations of heterodimers and homodimers, of which p50/p65 is the most common. In unstimulated cells NF- κ B is bound to members of an inhibitory family of proteins, the I κ Bs, of which there several known members (O'Neill & Kaltschmidt, 1997) and of these, I κ B α and I κ B β are the most common.

Activation of NF- κ B involves two distinct pathways. In the canonical pathway, stimulation of the cell by extracellular inducers leads to I κ B α being phosphorylated on serine residues 32 and 36 by an I κ B kinase (IKK) complex, leading to ubiquitination and proteasome mediated degradation of I κ B α . NF- κ B is then free to translocate to the nucleus and bind to κ B consensus sequences in responsive genes (Baldwin Jr, 1996; Karin, 1999). The IKK complex consists of three members: IKK α , IKK β and IKK γ . IKK β activates NF- κ B via the canonical pathways, whereas IKK α activates NF- κ B via a non-canonical pathway involving phosphorylation of p100 (Senftleben et al., 2001; Xiao et al., 2006). Another important regulator of NF- κ B is NF- κ B inducing kinase (NIK). This kinase acts as

a potent activator of members of the IKK and NF- κ B families and provides a link between the TNFR superfamily, via the TNF-receptor associated factor (TRAF) family, and the NF- κ B signalling pathways (Malinin et al., 1997; Regnier et al., 1997; Woronicz et al., 1997). Traditionally, NIK phosphorylates and activates IKK α in the non-canonical NF- κ B activation pathway (Dejardin, 2006), although there is evidence NIK can activate NF- κ B via the canonical pathway (Zarnegar et al., 2008).

NF- κ B has over 150 known downstream targets (Pahl, 1999). NF- κ B is a target of many important cellular regulators and many of the biological functions of TNFR family members are mediated by this transcription factor (Baeuerle & Hentkel, 1994; Rothe et al., 1995). NF- κ B has been shown to be widely expressed in the nervous system (O'Neill & Kaltschmidt, 1997; Bhakar et al., 2002). NF- κ B can be activated by a range of neurotransmitters and neurotrophins, and has been shown to regulate neuronal survival but can also bring about neuronal death (Kaltschmidt et al., 2005). NF- κ B promotes the survival of several neuronal populations including cerebellar granular cells, cortical neurons and sympathetic and sensory neurons (Bhakar et al., 2002; Maggirwar et al., 1998; Middleton et al., 2000). Other functions of NF- κ B in neuronal populations include the regulation of synaptic function, learning and memory and the myelination of peripheral nerves (Merlo et al., 2005; Albeni & Mattson, 2000; Nickols et al., 2003).

More recently NF- κ B was shown to have a role in positively regulating neurite outgrowth from sensory neurons of the nodose ganglia (Gutierrez et al., 2005). Inhibition of NF- κ B was found to significantly reduce the size and complexity of neuritic arbours of sensory neurons cultured with BDNF during a defined period in development. Inhibition of NF- κ B in pyramidal neurons of the CNS was also found to reduce the size and complexity of their dendritic arbours. Subsequently, NF- κ B was also found to be essential for the growth promoting effects of CNTF in nodose neurons and CNTF was found to activate NF- κ B via a non-canonical mechanism that involves activation of spleen tyrosine kinase and subsequent tyrosine phosphorylation of I κ B α (Gallagher et al., 2007). A subsequent study has shown that NF- κ B negatively regulates neurite outgrowth from sympathetic neurons, and can also negatively regulate neurite outgrowth from sensory neurons depending upon the phosphorylation state of the p65 subunit (Gutierrez et al., 2008).

1.5.4 RANK, RANKL and OPG

The Receptor Activator of NF- κ B Ligand (RANKL) is a member of the TNF superfamily that plays key roles in the regulation of the immune system and bone homeostasis (Kearns et al., 2008). The decoy receptor of RANKL, Osteoprotegerin (OPG), was the first member of this vital signalling trio to be discovered (Simonet et al., 1998) and RANKL was subsequently cloned as a ligand for OPG (Lacey et al., 1998). RANKL was then cloned by three other independent groups as an osteoclast differentiation factor (ODF) (Yasuda et al., 1998), a TNF-related activation-induced cytokine (TRANCE) (Wong et al., 1997), and as a factor necessary for T cell growth and dendritic cell function (Anderson et al., 1997). The name RANKL was finally accepted as standard.

RANK is a homotrimeric TNFR superfamily member initially characterized as the receptor for RANKL in dendritic cells before also being discovered in osteoclasts (Anderson et al., 1997; Li et al., 1997). RANK was cloned from a bone marrow-derived dendritic cell cDNA library as the receptor that mediated the survival of cultured dendritic cells promoted by RANKL (Anderson et al., 1997). RANK is a 616 amino-acid protein (a.a.) with a 184 amino acid extracellular domain and a cytoplasmic domain of 383 amino acids (Fig 10). RANK is a key regulator of bone physiology and the interplay between RANK, its ligand and its decoy receptor determine the kinetics of bone remodeling (Kearns et al., 2008).

RANKL is a type II transmembrane protein of 316 amino acids with a 48 amino acid cytoplasmic domain and an extracellular 248 amino acid domain. Murine RANKL shares an 85% homology with the human protein (Anderson et al., 1997). Subsequent studies have found RANKL has three known isoforms, two of which are type II transmembrane ligands, the second of which is a shorter splice variant of the first (Ikeda et al., 2001). The third variant of RANKL lacks a transmembrane domain and acts a soluble form.

OPG, the decoy receptor for RANK, was the first member of the RANK trio to be discovered (Simonet et al., 1998) and the first found to play a role in bone homeostasis (Tsuda et al., 1997). OPG was initially cloned as an osteoclastogenesis inhibitory factor (OCIF), due to its ability to act as an inhibitor of the formation of osteoclasts (Yasuda et al., 1998a). OCIF was subsequently named OPG and molecular binding experiments demonstrated OPG binds RANKL and functions as a decoy receptor (Yasuda et al., 1998). OPG, is a 401 amino acid secreted glycoprotein with similarities to TNFR-2 and CD40 (Simonet et al., 1997).

Since its discovery, RANK and its receptors have been found to regulate a number of functions in different situations. RANKL was initially characterised as a regulator of dendritic cell survival (Wong et al., 1997a) and subsequently, the binding of RANKL to its receptor was found to provide the signal to drive the development of osteoclasts, from haematopoietic progenitor cells (Lacey et al.,

1998; Hsu et al., 1999). RANK was also found to play a role in the activation of mature osteoclasts and has been characterised as an osteoclast differentiation and activation factor. Figure 11 shows an illustration of the action of RANK, RANKL and OPG in the regulation of osteoclastogenesis.

The expression patterns of RANK, RANKL and OPG are varied. RANK is ubiquitously expressed in human tissue with the highest expression of RANK mRNA in skeletal muscle, thymus, liver, colon, small intestine, and adrenal gland (Anderson et al., 1997). Cell surface expression of RANK has, however, been reported to be limited to dendritic cells, the CD4⁺ T cell line MP1 and foreskin fibroblasts (Anderson et al., 1997), suggesting complex post-transcriptional control of surface protein expression. Expression of RANK receptor protein is also found in splenic, lymph node and bone marrow derived dendritic cells, activated T-cells and osteoclast progenitors (Wong et al., 1997, Yasuda et al., 1998; Lacey et al., 1998). RANKL was found to be most highly expressed in thymus and lymph nodes and expression in nonlymphoid tissue is limited, and RANKL is abundantly found in T cells but not in B cells (Wong et al., 1997). RANKL is most highly expressed in spleen, bone marrow stroma and trabecular bone (Yasuda et al., 1998). Expression of OPG was detected in liver, lung, heart and kidneys as well as in the stomach, skin, and calveria and developing bone tissues (Simonet et al., 1997).

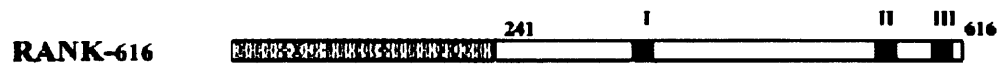


Fig 10: RANK is a 616 amino acid receptor with a 383 amino acid cytoplasmic domain. The RANK cytoplasmic domain (unshaded) contains 3 TRAF binding domains, which preferentially bind TRAF signalling mediators. Domain I preferentially binds TRAF6, while domains II and III bind TRAF2 and TRAF5 respectively. Adapted from Darnay et al., 1999.

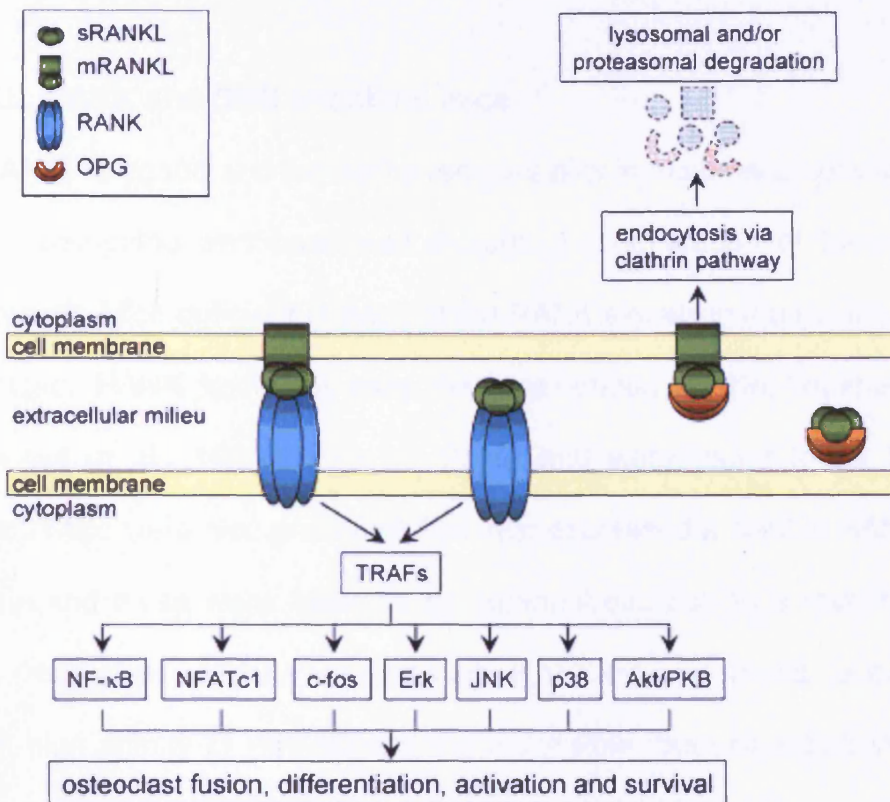


Fig 11: Mechanisms of action of OPG, RANKL and RANK in osteoclastogenesis. RANKL is produced by osteoblasts, which activates RANK on osteoblasts and preosteoclast precursors. OPG binds to and inactivates RANKL. RANK-RANKL interactions lead to osteoclast fusion, differentiation activation and survival via intracellular mediators including ERK, JNK, Akt and NF- κ B. Adapted from Blair et al., 2007.

1.5.5 RANKL, RANK and OPG knockout mice

The roles RANK, its ligand and the decoy receptor play in mammalian physiology have been investigated and confirmed through the generation of transgenic knockout animals. Mice deficient in each of the RANK signalling triumvirate have been generated. RANK knockout mice were generated by two independent groups (Dougall et al., 1999; Li et al., 2000) and were found to be highly osteopetrotic. Mice were also produced that over-expressed a soluble RANK-Fc fusion protein and these were found to be osteopetrotic due to a reduction in osteoclasts (Hsu et al., 1999). Recombinant RANK-Fc was found to bind to RANKL with high affinity *in vitro* suggesting a possible route of action *in vivo*. Mice lacking RANKL display severe osteopetrosis, show defects in tooth eruption and completely lack osteoclasts, due to an inability of osteoblasts to support osteoclastogenesis (Kim et al., 1998; Kong et al., 1999). RANKL deficient mice also lack lymph nodes and display defects in T and B lymphocyte development. OPG knockout mice have severe osteoporosis and very brittle bones, as well as increased arterial calcification (Bucay et al., 1998; Yun et al., 2001). OPG deficient mice were also shown to display abnormal remodeling of the otic capsule and progressive hearing loss (Zehnder et al., 2006).

1.5.6 RANK signalling

The binding of RANKL to RANK activates a large number of distinct and intricate downstream signalling cascades and a large body of work has focused on the elucidation of these. Two of the first to be investigated were NF- κ B and Jnk. Over-expression of RANK was found to be able to activate NF- κ B in dendritic cells (Anderson et al., 1997) and in 293T cells (Darnay et al., 1998; Wong et al., 1998) and RANK activates C-Jun N-terminal kinase (Jnk) in T Cells (Wong et al., 1997), 293T cells (Wong et al., 1998) and in HeLa cells (Kim et al., 1999). Other important intracellular regulators that have been shown to be activated by RANK signalling include Elk-1, a MAPK substrate (Wong et al., 1998), Akt (Wong et al., 1999) and p38 (Matsumoto et al., 2000), as well as AP-1, via other members of the MAPK family such as ERK (Karin, 1996). Figure 12 shows a schematic illustration of some of the important regulators of RANK signalling, activated upon the binding of RANKL to its receptor.

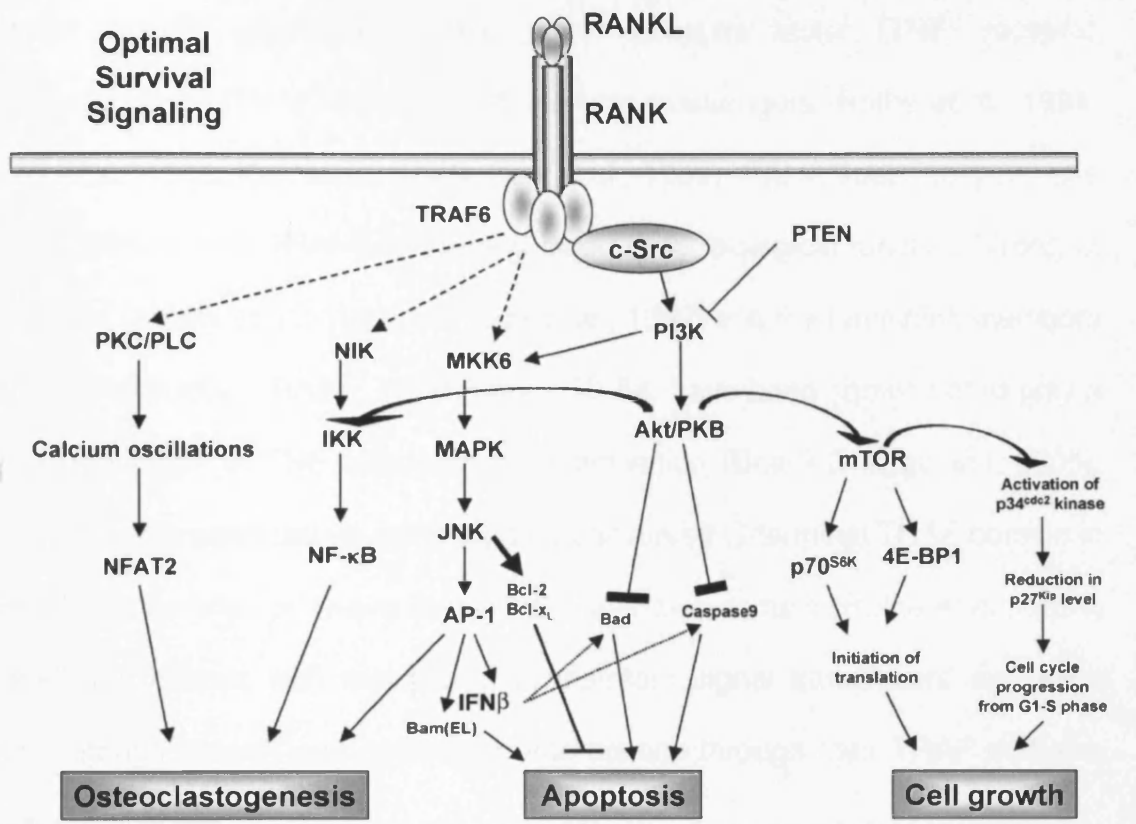


Fig 12: RANK signaling pathways important in the regulation of osteoclastogenesis and cell survival. Adapted from Bharti & Aggarwal, 2005.

As with other members of the TNF superfamily, the binding of RANKL to its receptor recruits members of the tumor necrosis factor (TNF) receptor associated factor (TRAF) family of intracellular messengers (Rothe et al., 1994; Wong et al., 1998; Kim et al., 1999; Hsu et al., 1999). RANK specifically recruits TRAF2, TRAF5 and TRAF6 in the regulation of its biological function (Wong et al., 1997a; Darnay et al., 1998; Lomaga et al., 1999) and the remaining members of the TRAF family, TRAF1, TRAF3 and TRAF4, have been shown not to play a role in regulation of TNF family member activation (Bharti & Aggarwal, 2005). TRAFs are characterized, in general, by a conserved C-terminal TRAF domain in concert with an effector N-terminal RING finger/zinc domain (Rothe et al., 1994) and TRAFs interact with receptors, downstream signal transducers and each other, through hetero- and homotypic interactions through their TRAF domains (Wong et al., 1998).

The TRAFs all serve distinct but similar roles in the regulation of TNFR family member biology. TRAF2, TRAF5 and TRAF6 have all been shown to be important in the regulation of NF- κ B signalling; all three activate NF- κ B upon over-expression (Rothe et al., 1995; Bishop et al., 2004; Cao et al., 1996) and all three have been shown to activate NF- κ B through interaction with NF- κ B inducing kinase (NIK), I κ B kinase- α and - β (Malinin et al., 1997; Regnier et al., 1997; Song et al., 1997; Woronicz et al., 1997). TRAF2 is a key regulator of the activation of NF- κ B by TNF α (Rothe et al., 1995), as well as playing important roles in the regulation of other TNF members including CD30 and CD40

(Ansieau et al., 1996; Rothe et al., 1995), as well as Jnk (Natoli et al., 1995; Reinhard et al., 1997). TRAF6 has been shown to not only strongly activate NF- κ B (Cao et al., 1996) but to be sufficient and necessary for the activation of NF- κ B by RANK (Darnay et al., 1999). The binding of RANKL to RANK can also activate the serine/threonine kinase Akt through a complex involving TRAF6 and c-Src (Wong et al., 1999), as well as MAPK signalling members such as ERK (Karin, 1996) and p38 (Matsumoto et al., 2000). TRAF6 also plays a key role in the regulation of osteoclastogenesis and in the regulation of RANK CD40 signalling (Wong et al., 1999a).

The binding of members of the TRAF family to RANK have been extensively explored and three separate studies have examined the domain that members of the TRAF family bind to on the RANK receptor. Darnay et al found that TRAF2, TRAF5 and TRAF6 bound to RANK in a region at the 85 amino acid C-terminal tail of the receptor and that this section was necessary for RANK mediated NF- κ B activation, but not activation of Jnk (Darnay et al., 1997). Wong et al. also conducted similar experiments and found that binding sites for TRAF2 and TRAF5 were located at the C-terminal portion of the cytoplasmic domain (Wong et al., 1998) with a more membrane proximal binding site for TRAF6. In a subsequent study Darnay et al. found that RANK binds TRAF2, TRAF5 and TRAF6 at distinct locations within the C-terminal tail. TRAF2 and TRAF5 bind at a C-terminal site between amino acids 565-568 and 606-611, respectively, whereas TRAF6 binds at a more membrane proximal location between residues

340-358 (Darnay et al., 1999). Another study found similar locations within the C-terminal tail necessary for the binding of TRAF family members by RANK. The authors also found that the TRAF6 binding site was essential for the activation of NF- κ B and Jnk seen when over-expressing RANK in 293T cells (Hsu et al., 1999). In general there seems to be a consensus on the location of TRAF binding sites within the C-terminal tail of the RANK receptor.

NF- κ B is a particularly important signalling mediator of activation of RANK so the way in which members of the NF- κ B signalling cascade are recruited by RANK signalling has been extensively explored. NF- κ B was shown to be activated by RANK (Anderson et al., 1997) and mice lacking p50 and p52 are severely osteopetrotic (Iotsova et al., 1996). Two members of the TRAF family, TRAF2 and TRAF6, have both been shown to be required for the activation of NF- κ B by RANK (Darnay et al., 1998) and NIK has been shown to bind both TRAF2 and stimulate NF- κ B, acting as part of a signalling cascade connecting members of the TNFR superfamily to the NF- κ B pathways (Malinin et al., 1997). Members of the I κ B kinase family have also been shown to be vital for RANK signalling in the regulation of osteoclastogenesis and IKK α and IKK β were both found to be important for RANK activated NF- κ B-mediated regulation of osteoclastogenesis (Ruocco et al., 2005). Another important NF- κ B regulator is NIK. This kinase can interact with TRAF2 and TRAF6 in the regulation of TNF-mediated NF- κ B activation and serves as a bifurcation point (Song, et al., 1997). NIK has also

been shown to be important in the regulation of the biological activity of RANK (Malinin et al., 1997).

1.6 ERK

The mitogen-activated protein kinase (MAPK) family constitutes an essential and widespread mechanism of eukaryotic cell regulation that facilitates the responses of cells to a large number of different stimulations. MAPK signalling cascades consist of at least three protein kinases in series that lead to the activation of a MAP kinase (Pearson et al., 2001). These signalling cascades can be activated by a range of stimuli including hormones, growth factors, inflammatory cytokines of the TNF family and a variety of environmental stresses including radiation and ischemic shock (Krishna & Narang, 2008). Three MAPK families that are critical regulators of mammalian cell function are the extracellular regulated kinases (ERKs), c-Jun N-terminal kinases (Jnks) and p38. These families have been extensively studied and two of these, ERK and Jnk, are vital for signalling by RANK (Wada et al., 2006).

The first MAPKs were discovered as mitogen-stimulated tyrosine kinases (reviewed in Cobb et al., 1991) and the family was subsequently named mitogen-activated protein kinases. MAPKs are grouped into a family due to their similar method of activation, requiring the interaction of a three-tiered cascade. This consists of an MAPK, an MAPK kinase (MAPKK) and an MAPKK kinase (MAPKKK or MAP3K) (Krishna & Narang, 2008). MAP3Ks are Ser/Thr kinases that are activated by extracellular stimuli through interaction with members of the Ras/Rho family of small G proteins. This leads to phosphorylation and activation

of MAPKKs and subsequent phosphorylation of threonine and tyrosine residues on MAPKs. MAPKs then activate downstream targets including transcription factors, other kinases and cytoskeletal proteins. Figure 13 shows a schematic diagram of MAPK signalling cascades, along with examples of downstream targets.

The ERKs, specifically ERK1 and ERK2, remain the most studied and best understood members of the MAPK family (Blenis, 2003). The fundamental roles of ERK1/ERK2, hereafter referred to as ERK, are in the regulation of survival, cell growth and proliferation in many different cells and ERK is known to be activated principally by mitogens and growth factors (Juntilla et al., 2008). The role of ERK in the regulation of neuronal populations is a more complex issue. ERK is involved in the regulation of diverse processes including the genesis of neural progenitors, learning and memory, and ERK has been widely accepted as a central regulator of differentiation and cell fate determination (Kawauchi et al., 2005; Samuels et al., 2009). ERK has also been found to play a role in the regulation of neurite growth from different neuronal populations. ERK is a positive regulator and a convergence point for growth promoting signals in embryonic chick retinal neurons (Perron & Bixby, 1999); inhibition of ERK was found to inhibit the growth of cultured hippocampal neurons (Veeranna et al., 1998), and ERK has been shown to be involved in the positive regulation of NGF-mediated neurite growth in SCG neurons in mice (O'Keeffe et al., 2008).

These reports suggest an ever expanding role for ERK in the regulation of neuronal populations.

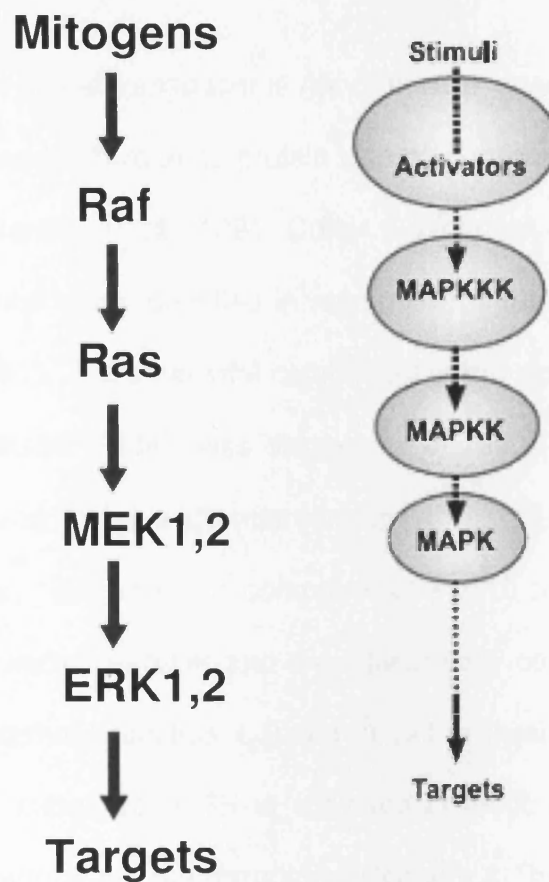


Fig 13. MAPK signalling pathways. The organisation of MAPK signalling cascades involves three sequential kinases. Activation of upstream kinases leads to phosphorylation of MAPKs, which then activate downstream targets. Adapted from Juntilla et al., 2008.

1.7 Akt/PI3K signalling

Another vital intracellular signal transducer is Akt or protein kinase B (PKB). PKB was first identified as a serine/threonine protein kinase in three separate studies (Jones et al., 1991; Bellacosa et al., 1991; Coffey & Woodgett, 1991) and three isoforms of Akt have since been identified in mammalian cells: Akt-1, -2 and -3 (Brazil & Hemmings, 2001). The other vital component in this signalling cascade, phosphatidylinositol 3-kinase (PI3K), was discovered in 1990 (Carpenter et al., 1991), and Akt was found to be a downstream target of PI3K (Franke et al., 1995; Burgering & Coffey, 1995). PI3K is composed of a p110 catalytic subunit in tandem with a p85 regulatory subunit and the PI3K family consists of various isoforms categorized into three families: I, II and III. In this thesis I am interested in the classical, class I subgroup. PI3K is activated in response to cytokines, trophic factors, growth factors and neurotrophins (Rodgers & Theibert, 2002) and generates phospholipids that activate Akt. PI3K phosphorylates 4,5 phosphoinositides to generate 3,4,5 phosphoinositides in vivo (Whitman et al., 1988) and these phosphoinositides exert their effect by recruiting effector proteins to intracellular membranes. Membrane-associated phosphoinositides interact with specific phospholipid-binding protein domains within their effector proteins and Akt contains pleckstrin homology (PH) domains that bind the specific phosphoinositides produced by PI3K. Figure 14 shows a representation of the activation and recruitment of Akt by PI3K and some of the signalling pathways involved.

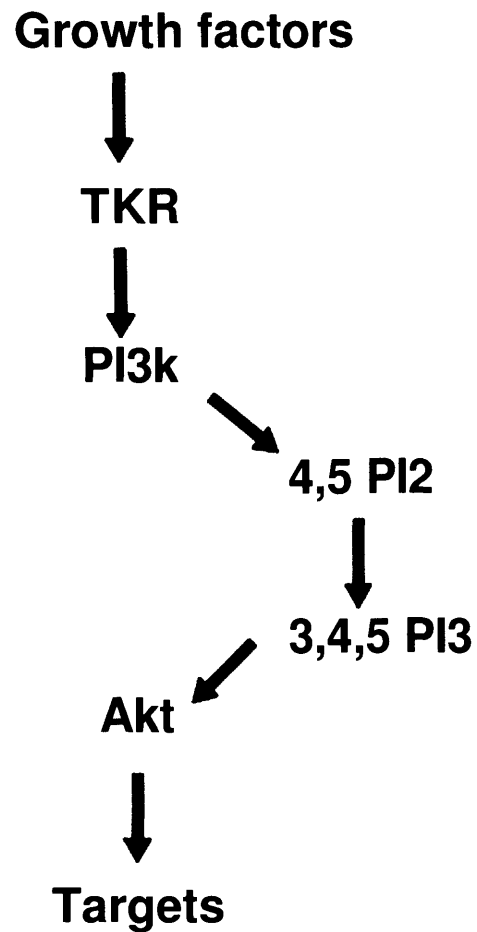


Fig 14: Activation of PKB signaling pathways. PI3K is activated by upstream receptors leading to the production of phosphoinositides and the activation of downstream targets in the cytoplasm and nucleus.

The primary role Akt plays in mammalian cells is in the regulation of survival and the inhibition of apoptosis and, as a result, Akt has been implicated in the regulation of many cancer cell types (Duronio, 2008). The minimal recognition sequence for an Akt substrate is R-X-R-X-X-S/T-B where X represents any amino acid and B represents bulky hydrophobic residues and Akt has been found to have over 100 candidate substrates (Alessi et al., 1996; Manning & Cantley, 2007). The activation of Akt can influence a remarkable number of intracellular events that regulate the survival of mammalian cells via targets such as BAD, FOXO family members, I κ B kinase β , and GSK-3 (Datta et al., 1999; Doble & Woodgett, 2003; Manning & Cantley, 2007; Cross et al., 1995). Although the primary role of Akt is thought to be the regulation of cell survival it has also been found to regulate a large number of other cellular processes including cell cycle progression, growth, motility and adhesion in many mammalian cells (Rodgers & Theibert, 2002). Akt activates the mTOR complex 1, a critical regulator of translation initiation and ribosome biogenesis, in the regulation of cell growth and other important Akt substrates include GSK3, TCS2 and PRAS40 in the regulation of cell proliferation (Manning & Cantley, 2007). Akt also displays an impressive level of crosstalk with other important intracellular pathways including NF- κ B, members of the MAPK families and c-RAF.

The role of Akt in neurons is more complicated. The PI3K/Akt signalling pathway is known to play a role in the regulation of neuronal survival in a wide range of

neuronal cell types (Brunet et al., 2001). This function was initially discovered in the NGF-mediated survival of PC12 cells (Yao & Cooper, 1995) but has since been confirmed in a variety of other neurons including primary cerebellar, sympathetic, sensory, motor cortical, hippocampal and retinal neurons (reviewed in Rodgers & Theibert, 2002). However, the role of Akt in sympathetic neurons is more controversial. Akt appears to play a key role in the regulation of survival in sympathetic neurons and was found to be vital for the NGF-mediated survival of embryonic (Crowder & Freeman, 1998) and postnatal rat sympathetic neurons (Philpott et al., 1997). Akt was also found to be important in the regulation of survival of adult sympathetic neurons (Oriike et al., 2001) suggesting a key role in regulating the survival of sympathetic neurons throughout development and into adulthood. However, other studies have disagreed (Tsui-Pierchala et al., 2000; Kuruvilla et al., 2000) and the issue remains controversial.

PI3K/Akt has also been found to play a role in is the regulation of neurite growth (Rodgers & Theibert, 2002). Blocking PI3K prevents outgrowth of processes from a wide variety of neuronal cell types including PC12 cells, neuroblastoma cell lines, sensory neurons, cerebellar and motor neurons, and hippocampal retinal neurons (reviewed in Rodgers & Theibert, 2002). Akt is also involved in positively regulating growth from cultured striatal neurons (Gavalda et al., 2004). Akt is required for the outgrowth promoting effects of many neurotrophins including NGF and BDNF (Patapoutian & Reichardt, 2001).

Hypothesis

A finding in a PCR screening for the mRNA expression of RANK indicated the presence of mRNA transcripts for this TNF family member in ganglia of the nodose, SCG and trigeminal. Other members of the TNF family have recently been shown to play roles in the regulation of growth and survival of these neuronal populations including GITR and LIGHT (O'Keeffe et al., 2008; Gavalda et al., 2009). NF- κ B, a key downstream target of RANK, had also been shown to play a role in the regulation of neuronal growth in nodose and SCG populations. NF- κ B can positively regulate the growth of nodose neurons (Gutierrez et al., 2005) but has also been shown to negatively regulate the growth depending upon its phosphorylation status (Gutierrez et al., 2008). NF- κ B has also been shown to negatively regulate the growth of SCG neurons cultured with NGF (Gutierrez et al., 2008).

We decided to investigate the potential role of RANK in the neurons of the nodose, SCG and trigeminal ganglia. A combination of antibodies directed against RANK and its associated family members, plasmids that express RANK or various deletion mutants, and RANK activating or blocking antibodies will be directed against neurons of the these ganglia. Known intracellular mediators of RANK activation will also be investigated through the use of dominant negative expression plasmids and pharmacological inhibitors directed against these signalling mediators.

Chapter 2

Materials and Methods

2.1 Introduction

This thesis contains work performed, using various *in vitro* protocols, to analyse neuronal survival and process outgrowth in wild-type CD1 mice. Fig 16 shows an example experimental overview of a protocol developed in this lab, now widely used, in the investigation of neuronal survival and neuronal outgrowth.

2.2 Maintenance of CD1 Mice

Timed matings of CD1 mice were established to provide embryonic (E) and post-natal (P) wild-type mice and adult mice were maintained on rodent global diet pellets (Harlan) and given free access to water.

2.3 Isolation of mouse embryos

Pregnant CD1 mice, at the appropriate stage of gestation, were killed by a rising concentration of CO₂, followed by cervical dislocation in accordance with Home Office Regulations, as per the Home Office Animals (Scientific Procedures) Act, ASPA, 1986, and death was confirmed by absence of pedal reflex. Laparotomy was performed to isolate embryos as follows: scissors were sterilised in 70% alcohol, then used to make a small incision across the abdomen. The underlying abdominal muscles were then exposed by pulling the skin above and below the incision in opposite directions. An incision was then made into the anterior abdominal muscle, using scissors and a pair of toothed forceps to hold the muscle, allowing air to enter the perinatal cavity. This incision was extended

across the abdominal muscles without the danger of cutting the intestines and contaminating the dissection with gut bacteria (Davies, 1995). Each gravid uterine horn was removed, using scissors to cut the tissue free and toothed forceps, and placed into a 50ml Falcon tube (Greiner) containing sterile L-15 medium (Gibco, Invitrogen). Embryos were then placed into a 90mm Petri dish (Greiner), containing L15 medium, and removed from their membranes by an incision along the anti-mesometrial border of each uterine horn (Davies, 1995). Embryos were then detached from their uterine horns, removed from their membranes and placed into fresh L-15 medium.

2.4 Dissection of peripheral ganglia

The nodose ganglion, trigeminal ganglion and superior cervical ganglion were removed from mice at the appropriate age as follows. Dissections were performed in a laminar flow hood under standard sterile conditions and embryos (E18) and pups (P0-P5) were killed by decapitation by a sharp pair of scissors. A rising concentration of CO₂ was used to kill mice older than P5 in line with ASPA (1986). To dissect the ganglia, the top of the skull was removed, in a plane just above the eyes and whisker pads. Trigeminal ganglia were identified by their elongated appearance and were found on the base of the skull. To locate nodose and SCG ganglia, heads from which the top of the skull and the forebrain had been removed, were cut in half along the sagittal plane. The nodose and SCG are found at the base of the jugular foramen by deflection of the occipital bone, using watchmaker's forceps, revealing the ganglia. The nodose is attached

to the vagus nerve at its distal aspect and is a characteristic spherical shape. The SCG lies along the carotid artery, attached to the sympathetic chain, and is a more elongated structure. All ganglia were cleaned, using tungsten needles, of any adherent tissue.

2.5 Preparation of tungsten needles

Two 3-5cm lengths of 0.5mm tungsten wire were bent at a 60° angle at the tips, and the ends placed into 1M KOH. A 3-12V AC current was passed through the wire and a second electrode was immersed in the solution. In this way, the end was gradually etched away and a taper was formed from the bend to the tip of the needle. A sharp tip was formed at the end, by placing the bent portion vertically in the solution. The needles were washed in water, and then held in chuck-grip platinum wire holders. Tungsten needles were sterilised before each use.

2.6 Dissociated neuronal cultures

2.6.1 Preparation of dishes

Culture dishes were coated with a laminin/poly-ornithin layer before seeding. 35mm culture dishes (Greiner) were coated in 2ml 500mg/l poly-DL-ornithine (Sigma)/borate solution and left at ambient temperature overnight. Dishes were washed three times with deionized H₂O and left to air dry in sterile conditions. 50µl HBSS (Gibco, Invitrogen) containing 0.02mg/ml laminin (Sigma) was added

to the centre of the dish and dishes were incubated at 37°C for 3 hours. Laminin was then removed before neurons were plated.

2.6.2 Culture media

Ham's Modified F14 medium (JRH Biosciences) was prepared as 10x concentrated stock solution and stored at -30°C. 25ml was then added to 250 ml of distilled water containing 500 mg of sodium hydrogen carbonate, from which 25ml had been removed, and penicillin (Sigma) and streptomycin (Sigma) were added. This 1x solution was then supplemented with 2.5ml 200mM glutamine (Gibco, Invitrogen) to a final concentration of 2mM. Supplemented F14 was then filtered using a 0.2µm filter unit (Greiner) and stored at 4°C.

2.6.3 Dissociation of ganglia

50µl 1% trypsin (Worthington) was added to 950µl HBSS (Invitrogen) and ganglia were added to this following dissection. This mixture was then incubated at 37°C for 20mins. The trypsin-HBSS mixture was removed and ganglia were washed twice with 10ml F12 (Gibco, Invitrogen) containing 10% heat activated horse serum. A fire-polished siliconised glass pipette was then used to gently dissociate cells to create a cell suspension (Davies, 1995).

2.6.4 Seeding of neurons

Neurons were seeded in laminin-coated 35mm dishes. 100-200 neurons were seeded per 12mm grid by creating a cell suspension and visualising 10µl of

dissociated neurons, using a Nikon Diaphot inverse phase-contrast microscope, to estimate volume needed. These dishes were used to study neurite growth and neuronal survival. The appropriate volume of cell suspension was added to the required volume of F14 in a 50ml Falcon tube. 1ml of cell suspension was added to each dish, while keeping the cell suspension uniform by tipping the tube end over end several times. Factors were added to the dishes at the time of plating, or afterwards depending upon the particular experiment. Neurotrophic factors or pharmacological inhibitors were added to the dishes at the concentrations indicated in figure legends.

2.7 Estimation of neuronal survival

A standard graticule was constructed from the base of a plastic Petri dish, to allow quantification of neuronal survival. A scalpel blade was used to inscribe the base of a 900mm dish with a 12 x 12mm² square. Cells were counted after 3 hours in culture by mounting the graticule on an inverted phase-contrast Nikon Diaphot microscope. Dishes were placed on the graticule and the number of neurons present in the grid was then counted. Non-attached neurons were ignored and the number of phase bright neurons in all dishes quantified at 24 and 48 hrs. The number of phase-bright neurons at 48 hrs, were then expressed as a percentage of those at 24hrs.

Transfected cells were co-transfected with a YFP-expression construct to allow visualisation and the number of YFP-labelled cells quantified 24 hrs and 48 hrs

post-transfection. The number of cells surviving at 48 hrs was quantified as a percentage of those at 24 hrs. The area counted was defined by the presence of gold particles embedded in the culture dish.

2.8 Quantification of neurite outgrowth

The establishment of a functional nervous system requires the growth and elaboration of neural processes and Sholl analysis is a widely used method for quantifying neural process complexity and size in proximity to the neuronal soma (Gutierrez & Davies, 2007). An Axioplan Zeiss laser scanning confocal microscope was used to visualise and digitally acquire images for analysis. Transfected neurons were co-transfected with a YFP-expression construct for visualisation. Non-transfected cells were stained with the vital dye, Calcein-AM and incubated for 20 mins at 37°C before imaging. For every condition studied between 50 and 60 neurons were captured and neuritic arbours were traced using LSM510 software (Dr H Gutierrez). From these traces mean total neurite length and mean number of branch points were calculated. Sholl analysis was also carried out using these traces and for this concentric digitally generated rings, 30µm apart were created, centred around the cell soma and the number of neurites intersecting each ring was counted (Sholl, 1953). The Sholl profile, that is number of intersections vs. radial distance from the cell soma, was then plotted. Fig. 15 shows a graphic illustration of the principles of Sholl analysis.

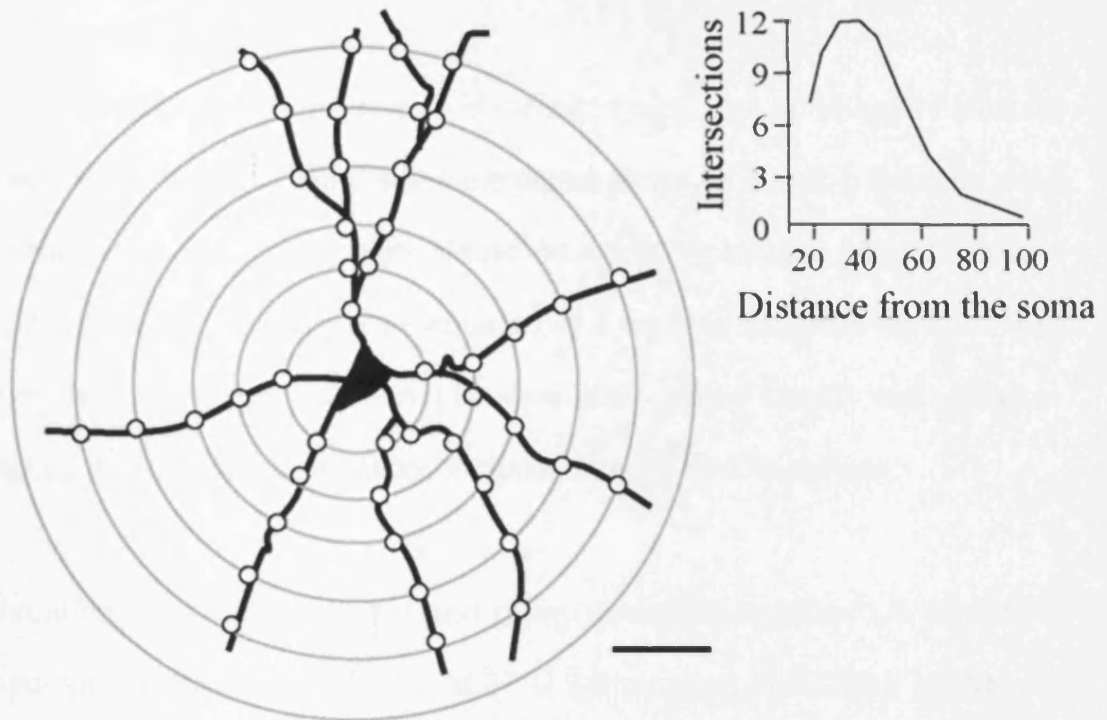


Fig 15: Graphic illustration of Sholl analysis. A number of concentric rings are centred around the neuronal soma and the number of neurites intersecting each ring are counted. A plot of number of intersections vs. distance from the soma is then generated from average data over the population. From Gutierrez & Davies, 2007.

2.9 Ballistic Transfection

2.9.1 Plasmid preparation

Competent *E.Coli* JM109 cells were defrosted on ice. 1µl of 100µg/ml plasmid DNA was added to 50µl bacteria and incubated on ice for 30 mins. Bacteria were heat shocked at 42°C for 90secs, placed on ice for 1min, then 950µl LB media (Merck) was added. Cells were incubated in a shaking incubator at 37°C with 200rpm for 1hr. 100µl cells in LB were then plated on LB agar (Merck) containing the appropriate antibiotic and incubated at 37°C overnight.

Individual colonies were selected and grown overnight in 250ml LB containing the appropriate selection antibiotic, at 37°C with shaking at 200rpm. Media was then spun, to extract the bacteria, and a high-speed plasmid maxiprep kit (Qiagen) was used, according to manufacturers instructions, to purify sufficient DNA for transfection experiments. Plasmid concentration was quantified using the nanodrop spectrophotometer system.

2.9.2 Preparation of gold microcarriers for ballistic transfection

Transfection of neurons was undertaken by ballistic means. Gold microcarriers were prepared by suspending 20mg of 1.6µm gold particles (Bio-Rad) in 100µl of 50mM spermidine (Sigma) and 2µg YFP expression plasmid (Clontech) together with 20µg of the appropriate experimental plasmid. Gold particles were precipitated with 100µl 2M CaCl₂, washed three times with 100% ethanol,

resuspended in 1.2ml 100% ethanol and loaded into Teflon tubing microcarriers. Gold particles were then thoroughly washed and stored at 4 °C.

2.9.3 Ballistic transfection

Coated gold particles were shot into dissociated neurons using a hand held gene gun (Helios gene gun, Biorad). 35mm tissue culture dishes were prepared with a poly-ornithine coating, and then laminin was added to the centre of the dish. Neurons were plated in a 50µl drop of defined medium, following removal of the laminin. Neurons were given time to attach through a 3hr incubation at 37 °C in a humidified 3.5% CO₂ incubator then medium was removed before transfection. The coated gold particles were shot into the dissociated neurons at a pressure of 200psi. A 70µm nylon mesh screen was placed between the gun and the cells to protect from the shock wave. Following transfection, 2ml of F14, with the appropriate neurotrophic factor, was added to the dish and cells were returned to the incubator.

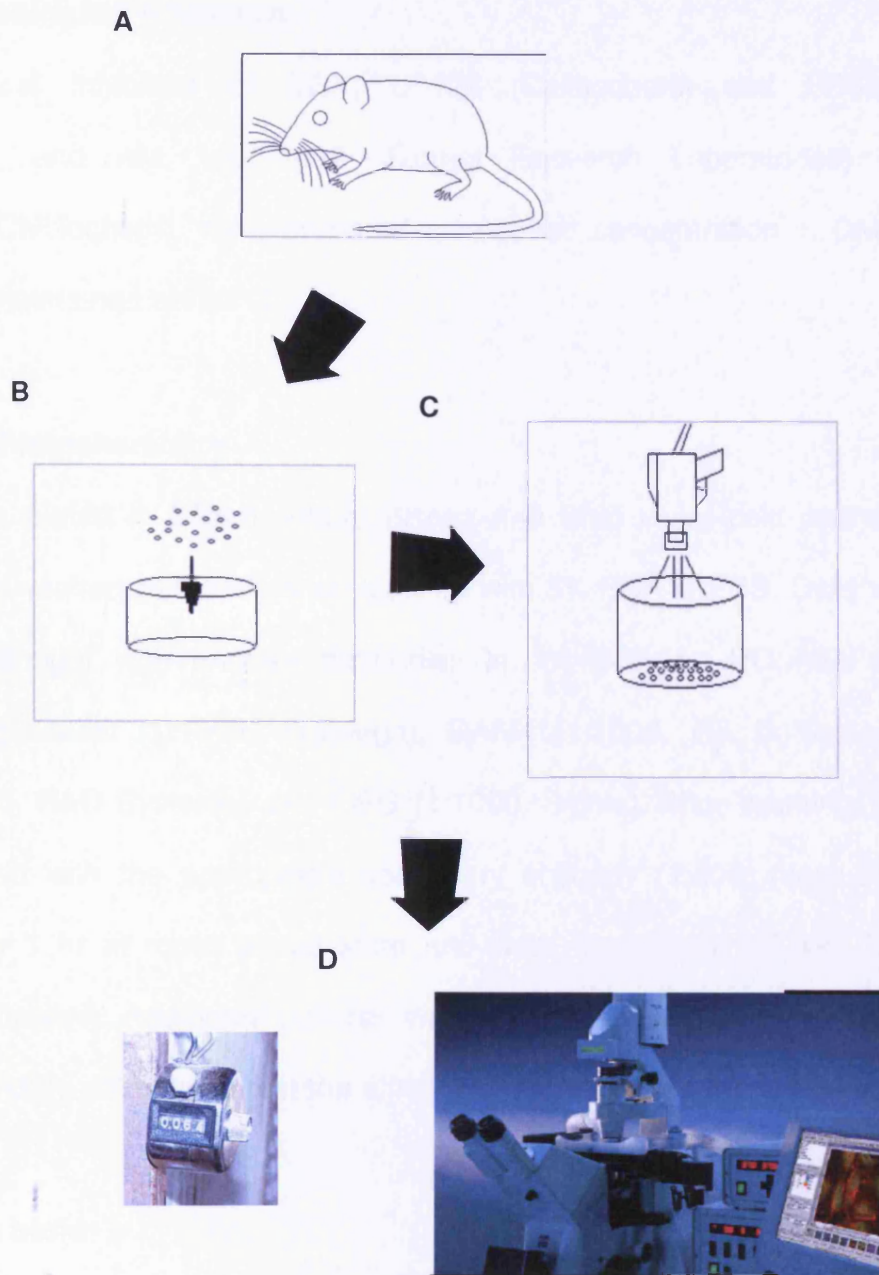


Fig 16: Experimental Outline. Flow chart describing the basic experimental design. (A) Ganglia are extracted from wild-type mice and plated in defined media (B). Neurons are transfected by ballistic means or pharmacological factors are added, together with neurotrophic factors (C). Neurons are counted after 24 hours and images taken for quantification of neuritic outgrowth (D) and surviving neurons counted again at 48 hours post transfection to allow calculation of percentage survival.

2.10 Pharmacological inhibitors

Pharmacological inhibitors of ERK, U0126 (Calbiochem) and PD98059 (Calbiochem), and Akt, LY294002 (Biomol Research Laboratories) and wortmannin (Calbiochem), were prepared to required concentration in DMSO. Stocks were maintained at -20 °C.

2.11 Immunohistochemistry

Neurons were plated in 35mm culture dishes and fixed in ice-cold methanol. Cultures were washed with PBS, then blocked with 5% BSA in PBS. Cells were incubated overnight with primary antibodies in 1% BSA at 4°C. We used antibody to β -tubulin (1:1000, Promega), RANK (1:1000, R& D Systems), RANKL (1:500, R&D Systems) and OPG (1:1000, Sigma). After washing, cells were incubated with the appropriate secondary antibody (1:500, Alexa-Fluor, Invitrogen) for 1 hr at room temperature and were counterstained with DAPI (Invitrogen; 50ng/ml). Additional cultures were established and screened using only the secondary antibody to test the efficacy of secondary antibody binding.

2.12 Western blots

P0 nodose ganglia were dissected and dissociated according to previous sections (2.4 and 2.6.3 respectively). Neurons were plated at high density in poly-ornithine/laminin coated 96-well plates (Greiner), with around 5,000 neurons per well, in defined medium. 10ng/ml BDNF was added to the wells for the

indicated time, two hours after plating. Following removal of the medium, RIPA buffer (50mM Tris pH7.4, 150mM NaCl, 10% glycerol, 1% Triton-X, 1mM EDTA and 100µg/ml PMSF) was added to lyse the cells. Centrifugation at greater than 10,000g and at 4°C was used to remove insoluble debris and the supernatant was stored at -80°C.

Protein extracts were analysed by sodium-dodecyl sulfate (SDS) polyacrylamide gel followed by western blotting as per Laemmli (1970) with modifications. A 10% polyacrylamide separating mini-gel was used with a 5% stacking gel (Bio-Rad, mini-PROTEAN® 3 Cell). Equal amounts of each sample and sample buffer, were mixed in an eppendorf tube and boiled for 5 min before being loaded in the gel. Biotinylated molecular weight markers were loaded onto the gels to confirm molecular weight. The gel was assembled and run for 20 min at 80V, then 45 min at 140V. Proteins were then transferred to polyvinyl-difluoride (PVDF) membranes (Amersham) using the Bio-Rad trans-blot system. Transfer was carried out in transfer buffer according to manufacturers protocol, for 1 hr at 100V.

Membranes were then blocked for 1hr using 5% dried milk in PBS with 1% Tween-20 (PBS-T) at room temperature with gentle agitation. Following this membranes were washed twice in PBS before being incubated with 1° antibodies at 4°C overnight. Antibodies for phospho-ERK1/2 (Thr202/Tyr204, 1:1000, Cell Signalling), total ERK (1:1000, Cell Signalling), phospho-Akt

(1:1000, Cell Signalling) and Akt (1:1000, Cell Signalling) or β -Tubulin (Promega; 1:1000) were diluted in 1% dried milk with 5% BSA and 0.002% sodium azide. Membranes were washed twice for 10 min in PBS-T and then incubated in the appropriate peroxidase linked secondary antibody (Amersham) in 1% BSA in PBS-T at room temperature for 1 hr with gentle agitation. ECL-plus (Amersham) was used to visualise stainings according to manufacturers instructions. ECL-plus was applied to the blot for 1 min, then drained from the membrane. The membrane was sandwiched between two sheets of acetate, placed in an autoradiography cassette and exposed to Hyperfilm (Amersham). The film was developed and fixed manually (Kodak GBX developing and fixing solution, Sigma). After visualisation of the antibody complexes, the blot was stripped of primary antibodies and incubated in mouse anti- β -tubulin (1:10,000, Chemicon) in 1% BSA in PBS-T for 1 hr at room temperature. Following washing, as described above, visualisation of the antibody complexes was carried out as above.

2.13 Statistical analyses

Data are presented as means \pm SEM, and pair-wise statistical significance comparison was determined by Student's t test. Multiple comparisons were made by one-way analysis of variance (ANOVA) followed by Fisher's *post hoc* test. Accepted level of significance was $P < 0.05$. For neurite growth analysis between 50 and 60 neurons were sampled per condition and each experiment was repeated three times.

Chapter 3

RANK is a novel regulator of neurite growth in the developing peripheral nervous system

3.1 Introduction

A large number of locally acting and diffusible signalling molecules regulate the growth and guidance of axons to their targets and the terminal arborization within these targets. A wide variety of cells provide these molecules, both en route to and within their final targets, and these molecules bind to receptors on the advancing axons to influence growth rate, branching and direction (Chilton, 2006; Zhou & Snider, 2006). Neurotrophic factors, such as members of the neurotrophin family, GDNF and gp130 cytokine families which regulate neuronal survival, also influence the growth and morphology of neural processes (Davies et al., 2003). Several members of the TNF superfamily have recently been implicated in the regulation of the growth of sensory and sympathetic neurites. GITR, and its ligand, GITRL, have been found to be essential for the NGF-dependent growth of axons and, consequently, innervation of targets in neurons of the SCG (O'Keeffe et al., 2008) and the TNF member LIGHT is a negative regulator of neurite growth in the sensory neurons of the nodose ganglia (Gavalda et al., 2009).

The TNF superfamily constitutes 19 members that are critical in the regulation and maintenance of the immune system (Hehlgans & Pfeffer, 2005). Increasingly, the role of this superfamily in other tissues and organs is also being recognized. TNF α was the first member of this family to be discovered (Carswell et al., 1975) and in the CNS this cytokine is upregulated during immune and

inflammatory responses and in a number of neurodegenerative diseases (Munoz-Fernandez & Fresno, 1998). TNF α also plays a role in facilitating naturally occurring neuronal death in developing sympathetic and sensory ganglia (Barker et al., 2001). Members of the TNF superfamily are expressed as type II transmembrane glycoproteins that bind a complementary receptor superfamily of type I transmembrane proteins (Hehlgans & Pfeffer, 2005).

RANK is a member of the TNFR superfamily that, together with its ligand, RANKL, and a decoy receptor, OPG, plays an essential role in the regulation of osteoclast differentiation, activity and survival (Bharti & Aggarwal, 2004). RANKL binding to its receptor induces haematopoietic progenitor cells to differentiate into osteoclasts, as well as activating mature osteoclasts (Wada et al., 2006) and OPG inhibits bone turnover by preventing RANK-RANKL binding. RANK is also known to play vital roles in the regulation of the immune system (Kearns et al., 2008) and in the regulation of dendritic cell survival (Wong et al., 1997). To date, there is no known expression or role for the RANK signalling system in the nervous system.

A finding in a PCR screen for the expression of members of the TNFR superfamily in developing sympathetic and sensory ganglia that RANK mRNA is expressed in the SCG, trigeminal and nodose ganglia of fetal and postnatal mice was the starting point for the studies reported here. Detailed real-time PCR analysis revealed the developmental time-course of expression of RANK mRNA

in these ganglia and immunocytochemistry localized RANK, RANKL and OPG to the neurons of these ganglia. Over-expression of RANK was found to inhibit neurotrophic factor-promoted neurite growth from the neurons without affecting their survival, suggesting that RANK signalling is a selective negative inhibitor of neurite growth from developing sensory and sympathetic neurons.

Results

3.2 RANK, RANKL and OPG are expressed in nodose, SCG and trigeminal neurons of developing mice

A PCR screen carried out in the laboratory for the expression of members of the TNFR superfamily in sympathetic and sensory ganglia of developing mouse embryos and neonates revealed that RANK mRNA is expressed in the SCG, trigeminal and nodose ganglia of fetal and postnatal mice (data not shown; Dr Gerard O'Keeffe). To establish which cells in the nodose ganglion express RANK, and to determine if RANKL and OPG are also expressed, specific antibodies were used to localize these proteins in P0 dissociated nodose neuron cultures. In addition to antibodies against either RANK, RANKL or OPG, nodose neurons were also probed with antibodies against the pan-neuronal marker β -III tubulin and cell nuclei were labeled with the fluorescent marker DAPI.

The cell bodies of all P0 nodose neurons examined were found to express RANK, RANKL and OPG (Fig. 17). In contrast, non-neuronal cells showed little or no immunoreactivity for any of these proteins (data not shown). A similar approach was used to determine which cells within P0 SCG and trigeminal ganglia expressed RANK, RANKL and OPG. In a similar manner to nodose neurons, P0 SCG and trigeminal neurons (Figs. 18 and 19, respectively) expressed all three proteins within their cell soma, but not within the neuronal

processes, whereas non-neuronal cells did not express detectable levels of the proteins (data not shown).

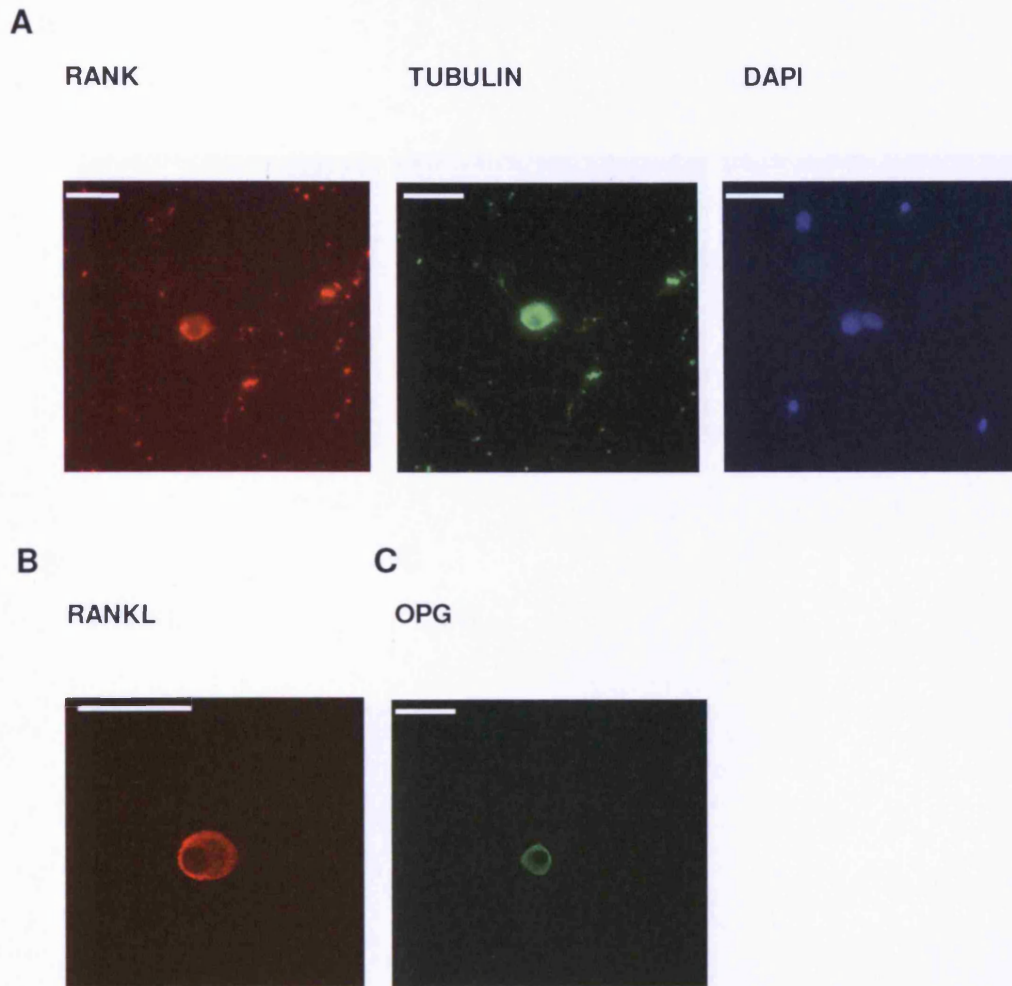


Figure 17: RANK, RANKL and OPG expression in developing nodose neurons. (A) Photomicrographs of the same fields of P0 dissociated cultures triple labelled for RANK, B-III tubulin and DAPI. (B, C) A neuron labelled for either RANKL or OPG, respectively. Scale bars=50 μ m.

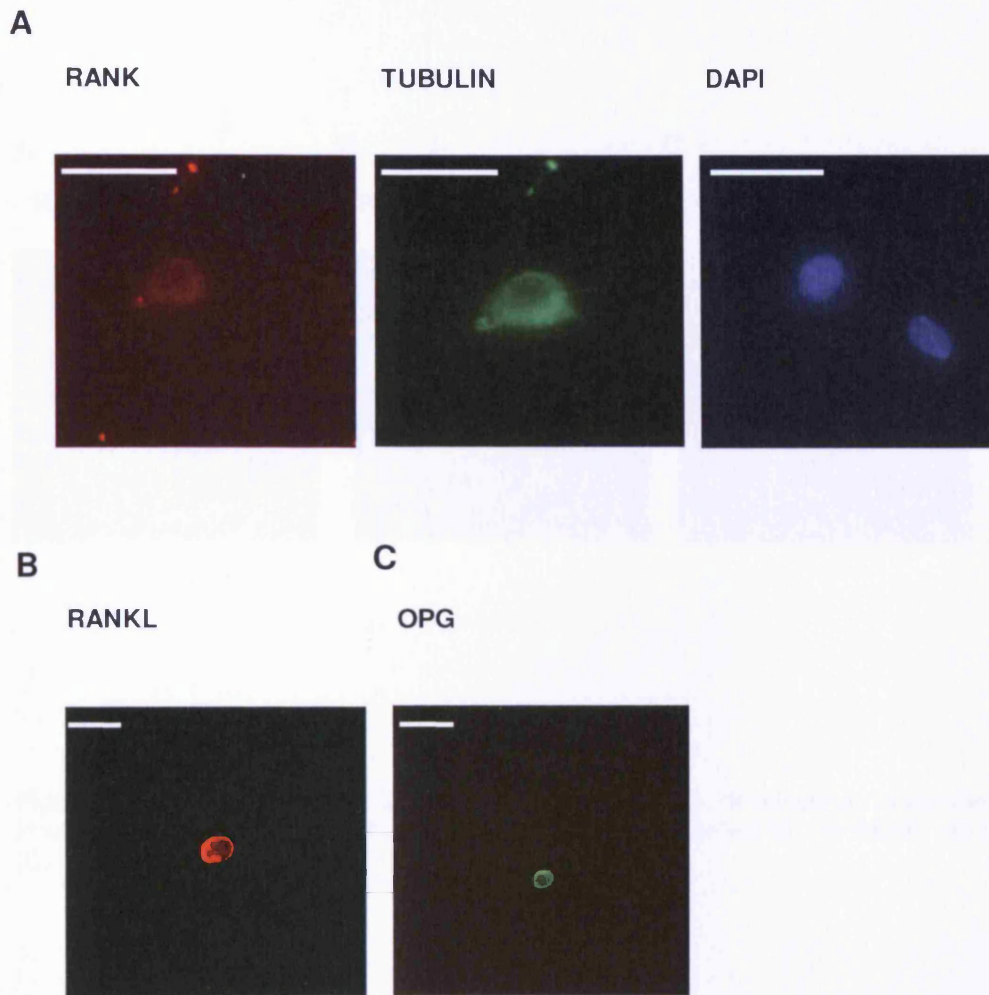


Figure 18: RANK, RANKL and OPG expression in developing SCG neurons. (A) Photomicrographs of the same fields of P0 SCG dissociated cultures triple labelled for RANK, B-Tubulin and DAPI. (B, C) A neuron labelled for either RANKL or OPG, respectively. Scale bars=50 μ m

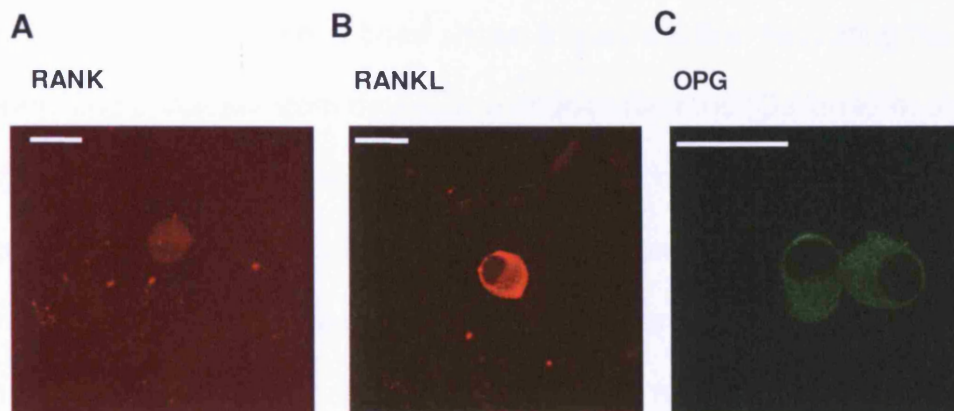


Figure 19: RANK, RANKL and OPG expression in developing trigeminal neurons. Photomicrographs of P0 trigeminal dissociated cultures labelled for (A) RANK, (B) RANKL and (C) OPG. Scale bars=50µm

3.3 Over-expression of RANK reduces the extent of neurite growth from P0 nodose neurons cultured with either BDNF or CNTF

Because NF- κ B signalling has been shown to play a role in regulating the growth and branching of neurite from developing nodose neurons (Gutierrez et al., 2005; Gutierrez et al., 2008; Gavalda et al., 2009) and because RANK is known to activate NF- κ B (Wada et al., 2006), it was hypothesized that RANK may play a role in regulating neurite outgrowth from these neurons through modulating the action of NF- κ B. To investigate this possibility, P0 nodose neurons were plated at high density in culture medium supplemented with 10ng/ml BDNF and co-transfected with a YFP expression construct, together with either a RANK expression construct to enhance RANK signalling by over-expression or an empty control plasmid. Fluorescent neurons were counted at 24 and 48 hours after plating to allow calculation of percentage survival. Over-expression of RANK was found to have no effect on the survival of P0 nodose neurons (Fig. 20A). The complexity of neuronal arbors was quantified 24 hours after plating, by imaging followed by Sholl analysis. Sholl analysis provides a graphic illustration of neurite length and branching with distance from the cell body (Gutierrez et al., 2007). RANK over-expression, but not the control plasmid, significantly decreased neurite growth from nodose neurons cultured in BDNF supplemented medium (Fig. 20). Over-expressing RANK reduced the mean extent of neurite growth from nodose neurons by 75%, as reflected in a downward shift in the Sholl profile (Fig. 20B), and significant decreases in the mean total length of

neurites (Fig. 20C) and the mean number of branch points (Fig. 20D). Figure 24 shows the typical appearance of nodose neurons transfected with the RANK expression construct compared to control-transfected cells.

The growth and survival of developing nodose ganglion neurons can be sustained by either BDNF or CNTF (Davies et al, 1993; Horton et al., 1998). To determine if the neurite growth inhibitory effect of RANK over-expression is specific for BDNF-promoted neurite growth or whether this also affects CNTF-promoted growth, the effect of over-expressing RANK on the extent of neurite outgrowth from nodose neurons supported by CNTF was also investigated. P0 nodose neurons were plated for 3 hours then co-transfected with a YFP expression plasmid together with either a RANK expression construct or an empty vector and cultured in medium containing CNTF (50ng/ml). Neurons were counted at 24 and 48 hours after plating, to calculate percentage survival and over-expressing RANK was found to have no effect on the survival of P0 nodose neurons cultured with CNTF (Fig. 21A). Neurons were imaged after 24 hours in culture for analysis of neurite growth. The over-expression of RANK significantly reduced the mean total length of P0 nodose neurons cultured with CNTF (Fig. 21C). Over-expression of RANK also reduced the mean number of branch points (Fig. 21D) and shifted the Sholl profile downwards (Fig. 21B). The decrease in growth was similar in magnitude to the effect found when over-expressing RANK in P0 nodose neurons cultured in medium containing BDNF (Fig. 20). Figure 24

shows the typical appearance of nodose neurons transfected with the RANK expression construct and cultured with CNTF.

3.4 Over-expression of RANK reduces neurite growth from P0 SCG and trigeminal neurons cultured with NGF

Because NF- κ B is also known to play a role in regulating neurite growth from the sympathetic neurons of the SCG (Gutierrez et al., 2008) and because RANK mRNA was found to be expressed in the SCG (data not shown) I decided to investigate whether RANK signalling is able to regulate neurite outgrowth from this neuronal population.

Dissociated P0 SCG neurons were plated for 3 hours in medium containing 10ng/ml NGF and then transfected with a YFP expression construct together with either a RANK expression construct or an empty control vector. Fluorescent neurons were counted at 24 and 48 hours to calculate the percentage of transfected neurons surviving at 48 hrs compared to 24 hrs. Over-expressing RANK was found to have no effect on the survival of P0 SCG neurons cultured with NGF (Fig. 22A). Neurons were imaged at 24 hours for Sholl analysis of neurite growth. Over-expressing RANK was found to significantly decrease neurite growth from P0 SCG neurons, compared to control transfected neurons, as reflected by a downward shift in the Sholl profile (Fig. 22B) as well as a decrease in mean total neurite length total length (Fig. 22C) and the mean number of branch points (Fig. 22D). The effect of over-expressing RANK on

reducing neurite outgrowth from P0 SCG neurons cultured with NGF was less than the effect of over-expressing RANK in P0 nodose neurons cultured with either BDNF or CNTF. In the case of P0 SCG neurons exogenous RANK expression decreased mean total neurite length and the mean number of branch points by approximately 50%, whereas over-expressing RANK reduced those parameters in P0 nodose neurons by approximately 75%. Figure 24 shows the typical appearance of RANK transfected P0 SCG neurons supplemented with NGF and the relevant controls.

To investigate whether over-expressing RANK reduced neurite outgrowth from trigeminal sensory neurons, neurons were co-transfected ballistically, 3 hours after plating, with a YFP-expression construct in concert with either a RANK expression plasmid or an empty control vector and then cultured in media supplemented with NGF (10ng/ml). Fluorescent neurons were counted after 24 and 48 hours in culture to allow the percentage survival at 48 hrs to be calculated. Over-expressing RANK did not effect the survival of P0 trigeminal neurons (Fig. 23A). However, over-expression of RANK significantly reduced neurite outgrowth, as shown by a downward shift in the Sholl profile (Fig. 23B), a significant decrease in mean total neurite length (Fig. 23C) and a significant decrease in the mean number of branching points (Fig. 23D). Like SCG neurons, neurite outgrowth from P0 trigeminal neurons was less affected by RANK over-expression than neurite outgrowth from P0 nodose neuron. Figure 24 shows the

typical appearance of RANK transfected P0 trigeminal neurons supplemented with NGF and the relative controls.

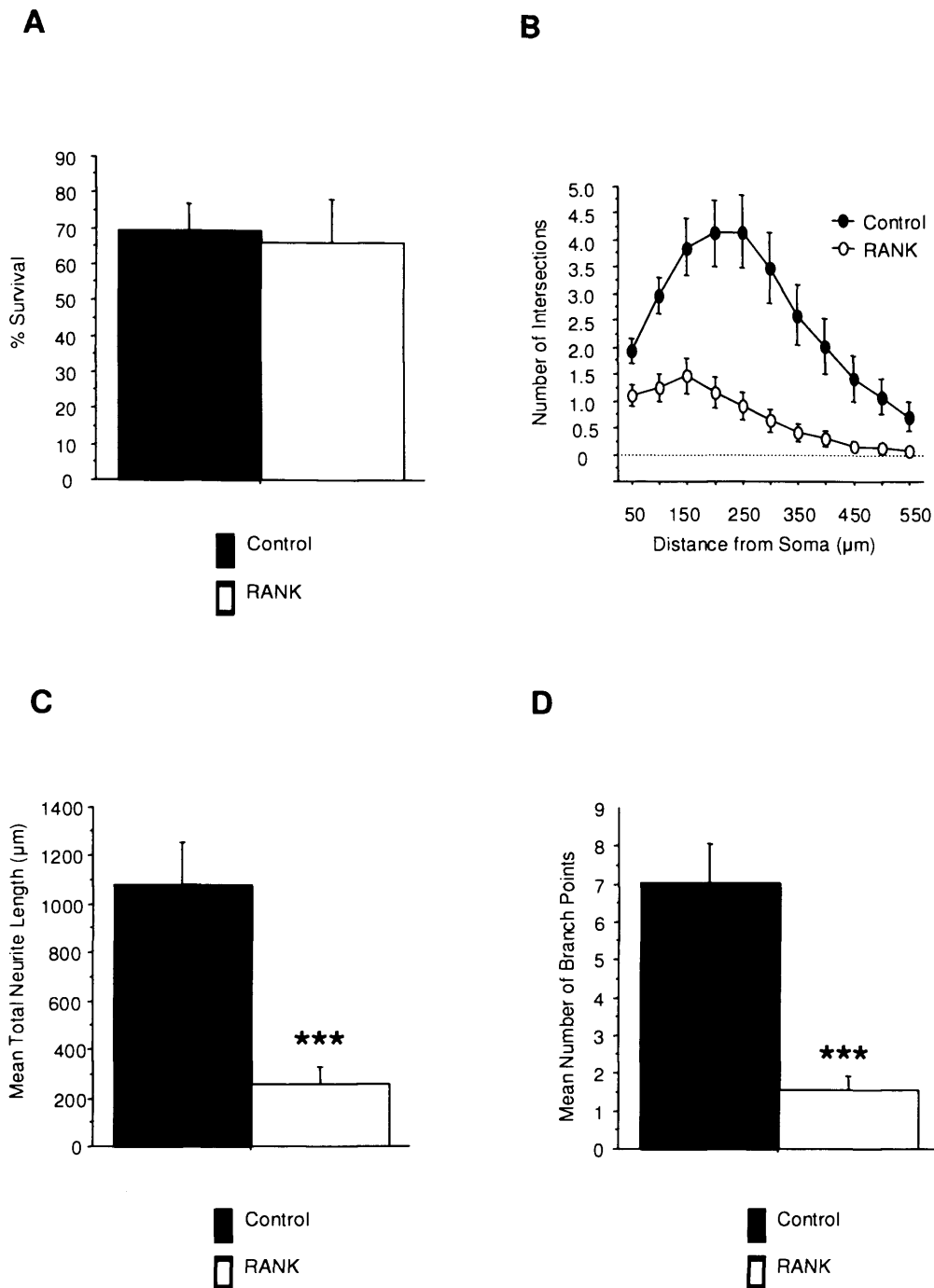


Figure 20: Effect of over-expressing RANK on BDNF-dependent growth from P0 nodose neurons. P0 nodose neurons were co-transfected 3 hours after plating with a YFP expression construct together with either a RANK expression construct or an empty vector and cultured with BDNF (10ng/ml). Percentage survival after 48 hours (A). Sholl analysis (B), total neurite length (C) and number of branch points (D). The results are derived from the grouped data of 50-70 neurons and very similar data were obtained in three independent experiments. Statistical comparison are with respect to control-transfected neurons (** $p < 0.001$, ANOVA with Fisher's *post hoc*).

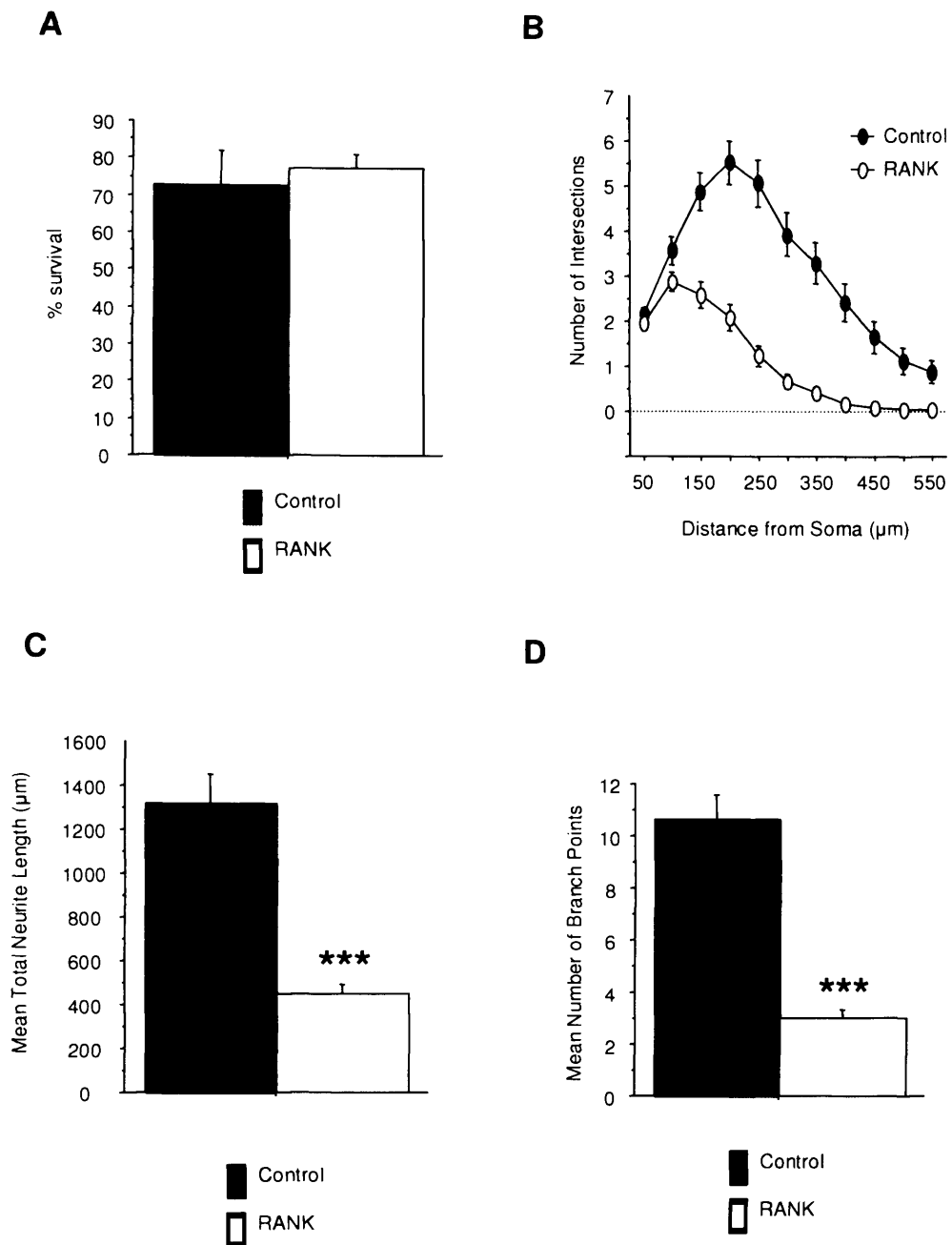


Figure 21: Effect of over expressing RANK on CNTF-dependent growth from P0 nodose neurons. P0 nodose neurons were co-transfected 3 hours after plating with a YFP expression construct together with either a RANK expression construct or an empty vector and cultured with CNTF (50ng/ml). Percentage survival after 48 hours (A). Sholl analysis (B), total neurite length (C) and number of branching points (D). The results are derived from the grouped data of 50-70 neurons and very similar data were obtained in three independent experiments. Statistical comparison are with respect to control-transfected neurons (***) $p < 0.001$, ANOVA with Fisher's *post hoc*.

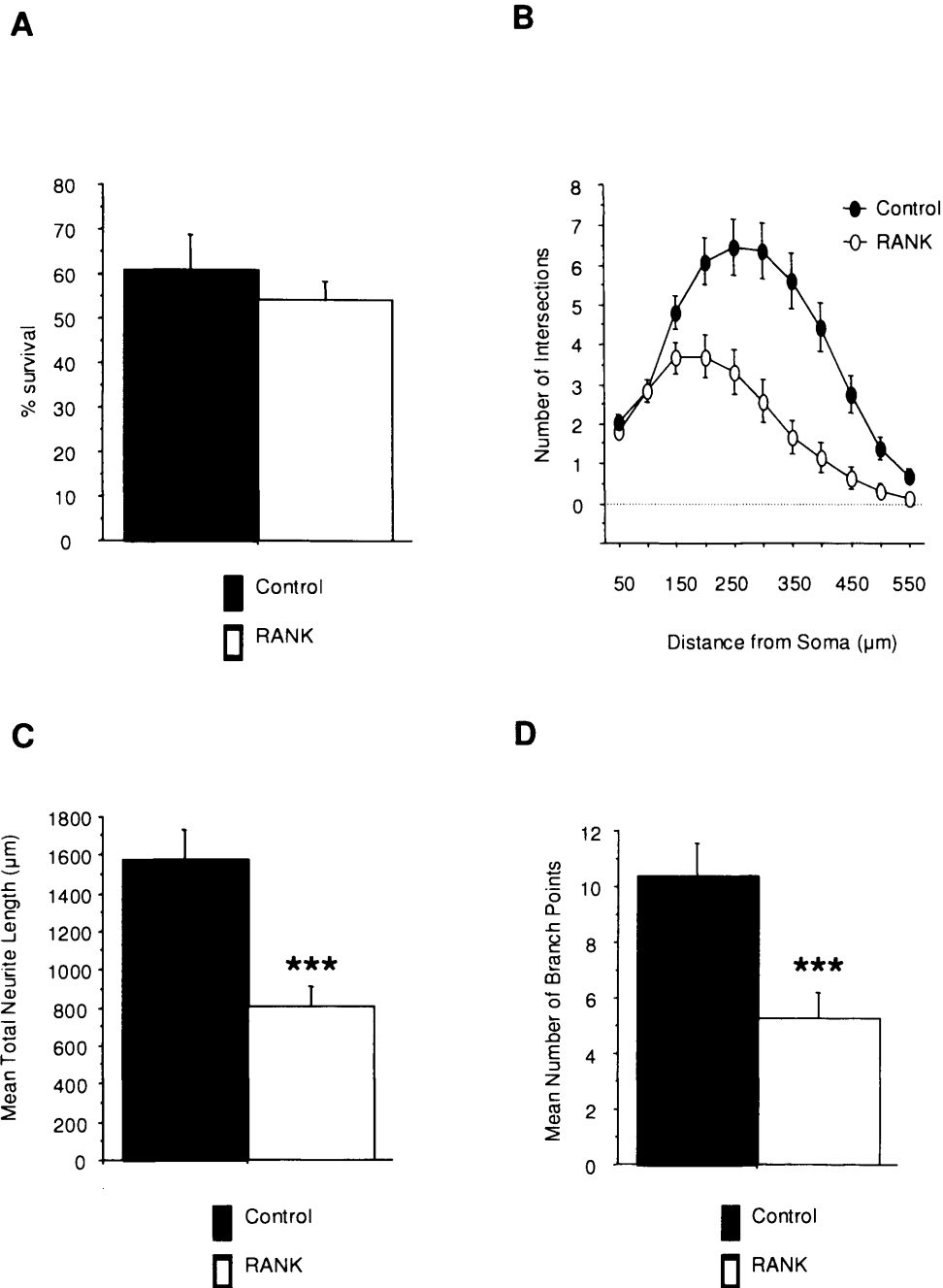


Figure 22: Effect of over expressing RANK on NGF-dependent growth from P0 SCG neurons. P0 SCG neurons were transfected 3 hours after plating with a YFP expression construct together with either a RANK expression construct or an empty vector and cultured with NGF (10ng/ml). Percentage survival after 48 hours (A). Sholl analysis (B), total neurite length (C) and number of branching points (D). The results are derived from the grouped data of 50-70 neurons and very similar data were obtained in three independent experiments. Statistical comparison are with respect to control-transfected neurons (** $p < 0.001$, ANOVA with Fisher's *post hoc*).

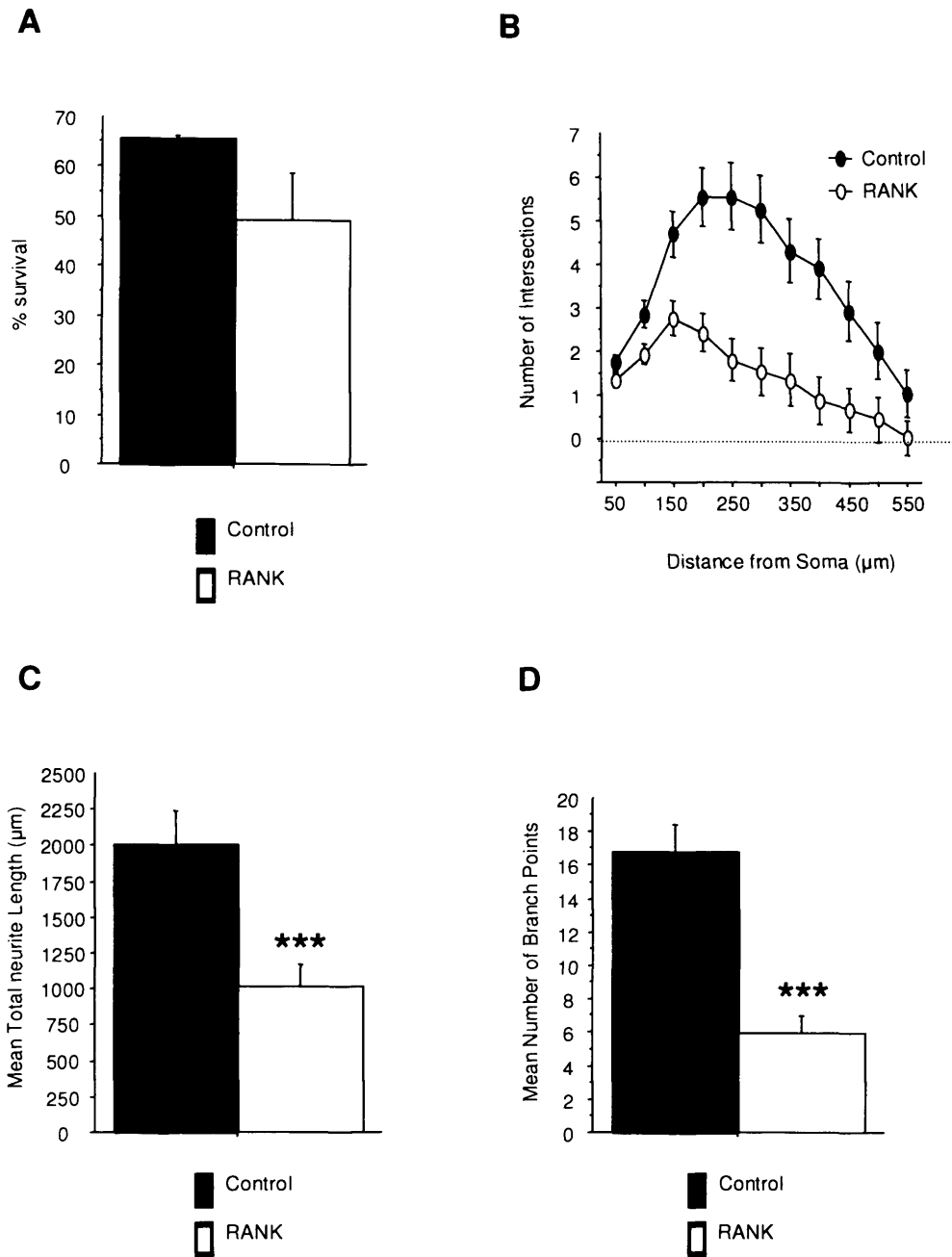


Figure 23: Effect of over expressing RANK on NGF-dependent growth from PO trigeminal neurons. P0 trigeminal neurons were co-transfected 3 hours after plating with a YFP expression construct together with either a RANK expression construct or an empty vector and cultured with NGF (10ng/ml). Percentage survival after 24 hours (A). Sholl analysis (B), total neurite length (C) and number of branching points (D). The results are derived from the grouped data of 50-70 neurons and very similar data were obtained in three independent experiments. Statistical comparison are with respect to control-transfected neurons (** $p < 0.001$, ANOVA with Fisher's *post hoc*).

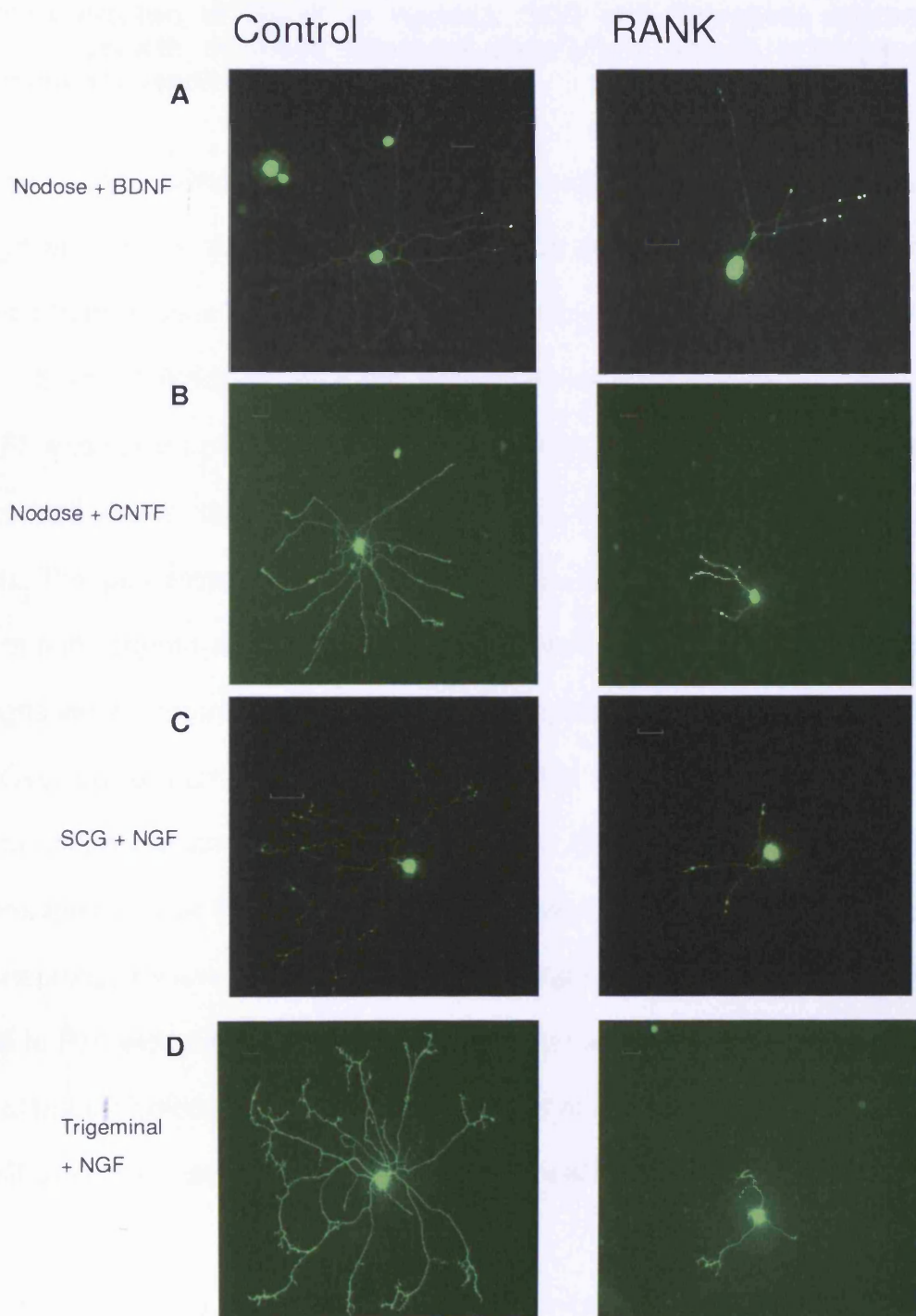


Figure 24: Effect of over-expressing RANK in different neuronal populations. Photomicrographs of typical neurons transfected with the RANK expression construct (RANK) or a control vector (Control) and incubated in the appropriate neurotrophin or cytokine. (A) Nodose neuron with BDNF, (B) Nodose neuron with CNTF (50ng/ml), (C) SCG neuron with NGF, (D) trigeminal neuron with NGF. Scale bar = 50 μ m.

3.5 Over-expression of RANK in nodose, SCG and trigeminal neurons reduces the growth of these neuronal populations across a range of developmental timepoints

To ascertain if the inhibitory effect of RANK over-expression on BDNF-promoted neurite growth occurs over a particular stage of development, cultures were established from nodose ganglia at a range of embryonic and postnatal stages. E18, P0, P5 and P10 nodose neurons were co-transfected 3 hours after plating with a YFP expression plasmid and either the RANK expression construct or an empty control vector, then incubated for 48 hrs in media containing BDNF (10ng/ml). The percentage neuronal survival was determined by counting the number of fluorescent transfected neurons at 24 and 48 hours post transfection and images were captured at 24 hours post transfection for analysis of neurite growth. Over-expression of RANK did not affect the survival of nodose neurons relative to controls at any age studied (Fig. 26A). Sholl analysis demonstrated that over-expression of RANK decreased the extent of neurite outgrowth from nodose neurons, relative to controls, at every stage investigated (Fig. 25A-D) from E18 to P10 with the effect increasing from earlier to later timepoints. Mean number of branch points (Fig. 26B) and mean total neurite length (Fig. 26C) were also significantly reduced compared to controls at each age investigated.

Similar analysis of the effects of RANK over-expression on NGF-promoted neurite growth from SCG neurons and trigeminal neurons of different developmental ages revealed that exogenous RANK expression does not affect

the survival of SCG and trigeminal neurons cultured with NGF at either E18, P0, P5 or P10 (Figs. 28A and 30A). Over-expression of RANK, however, significantly reduced neurite outgrowth from SCG and trigeminal neurons at all these ages, as revealed by Sholl analysis (Figs. 27A-D and 29A-D), mean total neurite length (Figs 28C and 30C) and branch point number (Figs 28B and 30B). The effect of over-expressing RANK on neurite growth from SCG neurons increased at later timepoints, in similar fashion to results in the nodose (Fig. 25). However, the effect of over-expression of RANK on NGF promoted neurite growth from trigeminal neurons was comparable at all ages examined.

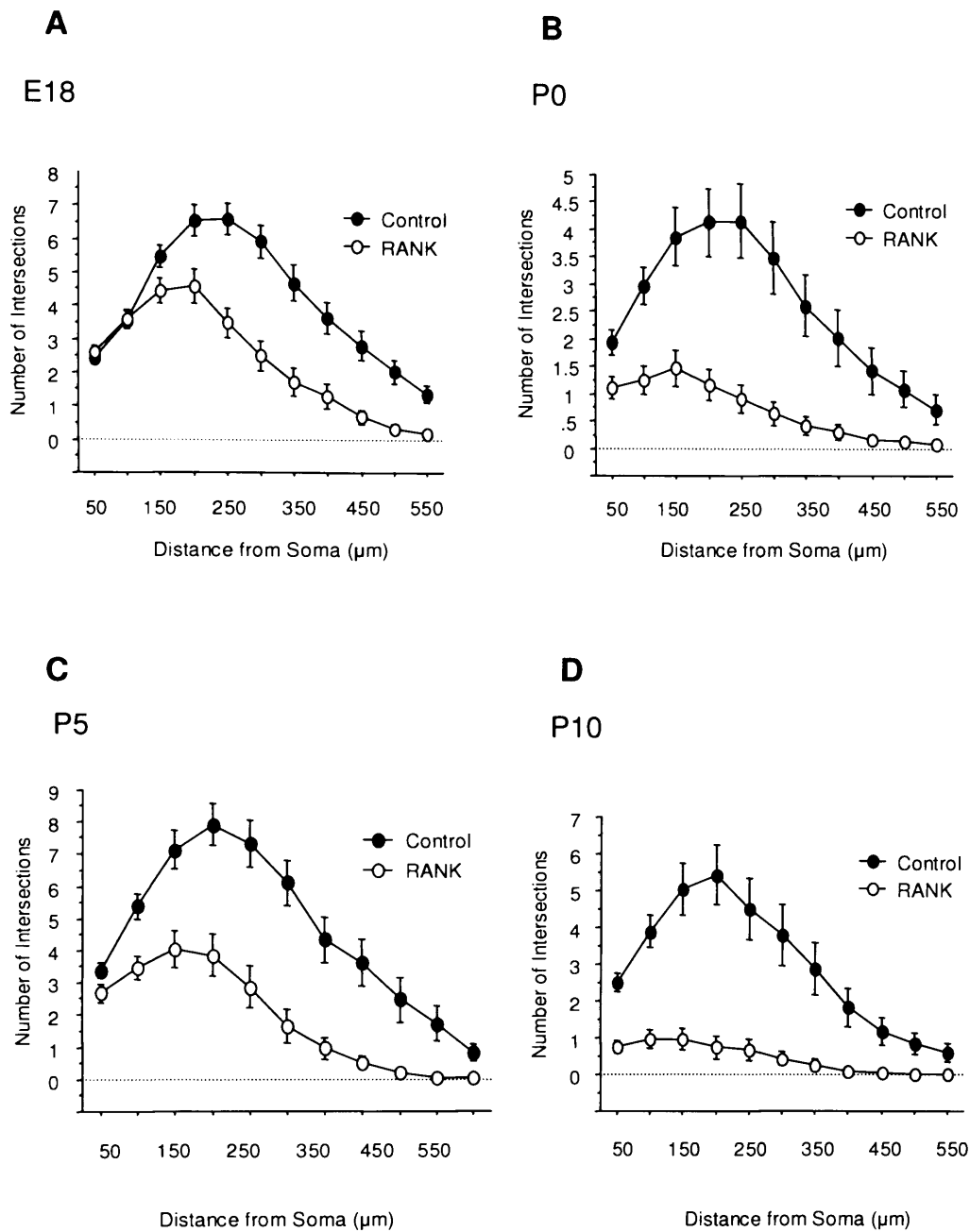


Figure 25: Over-expressing RANK reduces neurite growth from nodose neurons at different developmental stages. E18, P0, P5 and P10 nodose neurons were co-transfected 3 hours after plating with a YFP expression construct together with either a RANK expression construct or an empty vector and cultured with BDNF (10ng/ml). (A-D) Sholl analysis of neurite arbour morphology 24hr after transfection of E18, P0, P5 and P10 nodose neurons respectively. The results are derived from the grouped data of 50-70 neurons and very similar data were obtained in three independent experiments.

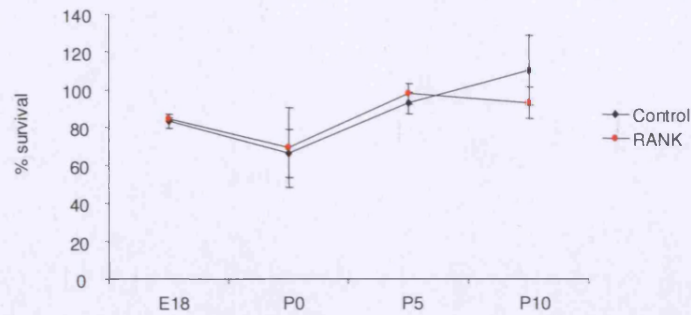
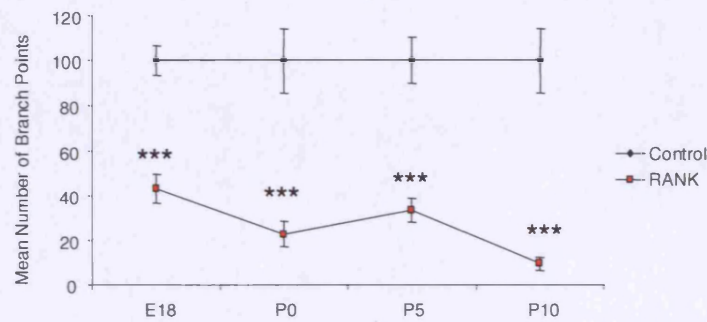
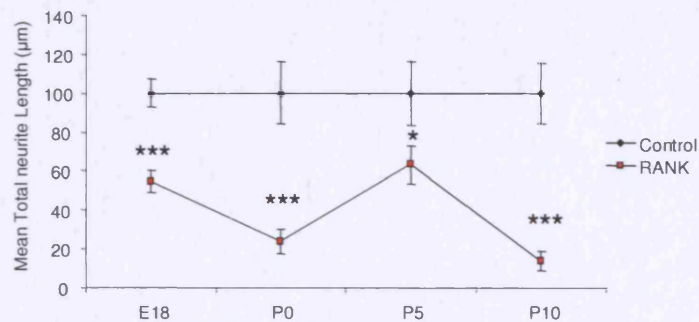
A**B****C**

Figure 26: Over-expressing RANK reduces neurite growth from nodose neurons at different developmental stages without affecting survival. E18, P0, P5 and P10 nodose neurons were co-transfected 3 hours after plating with a YFP expression construct together with either a RANK expression construct or an empty vector and cultured with BDNF (10ng/ml). (A) survival at 48 hours (B) Total neurite length (C) Number of branch points of E18, P0, P5 and P10 nodose neurons. Data have been normalised to 100% for controls to facilitate comparison of effects at different ages. The results are derived from the grouped data of 50-70 neurons and very similar data were obtained in three independent experiments. Statistical comparison are with respect to control-transfected neurons (* $p < 0.05$, *** $p < 0.001$, ANOVA with Fisher's *post hoc*).

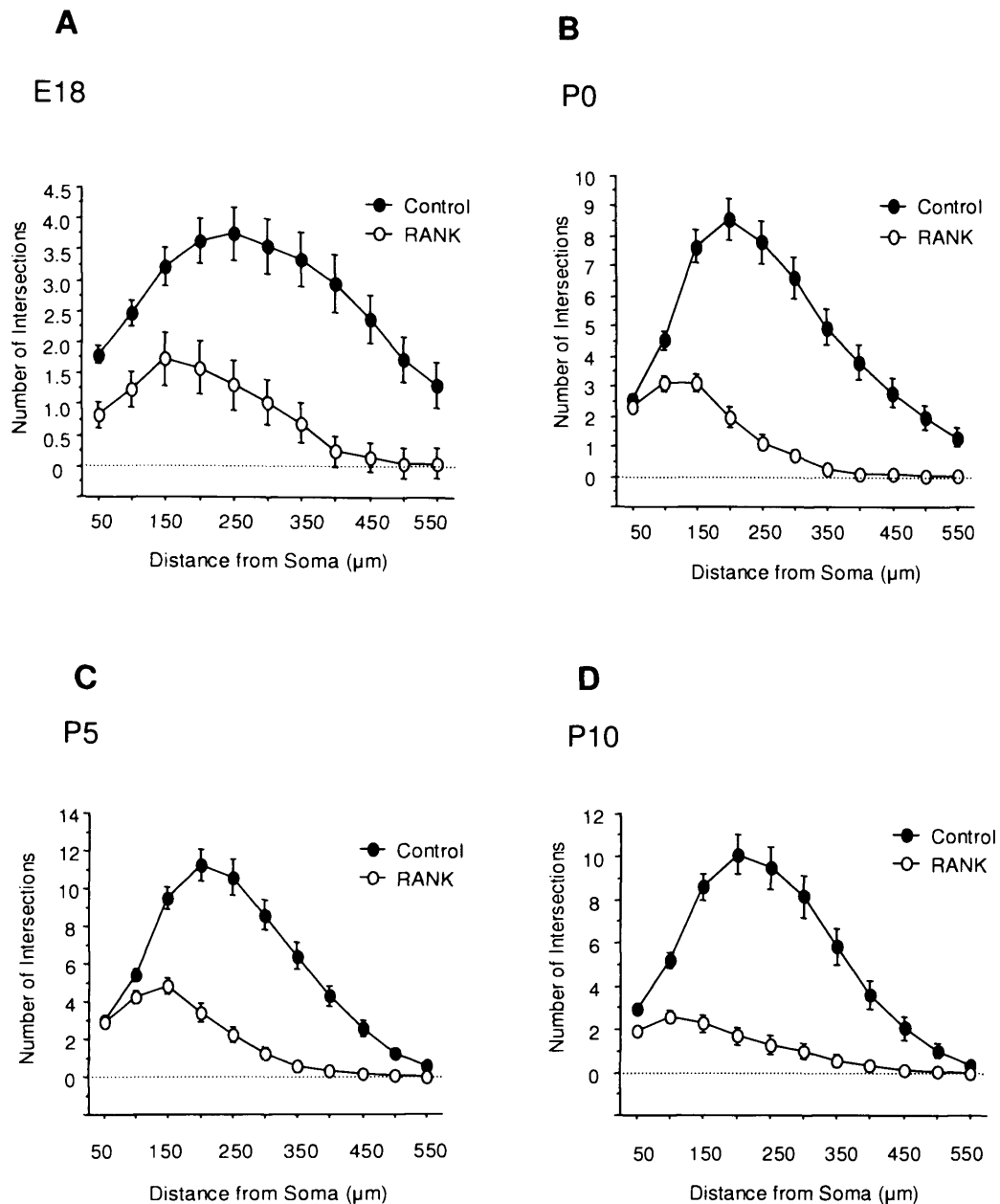


Figure 27: Over-expressing RANK reduces neurite growth from SCG neurons at different developmental stages. E18, P0, P5 and P10 SCG neurons were co-transfected 3 hours after plating with a YFP expression construct together with either a RANK expression construct or an empty vector and cultured with NGF (10ng/ml). (A-D) Sholl analysis of neurite arbour morphology 24hr after transfection of E18, P0, P5 and P10 SCG neurons respectively. The results are derived from the grouped data of 50-70 neurons and very similar data were obtained in three independent experiments.

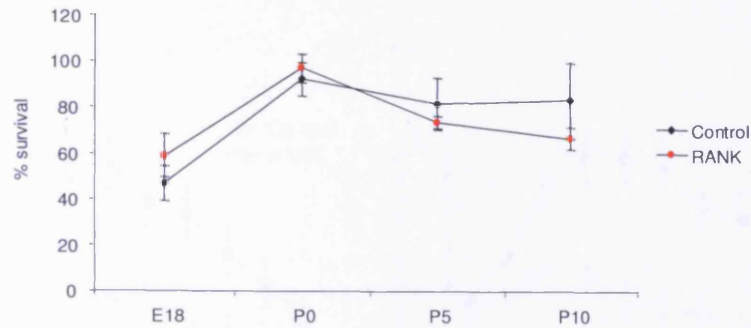
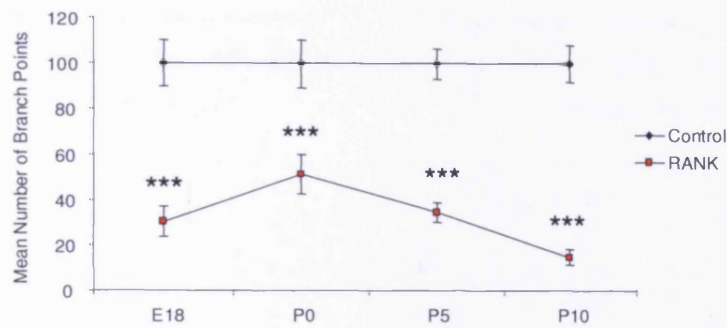
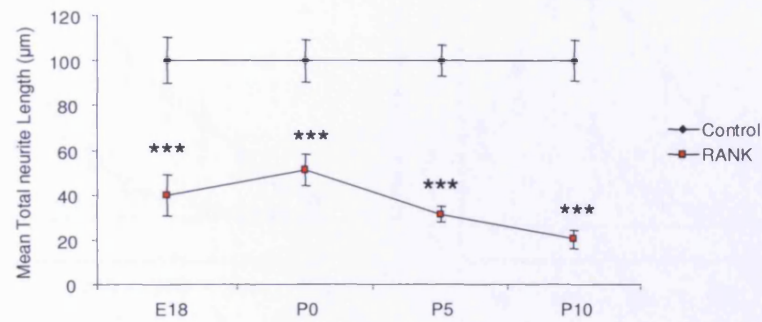
A**B****C**

Figure 28: Over-expressing RANK reduces neurite growth from SCG neurons at different developmental stages without affecting survival. E18, P0, P5 and P10 SCG neurons were co-transfected 3 hours after plating with a YFP expression construct together with either a RANK expression construct or an empty vector and cultured with BDNF (10ng/ml). (A) survival at 48 hours (B) Total neurite length (C) Number of branch points of E18, P0, P5 and P10 SCG neurons. Data have been normalised to 100% for controls to facilitate comparison of effects at different ages. The results are derived from the grouped data of 50-70 neurons and very similar data were obtained in three independent experiments. Statistical comparison are with respect to control-transfected neurons (***) $p < 0.001$, ANOVA with Fisher's *post hoc*.

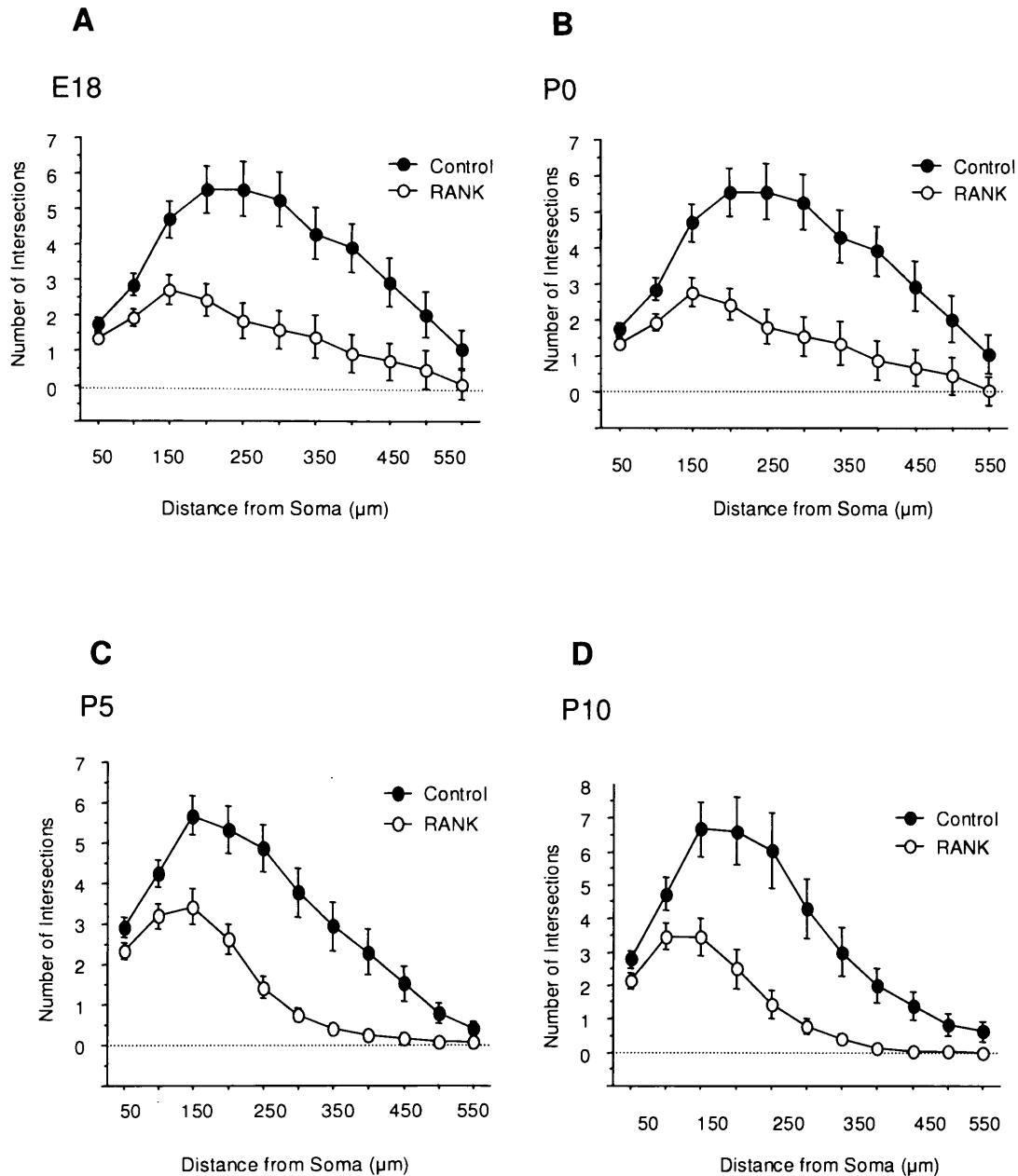


Figure 29: Over-expressing RANK reduces neurite growth from trigeminal neurons at different developmental stages. E18, P0, P5 and P10 trigeminal neurons were co-transfected 3 hours after plating with a YFP expression construct together with either a RANK expression construct or an empty vector and cultured with NGF (10ng/ml). (A-D) Sholl analysis of neurite arbour morphology 24hr after transfection of E18, P0, P5 and P10 trigeminal neurons respectively. The results are derived from the grouped data of 50-70 neurons and very similar data were obtained in three independent experiments.

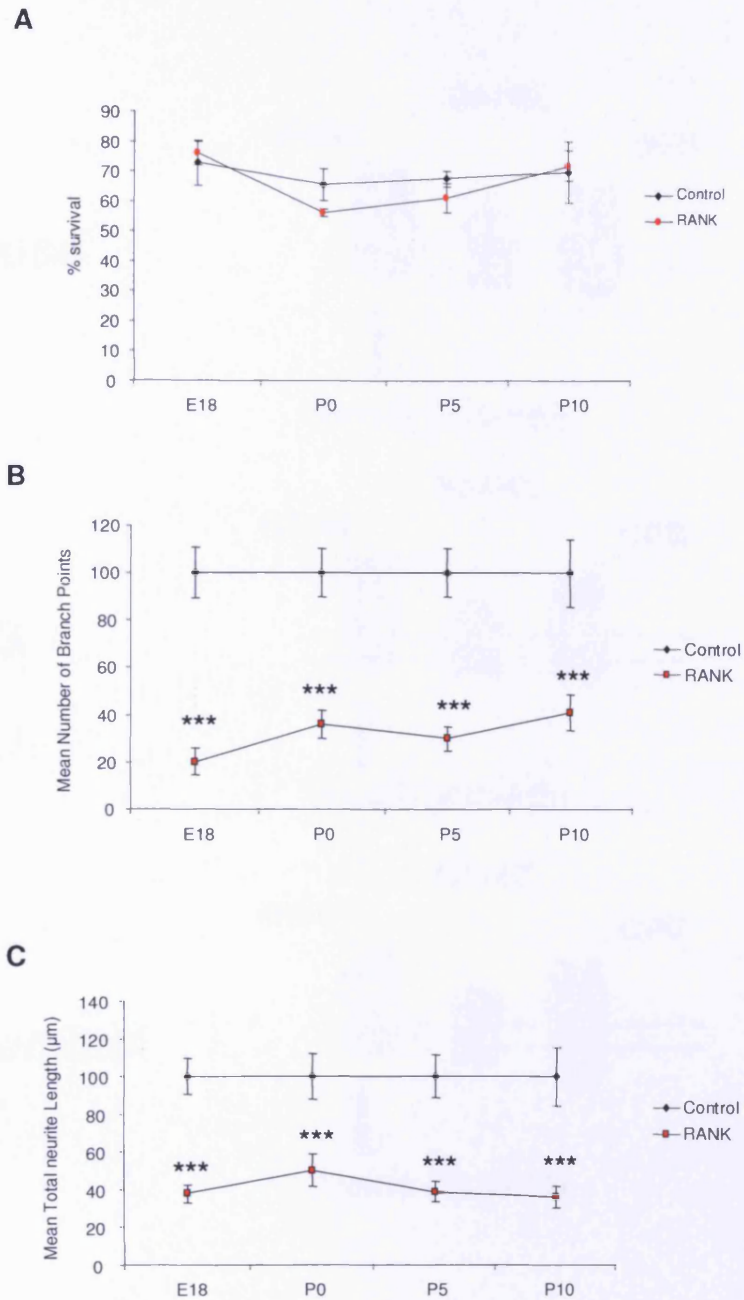


Figure 30: Over-expressing RANK reduces neurite growth from trigeminal neurons at different developmental stages without affecting survival. E18, P0, P5 and P10 trigeminal neurons were co-transfected 3 hours after plating with a YFP expression construct together with either a RANK expression construct or an empty vector and cultured with NGF (10ng/ml). (A) survival at 48 hours (B) Total neurite length (C) Number of branch points of E18, P0, P5 and P10 trigeminal neurons. Data have been normalised to 100% for controls to facilitate comparison of effects at different ages. The results are derived from the grouped data of 50-70 neurons and very similar data were obtained in three independent experiments. Statistical comparison are with respect to control-transfected neurons (***) $p < 0.001$, ANOVA with Fisher's *post hoc*.

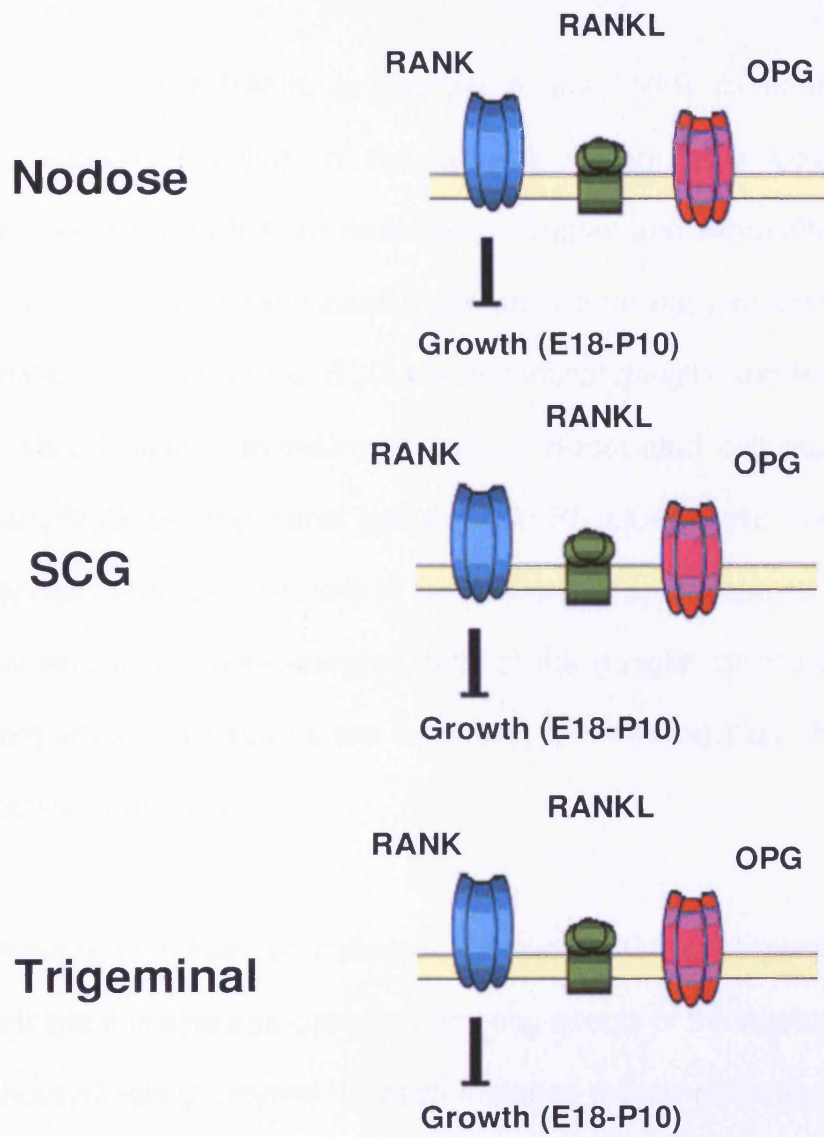


Figure 31: Summary of results. RANK, RANKL and OPG are detectable in neurons of the nodose, SCG and trigeminal and RANK OE decreases growth from these neurons across a range of ages.

3.6 Discussion

I have discovered that RANK, a member of the TNFR superfamily with no previously described function in the nervous system, is a potent negative regulator of neurite growth from developing sensory and sympathetic neurons. RANK mRNA expression significantly increased from early embryonic ages to early postnatal ages in nodose, SCG and trigeminal ganglia and RANK, RANKL and OPG were localized to neuronal cells in dissociated cultures established from nodose, SCG and trigeminal ganglia from P0 mice. These TNF and TNFR superfamily members were present in the neurons of each population examined, but were absent in the non-neuronal cells of the ganglia, during the period of development when the neurons are extending and refining their connections in their respective target fields.

Over-expression of RANK in cultured nodose, SCG and trigeminal neurons markedly inhibited the neurite-growth promoting effects of the appropriate growth factor, without affecting survival. In each instance the over-expression of RANK was found to significantly decrease the neuritic outgrowth from these neurons compared with control transfected neurons. Another member of the TNFR superfamily has also recently been found to play a role in the negative regulation of neurite outgrowth from sensory neurons. HVEM and its ligand, LIGHT, was found to inhibit BDNF-promoted neurite growth in nodose neurons (Gavalda et al., 2009). Additional experiments, using antibodies directed against RANK,

could have been used to confirm overexpression of this TNF family member by transfection of the expression construct.

Immunohistochemistry demonstrated that RANK and RANKL are expressed in neurons of nodose, SCG and trigeminal ganglia. All neurons examined were found to express both proteins suggesting they are co-expressed and that RANK-RANKL signalling may operate in either an autocrine manner within individual neurons or by a paracrine route between neurons. The basal level of RANK-RANKL signalling may play a role in restricting the neurite outgrowth from neurons that are unsuccessful in competition for *in vivo* target derived neurotrophic support. The presence of OPG also raises the possibility that this decoy plays a role in regulating the growth from these neuronal populations, through its interactions with RANKL. Although immunohistochemistry revealed the presence of RANK and its associated family members, in neurons of the nodose, SCG and trigeminal, additional controls to verify the efficacy of these antibodies on cells known to express RANK, such as dendritic cells (Anderson et al., 1997) would have been useful.

RANK over-expression results in a similar reduction in neurite growth from 3 distinct neuronal populations, without affecting the survival of these neurons. Previous studies have demonstrated that over-expression of RANK activates NF- κ B (Anderson et al., 1997; Darnay et al., 1997) as was found to be the case in nodose neurons (data not shown; Dr H Gutierrez, personal communication). The

effect of over-expressing RANK occurs when these neurons are supported by neurotrophins, as well as a cytokine and these findings raise the possibility that RANK signalling plays an important role in the regulation of neurite outgrowth from different populations of PNS neurons. Studies of sensory and sympathetic innervation density in RANK knockout mice (Dougall et al., 1999; Li et al., 2000) will further our understanding of the role of this receptor in neurotrophin-mediated growth in these neuronal populations. Further experiments, using siRNAs directed against RANK, RANKL and OPG, as well as transfection of neurons with RANKL and OPG expression plasmids, would be useful in increasing our understanding of the role that RANK signalling plays in the regulation of neurite growth from nodose, SCG and trigeminal neurons.

In addition to exogenous expression of RANK, sensory and sympathetic neurons were incubated with a variety of factors, including a RANK agonist, a soluble RANKL and a RANK blocking antibody, at a range of concentrations, to explore the role of RANK in the regulation of neuronal survival and growth. None of these factors provided a consistent effect on the growth or survival of nodose or SCG neurons cultured with BDNF or NGF respectively, possibly due to the inefficacy of commercially available ligands, or possibly due to the presence of OPG in neurons of sensory and sympathetic populations. Control experiments designed to test the efficacy of these antibodies against cell lines with a known response, such as dendritic cells (Anderson et al., 1997), are required. Additional experiments over-expressing RANKL in nodose neurons also displayed a similar

reduction in size of neuritic arbours when cultured in BDNF (data not shown; Dr H Gutierrez, personal communication), providing further evidence for the role of RANK and its ligand, in the regulation of neurotrophin-mediated growth.

Neuronal development within the sensory and sympathetic nervous systems is subject to stringent spatial and temporal regulation. To ascertain whether the inhibitory effect of over-expressing RANK on neurite growth occurs over a particular period of development, RANK was over-expressed in cultures established from sensory and sympathetic ganglia over a range of ages from E18 to P10. In each instance, a significant reduction was seen in the growth of neurites, compared to control transfected cells, with the magnitude of the effect increasing at later time points for nodose and SCG neurons. Other TNF family members, such as GITR (O’Keeffe et al., 2008) and LIGHT (Gavalda et al., 2009), have been found to have similar developmental “windows”. GITR regulates NGF-promoted growth of SCG neurons at P1 and P3, but not at E18 or P5. LIGHT displays a similar pattern with over-expression of LIGHT decreasing the growth of nodose neurons at E18 and P0, but not at E16 or P3. NF- κ B, a key regulator of RANK activation, was found to positively regulate the growth of processes of nodose neurons in a distinct period of development between E18 and P1 with maximal effect at P0 (Gutierrez et al., 2005). Thus the decrease in growth seen when over-expressing RANK, across a wide range of ages, is surprising and further experiments at earlier and later timepoints are warranted to expand the role of RANK in the regulation of the growth of sensory and

sympathetic neuronal populations. Experiments using conditional RANK knockout mice are necessary to confirm that RANK negatively regulates neurite growth across a range of ages in sensory and sympathetic neuronal populations. Figure 32 displays an overview of the results contained within this chapter.

Chapter 4

RANK signalling regulating neurite outgrowth from P0 nodose neurons.

4.1 Introduction

In Chapter 3 I demonstrated that RANK, RANKL and the decoy receptor, OPG, are all expressed in neurons of neonatal nodose, SCG and trigeminal ganglia (Figs. 17-19) and that over-expression of RANK decreases the extent of neurotrophin-promoted growth from these neurons without affecting survival (Figs. 20-23). Here, I report studies carried out on nodose neurons to ascertain which intracellular signalling proteins mediate the neurite growth-inhibitory effect of RANK over-expression.

Previous research has demonstrated that a large number of distinct signalling pathways can transduce RANK activation into defined biological outcomes. Two of the most important of these are the NF- κ B and JNK signalling pathways (Wada et al., 2006) which RANK activates in a variety of cell types (Anderson et al., 1997; Darnay et al., 1998; Wong et al., 1997; Wong et al., 1998; Kim et al., 1999). Other important targets of activated RANK include AP-1 via ERK (Karin, 1996), Akt (Wong et al., 1999) and members of the MAPK family, such as p38 (Matsumoto et al., 2000).

As with other members of the TNF receptor superfamily, RANK activates downstream signalling pathways through interactions with members of the TRAF family (Rothe et al., 1994; Wong et al., 1998; Kim et al., 1999; Hsu et al., 1999). This family consists of six members, TRAFs 1-6, though only TRAF2, TRAF5

and TRAF6 are involved with downstream activation of NF- κ B and JNK (Bharti & Aggarwal, 2004). TRAF2 and TRAF6 appear to be essential for RANK induced activation of NF- κ B (Darnay et al., 1999), and TRAF2 and TRAF6 interact with vital NF- κ B signalling mediators, including NIK, IKK α and IKK β (Malinin et al., 1997; Regnier et al., 1997; Song et al., 1997; Woronicz et al., 1997). The TRAFs also activate JNK and p38 through their amino-terminal RING-zinc finger domain (Darnay et al, 1999, Baud et al., 1999).

RANK has been shown to bind TRAF2, TRAF5 and TRAF6 at distinct locations within its cytoplasmic domain (Darnay et al., 1998; Wong et al., 1998; Hsu et al., 1999). RANK binds TRAF2 and TRAF5 at the C-terminal end of the cytoplasmic tail between amino acid residues 565-568 and 606-611, respectively. RANK binds TRAF6 at a site more proximal to the membrane, between residues 340-358 (Darnay et al., 1999), and the TRAF6 binding site was found to be sufficient for RANK-mediated activation of NF- κ B. TRAF2, however, has also been strongly linked to the activation of NF- κ B by RANK (Rothe et al., 1995). Similar domains necessary for the interaction of RANK with TRAF2, TRAF5 and TRAF6 were identified by Hsu et al. in the C-terminal tail of RANK (Hsu et al., 1999).

One of the key downstream targets of RANK activation is NF- κ B. This family of transcription factors is regulated by the I κ B inhibitory proteins, which in turn are regulated by the IKKs (Karin, 1999). The binding of RANKL to its receptor has been shown to activate NF- κ B in a variety of cells (Anderson et al., 1997; Darnay

et al., 1998; Wong et al., 1998) and, as previously stated, TRAF2, TRAF5 and TRAF6 have been shown to activate NF- κ B via interaction with NIK, IKK α and IKK β (Malinin et al., 1997; Regnier et al., 1997; Song et al., 1997; Woronicz et al., 1997). More recently, NF- κ B has been shown to positively or negatively regulate the growth of nodose neurons depending on the phosphorylation status of the p65 NF- κ B subunit (Gutierrez et al., 2005; Gutierrez et al., 2008).

This Chapter reports studies of the involvement of particular TRAF proteins and components of the NF- κ B signalling network in mediating the neurite growth inhibitory effects of RANK in neonatal nodose neurons. These studies involved documenting the consequences of co-transfecting the neurons with wild-type or mutant RANK expression plasmids together with plasmids expressing dominant-negative (DN) TRAF2, TRAF6, NIK, IKK α , IKK β , or NF- κ B and figure 32 displays the aims of this Chapter. I found that interfering with the function of TRAF2, NIK, IKK β or NF- κ B, but not TRAF 6 and IKK α , reduces the ability of RANK over-expressing to inhibit neurite outgrowth from P0 nodose neurons.

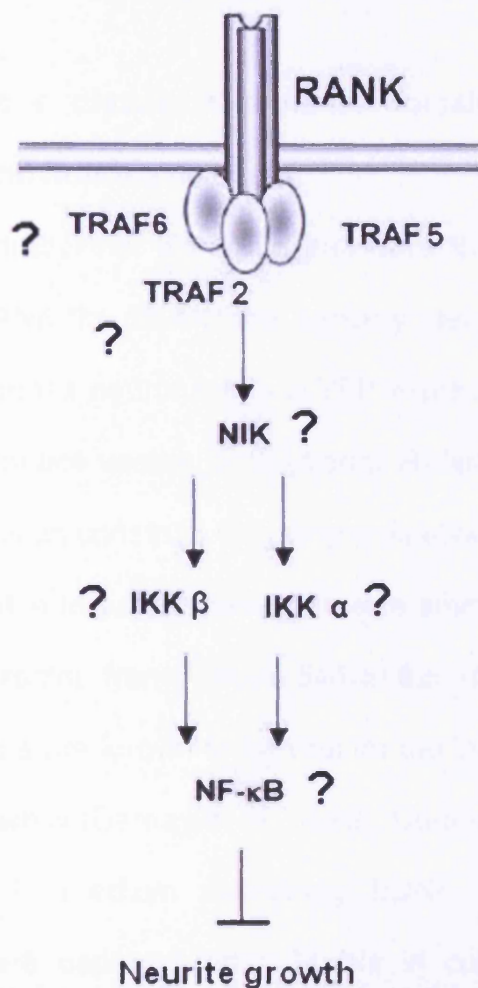


Figure 32: Aims of Chapter 4. RANK can signal via a large number of downstream mediators. Experiments were designed to investigate potential downstream mediators in P0 nodose neurons including members of the NF- κ B signalling pathway.

Results

4.2 RANK signals via a distinct C-terminal domain to reduce neurite outgrowth from neonatal nodose neurons

Investigation into the intracellular signalling pathways that mediate the growth inhibitory effects of RANK in developing sensory neurons, began with the co-transfection of P0 nodose neurons with a YFP expression plasmid, together with either an empty control vector, a functional RANK expression construct (wt-RANK), or an expression construct encoding a deletion mutant of RANK. The regions of RANK deleted in this latter construct were amino acid residues 312 to 391 and the C-terminal region from residue 544 to 626 (RANK-(Δ 312-391/544-626)). These two domains are known to be vital for the interaction of RANK with members of the TRAF family (Darnay et al., 1999). Co-transfected neurons were incubated for 48 hrs in medium containing BDNF (10ng/ml). Images of transfected neurons were captured after 24 hrs in culture to perform Sholl analysis to determine the extent of neurite outgrowth under each experimental condition. Fluorescent neurons were counted after 24 hrs and 48 hrs in culture to allow percentage neuronal survival at 48 hrs to be calculated, compared to the number of neurons present at 24 hrs. Over-expression of either wt-RANK or the RANK deletion mutant did not alter the survival of nodose neurons compared to control transfected neurons (Fig. 33A). In accordance with data in the previous Chapter (Fig. 21), over-expressing RANK dramatically reduced the extent of neurite outgrowth from P0 nodose neurons compared to control transfected

neurons, as evidenced by a downward shift in the Sholl profile (Fig. 31B), a reduction in mean total neurite length (Fig. 33C) and a reduction in the number of branch points (Fig. 33D). In contrast, exogenous expression of RANK-(Δ 312-91/544-626) did not result in either a shift in the Sholl profile, a reduction in mean total neurite length or a decrease in the mean number of branch points compared to controls (Figs. 33B, 33C and 33D, respectively). These data suggest that one or both of the domains deleted in RANK-(Δ 312-391/544-626) are essential for transducing RANK activation into reduced neurite outgrowth in nodose neurons in the presence of BDNF.

Having established that deleting amino acid residues 312-391 and 544-626 removes the ability of exogenously expressed RANK to inhibit BDNF-promoted neurite outgrowth from P0 nodose neurons, experiments were designed to determine which of these two deleted regions is more important for mediating the neurite outgrowth inhibitory effects of RANK. P0 nodose neurons were co-transfected with a YFP expression construct together with an empty control plasmid, a wt-RANK expression plasmid, an expression construct encoding a RANK receptor lacking amino acid residues 312-391 (RANK-(Δ 312-391)), or a RANK expression construct lacking amino acid residues 544-626 (RANK-(544-626)). Exogenous expression of wt-RANK or either of the deleted RANK isoforms, did not alter the number of neurons surviving after 48 hrs in culture compared to control transfected neurons (Fig. 34A). Over-expression of RANK-(Δ 312-391) was as effective as over-expression of wt-RANK in reducing the

extent of neurite outgrowth from P0 nodose, as shown by a downwardly shifted Sholl profile (Fig. 34B), a reduced mean total neurite length (Fig. 34C) and a reduced mean number of branch points (Fig. 34D). In contrast, over-expression of RANK-(Δ 544-626) did not significantly alter the Sholl profile of P0 nodose neurons compared to control transfected cultures (Fig. 34B) nor did it significantly reduce the mean total neurite length (Fig. 34C) or the mean number of branch points (Fig. 34D) compared to control cultures. These data suggest that RANK amino acid residues 544-626, but not residues 312-391, are necessary for RANK-mediated inhibition of BDNF-promoted neurite outgrowth from neonatal mouse nodose neurons.

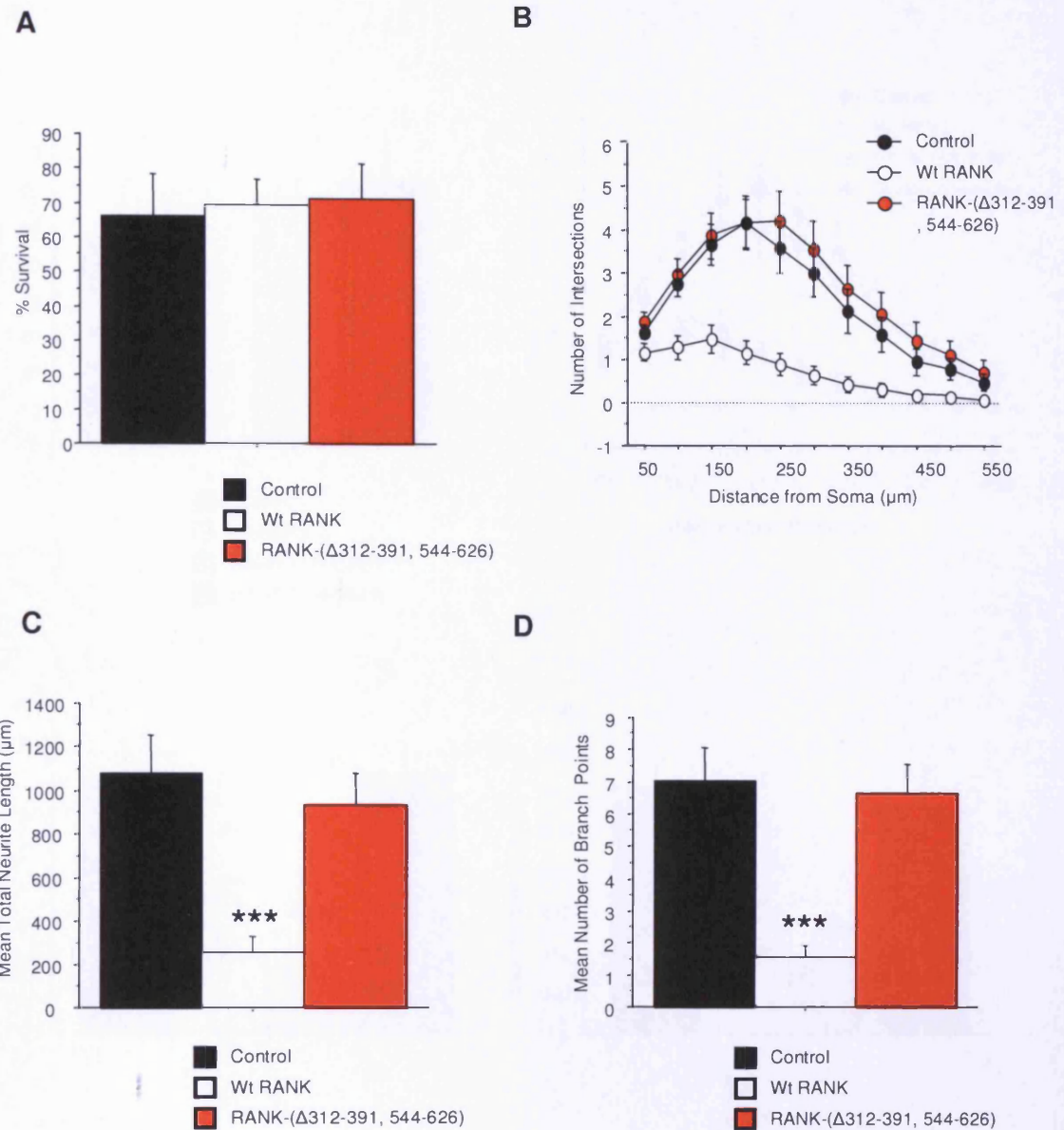


Figure 33. A RANK receptor deficient in two important signalling domains does not effect BDNF-dependent neurite growth. P0 nodose neurons were co-transfected 3 hours after plating with a YFP expression construct together with either a RANK expression construct, a RANK construct deficient in two signalling domains (RANK-(Δ 312-391, 544-626)) or an empty vector and cultured in medium containing 10ng/ml BDNF for 48hrs. Percentage survival after at 48hrs compared to 24 hrs (A). Sholl analysis (B), mean total neurite length (C) and mean number of branching points (D) after 24hrs in culture. The results are derived from the grouped data of 50-70 neurons and very similar data were obtained in three independent experiments. Statistical comparisons are with respect to control-transfected neurons (***) $p < 0.001$, ANOVA with Fisher's *post hoc*.

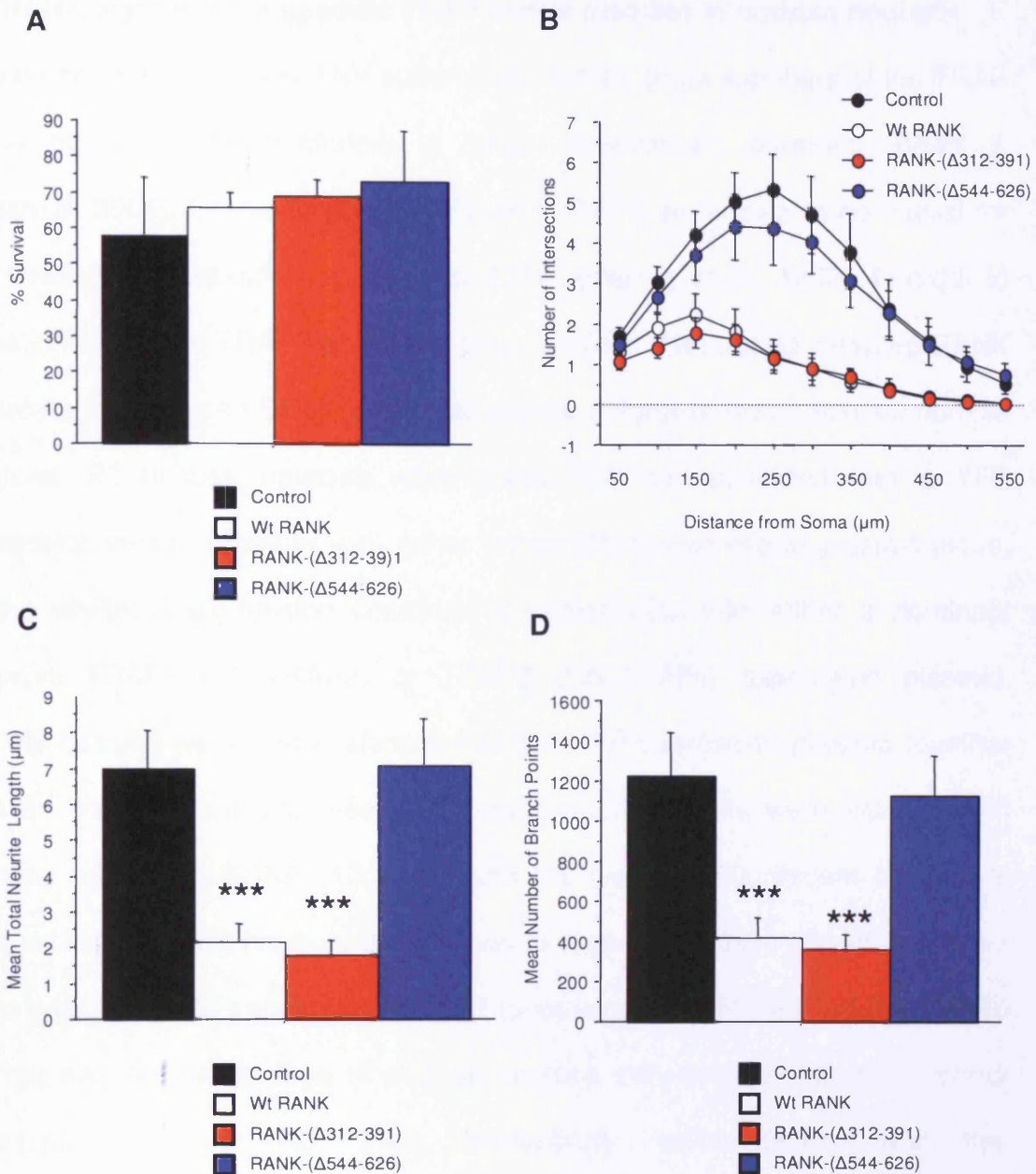


Figure 34. The C-terminal tail of RANK mediates its ability to inhibit neurite outgrowth from neonatal nodose neurons. P0 nodose neurons were co-transfected 3 hours after plating with a YFP expression construct together with either a RANK expression construct, a RANK construct deficient in the signalling domain between residues 312 and 391 (RANK-(Δ 312-391)) or with a truncated C-terminal tail (RANK-(Δ 544-626)), or an empty vector and cultured in medium containing 10ng/ml BDNF for 48 hrs. Percentage survival of neurons at 48hrs compared to that after 24 hrs (A). Sholl analysis (B), mean total neurite length (C) and mean number of branching points (D) after 24hrs in culture. The results are derived from the grouped data of 50-70 neurons and very similar data were obtained in three independent experiments. Statistical comparisons are with respect to control-transfected neurons (** p <0.001, ANOVA with Fisher's *post hoc*).

4.3 RANK signals via a specific TRAF family member in nodose neurons

Like other members of the TNF superfamily, RANK binds members of the TRAF family of intracellular mediators to initiate downstream signalling (Bharti & Aggarwal, 2004). Of this family, TRAF2 and TRAF6 are known to be crucial for the downstream activation of NF- κ B and JNK (Darnay et al., 1999). In order to investigate whether TRAF2 or TRAF6 plays a role in transducing elevated RANK signalling into reduced BDNF-promoted neurite outgrowth from neonatal nodose neurons, P0 nodose neurons were plated and co-transfected with a YFP expression vector, together with either the wt-RANK expression plasmid alone, or the wt-RANK expression construct in combination with either a dominant negative TRAF2 (DN-TRAF2) or TRAF6 (DN-TRAF6) expression plasmid. Control cultures were co-transfected with the YFP expression plasmid together with an empty expression vector. Co-transfected neurons were incubated in medium containing BDNF (10ng/ml), and the resultant fluorescent cells were counted at 24 and 48 hrs post transfection to allow percentage survival at 48 hrs to be calculated. Co-transfection of YFP together with wt-RANK and DN-TRAF6 did not alter the percentage of nodose neurons surviving compared to control transfected cultures (Fig. 35A). Interestingly, co-transfection with this combination of plasmids did not alter either the Sholl profile (Fig. 35B), mean total neurite length (Fig. 35C) or mean number of branch points (Fig. 35D), compared to neurons co-transfected with YFP and wt-RANK in the absence of DN-TRAF6. This suggests that TRAF6 is not vital for the transduction of RANK

activation into inhibition of BDNF-promoted neurite outgrowth from neonatal nodose neurons.

Co-transfection of P0 nodose neurons with the YFP expression construct together with the wt-RANK and DN-TRAF2 expression plasmids reduced the survival of P0 nodose neurons cultured in the presence of BDNF by approximately 50% compared to control transfected cultures (Fig. 35A), a value that was highly statistically significant ($p < 0.001$, ANOVA with Fisher's post hoc). Although over-expression of DN-TRAF2 significantly reduced the survival of P0 nodose neurons compared to neurons co-transfected with YFP and wt-RANK expression plasmids, it also partially prevented the ability of exogenously expressed wt-RANK to shift the Sholl profile of these neurons downwards (Fig. 35B), suggesting that TRAF2 may mediate the neurite growth inhibitory effects of RANK over-expression in nodose neurons.

To exclude the possibility that the effects of DN-TRAF2 on BDNF-promoted survival might confound interpretation of its apparent effects on neurite growth, I repeated the co-transfection experiments with YFP, wt-RANK, DN-TRAF2 and DN-TRAF6 expression plasmids in the presence of 25 μ M of the irreversible pan-caspase inhibitor Boc-D-FMK to prevent neuronal death. In the presence of this caspase inhibitor, over-expression of RANK, either alone or in combination with either DN-TRAF2 or DN-TRAF6, did not alter the survival of nodose neurons compared to control transfected cultures (Fig. 36A). However, in agreement with

the data shown in Figures 33B, 33C and 33D, DN-TRAF2 greatly reduced the downward shift in the Sholl profile, reduction in total neurite length and number of branch points caused by RANK over-expression of RANK in these caspase inhibitor containing cultures, whereas DN-TRAF6 had no effect. These findings provide additional support for a role of the C-terminal domain of RANK in RANK-mediated inhibition of neurite outgrowth (Fig. 34), since TRAF2 interacts with this region of the RANK receptor (Darnay et al., 1999). Additional experiments are needed to clarify the role of TRAF2 in the regulation of neurotrophin-mediated neuronal survival, for example transfection of nodose neurons with the TRAF2 dominant negative expression plasmid only. However, the requirement for caspase inhibition to prevent the decrease in survival seen when interfering with TRAF2 activity raises the possibility that TRAF2 regulates caspase activity. Further experiments to clarify the possible role of TRAF2 in the regulation of the caspase activity are necessary.

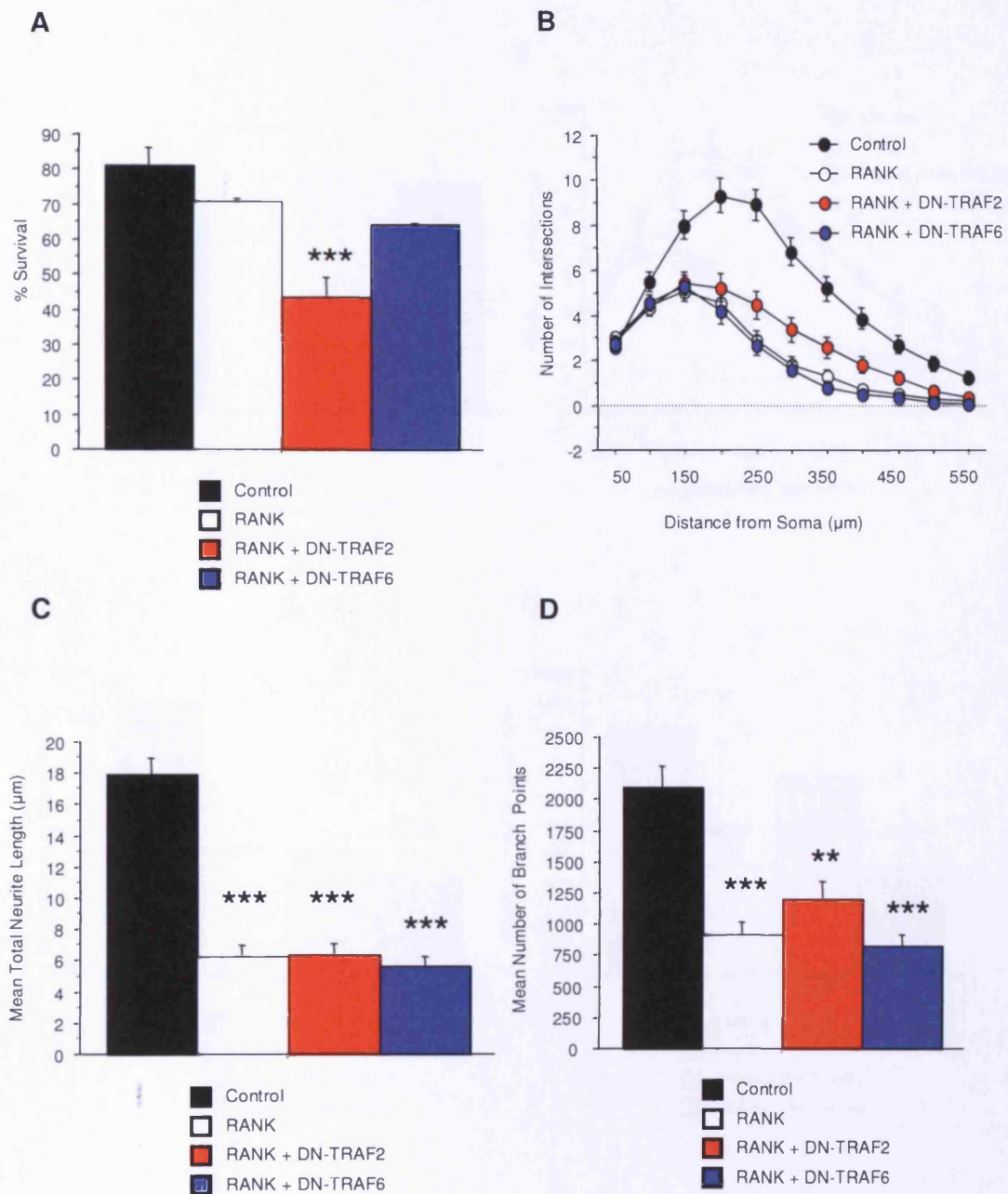


Figure 35. Blocking the function of TRAF2 reduces the survival of nodose neurons cultured with BDNF. P0 nodose neurons were co-transfected 3 hours after plating with a YFP expression construct together with either a RANK expression plasmid alone or a RANK expression plasmid in combination with either a dominant-negative TRAF2 (DN-TRAF2) or a DN-TRAF6 expression plasmid. Control cultures were co-transfected with the YFP plasmid together with an empty expression vector. Neurons were cultured in medium containing 10ng/ml BDNF for 48 hrs. Percentage neuronal survival at 48hrs compared to that at 24 hrs (A). Sholl analysis (B), mean total neurite length (C) and mean number of branching points (D) after 24hrs in culture. The results are derived from the grouped data of 50-70 neurons and very similar data were obtained in three independent experiments. Statistical comparison are with respect to control-transfected neurons (** $p < 0.01$, *** $p < 0.001$, ANOVA with Fisher's *post hoc*).

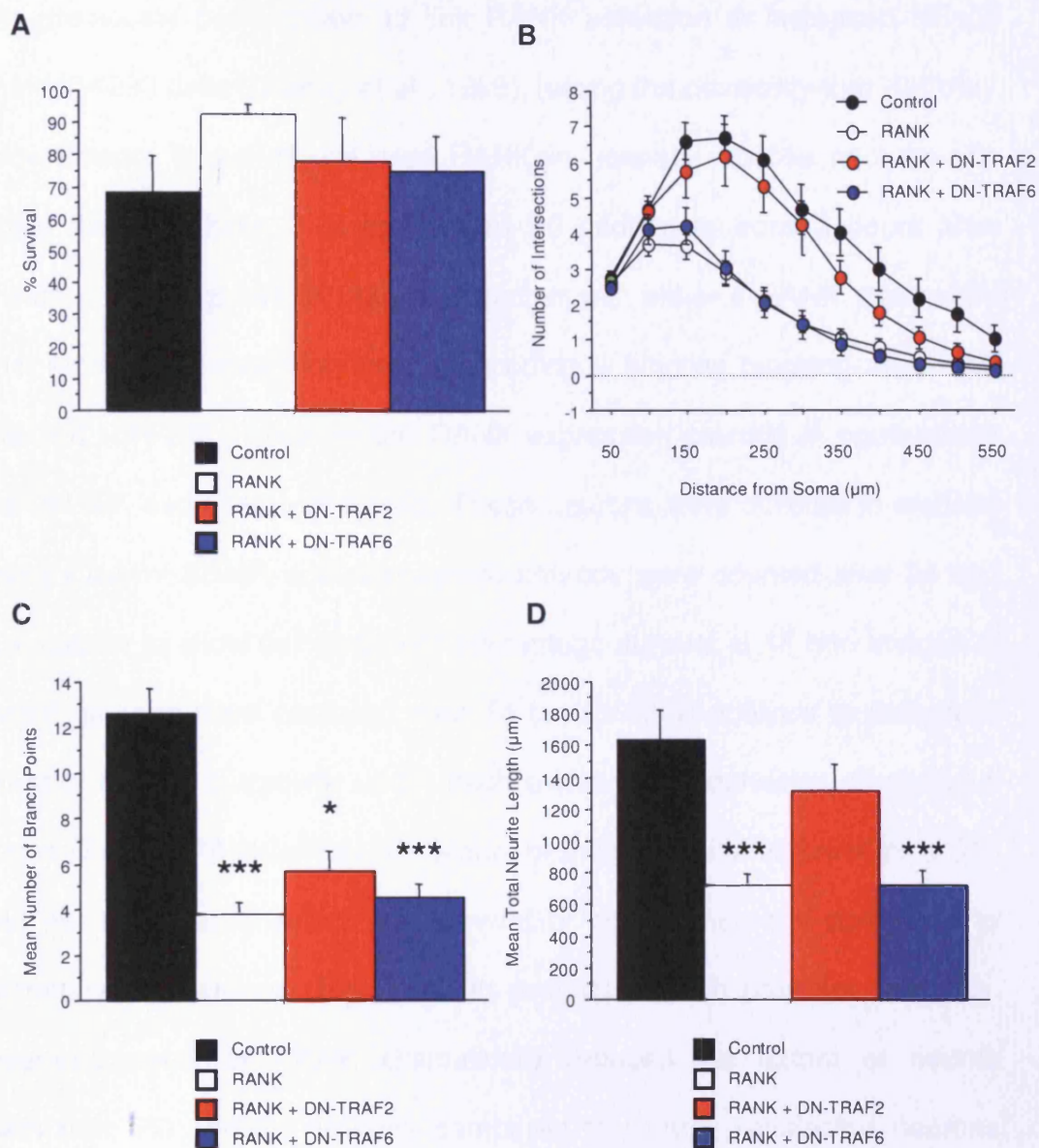


Figure 36. TRAF2 mediates RANK's ability to inhibit BDNF-promoted neurite outgrowth from P0 nodose neurons. P0 nodose neurons were co-transfected 3 hours after plating with a YFP expression construct together with either a RANK expression plasmid alone or a RANK expression plasmid in combination with either a dominant-negative TRAF2 (DN-TRAF2) expression construct or a DN-TRAF6 expression plasmid. Control cultures were co-transfected with the YFP plasmid and an empty vector. Co-transfected neurons were cultured for 48 hrs in medium containing 10ng/ml BDNF and 25 μM of the pan-caspase inhibitor, Boc-D-FMK. Percentage neuronal survival after 48hrs in culture compared to that after 24hrs (A). Sholl analysis (B), mean total neurite length (C) and mean number of branching points (D) after 24hrs in culture. The results are derived from the grouped data of 50-70 neurons and very similar data were obtained in three independent experiments. ***denotes $p < 0.001$ when data are compared with control transfected neurons (ANOVA with Fisher's *post hoc*). * denotes $p < 0.05$ when data are compared to neurons transfected with YFP and RANK alone (ANOVA with Fisher's *post hoc*).

4.4 RANK signals via NIK to inhibit neurite outgrowth from nodose neurons

NIK has previously been shown to link RANK activation to increased NF- κ B activity in HEK293 cells (Darnay et al., 1999), raising the possibility that NIK may be a downstream target of activated RANK in neonatal nodose neurons. To investigate this possibility, I co-transfected P0 nodose neurons 3 hours after plating with a YFP expression plasmid together with either a RANK expression construct alone, an expression vector encoding a function blocking dominant-negative NIK (DN-NIK) alone or the RANK expression plasmid in combination with the DN-NIK expression construct. These neurons were cultured in medium containing 10ng/ml BDNF, and fluorescent neurons were counted after 24 and 48 hrs in culture to allow calculation of percentage survival at 48 hrs. Images of fluorescent neurons were captured after 24 hrs for Sholl analysis to determine the extent of neurite outgrowth under each experimental condition. Exogenous expression of either RANK or DN-NIK alone, or a combination of RANK plus DN-NIK, did not significantly affect the survival of nodose neurons compared to control transfected neurons (Fig. 37A). In accordance with previous data (Fig. 21), over-expression of RANK dramatically reduced the extent of neurite outgrowth from P0 nodose neurons compared to control transfected neurons (Figs. 37B, 37C and 37D). Although exogenous expression of DN-NIK alone did not affect the extent of neurite outgrowth compared to control transfected neurons, co-expression of DN-NIK with RANK completely blocked the ability of over-expressed RANK to reduce neurite outgrowth as shown by the Sholl profile (Fig. 37B), mean total neurite length (Fig. 37C) and mean number of branch

points (Fig. 37D) of processes projecting from neonatal nodose neurons cultured in the presence of BDNF. Taken together, this data suggests that NIK does not mediate BDNF-promoted neurite outgrowth from neonatal nodose neurons, but it is a crucial signalling intermediate in the pathway that leads from RANK overexpression to inhibition of neurite outgrowth. This experiment also raises questions regarding the role of RANK in the negative regulation of neurite growth from nodose neurons. Constitutive activation of RANK would require the active involvement of NIK in the negative regulation of neurite growth, suggesting that interference with NIK signalling, via overexpression of the NIK dominant negative expression construct, would prevent downstream signalling of RANK. However, overexpression of the NIK dominant negative construct has no effect on the growth of nodose neurons supported by BDNF. This raises the possibility that RANK may not be constitutively active, a finding that would concur with experiments overexpressing RANK constructs deficient in vital signalling domains which fail to increase the growth of BDNF supported nodose neurons relative to control transfected neurons (Figs 33 and 34). Further confusing the issue is the fact that overexpression of plasmids designed to interfere with NF- κ B signalling show that NF- κ B is constitutively active and that NF- κ B can either promote or inhibit neurite growth from nodose neurons (Gutierrez et al., 2005; Gutierrez et al., 2008). Further experiments designed to block constitutive RANK activity, such as RANK blocking antibodies, are required to clarify the role of RANK in the regulation of neurotrophin-mediated neurite growth.

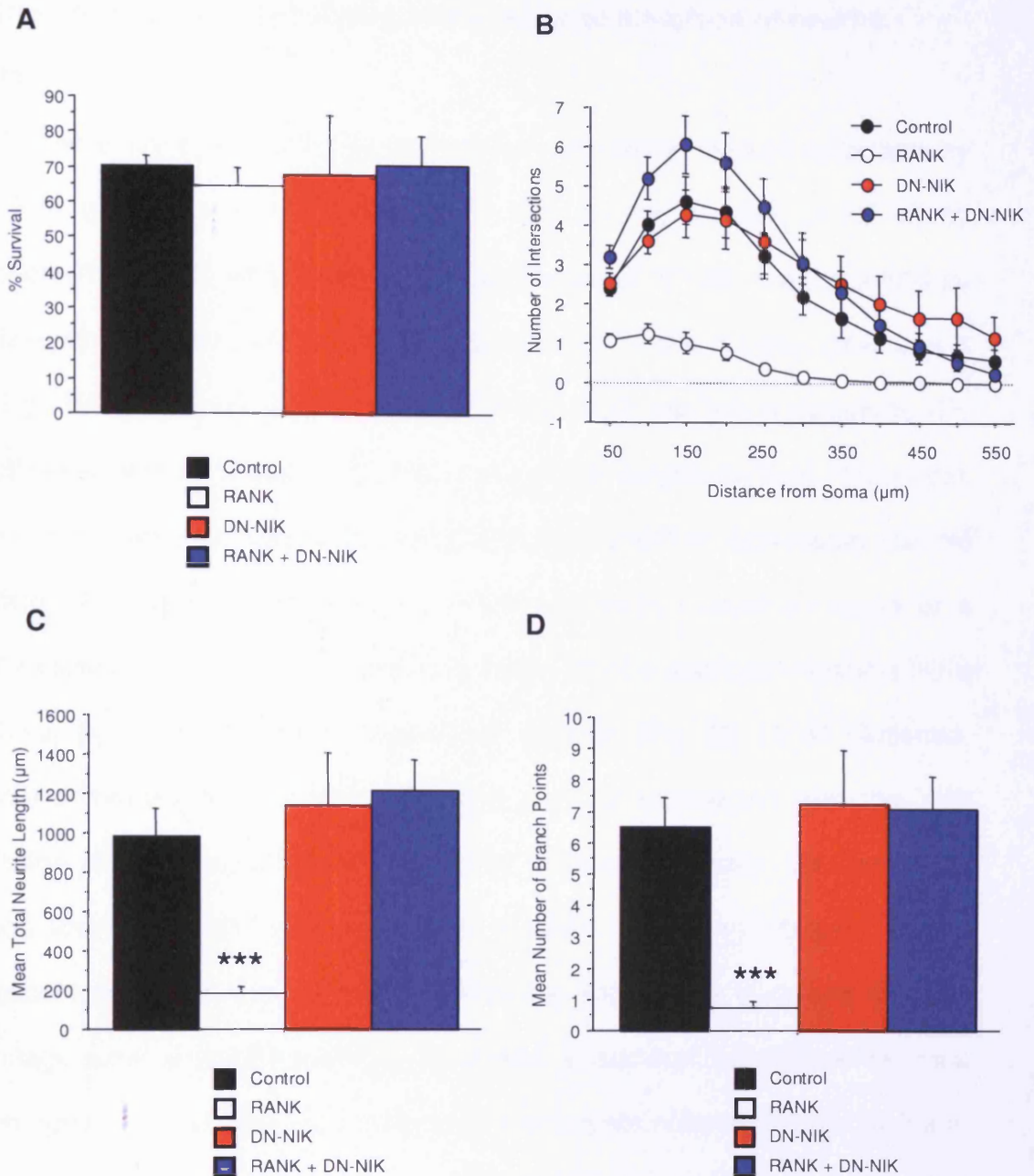


Figure 37. NIK plays a role in transducing RANK activation into reduced neurite outgrowth from neonatal nodose neurons. P0 nodose neurons were co-transfected, 3 hours after plating, with a YFP expression construct together with either a RANK expression construct or a dominant-negative NIK (DN-NIK) expression plasmid alone, or a combination of RANK and DN-NIK expression plasmids. Control cultures were co-transfected with the YFP expression plasmid and an empty expression vector. Co-transfected neurons were cultured for 48hrs in medium containing 10ng/ml BDNF. Percentage neuronal survival after 48hrs compared to 24hrs (A). Sholl analysis (B), mean total neurite length (C) and mean number of branching points (D) after 24hrs of culture. The results are derived from the grouped data of 50-70 neurons and very similar data were obtained in three independent experiments. Statistical comparisons are with respect to control-transfected neurons (***) $p < 0.001$, ANOVA with Fisher's *post hoc*.

4.5 IKK β plays a role in mediating RANK induced inhibition of neurite

growth

NF- κ B is normally sequestered in an inactive state within the cell cytoplasm by I κ B α . The I κ B kinases, IKK α and IKK β , regulate the function of NF- κ B by phosphorylating I κ B α , which results in the release of NF- κ B from its inhibitory complex with I κ B α and its subsequent translocation to the nucleus (Mercurio & Manning, 1999). To investigate whether IKK α or IKK β link NIK activation to NF- κ B activation and subsequent inhibition of neurite outgrowth from P0 nodose neurons, cells were co-transfected 3 hrs after plating with an expression plasmid encoding YFP together with either a RANK expression construct alone or a RANK expression construct in combination with either a dominant-negative IKK α (DN-IKK α) or IKK β (DN-IKK β) expression plasmid (Fig 38; Dr H Gutierrez, personal communication). Control neurons were co-transfected with the YFP expression plasmid together with an empty expression vector. Co-transfected neurons were incubated for 48 hrs in medium containing 10ng/ml BDNF. Fluorescent neurons were counted after 24 hrs and 48 hrs in culture to allow percentage survival at 48 hrs to be calculated. In addition, transfected neurons were imaged for Sholl analysis of the extent of neurite outgrowth after 24 hrs in culture. None of the combinations of co-transfected plasmids altered the survival of neonatal nodose neurons compared to control transfected neurons (Fig. 38A). Co-transfection of DN-IKK α with RANK and YFP expression plasmids did not ameliorate the ability of RANK to greatly reduce the extent of neurite outgrowth from P0 nodose neurons (Figs. 38B, 38C and 38D). In contrast, exogenous

expression of DN-IKK β almost completely abolished the ability of over-expressed RANK to inhibit neurite outgrowth from these neurons (Figs. 38B, 38C and 38D), suggesting that IKK β plays a vital role in transducing RANK over-expression into reduced neurite growth.

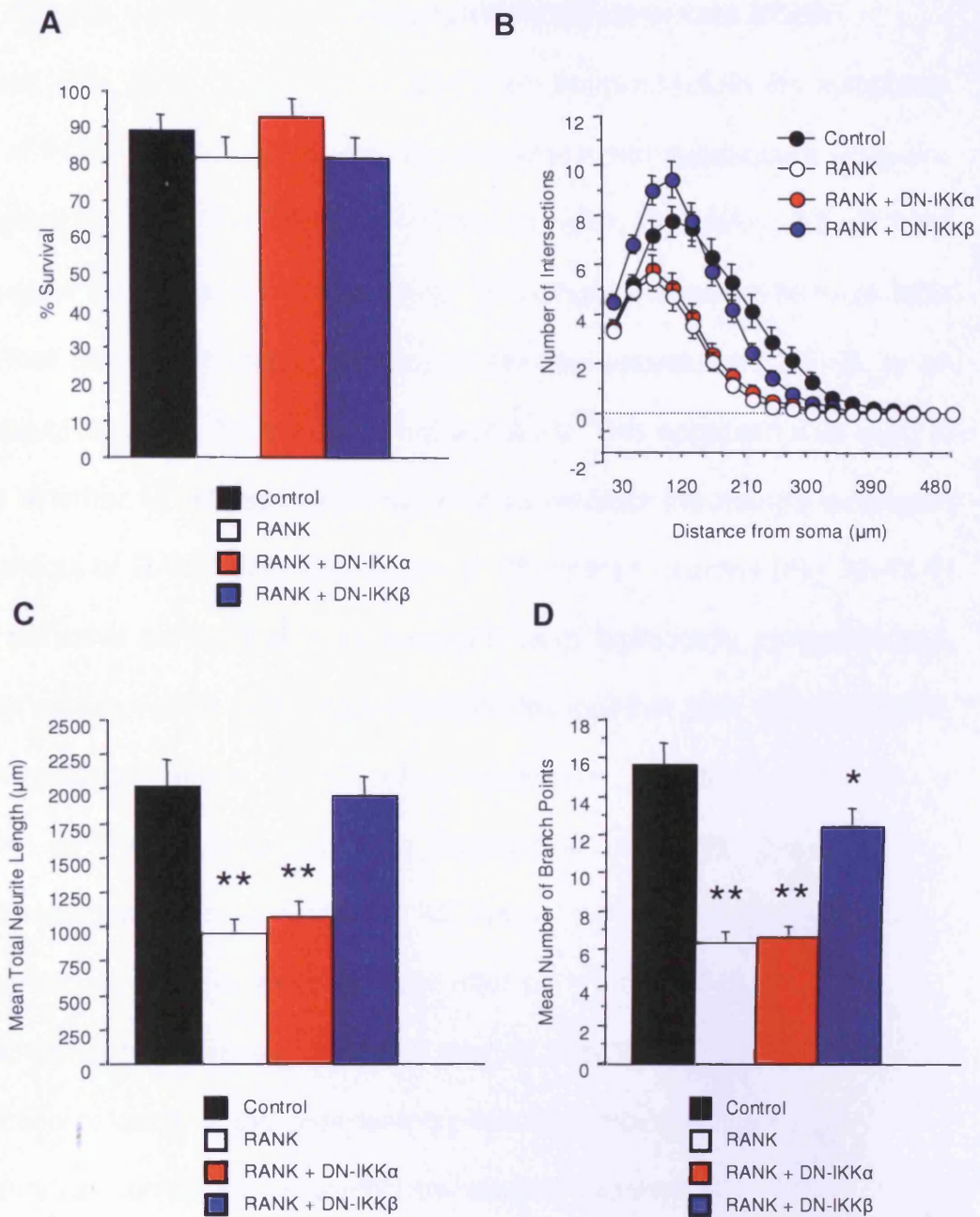


Figure 38. RANK signals via IKK β in to reduce neurite outgrowth from neonatal nodose neurons. P0 nodose neurons were co-transfected with a YFP-expression plasmid together with either a RANK expression plasmid alone or a RANK expression plasmid in combination with either a dominant-negative IKK α (DN-IKK α) or DN-IKK β expression. Control cultures were co-transfected with the YFP expression plasmid plus an empty expression vector. Co-transfected neurons were cultured for 48hrs in medium containing 10ng/ml BDNF. (A) percentage survival of co-transfected neurons at 48hrs compared to 24hrs. (B) Sholl analysis of neurite arbour morphology (C) mean total neurite length (D) mean number of branch points after 24hrs of culture. The means and standard errors obtained from 60-70 neurons in each experimental condition are shown. Statistical comparisons are with respect to control-transfected neurons (* $p < 0.05$, ** $p < 0.01$, ANOVA with Fisher's *post hoc*).

4.6 RANK signals via NF- κ B in nodose neurons cultured with BDNF

As discussed in Chapter 4.5, NF- κ B is held in an inactive form in the cytoplasm by I κ B α , and IKKs release NF- κ B via phosphorylation and subsequent ubiquitin-mediated degradation of the inhibitory protein complex. Preventing NF- κ B from translocating to the nucleus by expression of a super-repressor form of I κ B α (SR-I κ B α) that cannot be phosphorylated to release sequestered NF- κ B, is an effective way of disabling NF- κ B canonical signalling. This approach was used to investigate whether NF- κ B activity is required to mediate the neurite outgrowth inhibitory effects of RANK over-expression in P0 nodose neurons (Fig 39; Dr H Gutierrez, personal communication). Neurons were ballistically co-transfected, shortly after plating with a YFP expression vector together with either a RANK expression plasmid alone, a SR-I κ B α expression construct alone or a combination of RANK and SR-I κ B α expression plasmids together. Co-transfected neurons were cultured for 48 hrs in medium containing 10ng/ml BDNF. Fluorescent neurons were counted after 24 hrs and 48 hrs in culture, for the assessment of neuronal survival, and imaged after 24 hrs for Sholl analysis. Co-transfection of each of the expression plasmid combinations did not reduce neuronal survival compared to control transfected cultures (Fig. 39A). Once again, over-expression of RANK significantly reduced the extent of neurite outgrowth from P0 nodose neurons compared to control transfected neurons, as seen by a downward shift in the Sholl profile (Fig. 39B), a reduction in the mean total neurite length (Fig. 39C) and a reduction in the mean number of branch

points (Fig. 39D). Significantly, co-expression of SR-I κ B α together with RANK completely abolished the ability of RANK to reduce neurite outgrowth from neonatal nodose neurons, suggesting that RANK over-expression inhibits neurite extension and branching by an NF- κ B dependent mechanism (Figs. 39B, 39C and 39D). Interestingly, exogenous expression of SR-I κ B α alone resulted in a downward shift in the Sholl profile, compared to control transfected neurons (Fig. 39B), as well as a reduction in mean total neurite length (Fig. 39C) and mean number of branch points (Fig. 39D). This observation is in accordance with previously published data demonstrating that NF- κ B mediates BDNF-promoted neurite outgrowth from developing nodose neurons (Gutierrez et al., 2005; Gutierrez et al., 2008). My data suggest that NF- κ B activation is important for both BDNF-promoted neurite outgrowth from nodose neurons and RANK over-expression induced inhibition of neurite outgrowth from the same neurons. These somewhat conflicting data are intriguing and warrant further investigation. Previous results have shown that NF- κ B can either positively regulate the growth of nodose neurons (Gutierrez et al., 2005) or may indeed negatively regulate neurite growth from these neurons (Gutierrez et al., 2008) and RANK may play a role in regulating the function of NF- κ B and the subsequent effect on the growth of nodose neurons at this stage of development.

Figure 40 shows a schematic representation of the proposed pathway that leads to the activation of NF- κ B and subsequent inhibition of neurite outgrowth following RANK over-expression in P0 nodose neurons. RANK acts through its

C-terminal tail to activate TRAF2, which in turn activates NIK, IKK β and finally NF- κ B to regulate neurite outgrowth from P0 nodose neurons.

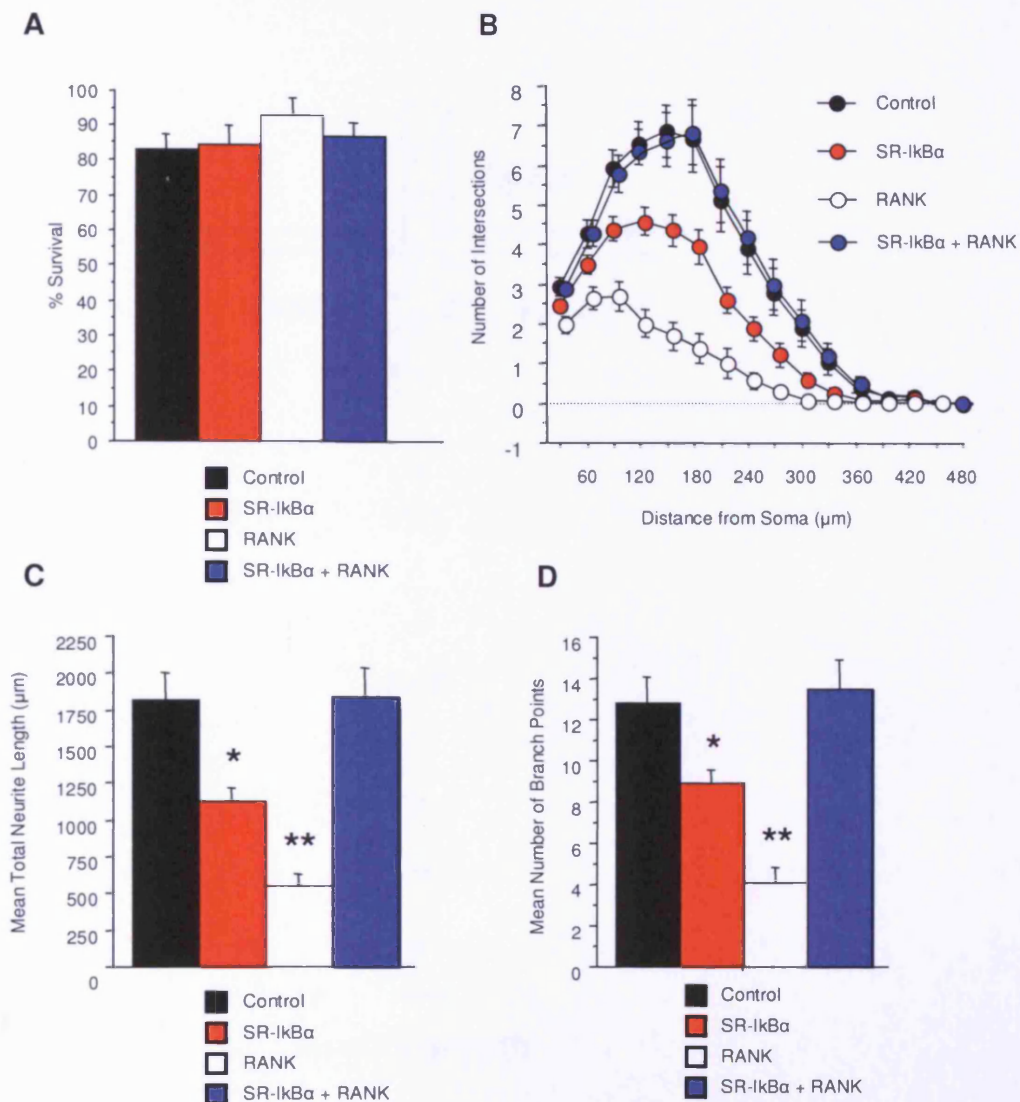


Figure 39. RANK signals via NF-κB in neonatal nodose neurons. P0 nodose neurons were co-transfected with a YFP-expression plasmid together with either a RANK expression plasmid alone, a super-repressor IκBα (SR-IκBα) expression construct alone or RANK and SR-IκBα expression plasmids together. Control cultures were co-transfected with the YFP expression plasmid and an empty expression vector. Co-transfected neurons were cultured for 48hrs in medium containing 10ng/ml BDNF. Fluorescent neurons were counted after 24hrs and 48hrs in culture and imaged for Sholl analysis after 24hrs in culture. (A) Percentage neuronal survival at 48hrs compared to 24hrs. (B) Sholl analysis of neurite arbour morphology, (C) mean total neurite length and (D) mean number of branch points 24 hrs after transfection. The means and standard errors obtained from 60-70 neurons in each experimental condition are shown. Statistical comparisons are with respect to control-transfected neurons (* $p < 0.05$, ** $p < 0.01$, ANOVA with Fisher's *post hoc*).

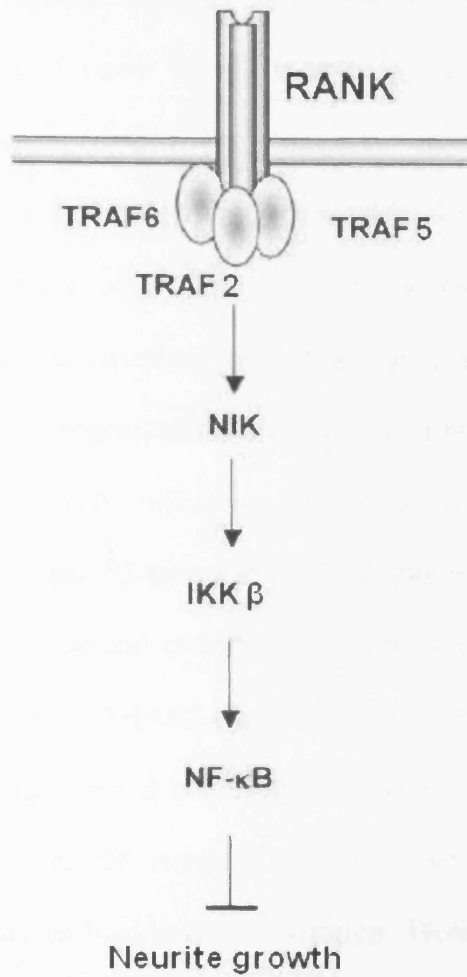


Fig 40. Proposed pathway of RANK signal transduction in nodose neurons. RANK signals via a defined section of the C-terminal tail and then via TRAF2, NIK, IKK and NF-κB in the regulation of the growth of P0 nodose neurons. (Adapted from Bharti & Aggarwal, 2004.)

4.7 Discussion

In Chapter 3, I provided evidence for a novel role for RANK in the regulation of neurite outgrowth from developing neurons of the nodose, SCG and trigeminal ganglia. In this Chapter, I have used ballistic co-transfection of expression constructs to define the pathway that appears to transduce RANK over-expression, and presumed activation, into the inhibition of neurite outgrowth from developing nodose neurons at a time in their development when they are establishing and refining connections with their peripheral and central targets. Initially, by studying the consequences of expressing RANK deletion mutants, I demonstrated that the growth inhibitory effects of over-expressing RANK in nodose neurons requires the C-terminal end of the protein, from amino acid residues 544 to 626. This section of the receptor is vital for interaction with two members of the TRAF family, TRAF2 and TRAF5 (Darnay et al., 1999; Wong et al., 1998; Hsu et al., 1999) both of which are known to activate NF- κ B and JNK. Accordingly, co-transfection of nodose neurons with a RANK expression construct in combination with dominant-negative TRAF expression plasmids, clearly demonstrated that functional TRAF2, but not TRAF6, was an essential part of the signalling pathway that leads from RANK over-expression to inhibition of BDNF-promoted neurite growth. Because exogenous DN-TRAF2 expression significantly reduced the survival of P0 nodose neurons cultured in medium containing BDNF, these experiments were performed in the presence of caspase inhibitors. The apoptosis-inducing effect of DN-TRAF2 was somewhat surprising, since TRAF2 has not previously been shown to interact with either TrkB or p75

neurotrophin receptors. Interestingly, although TRAF6 interacts with p75 and can either promote neuronal survival by mediating downstream activation of NF- κ B or promote apoptosis by mediating downstream activation of JNK (Reichardt, 2006), over-expression of DN-TRAF6 did not affect the survival of P0 nodose neurons. Further investigation of the roles of other TRAF family members, especially TRAF5, which interacts with the cytoplasmic C-terminal tail of RANK, are warranted to explore the role of these intracellular mediators in regulating RANK signalling in nodose neurons.

Having demonstrated that TRAF2 mediates the ability of RANK to inhibit neurite outgrowth from neonatal nodose neurons, I went on to examine whether NIK, a downstream target of TRAF2 and an activator of IKKs and hence NF- κ B (Malinin et al., 1997; Regnier et al., 1997; Song et al., 1997; Woronicz et al., 1997), was also involved in transducing the neurite growth inhibitory effects of RANK over-expression. Exogenous expression of a DN-NIK plasmid had no effect on the growth and survival of P0 nodose neurons cultured in medium containing BDNF, suggesting that this kinase does not play a role in the regulation of BDNF-mediated growth and survival induced by activation of TrkB and p75. Co-expression of RANK and the DN-NIK expression plasmid, however, prevented the decrease in neurite growth seen when expressing the RANK construct alone, suggesting that this kinase is vital for the regulation of RANK signalling in P0 nodose neurons. TRAF2 is a key regulator of NIK activity (Malinin et al., 1997) and the stimulation of NF- κ B by TRAF2 requires NIK

activity (Ramakrishan et al., 2004). These results provide evidence for the involvement of NIK in mediating the neurite growth inhibitory effects of RANK over-expressing.

The next intracellular mediators to be investigated were members of the IKK family, transducers vital for the activation of canonical NF- κ B signalling (Mercurio & Manning, 1999). Blocking IKK signalling by over-expressing dominant negative constructs targeted at IKK α or IKK β did not affect the survival of nodose neurons co-transfected with a RANK expression plasmid and cultured with BDNF. Co-transfection of RANK with a dominant negative IKK β , but not a dominant negative IKK α , was found to prevent the decrease in neurite growth seen when over-expressing RANK, suggesting IKK β is crucial for RANK signalling in P0 nodose neurons. IKK β is vital for canonical NF- κ B signalling, and has been shown to be activated by NIK (Regnier et al., 1997). The requirement for IKK β in the negative regulation of neuritic outgrowth by RANK further expands the role this kinase plays in the regulation of RANK signalling.

Finally, I investigated the participation of I κ B α , a central regulatory component of the canonical NF- κ B signalling pathway, in the neurite growth inhibitory effects of RANK over-expressing. Transfecting nodose neurons with a super-repressor form of I κ B α that prevents NF- κ B canonical signalling prevented the neurite growth inhibitory effects of co-expressed RANK without affecting neuronal survival, demonstrating that canonical NF- κ B signalling is essential for the

neurite growth inhibitory effects of RANK over-expressing in nodose neurons cultured with BDNF. At first glance this result seems surprising as NF- κ B has previously been shown to play a role in positively regulating neurite growth from nodose neurons at this stage in development (Gutierrez et al., 2005). However, NF- κ B has subsequently been shown to negatively regulate neurite growth from nodose neurons, depending on the phosphorylation status of p65 on serine 536 (Gutierrez et al., 2008). Thus NF- κ B activation can either promote (when serine 536 is dephosphorylated) or negatively regulate neurite growth (when serine 536 is phosphorylated) (Gutierrez et al., 2005; Gutierrez et al., 2008). In addition to activating NF- κ B, IKK β over-expression in nodose neurons leads to phosphorylation of p65 on serine 536, conferring a growth inhibitory function on NF- κ B (Gutierrez et al., 2008). These findings are entirely consistent with my demonstration that the neurite growth inhibitory effects of RANK depend on both IKK β and NF- κ B activation. However, in future work it will be important to confirm the anticipated phosphorylation of p65 on serine 536 following RANK over-expressing in nodose neurons.

I have dissected the components of a pathway that appears to play a role in the regulation of neurite growth from nodose ganglion sensory neurons supported by BDNF at a time in development when the axons of these neurons are ramifying in their targets and refining their connections. The neurite growth inhibitory effect of RANK over-expression requires the involvement of the intracellular mediators TRAF2, NIK, IKK β and NF- κ B. This pathway is a novel mechanism for the

regulation of BDNF-mediated neurite growth in nodose neurons. However, this pathway significantly varies from other known RANK signalling pathways. Darnay et al. found that the TRAF6 binding site, between positions 340 and 358, is necessary and sufficient for the activation of NF- κ B in embryonic kidney 293 cells and that the binding sites for TRAF2 and 5, located further along the C-terminal tail, were required for RANK-induced JNK activation (Darnay et al., 1998). In contrast, my results suggest that the C-terminal tail, the domain that interacts with TRAF2 and TRAF5, is essential for the reduction in neurite growth seen when over-expressing RANK, and that TRAF2 and NF- κ B are required for the negative regulation of neurite growth mediated by RANK in nodose neurons.

Further investigation of RANK signalling pathways, along with the role RANK plays in the development of other neuronal populations, is essential in order to understand the function this receptor plays in neuronal development. The use of knockout mice, such as TRAF2 (Yeh et al., 1997), TRAF6 (Lomaga et al., 2000) and TRAF5 deficient mice (Nakano et al., 1999), would also further our understanding of the role the TRAFs play in the regulation of BDNF-mediated neuronal survival and the negative regulation of neurite growth mediated by RANK in sensory neurons. Likewise, studying the consequences of targeted deletion of the *RANK* gene in developing neurons will be crucial in defining the precise roles of RANK signalling in these cells. Additional experiments could also focus on the possible requirement of other important intracellular mediators in RANK-regulated neurite outgrowth from sensory neurons. Other potential targets

involved in the regulation of RANK signalling include Akt (Wong et al., 1999), members of the MAPK family such as p38 (Matsumoto et al., 2000) and ERK (Karin, 1996).

Chapter 5

**Roles of MEK/ERK and PI3K/Akt signalling in neurite growth from
developing nodose neurons**

5.1 Introduction

Several intracellular signalling cascades mediate the effects of activation of the RANK receptor complex (Bharti & Aggarwal, 2004). These include members of the TRAF family, JNK, PI3K, NF- κ B and members of the MAPK family. Because ERK and PI3K have been implicated in regulating the growth of neural processes, I began investigating the role these signalling proteins play in mediating the effects of RANK over-expressing in nodose ganglion neurons. However, in the course of optimizing the experimental conditions for these studies, I made several completely unexpected and very surprising findings relating to the functions of these signalling proteins in nodose neurons, which are the topic of this chapter in addition to their roles in RANK signalling.

One of the most extensively studied and best understood MAPK signalling pathways is the ERK1/2 cascade (Krishna & Narang, 2008). This cascade is activated by a variety of extracellular and intracellular stimuli including G protein-coupled receptors and receptor tyrosine kinases. Small G proteins, such as Ras, then transduce the signal to Raf kinases which phosphorylate ERK kinases (MEK) -1 and -2. These in turn phosphorylate ERK1/2, which then activates over 150 substrates including cytosolic and membrane proteins, substrates in the nucleus and cytoskeletal proteins. The principal role of ERK is as a crucial regulator of survival, cell growth and proliferation in many cell types (Junttila, et al., 2008). In neuronal populations, the primary role of ERK is in the regulation of

differentiation and cell fate determination (Samuels et al., 2009) but ERK also regulates the genesis of neural progenitors, learning and memory processes and neurite growth in some neuronal populations including embryonic neurons of the chick retina, hippocampal neurons and sensory neurons (Perron & Bixby, 1999; Veeranna et al., 1998; Liu & Snider, 2001). ERK has also been shown to be involved in the positive regulation of NGF-mediated neurite growth in mouse SCG neurons (O'Keeffe et al., 2008).

Akt, also known as PKB, is one of the most important intracellular regulators in eukaryotic cells. In most cell types its primary function is the regulation of cell survival and because of this it has been implicated in cancer in many instances. Akt also has roles in a variety of other processes including cell-cycle progression and transcriptional regulation (Brazil et al., 2004; Duronio V, 2008). The key upstream regulator of Akt is PI3K, a membrane bound enzyme which generates phospholipids crucial for the activation of Akt (Brazil & Hemmings, 2001). PI3K is itself activated by receptor tyrosine kinases in response to cytokines, growth factors and neurotrophins (Rodgers & Theibert, 2002). Akt plays a critical role in the regulation of survival in a variety of neuronal populations (Brunet et al., 2001) including cerebellar (Dudek et al. 1997) and sympathetic neurons (Philpott et al., 1997; Crowder & Freeman, 1998). Akt is also known to regulate neuritic growth in neuronal populations including sensory neurons (Gallo, & Letourneau, 1998; Liu & Snider, 2001).

The growth and survival of nodose neurons is supported by a variety of different factors. BDNF, a member of the neurotrophin family, promotes the survival and neurite growth of nodose neurons *in vitro* (Davies et al., 1993). BDNF signals through TrkB and is known to activate many downstream pathways including Ras, MAPK, PI3K and PLC- γ (Patapoutian & Reichardt, 2001; Huang & Reichardt, 2003; Chao, 2003).

In order to investigate whether PI3K and ERK signalling cascades are involved in mediating the effects of RANK signalling in sensory neurons, the role of these mediators in BDNF-mediated survival and neurite growth in nodose neurons was first explored. Selective inhibitors were used to block activation of these kinases in nodose neurons supplemented with BDNF. My findings suggest that while PI3K signalling contributes to BDNF-promoted neurite growth, ERK acts, paradoxically, to limit BDNF-promoted neurite growth. Western blot analysis revealed that whereas BDNF increased Akt phosphorylation, it did not affect the levels of phosphorylated ERK.

Results

5.2 U0126 and PD98059 increase BDNF-promoted neurite growth from nodose neurons

The involvement of the MEK/ERK signalling cascade in mediating BDNF promoted survival and neurite outgrowth from neonatal mouse nodose neurons was investigated through the use of inhibitors directed against this pathway. Dissociated P0 nodose neurons were incubated in defined medium containing U0126 (10 μ M), a MEK1/2 inhibitor, for 2 hours prior to the addition of BDNF to the medium. The neurons were counted after the addition of BDNF and after a further 24 hours time period to calculate percentage survival. These counts showed that inhibiting MEK had no effect on BDNF promoted survival (Fig. 41A). Cells were imaged using the vital dye Calcein-AM, after 24 hours for Sholl analysis of neurite size and complexity. U0126 was found to have a significant effect on neurite growth from neurons cultured in the presence of BDNF, increasing the size of neuritic arbors with respect to controls (Fig. 41B). Total number of branch points (Fig. 41D) and total neurite length (Fig. 41C) were increased by around 50% following MEK inhibition. Figure 44 shows the typical appearance of neurons incubated with BDNF with and without U0126.

To order to confirm the role of MEK in the regulation of neurite growth from nodose neurons cultured with BDNF, the neurons were treated with another MEK inhibitor. P0 nodose neurons were incubated in medium containing

PD98059 (25 μ m) for 2 hours before the addition of BDNF (10ng/ml) to the medium. The number of neurons was counted after the addition of BDNF and again at 24 hours to allow percentage neuronal survival after 24hrs to be calculated. Calcein-AM stained neurons were also imaged at 24 hours for Sholl analysis of neurite growth. PD98059 was found to increase the growth of these neurons by around 50% with respect to controls (Fig. 42). Inhibiting MEK with PD98059 had no effect on the survival of P0 nodose neurons relative to controls (Fig. 42A) but increased the mean total length of neuritic arbors (Fig. 42C) as reflected by a shift in the Sholl analysis profile (Fig. 42B). Figure 44 shows the typical appearance of neurons incubated in PD98059 for 2 hours prior to the addition of BDNF compared to control neurons. Taken together, these data with MEK1/2 inhibitors suggest that MEK1/2 signalling normally restricts the extent of BDNF promoted neurite outgrowth from neonatal nodose neurons. This is a surprising result and will be discussed in more detail in section 5.7.

5.3 BDNF exposure does not alter the levels of phosphorylated ERK1/2 in nodose neurons

It is well established that BDNF can activate MAPK signalling cascades (Patapoutian & Reichardt, 2001; Huang & Reichardt, 2003; Chao, 2003) and that these cascades have functions in several neuronal populations (Samuels et al., 2009, Perron & Bixby, 1999). The phosphorylation status of ERK1/2 is essential to its function. In order to further explore the roles of MEK signalling in mediating BDNF promoted survival and neurite outgrowth, levels of phosphorylated ERK1/2 were quantified by western blotting following BDNF stimulation. P0

nodose neurons were plated for two hours in neurotrophin free medium then exposed to BDNF for a range of times from 5 minutes to two hours. Neurons were then lysed, followed by protein extraction and western blotting. The effect of BDNF exposure on the levels of phosphorylated ERK1/2 was examined using antibodies directed against the phosphorylated and non-phosphorylated forms of the proteins. Levels of phosphorylated ERK1/2 remain constant, as shown in Figure 43, despite increasing times of exposure to BDNF. This suggests that BDNF exposure does not alter levels of phosphorylated ERK1/2 and that BDNF may not regulate the activity of ERK in this neuronal population under this particular experimental paradigm.

Taken together, these results suggest that inhibiting MEK in nodose neurons markedly increases neurite growth without affecting survival, suggesting that MEK plays a role in limiting BDNF mediated neurite growth. The lack of effect of BDNF on ERK phosphorylation raises the possibility that MEK exerts its effect on neurite growth by an ERK-independent mechanism. As this results is so surprising, further experiments using known controls, such as the effect of MEK inhibition in cultures from DRG, would confirm the role of MEK in the regulation of BDNF-mediated growth from nodose neurons.

5.4 MEK/ERK is not crucial for the effect of over-expressing RANK

As MAPKs are known to be involved in RANK signalling (Bharti & Aggarwal, 2004), I decided to investigate whether the MEK/ERK signalling cascade was

crucial for RANK signalling in nodose neurons. In order to overcome the effect of blocking MEK on the growth of these neurons, I investigated whether this effect was abrogated by the addition of BDNF either concurrently with or prior to the addition of the inhibitor. P0 nodose neurons were cultured and plated and BDNF was then added to the media either at the same time as U0126 or at 1 or 2 hours prior to the addition of the blocker. Adding the inhibitor 2 hours prior to the addition of the neurotrophic factor gave a significant increase in the growth of neuritic arbors (Fig. 41). Concurrent addition of the inhibitor and the neurotrophic factor, or incubation of the cells in BDNF for 1 or 2 hours prior to the addition of the inhibitor, significantly reduced the effect on neurite growth to the point where it was no longer significant (Fig. 45). When the neurons were exposed to BDNF first, neurite growth (Fig. 45B), mean total length (Fig. 45C) and mean number of branching points (Fig. 45D) were not found to be significantly different than controls. This suggests that the timing of the addition of the inhibitor is crucial for the MEK-mediated inhibition of BDNF-promoted neurite growth.

In order to investigate whether MEK is crucial for the effect of over-expressing RANK on neurite growth, P0 nodose neurons were transfected with the RANK expression plasmid in the presence of the MEK1/2 inhibitor. The inhibitor was added to the culture media concurrently with BDNF, to prevent the increase in neurite growth seen when blocking this kinase prior to the addition of the neurotrophic factor (Fig. 45). Blocking MEK1/2 did not prevent the reduction in neurite growth seen when over-expressing RANK (Fig. 46). Mean total length

(Fig. 46C), and mean number of branching points (Fig. 46D) were comparable to neurons transfected with the RANK expression construct only. This was also reflected in the Sholl profile (Fig. 46B). These results suggest that MEK is not crucial for RANK mediated inhibition of neurite outgrowth from nodose neurons. Further experiments characterizing the involvement of other intracellular mediators in the regulation of RANK signalling are required.

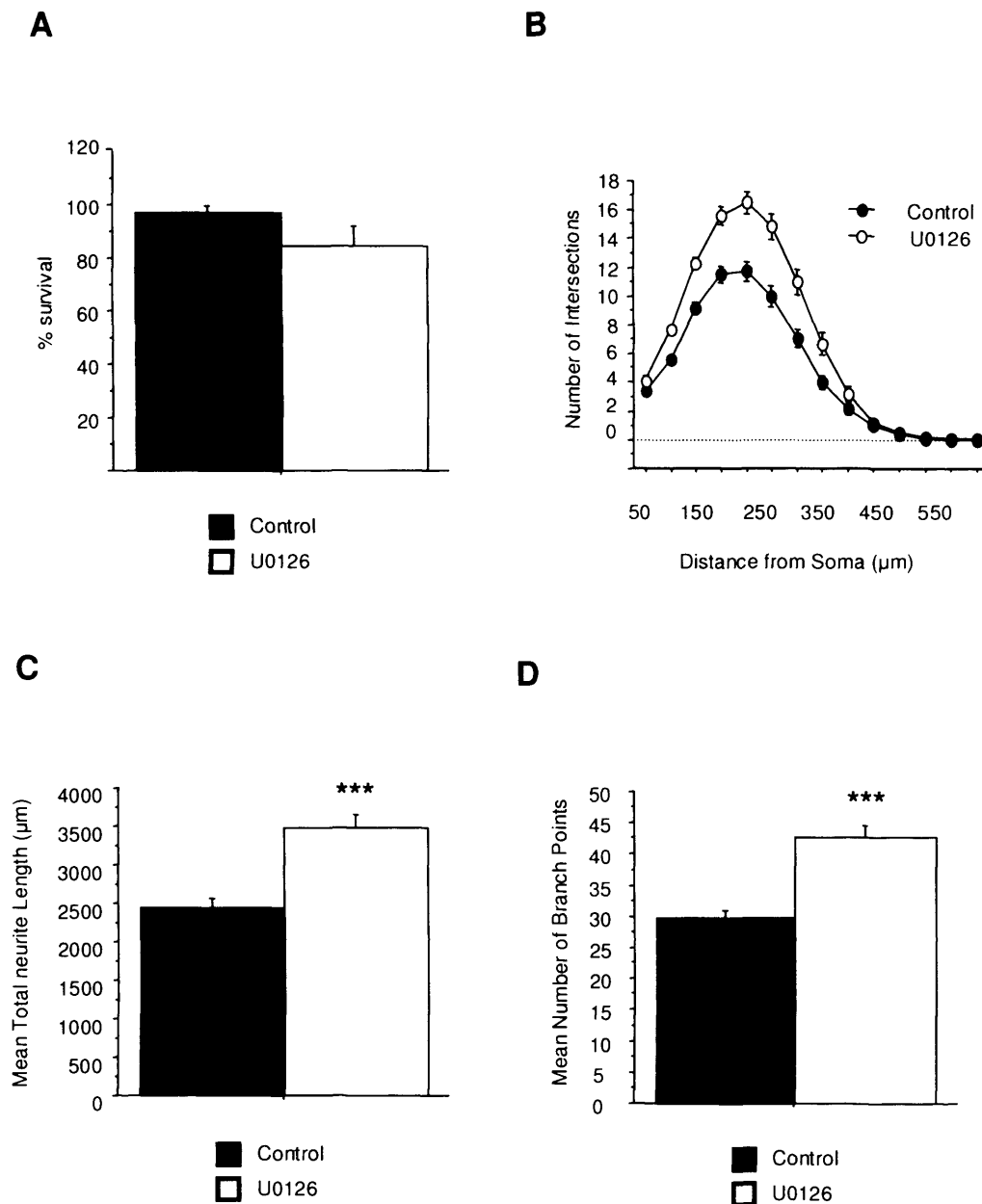


Figure 41: Effect of U0126 on BDNF-dependent growth from sensory neurons. P0 nodose neurons were treated with either U0126 (10 μM) or DMSO (control) for two hours prior to the addition of BDNF (10ng/ml). Neurons were fluorescently labelled with Calcein-AM dye and images were digitally acquired for analysis of neurite growth and morphology 24 hours after plating. Percentage survival after 24 hours (A). Sholl analysis (B), total neurite length (C) and number of branching points (D). The results are derived from the grouped data of three independent experiments. Statistical comparison are with respect to DMSO treated neurons (***) $p < 0.001$, ANOVA with Fisher's *post hoc*.

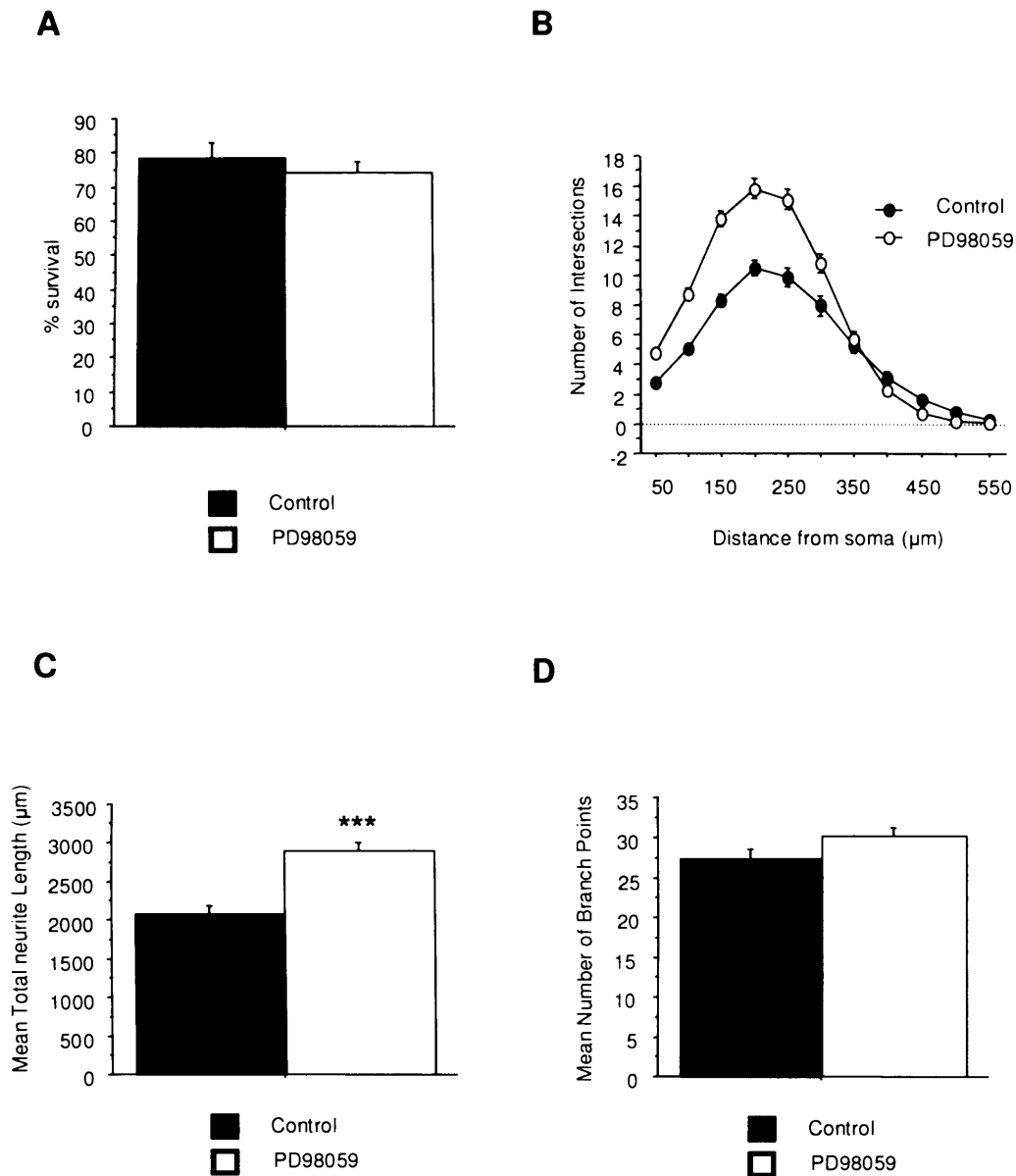


Figure 42: Effect of PD98059 on BDNF-dependent growth from sensory neurons. P0 nodose neurons were treated with either PD98059 (25 μM) or DMSO (control) for two hours prior to the addition of BDNF (10ng/ml). The neurons were fluorescently labelled with Calcein-AM dye and images were digitally acquired for analysis of neurite growth and morphology 24 hours after plating. Percentage survival after 24 hours (A). Sholl analysis (B), total neurite length (C) and number of branching points (D). The results are derived from the grouped data of three independent experiments. Statistical comparison are with respect to DMSO treated neurons (***) $p < 0.001$, ANOVA with Fisher's *post hoc*.

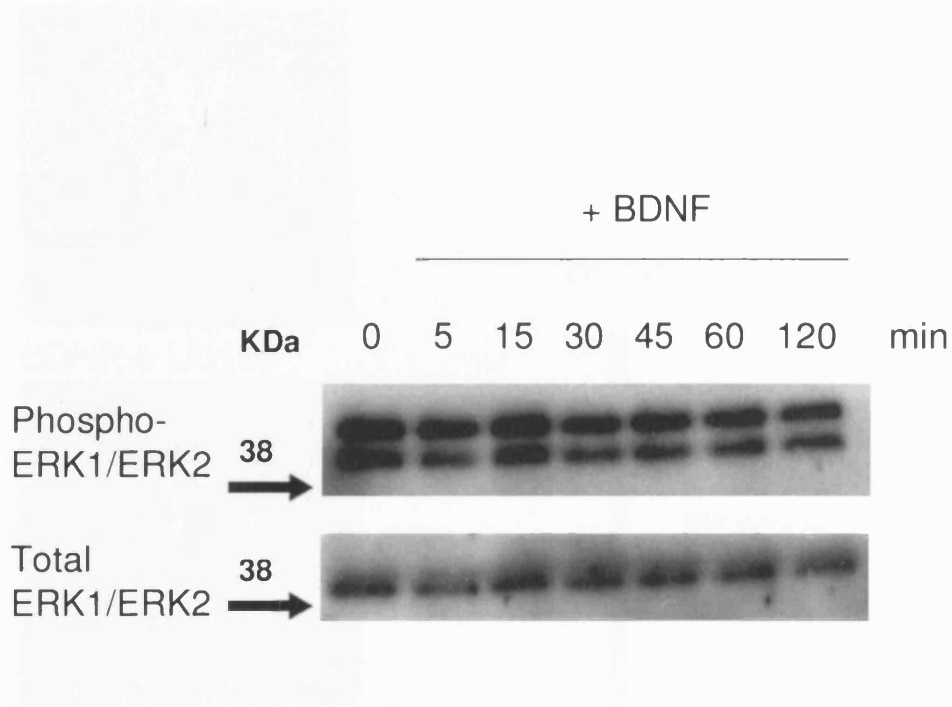


Figure 43: BDNF does not promote ERK1/2 phosphorylation in sensory neurons. Western blots showing phospho-ERK1/ERK2 and total ERK1/ERK2 in P0 nodose neurons treated with 10ng/ml BDNF for times ranging from 5 to 120 min (0' represents cultures not treated with BDNF). These experiments were repeated three times with consistent results.

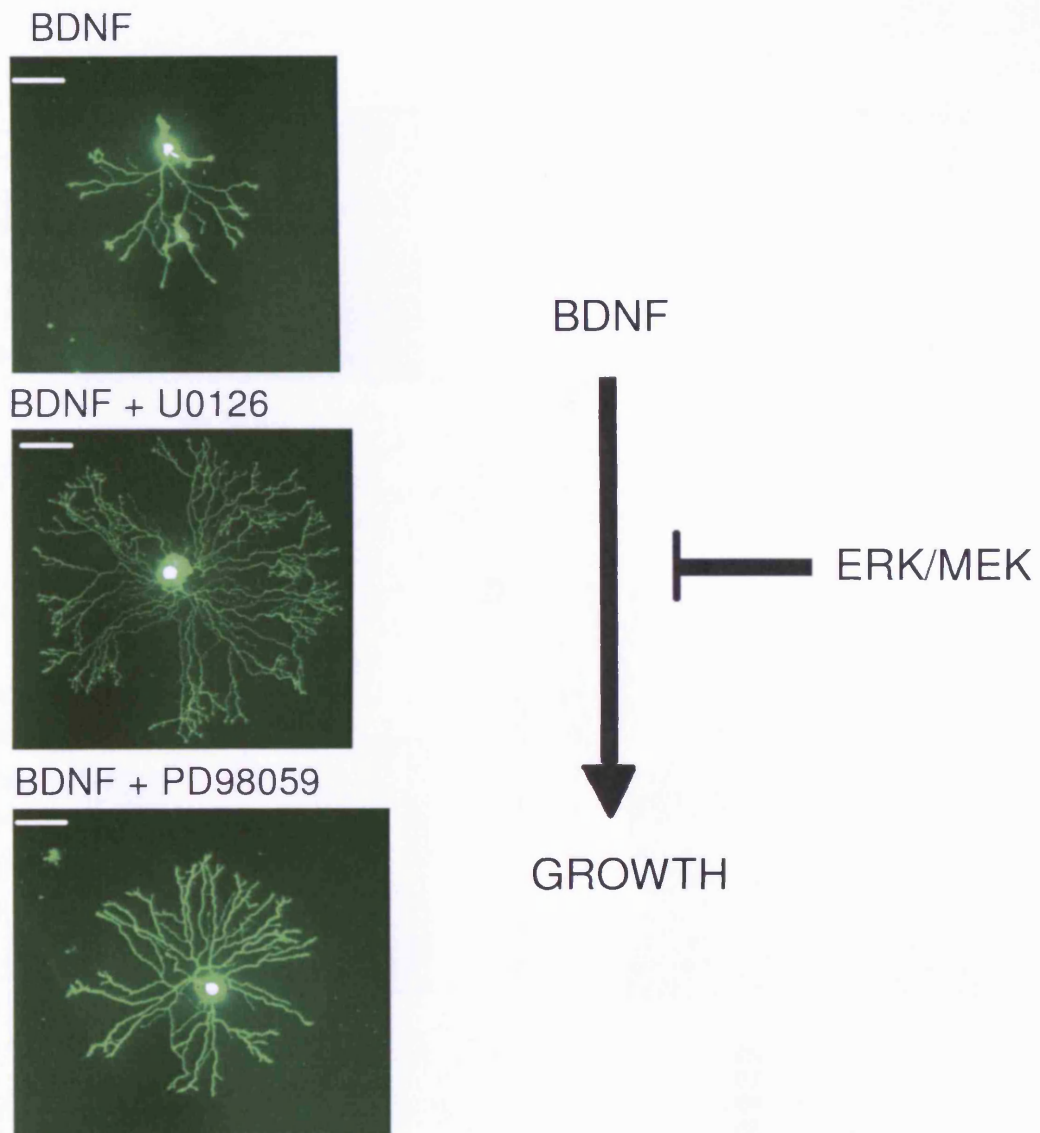


Figure 44: Effect of MEK inhibitors on BDNF dependent-growth in sensory neurons. (A) Photomicrographs of typical PO nodose neurons incubated for two hours with MEK inhibitors before the addition of BDNF and imaged at 24 hours. Scale bar = 50 μ m. (B) Proposed pathway for the role of ERK/MEK in BDNF mediated neuronal growth.

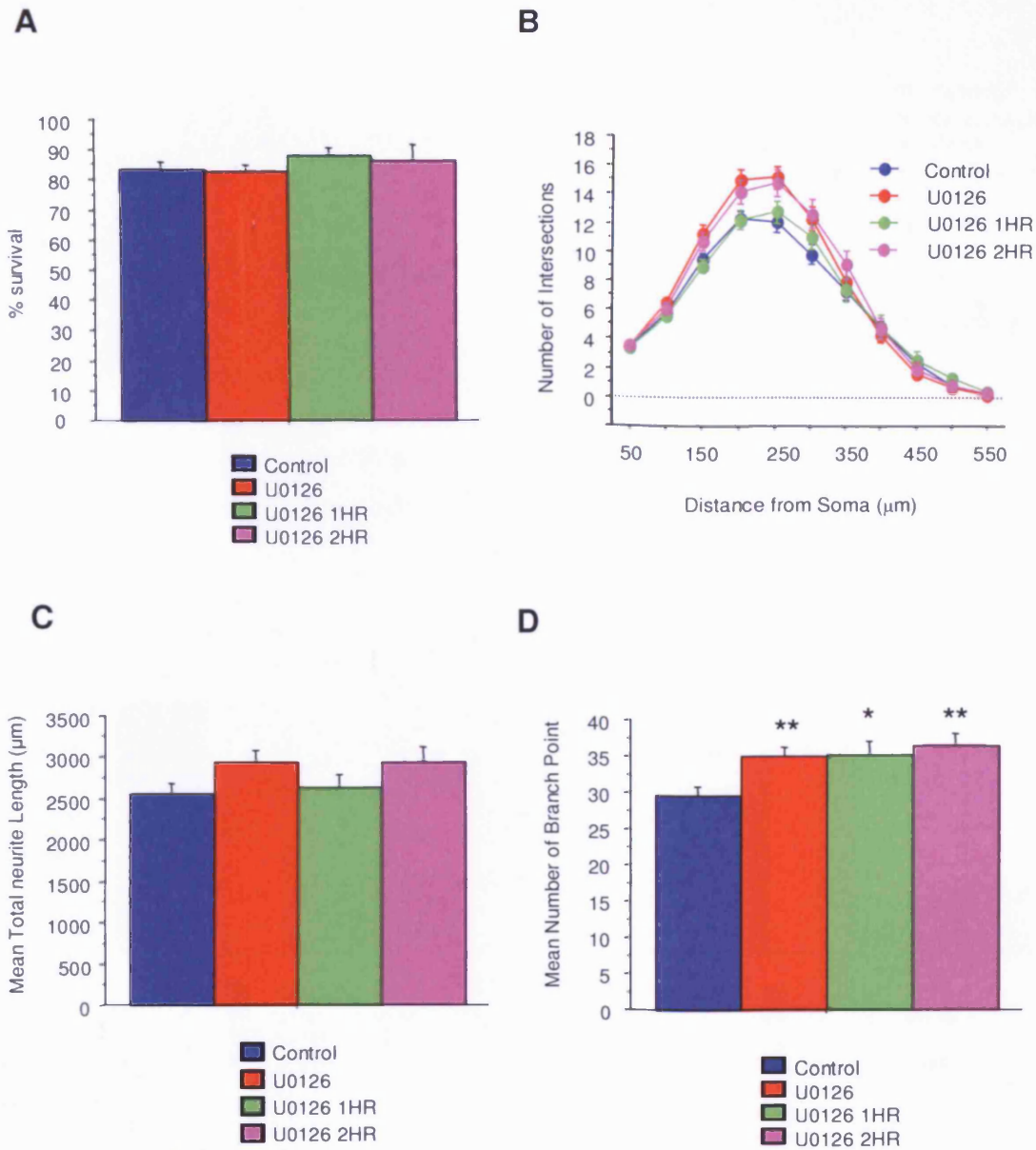


Figure 45: Adding BDNF at the same time or before the addition of U0126 abrogates its effect on neurite growth in sensory neurons. U0126 ($10\mu\text{M}$) was added to P0 nodose neuronal cultures either at the same time as BDNF (10ng/ml) (U0126) or after 1 (U0126 1HR) or 2 hours (U0126 2HR). Neurons were fluorescently labelled with calcein-AM dye and images digitally acquired for analysis of neurite growth and morphology 24 hours after plating. (A) Percentage survival after 24 hours. (B) Sholl analysis of neurite growth. Mean total neurite length (C) and mean number of branching points (D). Results are derived from the grouped data of three independent experiments. Statistical comparison are with respect to DMSO treated controls (* $p < 0.05$, ** $p < 0.01$, ANOVA with Fisher's *post hoc*).

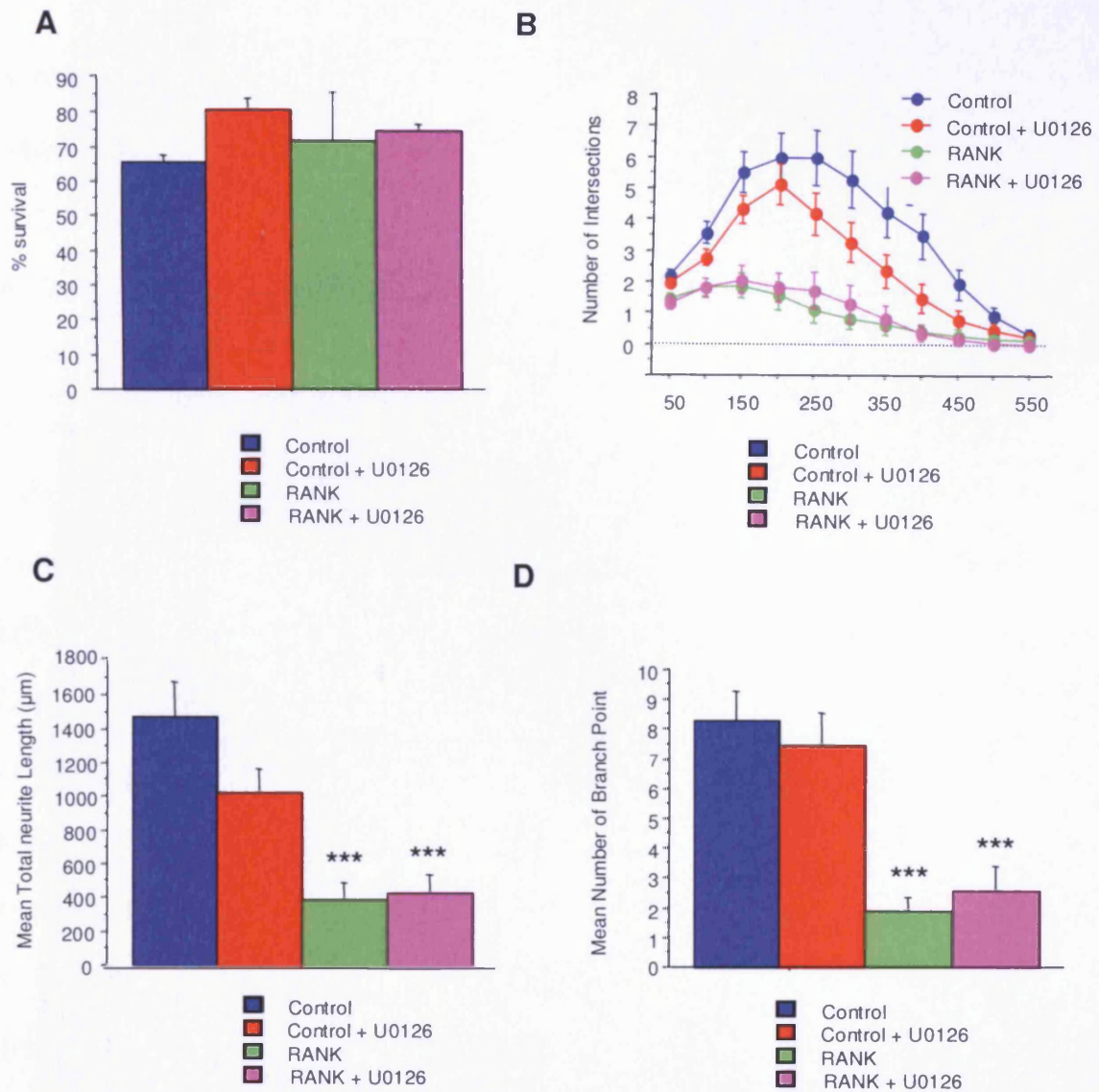


Figure 46: Blocking ERK1/2 does not prevent the effect of overexpressing RANK in sensory neurons. P0 nodose neurons were transfected with a YFP expression construct with or without a RANK expression construct and cultured with BDNF (10ng/ml) with or without U0126 (10µM). Neurons were fluorescently labelled with calcein-AM dye and images digitally acquired for analysis of neurite growth and morphology 24 hours after plating. (A) Percentage survival after 24 hours. (B) Sholl analysis of neurite growth. Mean total neurite length (C) and mean number of branching points (D) in the neurite arbours of 60-70 neurons in each condition from a typical experiment are shown (means \pm standard errors). Very similar data were obtained in three independent experiments. Statistical comparison are with respect to YFP transfected controls (***) $p < 0.001$, ANOVA with Fisher's *post hoc*.

5.5 Wortmannin and LY294002 decrease the growth of BDNF supplemented nodose neurons

To investigate whether PI3K is involved in mediating the survival-promoting and neurite growth-promoting effects of BDNF from nodose neurons, dissociated cultures of these neurons established from newborn mice were incubated in medium containing wortmannin (50nM), a specific PI3K inhibitor, for 2 hours prior to the addition of BDNF. The neurons were counted after the addition of the neurotrophin and again 24 hours later to calculate percentage neuronal survival. Wortmannin was found to have no effect on the BDNF-promoted survival (Fig. 45A). After 24 hours, the neurons were stained using Calcein-AM and imaged for Sholl analysis. Neurons pre-incubated in wortmannin grew significantly less than respective controls (Fig. 47). Wortmannin significantly reduced the extent of neurite growth (Fig. 47B), mean total length (Fig. 47C) and mean number of branching points (Fig. 47D). In the case of mean neurite length, Wortmannin reduced the extent of process outgrowth by around 30% and the reduction in the number of branch points with wortmannin was 25%.

To confirm the role of PI3K in the regulation of BDNF-mediated neurite growth, P0 nodose neurons were cultured in media containing another selective blocker of PI3K, LY294002 (50 μ M), for two hours prior to the addition of BDNF (10ng/ml) to the media. The neurons were counted after the addition of the inhibitor and at 24 hours to calculate survival. These counts showed that LY294002 had no

effect on the survival of these neurons (Fig. 48A). Inhibition of PI3K with LY294002 decreased the mean total neurite length and mean number of branch points of P0 nodose neurons relative to controls by around a third (Fig. 48C and 48D). This effect on neurite growth was reflected in a downward shift of the Sholl profile of neurons treated with LY294002 compared to controls (Fig. 48B). Figure 50 shows representative images of P0 nodose neurons treated with wortmannin and LY294002. Together, these results suggest a role for PI3K in positively regulating the BDNF-mediated neuritic growth from P0 nodose neurons.

5.6 BDNF increases the levels of phosphorylated Akt

Akt is a downstream target of activated PI3K and BDNF is known to activate Akt (Patapoutian & Reichardt, 2001; Huang & Reichardt, 2003; Chao, 2003). To determine if BDNF exposure alters the phosphorylation pattern of Akt, P0 nodose neurons were plated in neurotrophin free medium for two hours then exposed to BDNF for times ranging from 5 to 120 mins. The cells were then lysed and antibodies that specifically recognize phosphorylated-Akt and non-phosphorylated Akt were used to probe western blots. BDNF exposure was found to increase levels of phosphorylated Akt after 5 minutes (Fig 49), which subsequently returned to basal levels after two hours. This demonstrates that BDNF-signalling increases the levels of activated Akt in nodose neurons.

Treatment of sensory neurons with either wortmannin or LY294002 have been shown to decrease the growth of BDNF-supplemented nodose neurons, and

BDNF exposure increases the levels of phosphorylated Akt. This suggests a key role for the PI3K-Akt pathway in the positive regulation of BDNF-promoted neurite growth from developing nodose ganglion sensory neurons, when these neurons are extending axons and developing connections in their targets. Because RANK negatively regulates neurite growth from these neurons it seems unlikely that Akt is a necessary signal transducer for this effect of RANK.

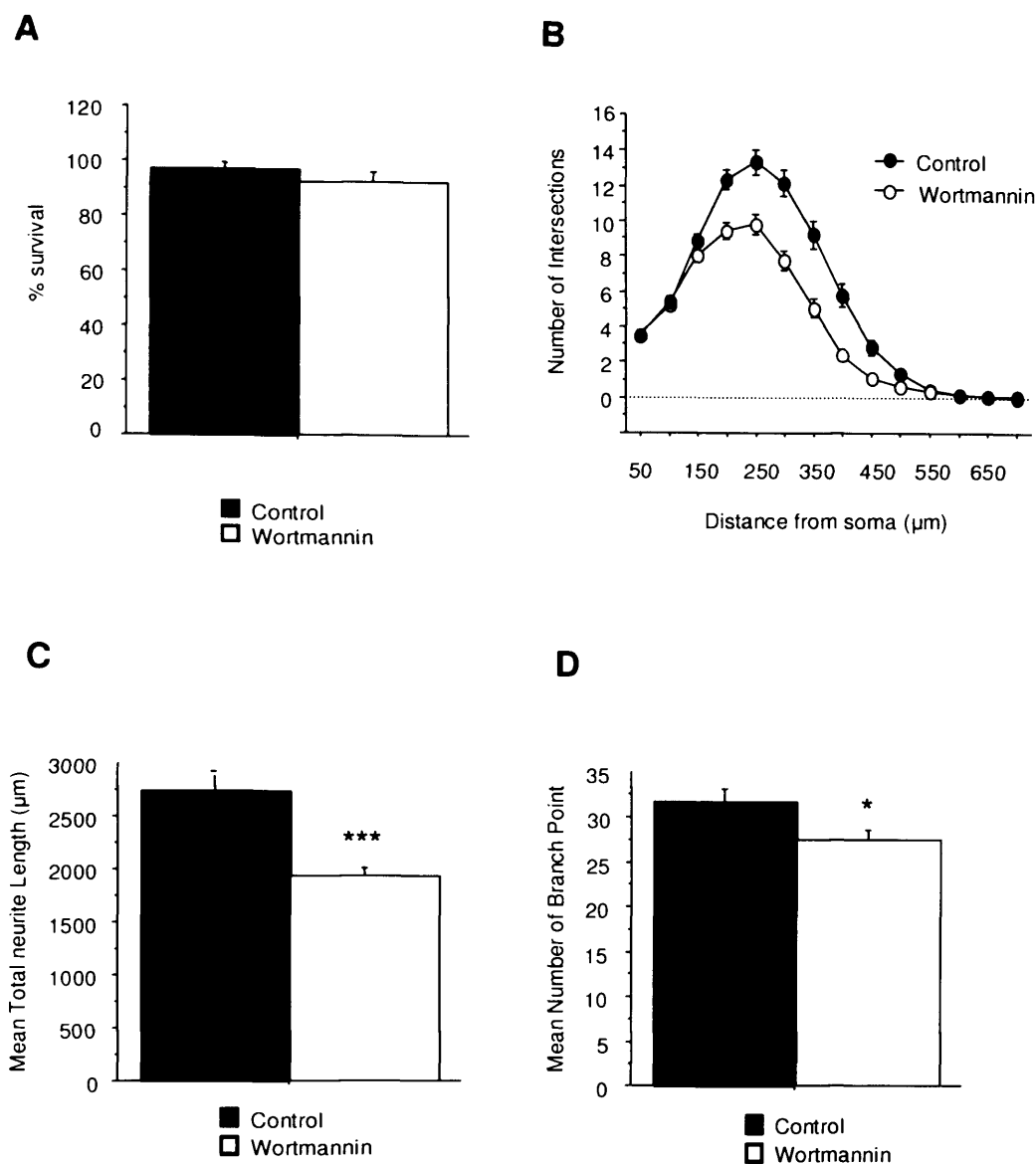


Figure 47: Effect of wortmannin on BDNF-dependent growth in sensory neurons. P0 nodose neurons were treated with either wortmannin (50nM) or DMSO (control) for two hours prior to the addition of BDNF (10ng/ml). The neurons were fluorescently labelled with Calcein-AM dye and images were digitally acquired for analysis of neurite growth and morphology 24 hours after plating. Percentage survival after 24 hours (A). Sholl analysis (B), total neurite length (C) and number of branching points (D). The results are derived from the grouped data of three independent experiments. Statistical comparison are with respect to DMSO treated neurons (* $p < 0.05$, *** $p < 0.001$, ANOVA with Fisher's *post hoc*).

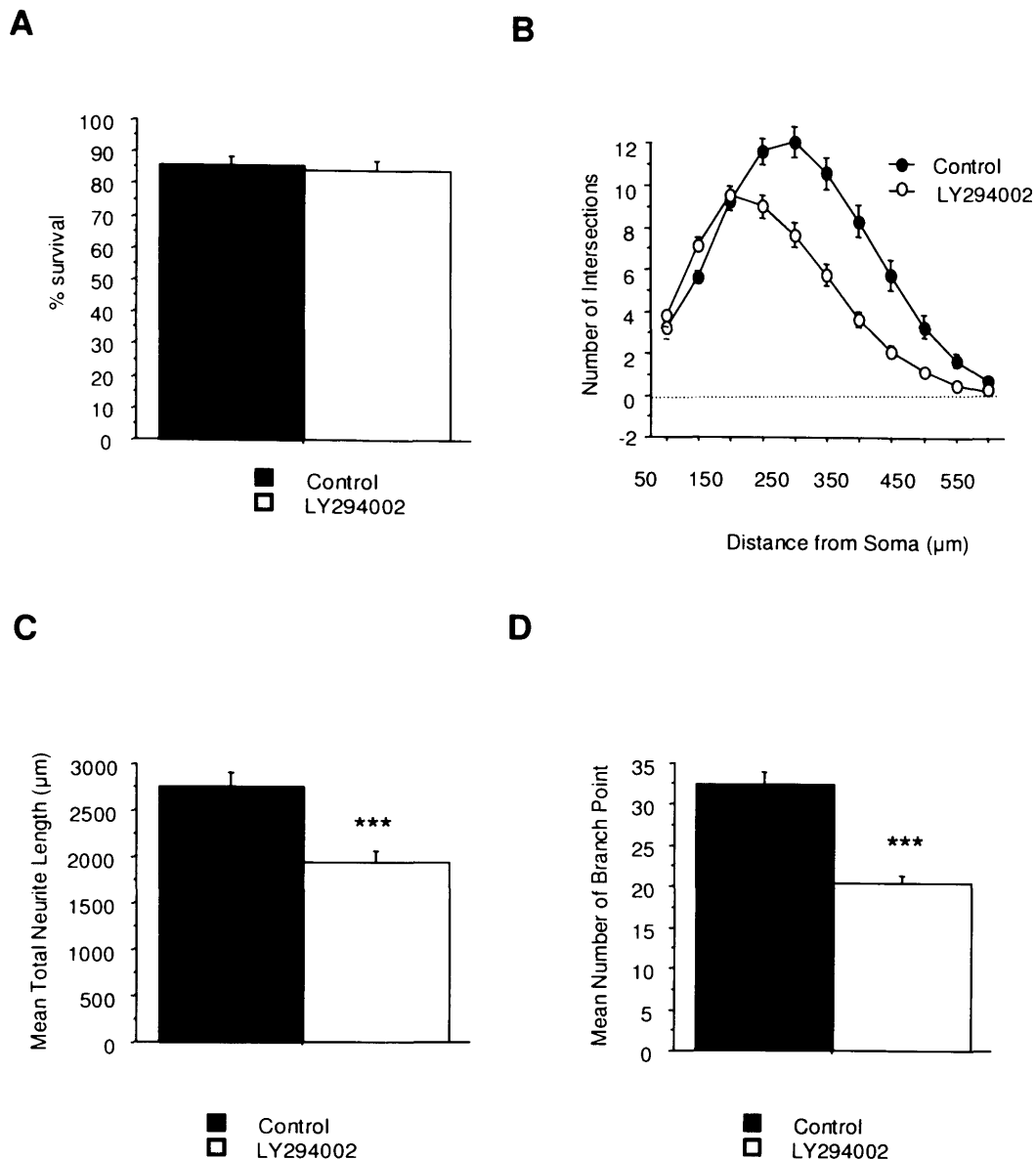


Figure 48: Effect of LY294002 on BDNF-dependent growth in sensory neurons. P0 nodose neurons were treated with either LY294002 (50 μM) or DMSO for two hours prior to the addition of BDNF (10ng/ml). The neurons were fluorescently labelled with Calcein-AM dye and images were digitally acquired for analysis of neurite growth and morphology 24 hours after plating. Percentage survival after 24 hours (A). Sholl analysis (B), mean total neurite length (C) and mean number of branching points (D). The results are derived from the grouped data of three independent experiments. Statistical comparison are with respect to DMSO treated neurons (***) $p < 0.001$, ANOVA with Fisher's *post hoc*.

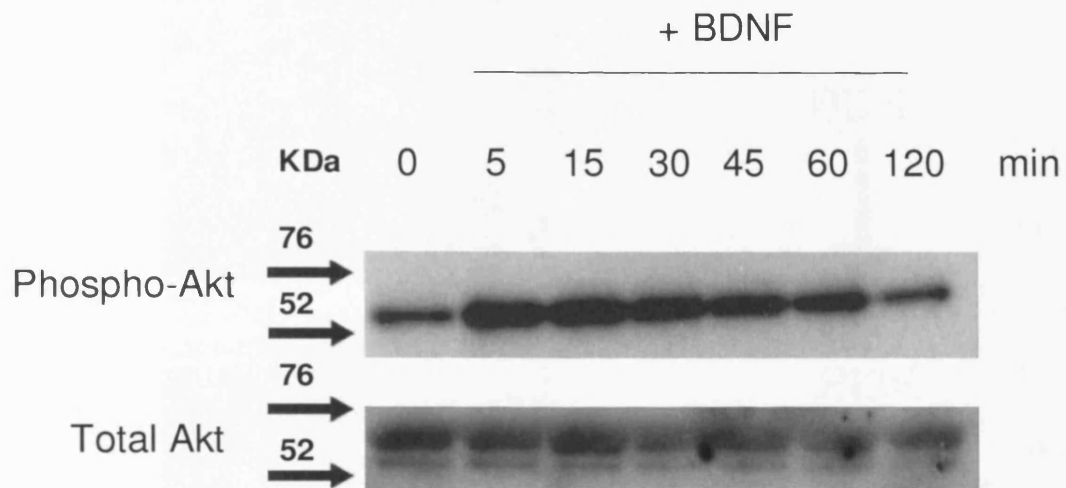


Figure 49: BDNF increases the phosphorylation of Akt in sensory neurons. Western blots showing phospho-Akt and total Akt in P0 nodose neurons treated with 10ng/ml BDNF for times ranging from 5 to 120 min (0 represents cultures not treated with BDNF). These experiments were repeated three times with consistent results.

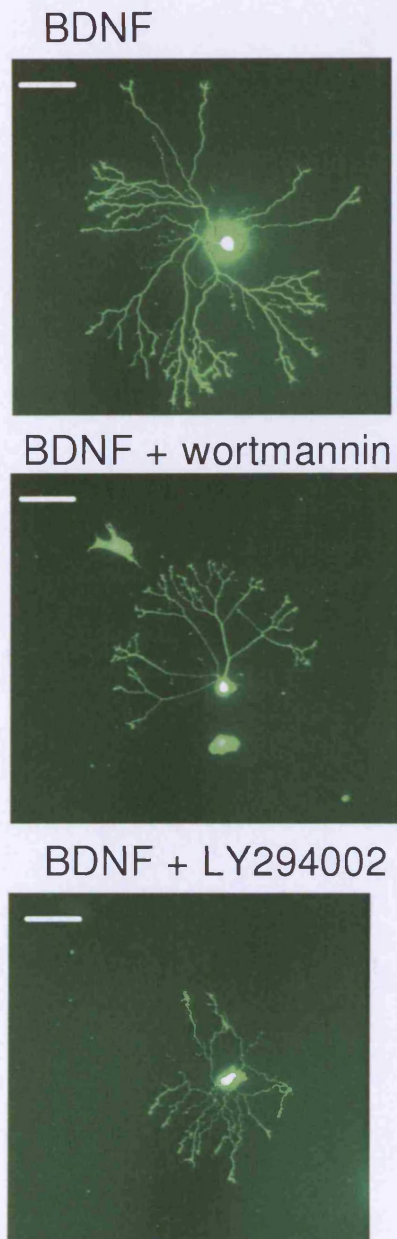
A**B**

Figure 48: Effect of PI3K inhibitors on BDNF dependent-growth in sensory neurons. (A) Photomicrographs of typical P0 nodose neurons incubated for two hours with inhibitor before the addition of BDNF and imaged at 24 hours. Scale bar = 50 μ m. (B) Proposed pathway for the role of Akt in BDNF mediated neuronal growth.

5.7 Discussion

I have provided evidence for roles for the important intracellular mediators MEK and PI3K in the regulation of neuritic outgrowth from developing nodose ganglion sensory neurons. Inhibition of the MEK in P0 nodose neurons, prior to BDNF treatment, increased mean total neurite length and mean number of branch points by around 50% without affecting survival. MEK is a key upstream regulator of ERK activation and ERK positively regulates neuritic growth in many neuronal populations including embryonic chick retinal neurons, cultured hippocampal neurons and sympathetic neurons (Perron & Bixby, 1999; Veeranna et al., 1998; O'Keefe et al., 2008). BDNF signalling is known to activate MAPK signalling pathways, including ERK (Patapoutian & Reichardt, 2001; Huang & Reichardt, 2003; Chao, 2003), therefore the finding that MEK negatively regulates BDNF-promoted neurite growth in nodose neurons is surprising. These inhibitors are highly selective for MEK, making the possibility of this effect being due to the inhibition of another target unlikely.

In order to clarify the role of ERK in the regulation of BDNF-mediated neuronal growth in nodose neurons, levels of phosphorylated ERK were quantified following exposure to BDNF. ERK is the only known MEK substrate (Shaul & Seger, 2007) and ERK is known to be activated by BDNF signalling (Patapoutian & Reichardt, 2001; Huang & Reichardt, 2003; Chao, 2003). However, exposure of sensory neurons to BDNF did not apparently change the levels of phosphorylated ERK. Basal levels of ERK phosphorylation, however, were high

in this particular experimental paradigm. Repetition of this experiment, following a longer period of incubation of the neurons to determine whether basal levels of phosphorylated-ERK decrease, may allow clarification of the relationship between BDNF signalling and ERK phosphorylation levels in nodose neurons. Alternatively, basal levels of phosphorylated-ERK may be high due to constitutive activation of ERK via MEK. This may constitute a BDNF-independent activation of MEK, possibly by an upstream regulator, and may be vital for the role of MEK in the negative regulation of BDNF-mediated neuronal growth.

The findings that MEK negatively regulates BDNF-mediated neuronal growth and that the levels of phosphorylated ERK are unaltered by exposure of nodose neurons to BDNF are surprising and in contradiction to the known roles of these kinases in the regulation of neurotrophin signalling. The possible activation of ERK, via MEK, independently of BDNF signalling to limit BDNF-promoted neuronal growth, is a novel mechanism for the regulation of the growth of sensory neurons. If MEK activation limits BDNF-promoted neuronal growth, either via ERK or via an unknown mechanism, then the inefficacy of BDNF to alter phosphorylated ERK levels is unsurprising. This intriguing situation warrants further exploration and may suggest a fundamental role for MEK/ERK in the negative regulation of BDNF-mediated neurite growth in sensory neurons. The use of expression and dominant negative constructs directed against the ERK signalling cascade, for example ERK and MEK expression plasmids, dominant negative ERK and MEK expression plasmids, and siRNAs directed against both

of this kinases, will further our understanding of the role of this important intracellular pathway in the regulation of BDNF-mediated neurite growth in sensory neuronal populations. The exploration of possible upstream regulators of MEK activity may also expand our knowledge of the regulation of BDNF-mediated neuronal growth in nodose neurons.

The inhibition of MEK was only found to increase neurite growth when MEK was inhibited prior to the addition of BDNF to the culture. Prior or concurrent addition of BDNF with the MEK inhibitor prevented this increase, suggesting the effect of blocking MEK may only be effective if TrkB signalling has not been activated. The negative effect of MEK signalling on BDNF regulated neurite growth may be dependent on a specific section of the TrkB signalling cascade, such as Ras or Raf, key transducers in the activation of MEK by BDNF (Kaplan & Miller, 2000). Further studies to elucidate the mechanism by which MEK reduces the ability of BDNF to promote neurite outgrowth are necessary to explore the role of this kinase in the regulation of neuronal growth. Blocking MEK activity also did not prevent the inhibition of neurite outgrowth seen when over-expressing RANK, suggesting that the ERK signalling cascade is not crucial for the inhibitory effects of exogenous RANK expression on neurite growth in this sensory neuronal population.

The role of Akt in BDNF signalling in sensory neurons was also investigated. Nodose neurons incubated with PI3K inhibitors, prior to the addition of BDNF,

grew significantly less than controls. Surprisingly, inhibition of PI3K has no effect on the survival of neurons cultured in BDNF. Exposure to this neurotrophin increased the levels of phosphorylated-Akt after five minutes and levels of phosphorylated-Akt then returned to initial quantities after two hours. These results suggest a role for PI3K in the positive regulation of BDNF-mediated neurite growth in nodose neurons.

The primary role of Akt in neurons is in the regulation of survival and Akt has been implicated as a key signalling protein for growth factor-dependent survival of a wide variety of cell types (Datta et al., 1999). PI3K is necessary and sufficient for growth factor-dependent activation of Akt (Burgering & Coffey, 1995; Alessi et al., 1997) and Akt is a key regulator of NGF-dependent survival. However, other studies have found that while Akt is necessary for the NGF-supported survival of sympathetic neurons, PI3K may not be (Philpott et al., 1997; Tsui-Pierchala et al., 2000). Akt is also known to be activated by BDNF (Patapoutian & Reichardt, 2001; Huang & Reichardt, 2003; Chao, 2003) and the survival effect of BDNF has been found to be dependent on PI3K (Atwal et al., 2000). Therefore, the lack of a survival effect when blocking PI3K in sensory neurons supported by BDNF is surprising. However, Akt is also known to have a role in positively regulating the growth of many cell types including cerebellar (Dudek et al. 1997), sympathetic (Philpott et al., 1997; Crowder & Freeman, 1998; Vaillant et al., 1999; Atwal et al., 2000), sensory (Gallo, & Letourneau, 1998; Liu & Snider, 2001) and striatal neurons (Gavalda et al., 2004). These

results provide further evidence that PI3K is important in the promotion of neurite growth by BDNF. Additional investigation, using Akt or PI3K expression plasmids, dominant negative constructs directed against PI3K and Akt and the use of siRNAs directed against these kinases, will increase our understanding of the role this signalling cascade plays in the regulation of BDNF-mediated neurite outgrowth in sensory neurons.

One of the most striking findings of these studies is the contrast between ERK and Akt signalling and the opposing roles these important signalling members play in the regulation of BDNF-mediated neurite outgrowth from sensory neurons. PI3K and MEK are both activated by BDNF and Ras transduces TrkB activation to both of these intracellular mediators (Kaplan & Miller, 2000), suggesting Ras could be a focal point for the regulation of neuronal growth by these kinases. Experiments designed to investigate the role of Ras, such as inhibitors directed against this protein, and other important downstream effectors, will be essential in increasing our understanding of the role of these intracellular mediators in BDNF-promoted neuronal growth. Further exploration of the role MEK and PI3K play in the regulation of the development of sensory neurons, including in the action of other neurotrophins, such as NT-4, and cytokines, such as CNTF, will expand our knowledge of the way these neurons are regulated at this crucial time in the development of their neuritic arbors. Exploration of whether PI3K and MEK play similar roles in the regulation of growth and survival in the small subset of NGF-responsive nodose neurons (Forgie et al., 2000)

would also be interesting. NF- κ B has recently been shown to display a developmental shift in the regulation of neurite growth in sensory neurons (Gavalda et al., 2009). Therefore, studies of the actions of PI3K and MEK at earlier and later stages in development will also increase our knowledge of the function of these intracellular signalling members in the development of sensory neurons. The findings reported in this chapter not only provide evidence for novel roles for MEK and PI3K in the regulation of neuronal growth, but form the basis of an important body of future research.

General Discussion

The growth and survival of neuronal populations are regulated by a variety of different molecules. Members of the neurotrophin family, the neurotrophic cytokines and other signals regulate these processes and are secreted by a wide variety of cells to support neuronal populations (Davies, 2003). Members of the TNF superfamily have recently been found to regulate the growth of several populations of neurons including GITR in sympathetic neurons and LIGHT in sensory neurons (O'Keeffe et al., 2008; Gavalda et al., 2009). I have provided evidence for a novel role for the TNFR superfamily member, RANK, in the regulation of neuritic growth from sensory neurons of the nodose and trigeminal ganglia, and sympathetic neurons of the SCG. RANK, along with the ligand for this receptor, RANKL, and a decoy receptor, OPG, were found to be present in all neurons of these ganglia. Over-expression of RANK significantly reduced the neuritic growth from all of these neurons, when cultured in the appropriate neurotrophic factor that supports their survival and growth, across a wide range of developmental timepoints from embryonic stages to postnatal ages.

Investigations into the intracellular mediators vital for the effect seen when over-expressing RANK in neurons of the nodose ganglia, via co-transfection of the RANK expression plasmid together with dominant negative expression plasmids targeted at known RANK-associated signalling mediators, revealed the

requirement of TRAF2, NIK, IKK β and NF- κ B. Inhibition of each of these mediators prevented the effect seen when over-expressing RANK on BDNF-mediated neuritic growth. TRAF6 and IKK α were found to not be required for the effect of over-expressing RANK. These signalling mediators constitute a distinct pathway in the regulation of RANK signalling in sensory neurons that differs significantly from previously published work (Darnay et al, 1998; Darnay et al., 1999).

Further investigations into the role of RANK, along with the ligand for this receptor, and the decoy receptor for RANKL, in the regulation of the development of neuronal populations, including the use of RANK deficient mice (Dougall et al., 1999; Li et al., 2000), will increase our knowledge of the role of this TNF receptor superfamily member in the regulation of neuronal development.

The roles of Akt and ERK, in the regulation of neuronal growth and survival, are well characterised and both have been shown to be vital for neurotrophin-mediated survival and outgrowth (Kaplan & Miller, 2000; Liu & Sinder, 2001). The finding that Akt positively contributes to BDNF-mediated neuritic outgrowth in sensory neurons is thus unsurprising, given the role of this kinase in other neuronal populations. The finding that ERK negatively regulates BDNF-mediated neuritic outgrowth, however, is very surprising. It has been posited that signalling by neurotrophins activates Trk receptors which then trigger ERK activation and

that this instructs morphological responses (Liu & Snider, 2001; Kaplan & Miller, 2000). This does not appear to be the case with sensory neurons of the nodose and the role of this kinase in the regulation of sensory neuron development warrants further investigation. Figure 51 show a graphic representation of the results contained with this thesis.

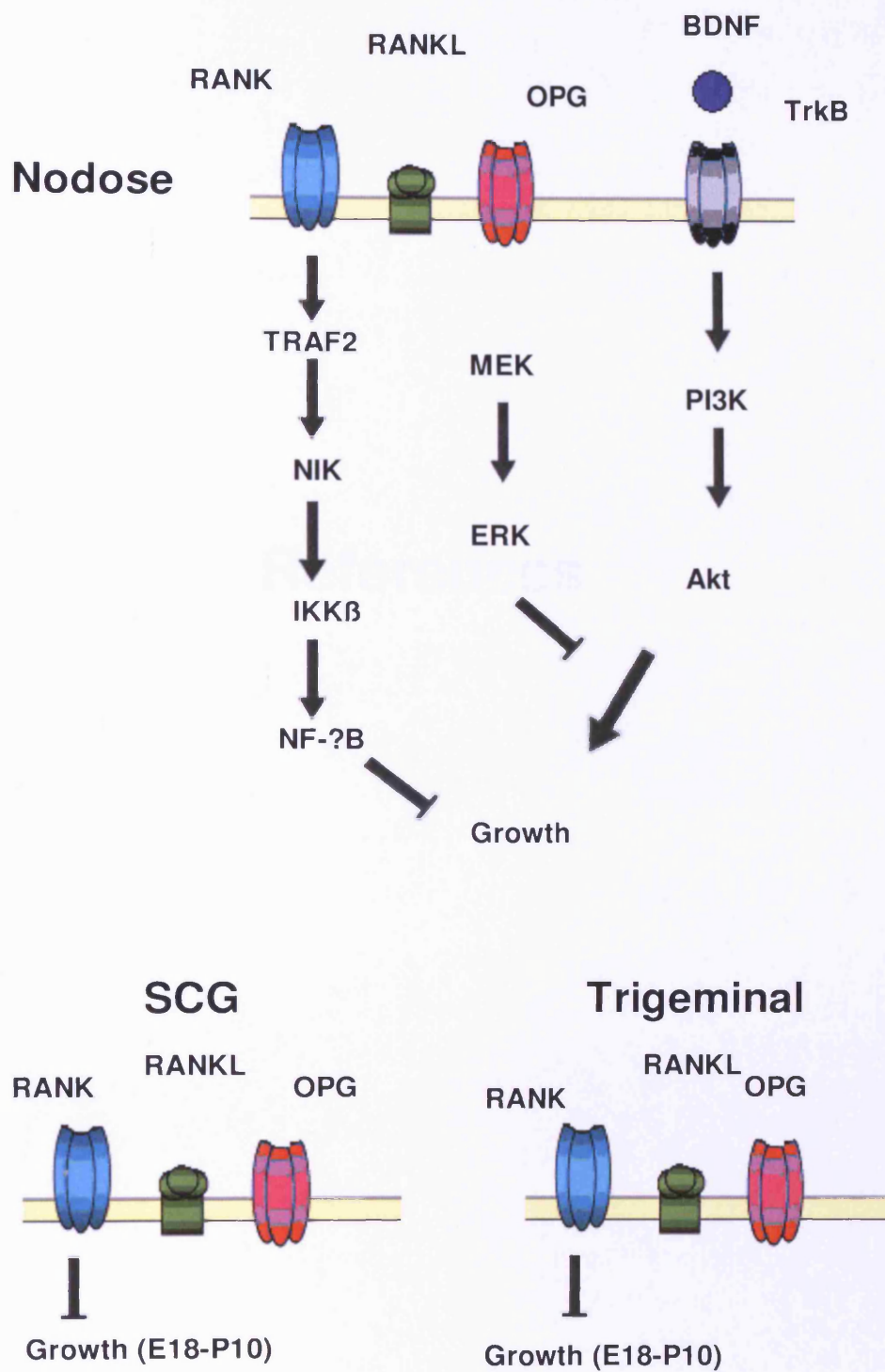


Figure 51: Summary of results. RANK decreases neurite growth in nodose, SCG and trigeminal neurons. In nodose neurons RANK signals via TRAF2, NIK, IKK β and NF- κ B. BDNF signals via Akt in nodose neurons and ERK acts to limit BDNF mediated neurite growth.

References

- Albensi BC, & Mattson MP, 2000. Evidence for the involvement of TNF and NF-KappaB in hippocampal synaptic plasticity. *Synapse* **35**: 151-159.
- Alessi DR, Andjelkovic M, Caudwell B, Cron P, Morrice N, Cohen P, & Hemmings BA, 1996. Mechanism of activation of protein kinase B by insulin and IGF-1. *EMBO J* **15**: 6541-6551.
- Alessi DR, James SR, Downes CP, Holmes AB, Gaffney PR, Reese CB, & Cohen P, 1997. Characterisation of a 3-phosphoinositide-dependent protein kinase which phosphorylates and activates protein kinase B alpha. *Curr Biol* **4**: 261-269.
- Anderson DM, Maraskovsky E, Billingsley WL, Dougall WC, Tometsko ME, Roux ER, Teepe MC, DuBose RF, Cosman D, & Galibert L, 1997. A homologue of the TNF receptor and its ligand enhance T-cell growth and dendritic-cell function. *Nature*: **390**: 175-179.
- Andres R, Forgie A, Wyatt S, Chen Q, de Sauvage FJ, & Davies AM, 2001. Multiple effects of artemin on sympathetic neurone generation, survival and growth. *Development* **128**: 3685-3695.
- Angevine JB, & Sidman RL, 1961. Autoradiographic study of the mammalian neocortex and evolution of the cortical plate. *Nature* **192**: 766-768.
- Ansieau S, Scheffrahn I, Mosialos G, Brand H, Duyster J, Kaye K, Harada J, Dougall B, Hübinger G, Kieff E, Herrmann F, Leutz A, & Gruss HJ, 1996. Tumor necrosis factor receptor-associated factor (TRAF)-1, TRAF-2 and TRAF-3 interact in vivo with the CD30 cytoplasmic domain; TRAF-2 mediates CD30-induced nuclear factor kappa B activation. *Proc Natl Acad Sci USA* **93**: 14053-14058.
- Arumae U, Pirvola U, Palgi J, Kiema TR, Palm K, Moshnyakov M, Ylikoski J, & Saarma M, 1993. Neurotrophins and their receptors in rat peripheral trigeminal system during maxillary nerve growth. *Journal of cell biology* **122**: 1053-1065.
- Atwal JK, Massie B, Miller FD, & Kaplan DR, 2000. The TrkB-Shc site signals neuronal survival and local axon growth via MEK and PI3-kinase. *Neuron* **27**: 265-277.
- Ayer-Le Lievre CS, & Le Douarin NM, 1982. The early development of cranial sensory ganglia and the potentialities of their component cells studied in quail-chick chimeras. *Dev Biol* **94**: 291-310.
- Baeuerle PA, & Henkel T, 1994. Function and activation of NF-κB in the immune system. *Annual Review of Immunology* **12**: 141-79.

- Baldwin Jr, AS, 1996. The NF- κ B and I κ B Proteins: New Discoveries and Insights. *Annual Review of Immunology* **14**: 649-681.
- Baloh RH, Tansey MG, Lampe PA, Fahrner TJ, Enomoto H, Simburger KS, Leitner ML, Araki T, Johnson EM Jr, & Milbrandt J, 1998. Artemin, a novel member of the GDNF ligand family, supports peripheral and central neurons and signals through the GFR-alpha3-RET receptor complex. *Neuron* **21**: 1291-1302.
- Barbin G, Manthorpe M, & Varon S, 1984. Purification of the chick eye ciliary neurotrophic factor. *J Neurochem* **43**: 1468-1478.
- Barde YA, 1989. Trophic Factors and neuronal survival. *Neuron* **2**: 1525-1534.
- Barde YA, Edgar D, & Thoenen H, 1982. Purification of a new neurotrophic factor from mammalian brain. *EMBO J* **1**: 549-553.
- Barker V, Middleton G, Davey F, & Davies AM, 2001. TNF α contributes to the death of NGF-dependent neurons during development. *Nature Neuroscience* **4**: 1194-1198.
- Barrett GL, & Bartlett PF, 1994. The p75 NGF receptor mediates survival or death depending on the stage of sensory neuron development. *Proc Natl Acad Sci USA* **9**: 6501-6505.
- Baud V, Liu ZG, Bennett B, Suzuki N, Xia Y, & Karin M, 1999. Signalling by pro-inflammatory cytokines: oligomerization of TRAF2 and 6 is sufficient for JNK and IKK activation and target gene induction via an amino-terminal effector domain. *Genes & Development* **13**: 1297-1308.
- Bellacosa A, Testa JR, Staal SP, & Tsichlis PN, 1991. A retroviral oncogene, akt, encoding a serine-threonine kinase containing an SH2-like region. *Science* **254**: 274-277.
- Bessis A, Bernard D, & Triller A, 2005. Tumor Necrosis Factor- α and Neuronal Development. *The Neuroscientist* **11**: 277-281.
- Bharti AC, & Aggarwal BB, 2004. Ranking the role of RANK ligand in apoptosis. *Apoptosis* **9**: 677-690.
- Bibel M, & Barde YA, 2000. Neurotrophins: key regulators of cell fate and cell shape in the vertebrate nervous system. *Genes Development* **14**: 2919-2937.
- Bishop GA, 2004. The multifaceted roles of TRAFs in the regulation of B Cell function. *Nat Rev Immunol* **4**: 775-786.

- Blair JM, Zheng Y & Dunstan CR, 2007. RANK ligand. *The international Journal of Biochemistry and Cell Biology* **39**: 1077-1081.
- Blenis J, 1993. Signal transduction via MAP kinases: Proceed at your own RSK. *Proc Natl Acad Sci USA* **90**: 5889-5892.
- Bottjer SW, & Arnold AP, 1997. Developmental Plasticity in neural circuits for a learned behaviour. *Annual Review of Neuroscience* **20**: 459-481.
- Bhakar AL, Tannis LL, Zeindler C, Russo MP, Jobin C, Park DS, MacPherson S, & Barker PA, 2002. Constitutive nuclear factor-kappa B activity is required for central neuron survival. *J Neurosci* **22**: 8466-8475.
- Bramham CR, & Messaoudi E, 2005. BDNF function in adult synaptic plasticity: the synaptic consolidation hypothesis. *Prog Neurobiol* **76**: 99-125.
- Brault V, Moore R, Kutsch S, Ishibashi M, Rowitch DH, McMahon AP, Sommer L, Boussadia O, & Kemler R, 2001. Inactivation of the beta-catenin gene by Wnt1-Cre-mediated deletion results in dramatic brain malformation and failure of craniofacial development. *Development* **128**: 1253-1264.
- Brazil DP, & Hemmings BA, 2001. Ten years of protein kinase B signalling: a hard Akt to follow. *TRENDS in Biological Sciences* **26**: 657-664.
- Brunet A, Datta SR, & Greenberg ME, 2001. Transcription-dependent and – independent control of neuronal survival by the PI3K-Akt signalling pathway. *Current Opinion in Neurobiology* **11**: 297-305.
- Bucay N, Sarosi I, Dunstan CR, Morony S, Tarpley J, Capparelli C, Scully S, Tan HL, Xu W, Lacey DL, Boyle WJ, & Simonet WS, 1998. Osteoprotegerin-deficient mice develop early onset osteoporosis and arterial calcification. *Genes Dev* **12**: 1260-1268.
- Buchman VL, & Davies AM, 1993. Different neurotrophins are expressed and act in a developmental sequence to promote the survival of embryonic sensory neurons. *Development* **118**: 989-1001.
- Buj-Bello, Pinon LG, & Davies AM, 1993. The survival of NGF-dependent but not BDNF dependent cranial sensory neurons is promoted by several different neurotrophins early in their development. *Development* **120**: 1573-1580.
- Burgering BM, & Coffey PJ, 1995. Protein kinase B (c-akt) in phosphatidylinositol 3-OH kinase signal transduction. *Nature* **376**: 599-602.
- Cao Z, Xiong J, Takeuchi M, Kurama T, & Goeddel DV, 1996. TRAF6 is a signal transducer for interleukin-1. *Nature* **383**: 443-446.

- Carswell, EA Old LJ, Kassel RL, Green S, Fiore N, & Williamson B, 1975. An endotoxin-induced serum factor that causes necrosis of tumours. *Proc Natl Acad Sci USA* **72**: 3666-70.
- Chao MV, Bothwell MA, Ross AH, Koprowski H, Lanahan AA, Buck CR, & Sehgal A, 1986. Gene transfer and molecular cloning of the human NGF receptor. *Science* **232**: 518-521.
- Chao MV, 2003. Neurotrophins and their receptors: a convergence point for many signalling pathways. *Nat Rev Neurosci* **4**: 299-309.
- Chen Z, Gibson TB, Robinson F, Silvestro L, Pearson G, Xu B, Wright A, Vanderbilt C, & Cobb MH, 2001. MAP kinases. *Chem Rev* **101**: 2449-2476.
- Chilton JK, 2006. Molecular Mechanisms of Axon Guidance. *Dev Biol* **292**: 13-24.
- Chitnis AB, 1999. Control of neurogenesis – lessons from frogs, fish, and flies. *Current Opinion in Neurobiology* **9**: 18-25.
- Cobb M, Boulton TG & Robbins DJ, 1991. Extracellular signal-regulated kinases: ERKs in progress. *Cell Regulation* **2**: 965-978.
- Coffer PJ, & Woodgett JR, 1991. Molecular cloning and characterisation of a novel putative serine-threonine kinase related to the cAMP-dependent and protein kinase C families. *Eur J Biochem* **201**: 475-481.
- Cohen S, Levi-Montalcini R, Hamburger V, 1954. A nerve growth stimulating factor isolated from sarcoma 37 and 180. *Proceedings of the national academy of sciences USA* **40**: 1014-18.
- Colas J-F, & Schoenwolf GC, 2001. Towards a Cellular and Molecular Understanding of Neurulation. *Developmental Dynamics* **221**: 117-145.
- Copp AJ, 2005. Neurulation in the cranial region – normal and abnormal. *J Anat* **207**: 623-635.
- Cory S, Huang DS, & Adams JM, 2003. The Bcl-2 family: roles in cell survival and oncogenesis. *Oncogene* **22**: 8590-8607.
- Cowley, Paterson H, Kemp P, & Marshall CJ, 1994. Activation of MAP kinase is necessary and sufficient for PC12 differentiation and for transformation of NIH 3T3 cells. *Cell* **77**: 841-852.

- Cross DA, Alessi DR, Cohen P, Andjelkovich M, & Hemmings BA, 1995. Inhibition of glycogen synthase kinase-3 by insulin mediated by protein kinase B. *Nature* **378**: 785-789.
- Crowder RJ & Freeman RS, 1998. Phosphatidylinositol 3-Kinase and Akt Protein Kinase are Necessary and Sufficient for the Survival of Nerve Growth Factor-Dependent Sympathetic Neurons. *Journal of Neuroscience* **18**: 2933-2943.
- Crowley C, Spencer SD, Nishimura MC, Chen KS, Pitts-Meek S, Armanini MP, Ling LH, McMahon SB, Shelton DL, Levinson AD, & Phillips HS, 1994. Mice lacking nerve growth factor display perinatal loss of sensory and sympathetic neurons yet develop basal forebrain cholinergic neurons. *Cell* **76**: 1001-1011.
- Darnay BG, Haridas V, Ni J, Moore PA, & Aggarwal BB, 1998. Characterization of the Intracellular Domain of Receptor Activator of NF- κ B (RANK). Interaction with tumor necrosis factor receptor-associated factors and activation of NF- κ B and C-Jun N-terminal kinase. *Journal of Biological Chemistry* **273**: 20551-20555.
- Darnay BG, Ni J, Moore PA, & Aggarwal BB, 1999. Activation of NF- κ B by RANK Requires Tumor Necrosis Factor Receptor-associated Factor (TRAF) 6 and NF- κ B-inducing Kinase. Identification of a novel TRAF6 interaction motif. *Journal of Biological Chemistry* **274**: 7724-7731.
- Datta SR, Brunet A, & Greenberg ME, 1999. Cellular survival: a play in three Akts. *Genes Dev* **13**: 2905-2927.
- Davies AM, 1989. Intrinsic differences in the growth rate of early nerve fibres related to target distance. *Nature* **337**: 553-555.
- Davies AM, Horton A, Burton LE, Schmelzer C, Vandlen R, & Rosenthal A, 1993b. Neurotrophin-4/5 is a mammalian-specific survival factor for distinct populations of sensory neurons. *J Neurosci* **13**: 4961-4967.
- Davies AM, & Lindsay RM, 1985. The cranial sensory ganglia in culture: Differences in the response of placode-derived and neural crest-derived neurons to nerve growth factor. *Dev Biol* **111**: 62-72.
- Davies AM, 1988. Role of neurotrophic factors in development. *Trends in Genetics* **4**: 139-143.
- Davies AM, 1994. The role of neurotrophins during successive stages of neuron development. *Progress in growth factor research* **5**: 263-289.
- Davies AM, 2000. Neurotrophins: neurotrophic modulation of neurite growth. *Curr Biol* **10**: R198-200.

- Davies AM, 2003. Regulation of neuronal survival and death by extracellular signals during development. *The EMBO Journal* **22**: 2537-2545.
- Davies AM, Thoenen H, & Barde YA, 1986b. Different factors from the central nervous system and periphery regulate the survival of sensory neurones. *Nature* **319**: 497-499.
- Davies AM, Thoenen H, & Barde YA, 1986. The response of chick sensory neurons to brain-derived neurotrophic factor. *J Neurosci* **6**: 1897-1904.
- Davies AM, in *Cranial sensory neurons. Neural cell culture a practical approach*. 1995, Oxford University Press. P. 153-176.
- Davies AM, Lee KF, & Jaenisch R, 1993. p75-deficient trigeminal neurons have an altered response to NGF but not to other neurotrophins. *Neuron* **11**: 565-574.
- Dechiara TM, Bowen DC, Valenzuela DM, Simmons MV, Poueymirou WT, Thomas S, Kinetz E, Compton DL, Rojas E, Park JS, Smith C, DiStefano PS, Glass DJ, Burden SJ, & Yancopoulos GD, 1996. The receptor tyrosine MuSK is required for neuromuscular junction formation in vivo. *Cell* **85**: 501-512.
- Deckwerth TL, Elliott JL, Knudson CM, Johnson EM Jr, Snider WD, & Korsmeyer SJ, 1996. Bax is required for neuronal death after trophic factor deprivation and during development. *Neuron* **17**: 401-411.
- Dejardin E, 2006. The alternative NF- κ B pathway from biochemistry to biology: pitfalls and promises for future drug development. *Biochemical pharmacology* **72**: 1161-1179.
- Doble BW, & Woodgett JR, 2003. GSK-3: tricks of the trade for a multi-tasking kinase. *Journal of Cell Science* **116**: 1175-1196.
- Domeniconi M, Hempstead BL, & Chao MV, 2007. Pro-NGF secreted by astrocytes promotes motor neuron death. *Mol Cell Neurosci* **34**: 271-279.
- Dougall WC, Glaccum M, Charrier K, Rohrbach K, Brasel K, De Smedt T, Daro E, Smith J, Tometsko ME, Maliszewski CR, Armstrong A, Shen V, Bain S, Cosman D, Anderson D, Morrissey PJ, Peschon JJ, & Schuh J, 1999. RANK is essential for osteoclast and lymph node development. *Genes & Development* **13**: 2412-2424.
- Duclert A, & Changeux JP, 1995. Acetylcholine receptor gene expression at the developing neuromuscular junction. *Physiol Rev* **75**: 339-368.

Dudek H, Datta SR, Franke TF, Birnbaum MJ, Yao R, Cooper GM, Segal RA, Kaplan DR, & Greenberg ME, 1997. Regulation of Neuronal Survival by the Serine-Threonine Protein Kinase Akt. *Science* **275**: 661-664.

Duronio V, 2008. The life of a cell: apoptosis regulation by the PI3K/PKB pathway. *Biochem J* **415**: 333-344.

Eagleson GW, & Harris WA, 1990. Mapping of the presumptive brain regions in the neural plate of *Xenopus laevis*. *J Neurobiol* **21**: 427-440.

Eksioglu YZ, Scheffer IE, Cardenas P, Knoll J, DiMario F, Ramsby G, Berg M, Kamuro K, Berkovic SF, Duyk GM, Parisi J, Huttenlocher PR, & Walsh CA, 1996. Periventricular heterotopia: an X linked dominant epilepsy locus causing aberrant cerebral cortical development. *Neuron* **16**: 77-87.

Elshamy WM, & Ernfors P, 1997. Brain-derived neurotrophic factor, neurotrophin-3 and neurotrophin-4 complement and cooperate with each other sequentially during visceral neuron development. *J Neurosci* **17**: 8667-8675.

Erickson JT, Conover JC, Borday V, Champagnat J, Barbacid M, Yancopoulos G, & Katz DM, 1996. Mice lacking brain-derived neurotrophic factor exhibit visceral sensory neuron losses distinct from mice lacking NT4 and display a severe developmental defect in control of breathing. *J Neurosci* **16**: 5361-5371.

Ernfors P, Lee KF, Kucera J, & Jaenisch R, 1994. Lack of neurotrophin-3 leads to deficiencies in the peripheral nervous system and loss of limb proprioception. *Cell* **77**: 503-512.

Ernfors P, Lee K-F, & Jaenisch R, 1994a. Mice lacking brain-derived neurotrophic factor develop sensory deficits. *Nature* **368**: 147-150.

Ernfors P, Merlio JP & Persson H, 1992. Cells expressing mRNA for neurotrophins and their receptors during embryonic rat development. *European journal of neuroscience* **11**: 1140-1158.

Farinas, 1999. Neurotrophin action during the development of the peripheral nervous system. *Microsc Res Tech* **45**: 233-42.

Forgie A, Kuehnel F, Wyatt S, & Davies AM, 2000. In vivo survival requirement of a subset of nodose ganglion neurons for nerve growth factor. *Eur J Neurosci* **12**: 670-676.

Franke TF, Yang SI, Chan TO, Datta K, Kazlauskas A, Morrison DK, Kaplan DR, & Tsichlis PN, 1995. The protein kinase encoded by the akt proto-oncogene is a target of the PDGF-activated phosphatidylinositol 3-kinase. *Cell* **81**: 727-736.

- Gallagher D, Gutierrez H, Gavalda N, O'Keeffe G, Hay R, & Davies AM, 2007. Nuclear Factor- κ B Activation via Tyrosine Phosphorylation of Inhibitor κ B- is crucial for Ciliary Neurotrophic Factor-Promoted Neurite Growth from Developing Neurons. *Journal of Neuroscience* **27**: 9664-9669.
- Gallo G, & Letourneau PC, 1998. Localised sources of neurotrophins initiate axon collateral sprouting. *Journal of Neuroscience* **18**: 5403-5414.
- Gao WQ, & Hatten ME, 1993. Neuronal differentiation rescued by implantation of Weaver granule cell precursors into wild-type cerebellar cortex. *Science* **260**: 367-369.
- Gautam M, Noakes PG, Moscoso L, Rupp F, Scheller RH, Merlie JP, & Sanes JR, 1996. Defective neuromuscular synaptogenesis in agrin-deficient mutant mice. *Cell* **85**: 525-535.
- Gavalda N, Pérez-Navarro E, Gratacòs E, Comella JX, & Alberch J, 2004. Differential involvement of phosphatidylinositol 3-kinase and p42/44 mitogen activated protein kinase pathways in brain-derived neurotrophic factor-induced trophic effects on cultured striatal neurons. *Molecular and Cellular Neuroscience* **25**: 460-468.
- Gavalda N, Gutierrez H, & Davies AM, 2009. Developmental Regulation of Sensory Neurite Growth by the Tumor Necrosis Factor Superfamily Member LIGHT. *Journal of Neuroscience* **29**: 1599-1607.
- Gilbert SF, 1994. Early vertebrate development: neurulation and the ectoderm. In *Developmental Biology*, fourth edition. Sinauer Associates, 1994: 244-294.
- Glebova NO, & Ginty DD, 2004. Heterogenous requirement of NGF for sympathetic target innervation In Vivo. *Journal of Neuroscience* **24**: 743-751.
- Glebova NO, & Ginty DD, 2005. Growth and survival signals controlling sympathetic nervous system development. *Annual Review of Neuroscience* **28**: 191-222.
- Gleeson JG, & Walsh CA, 2000. Neuronal migration disorders: from genetic diseases to developmental mechanisms. *Trends Neurosci* **23**: 352-359.
- Golan H, Levav T, Huleihel M, 2004. Distinct expression and distribution of vesicular proteins in the hippocampus of TNF α -deficient mice during development. *Synapse* **53**: 6-10.
- Goodman CS, 1996. Mechanisms that control growth cone guidance. *Ann Rev Neurosci* **19**: 341-377.

- Grivennikov SI, Kuprash DV, Liu ZG, & Nedospasov SA, 2006. Intracellular signals and events activated by cytokines of the tumor necrosis factor superfamily. From simple paradigms to complex mechanisms. *Int Rev Cytol* **252**: 129-161.
- Grunwald IC, & Klein R, 2002. Axon guidance: receptor complexes and signalling mechanisms. *Current Opinion in Neurobiology* **12**: 250-259.
- Gutierrez H, Hale VA, Dolcet X, & Davies A, 2005. NF- κ B signalling regulates the growth of neural processes in the developing PNS and CNS. *Development* **132**: 1713-1726.
- Gutierrez H, & Davies AM, 2007. A fast and accurate procedure for deriving the Sholl profile in quantitative studies of neuronal morphology. *Journal of Neuroscience Methods* **163**: 24-30.
- Gutierrez H, O'Keefe GW, Gavaldà N, Gallagher D, & Davies AM, 2008. Nuclear Factor B signalling either stimulates or inhibits neurite growth depending on the phosphorylation status of p65/RelA. *Journal of Neuroscience* **28**: 8246: 8256.
- Hansen CS, Marion CD, Steele K, George S, & Smith WC, 1997. Direct neural induction and selective inhibition of mesoderm and epidermis inducers by Xnr3. *Development* **124**: 483-492.
- Harland R, 2000. Neural Induction. *Current Opinion in Genetics and Development* **10**: 357-362.
- Hatten ME, 1999. Central nervous system neuronal migration. *Annu Rev Neurosci* **22**: 511-539.
- Hehlgans T, & Pfeffer K, 2005. The intriguing biology of the tumour necrosis factor/tumour necrosis factor receptor superfamily: players, rules and the games. *Immunology* **115**: 1-20.
- Hemmati-Brivanlou A & Melton DA, 1994. Inhibition of activin receptor signalling promotes neuralization in *Xenopus*. *Cell* **77**: 273-281.
- Hofer MM, & Barde YA, 1988. Brain-derived neurotrophic factor prevents neuronal death in vivo. *Nature* **331**: 261-262.
- Hohn A, Leibrock J, Bailey K, & Barde YA, 1990. Identification and characterization of a novel member of the nerve growth factor/brain-derived neurotrophic factor family. *Nature* **341**: 339-341.
- Horton AR, Bartlett PF, Pennica D, & Davies AM, 1998. Cytokines promote the survival of mouse cranial sensory neurons at different developmental stages. *Eur J Neurosci* **10**: 673-679.

Hsu H, Lacey DL, Dunstan CR, Solovyev I, Colombero A, Timms E, Tan HL, Elliott G, Kelley MJ, Sarosi I, Wang L, Xia XZ, Elliott R, Chiu L, Black T, Scully S, Capparelli C, Morony S, Shimamoto G, Bass MB, & Boyle WJ, 1999. Tumor Necrosis Factor receptor family member RANK mediates osteoclast differentiation and activation induced by osteoprotegerin ligand. *Proc Natl Acad Sci* **96**: 3540-3545.

Huang EJ, & Reichardt LF, 2001. Neurotrophins: Roles in Neuronal Development and Function. *Annual Reviews of Neuroscience* **24**: 677-736.

Huang EJ, & Reichardt LF, 2003. Trk Receptors: Roles in neuronal signal transduction. *Annu Rev Biochem* **72**: 609-642.

Ikeda, Kasai M, Utsuyama M, & Hirokawa K, 2001. Determination of Three Isoforms of the Receptor Activator of Nuclear Factor- κ B Ligand and Their Differential Expression in Bone and Thymus. *Endocrinology* **142**: 1419-1426.

Iotsova V, Caamaño J, Loy J, Yang Y, Lewin A, & Bravo R, 1997. Osteopetrosis in mice lacking NF-KappaB1 and NF-KappaB2. *Nat Med* **3**: 1285-1289.

Iverson S, Iverson L, & Saper CB, 2000. The autonomic nervous system and the hypothalamus. In *Principles of Neural Science*. Edited by Kandel ER, Schwartz, Jessell TM. New York Elsevier; 2000: 960-982.

Jessell TM, & Sanes JR, 2000. Development. The decade of the developing brain. *Current Opinion in Neurobiology* **10**: 599-611.

Jessell TM, & Sanes JR, 2000a. Induction and patterning of the nervous system. In *Principles of Neural Science*. Edited by Kandel ER, Schwartz, Jessell TM. New York Elsevier; 2000: 1019-1040.

Jessell TM, Sanes JR, 2000b. Formation and regeneration of synapses. In *Principles of Neural Science*. Edited by Kandel ER, Schwartz, Jessell TM. New York Elsevier; 2000: 1087-1114.

Jessell TM, Sanes JR, 2000c. The guidance of axons to their targets. *Principles of Neural Science*. Edited by Kandel ER, Schwartz, Jessell TM. New York Elsevier; 2000: 1063-1086.

Johnston MV, Rutkowski JL, Wainer BH, Long JB, & Mobley WC, 1987. NGF effects on developing forebrain cholinergic neurons are regionally specific. *Neurochem Res* **12**: 985-994.

Jones KR, Fariñas I, Backus C, & Reichardt LF, 1994. Targeted disruption of the BDNF gene perturbs brain and sensory neuron development but not motor neuron development. *Cell* **76**: 989-999.

Jones PF, Jakubowicz T, Pitossi FJ, Maurer F, & Hemmings BA, 1991. Molecular cloning and identification of a serine/threonine protein kinase of the second-messenger subfamily. *Proc Natl Acad Sci USA* **88**: 4171-4175.

Junttila MR, Li S-P, & Westermarck J, 2008. Phosphatase-mediated crosstalk between MAPK signalling pathways in the regulation of cell survival. *The FASEB Journal* **22**: 954-965.

Kafitz KW, Rose CR, Thoenen H, & Konnerth A, 1999. Neurotrophin-evoked rapid excitation through TrkB receptors. *Nature* **401**: 918-921.

Kaltschmidt B, Widera D, & Kaltschmidt C, 2005. Signalling via NF-KappaB in the nervous system. *Biochem Biophys Acta* **1745**: 276-99.

Kaplan DR, Hempstead BL, Martin-Zanca D, Chao MV, & Parada LF, 1991. The Trk proto-oncogene product: a signal transducing receptor for nerve growth factor. *Science* **252**: 554-558.

Kaplan DR, & Miller FD, 2000. Neurotrophin signal transduction in the nervous system. *Curr Opin Neurobiol* **10**: 381-391.

Karin M, 1996. The regulation of AP-1 activity by mitogen-activated protein kinases. *Phil Trans R Soc Lond B Biol Sci* **351**: 127-134.

Karin M, 1999. How NF-KappaB is activated: the role of the I-kappaB kinase (IKK) complex. *Oncogene* **18**: 6867-6874.

Katz, 1966. *Nerve, muscle and synapse*. New York: McGraw-Hill.

Kawamoto Y, Nakamura S, Nakano S, Oka N, Akiguchi I, & Kimura J, 1996. Immunohistochemical localization of brain-derived neurotrophic factor in adult rat brain. *Neuroscience* **74**: 1209-1226.

Kawauchi S, Shou J, Santos R, Hébert JM, McConnell SK, Mason I, & Calof AL, 2005. Fgf8 expression defines a morphogenetic center required for olfactory neurogenesis and nasal cavity development in the mouse. *Development* **132**: 5211-5223.

Kearns AE, Khosla S, & Kostenuik PJ, 2008. Receptor Activator of Nuclear Factor κ B Ligand and Osteoprotegerin Regulation of Bone Remodeling in Health and Disease. *Endocrine Reviews* **29**: 155-192.

Kim, Odgren PR, Kim DK, Marks SC Jr, & Choi Y, 2000. Diverse roles of the tumour necrosis factor family member TRANCE in skeletal physiology revealed by TRANCE deficiency and partial rescue by a lymphocyte-expressed TRANCE transgene. *PNAS* **97**: 10905-10910.

Kim H-H, Lee DE, Shin JN, Lee YS, Jeon YM, Chung CH, Ni J, Kwon BS, & Lee ZH, 1999. Receptor activator of NF- κ B recruits multiple TRAF family adaptors and activates c-Jun N-terminal kinase. *FEBS Letters* **443**: 297-302.

Klein R, Jing SQ, Nanduri V, O'Rourke E, & Barbacid M, 1991. The Trk proto-oncogene encodes a receptor for nerve growth factor. *Cell* **65**: 189-197.

Knudson CM, Tung KS, Tourtellotte WG, Brown GA, & Korsmeyer SJ, 1995. Bax-deficient mice with lymphoid hyperplasia and male germ cell death. *Science* **270**: 96-99.

Kong YY, Feige U, Sarosi I, Bolon B, Tafuri A, Morony S, Capparelli C, Li J, Elliott R, McCabe S, Wong T, Campagnuolo G, Moran E, Bogoch ER, Van G, Nguyen LT, Ohashi PS, Lacey DL, Fish E, Boyle WJ, & Penninger JM, 1999. Activated T Cells regulate bone loss and joint destruction in adjuvant arthritis through osteoprotegerin ligand. *Nature* **402**: 304-309.

Kong YY, Yoshida H, Sarosi I, Tan HL, Timms E, Capparelli C, Morony S, Oliveira-dos-Santos AJ, Van G, Itie A, Khoo W, Wakeham A, Dunstan CR, Lacey DL, Mak TW, Boyle WJ, & Penninger JM, 1999b. OPGL is a key regulator of osteoclastogenesis, lymphocyte development and lymph-node organogenesis. *Nature* **397**: 315-323.

Kotzbauer PT, Lampe PA, Estus S, Milbrandt J, & Johnson EM Jr, 1994. Postnatal development of survival responsiveness in rat sympathetic neurons to leukaemia inhibitory factor and ciliary neurotrophic factor. *Neuron* **12**: 763-773.

Krishna M & Narang H, 2008. The complexity of mitogen-activated protein kinases (MAPKs) made simple. *Cell. Mol. Life Sci.* **65**: 3525-3544.

Kuruvilla R, Zweifel LS, Glebova NO, Lonze BE, Valdez G, Ye H, & Ginty DD, 2004. A neurotrophin signalling cascade coordinates sympathetic neuron development through differential control of TrkA trafficking and retrograde signalling. *Cell* **118**: 243-255.

LaBonne C, & Bronner-Fraser M, 1998. Neural crest induction in *Xenopus*: evidence for a two-signal model. *Development* **125**: 2403-2414.

Lacey DL, Timms E, Tan HL, Kelley MJ, Dunstan CR, Burgess T, Elliott R, Colombero A, Elliott G, Scully S, Hsu H, Sullivan J, Hawkins N, Davy E, Capparelli C, Eli A, Qian YX, Kaufman S, Sarosi I, Shalhoub V, Senaldi G, Guo

- J, Delaney J, & Boyle WJ, 1998. Osteoprotegerin ligand is a cytokine that regulates osteoclast differentiation and activation. *Cell* **93**:165–176.
- Lamb TM, Knecht AK, Smith WC, Stachel SE, Economides AN, Stahl N, Yancopoulos GD, & Harland RM, 1993. Neural induction by the secreted polypeptide noggin. *Science* **262**: 713-718.
- Lee KF, Li E, Huber LJ, Landis SC, Sharpe AH, Chao MV, & Jaenisch R, 1992. Targeted mutation of the gene encoding the low affinity NGF receptor p75 leads to deficits in the peripheral sensory nervous system. *Cell* **69**: 737-749.
- Lee KF, Bachman K, Landis S, Jaenisch R, 1994. Dependence on p75 for innervation of some sympathetic targets. *Science* **263**: 1447-1449.
- Lee KF, Davies AM, & Jaenisch R, 1994a. p75-deficient embryonic dorsal root sensory and neonatal sympathetic neurons display a decreased sensitivity to NGF. *Development* **120**: 1027-1033.
- Lee KJ & Jessell TM, 1999. The specification of dorsal cell fates in the vertebrate central nervous system. *Annual Reviews of Neuroscience* **22**: 261-294.
- Lee R, Kermani P, Teng KK, Hempstead BL, 2001. Regulation of cell survival by secreted proneurotrophins. *Science* **294**: 1945-1948.
- Lentz SI, Knudson CM, Korsmeyer SJ, & Snider WD, 1999. Neurotrophins support the development of diverse sensory axon morphologies. *J Neurosci* **19**: 1038-1048.
- Levi-Montalcini R, & Booker B, 1960. Destruction of the sympathetic ganglia in mammals by an antiserum to a nerve-growth protein. *Proceedings of the national academy of sciences USA* **46**: 384-391.
- Levi-Montalcini R, 1987. The nerve growth factor 35 years later. *Science* **237**: 1154-1162.
- Levi-Montalcini, 1953. In-vivo and in-vitro experiments on the effect of mouse sarcoma 180 and 37 on the sensory and sympathetic system of the chick embryo. *Proc. 14th Congr. Zool, Copenhagen*, p. 309.
- Li J, Sarosi I, Yan XQ, Morony S, Capparelli C, Tan HL, McCabe S, Elliott R, Scully S, Van G, Kaufman S, Juan SC, Sun Y, Tarpley J, Martin L, Christensen K, McCabe J, Kostenuik P, Hsu H, Fletcher F, Dunstan CR, Lacey DL, & Boyle WJ, 2000. RANK is the intrinsic hematopoietic cell surface regulator that controls osteoclastogenesis and regulation of bone mass and calcium metabolism. *PNAS* **97**: 1566-1571.

Lindsay RM, & Rohrer H, 1985. Placode sensory neurons in culture. Nodose ganglia are unresponsive to NGF, lack NGF receptors but are supported by a liver-derived neurotrophic factor. *Dev Biol* **112**: 30-48.

Lindsay RM, Barde Y, Davies AM, & Rohrer H, 1985a. Differences and similarities in the neurotrophic growth factor requirements of sensory neurons derived from neural crest and neural placode. *J Cell Sci Suppl* **3**: 115-129.

Liu X, Ernfors P, Wu H, & Jaenisch R, 1995. Sensory but not motor neuron deficits in mice lacking NT4 and BDNF. *Nature* **375**: 238-41.

Liu R, & Snider W, 2001. Different signalling pathways mediate regenerative versus developmental sensory axon growth. *J Neurosci* **21**: RC164.

Locksley RM, Killeen N, & Lenardo MJ, 2001. The TNF and TNF Receptor Superfamilies: Integrating Mammalian Biology. *Cell* **104**: 487-501.

Lomaga MA, Yeh WC, Sarosi I, Duncan GS, Furlonger C, Ho A, Morony S, Capparelli C, Van G, Kaufman S, van der Heiden A, Itie A, Wakeham A, Khoo W, Sasaki T, Cao Z, Penninger JM, Paige CJ, Lacey DL, Dunstan CR, Boyle WJ, Goeddel DV, Mak TW. 1999. TRAF6 deficiency results in osteopetrosis and defective interleukin-1, CD40 and LPS signalling. *Genes Dev* **13**: 1015-1024.

Lumsden A, & Krumlauf R, 1996. Patterning the Vertebrate Neuraxis. *Science* **274**: 1109-1115.

Maggirwar SB, Sarmiere PD, Dewhurst S, & Freeman RS, 1998. Nerve-growth factor-dependent activation of NF-KappaB contributes to survival of sympathetic neurons. *J Neurosci* **18**: 10356-10365.

Maina F, Hilton MC, Andres R, Wyatt S, Klein R, & Davies AM, 1998. Multiple roles for hepatocyte growth factor in sympathetic neuron development. *Neuron* **20**: 835-846.

Malanin NL, Boldin MP, Kovalenko AV, & Wallach D, 1997. MAP3K-related kinase involved in NF-KappaB induction by TNF, CD95 and IL-1. *Nature* **385**: 540-545.

Marin-Padilla M, 1978. Dual origin of the mammalian neocortex and evolution of the cortical plate. *Anat Embryol* **152**: 109-126.

Markus A, Patel D, & Snider WD, 2002. Neurotrophic factors and axonal growth. *Curr Op Neurobiol* **12**: 523-531.

Martinou JC, Dubois-Dauphin M, Staple JK, Rodriguez I, Frankowski H, Missotten M, Albertini P, Talabot D, Catsicas S, Pietra C, & Huarte J, 1994.

Over-expressing of bcl-2 in transgenic mice protects neurons from naturally occurring cell death and experimental ischaemia. *Neuron* **13**: 1017-1030.

Martin-Zanca D, Hughes SH, & Barbacid M, 1986. A human oncogene formed by the fusion of truncated tropomyosin and protein kinase sequences. *Nature* **319**: 743-748.

Matsumoto M, Sudo T, Saito T, Osada H, & Tsujimoto M, 2000. Involvement of p38 mitogen-activated protein kinase signalling pathway in osteoclastogenesis mediated by receptor activator of NF-kappa B ligand (RANKL). *J Biol Chem* **275**: 31155-31161.

McMahan UJ, 1990. The agrin hypothesis. *Cold Spring Harb Symp Quant Biol* **55**: 407-418.

Meno C, Gritsman K, Ohishi S, Ohfuji Y, Heckscher E, Mochida K, Shimono A, Kondoh H, Talbot WS, Robertson EJ, Schier AF, & Hamada H, 1999. Mouse Lefty2 and zebrafish antivin are feedback inhibitors of nodal signalling during vertebrate gastrulation. *Mol Cell* **4**: 287-298.

Mercurio M, & Manning AM, 1999. Multiple signals converging on NF- κ B. *Current Opinion in Cell Biology*. **11**: 226-232.

Merlo E, Freudenthal R, Maldonado H, & Romano A, 2005. Activation of the transcription factor NF-KappaB by retrieval is required for long term memory consolidation. *Learn Mem* **12**: 23-29.

Middleton G, Hamanoue M, Enokido Y, Wyatt S, Pennica D, Jaffray E, Hay RT, & Davies AM, 2000. Cytokine-induced nuclear factor kappa B activation of developing neurons. *J Cell Biol* **148**: 325-332.

Mizuno T, Kawanokuchi J, Numata K, & Suzumura A, 2005. Production and neuroprotective functions of fractalkine in the central nervous system. *Brain Res* **979**: 65-70.

Munoz-Fernandez MA, & Fresno M, 1998. The role of tumour necrosis factor, interleukin 6, interferon-gamma and inducible nitric oxide synthase in the development and pathology of the nervous system. *Prog Neurobiol* **56**: 307-340.

Nakano H, Sakon S, Koseki H, Takemori T, Tada K, Matsumoto M, Munechika E, Sakai T, Shirasawa T, Akiba H, Kobata T, Santee SM, Ware CF, Rennert PD, Taniguchi M, Yagita H, & Okumura K, 1999. Targeted destruction of TRAF5 gene causes defects in CD40- and CD27-mediated lymphocyte activation. *Proc Natl Acad Sci USA* **96**: 9803-9808.

Natoli G, Costanzo A, Ianni A, Templeton DJ, Woodgett JR, Balsano C, & Levrero M, 1997. Activation of SAPK/JNK by TNF receptor 1 through a noncytotoxic TRAF2-dependent pathway. *Science*. **275**:200–203.

Nickols JC, Valentine W, Kanwal S, & Carter BD, 2003. Activation of the transcription factor NF-KappaB in Schwann cells is required for peripheral myelin formation. *Nature Neuroscience* **6**: 161-167.

Nolte J, 1999. Spinal Cord. In *The Human Brain*, Fourth Edition. Mosby Inc, 1999: 215-253.

O'Keeffe GW, Gutierrez H, Pandolfi PP, Riccardi C, & Davies AM 2008. NGF-promoted axon growth and target innervation requires GIRTL-GITR signalling. *Nature Neuroscience* **11**: 135-142.

O'Neill LA, & Kaltschmidt C, 1997. NF- κ B: a crucial transcription factor for glial and neuronal cell function. *Trends in Neuroscience* **20**: 252-258.

Oppenheim RW, 1996. Neurotrophic survival molecules for motoneurons: an embarrassment of riches. *Neuron* **17**: 195-7.

Orike N, Middleton G, Borthwick E, Buchman V, Cowen T, & Davies AM, 2001. Role of PI 3-kinase, Akt and Bcl-2-related proteins in sustaining the survival of neurotrophic factor-independent adult sympathetic neurons. *Journal of Cell Biology* **154**: 995-1005.

Pahl HL, 1999. Activators and target genes of Rel/NFkappaB transcription factors. *Oncogene* **18**: 6853-6866.

Patapoutian & Reichardt, 2003. Trk receptors: Mediators of neurotrophin action. *Curr Op Neurobiol* **11**: 272-280.

Patel TD, 2000. Development of sensory neurons in the absence of NGF/TrkA signalling. *Neuron* **25**: 345-357.

Paves H, & Saarma M, 1997. Neurotrophins as in vitro growth cone guidance molecules for embryonic sensory neurons. *Cell Tissue Res* **290**: 285-297.

Pearson G, Robinson F, Beers Gibson T, Xu BE, Karandikar M, Berman K, & Cobb MH, 2001. Mitogen-Activated Protein (MAP) Kinase Pathways: Regulation and Physiological Functions. *Endocrine Reviews* **22**: 153-183.

Perron JC, & Bixby JL, 1999. Distinct Neurite Outgrowth Signalling Pathways Converge on ERK Activation. *Molecular & Cellular Neuroscience* **13**: 362-378.

Pettman B, & Henderson CE, 1998. Neuronal Cell Death. *Neuron* **20**: 633-647.

- Philpott KL, McCarthy MJ, Klippel A, & Rubin LL, 1997. Activated Phosphatidylinositol 3-kinase and Akt Kinase Promote Survival of Superior Cervical Neurons. *Journal of Cell Biology* **139**: 809-815.
- Rabizadeh S, Oh J, Zhong LT, Yang J, Bitler CM, Butcher LL, & Bredesen DE, 1993. Induction of apoptosis by the low-affinity NGF receptor. *Science* **261**: 345-348.
- Radeke MJ, Misko TP, Hsu C, Herzenberg LA, & Shooter EM, 1987. Gene transfer and molecular cloning of the rat nerve growth factor receptor. *Nature* **325**: 593-597.
- Ramakrishnan P, Wang W, & Wallach D, 2004. Receptor-specific signalling for both the alternative and the canonical NF- κ B activation pathways by NF- κ B-inducing kinase. *Immunity* **21**: 477-489.
- Reed JC, 2008. Bcl-2-family proteins and hematologic malignancies: history and future prospects. *Blood* **111**: 3322-3330.
- Regnier CH, Song HY, Gao X, Goeddel DV, Cao Z, & Rothe M, 1997. Identification and characterisation of an I κ B kinase. *Cell* **90**: 373-383.
- Reichardt LF, 2006. Neurotrophin-regulated signalling pathways. *Phil Trans R Soc B* **361**: 1545-1564.
- Reinhard C, Shamon B, Shyamala V, & Williams LT, 1997. Tumor Necrosis Factor α -induced activation of c-jun N-terminal Kinase is mediated by TRAF2. *The EMBO Journal* **16**: 1080-1092.
- Rodgers EE, & Theibert AB, 2002. Functions of PI3-kinase in development of the nervous system. *Int J Devl Neuroscience* **20**: 187-197.
- Rothe, Wong SC, Henzel WJ, & Goeddel DV, 1994. A novel family of putative signal transducers associated with the cytoplasmic domain of the 75 kDa tumor necrosis factor receptor. *Cell* **78**: 681-692.
- Rothe, M, Sarma V, Dixit VM, & Goeddel DV, 1995. TRAF2-mediated activation of NF- κ B by TNF receptor 2 and CD40. *Science*. **269**:1424–1427.
- Samuels IS, Saitta SC, & Landreth GE, 2009. MAP'ing CNS development and cognition: An ERKsome process. *Neuron* **61**: 160-167.
- Sanes JR, & Jessell TM, 2000. The guidance of axons to their targets. In *Principles of Neural Science*. Edited by Kandel ER, Schwartz, Jessell TM. New York Elsevier; 2000: 1063-1086.

Sasai Y, Lu B, Steinbeisser H, Geissert D, Gont LK, & De Robertis EM, 1994. *Xenopus* chordin: a novel dorsalizing factor activated by organizer-specific homeobox genes. *Cell* **79**: 779-790.

Selleck MA, & Bronner-Fraser M, 1995. Origins of the avian neural crest: the role of neural plate-epidermal interactions. *Development* **121**: 525-538.

Senftleben U, Cao Y, Xiao G, Greten FR, Krähn G, Bonizzi G, Chen Y, Hu Y, Fong A, Sun SC, & Karin M, 2001. Activation by IKK α of a second, evolutionary conserved, NF- κ B signalling pathway. *Science* **293**: 1495-1459.

Shaul YD & Seger R, 2007. The MEK/ERK cascade: From signalling specificity to diverse functions. *Biochimica et Biophysica Acta* **1773**: 1213-1226.

Sholl DA, 1953. Dendritic organization in the neurons of the visual and motor cortices of the cat. *J Anat* **87**: 387-406.

Shooter EM, 2001. Early days of the nerve growth factor proteins. *Annu Rev Neurosci* **24**: 601-629.

Siegel SG, Patton B, & English AW, 2000. Ciliary neurotrophic factor is required for motoneuron sprouting. *Exp Neurol* **166**: 205-212.

Simonet WS, Lacey DL, Dunstan CR, Kelley M, Chang MS, Lüthy R, Nguyen HQ, Wooden S, Bennett L, Boone T, Shimamoto G, DeRose M, Elliott R, Colombero A, Tan HL, Trail G, Sullivan J, Davy E, Bucay N, Renshaw-Gegg L, Hughes TM, Hill D, Pattison W, Campbell P, Sander S, Van G, Tarpley J, Derby P, Lee R, & Boyle WJ, 1997. Osteoprotegerin: A Novel Secreted Protein Involved in the Regulation of Bone Density. *Cell* **89**: 309-319.

Smeyne RJ, Klein R, Schnapp A, Long LK, Bryant S, Lewin A, Lira SA, & Barbacid M, 1994. Severe sensory and sympathetic neuropathies in mice carrying a disrupted Trk/NGF receptor gene. *Nature* **368**: 246-249.

Song HY, Régnier CH, Kirschning CJ, Goeddel DV, & Rothe M, 1997. Tumor necrosis factor (TNF)-mediated kinase cascades: Bifurcation of Nuclear Factor- κ B and c-Jun N-terminal kinase (JNK/SAPK) pathways at TNF receptor-associated factor 2. *Proc. Natl. Acad. Sci. USA* **94**: 9792-9796.

Stahl N, & Yancopoulos GD, 1994. The tripartite CNTF receptor complex: activation and signalling involves components shared with other cytokines. *J Neurobiol* **25**: 1454-1466.

Taga T, & Kishimoto T, 1992. Cytokine receptors and signal transduction. *Feseb Journal* **6**: 3397-3396.

Tapia-Arancibia L, Rage F, Givalois L, & Arancibia S, 2004. Physiology of BDNF: focus on hypothalamic function. *Front Neuroendocrinol* **25**: 77-107.

Teng HK, Teng KK, Lee R, Wright S, Tevar S, Almeida RD, Kermani P, Torkin R, Chen ZY, Lee FS, Kraemer RT, Nykjaer A, Hempstead BL, 2005. ProBDNF induces neuronal apoptosis via activation of a receptor complex of p75NTR and sortilin. *J Neurosci* **25**: 5455-5463.

Thoenen H, 2000. Neurotrophins and activity-dependent plasticity. *Prog Brain Res* **128**: 183-191.

Thompson J, Dolcet X, Hilton M, Tolcos M, & Davies AM, 2004. HGF promotes survival and growth of maturing sympathetic neurons by PI-3 kinase- and MAP kinase-dependent mechanisms. *Mol Cell Neurosci* **27**: 441-452.

Tsuda E, Goto M, Mochizuki S, Yano K, Kobayashi F, Morinaga T, & Higashio K, 1997. Isolation of a Novel Cytokine from Human Fibroblasts That Specifically Inhibits Osteoclastogenesis. *Biochemical & Biophysical Research Communications* **234**: 137-142.

Tsui-Pierchala BA, Putchala GV & Johnson Jr EM, 2000. Phosphatidylinositol 3-kinase is required for the trophic, but not the survival-promoting, actions of NGF on sympathetic neurons. *Journal of Neuroscience* **20**: 7228-7237.

Tucker KL, Meyer M, & Barde YA, 2001. Neurotrophins are required for nerve growth during development. *Nat Neurosci* **4**: 29-37.

Vaillant AR, Mazzoni I, Tudan C, Boudreau M, Kaplan DR, & Miller FD, 1999. Depolarisation and neurotrophins converge on the phosphatidylinositol 3-kinase-Akt pathway to synergistically regulate neuronal survival. *Journal of Cell Biology* **146**: 955-966.

Veeranna, Amin ND, Ahn NG, Jaffe H, Winters CA, Grant P, & Pant HC, 1998. Mitogen-Activated Protein Kinases (ERK1/2) Phosphorylate Ly-Ser-Pro (KSP) Repeats in Neurofilament Proteins NF-H and NF-M. *Journal of Neuroscience* **18**: 4008-4021.

Vogel KS, & Davies AM, 1991. The duration of neurotrophic factor dependence in early sensory neurons is matched to the time course of target field innervation. *Neuron* **7**: 819-830.

Wada T, Nakashima T, Hiroshi N, & Penninger JM, 2006. RANK-RANKL signalling in osteoclastogenesis and bone disease. *TRENDS in Molecular Medicine* **12**: 17-25.

Weinstein DC, & Hemmati-Brivanlou A, 1999. Neural Induction. *Annu Rev Cell Dev Biol* **15**: 411-433.

Whitman M, & Kaplan D, Roberts T, & Cantley L, 1988. Type I phosphatidylinositol kinase makes a novel inositol phospholipid, phosphatidylinositol-3-phosphate. *Nature* **332**: 644-646.

Wong BR, Rho J, Arron J, Robinson E, Orlinick J, Chao M, Kalachikov S, Cayani E, Bartlett FS 3rd, Frankel WN, Lee SY, & Choi Y, 1997. TRANCE is a Novel Ligand of the Tumour Necrosis Factor Receptor Family that Activates c-Jun N-terminal Kinase in T Cells. *Journal of Biological Chemistry* **272**: 25190-25194.

Wong BR, Josien R, Lee SY, Sauter B, Li HL, Steinman RM, & Choi Y, 1997a. TRANCE (Tumor Necrosis Factor [TNF]-related Activation-induced Cytokine), a New TNF Family Member Predominantly Expressed in T cells, Is a Dendritic Cell-specific Survival Factor. *Journal of Experimental Medicine* **186**: 2075-2080.

Wong BR, Josien R, Lee SY, Vologodskaja M, Steinman RM, & Choi Y, 1998. The TRAF family of signal transducers mediates NF-kappaB activation by the TRANCE receptor. *J Biol Chem* **273**: 28355-28359.

Wong BR, Besser D, Kim N, Arron JR, Vologodskaja M, Hanafusa H, & Choi Y, 1999. TRANCE, a TNF Family Member, Activates Akt/PKB through a signalling complex involving TRAF6 and c-Src. *Molecular Cell* **4**: 1041-1049.

Wong BR, Josien R & Choi Y, 1999a. TRANCE is a TNF family member that regulates dendritic cell and osteoclast function. *J Leukoc Biol* **65**: 715-724.

Woronicz JD, Gao X, Cao Z, Rothe M, & Goeddel DV, 1997. IKappaB kinase-beta: NF-kappaB activation and complex formation with IKappaB kinase-alpha and NIK. *Science* **278**: 866-869.

Wyatt S, & Davies AM, 1993. Reevaluation of expression of mRNAs encoding the nerve growth factor receptors p75 and trkA in developing sensory neurons. *Development* **119**: 635-647.

Wyatt S, & Davies AM, 1995. Regulation of nerve growth factor receptor gene expression in sympathetic neurons during development. *Journal of cell Biology* **130**: 1435-1446.

Wyatt S, Piñon LG, Ernfors P, & Davies AM, 1997. Sympathetic neuron survival and TrkA expression in NT3-deficient mouse embryos. *The EMBO Journal* **16**: 3115-3123.

Xiao G, Rabson AB, Young W, Qing G, & Qu Z, 2006. Alternative pathways of NF-kappaB activation: a double-edged sword in health and disease. *Cytokine Growth Factor Rev* **17**: 281-293.

Yao R, & Cooper GM, 1995. Requirement for Phosphatidylinositol-3 kinase in the prevention of Apoptosis by Nerve Growth Factor. *Science* **267**: 2003-2006.

Yasuda H, Shima N, Nakagawa N, Mochizuki SI, Yano K, Fujise N, Sato Y, Goto M, Yamaguchi K, Kuriyama M, Kanno T, Murakami A, Tsuda E, Morinaga T, & Higashio K, 1998. Identity of osteoclastogenesis inhibitory factor (OCIF) and osteoprotegerin (OPG): A mechanism by which OPG/OCIF inhibits osteoclastogenesis in vitro. *Endocrinology* 1998 **139**: 1329–1337.

Yasuda H, Shima N, Nakagawa N, Yamaguchi K, Kinosaki M, Mochizuki S, Tomoyasu A, Yano K, Goto M, Murakami A, Tsuda E, Morinaga T, Higashio K, Udagawa N, Takahashi N, & Suda T, 1998a. Osteoclast differentiation factor is a ligand for osteoprotegerin/osteoclastogenesis-inhibitory factor and is identical to TRANCE/RANKL. *Proc Natl Acad Sci USA* **95**:3597–3602.

Yip HK, Rich KM, Lampe PA, & Johnson EM Jr, 1984. The effects of nerve growth factor and its antiserum on the postnatal development and survival after injury of sensory neurons in rat dorsal root ganglia. *J Neurosci* **4**: 2986-2992.

Yuan & Yankner, 2000. Apoptosis in the nervous system. *Nature* **407**: 802-809.

Yeh WC, Shahinian A, Speiser D, Kraunus J, Billia F, Wakeham A, de la Pompa JL, Ferrick D, Hum B, Iscove N, Ohashi P, Rothe M, Goeddel DV, & Mak TW, 1997. Early lethality, functional NF- κ B activation and increased sensitivity to TNF-Induced cell death in TRAF2-deficient mice. *Immunity* **7**: 715-725.

Youle RJ, & Strasser A, 2008. The BCL-2 protein family: opposing activities that mediate cell death. *Nat Rev Mol Cell Biol* **9**: 47-59.

Yun TJ, Tallquist MD, Aicher A, Rafferty KL, Marshall AJ, Moon JJ, Ewings ME, Mohaupt M, Herring SW, & Clark EA, 2001. Osteoprotegerin, a Crucial Regulator of Bone Metabolism, Also Regulates B Cell Development and Function. *Journal of Immunology* **166**: 1482-1491.

Zarnegar B, Yamazaki S, He JQ, & Cheng G, 2008. Control of canonical NF- κ B activation through the NIK-IKK complex pathway. *PNAS* **105**: 3503-3508.

Zehnder AF, Kristiansen AG, Adams JC, Kujawa SG, Merchant SN, & McKenna MJ, 2006. Osteoprotegerin knockout mice demonstrate abnormal remodeling of the otic capsule and progressive hearing loss. *The Laryngoscope* **116**: 201-206.

Zhou FQ, & Snider WD, 2006. Intracellular control of developmental and regenerative axon growth. *Phil Trans R Soc Lond* **361**: 1575-1592.