

Mathieu Beaupré

**CHARACTERIZATION OF ON-LINE SENSORS  
FOR WATER QUALITY MONITORING AND  
PROCESS CONTROL**

(Caractérisation des capteurs en ligne dans le domaine  
de la qualité de l'eau et du contrôle de procédé)

Mémoire présenté  
à la Faculté des études supérieures de l'Université Laval  
dans le cadre du programme de maîtrise en génie civil  
pour l'obtention du grade de maître ès sciences (M.Sc.)

Département de génie civil et génie des eaux  
FACULTÉ DES SCIENCES ET GÉNIE  
UNIVERSITÉ LAVAL  
QUÉBEC

2010





## **ABSTRACT**

New technologies and computers combined with increasing issues related to water quality made water quality monitoring literally explode during the last decades. Monitoring consists in observing something and keeping a record of it. It is commonly achieved with sensors. They can generate a lot of data with a measuring frequency that can be higher than one measurement per second. However, the quality of those data needs to be known before use.

What are the tools available to characterise sensors? What do they provide? And is the information coming out sufficient? Some protocols to evaluate the performance of sensors have been published. The ISO 15938:2003 protocol, Water quality – On-line sensors/analysing equipment for water – Specifications and performance tests, is the more important publication on evaluating sensor performance so far. It helps to evaluate the performance in the laboratory. However, are the results of applying such protocol helping end-users to select the right sensor for their application? To answer this question, the first step was to make a review on the sensor technologies available on the market. The following components were focused on: nitrate, nitrite, ammonium, phosphore, dissolved oxygen and turbidity. The review showed that manufacturers do not provide or provide really only a few numbers required by the ISO 15839:2003 protocol. Secondly, after the sensors review, a review of the ISO 15839:2003 protocol has been made to figure out why the ISO characteristics are not provided by manufacturers and to see whether the results of this protocol are suitable to select the right sensors for the end-user specific application.

The information resulting from the ISO testing and the way they are presented do not allow the end-users to select the right sensors for their application. The protocol should be more end-user oriented rather than being manufacturer oriented. It should include a more graphical display of the results, similar to the accuracy profile (Hubert et al., 2004) does and should include guidelines to interpret results. Applying the ISO protocol provides performance of sensors under laboratory conditions, but there is also a part concerning field testing. However, the results are time and site specific, which does not allow to compare



results obtained with different sensors. The need to develop a test under standardised field conditions was identified. Two interferences met in field conditions have been reproduced in the laboratory: turbidity and air bubbles (found in aeration tanks in wastewater treatment plants (WWTPs)). The results show that both an increase in the noise level and an offset are generated. By quantifying the noise and the offset, sensors can be compared and for end-users it is then easier to select the sensor suitable for their application.





## RÉSUMÉ

L'arrivée des nouvelles technologies et des ordinateurs en plus des problématiques grandissantes reliées à la qualité de l'eau ont fait que le monitoring dans le domaine de la qualité de l'eau a littéralement explosé au cours des dernières décennies. Le monitoring consiste à effectuer le suivi d'un système et de faire la conservation des données récoltées. Il est habituellement réalisé à l'aide de capteurs. Ces derniers peuvent générer une importante quantité de données. Dans certains cas, la fréquence d'échantillonnage peut atteindre plusieurs mesures à la seconde. Nonobstant la quantité de données recueillies, il faut en connaître la qualité afin de les utiliser.

Quels sont les outils disponibles pour caractériser les capteurs? Quelles informations fournissent-ils? Est-ce que ces dernières sont suffisantes? Certains protocoles pour évaluer la performance des capteurs sont disponibles. Le protocole ISO 15839:2003, Qualité de l'eau - Matériel d'analyse/capteurs directs pour l'eau - Spécifications et essais de performance, est le plus complet à ce jour. Il permet d'évaluer la performance des capteurs sous des conditions de laboratoire. Néanmoins, est-ce que de soumettre les capteurs à ce protocole permet aux usagers de choisir le capteur le plus approprié? Afin de répondre à cette question, la première étape de l'étude consistait à passer en revue les capteurs selon les technologies disponibles sur le marché. L'accent fut mis sur les substances suivantes : nitrate, nitrite, ammonium, phosphore, oxygène dissout et la turbidité. La revue a révélé que les fabricants ne fournissent pas ou très peu de spécifications découlant du protocole ISO 15839:2003. La deuxième étape fut de procéder à une revue critique du protocole ISO 15839:2003 afin de faire ressortir les raisons pour lesquelles les fabricants n'en fournissent pas les spécifications et de vérifier si ces dernières sont adéquates pour choisir le bon capteur pour une application précise.

Les spécifications résultant de l'application du protocole ISO 15839:2003 et la façon dont elles sont présentées ne permettent pas aux usagers de choisir le capteur le plus approprié pour leur application. Le protocole devrait davantage être orienté sur les besoins des usagers plutôt que sur ceux des fabricants. À l'instar des profils d'exactitudes



(Hubert et al., 2004), le protocole ISO 15839:2003 devrait chercher davantage à présenter les résultats sous forme graphique. Le protocole ISO 15839:2003 procure les spécifications des capteurs sous des conditions de laboratoire, mais il contient aussi une section traitant des spécifications sous des conditions de terrain (field conditions). Toutefois, les résultats sont subordonnés au temps et à l'emplacement où les tests sont effectués, ce qui rend impossible la comparaison des résultats provenant de différents capteurs. La revue de littérature a démontré la nécessité de développer un protocole de tests se faisant sous des conditions de terrain reproduites de façon standard. Deux interférences rencontrées sur le terrain furent reproduites en laboratoire : la turbidité ainsi que les bulles d'air retrouvées dans les bassins d'aération des usines de traitement des eaux usées. Les résultats ont démontré que ces deux interférences amplifient le bruit de mesure et génèrent un biais. En quantifiant le bruit de mesure et le biais les capteurs peuvent être comparés, ce qui permet aux usagers de sélectionner le capteur le plus approprié.





## AVANT-PROPOS

This project has been realised at Université Laval. Some experiment were conducted at Endress+Hauser Conducta in Gerlingen (Germany) and at EAWAG (Swiss Federal Institute of Aquatic Science and Technology) in Dübendorf (Switzerland).

I would like to thank my thesis director, Peter A. Vanrolleghem, first to welcome me in his research group and finance my research. Secondly for his trust by sending me to some conferences and in an overseas trip to perform research and, at the same time, represent the modelEAU group.

I would also like to thank Leiv Rieger, my thesis supervisor for his precious advice and his availability during my studies. I would like to thank him as well for the whole setup of my trip to Europe in 2007.

I would like to thank the collaborators of Endress+Hauser Conducta for their help during my stay in their company. I would like to thank in particular M. Bernd Marx to have helped me when I arrived and to have arranged my stay in Gerlingen.

I would like to also thank the people of EAWAG, in particular Dr. Hansruedi Siegrist, Mme Karin Rottermann and M. David Kaelin for their help and availability during my stay.

I would like to thank all members of modelEAU, I had great times with them as much at work as outside of the office. Moreover, they are very capable people and the agglomeration of their knowledge helped me to view my work from different perspectives.

J'aimerais remercier Mme. Marie-Claude Boudreault et Mme. Karen Lévesque-Cahill, toutes deux membres de modelEAU, pour leur aide dans la prise de données en laboratoire et leur recherche d'information.

J'aimerais remercier plus particulièrement M. Frédéric Cloutier, aussi membre de modelEAU, avec qui j'ai fait tout mon parcours universitaire et sans qui certaines journées au bureau auraient été plus longues.



J'aimerais aussi remercier feu la communauté du 104 St-Olivier, dorénavant connue sous le nom de la communauté du 100 St-Olivier. Les nombreuses soirées et discussions, les nombreux soupers et autres exutoires ont été appréciés au plus au point et, espérons-le, continuerons à opérer dans le futur.

J'aimerais remercier en particulier M. Dave Bussières, membre de la susdite communauté et ami depuis presque toujours. Étant lui aussi étudiant au deuxième cycle et ayant lui aussi éprouvé certaines difficultés au cours de ses études, il a su, tantôt par l'exemple, tantôt par le contre-exemple, mais surtout par l'émulation, m'indiquer la marche à suivre pour mener mes études à bon port.

Finalement, j'aimerais remercier mes parents pour leur soutien, leur compréhension et leur encouragement tout au long de mes études. Ils ont su voir mon potentiel et m'ont poussé à l'exploiter, non seulement dans mes études, mais dans tout ce que j'ai pu entreprendre. Je n'aurais jamais fait toutes ses études sans vous. Merci!



“On fait la science avec des faits, comme on  
fait une maison avec des pierres: mais une  
accumulation de faits n'est pas plus une  
science qu'un tas de pierres  
n'est une maison.”

Jules Henri Poincaré

“À l'échelle cosmique, l'eau est plus rare que l'or”

(Hubert Reeves)

“Oh, people can come with statistics to prove  
anything. 14% of people know that”

(Homer J. Simpson)

“Bart, don't make fun of grad students. They've  
just made a terrible life choice.”

(Marge Simpson)





# CONTENTS

<b>ABSTRACT</b> .....	i
<b>RÉSUMÉ</b> .....	v
<b>AVANT-PROPOS</b> .....	ix
<b>CONTENTS</b> .....	xv
<b>TABLE LIST</b> .....	xxi
<b>FIGURE LIST</b> .....	xxiii
<b>CHAPTER I GENERAL INTRODUCTION</b> .....	1
<b>1.1 Problem statement</b> .....	3
<b>1.2 Structure of the work done</b> .....	3
<b>1.3 Goals of this study</b> .....	5
<b>1.4 Thesis Outline</b> .....	5
<b>CHAPTER II REVIEW OF ON-LINE WATER QUALITY SENSORS</b> .....	7
<b>2.1 Review of on-line water quality sensors</b> .....	9
<b>2.2 Measuring principles</b> .....	9
2.2.1 Gas sensitive electrode.....	10
2.2.2 Ion sensitive electrode.....	10
2.2.3 Colorimetry.....	11
2.2.4 UV-absorbance.....	11
2.2.5 Light absorbance and scattering.....	12
2.2.6 Ultrasound.....	13
2.2.7 Dielectric probe.....	14
2.2.8 Electrochemistry.....	14
2.2.9 Luminescence.....	14
<b>2.3 Classification of information</b> .....	15
2.3.1 Technical information.....	16
2.3.2 Accuracy.....	17
2.3.2.1 Prior definitions.....	17
2.3.2.2 Sensor characteristics definitions.....	18
2.3.3 Cost.....	24
<b>2.4 Conclusion</b> .....	25
<b>CHAPTER III REVIEW OF SENSOR EVALUATION PROTOCOLS</b> .....	27
<b>3.1 Literature review introduction</b> .....	29
<b>3.2 Laboratory conditions</b> .....	32
3.2.1 ISO 15839:2003.....	32
3.2.2 Accuracy profile.....	34





3.3	<b>Field conditions</b> .....	37
3.4	<b>Conclusions</b> .....	39
<b>CHAPTER IV MATERIALS AND METHODS</b> .....		41
4.1	<b>Sensors tested</b> .....	43
4.1.1	Spectro::lyser <sup>tm</sup> from s::can.....	43
4.1.2	Sensor A.....	43
4.1.3	Nitratax from Hach.....	44
4.1.4	Sensor B-8mm and B-2mm.....	44
4.1.5	Sensor C.....	45
4.1.6	Solitax from Hach.....	45
4.2	<b>ISO 15839:2003 – Laboratory testing</b> .....	45
4.3	<b>Standardised field conditions protocol</b> .....	45
4.3.1	Air bubbles.....	46
4.3.1.1	Experimental Setup.....	46
4.3.1.2	Experimental Procedure.....	46
4.3.2	Turbidity.....	48
4.3.2.1	Experimental Setup.....	48
4.3.2.2	Standard.....	49
4.3.2.3	Experimental Procedure.....	51
4.4	<b>Data processing</b> .....	51
4.4.1	Turbidity standards.....	51
4.4.2	Air bubbles and turbidity effects.....	52
4.5	<b>Reference measurements</b> .....	52
4.5.1	Nitrate.....	52
4.5.2	Turbidity.....	52
<b>CHAPTER V RESULTS AND DISCUSSION</b> .....		53
5.1	<b>ISO 15839:2003 review</b> .....	55
5.1.1	Limit of detection and quantification, repeatability, lowest detectable change and day-to-day repeatability.....	56
5.1.2	Coefficient of variation.....	59
5.1.3	Bias.....	60
5.1.4	Short term drift.....	62
5.1.5	Conclusion.....	64
5.2	<b>Standardised field conditions</b> .....	65
5.2.1	Air bubbles.....	65
5.2.2	Turbidity.....	71
5.2.2.1	Formazine.....	71
5.2.2.2	AMCO Clear®.....	72
5.2.2.3	Effects of turbidity on nitrate measurements.....	75
5.2.3	Conclusion.....	76



<b>CHAPTER VI CONCLUSION .....</b>	<b>79</b>
<b>6.1 Study summary .....</b>	<b>81</b>
6.1.1 Protocol and sensors review .....	81
6.1.2 Standardized field conditions .....	82
<b>6.2 Further work .....</b>	<b>83</b>
<b>REFERENCES.....</b>	<b>85</b>
<b>ANNEX A SENSORS REVIEW TABLES – NITRATE .....</b>	<b>91</b>
<b>ANNEX B SENSORS REVIEW TABLES – NITRITE .....</b>	<b>97</b>
<b>ANNEX C SENSORS REVIEW TABLES - AMMONIUM .....</b>	<b>101</b>
<b>ANNEX D SENSORS REVIEW TABLES – PHOSPHATE.....</b>	<b>107</b>
<b>ANNEX E SENSORS REVIEW TABLES – TURIDITY.....</b>	<b>111</b>
<b>ANNEX F SENSORS REVIEW TABLES – DISLOVED OXYGEN.....</b>	<b>115</b>
<b>ANNEX G RAW DATA – ISO 15839:2003 TESTS.....</b>	<b>119</b>
<b>ANNEX H RAW DATA – AIR BUBBLES TESTS.....</b>	<b>123</b>
<b>ANNEX I RAW DATA – TURBIDITY TESTS .....</b>	<b>157</b>





## TABLE LIST

Table 1: Template of the table for sensor classification .....	16
Table 2: Costs of sensors.....	24
Table 3: Use of measurements and constraints on scheduling (source: ISO, 2003).....	33
Table 4: Life time of formazin solutions (source: Campbell Scientific, 2006).....	50
Table 5: Characteristics of nitrate sensors according the ISO 15839:2003 protocol.....	55
Table 6: Mean and standard deviation for each pressure applied to the Spectro::lyser <sup>tm</sup> for a solution at 0 mg NO <sub>3</sub> -N/L.....	66
Table 7: Mean and standard deviation for each pressure pressure applied to the Spectro::lyser <sup>tm</sup> for a solution at 3 mg NO <sub>3</sub> -N/L.....	68
Table 8: Mean and standard deviation for each pressure applied to the Nitratax for a solution at 10 mg NO <sub>3</sub> -N/L.....	69
Table 9: Mean and standard deviation for each pressure applied to the Solitax for a solution at 0 FNU .....	70
Table 10: Mean and standard deviation for each turbidity (0 and 10 FNU) with the Spectro::lyser <sup>tm</sup> for a solution at 3 mg NO <sub>3</sub> -N/L.....	76



## FIGURE LIST

Figure 1: Approach used to develop a testing protocol for sensors in water quality management.....	4
Figure 2: UV spectra and components absorption (Wedgewood Analatical, 2006) .....	12
Figure 3: Optical effect of a suspended particle (source: Vanrolleghem and Lee, 2003)...	13
Figure 4: Luminescence dissolved oxygen probe (source : Hach, 2005) .....	15
Figure 5: Repeatability vs accuracy.....	19
Figure 6: Typical sensor signal of an abrupt concentration change (source: ISO, 2003)....	20
Figure 7: Number of papers per year matching the keywords monitoring + water on the Engineering village web site .....	30
Figure 8: Accuracy profile (Hauduc, 2007) .....	36
Figure 9: Tank equipped with diaphragm aerator at 0 bar (above) and 1.5 bar (bottom)....	47
Figure 10: Offline measuring cell for Spectro::lyser™ .....	48
Figure 11: Scanning electron microscope (SEM) image of formazin (left) and AMCO Clear® (right) (source: Campbell Scientific, 2006) .....	50
Figure 12: Comparison of limit of detection and quantification .....	56
Figure 13: Comparison of repeatability .....	57
Figure 14: Comparison of lowest detectable change .....	58
Figure 15: Comparison of day-to-day repeatability.....	58
Figure 16: Comparison of coefficient of variation .....	59
Figure 17: Sensitivity study on the parameters of the coefficient of variation of the equation (6).....	61
Figure 18: Comparison of bias .....	62
Figure 19: Comparison of short term drift .....	63
Figure 20: Measurement vs time for Nitratax .....	63





Figure 21: Nitrate concentration vs time for different air pressures applied to the Spectro::lyser™ for a solution at 0 mg NO<sub>3</sub>-N/L..... 66

Figure 22: Nitrate concentration vs time for different air pressures applied to the Spectro::lyser™ for a solution at 3 mg NO<sub>3</sub>-N/L..... 67

Figure 23: Nitrate concentration vs time for different air pressures applied to the Nitratax for a solution at approximately 10 mg NO<sub>3</sub>-N/L..... 69

Figure 24: Turbidity vs time for different air pressures applied to the Solitax for a solution at 0 FNU ..... 70

Figure 25: Formazin stability (with and without mixing) for a concentration of 50 FNU .. 72

Figure 26: Formazin stability (with and without mixing) for a concentration of 10 FNU .. 72

Figure 27: AMCO Clear® stability (with and without mixing) for a concentration of 50 FNU (non-diluted)..... 73

Figure 28: AMCO Clear® stability (with and without mixing) for a concentration of 50 FNU (diluted) ..... 74

Figure 29: AMCO Clear® stability (with and without mixing) for a concentration of 10 FNU (diluted) ..... 74

Figure 30: Effects of turbidity on nitrate measurements with the Spectro::lyser™ (3 mg/L NO<sub>3</sub>-N and 10 FNU) ..... 76



## **CHAPTER I**

### **GENERAL INTRODUCTION**



## 1.1 Problem statement

The number of sensors on the market in water quality is large. For each component, except for some of them, there are different measuring methods, different configurations, and different manufacturers. All those factors are responsible for the multitude of sensors available to end-users. However, how can end-users make an informed choice among the available sensors? Which tools are available to characterise sensors? Are they sufficient? How can they be improved?

## 1.2 Structure of the work done

Figure 1 shows the different parts of the work in this study and how they are linked to each other. The literature review is divided in two parts. One part concerns a review of existing protocols to evaluate performance of in-line<sup>1</sup> and on-line<sup>2</sup> measuring equipments in the water quality field. The focus has been on protocols which provide standardized conditions. The term “standard conditions” is important for this study: it means that conditions are reproducible and the test can be repeated so that the same results can be expected whenever the test is conducted. The main publication found is the ISO 15839:2003 protocol: Water quality – On-line sensors/analysing equipment for water – Specifications and performances tests. A critical review of this protocol has been made to see which information it provides and if it is suitable to select the right sensors. The other part of the literature review concerns the sensors themselves. A review has been made to evaluate which sensors and measuring equipment are available for the following compounds: nitrite, nitrate, ammonium, phosphate, turbidity and dissolved oxygen.

The literature review showed that there was no protocol to evaluate the performance of sensors under field conditions, at least not in a reproducible way. Still in Figure 1, the main development of this study can be identified as the blue square in the middle of the left column. Based on testing methods found in the literature review, a standard method has been developed to simulate field conditions. The sensors review has helped to identify the most significant interferences for different measuring principles. In this study optical nitrate

---

<sup>1</sup> An in-line sensor is directly in the process, it measures without any treatment, e.g. filtration, chemicals additions, etc.

<sup>2</sup> An on-line sensor is not directly in the process, which means that a sample is sent to the sensors for measurement.



sensors were tested and the selected interferences were turbidity and air bubbles (typically present in aerated reactors in wastewater treatment plants). The literature and sensors review and the new protocol for standardised field conditions will be integrated into a new protocol. This protocol will come with a piece of software, which is a Matlab script, that will give end-users all sensor performance data. The protocol will also include a cost calculation tool. This protocol will finally lead end-users to make the right choice for their specific applications.

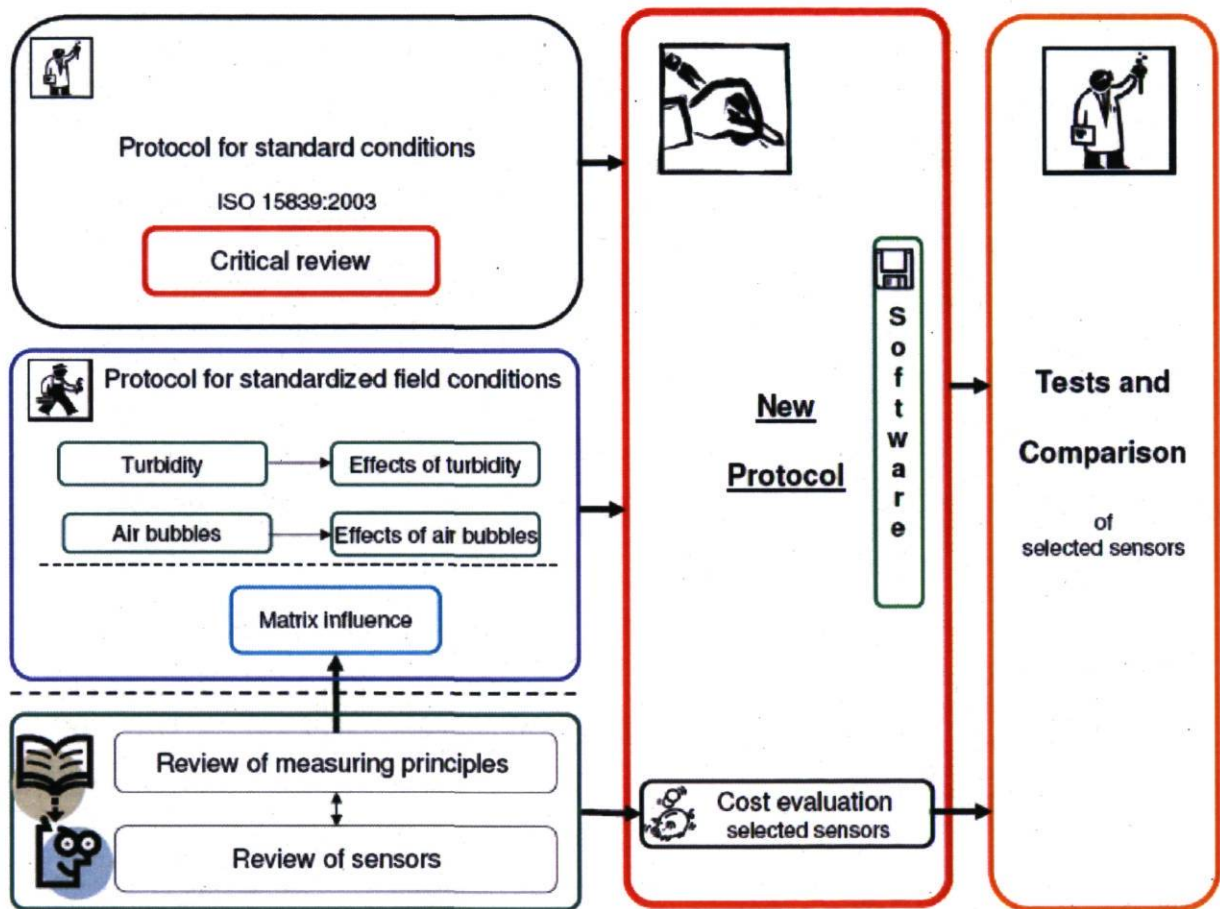

Figure 1: Approach used to develop a testing protocol for sensors in water quality management

### **1.3 Goals of this study**

The first objective of this study is to characterise sensors according to available protocols to evaluate the performance of on-line and in-line sensors in the water quality field and to determine if the results coming out of those tests are meaningful and useful to select the right sensor for a specific application.

The second objective is to develop a protocol in which field conditions are reproduced to mimic those under which sensors are exposed while they are measuring and evaluate the effects of the disturbances sensors are exposed to. It is important that those conditions are not time nor site specific. This new protocol will be appended to existing protocols to develop a tool that will help end-users to select the right sensors for their application.

### **1.4 Thesis Outline**

This master's thesis is divided in six chapters. The first one presents a general introduction of the topic, the context, the problem statement and the objectives of this work. The second and third chapters present the literature review with chapter two presenting a sensors review and chapter three presenting the protocol review. The fourth chapter describes the materials and methods used for this study. Chapter five presents the results obtained and their analysis and finally, chapter six provides an overview of the work done and the conclusion.





## **CHAPTER II**

### **REVIEW OF ON-LINE WATER QUALITY SENSORS**



## 2.1 Review of on-line water quality sensors

Before knowing how to evaluate, test or use sensors it is essential to know the sensors themselves, their measuring principle, the conditions for their operation, etc. Via the Google web search engine<sup>3</sup>, companies providing measuring devices for water have been identified and selected. There is a multitude of compounds that can be measured and since the aim was not to cover all of them, a selection was made. The variables most used in river water quality monitoring and in wastewater treatment plants (WWTP) have been selected, i.e. dissolved oxygen (DO), nutrients (ammonium, nitrate, nitrite, phosphate) and turbidity.

Recently, in 2005, the International Water Association (IWA) has published a book covering this topic, *Instrumentation, Control and Automation in Wastewater Systems*. This book covers sensors more widely, but one chapter is more important for the topic of this work, *Online Sensors/Analysers at Wastewater Treatment Plants*. There is a discussion about which kind of measuring methods are available to measure the most common parameters, i.e. flow, level, pressure, temperature, pH, redox potential, conductivity, DO, turbidity, sludge concentration, nutrients, total P and N, biological oxygen demand (BOD), chemical oxygen demand (COD) and total organic carbon (TOC). There is also a review of principal manufacturers of sensors/analysers. In this field the technological development is quite fast and that is why this sensors review has been made.

## 2.2 Measuring principles

The aim was to compile information collected in a way that can be easily found and that can be used to compare sensors among each other. So, one table has been made for each selected compound. In the heading of the table, one section has been made for each measuring principle. There are some descriptions of different measuring principles and a review of measuring principles has already been made (Vanrolleghem and Lee, 2003), while a synthesis of useful information has been added for this study.

---

<sup>3</sup> Keywords used were the compound desired and sensor, e.g. nitrate sensor



### 2.2.1 Gas sensitive electrode

This method is used to measure ammonium. By increasing the pH to 11, all ammonium ions ( $\text{NH}_4^+$ ) are transformed in ammonia gas ( $\text{NH}_3$ ). The gas selective electrode is equipped with a membrane which has the property to let pass the desired component, in this case ammonia. This method requires an ex-situ installation; it means that pumping is needed and in some cases a filtration unit as well. The reaction can be done in batch or in continuous mode (Wacheux et al., 1996). Typically, the response time of the whole measuring chain is 15 min (Thomsen and Nielsen, 1992). Measuring problems occurring during operation could be caused by clogging and hydroxide poisoning of the electrode (Aspegren et al., 1993), electrode drift (Patry and Takács, 1995) and gas bubble retention under the electrode tip (Andersen and Wagner, 1990).

### 2.2.2 Ion sensitive electrode

The method is based on the same principle as the gas sensitive electrode, i.e. the electrode has a membrane which lets pass the desired component. Such sensors are based on the potentiometric measurement principle (Cammann, 1979). However, in this case it is a direct measurement, i.e. the compound is directly measured and not a product of a chemical reaction. The result is a low consumption of chemicals and a short response time (Thomsen and Nielsen, 1992; Barnard and Crowther, 1993). For the time being, this principle is used for the measurement of ammonium and nitrate ( $\text{NO}_3^-$ ). This kind of sensors can be used directly in the process, river, lake, etc. It is an in-situ sensor. As for the gas sensitive electrodes, the ion sensitive electrodes (ISE) can be contaminated (Wacheux et al., 1993; Sikow and Pursiainen, 1995). ISE can also suffer from electrode drift (Wacheux et al., 1993).  $\text{HCO}_3^-$  (Sikow and Pursiainen, 1995),  $\text{Cl}^-$  (APHA, 1992), bromide (Rieger et al., 2002; Winkler et al., 2004) and iodine (Winkler et al., 2004) are interfering ions for nitrate. The nitrate electrode drift can be fixed by automatic calibration (Sin et al., 2003; Petersen et al., 2002). Amines, mercury and silver interfere in the ammonia measurement (APHA, 2005) as well as potassium and sodium (Rieger et al., 2002; Winkler et al., 2004).

### 2.2.3 Colorimetry

Usually colorimetric methods are implemented as ex-situ analyses (some models are based on the same principle but are directly immersed in the medium). A known volume is pumped through a filtering unit, and then the sample is brought in a small reactor. Chemicals are added to react with the component to measure. The reaction could be done both in batch or in a continuous flow (Wacheux et al., 1996). The reaction generates a coloured component. With an optical cell, the absorbance or transmittance is measured and this value is directly related to the component concentration. The principle is used for nutrients, i.e. phosphate ( $\text{PO}_4^{3-}$ ), nitrate, ammonium and nitrite ( $\text{NO}_2^-$ ). The reagent consumption is higher with such analysers (Thomsen and Nielsen, 1992) and the response time with batch reactors is longer than with electrodes. Also, measurements are sensitive to temperature variations (Wacheux et al., 1996) and are generally less reliable than ISE (Harremoës et al., 1993).

### 2.2.4 UV-absorbance

A lot of components present in wastewater matrix absorb UV light. UV-absorbance, as the other optical methods, has the advantage of being inexpensive, not requiring reagents or sample preparation (Vanrolleghem and Lee, 2003). The principle is known and used for more than fifty years (Dobbs et al., 1972), but in the last decade optical fibre technology development has enabled remote and multi-point measurement (MacCraith et al., 1993). This method is using a source of light in the UV spectral range from 190 nm to 720 nm. Figure 2 shows for which wavelength nitrates, chemical oxygen demand (COD)<sup>4</sup>, turbidity and spectral absorption coefficient at 254 nm ( $\text{SAC}_{254}$ ) generate absorption.  $\text{SAC}_{254}$  is an accepted standard parameter but it has limited dynamic range and usually underestimates the organic load in wastewater (STIP, 2006). The method is advantageous for its low maintenance need (Thomsen and Nielsen, 1992; Sikow and Pursiainen, 1995) and short response time, approximately 10 seconds (Wacheux et al., 1993). UV-absorbance is

---

<sup>4</sup> For nitrates and COD, the concentrations are estimated via the integration of the absorbance curve of the region where the compound absorbs light. A regression curve is made between lab analyses of samples and the selected absorbances.



suitable for environments with low concentrations<sup>5</sup> of organic compounds because a lot of them absorb UV in the same region of wavelength (Vanrolleghem and Lee, 2003).

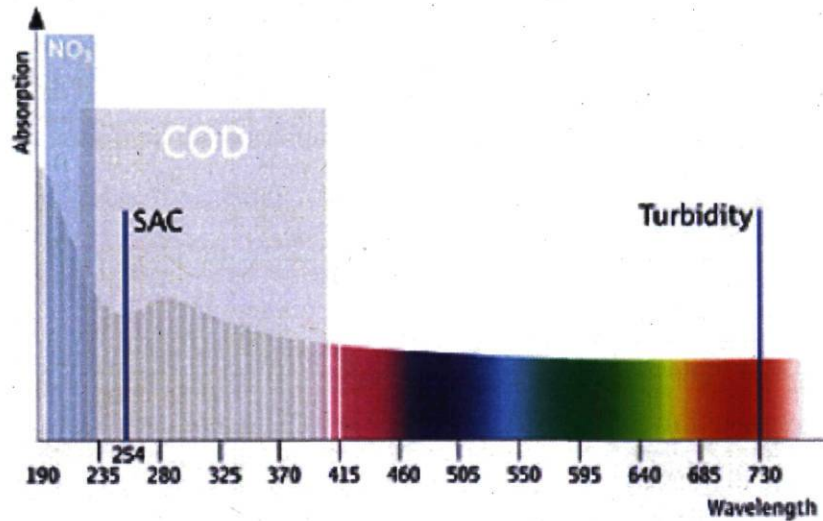
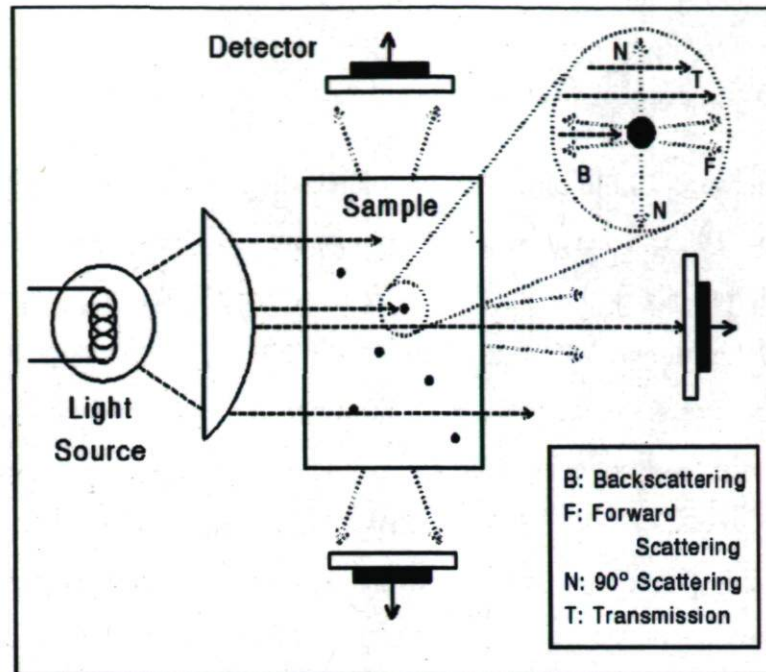

Figure 2: UV spectra and components absorption (Wedgewood Analytical, 2006)

### 2.2.5 Light absorbance and scattering

One of the most important variables measured in wastewater treatment plants is suspended solids (SS) and it is often measured by optical techniques (Vanrolleghem and Lee, 2003). Suspended solids are not directly measured, but first the turbidity is measured and then the SS concentration is calculated via a regression between turbidity and SS. Turbidity meters are frequently used because turbidity and the SS concentration are often well correlated (Gippel, 1995). Turbidity can be measured with light absorption, but also by using the scattering principle. It measures the amount of light reflected by suspended solids. There is 90° scattering, backscattering and surface scattering (without contact with the medium). The infrared light absorption principle measures the light absorbed by the suspended solids, whereas the transmitted light evaluates the non-absorbed. By measuring in the infrared wavelength range, the effect of ambient light is eliminated. The different optical effects of an illuminated particle can be seen on Figure 3.

<sup>5</sup> The concentrations depend on the source of organic compounds and the path length of the probe, so it is difficult to specify what “low” exactly stands for.



**Figure 3: Optical effect of a suspended particle**  
(source: Vanrolleghem and Lee, 2003)

The optical measurement to be preferred will depend on the expected SS concentration. For low concentrations (0-100 mg/l) scattering techniques are preferred because the signal to noise ratio is too low with transmission. Also, for very high SS concentrations, back scattering is advantageous if the absorbance is too high. If concentrations are too high, dilution can be an option (Yano et al., 1993). However, with a combination of different scattering angles, it is possible to obtain a wider measuring range (Jones et al., 1998). Air bubbles and fouling of the optics are the major sources of interference in turbidity measurement (Vanrolleghem and Lee, 2003) and in the calculation of the SS concentration from turbidity, particle sizes and other properties may change the correlation (Pfannkuche and Schmidt, 2003).

### 2.2.6 Ultrasound

An ultrasonic sensor provides another way to measure SS. The concentration is determined from the difference between the velocity of ultrasonic sound in the medium with and without SS (Blake-Coleman et al., 1986; Zips and Faust, 1989). This method



requires a SS-free reference, i.e. the sensor needs a calibration for each location (Olsson and Nielsen, 1997).

### 2.2.7 Dielectric probe

To measure viable biomass, the dielectric properties of intact cells have been used (Davey et al., 1993; Spierings, 1998; November and Van Impe, 2001). When an electric field is applied to a suspension of cells in an aqueous solution, it results in a movement of ions in the solution and within the cells. Then a charge separation or a polarization across the cell membrane is created. The measurement of the resulting capacitance can be used to monitor the biomass concentration (Davey et al., 1993). This method is advantageous to measure only metabolically active biomass, but a change of the water capacitance or of the cell membrane structure, composition and permeability can interfere (Vanrolleghem and Lee, 2003).

### 2.2.8 Electrochemistry

Electrochemical measuring principles have been identified during the sensors review for dissolved oxygen (DO). The electrochemical principle uses the oxidation by DO. Oxygen is reduced to hydroxide ions ( $\text{OH}^-$ ) on the gold cathode. On the counter electrode, DO oxidizes silver ions ( $\text{Ag}^+$ ) that adsorb on a silver bromide layer (AgBr). The associated release of electrons from the gold cathode and the acceptance of electrons at the counter electrode result in a current which, under constant conditions, is proportional to the concentration of oxygen in the medium (Endress+Hauser, 2006a). Some sensors have an exposed electrode while others are covered by a membrane which is DO selective.

### 2.2.9 Luminescence

More recently, another way to measure DO has been developed. It is using the fluorescence quenching principle. Oxygen-sensitive molecules, used as markers, are integrated in an optically active layer, called the fluorescent layer. The surface of this layer is in contact with the medium and there is an optical cell right at the back of the fluorescent layer. When the sensor is immersed in the medium, an equilibrium is achieved between the partial pressure of DO and the oxygen present in the fluorescent layer. The optical cell

emits green light pulses to the layer. The oxygen sensitive markers respond with a red light fluorescence that is captured by the photo-sensitive diode. The duration and intensity of the response signals of the markers depend directly on the oxygen content or partial pressure (Endress+Hauser, 2006b). Different components of this kind of sensor can be identified on Figure 4.

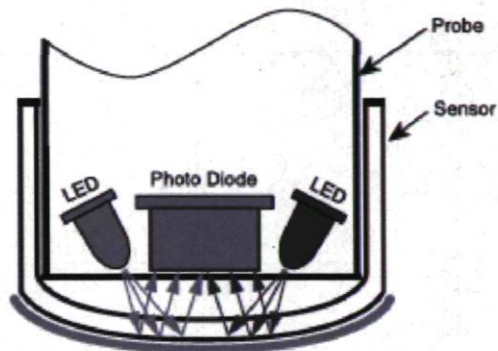

Figure 4: Luminescence dissolved oxygen probe<sup>6</sup> (source : Hach, 2005)

### 2.3 Classification of information

To clearly evaluate which information is provided or not by the manufacturers, tables have been made to classify the collected data. There is one table for each component and under each measuring principle the name of the manufacturer and the name of the model are provided. In the left column three categories have been created: Technical information, accuracy and cost with different specifications in each category. A template of these tables is given in table 1. The table with all collected information found can be found in ANNEX A to ANNEX F.

<sup>6</sup> LED: Light-emitting diode



**Table 1: Template of the table for sensor classification**

		principle 1			principle 2			...	principle n			
		model 1	model 2	... model n	model 1	model 2	... model n		model 1	model 2	... model n	
technical information	spec 1											
	spec 2											
	...											
	spec n											
accuracy	ISO 15839:2003	spec 1										
		spec 2										
		...										
		spec n										
	others	spec 1										
		spec 2										
		...										
		spec n										
cost	spec 1											
	spec 2											
	...											
	spec n											

### 2.3.1 Technical information

This section includes useful information about installation such as ex-situ or in-situ device, need for housing, filtration unit requirement, communication protocol and signal output. Also, information about sensor operation can be found such as measuring range, response time, measuring frequency, built-in auto cleaning device, auto calibration, etc.



### 2.3.2 Accuracy

Some companies use this term as precision, but the definition in the dictionary is “the state of being exact” (Oxford Online Dictionary, 2005). As the definition implies, this category includes evaluation criteria to determine data quality (see Table 1) . This category has been divided in two sub-sections, the first one including all terms defined in the (ISO 15839, 2003) the description of which will be given below. The other sub-section includes other information provided by the manufacturers but not defined by the ISO standard. The definitions of the terms used in the tables are taken from the ISO 15839:2003 standard:

#### 2.3.2.1 Prior definitions

##### **Accepted reference value**

Value that serves as an agreed reference value for comparison, and which is derived as:

- a) an assigned or certified value based on experimental work of some national or international organisation;
- b) a consensus or certified value based on collaborative experimental work;
- c) a theoretical or established value based on scientific principles;
- d) when a), b) and c) are not available, the expectation of the (measurable) quantity, i.e. the mean of a number of measurements.

##### **Day-to-day repeatability conditions**

Conditions whereby independent test results are obtained with the same method on identical test items in the same laboratory by the same operator using the same equipment and reagents over several days.

**Determinand**

Property/substance that is required to be measured and to be reflected by/present in a calibration solution.

**Measurement chain**

Set of instruments and actions that covers all steps involved in measuring a determinand, including the on-line sensor/analysing equipment, sampling and pre-treatment, transportation and storage of the sample.

**Measuring range**

Range between the lowest and the highest determinand value that a sensor/analysing equipment can measure.

**Repeatability conditions**

Conditions where independent test results are obtained with the same method on identical test items in the same laboratory by the same operator using the same equipment and reagents within short intervals of time (e.g. one day)

**Working range**

Range between the lowest and the highest determinand value for which tests to determine precision and bias have been carried out.

**2.3.2.2 Sensor characteristics definitions****Precision**

The closeness of agreement between independently measured values obtained under stipulated conditions (see Figure 5).

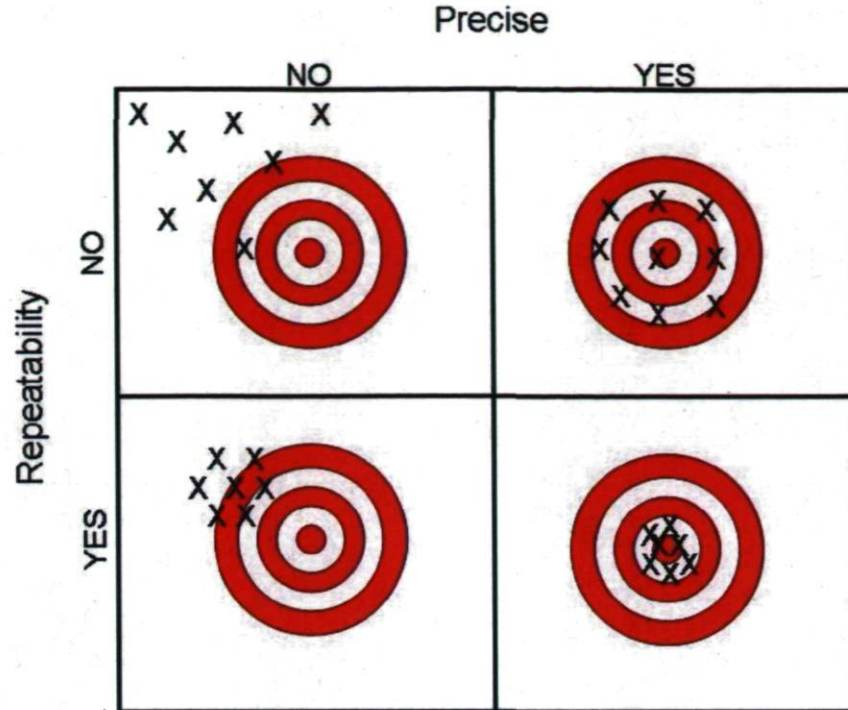

Figure 5: Repeatability vs accuracy

### Repeatability

Precision under repeatability conditions. It is equal to the standard deviation ( $s_{x_0}$ ) of 6 measurements carried out at 20% and 80% of the measuring range, see and Figure 5 equation (1).

$$s_{x_0} = \sqrt{\frac{1}{N} \sum_{i=1}^N (x_i - \bar{x})^2} \quad (1)$$

### Response time

Time interval between the instant when the on-line sensor/analysing equipment is subjected to an abrupt change in determinand value and the instant when the readings cross the limits of (and remain inside) a band defined by 90 % and 110 % of the difference between the initial and final value of the abrupt change (see Figure 6).

### Delay time

Time interval between the instant when the on-line sensor/analysing equipment is subjected to an abrupt change in determinand value and the instant when the readings pass (and



remain beyond) 10 % of the difference between the initial and final value of the abrupt change (see Figure 6).

### Rise time

Difference between the response time and the delay time when the abrupt change in determinand value is positive (see Figure 6).

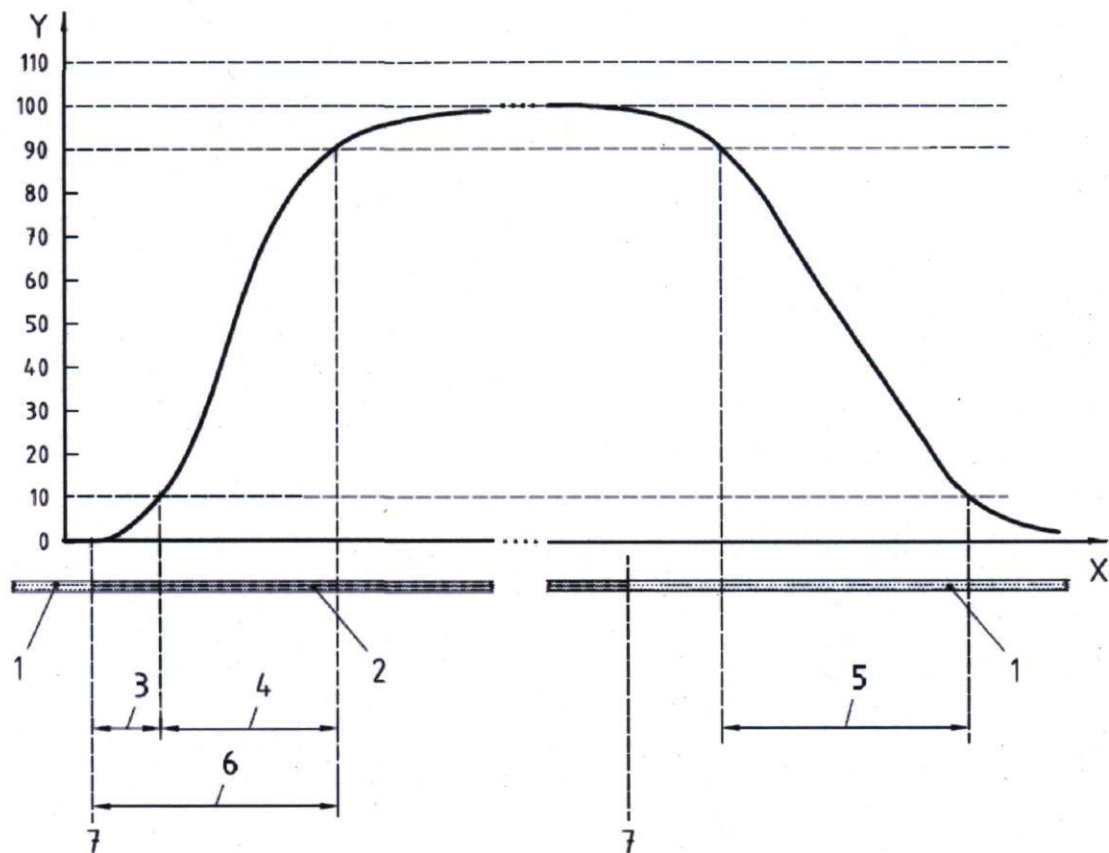

#### Key

- X time
- Y response (%age of value of abrupt change)
- 1 test solution (20 %)
- 2 test solution (80 %)
- 3 delay time
- 4 rise time
- 5 fall time
- 6 response time
- 7 change

Figure 6: Typical sensor signal of an abrupt concentration change (source: ISO, 2003)

**Fall time**

Difference between the response time and the delay time when the abrupt change in determinand value is negative (see Figure 6).

**Linearity**

Condition in which measurements made on calibration solutions having determinand values spanning the stated range of the on-line sensor/analysing equipment have a straight-line relationship (linear regression) with the calibration solution determinand values.

**Coefficient of variation**

Ratio of the standard deviation of the on-line sensor/analysing equipment to the mean of the working range of the equipment. see equation (2).

$$V_{xo} = \frac{s_{xo}}{x} \times 100 \quad (2)$$

where

$$s_{xo} = \frac{s_y}{b} \quad (3)$$

and

$$s_y = \sqrt{\frac{\sum_{i=1}^N (y_i - \hat{y}_i)^2}{N-2}} \quad (4)$$

and



$$b = \sqrt{\frac{\sum_{i=1}^N (x_i - \bar{x}) * (y_i - \bar{y})}{\sum_{i=1}^N (x_i - \bar{x})^2}}$$

$x_i$  = Concentration of the  $i^{\text{th}}$  standard sample (5)

$y_i$  = Concentration of the  $i^{\text{th}}$  analysed sample

### Limit of detection (LOD)

Lowest value, significantly greater than zero, of a determinand that can be detected. It is equal to three times the standard deviation ( $s_{x_0}$ ) of 6 measurements carried out at 5% of the measuring range, see equation (1).

### Limit of quantification (LOQ)

Lowest value of a determinand that can be determined with an acceptable level of accuracy and precision. It is equal to ten times the standard deviation ( $s_{x_0}$ ) of 6 measurements carried out at 5% of the measuring range, see equation (1).

### Lowest detectable change (LDC)

Smallest significantly measurable difference between two measurements. It is equal to three times the standard deviation ( $s_{x_0}$ ) of 6 measurements carried out at 20% and 80% of the measuring range, see equation (1).

### Bias

Consistent deviation of the measured value from an accepted reference value.

### Short-term drift

Slope of the regression line derived from a series of measurements carried out on the same calibration solution during laboratory testing, and expressed as a percentage of the measurement range over a 24 h period.

**Long term drift**

Slope of the regression line derived from a series of differences between reference and measurement values obtained during field testing, expressed as a percentage of the working range over a 24 h period.

**Day-to-day repeatability**

Precision under day-to-day repeatability conditions. It is equal to ten times the standard deviation ( $s_{x0}$ ) of 6 measurements carried out at 35% and 65% of the measuring range, see equation (1).

**Memory effect**

Temporary or permanent dependence of readings on one or several previous values of the determinand.

**Interferences**

Undesired output signal caused by a property(ies)/substance(s) other than the one being measured.

**Availability**

Percentage of the full measurement period during which the measurement chain is available for making measurements.

**Up-time**

Percentage of a full measurement period during which the measurement chain is actually measuring during field testing.

### 2.3.3 Cost

This section has been included in the tables in order to perform a cost-benefit analysis of sensors. In Table 2 the costs have been separated according to (Olsson et al., 2005).

**Table 2: Costs of sensors**

<b>Item</b>	<b>Example</b>
Instrumentation	Cost of the instrumentation itself
Conditioning	Cost of the rig, building, pumps, pipes, pre-treatment, etc.
Installation	Personnel costs for project and skilled workers
Integration	Personnel costs for programming of SCADA, control loops, etc.
Consumables	Costs of chemicals, power, etc.
Maintenance	Cost of service contract and personnel costs for calibration, cleaning, etc.
Spare parts	Cost of spare parts
Service conditions	Cost of service at site or by supplier
Guarantee	Terms and conditions
Lifetime	Includes development of new and better sensors <sup>7</sup>

First, tables have been filled only with information available on the web<sup>8</sup>. As can be deduced from ANNEX A to ANNEX F there is a significant lack of information and especially cost. Information given for the accuracy category is often not following the ISO standard. The problem with this information is that without a standard definition, companies could use it with a different meaning. Given these tables, the importance of a standard protocol for sensor characterisation is obvious. However, even if for the time being there is a protocol, manufacturers do not seem to use it or if they are using it, they do not provide the information in their ads. Without this information, it is hard for end-users to compare different sensors. Manufacturers could be forced to provide such information via legislation, market demands, etc.

<sup>7</sup> It is the combination of better sensors, more parameters, documentation and sound real time data handling and data validation that ultimately will increase efficiency, improve quality, change conservative design rules for the infrastructure and reduce operation and more important – investment cost. (Olsson et al, 2005). Lifetime could also include a lifecycle assessment. However, lifecycle assessment is a whole research topic in itself and has not been considered in this work.

<sup>8</sup> This information has been collected during the summer of 2007



## 2.4 Conclusion

By doing the sensors review and the classification of information, it has been observed that companies fail to provide information according the ISO 15839:2003 protocol. Moreover, definitions of the ISO protocol are not followed by companies in their sensors specifications. Why do companies fail to provide information according the ISO protocol and are not following definitions? It may be because the ISO 15839 standard is relatively new, dating from 2003. Maybe they did not have the time to implement it in their procedure. Another reason could be that it is complicated to use this protocol. To understand the underlying reasons for the observation that manufacturers do not supply the ISO-standard sensors characterisation it may be useful to apply standards. That is why a review of the ISO standard has to be made, first to see what is included and what is not. The procedure will be applied with different nitrate sensors using the optical measuring principle.

The sensors review has shown as well that there are a lot of different measuring principles for each compound selected. Each of these measuring principles has its pros and cons and they will perform differently in the laboratory and in the field. There is a need to be informed on their behaviour under field conditions in order to evaluate the quality of data that a sensor provides.





## **CHAPTER III**

### **REVIEW OF SENSOR EVALUATION PROTOCOLS**



### 3.1 Literature review introduction

Monitoring is defined, in the dictionary, as the act of observing something and sometimes keeping a record of it (Ultralingua Online Dictionary, 2008). In the scientific literature more specific definitions of monitoring can be found, e.g.: To track the current process operational state via the instrumentation (Olsson et al., 2005). In the water discipline (wastewater, rivers, catchments, etc.) monitoring has become easier with the arrival of computers and new technologies. As can be seen in Figure 7, research activities related to water monitoring have literally exploded since the seventies. It shows the number of publications per year for the research on the Engineering Village web site for the keywords “water” and “monitoring”. The exponential growth of papers published on this topic each year can be observed. Moreover, with all issues in water quality and management such as micro-pollutants, more restrictive legislation, energy efficiency, etc., the tendency will probably continue. New technologies have helped a lot in monitoring and control: with sensors it is easier to monitor remote places, to measure different variables at the same time and in control and automation it helps to meet regulatory requirements, improve process performance and reliability, record data and create reports, save chemicals, energy, labour and finally reduce risk and ensure a good night’s sleep (WEF, 2005).

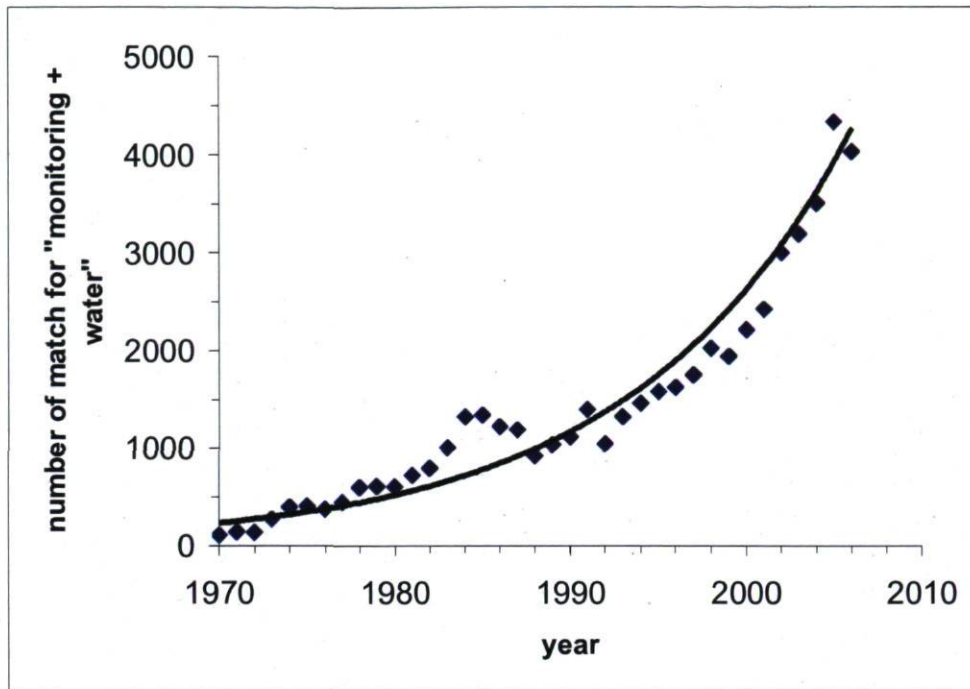

Figure 7: Number of papers per year matching the keywords monitoring + water on the Engineering village web site

Monitoring campaigns and measuring devices have created plenty of data. In itself, having a lot of data is not a problem, but to obtain significant results from those data it is necessary to know the level of uncertainty, in other words the quality of the data. For example, if data are used in modeling and their quality can not be quantified, it could be difficult to obtain good predictions, even if the model fits the data well. On the other hand, if the level of uncertainty of the data is known, then it is easy to state what the reliability of the model is. Moreover, in real-time control of sewer systems and wastewater treatment plants the sensors are, in general, the weakest part of the control chain (Rieger et al., 2004; Lynggaard-Jensen et al., 1996). However, it is not straightforward to quantify the level of uncertainty. It is difficult to know as it depends on what, where, how and when we are measuring.

**What** is measured: not all variables require a high level of precision. Some variables are used in control strategies or are legislated; in such situations it could be important to have measurements with high accuracy. Other variables are only measured as an indicator. In that case the accuracy could be lower because only trends are needed.



**Where** a variable is measured: depending on which variables are measured, there may be plenty of other substances present in the matrix, which may interfere in the measurement process. Moreover, the environmental conditions may also create interferences. For example, if the phosphate concentration is measured with a photometric analyser, the sample is pumped in a small reactor, and chemicals are added to generate a reaction changing the solution's color. The color intensity is subsequently measured with an optical module, the color's intensity being proportional to the phosphate concentration. However, the reaction's kinetics depend on sample temperature: if it is too cold the reaction will be incomplete and the measurement could be wrong. Also, since it is an optical measurement, suspended particles can interfere, and often it is therefore necessary to filter the sample before heading it to the analyser. However, filtration creates others problems: if the water is highly charged in total suspended solids (TSS), the filter will clog rapidly and the maintenance interval will be short. Moreover, the filtration unit adds a time delay into the measurement chain and this time delay is variable over time due to the clogging phenomenon that is increasing. This is only one example, but there are a lot more aspects to take into consideration.

**How** the variable is measured: for some substances there are only a few ways to measure them, e.g. phosphate measurements: there is only the colorimetric principle, with two different reactions depending on the concentration. For other compounds such as ammonium there are at least five different methods (gas sensitive electrode, ion sensitive electrode (ISE), colorimetric, titration, Fourier transform analysis of the absorption spectrum of  $\text{NH}_3$  by adding sodium hydroxide). In such case, each method has its own accuracy and each method reacts in a different way to other compounds present in the matrix. It is important to know how to prepare, install and maintain such sensors to get the maximum out of them.

**When** the variable is measured: this topic could have some similarities with the one "where a variable is measured". However, in this case the answer depends more on the period of the day, week, year... and all changes occurring during those periods, e.g. temperature, flow, concentration of the measured compound and the compounds of the matrix, etc.

As mentioned earlier, evaluating data uncertainties is not straightforward. There is a lot to consider to have a good idea regarding the uncertainties. Note that the same kind of reasoning is necessary to choose the best sensors for end-users needs. However, when the time comes to select and/or buy a measuring device, two main questions occur:

- What are the tools available to evaluate a sensor's performance?
- On which basis should the sensors be compared to make the right choice?

To answer these questions, a sensors review was first made; and companies' websites were consulted to know what kind of information they provide. Then a review of available evaluation tools for sensors was conducted. Publications, books and information provided by standard organisations (like ISO and ASTM International) were studied (1) to know what is currently available, (2) to evaluate whether the information is sufficient, useful and (3) to find out whether the protocols are user-friendly.

## **3.2 Laboratory conditions**

### **3.2.1 ISO 15839:2003**

The protocol ISO 15839:2003 "Water quality – On-line sensors/analysing equipment for water – Specifications and performance tests" is the most complete one found regarding sensor characterisation in water quality. It contains two main parts. The first one concerns the determination of the performance characteristics in the laboratory: all tests are to be conducted under standard laboratory conditions, i.e. solutions with pure water and the measured component. The second part deals with performance characteristics in the field (see below).

In the chapter of Automation of Wastewater Treatment Facilities (WEF, 2005) a section is devoted to *Characteristics of Online sensors*. Everything in this section corresponds to the ISO 15839:2003 standard, which is not surprising since one of the authors of the book, Anders Lynggaard-Jensen, was member of the ISO committee. The different definitions of the characteristics evaluated by the ISO standard are given, but without adding new elements.



All tests made in the laboratory testing section of the ISO 15839:2003 standard are conducted with seven solutions covering the measuring range of the sensor. Solutions are equally distributed over the measuring range, i.e. 5, 20, 35, 50, 65, 80 and 95 % of the measuring range. Solutions are made with pure (nano-pure) water and the compound measured by the sensor, e.g. ammonium, nitrate, phosphorus, etc. For every concentration, six measurements are carried out. Depending on the characteristic to be calculated, measurements are taken on the same day separated by blank or on different days, Table 3 shows this distribution.

**Table 3: Use of measurements and constraints on scheduling (source: ISO, 2003)**

Solution	Concentration (% of the measuring range)	Determinant level used for	To be measured
1	5	LOD, LOQ	On the same day separated by blanks
2	20	Repeatability, LDC, bias	On the same day separated by blanks
3	35	Day-to-day repeatability	On different days
4	50	short-term drift	Equally distributed over shortest period between maintenance operations
5	65	Day-to-day repeatability	On different days
6	80	Repeatability, LDC, bias	On the same day separated by blanks
7	95	Linearity check only	On the same day separated by blanks

Measurements at 50% of the working range should be equally distributed over the time between two periods of maintenance. Since the maintenance intervals depend on the application of the probe and the sensors have not been in use elsewhere than in the lab, measurements at 50% of the working range have been carried out on six consecutive days.

With the laboratory tests, the following characteristics can be determined:

- Response time for a positive change
- Response time for a negative change
- Delay time for a positive change

- Delay time for a negative change
- Rise time
- Fall time
- Linearity
- Coefficient of variation
- Limit of detection
- Limit of quantification
- Repeatability
- Lowest detectable change
- Bias
- Short-term drift
- Day-to-day repeatability
- Memory effect
- Interferences
- Environmental and operating conditions

This protocol provides a lot of information about testing under standard conditions. There is almost nothing that can disturb the measurements; it is a good way to characterize the maximum performance of sensors or to compare the performance of different measuring devices. In fact, however, it is very rare to operate sensors under such conditions. So, the sensors' behaviour under field conditions can not be predicted with this kind of procedure. As seen previously, manufacturers do not provide information resulting from applying this protocol. The first part of this study will therefore be to go through the protocol and do a critical review of it. Afterwards, it will be possible to come up with suggestions, and bring some clarifications if needed.

### 3.2.2 Accuracy profile

Other techniques used to certify laboratory methods could be applied to this particular topic as well. Accuracy profiles are used since a couple of years, mainly in the pharmaceutical and food-processing industry (Hauduc, 2007). The principle of an accuracy profile is based on a comparison of a limit of acceptance  $\lambda$ , which is representing the



maximum total error<sup>9</sup> tolerated and the total error of the method (Hubert et al., 2004). Performance criteria are evaluated as a function of the need of the end-users, i.e. an error tolerance is fixed and then, by plotting only one graph, one can come up with the following performance criteria:

**Linearity, repeatability, bias, limit of quantification**

See section 2.3.2.2

**Model validity**

Verification that requirements are suitable for a specific use

**Intermediate fidelity**

Variation of the results observed when one or many factors (e.g. time, apparatus, technician, etc.) vary within the same laboratory. (EURACHEM, 1998)

**Upper limit of validation**

Maximum concentration of the measuring range for which the tolerance interval is within the limit of acceptability.

**Method validation**

Global evaluation of parameters by the elaboration of an accuracy profile

The number of concentrations required to build accuracy profiles is not defined. The protocol says that at least four should be tested along the measuring range, but it could be as many as one wants. Every test concentration must be tested twice.

Figure 8 shows the accuracy profile obtained from the study of Hauduc (2007). This study has been made to determine the accuracy of a laboratory method to measure heavy metals in water samples such as zinc, lead, nickel, etc. The yellow dots (see Figure 8) represent the mean of the relative bias for one concentration. The interval going through the

---

<sup>9</sup> Total error: addition of bias and standard deviation.

yellow dots represents the uncertainties of the reference measurements. Blue dotted lines represent limits of tolerance ( $p$ ). The tolerance  $p$  is calculated with standard the deviation of repeatability and intermediate fidelity. For environmental analysis the tolerance must be 15% (Hubert et al., 2004). However, in the *Directive Cadre sur l'Eau* the tolerance on the detection limit should be at least 50% (Hauduc, 2007). The intersection of the limit of acceptability and of the limit of tolerance in the lower part of the measuring range determines the limit of quantification. Between the intersection of the upper limit and the lower limit, the higher value has to be considered as the limit of quantification.

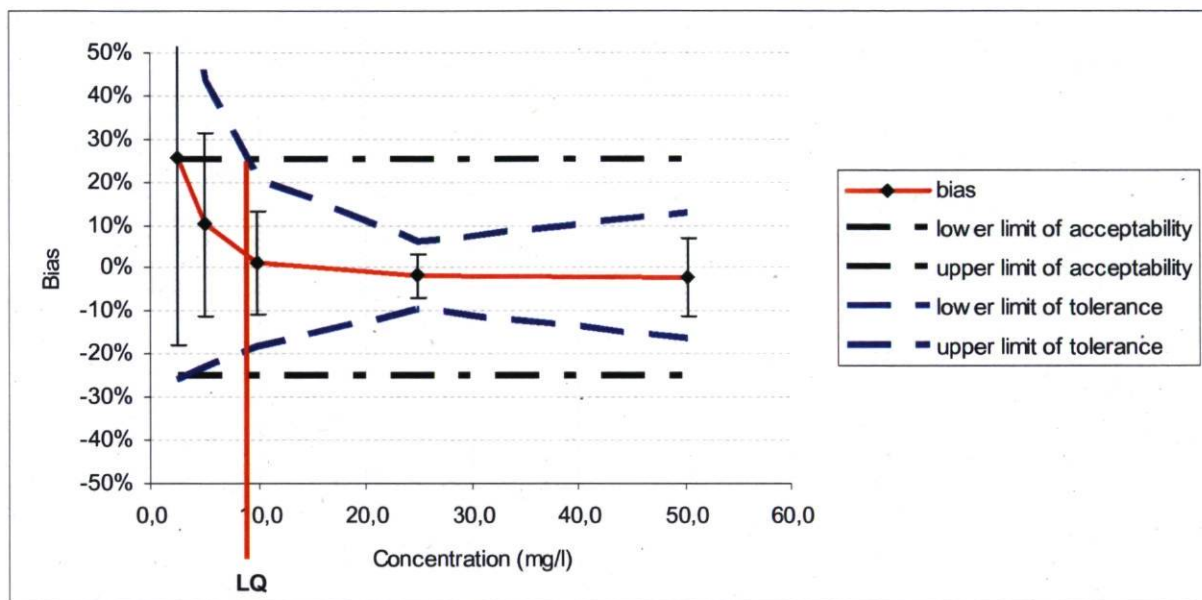

Figure 8: Accuracy profile (Hauduc, 2007)

If the limit of acceptability would have crossed the limit of tolerance in the upper part of the measuring range, there would have been an upper limit of validation. This means in this case that the measuring method is valid from the limit of quantification until 50 mg/l, which is the highest concentration tested.

The direct value of the linearity can not be seen on the figure; however, it can be estimated. For the best sensors all measurements are located on the line of 0% bias. A sensor with a nearly perfect linearity but with measuring noise would have its measurements equally distributed around the 0% bias line. If a sensor does not have a good linearity, measurements will more often be one side of the 0% bias than the other.



This method demands more statistical knowledge to build the profiles, but with only one figure, many performance criteria can be evaluated: bias, limit of quantification, repeatability, limit of validation, linearity.

The accuracy profile methodology has not been tested in this work because the sensors were no longer available when this methodology was found in the literature.

### 3.3 Field conditions

To overcome the problem of the lack of information on in field sensor performance, there is a protocol included in the ISO 15839:2003 norm to evaluate sensor characteristics during field operation. The main idea of this procedure is to expose sensors or analysers to real conditions. Several ways are suggested: the measuring device could be installed directly in the field (nearby the river, WWTP, lake, etc.). The problem with this set-up is that there are dynamics imposed due to parameters such as flow rate, concentrations, temperature, etc. Hence, when the moment comes to compare sensor data with real values (laboratory analysis), because of the non-steady state conditions, one analysis has to be made for each measurement taken by a sensor. Another approach consists of exposing sensors to a grab sample from a real process. With a big enough sample, all tests could be achieved with the same sample, but even in the absence of the outflow of the tank, there still is a non-steady state for some compounds due to processes such as biodegradation, stripping, etc. Hence, the problem could persist depending on what is measured. With this part of the ISO protocol, the following characteristics could be evaluated:

- Response time for positive change
- Response time for negative change
- Delay time for positive change
- Delay time for negative change
- Rise time
- Fall time
- Bias based on (relative/absolute) differences
- Long-term drift
- Availability
- Up-time

This procedure is useful to know how measuring devices will react under specific field conditions. However, in the case one wants to make a comparison of sensor performances, the only way to achieve it is to carry out the same procedure at exactly the same time and at the same place. The part in the ISO 15839:2003 protocol concerning the determination of the performance characteristics in the field is time and location specific. It means that, for example, results collected on two different days from the same sensors mounted at the same place can not be compared. Depending of what kind information is looked for, following this procedure could be the right thing to do if the aim is to know how the sensors will react in a specific process, river, lake, etc. However, when the goal is to compare the performance of sensors or to state the performance of one sensor under field conditions this procedure leads to non-significant results.

To have a procedure to test sensors that anybody could perform and always get the same results, it has to be free of time and location influences, similar to the procedure for determination of performance characteristics in the laboratory. This is called reproducibility. Consequently, the ISO 15839:2003 protocol does not include an evaluation tool for performance evaluation under reproducible field conditions. As can be seen in the protocol, the standard and laboratory conditions are well documented but the field condition testing is still an incompletely covered topic.

Moreover, this part of the protocol evaluates the performance of the whole measuring chain without making a distinction between the different segments of the chain (pump, filtering device, measuring cell, etc.). In other words, the measuring chain is evaluated as a black box. If a bad measurement occurs, it will be difficult to point out exactly where the problem is located.

From the above, it is clear there is a need to test sensors under standardized field conditions. First, to easily compare sensors without the need of doing tests at the same time and same location. Second, if it is possible to test field conditions in the lab, then it is easier to isolate the different segments of the measuring chain, to perform spot checking and to evaluate the effect of disturbances separately. With this knowledge, it will also be easier to plan maintenance that is directly geared to the problematic segment.



### 3.4 Conclusions

To date the ISO 15839:2003 protocol is the most complete protocol to characterise sensors for water quality. It provides a standard procedure to test sensors under laboratory conditions. Nomenclature is defined and must be followed by manufacturers rather than keep using their own nomenclature. This would help end-users to compare sensors from different manufacturers by knowing the definitions of the terms used and by knowing as well that manufacturers are following them.

On the other hand, information coming from laboratory testing does not give indications of how the sensors will perform under field conditions. In the ISO 15839:2003 protocol a section about field conditions testing is given. This section is incomplete and does not aim for reproducible results, the main reason being that tests are time and site specific. It can help end-users to know how a sensor will perform in his specific application, but at this step of characterisation, the sensor is already bought. In order to be able to compare sensors' performances under field conditions and help end-users to select the right sensor, a standardized protocol for field conditions is needed.



## **CHAPTER IV**

### **MATERIALS AND METHODS**





The goal of this work is to characterize sensors under different conditions. As seen before there are already some protocols available. So far the ISO 15839:2003 protocol is the most complete and specific. For this work only the part concerning laboratory testing will be conducted and described. Subsequently, the protocol to standardize field conditions, i.e. the effect of air bubbles and turbidity, will be described.

#### 4.1 Sensors tested

##### 4.1.1 Spectro::lyser™ from s::can

The Spectro::lyser™ from the s::can company is a spectrometer covering the UV spectrum from 190 to 390 nm. Different path lengths are available, depending on the application. The one used in this work is a 35 mm path length, usually used for river water quality monitoring. The sensor version is able to measure nitrate concentrations between 0 and 15 mg NO<sub>3</sub>-N/l. Auto-cleaning is performed with pressurized air. The probe is provided with a global calibration, in this case the river calibration. It is possible to add, on top of the global calibration, a local calibration or even a specific calibration (Rieger et al., 2006). In this work, a local calibration has been performed with two points, at 20 and 80 % of the working range, i.e. 3 and 12 mg NO<sub>3</sub>-N/l. The probe is connected to a computer via a relay box; this box provides power to the probe and is processing the signal to a USB port of the computer. s::can is also providing the data collection software. The one used is the ana::pro V5.3e-2399. For continuous measurements, the measuring interval has been set to the minimum, i.e. one minute. Tests with this probe have been conducted at Université Laval.

##### 4.1.2 Sensor A

Sensor A is a spectrometer using the same measuring principle as the s::can probe. The measuring cell is not directly immersed in the water: with a small piston water is pumped into a tube. The light source and the measuring cell are on each side of this cell. With this kind of setup it is also possible to measure settling properties and perform water quality measurements disturbed less by turbidity. The measuring range of sensor A is 0-20 mg/l of NO<sub>3</sub>-N. Every time the piston is moving in the tube, it is cleaning it. The calibration

used for the tests is the factory calibration. The only thing which has been added before testing, is to set the zero with the water used to make the solutions. This probe was not used in continuous measurement; only manual measurements were carried out. Tests were conducted at the company's laboratory.

#### 4.1.3 Nitratax from Hach

The measuring principle of this probe is using two specific wavelengths, instead of 256 for the Scan Spectrolyser<sup>™</sup>. The nitrate concentration is measured at 210 nm and a turbidity correction is made with a measurement at 350 nm. The path length of the probe used in the tests is 1 mm allowing the probe to measure nitrate (as NO<sub>3</sub>-N) concentrations from 0 to 100 mg/l. The auto-cleaning of lenses is made by a wiper. No additional calibration has been made for the tests. The calibration used is the one made by the technician of the company. The probe is connected to the SC100 controller that is connected to a central server for data logging. During continuous measurements, the measuring interval was set to the minimum value of 15 sec and during testing data filtering was set to zero. Tests with this probe have been conducted at EAWAG in Zurich.

#### 4.1.4 Sensor B-8mm and B-2mm

This sensor is still in development and is not yet on the market. It is also measuring nitrate with the two wavelengths principle. Two path lengths are available for this model: 2 mm with a measuring range of 0 to 50 mg/l of NO<sub>3</sub>-N and 8 mm with a measuring range of 0 to 10 mg/l of NO<sub>3</sub>-N. Both configurations were tested in this work. The auto-cleaning of the sensor is performed with pressurized air. The calibration used during the experimentation was the factory calibration. The sensors were connected to the controller provided by the company. Signal filtering and damping were set to zero. Since no continuous measurements were carried out, the data logger was not configured. Tests were conducted at the company's laboratory.



#### 4.1.5 Sensor C

Sensor C is also using the two wavelengths measuring principle. It can measure concentrations from zero to 50 mg/l of nitrate as  $\text{NO}_3\text{-N}$ . The auto-cleaning of lenses is ensured by pressurized air. The calibration used during the experimentation was the factory calibration. The probe was connected to the controller provided by the company. Data filtering was set to zero. Since this sensor was not used for continuous measurements, the data logger was not configured. Tests were conducted at the company's laboratory.

#### 4.1.6 Solitax from Hach

The Hach Solitax is a turbidity sensor. It is combining two different scattering angles:  $90^\circ$  and  $140^\circ$ , allowing the sensor to measure turbidity from 0.001 to 4000 NTU. The auto-cleaning of the lens is made by a wiper. The calibration used during the experiments was the factory calibration. The sensor was connected to a Hach SC1000 controller, and the controller was connected to a computer to download the log files. During continuous experimentation, the measurement frequency was set to the minimum, i.e. 5 seconds. Tests were conducted at Université Laval.

### 4.2 ISO 15839:2003 – Laboratory testing

All sensor testing was conducted according to the ISO 15839:2003 protocol, see section 3.2.1. Diluted solutions have been prepared from a high concentrate solution (1000 mg/l as  $\text{NO}_3\text{-N}$ ). Dilutions have been made with micropipettes and concentrations have been double-checked with Hach test kits.

### 4.3 Standardised field conditions protocol

In this part of the work, the aim was to reproduce, in the laboratory, interferences that can be found in the field. As mentioned previously, so far there is no methodology to evaluate the effects of a single disturbance on the measurements. It has always been a combination of effects. Therefore, a methodology has been developed to isolate disturbances and quantify their effects on the measurements. The methodology has been

developed for testing the effect of air bubbles and turbidity on the sensor output, for an optical measurement principle.

#### 4.3.1 Air bubbles

##### 4.3.1.1 Experimental Setup

To evaluate the effects of air bubbles in a standard way, a laboratory setup has been built in which conditions can be controlled. A 170 liters plastic tank has been equipped with a nine inch diameter diaphragm diffuser (Diffuser Express, Colombia). The diffuser is supplied with laboratory pressurised air. A regulator with pressure gauge has been installed on the line. The Spectro::lyser<sup>tm</sup> and Solitax sensor, have been installed in the tank according to manufacturer installation requirements, see Figure 9.

##### 4.3.1.2 Experimental Procedure

First, the sensors are installed in the tank with tap water, which means that the nitrate concentration is nearly 0 mg NO<sub>3</sub>-N/L<sup>10</sup>. During the first 30 minutes no air is supplied to the aerator. Then the air pressure is adjusted to 0.5 bar for another 30 minutes. After this the pressure is further incremented to 1.0 bar and 1.5 bar, which is the maximum. After reaching the maximum, the pressure is lowered by decrements of 0.5 bar every 30 minutes until reaching zero where measurements are carried out for another 30 minutes.

The Spectro::lyser<sup>tm</sup> has been tested in solutions without nitrate (tap water) and in a solution with a nitrate concentration at the lower end of its measuring range, i.e. around 3 mg NO<sub>3</sub>-N/L, which corresponds to 20% of the measuring range. The Solitax has been tested only in tap water. Finally, the Nitratax has only been tested in a solution with a concentration of around 10 mg NO<sub>3</sub>-N/L, which corresponds to 10% of its measuring range and not exactly according to the procedure mentioned in the previous paragraph<sup>11</sup>.

---

<sup>10</sup> The concentration is below the limit of detection and quantification of the tested sensors.

<sup>11</sup> The Nitratax has been tested before the final version of the procedure was completed. It has been exposed to 0, 0.5, 1.0, 1.5, 2.0, 2.5 and finally 0 bar for a period of 30 minutes each time. Since the Nitratax test was performed at EAWAG, it could not be tested according to the final version of the procedure.



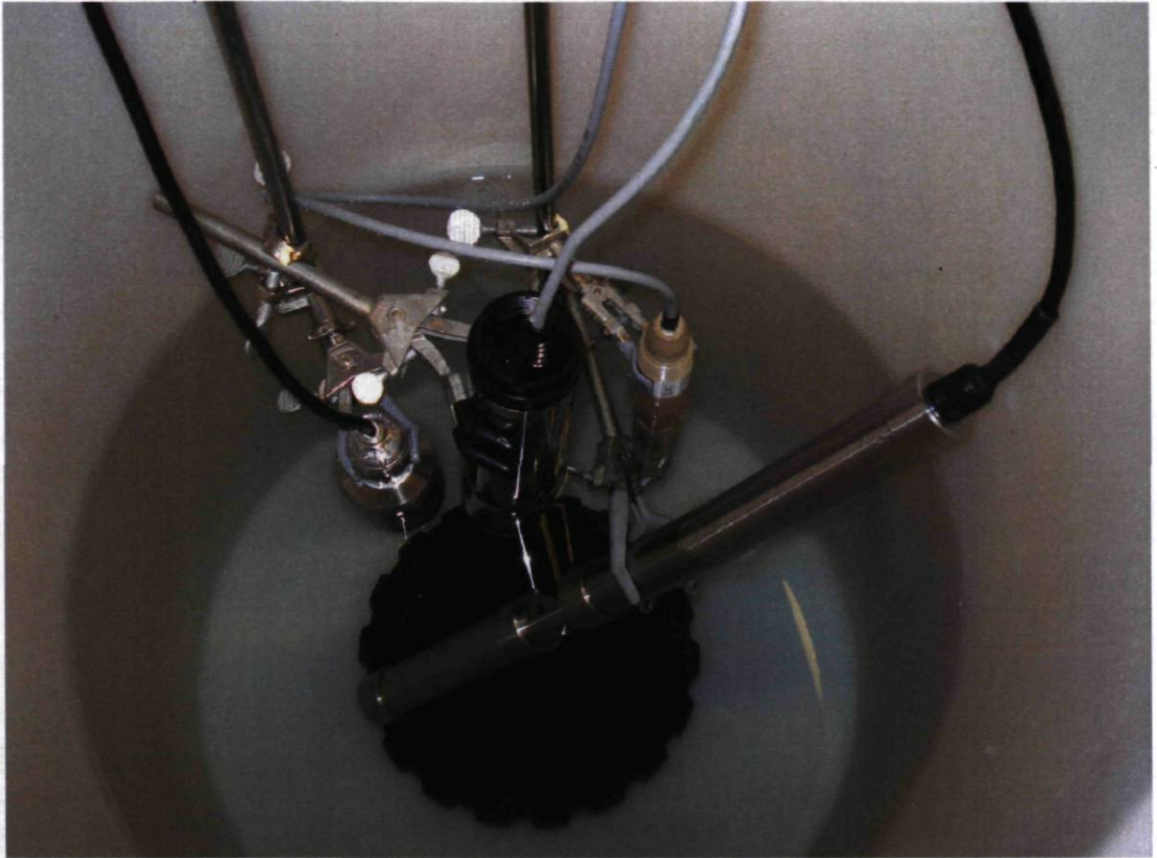

**Figure 9: Tank equipped with diaphragm aerator at 0 bar (above) and 1.5 bar (bottom)**

## 4.3.2 Turbidity

### 4.3.2.1 Experimental Setup

The effects of turbidity have only been tested on the Spectro::lyser™, because the other spectrometer and nitrate sensors were not available when this part of the experimentation was conducted. The Solitax was obviously not tested for effects of turbidity as it is a turbidity sensor.

The Spectro::lyser™ is coming with a recipient that fits around the measuring cell (see Figure 10). It allows using less solution than when the whole probe is to be immersed in a tank.

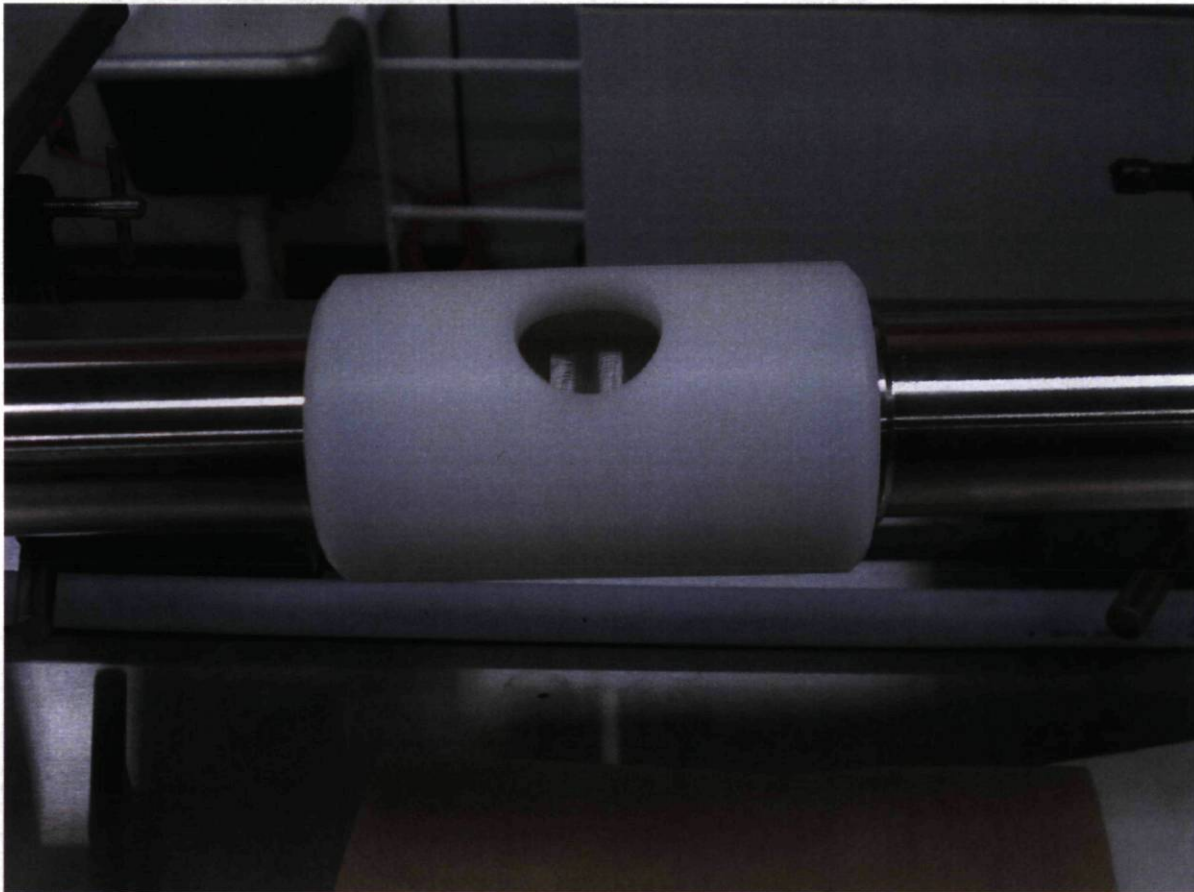

**Figure 10: Offline measuring cell for Spectro::lyser™**



#### 4.3.2.2 Standard

Two different turbidity standards were used: Formazin and AMCO Clear®. The first issue that has been checked is the stability of the suspension over time. Due to the way the cell used to make the lab measurements with the Spectro::lyser™ is configured (Figure 10), it is impossible to maintain agitation in the cell. Hence, the importance of evaluating the stability of the suspension. Two different measurements have been made, first 30 minutes of continuous measurements without touching the sensor or the sampling cell and another series of 30 minutes while shaking the measuring cell by performing quarter rotations every minute. Then, the effects of turbidity on the nitrate measurements were made with the one with better stability.

##### 4.3.2.2.1 Formazin

Formazin is the recognized standard for turbidity. It has even given its name to one of the units used to quantify turbidity; Formazin Nephelometric Units (FNU). Formazin is sold in high concentration solutions, and for this experimentation a solution of 4000 FNU was available. Dilutions were made to get the desired turbidity, i.e. 50 and 10 FNU.

Formazin has the following advantages:

- It is available from most chemical and scientific suppliers
- The least-expensive commercially available standard

and disadvantages:

- It has a Material Safety Data Sheet (MSDS) health-hazard rating of 2:  
Rating 2: Intense or continued exposure could cause temporary incapacitation or possible residual injury unless prompt medical attention is given (MSDS HyperGlossary, 2009).
- Turbidity can vary by  $\pm 2\%$  from batch-to-batch
- The size, shape and aggregation of formazin particles changes with temperature, time and concentration (see Figure 11).
- It settles during storage and it must be mixed immediately prior to use.
- Diluted formazin standards have a storage life as short as one day (see Table 4).

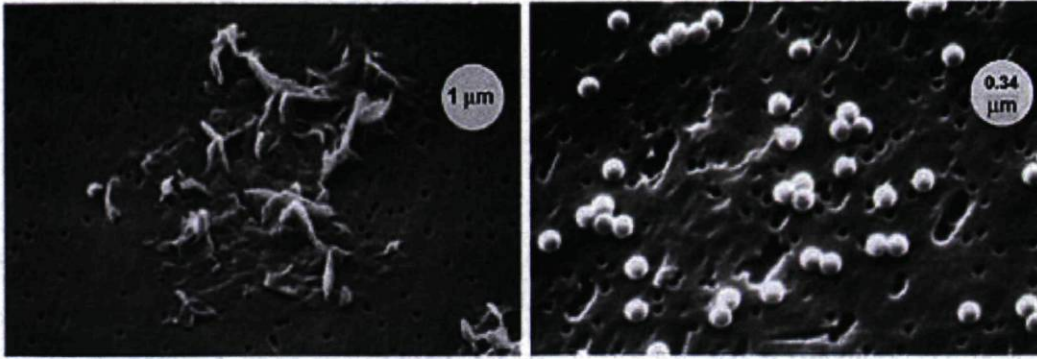

**Figure 11: Scanning electron microscope (SEM) image of formazin (left) and AMCO Clear® (right) (source: Campbell Scientific, 2006)**

**Table 4: Life time of formazin solutions (source: Campbell Scientific, 2006)**

Turbidity (FNU)	Maximum Storage Time
1 - 10	1 day
2 - 20	1 day
10 - 40	1 day
20 - 400	1 month
> 400	1 year

#### 4.3.2.2.2 AMCO Clear®

AMCO Clear® is an exclusive product supplied by GSF Chemicals. Next to formazin, it is the other calibration standard recognized by the U.S. Environmental Protection Agency (EPA) (Campbell Scientific, 2006). AMCO Clear® is a suspended solution of styrene divinylbenzene (SDVB) microspheres (see Figure 11). Particles have a specific gravity of one, allowing the particles to stay suspended. The density of the solution is adjusted to match the one of the particles, which is why dilutions are not suggested to settle. Two different standards have been acquired, 1000 and 50 FNU. Experiments were conducted with the original 50 FNU solution, with a solution of 50 FNU made by diluting from 1000 FNU and finally with a 10 FNU solution made with the 50 FNU standard.



AMCO Clear® has the following advantages:

- < 1% batch-to-batch variation in turbidity.
- Consistent optical properties from 10 to 30 °C.
- Guaranteed one year stability.
- Mixing and dilution are not required.
- It is not toxic.

and disadvantages:

- Standards are more expensive, about twice the price of formazin.
- It can only be used with the instruments for which they are made. The SDVB standards are formulated especially for the OBS sensors from Campbell Scientific and cannot be used with all sensors.

#### 4.3.2.3 Experimental Procedure

After the better turbidity standard for this application was identified, the tests to evaluate the effects of turbidity on the nitrate measurement are performed according the following steps. First, a solution containing nitrate (approximately 3 mg NO<sub>3</sub>-N/L) and nearly zero turbidity is introduced in the cell. A first series of measurements was made during 30 minutes. Then, the solution is spiked with the turbidity standard to reach a turbidity in the cell around 10 FNU. Another 30 minutes of measurements is made with this solution.

## 4.4 Data processing

### 4.4.1 Turbidity standards

To evaluate which standard is the most stable, measurements are plotted vs time. By performing a linear regression and calculate the slope, this will indicate which solution has a more stable suspension.

#### 4.4.2 Air bubbles and turbidity effects

Three indicators will be used to characterise the effects of air bubbles and turbidity on the measurements. The first one is the bias generated by the interference. The bias will be calculated by the difference between the mean of all measurements carried out without interference in the solution and the mean of the measurements for a particular level of interference. This will give an idea of the bias generated by the interference. Secondly, the same thing will be done by calculating the standard deviation. It will give an indication of the noise level created by the presence of air bubbles or turbidity. Finally, when the Spectro::lyser<sup>tm</sup> was not able to transmit a measurement because it was out of bounds, it gives NaN (not a number) as result. The number of NaN values obtained will be used as a third indicator.

### 4.5 Reference measurements

#### 4.5.1 Nitrate

The nitrate reference measurement was made with the Hach TNT test kit. It is following a colorimetric method. Test kits are available in two different measuring ranges: 0,23–13,5 (Hach # TNT835) and 5-35 mg/L NO<sub>3</sub>-N (Hach # TNT836). Measurements were made with the Hach DR5000 colorimeter.

#### 4.5.2 Turbidity

Turbidity reference measurements were made with a Hach model 2100N turbidimeter.

## **CHAPTER V**

### **RESULTS AND DISCUSSION**





Results shown in this chapter will be separated in two major sections. The first section will show the results of the review of the ISO 15839:2003 protocol. The second part will present the results of the standardized field conditions testing procedure. For both sections the results will mainly be displayed into figures, but the raw data can be found in ANNEX F to ANNEX I.

## 5.1 ISO 15839:2003 review

Table 5 shows the characteristics of different nitrate sensors determined following the ISO 15839:2003 protocol. The table is built according to suggestions in the annex of the ISO 15839:2003 protocol. When the time comes to select the right sensor, this way to show characteristic is not sufficiently visual to rapidly identify which sensor is better and to what extent. Hence, when the goal is to compare sensors, the first suggestion will be to add a graphical display of the results to the protocol. Figure 12 is an example that compares six sensors with two different characteristics. From such figure it is easier to rapidly identify which sensor gives the better performance.

**Table 5: Characteristics of nitrate sensors according the ISO 15839:2003 protocol**

	units	Sensor					Nitratax
		s::can	Sensor A	Sensor B (8mm)	Sensor B (2mm)	Sensor C	
coefficient of variation	%	6,6915	2,9327	3,4533	4,0384	1,8493	1,9751
limit of detection	mg NO <sub>3</sub> -N/L	0,1250	0,0455	0,0351	0,0245	0,0155	0,0923
limit of quantification	mg NO <sub>3</sub> -N/L	0,4167	0,1517	0,1169	0,0816	0,0516	0,3077
repeatability at 20 %	mg NO <sub>3</sub> -N/L	0,0232	0,0232	0,0089	0,0450	0,0516	0,0516
repeatability at 80 %	mg NO <sub>3</sub> -N/L	0,1959	0,0273	0,0494	0,0799	0,3082	0,0408
lowest detectable change at 20 %	mg NO <sub>3</sub> -N/L	0,0695	0,0695	0,0268	0,1351	0,1549	0,1549
lowest detectable change at 80 %	mg NO <sub>3</sub> -N/L	0,5878	0,0820	0,1482	0,2396	0,9247	0,1225
bias at 20 %	mg NO <sub>3</sub> -N/L	0,7217	-0,0983	0,0200	0,3633	0,3333	0,4267
bias at 80 %	mg NO <sub>3</sub> -N/L	0,0650	2,0567	0,3000	4,8617	4,6500	5,1767
short term drift	%/day	0,0248	-0,0171	0,0371	0,1103	0,2114	-0,1943
day-to-day repeatability at 35 %	mg NO <sub>3</sub> -N/L	0,5270	0,0407	0,0052	0,1036	0,3327	0,4502
day-to-day repeatability at 65 %	mg NO <sub>3</sub> -N/L	0,0886	0,1202	0,0475	0,1993	0,5282	0,8124

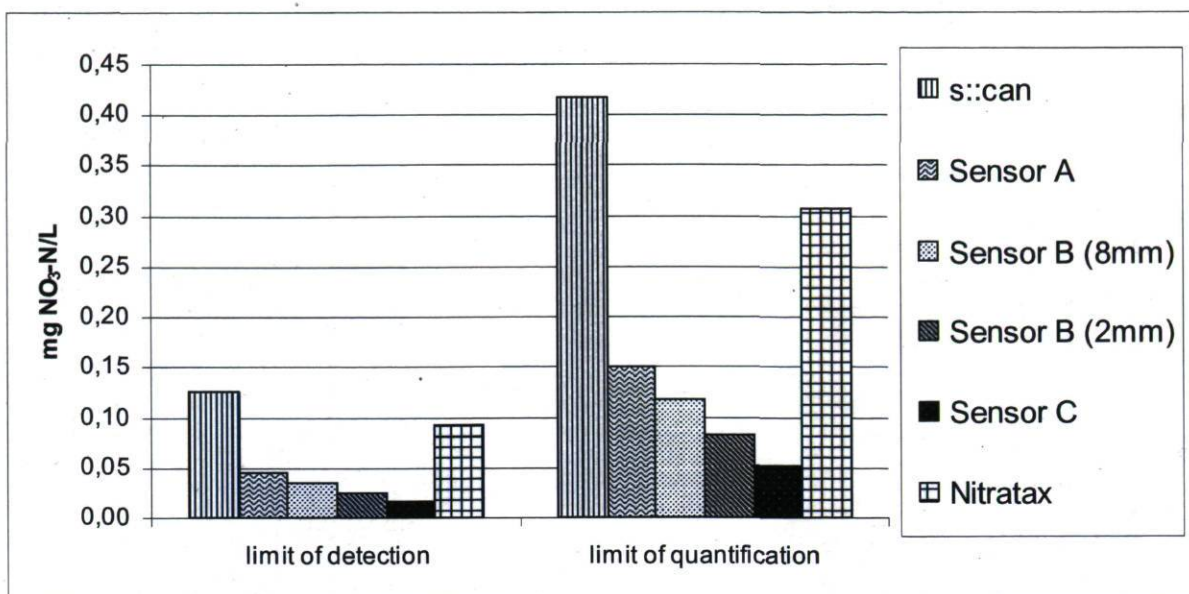

**Figure 12: Comparison of limit of detection and quantification**

### 5.1.1 Limit of detection and quantification, repeatability, lowest detectable change and day-to-day repeatability

The limit of detection, limit of quantification, repeatability, lowest detectable change and day-to-day repeatability are grouped together because they are all based on standard deviation. They are calculated from different data sets, some of them being multiplied with a weighting factor but their interpretation is similar.

As seen in the Materials and Methods section, the limit of detection and the limit of quantification are calculated from the same data and, basically, with the same equation. Hence, both have the same shape but with a different scale (see Figure 12).

Normally, when the time comes to select a sensor for a given application, the characteristic that an end-user will often check first is the measuring range. The lower the expected concentrations to measure are, the smaller will be the measuring range of the selected sensor. The results shown in Figure 12 tell something different, however. Except for the Nitratax, the higher the measuring range is, the lower the limits of detection and quantification are. In other words, according to these results, if the expected concentration to measure is low, a sensor with a high measuring range would be the right choice. Indeed,



the limit of detection and quantification are based on standard deviation at 5% of the measuring range that is depending on the sensor that is tested.

The repeatability and the lowest detectable change are evaluated at 20% and 80% of the working range. Figure 13 compares the repeatability of the tested sensors while Figure 14 shows a comparison of the lowest detectable change. For the same concentration, the graph of the repeatability and the lowest detectable change have the same shape because the repeatability is equal to the standard deviation and the lowest detectable change is equal to three the times the standard deviation. The figures show that sensors offer quite similar performances in the lower part of their measuring range, but in the upper part of their measuring range some seem to have a better performance. The repeatability could be understood as a measure of the level of noise generated by the measuring device for a same reference solution. It is equal to the standard deviation. The repeatability has nothing to do with calibrations; it could be seen as the performance of the hardware of the probe.

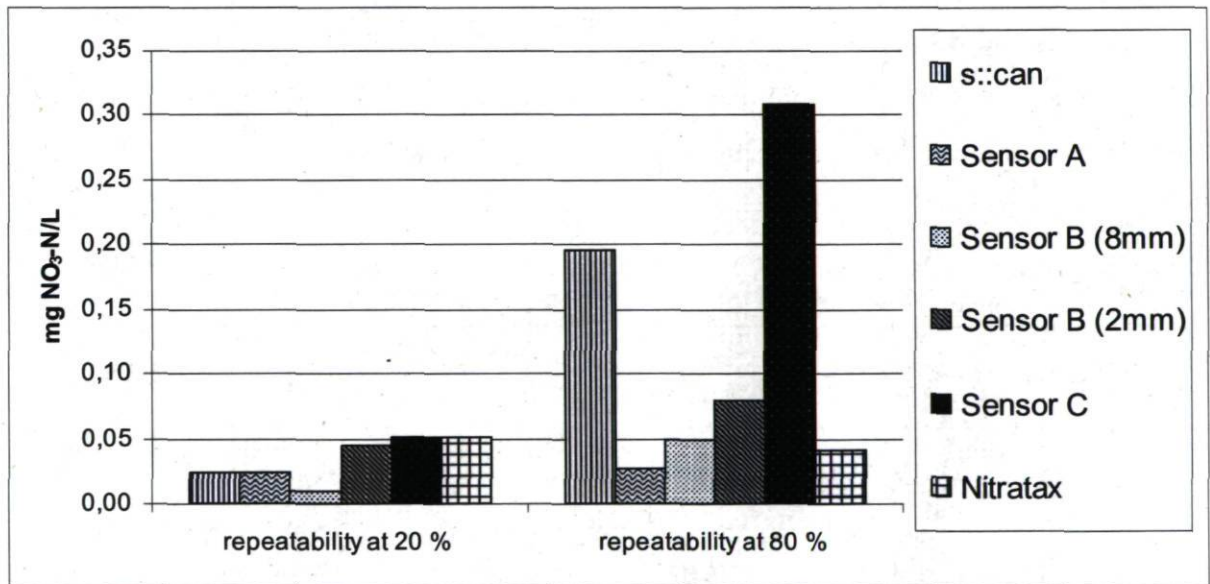

Figure 13: Comparison of repeatability

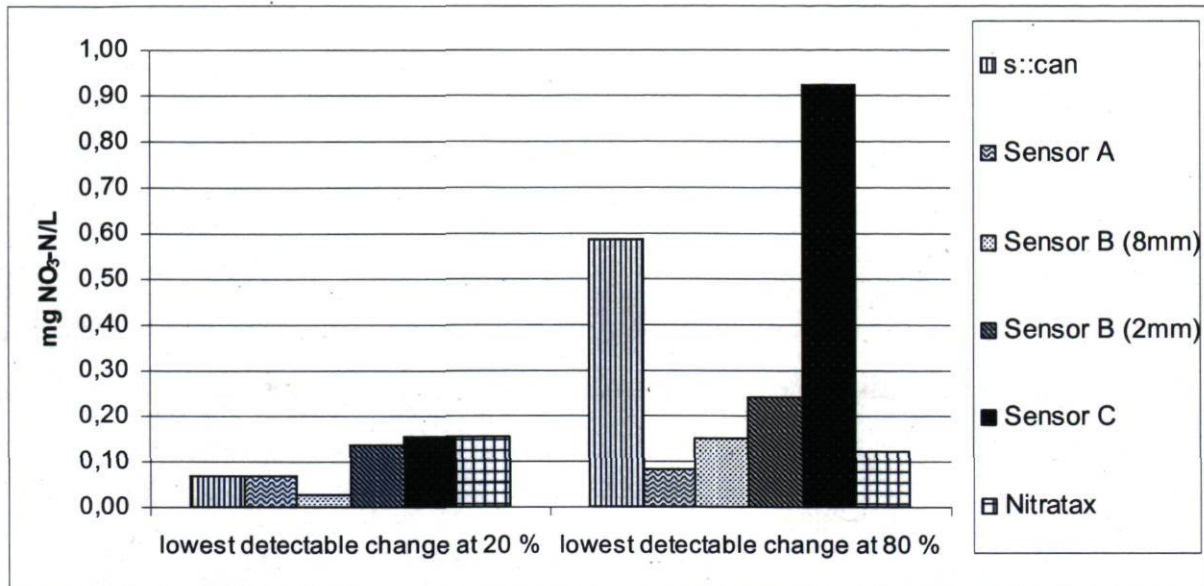

Figure 14: Comparison of lowest detectable change

Figure 15 compares the day-to-day repeatability of the six sensors tested. Besides the fact that the measurements are carried out at 35% and 65% of the working range instead of 20% and 80%, each measurement is made on six consecutive days. This characteristic can give an idea of the stability of the sensor over time. However, six days is a relatively short period and the measurements are made in clear water.

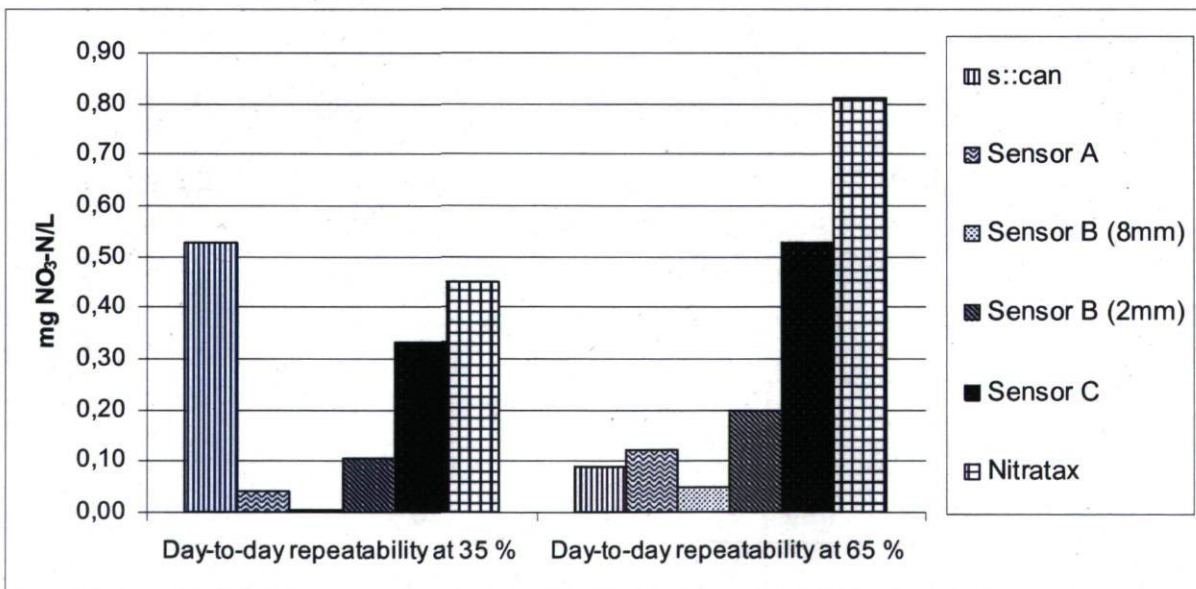
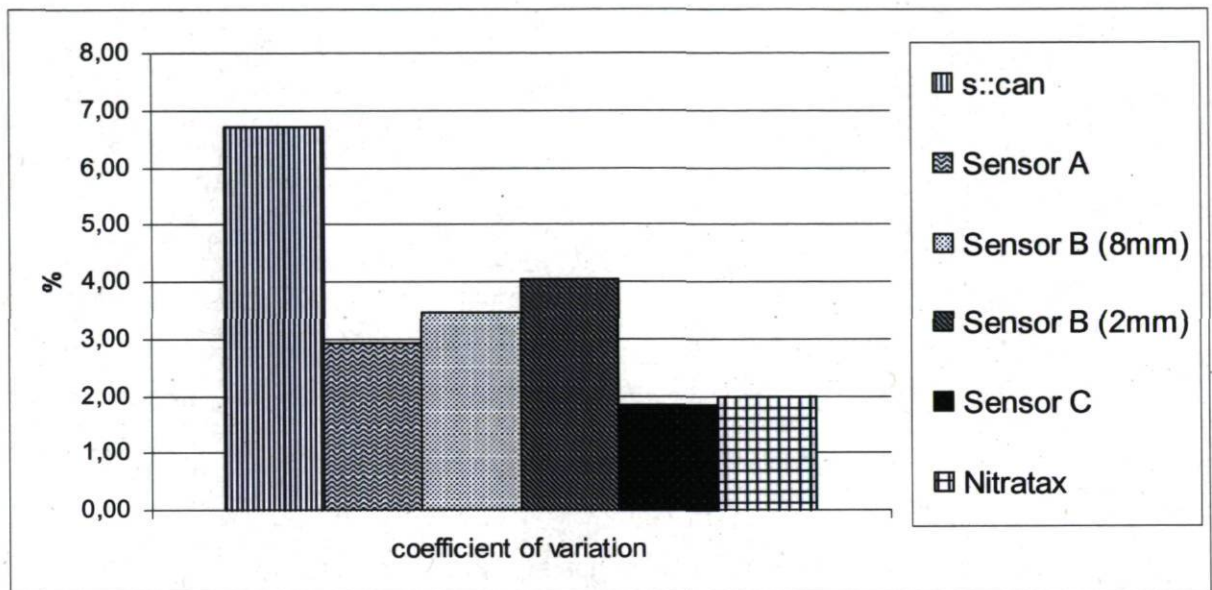

Figure 15: Comparison of day-to-day repeatability



### 5.1.2 Coefficient of variation

As seen in the introduction, the coefficient of variation is the ratio of the standard deviation of the on-line sensor/analysing equipment to the mean of the working range of the equipment. It is a dimensionless number and it allows comparing the standard deviation regardless of the measuring range. Figure 16 shows the coefficients of variation of the six sensors tested. The same kind of observation as for the limit of detection can be made, i.e. the higher the measuring range the lower the coefficient of variation is.



**Figure 16: Comparison of coefficient of variation**

By taking a closer look at equation (6) it can be seen that the coefficient of variation depends on: the sum of squared errors, the number of solutions tested, the mean of the measurements carried out and the slope of the correlation between the reference and the sensor measurement. A sensitivity study of the parameters in equation (6) shows in Figure 17 which one has the greater incidence on the coefficient of variation. First, the number of concentrations tested has influence, but since it is easy to control the number of measurements and carry out the same number for each sensor, the influence of this parameter can be eliminated. The slope, due to its small variation and its value being around one, has very little influence on the coefficient of variation. Two parameters have significant effects on the coefficient of variation: the sum of squared errors (SSE) and the mean of the measurements. There is no correlation between both, i.e. a sensor with a high

measuring range will not necessarily have a high SSE and vice-versa. The only thing that can be controlled or changed is the measuring interval, again stressing the importance of comparing sensors on the same basis. By exposing sensors to the same concentrations, this variation factor can be disabled. By doing so, a comparison of the coefficient of variation would be more important.

$$V_{xo} = \frac{s_{xo}}{x} \times 100 \quad \text{where} \quad s_{xo} = \frac{s_y}{b} \quad (6)$$

$$\text{and} \quad s_y = \sqrt{\frac{\sum_{i=1}^N (y_i - \hat{y}_i)^2}{N-2}} \quad \text{and} \quad b = \sqrt{\frac{\sum_{i=1}^N (x_i - \bar{x}) * (y_i - \bar{y})}{\sum_{i=1}^N (x_i - \bar{x})^2}}$$

### 5.1.3 Bias

The way that bias is tested in the ISO 154839:2003 protocol covers the lower and the higher part of the whole measuring range of the sensor. Bias is a calibration issue: it can be easily corrected by a local calibration around the normal operation conditions. Figure 18 shows a comparison of the bias results of the tested sensors. The bias is given as an absolute value (sensor measurement minus reference measurement). In the case of bias at 80% of the measuring range, Sensor B (2mm), Sensor C and Nitratax seem to give the same performance. But if they are compared according to their measuring range, results are different. Sensor B (2mm) and Sensor C have the same measuring range (0-50 mg NO<sub>3</sub>-N/L), so both will have a relative bias of 9-10%, but the Nitratax has a measuring range of 0 to 100 mg NO<sub>3</sub>-N/L, and so the relative bias will be around 5%.

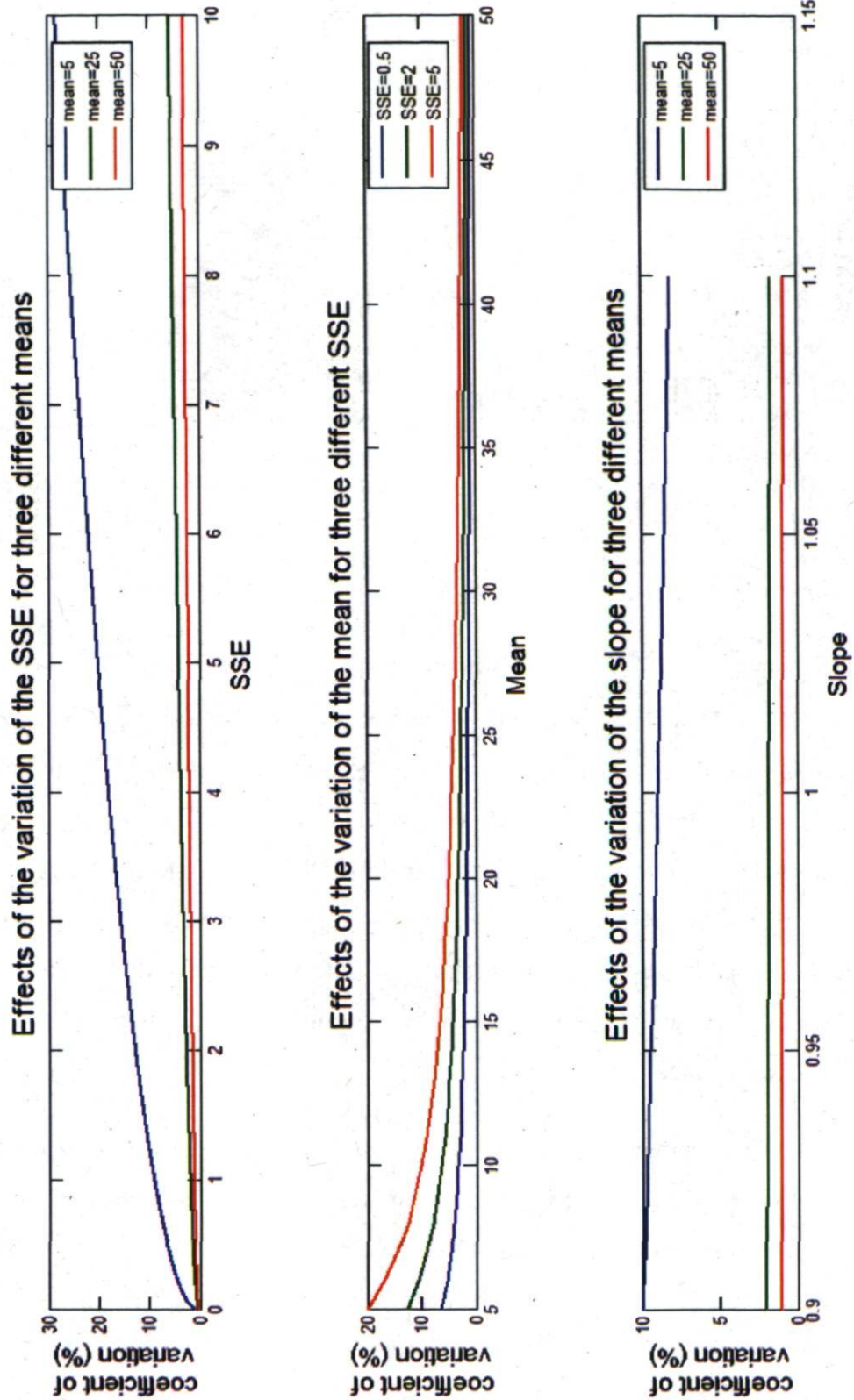

Figure 17: Sensitivity study on the parameters of the coefficient of variation of the equation (6)



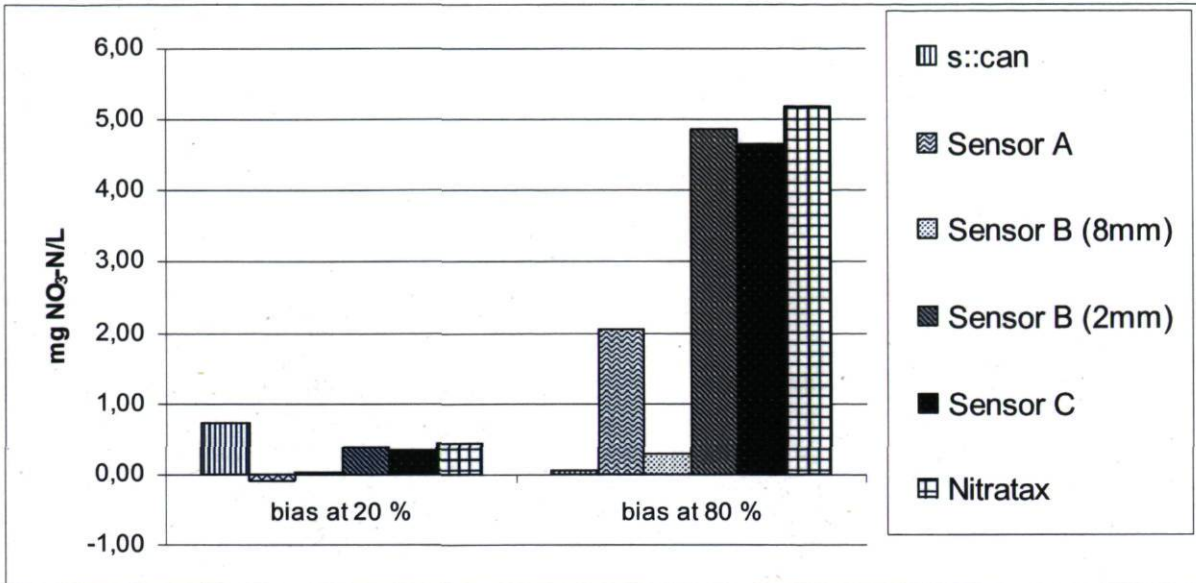

Figure 18: Comparison of bias

#### 5.1.4 Short term drift

Unlike the performance characteristics discussed so far, the short term drift gives an idea about the sensor behaviour over time. Short term drift is given in percentage of the working range per day. Figure 19 shows the comparison of the tested sensors. Another characteristic that distinguishes short term drift from other performance characteristics, is the fact that it is divided by the measuring range and by doing so, values are given in percentage, making them easily comparable. The value of the drift, before it is divided by the measuring range, is the slope of the regression of the measurement as function of time. The best value that a sensor could get is zero.

The problem with only showing slope values or with comparing values in a bar graph, like Figure 19, is that it is difficult to visualise the behaviour of the sensor over time. For each sensor it would be better to show the graph of measurements versus time (see Figure 20). With this way of showing the data, it can be seen that the slope value is not at all representative of the data set. Moreover, with only six measurements, each of them has a lot of influence on the calculated drift, like the measurement at day 0 in Figure 20.



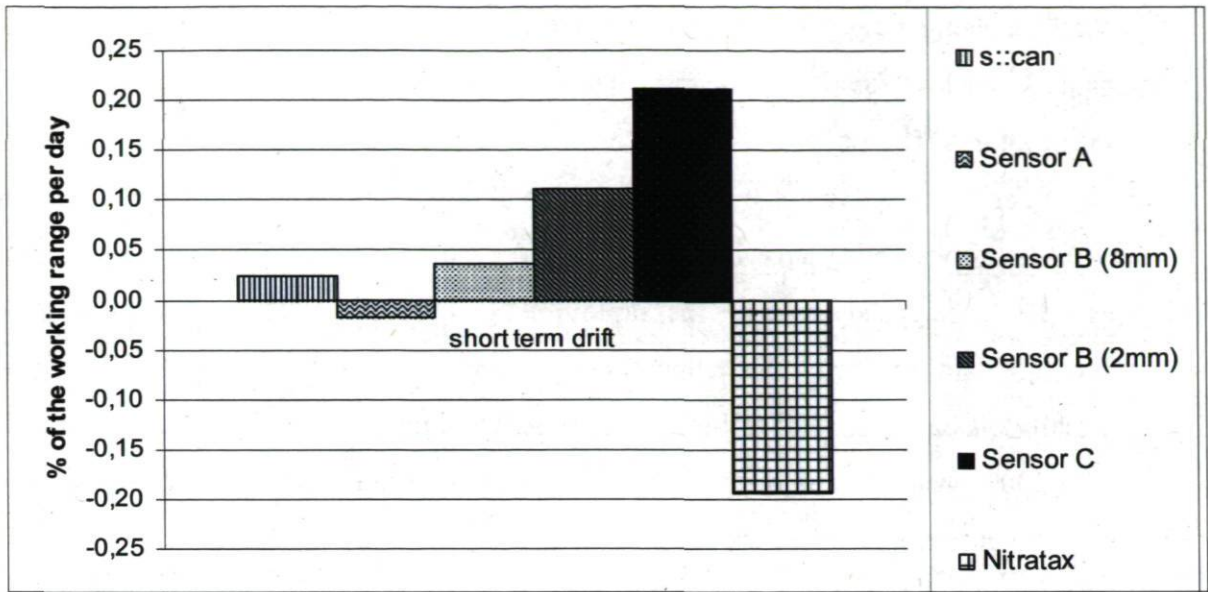

Figure 19: Comparison of short term drift

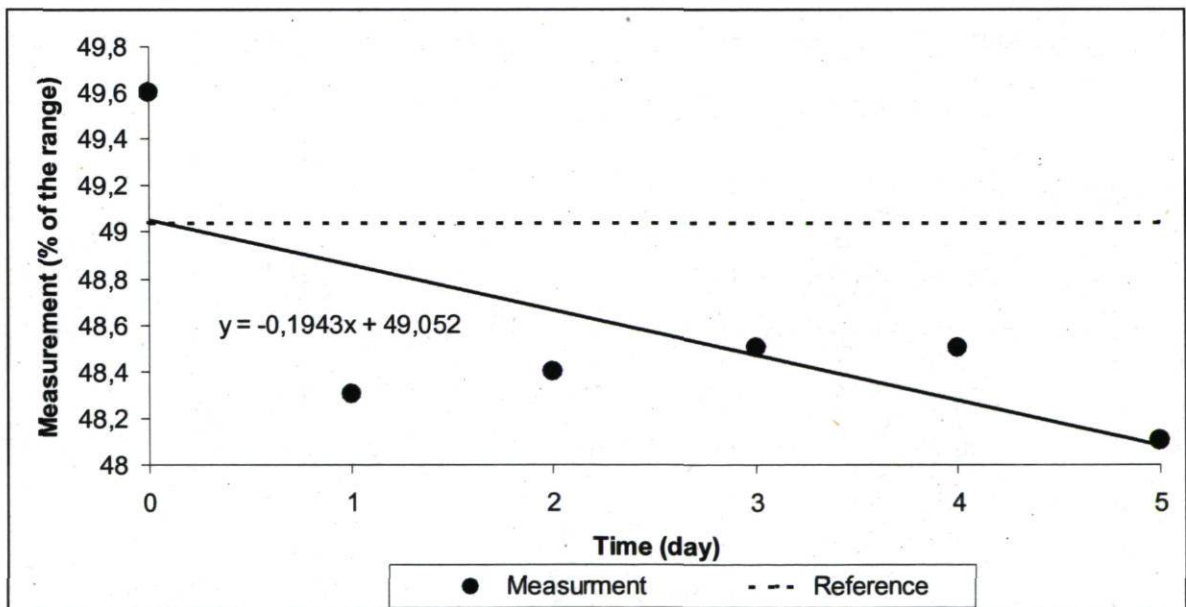

Figure 20: Measurement vs time for Nitratex

The protocol to evaluate sensors suggested by the ISO 15839:2003 is more manufacturer oriented, i.e. each sensor is tested according to its measuring range. For the end-user it would be more interesting to know what the performance of a sensor would be within the measuring range it will be exposed to. So, it would be better to test sensors

within the same range, whatever their measuring ranges are, except if the range of the sensor is too low for the application. By doing so, each sensor could be tested with the same solutions. It would also eliminate effects of the measuring range on the results. The limit of detection and quantification, the repeatability, the lowest detectable change and the day-to-day repeatability are all based on standard deviation, in other words, measurement noise. By testing sensors with the same solutions, those performance criteria would be comparable. In this way the comparison of biases would be more significant as well. Normally bias is distributed equally on both sides of the regression curve. So, with the ISO 15939:2003 protocol it is difficult to compare bias because the tests are not made at the same concentration, as they are dependent on the measuring range. Again it would be more useful for the sensor user to know the bias of each sensor at the same concentration. The last performance criterion that is easier to compare by testing sensors within the same measuring range is the coefficient of variation. As seen before, the coefficient of variation is used to normalise the standard deviation along the measuring range. Since the standard deviation and the measuring range have no links, the measuring range has a large effect on the coefficient of variation. In this case as well it would be better to carry out measurement within the same measuring range.

#### 5.1.5 Conclusion

In the ISO 15839:2003 protocol it is suggested to present results by putting data in a table. However, a graphical way to present results allows to rapidly identify which sensor gives the best performance. In addition, the accuracy profile approach should be taken into consideration, as it is more end-user oriented, i.e. end-users can evaluate the performance of sensors based on their needs.

Except for the case that one sensor gives the best performance for every criterion, it can be difficult to select the right sensor. Depending on the use of the sensor (monitoring, control, etc.) and the location it will be used in (process, river, lake, etc.) some criteria will take precedence over others. For example, if the sensor is to be used in control in an aeration tank of a WWTP, important criteria will be repeatability, in other words, measurement noise: low measurement noise helps to do better control. In that case the drift is not a big issue because maintenance and calibration can easily be conducted by



operators. On the other hand, if the sensor is used to do monitoring in a remote location, then the drift is an important issue because regular maintenance will be difficult. In addition to giving a standard procedure to test sensors, the ISO 15839:2003 protocol should provide guidelines for end-users to interpret the testing results.

The tests must be conducted according to the measuring range expected by the end-user rather than by the one of the sensor manufacturer. This method would allow to compare sensors on the same basis.

It has been seen in the review of sensors that manufacturers are not providing the values required by the ISO 15839:2003. Even if the ISO protocol could be improved, manufacturers should provide the ISO numbers because the definitions are standardized and end-users will be informed of where the results are coming from and how they are calculated.

## 5.2 Standardised field conditions

This section illustrates the behaviour of sensors under field conditions reproduced in laboratory. Two interferences occurring in the field have been reproduced in the lab: air bubbles and turbidity. Air bubble effects have been tested on a turbidity sensor (Solitax) and on two nitrate sensors (Spectro::lyser<sup>tm</sup> and Nitratax) while the effects of turbidity have only been tested on the Spectro::lyser<sup>tm12</sup>.

### 5.2.1 Air bubbles

Figure 21 shows some of the measurements made by the Spectro::lyser<sup>tm</sup> under aeration with different air pressures fed to the diffuser; the sensor was exposed to a nitrate-free solution. Two major effects can be observed. First, the noise is considerably increased: Table 6 shows the standard deviation and the mean of the measurements for each pressure. Depending on the pressure, the standard deviation is amplified between six to nine times compared to the one without aeration in the tank. A second effect is the bias that is generated. It is clear that a shift occurs between measurements with and without aeration.

---

<sup>12</sup> The Nitratax was not available when the tests about the effects of turbidity were conducted.



The value of the means are given in Table 6. The offset generated is from 0.8 to 1.5 mg NO<sub>3</sub>-N/L depending on the pressure.

Another interesting information is the amount of NaN (not a number) given by the sensor amplifier. Outputting a NaN means that the measurement is out of range (lower or upper limit of the range). It can be seen that the presence of air bubbles creates NaN, but there is no correlation between air flow and number of NaN.

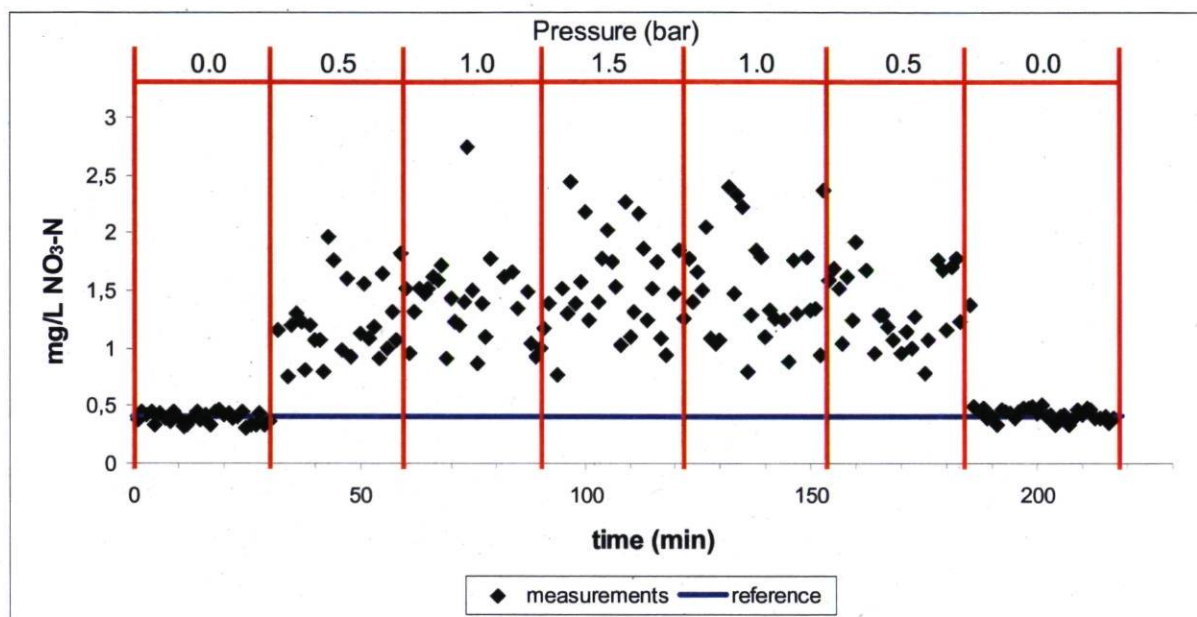

**Figure 21:** Nitrate concentration vs time for different air pressures applied to the Spectro::lyser™ for a solution at 0 mg NO<sub>3</sub>-N/L

**Table 6:** Mean and standard deviation for each pressure applied to the Spectro::lyser™ for a solution at 0 mg NO<sub>3</sub>-N/L

Pressure (bar)	mean (mg NO <sub>3</sub> -N/L)	standard deviation	NaN
0,0	0,39	0,05	0
0,5	1,22	0,32	4
1,0	1,41	0,38	5
1,5	1,54	0,42	2
1,0	1,51	0,45	3
0,5	1,29	0,35	6
0,0	0,42	0,05	0

Figure 22 and Table 7 show the data and results for a similar experiment but now with a solution at 3 mg NO<sub>3</sub>-N/L. The effects of air bubbles are similar, i.e. noise amplification and generation of a systematic bias. The bias and the noise are lower than the previous experiments at the maximum flow rate. On the other hand, the number of NaN is larger. At 1.5 bar there are twelve NaN, representing more than one third of the data taken at this pressure. It can be expected that these NaN's represent high values, so probably the bias and the measurement noise would be greater. For monitoring, having NaN values is not such a big issue, at least for a high measurement frequency, but if the measuring interval is greater, e.g. only one measurement every hour, losing one third of the measurements could be problematic. If the sensor is used in a control loop, the controller has to tolerate (or ignore) NaN as an input.

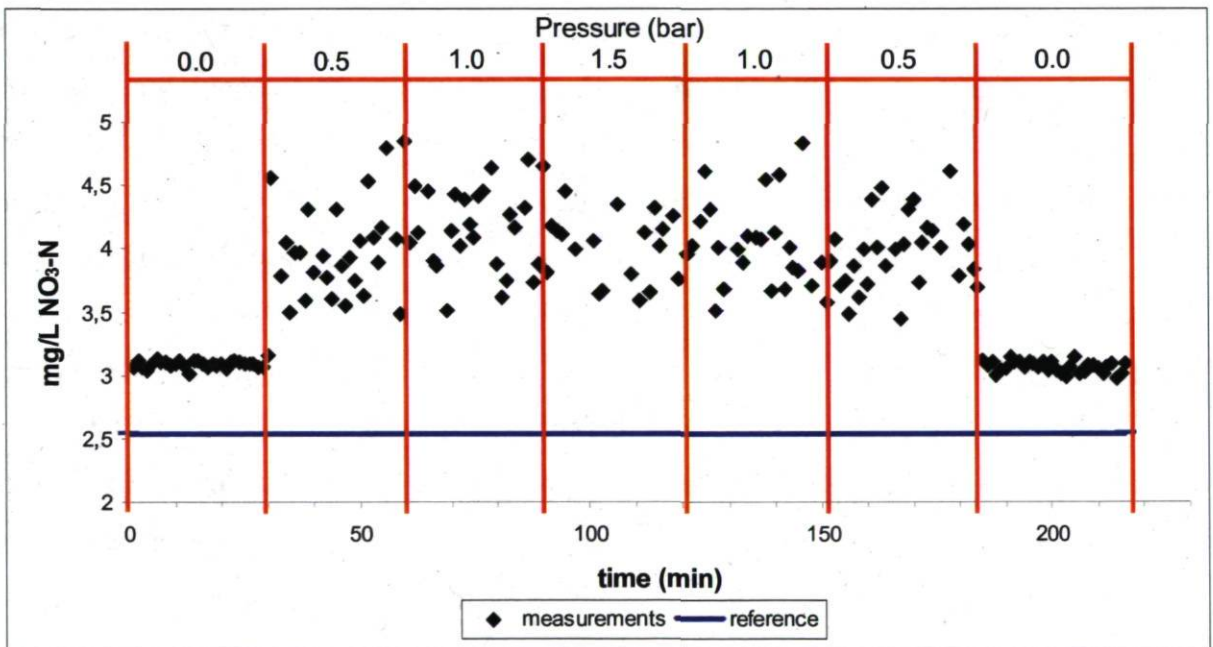

Figure 22: Nitrate concentration vs time for different air pressures applied to the Spectro::lyser<sup>tm</sup> for a solution at 3 mg NO<sub>3</sub>-N/L

**Table 7: Mean and standard deviation for each pressure pressure applied to the Spectro::lyser<sup>tm</sup> for a solution at 3 mg NO<sub>3</sub>-N/L**

Pressure (bar)	mean (mg NO <sub>3</sub> -N/L)	standard deviation	NaN
0,0	3,08	0,03	0
0,5	3,99	0,36	3
1,0	4,15	0,33	4
1,5	4,00	0,26	12
1,0	4,01	0,34	5
0,5	3,95	0,34	4
0,0	3,06	0,04	0

Figure 23 and Table 8 show the data and results for the Nitratax with a solution of approximately 10 mg NO<sub>3</sub>-N/L (9,11 mg NO<sub>3</sub>-N/L). As mentioned in Materials and Methods, the applied procedure in terms of pressures applied is not exactly the same. Air bubbles are again amplifying the noise. However, the noise with aeration is less than twice the one without aeration, compared to nearly ten times for the Spectro::lyser<sup>tm</sup>. This could be explained by the difference between the path lengths of the probes, 1 mm for the Nitratax vs. 35mm for the Spectro::lyser<sup>tm</sup>. With such a small gap, the Nitratax allows only few bubbles to pass between the lenses. The presence of air bubble generates again a bias, but it is less than 1%, which could also be explained by the narrower gap between the lenses. During aeration the trend is similar to what has been observed with the Spectro::lyser<sup>tm</sup>, i.e. the bias is proportional to the air pressure. Two things differ from what has been observed with the Spectro::lyser<sup>tm</sup>: first, the difference between the mean of the measurements of the first 30 minutes and the mean of the measurements of the first period of aeration is negative. However, the variation is smaller than the lowest detectable change at 20% of the measuring range (0.1549 mg NO<sub>3</sub>-N/L, see Table 5) of the Nitratax, which means that the variation is not significant. This non significance holds for every pressure tested. The second observation is the difference between the two periods without aeration. As said before the bias is not significant, but the observed noise amplification between both unaerated tests could be due to an air bubble stuck on the lens or by the presence of remaining small air bubbles in the tank after the aeration was stopped.



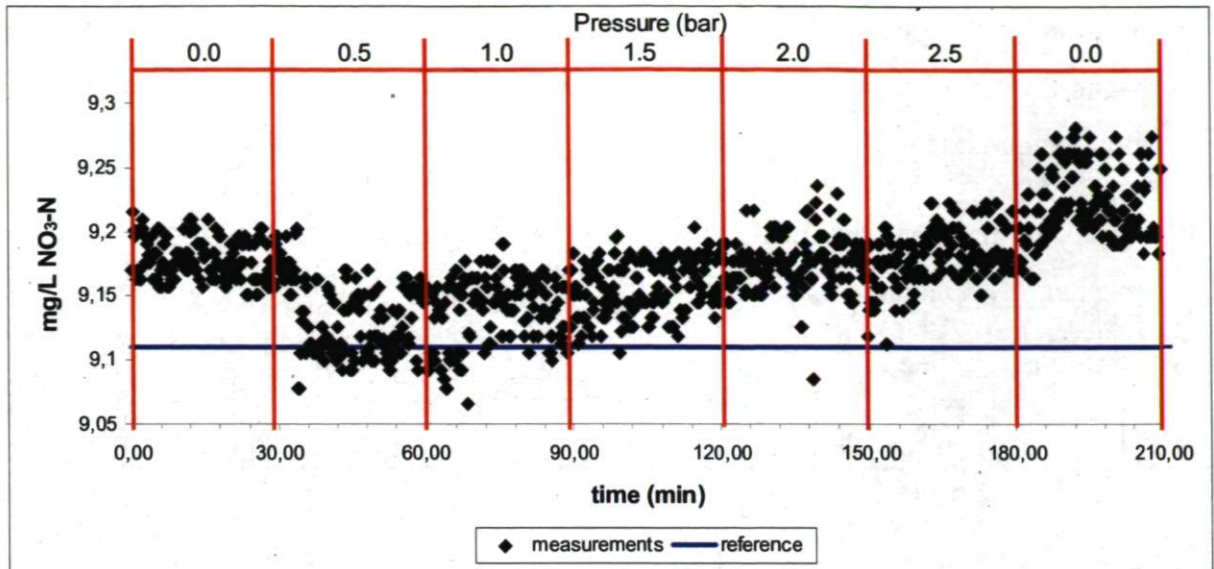

Figure 23: Nitrate concentration vs time for different air pressures applied to the Nitratax for a solution at approximately 10 mg  $\text{NO}_3\text{-N/L}$

Table 8: Mean and standard deviation for each pressure applied to the Nitratax for a solution at 10 mg  $\text{NO}_3\text{-N/L}$

Pressure (bar)	mean (mg $\text{NO}_3\text{-N/L}$ )	standard deviation	NaN
0,0	9,18	0,015	0
0,5	9,13	0,027	0
1,0	9,14	0,026	0
1,5	9,16	0,021	0
2,0	9,17	0,022	0
2,5	9,18	0,020	0
0,0	9,22	0,029	0

Figure 24 shows results from a similar experiment but with a turbidity sensor, the Solitax. Similar effects as seen before occur, i.e. systematic bias and amplification of measurement noise. However, Table 9 shows that in this case no NaN are generated. The standard deviation and bias seem to be correlated to the air flow rate; the higher the flow rate, the higher the standard deviation and the bias. Another thing that can be observed is that in the end, even with the aeration stopped there is still a bias. Figure 24 shows periods of 30 min for each step, but the recorder was still on hours after the end of experimentation. Only after approximately two hours after the last aeration period the turbidity measured by the sensor went down to its initial value. As for the Nitratax, two things could explain this

bias, i.e. an air bubble could have been stuck on the optics of the sensor and was only released after a certain period, or the presence of remaining small air bubbles in the tank after the aeration was stopped.

No test has been made with a solution with a higher turbidity due to the elevated cost that it would have induced to fill the tank with a standard turbidity solution.

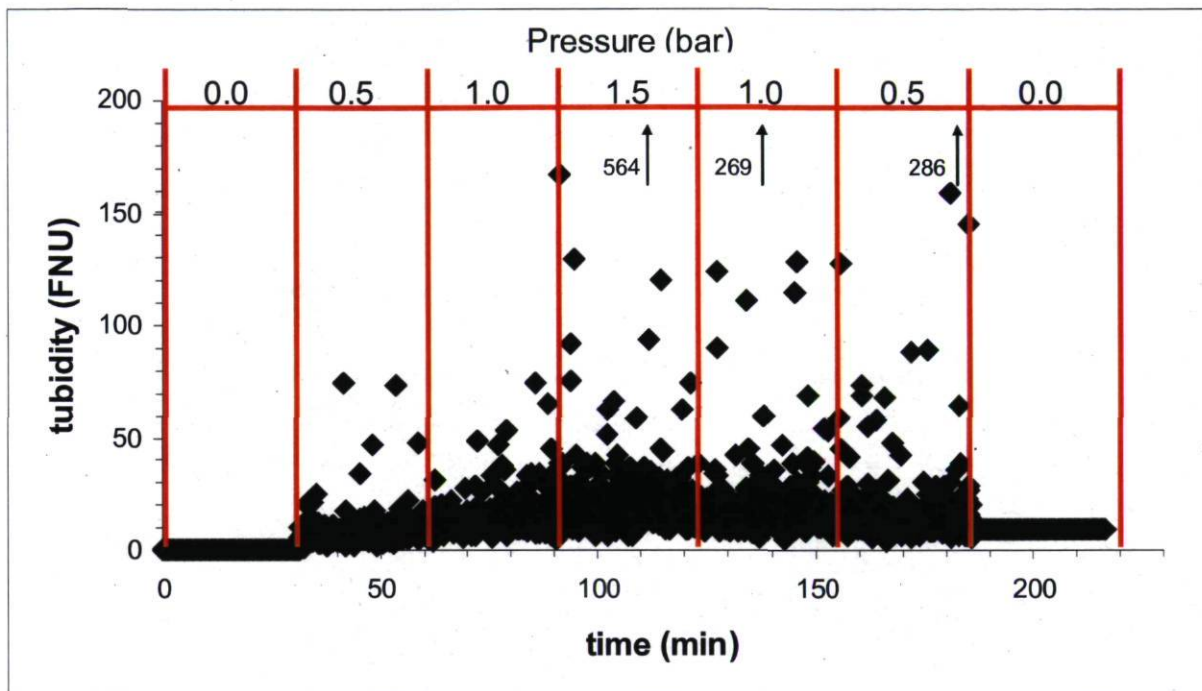

Figure 24: Turbidity vs time for different air pressures applied to the Solitax for a solution at 0 FNU

Table 9: Mean and standard deviation for each pressure applied to the Solitax for a solution at 0 FNU

Pressure (bar)	mean (FNU)	standard deviation	NaN
0,0	0,32	0,04	0
0,5	8,32	7,02	0
1,0	14,38	7,69	0
1,5	22,36	32,92	0
1,0	19,01	19,34	0
0,5	17,23	19,16	0
0,0	9,30	0,09	0

## 5.2.2 Turbidity

Two turbidity standards were used to evaluate the effects of turbidity on nitrate measurements: formazin and AMCO Clear<sup>®</sup>. As seen before, both have advantages and disadvantages. After testing both, based on the results and on the pros and cons, a choice will be made for further testing of the effect of turbidity on measurements.

### 5.2.2.1 Formazin

Figure 25 and Figure 26 show the stability of the suspension of formazin over time in the measuring cell of the Spectro::lyser<sup>™</sup>. On each figure, measurements for a given concentration, with and without mixing, can be seen. Figure 25 shows measurements at 50 FNU. A first thing to observe is the important offset, approximately 30 FNU. No local calibration was made before experimentation; all tests have been carried out with the global calibration (manufacturer calibration). Secondly, both tests do not start at the same turbidity even though they have been made with the same solution. This indicates that even with the same solution, it could happen that particles are not perfectly distributed. Thirdly, the particles tend to settle and agitation<sup>13</sup> seems to reduce suspension stability. The same observation can be made on Figure 26, i.e. the offset between tests is nearly the same but the settling rate of the test at 10 FNU with agitation is slower than the one at 50 FNU.

---

<sup>13</sup> Mixing was performed by performing rotations over 90° twice every minute (alternating between clockwise and anticlockwise).



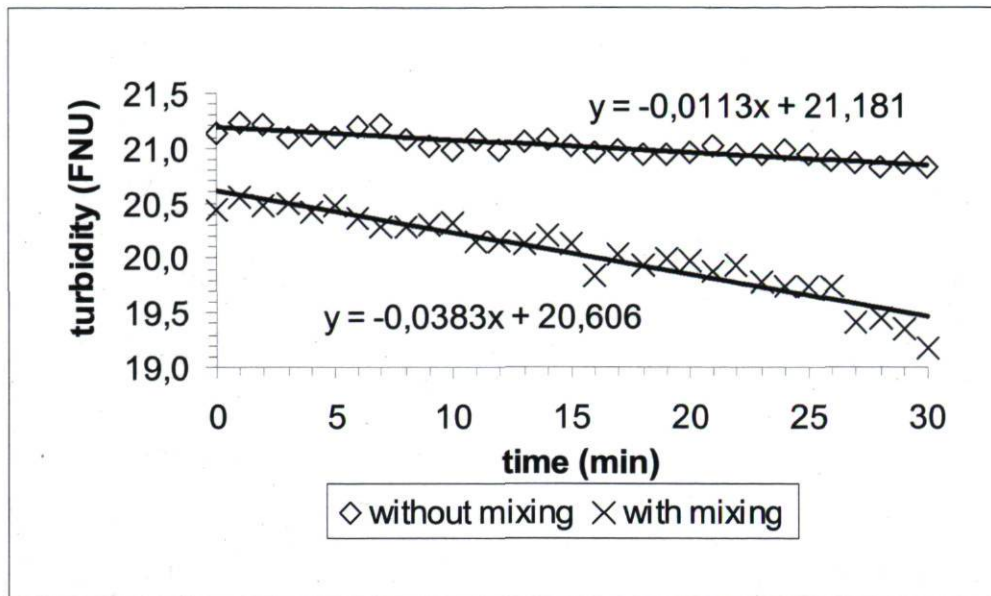

Figure 25: Formazin stability (with and without mixing) for a concentration of 50 FNU

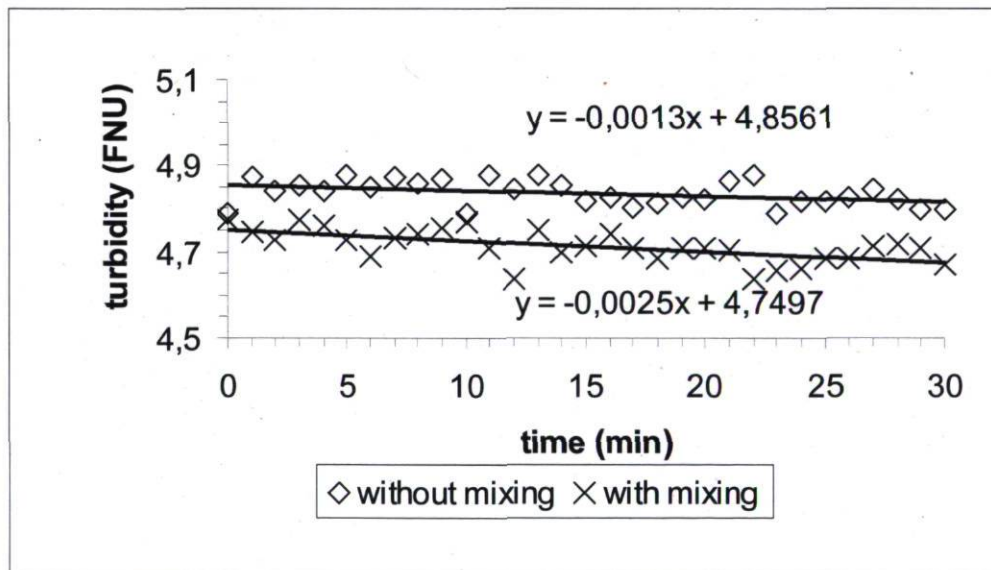
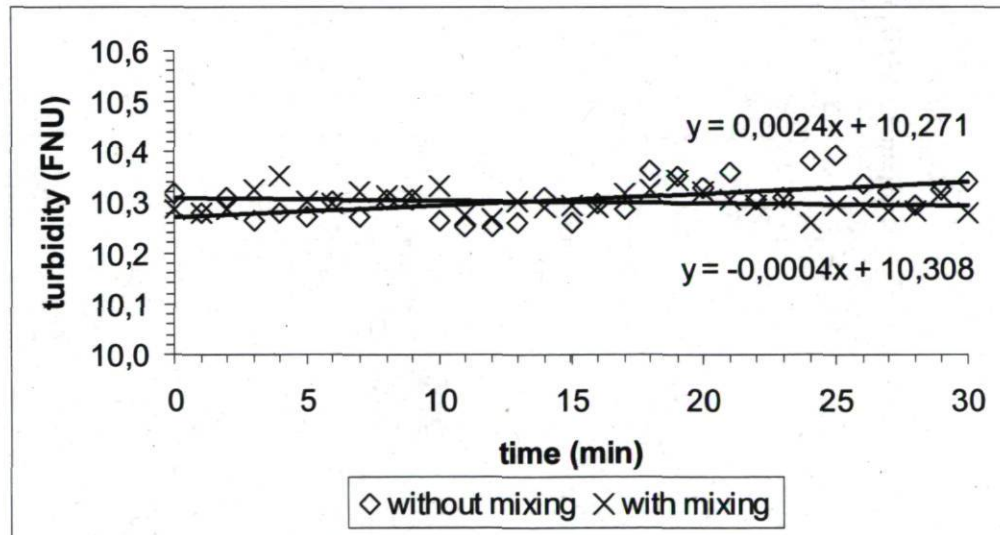

Figure 26: Formazin stability (with and without mixing) for a concentration of 10 FNU

#### 5.2.2.2 AMCO Clear®

Figure 27 and Figure 28 show the stability of the suspension of AMCO Clear® at 50 FNU with and without agitation for a concentration of a solution of 50 FNU directly from the manufacturer (Figure 27) and a solution of 50 FNU made in the laboratory by

dilution of a more concentrated solution with nano-water (Figure 28). Figure 29 shows results of the stability test for a 10 FNU solution made via dilution. It can be seen in Figure 27 that AMCO Clear® is more stable than formazin. The slope of the regression is less steep, and is even positive in one test. There is no significant difference between the two tests, which means that the particles are homogeneously distributed in the solution. However, experiments with the solution made with dilution seem to have the same behaviour as the formazin experiments, i.e. the density of the water used is lower than that of the particles. However, the dilution made to have a solution at 10 FNU is really stable, even more than the standard 50 FTU. The difference between the solution of 50 and 10 FNU diluted could be explained by the dilution ratio. The solution at 50 FNU was prepared based on the standard of 1000 FNU while the solution at 10 FNU was prepared from the standard of 50 FNU, i.e. the dilution ratio is 20:1 vs 5:1. Hence, the additives in the standard to adjust the solution density could still have their effects in the 10 FNU solution.



**Figure 27: AMCO Clear® stability (with and without mixing) for a concentration of 50 FNU (non-diluted)**

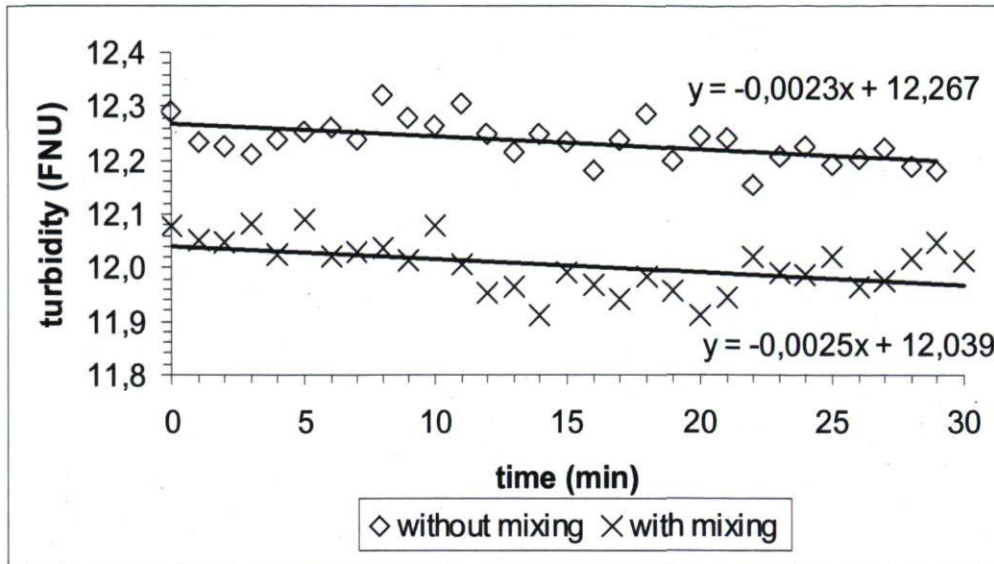

Figure 28: AMCO Clear® stability (with and without mixing) for a concentration of 50 FNU (diluted)

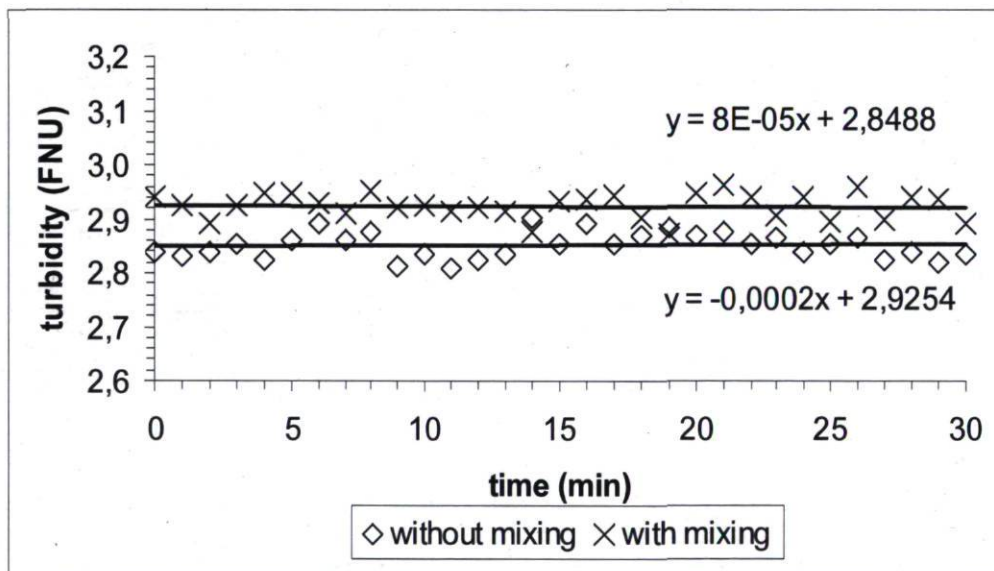

Figure 29: AMCO Clear® stability (with and without mixing) for a concentration of 10 FNU (diluted)

After these tests, it is obvious that AMCO Clear® has a better stability than formazin over time. Dilutions of AMCO Clear® are at least as good as formazin. For these reasons, the subsequent tests to determine the effects of turbidity on nitrate measurements have been carried out with AMCO Clear®. Since it is more reproducible to not agitate by hand, no mixing was performed during the further testing.



There are important biases found on the turbidity measurements; this can be explained by the fact that no local calibration was conducted on turbidity. In addition, the bias is not the same for formazin and AMCO Clear® for a specific turbidity. The optical properties of these compounds are probably responsible for those differences.

#### 5.2.2.3 Effects of turbidity on nitrate measurements

Figure 30 shows the effects of turbidity on nitrate measurements with the Spectro::lyser™. The first 30 minutes of measurements is made in a solution containing 3 mg/L of NO<sub>3</sub>-N and the second 30 minutes with the same solution but spiked with AMCO Clear® turbidity at 10 FNU. A first thing to observe is the bias generated by turbidity. As seen on Figure 30, before the addition of turbidity, measurements are equal to the reference value, but the addition of turbidity creates a negative shift of more than 50% (see Table 10). It would be logical to think that turbidity would generate a positive shift on an optical nitrate measurement because it is based on absorbance at a particular wavelength and particles in suspension absorb light in the entire measuring range of the Spectro::lyser™. So, for a same nitrate concentration but for a higher turbidity the absorbance should be greater and the nitrate measurement should be higher. In fact it is, but the software of the sensor compensates for the higher absorbance due to turbidity. In this case the software overcompensates, and this could probably be fixed with a local calibration. However, the problem with local a calibration is that by trying to increase the accuracy for specific conditions it will move the problem somewhere else and will appear again when conditions change.

Another effect observed in Figure 30 is that the measurement noise is increased by the presence of turbidity. Table 10 gives the standard deviation of the measurements before and after the addition of turbidity. The measurement noise with turbidity is more than twice the one of a clear solution. Again, for monitoring noise is not such a big issue, but in control this noise has to be filtered.

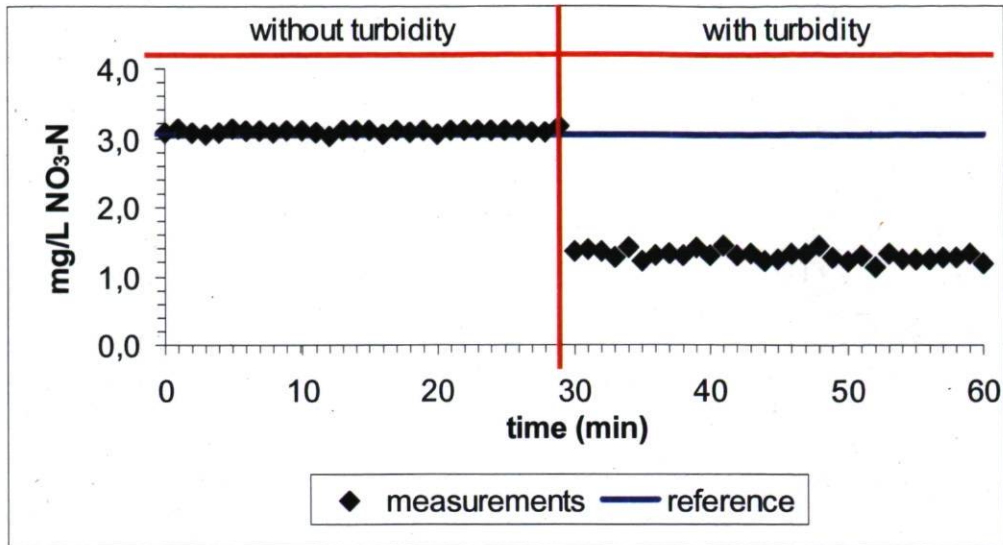

**Figure 30: Effects of turbidity on nitrate measurements with the Spectro::lyser™ (3 mg/L NO<sub>3</sub>-N and 10 FNU)**

**Table 10: Mean and standard deviation for each turbidity (0 and 10 FNU) with the Spectro::lyser™ for a solution at 3 mg NO<sub>3</sub>-N/L**

turbidity (FNU)	mean (mg NO <sub>3</sub> -N/L)	standard deviation
0	3,08	0,029
10	1,30	0,070

### 5.2.3 Conclusion

A procedure to evaluate effects of field conditions on measurements has been developed. First, a setup has been made to recreate conditions to which sensors are exposed in an aeration tank of a WWTP. Three indicators have been used to evaluate effects: bias, standard deviation and the number of NaN (not a number).

The effects of air bubbles, i.e. noise amplification and bias, are proportional to the air pressure supplied to the air diffuser. In the case of the NaN outputted by the Spectro::lyser™, no correlation could be clearly identified between the air pressure and the number of NaN, but the aeration clearly has an effect on it. Due to its small path length, the Nitratax is less affected by the presence of air bubbles: the bias is within the lowest detectable change, no NaN were outputted and the amplification of noise remained low.

The second interference simulated was turbidity. Tests to see which turbidity standard, formazin or AMCO Clear<sup>®</sup>, is the most stable shows that AMCO Clear<sup>®</sup> settles less than formazin, even when dilutions are made. In addition, AMCO Clear<sup>®</sup> has the advantages of being non toxic, having a more uniform particle size and having a longer shelf life. The same indicators of interference as for the air bubbles have been used. In this case no NaN occurred. In the case of the Spectro::lyser<sup>™</sup>, the presence of turbidity generated a negative bias and the standard deviation was increased.

The two simulated field conditions demonstrate that there is a gap between laboratory measurements and field measurements. End-users without a lot of knowledge about sensors, cannot predict, based on the laboratory performance of sensors, how sensors will behave during field operation. This is why there is a need for a standardized protocol for testing sensors under field conditions.





**CHAPTER VI**

**CONCLUSION**





## 6.1 Study summary

### 6.1.1 Protocol and sensors review

This study had two main objectives. The first one was to characterise sensors according to available protocols in order to evaluate the performance of on-line and in-line sensors in the water quality field and to determine whether the results of those tests are meaningful and useful to select the right sensor for a specific application.

The principle protocol available for this is the ISO 15839:2003 protocol, Water quality – On-line sensors/analysing equipment for water - Specifications and performances tests. First a sensors review was made to see whether manufacturers are providing ISO data about their sensors. The review has been made for sensors measuring the following compounds: nitrate, nitrite, ammonia, phosphate, dissolved oxygen and turbidity. The review showed that companies are providing really little information defined in the ISO 15839:2003 protocol. To figure out why companies are not providing information of the ISO 15839:2003 protocol, it has been critically reviewed.

The ISO 15839:2003 protocol has two main parts. The first one is for laboratory testing which gives the performance of sensors in reproducible conditions. Advantages of this part of the protocol are that the sensors can be compared on the same basis and results do not depend on the place and the time the tests are made. On the other hand, this part of the protocol does not help to predict what the sensor behaviour will be under field conditions. Six nitrate sensors using an optical measuring principle were subject to the laboratory tests for the review of this part of the protocol.

The results showed that when sensors have different measuring ranges, it would be better to test the sensors for a given, common measuring range so as to compare the performance characteristics obtained. Emphasis should be put on a graphical presentation of the data rather than just providing numbers, e.g. the short term drift (see Figure 19) or the accuracy profile where many characteristics can be calculated. The ISO 15839:2003 protocol is manufacturer oriented, and it should be more oriented to end-users to help them select the right sensors for their specific application. Guidelines should be added to the ISO

protocol to help end-users understand the performance criteria and to help them to know on which criteria they should put the emphasis for their application.

The second part of the ISO 15839:2003 protocol is about field testing. This part of the protocol is to evaluate the performance of sensors under specific field conditions. It has the disadvantage of being time and site specific, which does not give the opportunity to compare different sensors if they are not tested at the same time in the same place. The sensor review showed that there are different measuring principles for each compound and each of them reacts in different way to interferences. Since one of the goals is compare sensors, a need for standardized field conditions has occurred.

#### 6.1.2 Standardized field conditions

The second goal of this study was to develop a protocol reproducing conditions to which sensors are exposed while they are measuring and to evaluate effects of those perturbations.

Two different potential interferences have been selected: presence of air bubbles and turbidity. The effects of air bubbles have been tested on a spectrometer and on a turbidity sensor while the effects of turbidity have only been tested on a spectrometer. Air bubbles have different effects. They increase the measurement noise and they also generate an offset. Finally in the case of the spectrometer, when the measurements exceed the upper limit of the measuring range, the probe is giving NaN (not a number).

The nitrate measurement with the Spectro::lyser<sup>tm</sup> is influenced by the presence of turbidity in the solution. It increases the noise level and it generates a negative offset. This offset comes from the fact that the software tries to compensate for the presence of turbidity.

It also has been concluded that AMCO Clear® is a better product than formazin to carry out turbidity tests due to its greater stability, more homogeneous particle size and it is non toxic.



The standardised field conditions testing procedure is helpful to compare sensors and predict which one would give better performance under field operation. It would help end-users to select sensors according to their application in a far better way than if they only can be using laboratory performance information.

## **6.2 Further work**

This study has helped to go deeper into sensors characterisation. Regarding sensor characterisation of performances in the laboratory it would be interesting to test sensors according to the accuracy profiles (Hubert et al., 2004) to see how it could be integrated into standard protocols already in place. It would be important to extend the review of protocols on others measuring principles and on others compounds.

Concerning the standardized field conditions, it would be important to extend the proposed tests to other interferences (such as pH, ionic strength, temperature, etc.). So far, only two interferences have been tested for one measuring principle. For instance, an important issue for sensor operation is fouling, often caused by the formation of biofilms at the surface of the sensors. By simulating the occurrence of biofilms, effects on measurements could be tested and the efficiency of auto-cleaning systems as well.

Due to a lack of information provided by the manufacturers, cost could not been taken into account. It should have been included into the selection procedure, not only including the investment costs but all the costs presented in Table 2, i.e. maintenance, installation, consumables, etc. Lifecycle assessment could also be studied and included in selection criteria for sensors.





## **REFERENCES**





- APHA (1992). *Standard Methods for the Examination of Water and Wastewater*, 18th ed. Washington DC.
- Andersen, K.L. and Wagner, P. (1990). Testing on-line monitors for ammonia, orthophosphate and suspended solids in activated sludge treatment plants. In: *Instrumentation, Control and Automation of Water and Wastewater Treatment and Transport Systems (Advances in Water Pollution Control 10)*. Ed. Briggs R., Pergamon Press, London, 667–675.
- Aspegren, H., Nyberg, U. and Andersson, B. (1993). Integration of on-line instruments in the practical operation of the Klagshamn wastewater treatment plant. *Med. Fac. Landbouww. Univ. Gent*, **58**, 2019–2028.
- Automation of Wastewater Treatment Facilities* (2005). Water Environment Federation/McGraw-Hill, Alexandria, USA.
- Barnard, J.L. and Crowther, R. (1993). Instrumentation in biological nutrient removal plants. In: *Preprints of 6th IAWQ Workshop on ICA of Water and Wastewater Treatment and Transport Systems*. June 17–19, Banff, Canada.
- Blake-Coleman, B.C., Clarke, D.J., Calder, M.R. and Moody, S.C. (1986). Determination of reactor biomass by acoustic-resonance densitometry. *Biotech. Bioeng.*, **28**, 1241–1249.
- Cammann, K. and Schroeder, A. (1979). *Working with Ion-Selective Electrodes*. ISBN 0387-09320-6. Springer Verlag, New York, USA.
- Campbell Scientific (2006). *Turbidity Standards*: [http://www.d-a-instruments.com/turbidity\\_standards.html](http://www.d-a-instruments.com/turbidity_standards.html) (accessed 20 July 2009)
- Davey, C.L., Davey, H.M., Kell, D.B. and Todd, R.W. (1993). Introduction to the dielectric estimation of cellular biomass in real-time, with special emphasis on measurements at high-volume fractions. *Anal. Chim. Acta.*, **279**, 155–161.
- Dobbs, R.A., Wise, R.H. and Dean, R.B. (1972). The use of ultra-violet absorbance for monitoring the total organic carbon of water and wastewater. *Wat. Res.*, **6**, 1173–1180.
- Endress+Hauser (2006a). Measuring Dissolved Oxygen – OxyMax W COS 31.
- Endress+Hauser (2006b). OxyMax W COS 61- Dissolved oxygen measurement.
- EURACHEM (1998). *The Fitness for Purpose of Analytical Methods*. Edition 1.0, LGC (Teddington)
- Gippel, C.J. (1995). Potential of turbidity monitoring for measuring the transport of suspended-solids in streams. *Hydrol. Proc.*, **9**(1), 83–87.

Hach (2005). Hach LDO<sup>®</sup> Dissolved Oxygen Probe. *Lit. No. 2455*. Printed in USA.

Harremoës, P., Capodaglio, A.G., Hellström, B.G., Henze, M., Jensen, K.N., Lynggaard Jensen, A., Otterpohl, R. and Soeberg, H. (1993). Wastewater treatment plants under transient loading – performance, modelling and control. *Wat. Sci. Tech.*, **27**(12), 71–115.

Hauduc, H. (2007). *L'Application de la Méthode des Profils d'Exactitudes à Différentes Techniques d'Analyses Environnementales*. M.Sc thesis, AgroParisTech/brgm, Paris, France.

Hubert, P., Nguyen-Huu, J.-J., Boulanger, B., Chapuzet, E., Chiap, P., Cohen, N., Compagnon, P.-A., Dew'e, W., Feinberg, M., Lallier, M., Laurentie, M., Mercier, N., Muzard, G., Nivet, C. and Valat, L. (2004). Harmonisation of strategies for the validation of quantitative analytical procedures. A SFSTP proposal – part I. *J. Pharm. Biomed. Anal.*, **36**(2004), 579-586.

ISO (2008). *Water quality – On-line sensors/analysing equipment for water – Specifications and performances tests*, ISO Standard 15839, Geneva, Switzerland.

Jones, A., Young, D., Taylor, J., Kell, D.B. and Rowland, J.J. (1998). Quantification of Microbial productivity via multi-angle light scattering and supervised learning. *Biotech. Bioeng.*, **59**, 131–143.

Lynggaard-Jensen, A., Eisum, N.H., Rasmussen, I., Svankjær Jacobsen, H. and Stenstrøm, T. (1996). Description and test of a new generation of nutrient sensors. *Wat. Sci. Tech.*, **33**(1), 25–35.

MacCraith, B., Grattan, K.T.V., Connolly, D., Briggs, R., Boyle, W.J.O. and Avis, M. (1993). Cross comparison of techniques for the monitoring of total organic carbon (TOC) in water resources and supplies. *Wat. Sci. Tech.*, **28**(11–12), 457–463.

MSDS HyperGlossary (2009). ILPI: <http://www.ilpi.com/MSDS/ref/nfpa.html> (accessed 01 August 2009)

November, E.J. and Van Impe, J.F. (2001). On-line viable biomass measurement and estimation of the specific growth rate of activated sludge from municipal wastewater treatment. *Wat. Sci. Tech.*, **43**(7), 97–102.

Olsson, L. and Nielsen, J. (1997). On-line and *in situ* monitoring of biomass in submerged cultivations. *TIBTECH*, **15**, 517–522.

Olsson, G., Nielsen, M.K., Yuan, Z., Lynggaard-Jensen, A. and Steyer, J.P. (2005). *Instrumentation, Control and Automation in Wastewater Systems*. IWA, London, USA.



- Oxford Online Dictionary* (2005). University Press: [http://www.oup.com/oald/bin/web\\_getald7index1a.pl?search\\_word=Accuracy](http://www.oup.com/oald/bin/web_getald7index1a.pl?search_word=Accuracy) (accessed 07 July 2009)
- Patry, G.G. and Takács, I. (1995). Modelling, simulation and control of large-scale wastewater treatment plants: an integrated approach. *Med. Fac. Landbouww. Univ. Gent*, **60**, 2335–2343.
- Petersen, B., Gernaey, K. and Vanrolleghem, P.A. (2002). Anoxic activated sludge monitoring with combined nitrate and titrimetric measurements. *Wat. Sci. Tech.*, **45**(4–5), 181–190.
- Pfannkuche, J. and Schimdt, A. (2003). Determination of suspended particulate matter concentration from turbidity measurements: particle size effects and calibration procedures. *Hydrol. Proc.* **17**(10), 1951–1963.
- Rieger, L., Langergraber, G. and Siegrist, H. (2006). Uncertainties of spectral in situ measurements in wastewater using different calibration approaches. *Wat. Sci. Tech.*, **53**(12), 187–197.
- Rieger, L., Siegrist, H., Winkler, S., Saracevic, E., Votava, R. and Nadler, J. (2002). In-situ measurement of ammonium and nitrate in the activated sludge process. *Wat. Sci. Tech.*, **45**(4–5), 93–100.
- Rieger, L., Thomann, M., Joss, A., Gujer, W. and Siegrist, H. (2004). Computer-aided monitoring and operation of continuous measuring devices. *Wat. Sci. Tech.*, **50**(11), 31–39.
- Sikow, M. and Pursiainen, J. (1995). Use and maintenance of on-line measurements at Suomenoja wastewater plant. In: *Preprints of IAWQ Specialized Conference on Sensors in Wastewater Technology*, October 25–27, Copenhagen, Denmark.
- Sin, G., Malisse, K., Kotte, K. and Vanrolleghem, P.A. (2003). An integrated sensor for the monitoring of aerobic and anoxic activated sludge activities in biological nitrogen removal plants. *Wat. Sci. Tech.* **47**(2), 141–148.
- Spierings, L. (1998). On-line measurement of viable biomass. *Advanced Instrumentation, Data Interpretation and Control of Biotechnological Processes*. Eds. J. Van Impe, P. Vanrolleghem, and D.M. Iserentant. Kluwer Academic Publishers, Dordrecht, The Netherlands, 41–66.
- Standard Methods for the Examination of Water and Wastewater* (2005). 21st edn, American Public Health Association/American Water Works Association/Water Environment Federation, Washington DC, USA.
- STIP (2006). STIP-scan one sensor for multiple parameters.



Thomsen, H.A. and Nielsen, M.K. (1992). Practical experience with on-line measurements of  $\text{NH}_4^+$ ,  $\text{NO}_3^-$ ,  $\text{PO}_4^{3-}$ , redox, MLSS and SS in advanced activated sludge plants. In: *Proceedings HYDROTOP92, The City and The Water*. Vol. 2, Marseille, France, 378–388.

*Ultralingua Online Dictionary* (2008):

<http://www.ultralingua.com/onlinedictionary/index.html?nv=0&action=define&sub=1&searchtype=stemming&text=moniotoring&service=english2english> (accessed 07 July 2009)

Vanrolleghem, P.A. and Lee, D.S. (2003) On-line monitoring equipment for wastewater treatment processes: state of the art. *Wat. Sci. Tech.*, **47**(2), 1-34.

Wacheux, H., Da Silva, S. and Lesavre, J. (1993). Inventory and assessment of automatic nitrate analyzers for urban sewage works. *Wat. Sci. Tech.*, **28**(11–12), 489–498.

Wacheux, H., Million, J.-L., Guillo, C. and Alves, E. (1996).  $\text{NH}_4^+$  automatic analysers for wastewater treatment plant: evaluation test at laboratory and field level. *Wat. Sci. Tech.*, **33**(1), 193–201.

Wedgewood Analytical (2006):

<http://www.wedgewoodanalytical.com/eh/wedgewood/en/home.nsf/contentview/4FB> (accessed 13 September 2006)

Winkler, S., Rieger, L., Saracevic, E., Pressl, A., Gruber, G. (2004). Application of ion sensitive sensors in water quality monitoring. *Wat. Sci. Tech.*, **50**(11), 105-114.

Yano, T., Okano, K., Masduki, A. and Nishizawa, Y. (1993). Measurement of cell density in cultures of aggregate organisms by continuous-dilution-photometric-assay. *J. Ferm. Bioeng.*, **76**, 123–127.

Zips, A. and Faust, U. (1989). Determination of biomass by ultrasonic measurements. *Appl. Environ. Microbiol.*, **55**, 1801–1807.

**ANNEX A**

**SENSORS REVIEW TABLES – NITRATE**





Principles	UV absorption										
	Company model	AMB	HACH	HACH	HACH	HACH	Secon	CONTECH	WTW	WTW	WTW
	AV-250	loris plus 5100	nitra-plus sc	nitra-ace sc	nitra-clear sc		spectro2	slip scan	nitras	TracCon OS 210	TracCon OS 218
filtration required on/in situ	no on site	no in situ	no in situ	no in situ	no in situ	no in situ	no in situ	no in situ	no in situ	no if low TSS on site	no if low TSS on site
Needs housing											
Spectral range (nm)							190-280/190-780	190-750	200-750		
Number of wavelengths											
measuring range (NO <sub>3</sub> -N mg/L)	0 - 100	0-60	0.1 - 25.0 0.1 - 50.0 0.1 - 100.0	1.0 - 20.0	0.5 - 20.0	0.1-100	0.1-50	0.01 - 25 0.1 - 100	0.1 - 100 100 - 250	0.1 - 100 100 - 250	0.1 - 100 100 - 250
measuring frequency (min)			0.25	5	5	15s		adjustable	cont. - 30	cont. - 30	
Auto calibration	no, manual only	1 point and 3 point calibration						not necessary	yes (kind?)	yes (kind?)	
response time (min)			12 s/-1								
delay time/zero time (min)			5/9 s/-1								
Auto cleaning	wiper	yes						compressed air	cleaning solution	cleaning solution	
protocols available			modbus RS-485 and modbus RS 232								
signal outputs (mA)	0-10, 0-20, 4-20	0-4-20						0-4-20			
linearity											
coefficient of variation (%)											2
limit of detection (mg/L)		0.2	0.1 - 100.0	1.0 - 20.0	0.5 - 20.0			0.1			
limit of quantification (mg/L)		0.6									
repeatability (%)							±0.1 mg/l				
lowest detectable change											
bias											
short term drift											
day-to-day repeatability											
memory effect											
interference											
T <sub>90</sub> (min)	3		0.25	15	5				0.5	0.5	
reproducibility (%)	0.5 mg/l							3%			
precision (%)											
accuracy (%)	2.00	±50 mg/L : ±1-10% ±2mg/L : ±0.2mg/L	3	5	5	±0.2 mg/l		3			
drift (%)											
resolution (mg/L)	0.1		0.1	0.5	0.1				0.1 1	0.1 1	
investment cost (€)											
spare and wear parts cost (\$/year)											
annual cost w/o labor	#DN/01	#DN/01	#DN/01	#DN/01	#DN/01	#DN/01	#DN/01	#DN/01	#DN/01	#DN/01	#DN/01
annual cost w labor	#DN/01	#DN/01	#DN/01	#DN/01	#DN/01	#DN/01	#DN/01	#DN/01	#DN/01	#DN/01	#DN/01
manual maintenance duration (h/week)			1/month	2/month	1/month			none			
manual maintenance interval (month)	12	membrane replacement every 10 weeks		6					6	6	
reagent consumables* (\$/month)								none	0	none	none
consumable cost (\$/year)											
power consumption (W)											
foot	2xAMB AV 250-4	Hach loris plus	Hach nitra-plus sc	Hach nitra-ace sc	Hach nitra-clear sc	Secon spectro2	CONTECH slip scan	WTW nitras	WTW TracCon OS 210	WTW TracCon OS 218	
others		measures sum of nitrate and nitrite				<a href="http://www.secon.com">http://www.secon.com</a>					

technical information

accuracy according to ISO 15189:2003

others

cost





Principles	titration	Fourier transform of the absorption spectrum of NH <sub>2</sub> by adding NaOH			Photometry/colorimetry		
company	Apollon	Chemscan	Chemscan	Chemscan	Chemscan	Apollon	
model	Adi 2016	ur-6101	ur-6100	ur-2150	CA 7018	ad-2016	
technical info matters	filtration required		in dirty water	in dirty water	in dirty water	yes but can be replaced by a	
	or/in situ	or situ	or situ	or situ	or situ	or situ	
	Needs housing						
	Spectral range (nm)		200-450	200-450	200-450		
	Number of wavelengths		256	256	256		
	measuring range (NO <sub>2</sub> -N mg/L)				0.1-10 10-100	0.2-20 1-50 0-200	
	measuring frequency (min)		1	1	1	7	
	Auto calibration		autozeroing	autozeroing	autozeroing	yes (kind?)	yes
	response time (min)		0.5	0.5	0.5		
	delay time/zero time (min)						
Auto cleaning		yes	yes	yes			
protocols available					RS 222 C		
signal outputs (mA)		4-20	4-20	4-20	0/4-20		
accuracy	linearity						
	coefficient of variation (%)						
	limit of detection (mg/L)						
	limit of quantification (mg/L)						
	repeatability (%)						
	lowest detectable change						
	bias						
	short term drift						
	day-to-day repeatability						
	memory effect						
	interference						
	T <sub>90</sub> (min)						
	others	reproducibility (%)					
		precision (%)		2	2	2	
		accuracy (%)		2.5	2.5	2.5	3
drift (%)							
resolution (mg/L)							
cost	investment cost (\$)						
	spare and wear parts cost (\$/year)						
	annual cost w/o labor	#DN/OI	#DN/OI	#DN/OI	#DN/OI	#DN/OI	
	annual cost w labor	#DN/OI	#DN/OI	#DN/OI	#DN/OI	#DN/OI	
	manual maintenance duration (h/week)					0.5/week	
	manual maintenance interval (month)					3	
	reagent consumption* (L/month)		roll every 2 to 4 weeks	roll every 2 to 4 weeks	roll every 2 to 4 weeks	4,4	
	consumable cost (\$/year)					<1	
	power consumption (W)						
	link	Apollon adi 2016	Chemscan ur-6101	Chemscan ur-6100	Chemscan ur-2150	Chemscan CA 7018	Apollon adi 2016
others							





**ANNEX B**

**SENSORS REVIEW TABLES – NITRITE**





	Principle	Photometry/colorimetry			Fourier transform of the absorption spectrum of NH <sub>3</sub> by adding NaOH			
	company model	Endress + Hauser CA 71 NO	WTW TestCon CN 510	Applikon adi-201B	Chemscan ur-3150	Chemscan ur-4100	Chemscan ur-6101	
technical information	titration required	yes	no if low TSS		in dirty water	in dirty water	in dirty water	
	ex situ	ex situ	ex situ	ex situ	ex situ	ex situ	ex situ	
	heads housing							
	Spectral range (nm)				200-450	200-450	200-450	
	Number of wavelengths				256	256	256	
	measuring range (NO <sub>2</sub> -N mg/L)	0,00001 - 0,250 0,01 - 0,5 0,1 - 1 0,2 - 3	0,0004-0,045 0,005 - 0,600 0,020 - 2,000	0-1	0,1-10			
	resolution (mg/L)		0,0001 0,001 0,001					
	response time (min)				3,5	3,5	3,5	
	delay time / rise time (min)							
	measuring frequency	f <sub>max</sub> = 120	5		3	3	3	
	Auto calibration	yes (kind?)	2 points	yes	autozeroing	autozeroing	autozeroing	
	Auto cleaning	yes (kind?)			yes	yes	yes	
	protocols available	RS 232 C						
signal outputs (mA)	0/4 - 20			4-20	4-20	4-20		
accuracy according to ISO 15189:2003	linearity							
	coefficient of variation (%)		1					
	limit of detection (mg/L)							
	limit of quantification (mg/L)							
	repeatability (%)							
	lowest detectable change							
	bias							
	short term drift							
	day-to-day repeatability							
	memory effect	see table 3 below						
	interference							
	T <sub>90</sub> (min)		< 5					
	others	reproducibility (%)						
precision (%)					2	2	2	
accuracy (%)					2-5	2-5	2-5	
cost	investment cost (€)							
	spare and wear parts cost (€/year)							
	annual cost w/o labor	#DN/0/1	#DN/0/1	#DN/0/1	#DN/0/1	#DN/0/1	#DN/0/1	0,00
	annual cost w labor	#DN/0/1	#DN/0/1	#DN/0/1	#DN/0/1	#DN/0/1	#DN/0/1	0,00
	manual maintenance duration (h/week)	0,25						
	manual maintenance interval (month)	6						
	reagent consumption* (L/month)	3		<1	roll away 2 to 4 weeks	roll away 2 to 4 weeks	roll away 2 to 4 weeks	
consumable cost (€/year)								
power consumption (W)								
link	http://www.endress.com/Products/WTW/TestCon/CN510/adi-201B			chemscan ur-3150	chemscan ur-4100	chemscan ur-6101		
others								



**ANNEX C**

**SENSORS REVIEW TABLES - AMMONIUM**





Principles		Gas sensitive electrode				
		- conversion $\text{NH}_4 \rightarrow \text{NH}_3$ in alkaline condition				
company		STP	WTW	Hach	ABB	
model		PBS T-2	TrueCon CA 110	Amlax sc LXV421	8222	
technical information	filtration required	no	no if low TSS	yes	in dirty water	
	on/in situ	in situ	ex situ	ex situ	ex situ	
	Needs housing			no		
	Spectral range (nm)					
	Number of wavelengths					
	measuring range ( $\text{NH}_4\text{-N}$ mg/L)	0,1 - 50,0	0,1 - 10 10,0 - 100 100 - 1000	0,05-20,0 1,0-100 10-1000	any decade between 0,05 - 1000	
	response time (min)					
	resolution (mg/L)		0,01 0,1 1			
	measuring interval (min)			05-janv		
	Auto calibration	standard addition method	automatic 2-point calibration		automatic 2-point calibration	
	Auto clearing protocols available		yes	yes		
	signal outputs (mA)	RS 232 0-20 or 4-20			Modbus 0-1, 0-10, 0-20, 4-20	
accuracy according to ISO 15693:2003	linearity					
	coefficient of variation (%)		3 4 5			
	limit of detection (mg/L)					
	limit of quantification (mg/L)					
	repeatability (%)				2 of the reading	
	lowest detectable change					
	bias					
	short term drift					
	day-to-day repeatability					
	memory effect					
	interference					
	$T_{92}$ (min)	3-5	<3	5	<5	
	others	reproducibility (%)	3			3 of the reading
		precision (%)			3% ± 0,05 mg/l 3% ± 1,0 mg/l 4,5% ± 10 mg/l	
accuracy (%)						
drift (%)						
cost	investment cost (\$)					
	spare and wear parts cost (\$/year)					
	annual cost w/o labor	#DN/01	#DN/01	#DN/01	#DN/01	
	annual cost w labor	#DN/01	#DN/01	#DN/01	#DN/01	
	manual maintenance duration (h/week)					
	manual maintenance interval (month)		6		Month:reagent, cleaning flow system. Year: replace plumbing, pump tubing and pump capacitors	
	reagent consumption <sup>1</sup> (L/month)	1	20			
	consumable cost (\$/year)					
power consumption (W)	45					
link	<a href="#">Ammonia STP PBS T-2.pdf</a>	<a href="#">Ammonia WTW CA 110.pdf</a>	<a href="#">Ammonia Hach Amlax sc.pdf</a>	<a href="#">Ammonia ABB 8222.pdf</a>		
others		no filtration needed for low TSS concentration				

	Principles								
	Colorimetry								
	Ende ana - Hauer	Hach	Hach	Applikon	Hach	Walzen	Walzen		
	model	CA 71 AM	drka 4100	APA 6000 Low range ammonia s	sd-2019	Amtra Ammonia compact analyser	6040	7040	
technical information	filtration required	optional				yes			
	on site	on site	in situ	on site	on site	on site	on site	on site	
	Needs housing	yes				yes			
	Spectral range (nm)								
	Number of wavelengths								
	measuring range (NH <sub>4</sub> -N mg/L)	0.02 - 5 0.2 - 95	0.1-20 0.3-100	0.02 - 2.0 (as N)	0-10	0.5 - 12.0 5 - 120	0-7.5 ppm	0-7.5 ppm	
	response time (min)	0.2 - 100				50 - 1200	5	5	
	resolution (mg/L)								
	measuring interval (min)	1min** - 120	continuous			12			
	Auto calibration			yes (kind?)	yes	yes (kind?)	yes	yes	
Auto cleaning protocols available	RS 232 C				yes (kind?)	yes	yes		
signal outputs (mA)	0-20, 4-20		4 - 20		0.4 - 20	20-avr	20-avr		
accuracy according to ISO 15189:2003	linearity								
	coefficient of variation (%)								
	limit of detection (mg/L)					0.5			
	limit of quantification (mg/L)								
	repeatability (%)	0.005 - 0.1 mg/l 0.005 - 0.1 mg/l 0.5 - 0.2 mg/l		5					
	lowest detectable change								
	bias								
	short term drift								
	day-to-day repeatability								
	memory effect								
errors	interference	see table 1 below							
	T <sub>90</sub> (min)		12 24						
	reproducibility (%)						2%	2%	
	precision (%)		+ 0.3 mg/l ± 10%; < 0.6 mg/l ± 0.06 mg/l ± 1 mg/l ± 10%; < 1 mg/l ± 0.1 mg/l						
	accuracy (%)	2 of the max		5		2.5			
	drift (%)								
	cost	investment cost (€)							
		spare and wear parts cost (€/year)							
		annual cost/w/o labor	2DN/01	2DN/01	2DN/01	2DN/01	2DN/01	2DN/01	2DN/01
		annual cost/w labor	2DN/01	2DN/01	2DN/01	2DN/01	2DN/01	2DN/01	2DN/01
manual maintenance duration (h/week)		15 min/week	15 min						
manual maintenance interval (months)		6	2				once a month, replace	once a month, replace	
reagent consumption (L/month)				1	<1		tubing once a year	tubing once a year	
consumable cost (€/year)						100 VA	100 VA		
power consumption (W)									
link	mmoriaL-H CA 71 AM en.pdf	mmoriaHach drka 4100	mmoriaHach - APA 6000.pdf	mmoriaApplikon adi 2019.pdf	AmresnaHach Amtra.pdf	mmoriaWalzen 6040.pdf	mmoriaWalzen 7040.pdf		
others									





Principles		Fourier transform of the absorption spectrum of NH <sub>3</sub> by adding NaOH				titration	
company model		Chemscan ur-5101	Chemscan ur-4100	Chemscan ur-2150	Detailink AM200	Applikon Ad 2016	
technical information	filtration required	in dirty water	in dirty water	in dirty water	no		
	ex situ	ex situ	ex situ	ex situ	ex situ	ex situ	
	Needs housing						
	Spectral range (nm)	200-450	200-450	200-450			
	Number of wavelengths	256	256	256			
	measuring range (NH <sub>3</sub> -N mg/L)				0-10 0-500		
	response time (min)	3-5	3-5	3-5			
	resolution (mg/L)						
	measuring interval (min)	3	3	3			
	Auto calibration	auto-zeroing	auto-zeroing	auto-zeroing			
	Auto clearing protocols available	yes	yes	yes	yes		
	signal outputs (mA)	4-20	4-20	4-20	0-4-20		
accuracy according to ISO 15629:2003	linearity						
	coefficient of variation (%)						
	limit of detection (mg/L)				0.1		
	limit of quantification (mg/L)						
	repeatability (%)				1		
	lowest detectable change						
	bias						
	short term drift						
	day-to-day repeatability						
	memory effect						
	interference						
	t <sub>90</sub> (min)						
	others	reproducibility (%)					
		precision (%)					
accuracy (%)							
drift (%)							
cost	investment cost (\$)						
	spare and wear parts cost (\$/year)						
	annual cost w/o labor	#DIV/0!	#DIV/0!	#DIV/0!	#DIV/0!	#DIV/0!	
	annual cost w labor	#DIV/0!	#DIV/0!	#DIV/0!	#DIV/0!	#DIV/0!	
	manual maintenance duration (h/week)						
	manual maintenance interval (month)						
	reagent consumption* (L/month)	refill every 2 to 4 weeks	refill every 2 to 4 weeks	refill every 2 to 4 weeks			
	consumable cost (\$/year)						
power consumption (W)							
link	ia/Chemscan ur-5101	ia/Chemscan ur-4100	ia/Chemscan ur-2150.pdf	Ammonia/Amplikon ad 2			
others							

**ANNEX D**

**SENSORS REVIEW TABLES – PHOSPHATE**



	Principles	Fourier transform of the absorption spectrum of NH3 by adding NaOH			colorimetry		
		Chemscan	Chemscan	Chemscan	Hach	Gran-Luebbe	Hach
	company	Chemscan	Chemscan	Chemscan	Hach	Gran-Luebbe	Hach
	model	ur-6101	ur-4100	ur-2150	ovita in situ 4100	90s Kolormeter	Phosphax sc
technical information	filtration required	in dirty water	in dirty water	in dirty water	no		samples
	ex/in situ	ex situ	ex situ	ex situ	in situ	ex situ	ex situ
	Needs housing						
	Spectral range (nm)	200-450	200-450	200-450			
	Number of wavelengths	256	256	256			
	measuring range (PO <sub>4</sub> -P mg/L)				0.05 - 0.6 0.7 - 15	0-0.05 0-6.0	0.015 - 0.15 1 - 50
	resolution (mg/L)						
	measuring frequency (min)	3	3	3	continuous	35	05-janv
	response time (min)	3-5	3-5	3-5			
	Auto calibration	auto-zeroing	auto-zeroing	auto-zeroing	auto (kind?)	yes	yes (kind?)
Auto cleaning protocols available	yes	yes	yes	Hach		yes	
signal outputs (mA)	4-20	4-20	4-20	4-20	0/4-20		
accuracy according to ISO 15209:2003	linearity						
	coefficient of variation (%)						
	limit of detection (mg/L)					0.001 in the lowest detection rate	
	limit of quantification (mg/L)						
	repeatability (%)						
	lowest detectable change						
	bias						
	short term drift						
	day-to-day repeatability						
	memory effect						
interference							
T <sub>2</sub> (min)						< 5	
others	reproducibility (%)						2% of the measured value + 0,05 mg/l + 1,00 mg/l
	precision (%)	<0.5% of range	<0.5% of range	<0.5% of range	0.3-6.0 mg/l: ± 10% < 0.3 mg/l: ± 0.03 mg/l 2.4-15 mg/l: ± 10% < 2.4 mg/l: ± 0.24 mg/l	<3% of full scale	
	accuracy (%)	2 to 5% of range	2 to 5% of range	2 to 5% of range			2% of the measured value + 0,05 mg/l + 1,00 mg/l
	drift (%)					<1% of full scale per day	
cost	investment cost (\$)						
	spare and wear parts cost (\$/year)						
	annual cost w/o labor	#DIV/0!	#DIV/0!	#DIV/0!	#DIV/0!	#DIV/0!	#DIV/0!
	annual cost w labor	#DIV/0!	#DIV/0!	#DIV/0!	#DIV/0!	#DIV/0!	#DIV/0!
	manual maintenance duration (h/week)				0,25		
	manual maintenance interval (month)				2		
	reagent consumption* (L/month)	roll every 2 to 4 weeks	roll every 2 to 4 weeks	roll every 2 to 4 weeks		1 supply lasts 2-3 months	
consumable cost (\$/year)					150 VA		
power consumption (W)							
link	<a href="#">test/Chemscan ur-6</a>	<a href="#">test/Chemscan ur-4</a>	<a href="#">test/Chemscan ur-2</a>	<a href="#">test/Hach ovita in situ</a>	<a href="#">888s 90s Kolormeter</a>	<a href="#">Phosphax sc</a>	<a href="#">Phosphax sc</a>
others							







**ANNEX E**

**SENSORS REVIEW TABLES – TURIDITY**









**ANNEX F**

**SENSORS REVIEW TABLES – DISLOVED OXYGEN**









**ANNEX G**

**RAW DATA – ISO 15839:2003 TESTS**





**Spectro::lyser™**  
**Location: Université Laval**

% of the measuring range	Reference (mg NO <sub>3</sub> -N/L)	Sensor measurements (mg NO <sub>3</sub> -N/L)					
		1	2	3	4	5	6
5	0,75	1,01	0,93	1,00	0,96	1,05	0,98
20	3,00	3,73	3,70	3,75	3,74	3,69	3,72
35	5,25	6,00	6,02	6,09	6,07	6,13	6,12
50	7,50	7,29	7,27	7,26	7,26	7,38	7,25
65	9,75	9,19	9,15	9,24	9,29	9,17	9,03
80	12,00	12,05	12,18	11,80	12,16	12,32	11,88
95	14,25	14,66	14,01	14,09	14,85	13,92	14,39

**Sensor A**  
**Location: Company's laboratory**

% of the measuring range	Reference (mg NO <sub>3</sub> -N/L)	Sensor measurements (mg NO <sub>3</sub> -N/L)					
		1	2	3	4	5	6
5	1,12	0,95	0,93	0,97	0,95	0,96	0,97
20	4,20	4,14	4,11	4,09	4,10	4,10	4,07
35	7,10	7,30	7,28	7,22	7,21	7,21	7,21
50	9,80	10,06	10,09	10,16	10,13	10,06	10,06
65	12,80	13,72	13,99	14,05	14,03	13,98	13,98
80	15,80	17,87	17,86	17,85	17,90	17,84	17,82
95	19,00	21,07	21,04	21,04	21,06	21,04	20,97

**Sensor B (8mm)**  
**Location: Company's laboratory**

% of the measuring range	Reference (mg NO <sub>3</sub> -N/L)	Sensor measurements (mg NO <sub>3</sub> -N/L)					
		1	2	3	4	5	6
5	0,53	0,29	0,31	0,32	0,32	0,31	0,32
20	1,97	1,99	2,00	2,00	1,99	1,98	1,98
35	3,55	3,68	3,67	3,67	3,68	3,68	3,68
50	5,20	5,17	5,18	5,18	5,16	5,18	5,20
65	6,70	6,71	6,82	6,75	6,81	6,83	6,81
80	8,20	8,51	8,42	8,48	8,50	8,52	8,57
95	9,70	10,45	10,42	10,44	10,45	10,43	10,49

**Sensor B (2mm)**

Location: Company's laboratory

% of the measuring range	Reference (mg NO <sub>3</sub> -N/L)	Sensor measurements (mg NO <sub>3</sub> -N/L)					
		1	2	3	4	5	6
5	2,70	3,08	3,06	3,08	3,08	3,07	3,07
20	10,10	10,46	10,54	10,4	10,45	10,47	10,46
35	18,50	18,2	18,43	18,43	18,47	18,45	18,47
50	25,50	27,04	27,18	27,3	27,15	27,34	27,36
65	33,00	36,2	36,39	36,64	36,62	36,57	36,75
80	40,50	45,44	45,38	45,21	45,41	45,36	45,37
95	47,50	55	55,01	54,91	55,08	54,79	54,93

**Sensor C**

Location: Company's laboratory

% of the measuring range	Reference (mg NO <sub>3</sub> -N/L)	Sensor measurements (mg NO <sub>3</sub> -N/L)					
		1	2	3	4	5	6
5	2,70	3,02	3,01	3,02	3,02	3,01	3,02
20	10,10	10,4	10,4	10,4	10,4	10,5	10,5
35	18,50	19,1	19,2	19,7	19,8	19,7	19,9
50	25,50	28	27,9	28,3	28,3	28,3	28,5
65	33,00	36,2	35,7	36,8	36,6	36,8	37,2
80	40,50	45,2	45	45,6	44,9	45,4	44,8
95	47,50	52,7	52,1	53,3	52,8	52,9	52,6

**Nitratax**

Location: EAWAG, Zurich

% of the measuring range	Reference (mg NO <sub>3</sub> -N/L)	Sensor measurements (mg NO <sub>3</sub> -N/L)					
		1	2	3	4	5	6
5	4,81	4,1	4,0	4,1	4,1	4,0	4,1
20	19,04	19,5	19,5	19,5	19,4	19,5	19,4
35	34,78	36,9	35,9	35,7	35,9	35,7	36,1
50	49,04	49,6	48,3	48,4	48,5	48,5	48,1
65	62,66	66,7	64,9	64,8	65,1	64,6	64,5
80	77,74	82,9	82,9	82,9	82,9	83,0	82,9
95	92,83	97,4	96,9	97,3	97,2	96,9	96,8



**ANNEX H**

**RAW DATA – AIR BUBBLES TESTS**



Sensors: Spectro::lyser™

location: Université Laval

Conditions: solution at 0 mg NO<sub>3</sub>-N/L

Related figure: Figure 21

time (min)	measurements (mg NO <sub>3</sub> -N/L)	time (min)	measurements (mg NO <sub>3</sub> -N/L)	time (min)	measurements (mg NO <sub>3</sub> -N/L)
1	0,374	38	0,807	75	1,502
2	0,444	39	1,192	76	0,87
3	0,419	40	1,069	77	1,384
4	0,454	41	1,067	78	1,092
5	0,329	42	0,788	79	1,772
6	0,428	43	1,959	80	NaN
7	0,383	44	1,755	81	NaN
8	0,361	45	NaN	82	1,609
9	0,441	46	0,984	83	NaN
10	0,391	47	1,597	84	1,658
11	0,314	48	0,925	85	1,335
12	0,329	49	NaN	86	NaN
13	0,388	50	1,12	87	1,49
14	0,453	51	1,563	88	1,038
15	0,37	52	1,088	89	0,92
16	0,42	53	1,185	90	0,996
17	0,335	54	0,91	91	1,163
18	0,44	55	1,641	92	1,391
19	0,459	56	0,988	93	NaN
20	0,423	57	1,309	94	0,763
21	0,43	58	1,064	95	1,508
22	0,384	59	1,819	96	1,297
23	0,4	60	1,52	97	2,442
24	0,44	61	0,949	98	1,387
25	0,308	62	1,317	99	1,575
26	0,335	63	1,509	100	2,177
27	0,332	64	1,465	101	1,234
28	0,439	65	1,514	102	NaN
29	0,337	66	1,622	103	1,397
30	0,36	67	1,588	104	1,768
31	NaN	68	1,712	105	2,018
32	1,16	69	0,909	106	1,739
33	NaN	70	1,422	107	1,525
34	0,751	71	1,222	108	1,031
35	1,191	72	1,201	109	2,264
36	1,3	73	1,403	110	1,1
37	1,229	74	2,745	111	1,307



time (min)	measurements (mg NO3-N/L)	time (min)	measurements (mg NO3-N/L)	time (min)	measurements (mg NO3-N/L)
112	2,158	149	1,789	186	0,489
113	1,863	150	1,324	187	0,454
114	1,238	151	1,345	188	0,472
115	1,51	152	0,941	189	0,389
116	1,751	153	2,366	190	0,403
117	1,078	154	1,585	191	0,338
118	0,933	155	1,688	192	0,459
119	NaN	156	1,51	193	0,441
120	1,465	157	1,045	194	0,438
121	1,841	158	1,621	195	0,389
122	1,259	159	1,24	196	0,454
123	1,768	160	1,924	197	0,475
124	1,4	161	NaN	198	0,47
125	1,663	162	1,668	199	0,494
126	1,506	163	NaN	200	0,437
127	2,046	164	0,959	201	0,5
128	1,084	165	1,286	202	0,407
129	1,039	166	1,287	203	0,42
130	1,072	167	1,177	204	0,335
131	NaN	168	1,064	205	0,402
132	2,395	169	NaN	206	0,419
133	1,478	170	0,959	207	0,338
134	2,326	171	1,136	208	0,39
135	2,223	172	0,993	209	0,467
136	0,793	173	1,265	210	0,415
137	1,277	174	NaN	211	0,47
138	1,849	175	0,783	212	0,458
139	1,784	176	1,074	213	0,389
140	1,098	177	NaN	214	0,395
141	1,322	178	1,763	215	0,401
142	1,254	179	1,669	216	0,347
143	NaN	180	1,156	217	0,385
144	1,235	181	1,705		
145	0,873	182	1,781		
146	1,765	183	1,23		
147	1,303	184	NaN		
148	NaN	185	1,373		

Sensors: Spectro::lyser™

location: Université Laval

Conditions: solution at 3 mg NO<sub>3</sub>-N/L

Related figure: Figure 22

time (min)	measurements (mg NO <sub>3</sub> -N/L)	time (min)	measurements (mg NO <sub>3</sub> -N/L)	time (min)	measurements (mg NO <sub>3</sub> -N/L)
1	3,061	38	3,583	75	4,087
2	3,117	39	4,3	76	4,41
3	3,057	40	3,807	77	4,456
4	3,036	41	NaN	78	NaN
5	3,084	42	3,938	79	4,635
6	3,129	43	3,77	80	3,871
7	3,099	44	3,598	81	3,608
8	3,094	45	4,307	82	3,743
9	3,071	46	3,865	83	4,269
10	3,087	47	3,542	84	4,164
11	3,109	48	3,924	85	NaN
12	3,069	49	3,745	86	4,319
13	3,01	50	4,053	87	4,696
14	3,107	51	3,631	88	3,733
15	3,107	52	4,527	89	3,868
16	3,091	53	4,086	90	4,652
17	3,055	54	3,891	91	3,812
18	3,092	55	4,16	92	4,178
19	3,071	56	4,787	93	4,135
20	3,089	57	NaN	94	4,112
21	3,049	58	4,072	95	4,456
22	3,1	59	3,485	96	NaN
23	3,108	60	4,84	97	3,994
24	3,102	61	4,043	98	NaN
25	3,093	62	4,495	99	NaN
26	3,087	63	4,124	100	NaN
27	3,091	64	NaN	101	4,055
28	3,057	65	4,452	102	3,642
29	3,064	66	3,898	103	3,663
30	3,155	67	3,864	104	NaN
31	4,554	68	NaN	105	NaN
32	NaN	69	3,508	106	4,347
33	3,783	70	4,137	107	NaN
34	4,049	71	4,418	108	NaN
35	3,49	72	4,011	109	3,796
36	3,961	73	4,38	110	NaN
37	3,971	74	4,193	111	3,579

time (min)	measurements (mg NO <sub>3</sub> -N/L)	time (min)	measurements (mg NO <sub>3</sub> -N/L)	time (min)	measurements (mg NO <sub>3</sub> -N/L)
112	4,12	149	NaN	186	3,068
113	3,652	150	3,881	187	3,101
114	4,319	151	3,577	188	3,002
115	4,014	152	3,897	189	3,039
116	4,151	153	4,069	190	3,053
117	NaN	154	3,702	191	3,137
118	4,247	155	3,738	192	3,1
119	3,762	156	3,48	193	3,098
120	NaN	157	3,858	194	3,062
121	3,956	158	3,612	195	3,098
122	4,023	159	3,985	196	3,082
123	NaN	160	3,718	197	3,061
124	4,217	161	4,38	198	3,094
125	4,607	162	4,007	199	3,032
126	4,303	163	4,474	200	3,101
127	3,506	164	3,854	201	3,029
128	4,005	165	NaN	202	3,012
129	3,681	166	3,996	203	2,984
130	NaN	167	3,442	204	3,058
131	NaN	168	4,036	205	3,134
132	3,994	169	4,302	206	3,005
133	3,887	170	4,386	207	3,017
134	4,092	171	3,728	208	3,072
135	NaN	172	4,04	209	3,073
136	4,081	173	4,159	210	3,048
137	4,071	174	4,134	211	3,012
138	4,535	175	NaN	212	3,065
139	3,662	176	4,006	213	3,087
140	4,116	177	NaN	214	2,964
141	4,58	178	4,608	215	3,006
142	3,682	179	NaN	216	3,083
143	4,007	180	3,777		
144	3,843	181	4,188		
145	3,82	182	4,037		
146	4,83	183	3,828		
147	NaN	184	3,684		
148	3,704	185	3,107		



**Sensors: Nitratax**

**location: EAWAG, Zurich**

**Conditions: solution at 10 mg NO<sub>3</sub>-N/L**

Related figure: Figure 23

time (min)	measurements (mg NO <sub>3</sub> -N/L)	time (min)	measurements (mg NO <sub>3</sub> -N/L)	time (min)	measurements (mg NO <sub>3</sub> -N/L)	time (min)	measurements (mg NO <sub>3</sub> -N/L)
0	9,17	6,17	9,173	12,3	9,209	18,5	9,163
0,17	9,17	6,33	9,176	12,5	9,176	18,7	9,17
0,33	9,215	6,5	9,19	12,7	9,176	18,8	9,17
0,5	9,201	6,67	9,19	12,8	9,202	19	9,157
0,67	9,196	6,83	9,17	13	9,17	19,2	9,157
0,83	9,163	7	9,17	13,2	9,17	19,3	9,176
1	9,163	7,17	9,196	13,3	9,19	19,5	9,176
1,17	9,17	7,33	9,157	13,5	9,19	19,7	9,176
1,33	9,17	7,5	9,157	13,7	9,163	19,8	9,163
1,5	9,17	7,67	9,17	13,8	9,19	20	9,163
1,67	9,163	7,83	9,17	14	9,19	20,2	9,163
1,83	9,163	8	9,17	14,2	9,19	20,3	9,177
2	9,202	8,17	9,163	14,3	9,19	20,5	9,19
2,17	9,202	8,33	9,163	14,5	9,157	20,7	9,183
2,33	9,209	8,5	9,163	14,7	9,179	20,8	9,183
2,5	9,197	8,67	9,163	14,8	9,183	21	9,17
2,67	9,196	8,83	9,176	15	9,183	21,2	9,17
2,83	9,176	9	9,177	15,2	9,183	21,3	9,163
3	9,176	9,17	9,183	15,3	9,183	21,5	9,19
3,17	9,19	9,33	9,183	15,5	9,183	21,7	9,19
3,33	9,181	9,5	9,183	15,7	9,209	21,8	9,196
3,5	9,176	9,67	9,176	15,8	9,17	22	9,196
3,67	9,176	9,83	9,176	16	9,17	22,2	9,163
3,83	9,176	10	9,183	16,2	9,163	22,3	9,176
4	9,196	10,2	9,176	16,3	9,163	22,5	9,176
4,17	9,196	10,3	9,176	16,5	9,17	22,7	9,19
4,33	9,163	10,5	9,202	16,7	9,183	22,8	9,19
4,5	9,183	10,7	9,202	16,8	9,183	23	9,176
4,67	9,183	10,8	9,17	17	9,163	23,2	9,194
4,83	9,183	11	9,183	17,2	9,163	23,3	9,196
5	9,183	11,2	9,183	17,3	9,202	23,5	9,15
5,17	9,163	11,3	9,17	17,5	9,201	23,7	9,15
5,33	9,202	11,5	9,17	17,7	9,176	23,8	9,19
5,5	9,202	11,7	9,183	17,8	9,196	24	9,19
5,67	9,157	11,8	9,199	18	9,196	24,2	9,19
5,83	9,157	12	9,209	18,2	9,196	24,3	9,176
6	9,17	12,2	9,209	18,3	9,196	24,5	9,176

time (min)	measurements (mg NO <sub>3</sub> -N/L)	time (min)	measurements (mg NO <sub>3</sub> -N/L)	time (min)	measurements (mg NO <sub>3</sub> -N/L)	time (min)	measurements (mg NO <sub>3</sub> -N/L)
24,7	9,163	30,8	9,176	37	9,105	43,2	9,105
24,8	9,163	31	9,176	37,2	9,105	43,3	9,138
25	9,19	31,2	9,163	37,3	9,105	43,5	9,138
25,2	9,163	31,3	9,163	37,5	9,105	43,7	9,17
25,3	9,163	31,5	9,196	37,7	9,163	43,8	9,17
25,5	9,15	31,7	9,17	37,8	9,163	44	9,164
25,7	9,15	31,8	9,17	38	9,105	44,2	9,138
25,8	9,163	32	9,176	38,2	9,105	44,3	9,138
26	9,194	32,2	9,176	38,3	9,112	44,5	9,092
26,2	9,196	32,3	9,151	38,5	9,112	44,7	9,092
26,3	9,202	32,5	9,151	38,7	9,112	44,8	9,105
26,5	9,202	32,7	9,163	38,8	9,125	45	9,144
26,7	9,163	32,8	9,163	39	9,125	45,2	9,144
26,8	9,163	33	9,163	39,2	9,099	45,3	9,099
27	9,163	33,2	9,17	39,3	9,112	45,5	9,099
27,2	9,163	33,3	9,17	39,5	9,112	45,7	9,164
27,3	9,163	33,5	9,163	39,7	9,118	45,8	9,148
27,5	9,19	33,7	9,198	39,8	9,118	46	9,144
27,7	9,19	33,8	9,202	40	9,157	46,2	9,151
27,8	9,17	34	9,078	40,2	9,154	46,3	9,151
28	9,157	34,2	9,078	40,3	9,151	46,5	9,138
28,2	9,157	34,3	9,105	40,5	9,112	46,7	9,138
28,3	9,177	34,5	9,105	40,7	9,112	46,8	9,118
28,5	9,176	34,7	9,13	40,8	9,105	47	9,099
28,7	9,163	34,8	9,137	41	9,105	47,2	9,099
28,8	9,159	35	9,137	41,2	9,112	47,3	9,151
29	9,157	35,2	9,163	41,3	9,144	47,5	9,151
29,2	9,19	35,3	9,164	41,5	9,144	47,7	9,151
29,3	9,19	35,5	9,105	41,7	9,099	47,8	9,106
29,5	9,196	35,7	9,157	41,8	9,099	48	9,105
29,7	9,196	35,8	9,157	42	9,125	48,2	9,17
29,8	9,177	36	9,125	42,2	9,105	48,3	9,17
30	9,17	36,2	9,125	42,3	9,105	48,5	9,118
30,2	9,17	36,3	9,112	42,5	9,112	48,7	9,11
30,3	9,183	36,5	9,112	42,7	9,112	48,8	9,099
30,5	9,183	36,7	9,112	42,8	9,092	49	9,151
30,7	9,176	36,8	9,105	43	9,104	49,2	9,151



time (min)	measurements (mg NO <sub>3</sub> -N/L)	time (min)	measurements (mg NO <sub>3</sub> -N/L)	time (min)	measurements (mg NO <sub>3</sub> -N/L)	time (min)	measurements (mg NO <sub>3</sub> -N/L)
49,3	9,099	55,5	9,164	61,7	9,099	67,8	9,164
49,5	9,099	55,7	9,164	61,8	9,132	68	9,177
49,7	9,118	55,8	9,157	62	9,144	68,2	9,177
49,8	9,118	56	9,157	62,2	9,144	68,3	9,065
50	9,118	56,2	9,164	62,3	9,157	68,5	9,12
50,2	9,132	56,3	9,117	62,5	9,157	68,7	9,163
50,3	9,132	56,5	9,112	62,7	9,138	68,8	9,118
50,5	9,157	56,7	9,151	62,8	9,138	69	9,118
50,7	9,138	56,8	9,151	63	9,092	69,2	9,164
50,8	9,138	57	9,132	63,2	9,132	69,3	9,164
51	9,112	57,2	9,132	63,3	9,132	69,5	9,164
51,2	9,112	57,3	9,157	63,5	9,085	69,7	9,144
51,3	9,132	57,5	9,157	63,7	9,085	69,8	9,144
51,5	9,116	57,7	9,157	63,8	9,144	70	9,151
51,7	9,112	57,8	9,099	64	9,078	70,2	9,151
51,8	9,099	58	9,099	64,2	9,078	70,3	9,164
52	9,099	58,2	9,092	64,3	9,157	70,5	9,164
52,2	9,105	58,3	9,15	64,5	9,157	70,7	9,164
52,3	9,105	58,5	9,151	64,7	9,105	70,8	9,144
52,5	9,092	58,7	9,151	64,8	9,1	71	9,144
52,7	9,099	58,8	9,151	65	9,099	71,2	9,177
52,8	9,099	59	9,164	65,2	9,164	71,3	9,146
53	9,112	59,2	9,158	65,3	9,164	71,5	9,138
53,2	9,112	59,3	9,157	65,5	9,157	71,7	9,105
53,3	9,138	59,5	9,144	65,7	9,155	71,8	9,105
53,5	9,118	59,7	9,144	65,8	9,099	72	9,164
53,7	9,118	59,8	9,157	66	9,17	72,2	9,164
53,8	9,105	60	9,157	66,2	9,17	72,3	9,157
54	9,105	60,2	9,157	66,3	9,105	72,5	9,177
54,2	9,118	60,3	9,092	66,5	9,105	72,7	9,177
54,3	9,136	60,5	9,092	66,7	9,138	72,8	9,112
54,5	9,138	60,7	9,105	66,8	9,092	73	9,112
54,7	9,105	60,8	9,105	67	9,092	73,2	9,125
54,8	9,105	61	9,151	67,2	9,151	73,3	9,176
55	9,118	61,2	9,105	67,3	9,151	73,5	9,177
55,2	9,125	61,3	9,105	67,5	9,105	73,7	9,144
55,3	9,157	61,5	9,099	67,7	9,159	73,8	9,144



time (min)	measurements (mg NO <sub>3</sub> -N/L)	time (min)	measurements (mg NO <sub>3</sub> -N/L)	time (min)	measurements (mg NO <sub>3</sub> -N/L)	time (min)	measurements (mg NO <sub>3</sub> -N/L)
74	9,144	80,2	9,164	86,3	9,164	92,5	9,151
74,2	9,157	80,3	9,164	86,5	9,157	92,7	9,17
74,3	9,164	80,5	9,132	86,7	9,144	92,8	9,17
74,5	9,157	80,7	9,132	86,8	9,144	93	9,125
74,7	9,157	80,8	9,105	87	9,118	93,2	9,163
74,8	9,151	81	9,163	87,2	9,118	93,3	9,164
75	9,151	81,2	9,164	87,3	9,112	93,5	9,17
75,2	9,144	81,3	9,151	87,5	9,117	93,7	9,17
75,3	9,118	81,5	9,151	87,7	9,125	93,8	9,118
75,5	9,118	81,7	9,118	87,8	9,157	94	9,138
75,7	9,19	81,8	9,141	88	9,157	94,2	9,144
75,8	9,19	82	9,157	88,2	9,125	94,3	9,177
76	9,17	82,2	9,164	88,3	9,156	94,5	9,177
76,2	9,141	82,3	9,164	88,5	9,157	94,7	9,177
76,3	9,138	82,5	9,157	88,7	9,105	94,8	9,177
76,5	9,151	82,7	9,157	88,8	9,105	95	9,164
76,7	9,151	82,8	9,118	89	9,17	95,2	9,183
76,8	9,118	83	9,157	89,2	9,17	95,3	9,183
77	9,118	83,2	9,157	89,3	9,125	95,5	9,118
77,2	9,138	83,3	9,132	89,5	9,17	95,7	9,118
77,3	9,138	83,5	9,132	89,7	9,17	95,8	9,132
77,5	9,138	83,7	9,17	89,8	9,183	96	9,157
77,7	9,138	83,8	9,138	90	9,151	96,2	9,157
77,8	9,138	84	9,138	90,2	9,151	96,3	9,144
78	9,151	84,2	9,151	90,3	9,157	96,5	9,144
78,2	9,17	84,3	9,151	90,5	9,157	96,7	9,132
78,3	9,17	84,5	9,164	90,7	9,132	96,8	9,137
78,5	9,164	84,7	9,136	90,8	9,132	97	9,138
78,7	9,164	84,8	9,132	91	9,112	97,2	9,17
78,8	9,151	85	9,105	91,2	9,15	97,3	9,17
79	9,158	85,2	9,105	91,3	9,151	97,5	9,151
79,2	9,17	85,3	9,118	91,5	9,118	97,7	9,151
79,3	9,17	85,5	9,118	91,7	9,118	97,8	9,144
79,5	9,17	85,7	9,099	91,8	9,132	98	9,157
79,7	9,17	85,8	9,138	92	9,132	98,2	9,157
79,8	9,13	86	9,138	92,2	9,177	98,3	9,183
80	9,118	86,2	9,164	92,3	9,151	98,5	9,183

time (min)	measurements (mg NO <sub>3</sub> -N/L)	time (min)	measurements (mg NO <sub>3</sub> -N/L)	time (min)	measurements (mg NO <sub>3</sub> -N/L)	time (min)	measurements (mg NO <sub>3</sub> -N/L)
98,7	9,144	105	9,144	111	9,157	117	9,177
98,8	9,195	105	9,144	111	9,118	117	9,183
99	9,196	105	9,125	111	9,183	118	9,183
99,2	9,17	105	9,125	112	9,183	118	9,19
99,3	9,17	106	9,177	112	9,183	118	9,19
99,5	9,105	106	9,177	112	9,183	118	9,19
99,7	9,122	106	9,177	112	9,138	118	9,151
99,8	9,132	106	9,132	112	9,132	118	9,151
100	9,17	106	9,132	112	9,132	119	9,144
100	9,17	106	9,144	113	9,17	119	9,132
100	9,132	107	9,17	113	9,17	119	9,132
101	9,132	107	9,17	113	9,138	119	9,177
101	9,177	107	9,151	113	9,176	119	9,177
101	9,144	107	9,151	113	9,177	119	9,157
101	9,144	107	9,151	113	9,183	120	9,15
101	9,125	107	9,157	114	9,183	120	9,144
101	9,125	108	9,157	114	9,157	120	9,183
102	9,183	108	9,177	114	9,157	120	9,183
102	9,145	108	9,177	114	9,177	120	9,157
102	9,144	108	9,144	114	9,17	120	9,157
102	9,125	108	9,146	114	9,17	121	9,19
102	9,125	108	9,17	115	9,177	121	9,177
102	9,138	109	9,183	115	9,177	121	9,177
103	9,141	109	9,183	115	9,203	121	9,164
103	9,177	109	9,177	115	9,164	121	9,164
103	9,164	109	9,177	115	9,164	121	9,19
103	9,164	109	9,151	115	9,144	122	9,144
103	9,144	109	9,125	116	9,144	122	9,144
103	9,144	110	9,125	116	9,183	122	9,144
104	9,151	110	9,17	116	9,158	122	9,144
104	9,177	110	9,17	116	9,157	122	9,157
104	9,177	110	9,177	116	9,151	122	9,162
104	9,144	110	9,125	116	9,151	123	9,164
104	9,144	110	9,125	117	9,17	123	9,177
104	9,177	111	9,164	117	9,17	123	9,177
105	9,183	111	9,164	117	9,183	123	9,164
105	9,183	111	9,157	117	9,177	123	9,164



time (min)	measurements (mg NO <sub>3</sub> -N/L)	time (min)	measurements (mg NO <sub>3</sub> -N/L)	time (min)	measurements (mg NO <sub>3</sub> -N/L)	time (min)	measurements (mg NO <sub>3</sub> -N/L)
123	9,19	130	9,17	136	9,166	142	9,17
124	9,164	130	9,17	136	9,164	142	9,157
124	9,164	130	9,164	136	9,164	142	9,157
124	9,177	130	9,174	136	9,164	142	9,216
124	9,177	130	9,177	136	9,125	143	9,151
124	9,164	130	9,203	137	9,125	143	9,151
124	9,183	131	9,203	137	9,17	143	9,164
125	9,183	131	9,196	137	9,157	143	9,164
125	9,177	131	9,196	137	9,157	143	9,177
125	9,177	131	9,157	137	9,19	143	9,177
125	9,151	131	9,203	137	9,19	144	9,177
125	9,154	131	9,203	138	9,183	144	9,19
125	9,216	132	9,177	138	9,215	144	9,19
126	9,177	132	9,177	138	9,216	144	9,23
126	9,177	132	9,183	138	9,177	144	9,195
126	9,183	132	9,196	138	9,177	144	9,19
126	9,183	132	9,196	138	9,176	145	9,164
126	9,177	132	9,196	139	9,164	145	9,164
126	9,17	133	9,196	139	9,163	145	9,19
127	9,17	133	9,17	139	9,085	145	9,193
127	9,151	133	9,175	139	9,085	145	9,209
127	9,151	133	9,177	139	9,177	145	9,177
127	9,216	133	9,17	139	9,209	146	9,177
127	9,153	133	9,17	140	9,222	146	9,151
127	9,151	134	9,203	140	9,235	146	9,151
128	9,17	134	9,203	140	9,235	146	9,164
128	9,17	134	9,203	140	9,196	146	9,151
128	9,177	134	9,177	140	9,196	146	9,151
128	9,177	134	9,177	140	9,183	147	9,144
128	9,183	134	9,164	141	9,196	147	9,144
128	9,151	135	9,164	141	9,196	147	9,177
129	9,151	135	9,157	141	9,183	147	9,183
129	9,157	135	9,164	141	9,183	147	9,183
129	9,157	135	9,164	141	9,196	147	9,19
129	9,177	135	9,151	141	9,177	148	9,19
129	9,165	135	9,151	142	9,177	148	9,177
129	9,164	136	9,183	142	9,17	148	9,177



time (min)	measurements (mg NO <sub>3</sub> -N/L)	time (min)	measurements (mg NO <sub>3</sub> -N/L)	time (min)	measurements (mg NO <sub>3</sub> -N/L)	time (min)	measurements (mg NO <sub>3</sub> -N/L)
148	9,177	154	9,177	160	9,17	167	9,222
148	9,183	154	9,178	161	9,17	167	9,17
148	9,183	155	9,19	161	9,17	167	9,19
149	9,19	155	9,177	161	9,17	167	9,19
149	9,19	155	9,177	161	9,183	167	9,203
149	9,164	155	9,164	161	9,19	167	9,203
149	9,17	155	9,164	161	9,19	168	9,216
149	9,17	155	9,138	162	9,164	168	9,216
149	9,177	156	9,176	162	9,164	168	9,216
150	9,177	156	9,177	162	9,196	168	9,164
150	9,118	156	9,157	162	9,196	168	9,164
150	9,188	156	9,157	162	9,196	168	9,203
150	9,19	156	9,183	162	9,19	169	9,181
150	9,138	156	9,189	163	9,19	169	9,164
150	9,138	157	9,19	163	9,222	169	9,196
151	9,144	157	9,19	163	9,222	169	9,196
151	9,144	157	9,19	163	9,203	169	9,196
151	9,164	157	9,138	163	9,164	169	9,196
151	9,138	157	9,138	163	9,164	170	9,19
151	9,138	157	9,17	164	9,164	170	9,17
151	9,144	158	9,164	164	9,164	170	9,17
152	9,144	158	9,164	164	9,209	170	9,177
152	9,157	158	9,19	164	9,196	170	9,177
152	9,177	158	9,19	164	9,197	170	9,17
152	9,177	158	9,17	164	9,183	171	9,176
152	9,19	158	9,177	165	9,183	171	9,177
152	9,19	159	9,177	165	9,177	171	9,19
153	9,157	159	9,19	165	9,17	171	9,19
153	9,172	159	9,19	165	9,17	171	9,216
153	9,177	159	9,144	165	9,203	171	9,215
153	9,177	159	9,152	165	9,203	172	9,183
153	9,177	159	9,164	166	9,196	172	9,164
153	9,203	160	9,183	166	9,196	172	9,164
154	9,203	160	9,183	166	9,196	172	9,164
154	9,112	160	9,17	166	9,183	172	9,164
154	9,196	160	9,17	166	9,183	172	9,177
154	9,197	160	9,164	166	9,222	173	9,183

time (min)	measurements (mg NO <sub>3</sub> -N/L)	time (min)	measurements (mg NO <sub>3</sub> -N/L)	time (min)	measurements (mg NO <sub>3</sub> -N/L)	time (min)	measurements (mg NO <sub>3</sub> -N/L)
173	9,183	179	9,183	185	9,19	191	9,261
173	9,151	179	9,183	185	9,19	191	9,222
173	9,151	179	9,17	185	9,261	192	9,242
173	9,216	179	9,216	186	9,261	192	9,242
173	9,174	180	9,216	186	9,23	192	9,274
174	9,17	180	9,17	186	9,203	192	9,274
174	9,177	180	9,17	186	9,203	192	9,261
174	9,177	180	9,17	186	9,23	192	9,28
174	9,222	180	9,203	186	9,23	193	9,281
174	9,203	180	9,203	187	9,196	193	9,209
174	9,177	181	9,177	187	9,197	193	9,209
175	9,216	181	9,177	187	9,197	193	9,261
175	9,216	181	9,203	187	9,209	193	9,255
175	9,177	181	9,178	187	9,209	193	9,255
175	9,177	181	9,177	187	9,248	194	9,222
175	9,177	181	9,17	188	9,245	194	9,222
175	9,183	182	9,17	188	9,242	194	9,216
176	9,183	182	9,216	188	9,203	194	9,216
176	9,164	182	9,194	188	9,203	194	9,202
176	9,164	182	9,19	188	9,216	194	9,255
176	9,222	182	9,19	188	9,216	195	9,255
176	9,185	182	9,19	189	9,274	195	9,261
176	9,183	183	9,23	189	9,209	195	9,261
177	9,183	183	9,23	189	9,209	195	9,209
177	9,183	183	9,203	189	9,261	195	9,274
177	9,209	183	9,164	189	9,262	195	9,274
177	9,209	183	9,164	189	9,222	196	9,216
177	9,177	183	9,164	190	9,216	196	9,216
177	9,17	184	9,164	190	9,216	196	9,203
178	9,17	184	9,164	190	9,235	196	9,218
178	9,183	184	9,183	190	9,235	196	9,222
178	9,183	184	9,183	190	9,255	196	9,235
178	9,177	184	9,216	190	9,222	197	9,235
178	9,202	184	9,216	191	9,216	197	9,222
178	9,203	185	9,248	191	9,261	197	9,222
179	9,17	185	9,217	191	9,261	197	9,228
179	9,17	185	9,216	191	9,261	197	9,209



time (min)	measurements (mg NO <sub>3</sub> -N/L)	time (min)	measurements (mg NO <sub>3</sub> -N/L)	time (min)	measurements (mg NO <sub>3</sub> -N/L)
197	9,209	204	9,209	210	9,248
198	9,261	204	9,196	210	9,248
198	9,261	204	9,196	210	9,248
198	9,196	204	9,209		
198	9,222	204	9,209		
198	9,222	204	9,203		
198	9,248	205	9,221		
199	9,248	205	9,222		
199	9,228	205	9,235		
199	9,228	205	9,235		
199	9,216	205	9,209		
199	9,196	205	9,209		
199	9,196	206	9,196		
200	9,216	206	9,261		
200	9,216	206	9,261		
200	9,235	206	9,248		
200	9,19	206	9,248		
200	9,19	206	9,183		
200	9,209	207	9,232		
201	9,209	207	9,235		
201	9,274	207	9,196		
201	9,19	207	9,196		
201	9,19	207	9,196		
201	9,261	207	9,196		
201	9,261	208	9,261		
202	9,19	208	9,197		
202	9,191	208	9,196		
202	9,248	208	9,274		
202	9,216	208	9,274		
202	9,216	208	9,203		
202	9,202	209	9,196		
203	9,203	209	9,196		
203	9,196	209	9,196		
203	9,228	209	9,196		
203	9,228	209	9,196		
203	9,196	209	9,183		
203	9,196	210	9,183		



**Sensors: Solitax****location: Université Laval****Conditions: solution at 0 mg NO<sub>3</sub>-N/L**

Related figure: Figure 24

time (min)	measurements (FNU)	time (min)	measurements (FNU)	time (min)	measurements (FNU)	time (min)	measurements (FNU)
0,00	0,34	3,08	0,41	6,17	0,38	9,25	0,36
0,08	0,34	3,17	0,42	6,25	0,39	9,33	0,36
0,17	0,35	3,25	0,41	6,33	0,39	9,42	0,35
0,25	0,35	3,33	0,42	6,42	0,39	9,50	0,34
0,33	0,35	3,42	0,41	6,50	0,39	9,58	0,34
0,42	0,36	3,50	0,42	6,58	0,40	9,67	0,33
0,50	0,37	3,58	0,40	6,67	0,41	9,75	0,33
0,58	0,39	3,67	0,39	6,75	0,42	9,83	0,34
0,67	0,41	3,75	0,39	6,83	0,45	9,92	0,34
0,75	0,42	3,83	0,38	6,92	0,45	10,00	0,34
0,83	0,41	3,92	0,37	7,00	0,42	10,08	0,34
0,92	0,41	4,00	0,38	7,08	0,41	10,17	0,32
1,00	0,41	4,08	0,39	7,17	0,40	10,25	0,32
1,08	0,44	4,17	0,37	7,25	0,40	10,33	0,32
1,17	0,46	4,25	0,37	7,33	0,39	10,42	0,31
1,25	0,45	4,33	0,38	7,42	0,38	10,50	0,31
1,33	0,42	4,42	0,38	7,50	0,38	10,58	0,32
1,42	0,40	4,50	0,38	7,58	0,38	10,67	0,32
1,50	0,38	4,58	0,38	7,67	0,38	10,75	0,31
1,58	0,36	4,67	0,36	7,75	0,38	10,83	0,31
1,67	0,36	4,75	0,34	7,83	0,38	10,92	0,31
1,75	0,36	4,83	0,33	7,92	0,39	11,00	0,31
1,83	0,37	4,92	0,34	8,00	0,39	11,08	0,31
1,92	0,36	5,00	0,33	8,08	0,39	11,17	0,31
2,00	0,37	5,08	0,33	8,17	0,39	11,25	0,31
2,08	0,38	5,17	0,33	8,25	0,39	11,33	0,31
2,17	0,38	5,25	0,33	8,33	0,39	11,42	0,31
2,25	0,38	5,33	0,34	8,42	0,40	11,50	0,30
2,33	0,38	5,42	0,34	8,50	0,40	11,58	0,30
2,42	0,38	5,50	0,35	8,58	0,40	11,67	0,30
2,50	0,38	5,58	0,35	8,67	0,40	11,75	0,31
2,58	0,37	5,67	0,35	8,75	0,42	11,83	0,31
2,67	0,37	5,75	0,35	8,83	0,40	11,92	0,31
2,75	0,38	5,83	0,37	8,92	0,38	12,00	0,31
2,83	0,38	5,92	0,37	9,00	0,37	12,08	0,31
2,92	0,39	6,00	0,37	9,08	0,37	12,17	0,31
3,00	0,40	6,08	0,38	9,17	0,37	12,25	0,31

time (min)	measurements (FNU)	time (min)	measurements (FNU)	time (min)	measurements (FNU)	time (min)	measurements (FNU)
12,33	0,31	15,42	0,32	18,50	0,30	21,58	0,30
12,42	0,31	15,50	0,32	18,58	0,30	21,67	0,30
12,50	0,31	15,58	0,31	18,67	0,30	21,75	0,30
12,58	0,31	15,67	0,31	18,75	0,30	21,83	0,30
12,67	0,31	15,75	0,31	18,83	0,30	21,92	0,30
12,75	0,31	15,83	0,31	18,92	0,30	22,00	0,29
12,83	0,31	15,92	0,31	19,00	0,30	22,08	0,29
12,92	0,31	16,00	0,31	19,08	0,30	22,17	0,29
13,00	0,31	16,08	0,31	19,17	0,29	22,25	0,29
13,08	0,30	16,17	0,30	19,25	0,30	22,33	0,29
13,17	0,31	16,25	0,31	19,33	0,29	22,42	0,30
13,25	0,31	16,33	0,30	19,42	0,30	22,50	0,30
13,33	0,31	16,42	0,31	19,50	0,30	22,58	0,29
13,42	0,31	16,50	0,32	19,58	0,30	22,67	0,30
13,50	0,31	16,58	0,31	19,67	0,31	22,75	0,30
13,58	0,31	16,67	0,30	19,75	0,31	22,83	0,29
13,67	0,32	16,75	0,30	19,83	0,31	22,92	0,30
13,75	0,32	16,83	0,30	19,92	0,31	23,00	0,29
13,83	0,31	16,92	0,30	20,00	0,31	23,08	0,29
13,92	0,32	17,00	0,30	20,08	0,31	23,17	0,29
14,00	0,33	17,08	0,30	20,17	0,31	23,25	0,29
14,08	0,33	17,17	0,31	20,25	0,32	23,33	0,29
14,17	0,33	17,25	0,31	20,33	0,32	23,42	0,29
14,25	0,32	17,33	0,31	20,42	0,32	23,50	0,29
14,33	0,32	17,42	0,31	20,50	0,32	23,58	0,29
14,42	0,32	17,50	0,32	20,58	0,31	23,67	0,29
14,50	0,32	17,58	0,32	20,67	0,31	23,75	0,29
14,58	0,32	17,67	0,32	20,75	0,31	23,83	0,29
14,67	0,32	17,75	0,32	20,83	0,32	23,92	0,29
14,75	0,31	17,83	0,32	20,92	0,32	24,00	0,29
14,83	0,31	17,92	0,31	21,00	0,32	24,08	0,29
14,92	0,31	18,00	0,30	21,08	0,32	24,17	0,29
15,00	0,31	18,08	0,31	21,17	0,31	24,25	0,29
15,08	0,31	18,17	0,30	21,25	0,30	24,33	0,29
15,17	0,30	18,25	0,30	21,33	0,31	24,42	0,29
15,25	0,31	18,33	0,30	21,42	0,31	24,50	0,29
15,33	0,31	18,42	0,31	21,50	0,31	24,58	0,29



time (min)	measurements (FNU)	time (min)	measurements (FNU)	time (min)	measurements (FNU)	time (min)	measurements (FNU)
24,67	0,29	27,75	0,30	30,83	0,29	33,92	0,29
24,75	0,29	27,83	0,29	30,92	0,29	34,00	0,30
24,83	0,29	27,92	0,29	31,00	0,29	34,08	0,29
24,92	0,29	28,00	0,29	31,08	0,29	34,17	0,30
25,00	0,29	28,08	0,29	31,17	0,29	34,25	0,30
25,08	0,29	28,17	0,29	31,25	0,29	34,33	0,30
25,17	0,29	28,25	0,29	31,33	0,29	34,42	0,30
25,25	0,29	28,33	0,29	31,42	0,29	34,50	0,30
25,33	0,29	28,42	0,29	31,50	0,30	34,58	0,30
25,42	0,29	28,50	0,29	31,58	0,30	34,67	0,29
25,50	0,29	28,58	0,29	31,67	0,30	34,75	0,29
25,58	0,29	28,67	0,29	31,75	0,30	34,83	0,29
25,67	0,29	28,75	0,29	31,83	0,30	34,92	0,29
25,75	0,30	28,83	0,29	31,92	0,30	35,00	0,29
25,83	0,29	28,92	0,29	32,00	0,30	35,08	0,29
25,92	0,29	29,00	0,29	32,08	0,30	35,17	0,29
26,00	0,29	29,08	0,29	32,17	0,30	35,25	0,29
26,08	0,29	29,17	0,30	32,25	0,30	35,33	0,29
26,17	0,29	29,25	0,30	32,33	0,30	35,42	0,29
26,25	0,29	29,33	0,30	32,42	0,30	35,50	0,29
26,33	0,29	29,42	0,30	32,50	0,30	35,58	0,29
26,42	0,30	29,50	0,30	32,58	0,30	35,67	0,29
26,50	0,30	29,58	0,30	32,67	0,30	35,75	0,29
26,58	0,30	29,67	0,31	32,75	0,30	35,83	0,29
26,67	0,30	29,75	0,30	32,83	0,30	35,92	0,29
26,75	0,30	29,83	0,31	32,92	0,30	36,00	0,29
26,83	0,30	29,92	0,30	33,00	0,30	36,08	0,29
26,92	0,30	30,00	0,29	33,08	0,30	36,17	0,29
27,00	0,30	30,08	0,29	33,17	0,30	36,25	0,29
27,08	0,30	30,17	0,29	33,25	0,30	36,33	0,29
27,17	0,30	30,25	0,29	33,33	0,30	36,42	0,29
27,25	0,29	30,33	0,29	33,42	0,29	36,50	0,29
27,33	0,29	30,42	0,30	33,50	0,30	36,58	0,38
27,42	0,30	30,50	0,29	33,58	0,30	36,67	9,79
27,50	0,30	30,58	0,29	33,67	0,30	36,75	5,44
27,58	0,30	30,67	0,30	33,75	0,29	36,83	1,76
27,67	0,29	30,75	0,29	33,83	0,29	36,92	0,70



time (min)	measurements (FNU)	time (min)	measurements (FNU)	time (min)	measurements (FNU)	time (min)	measurements (FNU)
37,00	0,93	40,08	7,49	43,17	6,20	46,25	6,29
37,08	6,81	40,17	9,24	43,25	6,53	46,33	6,59
37,17	3,12	40,25	6,96	43,33	8,43	46,42	5,79
37,25	1,46	40,33	25,15	43,42	7,39	46,50	6,18
37,33	1,44	40,42	7,54	43,50	3,90	46,58	3,48
37,42	1,17	40,50	3,92	43,58	3,37	46,67	74,01
37,50	1,99	40,58	8,32	43,67	6,64	46,75	17,40
37,58	3,81	40,67	10,45	43,75	6,60	46,83	4,16
37,67	2,06	40,75	8,44	43,83	3,41	46,92	1,91
37,75	4,37	40,83	4,11	43,92	5,78	47,00	6,11
37,83	3,71	40,92	2,92	44,00	3,73	47,08	4,78
37,92	1,46	41,00	11,60	44,08	9,58	47,17	9,33
38,00	2,35	41,08	4,75	44,17	10,58	47,25	6,17
38,08	20,62	41,17	2,97	44,25	4,00	47,33	5,04
38,17	8,99	41,25	7,38	44,33	7,96	47,42	11,69
38,25	7,63	41,33	5,00	44,42	4,26	47,50	6,43
38,33	5,38	41,42	3,78	44,50	8,08	47,58	9,21
38,42	7,20	41,50	3,38	44,58	9,55	47,67	5,27
38,50	13,35	41,58	4,55	44,67	9,78	47,75	6,46
38,58	6,44	41,67	4,97	44,75	5,82	47,83	3,24
38,67	4,67	41,75	6,62	44,83	5,87	47,92	7,45
38,75	4,70	41,83	6,05	44,92	3,51	48,00	4,72
38,83	3,54	41,92	8,54	45,00	8,99	48,08	11,47
38,92	13,55	42,00	4,09	45,08	4,72	48,17	6,41
39,00	4,36	42,08	8,20	45,17	5,83	48,25	4,74
39,08	6,88	42,17	7,68	45,25	8,41	48,33	5,62
39,17	4,29	42,25	7,75	45,33	8,80	48,42	5,13
39,25	4,91	42,33	6,32	45,42	5,16	48,50	6,80
39,33	5,19	42,42	11,33	45,50	3,25	48,58	5,97
39,42	4,09	42,50	9,60	45,58	6,64	48,67	5,09
39,50	9,17	42,58	5,80	45,67	6,35	48,75	1,95
39,58	21,01	42,67	4,31	45,75	3,90	48,83	4,09
39,67	12,60	42,75	2,12	45,83	6,76	48,92	3,69
39,75	5,25	42,83	8,06	45,92	5,18	49,00	2,59
39,83	6,75	42,92	3,50	46,00	3,42	49,08	5,01
39,92	9,85	43,00	3,59	46,08	5,71	49,17	9,28
40,00	6,31	43,08	6,35	46,17	4,74	49,25	3,34

time (min)	measurements (FNU)	time (min)	measurements (FNU)	time (min)	measurements (FNU)	time (min)	measurements (FNU)
49,33	7,21	52,42	6,36	55,50	5,70	58,58	73,18
49,42	3,72	52,50	5,59	55,58	2,40	58,67	15,56
49,50	6,66	52,58	7,43	55,67	6,06	58,75	13,72
49,58	5,28	52,67	6,86	55,75	4,05	58,83	8,85
49,67	5,20	52,75	10,21	55,83	3,68	58,92	13,03
49,75	8,76	52,83	8,30	55,92	4,63	59,00	7,25
49,83	11,13	52,92	6,76	56,00	6,02	59,08	5,58
49,92	8,58	53,00	46,76	56,08	3,81	59,17	11,80
50,00	5,97	53,08	10,60	56,17	6,57	59,25	18,01
50,08	4,88	53,17	7,15	56,25	4,67	59,33	15,02
50,17	4,81	53,25	11,23	56,33	9,50	59,42	12,30
50,25	9,44	53,33	10,52	56,42	7,11	59,50	12,03
50,33	6,37	53,42	6,63	56,50	9,69	59,58	8,68
50,42	34,27	53,50	5,08	56,58	6,87	59,67	5,03
50,50	14,07	53,58	9,67	56,67	12,38	59,75	4,72
50,58	8,47	53,67	17,82	56,75	7,88	59,83	5,93
50,67	8,89	53,75	11,54	56,83	4,40	59,92	6,64
50,75	7,96	53,83	11,04	56,92	5,94	60,00	5,68
50,83	4,44	53,92	8,71	57,00	3,43	60,08	11,55
50,92	4,45	54,00	2,14	57,08	5,69	60,17	8,71
51,00	11,62	54,08	11,71	57,17	7,10	60,25	5,47
51,08	14,43	54,17	13,49	57,25	10,54	60,33	12,27
51,17	13,55	54,25	9,44	57,33	7,65	60,42	6,52
51,25	10,59	54,33	6,54	57,42	5,17	60,50	9,38
51,33	9,00	54,42	9,17	57,50	7,46	60,58	9,99
51,42	6,69	54,50	9,64	57,58	10,41	60,67	8,88
51,50	13,25	54,58	10,05	57,67	7,52	60,75	8,16
51,58	6,84	54,67	7,40	57,75	6,82	60,83	14,51
51,67	7,21	54,75	11,67	57,83	8,31	60,92	15,46
51,75	10,53	54,83	8,79	57,92	11,25	61,00	9,73
51,83	7,47	54,92	9,69	58,00	6,71	61,08	8,19
51,92	6,87	55,00	7,15	58,08	4,43	61,17	21,91
52,00	5,47	55,08	13,23	58,17	3,13	61,25	9,17
52,08	3,42	55,17	8,75	58,25	3,78	61,33	4,82
52,17	4,75	55,25	8,06	58,33	9,22	61,42	10,45
52,25	7,63	55,33	6,79	58,42	7,70	61,50	10,80
52,33	7,60	55,42	8,76	58,50	7,40	61,58	11,18



time (min)	measurements (FNU)	time (min)	measurements (FNU)	time (min)	measurements (FNU)	time (min)	measurements (FNU)
61,67	10,33	64,75	6,48	67,83	8,38	70,92	9,97
61,75	10,31	64,83	17,69	67,92	10,52	71,00	13,56
61,83	9,52	64,92	13,56	68,00	7,52	71,08	22,36
61,92	13,61	65,00	12,80	68,08	9,86	71,17	17,12
62,00	9,22	65,08	9,62	68,17	15,75	71,25	14,68
62,08	9,99	65,17	8,55	68,25	8,98	71,33	12,81
62,17	7,82	65,25	11,27	68,33	11,78	71,42	12,27
62,25	10,06	65,33	7,12	68,42	8,20	71,50	10,09
62,33	12,99	65,42	7,66	68,50	9,77	71,58	8,93
62,42	9,94	65,50	8,38	68,58	8,03	71,67	10,78
62,50	9,28	65,58	8,41	68,67	11,15	71,75	8,82
62,58	11,99	65,67	5,93	68,75	9,38	71,83	7,26
62,67	11,08	65,75	7,15	68,83	18,36	71,92	9,80
62,75	11,91	65,83	4,77	68,92	19,77	72,00	9,73
62,83	8,09	65,92	5,19	69,00	19,16	72,08	15,70
62,92	8,64	66,00	7,73	69,08	12,12	72,17	14,61
63,00	7,67	66,08	7,21	69,17	11,25	72,25	14,34
63,08	9,87	66,17	7,50	69,25	12,43	72,33	16,48
63,17	13,22	66,25	7,02	69,33	12,90	72,42	15,95
63,25	9,86	66,33	10,48	69,42	11,79	72,50	7,80
63,33	7,89	66,42	9,76	69,50	8,58	72,58	14,73
63,42	47,86	66,50	7,02	69,58	6,84	72,67	15,72
63,50	11,47	66,58	8,57	69,67	12,04	72,75	11,95
63,58	6,37	66,67	10,49	69,75	12,03	72,83	10,84
63,67	5,04	66,75	6,01	69,83	13,75	72,92	16,69
63,75	11,34	66,83	3,34	69,92	10,51	73,00	14,00
63,83	6,81	66,92	11,90	70,00	17,37	73,08	9,53
63,92	10,79	67,00	8,90	70,08	15,44	73,17	10,44
64,00	10,87	67,08	15,89	70,17	11,01	73,25	10,46
64,08	9,71	67,17	11,39	70,25	12,13	73,33	13,05
64,17	9,41	67,25	31,49	70,33	10,15	73,42	12,57
64,25	9,13	67,33	17,73	70,42	12,79	73,50	14,22
64,33	7,06	67,42	19,00	70,50	10,59	73,58	10,49
64,42	8,60	67,50	11,97	70,58	18,56	73,67	8,91
64,50	11,91	67,58	10,49	70,67	12,42	73,75	10,12
64,58	8,84	67,67	12,19	70,75	11,18	73,83	11,95
64,67	8,00	67,75	10,29	70,83	17,98	73,92	11,33



time (min)	measurements (FNU)	time (min)	measurements (FNU)	time (min)	measurements (FNU)	time (min)	measurements (FNU)
74,00	12,31	77,08	15,09	80,17	9,18	83,25	14,20
74,08	5,87	77,17	28,30	80,25	17,26	83,33	17,94
74,17	10,36	77,25	13,64	80,33	18,51	83,42	16,31
74,25	14,17	77,33	48,97	80,42	14,04	83,50	18,37
74,33	12,89	77,42	16,10	80,50	9,50	83,58	19,46
74,42	14,13	77,50	19,11	80,58	10,93	83,67	10,85
74,50	27,60	77,58	12,78	80,67	5,07	83,75	8,04
74,58	16,91	77,67	14,75	80,75	11,66	83,83	35,84
74,67	8,01	77,75	13,60	80,83	13,73	83,92	16,71
74,75	7,80	77,83	11,45	80,92	10,89	84,00	9,52
74,83	12,56	77,92	13,74	81,00	32,72	84,08	6,79
74,92	11,81	78,00	12,75	81,08	13,87	84,17	53,36
75,00	17,61	78,08	13,91	81,17	9,69	84,25	18,86
75,08	10,47	78,17	16,98	81,25	16,16	84,33	10,72
75,17	12,28	78,25	12,35	81,33	28,94	84,42	16,53
75,25	16,87	78,33	25,45	81,42	17,24	84,50	16,27
75,33	9,70	78,42	11,82	81,50	12,14	84,58	21,49
75,42	12,09	78,50	14,66	81,58	12,64	84,67	14,59
75,50	15,40	78,58	11,46	81,67	17,50	84,75	11,67
75,58	11,05	78,67	14,23	81,75	11,39	84,83	11,47
75,67	12,84	78,75	12,44	81,83	14,88	84,92	13,15
75,75	15,19	78,83	11,50	81,92	13,44	85,00	13,08
75,83	14,88	78,92	11,41	82,00	8,73	85,08	14,85
75,92	9,98	79,00	11,70	82,08	46,81	85,17	14,46
76,00	15,36	79,08	12,17	82,17	14,15	85,25	12,36
76,08	6,56	79,17	11,19	82,25	10,59	85,33	13,79
76,17	11,70	79,25	16,77	82,33	15,01	85,42	14,92
76,25	13,74	79,33	11,79	82,42	14,91	85,50	10,61
76,33	13,91	79,42	8,07	82,50	12,65	85,58	15,94
76,42	7,08	79,50	8,56	82,58	13,29	85,67	16,55
76,50	13,42	79,58	12,08	82,67	21,47	85,75	19,01
76,58	11,97	79,67	9,69	82,75	11,05	85,83	19,40
76,67	6,91	79,75	11,26	82,83	10,86	85,92	18,78
76,75	12,24	79,83	12,78	82,92	26,92	86,00	16,53
76,83	6,08	79,92	16,90	83,00	14,80	86,08	22,93
76,92	9,67	80,00	13,79	83,08	14,78	86,17	15,69
77,00	13,83	80,08	14,81	83,17	37,72	86,25	11,33

time (min)	measurements (FNU)	time (min)	measurements (FNU)	time (min)	measurements (FNU)	time (min)	measurements (FNU)
86,33	12,60	89,42	11,12	92,50	12,97	95,58	7,49
86,42	10,88	89,50	23,19	92,58	18,59	95,67	6,72
86,50	10,16	89,58	28,07	92,67	14,06	95,75	6,78
86,58	9,56	89,67	13,64	92,75	10,48	95,83	7,74
86,67	25,92	89,75	14,54	92,83	16,11	95,92	13,63
86,75	11,70	89,83	19,64	92,92	11,48	96,00	5,98
86,83	11,10	89,92	13,49	93,00	16,51	96,08	9,42
86,92	13,75	90,00	33,98	93,08	13,97	96,17	23,29
87,00	9,46	90,08	31,00	93,17	18,21	96,25	17,20
87,08	13,90	90,17	21,34	93,25	6,88	96,33	11,37
87,17	16,41	90,25	21,77	93,33	30,15	96,42	38,81
87,25	11,16	90,33	17,60	93,42	21,56	96,50	13,40
87,33	9,78	90,42	17,50	93,50	15,06	96,58	166,87
87,42	10,44	90,50	14,45	93,58	64,84	96,67	36,83
87,50	13,40	90,58	74,11	93,67	27,29	96,75	15,82
87,58	9,66	90,67	19,03	93,75	12,44	96,83	9,31
87,67	16,75	90,75	14,22	93,83	12,77	96,92	18,05
87,75	17,69	90,83	7,76	93,92	12,40	97,00	13,01
87,83	10,42	90,92	11,83	94,00	10,64	97,08	38,27
87,92	8,79	91,00	12,28	94,08	13,96	97,17	19,30
88,00	13,02	91,08	13,81	94,17	18,32	97,25	14,63
88,08	11,96	91,17	11,93	94,25	32,21	97,33	15,58
88,17	9,51	91,25	10,99	94,33	20,79	97,42	13,71
88,25	11,47	91,33	16,06	94,42	13,27	97,50	16,44
88,33	11,82	91,42	20,14	94,50	13,61	97,58	12,34
88,42	11,28	91,50	12,29	94,58	45,29	97,67	29,14
88,50	9,63	91,58	11,35	94,67	18,05	97,75	20,10
88,58	13,27	91,67	7,23	94,75	5,98	97,83	19,83
88,67	12,73	91,75	15,76	94,83	14,78	97,92	12,79
88,75	8,59	91,83	16,87	94,92	10,29	98,00	20,36
88,83	16,91	91,92	33,52	95,00	13,61	98,08	14,01
88,92	32,71	92,00	16,58	95,08	15,10	98,17	13,99
89,00	28,44	92,08	16,02	95,17	12,84	98,25	13,96
89,08	10,31	92,17	12,37	95,25	6,10	98,33	15,48
89,17	12,34	92,25	14,87	95,33	14,60	98,42	12,92
89,25	9,13	92,33	8,17	95,42	13,41	98,50	10,25
89,33	11,38	92,42	12,76	95,50	4,43	98,58	12,39



time (min)	measurements (FNU)	time (min)	measurements (FNU)	time (min)	measurements (FNU)	time (min)	measurements (FNU)
98,7	15,6	101,7	13,7	104,8	24,4	107,9	13,4
98,7	13,3	101,8	19,6	104,9	20,0	108,0	15,6
98,8	92,1	101,9	16,3	105,0	28,1	108,1	16,4
98,9	75,6	102,0	38,7	105,1	17,2	108,2	19,4
99,0	28,3	102,1	20,3	105,2	22,4	108,2	18,5
99,1	16,7	102,2	11,7	105,2	19,6	108,3	19,7
99,2	23,0	102,2	14,4	105,3	23,7	108,4	12,5
99,2	14,8	102,3	15,2	105,4	16,2	108,5	13,6
99,3	11,4	102,4	20,3	105,5	16,4	108,6	14,2
99,4	15,1	102,5	17,1	105,6	14,6	108,7	14,2
99,5	9,4	102,6	18,9	105,7	15,5	108,7	14,6
99,6	13,5	102,7	19,3	105,7	14,1	108,8	14,8
99,7	28,6	102,7	35,9	105,8	19,4	108,9	17,0
99,7	12,8	102,8	16,4	105,9	16,0	109,0	14,4
99,8	20,3	102,9	38,3	106,0	19,0	109,1	65,8
99,9	16,1	103,0	25,3	106,1	25,0	109,2	38,9
100,0	15,9	103,1	12,2	106,2	33,7	109,2	24,1
100,1	129,7	103,2	21,5	106,2	16,5	109,3	16,4
100,2	42,3	103,2	16,4	106,3	15,2	109,4	33,2
100,2	20,3	103,3	16,4	106,4	9,5	109,5	19,1
100,3	18,1	103,4	14,0	106,5	11,5	109,6	8,2
100,4	19,1	103,5	10,1	106,6	20,2	109,7	20,6
100,5	21,6	103,6	14,6	106,7	12,4	109,7	10,5
100,6	19,3	103,7	24,6	106,7	12,4	109,8	20,5
100,7	22,6	103,7	36,6	106,8	26,1	109,9	42,5
100,7	12,3	103,8	18,6	106,9	16,3	110,0	28,0
100,8	9,9	103,9	24,9	107,0	18,6	110,1	21,7
100,9	8,1	104,0	18,0	107,1	16,9	110,2	20,7
101,0	29,8	104,1	15,6	107,2	26,4	110,2	16,8
101,1	16,4	104,2	19,3	107,2	23,7	110,3	17,5
101,2	19,3	104,2	15,6	107,3	15,9	110,4	15,7
101,2	18,0	104,3	15,1	107,4	6,7	110,5	14,3
101,3	13,1	104,4	15,6	107,5	62,2	110,6	18,1
101,4	19,4	104,5	27,1	107,6	51,8	110,7	24,0
101,5	13,4	104,6	13,0	107,7	20,8	110,7	17,5
101,6	36,9	104,7	6,8	107,7	21,4	110,8	13,0
101,7	20,1	104,7	38,3	107,8	19,0	110,9	13,9



time (min)	measurements (FNU)	time (min)	measurements (FNU)	time (min)	measurements (FNU)	time (min)	measurements (FNU)
111,0	13,2	114,1	20,6	117,2	17,7	120,2	15,5
111,1	15,7	114,2	14,2	117,2	17,4	120,3	44,5
111,2	18,3	114,2	16,7	117,3	21,0	120,4	13,5
111,2	26,8	114,3	12,7	117,4	17,4	120,5	13,1
111,3	19,9	114,4	34,1	117,5	16,6	120,6	19,6
111,4	20,2	114,5	29,6	117,6	35,1	120,7	16,9
111,5	20,9	114,6	20,8	117,7	32,1	120,7	9,5
111,6	13,5	114,7	17,6	117,7	20,3	120,8	13,6
111,7	17,1	114,7	14,6	117,8	20,2	120,9	27,6
111,7	8,3	114,8	12,7	117,9	15,4	121,0	14,5
111,8	26,0	114,9	14,7	118,0	12,3	121,1	22,4
111,9	24,7	115,0	16,1	118,1	14,2	121,2	31,3
112,0	16,6	115,1	13,9	118,2	17,2	121,2	15,5
112,1	8,5	115,2	10,7	118,2	16,9	121,3	11,4
112,2	6,6	115,2	32,7	118,3	27,0	121,4	16,4
112,2	11,7	115,3	17,3	118,4	18,8	121,5	19,9
112,3	13,1	115,4	15,2	118,5	16,8	121,6	23,3
112,4	17,8	115,5	13,1	118,6	17,8	121,7	9,6
112,5	36,6	115,6	11,1	118,7	17,8	121,7	18,4
112,6	18,5	115,7	12,9	118,7	21,2	121,8	30,0
112,7	14,5	115,7	18,0	118,8	21,7	121,9	23,7
112,7	18,0	115,8	13,5	118,9	18,5	122,0	22,9
112,8	14,0	115,9	36,3	119,0	20,3	122,1	17,5
112,9	17,6	116,0	21,4	119,1	13,6	122,2	21,6
113,0	14,5	116,1	13,9	119,2	15,7	122,2	23,4
113,1	6,5	116,2	13,9	119,2	18,2	122,3	22,8
113,2	18,6	116,2	20,1	119,3	32,5	122,4	26,3
113,2	16,0	116,3	23,6	119,4	13,9	122,5	19,9
113,3	17,1	116,4	25,2	119,5	10,6	122,6	17,5
113,4	30,8	116,5	15,6	119,6	16,1	122,7	15,6
113,5	15,9	116,6	15,4	119,7	13,2	122,7	23,1
113,6	19,3	116,7	27,6	119,7	120,6	122,8	17,8
113,7	34,7	116,7	564,2	119,8	30,7	122,9	17,2
113,7	25,6	116,8	93,5	119,9	17,6	123,0	19,1
113,8	14,2	116,9	26,4	120,0	44,9	123,1	14,0
113,9	58,5	117,0	21,9	120,1	19,4	123,2	14,7
114,0	16,0	117,1	20,3	120,2	18,2	123,2	14,2

time (min)	measurements (FNU)	time (min)	measurements (FNU)	time (min)	measurements (FNU)	time (min)	measurements (FNU)
123,3	21,2	126,4	21,5	129,5	12,9	132,6	14,8
123,4	18,4	126,5	11,8	129,6	10,5	132,7	22,4
123,5	31,7	126,6	12,9	129,7	14,0	132,7	90,0
123,6	25,2	126,7	16,7	129,7	9,1	132,8	123,8
123,7	23,5	126,7	23,0	129,8	14,7	132,9	33,2
123,7	14,9	126,8	26,3	129,9	15,9	133,0	27,1
123,8	17,9	126,9	14,6	130,0	8,6	133,1	23,1
123,9	24,0	127,0	20,5	130,1	18,1	133,2	8,3
124,0	32,4	127,1	17,3	130,2	11,6	133,2	12,2
124,1	16,0	127,2	14,1	130,2	15,4	133,3	14,3
124,2	16,5	127,2	13,4	130,3	22,9	133,4	12,3
124,2	15,5	127,3	25,5	130,4	19,8	133,5	12,9
124,3	17,1	127,4	20,4	130,5	15,7	133,6	15,5
124,4	15,7	127,5	13,3	130,6	18,8	133,7	22,2
124,5	19,1	127,6	14,4	130,7	12,0	133,7	18,3
124,6	62,4	127,7	9,8	130,7	17,7	133,8	11,8
124,7	21,9	127,7	24,9	130,8	12,1	133,9	13,5
124,7	15,6	127,8	16,6	130,9	10,3	134,0	17,0
124,8	28,7	127,9	19,8	131,0	12,5	134,1	20,3
124,9	22,0	128,0	13,5	131,1	13,5	134,2	13,5
125,0	16,6	128,1	11,8	131,2	15,5	134,2	20,5
125,1	14,2	128,2	17,1	131,2	17,5	134,3	26,4
125,2	11,0	128,2	14,6	131,3	19,9	134,4	13,6
125,2	13,9	128,3	14,5	131,4	16,2	134,5	14,5
125,3	21,5	128,4	23,8	131,5	19,0	134,6	9,0
125,4	9,1	128,5	38,7	131,6	17,4	134,7	10,3
125,5	12,6	128,6	17,6	131,7	18,1	134,7	20,6
125,6	15,5	128,7	23,7	131,7	15,1	134,8	16,1
125,7	20,4	128,7	18,1	131,8	17,7	134,9	11,1
125,7	13,1	128,8	16,4	131,9	14,3	135,0	14,9
125,8	16,3	128,9	9,7	132,0	13,3	135,1	14,7
125,9	36,5	129,0	16,9	132,1	13,8	135,2	15,4
126,0	22,7	129,1	16,1	132,2	35,4	135,2	11,2
126,1	9,1	129,2	17,4	132,2	33,7	135,3	15,6
126,2	10,7	129,2	21,7	132,3	24,3	135,4	16,2
126,2	10,4	129,3	18,2	132,4	17,6	135,5	12,2
126,3	74,5	129,4	9,3	132,5	14,0	135,6	15,3



time (min)	measurements (FNU)	time (min)	measurements (FNU)	time (min)	measurements (FNU)	time (min)	measurements (FNU)
135,7	9,9	138,7	13,3	141,8	13,7	144,9	16,1
135,7	8,5	138,8	11,4	141,9	11,1	145,0	29,7
135,8	12,2	138,9	17,6	142,0	9,7	145,1	19,2
135,9	16,9	139,0	8,7	142,1	5,6	145,2	18,8
136,0	10,8	139,1	15,5	142,2	14,3	145,2	28,4
136,1	10,4	139,2	27,7	142,2	26,5	145,3	12,3
136,2	15,3	139,2	20,2	142,3	17,7	145,4	12,0
136,2	8,8	139,3	20,0	142,4	15,2	145,5	14,9
136,3	21,1	139,4	16,5	142,5	32,8	145,6	22,8
136,4	15,2	139,5	110,6	142,6	17,8	145,7	35,6
136,5	12,7	139,6	26,7	142,7	10,7	145,7	19,5
136,6	15,7	139,7	16,5	142,7	10,6	145,8	19,0
136,7	11,5	139,7	16,5	142,8	14,6	145,9	19,1
136,7	11,2	139,8	14,6	142,9	16,5	146,0	15,7
136,8	9,9	139,9	45,0	143,0	17,8	146,1	16,2
136,9	17,4	140,0	18,2	143,1	11,6	146,2	9,5
137,0	16,7	140,1	13,6	143,2	13,0	146,2	12,8
137,1	16,1	140,2	16,8	143,2	268,7	146,3	14,6
137,2	42,5	140,2	14,3	143,3	59,4	146,4	15,2
137,2	14,5	140,3	11,7	143,4	20,9	146,5	12,4
137,3	14,4	140,4	16,7	143,5	19,4	146,6	14,3
137,4	10,4	140,5	9,9	143,6	32,2	146,7	16,3
137,5	21,0	140,6	11,9	143,7	16,3	146,7	13,5
137,6	16,6	140,7	7,0	143,7	14,4	146,8	14,4
137,7	8,5	140,7	38,8	143,8	13,4	146,9	12,7
137,7	15,6	140,8	19,6	143,9	24,2	147,0	12,5
137,8	16,2	140,9	13,9	144,0	24,2	147,1	14,2
137,9	16,2	141,0	17,1	144,1	23,7	147,2	17,8
138,0	16,7	141,1	25,2	144,2	14,0	147,2	10,6
138,1	19,8	141,2	10,7	144,2	14,0	147,3	47,2
138,2	15,4	141,2	11,9	144,3	12,9	147,4	18,5
138,2	13,8	141,3	16,0	144,4	13,2	147,5	13,7
138,3	12,6	141,4	21,4	144,5	11,2	147,6	8,6
138,4	15,7	141,5	29,7	144,6	11,6	147,7	9,1
138,5	18,4	141,6	19,5	144,7	13,2	147,7	17,5
138,6	18,8	141,7	14,7	144,7	16,6	147,8	23,8
138,7	11,3	141,7	15,5	144,8	15,9	147,9	13,0



time (min)	measurements (FNU)	time (min)	measurements (FNU)	time (min)	measurements (FNU)	time (min)	measurements (FNU)
148,0	12,0	151,1	12,3	154,2	11,8	157,3	15,7
148,1	12,9	151,2	14,3	154,3	13,5	157,3	9,0
148,2	4,8	151,3	14,1	154,3	16,0	157,4	10,7
148,2	16,3	151,3	13,6	154,4	17,1	157,5	14,0
148,3	17,0	151,4	20,8	154,5	24,8	157,6	11,0
148,4	11,0	151,5	15,3	154,6	16,0	157,7	11,3
148,5	10,3	151,6	10,4	154,7	14,0	157,8	16,3
148,6	17,7	151,7	13,4	154,8	11,5	157,8	13,7
148,7	20,0	151,8	16,9	154,8	39,8	157,9	11,2
148,7	11,9	151,8	21,6	154,9	17,9	158,0	32,9
148,8	16,2	151,9	14,5	155,0	20,1	158,1	14,0
148,9	9,8	152,0	16,8	155,1	14,1	158,2	53,1
149,0	9,4	152,1	15,9	155,2	14,5	158,3	16,5
149,1	15,8	152,2	14,4	155,3	14,8	158,3	7,0
149,2	28,2	152,3	12,2	155,3	15,5	158,4	21,3
149,2	22,3	152,3	15,2	155,4	14,4	158,5	16,3
149,3	13,8	152,4	12,7	155,5	10,9	158,6	13,0
149,4	12,4	152,5	10,9	155,6	18,1	158,7	13,3
149,5	11,8	152,6	10,9	155,7	10,4	158,8	6,8
149,6	14,0	152,7	11,7	155,8	13,2	158,8	12,5
149,7	13,9	152,8	8,6	155,8	12,9	158,9	19,7
149,8	9,6	152,8	11,0	155,9	13,5	159,0	10,3
149,8	10,4	152,9	21,0	156,0	9,9	159,1	14,7
149,9	15,2	153,0	16,3	156,1	12,1	159,2	16,7
150,0	15,6	153,1	40,9	156,2	15,1	159,3	14,5
150,1	38,2	153,2	68,4	156,3	17,6	159,3	12,3
150,2	114,4	153,3	30,2	156,3	11,8	159,4	13,1
150,3	26,7	153,3	12,6	156,4	14,4	159,5	12,7
150,3	24,7	153,4	14,6	156,5	12,9	159,6	10,3
150,4	13,3	153,5	37,0	156,6	21,1	159,7	10,0
150,5	9,1	153,6	20,9	156,7	18,0	159,8	20,7
150,6	13,6	153,7	14,6	156,8	12,8	159,8	19,7
150,7	128,4	153,8	17,3	156,8	12,4	159,9	12,9
150,8	30,1	153,8	9,8	156,9	18,3	160,0	12,8
150,8	14,8	153,9	15,3	157,0	10,8	160,1	13,9
150,9	10,3	154,0	33,1	157,1	54,4	160,2	16,3
151,0	13,9	154,1	16,6	157,2	22,3	160,3	17,3

time (min)	measurements (FNU)	time (min)	measurements (FNU)	time (min)	measurements (FNU)	time (min)	measurements (FNU)
160,3	58,3	163,4	11,9	166,5	16,8	169,6	18,8
160,4	15,9	163,5	19,7	166,6	12,1	169,7	10,0
160,5	11,5	163,6	13,6	166,7	14,1	169,8	24,2
160,6	16,4	163,7	11,4	166,8	29,0	169,8	11,3
160,7	11,1	163,8	15,9	166,8	15,7	169,9	14,2
160,8	44,7	163,8	12,4	166,9	55,0	170,0	11,0
160,8	14,8	163,9	11,4	167,0	16,1	170,1	9,6
160,9	14,5	164,0	24,2	167,1	23,2	170,2	12,2
161,0	127,7	164,1	16,6	167,2	16,8	170,3	13,4
161,1	26,7	164,2	10,9	167,3	10,4	170,3	13,8
161,2	17,2	164,3	20,9	167,3	13,9	170,4	18,1
161,3	11,9	164,3	12,6	167,4	15,7	170,5	15,6
161,3	12,5	164,4	12,5	167,5	18,7	170,6	18,9
161,4	23,7	164,5	17,9	167,6	25,5	170,7	14,3
161,5	11,4	164,6	15,0	167,7	15,2	170,8	15,5
161,6	10,2	164,7	16,4	167,8	9,1	170,8	68,1
161,7	8,5	164,8	9,5	167,8	14,0	170,9	21,3
161,8	17,5	164,8	13,7	167,9	12,9	171,0	13,3
161,8	14,1	164,9	17,0	168,0	5,4	171,1	10,9
161,9	14,4	165,0	15,3	168,1	10,9	171,2	4,1
162,0	12,0	165,1	18,0	168,2	12,8	171,3	16,5
162,1	6,8	165,2	18,2	168,3	11,0	171,3	13,9
162,2	11,0	165,3	20,2	168,3	9,4	171,4	11,7
162,3	15,9	165,3	8,7	168,4	8,6	171,5	15,9
162,3	28,3	165,4	73,0	168,5	9,5	171,6	31,4
162,4	22,8	165,5	19,6	168,6	6,1	171,7	18,0
162,5	19,8	165,6	11,8	168,7	10,8	171,8	14,6
162,6	20,9	165,7	69,3	168,8	15,3	171,8	10,7
162,7	41,4	165,8	19,8	168,8	13,7	171,9	14,4
162,8	15,5	165,8	10,6	168,9	11,9	172,0	8,5
162,8	11,4	165,9	16,1	169,0	57,5	172,1	16,6
162,9	13,8	166,0	12,1	169,1	26,2	172,2	17,6
163,0	11,6	166,1	10,6	169,2	18,2	172,3	14,6
163,1	10,3	166,2	15,3	169,3	21,8	172,3	12,4
163,2	18,2	166,3	11,0	169,3	19,1	172,4	15,8
163,3	15,5	166,3	8,0	169,4	15,2	172,5	11,9
163,3	20,4	166,4	17,6	169,5	17,7	172,6	10,1



time (min)	measurements (FNU)	time (min)	measurements (FNU)	time (min)	measurements (FNU)	time (min)	measurements (FNU)
172,7	9,5	175,8	10,6	178,8	11,3	181,9	11,7
172,8	14,4	175,8	23,3	178,9	9,2	182,0	11,5
172,8	47,6	175,9	8,4	179,0	6,1	182,1	10,1
172,9	19,3	176,0	12,8	179,1	8,1	182,2	12,3
173,0	15,0	176,1	18,6	179,2	11,1	182,3	9,0
173,1	15,5	176,2	12,1	179,3	14,4	182,3	8,4
173,2	11,8	176,3	8,9	179,3	10,2	182,4	8,6
173,3	14,6	176,3	16,2	179,4	14,9	182,5	12,7
173,3	13,2	176,4	10,9	179,5	16,3	182,6	28,7
173,4	13,5	176,5	10,3	179,6	10,0	182,7	14,0
173,5	14,2	176,6	12,6	179,7	12,9	182,8	11,5
173,6	13,7	176,7	8,7	179,8	8,6	182,8	11,5
173,7	8,0	176,8	5,5	179,8	17,0	182,9	10,3
173,8	12,8	176,8	20,2	179,9	30,1	183,0	10,7
173,8	10,9	176,9	11,3	180,0	12,2	183,1	18,7
173,9	9,1	177,0	88,1	180,1	15,1	183,2	13,4
174,0	10,3	177,1	21,2	180,2	11,0	183,3	9,9
174,1	16,3	177,2	15,3	180,3	14,8	183,3	17,2
174,2	12,0	177,3	12,1	180,3	12,0	183,4	15,7
174,3	15,8	177,3	10,6	180,4	10,2	183,5	14,3
174,3	10,8	177,4	9,3	180,5	10,6	183,6	13,8
174,4	12,4	177,5	9,0	180,6	11,0	183,7	14,0
174,5	12,2	177,6	19,9	180,7	89,1	183,8	14,2
174,6	14,1	177,7	14,7	180,8	24,9	183,8	14,6
174,7	9,6	177,8	11,7	180,8	10,7	183,9	13,9
174,8	6,5	177,8	10,8	180,9	13,6	184,0	11,9
174,8	42,1	177,9	15,4	181,0	11,2	184,1	8,7
174,9	17,9	178,0	13,1	181,1	17,7	184,2	7,7
175,0	9,9	178,1	12,4	181,2	9,8	184,3	12,3
175,1	15,1	178,2	16,4	181,3	8,3	184,3	18,1
175,2	11,4	178,3	9,7	181,3	21,8	184,4	18,1
175,3	11,0	178,3	13,1	181,4	13,1	184,5	11,7
175,3	9,6	178,4	11,0	181,5	8,2	184,6	14,2
175,4	11,9	178,5	11,2	181,6	11,8	184,7	12,0
175,5	13,2	178,6	10,1	181,7	8,2	184,8	14,0
175,6	11,3	178,7	7,9	181,8	13,1	184,8	28,6
175,7	9,0	178,8	8,1	181,8	11,2	184,9	23,7



time (min)	measurements (FNU)	time (min)	measurements (FNU)	time (min)	measurements (FNU)	time (min)	measurements (FNU)
185,0	12,8	188,1	17,2	191,2	12,3	194,3	9,3
185,1	12,8	188,2	22,6	191,3	11,8	194,3	9,3
185,2	14,6	188,3	20,1	191,3	11,3	194,4	9,2
185,3	12,4	188,3	38,1	191,4	11,2	194,5	9,3
185,3	11,1	188,4	16,8	191,5	11,2	194,6	9,3
185,4	13,4	188,5	12,9	191,6	11,2	194,7	9,3
185,5	13,2	188,6	12,7	191,7	11,1	194,8	9,3
185,6	11,4	188,7	9,8	191,8	10,3	194,8	9,3
185,7	15,4	188,8	14,2	191,8	10,5	194,9	9,3
185,8	7,1	188,8	11,9	191,9	10,1	195,0	9,3
185,8	11,1	188,9	7,0	192,0	10,0	195,1	9,3
185,9	13,0	189,0	12,0	192,1	10,0	195,2	9,3
186,0	159,1	189,1	8,3	192,2	9,7	195,3	9,3
186,1	30,3	189,2	10,3	192,3	9,7	195,3	9,3
186,2	13,5	189,3	14,8	192,3	9,7	195,4	9,3
186,3	5,9	189,3	14,1	192,4	9,7	195,5	9,3
186,3	8,0	189,4	13,7	192,5	9,6	195,6	9,3
186,4	9,1	189,5	6,5	192,6	9,5	195,7	9,3
186,5	10,6	189,6	6,0	192,7	9,5	195,8	9,3
186,6	10,1	189,7	6,0	192,8	9,6	195,8	9,3
186,7	10,4	189,8	22,7	192,8	9,5	195,9	9,3
186,8	13,4	189,8	15,8	192,9	9,6	196,0	9,3
186,8	12,6	189,9	19,8	193,0	9,4	196,1	9,3
186,9	17,2	190,0	15,4	193,1	9,3	196,2	9,3
187,0	13,3	190,1	8,9	193,2	9,3	196,3	9,3
187,1	13,1	190,2	145,1	193,3	9,3	196,3	9,3
187,2	11,0	190,3	28,5	193,3	9,3	196,4	9,3
187,3	17,0	190,3	27,0	193,4	9,4	196,5	9,3
187,3	15,6	190,4	15,8	193,5	9,3	196,6	9,3
187,4	35,9	190,5	12,8	193,6	9,3	196,7	9,3
187,5	13,6	190,6	19,8	193,7	9,3	196,8	9,3
187,6	15,3	190,7	13,0	193,8	9,3	196,8	9,3
187,7	15,1	190,8	9,6	193,8	9,3	196,9	9,3
187,8	285,7	190,8	7,0	193,9	9,3	197,0	9,3
187,8	64,5	190,9	5,4	194,0	9,3	197,1	9,3
187,9	17,5	191,0	5,4	194,1	9,3	197,2	9,3
188,0	6,9	191,1	12,6	194,2	9,3	197,3	9,3

time (min)	measurements (FNU)	time (min)	measurements (FNU)	time (min)	measurements (FNU)	time (min)	measurements (FNU)
197,3	9,3	200,4	9,2	203,5	9,2	206,6	9,2
197,4	9,3	200,5	9,2	203,6	9,2	206,7	9,2
197,5	9,3	200,6	9,2	203,7	9,2	206,8	9,2
197,6	9,3	200,7	9,2	203,8	9,2	206,8	9,2
197,7	9,3	200,8	9,2	203,8	9,2	206,9	9,2
197,8	9,3	200,8	9,2	203,9	9,2	207,0	9,2
197,8	9,3	200,9	9,2	204,0	9,2	207,1	9,2
197,9	9,3	201,0	9,3	204,1	9,2	207,2	9,2
198,0	9,3	201,1	9,3	204,2	9,2	207,3	9,2
198,1	9,2	201,2	9,3	204,3	9,2	207,3	9,2
198,2	9,2	201,3	9,2	204,3	9,2	207,4	9,2
198,3	9,3	201,3	9,2	204,4	9,2	207,5	9,3
198,3	9,2	201,4	9,2	204,5	9,3	207,6	9,3
198,4	9,2	201,5	9,3	204,6	9,2	207,7	9,3
198,5	9,3	201,6	9,2	204,7	9,2	207,8	9,2
198,6	9,2	201,7	9,2	204,8	9,3	207,8	9,2
198,7	9,3	201,8	9,2	204,8	9,2	207,9	9,2
198,8	9,2	201,8	9,2	204,9	9,2	208,0	9,2
198,8	9,2	201,9	9,2	205,0	9,2	208,1	9,2
198,9	9,2	202,0	9,2	205,1	9,2	208,2	9,2
199,0	9,2	202,1	9,2	205,2	9,2	208,3	9,2
199,1	9,2	202,2	9,2	205,3	9,2	208,3	9,3
199,2	9,2	202,3	9,2	205,3	9,2	208,4	9,2
199,3	9,3	202,3	9,2	205,4	9,2	208,5	9,2
199,3	9,2	202,4	9,2	205,5	9,2	208,6	9,2
199,4	9,2	202,5	9,2	205,6	9,2	208,7	9,2
199,5	9,2	202,6	9,2	205,7	9,2	208,8	9,2
199,6	9,2	202,7	9,2	205,8	9,2	208,8	9,2
199,7	9,2	202,8	9,2	205,8	9,2	208,9	9,2
199,8	9,2	202,8	9,2	205,9	9,2	209,0	9,2
199,8	9,2	202,9	9,2	206,0	9,3	209,1	9,3
199,9	9,2	203,0	9,2	206,1	9,2	209,2	9,3
200,0	9,2	203,1	9,2	206,2	9,2	209,3	9,2
200,1	9,2	203,2	9,2	206,3	9,2	209,3	9,2
200,2	9,2	203,3	9,2	206,3	9,2	209,4	9,2
200,3	9,2	203,3	9,2	206,4	9,2	209,5	9,2
200,3	9,2	203,4	9,2	206,5	9,2	209,6	9,2



time (min)	measurements (FNU)	time (min)	measurements (FNU)	time (min)	measurements (FNU)	time (min)	measurements (FNU)
209,7	9,2	212,8	9,3	215,8	9,4	218,9	9,4
209,8	9,3	212,8	9,3	215,9	9,4	219,0	9,4
209,8	9,3	212,9	9,3	216,0	9,4	219,1	9,4
209,9	9,3	213,0	9,3	216,1	9,4	219,2	9,4
210,0	9,3	213,1	9,3	216,2	9,4	219,3	9,4
210,1	9,2	213,2	9,3	216,3	9,4	219,3	9,4
210,2	9,3	213,3	9,3	216,3	9,4	219,4	9,4
210,3	9,3	213,3	9,3	216,4	9,4	219,5	9,4
210,3	9,3	213,4	9,3	216,5	9,4	219,6	9,4
210,4	9,3	213,5	9,3	216,6	9,4	219,7	9,4
210,5	9,3	213,6	9,3	216,7	9,4	219,8	9,4
210,6	9,3	213,7	9,3	216,8	9,4	219,8	9,4
210,7	9,3	213,8	9,3	216,8	9,4	219,9	9,4
210,8	9,3	213,8	9,3	216,9	9,4	220,0	9,4
210,8	9,3	213,9	9,3	217,0	9,4	220,1	9,4
210,9	9,3	214,0	9,3	217,1	9,4	220,2	9,4
211,0	9,3	214,1	9,3	217,2	9,4	220,3	9,4
211,1	9,3	214,2	9,3	217,3	9,4	220,3	9,4
211,2	9,3	214,3	9,3	217,3	9,4	220,4	9,4
211,3	9,3	214,3	9,3	217,4	9,4	220,5	9,4
211,3	9,3	214,4	9,3	217,5	9,4	220,6	9,4
211,4	9,3	214,5	9,3	217,6	9,4	220,7	9,4
211,5	9,3	214,6	9,3	217,7	9,4	220,8	9,4
211,6	9,3	214,7	9,3	217,8	9,4	220,8	9,4
211,7	9,3	214,8	9,4	217,8	9,4	220,9	9,4
211,8	9,3	214,8	9,4	217,9	9,4	221,0	9,4
211,8	9,3	214,9	9,4	218,0	9,4	221,1	9,4
211,9	9,3	215,0	9,4	218,1	9,4	221,2	9,4
212,0	9,3	215,1	9,4	218,2	9,4	221,3	9,4
212,1	9,3	215,2	9,4	218,3	9,4	221,3	9,4
212,2	9,3	215,3	9,4	218,3	9,4	221,4	9,4
212,3	9,3	215,3	9,4	218,4	9,4	221,5	9,4
212,3	9,3	215,4	9,4	218,5	9,4	221,6	9,4
212,4	9,3	215,5	9,4	218,6	9,4	221,7	9,4
212,5	9,3	215,6	9,3	218,7	9,4	221,8	9,4
212,6	9,3	215,7	9,4	218,8	9,4	221,8	9,4
212,7	9,3	215,8	9,4	218,8	9,4	221,9	9,4





**ANNEX I**

**RAW DATA – TURBIDITY TESTS**





**Sensors: Spectro::lyser™**

**location: Université Laval**

**Conditions: Formazin 50 and 10 FNU**

Related figures: Figure 25 and Figure 26

time (min)	measurements (FNU)			
	50 FNU solution		10 FNU solution	
	without mixing	with mixing	without mixing	with mixing
0	21,14	20,437	4,788	4,773
1	21,229	20,543	4,873	4,746
2	21,202	20,473	4,84	4,726
3	21,09	20,497	4,852	4,773
4	21,113	20,406	4,841	4,759
5	21,097	20,469	4,88	4,726
6	21,197	20,35	4,851	4,69
7	21,21	20,286	4,875	4,731
8	21,068	20,279	4,861	4,741
9	21,012	20,291	4,869	4,755
10	20,98	20,317	4,787	4,767
11	21,074	20,136	4,877	4,706
12	20,975	20,141	4,844	4,636
13	21,061	20,127	4,878	4,75
14	21,071	20,202	4,852	4,698
15	21,024	20,131	4,817	4,714
16	20,967	19,836	4,824	4,74
17	20,981	20,027	4,804	4,707
18	20,939	19,93	4,812	4,683
19	20,938	19,981	4,824	4,709
20	20,959	19,961	4,822	4,706
21	21,017	19,879	4,862	4,705
22	20,931	19,926	4,879	4,636
23	20,937	19,766	4,787	4,656
24	20,972	19,735	4,817	4,662
25	20,932	19,735	4,816	4,686
26	20,873	19,738	4,826	4,683
27	20,866	19,407	4,844	4,714
28	20,821	19,45	4,82	4,716
29	20,858	19,341	4,797	4,707
30	20,824	19,18	4,797	4,671

**Sensors:****Spectro::lyser™****location: Université Laval****Conditions: AMCO Clear® 50 and 10 FNU**

Related figures: Figure 25 to Figure 29

time (min)	measurements (FNU)					
	50 FNU solution (non-diluted)		50 FNU solution (diluted)		10 FNU solution (diluted)	
	Without mixing	With mixing	Without mixing	With mixing	Without mixing	With mixing
0	10,317	10,286	12,288	12,077	2,838	2,938
1	10,28	10,28	12,232	12,052	2,83	2,924
2	10,308	10,285	12,227	12,046	2,837	2,89
3	10,263	10,324	12,209	12,082	2,853	2,925
4	10,278	10,351	12,237	12,025	2,821	2,948
5	10,27	10,302	12,252	12,087	2,86	2,948
6	10,303	10,299	12,258	12,02	2,891	2,928
7	10,271	10,32	12,236	12,026	2,86	2,91
8	10,304	10,312	12,322	12,034	2,877	2,95
9	10,306	10,313	12,279	12,011	2,813	2,919
10	10,262	10,334	12,262	12,076	2,835	2,924
11	10,254	10,277	12,305	12,004	2,807	2,912
12	10,251	10,269	12,248	11,952	2,822	2,919
13	10,26	10,302	12,215	11,962	2,834	2,912
14	10,308	10,29	12,249	11,911	2,902	2,876
15	10,261	10,296	12,233	11,99	2,852	2,931
16	10,297	10,291	12,18	11,968	2,89	2,934
17	10,286	10,318	12,236	11,939	2,852	2,942
18	10,364	10,323	12,285	11,981	2,869	2,902
19	10,351	10,345	12,197	11,954	2,883	2,872
20	10,329	10,32	12,243	11,912	2,867	2,946
21	10,359	10,307	12,241	11,943	2,874	2,961
22	10,304	10,296	12,154	12,02	2,852	2,938
23	10,309	10,307	12,208	11,989	2,864	2,906
24	10,384	10,258	12,227	11,987	2,839	2,94
25	10,395	10,296	12,19	12,022	2,851	2,893
26	10,337	10,289	12,203	11,962	2,863	2,957
27	10,322	10,282	12,222	11,976	2,823	2,899
28	10,293	10,284	12,187	12,017	2,838	2,94
29	10,326	10,316	12,179	12,046	2,818	2,936
30	10,339	10,279		12,011	2,835	2,889

Sensors: Spectro::lyser™

location: Université Laval

Conditions: AMCO Clear 0 and 10 FNU, 3 mg NO<sub>3</sub>-N/L

Related figure: Figure 30

time (min)	measurements (mg NO <sub>3</sub> -N/L)	time (min)	measurements (mg NO <sub>3</sub> -N/L)
0	3,061	31	1,372
1	3,117	32	1,35
2	3,057	33	1,28
3	3,036	34	1,401
4	3,084	35	1,225
5	3,129	36	1,298
6	3,099	37	1,318
7	3,094	38	1,295
8	3,071	39	1,398
9	3,087	40	1,292
10	3,109	41	1,428
11	3,069	42	1,303
12	3,01	43	1,31
13	3,107	44	1,2
14	3,107	45	1,227
15	3,091	46	1,328
16	3,055	47	1,316
17	3,092	48	1,431
18	3,071	49	1,277
19	3,089	50	1,2
20	3,049	51	1,292
21	3,1	52	1,133
22	3,108	53	1,312
23	3,102	54	1,252
24	3,093	55	1,24
25	3,087	56	1,24
26	3,091	57	1,278
27	3,057	58	1,28
28	3,064	59	1,327
29	3,155	60	1,189
30	1,355	61	1,355



