

**Aspects non-canalisisés de la dynamique de population  
de la grande oie des neiges  
Probabilités de reproduction et de survie juvénile**

**Thèse en cotutelle  
Doctorat en Biologie**

**Guillaume Souchay**

Université Laval  
Québec, Canada  
Philosophiae Doctor (Ph.D.)

et

Université de Montpellier 2  
Montpellier, France  
Grade de docteur



## Résumé

Chez les espèces longévives, une relation inverse entre la variabilité des paramètres démographiques et leur élasticité (i.e. la contribution relative du paramètre au taux de croissance de la population) semble exister. La théorie de la canalisation environnementale permet d'expliquer une telle relation. Les paramètres ayant la plus haute élasticité auraient évolué de façon à être moins variable face aux variations environnementales afin d'optimiser la fitness individuelle et ainsi maximiser la croissance de la population.

Afin de tester l'existence d'une telle hypothèse chez une espèce, il est nécessaire d'estimer les paramètres démographiques ainsi que leur contribution relative au taux de croissance. À l'aide des modèles les plus récents de capture-marquage-recapture, nous avons donc estimé les paramètres de survie juvénile et de reproduction chez la grande oie des neiges pour les comparer au taux de survie adulte, paramètre le plus élastique.

Notre étude a montré que les paramètres de survie juvéniles et de probabilité de nicher étaient très variables, tel qu'attendu. Le taux de survie juvénile dépend des conditions environnementales, avec notamment un fort effet du parasitisme. En vermifugeant des individus, nous avons trouvé un effet négatif des parasites intestinaux sur la survie des oies juvéniles femelles mais pas sur celle des mâles, ce qui s'explique probablement par une différence d'investissement dans le système immunitaire en fonction du sexe chez les individus en croissance. La probabilité de nicher est aussi dépendante des conditions environnementales mais notre étude a également révélé l'existence de coûts associés à la reproduction. En effet, la probabilité de nicher l'année suivante était fortement réduite suite à une reproduction avec succès comparé aux individus qui avaient eu un échec. Par contre, parmi les individus qui nichent, ceux qui avaient du succès l'année précédente avaient plus de chance d'avoir à nouveau du succès l'année suivante que ceux qui avaient eu un échec, ce qui suggère une hétérogénéité dans la qualité des individus. En parallèle de ces estimations, nous avons montré que le taux de survie adulte était constant au cours du temps et indépendant du statut reproducteur l'année précédente. Finalement, nous avons également trouvé que la survie adulte ne différait pas entre

2 colonies situés à 800 km de distance dans l'Arctique canadien, ce qui suggère une faible variabilité spatiale pour ce paramètre démographique.

Notre étude a donc démontré la faible variabilité temporelle et spatiale du paramètre démographique le plus important pour le taux de croissance de la population, contrairement aux autres paramètres qui montrent une forte variabilité chez la grande oie des neiges. Notre étude permet donc d'appuyer la théorie de la canalisation environnementale des paramètres démographiques chez les espèces longévives.

## **Abstract**

In long-lived species, an inverse relationship apparently exists between variability of demographic parameters and their elasticity (i.e. the relative contribution of a given parameter to the population growth rate). The environmental canalization theory has been proposed to explain such a relationship. Demographic parameters with the highest elasticity should have evolved in a way that reduces their variability in presence of environmental variations in order to optimize individual fitness and hence to maximize the population growth rate.

To test this hypothesis in a given species, demographic parameters and their elasticity need to be accurately estimated. Using advanced capture-mark-recapture models, we estimated juvenile survival and breeding probabilities in the greater snow goose and we compared their variability to adult survival, the parameter with the highest elasticity.

Our study showed that both juvenile survival rate and breeding propensity were highly variable, as expected. The juvenile survival probability varied in response to environmental conditions, with a strong impact of parasitism. An anthelmintic drug treatment applied to juveniles revealed a negative effect of intestinal parasites on survival of juvenile females but not males, which could be explained by a sex-differential investment in the immune system in growing individuals. We found that the breeding propensity also varied with environmental conditions but we also found some evidence for costs of reproduction. Breeding propensity in the following year was greatly reduced after a successful reproduction compared to birds that had a failed attempt. However, among birds that bred, those that had a success the year before were more likely to be successful again the following year than those that had failed, which suggests heterogeneity in individual quality. In those studies, we showed that adult survival was constant over time and independent of the breeding status the year before. Finally, we also found that adult survival did not differ between 2 breeding colonies distant of 800 km in the Canadian Arctic, which suggests a low spatial variability for this demographic parameter.

We thus demonstrated a low temporal and spatial variability in the most important demographic parameter for population growth, which contrasts with the high variability of other parameters in the greater snow goose. Our study supports the environmental canalization theory as applied to demographic parameters in long-lived species.



## **Avant-Propos**

Cette thèse s'articule autour de quatre manuscrits rédigés sous formes d'articles scientifiques, déjà publiés ou destinés à être publiés dans un futur très proche. Une introduction et une conclusion générale viennent apporter la cohésion nécessaire à cette thèse de doctorat en Biologie et souligner la contribution du présent travail au domaine. Cette thèse est l'aboutissement de plus de 3 ans de collaboration avec mes 2 directeurs de thèse, Gilles Gauthier (Université Laval, Québec, QC, Canada) et Roger Pradel (Centre d'Écologie Fonctionnelle et Évolutive, Montpellier, France). Ils sont d'ailleurs co-auteurs sur chacun des articles présentés dans cette thèse. Olivier Gimenez (Centre d'Écologie Fonctionnelle et Évolutive, Montpellier, France) et Josée Lefebvre (Service Canadien de la Faune, Québec, QC, Canada), sont également des co-auteurs dans cette thèse, respectivement sur le chapitre 1 pour sa très grande aide pour le décryptage et l'écriture du notre code sous R, et sur le chapitre 4 pour avoir été sur l'île d'Ellesmere sous l'égide du Service Canadien de la Faune afin de baguer les oies et de nous avoir permis d'utiliser ces données dans la présente thèse. Je les remercie tous pour m'avoir aidé à rédiger et à me guider sur la voie de la publication.

J'adresse également tous mes remerciements aux membres de mes différents comités : Gwénaél Beauplet (Université Laval, Québec, Qc, Canada), Arnaud Béchet (Tour du Valat, Arles, France), Daniel Fortin (Université Laval, Québec, Qc, Canada), Matthieu Guillemain (ONCFS, Arles, France) et Jean-Pierre Tremblay (Université Laval, Québec, Qc, Canada). Je remercie également les membres de mon jury de thèse d'avoir accepté de m'évaluer : Gwénaél Beauplet (Université Laval, Québec, Qc, Canada), Arnaud Béchet (Tour du Valat, Arles, France), Emmanuelle Cam (Université de Toulouse 3, Toulouse, France), Matthieu Guillemain (ONCFS, Arles, France), Michael Schaub (Swiss Institute of Ornithology, Sempach, Suisse), Gilles Gauthier et Roger Pradel. Ce travail est également le fruit de discussion avec Joël Bêty, Josée Lefebvre, Tim Möser, Rémi Choquet, Olivier Gimenez et Pierre Legagneux.

Toutes les données utilisées dans cette thèse proviennent d'un programme de suivi à long-terme de la grande oie des neiges dirigée par l'Université Laval et le Service Canadien de la Faune, qui fut initié à l'époque par Gilles Gauthier et Austin Reed. J'ai ajouté ma petite contribution à ce suivi en allant dans l'Arctique, sur l'île Bylot et en participant un tout petit peu au suivi des oies au Québec à l'automne.

Mais je tiens à remercier tous les participants à ce projet qui ont permis l'accumulation de données d'une richesse inouïe. Ce travail est responsable de la qualité et de la précision des études que j'ai pu mener. Ce travail n'aurait pas pu se faire évidemment sans Marie-Christine Cadieux, qui gère toute la base de données Grande oie des neiges, toute la logistique (>90%) liée à Bylot et qui m'a beaucoup aidé à tripatouiller la base de données et à comprendre aussi le système administratif de l'Université Laval. Et je n'oublierai pas le célèbre moustachu, Gérald Picard, qui fut responsable du baguage des oies pendant 20 ans avant de céder sa place à Marie-Christine.

Je remercie grandement tous les organismes subventionnaires et les personnes qui, par leur aide financière et logistique, ont permis la réalisation de cette thèse, en particulier : le Centre d'Écologie Fonctionnelle et Évolutive (CNRS), le Centre d'Études Nordiques, le Groupement De Recherche International « Dynamique de la Biodiversité et Traits d'Histoire de Vie », le Conseil de Recherche en Sciences Naturelles et en Génie du Canada, le Département de Biologie de l'Université Laval, le Groupement de le Projet du Plateau Continental Polaire, le Fonds Québécois pour la Recherche sur la Nature et les Technologies, le réseau de centre d'excellence ArcticNet, le programme de l'Année Polaire Internationale (API) du ministère des affaires indiennes et du nord du Canada, Hunters and Trappers Association of Pond Inlet, Parcs Canada, le Service Canadien de la Faune et l'Université Laval.

Je tiens également à remercier Martine Boucher, Jocelyne Roy, Julie Turgeon de l'Université Laval, Guillaume Gary du CEFÉ, Joelle Lopez, Margaret Paul de l'Université de Montpellier 2 pour m'avoir aidé à me sortir de toute l'administration à faire lors d'une co-tutelle. Je crois que maintenant, je peux être fonctionnaire, je commence à connaître tous les rouages !!

Je souhaite remercier plus particulièrement certaines personnes qui ont collaboré de près ou de loin à mon doctorat (je m'excuse par avance pour les oubliés, mais j'ai rencontré tellement de monde qu'il aurait fallu encore plus de pages pour tous vous inclure) :

- Gilles, tu m'as permis de poursuivre mes études supérieures, en acceptant de prendre un français (encore un !!) sous son aile, en me disant oui au téléphone alors que tu ne m'avais encore jamais vu. Mon « incroyable » anglais a, je pense, fini de t'achever ce jour-là et tu as dit « oui » car tu n'en pouvais plus de m'entendre.



Gilles, je te remercie énormément pour m'avoir fait venir à Québec, m'avoir donné l'opportunité de découvrir la belle province, la ville de Québec, et surtout de m'avoir envoyé dans l'Arctique pendant 3 magnifiques saisons de terrain (même si la dernière fut très humide). Tu m'as également permis de côtoyer le haut niveau scientifique, la rigueur et la précision que cela requiert, merci de tout cet enseignement et d'avoir été là quand j'ai eu besoin ;

- Roger, merci à toi aussi. Lors de mes premiers contacts avec Gilles, il m'a dit d'aller te voir à Montpellier, tu m'as accueilli les bras ouverts et on a discuté un peu du projet. Je pense que si Gilles a accepté, c'est aussi car tu étais partant pour me soutenir dans cet effort. J'ai toujours apprécié travaillé avec toi, ta disponibilité et tes nombreux sujets de conversation, tels que les coins à champignons et à asperges sauvages. Ton mode de travail décalé me conforte un peu dans ma façon de faire, à ne pas se stresser pour un rien mais à savoir se mettre un coup de pied là où il faut quand il faut. Nos discussions devant les tableaux blancs et nos inspirations de modélisation resteront toujours de grands moments ☺ ;

- Laetitia, ... que dire pour toi. Tu es juste après mes directeurs de recherche mais tu es bien plus qu'une simple collègue de travail. Ta présence m'a toujours rassuré et m'a toujours apporté de bons moments de rigolade ! Sans toi cette thèse aurait été bien triste !! J'ai non seulement découvert une collègue avec toi mais aussi l'une de mes plus proches et plus fidèles amies (une vraie Wolfy version humaine !!). Tu auras été celle qui aura été la plus proche de moi durant toutes ces années, en partie grâce à cette cohabitation dans le bureau qui t'a parfois rendu folle. Tu auras également pu remarquer l'évolution de Guillaume le thésard à Montpellier, passant du « mais tu viens d'où à parler comme ça ? » à « Sweetie, faut que t'arrêtes de dire des conneries » et aussi merci pour tes « faut que tu bosses, t'as une thèse à finir !! ». Laetitia (attention, j'ai dit ton prénom en entier mais c'est un moment important), MERCI !!

- Pierrot, tu es certainement le français possédant la plus grande gueule que je n'ai jamais connu ! :D Tu es surtout l'exemple de l'étudiant en post-doc que je souhaite être : toujours présent pour remettre les étudiants de son équipe dans le bon contexte, présent pour nous guider aussi bien dans la recherche qu'en dehors, une source de discussion incommensurable et de chansons, mais surtout une verve inégalable. ^\_^

- toute l'équipe Biométrie, maintenant sous l'appellation Biostatistique et Biologie des Populations (pour faire court) : Olivier (le boss qui procrastine autant que nous mais qui se rattrape en travaillant à 2h du matin !! merci Gabriel ...) ; Rémi le cerveau derrière E-SURGE, qui nous règle tous nos tracas de modélisation, grand tailleur de veste sur son temps libre et grand référent en matière de vin ; la team des Boulets (Sarah, Mathieu, Luce, Ana, ...) pour ces grosses soirées de débauche, ses grandes réflexions sur le canapé ou autour d'une bière, les stagiaires (qu'on encadre un peu et avec qui on boit souvent) et les autres membres de l'équipe que j'ai pu croiser au cours de mes différents passages dans l'équipe ;

- toute l'équipe du labo Gilles Gauthier à l'Université Laval : Dom Fauteux de trouble, Audrey, Fred le lemming-guy, J. Mr Harfang, Noémie ma camarade qui a débarqué en même temps que moi dans cette équipe et qui a terminé il y a peu également, Meg la licorne et également secrétaire personnel de JR, JR le laser-boy, Madeleine la mademoiselle végétation, Louise qui fait aussi partie de l'équipe Biostat, Vincent, la relève des français !!. Je remercie également Marie-Claude pour son sourire et sa bonne humeur ; je ne remercierai jamais assez Marie-Christine, alias MC, pour toute l'aide qu'elle m'a apportée depuis le début de ma thèse, aide sous Access, pour comprendre les données, pour la logistique de Bylot, pour l'administratif également, et aussi pour sa personnalité, sa façon d'être, sa présence aussi, toujours là au poste, cette thèse c'est un peu de toi ^^ ; Gérald P. le Mr oie, qui m'a accueilli de la meilleure façon qui soit, en me parlant avec son accent à n'y rien comprendre pendant 3 mois et qui a finalement arrêté de me niaiser au moment où je me suis enfin dégêné !

- tous les membres de l'ACCEBUL, les secrétaires du département de Biologie pour leur aide avec toute ma paperasserie !!

- toutes les personnes que j'ai côtoyé à Bylot :Chêf, Cath, Laurence, Joël, Dominique B, Sakura, Clemi, Nico, Émilie, Vince, Hugo, Sam et Trevor Arreak, mes amis Inuit et tous ceux que j'oublie...

- la gang de Québec (Émilie, Maya, Agathe, Laure, Camille, Hm, Francis, Joanne, Bertrand, John, Tommy, Josh, ...) que j'ai rencontré au fur et à mesure, gang qui a évolué quand je rentrais en France, qui m'a permis de m'amuser et de passer du bon temps à Québec et ailleurs ;

- les amies « d'avant », présentes bien avant cette thèse et qui ont accepté de moins me voir ou alors juste en coup de vent (Noémie, Nath, Yonna, Delphine,

Estelle...), de partager ma vie entre les 2 continents et plusieurs villes, avec une mention spéciale pour Marina ;

- Maïthé, pour m'avoir accueilli quand je suis arrivé à Montpellier quand je n'avais pas d'autres endroits où aller, pour ces repas et ces moments passés tous les 2, tu es comme ma maman scientifique ...

- Séverine, qui partage ma vie, me soutient et m'a accueilli afin que je rédige ma thèse au calme, tu sais déjà ce que je ressens pour toi ;

- enfin, « the last but not the least », ma famille (m'man, Gamin, ma fille), merci de m'avoir toujours soutenu car je voulais faire une thèse, car j'ai beaucoup voyagé. Maman, jamais je ne serai assez reconnaissant pour tout ce que tu as fait pour moi depuis toujours.



## Table des Matières

|  |                  |
|--|------------------|
| Résumé.....  | iii              |
| Abstract.....  | v                |
| Avant-Propos .....   | vii              |
| Table des Matières.....  | xiii             |
| Liste des Tableaux.....  | xvii             |
| Liste des Figures .....  | xxi              |
| <b><i>Introduction .....</i></b>   | <b><i>1</i></b>  |
| 1. Dynamique de population.....  | 1                |
| 2. Théorie de la Canalisation .....  | 3                |
| 3. Méthodes de Capture-Marquage-Recapture.....   | 5                |
| 4. La grande oie des neiges.....   | 9                |
| 5. Objectifs de la présente thèse.....   | 14               |
| <b><i>Chapitre 1 : Variation du taux de retour de bagues par les chasseurs et implications .....</i></b> | <b><i>15</i></b> |
| Variations in Band Reporting Rate and Implications for Kill Rate in Greater Snow Geese.....              | 17               |
| Abstract.....  | 18               |
| KEY WORDS.....   | 18               |
| Résumé.....  | 19               |
| Introduction.....  | 20               |
| Methods.....   | 21               |
| Results.....   | 24               |
| Discussion.....  | 28               |
| Acknowledgments .....  | 31               |
| APPENDIX A.....  | 32               |
| APPENDIX B. R code for multinomial modeling.....   | 33               |
| <b><i>Chapitre 2 : Coût de la reproduction chez un oiseau nicheur arctique.....</i></b>                  | <b><i>41</i></b> |

|   |                  |
|---|------------------|
| <b>Abstract .....</b>   | <b>44</b>        |
| <b>Key words.....</b>   | <b>45</b>        |
| <b>Résumé.....</b>  | <b>46</b>        |
| <b>Introduction .....</b>   | <b>48</b>        |
| <b>Discussion.....</b>  | <b>63</b>        |
| <b>Appendix A: Goodness-of-Fit tests .....</b>  | <b>69</b>        |
| <b><i>Chapitre 3 : Variations temporelles du taux de survie juvénile chez une espèce longévive : rôle du parasitisme et de la condition corporelle.....</i></b> | <b><i>72</i></b> |
| <b>Temporal variation of juvenile survival in a long-lived species: the role of parasites and body condition .....</b>  | <b>73</b>        |
| <b>Abstract .....</b>   | <b>74</b>        |
| <b>Résumé.....</b>  | <b>75</b>        |
| <b>Introduction .....</b>   | <b>76</b>        |
| <b>Methods .....</b>  | <b>78</b>        |
| <b>Results.....</b>   | <b>81</b>        |
| <b>Discussion.....</b>  | <b>86</b>        |
| <b>Conclusion .....</b>   | <b>88</b>        |
| <b>Acknowledgements .....</b>   | <b>89</b>        |
| <b>Electronic Supplemental Material .....</b>   | <b>90</b>        |
| <b><i>Chapitre 4 : Évaluation de la canalisation spatiale du taux de survie adulte chez un oiseau migrateur.....</i></b>  | <b><i>91</i></b> |
| <b>Absence of spatial variation in adult survival in an Arctic-nesting goose.....</b>   | <b>92</b>        |
| <b>Abstract .....</b>   | <b>93</b>        |
| <b>Résumé.....</b>  | <b>94</b>        |
| <b>Introduction .....</b>   | <b>95</b>        |
| <b>Methods .....</b>  | <b>96</b>        |
| <b>Result.....</b>  | <b>104</b>       |
| <b>Discussion.....</b>  | <b>111</b>       |

|  |            |
|--|------------|
| Appendix A: Implementation of matrices in E-SURGE.....                                 | 116        |
| Appendix B: Transition matrices for each season .....                                  | 119        |
| <b>Conclusion générale .....</b>   | <b>121</b> |
| 1. Principaux résultats .....  | 121        |
| 2. La canalisation des paramètres démographiques chez la grande oie des neiges.. ..... | 125        |
| 3. Perspectives .....  | 127        |
| 4. Conclusion.....   | 129        |
| <b>Références bibliographiques .....</b>   | <b>130</b> |





## Liste des Tableaux

### Chapitre 1

Table 1: Number of banded birds ( $N$ ), number of direct recoveries ( $n$ ), and direct recovery rates ( $\hat{f}$ ) of greater snow geese marked at Bylot Island from 2003 to 2005 for each dollar value ( $x$ ) of reward bands. ....25

Table 2: Model selection for the effects of year (2003 to 2005) and geographic region (Quebec vs USA) on greater snow goose harvest and band reporting rates by hunters. All models include a linear effect (logit scale) of dollar value on reporting rate. Mean deviance ( $\bar{D}$ ), effective number of parameters ( $p_D$ ) and DIC (deviance information criterion) are given. Models are sorted by  $\Delta$ DIC with respect to the best model. ....26

Table 3: Point estimate of reporting rate of greater snow geese with standard metal band (i.e. \$0 value) from models M1 to M4 in Table 2, where the harvest rate is only region-dependent. ....27

Table A1: Number of greater snow geese banded ( $N$ ) on Bylot Island and of direct recoveries ( $n$ ) according to dollar value of reward bands, year and geographic locations of recoveries from 2003 to 2005. ....32

### Chapitre 2

Table 1: Model selection for survival, breeding propensity, nesting success, resighting, recovery and recapture probabilities of adult female greater snow geese marked with a neck-collar on Bylot Island from 1990 to 2010 ( $N = 11,764$ ) and reencountered from 1991 to 2011. For each model, we give deviance, number of estimable parameters ( $k$ ), and difference in QAIC with the best model ( $\Delta$ i). Best models are in bold and starting model is in italic. A variance inflation factor  $\hat{c} = 1.54$  accounts for lack of fit. ....60

Table A1: Components of the goodness-of-fit test for a multistate model with full time variation with the greater snow goose dataset, adult females banded from 1990 to 2010 and reencountered from 1991 to 2011..... 69

Table A2: Components of the goodness-of-fit test for a multistate model with full time variation with the greater snow goose dataset, adult females banded from 1990 to 2010 and reencountered from 1991 to 2011, after removing the first encounter..... 69

Table A3: Complete model selection for resighting, recovery, recapture, survival, breeding propensity and nestingsuccess of collared adult female greater snow geese banded at Bylot Island from 1990 to 2010 (N = 11,764) and reencountered from 1991 to 2011. For each model, we give deviance, number of estimable parameters (k), and difference in QAIC with the best model ( $\Delta_i$ ). Best models are in bold and starting model is in italic. A variance inflation factor  $\hat{c} = 1.54$  accounts for any remaining lack of fit..... 70

### Chapitre 3

Table 1: Model selection for the effects of time, age, sex and anti-parasite treatment on survival, recapture and conditional recovery probabilities of Greater Snow Geese banded from 2002 to 2005 (N = 12,451 individuals) and re-encountered until 2010. For each model, we give deviance, number of estimable parameters (k), and difference in QAIC with the best model ( $\Delta_i$ ). Best models are in bold and starting model is in italic. A variance inflation factor  $\hat{c} = 1.377$  accounts for any remaining lack of fit..... 82

Table 2: Selection of models examining the effects of body condition index (BCI) on first-year survival of Greater Snow Geese banded from 2002 to 2005 using a reduced dataset (N = 4,742 individuals). Parameterization of sub-adult and adult survival, recapture and conditional recovery probabilities is maintained as in Model 22 (Table 1). For each model, deviance, number of estimable parameters (k) and QAIC difference with the best model ( $\Delta_i$ ) are given. Best models are in

bolt and starting model is in italic. A variance inflation factor  $\hat{c} = 1.127$  accounts for any remaining lack of fit. ....85

Table A1: Components of Goodness-of-Fit test for a multistate model with the greater snow goose dataset. ....90

Table A2: Components of Goodness-of-Fit test for a multistate model with the greater snow goose dataset after removing the first encounter for Young. ....90

#### *Chapitre4*

Table 1: Number of individuals banded on Bylot and Ellesmere Islands every summer from 2007 to 2009, recaptured at least once during the summer at Bylot and Ellesmere Islands, recovered and resighted at least once from Fall to Summer. No movement of marked adults between colonies was detected. ....99

Table 2: Goodness-of-fit test for adult Greater snow geese banding from 2007 to 2009 and seasonally reencountered (dead or alive) from summer 2009 to summer 2011. .... 108

Table 3: Model selection for adult greater snow geese banded with legband only or legband+neckband, on Bylot or Ellesmere Islands from 2007 to 2009 and seasonally reencountered up to summer 2011. We provide the parameterization of transition and event probabilities, the number of estimated parameters (k), the deviance and the difference in QAIC ( $\Delta_i$ ) between the current and the best model. Initial and best model are in bold. .... 109



## Liste des Figures

### *Introduction*

Figure 1: Effet de la canalisation sur la variabilité d'un trait. Sous l'effet continu de mutations, les traits montrent une augmentation de leur variance et de la gamme de leur valeur (partie de gauche). Les traits canalisés (partie de droite) sont protégés des effets des mutations. Ainsi, il n'y a pas ou peu d'augmentation de leur variabilité. Les diagrammes représentent la distribution des fréquences de phénotypes pour un trait d'un génotype donné, avant et après mutation. Les valeurs de trait varient selon une échelle arbitraire en abscisse, et l'axe des ordonnées représente la fréquence relative des individus : en nature, la plupart des traits montre une distribution en cloche. Tiré de Gibson & Wagner (2000). ..4

Figure 2: Structure de base du modèle CJS avec plusieurs exemples d'histoires de capture. ....5

Figure 3: Structure de base du Design robuste de Pollock (1982) .....7

Figure 4: Raisonnement du modèle multi-événement. L'histoire de capture d'un individu (boîte en haut à droite) est composée des différents événements  $E_i$ , non pas des états. Les états  $S_i$  sont reliés à l'histoire de capture observée via les probabilités des événements sachant l'état, b. Tiré de Pradel (2009). ....9

Figure 5: (a) Aire de répartition (zone en rouge) de la grande oie des neiges (*Chen caerulescens atlantica*), (b) aire de reproduction de la grande oie des neiges et principale colonie : île Bylot, (c) Aire de haltes migratoires le long du fleuve Saint-Laurent et d'hivernage sur la côte Nord-Est des Etats-Unis (principalement dans les états du Delaware, New Jersey et du Maryland). .... 11

Figure 6: Abondance de la grande oie des neiges depuis 1965 (Calvert et al. 2007 et Service Canadien de la Faune, données non-publiées). .... 13

## Chapitre 1

Figure 1: Fitted reporting rate function ( $\text{logit}(\lambda x) = 0.3207 + 0.0910x$ ) and moment estimates of standard band reporting rate ( $\lambda x$ ) of greater snow geese banded from 2003 to 2005. Each reward-band dollar value was obtained assuming that  $\lambda 100 = 1$ . The horizontal dotted line is  $\lambda = 1.0$ . ..... 25

Figure 2: Estimated Kill rate ( $\pm$  SE) for each year of the reward band study using various point estimates of reporting rate ( $\lambda$ ) from models M1 to M4 in Table 4 or from 2 other studies (Calvert and Gauthier 2005 and Zimmerman et al. 2009b) and a uniform value for retrieval rate (0.8; see methods). ..... 27

Figure 3: Temporal trend in kill rates ( $\pm$  SE) of juvenile and adult greater snow geese banded from 2002 to 2010 using various point estimates of kill rate (value from constant model in Table 4, Calvert and Gauthier 2005 and Zimmerman et al. 2009b) based on annual recoveries obtained from a standard band recovery analysis and a uniform value of retrieval rate (0.8 see methods).....28

## Chapitre 2

Figure 1: Diagram of fate of adult female greater snow geese marked at the Bylot Island colony at the end of the breeding season  $t$  until season  $t+1$ . ..... 53

Figure 2: Estimates (means  $\pm$  SE) of reencounter probabilities of adult female greater snow geese marked with a neck-collar from 1990 to 2010 and reencountered from 1991 to 2011. A) resighting probability during nesting; B) recapture probability during banding; and C) recovery probability by hunters. Estimated values are from model M16, Table 1. .... 6161

Figure 3: Estimates (means  $\pm$  SE) of annual survival probability of adult female greater snow geese marked with a neck-collar on Bylot Island before and after implementation of the special management action during winter 1998-1999. 6262

Figure 4: Estimates (means  $\pm$  SE) of annual breeding propensity of adult female greater snow geese marked with a neck-collar on Bylot Island according to their reproductive status during the previous breeding season (Successful or Failed nester at the breeding colony or Alive elsewhere).....62

Figure 5: Estimates (means  $\pm$  SE) of the annual nesting success of adult female greater snow geese marked with a neck-collar on Bylot Island according to their reproductive status during the previous breeding season (Successful or Failed nester at the breeding colony or Alive Elsewhere).....63

*Chapitre 3*

Figure 1: Estimates (mean  $\pm$  SE) of recapture probabilities of greater snow geese banded from 2002 to 2005 on Bylot Island. Estimations are from model M22, Table 1. Square and circle symbols represent estimations for individuals banded as young and adults and full and empty symbols for males and females, respectively. ....83

Figure 2: Estimates (mean  $\pm$  SE) of recovery probabilities conditional upon death of greater snow geese banded from 2002 to 2005 on Bylot Island. Estimations are from model M22, Table 1. Squared and circle symbols represent estimations for juveniles (<1 year old) and older ( $\geq$ 1 year old), respectively. ....83

Figure 3: Estimates (mean  $\pm$  SE) of survival probabilities of (a) juvenile and (b) subadult greater snow geese banded from 2002 to 2005 on Bylot Island. Estimations are from model M22, Table 1. a) Full and empty circles represent first-year survival estimation of Droncit-injected females and all other individuals respectively; b) Full and empty squares represent subadult survival estimation of Droncit-injected individuals and non-Droncit-injected individuals respectively. ...84

Figure 4: Predicted relationship between survival probability and body condition index of young females injected with an anti-helmintic drug (Droncit®) according to model C6, Table 2. Solid (-) and dotted (···) lines represent the logit-linear relationship and the 95% confidence intervals respectively. ....85

Chapitre 4

Figure 1: Distribution maps of the greater snow goose. A: map showing migration between the breeding areas (delimited by dotted line) and wintering areas in South; B: Breeding area (crosses represent Bylot and Ellesmere Islands); C: Staging areas among the Saint-Lawrence River in Quebec; D: Wintering areas in the United States (Delaware, Maryland and New Jersey). ..... 97

Figure 2: Definition of occasions and events for the greater snow goose population over time depending on presence/absence of neckband. Gray bars represent recapture occasions in the Arctic every summer, open bars represent observation occasions outside the breeding season (available only for adult females with neckbands) and open cross represents the absence of observations for legbanded-only adults outside the breeding season. Gray arrows represent hunting recoveries: each recovery occurring during an interval was coded in the dataset at the end of the interval. Notation: Su = summer occasion, Fa = fall, Wi = winter, Sp = spring, † = recoveries. Adapted from Juillet et al. (2011)..... 100

Figure 3: Diagram of fate of all individuals leaving the breeding colony during the post-breeding season. Number inside bracket correspond to the code used in individual encounters histories. We separated the transition between summer and fall in several steps. The first step is the loss of the neckband with a probability  $L$ . The second step corresponds to the survival  $S$  of individuals, depending on both colony of departure and presence of a neckband. Two events were possible at the fall occasion: dead individuals can be recovered with a probability  $r$  depending on presence of neckband, alive individuals with a neckband can be observed with a probability  $o$  whereas individuals marked with a legband only cannot be detected at the fall occasion. Notation: E = Ellesmere; B = Bylot; N = presence of a neckband; W = absence of a neckband. .... 101



Figure 4: Diagram of fate of individuals from fall to winter or from winter to spring occasions. Number inside bracket correspond to the code used in individual encounters histories. For these seasons, we also separated transitions into several steps: a step accounting for neckband loss with a probability L and a survival step with a probability S depending on the presence of a neckband. Two events were possible: recovery of dead individuals with a probability r depending on the presence of a neckband or the resighting of neckbanded individuals with a probability o. Alive legband individuals cannot be detected. Notation: N = presence of a neckband; W = absence of a neckband..... 102

Figure 5: Diagram of fate for individuals going back to the breeding colony, from spring to summer. Number inside bracket correspond to the code used in individual encounters histories. We decomposed the transition into several steps. The first step describes the loss of neckband with a probability L, the second step describes the choice of the breeding ground with a movement probability  $\Psi$  and finally the survival step with a probability S depending on the colony of arrival. The possible events at the summer occasion were: recovery of dead individual with a probability r depending on the presence of neckband, capture of alive individuals with a probability p depending on both colony of capture and presence of neckband. .... 103103

Figure 6: Estimates (mean  $\pm$  SE) of seasonal resighting probabilities of neckbanded female greater snow geese banded from 2007 to 2009 and resighted annually up to spring 2011. .... 105

Figure 7: Estimates (mean  $\pm$  SE) of seasonal recovery probabilities of adult greater snow geese, banded from 2007 to 2009 and resighted every season up to summer 2011. .... 106

Figure 8: Estimates (mean  $\pm$  SE) of recapture probabilities of adult greater snow geese, banded from 2007 to 2009 and recaptured up to summer 2011 on Bylot Island..... 107

Figure 9: Estimates (mean  $\pm$  SE) of seasonal neckband loss probabilities of adult female greater snow geese marked from 2007 to 2009 and reencountered up to summer 2011..... 110

Figure 10: Estimates (mean  $\pm$  SE) of seasonal survival probabilities of adult greater snow geese banded from 2007 to 2009 and reencountered up to summer 2011 ..... 111

# Introduction

---

'Since population is a changing entity, we are interested not only in its size and composition at any one moment, but also how it is changing. A number of important population characteristics are concerned with rates' (Odum 1971).

## 1. Dynamique de population

La population est définie comme un ensemble d'individus de la même espèce occupant une aire géographique commune et jouant un rôle particulier dans l'écosystème (Odum 1983).

En biologie des populations, un paramètre majeur est la taille de population, i.e. le nombre d'individus dans une population à un temps donné. La dynamique de populations s'intéresse à comprendre et expliquer pourquoi cette taille de population change au cours du temps (Odum 1971, Williams et al. 2002, Krebs 2009). Les changements temporels de ce paramètre peuvent s'exprimer à l'aide d'une équation intégrant les gains et les pertes au sein de la population :

$$N(t + 1) = N(t) + B(t) + I(t) - D(t) - E(t), \text{ (Eq.1)}$$

où  $N(t+1)$ , la taille de population au temps  $t+1$ , est une fonction de la taille de population  $N(t)$  au temps  $t$ , qui va augmenter dans l'intervalle entre  $t$  et  $t+1$  avec le nombre de naissances  $B(t)$  et l'immigration  $I(t)$ , et diminuer avec la mortalité  $D(t)$  et l'émigration  $E(t)$ . Les quatre variables  $B(t)$ ,  $D(t)$ ,  $I(t)$  et  $E(t)$  reflètent les processus primaires responsable des changements de taille de population. Les naissances et les morts étant dépendantes du nombre d'individus présents dans la population, il est possible de réécrire  $B(t)$  tel que  $B(t) = b(t) \times N(t)$ , où  $b(t)$  est défini comme un taux de reproduction per capita, i.e. le nombre d'individus produits par parent ayant survécu à l'intervalle  $t$ ,  $t+1$ . De même, le nombre de morts peut se réécrire tel que  $D(t) = [1 - S(t)] \times N(t)$ , où  $S(t)$  est le taux de survie pour l'intervalle entre  $t$  et  $t+1$ , i.e. le nombre d'individus ayant survécu à l'intervalle entre  $t$  et  $t+1$ . Pour les populations géographiquement fermées (i.e. sans pertes ou gains dus à des mouvements), l'équation 1 peut donc se réécrire :

$$N(t + 1) = N(t)[b(t) + S(t)], \text{ (Eq.2)}$$

Les paramètres démographiques varient souvent avec l'âge des individus. Les modèles de dynamique de population permettent alors de modéliser une population

donnée comme l'agrégation de classes d'âge, chacune pouvant posséder des taux de survie et/ou de reproduction distincts. L'approche traditionnelle pour présenter de tels modèles est l'écriture matricielle, telle que les matrices de Leslie (Leslie 1945), e.g. :

$$\mathbf{N}(t + 1) = \begin{bmatrix} 0 & s_a F_a \\ s_j & s_a \end{bmatrix} \times \mathbf{N}(t), \text{ (Eq. 3)}$$

L'équation 3 représente une matrice de projection post-reproduction pour une population géographiquement fermée à 2 classes d'âge, de survie respective  $s_j$  et  $s_a$ , et où seuls les individus adultes se reproduisent avec une fécondité  $F_a$ . Ces matrices permettant de calculer le taux de croissance de la population, il est alors possible d'estimer l'élasticité de chacun des paramètres, i.e. la contribution relative de chacun des paramètres démographiques au taux de croissance de la population (Caswell 2000, de Kroon et al. 2000, Heppell et al. 2000). Les études d'élasticités ont permis de classer différentes espèces de vertébrés en fonction de l'importance relative des paramètres de reproductions et de survie (Gaillard et al. 1998, Saether & Bakke 2000, Gaillard & Yoccoz 2003, Becker et al. 2008, Desholm 2009). Saether (1988) proposa même un continuum pour classer les espèces d'oiseaux en fonction de l'élasticité du taux de reproduction et de la survie adulte (Saether 1988, Saether & Bakke 2000). Plusieurs études ont montré la présence d'une corrélation négative entre élasticité et variabilité des paramètres démographiques (Pfister 1998, Gaillard et al. 2000). De plus, certaines ont aussi montré que les paramètres les plus variables avaient un plus grand impact sur les variations du taux de croissance que les paramètres peu variables (Gaillard et al. 2000, Saether & Bakke 2000). Un patron général serait le suivant : les paramètres démographiques les plus variables seraient les moins élastiques mais seraient néanmoins responsables des variations du taux de croissance des populations en conditions naturelles à cause de cette forte variabilité (Gaillard et al. 1998, Pfister 1998, de Kroon et al. 2000, Gaillard et al. 2000, Saether & Bakke 2000).

Durant la dernière décennie et face à la nécessité de prévoir l'évolution démographique des populations face aux perturbations environnementales comme les changements climatiques, de nombreuses études se sont intéressées au taux de croissance des populations et à sa variabilité. S'agissant d'un processus multiplicatif, l'augmentation de la variabilité interannuelle des paramètres démographiques et donc du taux annuel de croissance entraîne forcément une diminution du taux de

croissance à long-terme de la population, à valeurs moyennes constantes des paramètres (Lewontin & Cohen 1969). La sélection naturelle devrait donc favoriser une réduction de la variabilité des paramètres les plus importants pour la fitness individuelle, et ainsi maximiser le taux de croissance de population. Un tel processus est appelé canalisation environnementale et pourrait expliquer la plus grande variabilité des paramètres les moins élastiques (Gaillard & Yoccoz 2003, Morris & Doak 2004b, Frederiksen et al. 2008).

## **2. Théorie de la Canalisation**

La notion de canalisation des traits vient du domaine de la biologie du développement et des relations génotype-phénotype (Schmalhausen 1949, Stearns 2002): la canalisation y est définie comme un processus de sélection stabilisante façonnant les mécanismes de développement pour tempérer l'expression de traits, les maintenant ainsi proche de leur état optimal en dépit des perturbations génétiques et environnementales (Fig.1, Schmalhausen 1949). Stearns & Kawecki (1994), puis Wagner et al. (1997) subdivisèrent le concept de canalisation en fonction des causes de variations phénotypiques en utilisant le terme de canalisation génétique pour décrire l'insensibilité d'un caractère face au mutation et la canalisation environnementale pour l'insensibilité face aux facteurs environnementaux. Par la suite, Gibson & Wagner (2000) ont redéfini la canalisation comme la réduction de variabilité d'un trait.

La canalisation environnementale des paramètres démographiques peut donc être vue comme la réduction de variabilité des paramètres majeurs afin, ultimement, d'optimiser la croissance d'une population. De cette théorie, il est possible de formuler plusieurs hypothèses à propos de la variabilité des paramètres démographiques : (i) pour une population donnée, la variance des composants majeurs de la fitness devrait être plus faible que la variance des autres composants de la fitness ; (ii) une relation négative devrait apparaître entre l'élasticité potentielle des paramètres démographiques et leur variabilité.

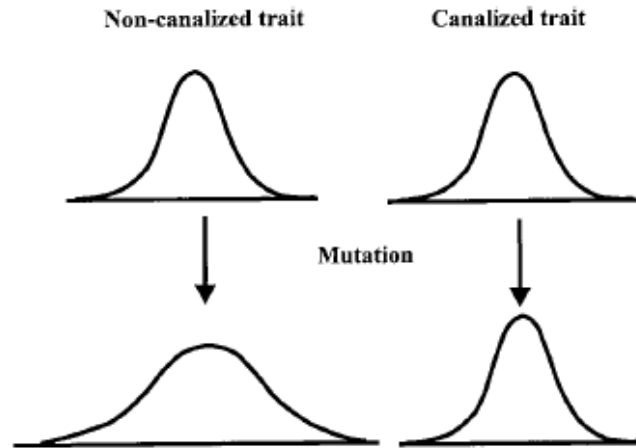

Figure 1: Effet de la canalisation sur la variabilité d'un trait. Sous l'effet continu de mutations, les traits montrent une augmentation de leur variabilité et de la gamme de leur valeur (partie de gauche). Les traits canalisés (partie de droite) sont protégés des effets des mutations. Ainsi, il n'y a pas ou peu d'augmentation de leur variabilité. Les diagrammes représentent la distribution des fréquences de phénotypes pour un trait d'un génotype donné, avant et après mutation. Les valeurs de trait varient selon une échelle arbitraire en abscisse, et l'axe des ordonnées représente la fréquence relative des individus : en nature, la plupart des traits montre une distribution en cloche. Tiré de Gibson & Wagner (2000).

Chez les espèces longévives, le temps de génération (i.e. l'âge moyen des femelles reproductrices d'une population, Leslie 1966) est élevé et d'après la relation trouvée entre l'élasticité de la survie et de la fécondité en fonction du temps de génération par Lebreton & Clobert (1991), le taux de survie adulte devrait être le paramètre démographique le plus élastique (Lebreton & Clobert 1991). D'après la théorie de la canalisation, le taux de survie adulte, paramètre avec la plus grande élasticité, devrait donc être le paramètre canalisé chez les espèces longévives et montré moins de variabilité que les autres composants de la fitness, comme les taux de reproduction et de survie juvéniles.

Plusieurs études ont exploré l'élasticité des paramètres démographiques chez les espèces longévives et toutes ont trouvé une plus forte élasticité du taux de survie adulte (Gaillard et al. 1998, Gauthier & Brault 1998, Cooch et al. 2001, Jenouvrier et al. 2005a). Cependant, certaines études utilisent des approximations pour la survie juvénile et/ou les paramètres de reproduction. Or, afin de comprendre les patrons, causes et conséquences de la variabilité temporelle dans les paramètres démographiques, il est nécessaire d'être capable d'estimer précisément chacun de ceux-ci.

### 3. Méthodes de Capture-Marquage-Recapture

Les paramètres démographiques sont estimés à partir d'un échantillonnage de la population en utilisant les techniques statistiques appropriées (Clobert & Lebreton 1991). La méthode la plus adaptée chez les vertébrés est l'analyse de données issues de programme de Capture-Marquage-Recapture (CMR), qui a recours à un échantillonnage aléatoire et répété d'animaux individuellement identifiés. Ce type d'analyse a été développé au milieu du XX<sup>e</sup> siècle. L'un des premiers modèles de CMR a été le modèle de Cormack-Jolly-Seber (CJS, Cormack 1964, Jolly 1965, Seber 1965), permettant d'estimer le taux de survie des individus marqués tout en prenant en compte la probabilité d'être capturé ou non à chaque occasion (Fig.2). Ce type de modèles s'appuie sur le recensement des recaptures (physiques ou visuelles) d'individus vivants. De nombreux autres modèles ont également été développés à partir de modèles linéaires (pour un historique plus complet, voir Lebreton et al. 2009). L'utilisation de tests pour vérifier l'adéquation des modèles aux données (tests de Goodness-of-Fit ou GoF) a été développée en parallèle. Lebreton et al. (1992) a décrit l'approche globale pour l'utilisation du modèle CJS afin d'estimer des paramètres de survie et de capture.

Le modèle de CJS et ses dérivés ont été utilisés pour estimer les taux de survie (pour une revue, voir Lebreton et al. 1992) et étudier l'influence de covariables environnementales (Barbraud & Weimerskirch 2001, 2003), mais également pour comprendre les patrons de mouvements (Schaub et al. 2001). Ces modèles ont également été utilisés pour voir le lien entre les probabilités de détection et de nicher (Pugesek et al. 1995), pour estimer des coûts de reproduction (Viallefont et al. 1995) et même pour estimer l'accession à la reproduction en inversant le temps dans les histoires de capture (Pradel et al. 1997b).

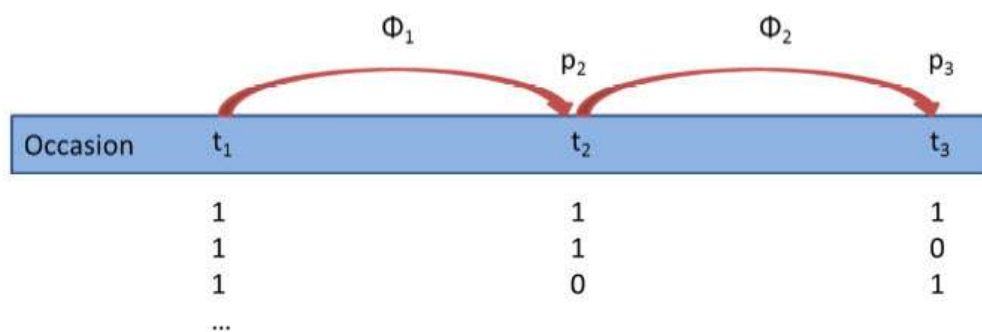
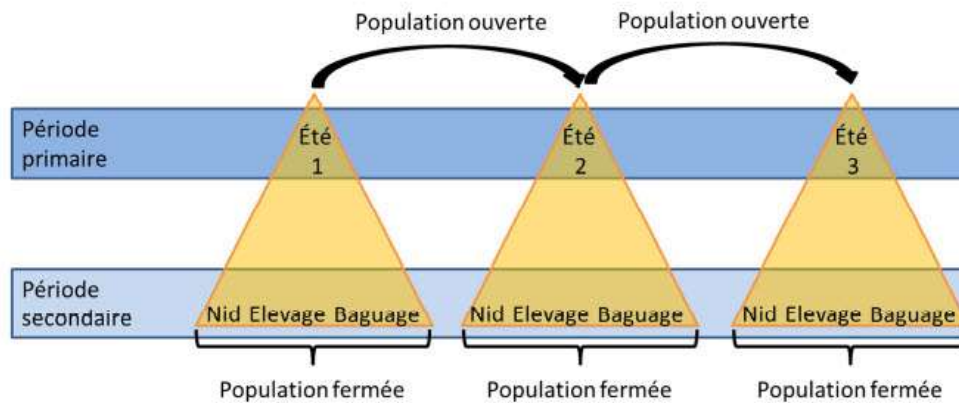

Figure 2: Structure de base du modèle CJS avec plusieurs exemples d'histoires de capture.

En parallèle des développements du modèle CJS, Arnason et Schwarz (Arnason 1972, 1973, Schwarz et al. 1993) se sont intéressés à développer un modèle permettant la prise en compte de plusieurs sites. Burnham (1993), Barker (1997) et Catchpole et al. (1998) se sont intéressés de leur côté aux modèles avec mélange d'information où les recaptures et les reprises d'individus morts sont combinés. Finalement, Burnham (1993) a considéré les problèmes liés à l'émigration temporaire (mouvement temporaire hors de la population, assimilé à un état non-observable) dans les modèles de population ouverte, et Kendall & Nichols (1995), Kendall et al. (1997) ont, quant à eux, montré comment modéliser l'émigration temporaire à partir du modèle du Design Robuste (RD, Pollock 1982). Le RD est un protocole développé au début des années 1980 permettant d'estimer simultanément la taille de population ainsi que l'émigration et l'immigration. Le RD utilise des occasions primaires, tout comme le modèle CJS (chaque été par exemple) mais subdivise ces occasions primaires en occasions secondaires (plusieurs occasions à l'intérieur du même été, Fig.3). Ce protocole permet de séparer la probabilité de détection en plusieurs composantes dont la fidélité à la zone d'étude, le fait d'être disponible à la capture et enfin la probabilité de capture (Pollock 1982, Cooch & White 2007). En faisant l'hypothèse d'une population fermée entre les occasions secondaires, le RD permet d'utiliser les modèles pour population fermée afin d'estimer la probabilité d'être détecté sachant que l'individu est dans la population (i.e. la probabilité vraie de détection) et la taille de population, alors que les modèles pour population ouverte (de type CJS) appliqués entre les occasions primaires permettent d'estimer la survie des individus et la probabilité de détection apparente. Kendall & Nichols (1995) et Kendall et al. (1997) ont utilisé la particularité du design robuste d'allier les modèles pour population fermée et ouverte pour démontrer qu'il était possible d'estimer l'émigration temporaire en faisant le ratio des probabilités de détection apparente et vraie. Cependant, l'une des limites de ce modèle est l'hypothèse forte d'une population géographiquement fermée à l'intérieur d'une occasion primaire. Chez plusieurs espèces comme les tortues de mer par exemple, les individus arrivent et quittent les sites de reproduction de manière échelonné, violant cette hypothèse (Kendall & Bjorkland 2001).





**Figure 3: Structure de base du Design robuste de Pollock (1982)**

Les modèles multi-sites, originellement développés par Arnason et Schwarz, ont connu un essor considérable au début des années 2000 (Lebreton & Pradel 2002). Ils ont permis l'étude et la comparaison de la survie pour des individus fréquentant des sites de reproduction ou d'hivernage différents ainsi que l'estimation des mouvements entre ces sites. Une généralisation du modèle multi-sites est le modèle multi-états où l'individu peut passer d'un état à un autre, un état pouvant représenter un site géographique ou un état individuel tel que le statut reproducteur (individu reproducteur vs. individu non-reproducteur), ou le statut de mortalité (individu vivant vs. Individu mort). Ce type de modèle présente un avantage majeur vis-à-vis du modèle CJS : il permet une approche plus intuitive pour la conceptualisation et l'estimation des paramètres démographiques nécessaires aux matrices de populations. Il rend également plus facile l'utilisation du mélange d'information (recaptures vivantes et reprise d'individus morts, Lebreton et al. 1999). Ces développements permettent alors de répondre à des questions sur la variabilité individuelle, les composants de la fitness et les stratégies d'histoire de vie (Lebreton et al. 2009).

Malgré tous ces avantages, les modèles multi-états présentent certains inconvénients. Au niveau biologique, les modèles multi-états considèrent que les états sont attribués avec certitude aux individus. Si cela est habituellement vrai quand il s'agit de sites géographiques, les erreurs ou l'incertitude sur certains états physiologique peut engendrer certains biais, en particulier lors de l'attribution du statut de reproducteur si ce statut n'est pas systématiquement observé (Pradel 2005). D'un point de vue statistique, l'utilisation d'états non-observables peut conduire à des problèmes d'identifiabilité de paramètres (i.e. l'estimation unique de

chaque paramètre, Kendall & Nichols 2002). De plus, même si les modèles multi-états permettent de mélanger recaptures (physique ou visuelle) et reprises, ils ne permettent pas d'intégrer à la fois recaptures physiques et visuelles lors d'une même occasion. En effet, si les modèles multi-états permettent l'analyse d'histoires d'individus observés pendant plusieurs occasions de terrain puis retrouvés morts une session ultérieure, ils ne permettent pas d'accommoder des situations plus complexes, comme l'observation d'un individu en début de saisons de terrain et sa capture en fin de saison ou son observation suivi de la reprise de cet individu au sein de la même saison de terrain.

Pour répondre en partie à ces problèmes, Pradel (2005) a proposé une autre évolution des modèles multi-états, les modèles multi-événements. Dans ces modèles, Pradel (2005) propose de séparer l'observation de l'assignement à un statut. Les histoires de capture ne seraient plus une suite de « reproducteur, non-observé, reproducteur » mais plutôt de « vu sur la colonie, non-vu, vu se nourrissant proche de la colonie » (Pradel 2009). L'évènement est alors défini comme l'observation faite à propos de l'individu. Les modèles multi-événements permettent donc de décrire les transitions entre les états (survie, mouvement géographique, changement physiologique, reproducteur, etc.) et le processus de génération des événements sachant leur correspondance avec les états sous-jacents (Fig. 4). Pour un même état « vivant », un individu peut être vu, capturé ou non-rencontré. Dans certains cas, le type de rencontre « observation ou recapture » peut être différent en fonction du statut d'un individu. Par exemple, un individu reproducteur pourra être vu sur le site de reproduction et capturé au nid, tandis qu'un individu non-reproducteur pourra seulement être vu sur le site de reproduction.

L'avantage des modèles multi-événements est d'être une généralisation des modèles multi-états qui permet de se rapprocher encore plus de la réalité biologique des individus tout en intégrant l'incertitude sur l'assignation des états, et donc de réduire les biais possibles dans les estimations de transition entre états. Au niveau statistique, les modèles multi-événements permettent maintenant d'intégrer tous les types d'information à la fois sans perte d'information biologique.

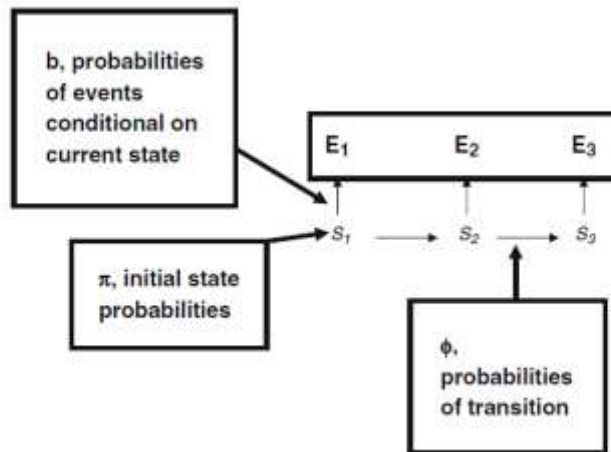

Figure 4: Raisonnement du modèle multi-évènement. L'histoire de capture d'un individu (boite en haut à droite) est composée des différents évènements  $E_i$ , non pas des états. Les états  $S_i$  sont reliés à l'histoire de capture observée via les probabilités des évènements sachant l'état,  $b$ . Tiré de Pradel (2009).

Avec ces différents outils d'estimation de paramètres, il devient alors possible d'estimer les paramètres d'intérêt pour tester les hypothèses de la théorie de la canalisation. Cependant, ces analyses doivent se faire sur des données à long-terme afin d'appréhender correctement les causes et conséquences des variations temporelles dans les paramètres démographiques (Frederiksen et al. 2008).

#### 4. La grande oie des neiges

La grande oie des neiges (*Chen caerulescens atlantica*) est une sous-espèce longévive et migratrice d'Amérique du Nord. Elle se reproduit dans l'est de l'Arctique canadien et hiverne sur la côte nord-est des États-Unis (Fig. 5). Durant leur migration printanière et automnale, les grandes oies des neiges font une halte migratoire dans la province du Québec, essentiellement sur les rives du fleuve Saint-Laurent. Les oies arrivent au Québec à la mi-mars et repartent vers l'Arctique à la fin du mois de mai (Béchet et al. 2004). À l'automne, elles arrivent sur les bords du Saint-Laurent au début du mois d'octobre et quittent cette région vers la fin du mois de novembre pour rejoindre leurs aires d'hivernage aux États-Unis (Menu et al. 2005). L'aire de reproduction de l'espèce couvre un vaste territoire dans l'Arctique, du milieu de la Terre de Baffin au sud au nord de l'île Ellesmere (une distance de près de 1500 km), et de la côte ouest du Groenland à l'est jusqu'à l'île Bathurst à l'ouest (une distance supérieure à 1200 km).

La plus grande concentration connue d'individus reproducteurs (soit 10 à 15 % de la population mondiale) niche sur l'île Bylot (Nunavut, 73° N, 80°W, Gauthier et al. 2005, Desnoyers et al. 2012) . Les oies arrivent entre le 25 mai et le 10 juin à l'île Bylot (Gauthier et al. 2003) pour la nidification (date médiane de ponte : 12 juin, Gauthier et al, données non-publiées). La grande oie des neiges est une espèce coloniale nichant de préférence dans les milieux humides. Les femelles pondent en moyenne 4 œufs, l'incubation dure environ 24 jours et la date d'éclosion médiane est autour du 9 juillet. La grande oie des neiges étant une espèce nidifuge, la femelle quitte le nid avec ses jeunes dans les 24h suivant l'éclosion pour rejoindre l'aire d'élevage sur l'île Bylot (Mainguy et al. 2006). Les familles d'oies restent dans la zone d'élevage jusqu'à la fin du mois d'août avec un nombre moyen de 2.5 jeunes par couple à l'envol (Gauthier et al, données non-publiées). Les couples ayant connu un échec pendant la nidification quittent l'île afin d'effectuer leur mue sur un site plus favorable (Reed et al. 2003a).

La population d'oies des neiges de l'île Bylot fait l'objet d'un suivi intensif pendant la saison de reproduction, incluant une campagne de marquage des individus à la fin de chaque été depuis 1990. Le baguage des individus a lieu au début du mois d'août, pendant environ 7 à 10 jours, quand les individus ne peuvent pas voler, c'est-à-dire quand les adultes sont en mue et que les jeunes ne sont pas encore aptes au vol. Tous les individus sont âgés (jeunes de l'année ou adultes  $\geq 1$  an) et sexés par examen du cloaque. Chaque oiseau reçoit une bague métallique portant un code d'identification unique à 9 chiffres du Bird Banding Laboratory (US Fish and Wildlife Service), lequel consigne les informations de baguage et de retours de bagues à l'échelle du continent. La majorité des jeunes de l'année sont également mesurés (taille du bec, de la tête, tarse, de la 9<sup>ème</sup> primaire) et pesés pour déterminer leur croissance. Enfin, environ 2/3 des femelles adultes capturées sont marquées avec un collier jaune portant un code alphanumérique unique à 4 caractères (Menu et al. 2000). Jusqu'à l'été 2011, la base de données de la population de grande oie des neiges de Bylot compte environ 76 000 individus marqués sur l'île Bylot, plus de 7 800 recaptures, environ 80 000 réobservations de colliers et plus de 14 000 récupérations de bagues.

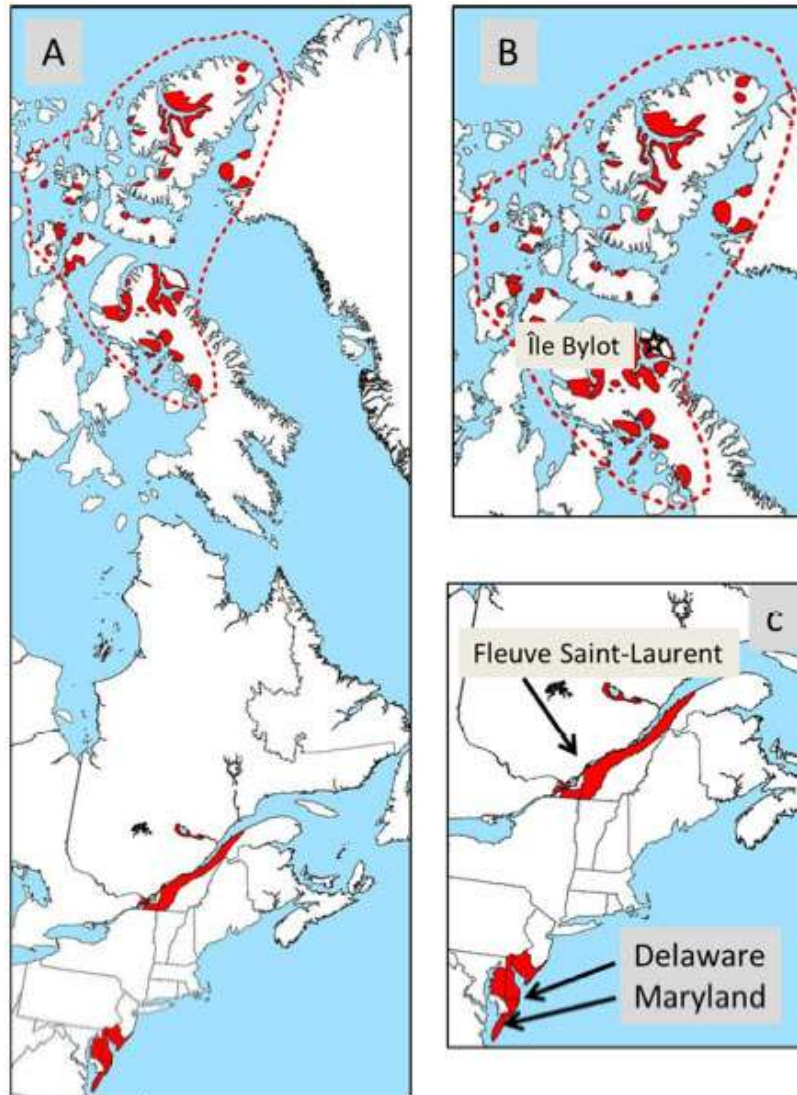

Figure 5: (a) Aire de répartition (zone en rouge) de la grande oie des neiges (*Chen caerulescens atlantica*), (b) aire de reproduction de la grande oie des neiges et principale colonie : île Bylot, (c) Aire de haltes migratoires le long du fleuve Saint-Laurent et d'hivernage sur la côte Nord-Est des États-Unis (principalement dans les états du Delaware, New Jersey et du Maryland).

La grande oie des neiges est une espèce chassée dans toute son aire de répartition, par les peuples Inuit dans l'Arctique mais surtout par les chasseurs sportifs sur les haltes migratoires et les zones d'hivernage du sud. La chasse de cette espèce est réglementée par la Convention sur les oiseaux migrateurs au Canada et aux États-Unis depuis 1918 (Williams & Nichols 2001). Cette population fait partie des populations nord-américaines d'oies ayant connu une augmentation exponentielle au cours des 60 dernières années (Ankney 1996, Abraham & Jefferies 1997). En effet, il était dénombré environ 25 000 grandes oies des neiges en 1965. Entre 1970 et la fin du XXe siècle, ce chiffre a été multiplié par 40 pour atteindre 1 000 000 d'individus en 1999, avec un taux de croissance annuel moyen de 9% (Fig.

6, Reed et al. 1998, Menu et al. 2002). Le taux de survie adulte est le déterminant le plus important du taux de croissance de la population (responsable de 60 % à 98% du taux d'accroissement annuel dans les années de bonne et mauvaise reproduction, respectivement), devant le taux de survie des jeunes (Gauthier & Brault 1998). En 2011, la population était estimée à 925 000 individus, indiquant une potentielle stabilisation de cette population. La principale cause de cette augmentation est un changement de régime alimentaire, à l'origine entièrement basé sur les plantes des marais côtiers, pour un régime dominé par les céréales et le maïs en hiver et au printemps (Gauthier et al. 2005, Calvert et al. 2007), une conséquence de la disponibilité et de la qualité nutritive accrue des cultures agricoles comme source d'alimentation (Jefferies et al. 2004, Abraham et al. 2005).

Les conséquences de cette croissance démographique sur l'habitat des oies sont variables. Certaines aires de marais traditionnels aux abords du fleuve du St-Laurent montrent un déclin dans la production de scirpe (*Scirpus americanus*) dû au broutement par les oies (Gauthier et al. 2005). Dans l'Arctique, l'utilisation d'exclos a mis en évidence l'impact des oies sur la végétation locale ; elles consomment environ 40% des plantes aériennes de la toundra chaque année (Black & Owen 1989). Ce broutement a modifié la communauté de plantes en changeant la composition spécifique des herbacées et graminées (Gauthier et al. 2004). Cependant, il semble que la grande oie des neiges n'avait pas encore atteint la capacité de charge de son site de nidification à la fin des années 1990 (Masse et al. 2001). Les conséquences de cette augmentation de la population sur les oies elle-même via des facteurs dépendant de la densité sont encore faibles. Il est toutefois à noter que la condition corporelle des grandes oies des neiges tuées à l'automne semble avoir diminuée au cours du temps (Reed & Plante 1997).

Face à l'impact actuel et potentiel de la grande oie des neiges sur son environnement et l'accroissement continue de sa population (Gauthier et al. 2004, Gauthier et al. 2005), les membres du Groupe de travail sur l'habitat des oies Arctiques ont considéré la population de grandes oies des neiges comme surabondante et ont proposé une série de mesures de conservation visant à stabiliser la croissance de cette population (Batt 1998). En 1998-1999, une nouvelle réglementation a été mise en place en suivant les recommandations de Giroux et al. (1998) afin de diminuer les taux de survie des adultes et ainsi stabiliser le niveau de population de grandes oies des neiges à 1 million d'individus ou moins. Ces mesures

de conservation touchent la population d'oies sur l'ensemble de son aire de répartition bien que le modèle de population sur lequel repose ces mesures ne soit basé que sur les paramètres démographiques estimés pour une seule colonie de nidification, celle de l'île de Bylot, la seule qui fasse l'objet d'un suivi à long terme (Reed et al. 1998, Reed & Calvert 2007). Les mesures de conservations prévoyaient l'emploi de méthodes de chasse auparavant interdites comme l'appâtage et les enregistrements d'appels électroniques, l'ouverture d'une récolte de conservation à l'extérieur des saisons régulières de chasse au Canada et la libéralisation des limites de prises et possession au Canada et aux États-Unis. L'instauration d'une récolte de conservation printanière au Québec en avril et en mai a été la plus importante de toutes les mesures (Reed & Calvert 2007).

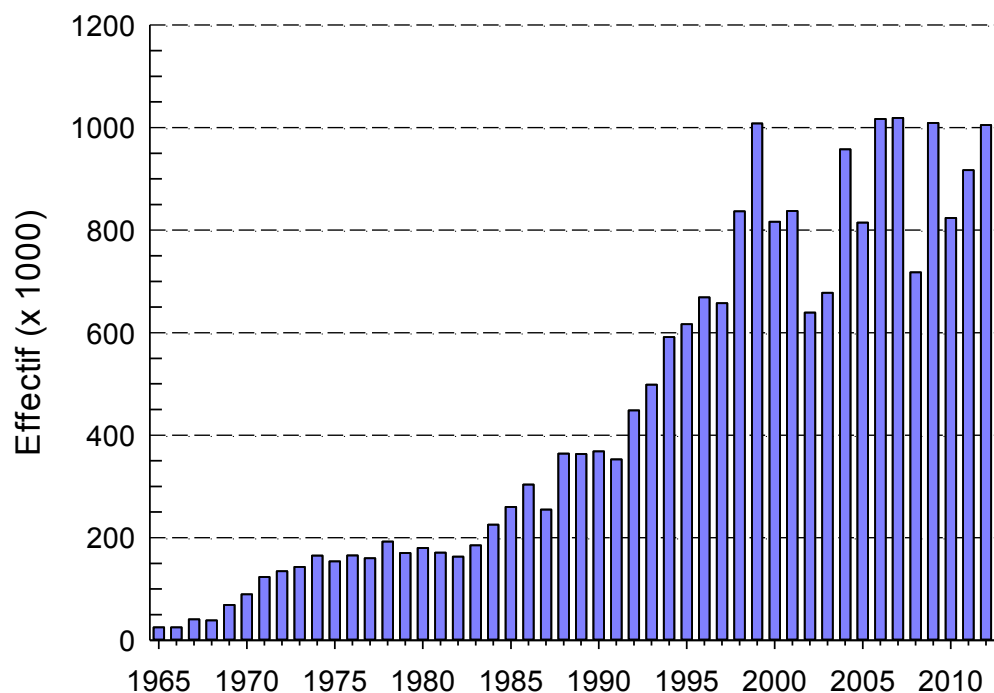

**Figure 6: Abondance de la grande oie des neiges depuis 1965 (Calvert et al. 2007 et Service Canadien de la Faune, données non-publiées).**

Une première évaluation de ces mesures de conservation pour la période 1998-2003 a été publiée en 2007 (Reed & Calvert 2007). Calvert & Gauthier (2005) ont étudié plus précisément l'effet de ces mesures sur la survie et la mortalité à la chasse. Ces auteurs ont trouvé que (i) le taux de reprises des adultes a considérablement augmenté, suggérant une augmentation de la mortalité à la chasse, et, tel qu'attendu par l'hypothèse de mortalité additive, le taux de survie des

adultes a diminué. *(ii)* Le taux de reprise des jeunes a légèrement augmenté mais aucun changement du taux de survie n'a été noté. Plusieurs explications sont possibles pour ce dernier résultat: *(i)* le taux de reprise n'est pas un bon indice du taux de mortalité à cause du manque d'information sur le taux de retour des bagues, *(ii)* les facteurs environnementaux ont une influence plus grande que la chasse sur le taux de survie des jeunes ou *(iii)* la mortalité à la chasse pourrait être en partie compensatoire chez les jeunes.

## **5. Objectifs de la présente thèse**

L'objectif principal de ma thèse est d'évaluer la canalisation environnementale des paramètres démographiques chez les espèces longévives. La population de grande oie des neiges, qui est ici utilisée comme modèle d'étude, est une sous-espèce longévive dont le taux de croissance est déterminé par le taux de survie adulte. De plus, le suivi à long-terme de l'espèce, ainsi que la gestion liée à son exploitation par l'humain, ont permis l'accumulation d'une base de données considérable sur une période de 20 ans pour cette population. La grande oie des neiges est donc une espèce modèle offrant le cadre nécessaire afin de tester différentes hypothèses liées à la canalisation environnementale.

Les objectifs de cette thèse sont : *(i)* d'affiner les estimations des paramètres démographiques sur l'ensemble de la période de suivi, en particulier le taux de survie des jeunes et certains paramètres de reproduction comme la probabilité annuelle de nicher, à l'aide de modèles de capture-recapture déjà existant ou à développer ; *(ii)* de déterminer les facteurs de variation de ces paramètres, et *(iii)* d'évaluer la variation spatiale du taux de survie adulte. Ces différents objectifs me permettront d'évaluer l'hypothèse de la canalisation environnementale chez la grande oie des neiges, une espèce longévive.



# Chapitre 1 : Variation du taux de retour de bagues par les chasseurs et implications

---

*Soumis à Avian Conservation & Ecology*

La grande oie des neiges est une espèce exploitée depuis le début du XXe siècle dont la chasse est réglementée de façon étroite par la Convention sur les oiseaux migrateurs au Canada et Etats-Unis en 1918, (Williams & Nichols 2001). Ce type de traité permet d'adopter périodiquement des règles de chasse cohérentes entre différents pays.

Ces règles sont basées sur l'idée qu'une partie de la ressource (forêt, population animale) peut être prélevée sans risque à long terme. Ce rendement durable peut être exprimé dans un modèle général d'exploitation d'une population :

$$N(t+1) = N(t) + f(N,H,t),$$

où  $f(N,H,t)$  est le taux de croissance annuelle de la population qui dépend de sa taille,  $N$ , et des prises annuelles,  $H$  (Williams et al. 2002). A partir de ce modèle théorique, une méthode de prise de décision pour la régulation de l'exploitation a été développée, la gestion adaptative des ressources, dont le but est de permettre une exploitation durable à long terme (Shea & NCEAS Working Group on Population Management 1998, Johnson et al. 2002, Williams et al. 2002). L'un des principes clés est que la prise de décision se base sur des objectifs chiffrés et sur les informations disponibles pour améliorer les décisions futures. L'un des meilleurs exemples d'application de cette méthode est la gestion de la sauvagine en Amérique du Nord (Nichols & Williams 2006). Une approche adaptative de la gestion de la chasse peut être décrite en 4 étapes: (i) chaque année, une décision optimale est prise basée sur le statut de la ressource et des différentes options possibles (régulation libérale, modérée ou restrictive par exemple); (ii) la population reproductrice à venir est estimée à partir du modèle correspondant à l'option choisie; (iii) quand les données de suivi sont disponibles, les probabilités de fiabilité du modèle sont calculées et évaluées par le degré de similitude entre les projections théoriques et les recensements; (iv) un nouvel ensemble de modèles est utilisé pour préparer l'année suivante basé sur l'information recueillie durant l'année.

Un pré-requis essentiel pour ces modèles est de pouvoir établir la cause de la mort des individus, soit la chasse ou un autre type de mortalité (Nichols et al. 1984, Schaub & Lebreton 2004). Classiquement, les bagues d'oiseaux tués à la chasse et retournées par les chasseurs permettent d'établir un index du taux de mortalité à la chasse communément appelé le taux de récupération des bagues (Burnham & Anderson 1984, Nichols et al. 1984, Rexstad 1992, Smith & Reynolds 1992, Francis et al. 1998, Schmutz & Ely 1999, Gauthier et al. 2001, Poysa et al. 2004). De plus, dans les modèles de CMR se basant sur les reprises d'individus morts pour estimer les probabilités de survie, le taux de reprise estimé pour les oiseaux chassés intègre plusieurs composantes: la probabilité d'être tué à la chasse, la probabilité que le chasseur retrouve un oiseau tiré et la probabilité que la bague soit rapportée. Le taux de reprise  $f_i$  peut alors être exprimé en fonction du taux de mortalité à la chasse  $h_i$  et de la probabilité que la bague soit rapportée  $\lambda_i$ . En général, le taux de mortalité à la chasse est le paramètre d'intérêt et ne peut être estimé précisément que si l'on connaît le taux de retour des bagues par les chasseurs (i.e. « *reporting rate* »). Une technique généralement utilisée pour estimer ce paramètre est l'utilisation d'un marqueur auxiliaire comme les bagues « récompense ». Le principe est que la récompense permet d'assumer *a priori* que le taux de retour de ces bagues est égal à 1 à partir d'un certain montant d'argent. Un oiseau bagué avec juste une bague standard aura donc une probabilité d'être repris égale à  $h \times \lambda$  alors qu'un oiseau bagué avec une bague standard et une bague récompense aura une probabilité d'être repris égale à  $h$ , ce qui permet d'estimer le taux de mortalité à la chasse (Williams et al. 2002, Zimmerman et al. 2009b). Une précédente étude a permis d'estimer ces taux pour différentes espèces de sauvagine à l'échelle Nord-Américaine (Zimmerman et al. 2009b) tout en pointant certaines différences selon les zones de chasse. Des variations du taux de retour de bagues pourraient entraîner des biais d'estimation du taux de chasse dans les modèles de gestion adaptative mais également des imprécisions dans les estimations de taux de survie à partir des modèles CMR se basant sur la reprise d'individus morts.

Cette thèse, ayant pour but d'évaluer les prédictions de la théorie de la canalisation, nécessite que l'estimation des paramètres démographiques soit la plus précise possible. Le but de ce chapitre est donc d'estimer le taux de retour de bagues spécifiquement à la grande oie des neiges et de voir les conséquences potentielles de variations dans ce taux sur la gestion de la grande oie des neiges.

## **Variations in Band Reporting Rate and Implications for Kill Rate in Greater Snow Geese**

GUILLAUME SOUCHAY, *Département de Biologie & Centre d'Études Nordiques and Centre d'Écologie Fonctionnelle et Évolutive - UMR 5175, Campus CNRS 1919 route de Mende, F-34293 Montpellier Cedex 05 France*

OLIVIER GIMENEZ, *Centre d'Écologie Fonctionnelle et Évolutive - UMR 5175, Campus CNRS, 1919 route de Mende, F-34293 Montpellier Cedex 05, France*

GILLES GAUTHIER, *Département de Biologie & Centre d'Études Nordiques, 1045 avenue de la Médecine, Université Laval, Québec, QC, G1V 0A6, Canada*

ROGER PRADEL, *Centre d'Écologie Fonctionnelle et Évolutive - UMR 5175, Campus CNRS, 1919 route de Mende, F-34293 Montpellier Cedex 05, France*

## **Abstract**

We assessed spatial and temporal variations in reporting probability of banded greater snow geese (*Chen caerulescens atlantica*) shot by hunters in eastern North America and evaluated potential residual biases in kill rate estimation. Adult greater snow geese were marked with reward (value: US\$10, \$20, \$30, \$50 and \$100) and standard bands (\$0, control) in the Canadian Arctic from 2003 to 2005. We used a spatially explicit multinomial model based on 200 direct recoveries from 4,256 banded geese to estimate reporting and harvesting probabilities. We found that reporting rate of standard bands varied over time whereas harvest rate was higher in Canada than in the USA. The reporting probability increased from  $0.40 \pm 0.11$  in the first-year of the study to  $0.82 \pm 0.14$  and  $0.84 \pm 0.13$  the second and third years respectively. Overall, these reporting rates are higher than two previous estimates for this population, which leads to lower estimates of kill rate. However, the large annual differences in reporting rates found in this study create great uncertainty in the estimation of kill rate. We suggest that the increase in reporting rate in the last two year of the study may be due to the spread of information among hunters regarding the presence of reward-bands on birds, resulting in increased reporting rate for all bands. This raises issues about the need to adequately inform the public in such large-scale studies to avoid undesirable temporal trends over the course of the study.

## **KEY WORDS**

Atlantic Flyway, band recovery, greater snow goose, kill rate, reporting rate, reward band, spatial variation, temporal variation, waterfowl.

## Résumé

Nous avons étudié les variations spatiales et temporelles du taux de reprise de grandes oies des neiges bagués (*Chen caerulescens atlantica*) et tuées par les chasseurs dans l'est de l'Amérique du Nord et évalué les biais potentiels pour l'estimation des taux de mortalité à la chasse. Les grandes oies des neiges adultes ont été marquées à l'aide de bagues « récompense » (valeur : US\$10, \$20, \$30, \$50 and \$100) et de bagues standards (bagues « témoin », valeur : \$0) dans l'Arctique Canadien de 2003 à 2005. Nous avons utilisé un modèle multinomial spatialement explicite basé sur 200 reprises directes d'individus morts sur les 4 256 oies baguées pour estimer les probabilités de retour de bague par les chasseurs et les taux de chasse. Nous avons trouvé que le taux de retour des bagues standards a varié au cours du temps tandis que le taux de récolte à la chasse était plus élevé au Canada qu'aux États-Unis d'Amérique. Le taux de retour de bague a augmenté de  $0.40 \pm 0.11$  la première année à  $0.82 \pm 0.14$  et  $0.84 \pm 0.13$ , respectivement les deuxième et troisième années de l'étude. Globalement, ces taux de retour de bague sont plus élevés que ceux précédemment estimés pour cette même population, conduisant à une plus faible estimation du taux de mortalité à la chasse. Cependant, les importantes différences annuelles du taux de retour de bague trouvées dans cette étude engendrent une grande incertitude autour de l'estimation du taux de mortalité à la chasse. Nous suggérons que l'augmentation du taux de retour de bague par les chasseurs dans les 2 dernières années de l'étude est due à la dispersion de l'information concernant la présence de bagues « récompense » sur les oies auprès des chasseurs, ayant pour conséquence une augmentation du retour de toutes les bagues, avec ou sans récompense. Cette étude amène une réflexion sur le type d'information à transmettre au grand public lors d'études à grande échelle afin d'éviter des tendances temporelles au cours de telles études.

## Introduction

An accurate estimation of harvest rate, the proportion of the population killed and retrieved by sport hunters, is critical for the management of most hunted populations (Williams et al. 2002). For instance, within the framework of adaptive harvest management used by the US Fish and Wildlife Service (FWS), annual harvest rates are used to update annual hunting regulations of several waterfowl populations (Williams et al. 2002, Baldassarre & Bolen 2006). In several species, estimates of the absolute numbers harvested are obtained through annual hunter survey (i.e. questionnaires sent to a sample of randomly selected hunters where they reported the number of birds killed and retrieved; Baldassarre & Bolen 2006, Padding & Royle 2012). These values are then converted into rates using population size estimates.

An alternative method to estimate harvest rate relies on direct recoveries of banded birds (Baldassarre & Bolen 2006). Newly banded birds can be re-encountered when shot and retrieved during the following hunting season (i.e. direct recoveries). Most of harvested species bands are reported by hunters (e.g. > 97% in the Greater Snow Goose), thus others kind of recoveries can be neglected. However, because all banded birds that are killed and retrieved are not reported to the Bird Band Laboratory (BBL), the recovery rate, defined as the probability that a bird will be shot, retrieved by a hunter and reported to the BBL, is a biased estimation of harvest rate ( $h$ ). Estimating reporting rate ( $\lambda$ , i.e. the probability that the band of a shot and retrieved bird is reported to the BBL) is thus critical to assess hunting mortality of managed populations (Padding & Royle 2012).

Reward band studies are typically used to estimate reporting rate (Nichols et al. 1991, Nichols et al. 1995, Royle & Garrettson 2005, Zimmerman et al. 2009b, Padding & Royle 2012). This method allows the estimation of harvest probability ( $h$ ) separately from reporting ( $\lambda$ ) probability (Henny & Burnham 1976), based on the assumption that a reward value is high enough to obtain a reporting rate approximating 1.0. A bird which carries the highest reward will be recovered with probability  $h$  whereas a standard-banded bird will be recovered with probability  $h \times \lambda$ . These two parameters can thus be estimated separately. Multivalued reward band studies also enable a test of the assumption that the highest reward value is sufficient to ensure that the asymptotic reporting rate (assumed to be 1) is reached. This can be verified by regressing reporting probability on reward value (Royle & Garrettson 2005).

Previous studies have examined reporting probabilities in duck and goose populations across North America (Nichols et al. 1991, Nichols et al. 1995, Royle & Garrettson 2005, Zimmerman et al. 2009b). Zimmerman et al. (2009b) examined the reporting probability in 12 populations of 4 goose species (Canada Geese *Branta canadensis*, Cackling Geese *B. hutchinsii*, Snow Geese *Chen caerulescens* and Ross's Geese *C. rossii*) after introduction in the mid-1990s of the toll-free phone number to report banded birds that are shot. They assessed variation in reporting probabilities among species, populations and harvest locations. In particular, they found spatial variation in reporting probability depending on the harvesting area with lower reporting probabilities in Canada compared to U.S.

Our objectives were to study geographical and temporal variation in reporting probability by Greater Snow Goose hunters in eastern North America. This goose population is unique in two ways, namely that harvest is equal or higher in Canada than in the U.S. (Calvert & Gauthier 2005), unlike most other waterfowl populations, and Canadian hunting occurs almost exclusively in Quebec, the predominantly French-speaking province of Canada. Anecdotal observations (G. Gauthier, per. obs.) suggested that cultural or linguistic differences could lead to differences in reporting rates between Quebec and the U.S. for this population (see also Zimmerman et al 2009b). Our analysis was based on a 3-year reward band study conducted in greater snow geese from 2003 to 2005, a subset of the large scale study analyzed by Zimmerman et al (2009b). We expected no temporal variation in the reporting probability over that period but a higher reporting probability in northeastern United States than in Quebec.

## **Methods**

### *Field Methods*

Greater Snow Geese were marked at the end of the summer on their arctic breeding ground at the Bylot Island, Nunavut, Canada (73°N, 80°W) colony from 1990 to 2010 (see Gauthier et al. 2001 for details). Goose families were captured during a ten-day period, when adults were molting and before young could fly. Birds were aged (young of the year or adult  $\geq 1$  year-old) and all were banded with standard United States Geological Survey (USGS) bands. From 2003 to 2005, reward bands were applied to adults only. Control-banded birds (both males and females) received the standard

USGS band inscribed with a unique 9-digit number and “CALL 1-800-327-BAND, WRITE BIRD BAND LAUREL MD 20708 USA”. Reward-banded geese were marked with the same standard band on one leg and with an additional band inscribed with “REWARD \$XXX” and a unique 6-digit number on the other leg. Reward bands were manufactured to the same specifications as standard bands and were not permanently colored, unlike similar reward band programs in ducks (bands were only temporarily marked with a water-soluble, nontoxic green dye to aid in banding logistic). Bands of each type were alternatively applied in a 1:1 ratio ( $N = 2,139$  control-banded geese and  $N = 2,117$  reward-banded geese, Table 1) and no other markers were used on the birds. Reward bands were divided into 5 values (US\$10, \$20, \$30, \$50 and \$100) and were equally distributed within the banded sampled.

### *Data Analysis*

For all analyses, we only used direct recoveries (i.e. bands recovered and reported during the first hunting season following banding) of birds reported to the BBL as shot (e.g. > 97 %) or found dead by hunters ( $n = 200$  in total). We excluded indirect recoveries (i.e. bands recovered > 1 year after banding) due to the small amount of information provided by these data and because more complex models would have been required to account for this information. A summary of number of banded and recovered individuals by dollar value, year and harvest area is available in Appendix A.

We first assessed the validity of the assumption that the asymptotic reporting rate ( $\lambda$ ) was reached for \$100. The direct recovery rate of bands with dollar value  $x$  was estimated as the ratio of direct recoveries  $n_x$  to the number of bandings  $N_x$  of dollar value  $x$  ( $\hat{f} = n_x / N_x$ ). The reporting rate for each dollar value may be estimated assuming  $\lambda_{100} = 1$ . The estimated reporting rate for bands of dollar value  $x$  is then  $\hat{\lambda}_x = \hat{f}_x / \hat{f}_{100}$ . Following Royle and Garrettson (2005), we used a generalized linear model to evaluate the effect of dollar value on band reporting rate using a logit link. We assumed a binomial distribution for direct recoveries with recovery probability equal to the product of dollar-value specific reporting rate and harvest rate. We used the function *nlm* in the software R (R Development Core Team 2010) to perform this analysis. To evaluate whether the model fitted the data, we evaluated goodness-of-fit



using a chi-squared statistic based on the expected recoveries  $e_x$ . Under the null hypothesis that the model provides a good fit to the data, the statistic

$$\sum_x \frac{(j_x - e_x)^2}{e_x} \quad (1)$$

has a  $\chi^2$  distribution with  $(j - k)$  degrees of freedom, where  $j$  is the number of categories of observed recoveries and  $k$  is the number of estimated parameters.

In a second step, we tested temporal and regional effects on reporting rate. We started by estimating annual reporting ( $\lambda$ ) and harvest ( $h$ ) rates of Greater Snow Geese in two different geographical areas (Quebec and U.S.) from direct recoveries. Following Nichols et al. (1995), the harvest rate represents the probability that an individual is harvested in a particular recovery unit (Quebec or USA). Due to potential band loss, we introduced a band retention probability ( $\theta = 0.9995$ ) estimated by Zimmerman et al. (2009a). We assumed that the vector of band recoveries in Quebec and USA was distributed as

$$\text{Multinomial}(N_t; \theta \times h_{it} \times \lambda_{ixt}) \quad (2)$$

where  $N_t$  is the number of individuals banded and released just before hunting season  $t$  from the greater snow goose population,  $h_{it}$  is the probability that a bird is harvested in spatial area  $i$  in hunting season  $t$  and  $\lambda_{ixt}$  is the reporting probability for geese recovered in spatial area  $i$  with dollar value  $x$  in hunting season  $t$ . We considered a linear logistic model relating reporting rate to dollar value  $x$ :

$$\text{logit}(\lambda_{ixt}) = \log\left(\frac{\lambda_{ixt}}{1 - \lambda_{ixt}}\right) = \alpha + \beta_{ixt} \quad (3)$$

where  $\alpha$  and  $\beta$  are regression parameters to be estimated. From Eqn. 3, it can be seen that the intercept  $\alpha$  is the reporting rate for band with  $x = 0$ , *i.e.* standard band. We also set  $\lambda = 1$  for \$100 value in this analysis because of difficulties in estimating this parameter in presence of both temporal and spatial effects.

We adopted a Bayesian approach using Markov Chain Monte Carlo (MCMC) simulations to implement all models. We specified the model to run in the form of the likelihood and non-informative prior distributions for all parameters to be estimated. We used empirical means and standard deviations to summarize these posterior parameter distributions (Gimenez et al. 2009, Gimenez et al. 2012). For priors, we used a Normal distribution (0, 10) for  $\alpha$ , a Normal distribution (0, 100) for  $\beta$  and a Uniform distribution (0, 1) for  $h$ . We used program JAGS (Plummer 2003) called from

R (R Development Core Team 2010). We ran 200,000 iterations including 100,000 burn-in. We also tested reduced models where reporting and harvest rates did not vary according to time and / or area of recovery. Model selection was conducted using the Deviance Information Criterion (DIC, Spiegelhalter et al. 2002). The code is available in Appendix B.

Based on the estimation of reporting rate  $\lambda$  obtained in the Bayesian analysis, we estimated the probability of being killed by a hunter or kill rate ( $K$ ). This probability must account for the proportion of birds that are shot by hunters but not retrieved because the harvest rate is based solely on retrieved birds (Anderson & Burnham 1976). Thus, we estimated  $K$  as follows

$$K = \frac{f}{c \times \lambda} \quad (4)$$

where  $c$  the retrieval rate (i.e. the probability that a hunter retrieves a shot bird). We used a constant value of 0.80 for retrieval rate from Henny & Burnham (1976) as this is the only available estimate for this parameter. Values of  $f$  were obtained by applying a standard, annual band recovery analysis to both adults and young for the later period of the banding study (2002 to 2010). We used the same procedure as Calvert and Gauthier (2005) except that we did not include birds that received a neck band during this period. To obtain the standard error of the estimated kill rate, we used the delta-method (Seber 1982).

## Results

Overall, direct recovery rates ( $\hat{f}$ ) was 0.037 in control birds and ranged from 0.042 to 0.075 for reward-banded birds with different dollar values (Table 1). The band reporting rate based on our binomial model increased rapidly with dollar value. The estimated reporting rate function ( $\text{logit}(\lambda_x) = 0.3207 + 0.0910x$ ) showed a reasonable fit with the observed reporting rate for each dollar value (Fig.1). The predicted reporting rate was equal to 1.0 (horizontal line on the figure) at a dollar value around \$60, although point estimate at a value of \$30 was  $> 1.0$  (Fig.1). Based on parameter of the fitted model, the expected number of recoveries for each dollar value were 78.0, 20.7, 23.6, 25.5, 26.5 and 26.6 for  $x = 0, 10, 20, 30, 50$  and \$100, respectively. Our goodness-of-fit test ( $\chi^2(3) = 2.50, P = 0.475$ ) suggested no lack-of-fit.

**Table 1: Number of banded birds ( $N$ ), number of direct recoveries ( $n$ ), and direct recovery rates ( $\hat{f}$ ) of greater snow geese marked at Bylot Island from 2003 to 2005 for each dollar value ( $x$ ) of reward bands.**

| \$ Value<br>( $x$ ) | $N_x$ | $n_x$ | $\hat{f}_x$ |
|---------------------|-------|-------|-------------|
| 0                   | 2139  | 79    | 0.038       |
| 10                  | 425   | 18    | 0.042       |
| 20                  | 420   | 23    | 0.057       |
| 30                  | 425   | 32    | 0.075       |
| 50                  | 425   | 23    | 0.061       |
| 100                 | 422   | 26    | 0.064       |

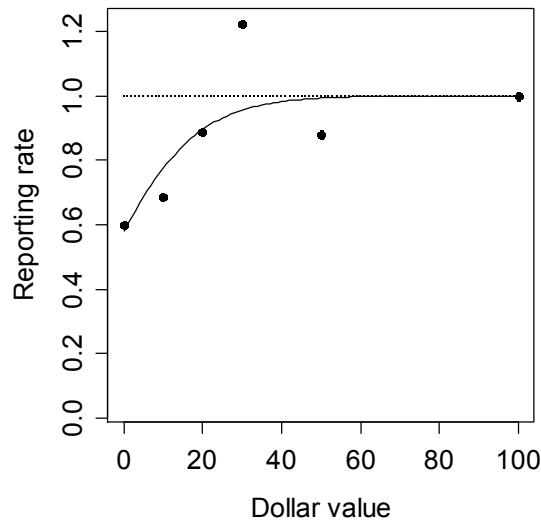

**Figure 1: Fitted reporting rate function ( $\text{logit}(\lambda x) = 0.3207 + 0.0910x$ ) and moment estimates of standard band reporting rate ( $\lambda x$ ) of greater snow geese banded from 2003 to 2005. Each reward-band dollar value was obtained assuming that  $\lambda_{100} = 1$ . The horizontal dotted line is  $\lambda = 1.0$ .**

In our evaluation of temporal and spatial effects on reporting rate, the preferred model retained both of these effects in interaction (Table 2). Whereas adding time greatly improved the fit compared to the constant model, region improved the fit only when added in combination with time. However, both models with temporal variations were equivalent ( $\Delta\text{DIC} < 2$ ). Reporting rate of birds with standard USGS bands only was very similar in 2004 and 2005 but was only half of those values in the first year of the study (2003; Model M3, Table 3). The interaction with region was mostly due to the very low reporting rate in the USA compared to Quebec in the first year of the study ( $0.24 \pm 0.13$  [SE] and  $0.56 \pm 0.18$  respectively). Our preferred models included only spatial effect on the harvest rate with no time-dependent effects (models M5 and

M6 compared to best model:  $\Delta\text{DIC} > 5$ , Table 2). Harvest rates estimates were higher for Québec ( $0.034 \pm 0.004$ ) than for the USA ( $0.023 \pm 0.003$ ), as expected.

We estimated kill rate for the period of the reward-band study (2003-2005) using the various point estimates of  $\lambda$  obtained in models M1 to M4 (Table 3) to examine the sensitivity of this parameter to reporting rate. We also included estimation of kill rate using reporting rate values calculated by Calvert and Gauthier (2005) and by Zimmerman et al. (2009b) for this population. We found that kill rate estimated based on the three time-independent reporting rates (constant over region and region-specific) were similar (Fig. 2). These kill rates were generally lower than kill rates estimated based on reporting rate from Calvert and Gauthier (2005) and Zimmerman et al. (2009b) ( $\lambda = 0.36$  and  $0.52$ , respectively). Kill rates estimated with temporal-dependent reporting rate were higher than kill rate based on our constant reporting rate for 2003 and lower for 2004 and 2005 (Fig. 2).

**Table 2: Model selection for the effects of year (2003 to 2005) and geographic region (Quebec vs USA) on greater snow goose harvest and band reporting rates by hunters. All models include a linear effect (logit scale) of dollar value on reporting rate. Mean deviance ( $\bar{D}$ ), effective number of parameters ( $p_D$ ) and DIC (deviance information criterion) are given. Models are sorted by  $\Delta\text{DIC}$  with respect to the best model.**

| #  | Effect on   |             | $\bar{D}$ | $p_D$ | $\Delta\text{DIC}$ |
|----|-------------|-------------|-----------|-------|--------------------|
|    | $h$         | $\lambda$   |           |       |                    |
| M4 | Region      | Region*Year | 153.4     | 7.2   | 0.0                |
| M3 | Region      | Year        | 156.0     | 4.8   | 0.2                |
| M1 | Region      | Constant    | 162.2     | 3.1   | 4.7                |
| M5 | Region*Year | Region      | 157.3     | 8.3   | 5.0                |
| M6 | Region*Year | Region*Year | 154.6     | 11.5  | 5.5                |
| M2 | Region      | Region      | 163.3     | 4.2   | 6.9                |

**Table 3: Point estimate of reporting rate of greater snow geese with standard metal band (i.e. \$0 value) from models M1 to M4 in Table 2, where the harvest rate is only region-dependent.**

| #  | Effects on $\lambda$ | Region | Year | $\lambda$ (SE) |
|----|----------------------|--------|------|----------------|
| M1 | Constant             | -      | -    | 0.65 (0.10)    |
| M2 | Region               | Qc     | -    | 0.65 (0.14)    |
|    |                      | USA    | -    | 0.75 (0.15)    |
| M3 | Year                 | -      | 2003 | 0.40 (0.11)    |
|    |                      | -      | 2004 | 0.82 (0.14)    |
|    |                      | -      | 2005 | 0.84 (0.13)    |
| M4 | Region*Year          | Qc     | 2003 | 0.56 (0.18)    |
|    |                      | Qc     | 2004 | 0.66 (0.19)    |
|    |                      | Qc     | 2005 | 0.84 (0.14)    |
|    |                      | USA    | 2003 | 0.24 (0.13)    |
|    |                      | USA    | 2004 | 0.90 (0.11)    |
|    |                      | USA    | 2005 | 0.82 (0.16)    |

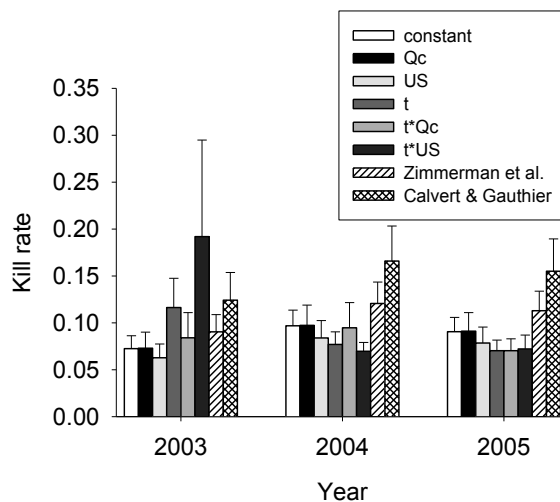

**Figure 2: Estimated Kill rate ( $\pm$  SE) for each year of the reward band study using various point estimates of reporting rate ( $\lambda$ ) from models M1 to M4 in Table 4 or from 2 other studies (Calvert and Gauthier 2005 and Zimmerman et al. 2009b) and a uniform value for retrieval rate (0.8; see methods).**

We finally examined how using various estimates of reporting rate could have affected our evaluation of temporal trends in kill rates of greater snow geese over the period 2002-2010 (Fig. 3). For both juvenile and adult, kill rates estimated using our constant reporting rate value were the lowest. Kill rates based on Zimmerman et al. (2009b) and Calvert and Gauthier (2005) reporting rates were 24% and 70% higher, respectively, than based on our estimate.

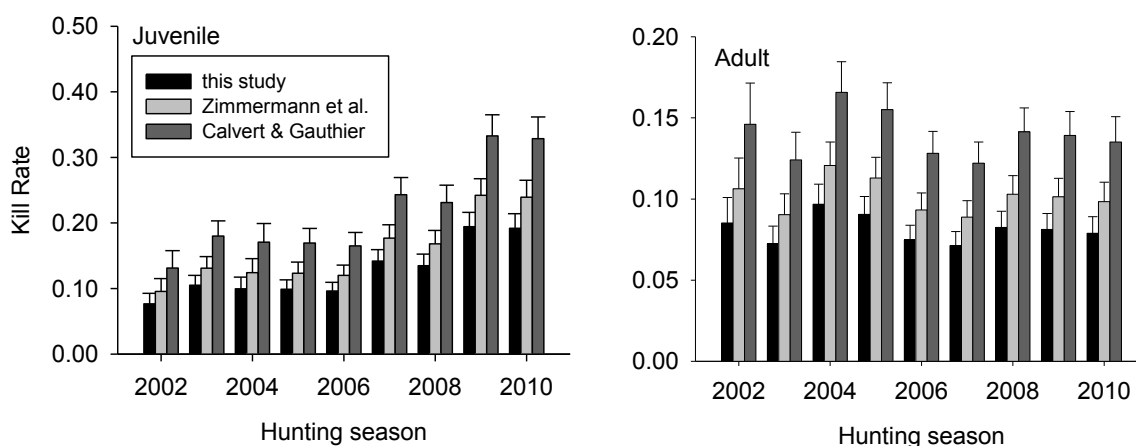

**Figure 3: Temporal trend in kill rates ( $\pm$  SE) of juvenile and adult greater snow geese banded from 2002 to 2010 using various point estimates of kill rate (value from constant model in Table 4, Calvert and Gauthier 2005 and Zimmerman et al. 2009b) based on annual recoveries obtained from a standard band recovery analysis and a uniform value of retrieval rate (0.8 see methods).**

## Discussion

Our study provided strong evidence for temporal variation in reporting rates in greater snow geese over the course of the 3-year reward band study. However, evidence for variations in reporting rates between Quebec and the USA were limited, and we found little support for the hypothesis of a lower reporting rate in Quebec than in the USA.

In an analysis combining both Canada Geese and Snow Geese, Zimmerman et al. (2009b) found lower reporting rate in Canada than in United States and lower in the Atlantic Flyway than in the nearby Mississippi Flyway. They suggested three explanations for these results. The first one was related to the dominance of French-speaking people in Quebec, which may have created a language barrier to reporting reward bands with English-only inscriptions. A second explanation referred to the reluctance of hunters to report harvested Canada Geese due to hunting closure in the previous decade as they may have thought that reporting harvest could lead to another closure. Lastly, they suggested a lack of incentive to report non-reward bands by Canadians, as Canadian routinely receive financial rewards when reporting tagged fish. Our study, which concerned only the Greater Snow Goose, found little difference in reporting rates between the two countries with only a weak trend toward lower reporting rate in Canada. This suggests that the higher U.S. reporting rate found by Zimmerman et al. (2009b) was probably due more to the inclusion of

Canada geese in the dataset than to a language barrier between Quebec and the eastern U.S. Contrary to Canada geese in the Atlantic flyway, the Greater Snow Goose population is considered overabundant, and special measures have been implemented to increase harvest (Giroux et al. 1998, Reed & Calvert 2007). Therefore, hunters are not concerned with possible closure of their hunt and should have no issue in reporting their harvest in the U.S. or Canada.

Our most surprising finding is the strong evidence for temporal variation in reporting rate over the 3-year reward-band study, which was not documented by Zimmerman et al. (2009b) for all goose populations at the continental scale. The pattern in our study was for a much lower reporting rate in the first year than in the subsequent two years, with a possible greater difference in the U.S. than in Quebec. We suggest that this pattern may be a consequence of the study design. No public information was provided to the hunting public in either country regarding the reward-band study before the beginning of the study to avoid a change in hunters' behavior. Hunters received information on this reward band program only when they reported one of the bands to the BBL (T. Moser, US FWS, personal communication). However, after the first hunting season, the word apparently spread within the hunting community about the presence of birds with reward bands, likely aided by internet forums. Thus, increased awareness may have resulted in hunters paying more attention to the presence of bands on geese and may have motivated them to report them at a greater rate, even in the absence of a reward band. Confusion as to whether only some bands or all bands were subject to a reward may have been a factor also. We do not know why temporal trends were not found by Zimmerman et al. (2009b), though the complexity of their models (with 16 different goose populations) and/or regional differences are possible explanations. Indeed, our analysis represents only single goose population in one geographic region (Atlantic Flyway).

The presence of temporal variation in the estimation of reporting rate creates problems for the estimation of kill rate. If hunters indeed changed their attitude after the first year of this reward-band study and reported bands at a higher rate as we suggested, then the more realistic and least biased reporting rate should be the one associated with the first year of the study,  $0.40 \pm 0.11$  in our case. We note that this estimation of reporting rate is similar to the one (0.36 to 0.40) of Calvert and Gauthier (2005) based on the relationship between band-recovery rate and harvest rate,

independent of any reward-band study. However, because reward bands persist in the marked population for a few years and hunters remain aware of them, then a reporting rate close to  $0.84 \pm 0.13$  may be more appropriate in the short term. We note that these differences are not trivial because they would result in a two-fold difference in the estimation of kill rate. However, because we are unable to determine which estimate is most appropriate, using the intermediate value provided by our constant model ( $\lambda = 0.65 \pm 0.10$ ) may be the most representative estimate. This estimate is higher than the one from Zimmerman et al (2009b) for the same population ( $0.52 \pm 0.09$ ) but lower than their overall estimation for all geese across North America ( $0.73 \pm 0.02$ ). These results suggest that applying a common reporting rate to all goose populations may not be appropriate and that estimates based on population-specific analyses are preferable.

### **Management implications**

Although reward-band studies are thought to produce less biased harvest rate estimates than those based on harvest survey (e.g. Parts Collection Survey; Padding & Royle 2012), we found unexpected temporal variation associated with the estimation of reporting rate with a reward-band study for one goose population. Thus, managers should be aware that using a constant reporting rate could introduce biases when estimating harvest rate from band recoveries. If our interpretation that reporting rate may have been inflated in the recent reward-band study conducted in North America, then using such values would likely underestimate harvest once the “reward-band effect” is no longer present.

The increase in reporting rates after the first year of the reward-band study that we observed raises questions about what is the best public policy strategy to adopt when implementing such large scale programs. When no public information is released at the onset of the program as it was the case here, spread of the information or misinformation during the study could result in undesirable temporal changes in reporting rates over the period of the study. Alternatively, publicizing the program from the start could lead to increased harvest rate if hunters increased their activity in the hope of shooting a bird with a reward band. Nonetheless, we believe that a carefully designed public information campaign at the start of such a program may be desirable, especially if hunters are made aware of the low probability of shooting a bird with a reward-band.



## **Acknowledgments**

This study was funded by the Natural Sciences and Engineering Research Council of Canada, the Arctic Goose Joint Venture (Canadian Wildlife Service), the Centre d'Études Nordiques, the Department of Indian and Northern Affairs Canada and the International Research Group Dynamics of Biodiversity and Life-History traits. Funding for the reward program (bands and rewards) was provided by the United States Geological Service. We especially thank T. J. Moser for managing the reward-band program and for valuable information about the program. P. Garrettson and A. Royle provided precious help to carry out the statistical analyses. We are grateful to the numerous field assistant that helped for goose banding and especially G. Picard, to hunters who reported the banded birds that they shot and to M.-C. Cadieux for managing the database and for assistance in the field.

## APPENDIX A.

Table A1: Number of greater snow geese banded (*N*) on Bylot Island and of direct recoveries (*n*) according to dollar value of reward bands, year and geographic locations of recoveries from 2003 to 2005.

| \$ VALUE | YEAR  | <i>N</i> | <i>n</i> |     |
|----------|-------|----------|----------|-----|
|          |       |          | QC       | USA |
| 0        | 2003  | 762      | 13       | 5   |
|          | 2004  | 665      | 13       | 16  |
|          | 2005  | 712      | 19       | 13  |
|          | TOTAL | 2139     | 45       | 34  |
| 10       | 2003  | 151      | 2        | 0   |
|          | 2004  | 133      | 5        | 4   |
|          | 2005  | 141      | 5        | 2   |
|          | TOTAL | 425      | 12       | 6   |
| 20       | 2003  | 147      | 3        | 3   |
|          | 2004  | 132      | 3        | 2   |
|          | 2005  | 141      | 6        | 6   |
|          | TOTAL | 420      | 12       | 11  |
| 30       | 2003  | 150      | 8        | 2   |
|          | 2004  | 133      | 6        | 5   |
|          | 2005  | 142      | 9        | 2   |
|          | TOTAL | 425      | 23       | 9   |
| 50       | 2003  | 151      | 4        | 6   |
|          | 2004  | 132      | 6        | 2   |
|          | 2005  | 142      | 4        | 1   |
|          | TOTAL | 425      | 14       | 9   |
| 100      | 2003  | 151      | 5        | 4   |
|          | 2004  | 131      | 3        | 5   |
|          | 2005  | 140      | 5        | 4   |
|          | Total | 422      | 13       | 13  |

## APPENDIX B. R code for multinomial modeling.

```
#####
##### spatial effect on harvesting rate
#-----
#----- multinomial model
#----- model null
#-----
#setwd("D: [...] notre code")
setwd("D: [...]notre code")
#recovery of data
dat <- read.table('report_rate_region_year.txt',header=T)
head(dat)

# filters
mask.allregion = (dat$region == 'All')
mask.quebec = (dat$region == 'Qc')
mask.usa = (dat$region == 'USA')

mask.year.total = (dat$annee == 'Total')
mask.year.2003 = (dat$annee == '2003')
mask.year.2004 = (dat$annee == '2004')
mask.year.2005 = (dat$annee == '2005')

# data
mask1 <- mask.quebec # Quebec only
mask2 <- mask.usa # USA only
mask3 <- !mask.year.total # all years
mask <- (mask1 | mask2) & mask3
newdat <- dat[mask,] # dataset with all years recoveries from Quebec and
USA

m1 <- newdat$region=='Qc'
m2 <- newdat$region=='USA'

Nx <- newdat$NNx[m1] # number of bandings
ns <- cbind(newdat[m1,5],newdat[m2,5],Nx)
apply(cbind(newdat[m1,5],newdat[m2,5]),1,sum)
x <- newdat$valeurs[m1] # dollar value
N <- length(Nx)

sink("multinom.bug")
cat("
model{
# Likelihood - see Zimmerman et al 2009
for(i in 1:N) { # Loops over N trials
ns[i,1:3] ~ dmulti(prob[i,1:3],Nx[i])

# prob <- lambda * harvesting rate * band retention rate
# pi1 & pi2 refer to harvesting rate in Quebec and USA, respectively

prob[i,1] <- lambdax[i] * pi1 * 0.9995 # probability to be returned from
Quebec area
prob[i,2] <- lambdax[i] * pi2 * 0.9995 # probability to be returned from
USA area
prob[i,3] <- 1 - prob[i,1] - prob[i,2] #probability of not being returned
logit(lamdax[i]) <- (alpha + beta * x[i])*(1-equals(x[i],100)) +
100000000*equals(x[i],100) #the second part allows lambda = 1 for reward
band of $100
```

```

}
# Priors
alpha ~ dnorm(0,0.1)
# monitor derived quantities
lambda0 <- 1/(1+exp(-alpha))
beta ~ dnorm(0,0.01)
pii1 ~ dunif(0,1) # Qc
pii2 ~ dunif(0,1) # USA

}
",fill=TRUE)
sink()

# 2 sets of initial values
init1 = list(alpha = -0.1,beta = -0.2,pii1 = 0.1,pii2 = 0.1)
init2 = list(alpha = 0.1,beta = 0.2,pii1 = 0.1, pii2 = 0.1)
inits = list(init1,init2)
nb.chains = length(inits)

# Load rjags package
library(rjags)

# build dataset
datax = list(N=N,ns=as.matrix(ns),Nx=Nx,x=x)

# store the starting point
deb = Sys.time()

# run jags
model <- jags.model('multinom.bug',
                    data = datax,
                    n.chains = 2,
                    inits=inits,n.adapt=100000)
# store the ending point
fin = Sys.time()

# duration of the run
duration=fin - deb # approx. ? minutes
duration

# post inference
mcmc <- coda.samples(model, c("alpha","beta","lambda0","pii1","pii2"),
n.iter = 100000)#, n.thin= 10)
dic.H_area.L_null <- dic.samples(model, n.iter=100000, type='pD')
dic.H_area.L_null

# post dens & summ
plot(mcmc, trace = FALSE, density = TRUE,ask = dev.interactive())
summary(mcmc)

# diagnostic
plot(mcmc, trace = TRUE, density = FALSE,ask = dev.interactive())
gelman.diag(mcmc)

# save results
save(mcmc, dic.H_area.L_null, duration,file="model_H_area.L_null.RData")

```

```

#-----
#----- multinomial model
#----- region effect
#-----

dat <- read.table('report_rate_region_year.txt',header=T)
head(dat)

# filters
mask.allregion = (dat$region == 'All')
mask.quebec = (dat$region == 'Qc')
mask.usa = (dat$region == 'USA')

mask.year.total = (dat$annee == 'Total')
mask.year.2003 = (dat$annee == '2003')
mask.year.2004 = (dat$annee == '2004')
mask.year.2005 = (dat$annee == '2005')

# data
mask1 <- mask.quebec
mask2 <- mask.usa
mask3 <- !mask.year.total
mask <- (mask1 | mask2) & mask3
newdat <- dat[mask,]

m1 <- newdat$region=='Qc'
m2 <- newdat$region=='USA'

Nx <- newdat$NNx[m1]
ns <- cbind(newdat[m1,5],newdat[m2,5],Nx)
apply(cbind(newdat[m1,5],newdat[m2,5]),1,sum)
x <- newdat$valeurs[m1]
N <- length(Nx)

sink("multinom.bug")
cat("
model{

# Likelihood - see Zimmerman et al 2009
for(i in 1:N) { # Loops over N trials
ns[i,1:3] ~ dmulti(prob[i,1:3],Nx[i])

#2 lambdas, one for each region: lambda[i,1] for Qc and lambda[i,2] for USA
prob[i,1] <- lambdax[i,1] * pii1 * 0.9995
prob[i,2] <- lambdax[i,2] * pii2 * 0.9995
prob[i,3] <- 1 - prob[i,1] - prob[i,2]

logit(lambdax[i,1]) <- (alpha[1] + beta * x[i])*(1-equals(x[i],100)) +
1000000000*equals(x[i],100)
logit(lambdax[i,2]) <- (alpha[2] + beta * x[i])*(1-equals(x[i],100)) +
1000000000*equals(x[i],100)

}
# Priors
for(j in 1:2){
alpha[j] ~ dnorm(0,0.1)
# monitor derived quantities
lambda0[j] <- 1/(1+exp(-alpha[j])) # lambda1 = lambda Qc - lambda2 = USA
}
}

```

```

beta ~ dnorm(0,0.01)
pii1 ~ dunif(0,1)
pii2 ~ dunif(0,1)
}
",fill=TRUE)
sink()

# 2 sets of initial values
init1 = list(alpha = c(-0.1,-0.1),beta = -0.2,pii1 = 0.1,pii2 = 0.1)
init2 = list(alpha = c(0.1,0.1),beta = 0.2,pii1 = 0.1,pii2 = 0.1)
inits = list(init1,init2)
nb.chains = length(inits)

# Load rjags package
library(rjags)

# build dataset
datax = list(N=N,ns=as.matrix(ns),Nx=Nx,x=x)

# store the starting point
deb = Sys.time()

# run jags
model <- jags.model('multinom.bug',
                    data = datax,
                    n.chains = 2,
                    inits=inits,n.adapt=100000)
# store the ending point
fin = Sys.time()

# duration of the run
duration=fin - deb # approx. ? minutes
duration

# post inference
mcmc <- coda.samples(model, c("alpha","beta","lambda0","pii1","pii2"),
n.iter = 100000)#, n.thin= 10)
dic.H_region.L_region <- dic.samples(model, n.iter=100000, type='pD')
dic.H_region.L_region

# post dens & summ
plot(mcmc, trace = FALSE, density = TRUE,ask = dev.interactive())
summary(mcmc)

# diagnostic
plot(mcmc, trace = TRUE, density = FALSE,ask = dev.interactive())
gelman.diag(mcmc)

# save results
save(mcmc,
duration,file="model_H_region.L_region.RData")
dic.H_region.L_region,

```

```

#-----
#----- multinomial model
#----- year effect

dat <- read.table('report_rate_region_year.txt',header=T)
head(dat)

# filters
mask.allregion = (dat$region == 'All')
mask.quebec = (dat$region == 'Qc')
mask.usa = (dat$region == 'USA')

mask.year.total = (dat$annee == 'Total')
mask.year.2003 = (dat$annee == '2003')
mask.year.2004 = (dat$annee == '2004')
mask.year.2005 = (dat$annee == '2005')

# data
mask1 <- mask.quebec
mask2 <- mask.usa
mask3 <- !mask.year.total
mask <- (mask1 | mask2) & mask3
newdat <- dat[mask,]

m1 <- newdat$region=='Qc'
m2 <- newdat$region=='USA'

Nx <- newdat$NNx[m1]
ns <- cbind(newdat[m1,5],newdat[m2,5],Nx)
apply(cbind(newdat[m1,5],newdat[m2,5]),1,sum)
x <- newdat$valeurs[m1]
N <- length(Nx)

year <- c(rep(1,6),rep(2,6),rep(3,6))

sink("multinom.bug")
cat("
model{
# Likelihood - see Zimmerman et al 2009
for(i in 1:N) { # Loops over N trials
ns[i,1:3] ~ dmulti(prob[i,1:3],Nx[i])

prob[i,1] <- lambdax[i] * pii1 * 0.9995
prob[i,2] <- lambdax[i] * pii2 * 0.9995
prob[i,3] <- 1 - prob[i,1] - prob[i,2]

#same lambda for both Qc & USA but alpha varies by year

logit(lambdax[i]) <- (alpha[year[i]] + beta * x[i])*(1-equals(x[i],100)) +
1000000000*equals(x[i],100)

}
# Priors
alpha[1] ~ dnorm(0,0.1) # an 03
alpha[2] ~ dnorm(0,0.1) # an 04
alpha[3] ~ dnorm(0,0.1) # an 05

# monitor derived quantities

```

```

lambda0[1] <- 1/(1+exp(-alpha[1])) # lambda 2003
lambda0[2] <- 1/(1+exp(-alpha[2])) # lambda 2004
lambda0[3] <- 1/(1+exp(-alpha[3])) # lambda 2005
beta ~ dnorm(0,0.01)
pii1 ~ dunif(0,1)
pii2 ~ dunif(0,1)
}
",fill=TRUE)
sink()

# 2 sets of initial values
init1 = list(alpha = rep(-0.1,3),beta = -0.2,pii1 = 0.1, pii2 = 0.1)
init2 = list(alpha = rep(0.1,3),beta = 0.2,pii1 = 0.1, pii2 = 0.1)
inits = list(init1,init2)
nb.chains = length(inits)

# Load rjags package
library(rjags)

# build dataset
datax = list(N=N,ns=as.matrix(ns),Nx=Nx,x=x,year=year)

# store the starting point
deb = Sys.time()

# run jags
model <- jags.model('multinom.bug',
                    data = datax,
                    n.chains = 2,
                    inits=inits,n.adapt=100000)

# store the ending point
fin = Sys.time()

# duration of the run
duration=fin - deb # approx. ? minutes
duration

# post inference
mcmc <- coda.samples(model, c("alpha","beta","lambda0","pii1","pii2"),
n.iter = 100000)#, n.thin= 10)
dic.H_region.L_year <- dic.samples(model, n.iter=100000, type='pD')
dic.H_region.L_year

# post dens & summ
plot(mcmc, trace = FALSE, density = TRUE,ask = dev.interactive())
summary(mcmc)

# diagnostic
plot(mcmc, trace = TRUE, density = FALSE,ask = dev.interactive())
gelman.diag(mcmc)

# save results
save(mcmc,
                                           dic.H_region.L_year,
duration,file="model_H_region.L_year.RData")

#-----
#----- multinomial model
#----- region + year effect

dat <- read.table('report_rate_region_year.txt',header=T)

```



```

head(dat)

# filters
mask.allregion = (dat$region == 'All')
mask.quebec = (dat$region == 'Qc')
mask.usa = (dat$region == 'USA')

mask.year.total = (dat$annee == 'Total')
mask.year.2003 = (dat$annee == '2003')
mask.year.2004 = (dat$annee == '2004')
mask.year.2005 = (dat$annee == '2005')

# data
mask1 <- mask.quebec
mask2 <- mask.usa
mask3 <- !mask.year.total
mask <- (mask1 | mask2) & mask3
newdat <- dat[mask,]

m1 <- newdat$region=='Qc'
m2 <- newdat$region=='USA'

Nx <- newdat$NNx[m1]
ns <- cbind(newdat[m1,5], newdat[m2,5], Nx)
apply(cbind(newdat[m1,5], newdat[m2,5]), 1, sum)
x <- newdat$valeurs[m1]
N <- length(Nx)

year <- c(rep(1,6), rep(2,6), rep(3,6))

sink("multinom.bug")
cat("
model{
# Likelihood - see Zimmerman et al 2009
for(i in 1:N) { # Loops over N trials
ns[i,1:3] ~ dmulti(prob[i,1:3],Nx[i])

# 1 lambda for each reigion

prob[i,1] <- lambdax[i,1] * pii1 * 0.9995
prob[i,2] <- lambdax[i,2] * pii2 * 0.9995
prob[i,3] <- 1 - prob[i,1] - prob[i,2]

# each lambda varying by year

logit(lambdax[i,1]) <- (alpha1[year[i]] + beta * x[i])*(1-equals(x[i],100))
+ 1000000000*equals(x[i],100)
logit(lambdax[i,2]) <- (alpha2[year[i]] + beta * x[i])*(1-equals(x[i],100))
+ 1000000000*equals(x[i],100)

}
# Priors
alpha1[1] ~ dnorm(0,0.1) # an 03
alpha1[2] ~ dnorm(0,0.1) # an 04
alpha1[3] ~ dnorm(0,0.1) # an 05
alpha2[1] ~ dnorm(0,0.1) # an 03
alpha2[2] ~ dnorm(0,0.1) # an 04
alpha2[3] ~ dnorm(0,0.1) # an 05
# monitor derived quantities
lambda01[1] <- 1/(1+exp(-alpha1[1])) # lambda Qc 2003

```

```

lambda01[2] <- 1/(1+exp(-alpha1[2])) # lambda Qc 2004
lambda01[3] <- 1/(1+exp(-alpha1[3])) # lambda Qc 2005
lambda02[1] <- 1/(1+exp(-alpha2[1])) # lambda USA 2003
lambda02[2] <- 1/(1+exp(-alpha2[2])) # lambda USA 2004
lambda02[3] <- 1/(1+exp(-alpha2[3])) # lambda USA 2005
beta ~ dnorm(0,0.01)
pii1 ~ dunif(0,1)
pii2 ~ dunif(0,1)
}
",fill=TRUE)
sink()

# 2 sets of initial values
init1 = list(alpha1 = rep(-0.1,3),alpha2 = rep(-0.1,3),beta = -0.2,pii1 =
0.1, pii2 = 0.1)
init2 = list(alpha1 = rep(0.1,3),alpha2 = rep(0.1,3),beta = 0.2,pii1 = 0.1,
pii2 = 0.1)
inits = list(init1,init2)
nb.chains = length(inits)

# Load rjags package
library(rjags)

# build dataset
datax = list(N=N,ns=as.matrix(ns),Nx=Nx,x=x,year=year)

# store the starting point
deb = Sys.time()

# run jags
model <- jags.model('multinom.bug',
                    data = datax,
                    n.chains = 2,
                    inits=inits,n.adapt=100000)
# store the ending point
fin = Sys.time()

# duration of the run
duration=fin - deb # approx. ? minutes
duration

# post inference
mcmc <- coda.samples(model,
c("alpha1","alpha2","beta","lambda01","lambda02","pii1","pii2"), n.iter =
100000)#, n.thin= 10)
dic.H_region.L_full <- dic.samples(model, n.iter=100000, type='pD')
dic.H_region.L_full

# post dens & summ
plot(mcmc, trace = FALSE, density = TRUE,ask = dev.interactive())
summary(mcmc)

# diagnostic
plot(mcmc, trace = TRUE, density = FALSE,ask = dev.interactive())
gelman.diag(mcmc)

# save results
save(mcmc,
dic.H_region.L_full,duration,file="model_H_region.L_region.RData")

```

## Chapitre 2 : Coût de la reproduction chez un oiseau nicheur arctique.

---

*En préparation pour Ecology*

La théorie de la canalisation prédit une plus grande variabilité des paramètres démographiques les moins élastiques tels que la reproduction. Néanmoins, ce paramètre regroupe plusieurs composantes. Chez les oiseaux, la fécondité est un processus hiérarchique avec la construction du nid, où l'œuf est contenu à l'intérieur de la couvée (ensemble des œufs) pondue par une femelle qui peut pondre plusieurs fois à l'intérieur de la même saison (Etterson et al. 2011). Le succès reproducteur à chaque stade peut donc être exprimé en fonction du nombre d'œufs pondus (la taille de ponte), le nombre de jeunes à l'éclosion (la taille de portée) et le nombre de jeunes à l'envol produit. La mesure la plus commune de la fécondité est le succès de nidification, défini comme la probabilité qu'un nid va donner au moins un jeune capable de voler (Etterson et al. 2011).

Une prémisses au processus précédent est la décision d'aller se reproduire de la femelle, i.e. la probabilité de nicher. Chez certaines espèces, ce paramètre est assumé être égal à 1. Cependant, chez les espèces longévives ou ayant une courte saison de reproduction, une large proportion des femelles ne se reproduit pas chaque année (Etterson et al. 2011). Chez certaines espèces, la reproduction peut donc être périodique (e.g. tous les 2 ans chez l'albatros hurleur *Diomedea exulans*, Weimerskirch 1992) ou irrégulière (e.g. selon l'abondance des proies chez le harfang des neiges *Bubo scandiaca*, Gauthier et al. 2004). La non-reproduction une année donnée peut également être une conséquence de l'existence de coûts à la reproduction, i.e. une corrélation négative entre 2 éléments de la fitness (e.g. survie et reproduction ou reproduction actuelle et reproduction future, Williams 1966). L'estimation de la probabilité de nicher est donc importante pour l'estimation du taux de croissance de la population mais également pour l'étude des compromis évolutifs. Cependant, il s'agit de l'un des paramètres les plus difficiles à estimer. En effet, les individus non-reproducteurs peuvent changer de comportements et être plus difficile à détecter ou être simplement absent du site de reproduction. Il faut alors prendre en compte l'émigration temporaire, i.e. la probabilité d'être absent du site de capture, qui

est le complément de la probabilité de nicher lorsque les individus non-reproducteurs sont absents du site de reproduction.

Les méthodes traditionnelles d'estimation de ce paramètre sont l'utilisation du modèle Robust Design (Pollock 1982, Kendall et al. 1997) ou l'utilisation de modèles multi-états avec un état non-observable (Henaux et al. 2007). Cependant, ces 2 techniques présentent d'importantes limitations (hypothèse violée, problème d'identifiabilité, voir la section Introduction pour plus de détails). Les modèles multi-événements présentent l'avantage d'être plus flexible que ces précédents modèles et permettraient donc d'estimer plus précisément la probabilité de nicher (Pradel 2005).

Le but de ce chapitre est donc de présenter une nouvelle méthode d'estimation basée sur les modèles multi-événements permettant d'estimer la probabilité de nicher des femelles grandes oies des neiges, et d'étudier l'existence potentielle de coûts liés à la reproduction.

Running head: Costs of reproduction in Arctic geese

**To breed or not to breed: evidence of costs of reproduction in an Arctic-nesting goose**

GUILLAUME SOUCHAY, *Département de Biologie & Centre d'Études Nordiques and Centre d'Écologie Fonctionnelle et Évolutive - UMR 5175, Campus CNRS 1919 route de Mende, F-34293 Montpellier Cedex 05 France*

GILLES GAUTHIER, *Département de Biologie & Centre d'Études Nordiques, 1045 avenue de la Médecine, Université Laval, Québec, QC, G1V 0A6, Canada*

ROGER PRADEL, *Centre d'Écologie Fonctionnelle et Évolutive - UMR 5175, Campus CNRS, 1919 route de Mende, F-34293 Montpellier Cedex 05, France*

## Abstract

The trade-off between current reproduction and future survival or reproduction is one of the most investigated compromises in vertebrate life-history. In long-lived species, breeding propensity, *i.e.* the probability that a mature female attempts to breed in a given year, is critical to understand such trade-off but is also one of the most difficult parameters to estimate. Non-breeders are elusive and often rare or completely absent from the breeding area. Thus, estimation of breeding propensity is closely linked to the estimation of temporary emigration from the breeding population. Traditionally, the robust design (a class of capture-recapture models) has been used to estimate temporary emigration. Alternatively, multi-state models with unobservable state can also be used. However, those 2 methods have strong limitations. We provide here a new methodological approach using a robust design sampling approach within the multi-event, capture-recapture framework. We used a long-term dataset of female greater snow geese to estimate breeding propensity and to investigate costs of reproduction with this approach. We combined resighting during the nesting stage and recapture at the end of the breeding season with recoveries during winter to estimate breeding propensity, nesting success and true survival probabilities. We found no relationship between current reproduction and survival rate during the following year, but a clear effect on subsequent reproduction. Successful breeders had a lower breeding propensity than failed breeders in the following year although reproductive success was higher for formerly successful breeders than failed ones. Individuals absent from the breeding colony in a given year had a low breeding propensity the following year but a high nesting success if they bred. Our results suggest costs of reproduction in terms of future reproductive attempt. However, once a female decided to breed, individual quality might explain differences in nesting success. Our result also suggested a bet-hedging strategy in the greater snow goose population, with a reduced number of breeding attempts but with a high probability of success.

Our multi-event framework is a flexible tool that can be applied to a large range of species. It allowed us to investigate survival and reproductive trade-offs and to examine individual heterogeneity in reproductive success in a long-lived species.

**Key words**

Breeding propensity, multi-event models, temporary emigration, reproduction, survival, greater snow goose, heterogeneity, reproduction strategy, cost of reproduction.

## Résumé

Le compromis évolutif entre reproduction actuelle et reproduction future ou survie subséquente est l'un des compromis d'histoire de vie le plus étudié chez les vertébrés. Chez les espèces longévives, la probabilité de nicher, i.e. la probabilité qu'une femelle adulte mature tente de se reproduire une année donnée, est cruciale pour comprendre ce compromis mais est également l'un des paramètres démographiques le plus difficile à estimer. En effet, les individus non-reproducteurs sont peu détectables, souvent rares voire complètement absents des sites de reproduction. De ce fait, l'estimation de la probabilité de nicher est liée étroitement à celle de l'émigration temporaire. Le design robuste (une catégorie de modèles de capture-recapture) est traditionnellement utilisé pour estimer l'émigration temporaire. Les modèles multi-états avec un état non-observable sont une alternative pour l'estimation de ce paramètre. Cependant, d'importantes limitations sont associées à ces 2 méthodes. Dans cette étude, nous proposons une nouvelle approche méthodologique utilisant la méthode d'échantillonnage du design robuste dans le cadre des modèles de capture-recapture multi-événements. Nous avons utilisé le jeu de données à long-terme des femelles grande oie des neiges pour estimer la probabilité de nicher et évaluer les coûts de la reproduction avec cette approche. Nous avons combiné les réobservations visuelles durant la nidification, les recaptures physiques à la fin de la saison de reproduction et les reprises d'individus morts pour estimer les probabilités de nicher, de succès reproducteur, et de survie réelle. Nous n'avons trouvé aucune relation entre la reproduction actuelle et la survie durant l'année suivante mais un effet clair de la reproduction actuelle sur la reproduction suivante. Les individus s'étant reproduit avec succès avaient une probabilité de nicher l'année suivante plus faible que ceux ayant échoué bien que le succès reproducteur soit plus élevé pour les individus venant de réussir que ceux ayant échoué. Enfin, les individus absents de la colonie une année donnée avaient une faible probabilité de nicher l'année suivante, mais ont une très forte probabilité de succès s'ils se reproduisaient. Nos résultats suggèrent l'existence de coûts de la reproduction en termes de décision future de reproduction. Cependant, une fois qu'une femelle a décidé de se reproduire, la qualité individuelle pourrait expliquer les différences observées au niveau du succès reproducteur. Nos résultats suggèrent également l'existence d'une stratégie de reproduction dite « bet-hedging » chez la



grande oie des neiges avec un nombre réduit de tentatives de reproduction mais avec une forte probabilité de succès.

Notre modèle multi-événement est un outil flexible pouvant être appliqué à une large gamme d'espèces. Il nous a permis d'étudier les compromis entre survie et reproduction et d'évaluer l'hétérogénéité individuelle dans le succès reproducteur chez une espèce longévive.

## Introduction

Although the population growth rate of long-lived species is typically most sensitive to adult survival, temporal variations in reproductive success can still have a strong effect on population growth and ultimately individual fitness (Gaillard et al. 1998, Pfister 1998, Saether & Bakke 2000). Reproduction can be decomposed into several components such as the probability of attempting to breed, the probability of success and the number of offspring produced. Variations in reproductive output can be due to extrinsic (e.g. environmental conditions, predation) or intrinsic factors (individual quality, past reproductive history, Newton 1989). Among the latter category, costs of reproduction, i.e. negative co-variation between fitness components, can be an important factor, especially in long-lived species (Williams 1966). Costs of reproduction have received considerable attention, especially in vertebrates (Cam et al. 1998, Hamel et al. 2010, Arnold et al. 2012). However, the occurrence and intensity of such costs can vary greatly depending on which life-history traits and/or species are studied (Hanssen et al. 2005, Hamel et al. 2010). Furthermore, empirical support for a cost of reproduction in terms of fitness remains ambiguous in many wild organisms (Aubry et al. 2009). These costs can be divided into two broad categories: those paid in terms of survival and those paid in terms of future reproduction (Stearns 1989, Roff 1992). Thus, reproducing individuals may sometimes be forced to skip breeding or to reduce breeding investment in subsequent years (Cubaynes et al. 2011).

Annual breeding skips in long-lived species are common. For instance, some albatross species reproduce on a biannual schedule (Weimerskirch 1992, Converse et al. 2009) and in several goose species, annual breeding probability range from 0.60 to 0.90 (Kendall & Nichols 1995, Reed et al. 2004b, Sedinger et al. 2008). In avian populations, breeding propensity is defined as the probability that a sexually mature female attempts to breed in a given year irrespective of the success of that attempt (Etterson et al. 2011). The decision of an individual to breed obviously has a strong impact on its fitness, and is thus a life-history trait likely to be exposed to trade-offs (Aubry et al. 2009). However, reliable estimates of breeding propensity or studies of associated trade-offs are scarce because it is one of the most difficult fecundity parameter to properly estimate (Etterson et al. 2011). The main reason is that non-breeding individuals are often elusive or are simply totally absent from the

breeding area during breeding skips (Reed et al. 2004b, Sedinger et al. 2008, Converse et al. 2009). In the latter situation, absence from the breeding site can be assimilated to temporary emigration.

Two statistical approaches based on capture-recapture models have been developed to estimate temporary emigration of individuals from the breeding segment of their population. The first method is based on the robust design (Pollock 1982), which combines models for open and closed populations. In this hierarchical model, secondary occasions, which correspond to short periods within the breeding season when the population is assumed to be closed (e.g. nesting and chick-rearing), are nested within primary occasions, which correspond to annual breeding seasons. Applying closed population models to secondary periods allows estimation of detection probabilities, which can be used to extract the part due to temporary emigration in the apparent detection probabilities estimated when using models for open populations between primary periods (Kendall & Nichols 1995, Kendall et al. 1997, Lindberg et al. 2001). This method has been used to estimate breeding propensity in Brent geese (*Branta bernicla*, Sedinger et al. 2001, Sedinger et al. 2008). An alternative approach is based on multi-state models (Schwarz et al. 1993) and uses observable and unobservable states to deal with temporary migrants. Estimation of transitions between these states has been proposed as a solution to estimate temporary emigration (Fujiwara & Caswell 2002, Schaub et al. 2004). Henaux et al. (2007) used a non-observable state (non-breeder status) to estimate simultaneously settlement, natal dispersal and survival of great cormorants (*Phalacrocorax carbo sinensis*, Henaux et al. 2007).

Both of these approaches, however, present some drawbacks. The most serious ones are the often violated closure assumption between secondary occasions for the robust design (Converse et al. 2009), and parameter identifiability issues due to the unobservable state for the multi-state framework (Kendall & Nichols 2002). A solution to the problem of closure assumption violation in the robust design has been proposed by Schwarz & Stobo (1997) and Kendall & Bjorkland (2001), and is referred to as the “open-robust design”. This model allows individuals to arrive and leave the breeding area at staggered times within the breeding season, thereby relaxing the geographic-closure assumption. Converse et al. (2009) tested the effectiveness of these models (multi-state models with unobservable states, closed- and open robust design models) to estimate breeding probability in the grey-headed

albatross (*Thalassarche chrysostoma*). They concluded that robust design models are preferable to multi-state models with unobservable states due to their greater flexibility and that the open robust design model is more appropriate than the classical design when the closure assumption is not met. However, they noted that the open robust design may not be suitable for data consisting of few (2-3) secondary occasions, as is often the case (e.g. Sedinger et al. 2008).

Here, we present a new method based on a multi-event framework to estimate breeding propensity in species where breeding skip is equivalent to temporary emigration. Multi-event capture-recaptures models allow departures and entries at any time (Pradel 2005). Our suggestion is to combine an unobservable state as in multi-state models with two secondary occasions (nesting and chick-rearing) as in a robust design. This method allows the use of all information gathered during the breeding season and to relax the geographically closed assumption of the robust design between secondary occasions, a more realistic assumption in most avian species. We applied this new approach to a long-term study of the greater snow goose (*Chen caerulescens atlantica*), combining both visual and physical recaptures within the breeding season and recoveries all year round.

The greater snow goose is a migrant species that breed colonially in the High Arctic. Breeding skips are frequent in this species (Reed et al. 2004b) and non-breeders typically do not come to the colony but migrate elsewhere to molt during the summer. Marked individuals are resighted at their nest in the breeding colony and recaptured during banding at the end of the brood-rearing season, providing for two capture occasions during the summer. However, individuals that fail to hatch a clutch leave the breeding area during the summer to join non-breeders at molting sites, thereby violating the assumption of a geographically closed population. The use of a closed robust design model is thus not suitable and an open robust design would require more secondary occasions. A multi-state approach could be used to estimate the breeding probability, but such a model would not allow the separation of failed and successful breeders and thus breeding propensity and nesting success would be confounded.

We used the new approach described in this paper to estimate annual breeding propensity and examine for possible costs of reproduction in greater snow geese. Considering that this species breeds in the harsh Arctic environment and provides extended parental care like most goose species (young accompany the

parents for up to a year, Pevett & MacInnes 1980, Reed 1993, Reed 2003), we hypothesized that breeding should entail significant costs. We thus predicted a lower probability of survival and of breeding in the subsequent year for individuals that attempted to breed. Furthermore, based on the canalization theory (Gaillard & Yoccoz 2003) and because the greater snow goose is a relatively long-lived species, we expected that temporal variation should be greater in breeding propensity than in survival.

## **Methods**

### *Study species*

The greater snow goose breeds in the Canadian High Arctic, winters along the Atlantic Coast of North-eastern United States and stages in both Spring and Fall in the Quebec province, along the St-Lawrence River (Gauthier et al. 2005). Recruitment is a gradual process starting at age 2 and with most females having started to breed by 4 years (Reed et al. 2003b, Juillet et al. 2012). Greater snow geese are precocial, nest in large colonies, with females laying on average close to 4 eggs in mid-June, and incubation lasts ca. 24 days. Females leave the nest 24h after all goslings have hatched and move to distant areas to rear the young during the summer (Mainguy et al. 2006).

### *Field methods*

From 1990 to 2010, we captured and banded individuals at the end of the brood-rearing period on Bylot Island, Nunavut, Canada (73°N, 80°W), the most important breeding site for this population. Only successful nesters can be captured because individuals that failed to hatch a clutch initiate a molt migration in early July and are thus no longer available for capture at the end of the summer (Reed et al. 2003a). Goose families were captured in mass banding drives during a ten-day period in mid-August, when adults were flightless and molting and before young could fly (see Menu et al. 2005 for details). Birds were aged (young of the year or adult  $\geq 1$  year-old) and sexed based on cloacal eversion. Each bird received a U.S. Fish & Wildlife Service metal band and 2/3 of the adult females received a plastic neck collar with a four-digit unique code. All recaptures of previously-marked birds were noted and included until 2011.

Marked birds could be encountered at other occasions than during the banding event. Each year, resightings of neck-collared females were conducted systematically in the colony throughout the nesting period, from 1 June to 19 July. Since 95% of resightings were obtained after 10 June, close to the long-term median laying date of the first egg at the colony, we are confident that almost all resighted geese were nesting or at least attempted to do so. Geese are hunted in Southern Québec in autumn (October-November) and in spring (April-May) during a special hunting season since 1999, and in the United States during winter (October to February). Hunter band recoveries returned to the Bird Banding Laboratory up to summer 2011 were added to the data. Our dataset included the capture history of 11,764 adult, neck-collared females, of which 1,311 were recaptured at least once (range: 1 to 4 recaptures), 2,272 were resighted at least once (range: 1 to 9 resightings) and 2,994 were recovered by hunters over the period 1990 to 2011.

#### *Multi-event model design*

Our multi-event capture-recaptures model, which combines recaptures, resightings and recoveries, can estimate the probability of being present at the site conditional on survival while allowing departures and entries at any time (Pradel 2005). The model takes into account the “secondary occasions” as defined in the robust design by keeping track if an individual was encountered during the nesting period, the brood-rearing period (i.e. banding) or both, thereby allowing the estimation of the probability of being present and breeding at the site. The model follows a diagram of fate (Fig.1) that enables individuals surviving from one breeding season to the next to either go back to their colony to breed (Bylot Island in our case) or to go elsewhere during the summer. Considering that geese are highly faithful to their breeding site (Rohwer & Anderson 1988, Reed et al. 2003b, Sedinger et al. 2008), birds going elsewhere for one summer most likely skipped breeding. For those going back to Bylot Island, they can be observed or not at the nesting colony. Birds that fail to hatch a brood leave the island to molt and thus cannot be captured later during the summer. Birds that successfully hatch a brood move to the brood-rearing area and remain on the island with their young to molt; hence they are susceptible to be captured during banding.

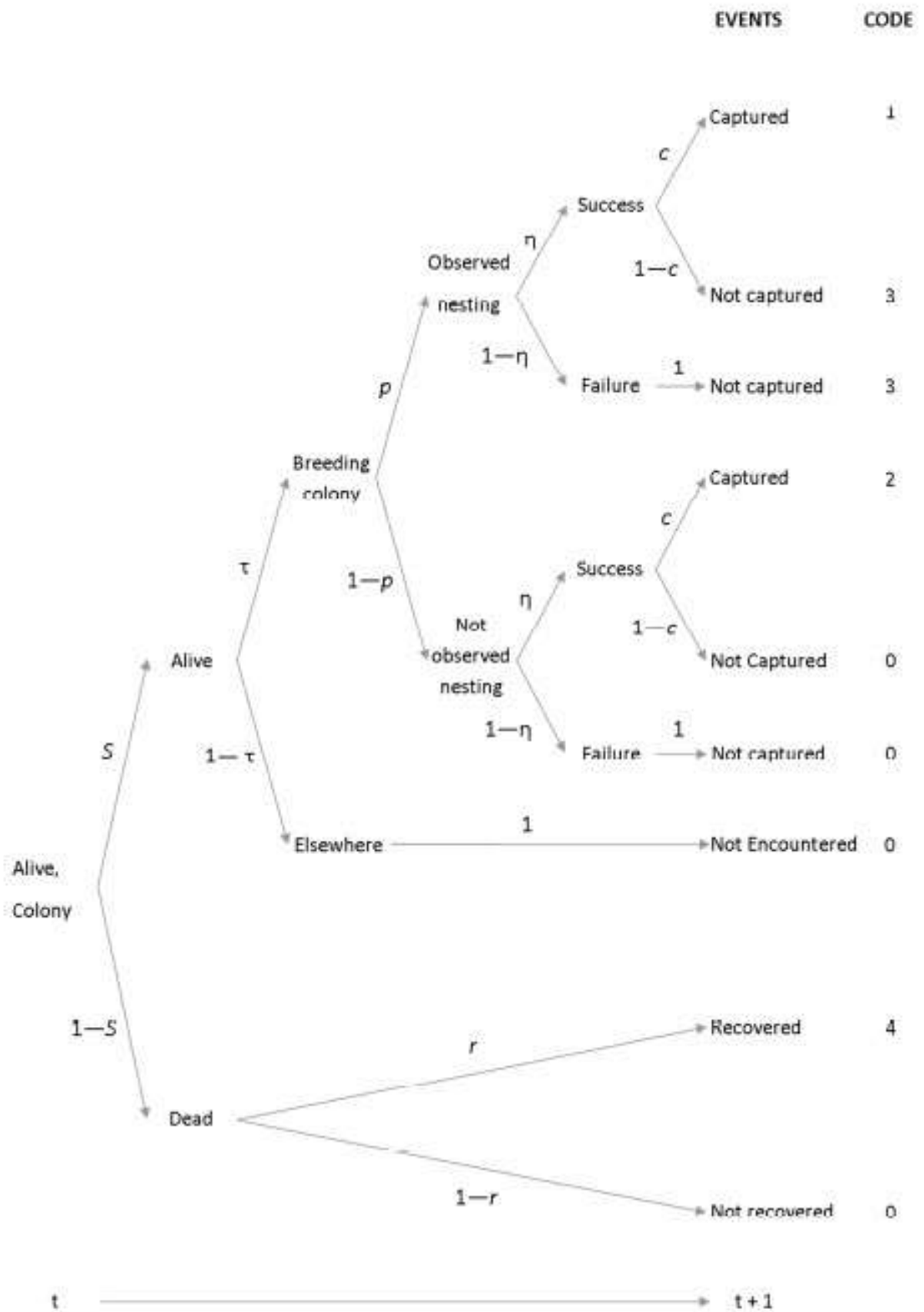

Figure 1: Diagram of fate of adult female greater snow geese marked at the Bylot Island colony at the end of the breeding season  $t$  until season  $t+1$ .

The model allows estimating the probabilities of survival ( $S$ ), breeding ( $\tau$ , the complement of temporary emigration in our case) and successful reproduction ( $\eta$ ) of collared females. The multi-event framework distinguishes what can be observed in the field (i.e. the events coded in the encounters histories) from the biological states of the individuals, which are hidden and must be inferred. The events are coded as follow: “0”, individuals not encountered; “1”, individuals banded when captured for the first time and those that are both observed and recaptured during the same summer at subsequent occasions; “2”, individuals not observed but captured during the same summer; “3”, individuals observed but not captured during the same summer; “4”, individuals recovered. We considered the following biological states: “ABS”, Alive at the Breeding colony (Bylot Island) and Successful breeder, “ABF”, Alive at the Breeding colony but Failed breeder; “AE”, Alive Elsewhere; “ND”, individual Newly Dead; “D”, Dead individual. Because we integrated recoveries in our dataset, we used the state “Newly Dead” for individuals that die during the intervening interval because they are then available for recovery and the state “Dead” for individuals dead in an earlier interval because they are no longer susceptible to recovery. Multi-event models use three kinds of parameters: the initial state probabilities, the probabilities of transition between states, and the probabilities of the events conditional on the underlying states. As every individual was initially marked as a successful adult female alive on Bylot, the initial state probability was trivially 1 for the state ABS. The transition probabilities correspond to the annual survival, the probability to go to the breeding colony (Bylot Island) and the probability of nesting successfully. The event probabilities correspond to the probabilities of being seen and/or being recaptured at the breeding colony for individuals present there and the probabilities of being recovered for individuals dying from hunting during the non-breeding season.

Transition probabilities can be decomposed in several steps. Traditionally, the first step is to estimate survival  $S^i$ , i.e. probability of survival from the previous to the current breeding season. Subsequent steps usually describe other transitions (Hestbeck et al. 1991, Schwarz et al. 1993, Sanz-Aguilar et al. 2012). In our case (Fig.1), the second step describes the breeding propensity  $\tau^i$ , i.e. the probability of going to the breeding colony to attempt to breed for surviving birds, potentially dependent on the state ( $i = \text{ABS}, \text{ABF}$  or  $\text{AE}$ ) during the previous season. Finally, the



third step is the nesting success of breeding birds  $\eta^i$ , i.e. the probability to successfully hatch at least one young during the current breeding season, also potentially depending on the state during the previous season. Matrix representations with departure state in row and arrival states in columns are commonly used. We used bold script to highlight what part of the state has been updated during each transition. For the survival step, we have:

$$S^i = \begin{matrix} & \mathbf{ABS} & \mathbf{ABF} & \mathbf{AE} & \mathbf{ND} & \mathbf{D} \\ \mathbf{ABS} & \left[ \begin{array}{ccccc} S & 0 & 0 & 1-S & 0 \\ 0 & S & 0 & 1-S & 0 \\ 0 & 0 & S & 1-S & 0 \\ 0 & 0 & 0 & 0 & 1 \\ 0 & 0 & 0 & 0 & 1 \end{array} \right] \end{matrix}$$

The next step describes the breeding propensity  $\tau^i$  of survivors:

$$\tau^i = \begin{matrix} & \mathbf{ABS} & \mathbf{ABF} & \mathbf{AB} & \mathbf{AE} & \mathbf{ND} & \mathbf{D} \\ \mathbf{ABS} & \left[ \begin{array}{cccccc} \tau & 0 & 0 & 1-\tau & 0 & 0 \\ 0 & \tau & 0 & 1-\tau & 0 & 0 \\ 0 & 0 & \tau & 1-\tau & 0 & 0 \\ 0 & 0 & 0 & 0 & 1 & 0 \\ 0 & 0 & 0 & 0 & 0 & 1 \end{array} \right] \end{matrix}$$

Thus, at the second step, a previously successful breeder that has survived (first row) may come back to the colony to breed again (first column) or may temporarily go elsewhere (column 4), in which case its current state is fully known (heading AE). The same applies to previously unsuccessful birds (second row). A survivor from elsewhere (third row) may return to the breeding colony but since its previous breeding state was neither successful nor failed, we place it in a different category (column 3 with the heading AB). The next step describes the nesting success  $\eta^i$  of individuals present at the colony during the current breeding season:

$$\eta^i = \begin{matrix} & \mathbf{ABS} & \mathbf{ABF} & \mathbf{AE} & \mathbf{ND} & \mathbf{D} \\ \mathbf{ABS} & \left[ \begin{array}{ccccc} \eta & 1-\eta & 0 & 0 & 0 \\ \eta & 1-\eta & 0 & 0 & 0 \\ \eta & 1-\eta & 0 & 0 & 0 \\ 0 & 0 & 1 & 0 & 0 \\ 0 & 0 & 0 & 1 & 0 \\ 0 & 0 & 0 & 0 & 1 \end{array} \right] \end{matrix}$$

A formerly successful breeder that returned to the colony (first row) may successfully breed (first column) or fail (column two). Its current state is now completely determined and noted as bold in columns headings. This also applies to birds that were unsuccessful (second row) or absent (third row) the previous year. We note that a robust design framework could be obtained with our multi-event

model by fixing the nesting success parameter to 1. This would force all breeders to be successful and thus to be present at the end of the season (i.e assumption of geographically closed population within a breeding season).

The event probabilities relating the observations coded in encounter histories to the biological states have also been decomposed in two steps to describe the observation process taking place during the nesting ( $n$ ) and brood-rearing ( $m$ ) periods, respectively. The first step additionally describes the observation fate of individuals that died during the interval between two breeding seasons. At the end of this step, the code that appears in the capture history is determined unequivocally for all but successful breeders. We used a matrix representation with states in rows and intermediate events in columns for the first step, and intermediate events in rows and final events in columns for the second step matrix. With the resighting probability denoted  $p$  and the recovery probability denoted  $r$ , the matrix ( $B^n$ ) for the first step is:

$$B^n = \begin{matrix} & ABSO & ABSU & '3' & '0' & '4' \\ \begin{matrix} ABS \\ ABF \\ AE \\ ND \\ D \end{matrix} & \begin{bmatrix} p & 1-p & 0 & 0 & 0 \\ 0 & 0 & p & 1-p & 0 \\ 0 & 0 & 0 & 1 & 0 \\ 0 & 0 & 0 & 1-r & r \\ 0 & 0 & 0 & 1 & 0 \end{bmatrix} \end{matrix}$$

We distinguish two kinds of successful breeders at the end of the nesting stage: “ABSO” – Alive Breeder Successful and Observed, “ABSU” – Alive Breeder Successful Unobserved. An individual alive elsewhere (third row) cannot be encountered (fourth column) and a newly-dead individual (fourth row) can be recovered with probability  $r$  (fifth column). The next step describes the capture probability, denoted  $c$ , a process that takes place during brood-rearing and the outcome of which fully determines the codes appearing in the capture history, including for successful breeders:

$$B^m = \begin{matrix} & '0' & '1' & '2' & '3' & '4' \\ \begin{matrix} ABSO \\ ABSU \\ '3' \\ '0' \\ '4' \end{matrix} & \begin{bmatrix} 0 & c & 0 & 1-c & 0 \\ 1-c & 0 & c & 0 & 0 \\ 0 & 0 & 0 & 1 & 0 \\ 1 & 0 & 0 & 0 & 0 \\ 0 & 0 & 0 & 0 & 1 \end{bmatrix} \end{matrix}$$

### *Goodness-of-fit and model selection*

The goodness-of-fit of our multi-event model was assessed after pooling all “alive” events, which resulted into a multi-state data set with only alive and dead

encounters. We then applied the goodness-of-fit for multi-state models with full-time variation on event and transition parameters using program U-CARE (v.2.3.2, Choquet et al. 2009a).

Model selection and parameters estimation were performed using program E-SURGE (v.1.8.6, Choquet et al. 2009b). To avoid local minima issues, we used the “Multiple Random” option in E-SURGE allowing the use of repeated random initial values over several successive runs. We also used the diagnostic tool incorporated in E-SURGE to investigate redundancy and identifiability issues in our model (Choquet et al. 2009b). To build our initial model, we first included all effects we wished to test: time and status on every transition and event probabilities. Due to the results of Goodness-of-fit tests (see Result section), we also introduced specific parameters for the first interval following initial marking (age-effect below) in our initial model.

We followed a step-down approach for the model selection, focusing on event probabilities first (resighting, recovery and then recapture parameters), and then on transition probabilities (survival, breeding propensity and then nesting success parameters). Our model selection relied on the Akaike’s Information Criterion corrected for the overdispersion (QAIC, Burnham & Anderson 2002) and we examined the effect of status, time, and marking by contrasting QAIC scores. Based on previous knowledge of the population, we also tested the effect on survival and recovery probabilities of special management actions introduced from winter 1998-1999 onward and designed to increase hunting mortality, such as the spring hunt (Calvert & Gauthier 2005). As a recovery is recorded at the occasion following its occurrence, an individual shot and recovered during winter 1998-1999 would be recorded as dead at year 1999. Thus, we pooled years from 1990 to 1998 and from 1999 to 2011 in two separate periods with contrasted hunting regimes. All parameter estimation values are given  $\pm$  SE.

## **Result**

### *Goodness-of-fit tests*

The overall goodness-of-fit test was highly significant ( $\chi^2 = 1117$  df = 451,  $p < 0.001$ , variance inflation factor  $\hat{c} = 2.48$ ). Looking at the contingency tables making up test 3G (test for transience), we found that newly marked individuals were less

encountered alive and more recovered than formerly marked birds (Table A1), hinting at a potential effect of the initial marking or of the presence of transient individuals. When suppressing the first encounters, the remaining heterogeneity, though still significant ( $\chi^2 = 343$ ,  $df = 222$ ,  $p < 0.001$ ), was much weaker ( $\hat{c} = 1.54$ ; Table A2). To take into account the detected specificity of the first interval following marking, we introduced a 2 age-class effect in our initial model, namely specific survival and recovery probabilities in the first interval following marking. Due to significance of test-M, we carefully examined the associated contingency tables. This led us to consider that recapture probability might be lower at the occasion following marking than afterwards and we also introduced specific recapture probabilities at this occasion. The remaining heterogeneity was treated by scaling down all model deviances with a variance inflation factor of 1.54.

#### *Encounter probabilities*

Our preferred model (M16, Table 1) retained only time-dependence on resighting and recovery probabilities, and both time and whether individuals were seen at the nesting period on recapture probability (Table 1). A close inspection of the results of this model revealed that all parameters were identifiable. We also tested if temporal variation in recovery probability could be reduced to two time periods, before and after introduction of the special conservation measures during winter 98-99 (model A6 vs. A4 in Appendix Table A3), but that model was rejected based on the QAIC score ( $\Delta_i = 6.6$ ).

The temporal variation in resighting probability (Figure 2) reflects both annual variation in observation effort in the field (e.g. effort increased considerably after 1996) as well as annual variation in the spatial distribution and density of geese in the colony due to environmental conditions, which made birds harder to observe in some years (e.g. this was the case in 2004 and 2010). Recapture probabilities of collared females were generally less variable than resighting probability after the first few years of the study owing to a relatively constant marking effort. Years of very low recapture probabilities (e.g. 1992 and 1999) often resulted from a low breeding effort of geese in the colony due to poor environmental conditions. We note that individuals that were not observed at the nesting stage had a slightly higher recapture probability than individuals seen during the nesting. A possible explanation for that pattern would be a slightly lower probability of nesting success in the latter group, and thus a

higher chance of leaving the island to molt during the summer (see methods). The temporal variation in recovery rate followed a pattern similar to the one described by Calvert & Gauthier (2005) up to 2002 for this population (although absolute values of recovery are not comparable due to different parameterization of the recovery rate in the two studies). Recovery rate was generally higher following the introduction of the special conservation measures in 1998-99 though relatively high recoveries were also observed in the first 3 years of the study due to some band solicitation carried out with hunters at that time.

### *Transition probabilities*

Our best model included an effect of age and of implementation of the special conservation actions on survival probability, an additive effect of the former breeding status and time on breeding propensity, and an effect of age and of the former breeding status on nesting success (Table 1). This model did not include any time-dependence on survival and nesting success probabilities and another model without any time dependence on breeding propensity was a close competitor (M15,  $\Delta\text{QAIC} < 1$ ).

We found that annual survival probability was lower during the year following initial marking than in subsequent years ( $0.77 \pm 0.02$  vs.  $0.83 \pm 0.01$  for the period before implementation of the special management actions and  $0.69 \pm 0.01$  vs.  $0.73 \pm 0.01$  afterward, Fig. 3). When comparing the periods before and after implementation of the special conservation actions, we found that survival decreased by 12% and 14% in newly and formerly marked individuals, respectively.

The mean breeding propensity varied greatly depending on the former breeding status. Individuals that did not attempt to reproduce at the colony and were elsewhere the year before had a very low breeding propensity the following year (mean:  $0.16 \pm 0.02$  from model M15; annual range: 0.01, 0.48; Figure 4). In contrast, individuals that attempted to breed at the colony the year before had a mean probability  $\geq 0.5$  to come back and try to reproduce again the following year. However, breeders successful the year before had a markedly lower breeding propensity (mean:  $0.50 \pm 0.05$  from model M15; annual range: 0.25, 0.80; Figure 4) than failed breeders (mean:  $0.98 \pm 0.01$ ), suggesting a strong negative effect of previous nesting success on breeding propensity.

Table 1: Model selection for survival, breeding propensity, nesting success, resighting, recovery and recapture probabilities of adult female greater snow geese marked with a neck-collar on Bylot Island from 1990 to 2010 (N = 11,764) and reencountered from 1991 to 2011. For each model, we give deviance, number of estimable parameters (k), and difference in QAIC with the best model ( $\Delta_i$ ). Best models are in bold and starting model is in italic. A variance inflation factor  $\hat{c} = 1.54$  accounts for lack of fit.

| $\Delta_i$ | Deviance       | k         | recapture         | recovery        | Resightings     | Nesting Success          | Breeding propensity | Survival          | #          |
|------------|----------------|-----------|-------------------|-----------------|-----------------|--------------------------|---------------------|-------------------|------------|
| 181.1      | <i>1174.5</i>  | 188       | <i>0.0</i>        | <i>0.1</i>      | <i>0.1</i>      | <i>(f)2o(t)1o</i>        | <i>(f)2o(t)1o</i>   | <i>(f)2o(t)1o</i> | 1W         |
| 496.4      | 6305.45        | 558       | <i>0.0</i>        | <i>0.1</i>      | <i>1</i>        | <i>(f)2o(t)1o</i>        | <i>(f)2o(t)1o</i>   | <i>(f)2o(t)1o</i> | 2W         |
| 924.2      | 51519.6        | 346       | <i>0.0</i>        | <i>1</i>        | <i>1</i>        | <i>(f)2o(t)1o</i>        | <i>(f)2o(t)1o</i>   | <i>(f)2o(t)1o</i> | 3W         |
| 540.2      | 2030.45        | 192       | <i>1</i>          | <i>1</i>        | <i>1</i>        | <i>(f)2o(t)1o</i>        | <i>(f)2o(t)1o</i>   | <i>(f)2o(t)1o</i> | 4W         |
| 186.6      | 3128.45        | 202       | <i>1</i>          | <i>1</i>        | <i>1</i>        | <i>(f)2o(t)1o</i>        | <i>(f)2o(t)1o</i>   | <i>f</i>          | 9W         |
| 185.7      | 61816.9        | 122       | <i>1</i>          | <i>1</i>        | <i>1</i>        | <i>(f)2o(t)1o</i>        | <i>(f)2o(t)1o</i>   | <i>o.f</i>        | 8W         |
| 183.2      | 54652.9        | 273       | <i>1</i>          | <i>1</i>        | <i>1</i>        | <i>(f)2o(t)1o</i>        | <i>(f)2o(t)1o</i>   | <i>ft</i>         | 5W         |
| 161.2      | 54773.0        | 322       | <i>1</i>          | <i>1</i>        | <i>1</i>        | <i>(f)2o(t)1o</i>        | <i>(f)2o(t)1o</i>   | <i>fh</i>         | 7W         |
| 148.2      | 54765.3        | 219       | <i>1</i>          | <i>1</i>        | <i>1</i>        | <i>(f)2o(t)1o</i>        | <i>o1(t)2o(f)t</i>  | <i>h.o</i>        | 9W         |
| 127.6      | 54789.0        | 102       | <i>1</i>          | <i>1</i>        | <i>1</i>        | <i>(f)2o(t)1o</i>        | <i>ft</i>           | <i>h.o</i>        | 10W        |
| 103.0      | 54972.9        | 129       | <i>1</i>          | <i>1</i>        | <i>1</i>        | <i>ft</i>                | <i>f</i>            | <i>h.o</i>        | 12W        |
| 82.2       | 54879.3        | 149       | <i>1</i>          | <i>1</i>        | <i>1</i>        | <i>(f)2o(t)1o</i>        | <i>f</i>            | <i>h.o</i>        | 11W        |
| 34.3       | 55039.5        | 73        | <i>1</i>          | <i>1</i>        | <i>1</i>        | <i>f</i>                 | <i>f</i>            | <i>h.o</i>        | 13W        |
| 1.6        | 54986.2        | 74        | <i>1</i>          | <i>1</i>        | <i>1</i>        | <i>(f)2o(t)1o</i>        | <i>f</i>            | <i>h.o</i>        | 14W        |
| 0.4        | <b>54981.3</b> | <b>75</b> | <b><i>t+o</i></b> | <b><i>t</i></b> | <b><i>t</i></b> | <b><i>(f)2o(t)1o</i></b> | <b><i>f</i></b>     | <b><i>h.o</i></b> | <b>15W</b> |
| 0.0        | <b>54919.0</b> | <b>95</b> | <b><i>t+o</i></b> | <b><i>t</i></b> | <b><i>t</i></b> | <b><i>(f)2o(t)1o</i></b> | <b><i>f+t</i></b>   | <b><i>h.o</i></b> | <b>16W</b> |

Model notation: *h*: time effect reduced to 2 periods: before (1990-1998) and after (1999-2011) introduction of the special management actions to increase hunting; *a*: age effect ( $a_1 = 1^{\text{st}}$  interval after marking,  $a_2 =$  all subsequent intervals); *f*: former state effect (Successful nester at the colony, Failed nester at the colony, Alive Elsewhere); *t*: time; *o*: nesting stage encounter effect (Observed vs. Unobserved); *b*: current season nesting success effect; . = interaction, + = additive effect, - = constant.

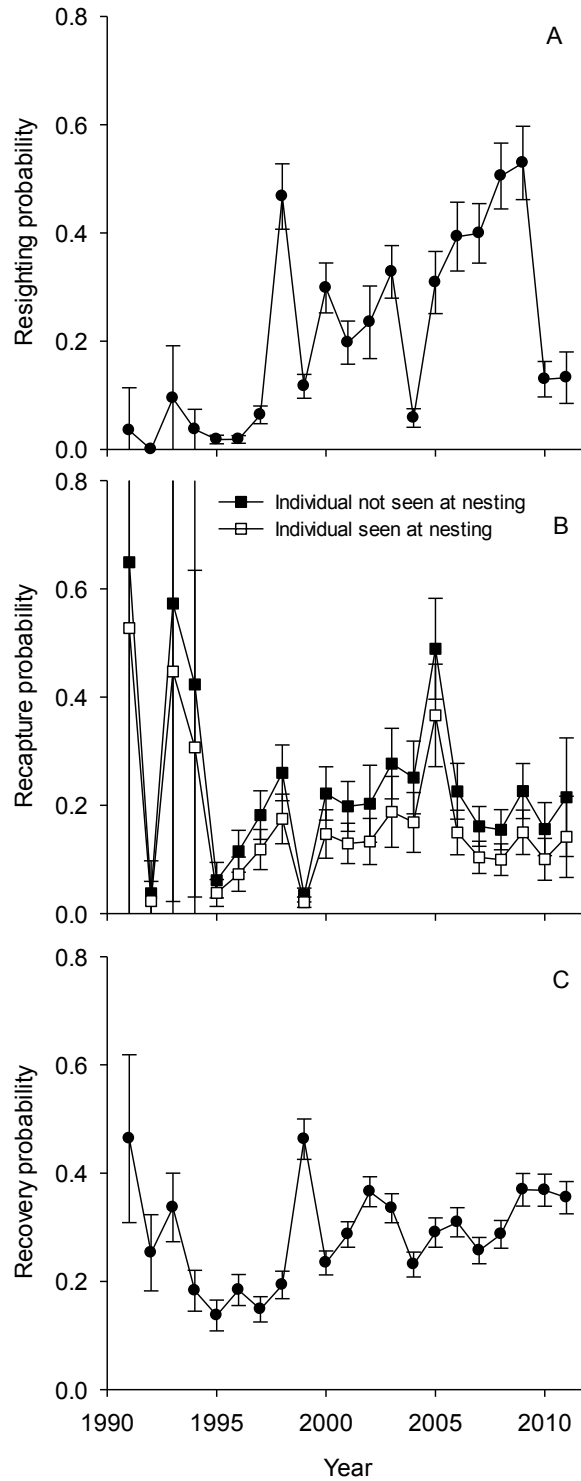

**Figure 2: Estimates (means  $\pm$  SE) of reencounter probabilities of adult female greater snow geese marked with a neck-collar from 1990 to 2010 and reencountered from 1991 to 2011. A) resighting probability during nesting; B) recapture probability during banding; and C) recovery probability by hunters. Estimated values are from model M16, Table 1.**

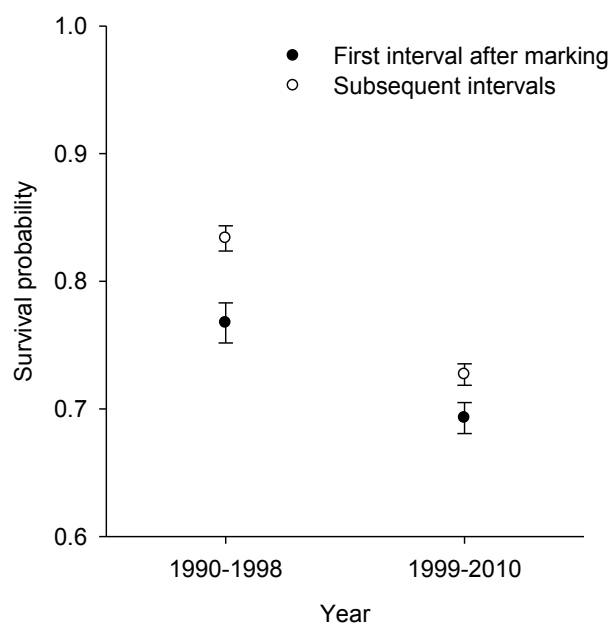

**Figure 3: Estimates (means  $\pm$  SE) of annual survival probability of adult female greater snow geese marked with a neck-collar on Bylot Island before and after implementation of the special management action during winter 1998-1999.**

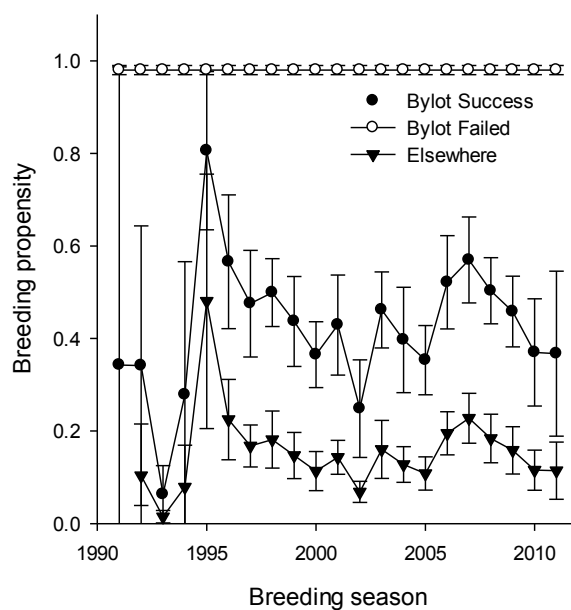
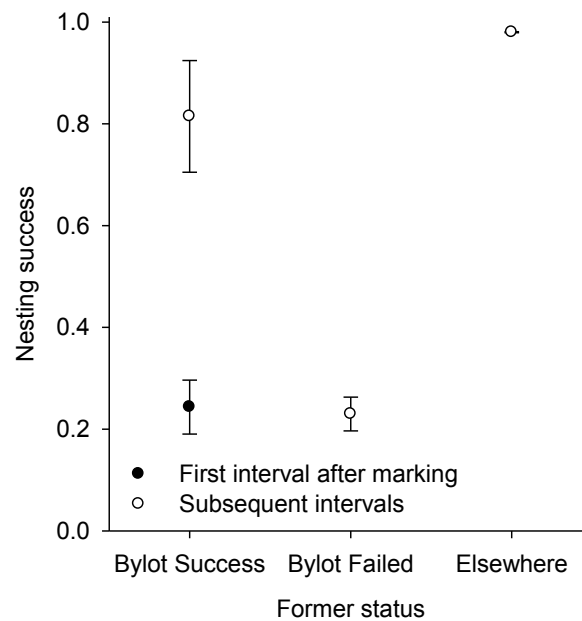

**Figure 4: Estimates (means  $\pm$  SE) of annual breeding propensity of adult female greater snow geese marked with a neck-collar on Bylot Island according to their reproductive status during the previous breeding season (Successful or Failed nester at the breeding colony or Alive elsewhere).**

The nesting success of individuals was dependent both upon its breeding status and nesting success during the previous year (Fig. 5). Individuals that came



back to the colony to breed after having been absent the year before had a nesting success close to 1 ( $0.98 \pm 0.01$ ). Individuals that nested successfully the year before and that returned to breed again the following year also had a very high nesting success ( $0.81 \pm 0.11$ ) except in the year following initial marking when their success was quite low ( $0.23 \pm 0.03$ ). Finally, individuals that had a failed nesting attempt the year before and that attempted to breed again the following year also had a low nesting success ( $0.23 \pm 0.03$ ).



**Figure 5: Estimates (means  $\pm$  SE) of the annual nesting success of adult female greater snow geese marked with a neck-collar on Bylot Island according to their reproductive status during the previous breeding season (Successful or Failed nester at the breeding colony or Alive Elsewhere).**

## Discussion

The use of advanced capture-recapture modelling allowed us to estimate breeding propensity and to investigate costs of reproduction, a fundamental question to understand life-histories trade-offs (Harshman & Zera 2007). Although the concept of cost of reproduction is well established, its role in the evolution of life-history traits is still unclear, with some studies showing evidence of such costs (Promislow 1992, Hanssen et al. 2005, Descamps et al. 2009, Hamel et al. 2010, Inger et al. 2010) while other showing on the contrary evidence of a cost of non-reproduction, i.e. a positive relationship between reproduction and survival or future reproduction (Cam et al. 1998, Cam et al. 2002, Barbraud & Weimerskirch 2005, Nevoux et al. 2007,

Pradel et al. 2012). Here, we investigated costs of reproduction in a long-lived bird nesting in a highly stochastic environment, the High Arctic. We found no relationship between reproductive status and survival rate during the following year, but a clear effect on subsequent reproduction: successful breeders had a lower breeding propensity than failed breeders in the following year although reproductive success was higher for former successful breeders than failed ones.

### *Breeding propensity and cost of reproduction*

The negative relationship between the decision to attempt breeding and the former reproductive status provides evidence for a cost of reproduction: females that failed to hatch a clutch had a probability to attempt breeding the following year equal to 1 whereas females that bred successfully only had a probability of ~0.5 to breed again the following year. The cost of parental care is usually the primary reason advanced for a cost of reproduction in vertebrates (Williams 1966, Roff 1992, Hanssen et al. 2005). Geese are precocial birds and thus parental care provided during the brood-rearing period are less costly than in the typical altricial species (Lazarus & Inglis 1986). Geese, however, are unusual because young accompany their parents for up to a year, and thus parental care extends for a very long period (Prevett & MacInnes 1980, Reed 1993, Warren et al. 1993). Although presence of young during non-breeding season may confer some advantages to their parents such as increased dominance and improved foraging conditions for their young (Lamprecht 1986, Gregoire & Ankney 1990), it may also entail some costs such as increased vigilance or competition for foraging patches within family members (Lazarus & Inglis 1978, Black & Owen 1989, Turcotte & Bédard 1989). Such costs may be especially serious in species like geese which are partly capital breeders and must accumulate enough reserves during their spring migration to ensure a successful breeding (Gauthier et al. 2003, Klaassen et al. 2006, Drent et al. 2007, Legagneux et al. 2012). If presence of young in spring interferes with energy acquisition of their parents, this could explain the reduced breeding propensity that we detected.

Incubation is another stage of reproduction that is potentially costly, especially for a species like the greater snow goose where only the female incubates with a very high consistency, thereby forcing her to fast almost completely during incubation (Reed et al. 1995, Poussart et al. 2001). Hanssen et al. (2005) recently provided evidence that incubation reduced immunocompetence and suggested that incubation

effort could negatively affect future reproduction through a trade-off between immune function and reproduction. The high energetic demands of both incubation and parental care could thus also reduce the future breeding propensity of former successful females through reduced immune function.

The temporal variability in breeding propensity that we detected may reflect the large inter-annual variation in environmental conditions encountered in the Arctic. Reed et al. (2004b) and Dickey et al. (2008) explored climatic effects on breeding success in this population and showed that most of the variation in breeding propensity was related to spring climatic factors in the Arctic: high mean temperature in spring and a low snow cover were associated to an increase in nest density and breeding propensity.

#### *Individual quality and nesting success*

Considering the evidence for a cost of reproduction in terms of reduced breeding propensity that we found, we could also have expected to find a similar negative relationship with nesting success. However, we found a positive relationship between former and subsequent nesting success. Detection of life-history trade-offs can sometimes be masked by heterogeneity among individuals (van Noordwijk & De Jong 1986, Cam & Monnat 2000). The positive relationship between former and subsequent nesting success suggests that it may indeed result from such heterogeneity, i.e. difference in quality among individuals: once the decision to breed has been made, a previously successful breeder will be more likely to succeed again than one that failed before. The existence of such individual heterogeneity in reproductive output has been widely reported in vertebrate studies (Beauplet et al. 2006, Hamel et al. 2008, McCleery et al. 2008, Sedinger et al. 2008). It also suggests that the cost associated with a former reproduction does not affect the intrinsic quality of individuals and their ability to complete incubation and to rear young. Hence, once a female choose to breed, her intrinsic quality will largely determine the success of her breeding attempt.

#### *Reproduction and survival*

We found no relationship between former reproductive status and survival during the following year, suggesting no cost of reproduction in terms of survival. This is consistent with the idea that in long-lived species, one would expect birds not to invest in young at the expense of their own survival because lifetime reproductive

success depends on adult survival (Erikstad et al. 1998). This is also in accordance with the canalization theory, which predicts that parameters most influential on fitness should be preserved, i.e. adult survival in long-lived species (Pfister 1998, Gaillard & Yoccoz 2003). Consistent with our result, a previous study in the greater snow goose showed no survival difference between females with young and those without young in fall (Reed 2003).

However, Reed also found a negative relationship between presence of young in spring and subsequent survival, suggesting a possible cost for females providing the longest parental care (Reed 2003). Difference in results between both studies may be explained by methodological differences. In our study, we used the nesting success at the end of the breeding season as an index of reproductive success to investigate survival costs whereas Reed (2003) used the presence/absence of young with females in spring to investigate such costs. Thus, an unknown proportion of successful females in our study may actually have been without young in the following spring. Such heterogeneity within our “successful breeder” class may have masked the negative relationship between reproduction and survival previously found by Reed (2003) for females providing the longest parental care.

*The “elsewhere” individual: long-term cost of reproduction or bet-hedging strategy?*

Based on the former reproductive success, we were able to find evidence for a cost of reproduction in terms of reduced breeding propensity. However, the breeding propensity of individuals that were “elsewhere” was very low. In our modelling, an “Elsewhere” individual is a female that has already bred at least once and did not come back to the colony to breed. The low breeding propensity of these birds may be because these females paid such a high cost of reproduction that they were not able to fully recover and had to delay their return to the breeding colony. This raises the possibility of long-term costs of reproduction, possibly at the scale of a lifetime (Aubry et al. 2009). Some individuals may thus skip breeding more than one year to be able to recover and breed again. This is also consistent with the capital breeder idea, where individuals have to exceed a body condition threshold to reproduce.

Another explanation for the low breeding propensity of elsewhere females could be due to different reproductive strategy. This low breeding propensity might reflect a bet-hedging strategy where a longer lifespan is associated with a reduced annual probability of reproduction (Roff 2002, Nevoux et al. 2010). Such strategy

would reduce investment during years when breeding conditions are poor. During “good” years, females would decide to breed and to invest heavily in reproduction. This would be consistent with the high nesting success of “elsewhere” individuals that return to breed, as we found. Bet-hedging is thought to be a response to high environmental variability as this strategy would ensure a high survival rate at the expense of a lower and more variable reproduction rate (Nevoux et al. 2010). This is also consistent with the hypothesis of environmental canalization in long-lived species, which tends to reduce variability in adult survival but not in reproduction rates (Gaillard & Yoccoz 2003).

#### *Marking effect: neckband vs. transient*

We found a lower survival and nesting success of adult females in the first year of marking compared to subsequent years. There are two possible explanations for that. First, it could be a transient effect (Pradel et al. 1997a) as some newly-marked females may have originated from another population and thus emigrated permanently after the first marking, thereby causing a reduction in apparent survival during the first year following marking. However, the combination of recoveries with live recaptures in our dataset should have reduced such an effect (Clobert & Lebreton 1991). An alternative explanation could be a short-term, negative effect of the neckband, at least in some individuals, during the first year of marking. Previous studies have found no negative effects of neckband on survival in greater snow geese but a reduced breeding propensity (Menu et al. 2000, Reed et al. 2005). Recent work showed a reduction in spring body condition of neck-banded females, possibly due to reduced foraging efficiency or increased energy expenditure during flight (Legagneux et al. *in press*). However, these authors also noted a reduction of the negative effect over time, suggesting some habituation. This short-term negative effect of neckband on body condition could explain both the reduced survival and nesting success in this first year of marking.

#### *The multi-event framework: an ideal approach for demographic parameter estimation?*

In this study, we were able to estimate breeding propensity and to determine how the former reproductive status of an individual affected this parameter due to the use of a multi-event framework. Breeding propensity is one of the most difficult demographic parameter to estimate and previous methods used to estimate it such as the

traditional robust design and multistate modelling all have serious drawbacks (Converse et al. 2009, Etersson et al. 2011). The multi-event framework allowed us to model underlying reproductive status based on what we observed in the field. It also allowed us to integrate a robust design approach (use of secondary occasions) to improve parameter identifiability. Our model was fully identifiable due to the mixture of recoveries and both visual and physical recaptures. Furthermore, the multi-event framework did not require strong assumptions (such as the closure assumption between secondary periods) and was flexible. It thus provided a statistically unbiased approach to investigate breeding propensity in the greater snow goose and is thus a promising approach for the future. Further comparisons between the traditional robust design, multi-state and multi-event models are nonetheless needed to quantify any possible biases in parameter estimation.

## **Acknowledgement**

Funding was provided by the Natural Sciences and Engineering Research Council of Canada, the Arctic Goose Joint Venture (Canadian Wildlife Service), the Centre d'Études Nordiques, the Department of Indian and Northern Affairs Canada, the network of center of excellence ArcticNet and by the International Research Group Dynamics of Biodiversity and Life-History traits. Logistic support in the Arctic was generously provided by the Polar Continental Shelf Project (Natural Resources Canada) and assistance in the field by Parks Canada. Finally, we are grateful to the numerous field assistant that helped for goose banding and especially Gérald Picard, to hunters who reported the banded birds that they shot and to Marie-Christine Cadieux for managing the database and for assistance in the field.

## Appendix A: Goodness-of-Fit tests

**Table A1: Components of the goodness-of-fit test for a multistate model with full time variation with the greater snow goose dataset, adult females banded from 1990 to 2010 and reencountered from 1991 to 2011.**

|           | $\chi^2$ | p-value | Df  |
|-----------|----------|---------|-----|
| Test 3G   | 343.4    | < 0.001 | 162 |
| Test M    | 773.8    | < 0.001 | 289 |
| Overall   | 1117.3   | < 0.001 | 451 |
| $\hat{c}$ | 2.48     |         |     |

**Table A2: Components of the goodness-of-fit test for a multistate model with full time variation with the greater snow goose dataset, adult females banded from 1990 to 2010 and reencountered from 1991 to 2011, after removing the first encounter.**

|           | $\chi^2$ | p-value | Df  |
|-----------|----------|---------|-----|
| Test 3G   | 96.9     | 0.177   | 85  |
| Test M    | 245.9    | < 0.001 | 137 |
| Overall   | 342.9    | < 0.001 | 222 |
| $\hat{c}$ | 1.54     |         |     |

Table A3: Complete model selection for resighting, recovery, recapture, survival, breeding propensity and nestingsuccess of collared adult female greater snow geese banded at Bylot Island from 1990 to 2010 (N = 11,764) and reencountered from 1991 to 2011. For each model, we give deviance, number of estimable parameters (k), and difference in QAIC with the best model ( $\Delta_i$ ). Best models are in bold and starting model is in italic. A variance inflation factor  $\hat{c} = 1.54$  accounts for any remaining lack of fit.

|     | Survival  | Breeding Propensity                          | Reproductive Success                                | Resightings                  | Recovery                     | Recapture                           | k         | Deviance        | $\Delta_i$ |
|-----|---|--|---|------------------------------|------------------------------|-------------------------------------|-----------|-----------------|------------|
| A40 | <i><b><math>h_a</math></b></i>                    | <b><i><math>f+t</math></i></b>               | <b><i><math>\sigma I(-), \sigma 2(f)</math></i></b> | <b><i><math>t</math></i></b> | <b><i><math>t</math></i></b> | <b><i><math>t+\sigma</math></i></b> | <b>95</b> | <b>54,919.0</b> | <b>0.0</b> |
| A30 | <i><b><math>h_a</math></b></i>                    | <b><i><math>f</math></i></b>                 | <b><i><math>\sigma I(-), \sigma 2(f)</math></i></b> | <b><i><math>t</math></i></b> | <b><i><math>t</math></i></b> | <b><i><math>t+\sigma</math></i></b> | <b>75</b> | <b>54,981.3</b> | <b>0.4</b> |
| A25 | <i><math>h_a</math></i>                           | <i><math>f</math></i>                        | <i><math>\sigma I(-), \sigma 2(f)</math></i>        | <i><math>t</math></i>        | <i><math>t</math></i>        | <i><math>t</math></i>               | 74        | 54,986.2        | 1.6        |
| A34 | <i><math>h_a</math></i>                           | <i><math>f</math></i>                        | <i><math>\sigma I(-), \sigma 2(f)</math></i>        | <i><math>t</math></i>        | <i><math>t+\sigma</math></i> | <i><math>t+\sigma</math></i>        | 76        | 54,980.2        | 1.8        |
| A32 | <i><math>h_a</math></i>                           | <i><math>\sigma I(-), \sigma 2(f)</math></i> | <i><math>\sigma I(-), \sigma 2(f)</math></i>        | <i><math>t</math></i>        | <i><math>t</math></i>        | <i><math>t+\sigma</math></i>        | 76        | 54,981.3        | 2.4        |
| A29 | <i><math>h_a</math></i>                           | <i><math>\sigma I(-), \sigma 2(f)</math></i> | <i><math>\sigma I(-), \sigma 2(f)</math></i>        | <i><math>t</math></i>        | <i><math>t</math></i>        | <i><math>t</math></i>               | 75        | 54,985.8        | 3.4        |
| A27 | <i><math>\sigma I(h_a, \sigma 2(h, s))</math></i> | <i><math>f</math></i>                        | <i><math>\sigma I(-), \sigma 2(f)</math></i>        | <i><math>t</math></i>        | <i><math>t</math></i>        | <i><math>t</math></i>               | 76        | 54,984.5        | 4.6        |
| A31 | <i><math>h_a</math></i>                           | <i><math>f</math></i>                        | <i><math>\sigma I(-), \sigma 2(f)</math></i>        | <i><math>t</math></i>        | <i><math>t</math></i>        | <i><math>t</math></i>               | 74        | 54,991.8        | 5.3        |
| A28 | <i><math>\sigma I(h_a, \sigma 2(f, h))</math></i> | <i><math>f</math></i>                        | <i><math>\sigma I(-), \sigma 2(f)</math></i>        | <i><math>t</math></i>        | <i><math>t</math></i>        | <i><math>t</math></i>               | 78        | 54,984.3        | 8.4        |
| A37 | <i><math>h</math></i>                             | <i><math>f</math></i>                        | <i><math>\sigma I(-), \sigma 2(f)</math></i>        | <i><math>t</math></i>        | <i><math>t</math></i>        | <i><math>t+\sigma</math></i>        | 73        | 55,013.6        | 17.4       |
| A36 | <i><math>h</math></i>                             | <i><math>f</math></i>                        | <i><math>f</math></i>                               | <i><math>t</math></i>        | <i><math>t</math></i>        | <i><math>t+\sigma</math></i>        | 73        | 55,013.6        | 17.4       |
| A44 | <i><math>h</math></i>                             | <i><math>\sigma I(-), \sigma 2(f)</math></i> | <i><math>\sigma I(-), \sigma 2(f)</math></i>        | <i><math>t</math></i>        | <i><math>t</math></i>        | <i><math>t+\sigma</math></i>        | 74        | 55,013.2        | 19.2       |
| A26 | <i><math>h_a</math></i>                           | <i><math>f</math></i>                        | <i><math>f</math></i>                               | <i><math>t</math></i>        | <i><math>t</math></i>        | <i><math>t</math></i>               | 73        | 55,039.5        | 34.3       |
| A35 | <i><math>h_a</math></i>                           | <i><math>f</math></i>                        | <i><math>f</math></i>                               | <i><math>t</math></i>        | <i><math>t</math></i>        | <i><math>t+\sigma</math></i>        | 74        | 55,041.7        | 37.7       |
| A38 | <i><math>h_a</math></i>                           | <i><math>\sigma I(-), \sigma 2(f)</math></i> | <i><math>f</math></i>                               | <i><math>t</math></i>        | <i><math>t</math></i>        | <i><math>t+\sigma</math></i>        | 75        | 55,039.8        | 38.5       |
| A39 | <i><math>h_a</math></i>                           | <i><math>ft</math></i>                       | <i><math>\sigma I(-), \sigma 2(f)</math></i>        | <i><math>t</math></i>        | <i><math>t</math></i>        | <i><math>t+\sigma</math></i>        | 133       | 54,881.7        | 51.8       |
| A22 | <i><math>h_a</math></i>                           | <i><math>f</math></i>                        | <i><math>\sigma I(t), \sigma 2(ft)</math></i>       | <i><math>t</math></i>        | <i><math>t</math></i>        | <i><math>t</math></i>               | 149       | 54,879.3        | 82.2       |
| A21 | <i><math>h_a</math></i>                           | <i><math>\sigma I(-), \sigma 2(f)</math></i> | <i><math>\sigma I(t), \sigma 2(ft)</math></i>       | <i><math>t</math></i>        | <i><math>t</math></i>        | <i><math>t</math></i>               | 150       | 54,879.3        | 84.2       |
| A24 | <i><math>h_a</math></i>                           | <i><math>f</math></i>                        | <i><math>ft</math></i>                              | <i><math>t</math></i>        | <i><math>t</math></i>        | <i><math>t</math></i>               | 129       | 54,972.9        | 103.0      |
| A20 | <i><math>h_a</math></i>                           | <i><math>ft</math></i>                       | <i><math>\sigma I(t), \sigma 2(ft)</math></i>       | <i><math>t</math></i>        | <i><math>t</math></i>        | <i><math>t</math></i>               | 201       | 54,789.0        | 127.6      |



|     |                                |                          |        |        |           |     |          |       |
|-----|--------------------------------|--------------------------|--------|--------|-----------|-----|----------|-------|
| A19 | $h, a$                         | $\sigma 1(t), a 2(f, t)$ | $t$    | $t$    | $t$       | 219 | 54,765.3 | 148.2 |
| A16 | $t, a, s$                      | $\sigma 1(t), a 2(f, t)$ | $t$    | $t$    | $t$       | 223 | 54,765.1 | 156.1 |
| A13 | $\sigma 1(h, s), a 2(f, h, s)$ | $\sigma 1(t), a 2(f, t)$ | $t$    | $t$    | $t$       | 225 | 54,763.8 | 159.2 |
| A17 | $h, s$                         | $\sigma 1(t), a 2(f, t)$ | $t$    | $t$    | $t$       | 221 | 54,778.8 | 161.0 |
| A15 | $f, h$                         | $\sigma 1(t), a 2(f, t)$ | $t$    | $t$    | $t$       | 223 | 54,773.0 | 161.2 |
| A23 | $h, a$                         | $s$                      | $t$    | $t$    | $t$       | 146 | 55,013.4 | 163.3 |
| A18 | $h$                            | $\sigma 1(t), a 2(f, t)$ | $t$    | $t$    | $t$       | 217 | 54,801.4 | 167.6 |
| A14 | $t, s$                         | $\sigma 1(t), a 2(f, t)$ | $t$    | $t$    | $t$       | 255 | 54,686.1 | 168.7 |
| A10 | $f, t$                         | $\sigma 1(t), a 2(f, t)$ | $t$    | $t$    | $t$       | 273 | 54,652.9 | 183.2 |
| A11 | $f, a$                         | $\sigma 1(t), a 2(f, t)$ | $t$    | $t$    | $t$       | 221 | 54,816.9 | 185.7 |
| A12 | $f$                            | $\sigma 1(t), a 2(f, t)$ | $t$    | $t$    | $t$       | 220 | 54,821.3 | 186.6 |
| A9  | $\sigma 1(t), a 2(f, t)$       | $\sigma 1(t), a 2(f, t)$ | $t$    | $t$    | $t$       | 291 | 54,630.2 | 204.5 |
| A7  | $\sigma 1(t), a 2(f, t)$       | $\sigma 1(t), a 2(f, t)$ | $t$    | $t$    | $t, a$    | 309 | 54,583.3 | 210.0 |
| A8  | $\sigma 1(t), a 2(f, t)$       | $\sigma 1(t), a 2(f, t)$ | $t$    | $t$    | $-$       | 274 | 54,691.4 | 210.2 |
| A4  | $\sigma 1(t), a 2(f, t)$       | $\sigma 1(t), a 2(f, t)$ | $t$    | $t$    | $t, a, a$ | 346 | 54,519.6 | 242.6 |
| A6  | $\sigma 1(t), a 2(f, t)$       | $\sigma 1(t), a 2(f, t)$ | $t$    | $h$    | $t, a, a$ | 328 | 54,585.1 | 249.2 |
| A2  | $\sigma 1(t), a 2(f, t)$       | $\sigma 1(t), a 2(f, t)$ | $t$    | $t, a$ | $t, a, a$ | 363 | 54,503.9 | 266.4 |
| A5  | $\sigma 1(t), a 2(f, t)$       | $\sigma 1(t), a 2(f, t)$ | $t$    | $a$    | $t, a, a$ | 328 | 54,625.0 | 275.1 |
| A1  | $\sigma 1(t), a 2(f, t)$       | $\sigma 1(t), a 2(f, t)$ | $t, b$ | $t, a$ | $t, a, a$ | 381 | 54,471.1 | 281.1 |
| A3  | $\sigma 1(t), a 2(f, t)$       | $\sigma 1(t), a 2(f, t)$ | $-$    | $t, a$ | $t, a, a$ | 346 | 54,655.7 | 331.0 |

Model notation:  $h$ : time effect reduced to 2 periods: before (1990-1998) and after (1999-2011) introduction of the special management actions to increase hunting;  $a$ : age effect ( $a1 = 1^{st}$  interval after marking,  $a2 =$  all subsequent intervals);  $f$ : former state effect (Successful nester at the colony, Failed nester at the colony, Alive Elsewhere);  $t$  = time;  $o$ : nesting stage encounter effect (Observed vs. Unobserved);  $b$ : current season nesting success effect;  $.$  = interaction,  $+$  = additive effect,  $-$  = constant.

## Chapitre 3 : Variations temporelles du taux de survie juvénile chez une espèce longévive : rôle du parasitisme et de la condition corporelle

---

*Publié en ligne dans Oecologia*

<http://link.springer.com/article/10.1007/s00442-013-2613-z>

Étudier les variations des paramètres démographiques est un pré-requis nécessaire aux tests des prédictions de la théorie de la canalisation (Gaillard & Yoccoz 2003). Les variations temporelles des conditions environnementales ou les conditions rencontrées dans les premiers stages de vie des individus peuvent être responsables des variations des paramètres démographiques (Arlettaz et al. 2010, Cam & Aubry 2011). Chez les oiseaux longévifs, la plupart des études se sont surtout intéressées aux variations de la survie adulte, malgré le rôle important que peut jouer le taux de survie juvénile sur la dynamique de population (Lindström 1999, Jenouvrier et al. 2005a, van de Pol et al. 2010). Une explication potentielle vient de la difficulté à estimer ce paramètre. En effet, les études démographiques se déroulent essentiellement sur les sites de reproduction des espèces. Or, chez les oiseaux longévifs, le recrutement intervenant après plusieurs années de vie, peu d'individus juvéniles sont observés et/ou capturés sur les sites de reproduction (Clobert & Lebreton 1991, Frederiksen & Bregnballe 2000, Bogdanova et al. 2007). Cependant, chez les espèces chassées comme la grande oie des neiges, il est possible d'estimer les taux de survie des premières années de vie des jeunes grâce aux informations rapportées par les oiseaux tués à la chasse.

Le but de ce chapitre est donc d'estimer le taux de survie des jeunes individus (1<sup>ière</sup> et 2<sup>e</sup> année de vie) chez la grande oie des neiges à partir des données de reprises et de recapture, un paramètre a priori non-canalisé. Les conditions rencontrées lors des premiers moments de la vie des individus pouvant induire des variations du taux de survie juvénile (Lindström 1999, Cam & Aubry 2011), nous allons également étudier l'influence de la condition corporelle des jeunes et d'un traitement antiparasitaire juste avant l'envol sur leur survie.

## **Temporal variation of juvenile survival in a long-lived species: the role of parasites and body condition**

Guillaume Souchay<sup>1,2</sup>, Gilles Gauthier<sup>1,†</sup> & Roger Pradel<sup>2</sup>

<sup>1</sup> Département de Biologie & Centre d'Études Nordiques, 1045 avenue de la Médecine, Université Laval, Québec, QC, G1V 0A6, Canada

<sup>2</sup> Centre d'Ecologie Fonctionnelle et Evolutive, UMR 5175, Campus CNRS, 1919 route de Mende, F-34293 Montpellier, Cedex 05 France

†Corresponding author : Gilles Gauthier (e-mail : [Gilles.Gauthier@bio.ulaval.ca](mailto:Gilles.Gauthier@bio.ulaval.ca) ; (phone) +1-418-656-5507) Département de Biologie & Centre d'Études Nordiques, 1045 avenue de la Médecine, Université Laval, Québec, QC, G1V 0A6, Canada

## **Abstract**

Studies of population dynamics of long-lived species have generally focused on adult survival because population growth should be most sensitive to this parameter. However, actual variations in population size can often be driven by other demographic parameters such as juvenile survival when they show high temporal variability. We used Capture-Recapture data from a long-term study of a hunted, migratory species, the greater snow goose (*Chen caerulescens atlantica*), to assess temporal variability in first-year survival and the relative importance of natural and hunting mortality. We also conducted a parasite-removal experiment to determine the effect of internal parasites and body condition on temporal variation in juvenile survival. We found that juvenile survival showed a higher temporal variability than adult survival and that natural mortality was more important than hunting mortality, unlike in adults. Parasite removal increased first-year survival and reduced its annual variability in females only. Body condition at fledging was also positively correlated with first-year survival in treated females. With reduced parasite load, females, which are thought to invest more in their immune system than males according to Bateman's principle, could probably reallocate more energy to growth than males, leading to a higher survival. Treated birds also had a higher survival than control ones during their second year, suggesting a developmental effect that carried out later in life. Our study shows that natural factors such as internal parasites may be a major source of variation in juvenile survival of a long-lived, migratory bird, which has implications for its population dynamics.

**Key Words:** elasticity; mortality; cestodes; body mass; geese.

## Résumé

Les études en dynamique de population chez les espèces longévives se sont généralement concentrées sur le taux de survie adulte, ce paramètre étant le plus important pour le taux de croissance de la population. Cependant, les variations de la taille de population peuvent être expliquées par d'autres paramètres démographiques tels que le taux de survie juvénile. Nous avons utilisé un jeu de données de capture-recapture à long-terme de la grande oie des neiges (*Chen caerulescens atlantica*), une espèce migratrice chassée, pour étudier la variabilité temporelle du taux de survie lors de la première année de vie et l'importance relative de la mortalité naturelle et à la chasse. Nous avons également mené une expérience de vermifugation des jeunes pour déterminer l'effet de parasites internes et de la condition corporelle sur les variations temporelles de la survie juvénile. Nous avons montré que la survie juvénile était plus variable que la survie adulte et que la mortalité naturelle était plus importante que la mortalité à la chasse. La suppression des parasites internes a augmenté la survie de la première année et réduit sa variabilité annuelle chez les femelles seulement. La condition corporelle à l'envol est également positivement corrélée à la survie juvénile chez les femelles traitées. D'après le principe de Bateman, les femelles investissent plus dans leur système immunitaire que les mâles, ainsi, soulagées de la charge parasitaire, ces femelles pourraient réallouer de l'énergie à leur croissance, contrairement aux mâles, ce qui expliquerait leur meilleure survie. Nous avons également trouvé que les individus traités avaient une meilleure survie lors de leur deuxième année de vie que les individus « contrôle », suggérant un effet reporté du traitement. Notre étude montre que les facteurs naturels tels que les parasites internes, peuvent être une source importante de variation pour la survie juvénile chez une espèce longévive migratrice, ce qui a des conséquences sur sa dynamique de population.

## Introduction

Accurate predictions of future population trajectories require a good understanding of variations in life-history traits (Benton et al. 2006, Le Galliard et al. 2010). These variations can be caused by the age-structuration of the population, temporal variation in environmental conditions or conditions experienced during critical stages of life, such as early growth (Benton et al. 2006, Dickey et al. 2008, Arlettaz et al. 2010, Le Galliard et al. 2010, Cam & Aubry 2011, Roth et al. 2011). In long-lived species, variations in demographic parameters and their effects on population growth have received considerable attention (Gaillard et al. 1998, Toïgo & Gaillard 2003, Morris & Doak 2004a, Coulson et al. 2005). In these species, adult survival is the vital rate to which population dynamic is most sensitive. However, paradoxically, a large number of long-term field studies have shown that other demographic parameters with a relatively low elasticity, such as fecundity or juvenile survival, were actually responsible for the largest proportion of the observed variation in population size (Gaillard et al. 1998, Pfister 1998, de Kroon et al. 2000, Gaillard et al. 2000, Saether & Bakke 2000). Indeed, there is apparently an inverse relationship between the elasticity of a demographic parameter and its variability under natural conditions. This pattern has led some authors to propose that, due to their high elasticity, parameters such as adult survival have been canalized, i.e. that their variance has been reduced through evolutionary time (Gibson & Wagner 2000).

In long-lived birds, adult survival is probably the vital rate that has received the most attention (Lindström 1999, Jenouvrier et al. 2005b, van de Pol et al. 2010, O'Neal et al. 2011). However, a full understanding of the population dynamic of a species requires that demographic parameters with a high natural variability are also considered. In particular, juvenile survival has received much less attention even though this parameter is often highly variable (Frederiksen & Bregnballe 2000, Harris et al. 2007, Monticelli et al. 2008). A reason for the paucity of information on juvenile survival in several species of migratory birds is that this parameter is more difficult to estimate than adult survival because individuals often cannot be observed between fledging time and their first breeding, especially in long-lived species where recruitment can be delayed for several years (Bradley & Wooller 1991, Clobert & Lebreton 1991, Croxall & Rothery 1991, Frederiksen & Bregnballe 2000, Bogdanova et al. 2007, Harris et al. 2007). However, in hunted species, additional information is available during the elusive prebreeding period thanks to the recovery of harvested

individuals, thus compensating for the absence of recapture prior to first breeding. Using advances in capture-recapture analysis, accurate estimation of juvenile survival is possible by combining information from recaptures and recoveries in the same analysis (Lebreton et al. 2009).

In this study, we focused on the estimation of first-year survival of the greater snow goose (*Chen caerulescens atlantica*), a highly variable demographic parameter in this hunted species, and on natural factors that could explain its annual variation (Gauthier & Brault 1998). The greater snow goose population has increased exponentially during the second half of the XXth century to the point of threatening its natural habitats due to its overabundance (Menu et al. 2002). Thus, some special conservation measures were implemented with the aim of reducing both adult and juvenile survival (Giroux et al. 1998). Calvert and Gauthier (2005) made a first evaluation of the impact of these conservation measures. They found that first-year survival, although highly variable, did not change after the special measures contrary to adult survival. Calvert and Gauthier (2005) hypothesized that the apparent lack of change in juvenile survival despite an increase in kill rate was because natural mortality was a more important source of mortality than hunting in this age-class. In this paper, we address this hypothesis by examining the effect of two natural factors: internal parasitism, and body condition at fledging.

Internal parasites can affect fitness in birds either by impinging on fecundity or by decreasing survival (e.g. Newborn & Foster 2002, Amundson & Arnold 2010, Shutler et al. 2012), especially in juveniles due to their higher parasite load compared to adults (McLaughlin & McGurk 1987, Righi & Gauthier 2002). Parasites can act directly by causing the death of their host or indirectly by weakening or decreasing its body condition (Slattery & Alisauskas 2002, Monticelli et al. 2008, Amundson & Arnold 2010). In geese, young are often highly infested by intestinal parasites (primarily cestodes) during growth (Slattery and Alisauskas 2002, Righi and Gauthier 2002). A field experiment has thus been conducted to study the consequences of parasite removal on young greater snow geese. We expected that individuals treated with anthelmintic drugs at fledging would have a better survival than control ones.

In birds, environmental condition experienced during early life can strongly affect their development and body condition at fledging with a potentially strong impact on subsequent survival and recruitment (Lindström 1999, Gauthier et al. 2006, Cam & Aubry 2011). Survival of migratory birds is often condition-dependent

with individuals in better condition benefitting from increased survival, especially in young (Francis et al. 1992, Schmutz 1993, Naef-Daenzer et al. 2001, Cooch 2002, Sedinger et al. 2004, Braasch et al. 2009). Hence, we expected a positive relationship between body condition at fledging and juvenile survival, possibly in interaction with parasite load since birds in low body condition should benefit more from an anthelmintic treatment.

## Methods

### *Field methods*

The greater snow goose is a long-distance migrant that breeds in the Canadian High Arctic and winters in the North-eastern United States (Gauthier et al. 2005). We captured and banded individuals at the end of the summer on their Arctic breeding ground at the Bylot Island, Nunavut, Canada (73°N, 80°W) colony between 2002 and 2005, the most important breeding site for this population. Goose families were captured during a seven-day period, when adults were molting and before young could fly (see Menu et al. (2005) for details). Birds were aged (young of the year or adult  $\geq 2$  year-old; adults only starts breeding at 2-year of age in this species, Juillet et al. 2012) and sexed based on cloacal eversion (Taber 1971). Each bird received a U.S. Fish & Wildlife Service metal band and 2/3 of adult females received a plastic neck collar with a four-digit unique code. A large proportion of banded young (>50 %) were measured (length of head, culmen, tarsus and 9<sup>th</sup> primary feather) and weighed. During banding, a random sample of young ( $n = 2141$  over 4 years) were injected with an anthelmintic drug, Droncit® (0.33cc or ~10 mg/kg body mass). Droncit® was used due to its efficiency in removing 100% of intestinal cestodes in greater snow geese (Righi & Gauthier 2002). A similar number of young were treated with a saline solution ( $n = 2030$ ).

Recaptures occurred every subsequent year on Bylot using the same methods up to summer 2010. Geese are hunted in Southern Québec in autumn (October-November) and in spring (April-May), and in the United States during winter (October to February). Hunter band recoveries returned to the Bird Banding Laboratory up to 2010 were added to the dataset. Collared females were excluded from the dataset to avoid any collar effect in the analysis (Reed et al. 2005). Our dataset thus included the capture history of 12,451 geese.



### *Capture-recapture analysis*

We used a multi-state model mixing recaptures and recoveries to analyze annual survival rates corrected for permanent emigration (Lebreton et al. 2009). The states in our model were “Alive”, “Newly dead” and “Dead”. Birds recovered between occasions  $t$  and  $t+1$  were recorded as “Newly dead” at the  $t+1$  occasion. A “Newly dead” bird at  $t+1$  automatically became “Dead” at  $t+2$  and could no longer be recovered. We used a  $\{S;r\}$  parameterization where the recovery rate  $r$  is conditional on death (Gauthier & Lebreton 2008), unlike the  $\{S;f\}$  parameterization where the recovery rate  $f$  is unconditional (i.e. it is the probability that a bird is killed by a hunter, retrieved and has its band reported). In our paper, we will refer to the conditional recovery rate when referring to parameter  $r$ .

We created separate groups for individuals banded as young or as adults. We further divided the young group according to the treatment they received (Droncit®, saline solution and no manipulation). We also considered the sex in each treatment group. Thus, we ended up with 8 groups: adult males, adult females, young males receiving Droncit, young males receiving a saline solution, untreated young males, young females receiving Droncit, young females receiving a saline solution and untreated young females.

Our initial model had parameters specific to all combinations of time, age, treatment, age at banding and sex. The way age was modeled differed between survival and capture or conditional recovery probabilities. We distinguished first-year (‘juv’), second-year (‘sub’) and older individuals (>2y, denoted ‘ad’) when modeling survival but only first-year vs older individuals (>1y denoted ‘ad1’) when modeling recapture and recovery. We assumed that individuals banded as adults had the same survival probability than individuals banded as young after 2 years of age to avoid identifiability problems. Using the notation recommended by Lebreton and Pradel (2002), this model was :

$$\phi_{t.3a.g.b.s} p_{t.2a.g.b.s} r_{t.2a.g.s} \quad (1)$$

where  $\phi$ ,  $p$  and  $r$  are survival, recapture and conditional recovery probabilities respectively,  $t$  is time,  $\#a$  an age effect with ‘2a’ for 2 age-classes (‘juv’ and ‘ad1’) and ‘3a’ for 3 age-classes (‘juv’, ‘sub’ and ‘ad’),  $g$  the treatment group,  $b$  the age-at-banding (young vs. adult) and  $s$  the sex.

### *Goodness-of-fit and model selection*

The ability of the initial model to describe the data was assessed by goodness-of-fit tests using program U-CARE (Choquet et al. 2009a). For model selection, we followed a step-down approach, starting with the initial model and sequentially fitting models with constrained parameterizations for conditional recovery, recapture and survival probabilities in that order. Model selection relied on the Akaike's Information Criterion (AIC, Burnham & Anderson 2002). Model selection and parameter estimation were performed using program E-SURGE (Choquet et al. 2009b). In a second step, we evaluated the covariates effects on first-year survival (see below) from the best model resulting from the previous selection.

### *Covariate*

We computed a body condition index on young with complete morphometric measurements ( $N = 4,742$  individuals). We excluded all individuals without complete information from the covariate analysis. We calculated a "scaled mass index of body condition" (sensu Peig & Green 2009) in several steps, taking into account that we were dealing with fast growing young. First, within-season age was estimated from annual relationships between 9<sup>th</sup> primary length and known age (in days) based on a sample of young marked at hatch in the nest (see Lepage et al. (1998) for details). Second, we corrected gosling body mass and size for their age by extracting residuals from annual relationships between mass or size and estimated within-season age, i.e. goslings were adjusted to a common age (Slattery & Alisauskas 2002). We used head length as a measure of body size because it was the morphometric measurement most highly correlated to body mass. Finally, we computed a Standard Major Axis (SMA) regression between the age-corrected body mass and size residuals. Our body condition index was the residuals of the previous SMA regression between body mass and size for each individual. Calculations of condition index were performed with the package "lmodel2" of R software (R Development Core Team 2010, Legendre 2011). Body condition indices were standardized before inputting them into E-SURGE. We looked at the 95% confidence interval of the slope to assess the relevance of body condition.

## Results

### *Goodness-of-fit*

The overall goodness-of-fit test of the Cormack-Jolly-Seber model was significant (for individuals banded as young:  $\chi^2 = 135.2$ ,  $df = 42$ ,  $p < 0.001$ , as adults:  $\chi^2 = 82.5$ ,  $df = 57$ ,  $p = 0.015$ ). Looking at test components (Table A1 Online Resource 1), we found a strong trap-dependence effect for young, most likely because the first breeding attempt does not occur before the age of 2 at the earliest. Indeed, when we suppressed the first encounter for young, the test was no longer significant (Table A2 Online Resource 1; similar results when the data is separated by sexes). For the adults, the lack of fit of our model was moderate ( $\hat{c} = 1.44$ ) and could be accounted with a variance inflation factor only. Because our analyses, unlike the Cormack-Jolly-Seber model, account for age effects, we calculated a variance inflation factor without the first encounter for young and on complete encounter histories for adults to correct for any remaining lack of fit ( $\hat{c} = 1.377$ , Table A2). The same procedure applied to the reduced dataset of measured young yielded  $\hat{c} = 1.127$ .

### *Re-encounter probabilities*

Starting from our initial model (Model M1, Table 1), model selection led to a model (M22) including time and age effects on conditional recovery, and time, sex and age at banding effects on recapture. Sex was retained on recapture but not on recovery (M17 vs M14), suggesting sex differences in presence at the breeding colony but no difference in susceptibility to hunting. Recapture probabilities were generally low (range: 0.00 to 0.08, Fig.1). Recapture probabilities were initially close to zero for birds banded as young (Fig.1) but gradually increased starting in 2006 as individuals started to recruit into the breeding population. However, recapture probabilities were always higher for females than for males of same age. Conditional recovery probabilities were higher for adults (around 0.20, range: 0.12 to 0.30, Fig.2) than for young (0.06 to 0.09; Fig. 2).

**Table 1: Model selection for the effects of time, age, sex and anti-parasite treatment on survival, recapture and conditional recovery probabilities of Greater Snow Geese banded from 2002 to 2005 (N = 12,451 individuals) and re-encountered until 2010. For each model, we give deviance, number of estimable parameters (k), and difference in QAIC with the best model ( $\Delta i$ ). Best models are in bold and starting model is in italic. A variance inflation factor  $\hat{c} = 1.377$  accounts for any remaining lack of fit.**

| #          | Survival         |                   |          | Recapture         | Recovery        | Deviance       | k          | $\Delta i$   |
|------------|------------------|-------------------|----------|-------------------|-----------------|----------------|------------|--------------|
|            | Juvenile         | Sub-adult         | Adult    |                   |                 |                |            |              |
| <b>M22</b> | <b>FD,O'(t)</b>  | <b>t.2g</b>       | <b>s</b> | <b>t.b.s</b>      | <b>t.2a</b>     | <b>18547.7</b> | <b>59</b>  | <b>0.0</b>   |
| <b>M21</b> | <b>FD,O'(t)</b>  | <b>t.2g</b>       | -        | <b>t.b.s</b>      | <b>t.2a</b>     | <b>18550.9</b> | <b>58</b>  | <b>0.4</b>   |
| M20        | FD,MD(t),O(t)    | t.2g              | s        | t.b.s             | t.2a            | 18544.0        | 63         | 5.3          |
| M19        | t.2g             | t.2g              | -        | t.b.s             | t.2a            | 18552.4        | 61         | 7.4          |
| M18        | t.2g             | t.2g              | s        | t.b.s             | t.2a            | 18549.8        | 62         | 7.5          |
| M17        | FD(t),MD,O(t)    | t.2g              | s        | t.b.s             | t.2a            | 18547.0        | 63         | 7.6          |
| M16        | FD(t),MD(t),O(t) | t.2g              | s        | t.b.s             | t.2a            | 18542.0        | 66         | 9.9          |
| M15        | FD(t),MD(t),O(t) | FD(t),MD(t),O(t)  | s        | t.b.s             | t.2a            | 18539.5        | 70         | 16.1         |
| M14        | t.2g             | t.2g              | -        | t.b.s             | t.2a.s          | 18544.2        | 73         | 25.5         |
| M13        | t.s.2g           | t.s.2g            | s        | t.b.s             | t.2a            | 18534.6        | 78         | 28.5         |
| M12        | t.2g             | t.2g              | -        | t.b               | t.2a            | 18688.2        | 45         | 74.1         |
| M11        | t.g              | t.g               | -        | t.b               | t.2a            | 18679.6        | 53         | 83.8         |
| M10        | t.g              | t.g               | g        | t.b               | t.2a            | 18679.4        | 55         | 87.7         |
| M9         |                  | t.3a              |          | t.b               | t.2a            | 18714.7        | 44         | 89.3         |
| M8         |                  | t.3a.g            |          | t.b               | t.2a            | 18661.0        | 72         | 108.3        |
| M7         |                  | t.3a.g.b          |          | t.b               | t.2a            | 18656.1        | 78         | 116.8        |
| M6         |                  | t.2a.g.b          |          | t.b               | t.2a            | 18683.4        | 69         | 118.6        |
| M5         |                  | t.3a.g.b          |          | t.2a.g.b          | t.2a            | 18636.4        | 100        | 146.5        |
| M4         |                  | t.3a.g.b          |          | t.2a.g.b          | t               | 18658.9        | 96         | 154.8        |
| M3         |                  | t.3a.g.b          |          | t.2a.g.b          | t.2a.g          | 18622.5        | 114        | 164.4        |
| M2         |                  | t.3a.g.b          |          | t.2a              | t.2a            | 18748.4        | 74         | 175.8        |
| <i>M1</i>  |                  | <i>t.3a.g.b.s</i> |          | <i>t.2a.g.b.s</i> | <i>t.2a.g.s</i> | <i>18401.5</i> | <i>213</i> | <i>201.8</i> |

Model notation: *t* = time; *3a* = 3 age-classes (juveniles, sub-adults, and adults); *2a* = 2 age-classes only (juveniles vs older individuals); *b* = banding group (banded as young or as adult); *s* = sex effect; *g* = treatment effect ('Droncit', 'saline solution', 'no treatment'); *2g* = treatment effect reduced to 2 levels ('Droncit' vs 'other treatments'); . = interaction. When different effects apply to different categories of individuals, the effects applying to each are specified between parentheses and the different categories are separated by commas; when the parameter is constant within the category, no effect is specified. The categories are: *FD*, Droncit-treated females; *MD*, Droncit-treated males; *O*, Droncit-untreated individuals; *O'*, all individuals but Droncit-treated females.

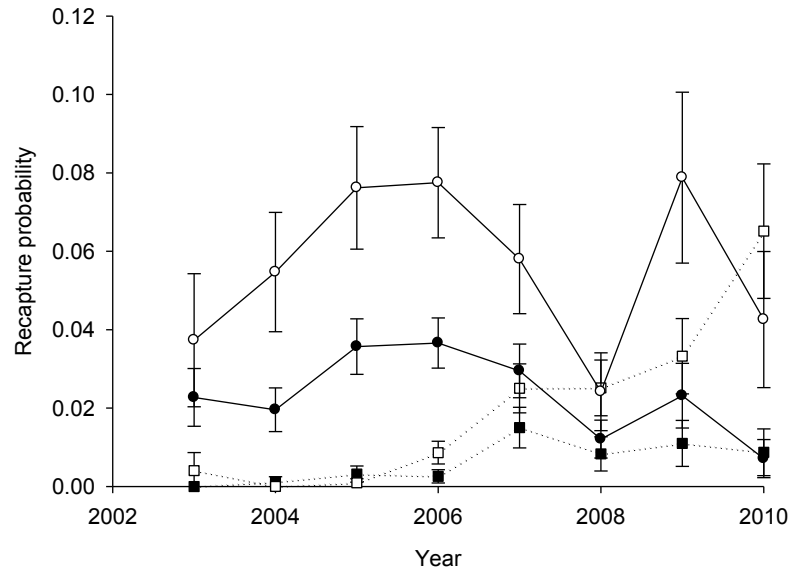

**Figure 1: Estimates (mean  $\pm$  SE) of recapture probabilities of greater snow geese banded from 2002 to 2005 on Bylot Island. Estimations are from model M22, Table 1. Square and circle symbols represent estimations for individuals banded as young and adults and full and empty symbols for males and females, respectively.**

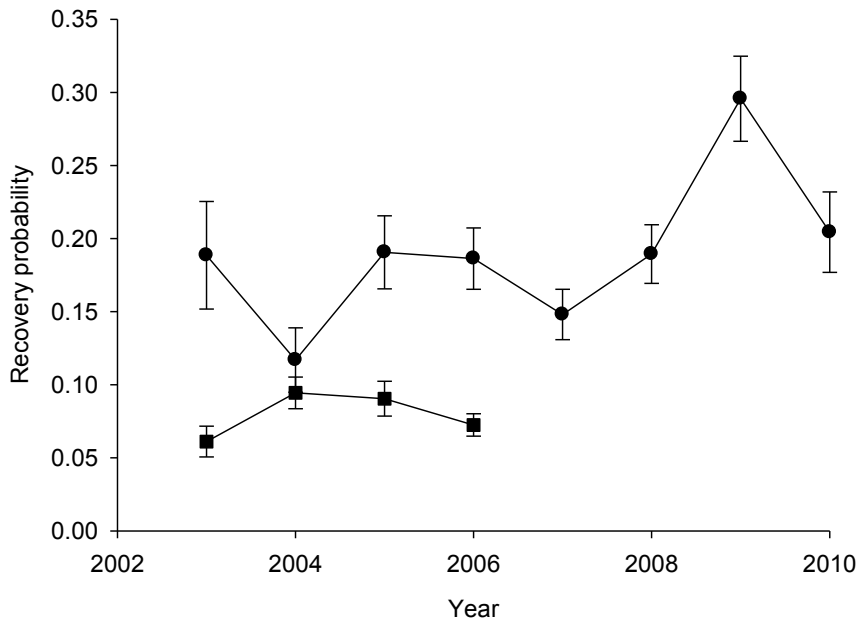
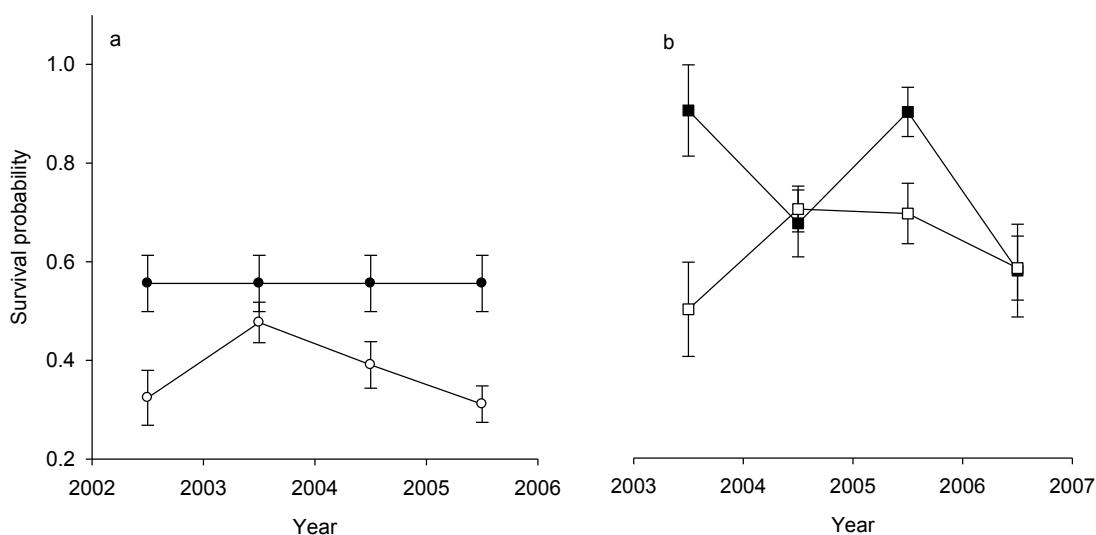

**Figure 2: Estimates (mean  $\pm$  SE) of recovery probabilities conditional upon death of greater snow geese banded from 2002 to 2005 on Bylot Island. Estimations are from model M22, Table 1. Squared and circle symbols represent estimations for juveniles (<1 year old) and older ( $\geq$ 1 year old), respectively.**

*Survival probabilities and treatment effects*

Our preferred model (M22, Table 1) included time, age, treatment and sex effects on survival. The analysis retained 3 age-classes rather than two (M7 vs. M6; Table 1) suggesting that sub-adult and adult survivals differed. Models with and without sex

effect in adults were close (M22 vs.M21). Adult survival was constant over time,  $0.78 \pm 0.02$  [SE]. The treatment effect was retained but only as a distinction between Droncit injection vs. any other treatment (i.e. saline injection or no injection), suggesting no handling effect on survival (M12 with two levels of treatment vs. M11 with 3 levels; Table 1). There was, however, a complex interaction between treatment, age, sex and time. In juveniles, survival of Droncit-injected females differed from that of Droncit-injected males and control individuals together; survival averaged  $0.40 \pm 0.03$  (range: 0.31 to 0.48) in the latter group but was 40% higher ( $0.55 \pm 0.06$ ) and constant over time for Droncit-injected females. In sub-adults, all Droncit-injected birds had the same time-varying survival (range 0.58 to 0.91), which was distinct from that of other birds (range 0.50 to 0.71); survival of Droncit-injected sub-adults was higher in 2 years out of 4 (Fig. 3).



**Figure 3: Estimates (mean  $\pm$  SE) of survival probabilities of (a) juvenile and (b) subadult greater snow geese banded from 2002 to 2005 on Bylot Island. Estimations are from model M22, Table 1. a) Full and empty circles represent first-year survival estimation of Droncit-injected females and all other individuals respectively; b) Full and empty squares represent subadult survival estimation of Droncit-injected individuals and non-Droncit-injected individuals respectively.**

#### *Effect of body condition on first-year survival*

The effects of body condition on first-year survival were tested on the reduced dataset of individuals measured at banding. We started from the best model selected with the full dataset (model M22 of Table 1 = model C1 of Table 2) and proceeded to a new model selection with the covariate. We retained a model including a BCI effect on survival of Droncit-injected females only (C6). The first-year survival of Droncit-

injected females was enhanced by good body condition (Fig.4;  $\beta_{BCI} = 1.66$ , 95%CI [-0.10, 3.41] from model C6). We also tested models where body size was included along with body condition but this covariate explained hardly any variation in survival beyond that already explained (results not presented).

**Table 2: Selection of models examining the effects of body condition index (BCI) on first-year survival of Greater Snow Geese banded from 2002 to 2005 using a reduced dataset (N = 4,742 individuals). Parameterization of sub-adult and adult survival, recapture and conditional recovery probabilities is maintained as in Model 22 (Table 1). For each model, deviance, number of estimable parameters (k) and QAIC difference with the best model ( $\Delta i$ ) are given. Best models are in bold and starting model is in italic. A variance inflation factor  $\hat{c} = 1.127$  accounts for any remaining lack of fit.**

| #           | First-year Survival     |                   | Deviance      | k         | $\Delta i$ |
|-------------|-------------------------|-------------------|---------------|-----------|------------|
|             | Droncit treated females | Other individuals |               |           |            |
| <b>C6</b>   | <b>BCI</b>              | –                 | <b>6125.1</b> | <b>57</b> | <b>0.0</b> |
| C5          | BCI                     | BCI               | 6124.8        | 58        | 1.7        |
| C4          | –                       | –                 | 6129.8        | 56        | 2.2        |
| C3          | BCI                     | t                 | 6122.2        | 60        | 3.4        |
| C2          | –                       | BCI               | 6129.5        | 57        | 3.9        |
| <i>M22-</i> | –                       |                   |               |           |            |
| <i>C1</i>   |                         | <i>t</i>          | <i>6127.1</i> | <i>59</i> | <i>5.8</i> |

Model notation: *t* = time; *BCI* = body condition index

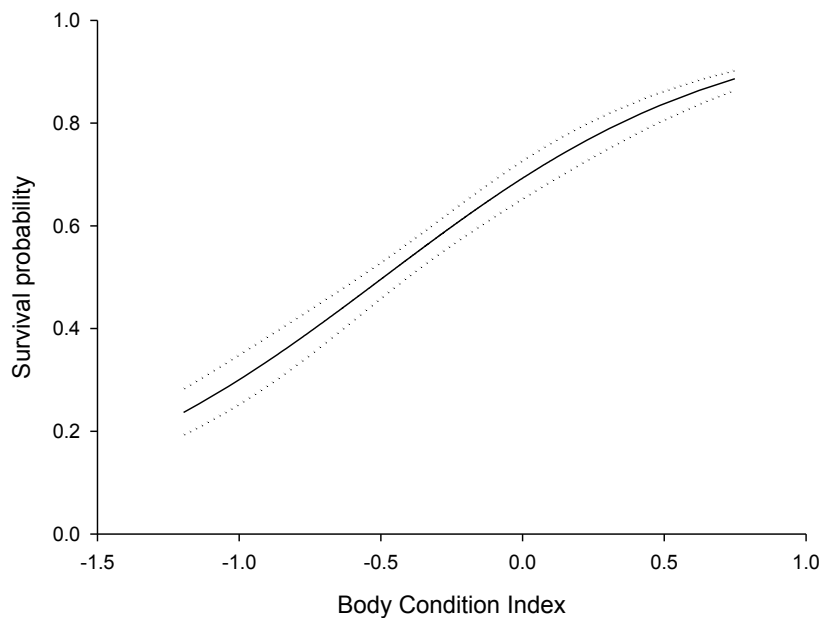

**Figure 4: Predicted relationship between survival probability and body condition index of young females injected with an anti-helminthic drug (Droncit®) according to model C6, Table 2. Solid (-) and dotted (···) lines represent the logit-linear relationship and the 95% confidence intervals respectively.**

## Discussion

Our study confirms that juvenile survival shows a much higher temporal variability than adult survival in geese, which is rather constant. This reinforces the idea that adult survival is more canalized than juvenile survival in long-lived species (Gaillard et al. 2000). Moreover, we show that juvenile mortality is mostly natural, and that factors such as parasitism and individual body condition explain part of its temporal variability. Our first-year survival estimates (around 0.40, range: 0.31-0.48) for control individuals are in the same range than previous studies on the same species (Calvert & Gauthier 2005, Juillet et al. 2012) or in other anserinae (Schmutz & Ely 1999, Anderson et al. 2001, Alisauskas et al. 2006, Sedinger & Nicolai 2011).

### *Hunting vs natural mortality*

Our results support the hypothesis of Calvert and Gauthier (2005) that a much greater proportion of juvenile mortality is due to natural factors compared to adults. This is confirmed by the probability of recovery by hunters conditional upon death,  $r$ , which is about 2.5 times higher in adults than in young ( $\sim 0.20$  vs  $\sim 0.08$ ). To compare our results to those of Calvert & Gauthier (2005), who used the unconditional recovery rate,  $f$ , we transformed our  $r$  values into  $f$  as suggested by Gauthier & Lebreton (2008). In our study, the range of  $f$  values was slightly lower for young (0.04 to 0.05 vs 0.04 to 0.10 in Calvert and Gauthier 2005) but similar for adults (0.02 to 0.07 vs 0.03 to 0.05) for periods with similar hunting regulations (i.e. 1998 onward). When one considers that juvenile survival tended to be lower in our study than in Calvert & Gauthier (2005) (0.40 vs 0.50, respectively), this suggests that the proportion of mortality due to hunting has decreased in juvenile greater snow geese in recent years, and thus that natural mortality has increased.

### *Parasites and variation in survival*

Parasite removal just before fledging affected first-year survival only in females and this in two ways: survival was increased compared to control birds and it remained constant over years. An increase in first-year survival following parasite removal was expected as other studies showed similar effects after anti-parasite drug treatments in a wide variety of species (Slattery 2000, Newborn & Foster 2002, Brown & Brown 2004, Monticelli et al. 2008, Pedersen & Greives 2008, Amundson & Arnold 2010). However, that this effect was present only in females and not in males is surprising because, according to the immunocompetence handicap hypothesis (ICHH, Folstad



& Karter 1992), males should have a weaker immune system due to testosterone, and thus should have benefitted more from the anti-parasite treatment than females. An alternative explanation can be provided by Bateman's principle, which states that males gain fitness by increasing their mating success while females increase fitness through longevity because their reproductive investment is much higher (Bateman 1948). Based on this concept, (Rolff 2002) predicted that females should invest more in their immune system than males to improve their longevity, which was supported by Nunn et al. (2009) in mammals. We can therefore expect young females to invest more in their immune system than males when challenged by internal parasites, a common occurrence in growing geese (Righi & Gauthier 2002; Slattery & Alisauskas 2002). Thus, when parasite load is eliminated by an anthelmintic drug, females may have more scope to reallocate some of the investment in their immune system to other physiological functions than males. A greater reallocation of energy to other functions such as growth in females than in males may explain why first-year survival was improved only in the former group after the treatment.

The anti-helmintic treatment not only improved the survival of young females but also considerably reduced its temporal variation as annual first-year survival of treated females was estimated at  $0.55 \pm 0.06$  in all years but ranged from 0.31 to 0.48 in untreated young and treated males. This suggests either that the temporal variation reflects annual variations in parasite infestation, or that it is due to an interaction between a constant parasite infestation and temporal variation in environmental conditions. An interaction between temporal variation in parasite load and demographic parameters has been found in the red grouse (*Lagopus lagopus scoticus*), a well-known cyclic population (Cattadori et al. 2005). Therefore, we suggest that removal of parasites in young females enable them to reallocate energy to other functions and hence to cope better with environmental conditions.

More surprisingly, we found an improvement of survival of all individuals treated with the anti-helmintic drug during their second year of life compared to untreated ones. The treatment happened near fledging time when growth is only about 70% completed (Lesage & Gauthier 1997). If individuals were able to reallocate energy from immunity to growth as we suggested, this may have improved their final growth and created a developmental effect (Lindstrom 1999). Indeed, it has been shown that individuals experiencing good conditions early in life can have improved survival and even fecundity later in life, including in geese (Sedinger et al.

1995, Sedinger et al. 2004). However, the positive effect of the treatment was only observable for 2 of 4 years, which suggest a possible interaction with other environmental conditions experienced early in life. Adult survival was not affected by our anti-parasite treatment so apparently any developmental effect present in the second year of life did not persist beyond that age.

#### *Body condition and survival*

Body condition during early stage of development has been shown to be strongly correlated to survival and recruitment in many species (for a review see Lindström 1999, Cam & Aubry 2011), especially in migratory birds (Francis et al. 1992, Schmutz 1993, Cooch 2002, Sedinger et al. 2004, Morrison et al. 2007, Braasch et al. 2009). In greater snow geese, Menu et al. (2005) did not find any relationship between body mass at fledging and fall migration survival but, in our study, body condition was positively related to first-year survival only in females from which parasites had been removed. A possible explanation may be that there is a trade-off between investment in growth and in the immune system. Under natural conditions, individuals growing rapidly and achieving good body condition at fledging may do so at the expense of their immune system and may suffer from higher parasite load, which may negatively affect their subsequent survival, thereby masking any relationship between body condition and survival. When parasites are removed, individuals that have invested more in growth may thus benefit from a higher survival due to their improved body condition. An interaction between parasite and body condition has also been documented in Ross' geese as survival of young treated for parasites was generally higher than control ones in high condition individuals (Slattery 2000). That result also suggested that individuals that invested more in growth benefited more from parasite removal.

#### **Conclusion**

Our study supports a growing body of evidence showing that juvenile survival exhibits considerable temporal variation compared to adults in long-lived species, and that natural factors are the primary drivers of this variation even for hunted species (Gaillard et al. 2000, Gaillard & Yoccoz 2003). Our experimental manipulation also showed that internal parasites can be a major source of mortality of young in their first-year but that they can act in a complex manner, in interaction

with sex and body condition. Until now, the role of parasites in the population dynamic of birds and mammals has received relatively little attention even though studies suggest that they can play a crucial role in some species, as in cyclic red grouse in Scotland (Hudson et al. 1998, Cattadori et al. 2005, Redpath et al. 2006). Therefore, more studies are needed to determine to what extent the effects of parasites on demographic parameters, such as those that we documented, can limit the growth of populations.

### **Acknowledgements**

Funding was provided by the Natural Sciences and Engineering Research Council of Canada, the Arctic Goose Joint Venture (Canadian Wildlife Service), the Centre d'Études Nordiques, the Department of Indian and Northern Affairs Canada and by the International Research Group Dynamics of Biodiversity and Life-History traits. Logistic support in the Arctic was generously provided by the Polar Continental Shelf Project (Natural Resources Canada) and assistance in the field by Parks Canada. Droncit®, the anthelmintic drug, was provided by Bayer Canada. Finally, we are grateful to the numerous field assistant that helped for goose banding and especially Gérald Picard, to hunters who reported the banded birds that they shot and to Marie-Christine Cadieux for managing the database and for assistance in the field.

## Electronic Supplemental Material

**Table A1: Components of Goodness-of-Fit test for a multistate model with the greater snow goose dataset.**

| Component    | Young                |    |         | Adult    |    |       |
|--------------|----------------------|----|---------|----------|----|-------|
|              | $\chi^2$             | df | p       | $\chi^2$ | df | p     |
| 3G.SR        | 2.30                 | 3  | 0.514   | 8.11     | 3  | 0.044 |
| 3G.Sm        | <i>Not available</i> |    |         | 3.58     | 7  | 0.837 |
| M.ITEC       | 74.48                | 11 | < 0.001 | 25.19    | 16 | 0.067 |
| M.LTEC       | 58.48                | 27 | < 0.001 | 45.61    | 31 | 0.044 |
| Overall Test | 135.26               | 41 | < 0.001 | 82.49    | 57 | 0.015 |
| $\hat{c}$    |                      |    |         | 2.22     |    |       |

**Table A2: Components of Goodness-of-Fit test for a multistate model with the greater snow goose dataset after removing the first encounter for Young.**

| Component    | Young         |    |       | Adult    |    |       |
|--------------|---------------|----|-------|----------|----|-------|
|              | $\chi^2$      | df | p     | $\chi^2$ | df | p     |
| 3G.SR        | 0.82          | 2  | 0.665 | 8.11     | 3  | 0.044 |
| 3G.Sm        | Not available |    |       | 3.58     | 7  | 0.837 |
| M.ITEC       | 2.98          | 4  | 0.562 | 25.19    | 16 | 0.067 |
| M.LTEC       | 4.58          | 3  | 0.205 | 45.61    | 31 | 0.044 |
| Overall Test | 8.38          | 9  | 0.592 | 82.49    | 57 | 0.015 |
| $\hat{c}$    |               |    |       | 1.377    |    |       |

## Chapitre 4 : Évaluation de la canalisation spatiale du taux de survie adulte chez un oiseau migrateur

---

### *En préparation*

La théorie de la canalisation des paramètres démographiques suggère que les paramètres les plus importants pour le taux de croissance de la population seront très peu variables (Gaillard & Yoccoz 2003). Chez les espèces longévives, le taux de survie adulte étant le paramètre important pour le taux de croissance, il sera donc moins variable que les taux de survie juvénile et de reproduction. Plusieurs études chez la grande oie des neiges ont déjà montré une faible variabilité temporelle de la survie adulte annuelle (Menu et al. 2002, Juillet et al. 2011, Juillet et al. 2012).

Toutes les études réalisées jusqu'à maintenant sur la grande oie des neiges ne concernent que la population de l'île Bylot. La population se reproduisant sur cette île représente environ 15% de la population de la grande oie des neiges et est considéré comme la plus grande colonie chez cette espèce (Gauthier et al. 2005). Cependant, au vue de l'étendue de l'aire de reproduction arctique de cet oiseau (1500 km du nord au sud et 1200 km de l'est à l'ouest), des individus utilisant des sites d'estivages différents pourraient avoir des taux de survie différents du fait de conditions environnementales différentes (Arlettaz et al. 2010) et/ou des distances de migration différentes (Newton 2010). Une campagne de baguage de grandes oies des neiges a eu lieu de 2007 à 2009 à la station de recherche d'Eureka, sur l'île d'Ellesmere, environ 800 km au nord de l'île Bylot. Cette seconde colonie nous permet donc d'étudier la représentativité des paramètres estimés à partir de la population de Bylot à travers la comparaison de la survie adulte chez la grande oie des neiges entre ces 2 sites.

Le but de ce chapitre est donc d'estimer le taux de survie des individus passant l'été à la colonie d'Ellesmere et à la colonie de Bylot et de voir s'il existe une différence entre ces 2 sites.

## **Absence of spatial variation in adult survival in an Arctic-nesting goose**

Guillaume Souchay<sup>1,2</sup>, Gilles Gauthier<sup>1</sup>, Josée Lefebvre<sup>3</sup> & Roger Pradel<sup>2</sup>

<sup>1</sup> Département de Biologie & Centre d'Études Nordiques, 1045 avenue de la Médecine, Université Laval, Québec, QC, G1V 0A6, Canada

<sup>2</sup> Centre d'Ecologie Fonctionnelle et Evolutive, UMR 5175, Campus CNRS, 1919 route de Mende, F-34293 Montpellier, Cedex 05 France

<sup>3</sup> Canadian Wildlife Service, Environment Canada, 801-1550, avenue d'Estimauville, Québec, QC, G1J 0C3, CANADA

## **Abstract**

Adaptive management of harvested waterfowl requires accurate estimations of demographic parameters. These must also be representative of the targeted population. In the greater snow goose, all demographic parameters have been estimated so far from a single nesting colony on Bylot Island, where 15% of the adult population breeds. We used data from a second banding program of this species conducted on Ellesmere Island, 800 km north of Bylot Island, to compare adult survival between these 2 populations over the period 2007-2011. This allowed us to examine the representativeness of parameters estimated from the Bylot population. Despite the differences in migration distance and in environmental conditions between the 2 breeding sites, we found no difference in survival rate between these 2 colonies. This apparent absence of a cost of migration on survival may be explained by the canalization hypothesis: variance in adult survival of the greater snow goose, a long-lived species, caused by environmental factors may have been reduced due to selection pressure on this trait, which is closely linked to fitness. The absence of spatial variation in adult survival suggests that the extrapolation of survival parameters estimated from the Bylot Island colony to the entire population may be valid.

## Résumé

La gestion adaptative des gibiers requiert une estimation précise des paramètres démographiques. Ceux-ci doivent aussi être représentatifs de la population ciblée. Chez la grande oie des neiges, tous les paramètres démographiques estimés jusqu'à maintenant proviennent de la seule population de l'île Bylot, où niche environ 15% de la population reproductrice. Nous avons utilisé des données d'un second programme de baguage de cette espèce, sur l'île Ellesmere, à 800 km au nord de l'île Bylot, pour comparer les taux de survie adulte entre ces 2 populations au cours de la période 2007-2011. Cela nous a permis d'examiner la représentativité des paramètres estimés à partir de la population de l'île Bylot. Malgré les différences dans les distances de migration et les conditions environnementales entre les 2 colonies, nous n'avons trouvé aucune différence de survie adulte entre les 2 sites. Cette absence apparente de coût de la migration sur la survie peut être expliquée par l'hypothèse de canalisation environnementale : la variabilité du taux de survie adulte engendrée par des facteurs environnementaux chez la grande oie des neiges, une espèce longévive, pourrait avoir été réduite par des pressions de sélection sur ce trait étroitement lié à la fitness. L'absence de variation spatiale du taux de survie adulte suggère que l'extrapolation des paramètres de survie estimés à partir de la population de Bylot à l'ensemble de la population est valide.



## **Introduction**

In North-America, the determination of hunting regulation in waterfowl is usually based on adaptive harvest management (Johnson et al. 2002, Williams et al. 2002). This strategy requires detailed information on the dynamic and demography of the targeted population. In most long-lived species, population growth is largely driven by variations in adult survival (Clobert & Lebreton 1991, Saether & Bakke 2000). Thus, identifying sources of variation in adult survival is critical to adequately forecast population growth rate, and hence to devise accurate management plan.

The greater snow goose is a population subjected to sport's hunting in eastern North America. This migrant species breeds in the high Arctic, winters in North-eastern United States and stops every spring and fall in Quebec, along the Saint-Laurent River (Fig.1). The population has dramatically increased during the last 60 years, from ca. 50,000 individuals in 1965, to ca. 1,000,000 individuals at the end of the 20<sup>th</sup> century (Batt 1998). Since then, a hunting management plan has been implemented to stop the increase and stabilize the population size (Reed & Calvert 2007). This plan is based on a population model in which demographic parameters were obtained from a long-term banding program conducted at a single site, Bylot Island (Nunavut, Canada), the most important breeding colony in the Arctic (15% of the breeding population, Gauthier et al. 2005). However, the breeding distribution of the greater snow goose extends from central Baffin Island to the south to Ellesmere Island to the north (ca. 1,500 km) and from the Greenland western coast in the east to Bathurst Island in the west (ca. 1,200 km). Demographic parameters estimated from a single colony may not be representative of the entire population due to spatial variations in environmental conditions across this large breeding range (Sanz-Aguilar et al. 2009, Alisauskas et al. 2011, Hernandez-Matias et al. 2013). Therefore, there is a risk that the population model used to manage greater snow geese may not be representative of the whole population.

An obvious difference between individuals breeding at the southern and northern limit of the breeding range is the length of the migration. Migrations are energetically costly and birds need to accumulate fat reserves to fuel their migratory flight (Newton 2010). A longer flight will obviously require more body stores and, depending of the ability of individuals to store enough fuel, "good" individual may enjoy increased survival and/or breeding performance, whereas mortality may increase for individuals in lower condition (Morrison et al. 2007). In greater snow

geese, over 50% of the fat reserves are depleted during the spring migration to Bylot Island (3,000 km, Gauthier et al. 1992). Like other arctic-nesting geese, this species is partly capital breeders (Gauthier et al. 2003, Legagneux et al. 2012), i.e. females rely on body stores to reproduce successfully (Klaassen et al. 2006, Drent et al. 2007). If more energy needs to be allocated to migration for individuals nesting at the northern end of the breeding range, then less resource may be available for reproduction or maintenance upon arrival on the breeding ground. A longer migration may also increase the probability of encountering adverse weather conditions (storms, cross-winds), especially across the Arctic regions, which could delay arrival on the breeding ground and negatively affect reproduction (Bety et al. 2003) or in the worst case increase mortality.

In addition to the long-term banding program occurring on Bylot Island, greater snow geese were also banded during a 3-year period in central Ellesmere Island, 800 km north of Bylot Island. This provided us with an unique opportunity to compare demographic parameters between these two distant breeding colonies and to investigate the representativeness of the parameters obtained from the sole Bylot Island colony. Our objective was thus to estimate and compare the adult survival of greater snow geese banded on Ellesmere and Bylot Islands. Based on the cost-of-migration hypothesis, we expected the survival of birds breeding on Ellesmere to be lower than that of Bylot Island due to the additional 800 km flown across the Arctic landscape during both the spring and fall migrations.

## **Methods**

### *Banding data*

Goose captures occurred during a ten-day period in August, when adults were molting and before young could fly. The same methods were used at both sites from 2007 to 2009 (see Menu et al. 2005 for details). Birds were aged (young of the year or adult  $\geq 2$  year-old; adults only starts breeding at 2-year of age in this species, Juillet et al. 2012) and sexed based on cloacal eversion (Taber 1971). Each bird received a U.S. Fish & Wildlife Service metal band and 2/3 of adult females received a plastic neck band with a four-digit unique code. In this study, we were only concerned with adults because too few young were banded on Ellesmere Island for a meaningful analysis. We thus distinguished groups based on the sex, type of mark received and colony of marking. We thus had 6 groups: male legbanded-only on

Bylot, female legbanded-only on Bylot, female neckbanded on Bylot, male legbanded-only on Ellesmere, female legbanded-only on Ellesmere and female neckbanded on Ellesmere (Table 1).

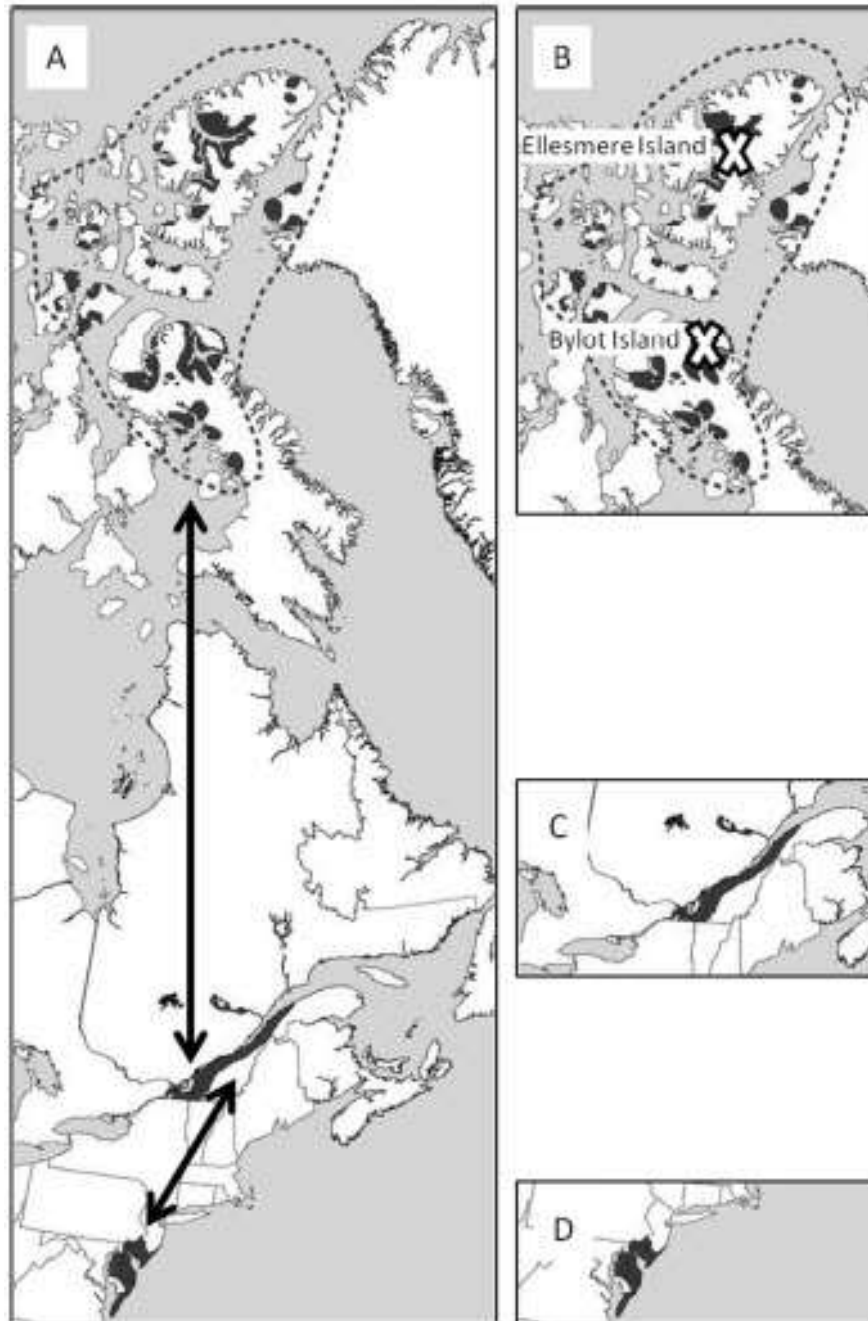

**Figure 1: Distribution maps of the greater snow goose. A: map showing migration between the breeding areas (delimited by dotted line) and wintering areas in South; B: Breeding area (crosses represent Bylot and Ellesmere Islands); C: Staging areas among the Saint-Lawrence River in Quebec; D: Wintering areas in the United States (Delaware, Maryland and New Jersey).**

### *Reencounter data*

Recaptures occurred every subsequent year on Bylot using the same methods up to summer 2011 and on Ellesmere Island up to summer 2009 (Fig. 2). No recaptured individuals received a neckband. Geese are hunted in Southern Québec in autumn (October-November) and in spring (April-May), and in the United States during winter (November to February). Hunter band recoveries returned to the Bird Banding Laboratory (BBL) up to summer 2011 were added to the dataset on a seasonal basis, i.e. each individual whose band was returned during an interval, was recorded as recovered at the next occasion in the dataset. All recorded recoveries used in our dataset were provided by hunters. Resighting of neckbanded females occurring during the summer at the Bylot colony were pooled with recaptures. No resighting occurred at the Ellesmere colony. Outside the breeding season, resightings were recorded every season by members of our team or volunteers: during the fall and the spring along the staging area of the Saint-Lawrence River, Quebec from fall 2007 to spring 2011 and from wintering area in the North-eastern United States from winter 2007-2008 to winter 2010-2011. Our dataset thus included the capture history of 7,352 adult geese, of which 621 were recaptured at least once, 931 were recovered and 1758 were resighted at least once (from 1 to 7 resightings per individual) (Table 1). We did not detect any movement of adult individuals between colonies in our dataset.

### *Time intervals*

We could estimate survival on a seasonal basis because at least one kind of reencounters data was available in all seasons (Fig.2). To calculate the length of time interval between each occasion, we used the median date of the period during which information was collected. The time intervals between occasions were 2.5 months from summer to fall, 3 months from fall to winter, 3 months from winter to spring and 3.5 months from spring to summer. Unequal time intervals were taken into account in the analysis to obtain monthly survival estimates.

**Table 1: Number of individuals banded on Bylot and Ellesmere Islands every summer from 2007 to 2009, recaptured at least once during the summer at Bylot and Ellesmere Islands, recovered and resighted at least once from Fall to Summer. No movement of marked adults between colonies was detected.**

| Colony    | Sex    | Band                  | Year         | Banded      | Recaptured | Recovered  | Resighted   |
|-----------|--------|-----------------------|--------------|-------------|------------|------------|-------------|
| Bylot     | Male   | Legband only          | 2007         | 989         | 57         | 116        | -           |
|           |        |                       | 2008         | 749         | 38         | 57         | -           |
|           |        |                       | 2009         | 1252        | 42         | 82         | -           |
|           |        |                       | <i>Total</i> | <i>2990</i> | <i>137</i> | <i>255</i> |             |
|           | Female | Legband only          | 2007         | 261         | 36         | 33         | -           |
|           |        |                       | 2008         | 273         | 16         | 32         | -           |
|           |        |                       | 2009         | 444         | 30         | 19         | -           |
|           |        |                       | <i>Total</i> | <i>978</i>  | <i>82</i>  | <i>84</i>  |             |
|           | Female | Legband+Neckband      | 2007         | 607         | 176        | 153        | 488         |
|           |        |                       | 2008         | 446         | 87         | 95         | 346         |
|           |        |                       | 2009         | 703         | 18         | 118        | 538         |
|           |        |                       | <i>Total</i> | <i>1756</i> | <i>281</i> | <i>366</i> | <i>1372</i> |
| Ellesmere | Male   | Legband only          | 2007         | 439         | 26         | 54         | -           |
|           |        |                       | 2008         | 102         | 7          | 16         | -           |
|           |        |                       | 2009         | 203         | -          | 19         | -           |
|           |        |                       | <i>Total</i> | <i>744</i>  | <i>33</i>  | <i>89</i>  |             |
|           | Female | Legband only          | 2007         | 263         | 40         | 28         | -           |
|           |        |                       | 2008         | 28          | 1          | 2          | -           |
|           |        |                       | 2009         | 108         | -          | 4          | -           |
|           |        |                       | <i>Total</i> | <i>399</i>  | <i>41</i>  | <i>34</i>  | <i>-</i>    |
|           | Female | Legband +<br>Neckband | 2007         | 327         | 42         | 64         | 270         |
|           |        |                       | 2008         | 64          | 5          | 20         | 45          |
|           |        |                       | 2009         | 94          | -          | 19         | 71          |
|           |        |                       | <i>Total</i> | <i>485</i>  | <i>47</i>  | <i>103</i> | <i>386</i>  |

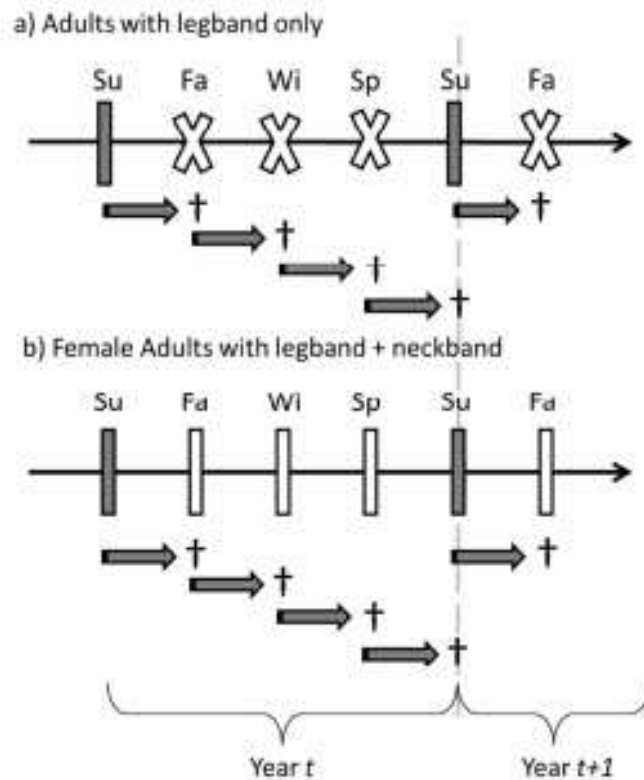

**Figure 2: Definition of occasions and events for the greater snow goose population over time depending on presence/absence of neckband. Gray bars represent recapture occasions in the Arctic every summer, open bars represent observation occasions outside the breeding season (available only for adult females with neckbands) and open cross represents the absence of observations for legbanded-only adults outside the breeding season. Gray arrows represent hunting recoveries: each recovery occurring during an interval was coded in the dataset at the end of the interval. Notation: Su = summer occasion, Fa = fall, Wi = winter, Sp = spring, † = recoveries. Adapted from Juillet et al. (2011).**

### *Multi-event model definition*

The aim of this study was to compare adult survival rate between breeding colonies. Using all available information (dead and live encounters), we were able to distinguish pre and post-breeding survival. Hence, we could estimate pre-breeding survival depending on where individuals were going and post-breeding survival depending on where the individual were coming from. As we included individuals with legband only and with both leg- and neckband, we also had to take into account neckband loss. Our model is thus a multi-site modification of the Juillet et al. (2011) model. We present the model for each interval between seasons (Fig.3-5).

In the post-breeding interval (summer to fall), the initial state of an individual marked during the summer depended on the colony (Bylot vs. Ellesmere) and the presence/absence of a neckband: “Alive at Bylot with a neckband”, “Alive at Bylot without neckband”, “Alive at Ellesmere with a neckband”, “Alive at Ellesmere without neckband”. When they departed from their breeding grounds, individuals migrated

toward the staging area in southern Quebec (Fig. 3). At the staging area, only 2 events were possible: observations of neckbanded individuals and recoveries of dead individuals. We divided the interval from summer to fall into several steps: first, we modeled the neckband loss. In a second step, we modeled survival depending on the colony of departure and the presence/absence of neckband. Finally, dead individuals could be recovered depending on presence/absence of a neckband (Juillet et al. 2011). We used the same event coding for recoveries with and without neckband because of the uncertainty of presence of the neckband on reports to the BBL: hunters usually declare the death of a neckbanded individual without reference to the presence of a neckband (Juillet et al. 2011).

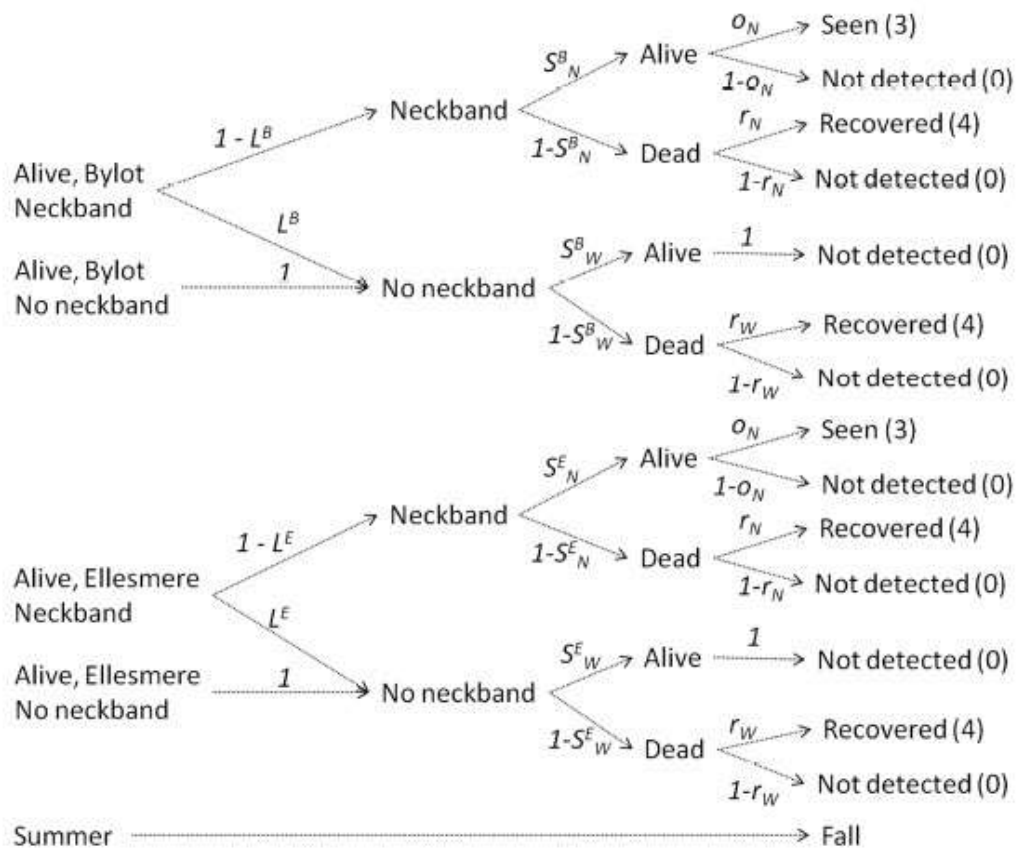

**Figure 3: Diagram of fate of all individuals leaving the breeding colony during the post-breeding season. Number inside bracket correspond to the code used in individual encounters histories. We separated the transition between summer and fall in several steps. The first step is the loss of the neckband with a probability  $L$ . The second step corresponds to the survival  $S$  of individuals, depending on both colony of departure and presence of a neckband. Two events were possible at the fall occasion: dead individuals can be recovered with a probability  $r$  depending on presence of neckband, alive individuals with a neckband can be observed with a probability  $o$  whereas individuals marked with a legband only cannot be detected at the fall occasion. Notation: E = Ellesmere; B = Bylot; N = presence of a neckband; W = absence of a neckband.**

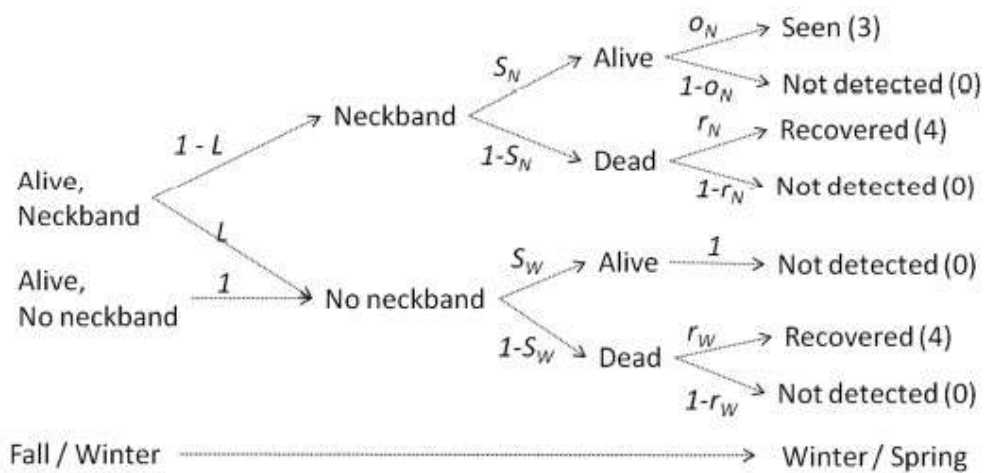

**Figure 4: Diagram of fate of individuals from fall to winter or from winter to spring occasions. Number inside bracket correspond to the code used in individual encounters histories. For these seasons, we also separated transitions into several steps: a step accounting for neckband loss with a probability  $L$  and a survival step with a probability  $S$  depending on the presence of a neckband. Two events were possible: recovery of dead individuals with a probability  $r$  depending on the presence of a neckband or the resighting of neckbanded individuals with a probability  $o$ . Alive legbanded individuals cannot be detected. Notation: N = presence of a neckband; W = absence of a neckband.**

The two subsequent intervals (fall to winter and winter to spring) were parameterized in the same way: a first step accounting for neckband loss, a second step accounting for survival depending on presence of neckband and an event step (Fig.4). Again, the only possible events at both winter and spring occasions were either recovery of dead individuals or observations of neckbanded individuals. Detection of legbanded-only individuals was constrained to 0. Individuals alive at the end of these intervals were either “Alive with a neckband” or “Alive without a neckband”.

The last season in our modeling corresponded to the pre-breeding season, between the spring and summer occasions (Fig. 5). Individuals alive at the spring occasion could go either to the Bylot or the Ellesmere colony. The season was again decomposed into several steps: the first one accounted for the loss of the neckband, the second one for the choice of the breeding colony and finally the survival step depended on where individuals are going. At the summer occasion, all alive individuals were available to capture. At the end of this interval, surviving individuals were either “Alive at Bylot with a neckband”, “Alive at Bylot without neckband”, “Alive at Ellesmere with a neckband”, “Alive at Ellesmere without neckband”, the 4 initial states. Due to the absence of movement of individuals between colonies, we constrained individuals to go back to their marking colony.



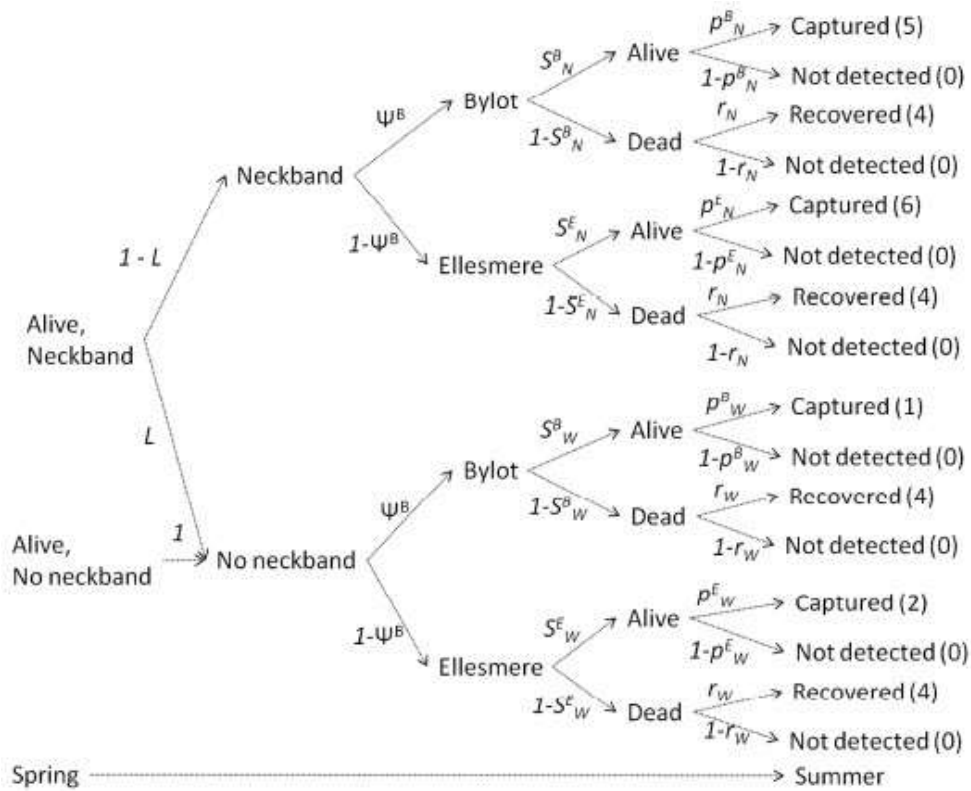

Figure 5: Diagram of fate for individuals going back to the breeding colony, from spring to summer. Number inside bracket correspond to the code used in individual encounters histories. We decomposed the transition into several steps. The first step describes the loss of neckband with a probability  $L$ , the second step describes the choice of the breeding ground with a movement probability  $\Psi$  and finally the survival step with a probability  $S$  depending on the colony of arrival. The possible events at the summer occasion were: recovery of dead individual with a probability  $r$  depending on the presence of neckband, capture of alive individuals with a probability  $p$  depending on both colony of capture and presence of neckband.

Due to the design of the study, we had 4 states “Alive at Bylot with neckband” (ABC+), “Alive at Bylot without neckband” (ABC-), “Alive at Ellesmere with neckband” (AEC+) and “Alive at Ellesmere without neckband” (AEC-) at the summer occasion. For the three occasions during the non-breeding seasons (Fall, Winter and Spring), the states were reduced to “Alive with neckband” (AC+) and “Alive without neckband” (AC-) for alive individuals. Because we integrated recoveries in our dataset, we used the state “Newly Dead” (ND) for individuals that die during the intervening interval because they are then available for recovery and the state “Dead” (D) for individuals dead in an earlier interval because they are no longer susceptible to recovery. All matrices were implemented in the software E-SURGE (Choquet et al. 2009b) and are given in Appendix.

### *Goodness-of-fit and model selection*

The goodness-of-fit of our multi-event model was assessed using the tests available for multi-state models with live and dead encounters. We assessed the fit by colony of marking and separately for adults with or without neckband. We applied the goodness-of-fit for multi-state models with full-time variation on event and transition parameters using program U-CARE (v.2.3.2, Choquet et al. 2009a).

Model selection and parameter estimation were performed using program E-SURGE (v.1.8.6, Choquet et al. 2009b). To build our initial model, we first included all effects we wished to test. Our initial model was thus:

$$L_{t,c}, S_{Post[c.y.g.n],FW[y.n],WS[y.n],Pre[c.y.g.n]}, P_{Ell[y.g],Byl[y.g.n]}, O_t, r_{t,n},$$

where  $L$ ,  $S$ ,  $p$ ,  $o$  and  $r$  are the probabilities of neckband loss, survival, recapture, resighting and recovery, respectively.  $Post$ ,  $FW$ ,  $WS$  and  $Pre$  correspond to the intervals Post-breeding (summer to fall), Fall-winter, winter-spring and Pre-breeding (spring to summer), respectively. Finally,  $t$ ,  $c$ ,  $y$ ,  $g$  and  $n$  correspond to a time, colony ( $Ell$  = Ellesmere,  $Byl$  = Bylot), year (i.e. a time effect with difference between years independent of seasons), sex and neckband effect, respectively.

We followed a step-down approach for the model selection, focusing on event probabilities first (resighting, recovery and recapture parameters), and then on transition probabilities (neckband loss and survival). Our model selection relied on the Akaike's Information Criterion corrected for the overdispersion (QAIC, Burnham & Anderson 2002) and we examined the effects of time, colony, year, sex and neckband by contrasting QAIC scores. All parameters values are given  $\pm$  SE. Transition estimations were monthly estimations due to unequal time interval, thus we calculated seasonal estimations values with standard error ( $\pm$  SE) using the delta method (Seber 1982) when appropriate.

## **Result**

### *Goodness-of-fit test*

The overall test for each group was significant only for adults banded on Bylot Island ( $\chi^2 = 49.3$ ,  $df = 29$ ,  $p < 0.01$  and  $\chi^2 = 200.3$ ,  $df = 125$ ,  $p < 0.001$  for adult banded with legband only and with legband + neckband, respectively) but non-significant for adults banded at Ellesmere (Table 2). However, all the variance inflation factors were

< 2.0, suggesting heterogeneity in our dataset but not necessarily a need for structural change in the model (Burnham & Anderson 2002). We thus calculated a global variance inflation factor (1.47) that we included in our analysis to scale down all model deviances.

### *Encounter probabilities*

Our best model retained a seasonal effect (i.e. a time effect with difference between seasons but independent of years) on resighting probability, an additive combination of season, year and neckband on recovery probability and a colony-dependant recapture probability with a constant recapture rate at Ellesmere and a year- and neckband-dependant recapture rate at Bylot (Table 3). The resighting probability was highest in fall ( $0.60 \pm 0.01$ ) than in spring and winter ( $0.27 \pm 0.01$  and  $0.11 \pm 0.01$ , respectively - Fig. 6).

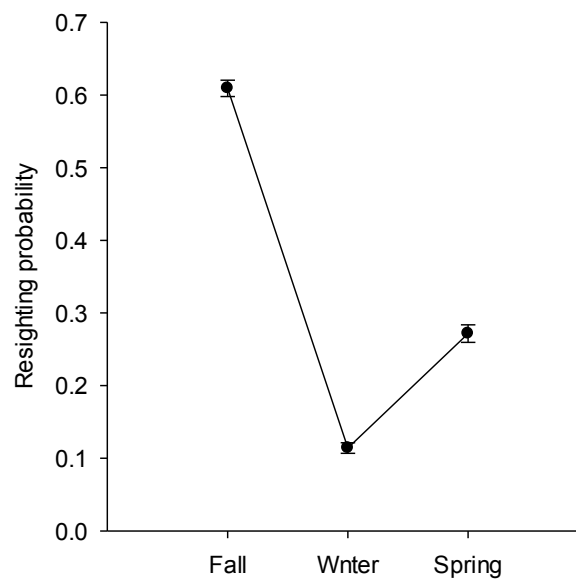

**Figure 6: Estimates (mean ± SE) of seasonal resighting probabilities of neckbanded female greater snow geese banded from 2007 to 2009 and resighted annually up to spring 2011.**

The recovery probabilities were lower for individuals with legband only compared to recovery probabilities of neckbanded individuals, suggesting a neckband effect on this encounter parameter. We also found an additive relationship between year and season effect suggesting that the seasonal differences in recovery rate among seasons were constant across years (Fig. 7). The recovery probability estimates were highest during the fall-winter and spring-summer intervals, close to zero during the summer-fall interval and low during the winter-spring interval.

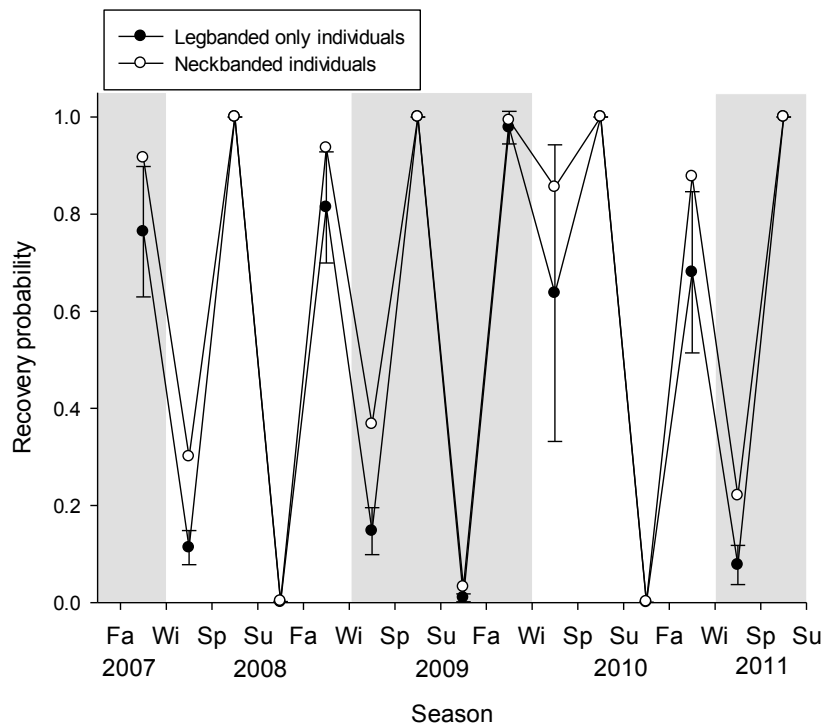

**Figure 7: Estimates (mean  $\pm$  SE) of seasonal recovery probabilities of adult greater snow geese, banded from 2007 to 2009 and resighted every season up to summer 2011.**

The recapture probability was low and constant over time at Ellesmere ( $0.08 \pm 0.01$ ) and did not differ between birds with and without a neckband. This was not surprising considering the absence of resightings of neckbanded birds at this site. At Bylot, the recapture probability varied over the years and was higher for individuals marked with a neckband because resightings, which occurred at this site, were pooled with physical recaptures at the summer occasions. The recapture probability of legbanded-only individuals at Bylot was low (range from 0.02 to 0.05; Fig. 8) but similar to previous estimates for this population (0.02-0.07 over a 10-year study, Reed et al. 2005, 0.02-0.09 over a 15-year study, Juillet et al. 2012).

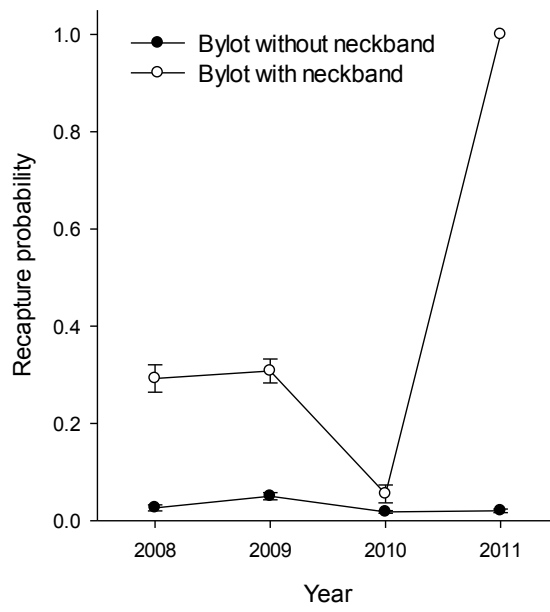

**Figure 8: Estimates (mean  $\pm$  SE) of recapture probabilities of adult greater snow geese, banded from 2007 to 2009 and recaptured up to summer 2011 on Bylot Island.**

**Table 2: Goodness-of-fit test for adult Greater snow geese banding from 2007 to 2009 and seasonally reencountered (dead or alive) from summer 2009 to summer 2011.**

|                  | Bylot          |      |                  |                | Ellesmere    |         |                  |      |         |       |      |      |
|------------------|----------------|------|------------------|----------------|--------------|---------|------------------|------|---------|-------|------|------|
|                  | Legband only   |      | Legband+neckband |                | Legband only |         | Legband+neckband |      |         |       |      |      |
|                  | X <sup>2</sup> | df   | p-value          | X <sup>2</sup> | df           | p-value | X <sup>2</sup>   | df   | p-value |       |      |      |
| Test 3G          | 22.17          | 7    | <0.001           | 23.78          | 14           | <0.001  | 13.80            | 5    | 0.02    | 6.72  | 6    | 0.35 |
| Test M           | 27.14          | 22   | 0.20             | 176.54         | 111          | <0.001  | 14.76            | 15   | 0.47    | 87.72 | 74   | 0.13 |
| Overall test     | 49.32          | 29   | 0.01             | 200.32         | 125          | <0.001  | 28.57            | 20   | 0.10    | 94.44 | 80   | 0.13 |
| $\hat{c}$        |                | 1.70 |                  |                | 1.60         |         |                  | 1.43 |         |       | 1.18 |      |
| Global $\hat{c}$ | 1.47           |      |                  |                |              |         |                  |      |         |       |      |      |

Table 3: Model selection for adult greater snow geese banded with legband only or legband+neckband, on Bylot or Ellesmere Islands from 2007 to 2009 and seasonally reencountered up to summer 2014. We provide the parameterization of transition and event probabilities, the number of estimated parameters (k), the deviance and the difference in QAIC ( $\Delta i$ ) between the current and the best model. Initial and best model are in bold.

| #         | Neckband loss |                | Survival   |            | Events         |                            | k        | Deviance     | $\Delta i$   |
|-----------|---------------|----------------|------------|------------|----------------|----------------------------|----------|--------------|--------------|
|           | Post          | FW WS          | Pre        | Recapture  | Resighting     | Recovery                   |          |              |              |
| M14       | <b>s+y</b>    | <b>y</b>       | <b>n</b>   | <b>n.y</b> | <b>n</b>       | <b>E  [-],Byl[y:n]</b>     | <b>s</b> | <b>s+y+n</b> | <b>0.0</b>   |
| M13       | s+y           | y.n            | n          | n.y        | n              | E  [-],Byl[y:n]            | s        | s+y+n        | 6.1          |
| M12       | s+y           | y.n            | n          | n.y        | y.n            | E  [-],Byl[y:n]            | s        | s+y+n        | 10.8         |
| M11       | s+y           | y.n            | n          | n.y        | c.y.g.n        | E  [-],Byl[y:n]            | s        | s+y+n        | 14.0         |
| M10       | s+y           | y.n            | n.y        | n.y        | c.y.g.n        | E  [-],Byl[y:n]            | s        | s+y+n        | 15.9         |
| M9        | s+y           | c.y.n          | n.y        | n.y        | c.y.g.n        | E  [-],Byl[y:n]            | s        | s+y+n        | 28.6         |
| M7        | t             | c.y.g.n        | n.y        | n.y        | c.y.g.n        | E  [-],Byl[y:n]            | s        | s+y+n        | 35.7         |
| M8        | s+y           | c.y.g.n        | n.y        | n.y        | c.y.g.n        | E  [-],Byl[y:n]            | s        | s+y+n        | 36.3         |
| M6        | t.c           | c.y.g.n        | n.y        | n.y        | c.y.g.n        | E  [-],Byl[y:n]            | s        | s+y+n        | 38.4         |
| M5        | t.c           | c.y.g.n        | n.y        | n.y        | c.y.g.n        | E  [y],Byl[y:n]            | s        | s+y+n        | 38.7         |
| M4        | t.c           | c.y.g.n        | n.y        | n.y        | c.y.g.n        | E  [y.g],Byl[g.y.n]        | s        | s+y+n        | 45.6         |
| M3        | t.c           | c.y.g.n        | n.y        | n.y        | c.y.g.n        | E  [y.g],Byl[g.y.n]        | s        | t            | 46.7         |
| M2        | t.c           | c.y.g.n        | n.y        | n.y        | c.y.g.n        | E  [y.g],Byl[g.y.n]        | s        | t.n          | 52.0         |
| <b>M1</b> | <b>t.c</b>    | <b>c.y.g.n</b> | <b>n.y</b> | <b>n.y</b> | <b>c.y.g.n</b> | <b>E  [y.g],Byl[g.y.n]</b> | <b>t</b> | <b>t.n</b>   | <b>112.3</b> |

Model notation: *n*: neckband status (individuals wearing a neckband or not); *c*: breeding colony effect (Bylot vs. Ellesmere), *g*: sex effect (male vs. female); *t*: time effect; *y*: year effect (i.e. time effect with difference between years independent of seasons); *s*: seasonal effect (i.e. time effect with difference between seasons but independent of years); *Byl* = Bylot Island; *E||* = Ellesmere Island; *Post* = post-breeding interval (summer to fall); *FW* = Fall-winter interval; *WS* = Winter-spring interval; *Pre* = pre-breeding interval (spring to summer).

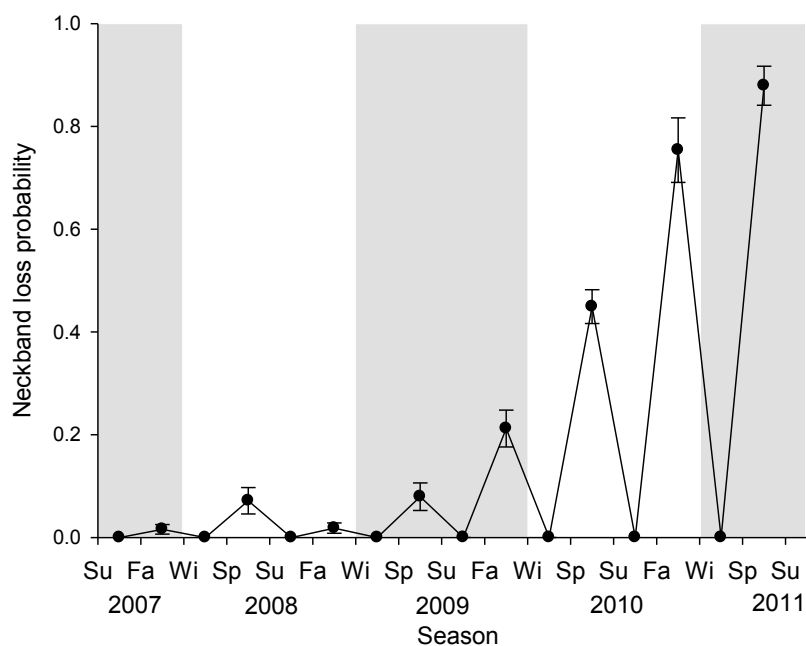

**Figure 9: Estimates (mean ± SE) of seasonal neckband loss probabilities of adult female greater snow geese marked from 2007 to 2009 and reencountered up to summer 2011.**

#### *Neckband loss and survival*

Neckband loss probabilities varied across season with an additive effect of year suggesting the same seasonal pattern of neckband loss every year (Table 3). The probability of loss was close to 0 during the post-breeding (summer to fall) and winter-spring intervals (Fig. 9). The loss was greatest in the pre-breeding season (spring to summer) and intermediate during the fall-winter interval. Neck-band loss increased over time and especially in the last two years, a period when there was no newly marked individuals in the sample.

The survival probabilities were year-dependent for the Winter-spring and post-breeding intervals and neckband-dependent for the Fall-winter and Winter-spring intervals (Table 3). No effect of the breeding colony was found either during the post-breeding or the pre-breeding intervals, indicating similar survival rate between the two colonies. Seasonal survival of neckbanded individuals was slightly lower than survival of individuals without a neckband from fall to spring in all years except the last one when the difference was surprisingly large (Fig.10). The seasonal survival was high (range: 0.85-0.98 and 0.86-0.99 for individuals with and without neckband, respectively), except during the winter-spring interval in 2011 ( $0.32 \pm 0.12$  for birds with neckbands). Seasonal survival tended to be the lowest at the winter-spring



interval. When excluding the last year, annual survival estimates for individual with and without a neckband ranged from 0.73 to 0.82 and from 0.75 to 0.92, respectively.

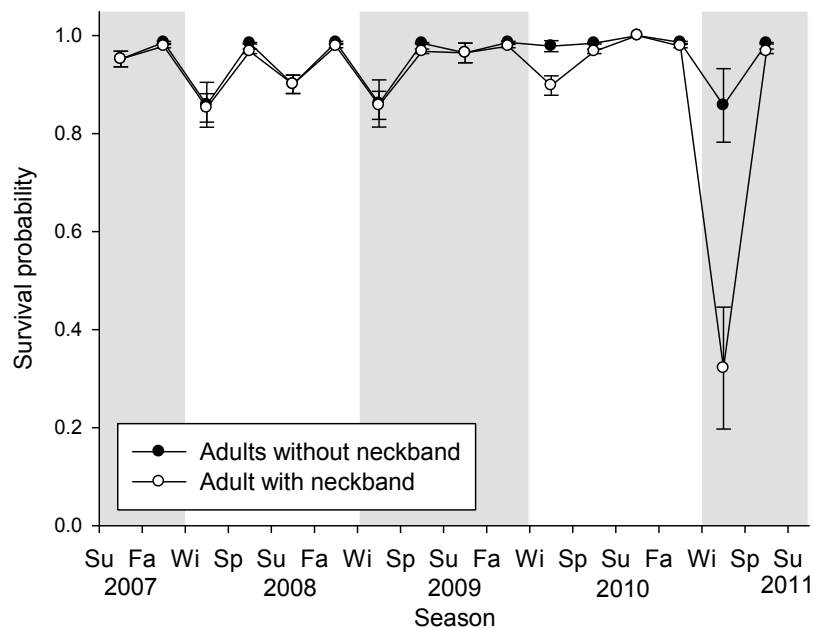

**Figure 10: Estimates (mean  $\pm$  SE) of seasonal survival probabilities of adult greater snow geese banded from 2007 to 2009 and reencountered up to summer 2011.**

## Discussion

We used a unique opportunity to test whether demographic parameters obtained from individuals marked at a single greater snow goose colony could be representative of the whole population. To do so, we relied on 3 years of banding data from 2 distant colonies in the Canadian Arctic (Bylot and Ellesmere Islands) and reencounters collected throughout the annual cycle to obtain seasonal estimates of true survival. The colony of Ellesmere Island is about 800 km further north than Bylot Island, which represents a 20% increase in total migration length considering that the annual migration of birds breeding on Bylot Island is about 8,000 km (Gauthier et al. 2005). Based on the cost-of-migration hypothesis, we expected that the survival of birds breeding on Ellesmere Island should be reduced, but we found no differences in survival between birds breeding at the two colonies over a 5-year period.

### *Colony effect on survival*

Our results suggest that the lengthier migration of birds breeding on Ellesmere Island does not impose a survival cost to these birds compared to those breeding further south. Migration is a highly energetic process (Newton 2010) and in greater snow

geese, up to 50 % of body stores are depleted during the spring migration to Bylot Island (Gauthier et al. 1992). It is likely that birds migrating to Ellesmere Island will deplete a larger proportion of their body stores to complete their migration although data on body condition of birds are not available to verify that. Because greater snow geese are partly capital breeders like other arctic-nesting geese (Gauthier et al. 2003, Klaassen et al. 2006, Drent et al. 2007), bird breeding on Ellesmere Island may arrive with lower body reserves and thus may need to forage more upon arrival to compensate. This could potentially negatively affect breeding, for instance by delaying nesting activity (Bety et al. 2003). At the end of the summer, individuals need to prepare for migration by foraging and accumulating reserves to initiate the return migration. Even if birds breeding in Ellesmere Island may have less time to regain body condition following breeding than those breeding further south, either due to a shorter breeding season or a later nesting phenology, this was apparently not sufficient to negatively impact their survival during the post-breeding migration. In the midcontinent lesser snow geese (*Chen caerulescens caerulescens*), a north-south gradient has been found in survival with higher survival rate for the northern (nesting north of 60°N latitude, mean survival = 0.96) population than the southern one (nesting south of 60°N latitude, mean survival = 0.828, Alisauskas et al. 2011). However, the spatial variation in survival may be explained by difference in harvesting rates: annual harvest rate of southern geese was about 30% higher than of northern geese (Alisauskas et al. 2011).

The environmental canalization hypothesis (Gaillard & Yoccoz 2003) may explain the absence of difference in adult survival between the two colonies. Environmental canalization is a process that will reduce the variance of traits in presence of variable environmental conditions (Wagner et al. 1997, Gibson & Wagner 2000). The canalization should act on the most important parameters for population growth. In the greater snow goose, it is adult survival that drives the population growth rate (Gauthier & Brault 1998). Under environmental canalization, individuals may have evolved strategies that minimize variations in adult survival even in presence of environmental stochasticity (e.g. Nevoux et al. 2010). The same process occurring in presence of temporal environmental variations at a single site may also act in presence of spatial environmental variations, hence explaining the absence of differences in adult survival of greater snow geese breeding in the northern and southern parts of the summer breeding range.

Our study focused on only one demographic parameter, adult survival. Even though this parameter has the greatest impact on population growth rate, we cannot exclude that other demographic parameters not investigated in this study could differ between the two distant colonies. For example, breeding propensity and juvenile survival may differ between the two sites. In greater snow geese, young individuals fledge with low fat reserves and at around 70% of adult body mass (Menu et al. 2005). A longer migration may increase the energetic demand and could increase young mortality. Breeding propensity is also condition-dependent in capital breeders like geese. Migration to Ellesmere Island should increase the depletion of body stores accumulated in spring. At arrival, some individuals could have a low body condition and may not be able to breed. Thus, we can expect breeding propensity and juvenile survival to be lower for Ellesmere individuals than for those of Bylot Island. Furthermore, based on the environmental canalization theory, parameters with lower elasticity may experience more variation and we can thus expect demographic parameters other than adult survival to show more variation between the two colonies.

#### *Neckband effect on survival*

We found evidence that survival of neckbanded greater snow geese was slightly lower than that of legbanded-only individuals. Previous studies in this population failed to find an effect of neckband on survival (Menu et al. 2000, Reed et al. 2005, Juillet et al. 2011) although negative effects of neckbands on survival have been found in other goose species (Schmutz & Morse 2000, Alisauskas & Lindberg 2002, Alisauskas et al. 2006, Caswell et al. 2012). Several hypotheses have been proposed to explain the reduced survival including icing on neckband (Greenwood & Bair 1974), compromised energy or nutrient balance (Schmutz & Morse 2000) and selective harvest by hunters (Craven 1979). Caswell et al. (2012) specifically studied the effect of neckband color on survival and showed that hunter selection for colored neckband did not contribute to reduce survival of neckbanded individuals. Recently, Legagneux et al. (*in press*) found a negative effect of neck bands on body condition of birds during spring staging, either due to an increase in energy expenditure (due to increased drag and flight cost or chronic stress) or a reduced foraging efficiency. This effect could explain the reduced breeding propensity of neckbanded greater snow geese reported in previous studies (Menu et al. 2005). It is possible that reduced

body condition of neckbanded birds could increase their mortality under some circumstances, such as in birds with the lengthiest migration.

To accurately estimate survival rate of neckbanded geese, we had to account for neckband loss. This parameter showed important temporal variation and was higher compared to previous findings in the greater snow goose, which estimated annual loss rate around 0.03-0.05 (Reed et al. 2005, Juillet et al. 2011). In these studies, the neckband retention was constrained to be constant over time. It is noteworthy that the higher loss rates in our study occurred in the two years after we had stopped marking birds. We cannot exclude the possibility that ageing of the neckbands, or some other unknown factors associated with the parameterization of our model could have contributed to these differences.

### *Reencounter probabilities*

The patterns observed in reencounter probabilities over time and between sites can be explained by variations in sampling design or hunter activity. For instance, seasonal differences in resighting probabilities reflect variations in observation effort, which was highest on the fall staging area in Quebec when geese are concentrated in wildlife refuges and easiest to observe compared to spring staging and the wintering period in the United States. The seasonal variations in recovery probabilities are probably due to differences in hunting pressure. In fall and spring, greater snow geese are staging in Quebec, while they are in North-eastern United States during winter. Higher recovery rates during spring to summer and fall to winter intervals may reflect either a higher hunting pressure in Quebec than in US, or a higher reporting rate in Quebec than in US (Chapter 1). In summer in the Arctic, hunting pressure is low with only a small number of Inuit people shooting geese, and these people generally have a low propensity in reporting banded birds. The higher recovery probability of neckbanded geese is probably due to a higher chance that these birds are reported by hunters compared to birds with only legbands, which may even sometimes be unnoticed by hunters (Calvert & Gauthier 2005). Finally, the large variation in recapture probability of neckbanded birds at Bylot reflects annual variation in resighting effort and especially breeding effort by the birds (Chapter 2).

### *Conclusion*

Our study allowed us to compare adult survival between two distant breeding colonies of greater snow geese in the Canadian Arctic. We obtained unbiased

survival estimations due to the mixture of dead and live reencounters in a multi-event framework accounting for neckband loss. The absence of differences in adult survival between birds marked at the colonies of Bylot Island and Ellesmere Island, 800 km further north, suggests that adult survival estimated from the colony of Bylot Island is applicable to the entire population. Absence of spatial variation also suggests the environmental canalization of this key demographic parameter in the greater snow goose. Nonetheless, we cannot exclude the possibility that other demographic parameters less likely to be exposed to environmental canalization, such as fecundity of first-year survival, may show some spatial variations among breeding colonies.

#### *Acknowledgement*

Funding was provided by the Natural Sciences and Engineering Research Council of Canada, the Arctic Goose Joint Venture (Canadian Wildlife Service), the Centre d'Études Nordiques, the network of center of excellence ArcticNet, the International Polar Year program of the Canadian Government, the Department of Indian and Northern Affairs Canada and by the International Research Group Dynamics of Biodiversity and Life-History traits. Logistic support in the Arctic was generously provided by the Polar Continental Shelf Project (Natural Resources Canada) and assistance in the field by Parks Canada. Finally, we are grateful to the numerous field assistant that helped for goose banding and especially Gérald Picard, to hunters who reported the banded birds that they shot and to Marie-Christine Cadieux for managing the database and for assistance in the field.

## Appendix A: Implementation of matrices in E-SURGE

Matrix representations with departure state in row and arrival states in columns are commonly used. We used bold script to highlight what part of the state has been updated during each transition. The transition has been decomposed into 4 steps. Matrices used for each season are given in Appendix B.

The first step matrix describes the neckband loss  $L$  – used for every season:

|                   |                   |                   |              |              |          |
|-------------------|-------------------|-------------------|--------------|--------------|----------|
|                   | <i>ABC +/AC +</i> | <i>ABC –/AC –</i> | <i>AEC +</i> | <i>AEC –</i> | <i>D</i> |
| <i>ABC +/AC +</i> | $1 - L$           | $L$               | –            | –            | –        |
| <i>ABC –/AC –</i> | –                 | $1$               | –            | –            | –        |
| <i>AEC +</i>      | –                 | –                 | $1 - L$      | $L$          | –        |
| <i>AEC –</i>      | –                 | –                 | –            | $1$          | –        |
| <i>ND</i>         | –                 | –                 | –            | –            | $1$      |
| <i>D</i>          | –                 | –                 | –            | –            | $1$      |

Depending on the season, the initial state could be colony dependent or not. For the post-breeding interval, we use the state *ABC+/ABC-/AEC+/AEC-/ND* and *D*, but for the other intervals, the initial state are either Alive with neckband (*AC+*), Alive without neckband (*AC-*). Thus, for the post-breeding interval, we use all the rows and columns but for the other interval, the 3<sup>rd</sup> and 4<sup>th</sup> rows are not be used. An individual with a neckband (1<sup>st</sup> row) may lose its neckband and become an individual without neckband (2<sup>nd</sup> column) or keep it (1<sup>st</sup> column). No legbanded-only individual could receive a neckband, thus, we constrained legbanded-only individuals to stay in that state. At the end of this step, only the presence/absence of the neckband is determined in the individual status.

The second step describes the survival probability  $S$  based on the state of departure and is used for the post-breeding season, the fall-winter and the winter-spring interval:

|                   |                   |                   |           |          |
|-------------------|-------------------|-------------------|-----------|----------|
|                   | <i>ABC +/AC +</i> | <i>ABC –/AC –</i> | <i>ND</i> | <i>D</i> |
| <i>ABC +/AC +</i> | $S$               | –                 | $1 - S$   | –        |
| <i>ABC –/AC –</i> | –                 | $S$               | $1 - S$   | –        |
| <i>AEC +</i>      | $S$               | –                 | $1 - S$   | –        |
| <i>AEC –</i>      | –                 | $S$               | $1 - S$   | –        |
| <i>D</i>          | –                 | –                 | –         | $1$      |

For the post-breeding interval, an individual from Bylot without neckband (2<sup>nd</sup> row) may survive and become an individual Alive without neckband (2<sup>nd</sup> column) or die (3<sup>rd</sup> column), in both case its state is fully determined. Similarly, an individual from Ellesmere with a neckband (3<sup>rd</sup> row) may survive and become alive with a neckband

(1<sup>st</sup> column) or die (3<sup>rd</sup> column). At the end of the second step, the state Alive with/without neckband is fully determined for post-breeding, fall-winter and winter-spring intervals. For fall-winter and winter-spring intervals, only the first two rows are used, thus we fixed  $S = 0$  in row 3 and 4 for these intervals. Furthermore, for the pre-breeding interval, we did not use this matrix, we thus fixed all survival parameters to 1.

The third step describes the movement probability  $\Psi$  during the pre-breeding interval:

|                   | <i>ABC +/AC +</i> | <i>ABC -/AC -</i> | <i>AEC +</i> | <i>AEC -</i> | <i>ND</i> | <i>D</i> |
|-------------------|-------------------|-------------------|--------------|--------------|-----------|----------|
| <i>ABC +/AC +</i> | $\Psi$            | –                 | $1 - \Psi$   | –            | –         | –        |
| <i>ABC -/AC -</i> | –                 | $\Psi$            | –            | $1 - \Psi$   | –         | –        |
| <i>ND</i>         | –                 | –                 | –            | –            | 1         | –        |
| <i>D</i>          | –                 | –                 | –            | –            | –         | 1        |

The matrix of movement is used only during the pre-breeding interval. Before this step, only the presence/absence of the neckband is determined. An individual with a neckband (1<sup>st</sup> row) may go to Bylot (1<sup>st</sup> column) or to Ellesmere (3<sup>rd</sup> column). However, in our dataset, we found that no individual marked in one colony was recaptured in the other one, suggesting no flow between the two colonies. We thus fixed the movement toward the marking colony in each group (i.e. birds originally marked at Bylot or Ellesmere). At the end of that step, the status of individual is only partially determined. Outside the pre-breeding interval, the status of every individual is already fully determined at the end of the second step.

The fourth step describes the survival  $S$  during the pre-breeding interval only depending on the destination of individuals:

|                   | <i>ABC +/AC +</i> | <i>ABC -/AC -</i> | <i>AEC +</i> | <i>AEC -</i> | <i>ND</i> | <i>D</i> |
|-------------------|-------------------|-------------------|--------------|--------------|-----------|----------|
| <i>ABC +/AC +</i> | $S$               | –                 | –            | –            | $1 - S$   | –        |
| <i>ABC -/AC -</i> | –                 | $S$               | –            | –            | $1 - S$   | –        |
| <i>AEC +</i>      | –                 | –                 | $S$          | –            | $1 - S$   | –        |
| <i>AEC -</i>      | –                 | –                 | –            | $S$          | $1 - S$   | –        |
| <i>ND</i>         | –                 | –                 | –            | –            | –         | 1        |
| <i>D</i>          | –                 | –                 | –            | –            | –         | 1        |

During the pre-breeding interval, an individual may lose its neckband or not (step 1), then it decides where it is going to breed (step 3) and may then survive. An individual with a neckband that go to Bylot (1<sup>st</sup> row) may survive (1<sup>st</sup> column) or die (5<sup>th</sup> column). An individual without a neckband that go to Ellesmere may either survive (3<sup>rd</sup> column) or die (5<sup>th</sup> column). In both case, at the end of step 4, the status of an individual is fully determined. Outside the pre-breeding interval, this matrix is not

used and parameters are thus fixed to 1. We provided all matrix used for each season in Appendix 1.

The event matrix relates the observations coded in encounter histories to the biological states. With  $p$  the capture probability,  $o$  the resighting probability and  $r$  the recovery probability, the event matrix in which row and columns represent biological states and encounters respectively, is:

|                   | 0 | 1        | 2        | 3        | 4        | 5        | 6        |
|-------------------|---|----------|----------|----------|----------|----------|----------|
| <i>ABC +/AC +</i> | * | -        | -        | <i>o</i> | -        | <i>p</i> | -        |
| <i>ABC -/AC -</i> | * | <i>p</i> | -        | -        | -        | -        | -        |
| <i>AEC +</i>      | * | -        | -        | -        | -        | -        | <i>p</i> |
| <i>AEC -</i>      | * | -        | <i>p</i> | -        | -        | -        | -        |
| <i>ND</i>         | * | -        | -        | -        | <i>r</i> | -        | -        |
| <i>D</i>          | * | -        | -        | -        | -        | -        | -        |

Due to the design of the study, we had to constrain some parameters: (i) Ellesmere recapture parameters were fixed to 0 for summer 2010 and 2011 due to absence of recapture occasion those two years, (ii) the resighting parameters were fixed to 0 for individuals banded with legband only; (iii) resighting parameters were fixed to 0 for summer occasions due to pooling resighting and capture event for summer occasion.



## Appendix B: Transition matrices for each season

### Post-breeding season

Step 1 : Neckband loss

|              | <i>ABC +</i> | <i>ABC -</i> | <i>AEC +</i> | <i>AEC -</i> | <i>D</i> |
|--------------|--------------|--------------|--------------|--------------|----------|
| <i>ABC +</i> | $1 - L$      | $L$          | –            | –            | –        |
| <i>ABC -</i> | –            | 1            | –            | –            | –        |
| <i>AEC +</i> | –            | –            | $1 - L$      | $L$          | –        |
| <i>AEC -</i> | –            | –            | –            | 1            | –        |
| <i>ND</i>    | –            | –            | –            | –            | 1        |
| <i>D</i>     | –            | –            | –            | –            | 1        |

Step 2: Survival

|              | <i>AC +</i> | <i>AC -</i> | <i>ND</i> | <i>D</i> |
|--------------|-------------|-------------|-----------|----------|
| <i>ABC +</i> | $S$         | –           | $1 - S$   | –        |
| <i>ABC -</i> | –           | $S$         | $1 - S$   | –        |
| <i>AEC +</i> | $S$         | –           | $1 - S$   | –        |
| <i>AEC -</i> | –           | $S$         | $1 - S$   | –        |
| <i>D</i>     | –           | –           | –         | 1        |

### Fall – winter interval

Step 1 : Neckband loss

|             | <i>AC +</i> | <i>AC -</i> | <i>D</i> |
|-------------|-------------|-------------|----------|
| <i>AC +</i> | $1 - L$     | $L$         | –        |
| <i>AC -</i> | –           | 1           | –        |
| <i>ND</i>   | –           | –           | 1        |
| <i>D</i>    | –           | –           | 1        |

Step 2: Survival

|             | <i>AC +</i> | <i>AC -</i> | <i>ND</i> | <i>D</i> |
|-------------|-------------|-------------|-----------|----------|
| <i>AC +</i> | $S$         | –           | $1 - S$   | –        |
| <i>AC -</i> | –           | $S$         | $1 - S$   | –        |
| <i>D</i>    | –           | –           | –         | 1        |

*Winter-spring interval*

Step 1 : Neckband loss

|             |             |             |          |
|-------------|-------------|-------------|----------|
|             | <i>AC +</i> | <i>AC -</i> | <i>D</i> |
| <i>AC +</i> | $1 - L$     | $L$         | -        |
| <i>AC -</i> | -           | 1           | -        |
| <i>ND</i>   | -           | -           | 1        |
| <i>D</i>    | -           | -           | 1        |

Step 2: Survival

|             |             |             |           |          |
|-------------|-------------|-------------|-----------|----------|
|             | <i>AC +</i> | <i>AC -</i> | <i>ND</i> | <i>D</i> |
| <i>AC +</i> | $S$         | -           | $1 - S$   | -        |
| <i>AC -</i> | -           | $S$         | $1 - S$   | -        |
| <i>D</i>    | -           | -           | -         | 1        |

*Pre-breeding interval*

Step 1: neckband loss

|             |             |             |          |
|-------------|-------------|-------------|----------|
|             | <i>AC +</i> | <i>AC -</i> | <i>D</i> |
| <i>AC +</i> | $1 - L$     | $L$         | -        |
| <i>AC -</i> | -           | 1           | -        |
| <i>ND</i>   | -           | -           | 1        |
| <i>D</i>    | -           | -           | 1        |

Step 2: Colony of destination

|             |              |              |              |              |           |          |
|-------------|--------------|--------------|--------------|--------------|-----------|----------|
|             | <i>ABC +</i> | <i>ABC -</i> | <i>AEC +</i> | <i>AEC -</i> | <i>ND</i> | <i>D</i> |
| <i>AC +</i> | $\Psi$       | -            | $1 - \Psi$   | -            | -         | -        |
| <i>AC -</i> | -            | $\Psi$       | -            | $1 - \Psi$   | -         | -        |
| <i>ND</i>   | -            | -            | -            | -            | 1         | -        |
| <i>D</i>    | -            | -            | -            | -            | -         | 1        |

Step 3: Survival

|              |              |              |              |              |           |          |
|--------------|--------------|--------------|--------------|--------------|-----------|----------|
|              | <i>ABC +</i> | <i>ABC -</i> | <i>AEC +</i> | <i>AEC -</i> | <i>ND</i> | <i>D</i> |
| <i>ABC +</i> | $S$          | -            | -            | -            | $1 - S$   | -        |
| <i>ABC -</i> | -            | $S$          | -            | -            | $1 - S$   | -        |
| <i>AEC +</i> | -            | -            | $S$          | -            | $1 - S$   | -        |
| <i>AEC -</i> | -            | -            | -            | $S$          | $1 - S$   | -        |
| <i>ND</i>    | -            | -            | -            | -            | 1         | -        |
| <i>D</i>     | -            | -            | -            | -            | -         | 1        |

# Conclusion générale

---

## 1. Principaux résultats

### *1.1. Variation du taux de retour de bagues par les chasseurs et implications.*

Dans les études de dynamique des populations, il est nécessaire de pouvoir estimer avec le plus de précision possible les paramètres démographiques. La grande oie des neiges étant chassée, les récupérations de bagues par les chasseurs sont une grande source d'information. Cependant, il est impossible de contrôler la fiabilité de ces informations. Dans le premier chapitre, notre but a donc été d'estimer le taux de retour de bagues par les chasseurs et de voir les conséquences des variations de ce paramètre sur la gestion de cette espèce et sur l'utilisation des données de retour de bagues dans les modèles de Capture-Marquage-Recapture (CMR). Les résultats de ce chapitre mettent en avant une augmentation du taux de retour de bagues standard (de 0.40 à 0.80 environ) pendant la campagne d'utilisation des bagues avec récompense. Cette variation temporelle suggère un effet du protocole de l'étude sur les résultats. En effet, le grand public n'a pas été informé de la présence de bagues récompense pour éviter de biaiser le taux de prélèvement. Les premiers chasseurs ayant reçu les récompenses ont pu diffuser l'information via le bouche à oreille ou via des forums internet, créant une certaine confusion sur le type de bagues amenant à une récompense. Ainsi, les chasseurs auraient prêté une plus grande attention à la présence de bagues sur les oiseaux et renvoyé l'information, que la bague soit porteuse d'une récompense ou non. La variabilité temporelle du taux de retour de bagues amène la question de savoir quel est le taux à utiliser dans les modèles de gestion de la chasse chez cette espèce. Dans un souci de simplicité, le taux de retour de bagues constant (0.66) est le taux que nous recommandons d'utiliser pour la gestion adaptative de la grande oie des neiges. Cependant, nous rappelons aux gestionnaires qu'un biais dans l'estimation de la mortalité à la chasse est possible en utilisant ce taux constant. Nos estimations indiquent par ailleurs que le taux de retour de bagues par les chasseurs est très inférieur à 1. L'estimation directe des taux de mortalité à la chasse par les modèles de CMR est donc biaisée et nécessite une correction pour le taux de retour de bague. Les études prenant en compte à la fois recaptures physiques et reprises d'individus morts n'ont pas besoin de telle

correction. En effet, l'estimation de la probabilité de survie ne nécessite que celle du taux de reprise, dont le taux de retour de bague n'est qu'une composante. Cependant, vu la variabilité temporelle de ce dernier paramètre, il est important de contraindre le taux de reprise à varier au cours du temps, afin d'estimer précisément les taux de survie et d'évaluer leur variabilité.

### *1.2. Coût de la reproduction chez un oiseau nicheur arctique.*

Dans ce second chapitre, nous voulions étudier avec le moins de biais possible la probabilité de nicher d'une femelle adulte. L'utilisation d'un modèle intégrant le protocole d'échantillonnage du design robuste dans un modèle multi-événement nous a permis de prendre en compte le choix des individus d'aller ou pas sur la colonie reproductrice mais également la possibilité de quitter le site en cas d'échec de nidification. Les informations recueillies nous ont alors permis d'utiliser le statut reproductif des individus l'année précédente pour étudier la présence de coût de la reproduction chez la grande oie des neiges. Nos résultats ont montré l'absence d'effet du statut reproducteur des femelles sur le taux de survie subséquent. Cependant, un effet négatif du succès reproducteur sur la probabilité de nicher a été trouvé, suggérant l'existence d'un coût de la reproduction. Il serait lié à la fois à l'incubation et à l'élevage des jeunes car les individus ayant échoué leur nidification avaient une probabilité de nicher proche de 1. Cet effet négatif sur la probabilité de nicher serait vraisemblablement dû aux soins parentaux qui se prolongent jusqu'à 1 an chez les oies et qui pourraient donc interférer avec le conditionnement des femelles au printemps suivant en prévision de la reproduction à venir. Notre second résultat portant sur le succès de nidification suggère un effet de la qualité individuelle chez les individus qui se reproduisent, avec des « bons » individus qui réussiront presque à chaque tentative et d'autres qui échoueront dans la majorité des cas. Troisièmement, notre étude suggère l'existence possible d'une stratégie proche de la stratégie « bet-hedging », i.e. un faible investissement dans la reproduction les années défavorables et une survie élevée afin de maximiser le nombre de tentatives de reproduction, et ainsi la fitness. Cette stratégie permettrait d'expliquer le faible taux de retour des individus qui ne tentent pas la reproduction mais qui, lorsqu'ils décident de se reproduire, réussissent presque à chaque fois. Les paramètres de probabilité de reproduction étaient également variables dans le temps, cette variabilité temporelle pouvant être liée aux conditions environnementales au

printemps dans l'Arctique. La probabilité de nicher serait donc à la fois dépendante de l'histoire reproductive de l'individu et des conditions environnementales. Enfin, dans cette étude utilisant 20 années de données, nous avons pu également estimer la probabilité de survie de ces femelles. Le résultat suggère que le taux de survie est remarquablement stable, indépendamment du statut reproducteur mais également dans le temps. Le seul facteur de variation de cette survie adulte est la pression de chasse, la survie ayant diminué entre la période avant et après l'instauration d'une chasse printanière au Québec. Ce dernier résultat démontre également la variabilité beaucoup plus forte de la probabilité de nicher que de la survie adulte chez la grande oie des neiges.

### *1.3. Variations temporelles du taux de survie juvénile chez une espèce longévive : rôle du parasitisme et de la condition corporelle*

Dans ce chapitre, nous nous sommes intéressés aux facteurs de variations du taux de survie juvénile chez la grande oie des neiges. Bénéficiant d'une expérience de vermifugation chez de jeunes individus bagués durant 4 ans, nous avons pu explorer l'effet des parasites intestinaux et de la condition corporelle des individus juste avant l'envol sur le taux de survie. Nos résultats ont montré un effet du parasitisme sur les 2 premières années de vie des individus bagués jeune. L'effet du parasitisme s'est toutefois avéré assez complexe. La première année, seule la survie des jeunes femelles a été améliorée par la vermifugation, alors que les jeunes mâles ont eu une survie similaire aux individus non-traités. D'après le principe de Bateman, un investissement différentiel suivant le sexe dans le système immunitaire des jeunes pourrait expliquer cette différence. L'investissement des femelles serait alors soulagé par le traitement antiparasitaire et permettrait une réallocation d'énergie du système immunitaire vers d'autres fonctions comme la croissance augmentant ainsi la survie des jeunes femelles. Les jeunes mâles, n'investissant pas ou peu dans leur système immunitaire, ne pourraient pas faire une telle réallocation, ce qui expliquerait leur survie identique aux individus n'ayant pas reçu le traitement. La survie de seconde année des individus traités a aussi été supérieure à celle des individus non-traités durant 2 années sur 4, mais sans différence entre les sexes. Un effet reporté du traitement antiparasitaire, par exemple via une amélioration de la croissance des individus la première année, pourrait expliquer cet effet positif à long-terme sur la survie des individus traités. Enfin, un effet significatif de la condition corporelle sur la

survie a été trouvé seulement chez les jeunes femelles traitées. Une explication possible serait un compromis entre l'investissement dans le système immunitaire et la croissance chez ces individus. En effet, les individus traités auraient eu l'avantage de pouvoir réinvestir davantage d'énergie dans leur croissance, ce qui aurait permis une meilleure survie. Ce chapitre a permis de mettre en évidence la plus grande variabilité de la survie juvénile vis-à-vis de la survie adulte et l'importance du parasitisme dans les variations du taux de survie juvénile chez la grande oie des neiges.

#### *1.4. Évaluation de la canalisation spatiale du taux de survie adulte chez un oiseau migrateur*

L'objectif du quatrième chapitre était d'estimer et comparer la survie adulte chez des individus provenant de 2 colonies différentes afin évaluer la représentativité des paramètres démographiques estimés à partir des données d'une seule colonie, l'île Bylot, pour l'ensemble de la population de grande oie des neiges. Les résultats montrent une absence de différence dans la survie adulte entre les oies baguées sur l'île Bylot et celles baguées sur l'île d'Ellesmere, située 800 km au nord. Ceci infirme donc l'hypothèse selon laquelle la distance supplémentaire à parcourir pour rejoindre l'île d'Ellesmere aurait pu avoir un effet négatif sur la survie des individus de cette colonie. La migration est un système qui nécessite l'utilisation des réserves énergétiques stockées par les individus. Cependant, la distance supplémentaire que les oiseaux qui nichent à Ellesmere doit parcourir n'était vraisemblablement pas suffisante pour diminuer la condition corporelle à un point tel que la mortalité des individus serait augmentée. De plus, si les réserves sont suffisantes, les individus qui atteignent leur destination finale peuvent se nourrir et possiblement récupérer les réserves utilisées. Ces résultats sont en accord avec la théorie de la canalisation environnementale. Cette théorie a surtout été appliquée pour expliquer la réduction de variabilité des paramètres démographiques au cours du temps. Cependant, il est possible que la canalisation environnementale puisse aussi s'appliquer spatialement, expliquant ainsi les taux de survie identique pour les populations de ces 2 colonies.

## **2. La canalisation des paramètres démographiques chez la grande oie des neiges**

La canalisation environnementale des paramètres démographiques est la théorie expliquant la réduction de variabilité des paramètres les plus élastiques, optimisant ainsi la fitness des individus et maximisant la croissance d'une population. Stearns & Kawecki (1994) furent parmi les premiers à tester la théorie de la canalisation génétique chez la drosophile *Drosophila melanogaster*. Ils suggérèrent que pour tester l'hypothèse de canalisation, il fallait mesurer la canalisation d'une série de traits impactant la fitness et exclure les différences dans le nombre de loci ou d'allèles comme sources de variabilité (Stearns & Kawecki 1994). L'application à la dynamique des populations est venue plus tardivement. À la fin des années 1990, suite à des études d'élasticité chez les espèces longévives, un patron est apparu : le paramètre avec la plus forte élasticité était généralement le moins variable alors que les paramètres peu élastiques étaient les plus variables et semblaient de fait contribuer le plus aux variations observées du taux de croissance des populations (Gaillard et al. 1998, Pfister 1998, Saether & Bakke 2000). Dans leur étude sur les ongulés, Gaillard & Yoccoz (2003) ont alors proposé l'hypothèse de la canalisation des traits d'histoire de vie comme explication à la faible variabilité des paramètres ayant le plus fort impact sur le taux de croissance. Les pré-requis pour tester l'existence de la canalisation sont la disponibilité de données à long-terme de qualité, permettant d'estimer les paramètres démographiques et d'explorer leurs variations temporelles ainsi que les facteurs de variations potentiels. Enfin, une étude d'élasticité permet de classier l'importance relative de ces paramètres sur cette échelle.

Le projet de suivi de la population de la grande oie des neiges sur l'île Bylot depuis le tout début des années 1990 a permis d'obtenir une base de données de capture-marquage-recapture de plus de 20 ans. Gauthier & Brault (1998) ont utilisé les premières estimations des taux de survie et de fécondité pour évaluer l'élasticité de ces paramètres. Ils ont montré que la survie adulte comptait pour 60% du taux de croissance, tandis que survie juvénile et fécondité comptaient chacun pour 20%. Gauthier & Lebreton (2004) ont montré plus récemment que l'élasticité du taux de survie adulte peut même atteindre 0.84 sur une plus longue période. Avec l'accumulation de nouvelles données depuis, une étude plus poussée des variations

temporelles de chacun des paramètres a été rendue possible. Le taux de survie adulte moyen est élevé et peu variable (moyenne : 0.86, amplitude : 0.72-0.94) en comparaison du taux de survie juvénile (moyenne : 0.36, amplitude : 0.16-0.56, Juillet et al. 2012).

Dans la présente thèse, j'ai pu estimer les différents paramètres démographiques de la grande oie des neiges : une composante majeure de la reproduction, la probabilité de nicher ainsi que le taux de survie adulte (chapitre 2), le taux de survie juvénile en lien avec le parasitisme (chapitre 3) et enfin le taux de survie adulte sur 2 colonies différentes (chapitre 4). Basé sur les effets retenus sur les différents paramètres et l'amplitude des estimations, nous avons montré une plus grande variabilité de la probabilité de nicher (moyenne = 0.50, amplitude : 0.25-0.80 pour les individus s'étant reproduit l'année précédente ; moyenne = 0.16, amplitude : 0.01-0.48 pour les individus n'étant pas présent sur la colonie) que de la survie adulte des femelles. Basée sur une série temporelle de 20 ans, nous avons d'ailleurs trouvé un taux de survie pour les femelles adultes avec collier de  $0.83 \pm 0.01$  sur la période pré-mesures de conservation (1990-1998) et de  $0.73 \pm 0.01$  sur la période après l'entrée en vigueur de ces mesures (1999-2011). Le taux de survie juvénile estimé au cours de cette thèse (moyenne 0.40, amplitude : 0.31-0.48) est également plus variable que le taux de survie adulte ( $0.78 \pm 0.02$ , estimé constant pour la période post-mesures de conservation). Le taux de survie adulte, paramètre le plus élastique, est le moins variable temporellement et semble même identique sur 2 colonies distantes de 800 km l'une de l'autre tandis que le taux de survie juvénile et la probabilité de nicher montrent une variabilité annuelle très importante et en lien avec les conditions environnementales (Reed et al. 2004a, Menu et al. 2005).

Bien que toutes ces estimations proviennent d'analyses de données différentes, les paramètres démographiques de la grande oie des neiges correspondent aux prédictions liées à la théorie de la canalisation. La dynamique de cette population semble donc être soumise à différentes pressions de sélection optimisant ultimement le taux de croissance de l'espèce.



### **3. Perspectives**

#### *3.1. Modélisation populationnelle*

L'aboutissement ultime de cette thèse aurait pu être l'utilisation d'un modèle populationnelle afin de formaliser la relation inverse entre élasticité et variations des paramètres démographiques. Cependant, il n'a pas été possible d'arriver jusqu'à cette étape. L'utilisation d'un modèle matriciel intégrant les nouvelles estimations des paramètres démographiques pourrait permettre de réévaluer l'élasticité d'eux et ainsi, le lien prédit par la théorie de la canalisation serait testé dans un cadre plus robuste.

#### *3.2. Canalisation du taux de survie et pression de chasse*

Suite aux résultats de nos différentes analyses, nous avons estimé un taux de survie adulte constant dans le temps, indiquant très peu de variation dans ce paramètre. Cependant, nous avons noté une diminution du taux de survie des femelles adultes avec collier entre les périodes avant et après la mise en place des mesures de conservation (augmentation des quotas de chasses et instauration d'une chasse au printemps à partir de l'hiver 1998-1999, Giroux et al. 1998). La diminution observée dans notre étude correspond à l'impact des mesures de chasse observé par Calvert & Gauthier (2005). La chasse est une source de mortalité additive chez les adultes de la grande oie des neiges (Gauthier et al. 2001, Calvert & Gauthier 2005, Juillet 2011). Il serait donc intéressant de voir si une canalisation du taux de survie adulte contre la pression de chasse serait possible. Même s'il est courant de penser que la réponse évolutive pourrait être à long-terme (Gamelon et al. 2011), il serait possible de voir apparaître un tel processus évolutif à la même échelle temporelle que le processus écologique (Pemberton 2010). L'estimation de la variation de ce paramètre démographique selon différentes pression de chasse permettrait d'évaluer cette canalisation.

#### *3.3. Étude de la canalisation dans un contexte de changement climatique*

Les changements climatiques pourraient entraîner un décalage de l'aire de distribution des espèces en direction des pôles (Jensen et al. 2008). Ces modifications pourraient entraîner un déclin des populations spécialisées du haut-Arctique selon la capacité de réponse des espèces à ces changements. Sous la théorie de la canalisation pour les espèces longévives, le taux de survie adulte a

évolué afin d'être peu sensible aux variations environnementales. Cependant, dans un contexte de changement global, les variations pourraient être de grande ampleur en Arctique (augmentation de température de +3 à +6 °C, modification de l'habitat, Kaplan & New 2006). Due à la vitesse de ces changements (prédictions à l'horizon 2050), il est possible qu'une canalisation des paramètres démographiques ne corresponde plus à l'optimum pour la population de grande oie des neiges. L'étude des relations entre variables climatiques et paramètres démographiques ainsi que des interactions trophiques devrait permettre d'appréhender les réponses théoriques et réelles de la population à ces changements et voir si une évolution de la variabilité des paramètres démographiques est à prévoir.

#### *3.4. Études des stratégies reproductives chez la grande oie des neiges*

Le chapitre 2 de la présente thèse a permis de mettre à jour des coûts de reproduction et l'existence potentielle de stratégies différentes de reproduction. Il pourrait donc s'avérer utile de développer un modèle prenant en compte ces stratégies. La mise en place d'un tel modèle pourrait se faire en combinant notre modèle multi-événement à un modèle à effet mémoire, i.e. permettant l'estimation de transition entre  $t$  et  $t+1$  en fonction de l'état des individus à  $t$  et  $t-1$  (Brownie et al. 1993). Une étude statistique préliminaire de ce modèle en termes d'identifiabilité des paramètres et de robustesse serait toutefois nécessaire avant de songer à l'appliquer aux données de la grande oie des neiges ou d'autres espèces.

#### *3.5. Développement et comparaison de modèles pour l'estimation de la probabilité de nicher*

Dans le chapitre 2 de cette thèse, nous avons pour but d'estimer la probabilité de nicher. À cette fin, nous avons développé un modèle multi-événement basé sur l'échantillonnage du design robuste dans un cadre de multi-événement avec utilisation d'un état non-observable. Ce modèle nous a permis d'estimer la probabilité des individus d'aller sur la colonie reproductrice, tout en permettant à ces individus de partir de la colonie en cas d'échec de nidification. Ce modèle a permis de s'affranchir de l'hypothèse de population fermée, entre la nidification et le baguage, inhérent au design robuste (Pollock 1982, Kendall et al. 1997), et nous a permis d'utiliser toute l'information disponible pendant l'été, contrairement au modèle multi-état (Pradel 2005). Une seconde étape importante de validation de cette approche serait de la confronter aux approches classiques évoquées ci-dessus à partir de

données simulées et/ou réelles afin d'estimer les biais, les forces et désavantages de chacune de ces approches.

Ce modèle développé dans le chapitre 2 utilise les données de capture-recapture des individus marqués à la fois avec une bague à la patte et un collier autour du cou. La marque secondaire sur le cou permet une identification à distance sans capture physique de l'individu. Cependant, différentes études ont montré l'effet négatif des colliers sur les probabilités de reproduction (Schmutz & Morse 2000, Reed et al. 2005). Développer le modèle afin d'intégrer les individus ayant seulement une bague de métal pourrait permettre d'étudier la probabilité de nicher des individus sans biais lié au type de marqueur reçu. De même, l'intégration de la perte de collier (Juillet et al. 2011) dans ce modèle permettrait de réduire encore les biais existants.

#### **4. Conclusion**

Ma thèse se porte sur la dynamique de population de la grande oie des neiges, une espèce migratrice chassée en Amérique du Nord. Lors de ma thèse, j'ai pu montrer la faible variabilité du taux de survie adulte, paramètre le plus important pour le taux de croissance de populations longévives comme la grande oie des neiges. Le seul facteur de variation du taux de survie adulte est le facteur chasse. Les autres paramètres démographiques comme la survie juvénile et la probabilité de nicher présentent une haute variabilité interannuelle liée aux variations climatiques et environnementales mais également à l'histoire reproductive des individus.

Ma thèse apporte des éléments nouveaux pour la compréhension des compromis évolutifs et permet d'appuyer la théorie de la canalisation environnementale. De plus, outre la portée évolutive de ce travail, il est également possible de mettre en exergue l'importance de la chasse pour la gestion de la grande oie des neiges. En effet, l'augmentation de la pression de chasse a été le seul facteur ayant diminué la valeur du taux de survie adulte. Les mesures visant à réduire ce paramètre sont donc à préconiser afin de réguler la population de la grande oie des neiges.

## Références bibliographiques

---

- Abraham, K. E. & R. L. Jefferies. 1997. High goose populations: causes, impacts and implications. Pages 7-72 in B. D. J. Batt, editor. Arctic Ecosystems in Peril: Report of the Arctic Goose Habitat Working Group. Arctic Goose Joint Venture Special Publication. U.S. Fish and Wildlife Service, Washington, D.C. and Canadian Wildlife Service, Ottawa, Ontario.
- Abraham, K. F., R. L. Jefferies, & R. F. Rockwell. 2005. Goose-induced changes in vegetation and land cover between 1976 and 1997 in an arctic coastal marsh. *Arctic Antarctic and Alpine Research* **37**:269-275.
- Alisauskas, R. T., K. L. Drake, S. M. Slattery, & D. K. Kellett. 2006. Neckbands, harvest, and survival of Ross's geese from Canada's Central Arctic. *Journal of Wildlife Management* **70**:89-100.
- Alisauskas, R. T. & M. S. Lindberg. 2002. Effects of neckbands on survival and fidelity of white-fronted and Canada geese captured as non-breeding adults. *Journal of Applied Statistics* **29**:521-537.
- Alisauskas, R. T., R. F. Rockwell, K. W. Dufour, E. G. Cooch, G. Zimmerman, K. L. Drake, J. O. Leafloor, T. J. Moser, & E. T. Reed. 2011. Harvest, Survival, and Abundance of Midcontinent Lesser Snow Geese Relative to Population Reduction Efforts. *Wildlife Monographs*:1-42.
- Amundson, C. L. & T. W. Arnold. 2010. Anthelmintics increase survival of American coot (*Fulica Americana*) Chicks. *Auk* **127**:653-659.
- Anderson, D. R. & K. P. Burnham. 1976. Population ecology of the mallard: VI. The effect of exploitation on survival. U.S. Fish and Wildlife Service Resource Publication 128, Washington, D.C., USA.
- Anderson, M. G., M. S. Lindberg, & R. B. Emery. 2001. Probability of survival and breeding for juvenile female canvasbacks. *Journal of Wildlife Management* **65**:385-397.
- Ankney, C. D. 1996. An embarrassment of riches: Too many geese. *Journal of Wildlife Management* **60**:217-223.
- Arlettaz, R., M. Schaad, T. S. Reichlin, & M. Schaub. 2010. Impact of weather and climate variation on Hoopoe reproductive ecology and population growth. *Journal of Ornithology* **151**:889-899.

- Arnason, A. N. 1972. Parameter estimates from mark recapture experiments on 2 populations subject to migration and death. *Researches on Population Ecology (Tokyo)* **13**:97-113.
- Arnason, A. N. 1973. The estimation of population size migration rates and survival in a stratified population. *Researches on Population Ecology (Tokyo)* **15**:1-8.
- Arnold, T. W., E. A. Roche, J. H. Devries, & D. W. Howerter. 2012. Costs of Reproduction in Breeding Female Mallards: Predation Risk during Incubation Drives Annual Mortality. *Avian Conservation and Ecology* **7**.
- Aubry, L. M., D. N. Koons, J. Y. Monnat, & E. Cam. 2009. Consequences of recruitment decisions and heterogeneity on age-specific breeding success in a long-lived seabird. *Ecology* **90**:2491-2502.
- Baldassarre, G. A. & E. G. Bolen. 2006. *Waterfowl ecology and management*. Second edition. Krieger Publishing Company, Malabar, Florida, USA.
- Barbraud, C. & H. Weimerskirch. 2001. Emperor penguins and climate change. *Nature* **411**:183-186.
- Barbraud, C. & H. Weimerskirch. 2003. Climate and density shape population dynamics of a marine top predator. *Proceedings of the Royal Society B-Biological Sciences* **270**:2111-2116.
- Barbraud, C. & H. Weimerskirch. 2005. Environmental conditions and breeding experience affect cost of reproduction in Blue Petrels. *Ecology* **86**:682-692.
- Barker, R. J. 1997. Joint modeling of live-recapture, tag-resight, and tag-recovery data. *Biometrics* **53**:666-677.
- Bateman, A. J. 1948. Intra-sexual selection in *Drosophila*. *Heredity* **2**:349-368.
- Batt, B. D. J. 1998. *The Greater Snow Goose: Report of the Arctic Goose Habitat Working Group*. Arctic Goose Joint Venture Special Publication. U.S. Fish and Wildlife Service, Washington, D.C. and Canadian Wildlife Service, Ottawa, Ontario.
- Beauplet, G., C. Barbraud, W. Dabin, C. Kussener, & C. Guinet. 2006. Age-specific survival and reproductive performances in fur seals: evidence of senescence and individual quality. *Oikos* **112**:430-441.
- Béchet, A., J. F. Giroux, & G. Gauthier. 2004. The effects of disturbance on behaviour, habitat use and energy of spring staging snow geese. *Journal of Applied Ecology* **41**:689-700.

- Becker, P. H., T. H. G. Ezard, J. D. Ludwigs, H. Sauer-Gurth, & M. Wink. 2008. Population sex ratio shift from fledging to recruitment: consequences for demography in a philopatric seabird. *Oikos* **117**:60-68.
- Benton, T. G., S. J. Plaistow, & T. N. Coulson. 2006. Complex population dynamics and complex causation: devils, details and demography. *Proceedings of the Royal Society B-Biological Sciences* **273**:1173-1181.
- Bety, J., G. Gauthier, & J. F. Giroux. 2003. Body condition, migration, and timing of reproduction in Snow Geese: A test of the condition-dependent model of optimal clutch size. *American Naturalist* **162**:110-121.
- Black, J. M. & M. Owen. 1989. Agonistic behaviour in barnacle goose flocks: assessment, investment and reproductive success. *Animal Behaviour* **37**:199-209.
- Bogdanova, M. I., R. G. Nager, & P. Monaghan. 2007. Age of the incubating parents affects nestling survival: an experimental study of the herring gull *Larus argentatus*. *Journal of Avian Biology* **38**:83-93.
- Braasch, A., C. Schaub, & P. H. Becker. 2009. Post-fledging body mass as a determinant of subadult survival in Common Terns *Sterna hirundo*. *Journal of Ornithology* **150**.
- Bradley, J. S. & R. D. Wooller. 1991. Philopatry and age of first-breeding in long-lived birds. *Acta XX congressus international ornithologici*:1657-1665.
- Brown, C. R. & M. B. Brown. 2004. Group size and ectoparasitism affect daily survival probability in a colonial bird. *Behavioral Ecology and Sociobiology* **56**:498-511.
- Brownie, C., J. E. Hines, J. D. Nichols, K. H. Pollock, & J. B. Hestbeck. 1993. Capture-recapture studies for multiple strata including non-Markovian transitions. *Biometrics* **49**:1173-1187.
- Burnham, K. P. 1993. A theory for combined analysis of ring recovery and recapture data. Pages 199-213 *Advances in Life Sciences; Marked individuals in the study of bird population*. Birkhaeuser Verlag; Birkhaeuser Boston, Inc.
- Burnham, K. P. & D. A. Anderson. 2002. *Model selection and multimodel inference: a practical information-theoretic approach*. 2nd edition. Springer, New York.
- Burnham, K. P. & D. R. Anderson. 1984. Tests of compensatory vs. additive hypotheses of mortality in mallards *Anas platyrhynchos*. *Ecology (Washington D C)* **65**:105-112.

- Calvert, A. M. & G. Gauthier. 2005. Effects of exceptional conservation measures on survival and seasonal hunting mortality in greater snow geese. *Journal of Applied Ecology* **42**:442-452.
- Calvert, A. M., G. Gauthier, E. T. Reed, L. Bélanger, J. F. Giroux, J.-F. Gobeil, M. Huang, J. Lefebvre, & A. Reed. 2007. Present status of the population and evaluation of the effects of the special conservation measures. Pages 6-65 *in* E. T. Reed and A. M. Calvert, editors. Evaluation of the special conservation measures for Greater Snow Geese: Report of the Greater Snow Goose Working Group. Arctic Goose Joint Venture Special Publication. Canadian Wildlife Service, Sainte-Foy, Québec.
- Cam, E. & L. Aubry. 2011. Early development, recruitment and life history trajectory in long-lived birds. *Journal of Ornithology* **152**:187-201.
- Cam, E., J. E. Hines, J. Y. Monnat, J. D. Nichols, & E. Danchin. 1998. Are adult nonbreeders prudent parents? The Kittiwake model. *Ecology* **79**:2917-2930.
- Cam, E., W. A. Link, E. G. Cooch, J. Y. Monnat, & E. Danchin. 2002. Individual covariation in life-history traits: Seeing the trees despite the forest. *American Naturalist* **159**:96-105.
- Cam, E. & J.-Y. Monnat. 2000. Apparent inferiority of first-time breeders in the kittiwake: the role of heterogeneity among age classes. *Journal of Applied Ecology* **169**:380-394.
- Caswell, H. 2000. Prospective and retrospective perturbation analyses: Their roles in conservation biology. *Ecology* **81**:619-627.
- Caswell, J. H., R. T. Alisauskas, & J. O. Leafloor. 2012. Effect of neckband color on survival and recovery rates of Ross's geese. *Journal of Wildlife Management* **76**:1456-1461.
- Catchpole, E. A., S. N. Freeman, B. J. T. Morgan, & M. P. Harris. 1998. Integrated recovery/recapture data analysis. *Biometrics* **54**:33-46.
- Cattadori, I. M., D. T. Haydon, & P. J. Hudson. 2005. Parasites and climate synchronize red grouse populations. *Nature* **433**:737-741.
- Choquet, R., J. D. Lebreton, O. Gimenez, A. M. Reboulet, & R. Pradel. 2009a. U-CARE: Utilities for performing goodness of fit tests and manipulating CApture-REcapture data. *Ecography* **32**:1071-1074.
- Choquet, R., L. Rouan, & R. Pradel. 2009b. Program E-Surge: A Software Application for Fitting Multievent Models. Pages 845-865 *in* D. L. Thomson, E.

- G. Cooch, and M. J. Conroy, editors. Modeling Demographic Processes In Marked Populations. Springer US.
- Clobert, J. & J. D. Lebreton. 1991. Estimation of demographic parameters in birds population. Pages 75-104 *in* C. M. Perrins, J.-D. Lebreton, and G. J. M. Hirons, editors. Oxford University Press, Oxford.
- Converse, S. J., W. L. Kendall, P. F. Doherty, & P. G. Ryan. 2009. Multistate Models for Estimation of Survival and Reproduction in the Grey-Headed Albatross (*Thalassarche chrysostoma*). *Auk* **126**:77-88.
- Cooch, E., R. F. Rockwell, & S. Brault. 2001. Retrospective analysis of demographic responses to environmental change: A Lesser Snow Goose example. *Ecological Monographs* **71**:377-400.
- Cooch, E. & G. White. 2007. Program Mark "A Gentle Introduction". Page 741.
- Cooch, E. G. 2002. Fledging size and survival in snow geese: timing is everything (or is it?). *Journal of Applied Statistics* **29**:143-162.
- Cormack, R. M. 1964. Estimates of survival from the sighting of marked animals. *Biometrika* **51**:429-438.
- Coulson, T., J. M. Gaillard, & M. Festa-Bianchet. 2005. Decomposing the variation in population growth into contributions from multiple demographic rates. *Journal of Animal Ecology* **74**:789-801.
- Craven, S. R. 1979. Some problems with Canada goose neckbands. *Wildlife Society Bulletin*:268-273.
- Croxall, J. P. & P. Rothery. 1991. Population regulation of seabirds: implications of their demography for conservation. Pages 272-296 *in* C. M. Perrins, J.-D. Lebreton, and G. J. M. Hirons, editors. *Bird Population Studies*. Oxford University Press, Oxford.
- Cubaynes, S., P. F. Doherty, E. A. Schreiber, & O. Gimenez. 2011. To breed or not to breed: a seabird's response to extreme climatic events. *Biology Letters* **7**:303-306.
- de Kroon, H., J. Van Groenendael, & J. Ehrlen. 2000. Elasticities: A review of methods and model limitations. *Ecology* **81**:607-618.
- Descamps, S., H. G. Gilchrist, J. Bety, E. I. Buttler, & M. R. Forbes. 2009. Costs of reproduction in a long-lived bird: large clutch size is associated with low survival in the presence of a highly virulent disease. *Biological Letters* **5**:278-281.



- Desholm, M. 2009. Avian sensitivity to mortality: Prioritising migratory bird species for assessment at proposed wind farms. *Journal of Environmental Management* **90**:2672-2679.
- Desnoyers, M., G. Gauthier, & J. Lefebvre. 2012. Stable Associations within Flocks of Greater Snow Geese (*Chen caerulescens atlantica*): Do They Exist Beyond Family Bonds? *The Auk* **129**:611-622.
- Dickey, M. H., G. Gauthier, & M. C. Cadieux. 2008. Climatic effects on the breeding phenology and reproductive success of an arctic-nesting goose species. *Global Change Biology* **14**:1973-1985.
- Drent, R. H., G. Eichhorn, A. Flagstad, A. J. Graaf, K. E. Litvin, & J. Stahl. 2007. Migratory connectivity in Arctic geese: spring stopovers are the weak links in meeting targets for breeding. *Journal of Ornithology* **148**:501-514.
- Erikstad, K. E., P. Fauchald, T. Tveraa, & H. Steen. 1998. On the cost of reproduction in long-lived birds: the influence of environmental variability. *Ecology* **79**:1781-1788.
- Etterson, M. A., S. N. Ellis-Felege, D. Evers, G. Gauthier, J. A. Grzybowski, B. J. Mattsson, L. R. Nagy, B. J. Olsen, C. M. Pease, M. Post van der Burg, & A. Potvien. 2011. Modeling fecundity in birds: Conceptual overview, current models, and considerations for future developments. *Ecological Modelling* **222**:2178-2190.
- Folstad, I. & A. J. Karter. 1992. Parasites, bright males, and the immunocompetence handicap. *American Naturalist* **139**:603-622.
- Francis, C. M., M. H. Richards, F. Cooke, & R. F. Rockwell. 1992. Long-term changes in survival rates of lesser snow geese. *Ecology* **73**:1346-1362.
- Francis, C. M., J. R. Sauer, & J. R. Serie. 1998. Effect of restrictive harvest regulations on survival and recovery rates of American black ducks. *Journal of Wildlife Management* **62**:1544-1557.
- Frederiksen, M. & T. Bregnballe. 2000. Diagnosing a decline in return rate of 1-year-old cormorants: mortality, emigration or delayed return? *Journal of Animal Ecology* **69**:753-761.
- Frederiksen, M., F. Daunt, M. P. Harris, & S. Wanless. 2008. The demographic impact of extreme events: stochastic weather drives survival and population dynamics in a long-lived seabird. *Journal of Animal Ecology* **77**:1020-1029.

- Fujiwara, M. & H. Caswell. 2002. A general approach to temporary emigration in mark-recapture analysis. *Ecology* **83**:3266-3275.
- Gaillard, J. M., M. Festa-Bianchet, & N. G. Yoccoz. 1998. Population dynamics of large herbivores: variable recruitment with constant adult survival. *Trends in Ecology & Evolution* **13**:58-63.
- Gaillard, J. M., M. Festa-Bianchet, N. G. Yoccoz, A. Loison, & C. Toïgo. 2000. Temporal variation in fitness components and population dynamics of large herbivores. *Annual Review of Ecology and Systematics* **31**:367-393.
- Gaillard, J. M. & N. G. Yoccoz. 2003. Temporal variation in survivals in Mammals: a case of environment canalization? *Ecology* **84**:3294-3306.
- Gamelon, M., A. Besnard, J. M. Gaillard, S. Servanty, E. Baubet, S. Brandt, & O. Gimenez. 2011. High hunting pressure selects for earlier birth date: wild boar as a case study. *Evolution* **65**:3100-3112.
- Gauthier, G., J. Bety, J. F. Giroux, & L. Rochefort. 2004. Trophic interactions in a high arctic snow goose colony. *Integrative and Comparative Biology* **44**:119-129.
- Gauthier, G., J. Bety, & K. A. Hobson. 2003. Are greater snow geese capital breeders? New evidence from a stable-isotope model. *Ecology* **84**:3250-3264.
- Gauthier, G. & S. Brault. 1998. Population model of the greater snow goose: projected impacts of reduction in survival on population growth rate. Pages 65-80 in B. D. J. Batt, editor. *The greater snow goose: report of the Arctic Goose Habitat Working Group*. Arctic Goose Joint Venture Special Publication. U.S. Fish and Wildlife Service, Washington and Canadian Wildlife Service, Ottawa.
- Gauthier, G., F. Fournier, & J. Larochelle. 2006. The effect of environmental conditions on early growth in geese. *Acta Zoologica Sinica* **52 (Supplement)**:670-674.
- Gauthier, G., J. F. Giroux, & J. Bedard. 1992. Dynamics of fat and protein reserves during winter and spring migration in greater snow geese. *Canadian Journal of Zoology-Revue Canadienne De Zoologie* **70**:2077-2087.
- Gauthier, G., J. F. Giroux, A. Reed, A. Béchet, & L. Belanger. 2005. Interactions between land use, habitat use, and population increase in greater snow geese: what are the consequences for natural wetlands? *Global Change Biology* **11**:856-868.

- Gauthier, G. & J. D. Lebreton. 2004. Population models for Greater Snow Geese: a comparison of different approaches to assess potential impacts of harvest. *Animal Biodiversity and Conservation* **27**:503-514.
- Gauthier, G. & J. D. Lebreton. 2008. Analysis of band-recovery data in a multistate capture-recapture framework. *Canadian Journal of Zoology* **36**:59-73.
- Gauthier, G., R. Pradel, S. Menu, & J. D. Lebreton. 2001. Seasonal survival of greater snow geese and effect of hunting under dependence in sighting probability. *Ecology* **82**:3105-3119.
- Gibson, G. & G. Wagner. 2000. Canalization in evolutionary genetics: a stabilizing theory? *BioEssays* **22**:372-380.
- Gimenez, O., S. J. Bonner, R. King, R. A. Parker, S. P. Brooks, L. E. Jamieson, V. Grosbois, B. J. T. Morgan, & L. Thomas. 2009. WinBUGS for population ecologists: Bayesian modeling using Markov chain Monte Carlo methods. *Modeling Demographic Processes in Marked Populations* **3**:883-915.
- Gimenez, O., J. Lebreton, J. Gaillard, R. Choquet, & R. Pradel. 2012. Estimating demographic parameters using hidden process dynamic models. *Theoretical Population Biology* **82**:307-316.
- Giroux, J. F., B. Batt, S. Brault, G. Costanzo, B. Filion, G. Gauthier, D. Luszczyk, & A. Reed. 1998. Conclusions and management recommendations. Pages 81-88 *in* B. Batt, editor. *The Greater Snow Goose, Report of the Arctic Goose Habitat Working Group*. U.S. Fish and Wildlife Service, Washington, D.C. and Canadian Wildlife Service, Ottawa, Ontario.
- Greenwood, R. J. & W. C. Bair. 1974. Ice on waterfowl markers. *Wildlife Society Bulletin*:130-134.
- Gregoire, P. E. & C. D. Ankney. 1990. Agonistic behavior and dominance relationships among Lesser Snow Geese during winter and spring migration. *The Auk* **107**:550-560.
- Hamel, S., S. D. Côté, J. M. Gaillard, & M. Festa-Bianchet. 2008. Individual variation in reproductive costs of reproduction: high-quality females always do better. *Journal of Animal Ecology* **78**:143-151.
- Hamel, S., J. M. Gaillard, N. G. Yoccoz, A. Loison, C. Bonenfant, & S. Descamps. 2010. Fitness costs of reproduction depend on life speed: empirical evidence from mammalian populations. *Ecology Letters* **13**:915-935.

- Hanssen, S. A., D. Hasselquist, I. Folstad, & K. E. Erikstad. 2005. Cost of reproduction in a long-lived bird: incubation effort reduces immune function and future reproduction. *Proceedings of the Royal Society B* **272**:1039-1046.
- Harris, M. P., M. Frederiksen, & S. Wanless. 2007. Within- and between-year variation in the juvenile survival of Common Guillemots *Uria aalge*. *Ibis* **149**:472-481.
- Harshman, L. G. & A. J. Zera. 2007. The cost of reproduction: the devil in the details. *Trends in Ecology & Evolution* **22**:80-86.
- Henaus, V., T. Bregnballe, & J. D. Lebreton. 2007. Dispersal and recruitment during population growth in a colonial bird, the great cormorant *Phalacrocorax carbo sinensis*. *Journal of Avian Biology* **38**:44-57.
- Henny, C. J. & K. P. Burnham. 1976. A reward band study of mallards to estimate band reporting rates. *Journal of Wildlife Management* **40**:1-14.
- Heppell, S., C. Pfister, & H. de Kroon. 2000. Elasticity analysis in population biology: Methods and applications. *Ecology* **81**:605-606.
- Hernandez-Matias, A., J. Real, M. Moleón, L. Palma, J. Sánchez-Zapata, R. Pradel, M. Carrete, J. M. Gil-Sánchez, P. Beja, J. Balbontín, N. Vincent-Martin, A. Ravayrol, J. R. Benítez, B. Arroyo, C. Fernández, E. Ferreiro, & J. García. 2013. From local monitoring to a broad-scale viability assessment: a case study for the endangered Bonelli's eagle in W Europe. *Ecological Monographs* **online first**.
- Hestbeck, J. B., J. D. Nichols, & R. A. Malecki. 1991. Estimates of movement and site fidelity using mark-resight data of wintering Canada geese. *Ecology* **72**:523-533.
- Hudson, P. J., A. P. Dobson, & D. Newborn. 1998. Prevention of population cycles by parasite removal. *Science* **282**:2256-2258.
- Inger, R., X. A. Harrison, G. D. Ruxton, J. Newton, K. Colhoun, G. A. Gudmundsson, G. McElwaine, M. Pickford, D. Hodgson, & S. Bearhop. 2010. Carry-over effects reveal reproductive costs in a long-distance migrant. *Journal of Animal Ecology* **79**:974-982.
- Jefferies, R. L., R. E. Rockwell, & K. E. Abraham. 2004. Agricultural food subsidies, migratory connectivity and large-scale disturbance in arctic coastal systems: A case study. *Integrative and Comparative Biology* **44**:130-139.

- Jenouvrier, S., C. Barbraud, & H. Weimerskirch. 2005a. Long-term contrasted responses to climate of two Antarctic seabird species. *Ecology* **86**:2889-2903.
- Jenouvrier, S., C. Barbraud, & H. Weimerskirch. 2005b. Long-term contrasted responses to climate of two Antarctic seabird species. *Ecology* **86**:2889-2903.
- Jensen, R. A., J. Madsen, M. O'CONNELL, M. S. WISZ, H. Tømmervik, & F. Mehlum. 2008. Prediction of the distribution of Arctic-nesting pink-footed geese under a warmer climate scenario. *Global Change Biology* **14**:1-10.
- Johnson, F. A., W. L. Kendall, & J. A. Dubovsky. 2002. Conditions and limitations on learning in the adaptive management of mallard harvests. *Wildlife Society Bulletin* **30**:176-185.
- Jolly, G. M. 1965. Explicit estimates from capture-recapture data with both death and immigration-stochastic model. *Biometrika* **52**:225-247.
- Juillet, C. 2011. Impact de la chasse sur la dynamique d'une population migratrice Le cas de la Grande Oie des neiges. Université Laval, Québec.
- Juillet, C., R. Choquet, G. Gauthier, & R. Pradel. 2011. A Capture–Recapture Model with Double-Marking, Live and Dead Encounters, and Heterogeneity of Reporting Due to Auxiliary Mark Loss. *Journal of Agricultural, Biological, and Environmental Statistics* **16**:88-104.
- Juillet, C., R. Choquet, G. Gauthier, & R. Pradel. 2012. Carry-over effects of spring hunt and climate on recruitment to the natal colony in a migratory species. *Journal of Applied Ecology* **49**:1237-1246.
- Kaplan, J. O. & M. New. 2006. Arctic climate change with a 2° C global warming: Timing, climate patterns and vegetation change. *Climatic Change* **79**:213-241.
- Kendall, W. L. & R. Bjorkland. 2001. Using Open Robust Design Models to Estimate Temporary Emigration from Capture—Recapture Data. *Biometrics* **57**:1113-1122.
- Kendall, W. L. & J. D. Nichols. 1995. On the use of secondary capture-recapture samples to estimate temporary emigration and breeding proportions. *Journal of Applied Statistics* **22**:751-762.
- Kendall, W. L. & J. D. Nichols. 2002. Estimating state-transition probabilities for unobservable states using capture-recapture/resighting data. *Ecology* **83**:3276-3284.

- Kendall, W. L., J. D. Nichols, & J. E. Hines. 1997. Estimating temporary emigration using capture-recapture data with Pollock's robust design. *Ecology* **78**:563-578.
- Klaassen, M., K. F. Abraham, R. L. Jefferies, & M. Vrtiska. 2006. Factors affecting the site of investment, and the reliance on savings for arctic breeders: the capital-income dichotomy revisited. *Ardea* **94**:371-384.
- Krebs, C. J. 2009. *Ecology: The Experimental Analysis of Distribution and Abundance*. Sixth Edition. 6th edition. Benjamin Cumming, San Francisco.
- Lamprecht, J. 1986. Structure and causation of the dominance hierarchy in a flock of bar-headed geese (*Anser indicus*). *Behaviour* **96**:28-48.
- Lazarus, J. & I. Inglis. 1978. The breeding behaviour of the pink-footed goose: parental care and vigilant behaviour during the fledging period. *Behaviour*:62-88.
- Lazarus, J. & I. R. Inglis. 1986. Shared and unshared parental investment, parent-offspring conflict and brood size. *Animal Behaviour* **34**:1791-1804.
- Le Galliard, J. F., O. Marquis, & M. Massot. 2010. Cohort variation, climate effects and population dynamics in a short-lived lizard. *Journal of Animal Ecology* **79**:1296-1307.
- Lebreton, J. D., T. Almeras, & R. Pradel. 1999. Competing events, mixtures of information and multistratum recapture models. *Bird Study* **46**:39-46.
- Lebreton, J. D., K. P. Burnham, J. Clobert, & D. R. Anderson. 1992. Modeling survival and testing biological hypotheses using marked animals: a unified approach with case-studies. *Ecological Monographs* **62**:67-118.
- Lebreton, J. D. & J. Clobert. 1991. Bird population dynamics, management, and conservation: the role of mathematical modelling. Pages 105-125 *in* C. M. Perrins, J.-D. Lebreton, and G. J. M. Hirons, editors. Oxford University Press, Oxford.
- Lebreton, J. D., J. D. Nichols, R. J. Barker, R. Pradel, & J. A. Spendelow. 2009. Modeling Individual Animal Histories with Multistate Capture-Recapture Models. *Advances in Ecological Research* **41**:87-173.
- Lebreton, J. D. & R. Pradel. 2002. Multistate recapture models: modelling incomplete individual histories. *Journal of Applied Statistics* **29**:353-369.

- Legagneux, P., P. L. Fast, G. Gauthier, & J. Bety. 2012. Manipulating individual state during migration provides evidence for carry-over effects modulated by environmental conditions. *Proc Biol Sci* **279**:876-883.
- Legagneux, P., A. A. Simard, G. Gauthier, & J. Bety. *in press*. Effect of neck collars on the body condition of migrating Greater Snow Geese. *Journal of Field Ornithology*.
- Legendre, P. 2011. Package 'lmodel2' : Model II regression.
- Lepage, D., G. Gauthier, & A. Reed. 1998. Seasonal variation in growth of greater snow goose goslings: the role of food supply. *Oecologia* **114**:226-235.
- Lesage, L. & G. Gauthier. 1997. Growth and organ development in greater snow goose goslings. *Auk* **114**:229-241.
- Leslie, P. 1966. The intrinsic rate of increase and the overlap of successive generations in a population of Guillemots (*Uria aalge* Pont.). *Journal of Animal Ecology* **35**:291-301.
- Leslie, P. H. 1945. On the use of matrices in certain population mathematics. *Biometrika*:183-212.
- Lewontin, R. C. & D. Cohen. 1969. On population growth in a randomly varying environment. *Proceedings of the National Academy of Sciences* **62**:1056-1060.
- Lindberg, M. S., W. L. Kendall, J. E. Hines, & M. G. Anderson. 2001. Combining band recovery data and Pollock's robust design to model temporary and permanent emigration. *Biometrics* **57**:273-281.
- Lindström, J. 1999. Early development and fitness in birds and mammals. *Trends in Ecology & Evolution* **14**:343-348.
- Mainguy, J., G. Gauthier, J. F. Giroux, & J. Bety. 2006. Gosling growth and survival in relation to brood movements in Greater Snow Geese (*Chen caerulescens atlantica*). *Auk* **123**:1077-1089.
- Masse, H., L. Rochefort, & G. Gauthier. 2001. Carrying capacity of wetland habitats used by breeding greater snow geese. *Journal of Wildlife Management* **65**:271-281.
- McCleery, R., C. Perrins, B. Sheldon, & A. Charmantier. 2008. Age-specific reproduction in a long-lived species: the combined effects of senescence and individual quality. *Proceedings of the Royal Society B: Biological Sciences* **275**:963-970.

- McLaughlin, J. D. & B. P. McGurk. 1987. An analysis of gizzard worm infections in fall migrant ducks at Delta, Manitoba, Canada. *Canadian Journal of Zoology* **65**:1470-1477.
- Menu, S., G. Gauthier, & A. Reed. 2002. Changes in survival rates and population dynamics of greater snow geese over a 30-year period: implications for hunting regulations. *Journal of Applied Ecology* **39**:91-102.
- Menu, S., G. Gauthier, & A. Reed. 2005. Survival of young greater snow geese (*Chen caerulescens atlantica*) during fall migration. *Auk* **122**:479-496.
- Menu, S., J. B. Hestbeck, G. Gauthier, & A. Reed. 2000. Effects of neck bands on survival of greater snow geese. *Journal of Wildlife Management* **64**:544-552.
- Monticelli, D., J. A. Ramos, J. E. Hines, J. D. Nichols, & J. A. Spendelow. 2008. Juvenile survival in a tropical population of roseate terns: interannual variation and effect of tick parasitism. *Marine Ecology-Progress Series* **365**:277-287.
- Morris, W. F. & D. F. Doak. 2004a. Buffering of life histories against environmental stochasticity: Accounting for a spurious correlation between the variabilities of vital rates and their contributions to fitness. *American Naturalist* **163**:579-590.
- Morris, W. F. & D. F. Doak. 2004b. Buffering of life histories against environmental stochasticity: accounting for a spurious correlation between the variabilities of vital rates and their contributions to fitness. *American Naturalist* **163**:579-590.
- Morrison, R. I. G., N. C. Davidson, & J. R. Wilson. 2007. Survival of the fattest: body stores on migration and survival in red knots *Calidris canutus islandica*. *Journal of Avian Biology* **38**:479-487.
- Naef-Daenzer, B., F. Widmer, & M. Nuber. 2001. Differential post-fledging survival of great and coal tits in relation to their condition and fledging date. *Journal of Animal Ecology* **70**:730-738.
- Nevoux, M., J. Forcada, C. Barbraud, J. Croxall, & H. Weimerskirchi. 2010. Bet-hedging response to environmental variability, an intraspecific comparison. *Ecology* **91**:2416-2427.
- Nevoux, M., H. Weimerskirch, & C. Barbraud. 2007. Environmental variation and experience-related differences in the demography of the long-lived black-browed albatross. *Journal of Animal Ecology* **76**:159-167.
- Newborn, D. & R. Foster. 2002. Control of parasite burdens in wild red grouse *Lagopus lagopus scoticus* through the indirect application of anthelmintics. *Journal of Applied Ecology* **39**:909-914.



- Newton, I. 1989. Lifetime Reproduction in Birds. Academic Press London.
- Newton, I. 2010. Bird Migration. Collins New Naturalist Library, London.
- Nichols, J. D., R. J. Blohm, R. E. Reynolds, R. E. Trost, J. E. Hines, & J. P. Bladen. 1991. Band reporting rates for mallards with reward bands of different dollar values. *Journal of Wildlife Management* **55**:119-126.
- Nichols, J. D., M. J. Conroy, D. R. Anderson, & K. P. Burnham. 1984. Compensatory mortality in waterfowl population: a Review of the evidence and implications for research and management. *Transactions of the North American Wildlife and Natural Resources Conference* **49**:535-554.
- Nichols, J. D., R. E. Reynolds, R. J. Blohm, R. F. Trost, J. E. Hines, & J. P. Bladen. 1995. Geographic-variation in band reporting rates for mallards based on reward banding. *Journal of Wildlife Management* **59**:697-708.
- Nichols, J. D. & B. K. Williams. 2006. Monitoring for conservation. *Trends in Ecology & Evolution* **21**:668-673.
- Nunn, C. L., P. Lindenfors, E. R. Pursall, & J. Rolff. 2009. On sexual dimorphism in immune function. *Philosophical Transactions of the Royal Society B-Biological Sciences* **364**:61-69.
- O'Neal, D. M., R. P. Kiley, & E. D. Ketterson. 2011. The effect of winter sex ratio on immune function and condition in a differential migrant. *Physiology & Behavior* **102**:406-413.
- Odum, E. P. 1971. *Fundamentals of Ecology*.
- Odum, E. P. 1983. *Basic Ecology*. Saunders College Publishing, Philadelphia.
- Padding, P. I. & J. A. Royle. 2012. Assessment of bias in US waterfowl harvest estimates. *Wildlife Research* **39**:336-342.
- Pedersen, A. B. & T. J. Greives. 2008. The interaction of parasites and resources cause crashes in a wild mouse population. *Journal of Animal Ecology* **77**:370-377.
- Peig, J. & A. J. Green. 2009. New perspectives for estimating body condition from mass/length data: the scaled mass index as an alternative method. *Oikos* **118**:1883-1891.
- Pemberton, J. M. 2010. Evolution of quantitative traits in the wild: mind the ecology. *Philosophical Transactions of the Royal Society B: Biological Sciences* **365**:2431-2438.

- Pfister, C. A. 1998. Patterns of variance in stage-structured populations: Evolutionary predictions and ecological implications. *Proceedings of the National Academy of Sciences of the United States of America* **95**:213-218.
- Plummer, M. 2003. JAGS: A program for analysis of Bayesian graphical models using Gibbs sampling. <http://citeseer.ist.psu.edu/plummer03jags.html>.
- Pollock, K. H. 1982. A capture-recapture design robust to unequal probability of capture. *Journal of Wildlife Management* **46**:752-757.
- Poussart, C., G. Gauthier, & J. Larochelle. 2001. Incubation behaviour of greater snow geese in relation to weather conditions. *Canadian Journal of Zoology- Revue Canadienne De Zoologie* **79**:671-678.
- Poysa, H., J. Elmer, P. Nummi, G. Gunnarsson, & K. Sjöberg. 2004. Ecological basis of sustainable harvesting: Is the prevailing paradigm of compensatory mortality still valid? *Oikos* **104**:612-615.
- Pradel, R. 2005. Multievent: An extension of multistate capture-recapture models to uncertain states. *Biometrics* **61**:442-447.
- Pradel, R. 2009. The stakes of capture–recapture models with state uncertainty. Pages 781-795 *in* D. Thomson, E. Cooch, and M. Conroy, editors. *Modeling Demographic Processes In Marked Populations*. Springer US.
- Pradel, R., R. Choquet, & A. Béchet. 2012. Breeding Experience Might Be a Major Determinant of Breeding Probability in Long-Lived Species: The Case of the Greater Flamingo. *PLoS ONE* **7**:e51016.
- Pradel, R., J. E. Hines, J. D. Lebreton, & J. D. Nichols. 1997a. Capture-recapture survival models taking account of transients. *Biometrics* **53**:60-72.
- Pradel, R., A. R. Johnson, A. Viallefont, R. G. Nager, & F. Cezilly. 1997b. Local recruitment in the Greater Flamingo: A new approach using capture-mark-recapture data. *Ecology* **78**:1431-1445.
- Prevett, J. & C. D. MacInnes. 1980. Family and other social groups in Snow Geese. *Wildlife Monographs*:3-46.
- Promislow, D. E. L. 1992. Costs of sexual selection in natural population of Mammals. *Proceedings of the Royal Society of London: B* **247**:203-210.
- Pugesek, B. H., C. Nations, K. L. Diem, & R. Pradel. 1995. Mark-resighting analysis of a California gull population. *Journal of Applied Statistics* **22**:625-639.
- R Development Core Team. 2010. R: a language and environment for statistical computing. R Foundation for Statistical Computing, Vienna, Austria.

- Redpath, S. M., F. Mougeot, F. M. Leckie, D. A. Elston, & P. J. Hudson. 2006. Testing the role of parasites in driving the cyclic population dynamics of a gamebird. *Ecology Letters* **9**:410-418.
- Reed, A. 1993. Duration of family bonds of brent geese *Branta bernicla* on the Pacific coast of North America. *Wildfowl* **44**:33-38.
- Reed, A., J. F. Giroux, & G. Gauthier. 1998. Population size, productivity, harvest and distribution. Pages 5-31 in B. D. J. Batt, editor. *The Greater Snow Goose: report of the arctic Goose Habitat Working Group*. Arctic Goose Joint Venture Special Publication. U.S. Fish and Wildlife Service, Washington, D.C. and Canadian Wildlife Service, Ottawa, Ontario.
- Reed, A., R. J. Hughes, & G. Gauthier. 1995. Incubation behavior and body-mass of female greater snow geese. *Condor* **97**:993-1001.
- Reed, A. & N. Plante. 1997. Decline in body mass, size, and condition of greater snow geese, 1975-94. *Journal of Wildlife Management* **61**:413-419.
- Reed, E. T. 2003. Coûts des soins parentaux et effets des conditions environnementales sur la reproduction de la grande oie des neiges. Université Laval, Québec, QC, Canada.
- Reed, E. T., J. Bêty, J. Mainguy, G. Gauthier, & J.-F. Giroux. 2003a. Molt migration in relation to breeding success in Greater Snow Geese. *Arctic* **56**:76-81.
- Reed, E. T. & A. M. Calvert. 2007. Evaluation of special conservation measures for Greater Snow Geese: report of the greater snow goose working group Arctic Goose Joint Venture Special Publication. Canadian Wildlife Service, Sainte-Foy (Québec).
- Reed, E. T., G. Gauthier, & J. F. Giroux. 2004a. Effects of spring conditions on breeding propensity of greater snow goose females. *Animal Biodiversity and Conservation* **27**:35-46.
- Reed, E. T., G. Gauthier, & J. F. Giroux. 2004b. Effects of spring conditions on breeding propensity of Greater Snow Goose females. *Animal Biodiversity and Conservation* **27**:35-46.
- Reed, E. T., G. Gauthier, & R. Pradel. 2005. Effects of neck bands on reproduction and survival of female greater snow geese. *Journal of Wildlife Management* **69**:91-100.
- Reed, E. T., G. Gauthier, R. Pradel, & J. D. Lebreton. 2003b. Age and environmental conditions affect recruitment in greater snow geese. *Ecology* **84**:219-230.

- Rexstad, E. A. 1992. Effect of hunting on annual survival of Canada geese in Utah. *Journal of Wildlife Management* **56**:297-305.
- Righi, M. & G. Gauthier. 2002. Natural infection by intestinal cestodes: variability and effect on growth in greater snow goose goslings (*Chen caerulescens atlantica*). *Canadian Journal of Zoology* **80**:1077-1083.
- Roff, D. A. 1992. *The Evolution of Life Histories. Theory and Analysis*. Chapman & Hall, New York.
- Roff, D. A. 2002. *Life History Evolution*. Sinauer Associates, Sunderland, USA.
- Rohwer, F. & M. Anderson. 1988. Female-biased philopatry, monogamy, and the timing of pair formation in migratory waterfowl. *Current Ornithology* **5**:187-221.
- Rolff, J. 2002. Bateman's principle and immunity. *Proceedings of the Royal Society of London Series B-Biological Sciences* **269**:867-872.
- Roth, O., J. P. Scharsack, I. Keller, & T. B. H. Reusch. 2011. Bateman's principle and immunity in a sex-role reversed pipefish. *Journal of Evolutionary Biology* **24**:1410-1420.
- Royle, J. A. & P. R. Garrettson. 2005. The effect of reward band value on mid-continent mallard band reporting rates. *Journal of Wildlife Management* **69**:800-804.
- Saether, B. E. 1988. Pattern of Covariation between Life-History Traits of European Birds. *Nature* **331**:616-617.
- Saether, B. E. & O. Bakke. 2000. Avian life history variation and contribution of demographic traits to the population growth rate. *Ecology* **81**:642-653.
- Sanz-Aguilar, A., A. Béchet, C. Germain, A. Johnson, & R. Pradel. 2012. To leave or not to leave: survival tradeoff between different migratory strategies in the greater flamingo. *Journal of Animal Ecology*.
- Sanz-Aguilar, A., B. Massa, F. Lo Valvo, D. Oro, E. Minguez, & G. Tavecchia. 2009. Contrasting age-specific recruitment and survival at different spatial scales: a case study with the European storm petrel. *Ecography* **32**:637-646.
- Schaub, M., O. Gimenez, B. R. Schmidt, & R. Pradel. 2004. Estimating survival and temporary emigration in the multistate capture-recapture framework. *Ecology* **85**:2107-2113.
- Schaub, M. & J. D. Lebreton. 2004. Testing the additive versus the compensatory hypothesis of mortality from ring recovery data using a random effects model. *Animal Biodiversity and Conservation* **27**:73-85.

- Schaub, M., R. Pradel, L. Jenni, & J. D. Lebreton. 2001. Migrating birds stop over longer than usually thought: An improved capture-recapture analysis. *Ecology* **82**:852-859.
- Schmalhausen, I. I. 1949. Factors of evolution: the theory of stabilizing selection.
- Schmutz, J. A. 1993. Survival and pre-fledging body-mass in juvenile emperor geese. *Condor* **95**:222-225.
- Schmutz, J. A. & C. R. Ely. 1999. Survival of greater white-fronted geese: Effects of year, season, sex, and body condition. *Journal of Wildlife Management* **63**:1239-1249.
- Schmutz, J. A. & J. A. Morse. 2000. Effects of neck collars and radiotransmitters on survival and reproduction of emperor geese. *Journal of Wildlife Management* **64**:231-237.
- Schwarz, C. J., J. F. Schweigert, & A. N. Arnason. 1993. Estimating migration rates using tag-recovery data. *Biometrics* **49**:177-193.
- Schwarz, C. J. & W. T. Stobo. 1997. Estimating temporary migration using the robust design. *Biometrics*:178-194.
- Seber, G. A. F. 1965. A note on the multiple-recapture census. *Biometrika* **52**:249-259.
- Seber, G. A. F. 1982. The estimation of animal abundance and related parameters. Second edition. Chapman, London and Macmillan, New York, USA.
- Sedinger, J. S., N. D. Chelgren, D. H. Ward, & M. S. Lindberg. 2008. Fidelity and breeding probability related to population density and individual quality in black brent geese *Branta bernicla nigricans*. *Journal of Animal Ecology* **77**:702-712.
- Sedinger, J. S., P. L. Flint, & M. S. Lindberg. 1995. Environmental Influence on life-history traits - growth, survival, and fecundity in black brant (*Brant bernicla*). *Ecology* **76**:2404-2414.
- Sedinger, J. S., M. P. Herzog, & D. H. Ward. 2004. Early environment and recruitment of black brant (*Branta bernicla nigricans*) into the breeding population. *Auk* **121**:68-73.
- Sedinger, J. S., M. S. Lindberg, & N. D. Chelgren. 2001. Age-specific breeding probability in black brant: effects of population density. *Journal of Animal Ecology* **70**:798-807.
- Sedinger, J. S. & C. A. Nicolai. 2011. Recent trends in first-year survival for black brant breeding in Southwestern Alaska. *Condor* **113**:511-517.

- Shea, K. & NCEAS Working Group on Population Management. 1998. Management of populations in conservation, harvesting and control. *Trends in Ecology & Evolution* **13**:371-375.
- Shutler, D., R. T. Alisauskas, & J. Daniel McLaughlin. 2012. Associations between body composition and helminths of lesser snow geese during winter and spring migration. *International Journal for Parasitology* **42**:755-760.
- Slattery, S. M. 2000. Factors affecting first-year survival in Ross' Geese. University of Saskatchewan, Saskatoon, Saskatchewan, Canada.
- Slattery, S. M. & R. T. Alisauskas. 2002. Use of the Barker model in an experiment examining covariate effects on first-year survival in Ross's Geese (*Chen rossii*): a case study. *Journal of Applied Statistics* **29**:497-508.
- Smith, G. W. & R. E. Reynolds. 1992. Hunting and Mallard Survival 1979-88. *Journal of Wildlife Management* **56**:306-316.
- Spiegelhalter, D. J., N. G. Best, B. P. Carlin, & A. Van Der Linde. 2002. Bayesian measures of model complexity and fit. *Journal of the Royal Statistical Society: Series B (Statistical Methodology)* **64**:583-639.
- Stearns, S. C. 1989. Trade-offs in life-history evolution. *Functional Ecology* **3**:259-268.
- Stearns, S. C. 2002. Progress on canalization. *Proceedings of the National Academy of Sciences of the United States of America* **99**:10229-10230.
- Stearns, S. C. & T. J. Kawecki. 1994. Fitness sensitivity and the canalization of life-history traits. *Evolution* **48**:1438-1450.
- Taber, R. D. 1971. Criteria of Sex and Age. Pages 325-402 *in* R. H. Giles Jr., editor. *Wildlife Management Techniques*. The Wildlife Society, Washington, D.C.
- Toïgo, C. & J. M. Gaillard. 2003. Causes of sex-biased adult survival in ungulates: sexual size dimorphism, mating tactic or environment harshness? *Oikos* **101**:376-384.
- Turcotte, Y. & J. Bédard. 1989. Shared parental investment, parent-offspring conflict and brood size in greater snow geese. *Animal Behaviour* **38**:703-706.
- van de Pol, M., Y. Vindenes, B. E. Saether, S. Engen, B. J. Ens, K. Oosterbeek, & J. M. Tinbergen. 2010. Effects of climate change and variability on population dynamics in a long-lived shorebird. *Ecology* **91**:1192-1204.

- van Noordwijk, A. J. & G. De Jong. 1986. Acquisition and allocation of resources: their influence on variation in life history tactics. *The American Naturalist* **128**:137-142.
- Viallefont, A., F. Cooke, & J. D. Lebreton. 1995. Age-specific costs of first-time breeding. *Auk* **112**:67-76.
- Wagner, G. P., G. Booth, & H. Bagheri-Chaichian. 1997. A population genetic theory of canalization. *Evolution* **51**:329-347.
- Warren, S. M., A. Fox, A. Walsh, & P. O'Sullivan. 1993. Extended parent-offspring relationships in Greenland White-fronted Geese (*Anser albifrons flavirostris*). *The Auk* **110**:145-148.
- Weimerskirch, H. 1992. Reproductive effort in long-lived birds: age-specific patterns of condition, reproduction and survival in the wandering albatross. *Oikos* **64**:464-473.
- Williams, B. K. & J. D. Nichols. 2001. Systems identification and the adaptive management of waterfowl in the United States. *Wildlife Biology* **7**:223-236.
- Williams, B. K., J. D. Nichols, & M. J. Conroy. 2002. Analysis and management of animal populations. Academic Press, London.
- Williams, G. C. 1966. Natural selection, costs of reproduction, and a refinement of Lack's principle. *American Naturalist* **100**:687-&.
- Zimmerman, G. S., W. L. Kendall, T. J. Moser, G. C. White, & P. F. Doherty. 2009a. Temporal patterns of apparent leg band retention in North American geese. *Journal of Wildlife Management* **73**:82-88.
- Zimmerman, G. S., T. J. Moser, W. L. Kendall, P. F. Doherty, G. C. White, & D. F. Caswell. 2009b. Factors influencing reporting and harvest probabilities in North American geese. *Journal of Wildlife Management* **73**:710-719.