

EUROPEAN LABORATORY FOR PARTICLE PHYSICS

CERN-SPSC-2007-033

SPSC-P-330

November 16, 2007

Addendum-3 to the proposal P330

Report from the NA61/SHINE pilot run performed in October 2007

By NA61 Collaboration

<http://na61.web.cern.ch>

The NA61/SHINE Collaboration

N. Abgrall²³, A. Aduszkiewicz²⁴, B. Andrieu¹¹, T. Anticic¹³, N. Antoniou¹⁸, A. G. Asryan¹⁵, B. Baatar⁹, A. Blondel²³, J. Blumer⁵, L. Boldizsar¹⁰, A. Bravar²³, J. Brzychczyk⁸, S. A. Bunyatov⁹, K.-U. Choi¹², P. Christakoglou¹⁸, P. Chung¹⁶, J. Cleymans¹, D. A. Derkach¹⁵, F. Diakonos¹⁸, W. Dominik²⁴, J. Dumarchez¹¹, R. Engel⁵, A. Ereditato²¹, G. A. Feofilov¹⁵, Z. Fodor¹⁰, M. Gaździcki^{17,22}, M. Golubeva⁶, K. Grebieszko²⁵, F. Guber⁶, T. Hasegawa⁷, A. Haungs⁵, M. Hess²¹, S. Igolkin¹⁵, A. S. Ivanov¹⁵, A. Ivashkin⁶, K. Kadija¹³, R. Karabowicz⁸, N. Katrynska⁸, D. Kielczewska²⁴, D. Kikola²⁵, J.-H. Kim¹², T. Kobayashi⁷, V. I. Kolesnikov⁹, D. Kolev⁴, R. S. Kolevatov¹⁵, V. P. Kondratiev¹⁵, A. Kurepin⁶, R. Lacey¹⁶, A. Laszlo¹⁰, S. Lehmann²¹, B. Lungwitz²², V. V. Lyubushkin⁹, A. Maevskaya⁶, Z. Majka⁸, A. I. Malakhov⁹, A. Marchionni², M. Di Marco²³, V. Matveev⁶, G. L. Melkumov⁹, A. Meregaglia², M. Messina²¹, C. Meurer⁵, P. Mijakowski¹⁴, M. Mitrovski²², T. Montaruli^{18,*}, St. Mrówczyński¹⁷, S. Murphy²³, T. Nakadaira⁷, P. A. Naumenko¹⁵, V. Nikolic¹³, K. Nishikawa⁷, T. Palczewski¹⁴, G. Palla¹⁰, A. D. Panagiotou¹⁸, W. Peryt²⁵, A. Petridis¹⁸, R. Planeta⁸, J. Pluta²⁵, B. A. Popov⁹, M. Posiadala²⁴, P. Przewlocki¹⁴, W. Rauch³, M. Ravonel²³, R. Renfordt²², D. Röhrich²⁰, E. Rondio¹⁴, B. Rossi²¹, M. Roth⁵, A. Rubbia², M. Rybczynski¹⁷, A. Sadovsky⁶, K. Sakashita⁷, T. Schuster²², T. Sekiguchi⁷, P. Seyboth¹⁷, K. Shileev⁶, A. N. Sissakian⁹, E. Skrzypczak²⁴, M. Slodkowski²⁵, A. S. Sorin⁹, P. Staszal⁸, G. Stefanek¹⁷, J. Stepaniak¹⁴, C. Strabel², H. Stroebele²², T. Susa¹³, I. Szentpetery¹⁰, M. Szuba²⁵, A. Taranenko¹⁶, R. Tsenov⁴, M. Unger⁵, M. Vassiliou¹⁸, V. V. Vechernin¹⁵, G. Vesztegombi¹⁰, Z. Wlodarczyk¹⁷, A. Wojtaszek¹⁷, J.-G. Yi¹², I.-K. Yoo¹²

¹Cape Town University, Cape Town, South Africa

²ETH, Zurich, Switzerland

³Fachhochschule Frankfurt, Frankfurt, Germany

⁴Faculty of Physics, University of Sofia, Sofia, Bulgaria

⁵Forschungszentrum Karlsruhe, Karlsruhe, Germany

⁶Institute for Nuclear Research, Moscow, Russia

⁷Institute for Particle and Nuclear Studies, KEK, Tsukuba, Japan

⁸Jagellonian University, Cracow, Poland

⁹Joint Institute for Nuclear Research, Dubna, Russia

¹⁰KFKI Research Institute for Particle and Nuclear Physics, Budapest, Hungary

¹¹LPNHE, University of Paris VI and VII, Paris, France

¹²Pusan National University, Pusan, Republic of Korea

¹³Rudjer Boskovic Institute, Zagreb, Croatia

¹⁴Soltan Institute for Nuclear Studies, Warsaw, Poland

¹⁵St. Petersburg State University, St. Petersburg, Russia

¹⁶State University of New York, Stony Brook, USA

¹⁷Świętokrzyska Academy, Kielce, Poland

- ¹⁸University of Athens, Athens, Greece
²⁰University of Bergen, Bergen, Norway
²¹University of Bern, Bern, Switzerland
²²University of Frankfurt, Frankfurt, Germany
²³University of Geneva, Geneva, Switzerland
²⁴University of Warsaw, Warsaw, Poland
²⁵Warsaw University of Technology, Warsaw, Poland

1 Introduction

This documents presents a brief report from the NA61 [1, 2, 3] pilot run performed in October 2007.

The aims of this run were [2]:

- set up and test the NA61 apparatus and the detector prototypes,
- take pilot physics data on interactions of 31 GeV/c protons on a thin carbon and the T2K replica targets.

The NA61 detector and prototypes prepared for the 2007 run are describe in Section I. The run history and first results are given in Sections II and III, respectively.

2 The NA61 detector and detector prototypes

2.1 The NA61 detector

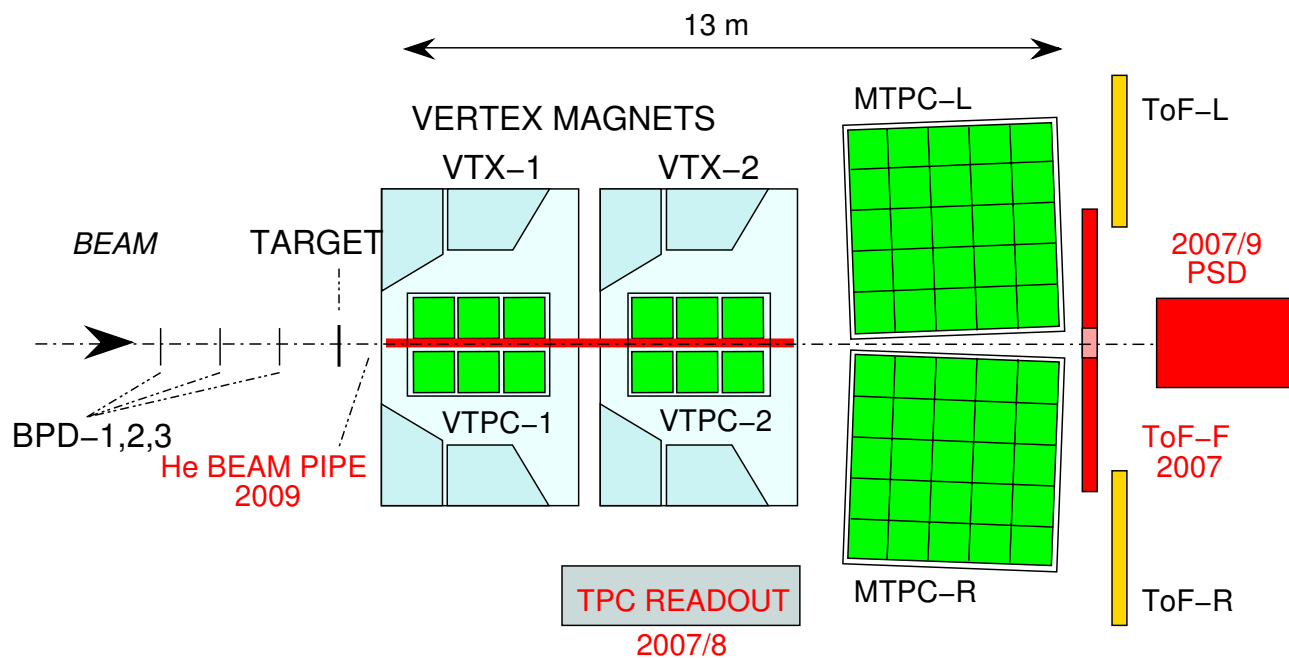

Figure 1: The NA61 set-up with the basic upgrades and years of their realization indicated in red.

The NA61 experiment is a large acceptance hadron spectrometer at the CERN-SPS for the study of the hadronic final states produced by collisions of various beam particles (π , p, C,

S and In) with a variety of fixed targets at the SPS energies. The main components of the current set-up were constructed and used by the NA49 experiment [4]. The main tracking devices are four large volume Time Projection Chambers (TPCs) (Fig. 1) which are capable of detecting up to 70% of all charged particles created in the studied reactions. Two of them, the vertex TPCs (VTPC-1 and VTPC-2), are located in the magnetic field of two super-conducting dipole magnets (maximum bending power of 9 Tm) and two others (MTPC-L and MTPC-R) are positioned downstream of the magnets symmetrically to the beam line. The NA61 TPCs allowed precise measurements of particle momenta p with a resolution of $\sigma(p)/p^2 \cong (0.3-7) \cdot 10^{-4} (\text{GeV}/c)^{-1}$. The setup is supplemented by two time of flight (ToF-L/R) detector arrays with a time measurement resolution $\sigma_{tof} \approx 60$ ps.

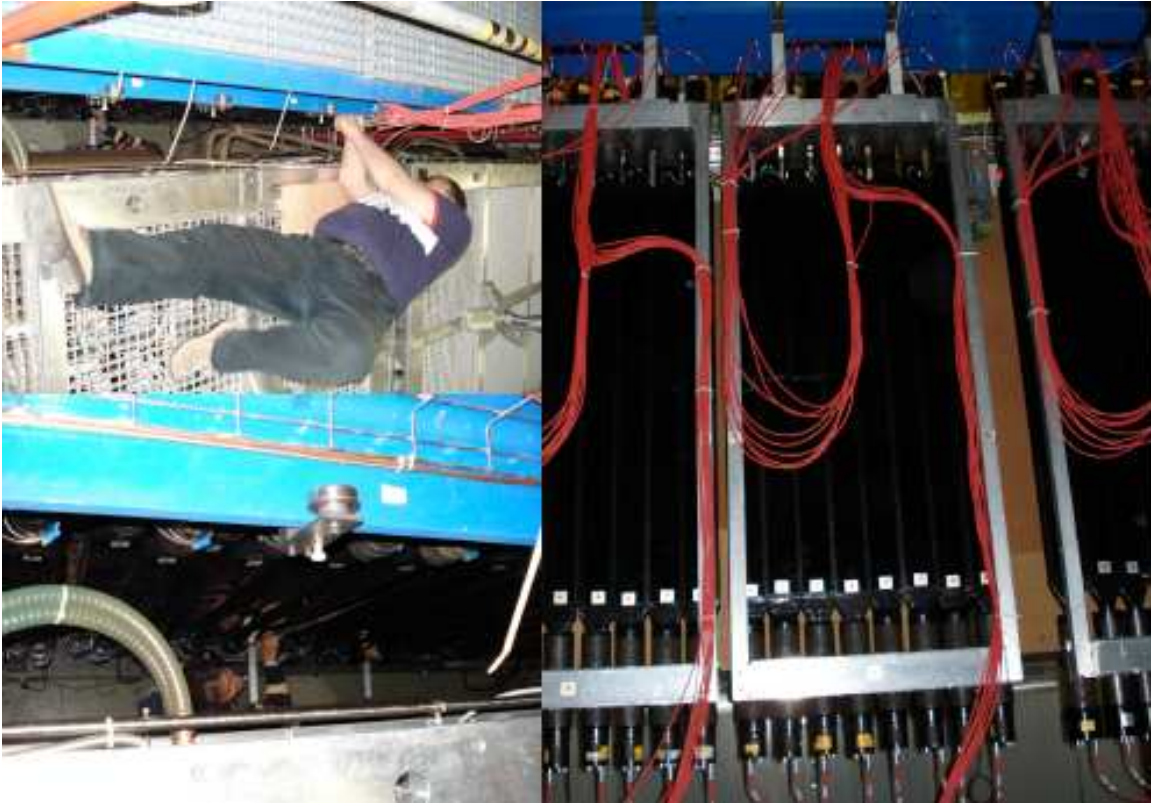

Figure 2: The installation (left) and the installed three modules (right) of the ToF-F detector constructed for the 2007 run.

For the 2007 run a new time of flight detector (ToF-F) was constructed in order to extend pion and kaon identification to low momenta ($p < 4 \text{ GeV}/c$) as required for the T2K measurements. The detector consists of 64 scintillator bars, oriented vertically, and read out on both sides with Hamamatsu R1828 photo-multipliers. The size of each scintillator bar is $120 \times 10 \times 2.5 \text{ cm}^3$. The expected resolution of the new ToF-F wall is ≤ 120 ps. This resolution

provides a $5 \sigma \pi/K$ separation at 3 GeV/c. The ToF-F wall is installed downstream of the MTPC-L and MTPC-R (Fig. 1), filling the gap between the ToF-R and ToF-L walls. The installation phase and the installed three modules of the ToF-F are shown in Fig. 2.

Furthermore, numerous small modifications and upgrades of the NA61 facility were performed before the run. They include:

- speed-up of the ToF-L/R readout,
- modification of the DAQ system to allow writing data on disc,
- refurbishing of the Beam Position Detectors,
- preparation of the targets and target holders,
- preparation and installation of the new beam counters.

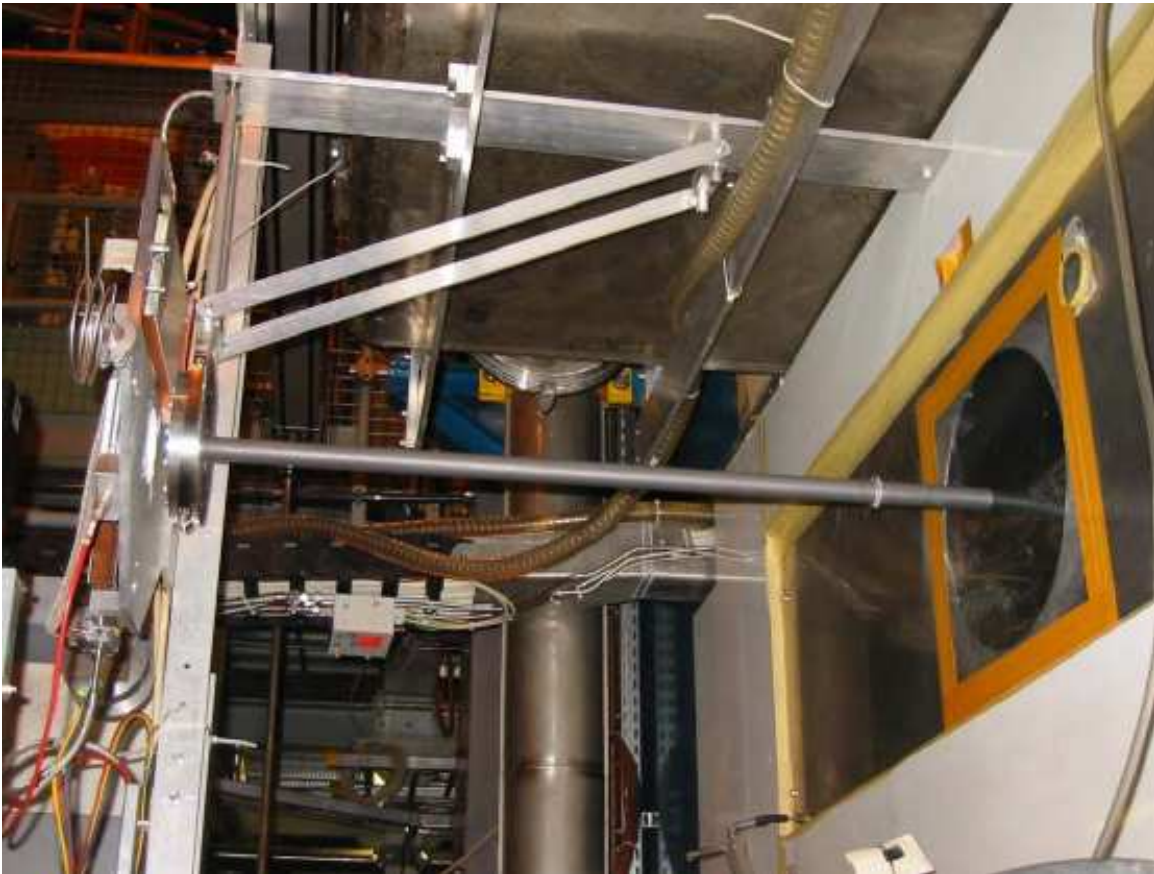

Figure 3: The T2K replica target installed in the NA61 set-up in front of the VTX-1 magnet.

Two carbon (isotropic graphite, $\rho = 1.82 \text{ g/cm}^3$) targets were used during the 2007 run:

- a 2 cm-long target (≈ 0.04 of an interaction length), the so-called thin target, and

- a 90 cm long cylinder of 2.6 cm diameter (≈ 1.9 interaction lengths), the so-called T2K replica target, see Fig. 3.

The center of the targets was positioned about 80 cm upstream from VTPC-1.



Figure 4: The PSD super-module positioned in the NA61 experiment downstream of the MTPC hut.

Proton beam particles are identified and selected by means of CEDAR-West and threshold Cerenkov counters as well as several scintillation counters. The trajectory of beam particles is precisely measured by the beam position detectors (BPD-1/2/3 in Fig. 1). These detectors consist of pairs of proportional chambers and are positioned along the beam line.

Interactions in the target were selected by an anti-coincidence of the incoming beam particle with a small scintillation counter (S4) placed on the beam axis between the two vertex magnets.

2.2 The detector prototypes

Two detector prototypes were constructed for and tested during the 2007 run, namely:

- the super-module of the Projectile Spectator Detector and
- the "FE tester" needed for the development of the new TPC readout electronics.

2.2.1 The PSD super-module

The Projectile Spectator Detector will be constructed for the ion runs of NA61. It allows a precise determination of the number of projectile spectator nucleons, which is crucial in the search for the critical point of strongly interacting matter.

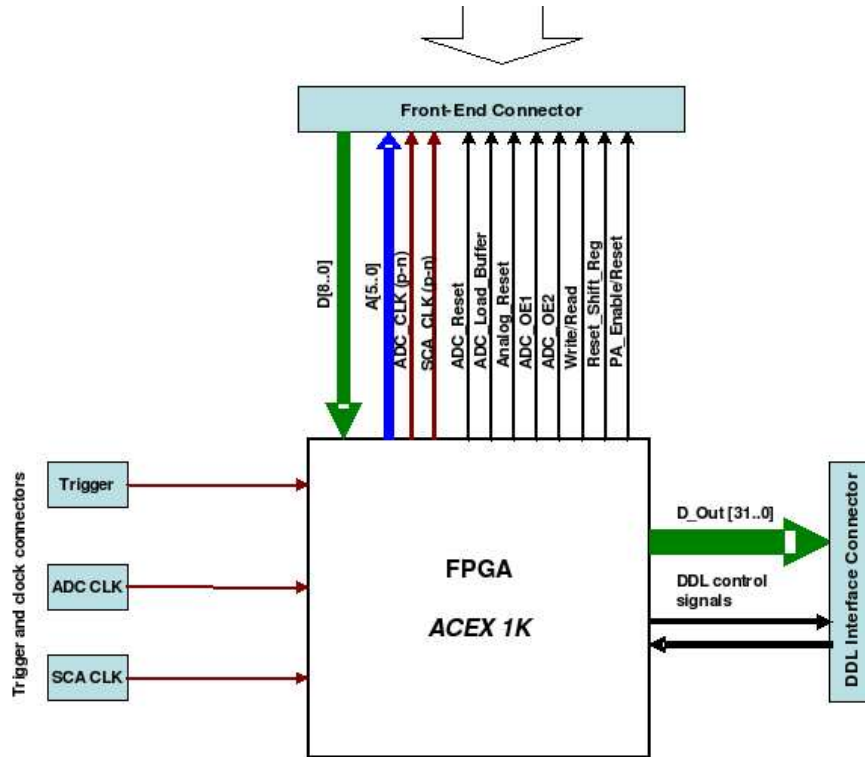

Figure 5: The layout of the front-end read out board (FE tester) used for the test purposes in the 2007 run.

To study the energy resolution of the PSD a new 3x3 array (super-module) of PSD modules has been constructed. A single PSD module is divided longitudinally into 10 sections with individual readout of each section by 3x3 mm² AMPDs produced by Dubna-Micron. Each section consists of 6 lead/scintillator layers with a thickness of about 0.6 nuclear interaction lengths. All 10 sections (60 lead/scintillator sandwiches) are loaded into a steel box with 0.5 mm thick walls. The sandwiches are tied by steel tape of the same thickness. The WLS-fibers coming from each scintillator tile are routed in a 2 mm air gap at the top side of the module. Every WLS-fiber is covered by a thin black pipe for light isolation and mechanical protection. The light from the 6 WLS-fibers from one section is collected by one optical connector viewed by an AMPD. The electrical signals from the 10 AMPDs of each module are fed to the amplifiers through short 10-15 cm coaxial cables.

9 modules were assembled in a 3x3 module array which was placed in the final position of the PSD detector, downstream of the MTPC hut on a movable support structure (see Fig. 4).

2.2.2 The "FE Tester"

A large amount of re-engineering work on the present TPC read-out system (i.e. understanding the operation of the FE and motherboards) had to be done. For testing and measurement purposes a dedicated FE readout board (FE Tester) was developed. It reads out 3 FE cards on a single flat cable and it has test points to access all FE interface signals. The data are transmitted to and stored on a server PC through a DDL link with the same DDL protocol as will be used in the new readout electronics. A simple graphical interface program has been written for visualization of data read out from the FE card(s). The FE Tester diagram is shown in Fig. 5.

3 The 2007 run

The 2007 NA61 pilot run started on September 27 and ended on October 29. In this period the following studies were performed:

- September 27 - October 3:
test of the PSD super-module with beams of muons at 75 GeV/c and hadrons at 20, 30, 40, 80 and 158 GeV/c,
- September 27 - October 12:
installation, test and tuning of the beam and trigger counters with beams of hadrons at 75 GeV/c and 30.9 GeV/c; optimization of the proton beam at 30.9 GeV/c
- October 13 - October 24:
pilot data taking with 30.9 GeV/c protons on the thin graphite target,
- October 25 - October 29:
pilot data taking with 30.9 GeV/c protons on the T2K replica graphite target,
- October 25 - October 29:
TPC readout tests with the FE Tester.

In total about $1.5 \cdot 10^6$ events were registered. This includes 660k events with the thin target, 220k events with the T2K replica target and 80k events without target (empty target events) which will be used to obtain first physics results for T2K.

Several unexpected problems were encountered, namely:

- the raw data transfer to the PC was limiting the event rate; in the 2008 run the TPC read-out system will be changed,
- the frequency controller of the VTPC-1 gas compressor had to be exchange; it was done within 24h without losing the beam time,
- the beam was unstable; several possibilities to improve beam stability in the 2008 run are under discussion,

-the NA49 DCS was not upgraded due to the problems with the firmware of the new controllers; it did not degraded the NA61 performance, the upgrade will be ready for the 2008 run.

Parallel to the run a workshop took place with lectures and discussions covering a broad range of subjects related to NA61, from safety during shifts to cosmic-ray physics [5].

4 The first results

4.1 The PSD super-module test

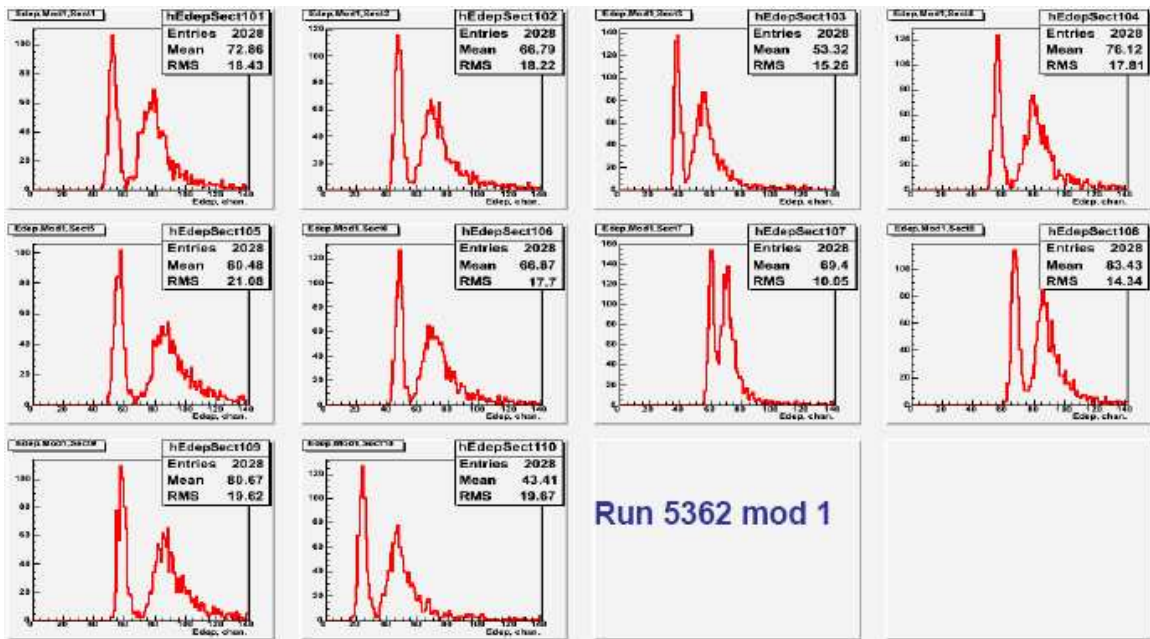

Figure 6: The response of the 10 subsequent longitudinal sections of the first module of the PSD prototype to the muon beam at 75 GeV/c. The muon peaks (second peak to the right of the pedestal peak) were used to determine the calibration coefficients.

The main goal of the PSD super-module test performed in 2007 was to determine the energy resolution and the linearity of the prototype.

The test started with calibration runs using the muon beam at 75 GeV/c. The muon energy calibration of each longitudinal section in the calorimeter is possible thanks to the large light yield of the scintillator tiles together with the AMPD's ability to detect low intensity signals. Peaks at 5 MeV from muon energy loss in 6 scintillator tiles are nicely separated from the pedestals, see Fig. 6. In order to obtain a full set of calibration coefficients the muon beam scan was performed for all 9 modules.

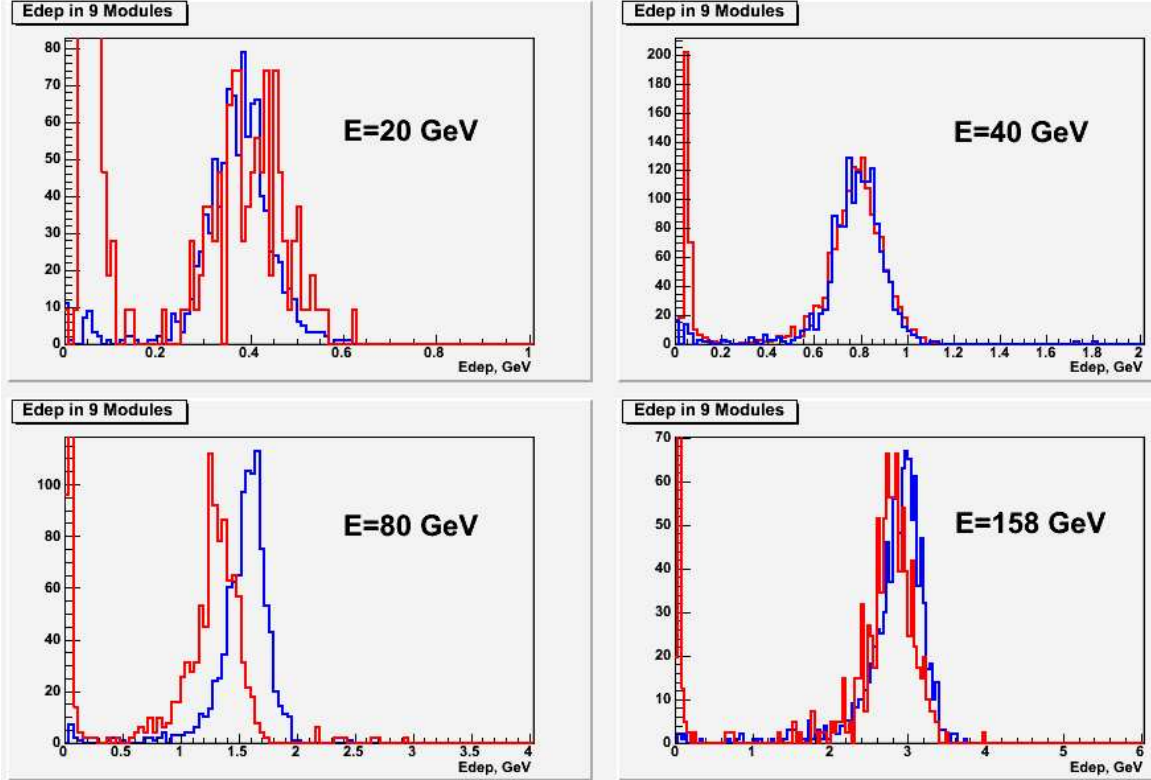

Figure 7: The measured (red) and simulated (blue) energy spectra for hadron beams at 20, 40, 80 and 158 GeV/c.

After the calibration runs the central module of the prototype was irradiated by hadron beams of 20, 30, 40, 80 and 158 GeV/c. The calibrated energy deposition summed over all 9 modules for hadron beams at all energies are shown in Fig. 7 together with the simulation results. As seen, the experimental and simulation spectra are in rather good agreement (with exception of the 80 GeV/c distribution).

The linearity of the calorimeter response to hadrons with different energies is shown in Fig. 8 (left). Here the dependence of the mean value of the deposited energies on the beam energy is presented. A linear response is observed. The significant deviation seen only for the 80 GeV point may indicate a problem with the beam energy definition at 80 GeV/c.

Fig. 8 (right) presents the energy dependence of the measured energy resolution. A fit to the experimental points yields a stochastic term of about 51% and a constant term of about 4.6%. The large constant term suggests the absence of full compensation in the calorimeter. Fig. 9 confirms this hypothesis. Here the energy deposition from hadrons and positrons is compared. As seen, the measured energy for positrons is about 20% higher than that for hadrons.

The test results, the non-zero constant term in the energy resolution and higher energy

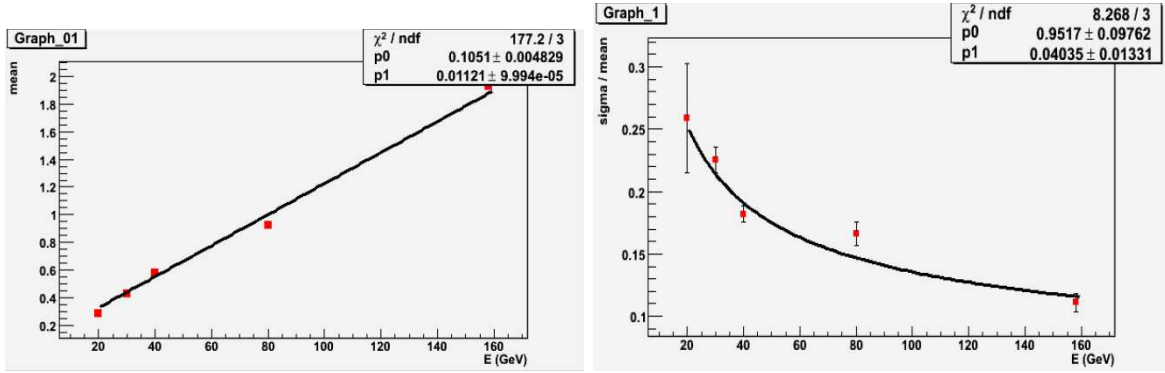

Figure 8: The linearity (left) and the resolution (right) of the PSD super-module.

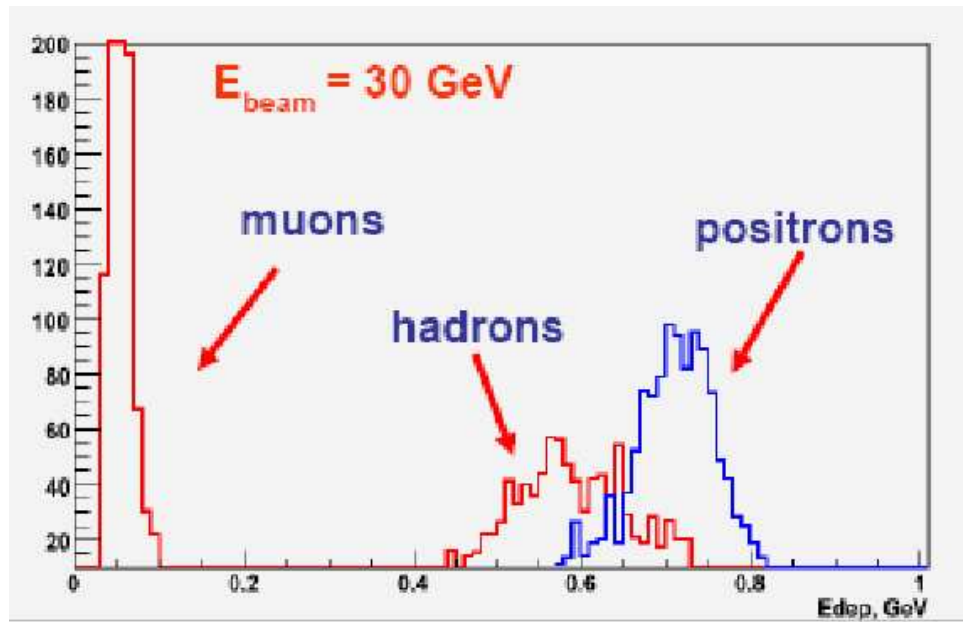

Figure 9: The energy deposition of hadron and positron beams of 30 GeV/c measured by the PSD super-module.

deposition for positrons than for hadrons, show that the selected ratio lead:scintillator=4:1 does not result in full compensation and should be modified in the final detector. A detailed study of the compensation for lead-scintillator calorimeters [6] indicates that full compensation might be achieved for the ratio lead:scintillator=4.55:1. Further R&D is requested for the determination of a fully compensating lead:scintillator ratio.

4.1.1 The "FE Tester"

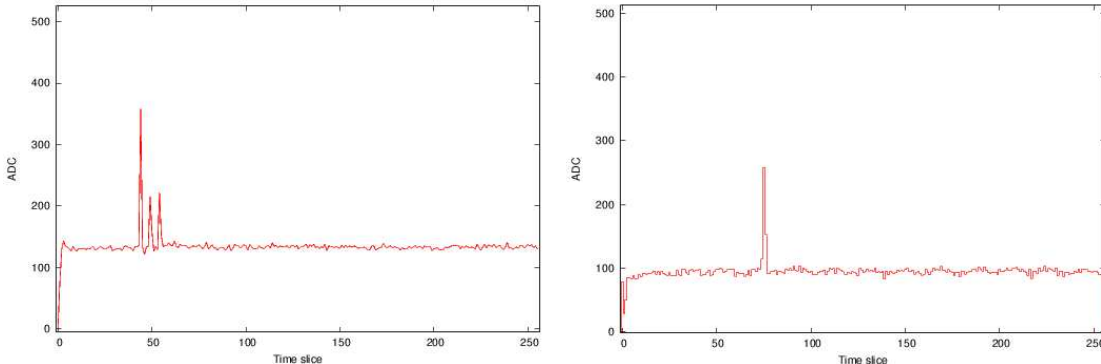

Figure 10: The pulser (left) and track (right) signals measured by the FE tester.

The FE Tester was connected to three consecutive front-end cards in one of the MTPC-L sectors. The signals generated by the pulser and by real tracks were recorded and are analyzed off-line. Two examples are shown in Figs. 10. The recorded track signals were matched and compared to the signals recorded by the current NA61 DAQ. The parameters of the clusters obtained via the FE Tester are similar to those of clusters recorded by the NA61 DAQ.

4.1.2 The pilot data for T2K

The major part of the 2007 run was devoted to recording pilot data for the T2K and cosmic-ray experiments. Charged hadrons produced in interactions of the 31 GeV/c proton beam on thin and T2K replica targets were registered using the NA61 TPCs. The data were taken with a magnetic field of total bending power of ≈ 1 Tm. In addition to the data production runs, numerous test and calibration runs were performed. They will allow to determine corrections and evaluate systematic errors of the final results. In the following several examples illustrating data quality are presented. They were produced during the 2007 run using the actual NA61 reconstruction software with approximate calibration parameters.

The "top view" display of the NA61 TPCs with tracks from a typical p+C interaction at 31 GeV/c is shown in Fig. 11. The low track multiplicity leads to a very low space density of tracks and consequently to almost 100 % track reconstruction efficiency.

The parameters of the TPCs (the Ar/CO₂ ratios, the drift voltages, the high voltages of the readout chambers) were tuned in order to reproduce the drift velocities and clusters properties established by NA49 as optimal. In Figs. 12 and 13 the distributions of the number of pad and time bins in the charged clusters created by the tracks passing the MTPC-L are shown in order to demonstrate the high quality of the taken data.

In order to perform an independent test of the beam properties the magnetic field was increased to its maximum value which deflected beam particles into the MTPC-L and VTPC-2

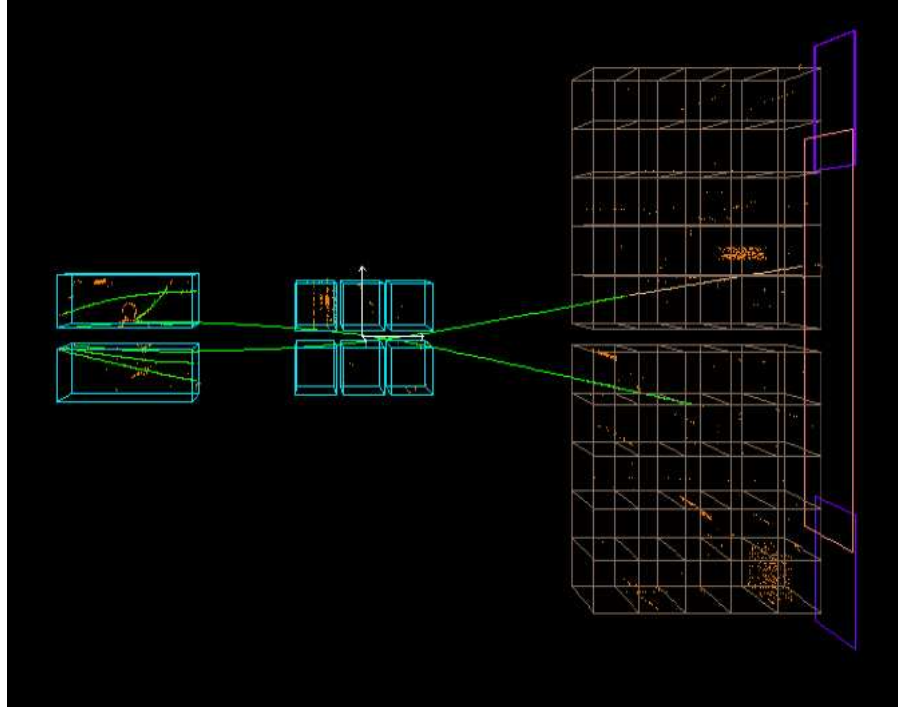

Figure 11: The "top view" display of a typical p+C interaction at 31 GeV/c registered by NA61 in the 2007 run.

detectors. The distribution of the reconstructed beam momentum is given in Fig. 14. Its mean value agrees within the beam line systematic error of about 130 MeV/c with the nominal set value of 30.92 GeV/c.

About 60% of all events registered with the thin target are interactions in the target. A first estimate of the inelastic cross section for p+C interactions at 31 GeV/c based on the target-in and target-out data yielded a value $265.3 \pm 3.5(stat. only)$ mb, which is only 7% higher than the expected value of 247 mb.

Finally, Fig. 15 shows the first invariant mass peak of K_S^0 mesons obtained after reconstruction of the V0 decay topology and fitting of the momenta at the decay point.

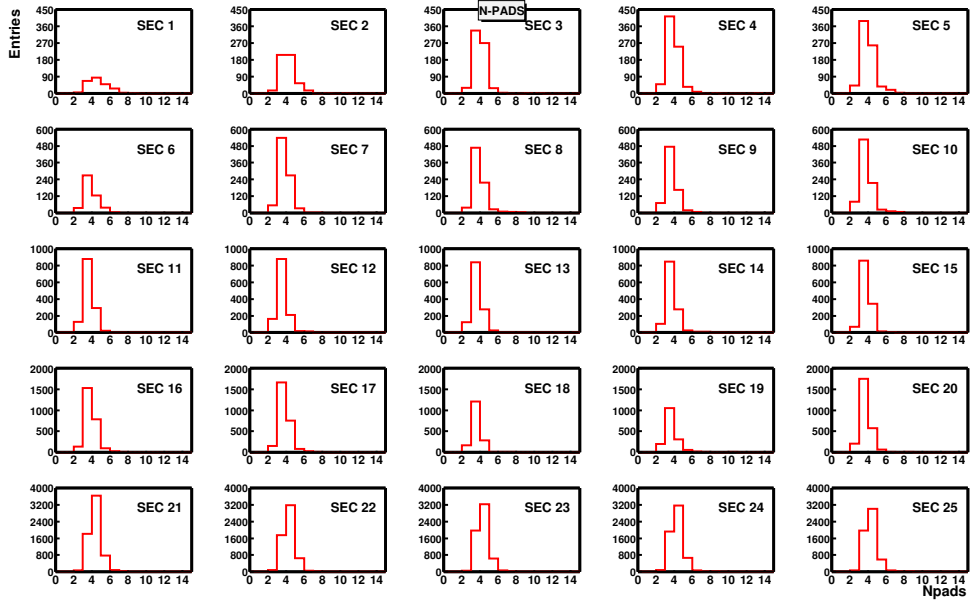

Figure 12: The distributions of the number of pad bins in the charged clusters created by the tracks passing the MTPC-L.

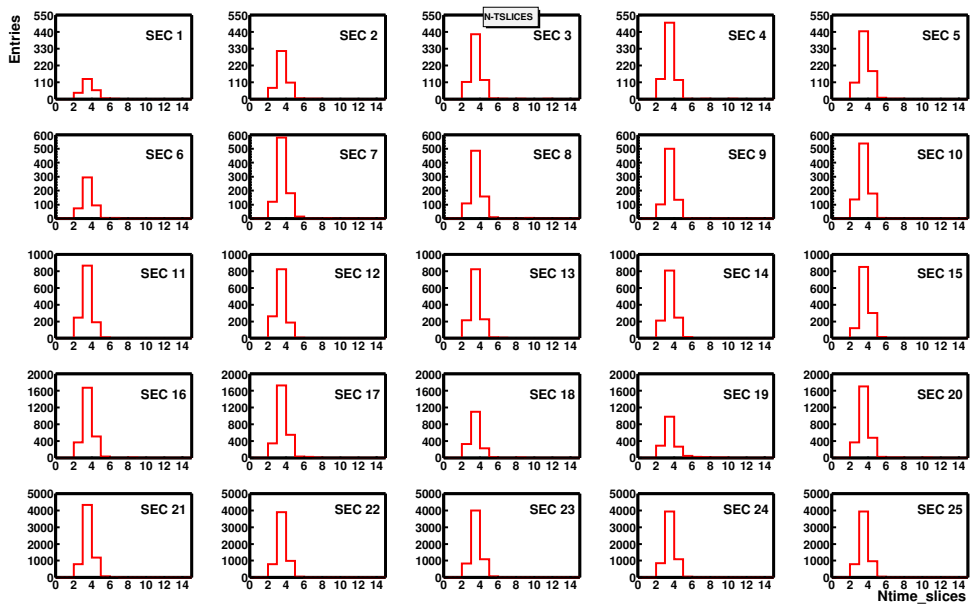

Figure 13: The distributions of the number of time bins in the charged clusters created by the tracks passing the MTPC-L.

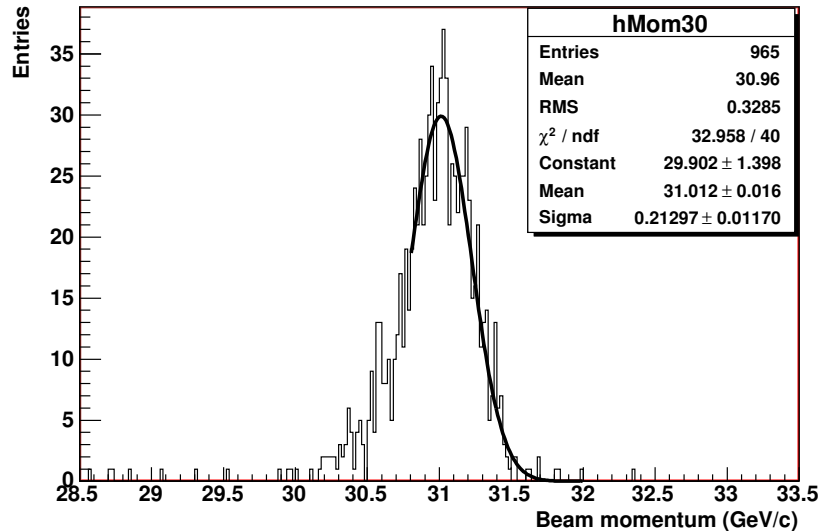

Figure 14: The distribution of the proton beam momentum measured by the NA61 TPCs in the 2007 run.

5 Summary

The main goals of the 2007 NA61 run were reached, namely:

- the NA61 apparatus (including the new ToF-F system) was run successfully and detector prototypes were installed and tested,
- pilot physics data on interactions of 31 GeV/c protons on thin and T2K replica targets were registered.

The test results are being analyzed, but already now it is clear that they were very useful and will lead to important improvements of the planned detector upgrades.

The pilot data taken for T2K are of a quality similar to that of NA49. Precise calibration work has started. Preliminary physics results are expected to be ready by May/June 2008.

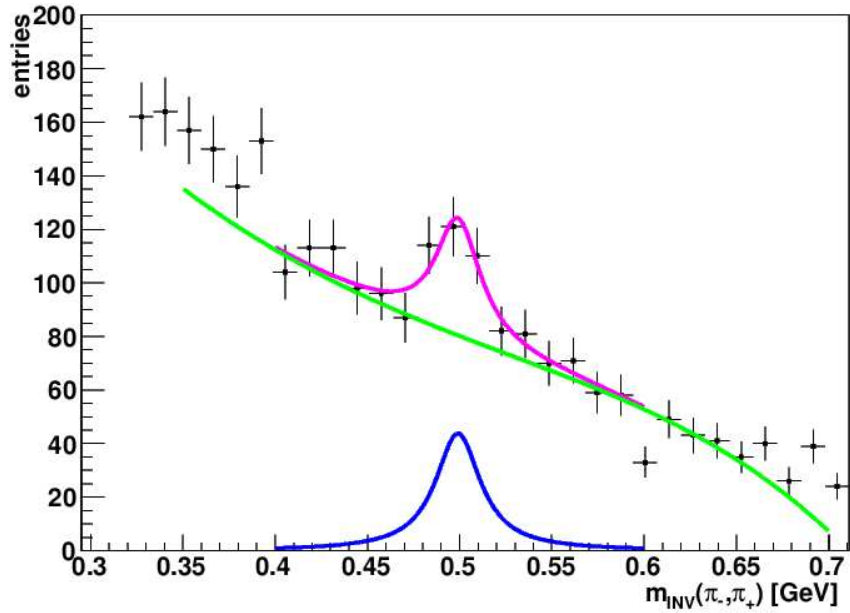

Figure 15: Invariant mass ($m_{INV}(\pi^+, \pi^-)$) distribution of charged pion pairs with a peak due to K_S^0 decays.

References

- [1] N. Antoniou *et al.* [NA61 Collaboration], CERN-SPSC-2006-034.
- [2] N. Antoniou *et al.* [NA61 Collaboration], CERN-SPSC-2007-004.
- [3] N. Abgrall *et al.* [NA61 Collaboration], CERN-SPSC-2007-019.
- [4] S. Afanasev *et al.* [NA49 Collaboration], Nucl. Instrum. Meth. A **430**, 210 (1999).
- [5] <http://indico.cern.ch/conferenceDisplay.py?confId=21907>
- [6] Y. Fujii, NIM A453, 237 (2000).