



Volume 107

2020

p-ISSN: 0209-3324

e-ISSN: 2450-1549

DOI: <https://doi.org/10.20858/sjsutst.2020.107.10>



Journal homepage: <http://sjsutst.polsl.pl>

Article citation information:

Pušár, M., Kopas, M., Pušár, D., Šoltésová, M. Influence of various homogenisation system configurations on output parameters of an experimental engine. *Scientific Journal of Silesian University of Technology. Series Transport*. 2020, **107**, 135-152. ISSN: 0209-3324.

DOI: <https://doi.org/10.20858/sjsutst.2020.107.10>.

Michal PUŠKÁR¹, Melichar KOPAS², Dušan PUŠKÁR³, Marieta ŠOLTÉSOVÁ⁴

INFLUENCE OF VARIOUS HOMOGENISATION SYSTEM CONFIGURATIONS ON OUTPUT PARAMETERS OF AN EXPERIMENTAL ENGINE

Summary. This article analyses the influence of various configurations concerning the homogenisation system on the output parameters of an experimental engine. The results presented in this article were obtained using experimental dynamometric measurement. A modular approach to the individual measurements consists of a sequential formation of the homogenisation system configurations. The experimentally obtained results are matches with the analytical relations, which are described in the related literature. These results can be presented for a wide spectrum of high-powerful engines because the homogenisation system does not depend on the construction and design arrangement of the engine itself. The analysed system was successfully applied in the motorcycles and it is a subject of the patent application.

Keywords: homogenisation system, output parameters, experimental engine

¹ Faculty of Mechanical Engineering, Technical University of Košice, Letná 9, 04001 Košice, Slovakia.
Email: michal.puskar@tuke.sk

² Faculty of Mechanical Engineering, Technical University of Košice, Letná 9, 04001 Košice, Slovakia.
Email: melichar.kopas@tuke.sk

³ Faculty of Mechanical Engineering, Technical University of Košice, Letná 9, 04001 Košice, Slovakia.
Email: dusan.puskar@tuke.sk

⁴ Faculty of Mining, Ecology, Process Control and Geotechnology, TU Košice, Park Komenského 19, 040 01 Košice, Slovakia, Email: marieta.soltesova@tuke.sk

1. INTRODUCTION

In this paper, results from the measurement of a high-powerful racing combustion engine are presented. These results were obtained by means of the system EW&C, which is operating as the data-recording process. This measuring equipment senses and records information during the engine working operation under real conditions and operational loading. A modular approach to the individual measuring consists of a sequential assembly of the individual components belonging to the engine inlet and exhaust system. An investigation of the individual configuration influences of both systems is performed by means of the sequential experimental measuring. The measurement of the exhaust pipe was based on the application of a tuned racing exhaust system. To perform experiments oriented to the inlet system, a new system of the thrust-ejector suction was developed to solve problems connected with an insufficient feeding of a cylinder with a fresh mixture. The pressure of air, which is sucked into the engine, is changed from the atmospheric value to the overpressure level. This phenomenon causes an increase of the engine power output and torque. According to the gained results, a relation between the newly developed inlet pipe and increasing of the engine torque was investigated. Furthermore, the experimentally obtained results align with the analytical relations described in the relevant literature. These results can be presented for a wide spectrum of high-powerful engines because the air inlet system is independent on the engine design and arrangement. The analysed system was successful in the motorbike applications. This can be seen in the positive results registered in the previous year as well as the patent application concerning this new design arrangement

2. EXPERIMENTAL MODEL AND MEASURING DEVICES

An analysis of the engine performance, as well as criteria for development of the inlet and exhaust pipe system, require deep knowledge of acoustics of both systems. The up-to-date known information from this area can be summarised into several conclusions.

In many scientific articles, experimental results and theoretical models of the acoustic waves and their impact on global efficiency of the piston combustion engines are presented. The fundamental information sources about the instable gas dynamics in internal distribution channels of combustion engines were presented during the '50s of the last century. Measuring methods of the local throughput in the pipe, together with computerised calculations, were improved considerably during the '80s [1]. A complete overview of topical knowledge oriented to the analysis and proposal of the inlet (suction) and exhaust systems of the internal combustion engine was published at the end of the '90s [2]. The theoretical Principia of one-dimensional acoustic models were described at the turn of the centuries. Then, the more complicated non-linear dynamic gas models were successfully transformed into simpler linear acoustic models [3, 4].

Very interesting results were obtained also by means of the Euler's equation solution for a pipe. This solution offered a high level of result reliability [5]. A principle of this methodology consists of solution of velocities and pressure equations with regard to the frequency using a method of matrix transfer, taking into consideration the theoretical limits for real values of the high-pressure levels in the exhaust gas system. This solution seems to be the most suitable method for analysis of the inlet and exhaust system with regard to noise reduction [6].

Some scientific works demonstrate acceptable conformity of the linear acoustic models with the experiments performed in the inlet and exhaust pipe of the piston combustion engines [7]. A wide range of the experimental tests and practical applications support the development criteria for the proposal of new theories. There are consistent efforts at integrating results obtained from research activities performed in the area of resonance and acoustic feedback among the inlet parts. Similarly, the abovementioned amount of information enables proposal of new methods for the projection of the inlet and exhaust systems of the piston engines [8].

A complex view on design and simulation of the high-power engines, including a proposal of the empirical methods for designers as well as the experimental data on the efficiency of the high-speed engines are summarised in the literature [9].

In spite of the present large amounts of publications and professional articles, only a small amount of measured data concerning mutual interrelations and influences among the individual parts of the inlet system are available. An arrangement of the inlet system is independent, usually on a constructional and technological conception of the engine itself in the case of high-power combustion engines. This article presents an experimental study of the high-power combustion engine applied in the motorbike, specified for racing purposes. In this article, the influence of the various inlet and exhaust systems, as well as their individual components on the volumetric efficiency, was investigated. This investigation was performed by means of various measurements using a data-recording system.

Several various inlet and exhaust system configurations were tested during this research process. The final complete configuration of the inlet system presented in Fig. 1, is a result of our own long-time development process. Another output of the successful development activities is the patent application of this invention that was registered in the previous year. This patent concerns a conceptual arrangement of the newly developed system.

This experimental analysis was realised according to various remarks and problem solutions occurring during realisation of various engine design [10].

The high-power racing motorbike engine was chosen for practical tests to perform individual experimental measurements. This engine is based on a serial engine production.

2.1. Inlet and Exhaust Systems

Motorcar engines usually use a system of supercharging that is based on turbine driven by exhaust gases, that is, turbocharging or turbo. This system can also be applied in motorbike engines, however, with various attendant problems with the final supercharging effect becoming insufficient. A possible solution to this task offers a system of thrust loading suction, which is applied for high-power motorbike engines due to its simplicity. A disadvantage of such solution is a fact that the sufficient level of overpressure, which is necessary for the production of an efficient engine power output, is generated only at high-speed levels of the vehicle (over $120 \text{ km}\cdot\text{h}^{-1}$ at least and over $150 \text{ km}\cdot\text{h}^{-1}$ in an ideal case). If the speed value is under these limits, the effect is almost none and vice-versa in such a situation, an undesirable under-pressure in the intake system would occur.

It is necessary, therefore, to develop a new system that will be able to generate the required effect of the pressurised air inlet during lower speeds as well as without the motion of the vehicle.

The newly developed inlet system installed in the engine, together with the resonance exhaust system as well as the motorbike silhouette are visible in Fig. 1. The blue arrows mark flows of fresh incoming air; the red arrows illustrate the streaming of exhaust gases in the resonance exhaust system. This inlet system is a subject of the registered patent application

with the title “System of the thrust-ejector suction”. This invention consists of the following design proposal: the suction inlet (1) is installed at the frontal surface of the vehicle. The suction inlet is connected with the inlet pipe (2), which is jointed with the ejector (3). The ejector is fixed to the compression pipeline (4). The compression pipeline is connected airtightly with the air accumulator (airbox) (5) and with the diffuser of the carburettor coming to the airbox.

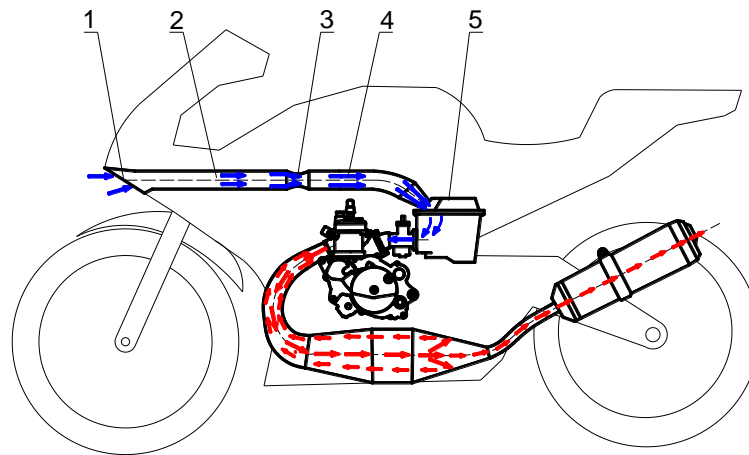

Fig. 1. The developed inlet system with the engine and resonance exhaust system

A supposed advantage of this construction is the possibility of partial supercharging of the vehicle in a static state. This assumption is based on the results obtained during testing of the engine prototype equipped with this new system. It was necessary to increase the amount of the delivered fuel during stationary measurements on the engine power brake because the new system reduced the fuel mixture as a result of the pressurised air inlet. The increasing values of the engine torque were recorded by means of the data-recording during the performed experiments (Fig. 14).

Fig. 2 offers a more complex description of the individual parts of the inlet and exhaust system. The complete inlet system with the external and internal air part is divided into the three main subsystems: the secondary pipeline, the airbox and the primary pipeline. The secondary pipeline feeds outer air from the frontal surface of the motorbike to the airbox. The airbox is an airtight box, which connects the secondary pipeline with the primary pipeline including the carburettor and the set of membrane suction valve. The geometrical characteristics of the inlet and exhaust channels in the engine cylinder were modified to improve the aerodynamic power output.

The exhaust pipe is a classic resonance exhaust system with the components described in details in Fig. 2.

Tab. 1 presents the main dimensions of the inlet and exhaust system of this engine. The silencer is an absorptive type made from external steel shell with thickness 1 mm. It is filled by an absorptive inlet, which covers the steel tube with the perforated middle part.

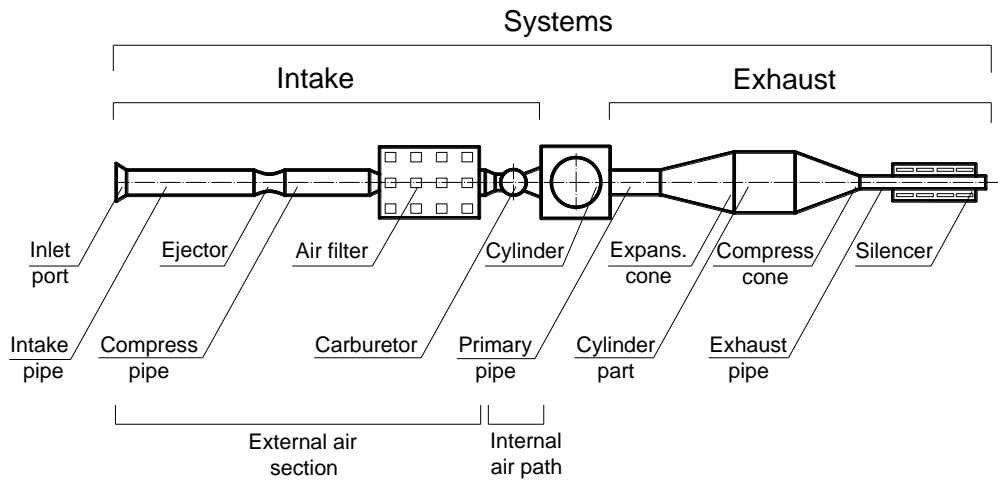

Fig. 2. Components of the intake and exhaust system

3. MEASURING EQUIPMENT

The engine was tested in a real loading by means of an EW&C system. It is a data-recording system, that is, a piece of equipment, which senses information during the engine working operation under real conditions and it simultaneously saves (recording), the necessary information into the internal memory. The data-recording system enables monitoring of all important combustion engine parameters, namely; the engine power output and the engine torque in dependence on the engine speed. Also, the exhaust system temperature and its time behaviour are measured as well as many other parameters. The concrete number and kind of recorded parameters depend on the type and amount of sensors installed in the given engine. Fig. 3 illustrates a fundamental scheme of the equipment used for data measuring, elaboration and evaluation.

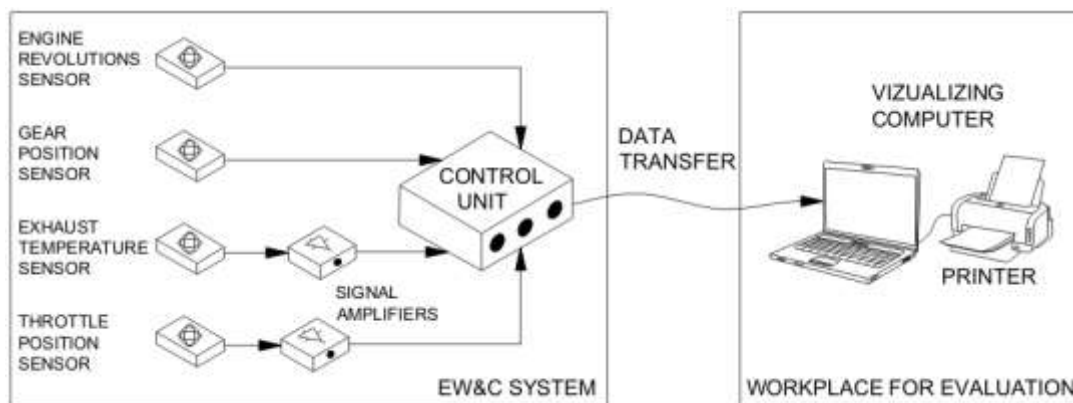

Fig. 3. Scheme of the EW&C system

It is evident from this figure that the principle of this system operation consists of monitoring of the actual engine speed, the temperature of the exhaust system and the speed gear. An additional input parameter is the throttle position in the carburettor. The measuring system is able to create a record of the current engine operation by means of the

abovementioned measured data taking into consideration the next supplemental information (for example, the wheel circuit, gear ratios of the individual speed gears, the curve of air resistance and mass of the motorcycle). This operational record is continuously saved to the system internal memory and copied into the PC after measurement. The time behaviour of the engine operation is displayed on the monitor. Each point of the obtained record represents a multi-functional source of information about the momentary speed, exhaust system temperature and the engine power output, which is measured on the crankshaft.

In the framework of the whole speed spectrum range, it was necessary to conduct several tests to perform the power output analysis of the various inlet and exhaust system configurations. Every measurement had to be repeated three times at least for accuracy verification and reliability. All tests are running at the 4th speed gear, which ensures operational stability in the whole speed spectrum considering the special racing requirements. The experimental measurements presented in this paper are described in the form of the output diagrams created according to the similarity of two basic parameters: the break mean effective pressure b_{mep} and the piston speed u_m . The diagrams are assembled using the factor values $b_{mep_{max}} = 1.77 \text{ MPa}$ and $u_{m_{max}} = 21.6 \text{ m}\cdot\text{s}^{-1}$, that is, by means of the maximum values of the break mean effective pressure and the piston speed. These data were obtained from the engine testing at the 4th speed gear and after the specific racing adjustment. A sketch of the appropriate testing configurations of both systems is a component part of the characteristics. All the relevant relations between the engine power output and the engine speed as well as between the engine torque and the engine speed can be obtained from the abovementioned curves.

4. MEASURING EQUIPMENT

Numerous design configurations were tested to analyse the influence of the inlet and exhaust system components. These systems were disassembled into the individual parts first. Thereafter, the individual components were mounted together into the partial systems and in this way, the final configuration was designed as illustrated in Fig. 2.

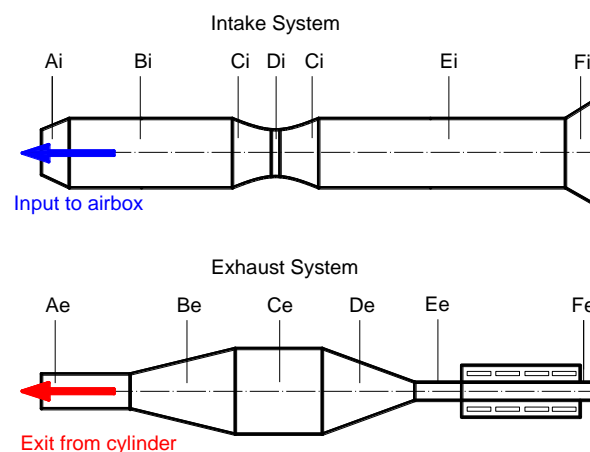

Fig. 4. Scheme of the inlet and exhaust pipe

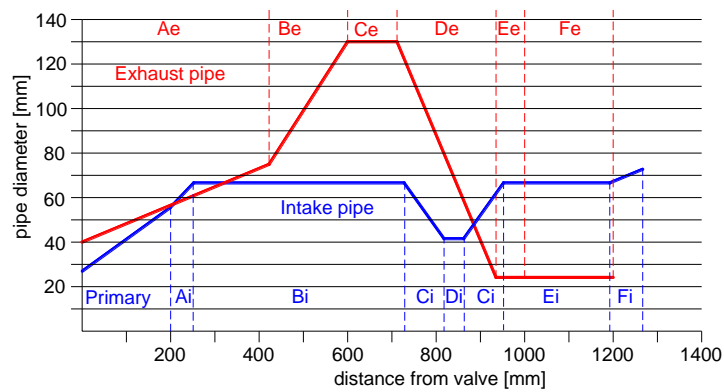

Fig. 5. Main dimensions of the inlet and exhaust pipe

Tab. 1

Main dimensions of inlet and exhaust system

System	Subsystem		Mark (Fig. 4, 5)	Length [mm]	Input diameter [mm]	Output diameter [mm]
Inlet	External air section	Inlet port	Fi	40	70	65
		Inlet pipe	Ei	270	65	65
		Ejector	Ci	75	65	40
			Di	25	40	40
		Compress pipe	Bi	475	65	65
		Connecting pipe	Ai	75	65	55
	Air filter			Length x Width x High (185 x 110 x 200) [mm]		
Internal air path	Primary pipe (Include carburettor)	Primary	200	28	55	
Exhaust	Primary pipe	Standard	Ae	430	40	75
		Trim		420		
	Expansion cone		Be	178	75	130
	Cylinder part		Ce	98	130	130
	Compression cone		De	210	130	24
	Exhaust pipe		Ee	82	24	24
	Silencer		Fe	200	24	24

The scheme of the inlet and exhaust pipe is depicted in Fig. 4. The secondary inlet pipe is presented in the upper part of the figure and the exhaust system at the bottom part. Both pipelines are divided into subsystems, marked Ai,e – Fi,e. The main dimensions of all pipe subsystems are given in Tab. 1. Following these dimensions, a graphical dependence between the pipe diameter and its distance from the cylinder was created. This relation is visible in Fig. 5.

The complete configuration of the inlet and exhaust system is shown in Fig. 2. The configuration was chosen to obtain more information about the engine power output of the inlet and exhaust pipe. The output information obtained from this configuration, including values of the optimal temperature interval (Fig. 6), was compared with the outputs from other subsystem configurations or with other temperature intervals, (Figs. 6-13).

Taken into consideration a linear relation between the bmep and the torque, the peaks of the bmep correspond to the maximums of the torque and efficiency. This is neglected in this case resulting in a reduction in the engine speed due to mechanical losses. It is possible, therefore, to estimate the peaks of the curves by means of the simplified equations derived from the theoretical wave models [2]. The ideal natural frequencies typical for the inlet system of combustion engines are calculated in the literature [10]. The inlet of air from the primary pipe is jointed with the secondary pipe by means of the connecting chamber (airbox). During the suction time, a wave effect is generated, which creates a maximal volumetric efficiency of the air inlet.

The maximal wave frequencies can be approximated according to the following Equations 1 and 2:

$$\cos\left(\frac{\omega \times l_p}{c_s}\right) = 0 \quad (1)$$

$$A_{sec} \times A_{pr} \times \cot\left(\frac{\omega \times l_{sec}}{c_s}\right) = \frac{\omega \times V_{pl}}{c_s \times A_{pr}} + 4 \times \tan\left(\frac{\omega \times l_p}{c_s}\right) \quad (2)$$

where:

ω is the natural frequency of the system,

l_p and l_{sec} are the primary and secondary lengths of pipes in section A_{pr} and A_{sec} ,

V_{pl} is the volume of the connecting chamber between the primary and the secondary tube,

c_s is the speed of sound.

Equation 2 does not offer any useful information in this case because the frequency value ω for the whole system is deep under the minimal operational speed of the engine. Instead, the air streaming is illustrated in Fig. 1 by means of the primary pipe length. Furthermore, Equation 1 enables to define the maximum point of the volumetric efficiency.

The wave effect is able to increase the volumetric efficiency because it generates the resonance phenomena as a result of the pressure impulses arising during closing of the membrane valve. The newest publication [12] defines Equation 3 of speed N_i for variable parts of the inlet pipe, where n_i is a number of pressure impulses entering the pipe during 720° rotation of the crankshaft:

$$\frac{N_i}{2} = \frac{1}{2 \times n_i} \times \frac{c_s}{2 \times l_p} \times \left(\sum_j \frac{K_j}{1 - \left(1.62 \times \frac{um(N_i)}{c_s} \times \frac{A_p}{A_j}\right)^2} \right)^{-1} \quad (3)$$

where:

l_p is the total pipe length, which is divided into the j pipe subsystems with the constant section A_i and length each of them is $K_j l_p$,

A_p is the piston area,

$um(N_i)$ is the piston speed.

The number and position of the impulse peaks can be defined by means of Equation 2. It is possible to say, according to our experiences, that this simplified relation also requires an additional tuning. However, it should be sufficient for a practical proposal of the racing engine pipes.

5. ACOUSTICS IN EXHAUST PIPE

The silencer influence on the torque during the optimal operational temperature using the complete set of the inlet and exhaust system is demonstrated in Fig. 9. A relevant difference among the braking torque values without and with the silencer was not observed. Some deviations are visible but they are in limits and can be regarded as measuring errors. This system arrangement is useful only for obtaining information and it is not applicable for practical purposes due to noise restrictions. Equation 3 is valid for the inlet pipe. The simplified analytical Equation 4, is appropriate for tuning of the exhaust pipe:

$$\frac{2 \times \pi \times N}{\theta_e} = \frac{c_s}{l_e} \times \left(\frac{3 - \frac{um(N)}{c_s} \times \frac{A_p}{A_e} \times \frac{T_e}{T_{air}}}{1 - \left(\frac{um(N)}{c_s} \times \frac{A_p}{A_e} \times \frac{T_e}{T_{air}} \right)^2} \right)^{-1} \quad (4)$$

The tuning regime N with the 83% value of the um_{max} (peak on the right in Fig. 6) is an assumption for Equation 4, whereas the average value of the exhaust gas temperature T_e is from the interval $520^\circ\text{C} \div 620^\circ\text{C}$ and the length of the exhaust gas is l_e . The initial analysis of the exhaust system was oriented to the determination of an optimal temperature interval in the exhaust system.

The speed of sound waves increases when the temperature is higher. This fact is in accordance with the theory of waving considering the relation (5) between the speed of sound waves and the air temperature:

$$C = \sqrt{K \times \frac{R \times T}{M}} \quad (5)$$

where:

C is the speed of sound waves,

$K = 1.4$,

R is the universal gas constant,

T is the temperature,

M is the molar mass.

If the exhaust pipe is defined with regard to its shape and dimensions, hence, in this case, there exists theoretically such temperature interval, which is limited by the maximum and minimum temperature values. The output engine characteristics are optimal in this interval. With regard to this assumption, the measurements focused on determination of the temperature interval were performed; this is optimal for the given exhaust system. The thermal sensor was installed in the point of maximal temperature in the exhaust system, that is, in the area of the primary pipe, approx. 150 mm from the upper edge of the exhaust channel (Fig. 2).

The increasing temperature of the exhaust system accelerates the resonance wave propagations. The back-wave in the exhaust pipe is returning faster. This way, the process of the cylinder reverse scavenging is also accelerated and the exhaust pipe is shortening theoretically. If the engine speed is increasing during the optimal regime, then the exhaust system temperature must be higher. Thus, the exhaust system is shorter theoretically at higher speed and longer theoretically (with a lower temperature) in slower engine speed.

Fig. 6 graphically illustrates a comparison of the output parameters of the complete inlet and exhaust pipes for two various temperature intervals. The vertical axis represents a ratio between the break mean effective pressure b_{mep} and the maximum of the break mean effective pressure $b_{mep_{max}}$, that is, the ratio value $b_{mep}/b_{mep_{max}}$. The horizontal axis represents a ratio between the piston speed u_m and the maximum of the piston speed $u_{m_{max}}$, that is, the ratio value $u_m/u_{m_{max}}$. The continuous curve describes the output parameters for the exhaust system temperature interval between 520°C and 620°C. The dashed curve is valid for the interval between 420°C and 520°C.

A significant difference among the output parameters is visible after comparison of both curves. The optimal output values are reached in the temperature interval between 520°C and 620°C. The engine torque is reduced significantly to the level 75% of the $u_m/u_{m_{max}}$ if the temperature is below 520°C. The output characteristic is improved up to the level 90% of the $u_m/u_{m_{max}}$. Another problem is in the point 95%, where the torque is dropped steeply. This phenomenon causes braking of the engine and it can be critical for the racing engines because the sudden decrease of the torque arises in the framework of the operational speed range. The Fig. 7 compares the output parameters for the temperature interval of the exhaust pipe between 520°C to 620°C with the output parameters for higher temperatures, specifically from 620°C to 720°C. The differences among the output parameters are also important in the case of overcooled exhaust system (Fig. 6). If the exhaust pipe is overheated, then the engine torque rises up to level 68% of the $u_m/u_{m_{max}}$, which is analogous to the optimal temperature interval. The characteristic is improved from 68% up to 75% and after this point, it declines steeply to the local minimum value. After this decline, the curve rises again up to peak 92%, which is identical to the compared temperature interval between 520°C and 620°C. According to the analysis of the obtained results, it is possible to say that for this engine, the optimal interval of operational temperatures in the exhaust pipe is from 520°C to 620°C. However, in the limit points of this temperature interval, that is, in the points 520°C and 620°C the output characteristics are not optimal. The best behaviour of the torque is reached in the middle value of the temperature interval, that is, at point 570°C. Between 420°C and 520°C, the exhaust system overcooled. The engine characteristics are improved significantly for higher temperatures and the exhaust pipe is shortened theoretically. The output characteristic is relatively suitable between 620°C and 720°C despite the fact of reduced torque at 68% of $u_m/u_{m_{max}}$. This statement is true, especially for temperature 620°C. If the temperature increases further, the system becomes overheated and the exhaust pipe is enormously theoretically shortened. The optimal value of the exhaust system temperature was applied in all of the next experimental measurements (Fig. 8-14) and the curve obtained between the temperatures from 520°C to 620°C (Figs. 6 and 7) served as the base for the next comparisons.

Fig. 8 illustrates the comparison of output parameters for the complete system of the inlet and exhaust pipe, however, in the second case the exhaust pipe is shortened about 10 mm in the primary pipe area. The continuous curve represents a comparative output of the complete system at optimal operational interval. The dashed characteristic means an output of the shortened exhaust pipe according to the scheme in the bottom part of Fig. 8. It is evident from

the comparison of these characteristics that the output curve was shifted into the area of higher engine speed due to shortening of the exhaust pipe. The maximal peak was shifted to the right about approx. 4% of the um/um_{max} .

The fourth graph concerning the exhaust system is in Fig. 9. It is focused on the influence of the silencer on the output characteristic. The output characteristic of the complete system without the silencer is dashed. Both comparative curves are almost identical. Removing the silencer caused a drop of the engine torque at value interval from 60% to 66% of the um/um_{max} .

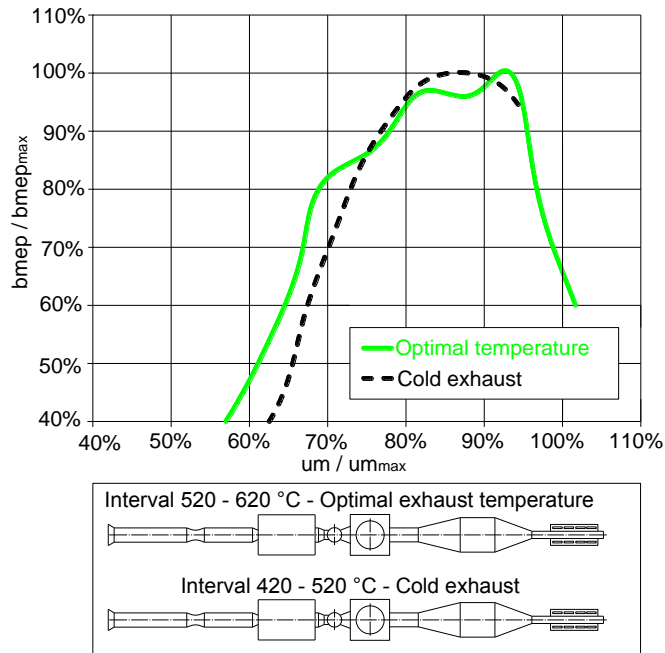

Fig. 6. Dimensionless bmep for various temperature states of the exhaust system

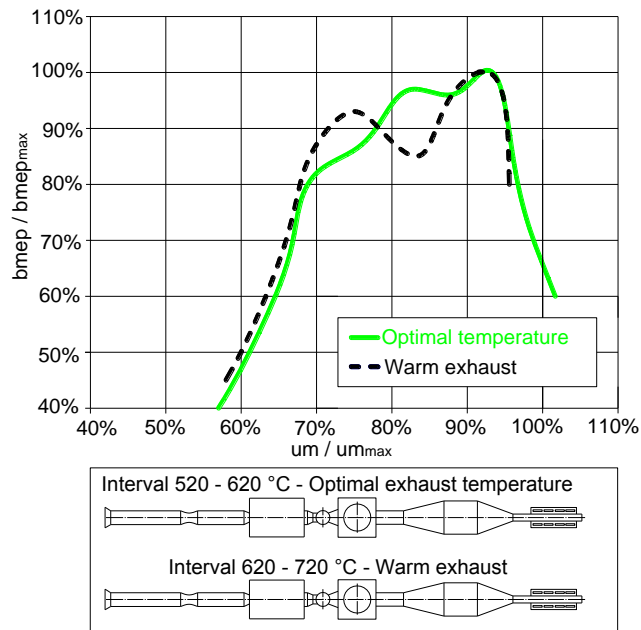

Fig. 7. Dimensionless bmep for various temperature states of the exhaust system

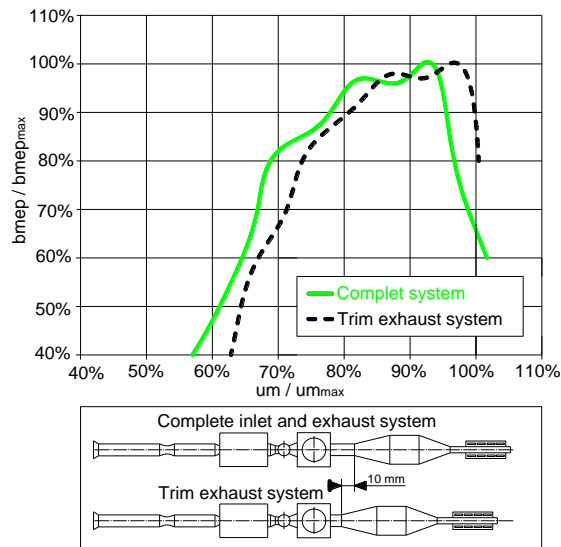

Fig. 8. Dimensionless bmep for various lengths of the exhaust system

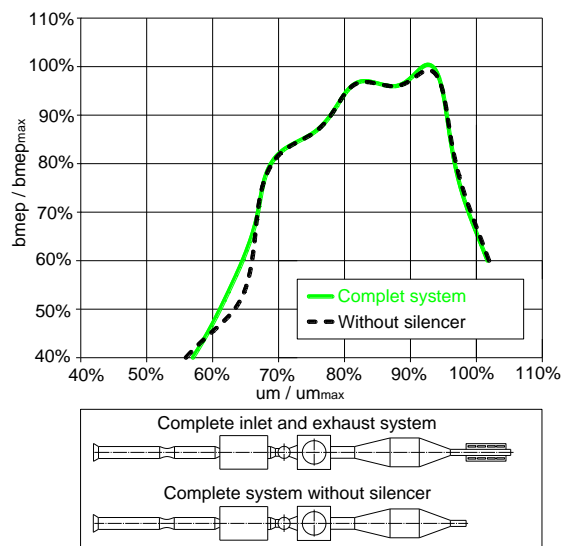

Fig. 9. Dimensionless bmep for various arrangements of the exhaust system

6. INFLUENCE OF THE INLET SYSTEM

Application of turbocharging for motorbike engines is problematic; therefore, the thrust loading system is used. This system has its own disadvantages, however, the thrust-ejector suction system was subsequently developed and patented (Fig. 2). This system was applied for the racing motorbike (Fig. 1). The main idea of this new solution is its use for the suction process, the phenomenon of the exhaust gases oscillation, which is typical for the exhaust pipe. The principle of the thrust-ejector system is as follows: the suction air flows through the inlet hole (1) due to underpressure. The air streams in the inlet pipe (2) to the ejector (3) whereas its speed is increased due to the contracted ejector cross-section. The suction air follows through the compression pipe (4) into the airbox (5), then directly to the carburettor

(Fig. 1). The experimental measurements performed in this section are adapted to various configurations of inlet pipes.

According to the obtained experimental results, it is possible to say that the inlet pipe influence on the final values of the engine torque is less than the influence of the exhaust system.

Fig. 10 compares the output characteristic of the complete suction and the exhaust system (continuous line) with the basic configuration characteristic (dashed line). It is evident from the comparison of these curves that the engine torque behaviour has got two points of its maximum, specifically, the values 68% and 83% of the um/um_{max} .

Fig. 11 demonstrates output parameters in the case of the comparison between the complete configuration of the inlet/exhaust piping with the atmospheric air intake and the same system with the pressurised air intake (overpressure value is 80 kPa – dashed curve). In this case, the increment of torque was in the critical area 88% of the um/um_{max} .

Fig. 12 illustrates the results of the measurements performed after removing the secondary part from the inlet pipe with the airbox intact. The dashed output characteristic shows a significant reduction of the torque at 75% and the increase to 82% of the um/um_{max} .

The final part of the measuring was focused on the investigation of the air filter influence (Fig. 13). The dashed curve was measured with the installed air filter and it is identical with the compared characteristic at values over 78% of the um/um_{max} . A moderate decrease of the curve (up to this value) in comparison to the reference curve due to the suction resistance of the air filter can be seen.

The final comparison offers an evaluation between the patented inlet system and the basic configuration (Fig. 14). The continuous curve illustrates the basic configuration, which has the best increase of power output value up to 65% of the um/um_{max} . From this point, a positive impact of supercharging is evident, that is, a distinctive growth of the engine torque except point 75%, where both curves are in a single-point contact. Correspondingly, both outputs are common as far as in maximal values at 92% of the um/um_{max} .

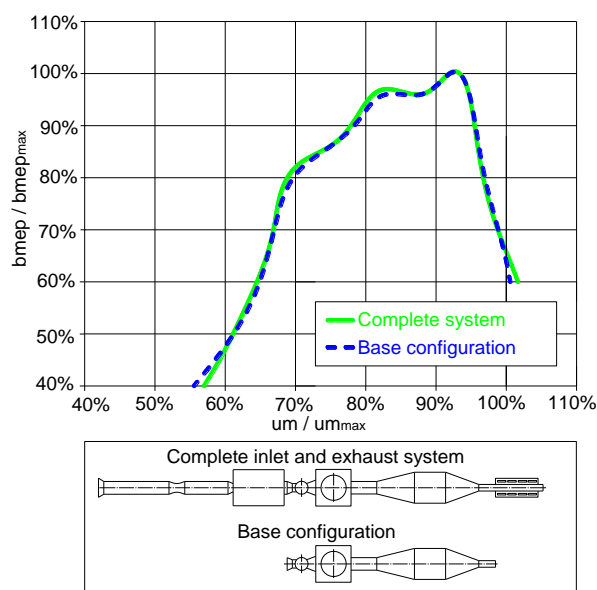

Fig. 10. Dimensionless bmep for various configurations of the inlet and exhaust system

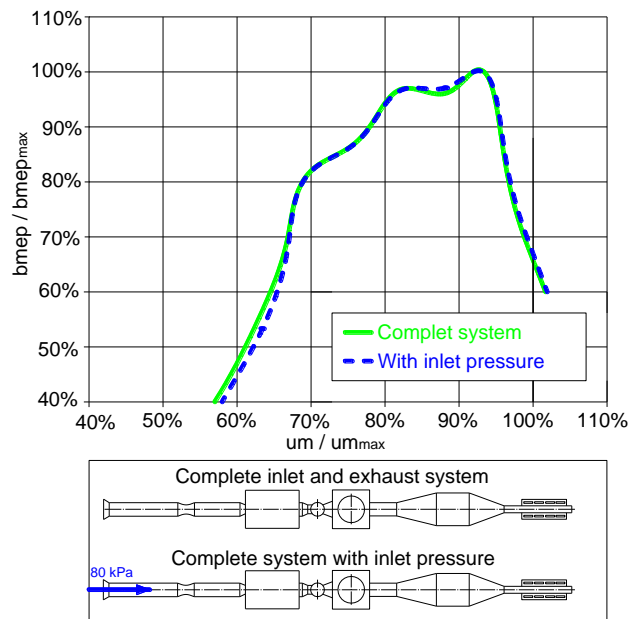

Fig. 11. Dimensionless bmep for various configurations of the inlet and exhaust system

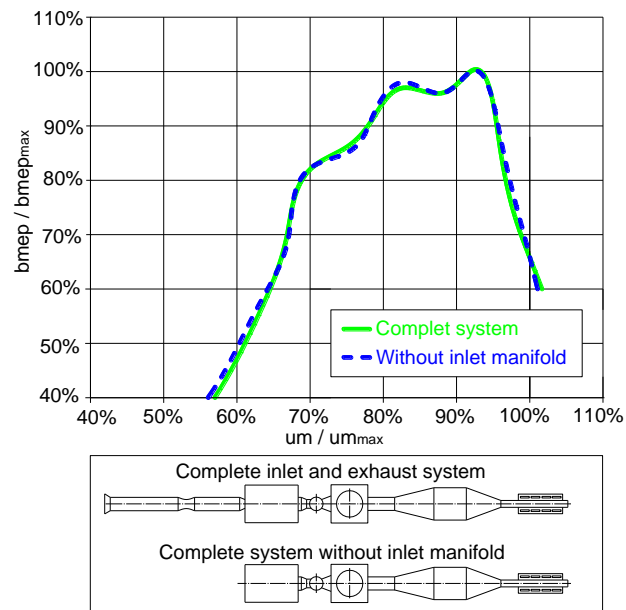

Fig. 12. Dimensionless bmep for various configurations of the inlet system

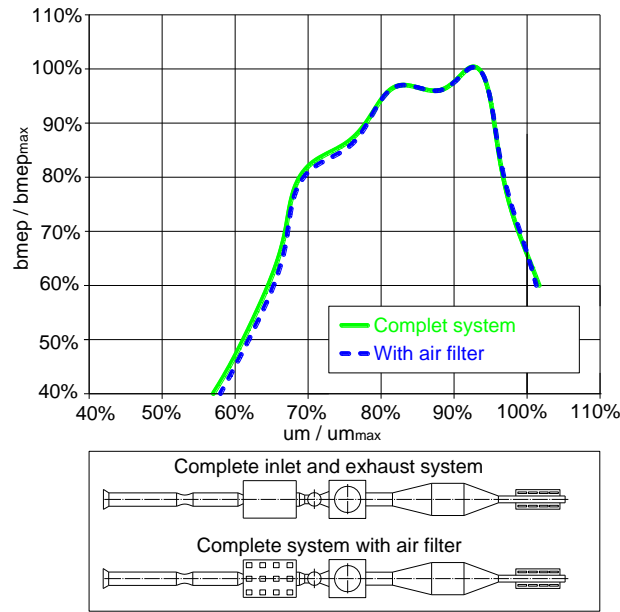

Fig. 13. Dimensionless bmep for various configurations of the airbox

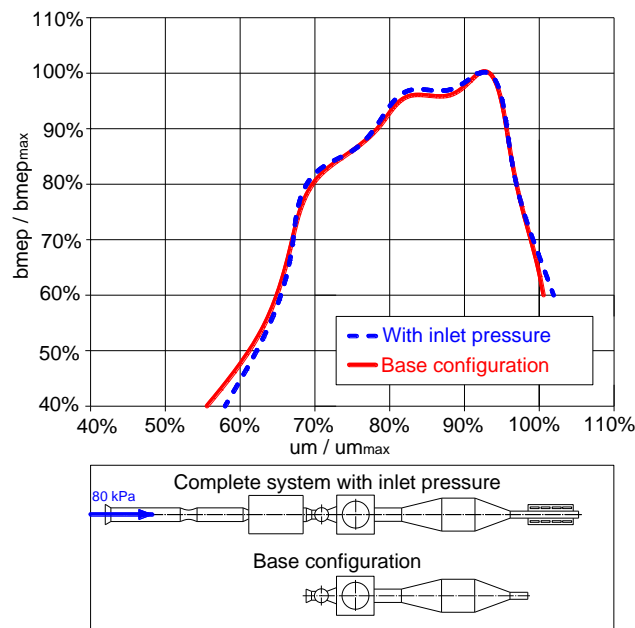

Fig. 14. Dimensionless bmep for an illustration of the global gains of the patented inlet system

7. CONCLUSIONS

Presented in this article are the analytical relations and experimental measurements obtained and performed during testing of various configurations of the inlet and exhaust system specified for a racing engine. Several systems were developed and analysed individually. The measurements were focused on:

1. Analysis of the exhaust system:
 - determination of the optimal operational interval,
 - changing of the exhaust pipeline length,
 - influence of the silencer.

2. Investigation of the developed and patented air inlet system:
 - comparison of the complete system with the basic version,
 - influence of the pressurised air intake,
 - influence of the secondary inlet pipe,
 - influence of the air filter.

The low-level temperature in the exhaust pipe means that the mixture is very rich (redundancy of the fuel), hence, the mixture burns imperfectly. The high temperature in the exhaust pipe corresponds to the lean mixture, it burns down in the exhaust pipe and this process lasts longer (lack of fuel).

The optimal temperature in the exhaust pipe is related to the optimal mixture composition and such mixture is able to transform heat to mechanical energy with high efficiency. Comprehensively, it is evident that the exhaust pipe temperature is substantial for the power output engine characteristic. It is necessary to ensure an optimal interval of this temperature. The shortening of the exhaust system length in the area of the exhaust tube enables shifting of the engine torque towards a higher operational engine speed. This allows variability of the power output curve according to the concrete requirement of the given transport vehicle. The influence of the silencer is markedly predominant in the area of low-level engine speed.

The system thrust-ejector air inlet is specified for all single-track vehicles equipped with the piston combustion engine. This system is designed in such a way that makes it possible to improve the filling of the cylinder with fresh fuel mixture (fuel with air), that is, it has a direct impact on the growth of the engine power output. Application of this newly developed system improves the technical level and reliability of these engines. The best results were recorded at high speeds. Fig. 14 presents the global benefit of this technical solution in comparison to the basic version. The importance of the inlet system for the racing engine tuning and improvement is very considerable despite the fact that a benefit in the area of the inlet system is not as essential as in the area of the exhaust system.

Acknowledgements

This work was supported by the Slovak Research and Development Agency under contract No. APVV-16-0259.

The article was written in the framework of Grant Projects: APVV-16-0259 “Research and development of combustion technology based on controlled homogenous charge compression ignition in order to reduce nitrogen oxide emissions of motor vehicles”, VEGA 1/0473/17 “Research and development of technology for homogeneous charge self-ignition using compression in order to increase engine efficiency and to reduce vehicle emissions” and KEGA 006TUKÉ-4/2020 “Implementation of Knowledge from Research Focused on Reduction of Motor Vehicle Emissions into the Educational Process.”

References

1. Toman R., M. Polóni, A. Chríbik. 2017. "Preliminary study on combustion and overall parameters of syngas fuel mixtures for spark ignition combustion engine". *Acta Polytechnica* 57(1): 38-48. ISSN: 1210-2709. DOI: <http://dx.doi.org/10.14311/AP.2017.57.0038>.
2. Chríbik A., M. Polóni, J. Lach, B. Ragan. 2014. "The effect of adding hydrogen on the performance and the cyclic variability of a spark ignition engine powered by natural gas". *Acta Polytechnica* 54(1): 10-14. ISSN: 1210-2709. DOI: <http://dx.doi.org/10.14311/AP.2014.54.0010>.
3. Czech P. 2011. "Diagnosing of disturbances in the ignition system by vibroacoustic signals and radial basis function - preliminary research". *Communications in Computer and Information Science* 239: 110-117. DOI: https://doi.org/10.1007/978-3-642-24660-9_13. Springer, Berlin, Heidelberg. ISBN: 978-3-642-24659-3. ISSN: 1865-0929. In: Mikulski Jerzy (eds), *Modern transport telematics*, 11th International Conference on Transport Systems Telematics, Katowice Ustron, Poland, October 19-22, 2011.
4. Czech Piotr. 2011. „An intelligent approach to wear of piston-cylinder assembly diagnosis based on entropy of wavelet packet and probabilistic neural networks". *Communications in Computer and Information Science* 239: 102-109. DOI: https://doi.org/10.1007/978-3-642-24660-9_12. Springer, Berlin, Heidelberg. ISBN: 978-3-642-24659-3. ISSN: 1865-0929. In: Mikulski Jerzy (eds), *Modern transport telematics*, 11th International Conference on Transport Systems Telematics, Katowice Ustron, Poland, October 19-22, 2011.
5. Sinay Juraj, Michal Puškár, Melichar Kopas. 2018. „Reduction of the NO_x emissions in vehicle diesel engine in order to fulfill future rules concerning emissions released into air". *Science of The Total Environment* 624: 1421-1428. DOI: <https://doi.org/10.1016/j.scitotenv.2017.12.266>.
6. Czech P. 2012. "Determination of the course of pressure in an internal combustion engine cylinder with the use of vibration effects and radial basis function - preliminary research". *Communications in Computer and Information Science* 329: 175-182. DOI: https://doi.org/10.1007/978-3-642-34050-5_21. Springer, Berlin, Heidelberg. ISBN: 978-3-642-34049-9. ISSN: 1865-0929. In: Mikulski Jerzy (eds), *Telematics in the transport environment*, 12th International Conference on Transport Systems Telematics, Katowice Ustron, Poland, October 10-13, 2012.
7. Brestovič Tomáš, Natalia Jasminská, Mária Čarnogurská, Michal Puškár, Michal Kelemen, Milan Fil'ó. 2014. „Measuring of thermal characteristics for Peltier thermopile using calorimetric method". *Measurement* 53: 40-48. DOI: <https://doi.org/10.1016/j.measurement.2014.03.021>.
8. Czech P. 2013. "Diagnosing a car engine fuel injectors' damage". *Communications in Computer and Information Science* 395: 243-250. DOI: https://doi.org/10.1007/978-3-642-41647-7_30. Springer, Berlin, Heidelberg. ISBN: 978-3-642-41646-0; 978-3-642-41647-7. ISSN: 1865-0929. In: Mikulski Jerzy (eds), *Activities of transport telematics*, 13th International Conference on Transport Systems Telematics, Katowice Ustron, Poland, October 23-26, 2013.
9. Kuric Ivan. 2011 „New methods and trends in product development and planning". *1st International Conference on Quality and Innovation in Engineering and Management (QIEM)*: 453-456. Cluj Napoca, 17.3.-19.3. ISBN: 978-973-662-614-2.

10. Puškár Michal, Tomáš Brestovič, Natalia Jasminská. 2015. „Numerical simulation and experimental analysis of acoustic wave influences on brake mean effective pressure in thrust-ejector inlet pipe of combustion engine”. *International Journal of Vehicle Design* 67(1): 63. DOI: [https://doi.org/ 10.1504/ijvd.2015.066479](https://doi.org/10.1504/ijvd.2015.066479).
11. Tlach Vladimír, Miroslav Císar, Ivan Kuric. Ivan Zajačko. 2017. „Determination of the industrial robot positioning performance”. *MATEC Web of Conferences* 137(01004). DOI: [https://doi.org/ 10.1051/matecconf/201713701004](https://doi.org/10.1051/matecconf/201713701004).
12. Košinár Matúš, Ivan Kuric. 2011. „Monitoring possibilities of CNC machin tools accuracy”. *1st International Conference on Quality and Innovation in Engineering and Management (QIEM)*: 115-118. Cluj Napoca, 17.3.-19.3.2011. ISBN: 978-973-662-614-2.

Received 12.04.2020; accepted in revised form 28.05.2020



Scientific Journal of Silesian University of Technology. Series Transport is licensed under a Creative Commons Attribution 4.0 International License