

G.V. Bezprozvannykh, O.A. Pushkar

**INCREASING NOISE IMMUNITY OF CABLES FOR FIRE PROTECTION SYSTEMS**

*Introduction. Technical means of fire protection systems are capable of operating at data rates from tens to hundreds of Kbit/s with components of a digital signal in the frequency spectrum up to several tens of MHz. Appropriate cable infrastructure with a high level of noise immunity is required to transmit broadband digital signals. Purpose. Substantiation of ways to increase noise immunity of cables based on twisted pairs for modern fire protection systems with the ability to transmit digital signals in the frequency spectrum up to 100 MHz. Methodology. A comparison is made of the influence of the twisting step of pairs in unshielded 4-pair and multi-pair shielded balanced cables on the parameters of electromagnetic effects. It has been experimentally shown that twisting each pair with different steps provides a higher level of noise immunity of cables based on twisted pairs. Practical value. The frequency dependencies of the near end crosstalk in 10-, 30- and 4-pair balanced cables are shown. The influence of the common shield on the attenuation coefficient of the shielded 4-pair cable is established. References 12, figures 8.*

*Key words: fire protection systems, electromagnetic influence, near end crosstalk, twisted pairs, unshielded and shielded cables, attenuation coefficient.*

*Наведено частотні залежності перехідного загасання на ближньому кінці в 10, 30 та 4-х парних симетричних кабелях. Експериментально доведено, що скручування кожної пари з різними кроками забезпечує більш високий рівень завадостійкості кабелів на основі витих пар. Застосування загального екрану призводить до зменшення електромагнітних впливів між витими парами кабелю. Діапазон значень перехідного затухання на ближньому кінці на верхній робочій частоті 100 МГц становить 44-54 дБ та 46-58 дБ для неекранованого та екранованого кабелів з витими парами відповідно. Ефект зростання коефіцієнту загасання та більший розкид параметрів впливу обумовлює більш жорсткі вимоги до щільності конструкції та налаштувань технологічного процесу виготовлення екранованих кабелів. Бібл. 12, рис. 8.*

*Ключові слова: системи протипожежного захисту, електромагнітний вплив, перехідне загасання на ближньому кінці, кручені пари, неекранований і екранований кабелі, коефіцієнт загасання.*

*Приведены частотные зависимости переходного затухания на ближнем конце в 10, 30 и 4-х парных симметричных кабелях. Экспериментально показано, что скрутка каждой пары с разными шагами обеспечивает более высокий уровень помехоустойчивости кабелей на основе витых пар. Применение общего экрана приводит к уменьшению электромагнитных влияний между витыми парами кабеля. Диапазон значений переходного затухания на ближнем конце на верхней рабочей частоте 100 МГц составляет 44-54 дБ и 46-58 дБ для неэкранированного и экранированного кабелей с витыми парами соответственно. Эффект роста коэффициента затухания и больший разброс параметров влияния обуславливают более жесткие требования к плотности конструкции и настройкам технологического процесса изготовления экранированных кабелей. Библ. 12, рис. 8.*

*Ключевые слова: системы противопожарной защиты, электромагнитное влияние, переходное затухание на ближнем конце, витые пары, неэкранированный и экранированный кабели, коэффициент затухания.*

**Introduction.** Fire protection and fire alarm systems have expanded from fairly simple electromechanical devices to modern microprocessor technologies that are highly sensitive to electromagnetic interference. Regardless of the devices used, fire protection systems use different interfaces of communication devices. Modern technical means of such systems are able to operate at data rates from tens to hundreds of kBit/s with components of the digital signal in the frequency spectrum up to several tens of MHz. For the transmission of broadband digital signals an appropriate cable infrastructure which should provide high requirements for noise immunity when transmitting signals over cables is required [1, 2]. The basis of such infrastructure is modern symmetrical cables based on twisted pairs [1, 2]. Twisting of conductors in pairs is carried out in order to increase the degree of communication between the conductors of one pair and further reduce electromagnetic interference from external sources, as well as mutual inducing in the transmission of differential signals [3, 4].

Category 5e cables with copper conductors are widely used in fire protection systems, structured cable systems [3, 4] and provide digital signals transmission in the frequency spectrum up to 100 MHz [5].

As the transmission speed increases, along with the need to provide digital signals, the interference increases, both inside and outside the cable [5, 6]. Reducing the level of electromagnetic interference is achieved due to the principle of balanced signal transmission over a pair of twisted wires [5, 6].

For a symmetric (balanced) pair, the property of symmetry is fundamentally important, i.e. the same physical and electrical properties of forward and reverse conductors. Otherwise, the currents and voltages of the interference that occur in the pair increase significantly. The essence of symmetry is that the induced currents and voltages have almost the same amplitude and opposite phases, i.e. compensate each other. A number of important cable parameters are related to the mechanism of interaction between pairs. Transient interference is the main source of noise which reduces the quality of signal transmission over the cable. The urgency of this problem is constantly growing, because the transient interference increases with increasing signal transmission rate, and hence the frequency [5, 6].

**Problem definition.** To characterize the noise immunity of cables, the parameters of mutual influence

© G.V. Bezprozvannykh, O.A. Pushkar

are used, in particular, transient attenuation at the near end (NEXT – Near End CrossTalk) [5, 6]. The influence parameters characterize the part of the electromagnetic energy of the signal which is converted into electromagnetic radiation. The transition of electromagnetic energy from one pair to another one is associated with the electromagnetic interaction between cable pairs [5-8].

The NEXT parameter depends on the cable design: the number of pairs (Fig. 1), twisting steps, fluctuations in the geometric dimensions of the conductive cores and the insulation thickness relative to the normalized values within the tolerances [8-11].

Figure 1 shows the transient attenuation at the near end in the form of level lines in 30-pair (Fig. 1,a) and 10-pair (Fig. 1,b) shielded symmetrical cables of the same length at frequency of 256 kHz:  $N_v$  is the pair that affects (source of interference);  $N_p$  is the pair that is affected (interference receiver).

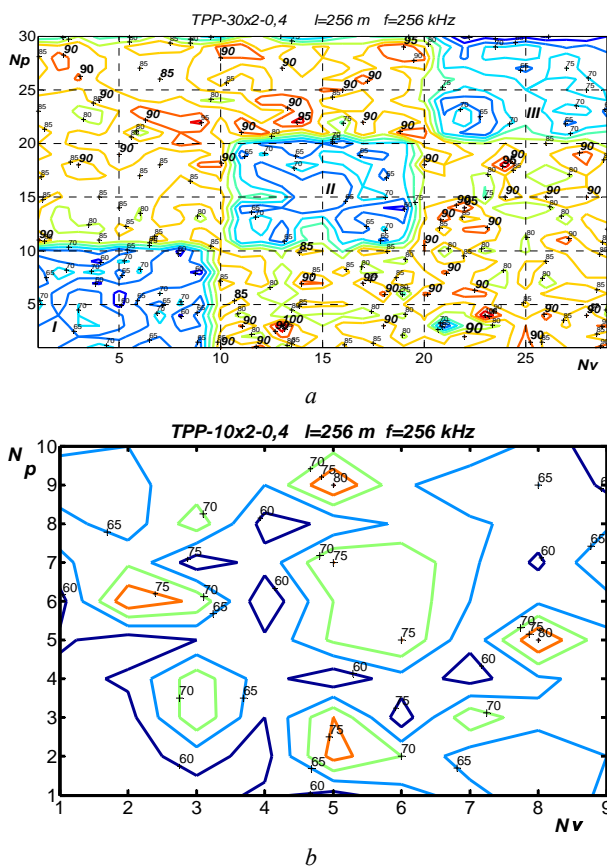

Fig. 1. Influence of design of symmetrical cables on transient attenuation at the near end

For the 30-pair cable, the impact parameters are clearly divided into three groups (denoted by the numbers *I, II, III*) (Fig. 1,a), within which the transient attenuation at the near end for pairs located nearby is the smallest and is 65 dB, i.e. mutual influences are the greatest. For pairs from different groups (the most distant) the transient attenuation is quite high: up to 90 and even 100 dB.

For 10-pairs cable (Fig. 1,b) the impact parameters are higher. The lowest value of the transient attenuation is 60 dB (for example, between pairs 5–1 and 8–7); the highest one is 80 dB (between pairs 5–9).

The reason for this is that in such a cable the pairs are located close to each other. The twisting step in 5 pairs is one, the same for these pairs, in the other 5 pairs is the other (coordinated), but also the same for these 5 pairs.

As the frequency increases, the transient attenuation at the near end decreases (Fig. 2), i.e. the level of interference increases.

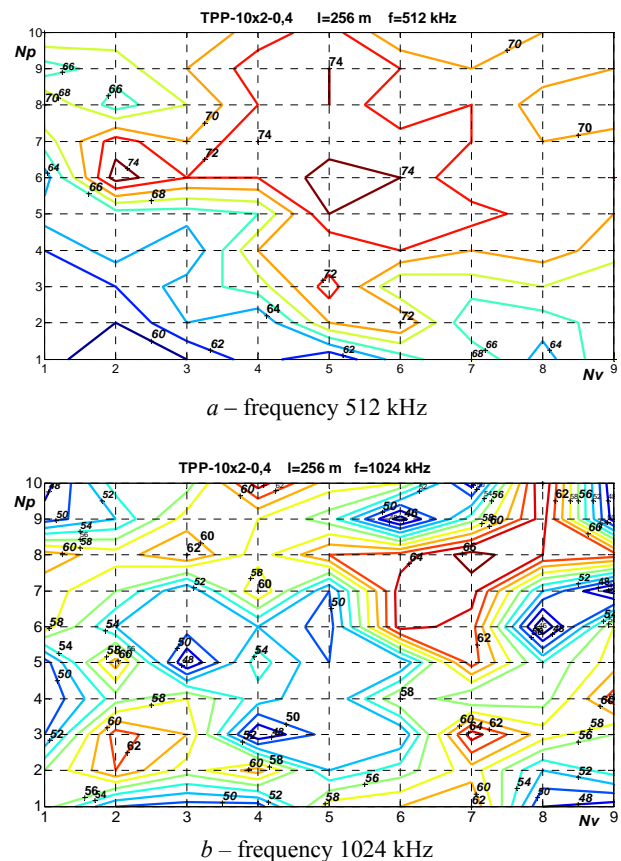

Fig. 2. Dynamics of change of transient attenuation at the near end on frequency in a multipaired symmetric cable

The goal of the paper is to substantiate ways to increase the noise immunity of twisted pair cables for modern fire protection systems with the ability to transmit digital signals in the frequency spectrum up to 100 MHz.

**Influence of cable twisting step on transient attenuation at the near end.** To reduce the electromagnetic influence in the high-frequency range between pairs in the cable, it is necessary to twist pairs of conductors with different coordinated steps [8]

$$\frac{h_i}{h_j} = \frac{2v \pm 1}{2w}, \quad (1)$$

where  $h_i, h_j$  are the steps of twisting pairs,  $v$  and  $w$  are the positive integers.

When twisting pairs in a cable of ideal design while ensuring the stability of the twisting step along the entire length, the electrical and magnetic components of the impact change their sign to the opposite with their constant value modulo.

The transient attenuation at the near end in this case noticeably increases (curve 3, Fig. 3) and consists of transient attenuation between non-twisted pairs (curve 1)

and additional transient attenuation due to twisting of pair's conductors (curve 2, Fig. 3).

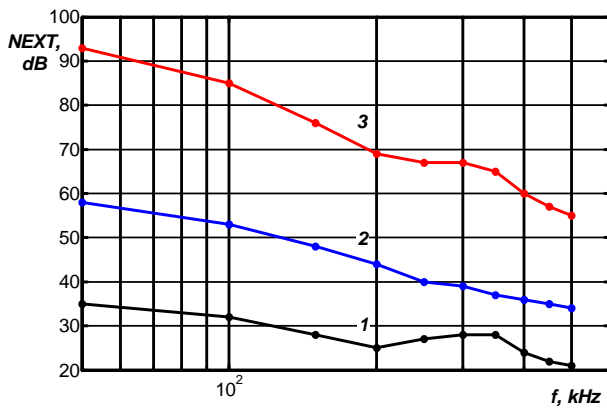

Fig. 3. Influence of twisting of conductors on transient attenuation at the near end in a symmetrical pair

The transient attenuation for twisted pairs is greater the smaller the twist step

$$NEXT = 20 \lg \left| \pi(h_i/h_j + 1) / \gamma_i h_i [1 + \kappa(h_i/h_j + 1) / (h_i/h_j - 1)] \right|,$$

where  $\gamma_j$  is the coefficient of propagation of the electromagnetic wave (signal) in the pair with the smallest step, in which the transient attenuation is determined,  $k = 0.2-0.8$  is the coefficient depending on the design of the cable and the location of the pairs.

In a cable consisting of  $N$  twisted pairs, the total number of combinations of circuits  $N_v$  influencing on each other is [8]

$$N_v = 2 \sum_{n=1}^{N-1} (N-n). \quad (2)$$

Thus, in an unshielded cable with 4 unshielded pairs, the total number of influencing circuits is 12, and 6 of them are inverse: their influence is identical to the direct influence. The number of influencing circuits will be 6 (Fig. 4). In this case, the cable has 6 values of transient attenuation at the near end (Fig. 5). In the 30-pair cable (Fig. 1,a) – 435, in the 10-pair one (Fig. 1,b) – 45.

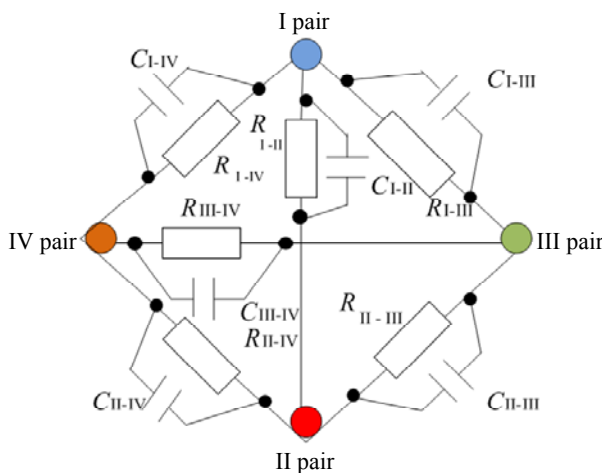

Fig. 4. Capacitive ( $C_{I-II}$ ,  $C_{I-III}$ ,  $C_{I-IV}$ ,  $C_{II-III}$ ,  $C_{II-IV}$ ,  $C_{III-IV}$ ) and active ( $R_{I-II}$ ,  $R_{I-III}$ ,  $R_{I-IV}$ ,  $R_{II-III}$ ,  $R_{II-IV}$ ,  $R_{III-IV}$ ) components of electromagnetic influences in a 4-pair unshielded cable

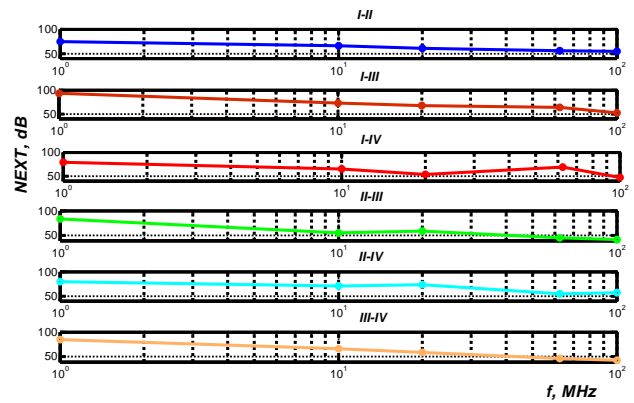

Fig. 5. Experimental frequency dependencies of transient attenuation at the near end in a 4-pair unshielded cable with length of 100 m

Twisting each pair with different coordinated steps provides a higher level of transient attenuation at the near end between pairs in a 4-pair unshielded cable compared to a shielded symmetrical 10-pair cable (compare NEXT values for 1 MHz in Fig. 6 and Fig. 2,b). The twist step in twisted-pair cables is in the range of 10 to 25 mm, which is at least 10 times less than in multi-pair symmetrical cables [8].

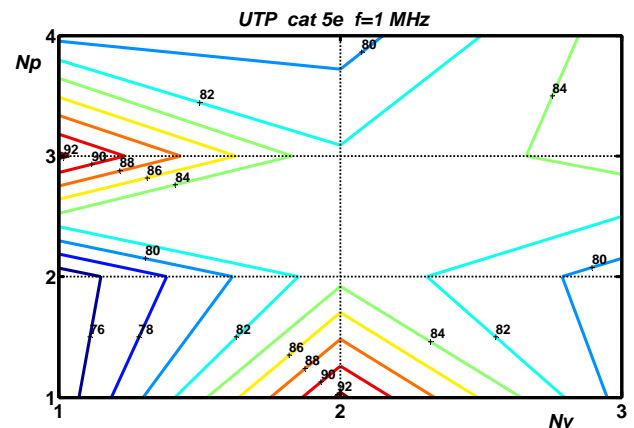

Fig. 6. Transient attenuation level lines at the near end in an unshielded 4-pair cable at 1 MHz

Comparing the values of transient attenuation at the same frequency of two cables of different lengths is quite correct. For a long line in the high frequency range

$$\alpha \cdot l > 6,5 \text{ dB},$$

(where  $\alpha$  is the attenuation coefficient of the signal when propagated in the cable (dB/m) of length  $l$  (m)), the transient attenuation at the near end does not practically depend on the length of the line (cable), but depends only on the frequency [8]. This is due to the fact that the interference currents from individual sections come to the near end of the interference receiver so weak that they do not increase the mutual interaction between the pairs.

**Shielding efficiency and the effect of the shield on the cable attenuation factor.** To increase the transient attenuation, reduce the level of intrinsic electromagnetic radiation of each twisted pair and increase the noise immunity of the cable, depending on the operating conditions, the shielding is used [5, 10, 12]:

- general shielding of 4 twisted pairs;
- individual shielding of each pair without general shielding of all 4 pairs;
- individual shielding of each pair with general shielding of all 4 pairs.

The most common cable design is one with a common shield for 4 twisted pairs [5, 10] for the operating frequency range of 100 MHz. External shields, superimposed on the core of 4 pairs longitudinally, are made of thin polymer film metallized with aluminum (aluminum-polyethylene). A tinned copper or galvanized drainage conductor with diameter of 0.5 mm is introduced into the film shield, which ensures electrical continuity of the shield in case of accidental rupture of the metal film shield during laying, installation and operation of the cable. This shield provides reliable shielding from the magnetic component of the electromagnetic interference. This interference is manifested in the high frequency range. It is possible to use an additional shield in the form of a braid, which protects the cable pairs from electrical interference, which is manifested in the lower frequency range. The use of two-layer shields provides reliable shielding over the entire operating frequency range of the cable [5].

Shielding leads to an increase in cable noise immunity, which is confirmed by the results of measurements of transient attenuation at the near end of unshielded (Fig. 7,a) and shielded (Fig. 7,b) cables of the same length of 100 m for 100 MHz.

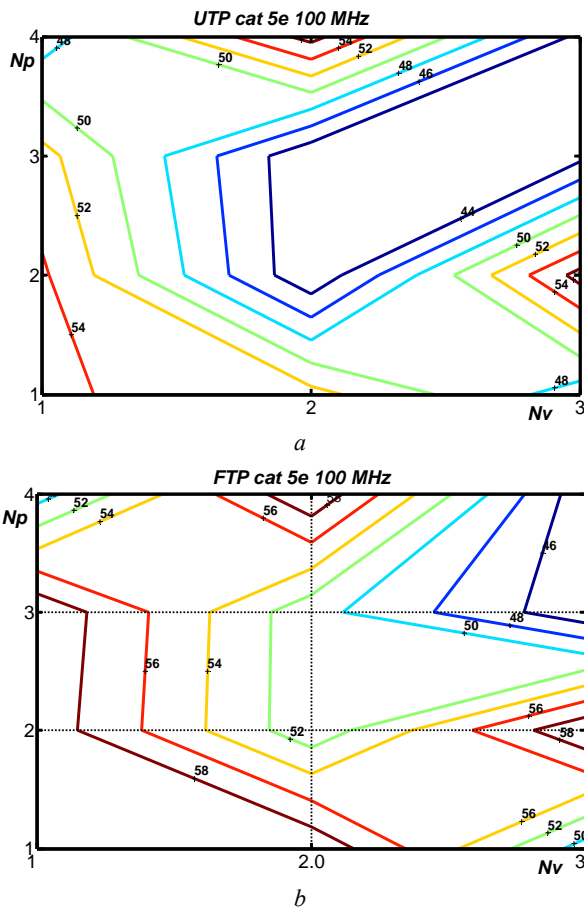

Fig. 7. Efficiency of shielding of cables on the basis of twisted pairs in the high-frequency range

Besides, the presence of a shield in the cable design affects the primary transmission parameters: active resistance  $R$  of pair's conductors, operating capacitance  $C$ , inductance  $L$ , active insulation conductivity  $G$  and, as a consequence, the secondary transmission parameters: impedance  $Z$  and attenuation coefficient  $\alpha$  (see formula (3), Fig. 8) with the same conductor diameters, insulation thickness and tolerances as in unshielded cable [10, 11].

$$\alpha = 8,69 \cdot \left( \frac{R}{2} \cdot \sqrt{\frac{C}{L}} + \frac{G}{2} \cdot \sqrt{\frac{L}{C}} \right), \text{ dB/m.} \quad (3)$$

Increase of the attenuation coefficient of 4 twisted pairs of shielded cable (Fig. 8, curve 3) in comparison with unshielded one (Fig. 8, curve 2) in the whole range of operating frequencies, due to higher values of resistance of pair's conductors and operation capacitance due to the proximity effect of the shield, reduces the tolerance relative to the upper limit of the values of the attenuation factor (Fig. 8, curve 1) in the operation of cables.

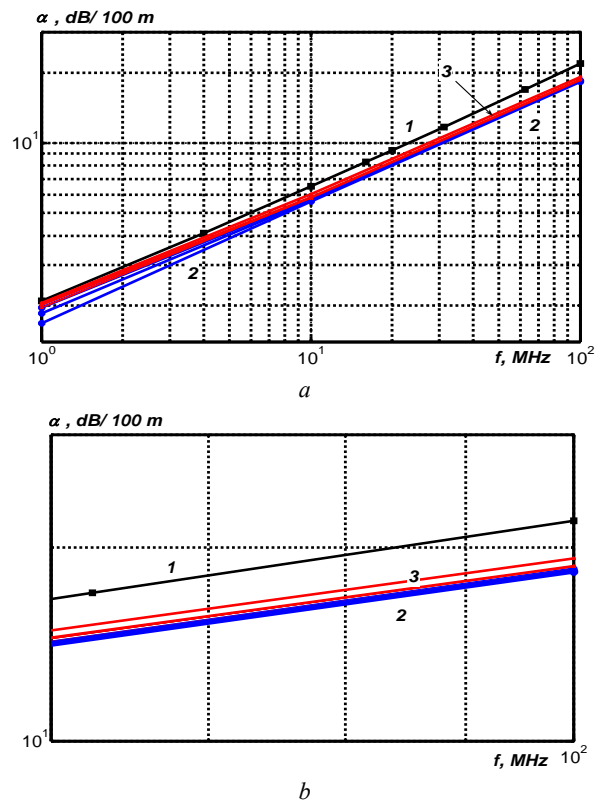

Fig. 8. On the effect of shielding on the attenuation factor in the operating frequency range of cables based on twisted pairs

The use of cables with shields requires mandatory and high-quality grounding. In case of unreliable grounding, the interference currents will repeatedly flow through the shield partially reflecting at its ends and emitting electromagnetic waves into space. In this case, the shield becomes a secondary source of radiation – a kind of antenna [5, 6, 12]. In this case, not only will the protection of twisted pair from external sources will be ineffective, but the electromagnetic effect of the cable on other adjacent cables and various electronic devices located in the same room of the fire protection system will be significantly increased.

## Conclusions.

It is experimentally proven that the twisting of each pair with different coordinated steps provides a higher level of noise immunity in a 4-pair unshielded cable compared to a shielded symmetrical multi-pair cable at the same frequency.

The use of a general shield reduces the electromagnetic effects between the twisted pairs of cable. The range of transient attenuation values at the near end at the upper operating frequency of 100 MHz is 44-54 dB and 46-58 dB for unshielded and shielded twisted pair cables with the same twisting steps.

The effect of increasing the attenuation coefficient and the greater scatter of the impact parameters cause more stringent requirements for the density of the structure and settings of the technological process of manufacturing shielded cables with twisted pairs.

## REFERENCES

1. Pigan R., Metter M. *Automating with PROFINET: Industrial Communication Based on Industrial Ethernet*. John Wiley & Sons Publ., 2015. 462 p.
2. Belous A., Saladukha V. *High-Speed Digital System Design: Art, Science and Experience*. Springer Nature Publ., 2019. 933 p.
3. *Catalog Nexans. Cables for alarm and safety systems*. 2018. 16 p.
4. *International Standard ISO/IEC 11801. Information Technology – Generic cabling for customer premises. Part 2: Office premises*. 2017. 24 p.
5. Penttinen Jyrki T.J. *The Telecommunications Handbook: Engineering Guidelines for Fixed, Mobile and Satellite Systems*. John Wiley & Sons Publ., 2015. 1008 p.
6. Weston David A. *Electromagnetic Compatibility: Methods, Analysis, Circuits, and Measurement*. CRC Press, 3rd Edition, 2016. 1160 p.
7. Solak V., Efendioglu H.S., Colak B., Garip M. Analysis and simulation of cable crosstalk. *IEEE IV International Electromagnetic Compatibility Conference (EMC Turkey)*, 24-27 Sept. 2017, Ankara, Turkey, pp 1-4. doi: **10.1109/EMCT.2017.8090354**.
8. Bezprozvannykh G.V., Ignatenko A.G. The influence of core twisting on the transmission parameters of network cables. *Bulletin of NTU «KhPI»*, 2004, no.7, pp. 82-87. (Rus).
9. Bezprozvannykh G.V., Ignatenko A.G. Optimization of the design of network cables by the attenuation coefficient in the tolerance zone of the geometric dimensions of the transmission parameters. *Electrical engineering & electromechanics*, 2004, no. 2. pp. 8-10. (Rus).
10. Boyko AM, Bezprozvannykh G.V. Justification of insulation thickness of twisted shielded pairs of structured cable systems. *Bulletin of NTU «KhPI»*, 2011, no. 3, pp. 21-35. (Ukr).
11. Bezprozvannykh G.V., Ignatenko A.G. Indirect estimates of tolerances on the diameters of conductive conductors of twisted pair conductors of network cables. *Bulletin of NTU «KhPI»*, 2005, no. 42, pp. 47-52. (Rus).
12. Baltag O., Rosu G., Rau M.C. Magnetic field of parallel and twisted wire pairs. *2017 10th International Symposium on Advanced Topics in Electrical Engineering (ATEE)*, 2017, pp. 324-329. doi: **10.1109/atee.2017.7905020**.

Received 22.05.2020

G.V. Bezprozvannykh<sup>1</sup>, Doctor of Technical Science, Professor,  
O.A. Pushkar<sup>2</sup>, General Director,

<sup>1</sup> National Technical University «Kharkiv Polytechnic Institute»,  
2, Kyrpychova Str., Kharkiv, 61002, Ukraine,  
phone +380 57 707 60 10,

e-mail: bezprozvannykh@kpi.kharkov.ua

<sup>2</sup> Company «Alay»,

95 A2, office 202, Otradny Ave., Kyiv, 03061, Ukraine.

## How to cite this article:

Bezprozvannykh G.V., Pushkar O.A. Increasing noise immunity of cables for fire protection systems. *Electrical engineering & electromechanics*, 2020, no. 4, pp. 54-58. doi: **10.20998/2074-272X.2020.4.07**.