

Cell-Cell Signaling and the Regulation of Development  
in *Bacillus subtilis*

by

Jonathan M. Solomon

B.A., Swarthmore College, 1987

M.M., DePaul University, 1989

Submitted to the Department of Biology in Partial Fulfillment  
of the Requirements for the Degree of  
Doctor of Philosophy  
at the

Massachusetts Institute of Technology

December, 1996

© Massachusetts Institute of Technology 1996

Signature of Author \_\_\_\_\_

Certified by \_\_\_\_\_  
Alan D. Grossman, Thesis Advisor

Accepted by \_\_\_\_\_  
Richard Young, Chairman, Biology Graduate Committee

MASSACHUSETTS INSTITUTE OF TECHNOLOGY

FEB 28 1997

Science

Cell-Cell Signaling and the Regulation of Development  
in *Bacillus subtilis*

by

Jonathan M. Solomon

Submitted to the Department of Biology in December 1996 in partial fulfillment of  
the requirements for the Degree of Doctor of Philosophy in Biology

**ABSTRACT**

Genetic competence is the natural ability of a cell to bind and take up exogenous DNA. In *B. subtilis*, a Gram-positive soil bacterium, genetic competence develops when the cells are at high density. The cells determine the density of the culture by cell-cell signaling. Cells monitor two peptide factors, competence stimulatory factor (CSF) and ComX pheromone, whose accumulation signals the initiation of competence.

I purified the competence stimulatory factor (CSF) from culture supernatants, and identified it as an unmodified pentapeptide: ERGMT. Synthetic ERGMT peptide has the same effects on competence gene expression as did the purified material and is maximally active at concentrations of 5-10 nM. The five amino acid peptide (CSF) is encoded by the C-terminal five codons of a 40 amino acid open reading frame, *phrC*. ComX pheromone had been previously characterized and is a ten amino acid peptide with a hydrophobic modification on a tryptophan residue.

I determined that CSF and ComX pheromone are sensed by two different pathways that converge to affect expression of the *srfA* operon. *srfA* expression is driven by the ComA transcription factor which is activated by phosphorylation. ComX pheromone stimulates a membrane-bound kinase, ComP, that phosphorylates ComA. CSF gains entry to the cell through the Spo0K oligopeptide permease. Evidence suggests that CSF inhibits a ComA phosphatase, RapC. In this way both factors positively stimulate *srfA* expression.

The initiation of sporulation is regulated by multiple cell density signals that are at least in part oligopeptides. Synthetic CSF has the ability to stimulate sporulation at low cell density, indicating that CSF is a sporulation factor as well as a competence factor.

Thesis Advisor: Dr. Alan D. Grossman  
Title: Associate Professor of Biology

## Acknowledgments

First I want to thank and acknowledge my advisor Alan Grossman, whose guidance, encouragement, patience, and support made this work possible. I will not forget the time that he bribed a meeting organizer with a box of chocolates so that I could give a talk at the meeting.

I also wish to acknowledge my classmates and my coworkers in the Grossman laboratory, a group of exceptionally interesting and talented people. It has been an honor to work with them over the years, and I fondly remember many stimulating discussions about science and other topics. I would especially like to thank Roy Magnuson, Beth Lazazzera, and Stanley Shyn with whom I got to work most closely.

I would like to thank my committee for helpful and interesting discussions. Special thanks go to Paul Matsudaira for his useful advice on peptide purification and the generous use of his HPLC and mass spectrometer.

I can not possibly repay the debt I owe my parents, Julius and Alice. They tolerated my lectures, which began at the age of two, and I thank them for listening attentively and encouraging me throughout the years.

This work would not have been possible without the sustenance provided by Quik Chow at the Kendall square food court. I especially relied upon the number 5 with liberal helpings also of the number 3 and number 4.

Finally I would like to thank my wife and partner, Irene Abrams. She has put up with my long hours of work, my tiny salary, and all the ups and downs of graduate school. This thesis is dedicated to her.

## Table of Contents

Abstract		2
Acknowledgments		3
Table of Contents		4
List of Tables		5
List of Figures		6
Thesis Plan		9
Chapter 1:	Introduction to genetic competence and sporulation	11
Chapter 2:	Convergent sensing pathways mediate response to two extracellular factors in <i>Bacillus subtilis</i>	41
Chapter 3:	Purification and characterization of an extracellular peptide factor that affects two different developmental pathways in <i>Bacillus subtilis</i>	79
Chapter 4:	The isolation and characterization of mutations that suppress a <i>spo0KA</i> null mutant for transport of peptides and development ( <i>ska</i> mutants)	119
Chapter 5:	Discussion	157



## List of Tables

Chapter 2	Table 1	Production of CSF and the ComX pheromone in different mutants.	51
	Table 2	<i>B. subtilis</i> strains used.	68
Chapter 3	Table 1	<i>B. subtilis</i> strains used.	108
Chapter 4	Table 1	<i>ska</i> mutations bypass $\Delta spo0KA$ for sporulation.	130
	Table 2	Deleting the <i>app</i> operon does not affect sporulation.	139
	Table 3	<i>B. subtilis</i> strains used.	144
	Table 4	Plasmids used.	148

## List of Figures

Chapter 1	Figure 1	DNA uptake in <i>Bacillus subtilis</i> .	14
	Figure 2	Regulation of the competence transcription factor, ComK.	17
	Figure 3	The <i>comX</i> gene product is processed and modified to produce the ComX pheromone.	21
	Figure 4	Model for cell density regulation of <i>srfA</i> expression and competence in <i>B. subtilis</i> .	23
	Figure 5	The Rap phosphatase family of <i>B. subtilis</i> .	24
	Figure 6	The phosphorylation and activation of the sporulation transcription factor, Spo0A, is controlled by a multicomponent phosphorelay.	28
Chapter 2	Figure 1	Model for the production of and response to the two extracellular competence factors.	46
	Figure 2	Expression of <i>srfA-lacZ</i> and <i>comG-lacZ</i> in wild type and a <i>spo0H</i> mutant in the presence and absence of conditioned medium.	49
	Figure 3	HPLC reverse phase chromatography of CSF.	54
	Figure 4	<i>comP</i> and <i>spo0K</i> are on different pathways for the activation of <i>srfA</i> transcription.	56
	Figure 5	Effects of double mutant combinations on expression of <i>srfA</i> .	58
	Figure 6	Response of <i>spo0K</i> and <i>comP</i> mutant cells to partly purified ComX pheromone and partly purified CSF.	60
Chapter 3	Figure 1	CSF activity and C18 reverse phase HPLC column profile.	86

	Figure 2	Expression of <i>srfA-lacZ</i> in response to chemically synthesized peptide (ERGMT) in the wild type and <i>rapC</i> mutant.	88
	Figure 3	DNA sequence and map of the <i>phrC</i> region.	90
	Figure 4	Effect of <i>phrC</i> and <i>rapC</i> null mutations on expression of <i>srfA</i> and <i>comG</i> .	93
	Figure 5	CSF is required for most of the residual expression of <i>srfA</i> in the absence of ComX pheromone.	95
	Figure 6	CSF stimulates sporulation of nutrient deprived cells at low cell density.	99
	Figure 7	Model for cell density regulation of <i>srfA</i> expression and competence in <i>B. subtilis</i> .	101
Chapter 4	Figure 1	The <i>spo0K</i> operon and a model of the Spo0K oligopeptide permease.	123
	Figure 2	The <i>ska200</i> mutation allows transport of the met-leu-phe tripeptide in a <i>spo0KA</i> mutant.	128
	Figure 3	<i>ska</i> mutations partly restore <i>srfA-lacZ</i> expression and do not restore <i>comG-lacZ</i> expression in <i>spo0KA</i> mutants in liquid culture.	131
	Figure 4	Three factor cross demonstrating that the <i>ska200</i> mutation is not in <i>spo0K</i> but is upstream of <i>spo0K</i> .	133
	Figure 5	Map of the region containing the <i>ska200</i> mutation and plasmids used for its cloning and characterization.	136
	Figure 6	Deleting the <i>app</i> operon does not affect expression of <i>srfA-lacZ</i> .	140
Chapter 5	Figure 1	Peptide signaling in four microorganisms, <i>Saccharomyces cerevisiae</i> , <i>Enterococcus faecalis</i> , <i>Streptococcus pneumoniae</i> , and <i>Bacillus subtilis</i> .	167

Figure 2	Organization of genes involved in peptide signaling from four different bacteria.	172
Figure 3	The structures of three homoserine lactone autoinducers and a <i>Streptomyces</i> A-Factor.	177

## Thesis Plan

**Chapter 1** is an introduction to genetic competence and sporulation in *Bacillus subtilis*. The focus is on the physiological signals and proteins that regulate the initiation of both of these developmental programs. Special emphasis is placed on introducing how cell-cell signaling regulates both competence and sporulation.

**Chapter 2** was published in *Genes and Development*, volume 9, pages 547-558, as "Convergent sensing pathways mediate response to two extracellular competence factors in *Bacillus subtilis*," by Jonathan M. Solomon, Roy Magnuson, Alok Srivastava, and Alan D. Grossman. Chapter 2 describes the partial characterization of a second extracellular competence factor, CSF (competence stimulatory factor) and our evidence that the two competence factors are sensed by two different, but converging pathways. Roy Magnuson was responsible for the partial purification of CSF and determining how much ComX pheromone and CSF were produced in various mutants. I performed the assays demonstrating that the two extracellular factors are sensed by two pathways and that the defect of the *spo0H* mutant in competence was mostly the failure to produce extracellular competence signals.

**Chapter 3** was published in *Genes and Development*, volume 10, pages 2014-2024, as "Purification and characterization of an extracellular peptide factor that affects two different developmental pathways in *Bacillus subtilis*," by Jonathan M. Solomon, Beth A. Lazazzera, and Alan D. Grossman. In Chapter 3 I describe the purification and identification of the competence stimulatory factor (CSF) and an analysis of how synthetic CSF affect both competence and sporulation. The *phrC* gene was determined to be responsible for the production of CSF, and the *rapC* gene product was required for CSF to stimulate competence gene expression. I purified CSF, determined that the *phrC* gene product was responsible for CSF production,

and assayed the effect of CSF on sporulation. Beth Lazazzera assayed the effects of synthetic CSF and the *phrC* and *rapC* gene knockouts on competence gene expression.

In chapter 4 I describe the isolation and initial characterization of mutations that suppress a *spo0KA* null mutant for transport of peptides and the regulation of genetic competence and sporulation (*ska* mutants). The mutations are second site suppressors that activate a cryptic oligopeptide permease operon in *Bacillus subtilis*. As we were characterizing this operon we were scooped and so the project was left incomplete. I isolated the mutations, did the initial characterization, cloned them, and did the initial sequencing that identified the second oligopeptide permease. Stanley Shyn, a UROP student, helped with the characterization of the the *ska* mutants and Nereus Gunther IV, a technician, was sequencing the entire oligopeptide permease operon.

Chapter 5 is a discussion of the the work presented in this thesis. I enumerate the many unanswered questions about how cell-cell signaling regulates competence and consider future directions for this work. The cell density signaling found in *Bacillus subtilis* is compared and contrasted to cell-cell signaling systems in other microorganisms.

**Chapter 1**  
**Introduction to Genetic Competence and Sporulation**

*Bacillus subtilis* is a low G+C content, non-pathogenic, Gram-positive bacterium which lives in the soil. From the soil it spreads to plants, foods, animals, and fresh and salt water environments (Priest, 1993). *B. subtilis* is the most studied of the Gram-positive bacteria. Its ~4200 kilobase-pair genome is being sequenced by a consortium of European and Japanese laboratories, and the project should be completed sometime in 1997 (<http://pasteur.fr/Bio/SubtiList.html>)(Moser et al., 1995). *B. subtilis* undergoes two remarkable adaptations, sporulation and genetic competence, making it an excellent system for studying questions of development, differentiation, and the regulation of gene expression. Sporulation is a developmental process that leads to production of dormant, environmentally-resistant endospores. During genetic competence *B. subtilis* differentiates into a cell type that can take up large pieces of DNA from the environment. More than 100 genes that affect sporulation and 30-40 that are required for genetic competence have been identified, reviewed in (Grossman, 1995). In recent years the functions of many of these genes have been elucidated by genetic, physiological, and biochemical studies.

Our laboratory studies the signals and gene products that regulate the initiation of genetic competence and sporulation. Both competence and sporulation are regulated by cell density signals; which are extracellular peptide factors which accumulate with increasing cell density. This thesis focuses on how cell-cell signaling, mediated by these peptide factors, regulates genetic competence and sporulation. Following is a brief introduction to genetic competence and sporulation with an emphasis on the regulatory pathways that control the initiation of both processes.

### **Genetic Competence**



Genetic competence is the natural ability of a cell to bind and take up large pieces of DNA from the environment (for reviews see (Dubnau, 1991; Grossman, 1995; Solomon and Grossman, 1996)). Competence has been reported in a wide variety of Gram-positive and Gram-negative genera (Lorenz and Wackernagel, 1994; Stewart and Carlson, 1986). The DNA taken into the cell during competence can efficiently replace homologous regions of the chromosome (Davidoff-Abelson and Dubnau, 1973; Dubnau and Cirigliano, 1972). This property allowed competence to play an important role in the history of molecular biology. Avery, MacCleod, and McCarty used it to give the first clear indication that DNA is the hereditary material (Avery et al., 1944). They demonstrated that DNA (and not RNA or protein) from a virulent strain of *Pneumococcus* (*Streptococcus pneumoniae*) could convert ('transform') a nonvirulent strain to virulence. Genetic competence also played an historic role in the study of *B. subtilis*. The demonstration that *B. subtilis* was competent in the late 1950's was partly responsible for its rise to prominence as a subject of modern microbiological study (Sonenshein et al., 1993). Researchers who study competence today are interested in understanding all the gene products required for DNA uptake and their regulation.

When *B. subtilis* cells become competent they actually differentiate into a distinct competent state and have different properties than non-competent cells. Competent cells have decreased buoyant density and can be separated from non-competent cells on Renografin gradients (Cahn and Fox, 1968; Hadden and Nester, 1968). Competent cells have low levels of macromolecular synthesis (Dooley et al., 1971). Only competent cells express the proteins which comprise the DNA uptake machinery (Dubnau, 1991; Hahn et al., 1987).

The well-described pathway by which DNA enters the *B. subtilis* cell is diagrammed in Figure 1 (Dubnau, 1991). Double-stranded DNA is bound, with no

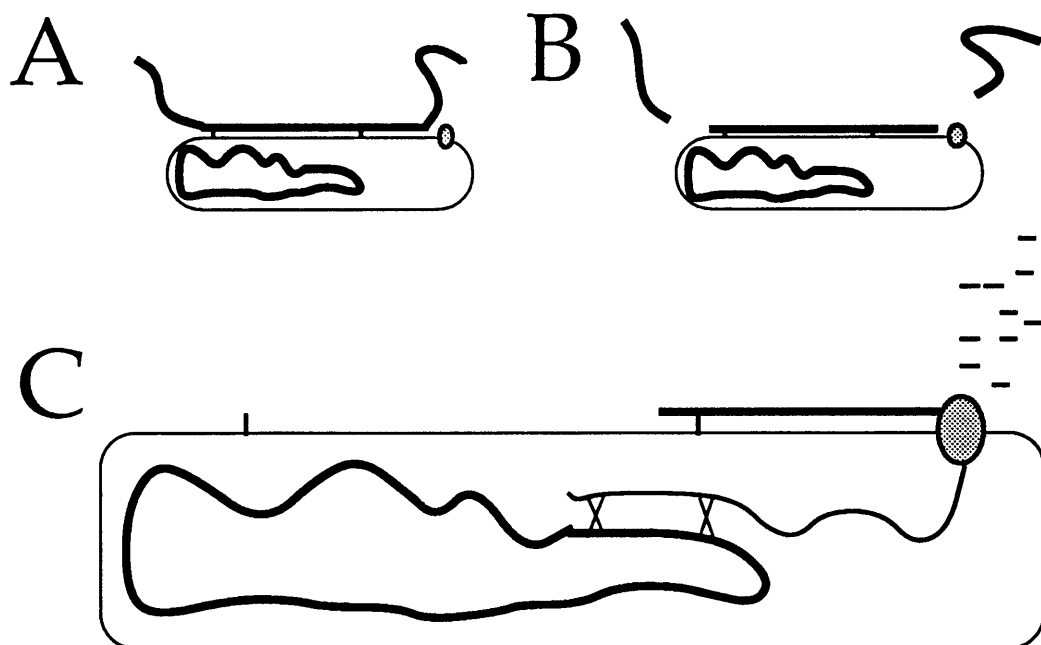

**Figure 1. DNA uptake in *Bacillus subtilis*** (A) Double-stranded DNA is bound, with no apparent sequence specificity, at a finite number of sites on the cell surface. (B) DNA undergoes double-strand cleavage. (C) One strand of DNA, chosen at random, enters the cell through the DNA-uptake machinery, while the other strand is degraded outside the cell. The diagram also depicts recombination between the entering single strand and complementary regions of the chromosome.

apparent sequence specificity, at a finite number of sites on the cell surface (Singh, 1972). The DNA undergoes double-strand cleavage and one strand, chosen at random (Vagner et al., 1990), is taken into the cell, while the other strand is degraded outside the cell (Davidoff-Abelson and Dubnau, 1973; Dubnau and Cirigliano, 1972). If the single-stranded DNA is complementary to a region of the genome it will almost always be recombined into the chromosome (Davidoff-Abelson and Dubnau, 1973).

Genetic analysis has identified genes for the proteins that make up the DNA uptake machinery (Hahn et al., 1987), and there has been progress in determining the functions of these gene products. DNA binding requires proteins (the products of the *comG* and *comC* operons) that resemble type IV pilins and enzymes involved in pilin processing and assembly (Chung and Dubnau, 1995; Hobbs and Mattick, 1993). The pilin-like proteins are thought to form a pore through the cell wall that allows the DNA access to the cytoplasmic membrane. DNA uptake requires a putative DNA helicase (ComFA) (Londono-Vallejo and Dubnau, 1993), a single stranded DNA binding protein (ComEA) (Prevvedi, personal communication), and a membrane-spanning protein through which DNA is thought to cross the cytoplasmic membrane (ComEC) (Hahn et al., 1993; Inamine and Dubnau, 1995).

The mechanism of DNA uptake might be similar in all competent organisms. The components of the DNA uptake machinery have homologues in other competent bacteria. Proteins homologous to ComEC have been found in *N. gonorrhoeae* (*comA*) (Facijs and Meyer, 1993) and in *H. influenzae* (*rec-2*) (Clifton et al., 1994). Analysis of the *H. influenzae* genome sequence has identified homologues of many of the *com* genes from other organisms (Fleischmann, 1995). The mechanism of DNA uptake in competence might also share similarities to other DNA transfer reactions like conjugation. Homologues of the products of the *comC* and *comG*

operons are required for conjugation in *E. coli* and the transfer of T-DNA from *Agrobacterium tumefaciens* to plants (Dreiseikermann, 1994; Hobbs and Mattick, 1993).

**Regulation of Genetic Competence in *B. subtilis*.** The initiation of competence in *B. subtilis* is regulated by nutritional signals and cell-density signals. Competence can occur during exponential or post-exponential growth, depending on the composition of the medium. The addition of all twenty amino acids to defined minimal medium shifts expression of competence genes from exponential to post-exponential growth (Dubnau et al., 1991; Serror and Sonenshein, 1996; Srivastava, personal communication). Competence genes are expressed at very low levels in some rich media, like Luria Broth, suggesting there are additional nutritional controls on competence (Dubnau, 1991).

Competence is also regulated by cell-density signals. In exponentially growing cells competence begins when the culture reaches high cell density ( $1-2 \times 10^8$  cells/ml) (Magnuson et al., 1994). Competence can be induced at low cell densities by adding cell-free supernatants from dense cultures. Two extracellular peptide factors, ComX pheromone and the Competence Stimulatory Factor (CSF), are responsible for cell-density regulation of competence (below and Chapters 2&3) (Magnuson et al., 1994; Solomon et al., 1995).

Only a fraction (at best 10%) of cells in a culture become competent. This phenomenon is called cell-type regulation (Cahn and Fox, 1968; Dubnau, 1991). The factors that limit competence to a relatively small sub-population are not known, but are probably related to the activation of the competence-specific transcription factor, encoded by *comK* (Hahn et al., 1994).

**Regulation of ComK, the competence transcription factor** All of the signals that affect competence impinge upon a single transcription factor, which is the key regulator of genetic competence, ComK (Figure 2). ComK activates expression of all

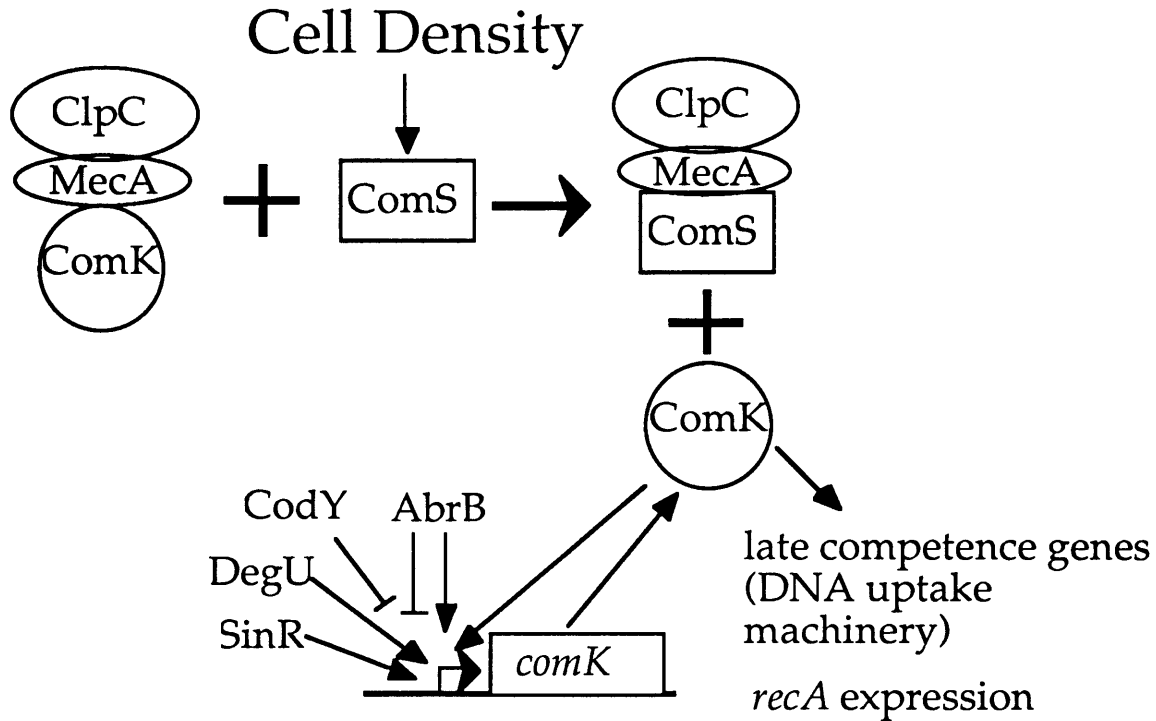

**Figure 2. Regulation of the competence transcription factor, ComK.**

Expression of the *comK* gene is regulated by multiple transcription factors. ComK stimulates its own expression, an autoregulatory loop that commits cells to competence (Hahn et al., 1994; van Sinderen and Venema, 1994). SinR activates *comK* expression and competence, but inhibits sporulation (Mandic-Mulec et al., 1992). CodY inhibits *comK* expression in response to unknown nutritional signals (Serror and Sonenshein, 1996). The unphosphorylated form of the DegU transcription factor is required for *comK* expression (Dahl et al., 1992). The sporulation pathway controls expression of the AbrB transcription factor which acts both positively and negatively at the *comK* promoter (Hahn et al., 1995b).

ComK is regulated post-transcriptionally by ClpC/MecA. ClpC and MecA negatively regulate ComK by binding ComK and keeping it inactive (Kong and Dubnau, 1994). The ComS protein, whose production is under the control of extracellular competence factors, can stimulate release of ComK from ClpC/MecA (Turgay et al., 1996).

the identified competence genes that encode the DNA processing and uptake machinery (van Sinderen et al., 1995). ComK also increases expression of *recA*, presumably to stimulate recombination between incoming DNA and the chromosome (Cheo et al., 1993). Finally, ComK increases its own transcription; creating an auto-regulatory loop that ensures a rapid regulatory response that probably contributes to committing cells to the competence pathway (Figure 2) (Hahn et al., 1994; van Sinderen and Venema, 1994).

Several transcription factors besides ComK itself (CodY, AbrB, DegU, and SinR) affect expression of *comK* (Figure 2)(Hahn et al., 1996). Some of the transcription factors are activated in response to as yet unknown nutritional signals (CodY, AbrB, DegU). Some of them might function to prevent competence from occurring at the same time as other processes, like sporulation (SinR, AbrB).

The post-transcriptional regulation of ComK is mediated by ClpC and MecA, which respond to cell-density signals. ClpC and MecA are negative regulators of ComK (Dubnau and Roggiani, 1990; Hahn et al., 1995a). *B. subtilis* ClpC (Msadek et al., 1994) is an ATPase, which is the homologue of the regulatory subunit of the Clp protease complex characterized in *E. coli* (Squires and Squires, 1992). MecA is similar to the ClpP subunit of the protease, but MecA is clearly not a protease as it is missing the conserved serine residue that is essential for protease activity (Kong and Dubnau, 1994). ClpC and MecA form a complex which binds to ComK, holding it inactive (Kong and Dubnau, 1994) (figure 2). The ComS protein, whose production is regulated by cell-cell signaling, stimulates the release of ComK from ClpC and MecA freeing it to function as a transcription factor (figure 2) (Turgay et al., 1996).

**Regulation of Competence by Cell Density Signals.** An indication that competence is regulated by cell density came from studies of the *srfA*(*comS*) promoter (Magnuson et al., 1994). Mutations in the *srfA* operon cause a defect in the

initiation of competence (Nakano et al., 1991). During exponential growth, *srfA* expression is low at low cell density and turns on as the cells reach a density of  $2-3 \times 10^7$  cells/ml. This unusual expression pattern suggested that the accumulation of a signal might be inducing *srfA* expression. This was confirmed by the observation that cell-free supernatants from cultures at high density can induce *srfA* expression when added to cells at low cell densities (when *srfA* is not normally expressed). This indicates that there are factors in the medium which are inducing *srfA* expression (Magnuson et al., 1994). *srfA* expression is the only part of the competence pathway that is regulated by cell-density factors. Expressing *srfA* from an inducible promoter bypasses the effect of cell density on competence (Hahn and Dubnau, 1991; Nakano and Zuber, 1991).

The *srfA* operon encodes subunits of the peptide synthetase that is required for synthesis of the lipopeptide antibiotic surfactin and also ComS (Cosmina et al., 1993). *comS* is the only open reading frame of the *srfA* operon that is required for competence (D'Souza et al., 1994; Hamoen et al., 1995). The *comS* gene is internal to one of the peptide synthetase open reading frames of the *srfA* operon. The reason that *comS* is internal to the *srfA* operon is unknown. Transcription of *comS* comes solely from the promoter at the beginning of the *srfA* operon (Nakano et al., 1991).

Roy Magnuson designed an assay for extracellular competence factors based on their ability to stimulate *srfA* expression at low cell density (Magnuson et al., 1994). Two *srfA* stimulating factors in the cell-free supernatants were identified, ComX pheromone and the competence stimulatory factor (CSF). ComX pheromone is a 10 amino acid peptide (ADPITRQWGD) with a hydrophobic modification on the tryptophan residue (Magnuson et al., 1994). CSF, as will be shown in Chapter 3, is an unmodified pentapeptide-ERGMT (Solomon et al., 1996). Conditioned medium

from mutants that do not make ComX pheromone or CSF has virtually no extracellular *srfA* -inducing ability (Solomon et al., 1996).

The *comX* gene product is processed and modified to produce the ComX pheromone (Figure 3) (Magnuson et al., 1994). *comX* encodes the 55 amino acid precursor to the active pheromone. The carboxy-terminal 10 amino acids of ComX constitute the peptide portion of the ComX pheromone. The pheromone precursor does not appear to have a typical leader sequence for secretion by the SecA-dependent pathway, so we suspect that ComX pheromone is secreted by a special export protein. *comQ*, the gene, immediately upstream of *comX*, is required for production of the active competence pheromone (Magnuson et al., 1994). *comQ* contains several motifs found in isoprenyl diphosphate synthases and is probably involved in the hydrophobic modification of the pheromone (Tanya Palmer, personal communication).

CSF is produced from the *phrC* gene product (Chapter 3)(Solomon et al., 1996). The CSF pentapeptide matches the carboxy-terminal five amino acids of the 40 amino acid PhrC protein. The gene was recently named *phrC* under the assumption that it encodes a phosphatase regulator (Perego et al., 1996). PhrC contains a signal sequence for secretion that should lead to secretion of the C-terminal half of the protein by the SecA-dependent pathway (Perego et al., 1996). It is not known how the extracellular peptide is processed from the secreted form to the five amino acid form.

**Sensing the Extracellular Competence Factors** The two extracellular competence factors are sensed by two different pathways that converge to affect *srfA*(*comS*) expression (Chapter 2). *srfA* expression is regulated by the ComA transcription factor, which was shown to bind directly to the *srfA* promoter (Figure 4)(Roggiani and Dubnau, 1993). ComA belongs to a family of transcriptional



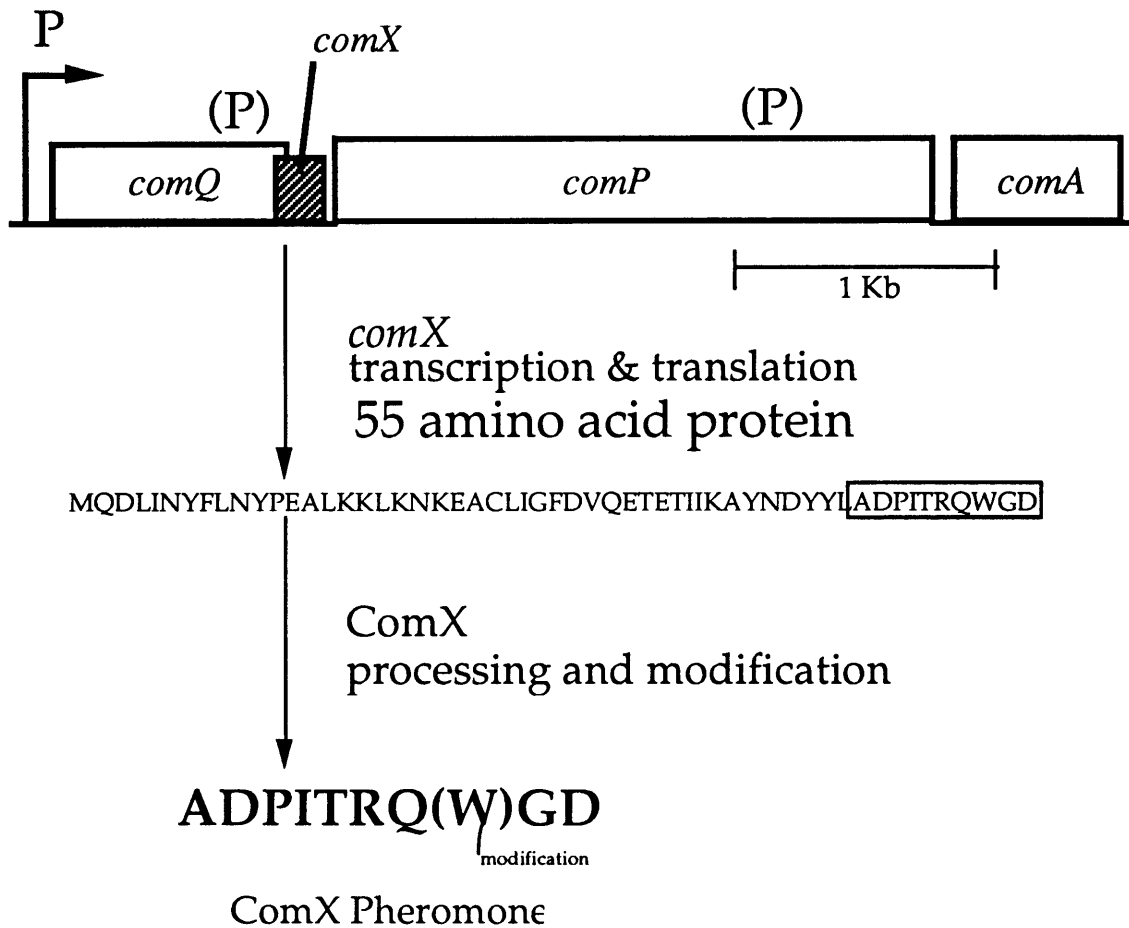
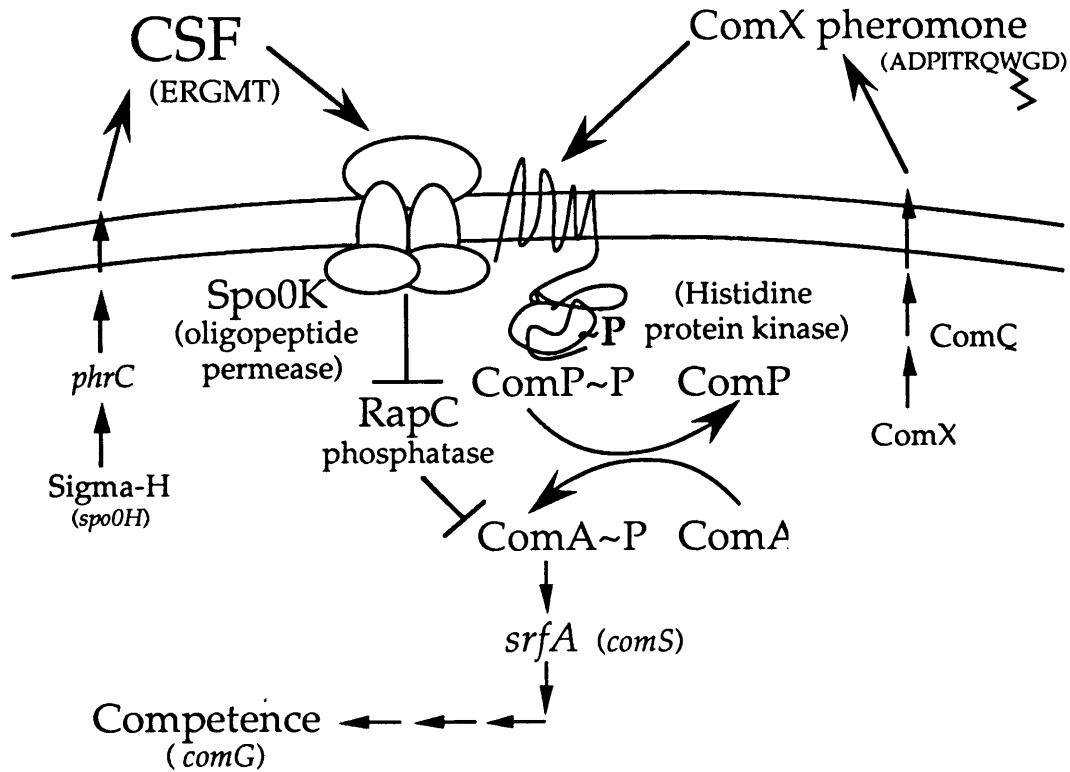

**Figure 3. The *comX* gene product is processed and modified to produce the ComX pheromone.** *comX* encodes a 55 amino acid protein. The C-terminal ten amino acids of ComX make up the peptide portion of the ComX pheromone. A hydrophobic modification of unknown structure is added to the tryptophan residue. The region of the chromosome containing *comX* is shown. *comQ* is upstream of *comX* and is required for production of ComX pheromone. ComQ has some similarity to isoprenyl diphosphate synthases and so we suspect that ComQ is involved in the modification of ComX (Palmer, 1995). Downstream of *comX* are the genes for the two component regulatory system ComP and ComA. ComP is a membrane-spanning histidine protein kinase that is required for response to the ComX pheromone and therefore is hypothesized to be the direct sensor of ComX pheromone.

regulators known as response regulators (Stock et al., 1995). Response regulators receive phosphate from and are activated by cognate histidine protein kinases known as sensor kinases. The sensor kinase autophosphorylates on a histidine residue in response to a particular signal. The phosphate is transferred to an aspartic acid residue on the response regulator. A sensor kinase and its cognate response regulator are known together as a two-component regulatory system (Stock et al., 1995). Two-component systems are found in a wide range of bacteria. There are an estimated 50 two-component systems in *E. coli* (Stock et al., 1989) and two-component systems have recently been identified in yeast and plants (Chang et al., 1993; Ota and Varshavsky, 1993).

Our model is that ComX pheromone activates the ComA transcription factor by stimulating ComP, the cognate histidine protein kinase for ComA (Figure 4)(Weinrauch et al., 1990). ComP has eight membrane-spanning domains in its amino-terminus. ComP is required for response to the ComX pheromone (Chapter 2)(Solomon et al., 1995), which suggests that ComX pheromone is the signal that stimulates ComP autophosphorylation.

Our model is that CSF stimulates the activity of the ComA transcription factor by inhibiting a putative ComA phosphatase, RapC (Chapter 3)(Solomon et al., 1996). The *rapC* gene is upstream of the gene encoding CSF. *rapC* is part of a recently discovered family of aspartyl-phosphate phosphatases found in *B. subtilis* (figure 5)(Perego et al., 1996; Perego and Hoch, 1996b). *rapC* is a negative regulator of competence gene expression. In *rapC* mutants competence gene expression begins at lower cell densities and reaches higher levels than that in *wt* cells (Chapter 3)(Solomon et al., 1996). Based on these data we hypothesize that RapC is a phosphatase for ComA. RapC is required for CSF to stimulate *srfA* expression



**Figure 4. Model for cell density regulation of *srfA* expression and competence in *B. subtilis*.** Two extracellular factors, ComX pheromone and CSF (competence stimulatory factor) stimulate expression of *srfA*(*comS*). The ComX pheromone is a 10 amino acid peptide with a hydrophobic modification in place of a tryptophan side chain. ComQ is required for production of the active pheromone. Response to the ComX pheromone requires the membrane-bound histidine protein kinase encoded by *comP*. CSF is a five amino acid peptide, ERGMT, encoded by *phrC*. Transcription of *phrC* is controlled, in part, by the sigma factor of RNA polymerase, sigma-H, encoded by *spo0H*. Response to CSF requires the oligopeptide permease encoded by *spo0K* and the phosphatase encoded by *rapC*. CSF is probably transported into the cell by the oligopeptide permease and inhibits activity of the RapC phosphatase (either directly or indirectly). ComA is the transcription factor that directly activates expression of *srfA*, and phosphorylation (activation) of ComA is controlled by ComP (kinase) and RapC (phosphatase).

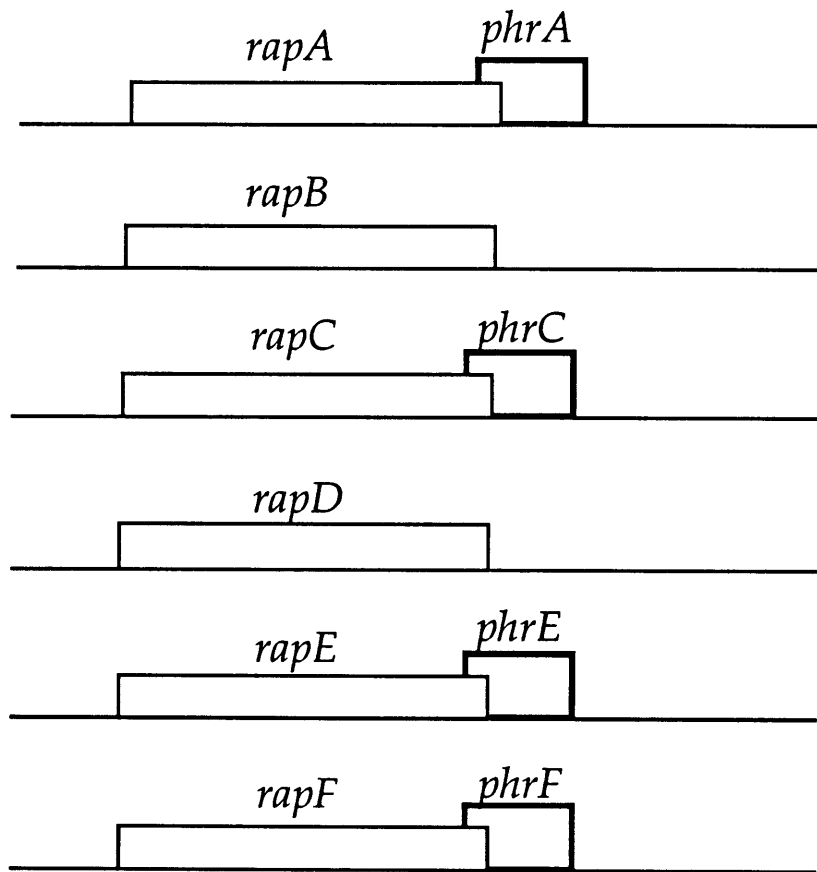

**Figure 5. The Rap phosphatase family of *B. subtilis*.** The information on the Rap phosphatase family comes from two reviews (Perego et al., 1996; Perego and Hoch, 1996b). There are at least seven Rap phosphatases in *B. subtilis*, RapA to RapG. RapG is not shown because no sequence information on *rapG* is available. RapB, RapC, RapE, and RapF are between 42-51% identical to RapA. RapD is more distantly related and is 23% identical to RapA. RapA and RapB are phosphatases for the Spo0F response regulator, which is involved in sporulation. We suspect that RapC is a phosphatase for ComA. The functions of the other Rap proteins are not known. Downstream of the genes for four of the *rap* phosphatases are genes for small peptides, *phrA*, *phrC*, *phrE*, and *phrF*. They have been named *phr* (phosphatase regulator) because it is assumed they regulate the upstream phosphatases. *rapB* has a downstream peptide gene, but it is not expressed. *rapD*, the most distantly related *rap* family member does not have a downstream peptide encoding gene.

suggesting that CSF, directly or indirectly, inhibits the activity of the RapC phosphatase (Figure 4).

The Spo0K oligopeptide permease is required for the initiation of competence. Transformation frequency of *spo0K* null mutants is 100- to 1000-fold lower than that of *wt* cells (Rudner et al., 1991). Spo0K is required for response to CSF, but is not required for response to ComX pheromone (Chapter 2) (Solomon et al., 1995). Our model is that Spo0K transports the CSF peptide into the cell where CSF interacts with the intracellular RapC target. Spo0K must have a role in competence in addition to its role as a transporter of CSF since the effect of a *spo0K* null mutant on competence is much greater than the effect of not producing CSF. This additional role has yet to be elucidated.

### **Sporulation**

Bacterial spores have fascinated researchers for decades. Some have been intrigued by their resistance properties. Although spores are made of the same stuff as vegetative cells (proteins, nucleic acids, etc), they show increased resistance to chemicals, heat, UV irradiation, and enzymes like lysozyme (Gould, 1983). The resistance properties of spores has also drawn the attention of more practical people. Heat-resistant spores can be a major source of food spoilage, thus the preparation of canned foods is governed largely by the need to eliminate spores (Ingram, 1969). Others have been intrigued by the dormancy of bacterial spores. Spores are a remarkable adaptation that allow the bacterium to hibernate during periods of famine and poor environmental conditions. The metabolic rate of spores is 1/10,000 that of vegetative cells (Lewis, 1969). Even after seventy years of dormancy the endospores can germinate and return to normal vegetative growth (Fischmann, 1995). Recently, researchers have been interested in the mechanisms by which gene

expression is carefully controlled to construct the spore structure and to regulate the entry into sporulation.

Spore formation in *B. subtilis* is a developmental process that takes about eight hours and involves an intricate series of morphological changes (Errington, 1993; Losick and Youngman, 1984). One of the early morphological events in sporulation is an asymmetric division which creates a large mother cell and a smaller forespore cell. The two cells have different developmental fates and have different programs of gene expression. The forespore is engulfed by the mother cell creating a cell within a cell. A peptidoglycan-like cortex is constructed between the forespore membrane and the mother-cell membrane that surrounds the forespore. A proteinaceous coat is constructed around the forespore on the cytoplasmic side of the mother-cell membrane surrounding the forespore. Small acid-soluble proteins wrap tightly around the DNA of the forespore, which protects it from irradiation and also shuts down all transcription (Setlow, 1994). The forespore also becomes dehydrated, which contributes to its dormancy and heat-resistant properties (Gerhardt and Marquis, 1989). Finally the mother cell lyses releasing the free spore.

**Initiation of Sporulation.** The primary signal to initiate sporulation is starvation. Starvation for carbon, nitrogen, and perhaps phosphate can initiate sporulation (Sonenshein, 1989). Freese and colleagues proposed that a drop in GTP or GDP levels is the direct indicator of starvation in sporulating cells. Conditions that limit the production of GDP and GTP, either adding drugs that partially block GMP synthesis or starving a guanine auxotroph for guanine, can stimulate sporulation even in the presence of excess nutrients (Freese et al., 1981). Furthermore all conditions that initiate sporulation lead to a drop in GTP and GDP levels (Lopez et al., 1981). How the drop in GTP levels is sensed by the sporulation regulatory circuits remains a mystery.

Many other signals affect the initiation of sporulation. DNA-related signals can affect the initiation of sporulation. If cells can not initiate DNA replication (Ireton and Grossman, 1994), replicate their DNA (Ireton and Grossman, 1992), or segregate their chromosomes properly (Ireton et al., 1994) sporulation will not initiate. The absence of some TCA cycle enzymes can also block the initiation of sporulation (Ireton et al., 1995). The TCA cycle is necessary to provide the energy to successfully complete sporulation. There are also cell-density signals that promote the initiation of sporulation (see below) (Grossman and Losick, 1988; Perego and Hoch, 1996a; Waldburger et al., 1993).

**Spo0A is the key regulator of the initiation of sporulation.** All the signals that affect the initiation of sporulation impinge upon a single transcription factor, which is the key regulator of sporulation, Spo0A (Grossman, 1995). Spo0A, like ComA, is a member of the response regulator family of the two-component regulatory systems (Ferrari et al., 1985). Spo0A is activated by phosphorylation on an aspartic acid residue (Burbulys et al., 1991). Spo0A stimulates transcription of sigma factors required for compartment-specific gene expression early in sporulation (Satola et al., 1992; Trach et al., 1991) and is responsible for altering the placement of the division septum from its symmetrical vegetative position to its asymmetric sporulation position (Levin and Losick, 1996; Piggot and Coote, 1976).

The phosphorylation and activation of Spo0A occurs by a phosphorelay (Figure 6). Phosphate from three cognate histidine protein kinases is transferred to Spo0F, which transfers the phosphate to Spo0B, which transfers the phosphate to Spo0A. (Figure 6) (Burbulys et al., 1991; Grossman, 1995; Hoch, 1993). This system is an expansion of the more common two-component system in which the response regulator receives phosphate directly from a single cognate histidine protein kinase. The phosphorelay is believed to allow the cells a greater opportunity to regulate the

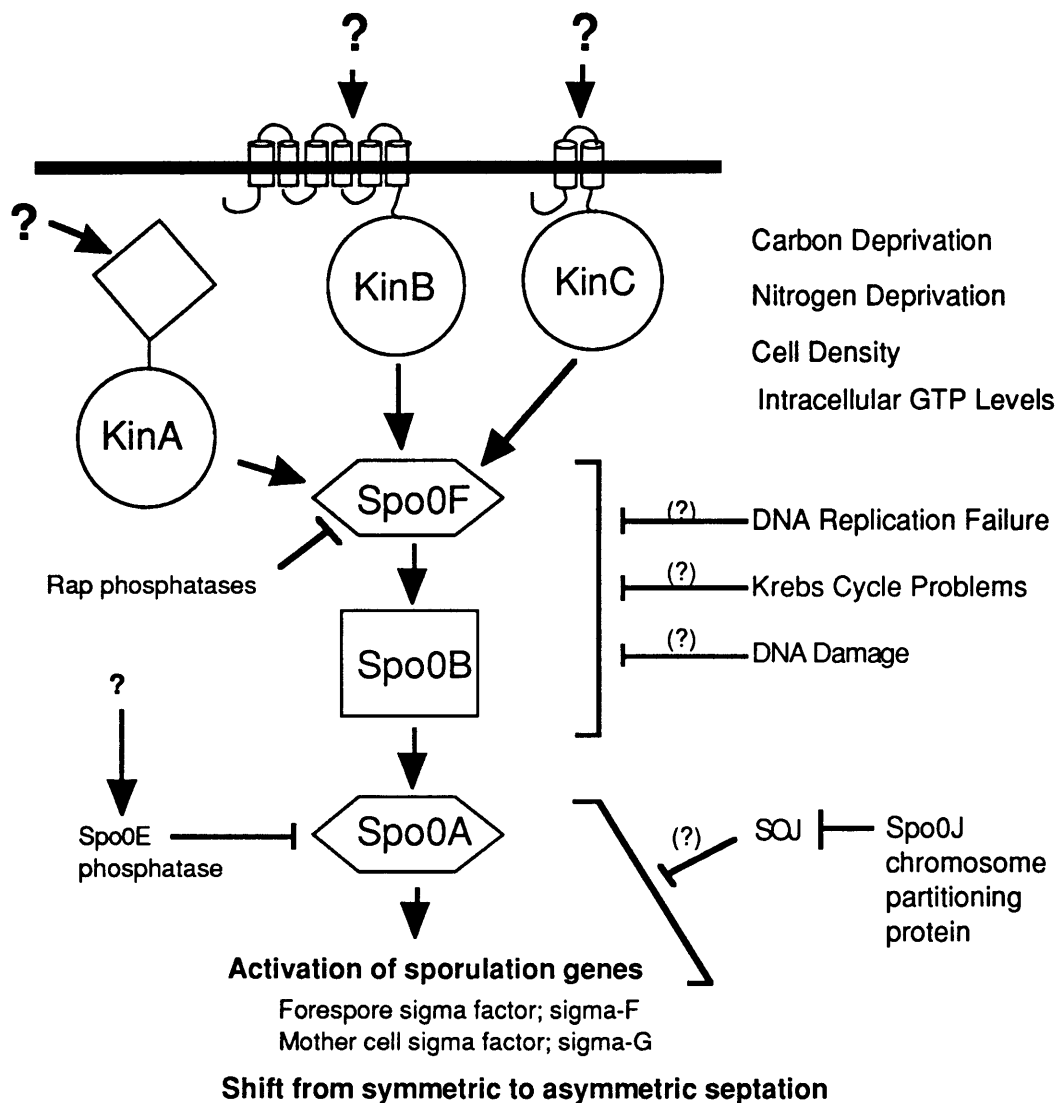

**Figure 6. The phosphorylation and activation of the sporulation transcription factor, Spo0A, is controlled by a multicomponent phosphorelay.** Three histidine kinases, KinA, KinB, and KinC autophosphorylate in response to unknown signals. Spo0F takes phosphate from the kinases and transfers it to Spo0B. Spo0B takes phosphate from Spo0F and transfers it to Spo0A. Activated Spo0A stimulates transcription of genes that establish forespore and mother-cell gene expression early in sporulation and that shift the position of the septum from its symmetrical vegetative site to its asymmetrical sporulation site. Three phosphatases are known to act on the phosphorelay. Spo0E is a phosphatase for Spo0A~P, and RapA and RapB are phosphatases for Spo0F~P. Also shown are the physiological signals that regulate the phosphorelay. It is still unknown how the signals affect the phosphorelay proteins.



flow of phosphate to Spo0A (Burbulys et al., 1991; Hoch, 1993). For example, the phosphorelay increases the number of targets at which phosphatases can act. There is a phosphatase that acts on Spo0A~P (Spo0E (Ohlsen et al., 1994)) and two that act on Spo0F~P (RapA, RapB (Perego et al., 1994)).

The three histidine kinases that affect the phosphorelay are KinA, KinB, and KinC (figure 6). KinB has six membrane-spanning regions in its sensor domain (Trach and Hoch, 1993), KinC is thought to have two membrane-spanning regions in its sensor domain (Kobayashi et al., 1995; LeDeaux and Grossman, 1995), and KinA is located in the cytoplasm (Antoniewski et al., 1990; Perego et al., 1989). It is not yet known which signals the kinases are responding to, but it is clear that different kinases are more or less important when sporulation is induced in different media (LeDeaux et al., 1995).

#### **Cell Density and Sporulation in *B. subtilis***

Many groups found evidence that extracellular factors regulate sporulation in *B. subtilis*. Grossman and Losick (1988) showed that sporulation was more efficient at high cell density than at low cell density when sporulation is induced by drugs that inhibit the production of GMP or transfer to resuspension medium (Grossman and Losick, 1988). Furthermore, the defect in sporulation of cells at low density could be partly rescued by adding cell-free supernatants from cultures that had been grown to high density. They named the factor(s) in the medium that stimulated sporulation extracellular differentiation factor A (EDF-A) and determined that it was at least in part an oligopeptide. Production of EDF-A was dependent on the Spo0A transcription factor.

The *phrA* gene encodes a small secreted peptide. Deletion of the *phrA* gene leads to a 10-fold decrease in sporulation frequency, which could be rescued by adding synthetic peptides matching the C-terminus of PhrA (Perego and Hoch,

1996a). This strongly suggests that PhrA encodes an extracellular sporulation factor that is an oligopeptide. It has not yet been determined if PhrA contributes to the effect of cell density on sporulation seen previously (Grossman and Losick, 1988).

The competence stimulatory factor (CSF) is also a sporulation factor (Chapter 3) (Solomon et al., 1996). The CSF pentapeptide can stimulate sporulation at low cell density when sporulation is induced with drugs that inhibit GMP synthesis. The concentration of CSF needed to affect sporulation are higher than the concentration needed to affect competence gene expression. Like EDF-A, production of CSF depends on the Spo0A transcription factor making it possible that CSF is part of the EDF-A signal.

Waldburger et al. (1993) reported the existence of a sporulation factor that stimulates sporulation at low density (Waldburger et al., 1993). The ability of cells to respond to this factor requires the addition of proline or arginine. This sporulation factor is resistant to proteases and its production is not dependent on Spo0A, which clearly distinguishes it from EDF-A and CSF.

There is evidence for yet another extracellular sporulation factor. During the purification of CSF, I noticed two activities that stimulated sporulation at low density. One activity copurified with CSF and the other did not. The second activity was not PhrA as it was still produced in a *phrA* mutant (Solomon, 1995, unpublished results). This activity is awaiting characterization.

Some of the gene products that affect the initiation of sporulation seem designed to interact with extracellular sporulation factors. A *spo0K* mutant blocks the initiation of sporulation. *spo0K* encodes an oligopeptide permease as revealed by its sequence homology and direct experimental tests (Perego et al., 1991; Rudner et al., 1991). It is hypothesized that the role of Spo0K in sporulation is to sense oligopeptide extracellular sporulation factors. It is also interesting that two of the

histidine protein kinases that provide phosphate for the phosphorelay, KinB and KinC, have membrane-spanning domains. They are also poised to interact with extracellular factors. While these facts are tantalizing, it remains to be determined if these proteins function in response to extracellular sporulation factors.

The physiological signals that affect sporulation; starvation, DNA signals, the TCA cycle, and cell density, all affect the activation of Spo0A. Mutations that make Spo0A active in the absence of phosphorylation bypass all of the physiological signals for early sporulation gene expression (Ireton et al., 1993). An active area of research is the identification of how the various physiological signals that affect sporulation impinge upon the phosphorelay. Spo0A activation is a switch that integrates all the information from intracellular and extracellular signals and calculates a yes or no decision about whether or not to initiate sporulation.

## REFERENCES

- Antoniewski, C., B. Savelli and P. Stragier. 1990. The *spoIIJ* gene, which regulates early developmental steps in *Bacillus subtilis*, belongs to a class of environmentally responsive genes. *J. Bacteriol.* **172**: 86-93.
- Avery, O.T., C.M. MacLeod and M. McCarty. 1944. Studies on the chemical nature of the substance inducing transformation of pneumococcal types. Induction of transformation by a deoxyribonucleic acid fraction isolated from pneumococcus type III. *J. Exp. Med.* **79**: 137-158.
- Burbulys, D., K.A. Trach and J.A. Hoch. 1991. Initiation of sporulation in *B. subtilis* is controlled by a multicomponent phosphorelay. *Cell* **64**: 545-552.
- Cahn, F.H. and M.S. Fox. 1968. Fractionation of transformable bacteria from competent cultures of *Bacillus subtilis* on renografin gradients. *J. Bacteriol.* **95**: 867-875.
- Chang, C., S.F. Kwok, A.B. Blecker and E.M. Meyerowitz. 1993. *Arabidopsis* ethylene-response gene *ETR1*: similarity of product to two-component regulators. *Science* **262**: 539-544.
- Cheo, D.L., K.W. Bayles and R.E. Yasbin. 1993. Elucidation of regulatory elements that control damage induction and competence induction of the *Bacillus subtilis* SOS system. *J. Bacteriol.* **175**: 5907-5915.
- Chung, Y.S. and D. Dubnau. 1995. ComC is required for the processing and translocation of ComGC, a pilin-like competence protein of *Bacillus subtilis*. *Mol. Microbiol.* **15**: 543-551.
- Clifton, S.W., D. McCarthy and B.A. Roe. 1994. Sequence of the *rec-2* locus of *Haemophilus influenzae*: homologies to *comE-orf3* of *Bacillus subtilis* and *msbA* of *Escherichia coli*. *Gene* **146**: 95-100.
- Cosmina, P., F. Rodriguez, F. de Ferra, G. Grandi, M. Perego, G. Venema and D. van Sinderen. 1993. Sequence and analysis of the genetic locus responsible for surfactin synthesis in *Bacillus subtilis*. *Mol. Microbiol.* **8**: 821-831.
- D'Souza, C., M.M. Nakano and P. Zuber. 1994. Identification of *comS*, a gene of the *srfA* operon that regulates the establishment of genetic competence in *Bacillus subtilis*. *Proc. Natl. Acad. Sci. USA* **91**: 9397-9401.

- Dahl, M.K., T. Msadek, F. Kunst and G. Rapoport. 1992. The phosphorylation state of the DegU response regulator acts as a molecular switch allowing either degradative enzyme synthesis or expression of genetic competence in *Bacillus subtilis*. *J. Biol. Chem.* **267**: 14509-14514.
- Davidoff-Abelson, R. and D. Dubnau. 1973. Kinetic analysis of the products of donor deoxyribonucleate in transformed cells of *Bacillus subtilis*. *J. Bacteriol.* **116**: 154-162.
- Dooley, D.C., C.T. Hadden and E.W. Nester. 1971. Macromolecular synthesis in *Bacillus subtilis* during development of the competent state. *J. Bacteriol.* **108**: 668-679.
- Dreiseikermann, B. 1994. Translocation of DNA across bacterial membranes. *Microbiol. Rev.* **58**: 293-316.
- Dubnau, D. 1991. Genetic competence in *Bacillus subtilis*. *Microbiol. Rev.* **55**: 395-424.
- Dubnau, D. and C. Cirigliano. 1972. Fate of Transforming DNA following Uptake by Competent *Bacillus subtilis* III. Formation and Properties of Products Isolated from Transformed Cells which are Derived Entirely from Donor DNA. *J. Mol. Biol.* **64**: 9-29.
- Dubnau, D., J. Hahn, L. Kong, M. Roggiani and Y. Weinrauch. 1991. Genetic competence as a post-exponential global response. *Seminars in Dev. Biol.* **2**: 3-11.
- Dubnau, D. and M. Roggiani. 1990. Growth medium-independent genetic competence mutants of *Bacillus subtilis*. *J. Bacteriol.* **172**: 4048-4055.
- Errington, J. 1993. *Bacillus subtilis* sporulation: Regulation of gene expression and control of morphogenesis. *Microbiol. Rev.* **57**: 1-33.
- Facius, D. and T. Meyer, F. 1993. A novel determinant (*comA*) essential for natural transformation competence in *Neisseria gonorrhoeae* and the effect of a *comA* defect on pilin variation. *Mol. Microbiol.* **10**: 699-712.
- Ferrari, F.A., K. Trach, D. LeCoq, J. Spence, E. Ferrari and J.A. Hoch. 1985. Characterization of the *spo0A* locus and its deduced product. *Proc. Natl. Acad. Sci. USA* **82**: 2647-2651.
- Fischmann, J. 1995. Have 25-Million-year-old bacteria returned to life? *Science* **268**: 977.

- Fleischmann, et.al. 1995. Whole-Genome random sequencing and assembly of *Haemophilus influenzae* Rd. *Science* **269**: 496-515.
- Freese, E., J.M. Lopez and K. Ochi. 1981. Role of guanine nucleotides and of the stringent response to amino acid deprivation in the initiation of bacterial sporulation, p. 11-16. In *Microbiology-1981* (ed. D. Schlessinger). Am. Soc. Microbiol., Washington, D.C.
- Gerhardt, P. and R.E. Marquis. 1989. Spore thermoresistance mechanisms, p. 43-63. In *Regulation of Prokaryotic Development* (ed. I. Smith, R. A. Slepecky and P. Setlow). American Society for Microbiology, Washington, D.C.
- Gould, G.W. 1983. Mechanisms of resistance and dormancy, p. 173-209. In *The Bacterial Spore* (ed. A. Hurst and G. W. Gould). Academic Press Inc., London.
- Grossman, A.D. 1995. Genetic networks controlling the initiation of sporulation and the development of genetic competence in *Bacillus subtilis*. *Annu. Rev. Genetics*. **29**: 477-508.
- Grossman, A.D. and R. Losick. 1988. Extracellular control of spore formation in *Bacillus subtilis*. *Proc. Natl. Acad. Sci. U.S.A.* **85**: 4369-4373.
- Hadden, C. and E.W. Nester. 1968. Purification of competent cells in *Bacillus subtilis* transformation system. *J. Bacteriol.* **95**: 876-885.
- Hahn, J., M. Albano and D. Dubnau. 1987. Isolation and characterization of Tn917lac-generated competence mutants of *Bacillus subtilis*. *J. Bacteriol.* **169**: 3104-3109.
- Hahn, J., J. Bylund, M. Haines, M. Higgins and D. Dubnau. 1995a. Inactivation of *mecA* prevents recovery from the competent state and interferes with cell division and the partitioning of nucleoids in *Bacillus subtilis*. *Mol. Microbiol.* **18**: 755-767.
- Hahn, J. and D. Dubnau. 1991. Growth stage signal transduction and the requirements for *srfA* induction in development of competence. *J. Bacteriol.* **173**: 7275-7282.
- Hahn, J., G. Inamine, Y. Kozlov and D. Dubnau. 1993. Characterization of *comE*, a late competence operon of *Bacillus subtilis* required for the binding and uptake of transforming DNA. *Mol. Microbiol.* **10**: 99-111.
- Hahn, J., L. Kong and D. Dubnau. 1994. The regulation of competence transcription factor synthesis constitutes a critical control point in the regulation of competence in *Bacillus subtilis*. *J. Bacteriol.* **176**: 5753-5761.

- Hahn, J., A. Luttinger and D. Dubnau. 1996. Regulatory inputs for the synthesis of ComK, the competence transcription factor of *Bacillus subtilis*. *Mol. Microbiol.* **21**: 763-775.
- Hahn, J., M. Roggiani and D. Dubnau. 1995b. The major role of Spo0A in genetic competence is to downregulate *abrB*, an essential competence gene. *J. Bacteriol.* **177**: 3601-3605.
- Hamoen, L.W., H. Eshuis, J. Jongbloed, G. Venema and D. van Sinderen. 1995. A small gene, designated *comS*, located within the coding region of the fourth amino acid-activation domain of *srfA*, is required for competence development in *Bacillus subtilis*. *Mol. Microbiol.* **15**: 55-63.
- Hobbs, M. and J.S. Mattick. 1993. Common components in the assembly of type 4 fimbriae, DNA transfer systems, filamentous phage and protein-secretion apparatus: a general system for the formation of surface-associated protein complexes. *Mol. Microbiol.* **10**: 233-243.
- Hoch, J.A. 1993. Regulation of the phosphorelay and the initiation of sporulation in *Bacillus subtilis*. *Ann. Rev. Microbiol.* **47**: 441-465.
- Inamine, G.S. and D. Dubnau. 1995. ComEA, A *Bacillus subtilis* Integral Membrane Protein Required for Genetic Transformation, Is Needed for Both DNA Binding and Transport. *J. Bacteriol.* **177**: 3045-3051.
- Ingram, M. 1969. Sporeformers as food spoilage organisms, p. 549-610. In *The Bacterial Spore* (ed. G. W. Gould and A. Hurst). Academic Press, London.
- Ireton, K. and A.D. Grossman. 1992. Coupling between gene expression and DNA synthesis early during development in *Bacillus subtilis*. *Proc. Natl. Acad. Sci. USA* **89**: 8808-8812.
- Ireton, K. and A.D. Grossman. 1994. A developmental checkpoint couples the initiation of sporulation to DNA replication in *Bacillus subtilis*. *EMBO J.* **13**: 1566-1573.
- Ireton, K., N.W. Gunther, IV and A.D. Grossman. 1994. *spoJ* is required for normal chromosome segregation as well as the initiation of sporulation in *Bacillus subtilis*. *J. Bacteriol.* **176**: 5320-5329.
- Ireton, K., S.F. Jin, A.L. Sonenshein and A.D. Grossman. 1995. Krebs cycle function is required for activation of the Spo0A transcription factor in *Bacillus subtilis*. *Proc. Natl. Acad. Sci. USA* **92**: 2845-2849.

- Ireton, K., D.Z. Rudner, K.J. Siranosian and A.D. Grossman. 1993. Integration of multiple developmental signals in *Bacillus subtilis* through the Spo0A transcription factor. *Genes & Dev.* 7: 283-294.
- Kobayashi, K., K. Shoji, T. Shimizu, K. Nakano, T. Sato and Y. Kobayashi. 1995. Analysis of a suppressor mutation *ssb* (*kinC*) of *sur0B20* (*spo0A*) mutation in *Bacillus subtilis* reveals that *kinC* encodes a histidine protein kinase. *J. Bacteriol.* 177: 176-182.
- Kong, L. and D. Dubnau. 1994. Regulation of competence-specific gene expression by Mec-mediated protein-protein interaction in *Bacillus subtilis*. *Proc. Natl. Acad. Sci. USA* 91: 5793-5797.
- LeDeaux, J.R. and A.D. Grossman. 1995. Isolation and characterization of *kinC*, a gene that encodes a sensor kinase homologous to the sporulation sensor kinases KinA and KinB in *Bacillus subtilis*. *J. Bacteriol.* 177: 166-175.
- LeDeaux, J.R., N. Yu and A.D. Grossman. 1995. Different roles for KinA, KinB, and KinC in the initiation of sporulation in *Bacillus subtilis*. *J. Bacteriol.* 177: 861-863.
- Levin, P.A. and R. Losick. 1996. Transcription factor Spo0A switches the localization of the cell division protein FtsZ from a medial to a bipolar pattern in *Bacillus subtilis*. *Genes & Dev.* 10: 478-488.
- Lewis, J.C. 1969. Dormancy, p. 301-358. In *The Bacterial Spore* (ed. G. W. Gould and A. Hurst). Academic Press, London.
- Londono-Vallejo, J.A. and D. Dubnau. 1993. *comF*, a *Bacillus subtilis* late competence locus, encodes a protein similar to ATP-dependent RNA/DNA helicases. *Mol. Microbiol.* 9: 119-131.
- Lopez, J.M., A. Dromerick and E. Freese. 1981. Response of guanosine 5'-triphosphate concentration to nutritional changes and its significance for *Bacillus subtilis* sporulation. *J. Bacteriol.* 146: 605-613.
- Lorenz, M.G. and W. Wackernagel. 1994. Bacterial gene transfer by natural genetic transformation in the environment. *Microbiol. Rev.* 58: 563-602.
- Losick, R. and P. Youngman. 1984. Endospore formation in *Bacillus*, p. 63-88. In *Microbial Development* (ed. R. Losick and L. Shapiro). Cold Spring Harbor Laboratory, Cold Spring Harbor, New York.
- Magnuson, R., J. Solomon and A.D. Grossman. 1994. Biochemical and genetic characterization of a competence pheromone from *B. subtilis*. *Cell* 77: 207-216.



- Mandic-Mulec, I., N. Gaur, U. Bai and I. Smith. 1992. Sin, a stage-specific repressor of cellular differentiation. *J. Bacteriol.* **174**: 3561-3569.
- Moser, I., P. Glaser and A. Danchin. 1995. SubtiList: a relational database for the *Bacillus subtilis* genome. *Microbiology* **141**: 261-268.
- Msadek, T., F. Kunst and G. Rapoport. 1994. MecB of *Bacillus subtilis*, a member of the ClpC ATPase family, is a pleiotropic regulator controlling competence gene expression and growth at high temperature. *Proc. Natl. Acad. Sci. USA* **91**: 5788-5792.
- Nakano, M.M., R. Magnuson, A. Meyers, J. Curry, A.D. Grossman and P. Zuber. 1991. *srfA* is an operon required for surfactin production, competence development, and efficient sporulation in *Bacillus subtilis*. *J. Bacteriol.* **173**: 1770-1778.
- Nakano, M.M. and P. Zuber. 1991. The primary role of ComA in establishment of the competent state in *Bacillus subtilis* is to activate expression of *srfA*. *J. Bacteriol.* **173**: 7269-7274.
- Ohlsen, K.L., J.K. Grimsley and J.A. Hoch. 1994. Deactivation of the sporulation transcription factor Spo0A by the Spo0E protein phosphatase. *Proc. Natl. Acad. Sci. USA* **91**: 1756-1760.
- Ota, I.M. and A. Varshavsky. 1993. A yeast protein similar to bacterial two-component regulators. *Science* **262**: 566-569.
- Perego, M., S.P. Cole, D. Burbulys, K. Trach and J.A. Hoch. 1989. Characterization of the gene for a protein kinase which phosphorylates the sporulation-regulatory proteins Spo0A and Spo0F of *Bacillus subtilis*. *J. Bacteriol.* **171**: 6187-6196.
- Perego, M., P. Glaser and J.A. Hoch. 1996. Aspartyl-phosphate phosphatases deactivate the response regulator components of the sporulation signal transduction system in *Bacillus subtilis*. *Mol. Microbiol.* **19**: 1151-1157.
- Perego, M., C. Hanstein, K.M. Welsh, T. Djavakhishvili, P. Glaser and J.A. Hoch. 1994. Multiple protein-aspartate phosphatases provide a mechanism for the integration of diverse signals in the control of development in *B. subtilis*. *Cell* **79**: 1047-1055.
- Perego, M., C.F. Higgins, S.R. Pearce, M.P. Gallagher and J.A. Hoch. 1991. The oligopeptide transport system of *Bacillus subtilis* plays a role in the initiation of sporulation. *Mol. Microbiol.* **5**: 173-185.

- Perego, M. and J.A. Hoch. 1996a. Cell-cell communication regulates the effects of protein aspartate phosphatases on the phosphorelay controlling development in *Bacillus subtilis*. *Proc. Natl. Acad. Sci. USA* **93**: 1549-1553.
- Perego, M. and J.A. Hoch. 1996b. Protein aspartate phosphatases control the output of two-component signal transduction systems. *Trends Genet.* **12**: 97-101.
- Piggot, P.J. and J.G. Coote. 1976. Genetic aspects of bacterial endospore formation. *Bacteriol. Rev.* **40**: 908-962 .
- Priest, F.G. 1993. Systematics and ecology of *Bacillus*, p. 3-16. In *Bacillus subtilis and Other Gram-Positive Bacteria* (ed. A. L. Sonenshein, J. A. Hoch and R. Losick). American Society for Microbiology, Washington, D. C.
- Roggiani, M. and D. Dubnau. 1993. ComA, a phosphorylated response regulator protein of *Bacillus subtilis*, binds to the promoter region of *srfA*. *J. Bacteriol.* **175**: 3182-3187.
- Rudner, D.Z., J.R. LeDeaux, K. Ireton and A.D. Grossman. 1991. The *spo0K* locus of *Bacillus subtilis* is homologous to the oligopeptide permease locus and is required for sporulation and competence. *J. Bacteriol.* **173**: 1388-1398.
- Satola, S.W., J.M. Baldus and C.P. Moran, Jr. 1992. Binding of Spo0A stimulates *spolIG* promoter activity in *Bacillus subtilis*. *J. Bacteriol.* **174**: 1448-1453.
- Serror, P. and A.L. Sonenshein. 1996. CodY is required for nutritional repression of *Bacillus subtilis* genetic competence. *J. Bacteriol.* **178**: 5910-5915.
- Setlow, P. 1994. DNA structure, spore formation, and spore properties, p. 181-194. In *Regulation of Bacterial Differentiation* (ed. P. Piggot, C. P. Moran Jr. and P. Youngman). American Society for Microbiology, Washington D.C.
- Singh, R.N. 1972. Number of deoxyribonucleic acid uptake sites in competent cells of *Bacillus subtilis*. *J. Bacteriol.* **110**: 266-272.
- Solomon, J.M. and A.D. Grossman. 1996. Who's competent and when: regulation of natural genetic competence in bacteria. *Trends Genetics* **12**: 150-155.
- Solomon, J.M., B.A. Lazazzera and A.D. Grossman. 1996. Purification and characterization of an extracellular peptide factor that affects two different developmental pathways in *Bacillus subtilis*. *Genes & Dev.* **10**: 2014-2024.

- Solomon, J.M., R. Magnuson, A. Srivastava and A.D. Grossman. 1995. Convergent sensing pathways mediate response to two extracellular competence factors in *Bacillus subtilis*. *Genes & Dev* .9: 547-558.
- Sonenshein, A.L. 1989. Metabolic regulation of sporulation and other stationary phase phenomena, p. 109-130. In *Regulation of Prokaryotic Development* (ed. I. Smith, R. Slepecky and P. Setlow). American Society for Microbiology, Washington, DC.
- Sonenshein, A.L., J.A. Hoch and R. Losick. 1993. *Bacillus subtilis* and Other Gram-Positive Bacteria, p. xi-xiii. In (ed. American Society for Microbiology, Washington, D.C.
- Squires, C. and C.L. Squires. 1992. The Clp proteins: proteolysis regulators or molecular chaperones? *J. Bacteriol.* 174: 1081-1085.
- Stewart, G.J. and C.A. Carlson. 1986. The Biology of natural transformation. *Ann. Rev. Microbiol.* 40: 211-235.
- Stock, J.B., A.J. Ninfa and A.M. Stock. 1989. Protein phosphorylation and regulation of adaptive responses in bacteria. *Microbiol. Rev.* 53: 450-490.
- Stock, J.B., M.G. Surette, M. Levit and P. Park. 1995. Two-component signal transduction systems: structure-function relationships and mechanisms of catalysis, p. 53-66. In *Two-Component Signal Transduction* (ed. J. A. Hoch and T. J. Silhavy). American Society for Microbiology, Washington, D.C.
- Trach, K., D. Burbulys, M. Strauch, J.-J. Wu, N. Dhillon, R. Jonas, C. Hanstein, C. Kallio, M. Perego, T. Bird, G. Spiegelman, C. Fogher and J.A. Hoch. 1991. Control of the initiation of sporulation in *Bacillus subtilis* by a phosphorelay. *Res. Microbiol.* 142: 815-823.
- Trach, K., J.W. Chapman, P.J. Piggot and J.A. Hoch. 1985. Deduced product of the stage 0 sporulation gene *spo0F* shares homology with the Spo0A, OmpR, and SfrA proteins. *Proc. Natl. Acad. Sci. USA* 82: 4189-4192.
- Trach, K.A. and J.A. Hoch. 1993. Multisensory activation of the phosphorelay initiating sporulation in *Bacillus subtilis*: identification and sequence of the protein kinase of the alternate pathway. *Mol. Microbiol.* 8: 69-79.
- Turgay, K., L.W. Hamoen, G. Venema and D. Dubnau. 1996. The heat shock protein, ClpC, together with MecA and ComS, comprise a molecular switch controlling the activity of ComK, the competence transcription factor of *Bacillus subtilis*. *Genes & Dev.* In press: .

- Vagner, V., J.-P. Claverys, S.D. Ehrlich and V. Mejean. 1990. Direction of DNA entry in competent cells of *Bacillus subtilis*. *Mol. Microbiol.* **4**: 1785-1788.
- van Sinderen, D., A. Luttinger, L. Kong, D. Dubnau, G. Venema and L. Hamoen. 1995. *comK* encodes the competence transcription factor, the key regulatory protein for competence development in *Bacillus subtilis*. *Mol. Microbiol.* **15**: 455-462.
- van Sinderen, D. and G. Venema. 1994. *comK* acts as an autoregulatory control switch in the signal transduction route to competence in *Bacillus subtilis*. *J. Bacteriol.* **176**: 5762-5770.
- Waldburger, C., D. Gonzalez and G.H. Chambliss. 1993. Characterization of a new sporulation factor in *Bacillus subtilis*. *J. Bacteriol.* **175**: 6321-6327.
- Weinrauch, Y., R. Penchev, E. Dubnau, I. Smith and D. Dubnau. 1990. A *Bacillus subtilis* regulatory gene product for genetic competence and sporulation resembles sensor protein members of the bacterial two-component signal-transduction systems. *Genes and Dev.* **4**: 860-872.

## Chapter 2

### Convergent sensing pathways mediate response to two extracellular competence factors in *Bacillus subtilis*

This work was published in *Genes & Development* (1995) 9: 547-558.

# Convergent sensing pathways mediate response to two extracellular competence factors in *Bacillus subtilis*

Jonathan M. Solomon, Roy Magnuson, Alok Srivastava, & Alan D.  
Grossman\*

Department of Biology; Building 68-530  
Massachusetts Institute of Technology  
Cambridge, MA 02139

Running Title: Sensing pathways for two competence factors

\*To whom correspondence should be addressed

phone: (617) 253-1515

fax: (617) 253-8699

e-mail: [adg@mit.edu](mailto:adg@mit.edu)

## ABSTRACT

Development of genetic competence in *Bacillus subtilis* is regulated by extracellular signaling molecules, including the ComX pheromone, a modified 9 or 10 amino acid peptide. Here we present characterization of a second extracellular competence stimulating factor, CSF. CSF appears to be, at least in part, a small peptide of between 520 and 720 daltons. Production of CSF requires several genes that are needed both for initiation of sporulation and development of competence (*spo0H*, *spo0A*, *spo0B*, and *spo0F*). Although both peptide factors regulate competence, two different sensing pathways mediate the response to the ComX pheromone and CSF. Analysis of double mutants indicated that ComX pheromone is on the same genetic pathway as the membrane-bound histidine protein kinase encoded by *comP*, and that CSF is on the same genetic pathway as the oligopeptide permease encoded by *spo0K*. Furthermore, the cellular response to partly purified ComX pheromone requires the ComP histidine protein kinase while the response to partly purified CSF requires the Spo0K oligopeptide permease. These two sensing pathways converge to activate transcription of *comS* (in the *srfA* operon), a key regulatory factor required for activation of additional competence genes. Both factors and their convergent sensing pathways are required for normal development of competence and might function to integrate different physiological signals.

## INTRODUCTION

Cells communicate with each other in order to coordinate their activities. In bacteria, the secretion of and response to signaling molecules regulates many aspects of differentiation, development, pathogenesis, and symbiosis [(Shapiro et al., 1993) and references therein]. Characterizing the mechanisms by which bacterial cells produce, sense, and respond to extracellular signals is crucial to understanding these processes. The exchange of genetic material between bacteria is frequently regulated by cell-cell signaling. Transfer of conjugative plasmids in *Enterococcus faecalis* is induced by peptide pheromones (Clewell, 1993). The development of genetic competence, the natural ability to take up DNA, is controlled by extracellular peptide factors in some species, including *Streptococcus pneumoniae* and *Bacillus subtilis* (Tomasz and Hotchkiss, 1964; Tomasz and Mosser, 1966; Joenje et al., 1972; Hui and Morrison, 1991; Magnuson et al., 1994).

Development of competence in *B. subtilis* involves major changes in gene expression and metabolism. Under appropriate nutritional and cell density conditions a sub-population of a culture of *B. subtilis* differentiates into a competent state (reviewed in (Dubnau, 1991)). Competent cells have a different buoyant density and are metabolically less active than non-competent cells. During competence development, cells express specialized proteins which bind and take up DNA. Recombination is efficient between incoming DNA and homologous host sequences. The regulation of competence can be divided into two stages. The first stage leads to expression of the *srfA* operon. Gene products involved in producing and sensing extracellular factors all affect transcription of *srfA* and expressing *srfA* from a heterologous promoter bypasses the need for genes upstream in the pathway and leads to constitutive levels of competence (Hahn and Dubnau, 1991; Nakano and Zuber, 1991). Within the *srfA* operon is an open reading frame, *comS* (D'Souza



et al., 1994; Hamoen et al., 1995), whose expression is required for the second stage of competence regulation, the activation of the ComK transcription factor (D'Souza et al., 1994; Kong and Dubnau, 1994; Msadek et al., 1994; van Sinderen et al., 1994; Hamoen et al., 1995). ComK activates transcription of the genes encoding components of the competence machinery, including the *comG* operon (Albano et al., 1987; Albano et al., 1989; Hahn et al., 1994; van Sinderen et al., 1994; van Sinderen and Venema, 1994).

Expression of *srfA* increases as cells grow to high density due to the accumulation of extracellular peptide factors in the culture medium (Magnuson et al., 1994). One of these extracellular factors, the ComX pheromone, has been purified to homogeneity. It is a 9-10 amino acid peptide with a modified tryptophan residue (Magnuson et al., 1994). The peptide portion of ComX pheromone is encoded by the last 10 codons of *comX*. Production of the active pheromone also requires *comQ*, the gene immediately upstream of *comX*.

We describe the characterization and partial purification of a second extracellular competence factor that is distinct from the ComX pheromone. This competence stimulating factor (called CSF) is, at least in part, a small peptide and is required for normal expression of *srfA* and the development of competence. Experiments described below also demonstrate that the two extracellular competence factors act upon two different sensing pathways that converge to stimulate expression of *srfA* to activate the next stage of competence regulation. The two pathways are summarized schematically in Figure 1.

The histidine protein kinase encoded by *comP* (Weinrauch et al., 1990) was found to be required for response to ComX pheromone (Figure 1). The ComP histidine protein kinase has eight putative membrane spanning domains (Weinrauch et al., 1990) and is a member of the large family of two component regulatory

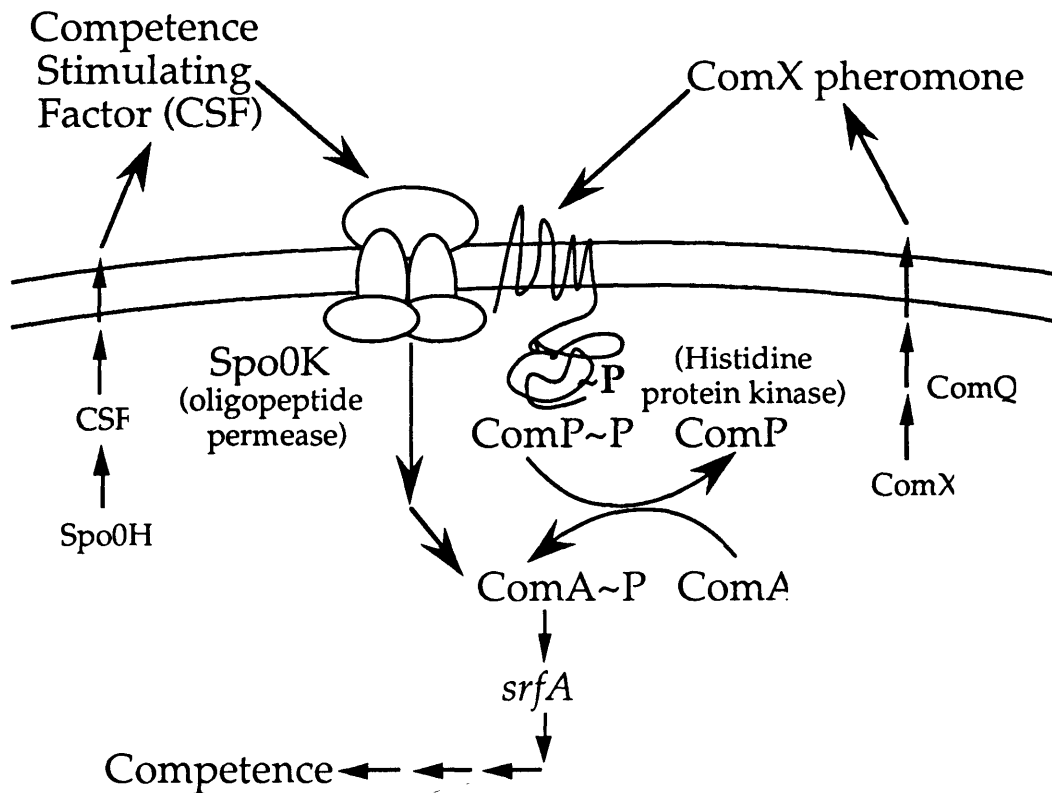

**Figure 1. Model for the production of and response to the two extracellular competence factors.** The cell membrane is shown with the two competence pheromones, ComX pheromone and CSF, outside the cell. ComX is the precursor for the peptide portion of ComX pheromone and ComQ is required for production (presumably processing or modification) of ComX pheromone (Magnuson et al., 1994). Normal production of CSF requires the alternate sigma factor encoded by *spo0H*. Other *spo0* genes affect expression of CSF by inactivating a negative regulator of CSF production, *abrB* (Table 1). Both competence factors stimulate expression of *srfA*, which is part of a network of regulators that lead to competence development. The ComP histidine protein kinase, with eight putative membrane spanning domains (Weinrauch et al., 1990), is required for detection of ComX pheromone but not for detection of CSF. Phosphate from ComP~P is probably transferred to and activates the ComA transcription factor, which acts directly at the *srfA* promoter (Roggiani and Dubnau, 1993). The Spo0K oligopeptide permease is essential for detection of CSF, but not for detection of ComX pheromone. (Spo0K is not required for production of either CSF or ComX pheromone). We hypothesize that Spo0K and CSF affect transcription of *srfA* by modulation of the levels of ComA~P, by activating another kinase, or by inhibiting a phosphatase, or by interacting directly with ComA.

systems that sense and transduce a variety of signals in prokaryotes and eukaryotes (Bourret et al., 1991; Chang et al., 1993; Ota and Varshavsky, 1993; Alex and Simon, 1994). These kinases autophosphorylate in response to a signal, often sensed by their N-terminal domain, and the phosphate is transferred to the cognate response regulator, usually a transcription factor, which is activated by phosphorylation. The cognate response regulator for ComP is the *comA* gene product, a transcription factor that binds to the *srfA* promoter region (Roggiani and Dubnau, 1993) and is required for transcription of *srfA* (Nakano and Zuber, 1989; van Sinderen et al., 1990; Hahn and Dubnau, 1991; Nakano et al., 1991; Nakano et al., 1991; Nakano and Zuber, 1991).

The oligopeptide permease encoded by *spo0K* (Perego et al., 1991; Rudner et al., 1991) was found to be required for sensing CSF. Spo0K oligopeptide permease transports oligopeptides into *B. subtilis* and is a member of the ATP-binding cassette (ABC) family of transporters (Perego et al., 1991; Rudner et al., 1991) that link ATP hydrolysis to the import and export of a variety of compounds (Higgins, 1992)

## RESULTS

**The defect in expression of *srfA* caused by a null mutation in *spo0H* is rescued extracellularly.** Expression of *srfA* is low at low cell densities, and when cells reach an optical density (OD 600) of 0.2 to 0.3 (~2-3 x 10<sup>7</sup> cells/ml) extracellular factors accumulate to a critical level and expression of *srfA* increases (Figure 2A) (Magnuson et al., 1994). Full expression of *srfA* (aka *csH293*, *comL*) requires the *spo0H* gene product (Jaacks et al., 1989; van Sinderen et al., 1990; Nakano et al., 1991), a sigma factor (sigma-H) of RNA polymerase that is required for the initiation of sporulation. Mutations in *spo0H* cause a defect in the development of

competence (Sadaie and Kada, 1983; Albano et al., 1987), at least in part due to a decrease in expression of *srfA* (Jaacks et al., 1989; Hahn and Dubnau, 1991). The defect in expression of *srfA* in the *spo0H* mutant was most severe before the culture entered stationary phase,  $\beta$ -galactosidase specific activity from a *srfA-lacZ* fusion in the *spo0H* mutant reached approximately 30% of that in wild type cells (data not shown), as previously described (Nakano et al., 1988; Hahn and Dubnau, 1991). The *spo0H* mutation also caused a defect in expression of *comG* (Albano et al., 1987) (Figure 2B), a late competence gene.

The defect in expression of *srfA* in the *spo0H* mutant was rescued by the addition of conditioned medium. Conditioned medium was made by growing *spo0H*<sup>+</sup> cells, (lacking any *lacZ* fusion) to high density, removing the cells by centrifugation, and filter sterilizing the medium (Materials and Methods). When added to a *spo0H* mutant, conditioned medium restored expression of *srfA* to a level similar to that in wild type cells (Figure 2C). The addition of conditioned medium to the *spo0H* mutant also substantially restored expression of *comG-lacZ* (figure 2D).

Extracellular rescue of the *spo0H* mutant was also demonstrated in cell mixing experiments. *spo0H* mutant cells containing the *comG-lacZ* fusion were grown in mixed culture with either wild type or *spo0H* cells, without a *lacZ* fusion, at a ratio of approximately 1:1. Expression of *comG-lacZ* in the *spo0H* mutant was restored to near wild type levels when mixed with wild type cells (data not shown).

The decreased transformation frequency of the *spo0H* mutant was partially rescued extracellularly. Addition of conditioned medium increased the transformation frequency of the *spo0H* mutant by 5- to 20-fold. This rescue was never up to wild type levels of transformation and was usually ~10% of wild type. Thus, the *spo0H* mutant can be fully rescued for expression of *srfA*, and partly

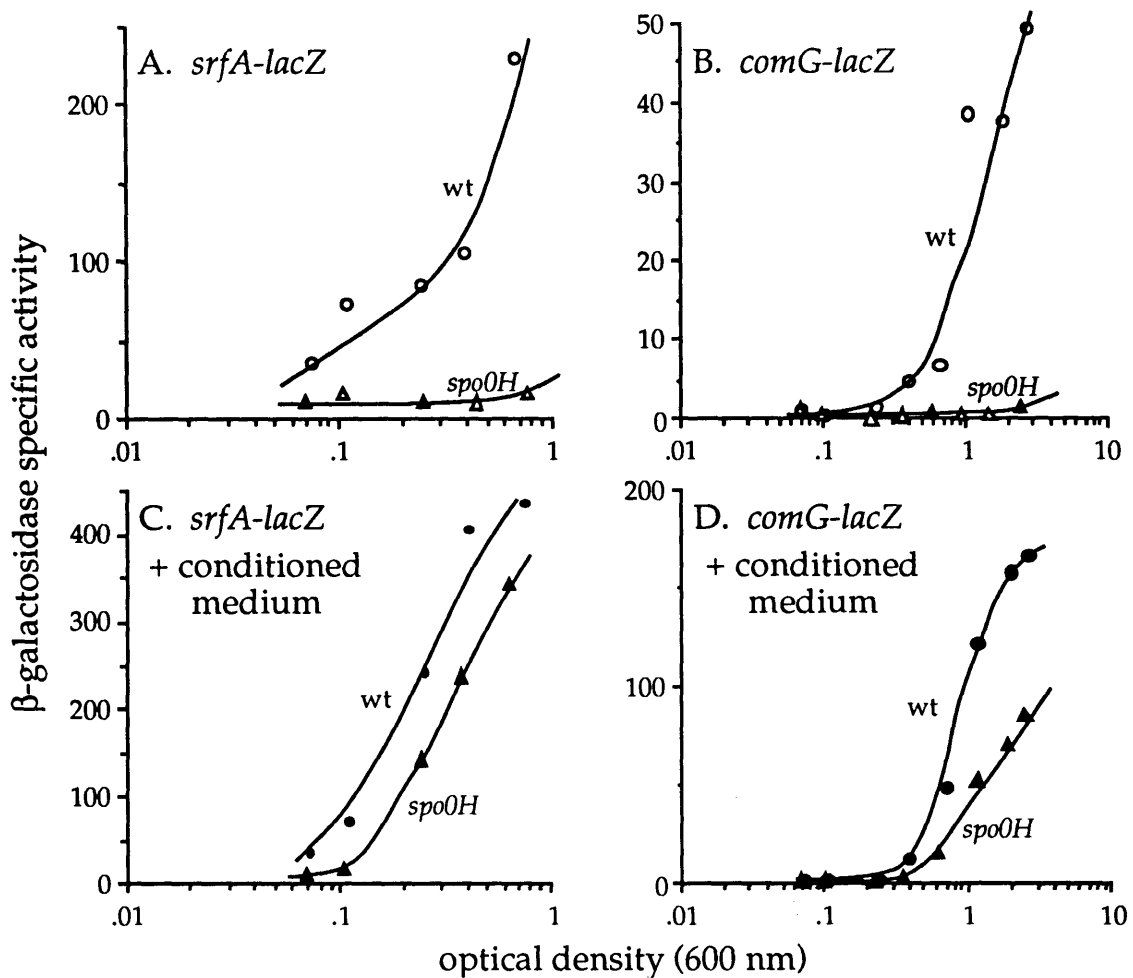

**Figure 2. Expression of *srfA-lacZ* and *comG-lacZ* in wild type and a *spo0H* mutant in the presence and absence of conditioned medium.** Cells were grown in defined minimal medium for at least three doublings before the start of the experiment. When cells reached an optical density (600 nm) of approximately 0.1, an equal volume of either fresh medium (A & B) or conditioned medium from wild type cells (C & D) was added. Samples were then taken at the indicated densities for determination of  $\beta$ -galactosidase specific activity. **A and C.** circles, JRL293 (*srfA-lacZ* $\Delta$ 1974 wild type); triangles, JMS139 (*srfA-lacZ* $\Delta$ 1974 *spo0H*::*cat*). **B and D.** circles, AG1046 (*comG-lacZ* wild type); triangles, JMS128 (*comG-lacZ* *spo0H*::*cat*). Note that the scales on the y-axis are different in the different panels.

rescued for expression of *comG* and competence, by the addition of conditioned medium.

**Production of competence stimulating factor, CSF, is reduced in a *spo0H* mutant.** Since expression of *srfA* is regulated by extracellular factors that accumulate in culture medium and the defect in expression of *srfA* caused by the *spo0H* mutation was rescued extracellularly, it seemed likely that the *spo0H* mutant (and possibly other *spo0* mutants) was defective in the production of an extracellular competence factor. While purifying the ComX pheromone from conditioned medium, we had noticed a second chromatographically distinct factor that stimulates expression of *srfA-lacZ* 2- to 3-fold (Magnuson et al., 1994). The *spo0H* mutant was defective in production of this second factor. We fractionated conditioned medium from *spo0H* and wild type strains and tested the fractions for the ability to induce expression of *srfA-lacZ*. Conditioned medium was adjusted to pH 2 and applied to a C-18 Sep-pak column. The column was washed and step-eluted with increasing concentrations of acetonitrile and fractions were dried in a speed-vac concentrator and resuspended in minimal medium (Materials and Methods). The ComX pheromone elutes at approximately 50% to 60% acetonitrile (Magnuson et al., 1994). Fractions from the 10% acetonitrile eluate contained a second activity that also stimulated expression of *srfA-lacZ* in cells at low density (Magnuson et al., 1994). Conditioned medium from the *spo0H* mutant had near normal levels of the ComX pheromone, but had a reduced amount of the second factor (CSF), relative to conditioned medium from wild type cells (Table 1). It appears therefore, that even a partial defect in the production of CSF, such as is observed in a *spo0H* mutant, is sufficient to cause a defect or delay in expression of *srfA* and the development of competence.

Table 1. Production of CSF and the ComX pheromone in different mutants.

strain	relevant genotype	percent production <sup>a</sup>	
		CSF	ComX pheromone
JH642	wild type	100	100
AG665	<i>spo0H::cat</i>	9.5	68
AG503	$\Delta$ <i>spo0A475::cat</i>	3.2	129
AG141 (JH648)	<i>spo0B136</i>	19	110
AG144 (JH649)	<i>spo0F221</i>	23	110
AG132	<i>spo0A204 abrB703</i>	124	167

<sup>a</sup>The amount of CSF and ComX pheromone per ml of conditioned medium was determined for each strain indicated. Data are normalized to the amount of CSF and ComX pheromone determined from wild type conditioned medium prepared and treated similarly to a given mutant. For the experiments shown, the amount of CSF from conditioned medium from wild type cells ranged from 1,170 units/ml to 1,460 units/ml. The amount of ComX pheromone in conditioned medium from wild type cells ranged from 72 units/ml to 210 units/ml. Some of the variability in the measurements of ComX pheromone probably result from its tendency to stick to glass surfaces (Magnuson et al., 1994). Similar results were obtained in multiple experiments from several different preparations of conditioned medium.

In addition to *spo0H*, several other early sporulation genes were found to be required for normal production of CSF. *spo0A* encodes a transcription factor, the activity of which is regulated by phosphorylation, and the *spo0F* and *spo0B* gene products are required to transfer phosphate from histidine protein kinases to Spo0A (Burbulys et al., 1991). One function of Spo0A~P is to repress transcription of *abrB* (Perego et al., 1988; Strauch et al., 1990), the product of which is a repressor of many functions that are expressed during the transition from growth to stationary phase (Strauch and Hoch, 1993), including competence development (Albano et al., 1987).

*spo0A*, *spo0B*, and *spo0F* were found to be required for normal production of CSF (Table 1). *spo0A* mutants are defective in expression of *srfA* (Nakano et al., 1988; Hahn and Dubnau, 1991) and the development of competence (Sadaie and Kada, 1983; Albano et al., 1987) as well as sporulation (Hoch, 1993). Mutations in *spo0F* and *spo0B* caused a defect in expression of *srfA-lacZ* and *comG-lacZ* (data not shown), and transformation frequencies were approximately 0.2% to 1% of wild type in both minimal and complex (SpII) competence medium. The defect in CSF production caused by a null mutation in *spo0A* was relieved by a null mutation in *abrB* (Table 1), indicating that production of CSF is controlled by AbrB, a regulator of stationary phase gene expression (Strauch and Hoch, 1993).

While *spo0A*, *0F*, and *0B* are needed for production of CSF, they also appear to be required for cells to respond to CSF. The defect in *srfA-lacZ* and *comG-lacZ* expression caused by mutations in *spo0A*, *spo0B*, and *spo0F* was not fully relieved by the addition of conditioned medium (data not shown), in contrast to results with *spo0H* (above). These findings are consistent with the requirement for *spo0A* and *abrB* in the expression of the late competence transcription factor encoded by *comK* (Hahn et al., 1994; van Sinderen and Venema, 1994).



**CSF is distinct from ComX pheromone and appears to be a small peptide.**

Preliminary characterization of CSF from conditioned medium indicated that it is at least in part a small peptide. CSF activity passed through filters with a nominal molecular weight cut-off of 10,000 daltons, and was sensitive to treatment with trypsin or pronase (data not shown). CSF was partially purified from conditioned medium from *spo0H*<sup>+</sup> cells (Materials and Methods). Briefly, conditioned medium was adjusted to pH 2 by addition of trifluoroacetic acid and passed over a Sep-pak C-18 cartridge. CSF was eluted with 10% acetonitrile, dried in a speed-vac concentrator and resuspended. Material was then applied to a sulfopropyl sephadex column, and CSF activity eluted at approximately 60 mM NaCl. Active fractions were pooled and rechromatographed over a C-18 Sep-pak cartridge and then applied to an HPLC C-18 column. The column was eluted with a gradient of acetonitrile from 0 to 10%, and active fractions were pooled and rerun under similar conditions. Active fractions were again pooled and rerun, this time eluting with a very shallow gradient (Figure 3).

To date, the most pure preparations of CSF have a complex elution profile from reverse phase chromatography (Figure 3) and contain multiple components as indicated by mass spectrometry. Mass spectrometry analysis of the active fractions from this purification (Figure 3) revealed seven components ranging in mass from approximately 520 to 720 daltons. If CSF is an unmodified peptide and its mass is identical or similar to any of the components detected, then CSF is probably a peptide of 4 to 7 amino acids.

***spo0K* and *comP* appear to be on different, but convergent, response pathways.**

To determine if there is more than one pathway activating expression of *srfA* in response to the two extracellular competence factors, a variety of double mutant strains were constructed and analysed. If two genes are on the same pathway, then

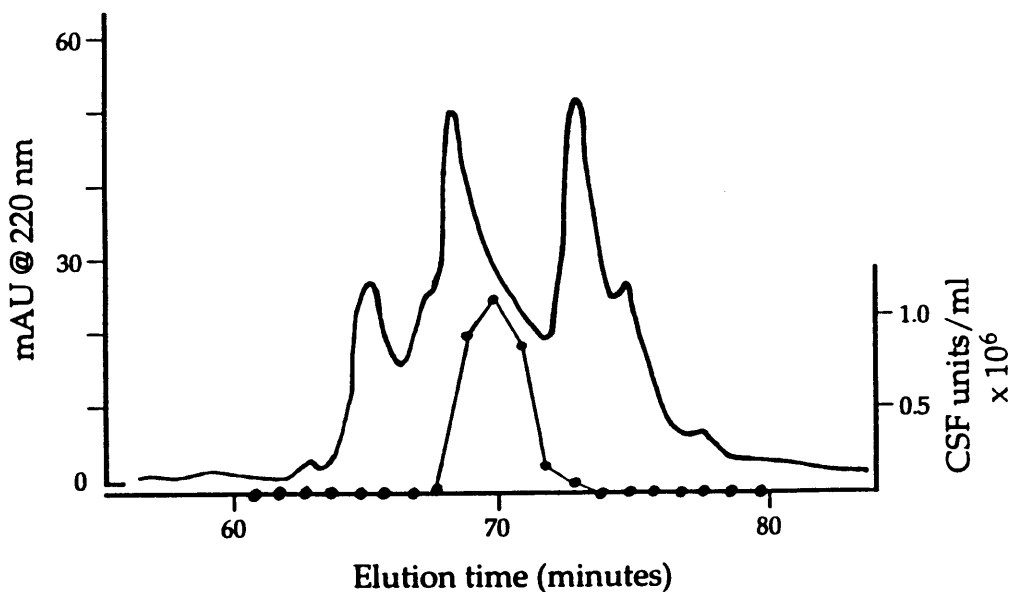

**Figure 3.** HPLC reverse phase chromatography of CSF. CSF was purified from conditioned medium and assayed as described in Materials and Methods. A C-18 reverse phase column was eluted with a gradient of acetonitrile (0.04% per minute), from 0% to 10% in 0.1% TFA. Milliabsorbance at 220 nm is indicated on the left, and CSF activity is indicated on the right (filled circles).

a double (null) mutant should have the same phenotype that is observed in the strongest single mutant. If two genes are on different pathways that affect the same process, then the double mutant should have a more severe phenotype than either of the single mutants.

Expression of *srfA* was greatly reduced in *comP* (histidine protein kinase) and *spo0K* (oligopeptide permease) null mutants (Figure 4A), as seen previously (Hahn and Dubnau, 1991; Magnuson et al., 1994). At an optical density of ~2 (at 600 nm), accumulation of  $\beta$ -galactosidase specific activity from *srfA-lacZ* in the *comP* mutant and the *spo0K* mutant was ~5% and ~2%, respectively, of that in the wild type (Figure 4). Despite the large effects (Figure 4A), there was still detectable expression of *srfA* in these mutants (Figure 4B). Expression of *srfA* was more readily detectable in these experiments than in previous work (Hahn and Dubnau, 1991; Magnuson et al., 1994) due to the use of a more active *srfA-lacZ* fusion (Materials and Methods).

Expression of *srfA* in the *comP spo0K* double mutant was significantly lower than that in either single mutant, ~0.1% of wild type and barely above background, and was similar to that in a *comA* null mutant (Figure 4B). These results indicate that the Spo0K oligopeptide permease and the ComP histidine protein kinase are on different pathways for activation of *srfA* transcription. The residual expression of *srfA* in cells lacking the Spo0K oligopeptide permease depends upon the presence of ComP, and the residual expression of *srfA* in cells lacking the ComP histidine protein kinase depends upon the presence of Spo0K. Normal expression of *srfA* requires both ComP and Spo0K, and eliminating both of these components is similar to eliminating the ComA transcription factor which directly regulates expression of *srfA*.

We also used double mutant analysis to determine which of the extracellular competence factors, ComX pheromone or CSF, is on the same pathway as the ComP

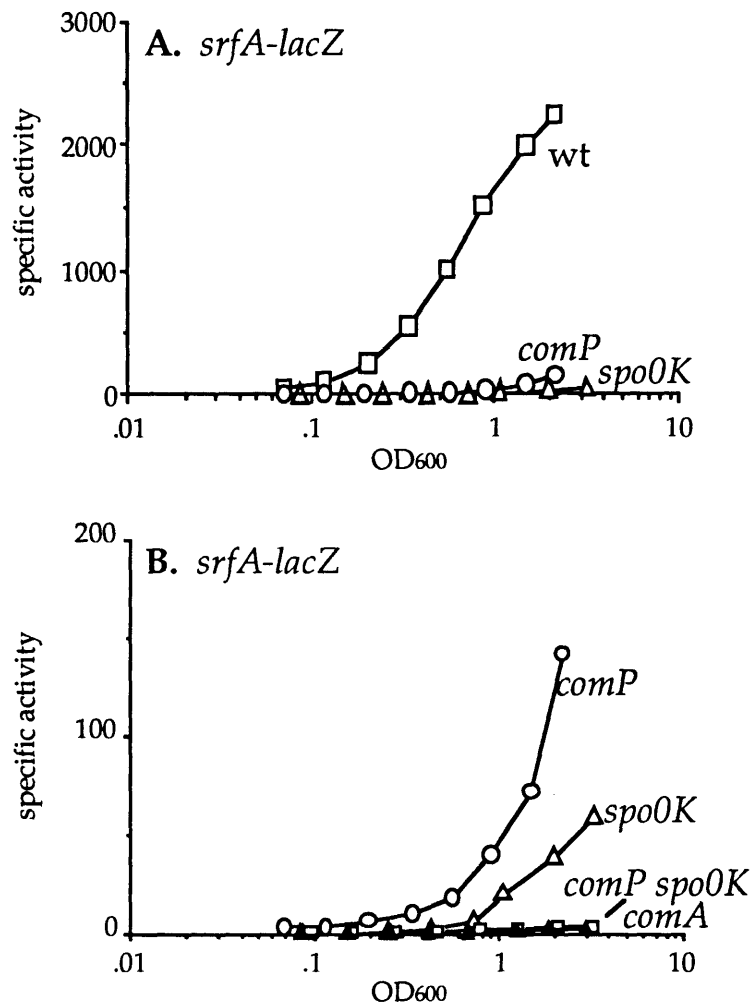

**Figure 4. *comP* and *spo0K* are on different pathways for the activation of *srfA* transcription.** Isogenic strains containing the *srfA-lacZ* $\Omega$ 374 fusion were grown in defined minimal medium for at least three generations before the start of the experiment. Samples were taken for determination of  $\beta$ -galactosidase specific activity at the indicated cell densities. (A) Expression of *srfA* is reduced in *comP* and *spo0K* mutants. open squares, JMS374 (*srfA-lacZ* $\Omega$ 374 wild type); open circles, JMS423 (*srfA-lacZ* $\Omega$ 374 *comP*::*cat*); open triangles, JMS384 (*srfA-lacZ* $\Omega$ 374  $\Delta$ *spo0K*::*erm*). (B) *srfA* expression in the *comPspo0K* double mutant is lower than in *spo0K* or *comP* single mutants. open circles, JMS423 (*srfA-lacZ* *comP*::*cat*); open triangles, JMS384 (*srfA-lacZ* $\Omega$ 374  $\Delta$ *spo0K*::*erm*); open squares, JMS425 (*srfA-lacZ* $\Omega$ 374 *comP*::*cat*  $\Delta$ *spo0K*::*erm*); closed triangles, ROM306 (*srfA-lacZ* $\Omega$ 374 *comA*::*cat*).

histidine protein kinase and/or the Spo0K oligopeptide permease. Cells lacking ComX pheromone (due to a non-polar mutation in *comQ*) and ComP (a *comQ comP* double mutant) were no more impaired in *srfA* transcription than cells lacking only ComP (Figure 5A), indicating that the ComX pheromone is on the same pathway as the ComP histidine protein kinase. In contrast, expression of *srfA* was lower in the *spo0H comP* double mutant than in either single mutant (Figure 5A and 5C). The *spo0H* mutation causes reduced production of CSF (above) and this combined effect on *srfA* expression suggests that CSF and ComP are on different pathways for activation of *srfA* transcription (Figure 1).

The Spo0K oligopeptide permease and CSF were found to be on the same pathway. Cells lacking Spo0K and producing reduced amounts of CSF (a *spo0K spo0H* double mutant) were no more impaired for *srfA* expression than cells lacking only Spo0K (Figure 5B). In contrast, when production of the ComX pheromone was eliminated in cells lacking Spo0K (a *comQ spo0K* double mutant), expression of *srfA* was lower than in either single mutant (Figure 5B). These results indicate that Spo0K and ComX pheromone are on different pathways (Figure 1).

We also measured expression of *srfA* in cells that are fully capable of responding to both factors but that do not produce ComX pheromone and produce reduced amounts of CSF, a *comQ spo0H* double mutant. As expected this double mutant was more defective in expression of *srfA* than either single mutant (Figure 5C).

The genetic evidence clearly shows that two pathways stimulate expression of *srfA*: ComX pheromone and the ComP histidine protein kinase are on one pathway, and CSF and Spo0K are on the other pathway. Double mutants affecting both pathways had a combined effect on *srfA* expression, and double mutants affecting only a single pathway had the same effect as the single mutants.

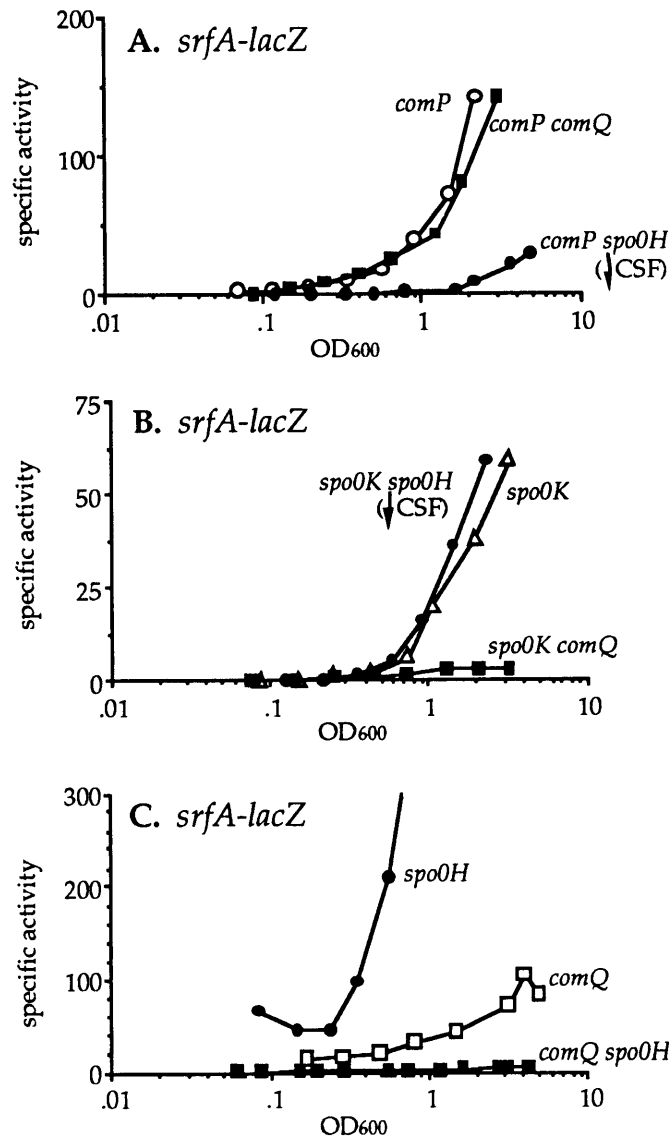

**Figure 5. Effects of double mutant combinations on expression of *srfA*.** Isogenic strains containing the *srfA-lacZ*Q374 fusion were grown as described in Figure 5. (A) *comP* is on the same genetic pathway as *comQ*, but on a different pathway than *spo0H*. open circles, JMS423 (*comP::cat*); closed squares, ROM294 (*comP::cat comQ::spc*); closed circles, JMS478 (*spo0H::cat comP::spc*). (B) *spo0K* is on the same genetic pathway as *spo0H*, but on a different pathway than *comQ*. open triangles, JMS384 (*spo0K::erm*); closed circles, JMS433 (*spo0K::erm spo0H::cat*); closed squares, JMS426 (*spo0K::erm comQ::spc*). (C) *comQ* and *spo0H* are on different genetic pathways for the activation of *srfA* expression. closed circles, JMS441 (*spo0H::cat*); open squares, JMS424 (*comQ::spc*); closed squares, JMS477 (*comQ::spc spo0H::cat*).

ComP is required for response to ComX pheromone and Spo0K is required for response to CSF. We directly determined whether the Spo0K oligopeptide permease or the ComP histidine protein kinase is needed for response to either ComX pheromone or CSF. We measured induction of *srfA-lacZ* in cells at low density in response to addition of either partly purified ComX pheromone or partly purified CSF. ComP was required for sensing of ComX pheromone. Cells lacking the ComP histidine protein kinase were unable to induce transcription of *srfA-lacZ* in response to the addition of partly purified ComX pheromone (Figure 6A). In contrast, cells lacking the Spo0K oligopeptide permease responded well to ComX pheromone, suggesting that Spo0K is not essential for detection of this factor (Figure 6A). Spo0K, however, was needed for the sensing of CSF. Cells lacking the Spo0K oligopeptide permease were unable to induce transcription of *srfA-lacZ* in response to the addition of partly purified CSF (Figure 6B). Cells lacking ComP had the normal two- to three-fold response to CSF (Figure 6B), indicating that ComP was not essential for detection of CSF.

**Effect of double mutants on transformation efficiency.** Analysis of the competence defects in double mutants indicates that a threshold level of *srfA* expression may be needed to activate the next step in competence development. Double mutations that had combined effects on expression of *srfA*, did not have combined effects on competence development, determined by measuring transformation frequency. *comP* (JRL177), *spo0K* (JRL358), and *srfA* (ROM77) single mutants all had transformation efficiencies approximately one to two percent of that of otherwise isogenic wild type, as reported previously (Jaacks et al., 1989; van Sinderen et al., 1990; Weinrauch et al., 1990; Rudner et al., 1991; van Sinderen and Venema, 1994). We found that a *spo0K comP* double mutant (JMS425) also had a transformation frequency approximately one to two percent of wild type,

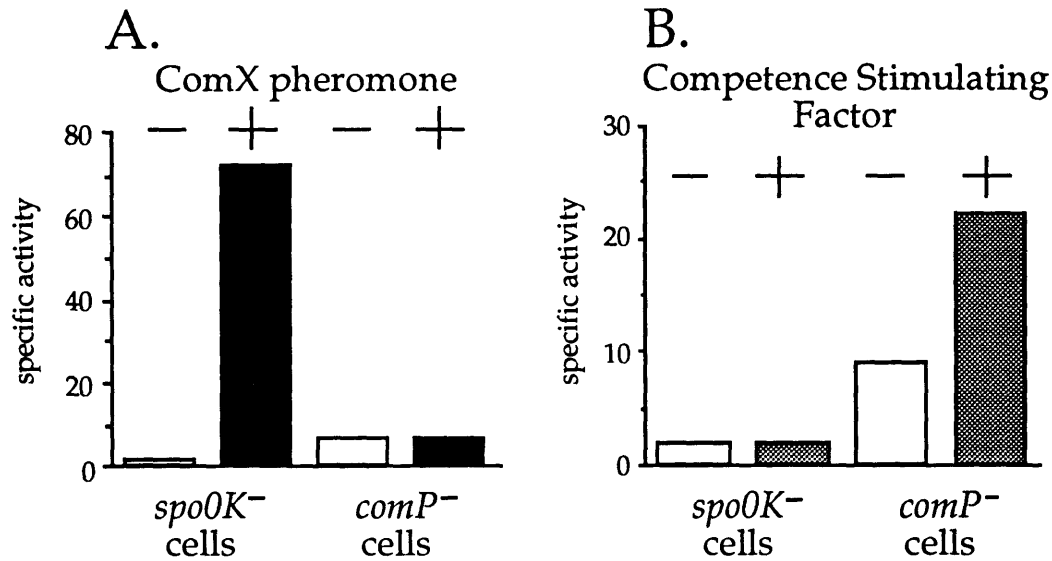

**Figure 6. Response of *spo0K* and *comP* mutant cells to partly purified ComX pheromone and partly purified CSF.** Strains JMS384 (*srfA-lacZ* $\Omega$ 374  $\Delta$ *spo0K::erm*) and JMS423 (*srfA-lacZ* $\Omega$ 374 *comP::cat*) were grown in defined minimal medium allowing at least three doublings before the start of the experiment. At an optical density (600 nm) of approximately 0.1, cells were diluted 1:1 into fresh medium, or fresh medium plus partly purified ComX pheromone or CSF. All samples contained 50  $\mu$ g/ml bovine serum albumin to prevent the factors from adhering to the glass. The samples were incubated at 37°C in flasks in shaking water baths. Aliquots were taken for determination of  $\beta$ -galactosidase specific activity 45, 90, and 135 minutes after dilution. (A) Response to ComX pheromone requires ComP but not Spo0K. Data from the 45 minute time point is shown. - and + indicate the absence and presence of ComX pheromone. (B) Response to CSF requires Spo0K but not ComP. Data from the 90 minute time point is shown. - and + indicate the absence and presence of CSF.



indistinguishable from that of either single mutant. In essence, mutations in either branch of the response pathway that cause reduced expression of *srfA* cause a defect in competence development similar to that caused by no expression of *srfA* (a null mutation in *srfA*, or *comA*). These results are most consistent with the notion that a critical threshold level of expression of *srfA* must be reached in order to activate the next step in competence development.

In addition, the residual expression of *srfA* in the *comP* and *spo0K* mutants probably does not represent a subpopulation of cells that are fully induced for expression of *srfA*. If a small fraction of the single mutants had full levels of expression of *srfA*, then it would be expected that some of the fully expressing cells would go on to develop competence. In the double mutant (*comP spo0K*) there is less expression of *srfA* than in either single mutant, and if this represented a further reduction in the size of the subpopulation that was expressing *srfA*, then this should also have caused a further reduction in the transformation frequency.

## DISCUSSION

This work demonstrates that two different extracellular signaling factors and two different response pathways, one for each of the extracellular factors, are necessary for the initiation of competence development in *B. subtilis* (Figure 1). Competence stimulating factor, CSF, is biochemically distinct from ComX pheromone and different genes are required for production of each of these factors. Production of ComX pheromone (but not CSF) absolutely depends on *comX* and *comQ*, the gene immediately upstream of *comX* (Magnuson et al., 1994). Production of CSF (but not ComX pheromone) is significantly reduced in *spo0H*, *spo0A*, *spo0B*, and *spo0F* mutants.

The oligopeptide permease encoded by *spo0K* is required for response to CSF, and the membrane-bound histidine protein kinase encoded by *comP* is required for response to the ComX pheromone (Figure 1). Double mutant analysis indicated that CSF is on the same signaling pathway as Spo0K oligopeptide permease and the ComX pheromone is on the same signaling pathway as ComP histidine protein kinase. Both pathways converge to activate expression of *srfA*, and we suspect that they converge to regulate production and accumulation of ComA~P. Consistent with this notion is the finding that overexpression of *comA* on a multicopy plasmid bypasses the need for *comP* and *spo0K* in competence development (Weinrauch et al., 1990; Dubnau, 1993), indicating that ComA is downstream of both the ComP histidine protein kinase and the Spo0K oligopeptide permease.

ComX pheromone probably interacts directly with ComP histidine protein kinase to stimulate autophosphorylation activity of ComP. ComP has eight putative membrane spanning domains and it is likely that several regions of the protein are exposed on the cell surface (Weinrauch et al., 1990). Many other members of the

family of histidine protein kinases are membrane proteins involved in signal transduction (Bourret et al., 1991; Parkinson and Kofoed, 1992).

Spo0K oligopeptide permease probably transports CSF into the cell where CSF then interacts with a downstream target. CSF is in the size range of peptides transported by oligopeptide permeases (Tynkkynen et al., 1993) and a functional transporter seems to be required for the response. In addition, mutations that activate a cryptic oligopeptide permease bypass the need for Spo0K in competence (Koide and Hoch, 1994) (JMS, N. Gunther, S. Shyn, & ADG, unpublished results), consistent with the notion that CSF is transported into the cell. Spo0K oligopeptide permease belongs to a large family of transporters that couple ATP hydrolysis to the import or export of specific compounds. The cystic fibrosis transmembrane regulator (CFTR), multidrug resistance protein (MDR), and many bacterial importers, including those for maltose, phosphate, and histidine, are members of this family (Higgins, 1992). Spo0K is able to transport a variety of peptides into *B. subtilis* and these peptides can be used as a nutrient source. However, such peptides do not stimulate competence development.

Another possibility that can not yet be ruled out is that Spo0K functions as a receptor, and in the presence of CSF, is able to send a transmembrane signal to stimulate *srfA* expression. The Pst ABC transporter imports phosphate ions into *E. coli* and also functions as a receptor to regulate the activity of the PhoR/PhoB two component regulatory system (Cox et al., 1988; Wanner, 1993). In either model, transporter or receptor, we suspect that Spo0K and CSF act to stimulate accumulation of ComA~P, perhaps by stimulating the activity of a kinase, or inhibiting the activity of a phosphatase, or by interacting with ComA directly.

It seems that sensing of extracellular signaling molecules by components of ABC transporters might be widespread. ABC transporters are involved in the response to

opines in *Agrobacterium tumefaciens* (Valdivia et al., 1991; Zanker et al., 1992). Some of the proteins required for the response to mating pheromones in *Enterococcus faecalis* are similar to the oligopeptide binding proteins OppA and Spo0KA (Clewell, 1993; Ruhfel et al., 1993; Tanimoto et al., 1993). In addition, oligopeptide binding proteins are involved in the response to extracellular competence factors in *Streptococcus pneumoniae* (Pearce et al., 1994).

While pathways with multiple intercellular signals occur frequently in higher organisms (Cornell and Kimelman, 1994), it is not clear why the development of genetic competence in *B. subtilis* requires two extracellular signals. One possibility is that two signals contribute to the species specificity of competence and DNA uptake. In contrast to some naturally competent organisms (e.g. *Haemophilus influenzae* and *Neisseria gonorrhoea*) which prefer to take up DNA containing a species-specific sequence (Smith and Danner, 1981; Stewart, 1989), *B. subtilis* will bind and take up DNA of any sequence. Two signals could help to ensure that competence is induced only in the presence of other *B. subtilis* cells, and not simply in the presence of a species that might produce one homologous signal.

It is also possible that the two signals each provide different information to the cells, perhaps indicating the density of the culture as well as some aspect of the nutritional state of the cells. For example, production of one or the other of the factors might be stimulated by glucose, which stimulates competence, or inhibited by glutamine, which inhibits competence. In this way, expression of *srfA* could serve to integrate two different signals that affect competence development. Signal integration during competence development also seems to happen at the step of activation of the ComK transcription factor, which depends on *srfA* (*comS*) and several other genes (Hahn et al., 1994; Kong and Dubnau, 1994; Msadek et al., 1994; van Sinderen et al., 1994; van Sinderen and Venema, 1994). Signal integration

affecting the activity of a single transcription factor also occurs during the initiation of sporulation, the other developmental process associated with *B. subtilis*. Multiple diverse signals regulate the initiation of sporulation by affecting the phosphorylation of the transcription factor encoded by *spo0A* (Burbulys et al., 1991; Ireton and Grossman, 1992; Ireton et al., 1993; Ireton and Grossman, 1994; Ireton et al., 1994).

Competence is not the only developmental process in *B. subtilis* that is regulated by extracellular peptide factors. The initiation of sporulation is also regulated, in part, by cell crowding or high cell density. Cultures at low cell density do not sporulate efficiently while similarly treated cultures at high density sporulate efficiently (Vasanth and Freese, 1979; Grossman and Losick, 1988; Waldburger et al., 1993). The decreased sporulation frequency of cells at low density is partly rescued by the addition of conditioned medium made from cells grown to high density (Grossman and Losick, 1988; Waldburger et al., 1993). The conditioned medium appears to contain peptide factors that accumulate as cells grow to high density. The production of at least one extracellular sporulation factor is regulated by *spo0A*, *spo0B*, *spo0F*, and *abrB* (Grossman and Losick, 1988), similarly to production of CSF.

It is tempting to speculate that CSF might be involved in the initiation of sporulation as well as the initiation of competence development. However, we have not found conditions in which partly purified CSF stimulates cells at low density to sporulate. It is possible that CSF is not involved in sporulation, and that another density factor with some properties similar to CSF is required for efficient sporulation. Alternatively, if CSF is involved in the initiation of sporulation, we might not have found the proper conditions in which to measure its activity. The ComX pheromone plays a role in sporulation, at least under some conditions (Magnuson et al., 1994). However, it is not responsible for the entire effect of cell

density on sporulation, and we have not found conditions in which CSF and ComX pheromone together have significantly greater effects on sporulation than ComX pheromone alone. We currently favor the hypothesis that there is probably a third extracellular factor, distinct from CSF and the ComX pheromone, that is involved in sporulation.

## MATERIALS and METHODS

**Strains.** Strains used are listed in Table 2. All are derived from *B. subtilis* strain JH642 and contain the *trpC2* and *pheA1* mutations. Mutant alleles used include *comP::cat* (Weinrauch et al., 1990), *comQ::spc* (Magnuson et al., 1994), *comA::cat* (D. Dubnau), *spo0H::cat* (Jaacks et al., 1989), *Δspo0K358::erm* (LeDeaux and Grossman, 1995), and *Δspo0A475::cat* (Grossman et al., 1992). The *comG-lacZ* fusion is a transcriptional fusion located at *amyE* (Magnuson et al., 1994).

***srfA-lacZ* fusions.** Two different *srfA-lacZ* fusions were used. The *srfA-lacZ* $\Omega$ 1974 fusion is a translational fusion located in single copy at the *amyE* locus and was provided by J. Hahn and D. Dubnau (Hahn et al., 1994). It was used in most of the experiments involving the purification of CSF and had previously been used in the characterization of the ComX pheromone (Magnuson et al., 1994). In addition, we constructed a new *srfA-lacZ* transcriptional fusion at the *amyE* locus, *amyE::(srfA-lacZ* $\Omega$ 374 *neo)*. The *srfA* promoter fragment, from -291 to +140 nucleotides relative to the *srfA* transcription start site, with flanking EcoRI and BamHI restriction sites, was first isolated by PCR amplification of chromosomal DNA and cloned into the vector pGEM-*cat*. (Youngman et al., 1989). DNA sequence was determined to verify that there were no changes compared to the published sequence of the *srfA* promoter region (Nakano et al., 1991). The promoter fragment was then cloned into the *lacZ* fusion vector pKS2 (Magnuson et al., 1994) to generate pJS34, and the fusion was recombined into the chromosome by double crossover, selecting for neomycin resistance.  $\beta$ -galactosidase specific activity from this transcriptional fusion is three- to four-fold higher than specific activity from the previously described *srfA-lacZ* translational fusion (Hahn et al., 1994; Magnuson et al., 1994). Expression of this fusion was similar to that of previously described

Table 2. Strains used.

Strain	Genotype or description
JH642 (AG174)	<i>trpC2 pheA1</i>
AG132	<i>spo0A204 abrB703</i> (Grossman and Losick, 1988)
AG141 (JH648)	<i>spo0B136</i> (Piggot and Coote, 1976)
AG144 (JH649)	<i>spo0F221</i> (Piggot and Coote, 1976)
AG503	$\Delta$ <i>spo0A475::cat</i> (Grossman et al., 1992)
AG665	<i>spo0H::cat</i> (Jaacks et al., 1989)
AG1046 (JMS107)	<i>amyE::(comG-lacZ neo)</i> (Magnuson et al., 1994; Siranosian and Grossman, 1994)
JMS128	<i>amyE::(comG-lacZ neo) spo0H::cat</i>
JMS139	<i>amyE::(srfA-lacZ<math>\Omega</math>1974 cat::spc) spo0H::cat</i>
JMS374	<i>amyE::(srfA-lacZ<math>\Omega</math>374 neo) fusion #374</i>
JMS384	$\Delta$ <i>spo0K::erm amyE::(srfA-lacZ<math>\Omega</math>374 neo)</i>
JMS423	<i>comP::cat amyE::(srfA-lacZ<math>\Omega</math>374 neo)</i>
JMS424	<i>comQ::spc amyE::(srfA-lacZ<math>\Omega</math>374 neo)</i>
JMS425	$\Delta$ <i>spo0K::erm comP::cat amyE::(srfA-lacZ<math>\Omega</math>374 neo)</i>
JMS426	<i>comQ::spc <math>\Delta</math>spo0K::erm amyE::(srfA-lacZ<math>\Omega</math>374 neo)</i>
JMS433	<i>spo0H::cat <math>\Delta</math>spo0K::erm amyE::(srfA-lacZ<math>\Omega</math>374 neo)</i>
JMS441	<i>spo0H::cat amyE::(srfA-lacZ<math>\Omega</math>374 neo)</i>
JMS477	<i>spo0H::cat comQ::spc amyE::(srfA-lacZ<math>\Omega</math>374 neo)</i>
JMS478	<i>spo0H::cat comP::spc amyE::(srfA-lacZ<math>\Omega</math>374 neo)</i>
JRL177	<i>comP::cat</i>
JRL293 (JMS108)	<i>amyE::(srfA-lacZ<math>\Omega</math>1974 cat)</i>
JRL358 (JMS122)	$\Delta$ <i>spo0K358::erm</i> (LeDeaux and Grossman, 1995)
ROM77 (JMS117)	<i>srfA::pRO106 (cat)</i> plasmid pRO106 integrated, disrupting <i>srfA</i>
ROM294	<i>comP::cat comQ::spc amyE::(srfA-lacZ<math>\Omega</math>374 neo)</i>
ROM297	<i>comQ::spc</i>
ROM302	<i>comQ::spc spo0H::cat</i>
ROM306	<i>comA::cat amyE::(srfA-lacZ<math>\Omega</math>374 neo)</i>



fusions(Nakano et al., 1988; Jaacks et al., 1989; van Sinderen et al., 1990; Hahn and Dubnau, 1991; Nakano and Zuber, 1991; Hahn et al., 1994; Magnuson et al., 1994)in that it was dependent on the same regulatory genes and was controlled similarly by cell density and nutritional conditions (data not shown).

**Media.** Defined minimal medium was used for most experiments and contained S7 salts (Vasanth and Freese, 1980) except that MOPS buffer was used at 50 rather than 100 mM (Jaacks et al., 1989). Medium contained glucose (1%) and glutamate (0.1%) and required amino acids (40 or 50  $\mu\text{g}/\text{ml}$ ) as needed. SpII competence medium (Dubnau and Davidoff-Abelson, 1971) was used in some experiments, except that  $\text{CaCl}_2$  was left out (Albano et al., 1987). The important difference between SpII medium and the defined minimal medium is the presence of yeast extract and casamino acids in the SpII medium. These components cause competence to develop after the end of exponential growth (Dubnau et al., 1991).

**$\beta$ -galactosidase assays.**  $\beta$ -galactosidase specific activity was measured essentially as described (Miller, 1972; Jaacks et al., 1989; Magnuson et al., 1994) and is presented as ( $\Delta A_{420}$  per min per ml of culture per  $\text{OD}_{600}$ )  $\times 1000$ .

**Competence assays.** Cells were grown in defined minimal medium (or SpII) and the transformation frequency was determined by mixing cells with chromosomal DNA ( $\sim 1 \mu\text{g}/\text{ml}$ ) containing a selectable marker (*e.g.*, *spc*, spectinomycin resistance) for 20 or 40 min (depending on the experiment) at  $37^\circ\text{C}$  and plating on selective plates. Transformation frequency is the total number of transformants per viable cell. Typical frequencies for our wild type strains (JH642 and derivatives) ranged from approximately  $5 \times 10^{-5}$  to  $8 \times 10^{-4}$  transformants per viable cell.

**Conditioned medium and separation of CSF from ComX pheromone.**

Conditioned medium was prepared by growing cultures in S7 minimal medium with glucose and glutamate, essentially as described (Grossman and Losick, 1988;

Magnuson et al., 1994) to an optical density of 2.5-3.5 at 600 nm. Cells were removed by centrifugation and supernatant medium was sterilized by filtration. CSF and the ComX pheromone were partially purified and separated from each other on a Sep-pak C-18 cartridge (Waters). Approximately 10 to 20 ml of conditioned medium was adjusted to pH 2 with trifluoroacetic acid (TFA) and applied to a 0.3 g Sep-pak cartridge. CSF was eluted in 10% acetonitrile (0.1% TFA) while the ComX pheromone was eluted in 60% acetonitrile (0.1% TFA). Before elution of the ComX pheromone, the column was washed with 20% and 30% acetonitrile. Samples were typically stored frozen at -20° C. Before use, samples were thawed at room temperature and dried down completely in a speed-vac concentrator, resuspended in fresh minimal medium for physiological assays and stored at -20°C.

**Purification of CSF.** CSF was purified from conditioned medium made from strain ROM186 (prototroph,  $\Delta spo0K357::neo spoIVC::Tn917$ ). The *spoIVC* mutation was used to completely block spore formation. The *spo0K* allele is a deletion insertion (LeDeaux and Grossman, 1995) and was used because preliminary results indicated that *spo0K* null mutations caused increased production of CSF, especially after entry into stationary phase (data not shown). The cells were grown in defined minimal medium with S7 salts (Vasanthan and Freese, 1980), trace metals, glucose (1%), and glutamate (0.1%), at 37°C essentially as described previously (Magnuson et al., 1994). Approximately two hours after the onset of stationary phase, cells were removed by centrifugation and the supernatant was filter sterilized to produce cell-free conditioned medium. 900 ml of this conditioned medium was adjusted to pH 2.0 with trifluoroacetic acid (TFA) and applied to a 10 g Sep-pak C18 cartridge (Waters). Active CSF was recovered after step elution with 10% acetonitrile, 0.1% TFA, pH 2.0. This material was applied to a sulfopropyl sephadex (SP) column and eluted with a linear gradient of NaCl in 25 mM sodium acetate, pH 4.0. CSF eluted

at approximately 60mM NaCl, and active fractions were pooled and applied to a Vydac C-18 column for HPLC purification. Material was eluted using a linear gradient of acetonitrile (approximately 0.2% per minute) in 0.1% TFA. Active fractions were pooled and rerun under similar conditions. Finally, active fractions were pooled and rerun, this time eluting with a very shallow gradient of acetonitrile (0.04% per minute). Under these condition, CSF elutes at less than 5% acetonitrile. After each step in the purification active fractions were concentrated by roto-vap and/or speed-vac as necessary. Concentrated fractions were resuspended in buffers appropriate for the next step in the purification and the pH was adjusted as necessary.

**Assay of CSF activity.** CSF activity was measured essentially as described for the ComX pheromone (Magnuson et al., 1994). Cells containing the *srfA-lacZ* $\Omega$ 1974 fusion (JRL293) were grown for at least three doublings to an optical density of approximately 0.1 at 600 nm. 0.25 ml of cells were mixed with 0.25 ml of the sample to be assayed, with 50  $\mu$ g/ml BSA to prevent nonspecific loss of activity (Magnuson et al., 1994), in a 2.2 ml plastic tube (Marsh Biomedical), incubated at 37°C for 70 minutes, and assayed for  $\beta$ -galactosidase specific activity. Samples to be assayed typically included conditioned medium, fresh medium, and column fractions diluted into fresh medium. Induced  $\beta$ -galactosidase specific activity is that induced by a given sample, above the background specific activity from cells incubated with fresh medium. The response to CSF was linear only over a small concentration range and assays were typically done on a series of two-fold dilutions. The greatest dilution that gave an induced specific activity approximately two-fold above background (fresh medium) was used to calculate the units of CSF per ml of conditioned medium. One unit of CSF activity is defined as the amount needed to induce expression of the *srfA-lacZ* $\Omega$ 1974 fusion in strain JRL293 to an activity of one

$\beta$ -galactosidase specific activity unit above the background of untreated cells (fresh medium) in 70 minutes.

## ACKNOWLEDGEMENTS

We are grateful to Paul Matsudaira for his advice and use of his HPLC equipment; T. Baker, and members of our lab for comments and suggestions on the manuscript. JMS was supported by a Howard Hughes predoctoral fellowship and RM was supported in part by an NIH predoctoral training grant. ADG was a Lucille P. Markey Scholar in Biomedical Sciences and this work was supported in part by a grant from the Lucille P. Markey Charitable Trust, and Public Health Services grants GM41934 and GM50895 to ADG from the NIH.

## REFERENCES

- Albano, M., R. Breitling and D. Dubnau. 1989. Nucleotide sequence and genetic organization of the *Bacillus subtilis comG* operon. *J. Bacteriol.* **171**: 5386-5404.
- Albano, M., J. Hahn and D. Dubnau. 1987. Expression of competence genes in *Bacillus subtilis*. *J. Bacteriol.* **169**: 3110-3117.
- Alex, L.A. and M.I. Simon. 1994. Protein histidine kinases and signal transduction in prokaryotes and eukaryotes. *TIG* **10**: 133-138.
- Bourret, R.B., K.A. Borkovich and M.I. Simon. 1991. Signal transduction pathways involving protein phosphorylation in prokaryotes. *Ann. Rev. Biochem.* **60**: 401-441.
- Burbulys, D., K.A. Trach and J.A. Hoch. 1991. Initiation of sporulation in *B. subtilis* is controlled by a multicomponent phosphorelay. *Cell* **64**: 545-552.
- Chang, C., S.F. Kwok, A.B. Bleecker and E.M. Meyerowitz. 1993. *Arabidopsis* ethylene-response gene *ETR1*: similarity of product to two-component regulators. *Science* **262**: 539-544.
- Clewell, D.B. 1993. Bacterial sex pheromone-induced plasmid transfer. *Cell* **73**: 9-12.
- Cornell, R.A. and D. Kimelman. 1994. Combinatorial signaling in development. *Bioessays* **16**: 577-581.
- Cox, G.B., D. Webb, J. Godovac-Zimmermann and H. Rosenberg. 1988. Arg-220 of the PstA protein is required for phosphate transport through the phosphate-specific transport system in *Escherichia coli* but not for alkaline phosphatase repression. *J. Bacteriol.* **170**: 2283-2286.
- D'Souza, C., M.M. Nakano and P. Zuber. 1994. Identification of *comS*, a gene of the *srfA* operon that regulates the establishment of genetic competence in *Bacillus subtilis*. *Proc. Natl. Acad. Sci. USA* **91**: 9397-9401.
- Dubnau, D. 1991. Genetic competence in *Bacillus subtilis*. *Microbiol. Rev.* **55**: 395-424.
- Dubnau, D. 1993. Genetic exchange and homologous recombination, p. 555-584. In *Bacillus subtilis and other Gram-positive bacteria: Biochemistry, physiology, and molecular genetics* (ed. A.L. Sonenshein, J.A. Hoch and R. Losick). Am. Soc. for Microbiol., Washington, D.C.
- Dubnau, D. and R. Davidoff-Abelson. 1971. Fate of transforming DNA following uptake by competent *B. subtilis*. *J. Mol. Biol.* **56**: 209-221.
- Dubnau, D., J. Hahn, L. Kong, M. Roggiani and Y. Weinrauch. 1991. Genetic competence as a post-exponential global response. *Seminars in Dev. Biol.* **2**: 3-11.
- Grossman, A.D., T. Lewis, N. Levin and R. DeVivo. 1992. Suppressors of a *spo0A* missense mutation and their effects on sporulation in *Bacillus subtilis*. *Biochimie* **74**: 679-688.
- Grossman, A.D. and R. Losick. 1988. Extracellular control of spore formation in *Bacillus subtilis*. *Proc. Natl. Acad. Sci. U.S.A.* **85**: 4369-4373.

- Hahn, J. and D. Dubnau. 1991. Growth stage signal transduction and the requirements for *srfA* induction in development of competence. *J. Bacteriol.* **173**: 7275-7282.
- Hahn, J., L. Kong and D. Dubnau. 1994. The regulation of competence transcription factor synthesis constitutes a critical control point in the regulation of competence in *Bacillus subtilis*. *J. Bacteriol.* **176**: 5753-5761.
- Hamoen, L.W., H. Eshuis, J. Jongbloed, G. Venema and D. van Sinderen. 1995. A small gene, designated *comS*, located within the coding region of the fourth amino acid-activation domain of *srfA*, is required for competence development in *Bacillus subtilis*. *Mol. Microbiol.* **15**: 55-63.
- Higgins, C.F. 1992. ABC transporters: From microorganisms to man. *Annu. Rev. Cell Biol.* **8**: 67-113.
- Hoch, J.A. 1993. *spo0* genes, the phosphorelay, and the initiation of sporulation, p. 747-755. In *Bacillus subtilis and other Gram-positive bacteria: Biochemistry, physiology, and molecular genetics* (ed. A.L. Sonenshein, J.A. Hoch and R. Losick). American Society for Microbiology, Washington, D.C.
- Hui, F.M. and D.A. Morrison. 1991. Genetic transformation in *Streptococcus pneumoniae*: Nucleotide sequence analysis shows *comA*, a gene required for competence induction, to be a member of the bacterial ATP-dependent transport protein family. *J. Bacteriol.* **173**: 372-381.
- Ireton, K. and A.D. Grossman. 1992. Coupling between gene expression and DNA synthesis early during development in *Bacillus subtilis*. *Proc. Natl. Acad. Sci. USA* **89**: 8808-8812.
- Ireton, K. and A.D. Grossman. 1994. A developmental checkpoint couples the initiation of sporulation to DNA replication in *Bacillus subtilis*. *EMBO J.* **13**: 1566-1573.
- Ireton, K., N.W. Gunther IV and A.D. Grossman. 1994. *spo0J* is required for normal chromosome segregation as well as the initiation of sporulation in *Bacillus subtilis*. *J. Bacteriol.* **176**: 5320-5329.
- Ireton, K., D.Z. Rudner, K.J. Siranosian and A.D. Grossman. 1993. Integration of multiple developmental signals in *Bacillus subtilis* through the Spo0A transcription factor. *Genes & Dev.* **7**: 283-294.
- Jaacks, K.J., J. Healy, R. Losick and A.D. Grossman. 1989. Identification and characterization of genes controlled by the sporulation regulatory gene *spo0H* in *Bacillus subtilis*. *J. Bacteriol.* **171**: 4121-4129.
- Joenje, H., M. Gruber and G. Venema. 1972. Stimulation of the development of competence by culture fluids in *Bacillus subtilis* transformation. *Biochim. Biophys. Acta* **262**: 189-199.
- Koide, A. and J.A. Hoch. 1994. Identification of a second oligopeptide transport system in *Bacillus subtilis* and determination of its role in sporulation. *Mol. Microbiol.* **13**: 417-426.

- Kong, L. and D. Dubnau. 1994. Regulation of competence-specific gene expression by Mec-mediated protein-protein interaction in *Bacillus subtilis*. *Proc. Natl. Acad. Sci. USA* **91**: 5793-5797.
- LeDeaux, J.R. and A.D. Grossman. 1995. Isolation and characterization of *kinC*, a gene that encodes a sensor kinase homologous to the sporulation sensor kinases KinA and KinB in *Bacillus subtilis*. *J. Bacteriol.* **177**: 166-175.
- Magnuson, R., J. Solomon and A.D. Grossman. 1994. Biochemical and genetic characterization of a competence pheromone from *B. subtilis*. *Cell* **77**: 207-216.
- Miller, J. 1972. *Experiments in molecular genetics*. Cold Spring Harbor Laboratory, Cold Spring Harbor, N. Y.
- Msadek, T., F. Kunst and G. Rapoport. 1994. MecB of *Bacillus subtilis*, a member of the ClpC ATPase family, is a pleiotropic regulator controlling competence gene expression and growth at high temperature. *Proc. Natl. Acad. Sci. USA* **91**: 5788-5792.
- Nakano, M.M., R. Magnuson, A. Meyers, J. Curry, A.D. Grossman and P. Zuber. 1991. *srfA* is an operon required for surfactin production, competence development, and efficient sporulation in *Bacillus subtilis*. *J. Bacteriol.* **173**: 1770-1778.
- Nakano, M.M., M.A. Marahiel and P. Zuber. 1988. Identification of a genetic locus required for biosynthesis of the lipopeptide antibiotic surfactin in *Bacillus subtilis*. *J. Bacteriol.* **170**: 5662-5668.
- Nakano, M.M., L. Xia and P. Zuber. 1991. Transcription initiation region of the *srfA* operon, which is controlled by the ComP-ComA signal transduction system in *Bacillus subtilis*. *J. Bacteriol.* **173**: 5487-5493.
- Nakano, M.M. and P. Zuber. 1989. Cloning and characterization of *srfB*, a regulatory gene involved in surfactin production and competence in *Bacillus subtilis*. *J. Bacteriol.* **171**: 5347-5353.
- Nakano, M.M. and P. Zuber. 1991. The primary role of ComA in establishment of the competent state in *Bacillus subtilis* is to activate expression of *srfA*. *J. Bacteriol.* **173**: 7269-7274.
- Ota, I.M. and A. Varshavsky. 1993. A yeast protein similar to bacterial two-component regulators. *Science* **262**: 566-569.
- Parkinson, J.S. and E.C. Kofoid. 1992. Communication modules in bacterial signaling proteins. *Annu. Rev. Genet.* **26**: 71-112.
- Pearce, B.J., A.M. Naughton and H.R. Masure. 1994. Peptide permeases modulate transformation in *Streptococcus pneumoniae*. *Mol. Microbiol.* **12**: 881-892.
- Perego, M., C.F. Higgins, S.R. Pearce, M.P. Gallagher and J.A. Hoch. 1991. The oligopeptide transport system of *Bacillus subtilis* plays a role in the initiation of sporulation. *Mol. Microbiol.* **5**: 173-185.



- Perego, M., G.B. Spiegelman and J.A. Hoch. 1988. Structure of the gene for the transition state regulator, *abrB*: regulator synthesis is controlled by the *spo0A* sporulation gene in *Bacillus subtilis*. *Mol. Microbiol.* **2**: 689-699.
- Piggot, P.J. and J.G. Coote. 1976. Genetic aspects of bacterial endospore formation. *Bacteriol. Rev.* **40**: 908-962 .
- Roggiani, M. and D. Dubnau. 1993. ComA, a phosphorylated response regulator protein of *Bacillus subtilis*, binds to the promoter region of *srfA*. *J. Bacteriol.* **175**: 3182-3187.
- Rudner, D.Z., J.R. LeDeaux, K. Ireton and A.D. Grossman. 1991. The *spo0K* locus of *Bacillus subtilis* is homologous to the oligopeptide permease locus and is required for sporulation and competence. *J. Bacteriol.* **173**: 1388-1398.
- Ruhfel, R.E., D.A. Manias and G.M. Dunny. 1993. Cloning and characterization of a region of the *Enterococcus faecalis* conjugative plasmid, pCF10, encoding a sex pheromone-binding function. *J. Bacteriol.* **175**: 5253-5259.
- Sadaie, Y. and T. Kada. 1983. Formation of competent *Bacillus subtilis* cells. *J. Bacteriol.* **153**: 813-821.
- Shapiro, L., D. Kaiser and R. Losick. 1993. Development and behavior in bacteria. *Cell* **73**: 835-836.
- Siranosian, K.J. and A.D. Grossman. 1994. Activation of *spo0A* transcription by sigma-H is necessary for sporulation but not for competence in *Bacillus subtilis*. *J. Bacteriol.* **176**: 3812-3815.
- Smith, H.O. and D.B. Danner. 1981. Genetic Transformation. *Ann. Rev. Biochem.* **50**: 41-68.
- Stewart, G.J. 1989. The mechanism of natural transformation, p. 139-164. In *Gene transfer in the environment* (ed. S.B. Levy and R.V. Miller). McGraw-Hill, New York.
- Strauch, M. and J.A. Hoch. 1993. Transition-state regulators: sentinels of *Bacillus subtilis* post-exponential gene expression. *Mol. Microbiol.* **7**: 337-342.
- Strauch, M.A., V. Webb, G. Spiegelman and J.A. Hoch. 1990. The Spo0A protein of *Bacillus subtilis* is a repressor of the *abrB* gene. *Proc. Natl. Acad. Sci. USA* **87**: 1801-1805.
- Tanimoto, K., F.Y. An and D.B. Clewell. 1993. Characterization of the *traC* determinant of the *Enterococcus faecalis* hemolysin-bacteriocin plasmid pAD1: Binding of sex pheromone. *J. Bacteriol.* **175**: 5260-5264.
- Tomasz, A. and R.D. Hotchkiss. 1964. Regulation of the transformability of pneumococcal cultures by macromolecular cell products. *Proc. Nat. Acad. Sci. USA* **51**: 480-487.
- Tomasz, A. and J.L. Mosser. 1966. On the nature of the pneumococcal activator substance. *Proc. Natl. Acad. Sci. USA* **55**: 58-66.
- Tynkkynen, S., G. Buist, E. Kunji, J. Kok, B. Poolman, G. Venema and A. Haandrikman. 1993. Genetic and biochemical characterization of the oligopeptide transport system of *Lactococcus lactis*. *J. Bacteriol.* **175**: 7523-7532.

- Valdivia, R.H., L. Wang and S.C. Winans. 1991. Characterization of a putative periplasmic transport system for octopine accumulation encoded by *Agrobacterium tumefaciens*. *J. Bacteriol.* **173**: 6398-6405.
- van Sinderen, D., A. ten Berge, B.J. Hayema, L. Hamoen and G. Venema. 1994. Molecular cloning and sequence of *comK*, a gene required for genetic competence in *Bacillus subtilis*. *Mol. Microbiol.* **11**: 695-703.
- van Sinderen, D. and G. Venema. 1994. *comK* acts as an autoregulatory control switch in the signal transduction route to competence in *Bacillus subtilis*. *J. Bacteriol.* **176**: 5762-5770.
- van Sinderen, D., S. Withoff, H. Boels and G. Venema. 1990. Isolation and characterization of *comL*, a transcription unit involved in competence development of *Bacillus subtilis*. *Mol. Gen. Genet.* **224**: 396-404.
- Vasantha, N. and E. Freese. 1979. The role of manganese in growth and sporulation of *Bacillus subtilis*. *J. Gen. Microbiol.* **112**: 329-336.
- Vasantha, N. and E. Freese. 1980. Enzyme changes during *Bacillus subtilis* sporulation caused by deprivation of guanine nucleotides. *J. Bacteriol.* **144**: 1119-1125.
- Waldburger, C., D. Gonzalez and G.H. Chambliss. 1993. Characterization of a new sporulation factor in *Bacillus subtilis*. *J. Bacteriol.* **175**: 6321-6327.
- Wanner, B.L. 1993. Gene regulation by phosphate in enteric bacteria. *J. Cellular Biochem.* **51**: 47-54.
- Weinrauch, Y., R. Penchev, E. Dubnau, I. Smith and D. Dubnau. 1990. A *Bacillus subtilis* regulatory gene product for genetic competence and sporulation resembles sensor protein members of the bacterial two-component signal-transduction systems. *Genes and Devel.* **4**: 860-872.
- Youngman, P., H. Poth, B. Green, K. York, G. Olmedo and K. Smith. 1989. Methods for genetic manipulation, cloning, and functional analysis of sporulation genes in *Bacillus subtilis*, p. 65-87. In *Regulation of Prokaryotic Development* (ed. I. Smith, R. Slepecky and P. Setlow). American Society for Microbiology, Washington, DC.
- Zanker, H., J. von Lintig and J. Schroeder. 1992. Opine transport genes in the octopine (*occ*) and the nopaline (*noc*) catabolic regions in Ti plasmids of *Agrobacterium tumefaciens*. *J. Bacteriol.* **174**: 841-849.

## Chapter 3

# Purification and characterization of an extracellular peptide factor that affects two different developmental pathways in *Bacillus subtilis*

This work was published in *Genes & Development* (1996) 10:2014-2024

Purification and characterization of an extracellular  
peptide factor that affects two different developmental  
pathways in *Bacillus subtilis*

Jonathan M. Solomon, Beth A. Lazazzera, & Alan D. Grossman\*

Department of Biology; Building 68-530

Massachusetts Institute of Technology

Cambridge, MA 02139

Running Title: Extracellular peptide signaling in *B. subtilis*

\*To whom correspondence should be addressed

phone: (617) 253-1515

fax: (617) 253-8699

e-mail: [adg@mit.edu](mailto:adg@mit.edu)

## ABSTRACT

We have purified and characterized an extracellular peptide factor that serves as a cell density signal for both competence development and sporulation in *Bacillus subtilis*. This competence and sporulation stimulating factor (CSF) was purified from conditioned medium (culture supernatant) based on its ability to stimulate expression of *srfA* (*comS*) in cells at low cell density. CSF is a 5 amino acid peptide; glu-arg-gly-met-thr (ERGMT), that is the C-terminal five amino acids of the 40 amino acid peptide encoded by *phrC*. No detectable CSF was produced in a *phrC* null mutant. The activity of chemically synthesized CSF (ERGMT) was virtually indistinguishable from that of CSF that was purified from culture supernatants. At relatively low concentrations (1 - 10 nM), CSF stimulated expression of *srfA*, while high concentrations of CSF stimulated the ability of cells at low cell density to sporulate. Stimulation of *srfA* expression by CSF requires the oligopeptide permease encoded by *spo0K*, a member of the ATP-binding-cassette family of transporters, and the putative phosphatase encoded by *rapC*, the gene immediately upstream of *phrC*. RapC was found to be a negative regulator of *srfA* expression, suggesting that the target of RapC is the transcription factor encoded by *comA*. We propose that CSF is transported into the cell by the Spo0K oligopeptide permease and stimulates competence gene expression by inhibiting (either directly or indirectly) the RapC phosphatase.

## INTRODUCTION

Cell-cell signaling is utilized by many types of cells to regulate gene expression and development. One form of cell-cell signaling involves a regulatory response to cell density signals. This process, sometimes called quorum sensing (Fuqua et al., 1994), is typically characterized by regulatory events that are induced as cells grow to high cell density. A variety of chemicals, including acyl homoserine lactones, peptides, and amino acids, are used for microbial cell-cell signaling (Kaiser and Losick, 1993) to regulate many biological processes, including genetic exchange, development, virulence, bioluminescence, and production of antibiotics.

In the Gram-positive bacterium *Bacillus subtilis*, the development of genetic competence is regulated by cell density signals (Magnuson et al., 1994; Solomon et al., 1995). *B. subtilis*, like many species of bacteria, has the natural ability to become competent for the uptake of exogenous DNA (Spizizen, 1958) and (reviewed in (Solomon and Grossman, 1996). Early regulatory steps in competence development occur in response to two peptide factors that accumulate in culture medium as cells grow to high density. One factor, the ComX pheromone, is a 9 or 10 amino acid peptide with a modified tryptophan residue (Magnuson et al., 1994). The second factor, CSF, was previously found to be a peptide between 520 and 720 daltons (Solomon et al., 1995). In this report, we describe the purification of CSF to homogeneity, and the biochemical and genetic characterization of this competence and sporulation stimulating factor.

Two convergent pathways control response to the two competence factors (Solomon et al., 1995). The histidine protein kinase encoded by *comP* (Weinrauch et al., 1990) is required for the response to the ComX pheromone (Solomon et al., 1995). The oligopeptide permease encoded by *spo0K* (Perego et al., 1991; Rudner et al., 1991) is required for the response to the second competence factor, CSF (Solomon et

al., 1995). Response to both competence pheromones contributes to the activation of the ComA transcription factor, a response regulator that is phosphorylated on an aspartate in the N-terminal regulatory domain. ComA~P, in turn, activates transcription of *srfA* (*comS*), which is required for competence development (Nakano and Zuber, 1989; van Sinderen et al., 1990; Hahn and Dubnau, 1991; Nakano et al., 1991a; Nakano et al., 1991b; Nakano and Zuber, 1991; Roggiani and Dubnau, 1993). High levels of expression of *comS*, a small open reading frame internal to the large *srfA* operon (D'Souza et al., 1994; Hamoen et al., 1995), contribute to activation of the ComK transcription factor and expression of the late *com* genes that encode the DNA uptake machinery (Hahn et al., 1994; van Sinderen et al., 1994; van Sinderen and Venema, 1994; van Sinderen et al., 1995).

We have found that CSF is a 5 amino acid peptide that stimulates expression of *srfA* when added to cells at low cell density. A synthetic peptide of the same sequence (ERGMT) as the peptide purified from culture supernatants was biologically active, with peak activity for *srfA* expression in the concentration range of 2-5 nM. CSF is encoded by the last 5 codons of a 40 codon open reading frame that was initially identified as being downstream from a promoter recognized by RNA polymerase containing sigma-H (Carter et al., 1991). This open reading frame, named *phrC* (Perego et al., 1996), is preceded by a gene (*rapC*) that encodes a product that is homologous to, and probably is, a response regulator aspartyl phosphate phosphatase (Perego et al., 1996). Our results indicate that the RapC phosphatase is a negative regulator of *srfA* expression and competence, probably by inhibiting accumulation of ComA~P, and that RapC is required for CSF to stimulate competence gene expression.

Under conditions of nutrient deprivation, cells of *B. subtilis* can initiate a developmental pathway that leads to the formation of dormant heat-resistant spores

(Errington, 1993). Like competence development, efficient sporulation requires a relatively high cell density (Vasantha and Freese, 1979; Grossman and Losick, 1988; Waldburger et al., 1993). Experiments characterizing the cell density signals for sporulation indicated that one extracellular sporulation factor was co-purifying with CSF, but that much more of the active fraction was needed to affect sporulation than to affect competence. Experiments with chemically synthesized CSF demonstrate that the pentapeptide can stimulate sporulation of nutrient-deprived cells at low cell density, indicating that CSF is both a competence and sporulation stimulating factor.



## RESULTS

### Purification of CSF

Expression of *srfA* increases as cells grow to high density in minimal medium due to the extracellular accumulation of two different peptide factors, ComX pheromone and CSF (Magnuson et al., 1994; Solomon et al., 1995; Solomon and Grossman, 1996). When added to cells at low cell density, ComX pheromone and CSF cause  $\beta$ -galactosidase specific activity from a *srfA-lacZ* fusion to increase approximately 10-fold and 3-fold, respectively, 70 minutes after addition of the factor (Magnuson et al., 1994; Solomon et al., 1995). CSF was separated from ComX pheromone and purified to homogeneity from cell-free conditioned medium (culture supernatant) made from cells grown to high density (Materials and Methods). The ability to stimulate expression of a *srfA-lacZ* fusion in cells at low cell density was used as an assay to follow CSF activity through the purification (see Materials and methods). Typically, two-fold serial dilutions of column fractions were assayed because CSF was active in a relatively small concentration range and too much seemed to inhibit expression of *srfA-lacZ* (see below).

Material from conditioned medium was adsorbed first to C18 reverse phase columns, washed to remove all media components, and CSF activity was eluted with 11% acetonitrile. Active material was then fractionated on a series of FPLC and HPLC columns (Materials and methods). The elution profile from the final reverse phase column is shown in Figure 1. There is a single peak of material that has CSF activity, assayed by the ability to induce expression of *srfA-lacZ* in cells at low cell density. This peak of CSF activity corresponds to a peak of absorbance at 218 nm (indicative of peptide bonds). This peak had no detectable absorbance at 280 nm, indicating the absence of aromatic amino acids.

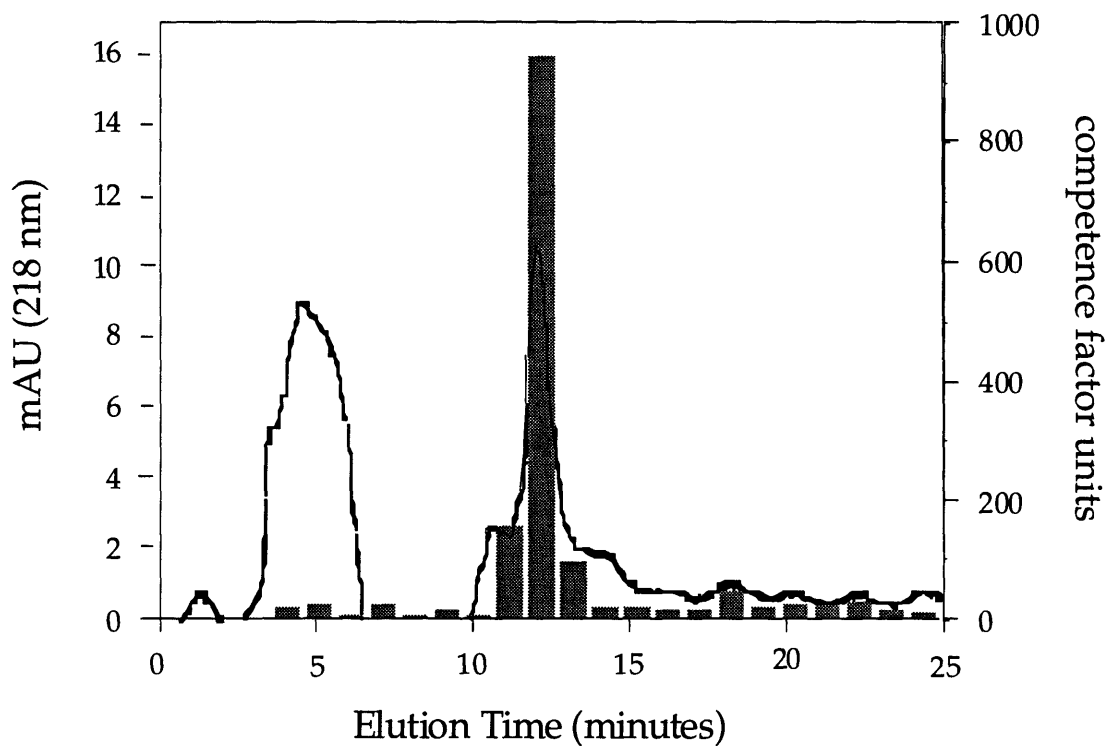

**Figure 1. CSF activity and C18 reverse phase HPLC column profile.**

Absorbance at 218 nm of the material eluting from the final C18 reverse phase column is plotted versus elution time. The bars represent units of CSF activity in the fractions, measured as the ability to induce expression of *srfA-lacZ* in cells at low cell density (Materials and Methods).

Mass spectrometry of the purified material indicated that CSF was 609 daltons (data not shown). Edman degradation and fragmentation mass spectrometry revealed the presence of a five amino acid peptide, N-glu-arg-gly-met-thr-C (ERGMT). This sequence is consistent with the previous finding that CSF activity is sensitive to treatment with trypsin (Solomon et al., 1995). The predicted mass of this peptide is 593 daltons, 16 daltons less than the mass of the purified material. However, it was apparent from the fragmentation mass spectrometry of the purified material that the methionine residue was oxidized (to a sulfoxide), accounting for the 16 dalton discrepancy. This oxidation probably occurred during the purification and did not detectably affect CSF activity. Reduction of the purified material yielded a mass peak of 593 daltons as expected (data not shown).

#### **Synthetic ERGMT has biological activity of CSF**

We determined that a chemically synthesized peptide (ERGMT) had the same biological activity as CSF purified from culture supernatants. Addition of the synthetic peptide to cells at low cell density induced expression of *srfA-lacZ* approximately 3-fold (Figure 2A), comparable to CSF that was purified from conditioned medium (Solomon et al., 1995). The synthetic peptide was most active in the concentration range from ~2 to 5 nM. High concentrations (greater than 50 nM) actually inhibited expression of *srfA-lacZ* (Figure 2A), similar to previous findings with partly purified CSF (R. Magnuson, JMS, & ADG, unpublished results). The mechanism of this inhibition is not yet understood, but might have to do with the activation of regulatory pathways affecting sporulation (see below).

#### **CSF is encoded by *phrC*, a gene downstream from a promoter controlled by sigma-H**

The CSF pentapeptide matches exactly the C-terminal five amino acids of a 40 amino acid open reading frame (Figure 3). This 40 amino acid ORF was initially

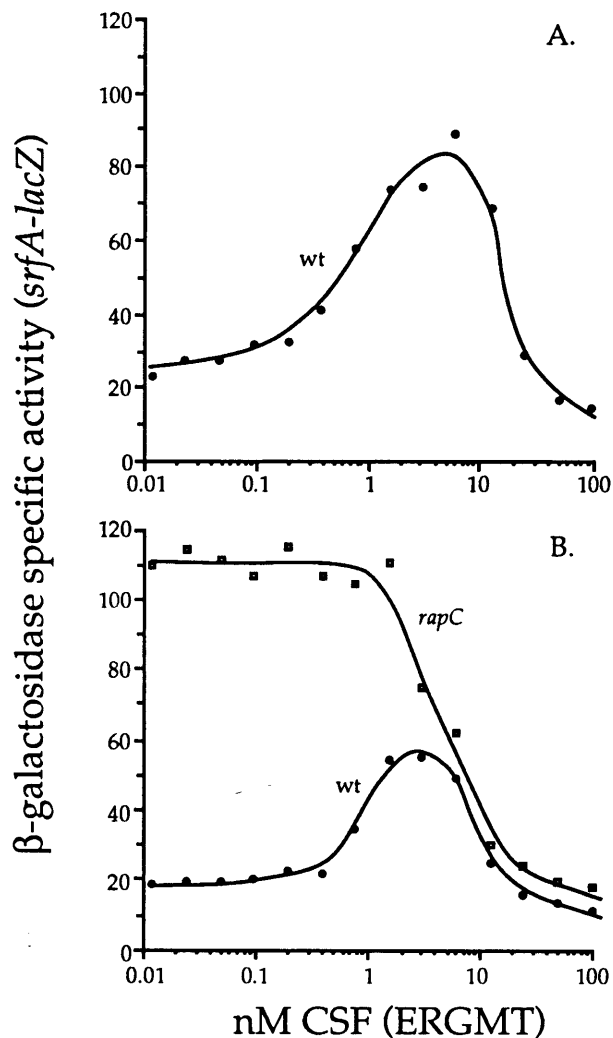

**Figure 2. Expression of *srfA-lacZ* in response to chemically synthesized peptide (ERGMT) in the wild type and *rapC* mutant.** Cells were grown in minimal medium, and at low cell density cells were mixed with indicated amounts of the chemically synthesized peptide, ERGMT, incubated for 70 min at 37°C and  $\beta$ -galactosidase specific activity was assayed.

A. Dose response of wild type cells (JRL293) to CSF. The  $\beta$ -galactosidase specific activity of cells with no added peptide was 23.

B. Dose response of wild type (JRL476) (filled circles) and the *rapC* mutant (BAL116) (open squares) to CSF. The  $\beta$ -galactosidase specific activity of cells with no added peptide was 20 for wild type and 108 for the *rapC* mutant. The initial level of *srfA-lacZ* at low cell density in the *rapC* mutant is higher than that in wild type, but there was no further induction upon addition of various amounts of CSF. The *rapC* mutant is able to respond to the ComX pheromone (data not shown).

identified because it is immediately downstream from a promoter controlled by the *spo0H* gene product, sigma-H (Carter et al., 1991). This is consistent with the previous finding that CSF production is greatly reduced in a *spo0H* null mutant (Solomon et al., 1995). The 40 amino acid ORF has recently been named *phrC* (Perego et al., 1996), based on the assumption that it encodes a phosphatase regulator. *phrC* is immediately downstream from *rapC*, whose gene product is homologous to a response regulator aspartyl phosphate phosphatase (Perego et al., 1996). DNA sequence of part of this region has been published (Carter et al., 1991) and the complete amino acid sequence of the *rapC* gene product was recently reported in a review (Perego et al., 1996).

To determine if *phrC* was the only source of active CSF in culture supernatant, we constructed a *phrC* null mutant and tested conditioned medium from the mutant for CSF activity. A deletion-insertion of *phrC*,  $\Delta phrC::erm$ , was made using clones generated by PCR based on the published DNA sequence (see Materials and Methods). Conditioned medium from the *phrC* null mutant was fractionated to distinguish CSF from ComX pheromone, as described previously (Solomon et al., 1995), and fractions were tested for induction of *srfA-lacZ* in cells at low cell density. The *phrC* null mutant produced no detectable CSF activity (data not shown), indicating that *phrC* is required for CSF production and that *phrC* is the only expressed gene encoding CSF.

The *phrC* null mutation had modest effects on competence gene expression. The onset of *srfA* expression was delayed approximately one-half of one generation and reached a maximal level of approximately 60% of that in wild-type cells (Figure 4A). The *phrC* null mutation also caused a delay and a slight reduction in expression of the late competence gene *comG*, as measured by expression of a *comG-lacZ* fusion (Figure 4B). This effect on expression of *comG-lacZ* was a reflection of a similar effect

**Figure 3. DNA sequence and map of the *phrC* region.**

A. DNA sequence and predicted amino acid sequence of *phrC*. DNA sequence is from published work (Carter et al., 1991). The DNA was originally characterized because of the promoter that is recognized and transcribed by RNA polymerase containing sigma-H (Carter et al., 1991). The DNA sequence of the putative -10 and -35 recognition sites are underlined and the start site of transcription is in bold and underlined. The start codon for *phrC* is in bold and the predicted *phrC* peptide is indicated. The C-terminal 5 amino acids (ERGMT) are indicated in bold and underlined. These correspond to the competence and sporulation stimulating factor (CSF).

B. Schematic of the *rapC phrC* region. *phrC* is downstream and overlaps *rapC*, which encodes a protein homologous to response regulator aspartyl phosphate phosphatases (Carter et al., 1991; Perego et al., 1996).

A.

GATGTTTCCAGTACTTAAAAATAAAAATATGTACGCTGATATAGAGGATTTAGCCCTAG  
AAGTAGCAAAATATTACTATGAACAGAAATGGTTTAAACTGTCTGCTTCCTACTTTCTAC  
AAGTTGAAGAGGCAAGAAAACAAATACAAAGGAGTGAAGGTTTGT**ATG**AAATTGAAATCT  
M K L K S  
AAGTTGTTTGTATTGTTTGGCCGCAGCCGCGATTTTTACAGCGGCTGGCGTTTCTGCT  
K L F V I C L A A A A I F T A A G V S A  
AATGCGGAAGCACTCGACTTTCATGTGACAGAAAGAGGAATGACGTAAGAACAAGCCCCT  
N A E A L D F H V T E R G M T \*

B.

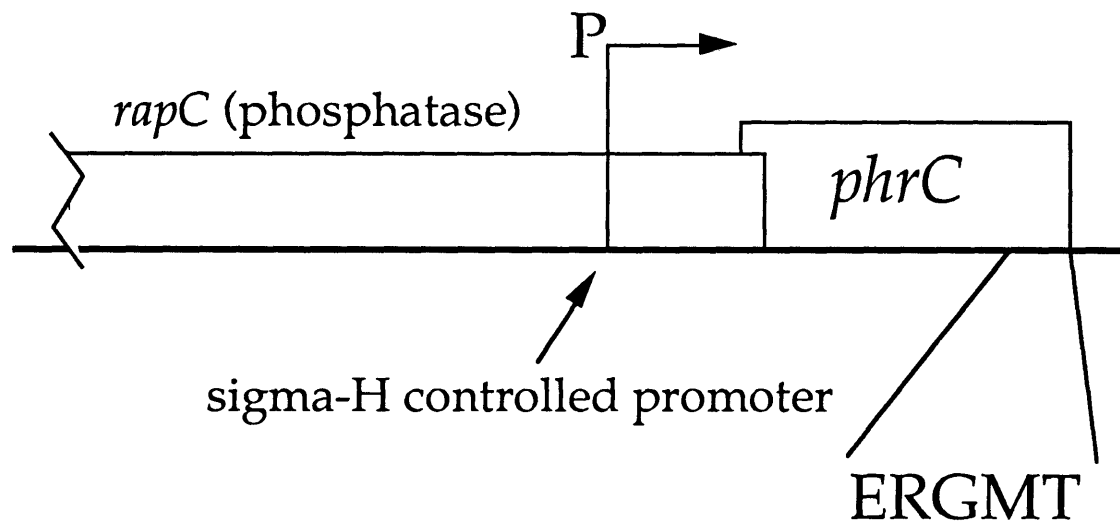

on competence development per se, as measured directly by determining transformation efficiency. The efficiency of transformation in the *phrC* null mutant was approximately 50% of that in wild type. This small change in transformation efficiency is difficult to measure and the effect of the *phrC* mutation on competence is much more reliably seen by measuring the effect on *comG-lacZ* expression. The decrease in *comG* expression (and competence) is probably due to the decrease in expression of *srfA*, as *srfA* is required for expression of the late competence genes (reviewed in (Grossman, 1995).

Previously, we found that *spo0H* null mutants had decreased expression of *srfA* (Jaacks et al., 1989), due, at least in part, to a decrease in production of CSF (Solomon et al., 1995). Interestingly, the defect in expression of *srfA* caused by a null mutation in *spo0H* is more severe than that caused by a null mutation in *phrC*. This could be due to slightly reduced production of the ComX pheromone (~60% of normal) in a *spo0H* mutant (Solomon et al., 1995), or could reflect an additional (indirect) role for sigma-H (*spo0H*) in expression of *srfA*.

Transcription from the sigma-H promoter that drives expression of *phrC* is known to increase as cells enter stationary phase, under the growth conditions tested (Carter et al., 1991), suggesting that the amount of CSF might also increase early in stationary phase. Preliminary experiments measuring the amount of CSF in culture medium from wild type cells at different stages of growth indicate that production of CSF increases upon entry into stationary phase (BAL & ADG, unpublished results).

### **CSF and ComX pheromone are the only major extracellular competence factors**

CSF is one of two extracellular factors that affect *srfA* expression (Magnuson et al., 1994; Solomon et al., 1995). Production of the ComX pheromone requires *comX*, which encodes a 55 amino acid precursor of the peptide moiety of the pheromone,



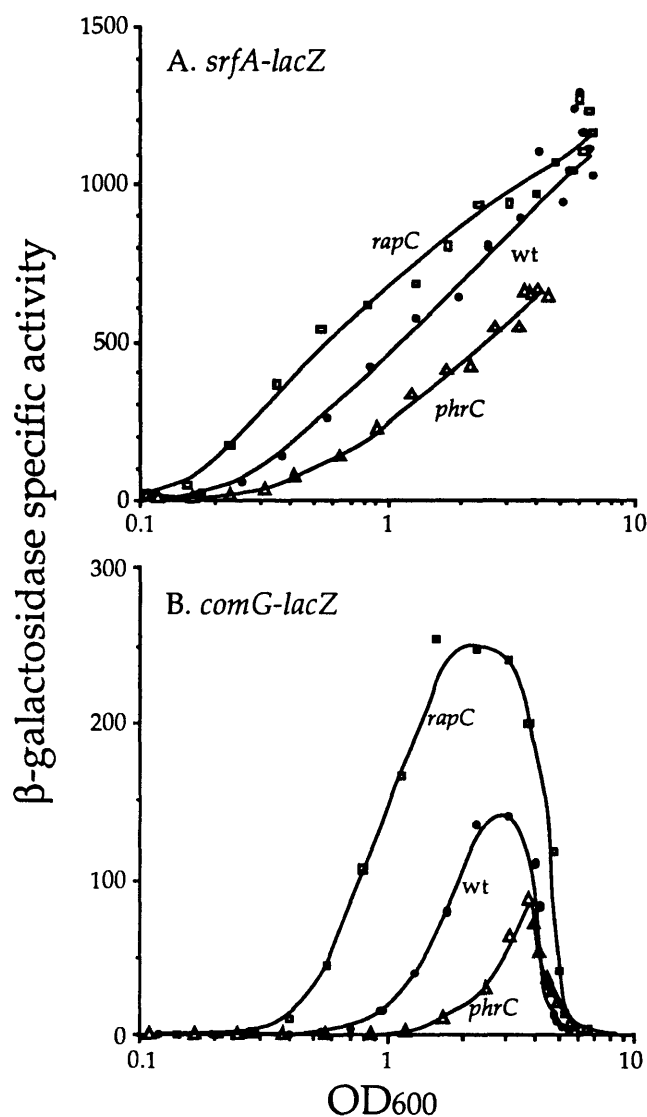

**Figure 4.** Effect of *phrC* and *rapC* null mutations on expression of *srfA* and *comG*. Strains containing the *srfA-lacZ* or *comG-lacZ* fusion were grown in defined minimal medium and samples were taken at the indicated cell densities for determination of  $\beta$ -galactosidase specific activity. **A.** wild type, JRL476 (filled circles); *rapC*, BAL116 (open squares); *phrC*, JMS 753, (open triangles). **B.** wild type, JMS107, (filled circles); *rapC*, BAL114, (open squares); *phrC*, JMS752 (open triangles).

and *comQ*, the gene immediately upstream of (and overlapping with) *comX*. Expression of *srfA* in the absence of the ComX pheromone (in a *comQ* null mutant) is reduced to approximately 10% of that in wild type cells (Magnuson et al., 1994; Solomon et al., 1995). Despite the strong dependence of *srfA* expression on the ComX pheromone, there is still a significant level of expression. We found that CSF is responsible for the bulk of the residual expression of *srfA* in the absence of the ComX pheromone. Expression of *srfA* in the absence of both ComX pheromone and CSF, in a *comQ phrC* double mutant, was less than 20% of that in a *comQ* single mutant (Figure 5). In addition, conditioned medium from the *phrC comQ* double mutant had no detectable competence factor activity. That is, it was unable to induce *srfA-lacZ* expression significantly above background in cells at low cell density (data not shown). These results indicate that ComX pheromone and CSF are the only extracellular competence factors that contribute significantly to expression of *srfA*.

Taken together, results with the *phrC* (missing CSF) and *comQ* (missing ComX pheromone) single and double mutants indicate that the ComX pheromone is the major competence pheromone that affects expression of *srfA*, and that CSF modulates the timing and levels of *srfA* induction (Figure 4). We suspect that physiological conditions alter production of each competence pheromone, and that different ratios of the two extracellular factors might cause different regulatory responses as cells grow to high density and enter stationary phase.

### **The RapC phosphatase is a negative regulator of *srfA* expression and competence**

The *rapC* gene product is a member of a growing family of response regulator aspartyl phosphate phosphatases (Perego et al., 1996). We examined the phenotype caused by a *rapC* mutation and found that RapC is a negative regulator of *srfA*

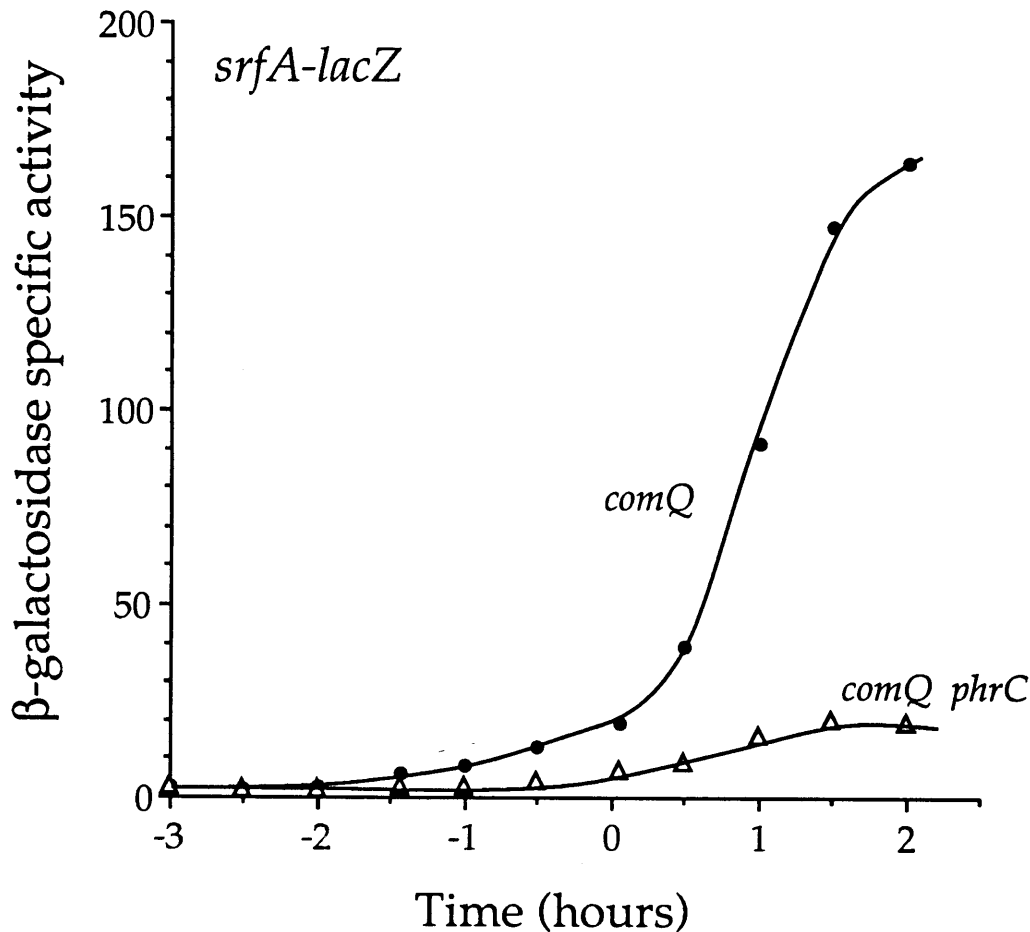

**Figure 5. CSF is required for most of the residual expression of *srfA* in the absence of ComX pheromone.** The *comQ* null mutant produces no detectable ComX pheromone (Magnuson et al., 1994), and was used because the *comX* null mutation is polar on the downstream gene, *comP* (histidine protein kinase). Strains containing the *srfA-lacZ* fusion were grown in minimal medium and  $\beta$ -galactosidase specific activity was measured at the indicated times. Time zero (0) is the time cells cease exponential growth. *comQ*, JMS761, (filled circles); *comQ phrC*, JMS762, (open triangles).  $\beta$ -galactosidase specific activity is presented as a function of time during the growth cycle (rather than as a function of optical density as in Figure 4) because most of the significant expression of *srfA* occurs after the exponential phase of growth when there is little or no increase in optical density.

expression. A null mutation in *rapC* (see Materials and Methods) caused expression of both *srfA-lacZ* (Figure 4A) and *comG-lacZ* (Figure 4B) to be earlier and higher than that in wild type cells. In addition, the transformation efficiency of the *rapC* mutant was approximately 2-3-fold higher than that of wild type cells. Since the phosphorylated form of the ComA response regulator is required for expression of *srfA* and the subsequent development of competence (reviewed in (Dubnau, 1991; Grossman, 1995), these results indicate that the RapC phosphatase is probably a phosphatase for the ComA transcription factor. The increase in *srfA* expression in the *rapC* null mutant is most likely due to increased accumulation of ComA~P, while the increase in competence and *comG* expression is probably due to the increase in *srfA* expression.

#### **CSF stimulation of *srfA* expression requires the RapC phosphatase**

To determine if the RapC phosphatase is required for the response to CSF *in vivo*, we measured the ability of the *rapC* null mutant to respond to various amounts of the chemically synthesized CSF. Expression of *srfA-lacZ* is higher in the *rapC* mutant and this is especially noticeable at low cell densities (Figure 2B & Figure 4A). We found that there was little or no increase in expression of *srfA-lacZ* in *rapC* mutant cells at low cell density in response to CSF (Figure 2B). Expression of *srfA-lacZ* in wild type cells at low density is typically induced approximately 3-fold upon addition of CSF (Figure 2A & B). Together, these results indicate that RapC negatively regulates expression of *srfA* and that CSF antagonizes this negative regulation.

Interestingly, in the *rapC* mutant, high concentrations of CSF inhibit expression of *srfA*, similar to the inhibition in wild type cells (Figure 2B). This indicates that the inhibition does not depend on RapC and that CSF is affecting other regulatory factors in the cell.

### **The oligopeptide permease encoded by *spo0K* can import CSF**

The oligopeptide permease encoded by *spo0K* is required for competence development (Rudner et al., 1991) and for the response to CSF (Solomon et al., 1995). We found that the Spo0K oligopeptide permease is able to transport the chemically synthesized CSF into the cell. We tested the ability of *spo0K*<sup>+</sup> and *spo0K*<sup>-</sup> cells to utilize the synthetic peptide ERGMT as a source of methionine to satisfy a methionine auxotrophy. The *spo0K*<sup>+</sup> (*met*<sup>-</sup>) cells were able to utilize ERGMT as a source of methionine while the *spo0K* (*met*<sup>-</sup>) null mutant was not, as judged by the ability to grow on solid minimal medium with a drop of concentrated peptide. While these results do not prove that the low amounts of CSF are actually imported to stimulate *srfA* expression, they do show that the Spo0K oligopeptide permease can import CSF. It seems likely that one role of the oligopeptide permease in competence development is to transport CSF into the cell where CSF then inhibits, either directly or indirectly, production or activity of the RapC phosphatase.

### **CSF enhances sporulation of nutrient-deprived cells at low cell density**

The initiation of sporulation is also controlled, in part, by cell density signals (Grossman and Losick, 1988; Ireton et al., 1993). In the course of characterizing the multiple peptide factors in conditioned medium that contribute to the cell density effect on sporulation, it became apparent that one extracellular sporulation factor was co-purifying with CSF (data not shown). Chemically synthesized CSF was able to stimulate the sporulation frequency of nutrient-deprived cells at low cell density. That is, CSF has the activity of an extracellular sporulation factor.

Addition of high concentrations of CSF ( $\geq 1 \mu\text{M}$ ) seemed to stimulate sporulation of nutrient-deprived cells at low cell density. This stimulation (2-50-fold) was variable and seemed to depend very much on the initial cell density (data not shown). To more reproducibly detect possible effects of CSF on sporulation, we

tried mixing CSF with conditioned medium from a *spo0A* mutant before addition to wild type cells at low cell density. *spo0A* null mutants are defective in production of several extracellular products, including CSF (Solomon et al., 1995) and at least one major sporulation factor (Grossman and Losick, 1988). When added to cells at low cell density, the combination of CSF (50 - 100 nM) and *spo0A*-conditioned medium reliably and reproducibly stimulated sporulation approximately 5-10-fold (Figure 6). Additional experiments indicated that increasing the amount of CSF (as high as 10  $\mu$ M) did not inhibit sporulation (data not shown). Addition of either 50 - 100 nM CSF or conditioned medium from a *spo0A* null mutant alone usually had little, if any, effect on the ability of nutrient-deprived cells at low cell density to sporulate. Preliminary experiments indicate that the amount of CSF in culture medium (defined minimal medium) from wild type cells grown to early stationary phase is probably  $\geq 100$  nM (BAL & ADG, unpublished results), in the range in which sporulation is stimulated by CSF.

The *phrC* null mutant makes no detectable CSF, but also had no obvious effect on sporulation (data not shown). This is not surprising given that there are multiple peptide factors in conditioned medium that contribute to the cell density effect on sporulation. The effects of the *phrC* mutation on *srfA* and *comG* expression are modest; there is a delay and an approximately 40% reduction in the peak level of expression. If the *phrC* mutation had a comparable effect on sporulation, we would not have detected it in our assays. The *rapC* null mutation also had no obvious effect on sporulation (data not shown). A much more detailed analysis will be necessary to detect possible effects of the *phrC* and *rapC* mutations on sporulation.

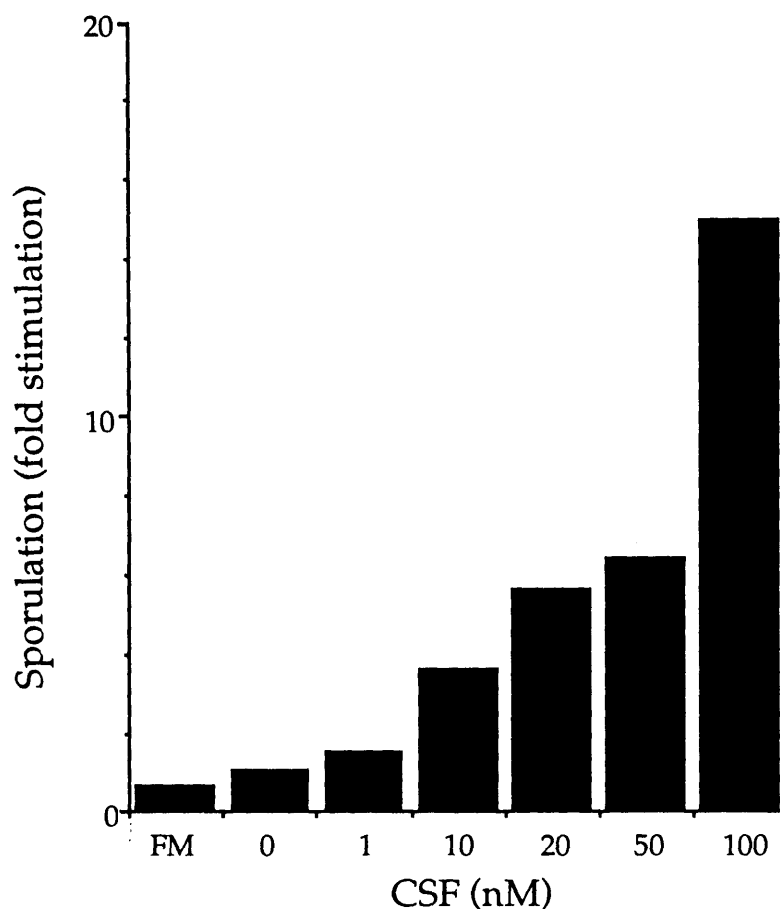

**Figure 6. CSF stimulates sporulation of nutrient deprived cells at low cell density.** Strain AG130 (wild type) was grown in minimal medium and diluted to low density ( $OD_{600} \sim 0.03$ ) in fresh medium (FM) or conditioned medium from a *spo0A* null mutant (JMS700) with the indicated concentration of the chemically synthesized ERGMT peptide. Decoyinine ( $500 \mu\text{g/ml}$ ) was added to initiate starvation conditions and viable cells and spores were measured 12 - 14 hours after the addition of decoyinine. The fold stimulation of sporulation is the percent sporulation under the indicated condition divided by the percent sporulation of cells at low density in untreated medium (fresh medium). Sporulation at high cell density was  $\sim 26\%$ ; sporulation at low cell density was  $\sim 0.1\%$ .

## DISCUSSION

We have purified and characterized a competence and sporulation stimulating factor, CSF, that accumulates as cells grow to high density. CSF is the C-terminal 5 amino acids (ERGMT) of a 40 amino acid peptide encoded by, *phrC* (Carter et al., 1991; Perego et al., 1996), an open reading frame downstream from a promoter controlled by the *spo0H* gene product, sigma-H. No detectable CSF is produced in a *phrC* deletion mutant, causing a delay in the induction of competence gene expression.

Under the conditions tested, CSF is an auxiliary competence pheromone, it modulates the timing and absolute levels of competence development. The major extracellular competence factor is the ComX pheromone, which is responsible for the bulk of the extracellular competence-inducing activity produced by growing cells. It is not clear why *B. subtilis* has two competence pheromones, but their relative abundance could vary under different growth conditions to control the timing of competence development.

A relatively simple model (Figure 7) explains the stimulatory effects of both competence pheromones on expression of *srfA*. The ComX pheromone probably interacts directly with the ComP histidine protein kinase, stimulating autophosphorylation by ComP and transfer of phosphate to ComA (Solomon et al., 1995). CSF is transported into the cell by the oligopeptide permease encoded by *spo0K*, a member of the ATP-binding-cassette family of transporters (Higgins, 1992), that is required for both competence development and sporulation (Perego et al., 1991; Rudner et al., 1991). CSF then affects competence by acting (directly or indirectly) as a negative regulator of the activity or expression of the phosphatase encoded by *rapC*, the gene immediately upstream of *phrC*. The RapC phosphatase is required for CSF to stimulate expression of *srfA* (Figure 2B) and RapC is a negative



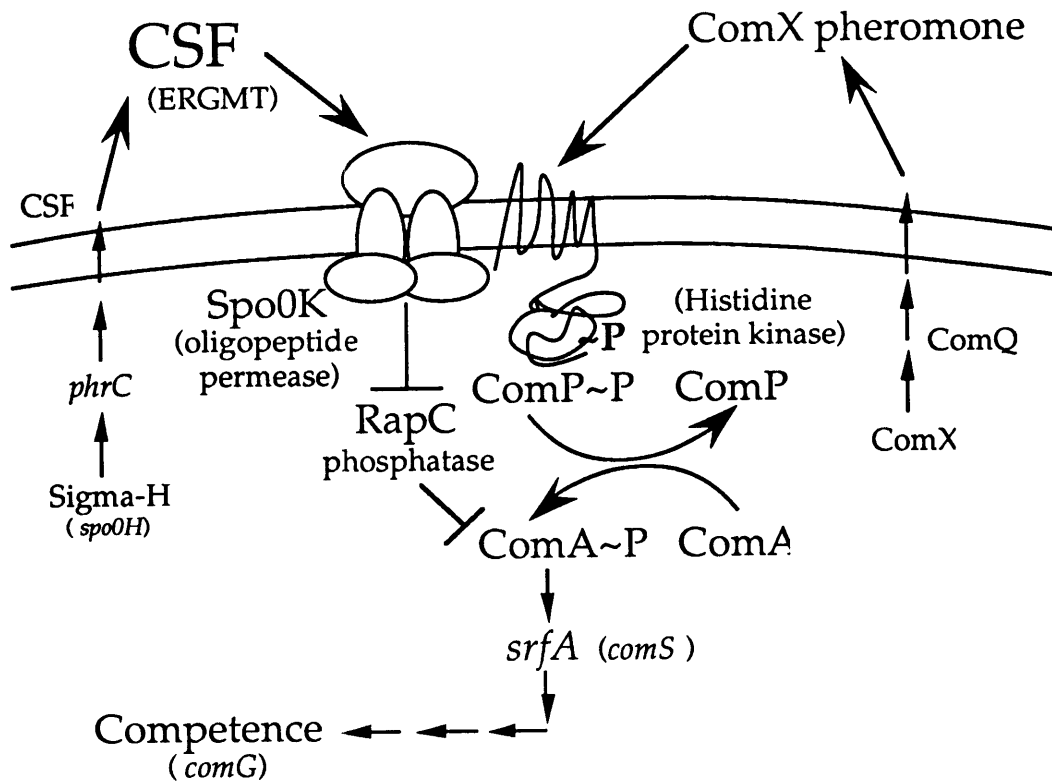

**Figure 7. Model for cell density regulation of *srfA* expression and competence in *B. subtilis*.** Two extracellular factors, ComX pheromone and CSF (competence and sporulation stimulating factor) stimulate expression of *srfA* (*comS*). CSF is the 5 amino acid peptide "ERGMT" and is encoded by *phrC*. Transcription of *phrC* is controlled, in part, by the sigma factor of RNA polymerase, sigma-H, encoded by *spo0H*. Response to CSF requires the oligopeptide permease encoded by *spo0K* and the phosphatase encoded by RapC. CSF is probably transported into the cell by the oligopeptide permease and inhibits activity of the RapC phosphatase (either directly or indirectly). The ComX pheromone is a 9 or 10 amino acid peptide with a hydrophobic modification in place of a tryptophan residue, and ComQ is required for production of the active pheromone (Magnuson et al., 1994). Response to the ComX pheromone requires the membrane-bound histidine protein kinase encoded by *comP*. ComA is the transcription factor that directly activates expression of *srfA*, and phosphorylation (activation) of ComA is controlled by ComP (kinase) and RapC (phosphatase).

regulator of *srfA* expression (Figure 4A), most likely by inhibiting accumulation of the phosphorylated form of the ComA transcription factor, the direct activator of *srfA* expression. In this way, the two extracellular competence factors control opposing processes; ComX pheromone stimulates a kinase, while CSF inhibits a phosphatase. It is not surprising that the factor (ComX pheromone) that regulates the kinase is the major competence pheromone, while CSF, which regulates the phosphatase, has a modulating effect.

While the Spo0K oligopeptide permease regulates induction of *srfA* in response to CSF (Solomon et al., 1995), the permease must also affect *srfA* expression in other ways. Expression of *srfA* is severely reduced (to ~5% of wild type) in a *spo0K* null mutant (Magnuson et al., 1994; Solomon et al., 1995). In contrast, a *phrC* (CSF) null mutation causes only a modest reduction in *srfA* expression (Figure 4). Since the oligopeptide permease is probably involved in regulating multiple phosphatases (and perhaps kinases), the severe defect in *srfA* expression in the *spo0K* null mutant might reflect hyper-activity of several other phosphatases (see below), leading to decreased expression of *srfA*. In addition, if the only role of the oligopeptide permease in competence was to transport CSF to inhibit the RapC phosphatase, then the competence defect caused by a *spo0K* null mutation should be suppressed by a *rapC* null mutation. This is not the case (data not shown). Together, these results indicate that Spo0K is affecting *srfA* expression by at least one pathway other than that involving CSF and RapC.

While relatively low concentrations (2 - 5 nM) of CSF stimulate expression of *srfA*, high concentrations (50 - 100 nM) actually inhibit expression. This inhibition does not depend on the RapC phosphatase, indicating that CSF is affecting at least one other regulatory factor. Candidate targets for this inhibition could be other phosphatases which might indirectly cause inhibition of *srfA* expression. The levels

of CSF that inhibit expression of *srfA* stimulate the sporulation pathway. Since activation of the early regulatory steps in sporulation can inhibit competence (reviewed in (Grossman, 1995), the inhibition of *srfA* at higher levels of CSF might be due to activation of the sporulation pathway.

In addition to the two extracellular peptide factors that affect competence (Figure 7), there are also multiple extracellular peptide factors that affect sporulation. We have shown that one of the sporulation factors is CSF. The initial indication that sporulation was influenced by peptide factors came from experiments done with cells subjected to starvation conditions at low cell density. Under these conditions, sporulation is inefficient (Vasantha and Freese, 1979; Grossman and Losick, 1988; Waldburger et al., 1993). Conditioned medium from cells grown to high density contains at least two different peptide factors that contribute to this cell density effect (JMS & ADG, unpublished results) and one of these factors co-purified with CSF. The identification of CSF allowed us to test its role in sporulation using the chemically synthesized peptide. CSF is able to enhance sporulation of nutrient-deprived cells at low cell density, but the amount that is needed (50 - 100 nM) is much greater than the amount needed (1 - 10 nM) to stimulate expression of *srfA*. Based on these results, we propose that CSF contributes to a regulatory switch that initially favors competence and then favors sporulation and inhibits competence. This is consistent with fact that competence can develop during exponential growth (Dubnau et al., 1991; Magnuson et al., 1994; Grossman, 1995), while the initiation of sporulation is post-exponential (Errington, 1993; Hoch, 1993; Grossman, 1995).

The cell density effect on sporulation affects activation of the Spo0A transcription factor (Ireton et al., 1993). Constitutively active forms of Spo0A completely bypass the need for high cell density, allowing efficient sporulation of cells at low density (Ireton et al., 1993). This indicates that the cell density factors needed for sporulation

stimulate production of the phosphorylated form of Spo0A (directly or indirectly). Spo0A normally obtains phosphate from a combination of three histidine protein kinases (Perego et al., 1989; Antoniewski et al., 1990; Trach and Hoch, 1993; Kobayashi et al., 1995; LeDeaux and Grossman, 1995; LeDeaux et al., 1995) and a multi-component phosphorelay (Burbulys et al., 1991; Hoch, 1993). The amount of Spo0A~P that accumulates is controlled, in part, by the activity of the kinases, and by the opposing activities of phosphatases (see below). While we have not identified the genes necessary for CSF to stimulate sporulation, we suspect that CSF might be inhibiting phosphatases on the sporulation pathway, perhaps RapA and RapB (see below). In addition, we suspect that some of the extracellular sporulation factors are stimulating at least one of the sporulation kinases, perhaps analogous to the role of ComX pheromone in stimulating the ComP histidine protein kinase (Figure 7).

Several genes have been identified in *B. subtilis* that encode products that are homologous to RapA, a response regulator aspartyl phosphate phosphatase (Mueller et al., 1992; Mueller and Sonenshein, 1992; Perego et al., 1994; Perego et al., 1996). While our results show that RapC is a negative regulator of competence, both RapA and RapB were found to be negative regulators of sporulation (Mueller et al., 1992; Mueller and Sonenshein, 1992; Perego et al., 1994). RapA has been purified and shown to be a phosphatase for Spo0F~P (Perego et al., 1994), an intermediate in the phosphorelay pathway that controls the initiation of sporulation (Burbulys et al., 1991; Hoch, 1993). Null mutations in *rapA* (*gsiA*) cause enhanced sporulation (Mueller et al., 1992; Mueller and Sonenshein, 1992; Perego et al., 1994) by allowing more efficient activation of Spo0A.

Many of the genes encoding response regulator aspartyl phosphate phosphatases are followed by small open reading frames that could encode extracellular peptides (Perego et al., 1996). *phrA*, downstream of *rapA*, is required for the initiation of

sporulation (Perego and Hoch, 1996) and this requirement is bypassed by a null mutation in *rapA* (Perego and Hoch, 1996), indicating that a *phrA* product is positively regulating phosphorylation of Spo0A. A *phrA* mutant can also be rescued extracellularly, either by mixing with other cells or by addition of various peptides corresponding the C-terminal region of the *phrA* gene product, indicating that a product of *phrA* probably accumulates extracellularly to regulate sporulation (Perego and Hoch, 1996). It is not clear if the *phrA* factor contributes to the cell density effect on sporulation, but *phrA* mutants still make at least two additional sporulation factors found in culture supernatant (JMS & ADG, unpublished results).

The Spo0K oligopeptide permease is clearly able to transport CSF (see results) and is almost certainly involved in transporting other peptide signaling factors. The requirement for the oligopeptide permease in sporulation is bypassed by a *rapA rapB* double mutation (Perego and Hoch, 1996), or by overexpressing either *kinA* (Rudner et al., 1991) or *kinC* (LeDeaux and Grossman, 1995), histidine protein kinases that donate phosphate to Spo0F, leading to activation of Spo0A. Together, these results imply two possible roles for peptides transported by the oligopeptide permease; to inhibit phosphatases, and/or to stimulate histidine protein kinases.

There appears to be a cell-cell signaling pathway for the initiation of sporulation that is independent of the oligopeptide permease and RapC. *rapC* null mutations have no obvious effect on sporulation (data not shown) and, like wild type cells, sporulate more poorly at low cell density. *spo0K* mutants have a decreased frequency of sporulation, but that frequency is still reduced further at low cell density (unpublished results). These results indicate that there is a cell-cell signaling pathway controlling the initiation of sporulation that is independent of RapC and Spo0K. We suspect that this pathway involves one or another of the histidine

protein kinases that contribute to the initiation of sporulation (reviewed in (Grossman, 1995).

It is apparent that *B. subtilis*, like many species of microbes, goes to great lengths to monitor its local concentration and modify gene expression and development in response to cell density signals. The multiplicity of *phr* genes indicates that many different processes in *B. subtilis* may be controlled by cell density factors or quorum sensing. Alternatively, the different peptides may be expressed under different conditions and might contribute to regulation of a limited number of regulatory responses (e.g., competence and sporulation). If these products are actually affecting gene expression, it seems fitting to call the *phr* products pheromones ("chemicals produced by an organism that can alter behavior or gene expression of other organisms of the same species") (Lodish et al., 1995).

## MATERIALS and METHODS

**Strains and *lacZ* fusions.** *B. subtilis* strains used are listed in Table 1 and unless indicated otherwise are derived from parent strain JH642 and contain *trpC* and *pheA* mutations. The *srfA-lacZ* $\Omega$ 1974 fusion is a translational fusion located in single copy at the *amyE* locus and was provided by J. Hahn and D. Dubnau (Hahn et al., 1994). It was used in most of the experiments involving the purification of CSF and had previously been used in the characterization of the ComX pheromone (Magnuson et al., 1994). The *comG-lacZ* fusion is a transcriptional fusion located at *amyE* (Magnuson et al., 1994).

**Construction of *phrC* and *rapC* mutants.** The *phrC* deletion was made by cloning regions upstream and downstream of the *phrC* open reading frame on either side of the erythromycin resistance gene (*erm*) and recombining this construct into the chromosome by double crossover. The deletion extends from codon 6 of *phrC* to 22 bp downstream of the stop codon of *phrC*, and removes the last five codons which encode CSF. The deletion-insertion mutation leaves intact the 3' end of *rapC*, which overlaps the 5' end of *phrC*.

pJS48 contains the  $\Delta$ *phrC::erm* mutation. The regions upstream and downstream of *phrC* were cloned by PCR amplification using Vent polymerase and primers with restriction sites added at the end (underlined) to aid in the sub-cloning. The region upstream of *phrC* region was amplified with primers rapC1: 5'-AAGGATCCTACGTGGAGCAGGAAAC-3' and rapC2: 5'-GGAATTCTGCGGCCAAACAAATAAC-3'. This fragment extends from 618 bp upstream of the *phrC* start codon to 24 bp into the structural gene and was sub-cloned between the BamHI and EcoRI restriction sites of pJPM8 (from J. Mueller & A.L. Sonenshein) making plasmid pJS47. The region downstream of *phrC* was amplified using primers phrC1: 5'-ATAATGTCGACCGAGAAGGGGTTTTTC-3'

Table 1. *B. subtilis* strains used.

<u>Strain</u>	<u>relevant genotype</u>	<u>reference</u>
JRL293	<i>amy::(srfA-lacZ<math>\Omega</math>1974 cat)</i>	(Magnuson et al., 1994)
JRL476	<i>amy::(srfA-lacZ<math>\Omega</math>1974 cat::spc)</i>	(Magnuson et al., 1994)
AG1046 (JMS107)	<i>amyE::(comG-lacZ neo)</i>	(Magnuson et al., 1994; Siranosian and Grossman, 1994)
AG130	<i>SP<math>\beta</math>::(spoVG-lacZ erm cat) trp<sup>+</sup> phe<sup>+</sup></i>	(Grossman and Losick, 1988)
BAL116	<i>rapC::pJS49 (cat) amy::(srfA-lacZ<math>\Omega</math>1974 cat::spc)</i>	
BAL114	<i>rapC::pJS49 amyE::(comG-lacZ neo)</i>	
JMS700	<i><math>\Delta</math>spo0A::cat pheA trp<sup>+</sup> SP<math>\beta</math><sup>0</sup></i>	
JMS752	<i><math>\Delta</math>phrC::erm amyE::(comG-lacZ neo)</i>	
JMS753	<i><math>\Delta</math>phrC::erm amy::(srfA-lacZ<math>\Omega</math>1974 cat::spc)</i>	
JMS761	<i><math>\Delta</math>comQ::spc amy::(srfA-lacZ<math>\Omega</math>1974 cat)</i>	
JMS762	<i><math>\Delta</math>comQ::spc <math>\Delta</math>phrC::erm amy::(srfA-lacZ<math>\Omega</math>1974 cat)</i>	



and *phrC2*: 5'-AGGGCCCCTCTTGTCCACTATTATC-3'. This fragment extends from 22 bp downstream from the *phrC* stop codon to 461 bp downstream of the stop codon and was sub-cloned into the *Sal*I and *Apa*I sites of pJS47 to make pJS48. pJS48 was linearized and transformed into wild-type *B. subtilis* selecting for *MLS<sup>R</sup>* transformants. The transformants were screened by PCR to confirm that a double crossover event had occurred (data not shown).

The *rapC* mutant was made by integrating a plasmid containing an internal fragment of *rapC* into the chromosome. The internal fragment was derived from the 1216 bp fragment that had been isolated following PCR amplification of the region between primers *rapC1* and *phrC2* (described above). The PCR product was digested with *Bam*HI and *Hind*III yielding a 327 bp piece that was subcloned into the *Bam*HI and *Hind*III sites of pJH101 (Ferrari et al., 1983) to make pJS49. The internal fragment stops 101 codons from the end of *rapC*. pJS49 was integrated into the *B. subtilis* chromosome by transformation into wild-type cells selecting for resistance to chloramphenicol.

**Media.** Defined minimal medium was used for most experiments and contained S7 salts (Vasanth and Freese, 1980) except that MOPS buffer was used at 50 rather than 100 mM (Jaacks et al., 1989). Medium contained glucose (1%) and glutamate (0.1%) and required amino acids (40 or 50  $\mu$ g/ml) as needed.

**$\beta$ -galactosidase assays.**  $\beta$ -galactosidase specific activity was measured essentially as described (Miller, 1972; Jaacks et al., 1989; Magnuson et al., 1994) and is presented as ( $\Delta A_{420}$  per min per ml of culture per  $OD_{600}$ )  $\times$  1000.

**Spore assays and the effect of CSF on sporulation.** Sporulation frequencies were determined as the number of heat resistant (80°C for 20 min) colony forming units as a fraction of total colony forming units on LB plates. Strain AG130 was grown to an  $OD_{600}$  of 0.3 -0.5 in defined minimal medium for at least 3 generations.

Cells were diluted to low density (typically a 10-fold and/or a 50-fold dilution) in fresh medium, conditioned medium from a *spo0A* mutant, or conditioned medium from a *spo0A* mutant with CSF peptide added at indicated concentrations.

Conditioned medium from JMS700 (*spo0A*) was made from cells grown to late exponential phase in defined minimal medium. Nutrient deprivation conditions were imposed by the addition of decoyinine (U-7984; Upjohn Co.), an inhibitor of GMP synthetase, to a concentration of 500 µg/ml, essentially as described previously (Mitani et al., 1977; Grossman and Losick, 1988). The numbers of viable cells and heat resistant spores were determined 12 - 14 hours after addition of decoyinine.

**Purification of CSF.** CSF was purified from conditioned medium made from strain ROM186 (prototroph,  $\Delta spo0K357::neo spoIVC::Tn917$ ). The *spoIVC* mutation was used to completely block spore formation. The *spo0K* allele is a deletion insertion (LeDeaux and Grossman, 1995) and was used because preliminary results indicated that *spo0K* null mutations caused increased production of CSF, especially after entry into stationary phase (Solomon et al., 1995). The cells were grown essentially as described previously (Magnuson et al., 1994). Approximately two hours after the onset of stationary phase, cells were removed by centrifugation and the supernatant was filter sterilized to produce cell-free conditioned medium.

One liter of conditioned medium was adjusted to pH 2 with trifluoroacetic acid (TFA), and run by gravity over C18 reverse phase column (Preparative C18 125Å, Waters). 250 ml portions of conditioned medium were applied to 100 g of column matrix. The column was washed with buffer containing 0.1% TFA and CSF was eluted with 11% acetonitrile in the same buffer. This 11% acetonitrile fractions were concentrated by speed-vac, resuspended in 50 mM citrate buffer (pH 3), and adsorbed to a 100 ml Source 30S cation exchange FPLC column (Pharmacia). After washing the column with 50 mM citrate buffer containing 25 mM NaCl, CSF was

eluted with 500 mM NaCl. The buffers and salts were removed from the active fractions by reverse phase chromatography as described for the treatment of crude conditioned medium, except that 10 g C18 reverse phase columns (Waters) were used.

All subsequent purification steps used high pressure liquid chromatography (HPLC). The material was first run on a sulfoethylaspartamide column (The Nest Group). The loading buffer was 5 mM  $\text{KH}_2\text{PO}_4$ , 25% acetonitrile, pH 3, and the material was eluted with a 12.5 mM/minute gradient of NaCl. Active fractions were then subjected to three reverse phase chromatography steps. The first was a Xorbax C18 column, 4.6 mm (DuPont). Material was adsorbed in 1.6% acetonitrile, 0.1% TFA and eluted in a very shallow gradient (0.05% acetonitrile/minute). Active fractions were again run on the Xorbax C18 column substituting 5 mM hydrochloric acid for 0.1% TFA. The CSF activity was eluted with an isocratic wash of 5 mM HCl. The final reverse phase step used a 1 mm Vydac C18 column (The Nest Group). The material was loaded in buffer containing 1.6% acetonitrile, 0.1% TFA, and CSF was eluted with a 10 minute isocratic wash followed by a gradient of 0.1 % acetonitrile/minute.

After each step in the purification, active fractions were concentrated by speed-vac as necessary. Concentrated fractions were resuspended in buffers appropriate for the next step in the purification and the pH was adjusted as necessary.

**Assay of CSF activity.** CSF activity was measured essentially as described previously (Solomon et al., 1995). Cells containing the *srfA-lacZ* $\Omega$ 1974 fusion (JRL293 or JRL476) were grown for at least three doublings to an optical density of approximately 0.05 - 0.1 at 600 nm. 0.25 ml of cells were mixed with 0.25 ml of the sample to be assayed, with 50  $\mu\text{g}/\text{ml}$  BSA to prevent nonspecific loss of activity (Magnuson et al., 1994), incubated at 37°C for 70 minutes, and assayed for  $\beta$ -

galactosidase specific activity. The response to CSF was linear only over a small concentration range and assays were typically done on a series of two-fold dilutions. Dilutions in the linear range were used to calculate the units of CSF per ml of conditioned medium. One unit of CSF activity is defined as the amount needed to induce expression of the *srfA-lacZ* $\Omega$ 1974 fusion in strain JRL293 (or JRL476) to an activity of one  $\beta$ -galactosidase specific activity unit above the background of untreated cells (fresh medium) in 70 minutes.

**Analysis and synthesis of CSF.** Peptide sequencing was done by the MIT Biopolymers Lab, in the Department of Biology, MIT and by the Microchemistry Lab, Harvard University. Synthesis of ERGMT was done by Genemed Biotechnologies, S. San Francisco, CA. MALDI/TOF mass spectrometry was done on a Voyager Elite machine (PerSeptive Biosystems) both in the lab of Paul Matsudaira, Whitehead Institute, Department of Biology, MIT and in the lab of Klaus Biemann by Susan Wolf in the Department of Chemistry, MIT.

## ACKNOWLEDGMENTS

We are grateful to P. Matsudaira and T. Baker for advice and use of HPLC equipment; P. Matsudaira for use of his mass spectrometer; R. Cook, W. Lane for peptide sequencing; and P. Matsudaira, Susan Wolf and K. Biemann for mass spectrophotometric analysis. R. Magnuson first noticed the unusual dose response properties of partly purified CSF. We are grateful to members of our lab for useful discussions, comments, and suggestions on the manuscript. We thank C. Price, D. Dubnau, and S. Bell for comments on the manuscript; M. Nakano and P. Zuber for communication of results prior to publication.

JMS was supported by a Howard Hughes predoctoral fellowship. ADG was a Lucille P. Markey Scholar in Biomedical Sciences and this work was supported in part by a grant from the Lucille P. Markey Charitable Trust, and Public Health Services grants GM41934 and GM50895 to ADG from the NIH.

## REFERENCES

- Antoniewski, C., B. Savelli and P. Stragier. 1990. The *spoIIJ* gene, which regulates early developmental steps in *Bacillus subtilis*, belongs to a class of environmentally responsive genes. *J. Bacteriol.* **172**: 86-93.
- Burbulys, D., K.A. Trach and J.A. Hoch. 1991. Initiation of sporulation in *B. subtilis* is controlled by a multicomponent phosphorelay. *Cell* **64**: 545-552.
- Carter, I., H. L., K.M. Tatti and J. Moran, C. P. 1991. Cloning of a promoter used by sigma-H RNA polymerase in *Bacillus subtilis*. *Gene* **96**: 101-105.
- D'Souza, C., M.M. Nakano and P. Zuber. 1994. Identification of *comS*, a gene of the *srfA* operon that regulates the establishment of genetic competence in *Bacillus subtilis*. *Proc. Natl. Acad. Sci. USA* **91**: 9397-9401.
- Dubnau, D. 1991. Genetic competence in *Bacillus subtilis*. *Microbiol. Rev.* **55**: 395-424.
- Dubnau, D., J. Hahn, L. Kong, M. Roggiani and Y. Weinrauch. 1991. Genetic competence as a post-exponential global response. *Seminars in Dev. Biol.* **2**: 3-11.
- Errington, J. 1993. *Bacillus subtilis* sporulation: Regulation of gene expression and control of morphogenesis. *Microbiol. Rev.* **57**: 1-33.
- Ferrari, F.A., A. Nguyen, D. Lang and J.A. Hoch. 1983. Construction and properties of an integrable plasmid for *Bacillus subtilis*. *J. Bacteriol.* **154**: 1513-1515.
- Fuqua, W.C., S.C. Winans and E.P. Greenberg. 1994. Quorum sensing in bacteria: the LuxR-LuxI family of cell density-responsive transcriptional regulators. *J. Bacteriol.* **176**: 269-275.
- Grossman, A.D. 1995. Genetic networks controlling the initiation of sporulation and the development of genetic competence in *Bacillus subtilis*. *Ann. Rev. Genet.* **29**: 477-508.
- Grossman, A.D. and R. Losick. 1988. Extracellular control of spore formation in *Bacillus subtilis*. *Proc. Natl. Acad. Sci. U.S.A.* **85**: 4369-4373.
- Hahn, J. and D. Dubnau. 1991. Growth stage signal transduction and the requirements for *srfA* induction in development of competence. *J. Bacteriol.* **173**: 7275-7282.
- Hahn, J., L. Kong and D. Dubnau. 1994. The regulation of competence transcription factor synthesis constitutes a critical control point in the regulation of competence in *Bacillus subtilis*. *J. Bacteriol.* **176**: 5753-5761.

- Hamoen, L.W., H. Eshuis, J. Jongbloed, G. Venema and D. van Sinderen. 1995. A small gene, designated *comS*, located within the coding region of the fourth amino acid-activation domain of *srfA*, is required for competence development in *Bacillus subtilis*. *Mol. Microbiol.* **15**: 55-63.
- Higgins, C.F. 1992. ABC transporters: From microorganisms to man. *Annu. Rev. Cell Biol.* **8**: 67-113.
- Hoch, J.A. 1993. Regulation of the phosphorelay and the initiation of sporulation in *Bacillus subtilis*. *Ann. Rev. Microbiol.* **47**: 441-465.
- Ireton, K., D.Z. Rudner, K.J. Siranosian and A.D. Grossman. 1993. Integration of multiple developmental signals in *Bacillus subtilis* through the Spo0A transcription factor. *Genes Dev.* **7**: 283-294.
- Jaacks, K.J., J. Healy, R. Losick and A.D. Grossman. 1989. Identification and characterization of genes controlled by the sporulation regulatory gene *spo0H* in *Bacillus subtilis*. *J. Bacteriol.* **171**: 4121-4129.
- Kaiser, D. and R. Losick. 1993. How and why bacteria talk to each other. *Cell* **73**: 873-885.
- Kobayashi, K., K. Shoji, T. Shimizu, K. Nakano, T. Sato and Y. Kobayashi. 1995. Analysis of a suppressor mutation *ssb (kinC)* of *sur0B20 (spo0A)* mutation in *Bacillus subtilis* reveals that *kinC* encodes a histidine protein kinase. *J. Bacteriol.* **177**: 176-182.
- LeDeaux, J.R. and A.D. Grossman. 1995. Isolation and characterization of *kinC*, a gene that encodes a sensor kinase homologous to the sporulation sensor kinases KinA and KinB in *Bacillus subtilis*. *J. Bacteriol.* **177**: 166-175.
- LeDeaux, J.R., N. Yu and A.D. Grossman. 1995. Different roles for KinA, KinB, and KinC in the initiation of sporulation in *Bacillus subtilis*. *J. Bacteriol.* **177**: 861-863.
- Lodish, H., D. Baltimore, A. Berk, S.L. Zipursky, P. Matsudaira and J. Darnell. 1995. *Molecular Cell Biology, 3d ed.* W.H. Freeman & Co., New York.
- Magnuson, R., J. Solomon and A.D. Grossman. 1994. Biochemical and genetic characterization of a competence pheromone from *B. subtilis*. *Cell* **77**: 207-216.
- Miller, J. 1972. *Experiments in molecular genetics*. Cold Spring Harbor Laboratory, Cold Spring Harbor, N. Y.
- Mitani, T., J.F. Heinze and E. Freese. 1977. Induction of sporulation in *Bacillus subtilis* by decoyinine or hadacidin. *Biochem. Biophys. Res. Commun.* **77**: 1118-1125.

- Mueller, J.P., G. Bukusoglu and A.L. Sonenshein. 1992. Transcriptional regulation of *Bacillus subtilis* glucose starvation-inducible genes: Control of *gsiA* by the ComP-ComA signal transduction system. *J. Bacteriol.* **174**: 4361-4373.
- Mueller, J.P. and A.L. Sonenshein. 1992. Role of the *Bacillus subtilis* *gsiA* gene in regulation of early sporulation gene expression. *J. Bacteriol.* **174**: 4374-4383.
- Nakano, M.M., R. Magnuson, A. Meyers, J. Curry, A.D. Grossman and P. Zuber. 1991a. *srfA* is an operon required for surfactin production, competence development, and efficient sporulation in *Bacillus subtilis*. *J. Bacteriol.* **173**: 1770-1778.
- Nakano, M.M., L. Xia and P. Zuber. 1991b. Transcription initiation region of the *srfA* operon, which is controlled by the ComP-ComA signal transduction system in *Bacillus subtilis*. *J. Bacteriol.* **173**: 5487-5493.
- Nakano, M.M. and P. Zuber. 1989. Cloning and characterization of *srfB*, a regulatory gene involved in surfactin production and competence in *Bacillus subtilis*. *J. Bacteriol.* **171**: 5347-5353.
- Nakano, M.M. and P. Zuber. 1991. The primary role of ComA in establishment of the competent state in *Bacillus subtilis* is to activate expression of *srfA*. *J. Bacteriol.* **173**: 7269-7274.
- Perego, M., S.P. Cole, D. Burbulys, K. Trach and J.A. Hoch. 1989. Characterization of the gene for a protein kinase which phosphorylates the sporulation-regulatory proteins Spo0A and Spo0F of *Bacillus subtilis*. *J. Bacteriol.* **171**: 6187-6196.
- Perego, M., P. Glaser and J.A. Hoch. 1996. Aspartyl-phosphate phosphatases deactivate the response regulator components of the sporulation signal transduction system in *Bacillus subtilis*. *Mol. Microbiol.* **19**: 1151-1157.
- Perego, M., C. Hanstein, K.M. Welsh, T. Djavakhishvili, P. Glasser and J.A. Hoch. 1994. Multiple protein-aspartate phosphatases provide a mechanism for the integration of diverse signals in the control of development in *B. subtilis*. *Cell* **79**: 1047-1055.
- Perego, M., C.F. Higgins, S.R. Pearce, M.P. Gallagher and J.A. Hoch. 1991. The oligopeptide transport system of *Bacillus subtilis* plays a role in the initiation of sporulation. *Mol. Microbiol.* **5**: 173-185.
- Perego, M. and J.A. Hoch. 1996. Cell-cell communication regulates the effects of protein aspartate phosphatases on the phosphorelay controlling development in *Bacillus subtilis*. *Proc. Natl. Acad. Sci. USA* **93**: 1549-1553.



- Roggiani, M. and D. Dubnau. 1993. ComA, a phosphorylated response regulator protein of *Bacillus subtilis*, binds to the promoter region of *srfA*. *J. Bacteriol.* **175**: 3182-3187.
- Rudner, D.Z., J.R. LeDeaux, K. Ireton and A.D. Grossman. 1991. The *spo0K* locus of *Bacillus subtilis* is homologous to the oligopeptide permease locus and is required for sporulation and competence. *J. Bacteriol.* **173**: 1388-1398.
- Siranosian, K.J. and A.D. Grossman. 1994. Activation of *spo0A* transcription by sigma-H is necessary for sporulation but not for competence in *Bacillus subtilis*. *J. Bacteriol.* **176**: 3812-3815.
- Solomon, J.M. and A.D. Grossman. 1996. Who's competent and when: regulation of natural genetic competence in bacteria. *Trends Genet.* **12**: 150-155.
- Solomon, J.M., R. Magnuson, A. Srivastava and A.D. Grossman. 1995. Convergent sensing pathways mediate response to two extracellular competence factors in *Bacillus subtilis*. *Genes Dev.* **9**: 547-558.
- Spizizen, J. 1958. Transformation of biochemically deficient strains of *Bacillus subtilis* by deoxyribonucleate. *Proc. Nat. Acad. Sci. USA* **44**: 1072-1078.
- Trach, K.A. and J.A. Hoch. 1993. Multisensory activation of the phosphorelay initiating sporulation in *Bacillus subtilis*: identification and sequence of the protein kinase of the alternate pathway. *Mol. Microbiol.* **8**: 69-79.
- van Sinderen, D., A. Luttinger, L. Kong, D. Dubnau, G. Venema and L. Hamoen. 1995. *comK* encodes the competence transcription factor, the key regulatory protein for competence development in *Bacillus subtilis*. *Mol. Microbiol.* **15**: 455-462.
- van Sinderen, D., A. ten Berge, B.J. Hayema, L. Hamoen and G. Venema. 1994. Molecular cloning and sequence of *comK*, a gene required for genetic competence in *Bacillus subtilis*. *Mol. Microbiol.* **11**: 695-703.
- van Sinderen, D. and G. Venema. 1994. *comK* acts as an autoregulatory control switch in the signal transduction route to competence in *Bacillus subtilis*. *J. Bacteriol.* **176**: 5762-5770.
- van Sinderen, D., S. Withoff, H. Boels and G. Venema. 1990. Isolation and characterization of *comL*, a transcription unit involved in competence development of *Bacillus subtilis*. *Mol. Gen. Genet.* **224**: 396-404.
- Vasantha, N. and E. Freese. 1979. The role of manganese in growth and sporulation of *Bacillus subtilis*. *J. Gen. Microbiol.* **112**: 329-336.

- Vasanthan, N. and E. Freese. 1980. Enzyme changes during *Bacillus subtilis* sporulation caused by deprivation of guanine nucleotides. *J. Bacteriol.* **144**: 1119-1125.
- Waldburger, C., D. Gonzalez and G.H. Chambliss. 1993. Characterization of a new sporulation factor in *Bacillus subtilis*. *J. Bacteriol.* **175**: 6321-6327.
- Weinrauch, Y., R. Penchev, E. Dubnau, I. Smith and D. Dubnau. 1990. A *Bacillus subtilis* regulatory gene product for genetic competence and sporulation resembles sensor protein members of the bacterial two-component signal-transduction systems. *Genes Dev.* **4**: 860-872.

## Chapter 4

The isolation and characterization of mutations that suppress a *spo0KA* null mutant for transport of peptides and development (*ska* mutants).

**Summary** This chapter describes the isolation and characterization of mutations that suppress a *spo0KA* null mutant for transport of peptides and the regulation of genetic competence and sporulation (*ska* mutants). *spo0KA* encodes the ligand-binding protein of an oligopeptide permease in *B. subtilis*. *spo0KA* null mutants do not transport peptides and are defective in the initiation of genetic competence and sporulation. Suppressors of a *spo0KA* null mutant that restore the transport of peptides were isolated by selecting for cells that could utilize a tripeptide to satisfy methionine and phenylalanine auxotrophies. Suppressors were screened for increased competence and sporulation gene expression relative to the *spo0KA*-parent. Approximately 1% of the tripeptide-utilizing *spo0KA* suppressors also increased developmental gene expression and were called *ska* mutants. To enrich for the possibility of finding *ska* mutations within the *spo0K* operon only mutations that were linked by transformation (within approximately 10kb) to a marker downstream of *spo0K* (*orfK::spc*) were characterized. The five independent *ska* mutations identified were linked to *spo0K* but surprisingly were not in *spo0K*. They were second site suppressors that activated a cryptic oligopeptide permease operon that happens to be linked by transformation to *spo0K*. This new oligopeptide permease is cryptic in wild-type cells because of a frame shift mutation in the gene coding for its ligand-binding protein (Koide and Hoch, 1994). The cryptic ligand-binding protein can be reactivated by frame shift mutations that restore the reading frame. As we were characterizing and sequencing this operon Koide and Hoch (1994) published a paper with the sequence and characterization of this cryptic oligopeptide permease which they called App (A peptide permease). The fact that a similar, but not identical oligopeptide transporter, can bypass *spo0K* for sporulation and partly bypass *spo0K* for competence, suggests that the transport functions of Spo0K are central to its role in development.

The Spo0K oligopeptide permease of *B. subtilis* Spo0K is a member of the large and important ABC transporter family. ABC refers to a highly conserved **A**TP **b**inding **c**assette found in all members of this family (Higgins, 1992). The ABC transporters link the hydrolysis of ATP to the import or export of a variety of compounds including sugars, amino acids, peptides, and ions. Some famous members of this family include the human Cystic Fibrosis Transmembrane Regulator protein (CFTR), the mammalian multi-drug resistance protein (mdr), the  $\alpha$ -factor exporter from yeast (STE6), and the maltose and histidine importers from *E. coli* (Higgins, 1992).

The Spo0K oligopeptide permease imports peptides of 3-5 amino acids into the cell and is required for the efficient initiation of both genetic competence and sporulation in *B. subtilis* (Perego et al., 1991; Rudner et al., 1991). Sporulation efficiency of a *spo0K* null mutant is 5-10% that of *wt*, and transformation efficiency is 0.1-1% of *wt*. Spo0K plays a regulatory role in competence and sporulation and, in both cases, contributes to activation of a developmental transcription factor. *spo0K* mutants can be bypassed by over-activating these transcription factors. Stimulating the phosphorelay that activates the sporulation transcription factor Spo0A, by overexpressing the *kinA* or *kinC* histidine protein kinases (Rudner et al., 1991; LeDeaux and Grossman, 1995) or by deleting the *rapA* and *rapB* phosphatases (Perego and Hoch, 1996) bypasses the need for *spo0K* in sporulation. Overexpressing the ComA transcription factor bypasses the need for *spo0K* in genetic competence (Weinrauch et al., 1990).

The *spo0K* operon (Figure 1A) encodes five proteins which are thought to form a complex as diagrammed in figure 1B (Perego et al., 1991; Rudner et al., 1991). Spo0KA is the ligand-binding protein. It is found outside the cell and is attached to the membrane by a lipid anchor (Perego et al., 1991). Ligand-binding proteins are

only found in ABC transporters that import compounds and are not present in ABC exporters (Higgins, 1992). Spo0KB and Spo0KC are each predicted to have six membrane-spanning alpha-helical regions and are thought to form the pore through which the peptides are imported. Spo0KD and Spo0KE contain the ATP-binding domains that energize peptide transport. All of the Spo0K peptides except Spo0KE are necessary for Spo0K function. Non-polar deletions in *spo0KA*, *spo0KB*, *spo0KC*, and *spo0KD* all cause defects in transport, competence, and sporulation similar to a complete deletion of the *spo0K* operon. Deletion of the *spo0KE* ATPase has a mild effect on the ability to transport peptides, only a slight effect on sporulation, and causes a delay in competence gene expression (Rudner et al., 1991; LeDeaux, 1994). This situation contrasts with the homologous oligopeptide permease from *S. typhimurium* in which all five subunits are essential for transporter function (Hiles et al., 1987).

**ABC Transporters** The mechanism by which ABC importers, like Spo0K, transport compounds into the cell is not completely understood. ABC importers bind substrates with high affinity ( $K_D = 0.01-1 \mu\text{M}$ ) and can import compounds into the cell against a concentration gradient (Furlong, 1987; Ames and Lecar, 1992; Higgins, 1992). The membrane-spanning proteins and ATP-binding proteins are thought to form a complex in the membrane to which the typically more abundant ligand-binding protein is transiently associated. (Ames and Lecar, 1992; Higgins, 1992). Elegant studies on the maltose transporter suggest that only ligand-binding protein bound with ligand can signal the membrane complex ATP-binding proteins to hydrolyze ATP (Davidson et al., 1992). The conformational changes associated with ATP binding, hydrolysis, and release are supposed to bring the ligand from outside the cell to inside the cell. Some studies suggest that two ATPs are hydrolyzed per substrate transported (Mimmack et al., 1989), but this is still not

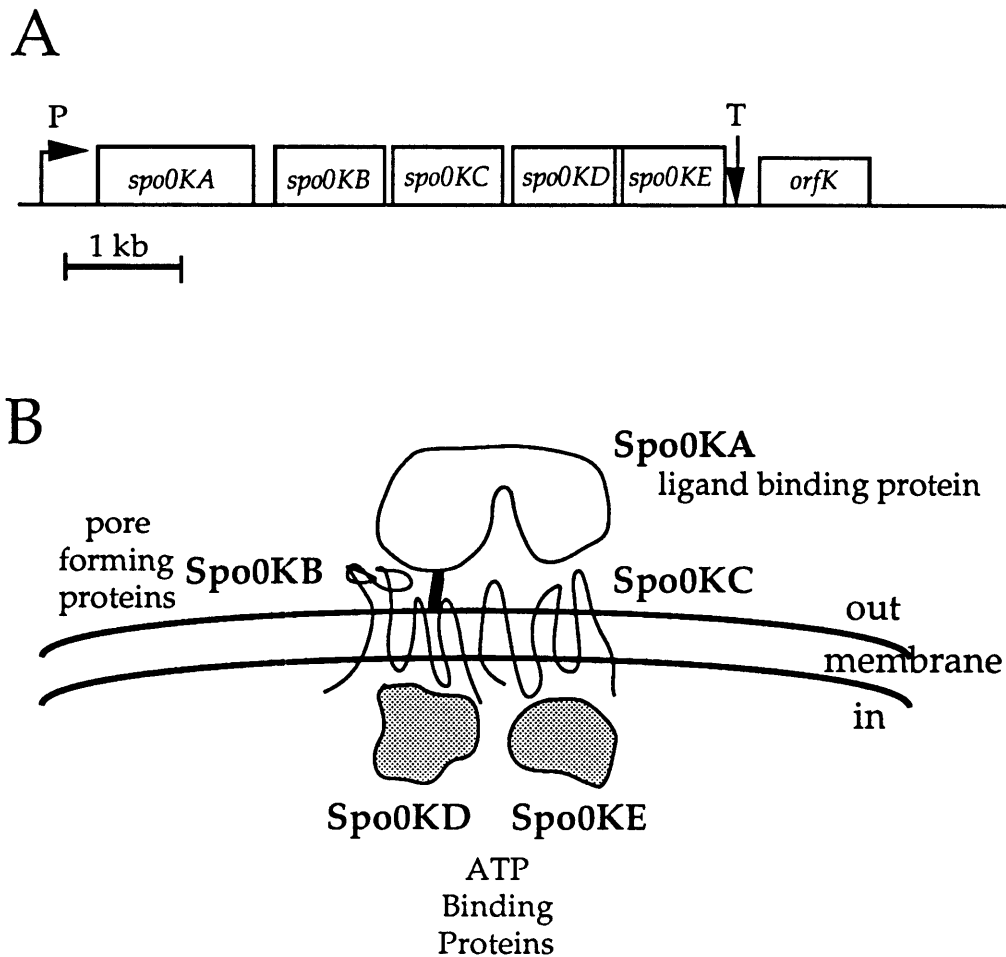

**Figure 1. The *spo0K* operon and a model of the Spo0K oligopeptide permease**  
 (A) The *spo0K* operon consists of five genes *spo0KA*, *spo0KB*, *spo0KC*, *spo0KD*, and *spo0KE*. The single promoter is indicated by the letter P and the transcription terminator is indicated by the letter T (Perego et al., 1991; Rudner et al., 1991). The location of the *orfK* open reading frame is also indicated.

(B) This diagram shows the hypothesized structure of the Spo0K transporter. The Spo0KA ligand binding-protein is outside the cell and linked to the cell membrane with a lipid anchor (Perego et al., 1991). Spo0KB and Spo0KC each have six membrane-spanning domains and form the pore through which peptides are transported. Spo0KD and Spo0KE are ATP binding proteins that link transport to ATP hydrolysis. The Spo0KB,C,D, and E proteins form a membrane complex to which Spo0KA delivers peptides for transport. This model is based on homology to other ABC transporters (Higgins, 1992).

completely proven. In the MDR protein both ATP-binding sites seem crucial to function and mutations that block ATP binding in one binding site prevent the other binding site from hydrolyzing ATP (Senior et al., 1995). Recent studies on the CFTR protein (which, because it is an ion channel, is amenable to very sensitive patch clamp analysis) suggest that one ATP-binding domain is crucial for opening and closing the channel and the other is secondary (Gunderson and Kopito, 1995).

**ABC transporters involved in regulation** Several bacterial ABC importers are involved in regulation of a variety of processes by either acting as receptors or transporters. In some cases only the ligand-binding protein is involved. In *E. coli*, the ligand-binding proteins for the dipeptide permease and the maltose transporter can also interact with the Tap and Tar chemotaxis receptors respectively, allowing cells to move toward dipeptides and maltose (Manson et al., 1986; Martineau et al., 1990). In *Agrobacterium tumefaciens*, the ChvE galactose ligand-binding protein can interact with the VirA histidine protein kinase making the kinase responsive to several sugars (Cangelosi et al., 1990). The *E. coli pst* ABC transporter imports inorganic phosphate into the cell and is part of the machinery that represses the expression of many genes involved in scavenging for phosphate (Wanner, 1993). The *pst* transporter is clearly acting as a receptor as there are mutations in *pst* that block transport of phosphate, but still allow repression of gene expression (Cox et al., 1988). *Enterococcus faecalis* possesses conjugative plasmids whose transfer is stimulated by peptide pheromones (Clewell, 1993; Dunny et al., 1995). The pheromones are transported into the cell by a plasmid-encoded oligopeptide-binding protein in conjunction with the chromosomally-encoded oligopeptide transporter membrane complex. The pheromones then interact with several intracellular targets (Leonard et al., 1996).



We have been interested in how the Spo0K oligopeptide permease regulates competence and sporulation. Both competence and sporulation are regulated in part by cell density signals that appear to be oligopeptides (Grossman and Losick, 1988; Magnuson et al., 1994; Solomon et al., 1995; Perego and Hoch, 1996). It has been hypothesized that the role of *spo0K* in development involves the sensing of these cell density signals. We know that Spo0K is required for response to CSF (Chapter 2) (Solomon et al., 1995), but we don't know whether Spo0K is acting as a receptor or a transporter of CSF. Two pieces of evidence suggest that Spo0K can transport CSF into the cell. CSF can be fed to cells to satisfy an auxotrophy in wild-type cells, but not in *spo0K*- cells (Chapter 3)(Solomon et al., 1996). Also CSF accumulates to higher levels in the medium of *spo0K* mutants (Roy Magnuson, personal communication). Genetic and physiological evidence demonstrates that CSF negatively regulates the intracellular RapC phosphatase. The transport model for Spo0K function could be proved sufficient if the CSF peptide were shown to directly interact with and by itself inhibit the phosphatase.

**Rationale for the mutant hunt.** If Spo0K were acting as a receptor, we thought that the cytosolic ATP-binding subunits would be the parts of Spo0K most likely to interact with sporulation and competence regulatory proteins. The mutant hunt was designed to identify mutations in *spo0KBCDE*, *spo0K*'s membrane complex, that could transport a tripeptide in the absence of Spo0KA, the ligand-binding protein. Analogous mutations had been found in the maltose transport system of *E. coli*. These mutations caused the ATP-binding proteins of the maltose transporter to hydrolyze ATP constitutively and not just when a ligand-binding protein bound with ligand docked on the membrane complex. We thought mutations in *spo0K* with activated ATP-binding proteins might have interesting effects on competence and sporulation.

**Description of the selection and screen.** Suppressors of a *spo0KA* null mutant were selected for the ability to utilize a tripeptide to satisfy two auxotrophies. During the selection the cells were grown on minimal medium plates with the tripeptide, met-leu-phe (200 µg/ml), as the only source of methionine and phenylalanine (tripeptide plates). *spo0K*<sup>+</sup> cells form single colonies on tripeptide plates while *spo0K* mutants do not. Simultaneous selection for two auxotrophic markers reduced the chance of isolating revertants of the auxotrophic mutations. The methionine auxotrophy (*metC85::Tn917*) was included specifically because of its low reversion frequency (<4.4 × 10<sup>-8</sup> revertants/viable cell). Forty-eight hours after plating on tripeptide plates there was a lawn of cells in the middle of the plates and single colonies around the edges of the plates. This made it difficult to accurately calculate the frequency with which mutants were arising, but hundreds of colonies grew on each plate giving an approximate mutation frequency of 1 in 10<sup>6</sup>.

The colonies that grew under selecting conditions were screened for an increase in developmental gene expression relative to the parental *spo0KA* null mutant. The cells used in the mutant hunt carried either a *lacZ* gene fusion expressed during competence (*comG-lacZ*) or a *lacZ* gene fusion expressed during sporulation (*spoIID-lacZ*). The screen was performed by patching the selected colonies onto X-gal indicator plates. Approximately 1% of the colonies selected for growth on tripeptide also restored developmental gene expression. The cells that grew on tripeptide plates and increased developmental gene expression were called *ska* mutants. Five independent alleles were identified and characterized: *ska100*, *ska102*, *ska200*, *ska201*, and *ska202*.

The ~99% of colonies growing on tripeptide plates that did not have increased developmental gene expression appeared to overexpress extracellular proteases. *spo0KA* mutants that grow on the tripeptide medium can satisfy their

auxotrophies either by transporting the met-leu-phe tripeptide or by breaking it down outside the cell and transporting the single amino acids. The production of extracellular proteases was measured by observing the zone of clearing around a patch of cells on milk plates. Eight random mutants that grew on tripeptide plates but did not affect developmental gene expression were tested. All eight produced a ~5 mm zone of clearing around their patches on milk plates while wild-type,  $\Delta spo0KA$ , and  $ska / \Delta spo0KA$  cells produced only a ~1 mm clearing around their patches. This increase in extracellular proteases was not due to an *abrB* mutation. Deleting the *abrB* regulatory gene is known to increase protease production in *B. subtilis* (Trowsdale et al., 1978) but the zone of clearing around the *abrB* patch was not significantly different than the zone of clearing around *wt* cells.

#### **Characterization of the *ska* mutants**

**Linkage to *spo0K*.** The *ska* mutants were back crossed into a *spo0KA* mutant strain and their linkage to the *orfK::spc* marker downstream of *spo0K* was determined. The five independently arising *ska* alleles, *ska100*, *102*, *200*, *201*, and *202* were linked by transformation to *orfK::spc* from 22-37% (*ska100*- 253/760=33%; *ska102*- 83/288=29%; *ska200*- 25/116=22%; *ska201*- 15/41=37%; *ska202*- 40/132=30%). The *ska* mutants were back crossed into strains carrying both competence and sporulation gene fusions which revealed that on indicator plates all five *ska* alleles restored both competence and sporulation gene expression to the *spo0KA* mutant.

**Transport of Oligopeptides.** The *ska/spo0KA* mutants can transport tripeptides more efficiently than *spo0KA* cells but less efficiently than wild-type cells. The ability of the *ska200/spo0KA* strain to transport the tripeptide, met-leu-phe, was measured in liquid culture (Figure 2). When tripeptide is the only source of amino acids, the rate of growth of the *spo0KA/ska200* strain is intermediate between that of *wt* and *spo0KA* cells. This indicates that the *ska200* mutation restores transport of

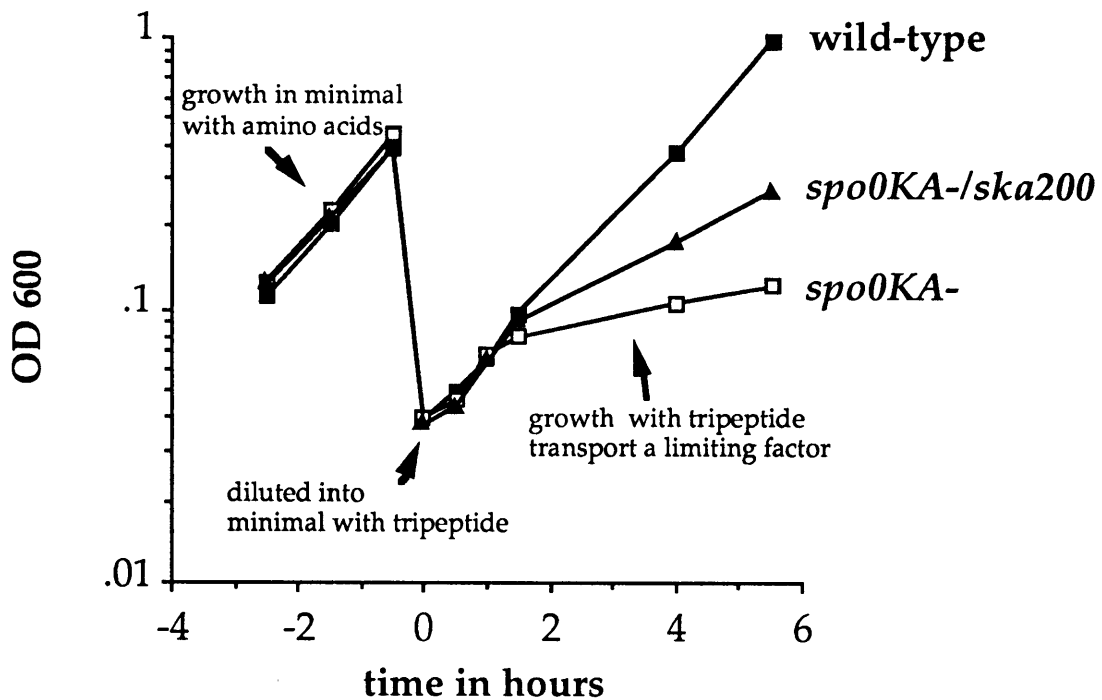

**Figure 2.** The *ska200* mutation allows transport of the met-leu-phe tripeptide in a *spo0KA* mutant Cell growth, as measured by light scattering at 600 nm, is plotted as a function of time in hours. The cells were initially grown in minimal medium supplemented with required amino acids. At time zero the cells were diluted into media where two of the required amino acids were provided only in a tripeptide, met-leu-phe. Wild type (JMS192) closed squares; *spo0KA* (JMS194) open squares; *spo0KA/ska200* (BAD153) closed triangles.

tripeptides to *spo0KA* cells, but not to wild-type levels. This could indicate a reduction in binding affinity for met-leu-phe relative to *wt* cells, or it could indicate a transporter with less efficient turnover than the Spo0K oligopeptide permease. The ability of all five *ska/spo0KA* strains to transport a toxic tripeptide, bialaphos (Behrmann et al., 1990) (phosphinothrycyl-alanyl-alanine), was also examined. At bialaphos concentrations of 5-250  $\mu\text{g/ml}$ , *wt* (Spo0K+/App-) cells do not form single colonies on minimal medium plates and *spo0KA* mutants (Spo0K-/App-) grow normally. The *ska/spo0KA* cells were more sensitive to bialaphos than *spo0KA* mutants but were less sensitive than *wt* cells. They formed normal colonies on minimal plates with 100 $\mu\text{g/ml}$  bialaphos, but formed only tiny colonies on minimal plates with 250  $\mu\text{g/ml}$  bialaphos. Koide and Hoch (1994) identified suppressors of *spo0KD* that are analogous to *ska* mutants. Their suppressors could transport a four or five amino acid peptide but not a tripeptide (phe-gly-gly) to satisfy an auxotrophy.

**Sporulation.** The five *ska* mutations bypassed *spo0KA* for sporulation (Table 1). Cells were grown in DS medium and the number of spores was determined after 24 hours of post-exponential growth. The number of spores/ml was virtually the same in wild-type and *ska/spo0KA* cells (Table 1). Both had 10-20 fold more spores/ml than a *spo0KA* mutant. On sporulation medium plates, it also appeared that all five *ska* alleles rescued sporulation of the *spo0KA* mutant to *wt* levels.

**Competence Gene Expression.** *ska* mutants partly restored early competence gene expression but did not restore late competence gene expression to *spo0KA* mutants in liquid culture (Figure 3). The effect of the *ska* alleles on competence was assayed by following expression of an early competence gene fusion, *srfA-lacZ*, and a late competence gene fusion, *comG-lacZ* during growth in defined minimal medium. *srfA-lacZ* expression was delayed until post-exponential growth in the *ska/spo0KA*

Table 1. *ska* mutations bypass  $\Delta spo0KA$  for sporulation

<b>Strain</b>	<b>allele</b>	<b><u>viabiles /ml</u></b>	<b><u>spores/ml</u></b>	<b><u>% sporulation<sup>a</sup></u></b>
JMS195	<i>wt</i>	$5.0 \times 10^8$	$4.4 \times 10^8$	89 %
JMS209	$\Delta spo0KA$	$6.4 \times 10^8$	$2.3 \times 10^7$	4 %
BAD131	$\Delta spo0KA/ska100$	$9.7 \times 10^8$	$5.1 \times 10^8$	53 %
BAD133	$\Delta spo0KA/ska102$	$7.3 \times 10^8$	$4.5 \times 10^8$	63 %
BAD109	$\Delta spo0KA/ska200$	$4.9 \times 10^8$	$3.1 \times 10^8$	62 %
BAD110	$\Delta spo0KA/ska201$	$6.4 \times 10^8$	$3.6 \times 10^8$	57 %
BAD112	$\Delta spo0KA/ska202$	$7.1 \times 10^8$	$3.5 \times 10^8$	49 %

<sup>a</sup>Cells were grown in DS medium and the percentage sporulation was determined as described in the materials and methods.

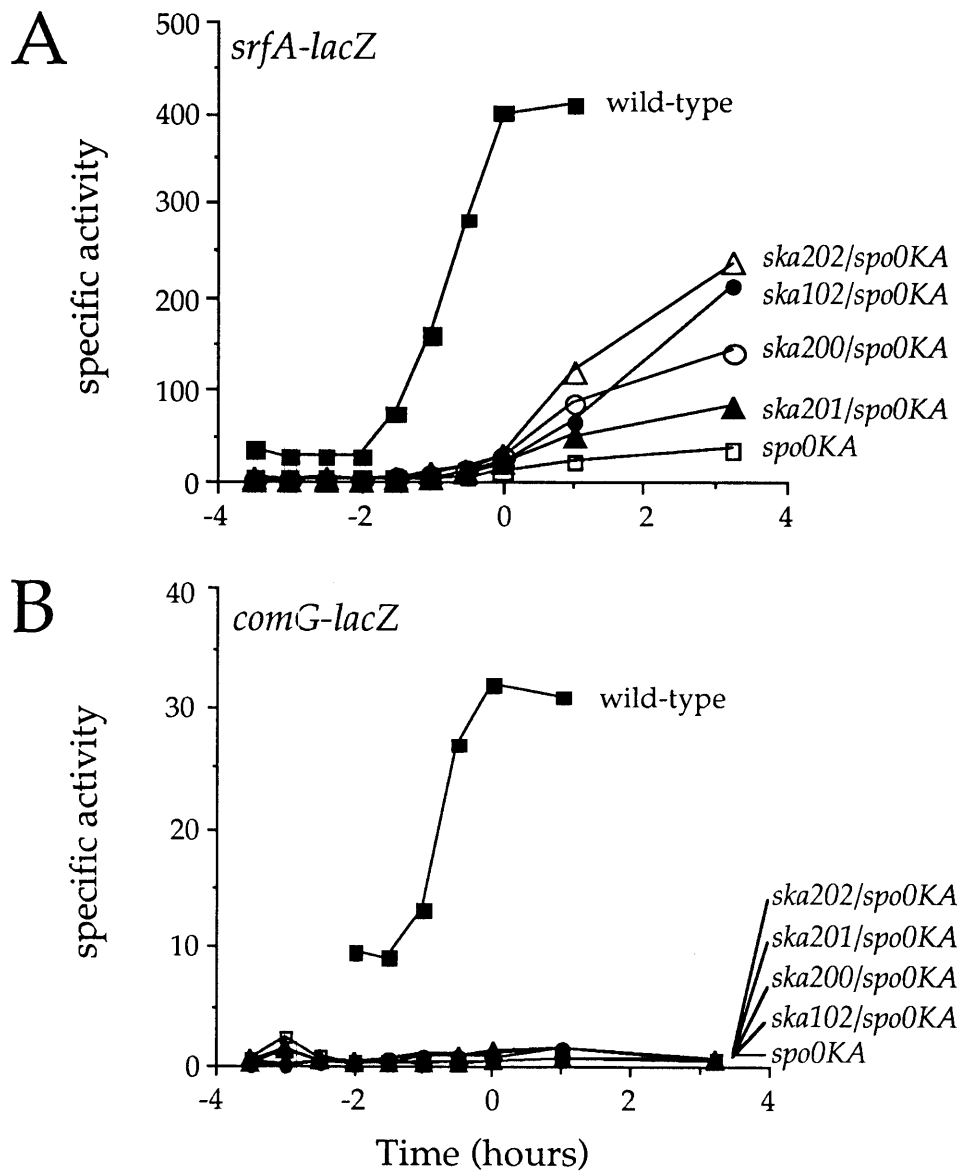

**Figure 3. *ska* mutations partly restore *srfA-lacZ* expression and do not restore *comG-lacZ* expression in *spo0KA* mutants in liquid culture** Cells were grown in S750 minimal medium.  $\beta$ -galactosidase specific activity is plotted as a function of time in hours with time zero denoting the entry into post-exponential growth. (A) Strains contain the *srfA-lacZ* $\Omega$ 1974 translational fusion. (B) Strains contain the *comG-lacZ* transcriptional fusion. Wild-type (JMS215/JMS196) closed squares; *spo0KA* (JMS213/JMS198) open squares; *ska102/spo0KA* (BAD158/BAD124) closed circles; *ska200/spo0KA* (BAD159/BAD153) open circles; *ska201/spo0KA* (BAD160/BAD154) closed triangles; *ska202/spo0KA* (BAD161/BAD155) open triangles.

strains, whereas it occurred during exponential growth in wild-type cells. It is not clear from the data whether the levels of *srfA* in the *ska/spo0KA* strains would eventually reach *wt* levels. Interestingly, *comG* expression was very low throughout growth in liquid medium in all the mutants, suggesting that the cells did not become competent. In contrast, *comG* expression on indicator plates was clearly higher in the *ska/spo0KA* strains than in the *spo0KA* strain. Koide and Hoch (1994) report that their *spo0KD* suppressor mutants were transformed as efficiently as *wt* cells.

***ska* mutations are not in *spo0K*, but are upstream of *spo0K*.** It was apparent that the *ska* mutations were not in *spo0K* because they bypassed a deletion of the *spo0K* operon. Replacing the *spo0KABCD* genes with a drug resistance cassette did not alter the *ska* phenotype in the *ska100/spo0KA* or *ska202/spo0KA* strains (data not shown). A three factor cross clearly indicated that the *ska200* mutation was upstream of the *spo0K* operon (Figure 4).

**Cloning the *ska200* mutation.** The *ska200* mutation was cloned by "walking" upstream from *spo0K*. The region of the chromosome containing the *ska200* mutation and all the relevant plasmids are shown in Figure 5. All the plasmids are integrative plasmids; they can not replicate in *B. subtilis* but can integrate into the *B. subtilis* chromosome by a single crossover. First I cloned approximately 3kb of DNA upstream of the *spo0K* operon from a *ska200* mutant on pJS9. pJS9 could not confer or disrupt the *ska200* phenotype when integrated into the chromosome suggesting that the *ska200* mutation was yet further upstream. The pJS15 walking plasmid was used to clone the chromosomal DNA that is 3-9 kb upstream of *spo0K* on pJS18. The *ska200* mutation was cloned on pJS18 by cutting the integrated pJS15 plasmid out of the chromosome with the SphI restriction enzyme, ligating the DNA, and recovering the plasmid by transforming *E. coli*.



**Figure 4. Three factor cross demonstrating that the *ska200* mutation is not in *spo0K* but is upstream of *spo0K*.** DNA from strain JMS245 ( $\Delta spo0KA$  *orfK::spc ska200 metC::Tn917erm amyE::(comG-lacZ neo) pDR13 (cat)*) was introduced into strain JMS198 ( $\Delta spo0KA metC::Tn917erm amyE::(comG-lacZ neo)$ ) by transformation. The relevant regions of the donor DNA and the recipient chromosomes are shown. The spectinomycin resistance gene is located downstream of *spo0K* in *orfK*. The chloramphenicol resistance gene was located upstream of *spo0K* on a plasmid, pDR13, which was integrated into the chromosome. Transformants were selected either for resistance to spectinomycin ( $spec^R$ ) or resistance to chloramphenicol ( $cm^R$ ), and other phenotypes were screened by patching colonies on appropriate plates. The numbers of each class of transformant are shown in the tables. The presence of the  $spec^R cm^R ska^+$  classes (marked by arrows) indicates that the *ska200* mutation is not between the spectinomycin and chloramphenicol markers and therefore is not in *spo0K*. Two pieces of evidence suggest that the *ska200* mutation is upstream of *spo0K*. The rare class of transformants,  $spec^R cm^S ska200$  (marked by a circle) suggests that the chloramphenicol marker is between the spectinomycin marker and *ska200*. Also the *ska200* mutation is more tightly linked to the chloramphenicol marker than to the spectinomycin marker.

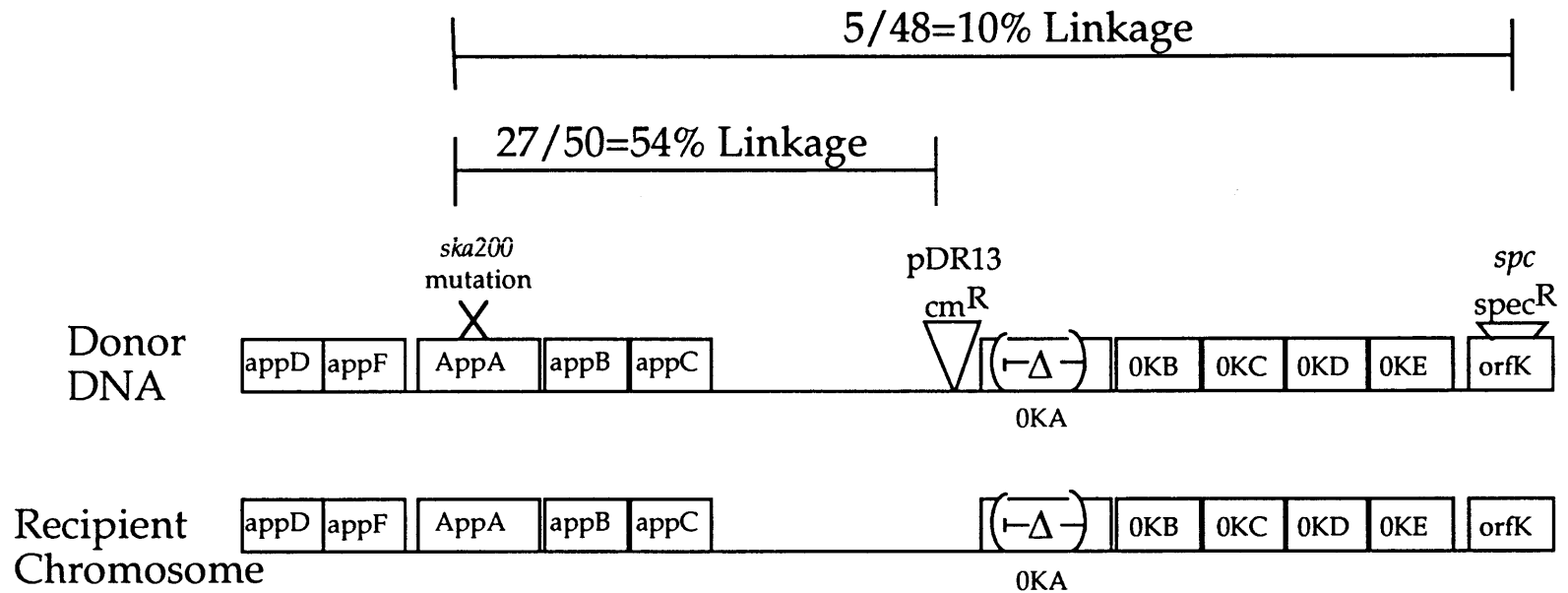

Select for spec<sup>R</sup>

- spec<sup>R</sup> cm<sup>S</sup> ska200 0/48
- spec<sup>R</sup> cm<sup>S</sup> ska+ 30/48
- spec<sup>R</sup> cm<sup>R</sup> ska200 5/48
- spec<sup>R</sup> cm<sup>R</sup> ska+ 13/48

Select for cm<sup>R</sup>

- cm<sup>R</sup> spec<sup>S</sup> ska200 9/50
- cm<sup>R</sup> spec<sup>S</sup> ska+ 9/50
- cm<sup>R</sup> spec<sup>R</sup> ska200 18/50
- cm<sup>R</sup> spec<sup>R</sup> ska+ 14/50

pJS18 carried the *ska200* mutation because integrating pJS18 into a *spo0KA* mutant could confer the *ska* phenotype 28% (13/46) of the time. These were probably gene conversion events. To further localize the *ska200* mutation plasmids pJS28, 29, 30, and pNG32 were sub-cloned from pJS18 (see figure 5) and tested for the ability to confer or disrupt the *ska200* phenotype. None of the sub-cloned plasmids disrupt the *ska200* phenotype when integrated into the chromosome. This indicates that they carry chromosomal regions that are either outside of the *ska200* region or that overlap the 5' or 3' ends of the *ska200* region. None of the sub-cloned plasmids could confer the *ska200* phenotype which localizes the *ska200* mutation between (or close to) the first SnaBI site and the second Pst site from left to right in figure 5. I sequenced the ends of the sub-cloned plasmids revealing the presence of a second oligopeptide permease operon in *B. subtilis* (*app* operon).

**Sequence information about the *app* operon.** The homology between *app* and *spo0K* ranges from 54.2 % identity for *appF* and *spo0KE* to 22.5% identity between *appA* and *spo0KA* (Koide and Hoch, 1994). This homology suggests that the two operons have similar functions. The gene order is different in *app* than in *spo0K*. In *app* the two ATP-binding proteins (*appD* and *appF*) are found first whereas in *spo0K* they are found last (see Figure 4). The other *app* genes are in the same order as in *spo0K*, the ligand-binding protein (*appA*) followed by the two membrane spanning proteins (*appB* and *appC*). In the sequence of the *app* operon from *wt* cells Koide and Hoch (1994) found a frame-shift mutation in the *appA* ligand binding protein gene. In wild-type cells (JH642) AppA does not function. Sequencing of three of their *app+* alleles indicated that each added a deoxyadenosine to a stretch of seven deoxyadenosines in the *appA* ligand-binding protein sequence which corrects for the frame shift mutation. I suppose that the *ska* alleles contain similar mutations and the preliminary mapping is consistent with this hypothesis. It is not clear if all the *ska*

**Figure 5. Map of the region containing the *ska200* mutation and plasmids used for its cloning and characterization** Restriction site abbreviations: Sp, SphI; RV, EcoRV; Bg, BglII; Sn, SnaBI; P, PstI; Pv, PvuII. The location of a Tn917*lac* insertion is indicated by a triangle and Tn (Rudner et al., 1991). The table in the figure indicates which plasmids could confer the *ska* phenotype to the  $\Delta spo0KA$  mutant or disrupt the *ska200* phenotype of a *ska200*/ $\Delta spo0KA$  strain when integrated into the chromosome.

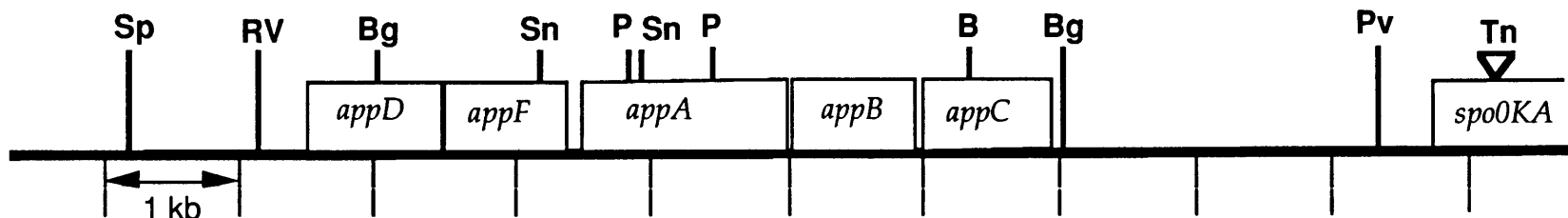

137

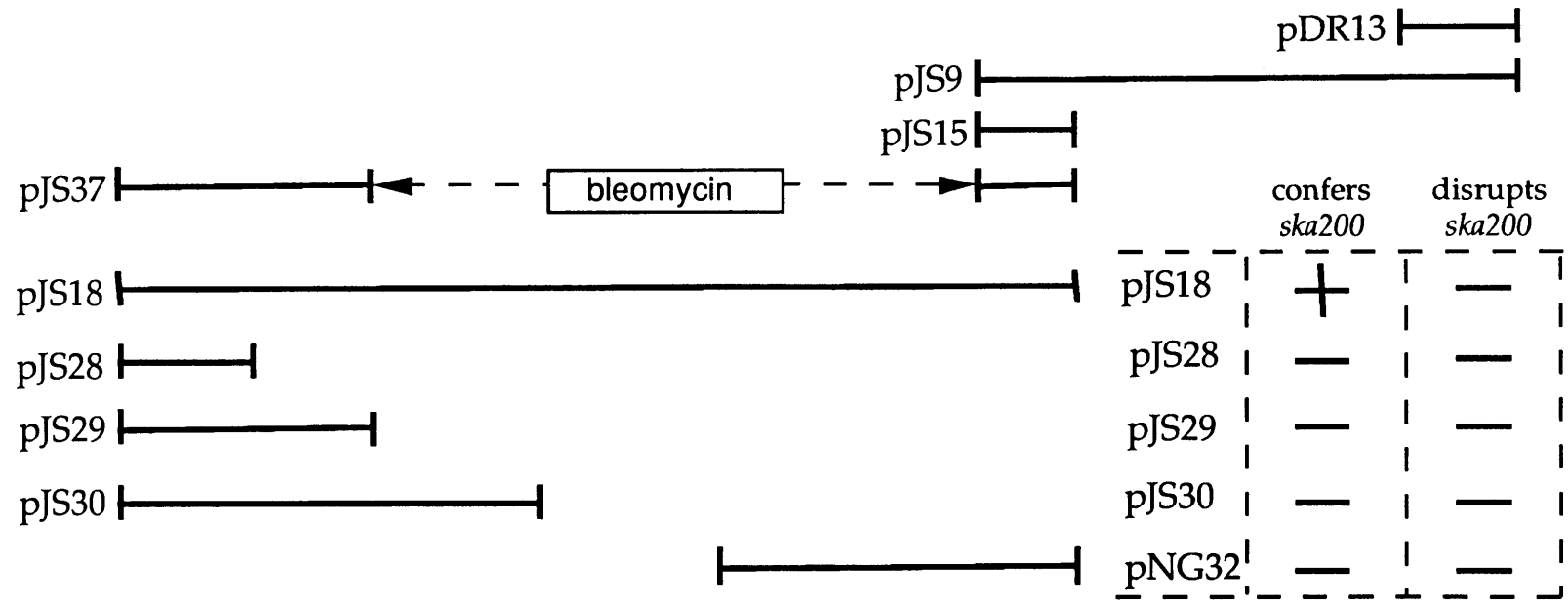

mutations are identical, they could restore the reading frame at different points in the sequence before or after the run of seven deoxyadenosines. The only evidence that they might be different from one another is that they seem to express different levels of *srfA-lacZ* (see Figure 3).

**Deleting the *app* operon.** I wanted to be sure that the intact App proteins (AppDFBC) play no role in competence or sporulation. The intact App proteins might interact with the Spo0K subunits to make mixed subunit transporters, or might act in conjunction with an as yet unidentified ligand binding protein to form a functional transporter. I constructed a total deletion of the *app* operon replacing most of the operon with the bleomycin cassette (Figure 5). The *app* deletion was examined for any effect on sporulation or competence gene expression, both by itself and in conjunction with a deletion of the *spo0K* operon. Deleting *app* had no detectable effect on sporulation as shown in table 2. The concentration of spores (spores/ml) was very similar in *wt* and  $\Delta app$  strains, and in the  $\Delta spo0K$  and  $\Delta spo0K / \Delta app$  strains. Similarly, deleting *app* has no detectable effect on competence gene expression as shown in Figure 6. Expression of *srfA* is virtually the same in the presence or absence of *app*. These data suggest that *app* and *spo0K* truly work separately and independently, and that if the remaining App proteins do have a function it does not affect competence and sporulation.

**Implications of the *ska* mutants.** The *ska* suppressors seem to separate the role of an oligopeptide permease in sporulation from its role in competence. They restore sporulation to wild-type levels in *spo0KA* mutants (Table 1) but do not restore competence gene expression in liquid culture (Figure 3). This is similar to the *spo0KE* mutant phenotype, which is normal for sporulation but is delayed for competence gene expression (Rudner et al., 1991; LeDeaux, 1994). The defect in

Table 2. Deleting the *app* operon does not affect sporulation

<u>Strain</u>	<u>allele</u>	<u>viabiles/ml</u>	<u>spores/ml</u>	<u>% sporulation<sup>a</sup></u>
JMS374	<i>wt</i>	$4.0 \times 10^8$	$2.7 \times 10^8$	68 %
JMS448	$\Delta app$	$3.5 \times 10^8$	$3.4 \times 10^8$	97 %
JMS384	$\Delta spo0K$	$4.1 \times 10^8$	$2.1 \times 10^7$	5 %
JMS454	$\Delta app/\Delta spo0K$	$5.5 \times 10^8$	$1.9 \times 10^7$	3 %

<sup>a</sup>Cells were grown in DS medium and the percentage of sporulation was determined as described in materials and methods.

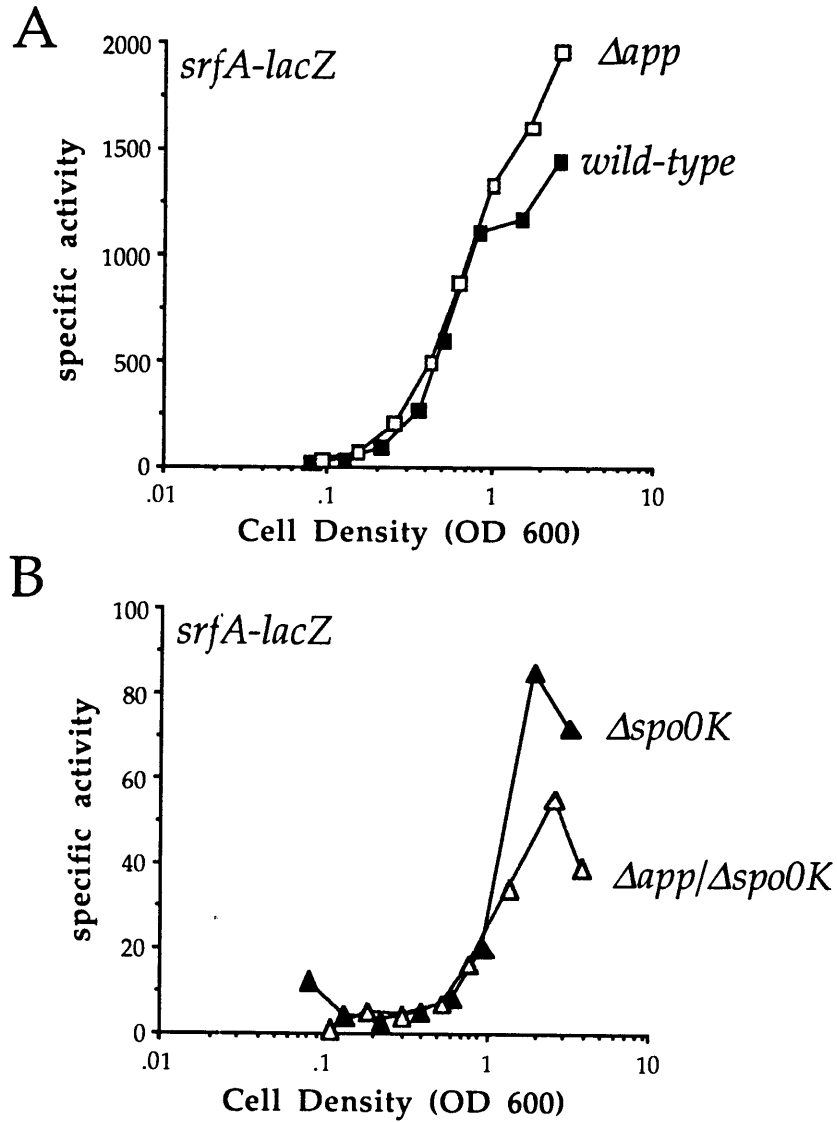

**Figure 6. Deleting the *app* operon does not affect expression of *srfA-lacZ*** Cells were grown in defined minimal medium (S750).  $\beta$ -galactosidase specific activity is plotted as a function of cell density as measured by light scattering at 600 nm. All strains contained the *srfA-lacZ* $\Omega$ 374 transcriptional fusion. (A). Wild-type (JMS374) closed squares;  $\Delta app$  (JMS448) open squares (B).  $\Delta spo0K$  (JMS384) closed triangles;  $\Delta spo0K/\Delta app$  (JMS454) open triangles.



competence gene expression is much worse in the *ska/spo0KA* mutants than in the *spo0KE* mutant.

If the *app* operon is expressed only post-exponentially this could explain why the *ska* mutations restore sporulation but not competence. Post-exponential expression would be fine for sporulation, but would not be adequate for competence in S750 minimal medium which occurs during exponential growth. Interestingly, *srfA* expression begins as cells enter post-exponential growth in the *ska/spo0KA* mutants (Figure 3). *comG* expression remains low, but we know that *comG* expression is repressed during post-exponential growth in S750. This might also explain why *comG* is expressed in the *ska* mutants on the indicator plates as competence is expressed post-exponentially in the medium in the indicator plates. This issue can be readily resolved by comparing *srfA* and *comG* expression in *wt* and *ska/spo0KA* mutants in a liquid medium in which competence is expressed post-exponentially.

Factors that an oligopeptide permease needs to interact with for sporulation might be different from those needed for competence. It is clear that the App permease has different specificity from the Spo0K permease as some tripeptides are not transported equally well by both transporters. Perhaps App is unable to interact with a peptide that is needed to allow competence but can interact with all the signals needed for sporulation.

The fact that a search for a suppressor of a *spo0K* null mutant led to the expression of an oligopeptide permease that is homologous to Spo0K suggests, but does not prove, that the transport functions of Spo0K are important for its role in development. If Spo0K is acting as a receptor there must be specific protein-protein interactions between Spo0K and downstream regulatory proteins. These interactions must also be present in the homologous App transporter. While this is

not impossible, it is more parsimonious to consider that Spo0K and App function without these interactions. It would be much more convincing if one could mutate a transporter unrelated to *spo0K* and cause it to bypass *spo0K* for competence or sporulation. Recently a new family of oligopeptide transporters (the PTR family) has been described (Steiner et al., 1995). They import peptides using the proton motive force and are structurally distinct from the ABC transporters. Discovering a PTR family member that bypasses *spo0K* for development would be more convincing data for the transport hypothesis.

**Why are there two oligopeptide transporters in *B. subtilis*?** The presence of a second oligopeptide transporter in *B. subtilis* is not very surprising because many bacteria have multiple peptide transporters. *E. coli* has three peptide uptake systems, one for oligopeptides, one for dipeptides, and one for hydrophobic tripeptides (Hiles and Higgins, 1986). *Streptococcus pneumoniae* has three different oligopeptide ligand-binding proteins that act through one oligopeptide-transporting membrane complex (Alloing et al., 1994). If App can transport a slightly different set of peptides than Spo0K, it could be important to the cell.

Why is the *app* operon is cryptic? It could be an accident that the strain from which all our strains are derived (168) happens to have the *appA* mutation. The *appA* mutation occurred in a region of DNA (seven deoxyadenosines in a row) that could be a hot spot for mutations caused by slipping of the DNA polymerase (Miller, 1992). This mutation might not be found in other *B. subtilis* isolates. There might even be a selection against expressing two oligopeptide permeases in *B. subtilis*. The ability to transport a wide variety of peptides while useful, does have its risks. The toxic tripeptide bialaphos, for example, is an antibiotic produced by *Streptomyces viridochromogenes* (Behrmann et al., 1990). Perhaps the number of peptide

transporters and their exact specificity of peptide transport is subject to constant selection by natural toxic peptides.

**Looking for more *ska* mutants.** The original rationale for the mutant hunt was to identify mutations in *spo0K* that could transport peptides in the absence of Spo0KA and that would have constitutively active ATPases. It should still be possible to find these mutants. The best approach would be to do localized mutagenesis on the *spo0KBCDE* genes to avoid recovering mutations that cause protease overexpression or that activate other cryptic oligopeptide permeases that lurk in the *B. subtilis* chromosome. If Spo0K is acting as a transporter, then these mutants might restore some competence and sporulation to a *spo0KA* mutant. If Spo0K is acting as a receptor, then one might see some unusual phenotypes such as high levels of competence and/or sporulation.

## Materials and Methods

**Strains.** *B. subtilis* strains are listed in table 3. All are derived from strain JH642 and contain *trpC2* and *pheA1* mutations (Perego et al., 1988). The *metC85::Tn917* allele (Vandeyar and Zahler, 1986) is from *Bacillus* stock center strain 1A607. The  $\Delta spo0KA131$  allele is a non-polar, in frame deletion of *spo0KA*, removing the DNA from codon 18 (at the EspI site) to codon 477 (at the EcoRI site) out of 545 codons total. The  $\Delta spo0K358erm$  allele is a deletion of the first four genes of the *spo0K* operon, from *spo0KA* codon 18 (at the EspI site) to *spo0KD* codon 127 (at the BglII site), with an inserted *erm* cassette.  $\Delta spo0KA131$  and  $\Delta spo0K358erm$  were constructed by John LeDeaux. The  $\Delta app448::phl$  allele is a deletion of all five genes of the *app* operon. The DNA between the BglII site in *appD* and the BamHI site in *appC* is replaced with the bleomycin cassette (*phl*), which confers phleomycin resistance. I introduced the  $\Delta app::phl$  mutation into the chromosome using plasmid pJS37 (table

Table 3: *B. subtilis* strains used

<u>Strains</u>	<u>Genotype</u>	<u>Comments or reference</u>
JH642	<i>trpC2 pheA1</i>	parent of all strains (Perego et al., 1988)
JMS192	<i>metC85::Tn917erm (metC::Tn917erm)</i>	<i>metC::Tn917</i> is from <i>Bacillus</i> genetic stock center strain 1A607
JRL131	$\Delta$ <i>spo0KA131</i> ( $\Delta$ <i>spo0KA</i> )	in frame, non-polar deletion of <i>spo0KA</i> (from John LeDeaux)
JMS194	$\Delta$ <i>spo0KA metC::Tn917erm</i>	parent strain is JRL131
JMS195	<i>metC::Tn917erm amyE::(spoIID-lacZ neo)</i>	<i>amyE::(spoIID-lacZ neo)</i> provided by Stragier (Stragier et al., 1988) parent strain is JMS192
JMS196	<i>metC::Tn917erm amyE::(comG-lacZ neo)</i>	<i>amyE::(comG-lacZ neo)</i> (Magnuson et al., 1994) parent strain is JMS192
JMS197	$\Delta$ <i>spo0KA metC::Tn917erm amyE::(spoIID-lacZ neo)</i>	parent strain is JMS194
JMS198	$\Delta$ <i>spo0KA metC::Tn917erm amyE::(comG-lacZ neo)</i>	parent strain is JMS194
JMS208	$\Delta$ <i>spo0KA orfK::spc206 (orfK::spc) metC::Tn917erm amyE::(comG-lacZ neo)</i>	parent strain is JMS198
JMS209	$\Delta$ <i>spo0KA orfK::spc metC::Tn917erm amyE::(spoIID-lacZ neo)</i>	parent strain is JMS197
JMS213	$\Delta$ <i>spo0KA metC::Tn917 erm amyE::(srfA-lacZ<math>\Omega</math>1974 cat )</i>	<i>amyE::(srfA-lacZ cat)</i> was provided by J. Hahn and D. Dubnau (Hahn et al., 1994) parent strain is JMS198
JMS215	<i>metC::Tn917erm amyE::(srfA-lacZ<math>\Omega</math>1974 cat)</i>	parent strain is JMS192

JMS245	<i>Δspo0KA orfK::spc ska200 metC::Tn917erm amyE::(comG-lacZ neo) pDR13 cat</i>	pDR13 (Rudner et al., 1991) parent strain is BAD153
JMS374	<i>amyE::(srfA-lacZ.Ω374 neo)</i>	<i>amyE::(srfA-lacZ neo)</i> (Solomon et al., 1995)
JMS384	<i>Δspo0K 358erm (Δspo0K::erm) amyE::(srfA-lacZ.Ω374 neo)</i>	<i>Δspo0K::erm</i> is a deletion of the <i>spo0K</i> operon (LeDeaux and Grossman, 1995) parent strain is JMS374
JMS448	<i>Δapp::phl448 (Δapp::phl) amyE::(srfA- lacZ.Ω374 neo)</i>	<i>Δapp::phl</i> is a deletion of the <i>app</i> operon parent strain is JMS374
JMS454	<i>Δapp::phl Δspo0K::erm amyE::(srfA- lacZ.Ω374 neo)</i>	parent strain is JMS448
BAD109	<i>Δspo0KA orfK::spc ska200 metC::Tn917erm amyE::(comG-lacZ neo)</i>	original isolate of <i>ska200</i>
BAD110	<i>Δspo0KA orfK::spc ska201 metC::Tn917erm amyE::(spoIID-lacZ neo)</i>	original isolate of <i>ska201</i>
BAD112	<i>Δspo0KA orfK::spc ska202 metC::Tn917erm amyE::(comG-lacZ neo)</i>	original isolate of <i>ska202</i>
BAD122	<i>Δspo0KA orfK::spc ska100 metC::Tn917erm amyE::(comG-lacZ neo)</i>	<i>ska100</i> back cross into JMS198
BAD124	<i>Δspo0KA orfK::spc ska102 metC::Tn917erm amyE::(comG-lacZ neo)</i>	<i>ska102</i> back cross into JMS198
BAD131	<i>Δspo0KA orfK::spc ska100 metC::Tn917erm amyE::(spoIID-lacZ neo)</i>	<i>ska100</i> back cross into JMS197
BAD133	<i>Δspo0KA orfK::spc ska102 metC::Tn917erm amyE::(spoIID-lacZ neo)</i>	<i>ska102</i> back cross into JMS197

BAD153	<i>Δspo0KA orfK::spc ska200</i> <i>metC::Tn917erm amyE::(comG-lacZ neo)</i>	<i>ska200</i> back cross into JMS198
BAD154	<i>Δspo0KA orfK::spc ska201</i> <i>metC::Tn917erm amyE::(comG-lacZ neo)</i>	<i>ska201</i> back cross into JMS198
BAD155	<i>Δspo0KA orfK::spc ska202</i> <i>metC::Tn917erm amyE::(comG-lacZ neo)</i>	<i>ska202</i> back cross into JMS198
BAD158	<i>Δspo0KA orfK::spc ska102</i> <i>metC::Tn917erm amyE::(srfA-lacZ.Ω1974 cat)</i>	<i>ska102</i> back cross into JMS213
BAD159	<i>Δspo0KA orfK::spc ska200</i> <i>metC::Tn917erm amyE::(srfA-lacZ.Ω1974 cat)</i>	<i>ska200</i> back cross into JMS213
BAD160	<i>Δspo0KA orfK::spc ska201</i> <i>metC::Tn917erm amyE::(srfA-lacZ.Ω1974 cat)</i>	<i>ska201</i> back cross into JMS213
BAD161	<i>Δspo0KA orfK::spc ska202</i> <i>metC::Tn917erm amyE::(srfA-lacZ.Ω1974 cat)</i>	<i>ska202</i> back cross into JMS213

4). pJS37 carries the  $\Delta app::phl$  construct and has the *cat* gene in the plasmid backbone. The plasmid was linearized and transformed into *wt* cells. One of the  $phl^R cm^S$  transformants, resulting from a double crossover, was chosen as the  $\Delta app::phl$  allele. The *orfK::spc206* allele is a deletion insertion in *orfK* and has no effect on competence or sporulation. The DNA between the BclI and SphI sites of *orfK* was replaced with a spectinomycin resistance cassette. The *orfK::spc206* allele was introduced into the chromosome using plasmid pJS4 (table 4). pJS4 carries the *orfK* deletion and a *cat* resistance gene in the plasmid backbone. One of the  $spc^R cm^S$  transformants, resulting from a double crossover, was chosen as the *orfK::spc* allele.

The *spoIID-lacZ* transcriptional fusion recombined into *amyE* was provided by Patrick Stragier (Stragier et al., 1988). The *amyE::(srfA-lacZ $\Omega$ 1974 cat)* fusion is a translational fusion located in single copy at *amyE* locus and was provided by J. Hahn and D. Dubnau (Hahn et al., 1994). It contains sequence from -243 to +319 nucleotides relative to the *srfA* transcription start site and ends after the first six codons of *srfA*. The *amyE::(srfA-lacZ $\Omega$ 374 neo)* fusion is a transcriptional fusion at the *amy* locus containing sequence from -291 to +140 nucleotides relative to the *srfA* transcription start site (Solomon et al., 1995). The *comG-lacZ* fusion is a transcriptional fusion located at *amyE* (Magnuson et al., 1994).

**Plasmids.** The plasmids used are listed in Table 4. The chromosomal regions carried on many of the plasmids are diagrammed in Figure 5. Plasmids were cloned and maintained in *E. coli* strain AG1111 which is MC1061 [*araD139*  $\Delta$ (*ara-leu*)7697  $\Delta$ *lacX74 galU galK rpsL hsdR*] containing F' *proAB<sup>+</sup> lacI<sup>q</sup> lacZM15 Tn10* (the F' in strain XL-1 Blue, Stratagene).

Plasmids pJS9 and pJS18 were constructed by cutting integrated plasmids out of the *Bacillus* chromosome. I constructed pJS9 by cutting the integrated pDR13

Table 4. Plasmids used

<u>Plasmid</u>	<u>Comment, source, or reference<sup>a</sup></u>
pJH101	Amp, Tet, Cm; integrative vector (Ferrari et al., 1983)
pGEM3Zf(+>:: <i>cat</i> -1 (pGEM:: <i>cat</i> )	Amp, Cm; integrative vector (Youngman et al., 1989)
pUC18- <i>ble</i> -1	Amp, Ble; source of bleomycin cassette (Youngman et al., 1989)
pJL6	Amp, Cm; clone of <i>spo0KD</i> , <i>spo0KE</i> , and <i>orfK</i> from the BamHI site upstream of <i>spo0KD</i> to the SphI site downstream of <i>orfK</i> in pGEM:: <i>cat</i> (from John LeDeaux)
pJL74	Amp, Spc; source of spectinomycin resistance cassette (LeDeaux and Grossman, 1995)
pDR13	Amp, Cm; clone of <i>spo0K</i> promoter and the first 121 codons of <i>spo0KA</i> from the PvuII site upstream of <i>spo0KA</i> to the ClaI site in a transposon integrated in <i>spo0KA</i> in pJH101 (Rudner et al., 1991)
pJS9	Amp, Cm; clone of region upstream of <i>spo0K</i> from the BamHI site 3 kb upstream of <i>spo0K</i> to the ClaI site in a transposon integrated in <i>spo0KA</i> in pJH101
pJS15	Amp, Cm; plasmid used for walking to <i>ska200</i> mutation, ClaI (blunted)-BglII (blunted) deletion of pJS9
pJS18	Amp, Cm; clone of the <i>app</i> operon region, from the SphI site upstream of <i>appD</i> to the BglII site downstream of <i>appC</i> in pJH101
pJS37	Amp, Cm, Ble; Deletion of the <i>app</i> operon, 0.7 kb bleomycin cassette from pUC18- <i>ble</i> -1 cloned into the BamHI and BglII sites of pJS18 to make $\Delta app::phl206$
pJS28	Amp, Cm; 0.9 kb SphI-EcoRV fragment from pJS18 cloned into the SphI-SmaI sites of pGEM:: <i>cat</i>



pJS29	Amp, Cm; 1.9 kb SphI-BglII fragment from pJS18 cloned into the SphI-BamHI sites of pGEM:: <i>cat</i>
pJS30	Amp, Cm; the 3 kb SphI-SnaBI fragment from pJS18 cloned into the SphI-SmaI sites of pGEM:: <i>cat</i>
pNG32	Amp, Cm; the 1.7 kb BglII-PstI fragment from pJS18 cloned into the BamHI-PstI sites of pGEM:: <i>cat</i>

<sup>a</sup>Amp, Tet, Cm, Spc, and Ble refer to resistance to ampicillin, tetracycline, chloramphenicol, spectinomycin, and phleomycin respectively. All sizes in kilobases (kb) are approximate. "Blunting" refers to the filling in or cutting back of restriction sites by the Klenow fragment of DNA polymerase as described (Ausubel et al., 1990).

plasmid out of the chromosome with BamHI restriction enzyme. I constructed pJS18 by cutting the integrated pJS15 plasmid out of the chromosome using SphI. In both cases the cut DNA was ligated under conditions that favor intramolecular reactions, and the plasmids were recovered by transformation into *E. coli*.

**Media.** Routine growth and maintenance of *E. coli* and *B. subtilis* was done on LB medium (Miller, 1972). *B. subtilis* was made competent by the two-step competence procedure (Dubnau and Davidoff-Abelson, 1971). The minimal medium used for the  $\beta$ -galactosidase assays (S7<sub>50</sub>) was the medium described by Vasantha and Freese (Vasantha and Freese, 1980) except that MOPS buffer was used at 50mM instead of 100mM. The minimal medium used in plates contained Spizizen's minimal salts (Harwood and Cutting, 1990). Both minimal media were supplemented with 1% glucose, 0.1% glutamate, and essential amino acids to 40  $\mu$ g/ml. met-leu-phe tripeptide was added to 200  $\mu$ g/ml. Nutrient sporulation medium was 2xSG (Leighton and Doi, 1971) or DS medium (Schaeffer et al., 1965). Competence indicator plates contained SpII medium (Dubnau and Davidoff-Abelson, 1971). Media in plates were solidified with 15g of agar (Difco Laboratories) per liter. Antibiotics were used at the following concentrations: ampicillin 100  $\mu$ g/ml; chloramphenicol 5  $\mu$ g/ml; spectinomycin 100  $\mu$ g/ml; neomycin 5  $\mu$ g/ml; phleomycin 0.4  $\mu$ g/ml; erythromycin 0.5  $\mu$ g/ml and lincomycin 12.5  $\mu$ g/ml together to select for the *erm* gene. X-gal (5-bromo-4-chloro-3-indolyl- $\beta$ -D galactopyranoside) was added to indicator plates from 30-120  $\mu$ g/ml.

**Isolation of the *ska* mutants.** JMS208 and JMS209 cells were grown to stationary phase in LB, washed twice with Spizizen's minimal salts to prevent nutrient carry over, and  $2 \times 10^8$ - $2 \times 10^9$  cells were spread on minimal medium plates with the tripeptide met-leu-phe (200  $\mu$ g/ml) and incubated at 37°C. Mutants were said to be in independent groups if they were grown to confluence in separate LB

cultures. For the screen, single colonies were picked and patched onto indicator plates for competence gene expression (SpII-Xgal plates) or sporulation gene expression (2XSG Xgal plates). Candidates were colony purified twice and stored at -70°C.

**Plate assay for protease production on milk plates.** 5 ml of LB top agar (1% agar) was melted and mixed with 0.8 ml of autoclaved 10% Carnation skim milk. A thin layer of the milk/LB mixture was poured onto LB plates. Cells were patched onto this top layer and the zone of clearing was determined by visual inspection.

**Met-leu-phe transport assay in liquid culture.** Cells were grown in S750 minimal medium at 37°C with essential amino acids to a density of 0.5 as measured by light scattering at 600 nm (OD 600). The cultures were diluted 1/20 into minimal medium with tryptophan and met-leu-phe as the only sources of amino acids and growth was followed by measuring OD 600.

**Sporulation Assays.** Cells were grown in DS medium at 37°C and sporulation was assayed 18-24 hours after the end of exponential growth. The concentration of viable cells was determined as the number of colony forming units (CFU) on LB plates per milliliter. The concentration of spores was determined as the number of colony forming units on LB plates per milliliter after heat treatment (80°C for 20 minutes). Percent sporulation is the ratio of spores/ml to viable cells/ml times 100.

**β-galactosidase assays.** β-galactosidase specific activity was measured essentially as described (Miller, 1972; Jaacks et al., 1989) and is presented as ( $\Delta A_{420}$  per minute per ml of culture per OD 600)  $\times$  1000.

## REFERENCES

- Alloing, G., P. de Phillip and J.P. Claverys. 1994. Three highly homologous membrane-bound lipoproteins participate in oligopeptide transport by the Ami system of the gram positive *Streptococcus pneumoniae*. *J. Mol. Biol.* **241**: 44-58.
- Ames, G.F.-L. and H. Lecar. 1992. ATP-dependent bacterial transporters and cystic fibrosis: analogy between channels and transporters. *The FASEB Journal* **6**: 2660-2666.
- Ausubel, F., R. Brent, R. Kingston, D. Moore, J. Seidman, J. Smith and K. Struhl. 1990. *Current Protocols in Molecular Biology*. John Wiley & Sons, New York, NY.
- Behrmann, I., D. Hillemann, A. Pühler, E. Strauch and W. Wohlleben. 1990. Overexpression of a *Streptomyces viridochromogenes* gene (*glnII*) encoding a glutamine synthetase similar to those of eucaryotes confers a resistance against the antibiotic phosphinothricyl-alanyl-alanine. *J. Bacteriol.* **172**: 5326-5334.
- Cangelosi, G.A., R.G. Ankenbauer and E.W. Nester. 1990. Sugars induce the *Agrobacterium* virulence genes through a periplasmic binding protein and a transmembrane signal protein. *Proc. Natl. Acad. Sci. USA* **87**: 6708-6712.
- Clewell, D.B. 1993. Bacterial sex pheromone-induced plasmid transfer. *Cell* **73**: 9-12.
- Cox, G.B., D. Webb, J. Godovac-Zimmermann and H. Rosenberg. 1988. Arg-220 of the PstA protein is required for phosphate transport through the phosphate-specific transport system in *Escherichia coli* but not for alkaline phosphatase repression. *J. Bacteriol.* **170**: 2283-2286.
- Davidson, A.L., H.A. Shuman and H. Nikaido. 1992. Mechanism of maltose transport in *Escherichia coli*: Transmembrane signaling by periplasmic binding proteins. *Proc. Natl. Acad. Sci. USA* **89**: 2360-2364.
- Dubnau, D. and R. Davidoff-Abelson. 1971. Fate of transforming DNA following uptake by competent *B. subtilis*. *J. Mol. Biol.* **56**: 209-221.
- Dunny, G.M., B.A. Leonard and P.J. Hedberg. 1995. Pheromone-Inducible Conjugation in *Enterococcus faecalis*: Interbacterial and Host-Parasite Chemical Communication. *J. Bacteriol.* **177**: 871-876.
- Ferrari, F.A., A. Nguyen, D. Lang and J.A. Hoch. 1983. Construction and properties of an integrable plasmid for *Bacillus subtilis*. *J. Bacteriol.* **154**: 1513-1515.

- Grossman, A.D. and R. Losick. 1988. Extracellular control of spore formation in *Bacillus subtilis*. *Proc. Natl. Acad. Sci. U.S.A.* **85**: 4369-4373.
- Gunderson, K.L. and R.R. Kopito. 1995. Conformational States of CFTR Associated with Channel Gating: The Role of ATP Binding and Hydrolysis. *Cell* **82**: 231-239.
- Hahn, J., L. Kong and D. Dubnau. 1994. The regulation of competence transcription factor synthesis constitutes a critical control point in the regulation of competence in *Bacillus subtilis*. *J. Bacteriol.* **176**: 5753-5761.
- Harwood, C.R. and S.M. Cutting. 1990. *Molecular Biological Methods for Bacillus*. John Wiley & Sons, Chichester, England.
- Higgins, C.F. 1992. ABC transporters: From microorganisms to man. *Annu. Rev. Cell Biol.* **8**: 67-113.
- Hiles, I.D., M.P. Gallagher, D.J. Jamieson and C.F. Higgins. 1987. Molecular characterization of the oligopeptide permease of *Salmonella typhimurium*. *J. Mol. Biol.* **195**: 125-142.
- Hiles, I.D. and C.F. Higgins. 1986. Peptide uptake by *Salmonella typhimurium*. *Eur. J. Biochem* **158**: 561-567.
- Jaacks, K.J., J. Healy, R. Losick and A.D. Grossman. 1989. Identification and characterization of genes controlled by the sporulation regulatory gene *spo0H* in *Bacillus subtilis*. *J. Bacteriol.* **171**: 4121-4129.
- Koide, A. and J.A. Hoch. 1994. Identification of a second oligopeptide transport system in *Bacillus subtilis* and determination of its role in sporulation. *Mol. Microbiol.* **13**: 417-426.
- LeDeaux, J.R. 1994. Thesis: Isolation and Characterization of Multicopy Suppressors of a *spo0K* Mutant in *Bacillus subtilis*. M.I.T.
- LeDeaux, J.R. and A.D. Grossman. 1995. Isolation and characterization of *kinC*, a gene that encodes a sensor kinase homologous to the sporulation sensor kinases KinA and KinB in *Bacillus subtilis*. *J. Bacteriol.* **177**: 166-175.
- Leighton, T.J. and R.H. Doi. 1971. The stability of messenger ribonucleic acid during sporulation in *Bacillus subtilis*. *J. Biol. Chem.* **252**: 268-272.

- Leonard, B.A.B., A. Podbielski, P.J. Hedberg and G.M. Dunny. 1996. *Enterococcus faecalis* pheromone binding protein, PrgZ, recruits a chromosomal oligopeptide permease system to import sex pheromone cCF10 for induction of conjugation. *Proc Natl. Acad. Sci. USA* 93: 260-264.
- Magnuson, R., J. Solomon and A.D. Grossman. 1994. Biochemical and genetic characterization of a competence pheromone from *B. subtilis*. *Cell* 77: 207-216.
- Manson, M.D., V. Blank, G. Brade and C.F. Higgins. 1986. Peptide chemotaxis in *E. coli* involves the Tap signal transducer and the oligopeptide permease. *Nature* 321: 253-256.
- Martineau, P., W. Saurin, M. Hofnung, J. Spurlino and F. Quioco. 1990. Progress in the identification of interaction sites on the periplasmic maltose binding protein from *E. coli*. *Biochimie* 72: 397-402.
- Miller, J. 1972. *Experiments in molecular genetics*. Cold Spring Harbor Laboratory, Cold Spring Harbor, N. Y.
- Miller, J.H. 1992. *A short course in bacterial genetics*. Cold Spring Harbor Laboratory Press, Cold Spring Harbor, NY.
- Mimmack, M.L., M.P. Gallagher, S.R. Pearce, S.C. Hyde, I.R. Booth and C.F. Higgins. 1989. Energy coupling to periplasmic binding protein-dependent transport systems: Stoichiometry of ATP hydrolysis during transport in vivo. *Proc. Natl. Acad. Sci. USA* 86: 8257-8261.
- Perego, M., C.F. Higgins, S.R. Pearce, M.P. Gallagher and J.A. Hoch. 1991. The oligopeptide transport system of *Bacillus subtilis* plays a role in the initiation of sporulation. *Mol. Microbiol.* 5: 173-185.
- Perego, M. and J.A. Hoch. 1996. Cell-cell communication regulates the effects of protein aspartate phosphatases on the phosphorelay controlling development in *Bacillus subtilis*. *Proc. Natl. Acad. Sci. USA* 93: 1549-1553.
- Perego, M., G.B. Spiegelman and J.A. Hoch. 1988. Structure of the gene for the transition state regulator, *abrB*: regulator synthesis is controlled by the *spo0A* sporulation gene in *Bacillus subtilis*. *Mol. Microbiol.* 2: 689-699.
- Rudner, D.Z., J.R. LeDeaux, K. Ireton and A.D. Grossman. 1991. The *spo0K* locus of *Bacillus subtilis* is homologous to the oligopeptide permease locus and is required for sporulation and competence. *J. Bacteriol.* 173: 1388-1398.

- Schaeffer, P., J. Millet and J. Aubert. 1965. Catabolite repression of bacterial sporulation. *Proc. Natl. Acad. Sci. USA* **54**: 704-711.
- Senior, A.E., M.K. Al-Shawi and I.L. Urbatsch. 1995. The catalytic cycle of P-glycoprotein. *FEBS Letters* **377**: 285-289.
- Solomon, J.M., B.A. Lazazzera and A.D. Grossman. 1996. Purification and characterization of an extracellular peptide factor that affects two different developmental pathways in *Bacillus subtilis*. *Genes & Dev.* **10**: 2014-2024.
- Solomon, J.M., R. Magnuson, A. Srivastava and A.D. Grossman. 1995. Convergent sensing pathways mediate response to two extracellular competence factors in *Bacillus subtilis*. *Genes & Dev.* **9**: 547-558.
- Steiner, H.-Y., F. Naider and J.M. Becker. 1995. The PTR family: a new group of peptide transporters. *Mol. Microbiol.* **16**: 825-834.
- Stragier, P., C. Bonamy and C. Karmazyn-Campelli. 1988. Processing of a sporulation sigma factor in *Bacillus subtilis*: How morphological structure could control gene expression. *Cell* **52**: 697-704.
- Trowsdale, J., S.M.H. Chen and J.A. Hoch. 1978. Genetic analysis of phenotypic revertants of *spo0A* mutants in *Bacillus subtilis*: a new cluster of ribosomal genes, p. 131-135. In *Spores VII* (ed. G. Chambliss and J.C. Vary). American Society for Microbiology, Washington, D.C.
- Vandeyar, M.A. and S.A. Zahler. 1986. Chromosomal Insertions of Tn917 in *Bacillus subtilis*. *J. Bacteriol.* **167**: 530-534.
- Vasanth, N. and E. Freese. 1980. Enzyme changes during *Bacillus subtilis* sporulation caused by deprivation of guanine nucleotides. *J. Bacteriol.* **144**: 1119-1125.
- Wanner, B.L. 1993. Gene regulation by phosphate in enteric bacteria. *J. Cellular Biochem.* **51**: 47-54.
- Weinrauch, Y., R. Penchev, E. Dubnau, I. Smith and D. Dubnau. 1990. A *Bacillus subtilis* regulatory gene product for genetic competence and sporulation resembles sensor protein members of the bacterial two-component signal-transduction systems. *Genes and Dev.* **4**: 860-872.

Youngman, P., H. Poth, B. Green, K. York, G. Olmedo and K. Smith. 1989. Methods for genetic manipulation, cloning, and functional analysis of sporulation genes in *Bacillus subtilis*, p. 65-87. In *Regulation of Prokaryotic Development* (ed. I. Smith, R. Slepecky and P. Setlow). American Society for Microbiology, Washington, DC.



## Chapter 5

### Discussion

In this thesis I have presented work that addresses the question of how cell-cell signaling affects genetic competence in *B. subtilis*. This research has uncovered one particular solution to the general problem of how cells communicate with each other. There are many other examples of cell-cell signaling in microorganisms and cell-cell signaling serves many important functions. Cell-cell signaling can be utilized to find a mate. This is true for *Enterococcus faecalis* which uses peptide signals to bring donor and recipient cells together for conjugal transfer of plasmids (Clewell, 1993; Dunny et al., 1995). It is also true for the yeast *Saccharomyces cerevisiae* which secretes peptide mating pheromones to attract cells of the opposite mating type for fusion and meiosis (Sprague Jr. and Thorner, 1992). Cell-cell signaling can coordinate cells as they construct morphological structures. Groups of *Myxococcus xanthus* cells can form fruiting bodies. During one stage of fruiting body formation the cells produce C-signal, which indicates whether the cells are properly oriented with each other (Kim and Kaiser, 1990b; Kim and Kaiser, 1990a). In the slime mold *Dictyostelium* the first stage of fruiting body formation occurs when multicellular aggregates form in response to nanomolar pulses of cyclic-AMP (Bretschneider et al., 1995). Cell-cell signaling is frequently used by microorganisms to count the number of cells of their own species in their environment. Each cell secretes a signaling molecule and the concentration of that molecule becomes an indicator of the number of cells. This process has been called "quorum sensing." (Fuqua et al., 1994). *Vibrio fischeri* produces N-acyl homoserine lactones to measure cell density to determine whether or not to become luminescent (Eberhard et al., 1981). *Streptococcus pneumoniae* measures cell density with a peptide to regulate the onset of competence (Håvarstein et al., 1995a).

We believe that extracellular signals that regulate competence and sporulation in *B. subtilis* are cell density signals that are used for quorum sensing.

For the competence signals, the quantity of *srfA*-inducing activity in the cell-free supernatant is roughly proportional to the cell density of the culture (Roy Magnuson, personal communication). Sporulation efficiency also improves with increasing cell density suggesting that it too is under cell density control (Grossman and Losick, 1988).

It is interesting to consider why both competence and sporulation should be regulated by the density of the culture. Genetic competence can be considered a primitive form of sex, with bacteria exchanging genetic information. Conditions of high density might make it more likely that the organism will encounter DNA from its own species. If this is the purpose of competence, then it would be sensible to become competent under conditions of high density. Interestingly, competence in *Streptococcus pneumoniae* is also regulated by cell density (Tomasz and Mosser, 1966). When *B. subtilis* cells are running out of nutrients they must determine whether or not to sporulate. Conditions of high cell density could indicate a greater competition for food. Even if more food does appear it must be shared by many cells. Under these conditions it might be more sensible to enter into dormancy than to persist in stationary phase and hope more food comes along. As a spore, there is a chance of being carried away to a more favorable environment.

**ComP/ComA, a cell density sensor for *B. subtilis*.** The ComP/ComA two-component system can be considered a general cell density sensor for *B. subtilis*. The activation of the ComA transcription factor is controlled by two peptides, ComX pheromone and CSF, that accumulate in the medium. This information can be used to regulate processes in the cell, in addition to competence. Only one ComA target, *srfA*(*comS*), is involved in competence.

Two other genes, *degQ* and *rapA*, are known to be regulated by ComA. The function of *degQ* is not known, but overexpressing *degQ* leads to overexpression of

degradative enzymes (Msadek et al., 1991). *rapA* encodes a phosphatase for Spo0F~P and is a negative regulator of the sporulation pathway (Perego et al., 1994). The ComA pathway might suppress sporulation in order to prevent both competence and sporulation from being expressed simultaneously (Grossman, 1995).

It would be interesting to determine what other cellular processes are regulated by cell density by undertaking a genetic screen to find more ComA-controlled genes. ComA production can be controlled by an inducible promoter and random *lacZ* fusions can be compared under conditions with and without *comA*. A similar approach has been used in the Grossman laboratory to identify genes controlled by sigma-H (Jaacks et al., 1989).

**Unanswered questions about cell-density regulation of competence in *B. subtilis*.** There are many questions that must be addressed before we understand how cell-cell signaling affects ComP/ComA and genetic competence in *B. subtilis*. To understand a cell-cell signaling system one needs to know the chemical identity of the signaling molecules, and the pathway by which the signals are produced and exported. The mechanism by which cells sense the signal should also be understood, determining what proteins interact with the signal and how this interaction leads to changes inside the cell.

The chemical identity of the modification on the ComX pheromone is still not known. The difference in mass between the purified ComX pheromone and the predicted mass of the 10 amino acid peptide is 206 daltons (Magnuson et al., 1994). The complicating factor is that the modification is on a tryptophan residue and it is not clear how much of the tryptophan side chain remains. ComX pheromone exhibits little absorbance at 280 nm, suggesting that at least the indole ring of the tryptophan is opened up. Other clues are that the modification is very hydrophobic

and that ComQ, which is required for production of active pheromone, has homology to isoprenyl diphosphate synthases. This suggests that the modification could be an isoprenyl group.

The pathway by which ComX pheromone is processed, modified, and exported also remains obscure. A mutant hunt to identify functions required for production of ComX pheromone only identified more mutations in *comQ* and *comX* (Tanya Palmer, personal communication). Other functions that are required for ComX pheromone production might be redundant or essential for cell viability. Another possibility is that ComQ and ComX are sufficient for ComX pheromone production.

The main mystery about CSF production is how the secreted carboxy terminus of PhrC is processed into the five amino acid peptide that is found in the cell-free supernatant and has CSF activity. The predicted signal sequence cleavage sites for PhrC would lead to secretion of peptides that are 12, 14, or 16 amino acids long (Perego et al., 1996). Perhaps the cell secretes a protease which is required for proper processing of PhrC into CSF.

The ComP histidine protein kinase is required for response to the ComX pheromone. This implies that there is an interaction between the two molecules but this is not yet proven. Attempts should be made to cross link ComX pheromone to ComP.

The mechanism by which the cells respond to CSF is the least well proven portion of our model. We hypothesize that CSF inhibits, directly or indirectly, the activity of a ComA~P phosphatase, RapC. To determine the merit of this hypothesis, it is worth considering the Rap phosphatase family and their putative regulators.

**The Rap phosphatase family.** Phosphatase activity is an important part of two component regulatory systems. Phosphate must be rapidly removed from the response regulator in order for the activity of the response regulator to be responsive to changes in kinase activity. The response regulator proteins often have autophosphatase activities, as demonstrated by the fact that the phosphoaspartate group is more stable on the denatured than on the native form of the response regulator (Stock et al., 1995). NRJ~P has a half life of 1.8 minutes in the native form but has a half life of 5.5 hours in its denatured form (Weiss and Magasanik, 1988). Phosphatases that act on response regulators are thought to work by stimulating the autophosphatase activity of the response regulator (Stock et al., 1995). In one case, the protein that stimulates autophosphatase activity is the cognate histidine protein kinase. It is the phosphatase activity of the NR<sub>II</sub> nitrogen regulatory kinase that is regulated by nitrogen levels and not its kinase activity (Ninfa and Magasanik, 1986). In many cases, two-component systems have phosphatase activities that reside on separate proteins. The Spo0E protein is a phosphatase for Spo0A in *B. subtilis* (Ohlsen et al., 1994) and CheZ is a phosphatase for the chemotaxis response regulator CheY in *E. coli*. (Amsler and Matsumura, 1995). Having the phosphatases as separate components could increase opportunities for regulating the two component system. It is the balance of kinase and phosphatase activities that will determine if a response regulator will become active.

There are at least seven members of the Rap phosphatase family in *B. subtilis* (Perego et al., 1996; Perego and Hoch, 1996b). Two of the phosphatases, RapA and RapB, were shown in vitro to dephosphorylate Spo0F, a response regulator involved in sporulation. Most of the *rap* phosphatases were identified by the *B. subtilis* sequencing project by virtue of amino acid similarity to RapA and RapB. It is assumed that the other members of the family are also aspartyl-phosphate

phosphatases. About 50% of the genome has been sequenced, so we might expect that several more Rap phosphatases will be discovered.

The mechanism by which the Rap phosphatases work is not clear. The Rap proteins might stimulate the inherent autophosphatase activities of the response regulators. Alternatively, the Rap proteins might possess a phosphatase activity. All have a conserved cysteine residue, and a cysteine is known to be involved in catalysis by tyrosine phosphatases (Perego et al., 1996). The Rap phosphatases show specificity towards their targets. RapA and RapB will dephosphorylate Spo0F, but not Spo0A in vitro (Perego et al., 1994) even though Spo0F is 56% similar to the amino-terminal domain of Spo0A (Trach et al., 1985).

The Rap phosphatases affect competence and sporulation and may affect other cellular processes. The RapC phosphatase is required for activation of *srfA* expression in response to CSF (Chapter 3). Three of the phosphatases, RapA, RapB, and RapE affect sporulation (Perego et al., 1996), and the others, RapD, RapF, and RapG are of unknown function. The Rap phosphatase family could be unique to *B. subtilis* as searches of the current databases (November 1996) have not revealed Rap homologues in other organisms.

**Regulation of the Rap phosphatases.** There is genetic and physiological evidence that two of the Rap phosphatases are regulated by small peptides. The *phrA* gene is just downstream of *rapA* and encodes a 44 amino acid protein. The sporulation efficiency of *phrA* mutants is 10-20% of *wt* levels. A mutation in *rapA* (a negative regulator of sporulation) bypasses the need for *phrA*, suggesting that *phrA* is negatively regulating RapA (Perego and Hoch, 1996a). The gene encoding CSF, *phrC*, is directly downstream of the gene for the putative ComA phosphatase, RapC. *rapC* mutants have higher levels of expression of *srfA* and do not increase *srfA* expression in response to CSF. This suggests that CSF is negatively regulates the

RapC phosphatase. PhrA and PhrC are named under the assumption that they are phosphatase regulators (Perego and Hoch, 1996a) or pheromones (Chapter 3)(Solomon et al., 1996).

How do the Phr peptides regulate the Rap phosphatases? An attractive model is that a peptide binds directly to the cognate phosphatase and alters its activity. Adding PhrA peptides to the RapA phosphatase has no obvious effect on its activity *in vitro* (Perego and Hoch, 1996b). Clearly the peptides either do not effect phosphatase activity directly, or a key component is missing from the reaction. The authors suggest that the peptides, which are secreted, might be modified upon re-entering the cell (Perego and Hoch, 1996a).

Not all the Rap phosphatases have matching Phr peptides. Small peptides are encoded downstream of *rapA*, *rapC*, *rapE*, and *rapF*. *rapD*, which is more distantly related to *rapA* than the other Rap proteins, has no small peptide gene downstream of it. There is a peptide gene downstream of *rapB*, but allegedly it is not expressed (Perego et al., 1996). There is a peptide gene downstream of *phrE*, but its product differs from the other Phr peptides in that it does not have a signal sequence for secretion by the SecA pathway (Perego et al., 1996).

An interesting possibility is that the Phr peptides interact with multiple Rap phosphatases. CSF, the PhrC peptide, has at least three activities. Low concentrations of CSF can stimulate *srfA* expression, high concentrations of CSF can inhibit *srfA* expression, and CSF can stimulate sporulation at low cell density (Chapter 3) (Solomon et al., 1996). The stimulation of *srfA* expression by CSF depends on RapC, but the inhibition does not indicate that CSF must be acting through a second target (Solomon et al., 1996). CSF could be interacting with multiple Rap phosphatases.



If the Phr peptides can interact with multiple targets it might be difficult to determine their physiological role. Adding enough of any Phr peptide might inhibit any of the Rap phosphatases. CSF was active at concentrations in the 5 -10 nM range for stimulating *srfA* expression and in the 100-1000 nM range for sporulation. It is possible that the effect on sporulation was caused by adding excess PhrC which "cross talked" with Rap phosphatases that affect sporulation. However, we suspect that the responses we saw are physiologically relevant because preliminary measurements of CSF concentration in the medium show that CSF accumulates to 1  $\mu$ M levels in stationary phase (Beth Lazazzera, personal communication).

**Role of Spo0K in competence and sporulation.** One paradox that came out of the discovery of CSF is that the competence defect of a *spo0K* mutant is so much more severe than the competence defect of a cell that doesn't make CSF. One explanation is that Spo0K has another role in activating *srfA* expression besides the transport of CSF. Another possibility, the "phosphatases-run-amok model," is that the absence of Spo0K affects not only the competence regulator, but also many other regulators whose combined effects are worse than the absence of the downstream competence regulator alone. More concretely, in the *spo0K* mutant, none of the Rap phosphatases are inhibited and they are "running amok," shutting down sporulation, competence, and all the other processes they effect. By this model, the only role of Spo0K in competence could be to transport CSF into the cell, but the absence of all the Phr signals leads to a greater repression of ComA activity because other Rap phosphatases are not repressed and now are acting on ComA. A corollary of this model is that the effect of deleting all the sporulation density signals on sporulation frequency might not be as severe as the loss of Spo0K itself.

**Cell-cell signaling in other microorganisms.** Many organisms utilize cell-cell signaling to regulate a variety of processes. In this next section, I will compare

some of these systems to the cell density regulation of genetic competence in *B. subtilis*. Figure 1 diagrams what is known about peptide signaling in four microorganisms, *Bacillus subtilis*, *Saccharomyces cerevisiae*, *Streptococcus pneumoniae*, and *Enterococcus faecalis*.

*Streptococcus pneumoniae*. *Streptococcus pneumoniae*, like *B. subtilis*, can become competent to take up DNA. Competence in *Streptococcus* is also regulated by a cell density signal. The elegant work of Tomasz (Tomasz and Hotchkiss, 1964; Tomasz and Mosser, 1966) defined the existence of a trypsin-sensitive competence factor, which accumulates in culture medium as cells grow to high density. Almost all of the cells in an exponential phase culture become competent when the competence factor reaches a critical concentration in the growth medium. It was approximately thirty years between the description of the *S. pneumoniae* competence factor and its identification.

*S. pneumoniae* competence factor is an unmodified 17 amino acid peptide that can fully induce competence at concentrations as low as 13 nM (Figure 1C)(Håvarstein et al., 1995a). Competence factor is derived from the 41 amino acid ComC gene product. It is processed and exported by a dedicated export protein, ComA (Hui and Morrison, 1991). ComA is an ABC transporter that is part of a newly described family of exporters that secrete bacteriocins, small ribosomally-encoded antibacterial compounds (Håvarstein et al., 1995b). These exporters contain a proteolytic domain that cleaves the leader peptide after two conserved glycine residues concomitant with transport. As expected, the competence factor gene, *comC*, encodes two glycines before the 17 amino acid C-terminus that is the competence factor.

Immediately downstream of *comC* are genes encoding a two-component regulatory system, *comD* and *comE*, whose products are involved in the response to

**Figure 1. Peptide signaling in four microorganisms, *Saccharomyces cerevisiae*, *Enterococcus faecalis*, *Streptococcus pneumoniae*, and *Bacillus subtilis*.** Each figure shows a model of what is known about the production and response to the peptide signaling molecules.

**A. Mating pheromone signaling in *Saccharomyces cerevisiae*.** The production and response pathways for both a-factor and alpha-factor are shown, but only one production and one response pathway is expressed in the haploid cell. a-factor is a farnesylated 12 amino acid peptide, and alpha-factor is an unmodified 13 amino acid peptide. Both are sensed by the same response pathway except that a different G-protein coupled receptor exists for each factor (STE2 and STE3). When the receptor binds the pheromone it's linked G-protein binds GTP. This stimulates a kinase that activates a MAP kinase cascade that activates a transcription factor (Sprague Jr. and Thorner, 1992; Kurjan, 1993; Herskowitz, 1995).

**B. Mating pheromones for transfer of conjugative plasmids in *Enterococcus faecalis*.** The recipient cells produce the pheromones, which are hydrophobic 7-8 amino acid peptides. The cCF10 pheromone is shown. The donor cells import the peptide through an oligopeptide permease. The pheromones interacts with unidentified intracellular targets (Clewell, 1993; Dunny et al., 1995).

**C. Competence pheromone from *Streptococcus pneumoniae*.** The competence factor is a 17 amino acid peptide. An ABC exporter cleaves the leader sequence from the factor and exports the factor from the cell. Competence factor stimulates a two-component regulatory system that increases expression of as yet unidentified genes (Håvarstein et al., 1995a; Håvarstein et al., 1996).

**D. Cell density regulation of competence in *B. subtilis*.** Two competence factors, ComX pheromone and CSF (competence stimulatory factor) stimulate expression of *srfA*(*comS*). ComX pheromone is a modified ten amino acid peptide, and CSF is an unmodified five amino acid peptide. Both factors stimulate phosphorylation and activation of the ComA transcription factor. ComX pheromone activates a kinase that phosphorylates ComA. CSF is probably transported into into the cell by an oligopeptide permease where it inhibits, directly or indirectly, the ComA~P phosphatase, RapC (Chapter 3)(Solomon and Grossman, 1996; Solomon et al., 1996).

## A. *Saccharomyces cerevisiae*

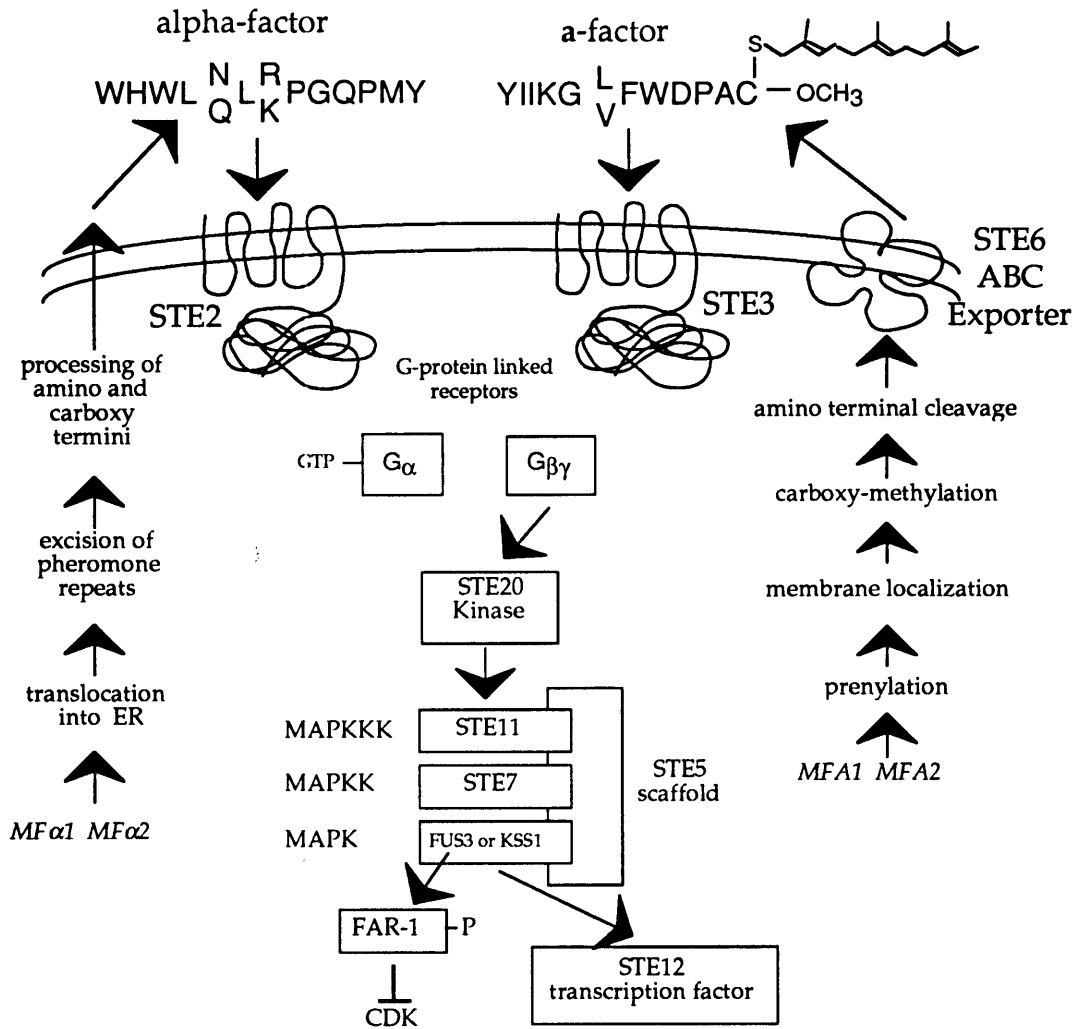

## B. *Enterococcus faecalis*

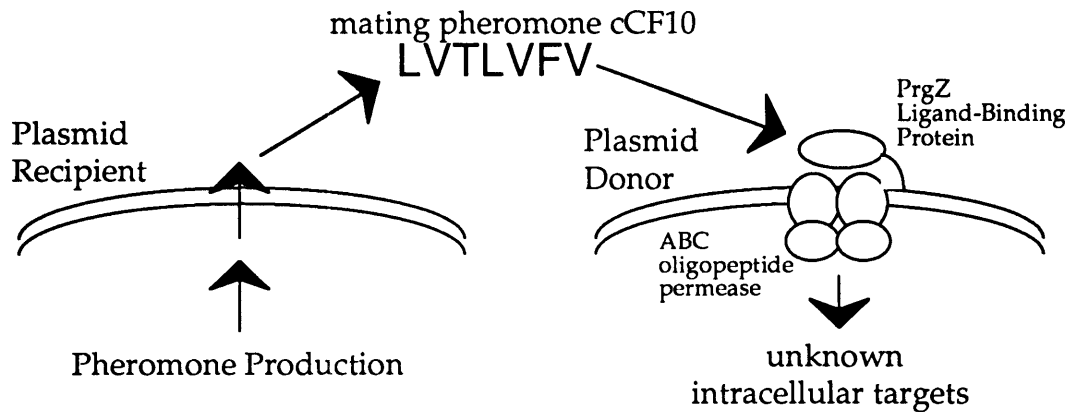

## C. *Streptococcus pneumoniae*

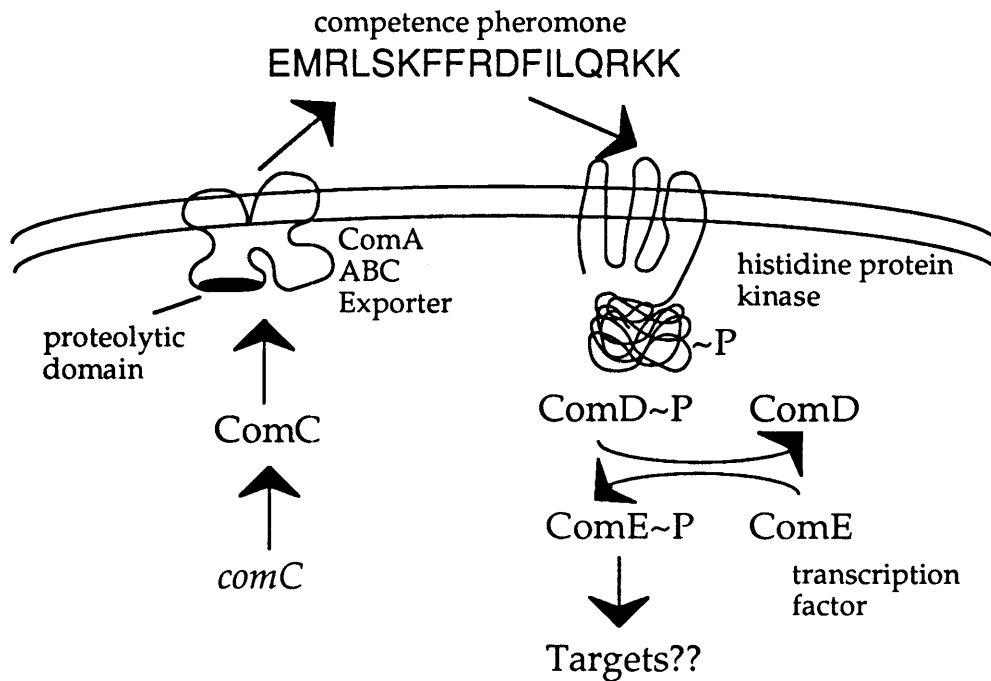

## D. *Bacillus subtilis*

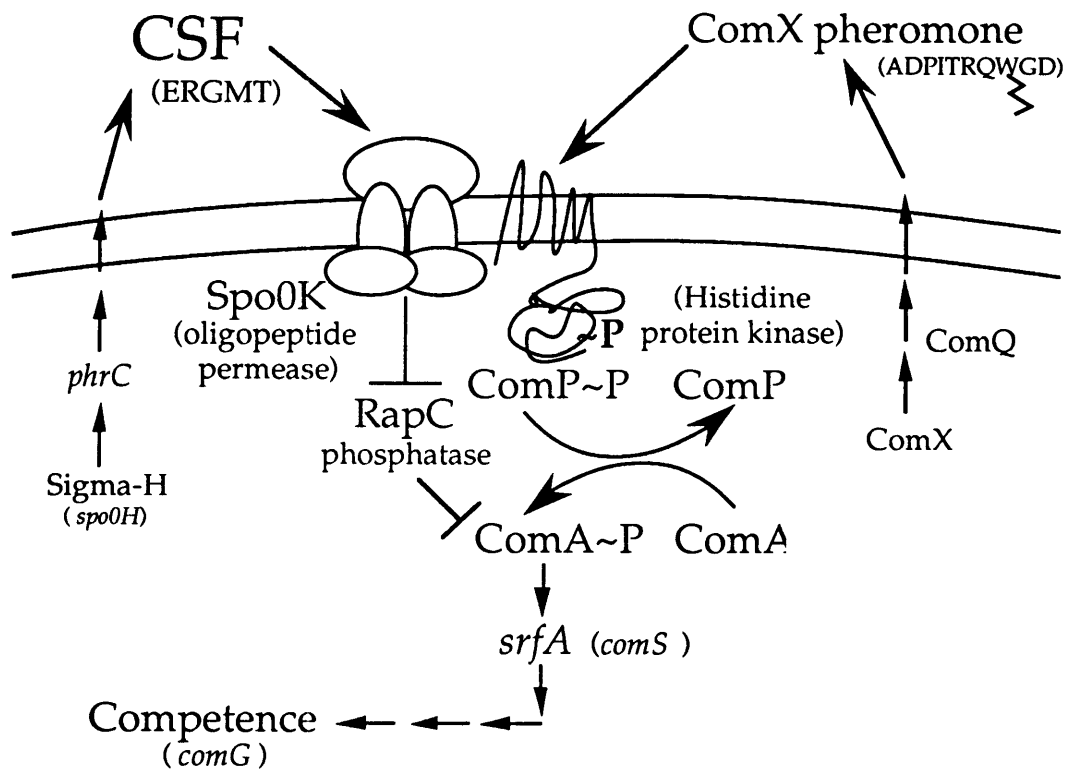

the competence factor (Pestova et al., 1996). ComD is a histidine protein kinase with from 5 to 7 predicted membrane-spanning alpha helices in its N-terminal sensing domain (Håvarstein et al., 1996). ComE is a response regulator which is probably a transcription factor (Pestova et al., 1996). The ComD histidine protein kinase is responsible for the specificity of the response to competence factor. Håvarstein and colleagues identified two strains of *Streptococci* with slightly different competence factors and ComD histidine protein kinases. When both versions of the ComD kinase were introduced into one strain, the cells gained the ability to respond to both competence factors when previously they could only respond to their strain-specific competence factor (Håvarstein et al., 1996).

There is a striking similarity between the competence factor of *Streptococcus pneumoniae* and ComX pheromone of *B. subtilis*. Both competence factor and ComX pheromone are ribosomally-encoded peptides that affect a two component system that is encoded immediately downstream of the gene encoding the peptide. There are some subtle differences: The ComX pheromone has a hydrophobic modification, while the *S. pneumoniae* competence factor is unmodified. The competence factor belongs to a family of secreted peptides with a double-glycine leader peptide with a dedicated ABC transporter to cleave and export the peptide. ComX pheromone does not have a double glycine leader sequence, and it is not known how the ComX peptide is processed and exported. ComX pheromone might also have a dedicated ABC transporter for export, but it is clearly not in the so-called double-glycine family.

Both the ComD histidine protein kinase that senses competence factor and the ComP histidine protein kinase that senses ComX pheromone are membrane-spanning kinases. ComD has between 5-7 putative membrane spanning domains (Håvarstein et al., 1996) and ComP has eight membrane spanning domains

(Weinrauch et al., 1990). ComP is a much larger protein, 749 amino acids, than ComD, 441 amino acids. An alignment of the two proteins showed 15.9% identity.

A secreted peptide followed by a two-component regulatory system is a density-sensing cassette that has found its way into many Gram-positive bacteria. Figure 2 shows the genes involved in peptide signaling from four different bacteria. In all four organisms the gene encoding the signaling molecule is immediately upstream of a two-component regulatory system involved in response to the signal. In *S. pneumoniae* and *L. plantarum* the pheromone precursor has a double-glycine leader peptide and, like bacteriocins, is processed and exported by a dedicated ABC exporter. In *B. subtilis* and *S. aureus* the peptide pheromone is modified and another gene immediately upstream of the pheromone gene is required for production of the signal.

*Enterococcus faecalis*. In the Gram-positive bacterium *Enterococcus faecalis*, peptide pheromones play a role in the transfer of conjugative plasmids (Figure 1B)(Clewell, 1993; Dunny et al., 1995). Plasmid-free recipient cells secrete a family of pheromones with specificity for donors carrying various conjugative plasmids. The donor cell detects the pheromone and synthesizes a protein which promotes aggregation of donor and recipient cells. Conjugal transfer of the plasmid then occurs efficiently. When the recipient cell obtains the plasmid, plasmid functions shut down production of the pheromone and produce an inhibitor peptide that blocks response to any remaining pheromone. Interestingly, *E. faecalis* produces at least five pheromones that can be used to obtain as many plasmids (Clewell, 1993). This seems to account for the rapid spread of drug resistance in these bacteria.

The pheromones are short hydrophobic peptides of seven or eight amino acids that have biological activity at concentrations as low as  $10^{-2}$  to  $10^{-3}$  nM (Mori et al., 1988). The genes that are responsible for production of the pheromones are on

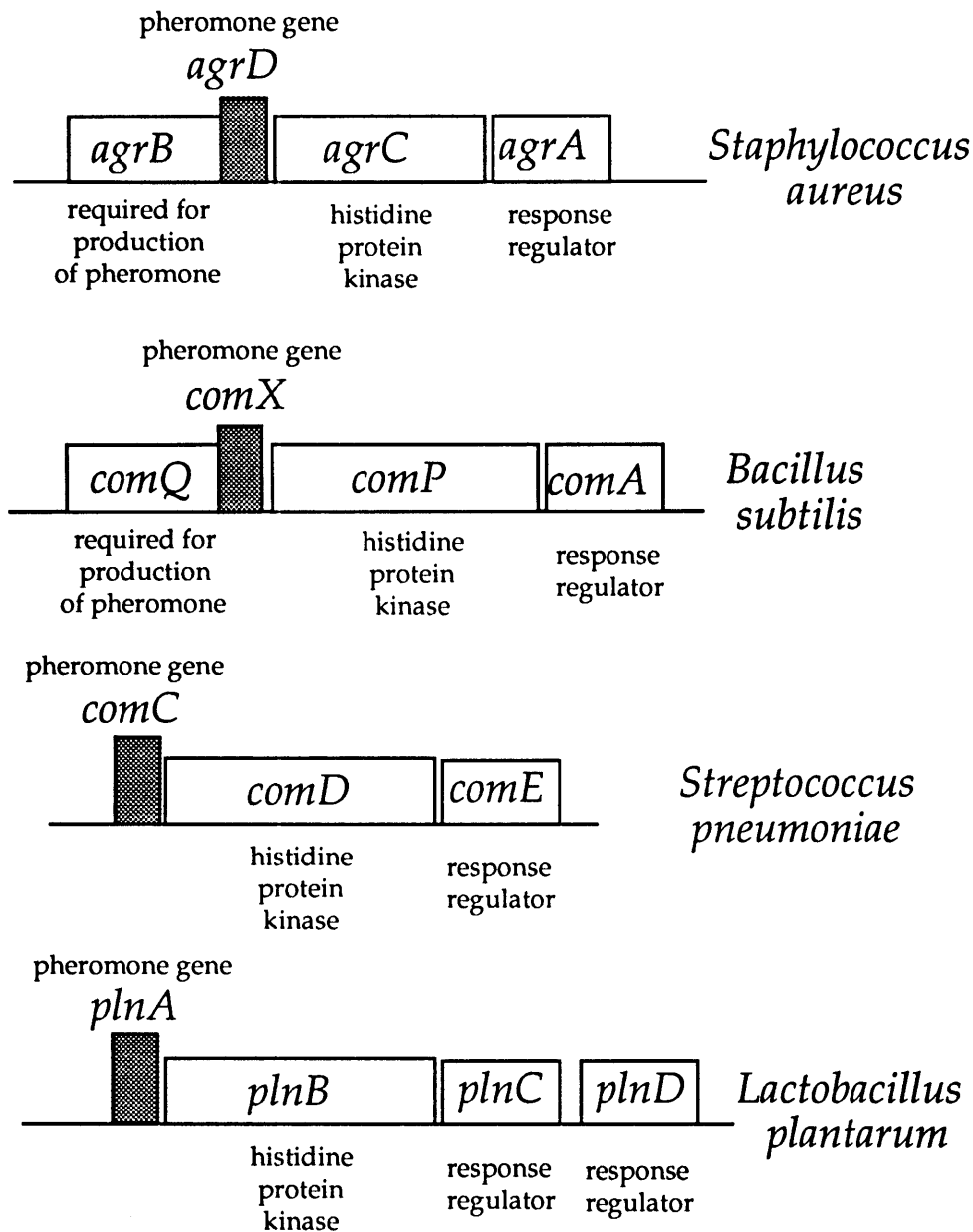

**Figure 2. Organization of genes involved in peptide signaling from four different bacteria.** In all four cases the pheromone genes are directly upstream of a two-component regulatory system involved in response to the pheromone (Magnuson et al., 1994; Diep et al., 1995; Guangyong et al., 1995; Pestova et al., 1996). In *S. aureus* and *B. subtilis* there is also a gene upstream of the pheromone gene that is required for production of the pheromone. In *L. plantarum* there are two response regulator genes. Similar gene arrangements are also found in *Streptococcus goordonii* (Håvarstein et al., 1996), *Lactobacillus sake* (Axelsson and Holck, 1995), and *Carnobacterium piscicola* (Quadri et al., 1995).



the chromosome and have not yet been identified. The production of the inhibitory peptide from plasmid pCF10 looks similar to the production of CSF. The peptide is ribosomally encoded and the N-terminus of the 23 amino acid protein resembles a signal peptide for secretion by the SecA pathway (Nakayama et al., 1994). Their model is that the inhibitor peptide is cleaved to its mature seven amino acid form during the secretion process. The inhibitor peptide can be expressed and properly processed in *E. coli* supporting the idea that processing occurs by general secretion factors and not by a dedicated processing system (Nakayama et al., 1994).

Like CSF, the response to the pheromones in *Enterococcus* requires an oligopeptide permease. The plasmids encode an oligopeptide permease ligand binding protein, homologous to Spo0KA, that binds the pheromone with high affinity (Ruhfel et al., 1993). The plasmid-encoded ligand binding protein functions in conjunction with the chromosomally-encoded oligopeptide permease membrane complex proteins (Leonard et al., 1996). The oligopeptide permease is hypothesized to transport the pheromone into the cell to interact with intracellular targets. Tethering the pheromone to Sepharose beads did not affect pheromone binding to the ligand binding protein, but did block mating responses. Several cytoplasmic proteins are retained by a column of pheromone conjugated to Sepharose beads, but these potential intracellular targets have not yet been identified (Leonard et al., 1996).

**Yeast mating pheromones.** The most studied cell-cell signaling system in microorganisms is the mating factors from the yeast *Saccharomyces cerevisiae* (Figure 1A)(Sprague Jr. and Thorner, 1992; Kurjan, 1993; Herskowitz, 1995). These are necessary for the haploid types of yeast, a and alpha, to mate with each other. a cells respond to alpha-factor and alpha cells respond to a-factor. The response involves

transcriptional induction of the yeast mating genes, cell-cycle arrest at G1, and morphological changes.

The mating pheromones are peptides. Alpha-factor is a 13 amino acid peptide. It is produced from the *MFalpha1* and *MFalpha2* gene products, which each contain multiple alpha-factor and alpha-factor like repeats. The alpha-factor precursors are processed and secreted by the general secretory pathway. a-factor consists of two modified 12 amino acid peptides. The two peptides differ by a single amino acid. Both have a C-terminal cysteine that is modified by carboxymethylation and farnesylation. a-factor is produced from the *MFA1* and *MFA2* gene products that are processed and modified in the cytoplasm. Export of a-factor is mediated by an ABC exporter encoded by *STE6*.

The mating factors are detected by two different G-protein linked receptors that are part of the large family of so-called "serpentine" receptors in Eukaryotes (Dohlman et al., 1991). The alpha-factor receptor (*STE2*) is expressed only in a cells, and the a-factor receptor (*STE3*) is expressed only in alpha cells. Pheromones bind to the receptors, which stimulates the G-protein (G-alpha/*SCG1*) to bind GTP and frees the G-beta/gamma (*STE4/STE18*) subunits to stimulate the pheromone response pathway. G-beta/gamma is thought to stimulate the *STE20* kinase, which stimulates a MAP kinase cascade: *STE11* phosphorylates *STE7*, which phosphorylates two MAP kinases, *FUS3* and *KSS1*. *FUS3* *KSS1* phosphorylate and activate the *STE12* transcription factor, which binds a consensus sequence upstream of pheromone controlled genes and stimulates their transcription. *FUS3* also phosphorylates and activates *FAR-1* which is involved in cell-cycle arrest (Herskowitz, 1995).

*B .subtilis* and *S. cerevisiae* both had to solve the problem of how to export peptide pheromones. CSF, like alpha factor, is probably secreted and processed by

the general secretory pathway of the cell. a-factor is exported by an ABC exporter which is similar to the mechanism by which *S. pneumoniae* competence factor is exported. It will be interesting to see if ComX pheromone is secreted by a similar mechanism.

The response pathways that control yeast mating and that control genetic competence both lead to the phosphorylation and activation of a transcription factor. Besides that their components are unrelated. Recently it was discovered that the STE5 protein acts as a scaffold that holds the three kinases of the MAP kinase cascade together (Choi et al., 1994; Marcus et al., 1994; Printen and Sprague Jr., 1994). One rationale for employing a kinase cascade is that the signal can be amplified. One MAP kinase kinase kinase can phosphorylate ten MAP kinase kinases and so on. The discovery that the proteins are tethered makes this scenario less likely. Another possibility for having a string of kinases is to allow for multiple points of regulation that would accommodate the need of several pathways to feed into the mating pheromone response. In this way the MAP kinase cascade could be analogous to the phosphorelay.

I have focused on the use of peptides as bacterial cell-cell signaling molecules because they are most relevant to *B. subtilis*, but other types of molecules are utilized for cell-cell signaling.

**Signaling by acylated homoserine lactones.** Many Gram-negative bacteria secrete N-acyl homoserine lactones that are used as cell density signals (Fuqua et al., 1994; Salmond et al., 1995). These compounds were first identified as regulating bioluminescence in *Vibrio fischeri*. Now they have been shown to regulate processes as varied as virulence and exoenzyme production in *Pseudomonas aeruginosa* and *Erwinia carotovora* and conjugal transfer of the Ti plasmid in *Agrobacterium tumefaciens* (Salmond et al., 1995).

*Vibrio fischeri* can live as a symbiont in the light organ of certain fish where the bacteria emits blue-green light generated by a luciferase enzyme (Meighen, 1991). The bacterium can determine that it has colonized a light organ because the cells will be at a very high density, greater than that found in the ocean. Production of luciferase enzyme occurs when a small molecule, autoinducer, reaches a critical concentration in the environment (Eberhard, 1972).

The autoinducer is an N-acyl-homoserine lactone (N-( $\beta$ -ketocaproyl)homoserine lactone)(Figure 3). The production of autoinducer depends on the LuxI gene product. A recent study on a protein related to LuxI, TraI, showed that the autoinducer is made from S-adenosyl-methionine and a fatty acid attached to the acyl carrier protein (Moré et al., 1996). Autoinducer diffuses freely from the cell so that high intracellular levels of autoinducer only occur in the presence of neighboring autoinducer producing cells, i.e. high density. Autoinducer also freely diffuses into the cell where it is detected by an intracellular transcription factor encoded by LuxR. LuxR induces expression of the light-producing genes and also LuxI (Fuqua et al., 1994).

N-acyl homoserine lactone signaling in other bacteria works similarly to the *Vibrio fischeri* system. The acyl groups of the homoserine lactones vary from system to system (Figure 3). All of them have homologues of the LuxR transcription factor that responds to the autoinducer and the LuxI protein involved in autoinducer production (Fuqua et al., 1994; Salmond et al., 1995).

The homoserine lactone signaling systems are simpler than the peptide signaling systems. Since the homoserine lactones are freely diffusable no special export or import mechanism is needed. The signals act directly on an intracellular transcriptional regulator with no need for a membrane spanning sensing component.

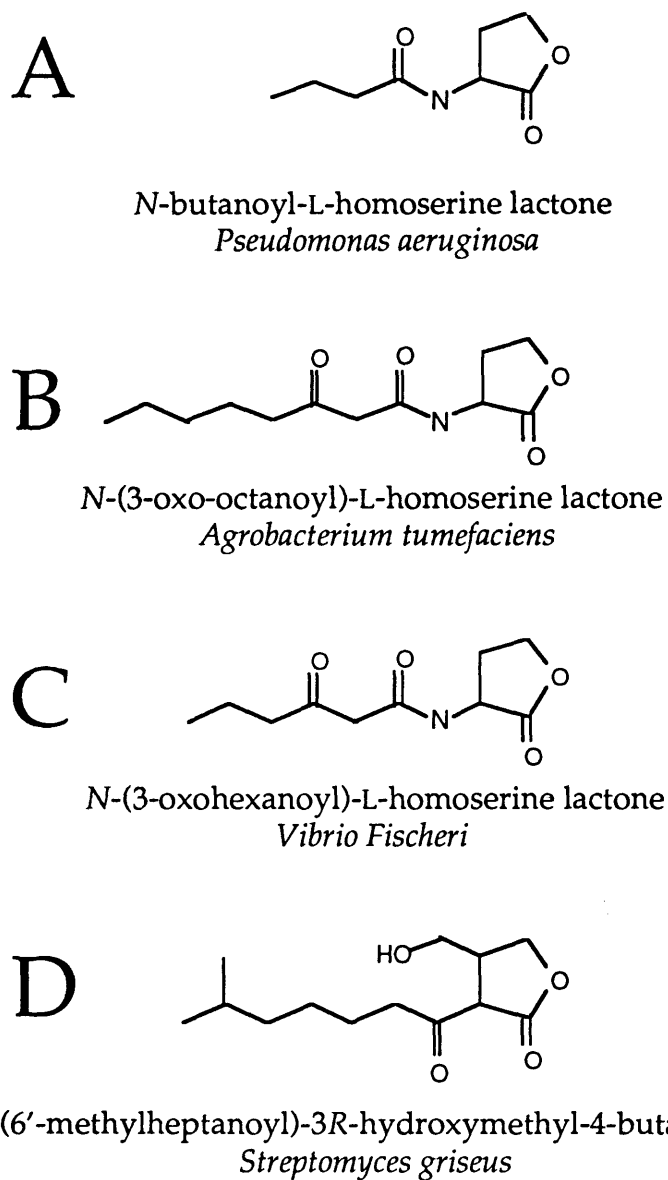

**Figure 3. The structures of three homoserine lactone autoinducers and a *Streptomyces* A-Factor.** Homoserine lactone autoinducers are from (A) *P. aeruginosa*, (B) *A. tumefaciens*, and (C) *V. Fischeri*. (D) A-Factor from *S. griseus* is a gamma-butyrolactone (Horinouchi and Beppu, 1992; Fuqua et al., 1994; Winson, 1995).

**Gamma butyrolactones.** The Gram-positive *Streptomyces* make signals, A-factor and its related compounds (Horinouchi and Beppu, 1992; Horinouchi and Beppu, 1994), that are similar in structure to N-acyl homoserine lactones that are found only in Gram-negative bacteria. The structure of A-factor from *S. griseus* and the autoinducer from *V. fischeri* are shown in Figure 3. Both structures have a butyrolactone ring. A-factor does not have a nitrogen and there are other differences in the carbon tail. A-factor triggers streptomycin biosynthesis and aerial mycelium formation in *Streptomyces griseus*. A-factor related compounds have been identified in other *Streptomyces* species; and it is suspected that they regulate secondary metabolism and morphogenesis.

The synthesis of A-factor occurs by mechanisms that are different from n-acyl homoserine lactones. A-factor is synthesized from a glycerol derivative and a  $\beta$ -keto acid (Horinouchi and Beppu, 1992). Like homoserine lactones, A-factor interacts with an intracellular transcription factor. The ArpA transcription factor, however, has no sequence homology to the LuxR family of regulators and ArpA acts as a repressor and not as an activator of gene expression (Onaka et al., 1995). It is likely that A-factor and homoserine lactones are an example of convergent evolution.

### **Conclusions**

Cell-cell signaling provides the bacterial cell with important information. It can help the cells to find partners for genetic exchange, which could be why cell-cell signaling controls competence and the transfer of plasmids. Cell-cell signaling can also indicate the density of cells in the environment, which indicates the amount of competition for food and whether it is appropriate to initiate processes that require many cells: production of antibiotics and extracellular scavenging enzymes, fruiting body formation, virulence, and bioluminescence. Bacteria have evolved many

mechanisms for communicating with each other using peptides, n-acyl homoserine lactones, and other molecules.

## REFERENCES

- Amsler, C.D. and P. Matsumura. 1995. Chemotactic signal transduction in *Escherichia coli* and *Salmonella typhimurium*, p. 89-103. In *Two-Component Signal Transduction* (ed. J.A. Hoch and T.J. Silhavy). American Society for Microbiology, Washington D.C.
- Axelsson, L. and A. Holck. 1995. The genes involved in production of and immunity to Sakacin A, a bacteriocin from *Lactobacillus sake* Lb706. *J. Bacteriol.* **177**: 2125-2137.
- Bretschneider, T., F. Siegert and C.J. Weijer. 1995. Three-dimensional scroll waves of cAMP could direct cell movement and gene expression in *Dictyostelium* slugs. *Proc. Natl. Acad. Sci. USA* **92**: 4387-4391.
- Choi, K.Y., B. Satterberg, D.M. Lyons and E.A. Elion. 1994. Ste5 tethers multiple protein kinases in the MAP kinase cascade required for mating in *S. cerevisiae*. *Cell* **78**: 499-512.
- Clewell, D.B. 1993. Bacterial sex pheromone-induced plasmid transfer. *Cell* **73**: 9-12.
- Diep, D.B., L. Håvarstein, Sigve and I.F. Nes. 1995. A bacteriocin-like peptide induces bacteriocin synthesis in *Lactobacillus plantarum* C11. *Mol. Microbiol.* **18**: 631-639.
- Dohlman, H.G., J. Thorner, M.G. Caron and R.J. Lefkowitz. 1991. Model systems for the study of seven-transmembrane-segment receptors. *Annu. Rev. Biochem.* **60**: 653-688.
- Dunny, G.M., B.A. Leonard and P.J. Hedberg. 1995. Pheromone-inducible conjugation in *Enterococcus faecalis*: interbacterial and host-parasite chemical communication. *J. Bacteriol.* **177**: 871-876.
- Eberhard, A. 1972. Inhibition and activation of bacterial luciferase synthesis. *J. Bacteriol.* **109**: 1101-1105.
- Eberhard, A., A.L. Burlingame, C. Eberhard, G.L. Kenyon, K.H. Nealson and N.J. Oppenheimer. 1981. Structural identification of Autoinducer of *Photobacterium fischeri* Luciferase. *Biochemistry* **20**: 2444-2449.
- Fuqua, C.W., S.C. Winans and E.P. Greenberg. 1994. Quorum sensing in bacteria: the LuxR-SuxI family of cell density-responsive transcriptional regulators. *J. Bacteriol.* **176**: 269-275.



- Grossman, A.D. 1995. Genetic networks controlling the initiation of sporulation and the development of genetic competence in *Bacillus subtilis*. *Annu. Rev. Genetics*. **29**: 477-508.
- Grossman, A.D. and R. Losick. 1988. Extracellular control of spore formation in *Bacillus subtilis*. *Proc. Natl. Acad. Sci. U.S.A.* **85**: 4369-4373.
- Guangyong, J., R.C. Beavis and R.P. Novick. 1995. Cell density control of *staphylococcal* virulence mediated by an octapeptide pheromone. *Proc. Natl. Acad. Sci. USA* **92**: 12055-12059.
- Håvarstein, L.S., G. Coomaraswamy and D.A. Morrison. 1995a. An unmodified heptadecapeptide pheromone induces competence for genetic transformation in *Streptococcus pneumoniae*. *Proc. Natl. Acad. Sci. USA* **92**: 11140-11144.
- Håvarstein, L.S., D.B. Diep and I.F. Nes. 1995b. A family of bacteriocin ABC transporters carry out proteolytic processing of their substrates concomitant with export. *Mol. Microbiol.* **16**: 229-240.
- Håvarstein, L.S., P. Gaustad, I.F. Nes and D.A. Morrison. 1996. Identification of the streptococcal competence-pheromone receptor. *Mol. Microbiol.* **21**: 863-869.
- Herskowitz, I. 1995. MAP Kinase Pathways in Yeast: For Mating and More. *Cell* **80**: 187-197.
- Horinouchi, S. and T. Beppu. 1992. Autoregulatory factors and communication in Actinomycetes. *Annu. Rev. Microbiol.* **46**: 377-98.
- Horinouchi, S. and T. Beppu. 1994. A-factor as a microbial hormone that controls cellular differentiation and secondary metabolism in *Streptomyces griseus*. *Mol. Microbiol.* **12**: 859-864.
- Hui, F.M. and D.A. Morrison. 1991. Genetic transformation in *Streptococcus pneumoniae*: Nucleotide sequence analysis shows *comA*, a gene required for competence induction, to be a member of the bacterial ATP-dependent transport protein family. *J. Bacteriol.* **173**: 372-381.
- Jaacks, K.J., J. Healy, R. Losick and A.D. Grossman. 1989. Identification and characterization of genes controlled by the sporulation regulatory gene *spo0H* in *Bacillus subtilis*. *J. Bacteriol.* **171**: 4121-4129.
- Kim, S.K. and D. Kaiser. 1990a. C-Factor: A cell-cell signaling protein required for fruiting body morphogenesis of *M. xanthus*. *Cell* **61**: 19-26.

- Kim, S.K. and D. Kaiser. 1990b. Cell alignment required in differentiation of *Myxococcus xanthus*. *Science* 249: 926-928.
- Kurjan, J. 1993. The Pheromone Response pathway in *Saccharomyces cerevisiae*. *Annu. Rev. Genet.* 27: 147-179.
- Leonard, B.A.B., A. Podbielski, P.J. Hedberg and G.M. Dunny. 1996. *Enterococcus faecalis* pheromone binding protein, PrgZ, recruits a chromosomal oligopeptide permease system to import sex pheromone cCF10 for induction of conjugation. *Proc. Natl. Acad. Sci. USA* 93: 260-264.
- Magnuson, R., J. Solomon and A.D. Grossman. 1994. Biochemical and genetic characterization of a competence pheromone from *B. subtilis*. *Cell* 77: 207-216.
- Marcus, S., A. Polverino, M. Barr and M. Wigler. 1994. Complexes between STE5 and components of the pheromone-responsive mitogen-activated protein kinase module. *Proc. Natl. Acad. Sci. USA* 91: 7762-7766.
- Meighen, E.A. 1991. Molecular biology of bacterial bioluminescence. *Microbiol. Rev.* 55: 123-142.
- Moré, M.I., D.L. Finger, J.L. Stryker, C. Fuqua, A. Eberhard and S.C. Winans. 1996. Enzymatic synthesis of a quorum-sensing autoinducer through use of defined substrates. *Science* 272: 1655-1658.
- Mori, M., Y. Sakagami, Y. Ishii, A. Isogai, C. Kitada, M. Fujino, J.C. Adsit, G.M. Dunny and A. Suzuki. 1988. Structure of cCF10, a peptide sex pheromone which induces conjugative transfer of the *Streptococcus faecalis* tetracycline resistance plasmid, pCF10. *J. Biol. Chem.* 263: 14574-14578.
- Msadek, T., F. Kunst, A. Klier and G. Rapoport. 1991. DegS-DegU and ComP-ComA modulator-effector pairs control expression of the *Bacillus subtilis* pleiotropic regulatory gene *degQ*. *J. Bacteriol.* 173: 2366-2377.
- Nakayama, J., R.E. Ruhfel, G.M. Dunny, A. Isogal and A. Suzuki. 1994. The *prgQ* gene of the *Enterococcus faecalis* tetracycline resistance plasmid pCF10 encodes a peptide inhibitor, iCF10. *J. Bacteriol.* 176: 7405-7408.
- Ninfa, A.J. and B. Magasanik. 1986. Covalent modification of the *glnG* product, NRI, by the *glnL* product, NRII, regulates the transcription of the *glnALG* operon in *Escherichia coli*. *Proc. Nat. Acad. Sci. USA* 83: 5909-5913.
- Ohlsen, K.L., J.K. Grimsley and J.A. Hoch. 1994. Deactivation of the sporulation transcription factor Spo0A by the Spo0E protein phosphatase. *Proc. Natl. Acad. Sci. USA* 91: 1756-1760.

- Onaka, H., N. Ando, T. Nihira, Y. Yamada, T. Beppu and S. Horinouchi. 1995. Cloning and characterization of the A-Factor receptor gene from *Streptomyces griseus*. *J. Bacteriol.* **177**: 6083-6092.
- Perego, M., P. Glaser and J.A. Hoch. 1996. Aspartyl-phosphate phosphatases deactivate the response regulator components of the sporulation signal transduction system in *Bacillus subtilis*. *Mol. Microbiol.* **19**: 1151-1157.
- Perego, M., C. Hanstein, K.M. Welsh, T. Djavakhishvili, P. Glasser and J.A. Hoch. 1994. Multiple protein-aspartate phosphatases provide a mechanism for the integration of diverse signals in the control of development in *B. subtilis*. *Cell* **79**: 1047-1055.
- Perego, M. and J.A. Hoch. 1996a. Cell-cell communication regulates the effects of protein aspartate phosphatases on the phosphorelay controlling development in *Bacillus subtilis*. *Proc. Natl. Acad. Sci. USA* **93**: 1549-1553.
- Perego, M. and J.A. Hoch. 1996b. Protein aspartate phosphatases control the output of two-component signal transduction systems. *Trends Genet.* **12**: 97-101.
- Pestova, E.V., L.S. Håvarstein and D.A. Morrison. 1996. Regulation of competence for genetic transformation in *Streptococcus pneumoniae* by an auto-induced peptide pheromone and a two-component regulatory system. *Molecular Microbiology* **21**: 853-862.
- Printen, J.A. and G.F. Sprague Jr. 1994. Protein-protein interactions in the yeast pheromone response pathway: Ste5p interacts with all members of the MAP kinase cascade. *Genetics* **138**: 609-619.
- Quadri, L.E.N., K.L. Roy, J.C. Vederas and M.E. Stiles. 1995. Characterization of four genes involved in the production of antimicrobial peptides by *Carnobacterium piscicola* LV17B. Published DNA sequence with accession number L47121. .
- Ruhfel, R.E., D.A. Manias and G.M. Dunny. 1993. Cloning and characterization of a region of the *Enterococcus faecalis* conjugative plasmid, pCF10, encoding a sex pheromone-binding function. *J. Bacteriol.* **175**: 5253-5259.
- Salmond, G.P.C., B.W. Bycroft, G.S.A.B. Stewart and P. Williams. 1995. The bacterial 'enigma': cracking the code of cell-cell communication. *Mol. Microbiol.* **16**: 615-624.
- Solomon, J.M. and A.D. Grossman. 1996. Who's competent and when: regulation of natural genetic competence in bacteria. *Trends Genet.* **12**: 150-155.

- Solomon, J.M., B.A. Lazazzera and A.D. Grossman. 1996. Purification and characterization of an extracellular peptide factor that affects two different developmental pathways in *Bacillus subtilis*. *Genes & Dev.* 10: 2014-2024.
- Sprague Jr., G.F. and J.W. Thorner. 1992. Pheromone response and signal transduction during the mating process of *Saccharomyces cerevisiae*, p. 657-744. In *Volume II: The Molecular and Cellular Biology of the Yeast Saccharomyces: Gene Expression* (ed. E.W. Jones, J.R. Pringle and J.R. Broach). Cold Spring Harbor Laboratory Press, Cold Spring Harbor, NY.
- Stock, J.B., M.G. Surette, M. Levit and P. Park. 1995. Two-component signal transduction systems: structure-function relationships and mechanisms of catalysis, p. 53-66. In *Two-Component Signal Transduction* (ed. J.A. Hoch and T.J. Silhavy). American Society for Microbiology, Washington, D.C.
- Tomasz, A. and R.D. Hotchkiss. 1964. Regulation of the transformability of pneumococcal cultures by macromolecular cell products. *Proc. Nat. Acad. Sci. USA* 51: 480-487.
- Tomasz, A. and J.L. Mosser. 1966. On the nature of the pneumococcal activator substance. *Proc. Natl. Acad. Sci. USA* 55: 58-66.
- Trach, K., J.W. Chapman, P.J. Piggot and J.A. Hoch. 1985. Deduced product of the stage 0 sporulation gene *spo0F* shares homology with the Spo0A, OmpR, and SfrA proteins. *Proc. Natl. Acad. Sci. USA* 82: 4189-4192.
- Weinrauch, Y., R. Penchev, E. Dubnau, I. Smith and D. Dubnau. 1990. A *Bacillus subtilis* regulatory gene product for genetic competence and sporulation resembles sensor protein members of the bacterial two-component signal-transduction systems. *Genes and Dev.* 4: 860-872.
- Weiss, V. and B. Magasanik. 1988. Phosphorylation of nitrogen regulator I (NRI) of *Escherichia coli*. *Proc. Nat. Acad. Sci. USA* 85: 8919-8923.
- Winson, e.a. 1995. Multiple N-acyl-L-homoserine lactone signal molecules regulate production of virulence determinants and secondary metabolites in *Pseudomonas aeruginosa*. *Proc. Natl. Acad. Sci. USA* 92: 9427-9431.