

**Structural Systems and Tuned Mass Dampers of Super-Tall Buildings:
Case Study of Taipei 101**

by

Ioannis Kourakis

Diploma in Civil Engineering
Aristotle University of Thessaloniki, 2005

SUBMITTED TO THE DEPARTMENT OF CIVIL AND ENVIRONMENTAL ENGINEERING IN
PARTIAL FULFILLMENT OF THE REQUIREMENTS FOR THE DEGREE OF

MASTER OF ENGINEERING IN CIVIL AND ENVIRONMENTAL ENGINEERING
AT THE
MASSACHUSETTS INSTITUTE OF TECHNOLOGY

JUNE 2007

© 2007 Ioannis Kourakis. All rights reserved.

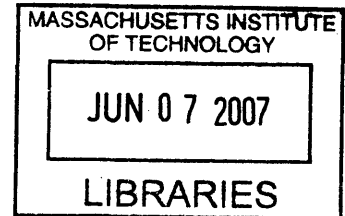

The author hereby grants to MIT permission to reproduce and to distribute publicly paper and electronic copies of this thesis document in whole or in part in any medium now known or hereafter created.

Signature of Author: _____
Department of Civil and Environmental Engineering
May 14, 2007

Certified by: _____
Professor of Civil and Environmental Engineering
Thesis Supervisor
Jerome J. Connor

Accepted by: _____
Chairman, Departmental Committee for Graduate Students
Daniele Veneziano

Structural Systems and Tuned Mass Dampers of Super-Tall Buildings: Case Study of Taipei 101

by

Ioannis Kourakis

Submitted to the Department of Civil and Environmental Engineering
on May 14, 2007 in Partial Fulfillment of the
Requirements for the Degree of Master of Engineering in
Civil and Environmental Engineering

ABSTRACT

The design of the first generation of skyscrapers was based on strength. Heavy masonry cladding and wall curtains used at that period added a considerable amount of stiffness and damping to the structure. Inter-storey drifts and peak accelerations were relatively small. Advances in the material science technology enabled the use of high-performance concrete, steel and composite sections. The former combined with the use of sophisticated 3-D structural design software packages resulted in the evolution of a new generation of more economical and structurally efficient skyscrapers. However, the increased flexibility and lower damping makes these structures more vulnerable to wind induced vibrations, causing severe human discomfort due to excessive accelerations. Several solutions have been engineered to mitigate the motions of Super-Tall buildings including structural, aerodynamic and auxiliary changes with the goal of increasing the inherent damping of the building. The current thesis is comprised of three parts: a review of past and current trends in structural systems of tall buildings, including a comparison of the twenty tallest buildings globally; an investigation of passive control-Tuned Mass Dampers-with also several examples of structures which have such a system; and a demonstration of the effectiveness of Tuned Mass Dampers through a case study of the current tallest building to the structural top in the world, a 508m tremendous architectural, engineering and construction achievement - Taipei 101. The change in the response of the tower due to a wind-induced vibration is illustrated by performing a time-history analysis with and without the TMD in a SAP2000 model. Finally, recommendations for future research in the field of distributed TMDs are offered.

Thesis Supervisor: Jerome J. Connor

Title: Professor of Civil and Environmental Engineering

Acknowledgements

First and foremost, I would like to thank my parents, Anna and Andreas Kouraki, for helping me come to this point in my life. Their principles, guidance and continuous help over the years have been invaluable to me and I am deeply grateful.

Professor Jerome J. Connor has been more than an academic advisor to me throughout the year. He truly mentored me on personal, professional and academic levels. His invaluable knowledge and experience shed light on many of my concerns and our discussions have contributed much to all my accomplishments here at MIT.

Bahjat Dagher and Andres de Antonio Crespo have been next to me throughout this year as classmates, friends and will continue to be as my future colleagues in New York City. Their support has meant much to me. They and the rest of the M.Eng. Class of 2007 have given me a year of great memories and friendships.

Finally, I would like to thank Drew Reese for her emotional support and companionship these last few weeks. She always knew when I needed another Boston Kreme to get the job done.

Table of Contents

Acknowledgements	- 3 -
1. Introduction: Human need to go higher and higher	- 8 -
1.1 Skyscraper Evolution.....	- 10 -
2. Structural Systems of Tall Buildings.....	- 11 -
2.1 Floor Systems	- 12 -
2.1.1 Concrete Floor Systems	- 12 -
2.1.2 Steel Floor Systems	- 12 -
2.2 Vertical Load Resisting Systems.....	- 12 -
2.3 Lateral Load Resisting Systems.....	- 13 -
2.3.1 Moment Resisting Frames	- 13 -
2.3.2 Braced Frames.....	- 14 -
2.3.3 Staggered Truss System.....	- 16 -
2.4 Outrigger and Belt Truss System	- 18 -
2.5 Framed Tube System.....	- 19 -
2.6 Trussed Tube	- 20 -
2.7 Bundled Tube.....	- 20 -
3. Comparison of Structural Systems of the twenty tallest buildings in the world	- 21 -
3.1 #1: Taipei 101 – 509m (Taipei)	- 22 -
3.2 #2,3: Petronas Towers 1&2 – 452m (Kuala Lumpur).....	- 22 -
3.3 #4: Sears Tower – 442m (Chicago)	- 23 -
3.4 #5: Jin Mao Tower – 421m (Shanghai)	- 23 -
3.5 #6: Two International Finance Center – 415m (Hong Kong).....	- 24 -
3.6 #8: Shun Hing Square – 384m (Shenzhen)	- 24 -
3.7 #9: Empire State Building – 381m (New York City).....	- 25 -
3.8 #10: Central Plaza – 374m (Hong Kong)	- 25 -
3.9 #11: Bank of China Tower – 367m (Hong Kong)	- 26 -
3.10 #16: John Hancock Center – 344m (Chicago)	- 26 -
3.11 New Generation of Skyscrapers.....	- 27 -
3.12 Human comfort in Tall buildings – Motion Criteria.....	- 27 -
4. The need for damping devices in structures	- 31 -
5. Tuned Mass Damper (TMD)	- 34 -
5.1 Introduction.....	- 34 -
5.2 Active TMD.....	- 36 -

6.	Case Studies: Tall buildings with TMD.....	- 37 -
6.1	John Hancock Tower, Boston: two 300-ton TMDs.....	- 38 -
6.2	Citicorp Tower, New York City: 400-ton TMD	- 39 -
6.3	Canadian National Tower: Two 9-ton TMD	- 40 -
6.4	Chiba Port Tower: 10-ton TMD	- 40 -
6.5	Crystal Tower, Japan: two TMD	- 41 -
6.6	Trump World Tower, New York: 600 ton TMD	- 42 -
6.7	Taipei 101: 730 ton TMD.....	- 43 -
7.	Case Study: Taipei 101.....	- 44 -
7.1	Design Development.....	- 45 -
7.1.1	Architectural Shaping	- 45 -
7.1.2	Exterior symbolism – Feng Shui.....	- 46 -
7.1.3	Native Bamboo Plant analogy	- 47 -
7.1.4	Leasing.....	- 47 -
7.1.5	Vertical Transportation Scheme	- 49 -
7.1.6	Structural System	- 50 -
7.1.7	Wind Engineering	- 55 -
7.2	Taipei 101 Modeling strategy	- 58 -
7.2.1	Modal Analysis	- 59 -
7.2.2	TMD modeling	- 60 -
7.2.3	Time History Analysis	- 61 -
8.	Overall Conclusions and Outlook.....	- 64 -
	Appendix 1 – Various floorplans and elevation schematics	- 65 -
	Appendix 2 – Calculations of Equivalent Beam	- 67 -
	References.....	- 68 -

List of Figures

Figure 1: The Tower of Babel, by Pieter Brueghel the Elder (1563) [2]	- 8 -
Figure 3: The Pyramids of Giza [4]	- 9 -
Figure 4: The Pharos of Alexandria, 290 B.C. [5]	- 9 -
Figure 5: Classification of Structural Systems of Buildings, by Dr. Hal S. Iyengar (1972)	- 11 -
Figure 6: A typical 9-story moment Frame	- 13 -
Figure 7 : Typical concentric braced Frame (CFB) configurations: (a) one-story x-bracing; (b) single diagonal bracing; (c), (d) chevron bracing; (e) single diagonal, alternate direction bracing; (f) two-story X-bracing	- 14 -
Figure 8: Common Types of Eccentric Braced Frames	- 15 -
Figure 9: Staggered Truss Arrangement (a) and Basic Concept (b)	- 16 -
Figure 10: Longitudinal Elevation (a); Double-Planar braced Frame (b)	- 17 -
Figure 11: Column orientation-Plan view	- 17 -
Figure 12: Double Outrigger effect to a tall building [10].....	- 18 -
Figure 13: Single Outrigger and belt truss schematic elevation [8].....	- 18 -
Figure 14: Framed tube construction principle: load-bearing external walls stiffened by the floors to form a torsionally rigid tube [11].....	- 19 -
Figure 15: Axial stress distribution in square hollow tube with and without shear lag [8]	- 19 -
Figure 16: John Hancock Center, Chicago. A trussed tube system [12].....	- 20 -
Figure 17: Bundled Tube Concept [8]	- 20 -
Figure 18: Various perception criteria for occupant comfort [26]	- 28 -
Figure 19: Aerodynamic Modifications to Square Building Shape	- 32 -
Figure 20: Shanghai WFC opening.....	- 33 -
Figure 21: Schematic of a TMD [17]: As the building sways to the left, the TMD moves to the right.....	- 35 -
Figure 22: TMD in Motion; Picture courtesy of J.J.Connor	- 35 -
Figure 23: Conceptual Diagram of an Active TMD (Kajima Corporation) [18]	- 36 -
Figure 24: Dual TMD system [8]	- 38 -
Figure 27: CN Tower [19].....	- 40 -
Figure 28: TMD of Chiba Port Tower, Japan; Picture courtesy of J.J. Connor	- 40 -
Figure 29: Layout of the ice-storage tanks that were used as pendulum dampers [17].....	- 41 -
Figure 30: Pendulum Damper (left) and Ice Storage Tank (right) used as the hanging mass; Pictures courtesy of J.J.Connor	- 41 -

Figure 31: Trump World Tower, NYC: The tallest residential building in the world; Picture courtesy of Motioneering, Inc.....	- 42 -
Figure 32: TMD of the Tower; Picture courtesy of the Bernstein Associates.....	- 42 -
Figure 33: Taipei 101-508m Tall.....	- 43 -
Figure 34: Workers Installing Pinnacle TMDs; Picture courtesy of Motioneering Inc.....	- 43 -
Figure 35: Taipei 101 –With a height of 508m it is currently the tallest building to structural top in the world	- 44 -
Figure 36: C.Y. Lee's renderings of Taipei-101	- 45 -
Figure 37: The "8" figure illustration of Taipei 101	- 46 -
Figure 38: The Chinese Ru-yi symbol (left) being used in Taipei 101	- 47 -
Figure 39: Leasing info [29]	- 48 -
Figure 40: Vertical Transportation Scheme [29]	- 49 -
Figure 41: Structural System [27]	- 50 -
Figure 42: Taipei 101 typical floorplan [28].....	- 51 -
Figure 43: Typical Exterior Moment Frame Elevation [28].....	- 52 -
Figure 44: Super-Columns Cross Section [31]	- 53 -
Figure 45: SuperColumn Cross Section [27]	- 54 -
Figure 46: Tapered flange trimming at selected link beams	- 54 -
Figure 47: Wind Critical Components and eddies generation [35].....	- 55 -
Figure 48: Wind Tunnel Testing of Taipei 101	- 56 -
Figure 49: Stepped corners was the result of Taipei 101's aerodynamic shape optimization [34] -	57 -
Figure 50: TMD of Taipei 101, hanging from floor 92; Picture courtesy of Motioneering, Inc. -	57 -
Figure 51: Equivalent 10-DOF beam model	- 58 -
Figure 52: First, Second and Third mode shapes.....	- 59 -
Figure 53: A simple pendulum Tuned Mass Damper [17].....	- 60 -
Figure 54: Modeling the TMD in SAP2000 using the NLLink option.....	- 60 -
Figure 55: Sinusoidal Wind Excitation, with frequency identical to Taipei 101's first modal frequency	- 61 -
Figure 56: Definition of Time History Case Data in SAP2000.....	- 62 -
Figure 57: Time History Trace of the top node (Model without TMD)	- 63 -
Figure 58: Time History Trace of the top node (Model with TMD)	- 63 -

1. Introduction: Human need to go higher and higher

Tall buildings have a unique appeal, even an air of romance and mystery associated with their design. Throughout the recorded history of building, perhaps nothing is more captivating than the human aspiration to create increasingly tall structures. Pride seems to have been the prime motivation for the building of such ancient structures as the Tower of Babel, Colossus of Rhodes, the pyramids of Egypt and the Pharos of Alexandria. Ego and competition still play a part in determining the height of a building, but various other social factors, such as increases in land values in urban areas and higher density of population, have led to a great increase in the number of tall buildings all over the world. What was once considered to be an American urban phenomenon can now be seen in many small towns and even in an open country. The skylines of the world's cities are continually being pierced by distinct and identifiable tall buildings as impressive as mountain ranges, and reaching upward continues to be the challenge and goal below [1].

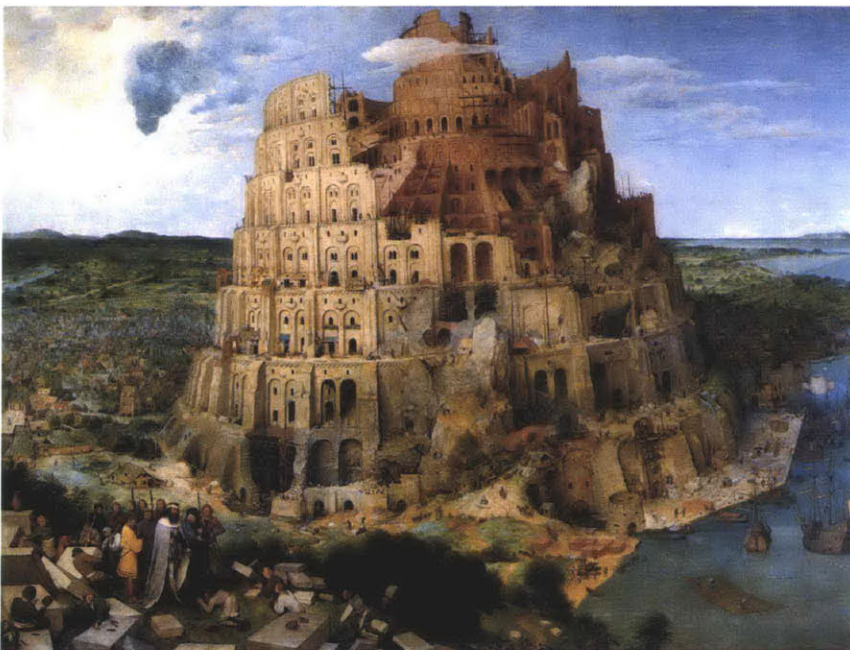

Figure 1: The Tower of Babel, by Pieter Brueghel the Elder (1563) [2]

These huge, squared-off stepped temples were intended as gateways for the gods to come to earth, literal stairways to heaven. "Reaching heaven" is a common description in temple tower inscriptions [2].



The statue itself was over 34 meters (110 feet) tall, straddling the harbor entrance to Rhodes. In 280 BC, 43 years after the death of Alexander the Great, the great statue was completed [3].

Figure 2: Colossus of Rhodes, imagined in a 16th-century engraving by Martin Heemskerck, part of his series of the Seven Wonders of the World [3]



Figure 2: The Pyramids of Giza [4]

In Egypt, kings and queens called pharaohs were buried in very large stone pyramids. There are also ancient pyramids in Africa, the Middle East, Central America, Greece and Rome. The largest of these huge buildings is the great pyramid at Giza near Cairo. It was built by the pharaoh Khafra. It is one of the seven wonders of the ancient world, as listed by the ancient Greeks [4].



Figure 3: The Pharos of Alexandria, 290 B.C. [5]

The Great Lighthouse, or Pharos, of Alexandria-the tallest structure in the ancient world- was built by Alexander the Great. It was 650ft. tall, slightly higher than the Great Pyramid of Cleops. It is one of the seven ancient wonders [6].

1.1 Skyscraper Evolution

In 1885, an American engineer named William LeBaron Jenney became the creator of the modern skyscraper, when he realized that an office building could be constructed using totally different materials. Instead of relying on heavy masonry walls to support the weight of upper floors, he had the ingenious idea of supporting the gravity loads of the 10-story Home Insurance Building in Chicago on a steel framework and hanging the masonry walls from this skeleton [1].

Two technological developments, the elevator (which was introduced in 1853 by Elisha Otis) and modern metal construction, removed the prevailing limitations on the height of the buildings, and the race for tallness was on. Competition to be the leading metropolis as judged by building heights developed between Chicago and New York. By the turn of the century, the downtown business district around Wall Street in New York had achieved the status of the nation's foremost financial center [1].

It is difficult to distinguish the characteristics of a building which categorize it as being tall. After all, the outward appearance of tallness is a relative matter. In a typical single-story area, a five-story building will appear tall. In Europe, a 20-story building in a city may be called a high rise, but the citizens of a small town may point to their skyscraper of six floors. In large cities as Chicago or Manhattan, which are comprised of a vast number of tall buildings, a structure must pierce the sky around 70 to 100 stories if it is to appear tall in comparison with its immediate neighbors. Tall building cannot be defined in specific terms related to height or number of floors. There is no consensus on what constitutes a tall building or at what magic height, number of stories, or proportion of a building can be called tall [1].

The author supports the opinion of the characterization of a building as tall, when its structural analyses and design are mainly governed by lateral loads (wind) versus gravity loads.

2. Structural Systems of Tall Buildings

The components of a tall building could be categorized as follows [7]:

Floor Systems, Vertical Load Resisting Systems, Lateral Loads Resisting Systems, Connections, Energy Dissipation Systems and Damping. Khan, Iyengar and Colaco (1972) have classified the structural systems which are most commonly used in the following graph.

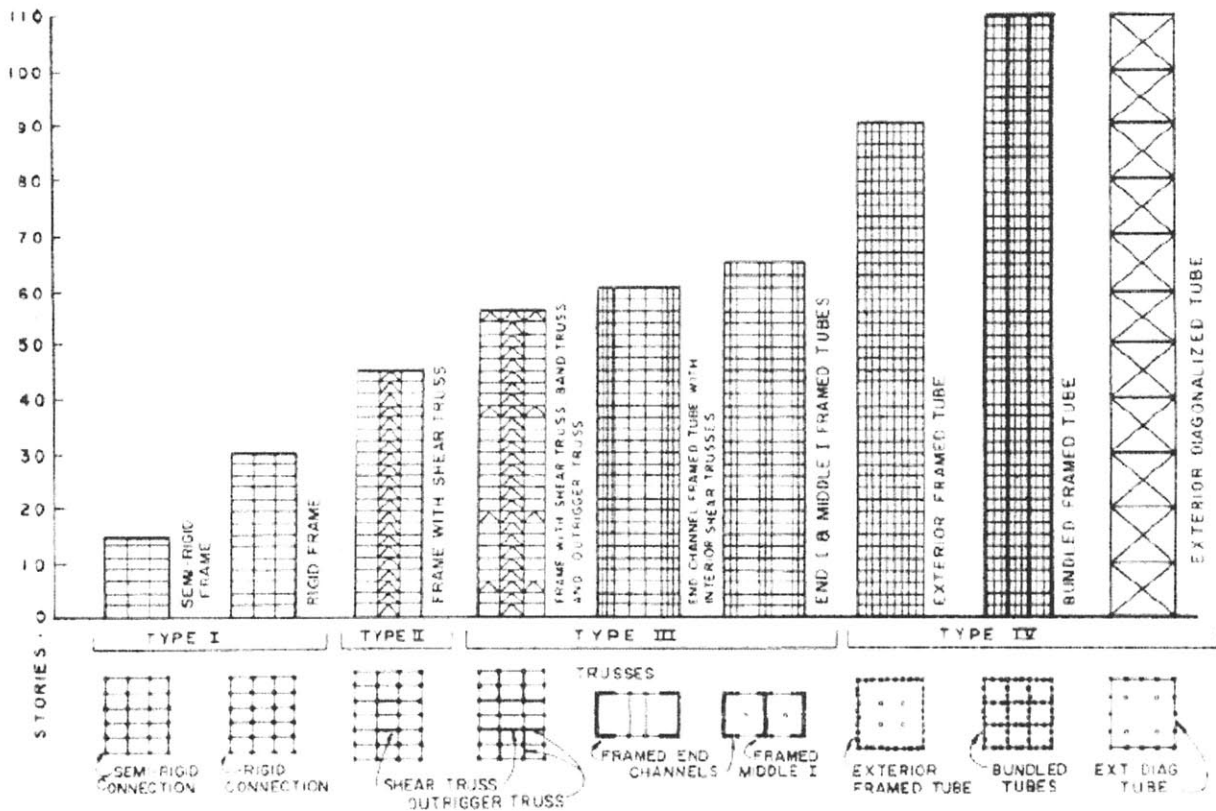

Figure 4: Classification of Structural Systems of Buildings, by Dr. Hal S. Iyengar (1972)

2.1 Floor Systems

The floor carries the gravity during and after construction. It also resists lateral loads through diaphragm action by providing a continuous path for transferring lateral loads from the bottom chord of one truss to the top chord of the adjacent truss down the structure. Finally, it accommodates the mechanical systems (heating, ventilating and air conditioning). It should also have fire resistance properties. It can be classified as: two-way systems, one-way systems and beam and slab systems. Two-way systems include flat plates supported by columns, flat slabs supported by columns with capitals or drop panels. Slab of constant thickness, slabs with waffles and two-way joists are also used. One-way systems include slabs of constant thickness with spans 3m to 8m [7].

2.1.1 Concrete Floor Systems

Slabs of constant thickness are often used with spans 3m to 8m. One or two-way systems can be used. The beams are spaced 3m to 8m, and they have usually a depth of $L/15$ to $L/20$.

2.1.2 Steel Floor Systems

Reinforce concrete on steel beams is used in Steel Floor Systems. The thickness of the slabs is in the range of $L/30$ to $L/15$ of the span. The spans can be between 1.2 to 9m. Pre-cast concrete slabs (with grouted shear connectors), or concrete slabs on metal decking (with shear connection) are often used.

2.2 Vertical Load Resisting Systems

Vertical elements are columns, shear walls, hangers, transfer girders and suspended systems such as cable suspended floors. Steel, concrete or composite materials are used. Shear walls carry the loads in compression, and sometimes, like staggered trusses between floors. Transfer girders are used to bridge large openings at lower levels of a tall building.

2.3 Lateral Load Resisting Systems

In contrast with the vertical load, lateral load effects on buildings are quite variable and increase rapidly with increase in height. For example, under wind load the overturning moment at the base of the building varies in proportion with the square of the height of the building, and lateral deflection varies as the fourth power of the building [1]. The essential role of the lateral system is to carry the wind and earthquake loads, as well as to resist the P-Delta effects due to secondary moments in columns, and to keep the inter-storey drift in a minimum range. The following lateral systems exist:

2.3.1 Moment Resisting Frames

They are column and girder plane frames with fixed or semi-rigid connections. They can be constructed from concrete, steel or composite materials. One can observe from Figure 5, that moment resisting frames can be sufficient for a building up to 30 stories.

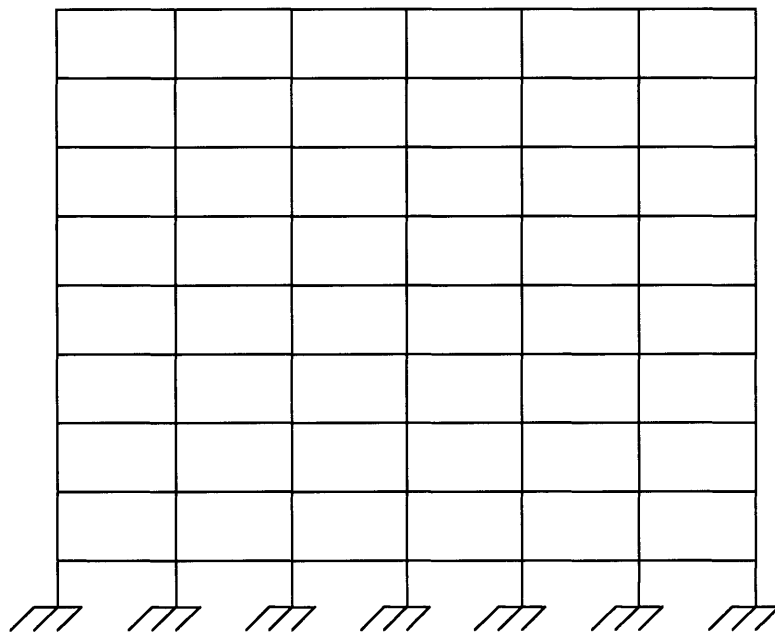

Figure 5: A typical 9-story moment Frame

2.3.2 Braced Frames

Braced Frames may be grouped into two categories, as either concentric braced frames (CBF) or eccentric braced frames (EBF), depending on their geometric characteristics [7].

CBF (the axes of all members-i.e. columns, beams and braces- intersect at a common point such that the member forces are axial. They can be configured in various forms, such as the following figures:

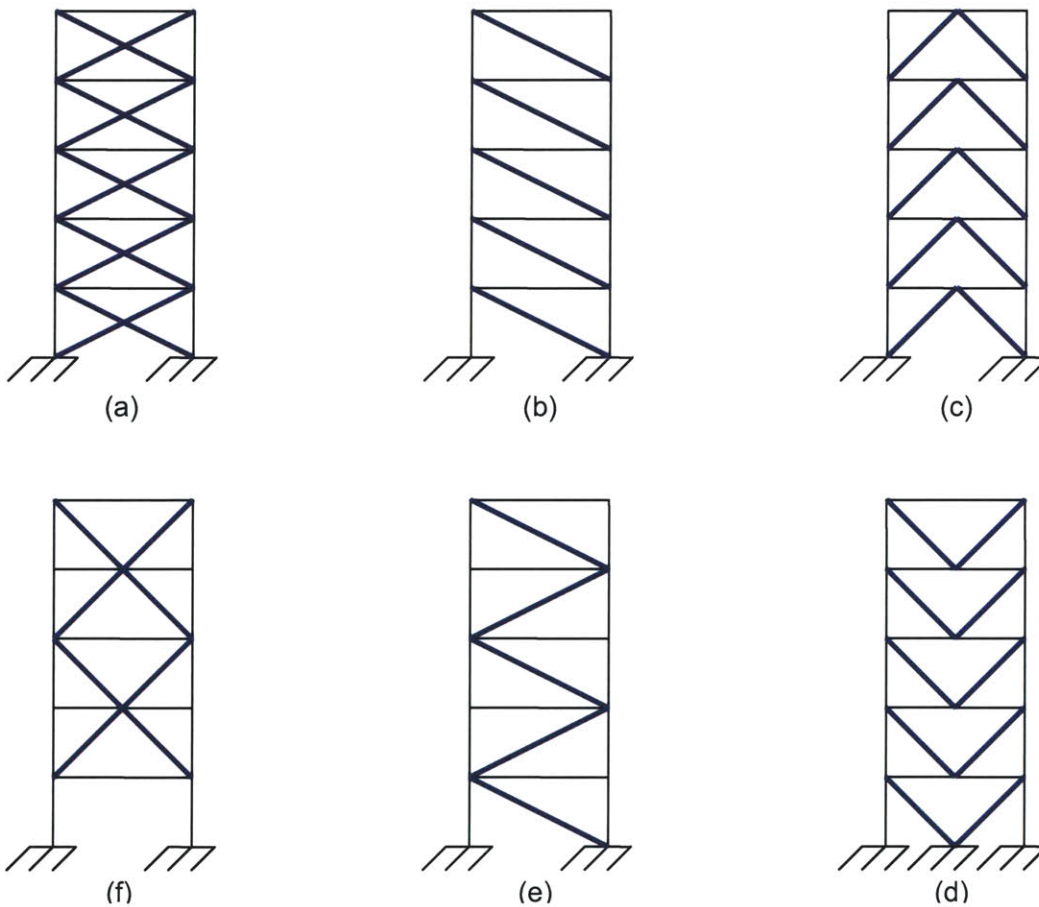

Figure 6 : Typical concentric braced Frame (CBF) configurations: (a) one-story x-bracing; (b) single diagonal bracing; (c), (d) chevron bracing; (e) single diagonal, alternate direction bracing; (f) two-story X-bracing

EFB (eccentric braced frames) utilize axis offsets to deliberately introduce flexure and shear into frame beams. The primary goal is to increase ductility. Eccentric beam elements yielding either in shear or in bending act as fuses to dissipate energy during severe earthquakes. The yielding of the link does not cause the structure to collapse because the structure continues to retain its vertical load-carrying capacity.

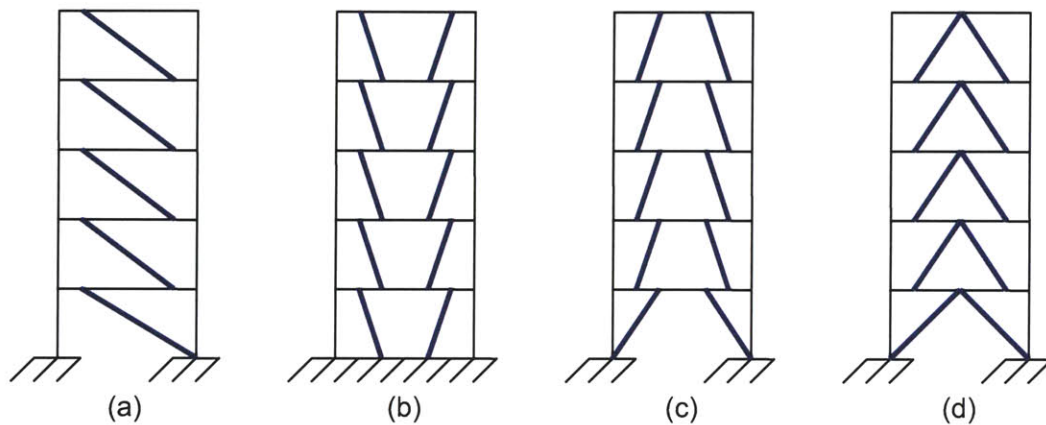

Figure 7: Common Types of Eccentric Braced Frames

Eccentric braced frames can be configured in various forms as long as the brace is connected to at least one link. The underlying principle is to prevent buckling of the brace from large overloads that may occur during major earthquakes. This is achieved by designing the link to yield prior to distress in other structural elements.

The most efficient (but also the most obstructive) types of bracing are those that form a fully triangulated vertical truss.

2.3.3 Staggered Truss System

The concept of the Staggered Truss System was developed by a team of architects and engineers from the Departments of Architecture and Civil Engineering at the Massachusetts Institute of Technology (M.I.T.) who combined their respective talents to achieve this imaginative and efficient steel framing system. The system consists of a series of story-high trusses spanning the total width between two rows of exterior columns and arranged in a staggered pattern on adjacent column lines, as shown in the following figures [9].

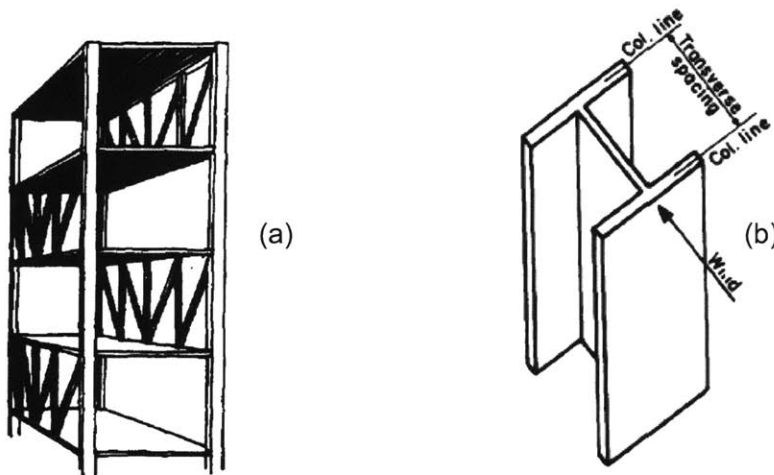

Figure 8: Staggered Truss Arrangement (a) and Basic Concept (b)

The basic concept of the staggered truss system is that the total frame of the building behaves as a cantilever beam when subjected to lateral loads. In this context, all columns are placed on the exterior wall of the building and function as flanges of the beam, while the trusses which span the total transverse width between columns function as the web of the cantilever beam (Figure 9b). With the columns only on the exterior walls of the building, the usual interior columns are omitted, thus providing a full width of column-free area.

The floor system spans from the top chord of one truss to the bottom chord of the adjacent truss. Therefore, the floor becomes a major component of the structural system as a diaphragm transferring the lateral shears from one column line to another, this enabling the structure to perform as a single braced frame, even though the trusses lie in two parallel lines.

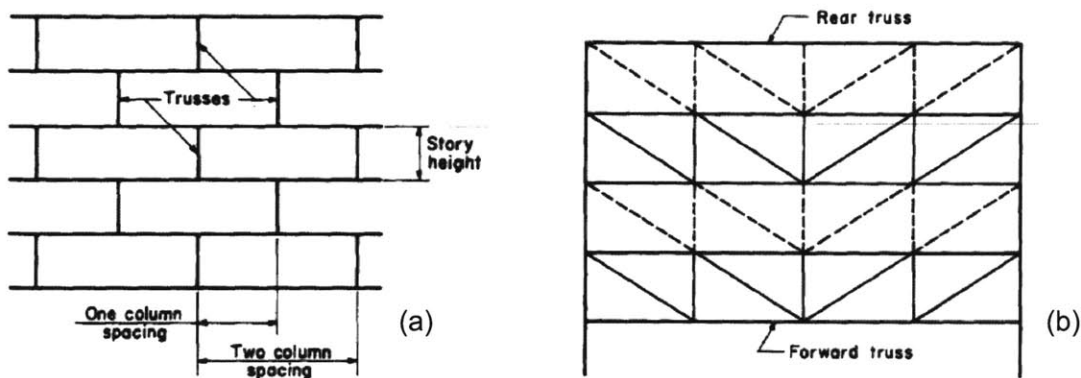
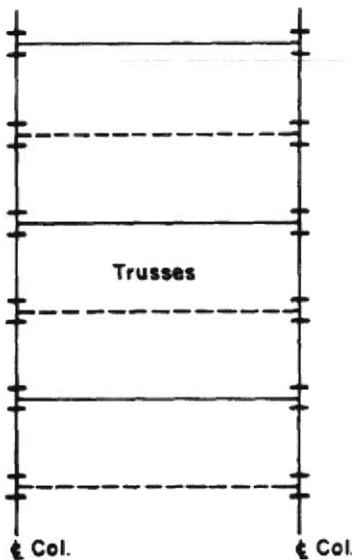

Figure 9: Longitudinal Elevation (a); Double-Planar braced Frame (b)



The cantilever action of the double-planar truss system (Figure 10b) due to lateral loads minimizes the bending moments in the columns. Therefore, in general, the columns are designed for axial loads only and can be oriented with their webs perpendicular to the trusses, thus eliminating local bending due to the connection of the truss chord.

Figure 10: Column orientation-Plan view

2.4 Outrigger and Belt Truss System

The structural arrangement for an outrigger system consists of a main core connected to the exterior columns by relatively stiff horizontal members commonly referred to as outriggers. The main core may consist of a steel braced frame or reinforced concrete shear walls, and may be centrally located with outriggers extending on both sides. It may also be located on one side of the building with outriggers extending to the building columns on one side [7].

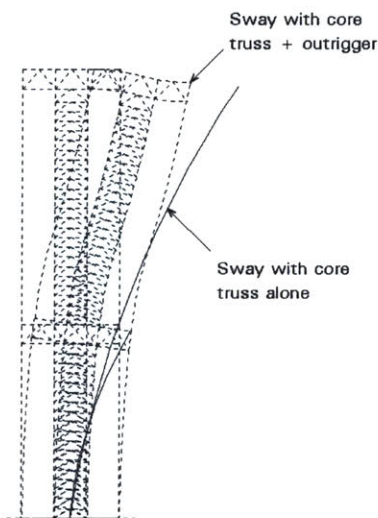

Figure 11: Double Outrigger effect to a tall building [10]

The structural response is quite simple: When subjected to lateral loads, the column-restrained outriggers resist the rotation of the core, causing the lateral deflections and moments in the core to be smaller than if the freestanding core alone resisted the loading. The external moment is now resisted not by bending of the core alone, but also by the axial tension and compression of the exterior columns connected to the outriggers [7].

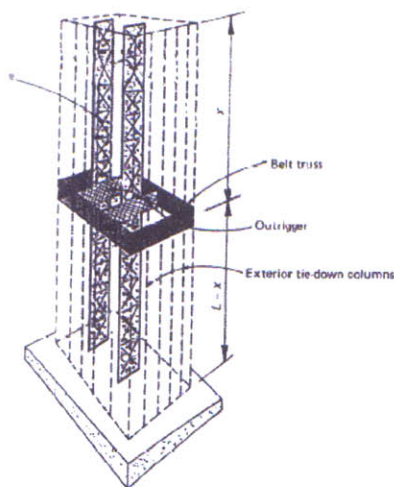
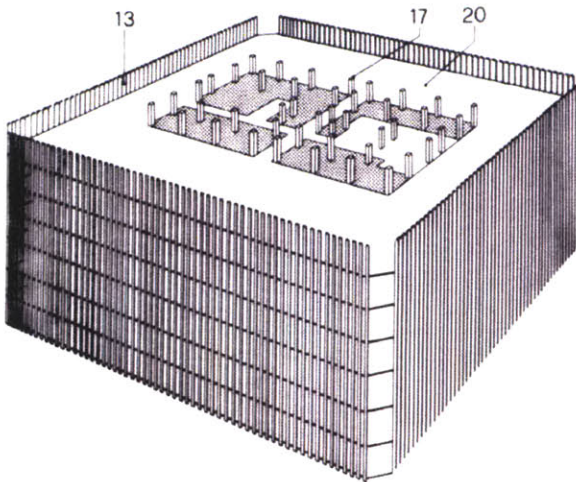

Figure 12: Single Outrigger and belt truss schematic elevation [7]

In addition to those columns located at the ends of the outriggers, it is also common to mobilize other peripheral columns to assist the restraining of the outriggers. This is achieved by including a “belt truss”, around the structure at the level of the outriggers. To make the outriggers and belt truss adequately stiff in flexure and shear, they are made at least one to two stories deep [7].

2.5 Framed Tube System



A framed tube can be defined as a three dimensional system utilized the entire building perimeter to resist lateral loads. A necessary requirement to achieve a behavior like this is to place columns on the building exterior relatively close to each other, joined by deep spandrel girders. Columns are usually placed 10-20ft apart, with spandrel depths varying from 3 to 5ft [7].

Figure 13: Framed tube construction principle: load-bearing external walls stiffened by the floors to form a torsionally rigid tube [11]

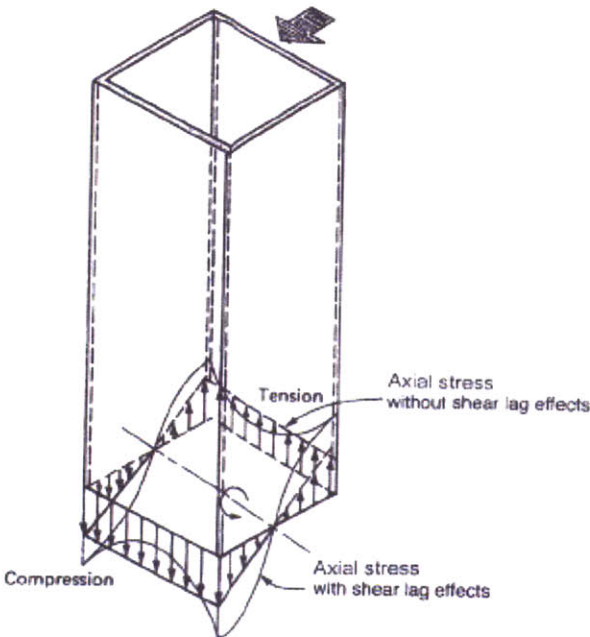

Although the structure has a tubelike form, its behavior is much more complex than that of a solid tube. Unlike a solid tube, it is subjected to the effects of shear lag, which have a tendency to modify the axial distribution in the columns. The axial stiffness in the corner columns is increased and the stiffness in the inner columns is decreased. The stresses in the inner columns lag behind those in the corner columns (due to the bending of the connecting spandrel), hence the term shear lag.

Figure 14: Axial stress distribution in square hollow tube with and without shear lag [7]

2.6 Trussed Tube



Figure 15: John Hancock Center, Chicago. A trussed tube system [12]

A trussed tube improves on the efficiency of the framed tube by increasing its potential for use in taller buildings and allowing greater spacing between the columns. This is achieved by adding diagonal bracing at the faces of the tube to virtually eliminate the shear lag in both the flange and web frames.

2.7 Bundled Tube

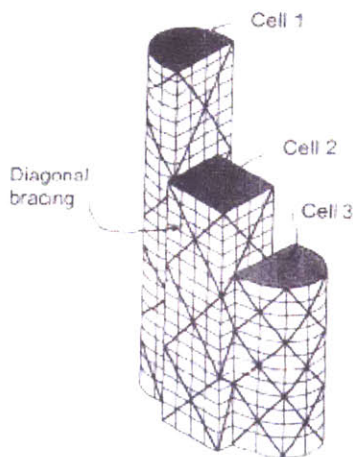

Figure 16: Bundled Tube Concept [7]

A bundled tube consists typically of a number of tubes interconnected to form a multicell tube, in which the frames in the lateral load direction resist the shears, while the flange frames carry most of the overturning moments. The cells can be curtailed at different heights without diminishing structural integrity. The shear lag experienced by conventional framed tubes is greatly reduced by the addition of interior framed web panels across the entire width of the building. When the building is subjected to bending under the action of lateral forces, the high in-plane rigidity of the floor slabs constrains the interior web flanges to deflect equally with the exterior web frames. Because a bundled tube is configured from a layout of individual tubes, it is possible to achieve a variety of floor configurations by simply terminating a given tube at any desired level.

3. Comparison of structural systems of the twenty tallest buildings in the world

The author believes that the best way of understanding how the above structural systems are implemented would be to review the solutions that structural engineers gave to existing buildings. Therefore, a review of a selection from the twenty tallest buildings in the world is being performed. "Emporis Buildings", the largest international real estate-buildings database, was used for this research [13].

#	Building	City	Height	Height	Floors	Year
1.	Taipei 101	 Taipei	509 m	1,671 ft	101	2004
2.	Petronas Tower 1	 Kuala Lumpur	452 m	1,483 ft	88	1998
3.	Petronas Tower 2	 Kuala Lumpur	452 m	1,483 ft	88	1998
4.	Sears Tower	 Chicago	442 m	1,451 ft	108	1974
5.	Jin Mao Tower	 Shanghai	421 m	1,380 ft	88	1998
6.	Two International Finance..	 Hong Kong	415 m	1,362 ft	88	2003
7.	CITIC Plaza	 Guangzhou	391 m	1,283 ft	80	1997
8.	Shun Hing Square	 Shenzhen	384 m	1,260 ft	69	1996
9.	Empire State Building	 New York City	381 m	1,250 ft	102	1931
10.	Central Plaza	 Hong Kong	374 m	1,227 ft	78	1992
11.	Bank of China Tower	 Hong Kong	367 m	1,205 ft	70	1990
12.	Emirates Office Tower	 Dubai	355 m	1,163 ft	54	2000
13.	Tuntex Sky Tower	 Kaohsiung	348 m	1,140 ft	85	1997
14.	Aon Center	 Chicago	346 m	1,136 ft	83	1973
15.	The Center	 Hong Kong	346 m	1,135 ft	73	1998
16.	John Hancock Center	 Chicago	344 m	1,127 ft	100	1969
17.	Rose Tower *	 Dubai	333 m	1,093 ft	72	2007
18.	Shimao International Plaz..	 Shanghai	333 m	1,093 ft	60	2006
19.	Minsheng Bank Building *	 Wuhan	331 m	1,087 ft	68	2007
20.	Ryugyong Hotel	 Pyongyang	330 m	1,083 ft	105	1992

Table 1: World's twenty tallest buildings

Source: © Emporis 12/2006

3.1 #1: Taipei 101 – 509m (Taipei)



The key features of the Structural System are 8 steel composite steel-concrete supercolumns (8'x10'), 8 outrigger trusses in both directions (every 8 storeys), a braced core and the largest Tuned Massed Damper (TMD) in the world-730 tons [14]. Furthermore, setbacks in the floor plan “confuse” the wind and reduce vortex shedding.

3.2 #2,3: Petronas Towers 1&2 – 452m (Kuala Lumpur)



Concrete Cores, Columns and Ring Beams, Steel Floor Beams and cantilevered “Points and arcs” are the main features of the Petronas Towers. Concrete of strengths up to 80Mpa was used. Furthermore, one TMD in each leg of the sky bridge was tuned to the frequency of each of the three mode shapes, based on field measurements [14].

3.3 #4: Sears Tower – 442m (Chicago)



Nine square tubes of varying heights are bundled together to create the larger overall tube. Each tube comprises columns at 15ft centers connected by stiff beams. Two adjacent tubes share one set of columns and beams. At three levels, the tubes incorporate trusses, provided to make the axial column loads more uniform where tube drop-offs occur [15].

3.4 #5: Jin Mao Tower – 421m (Shanghai)



A central reinforced concrete core linked to exterior composite megacolumns (up to 5x16ft) by outrigger trusses are the primary components of the structural system. A central shear-wall core houses the primary building functions. The outrigger trusses are located between three different levels. The truss between the levels 85 and 87 is capped with a three-dimensional steel space. Maximum Wind Speed is 125 mph at the top [7].

3.5 #6: Two International Finance Center – 415m (Hong Kong)

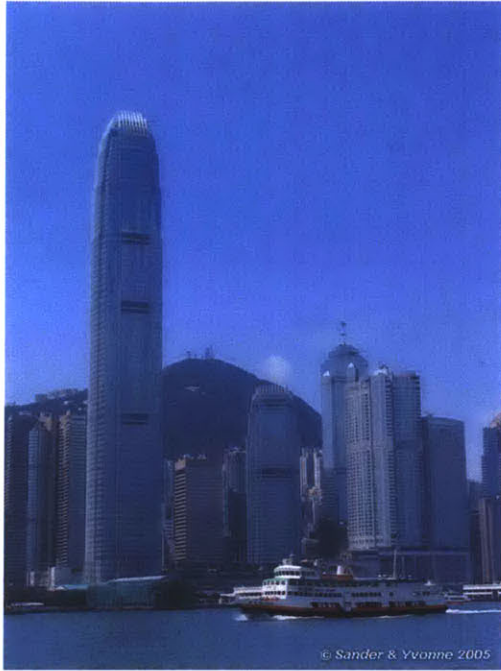

The fundamental requirement for flexible office layouts led to an outrigger lateral stability solution employing eight megacolumns (two per face) with small secondary columns in the four corners. The outriggers mobilized the columns directly without the need for truss through a belt truss system. A less accentuated belt truss system was incorporated however into some floors, to accept the heavy plant room floor loadings and transfer the secondary corner column loads into megacolumns [16].

3.6 #8: Shun Hing Square – 384m (Shenzhen)



The main frame is supported on trussed girders spanning foyer spaces. A large A-frame braces the structure down the entrance hall. The modeling of the tower facades recalls the Mandarin “mei”, which means “beauty”. Concrete-filled plate steel megacolumns act together with the large core to brace the building. Secondary frames form the cylindrical ends.

3.7 #9: Empire State Building – 381m (New York City)



The, was designed to carry 100% of the gravity and wind loads. The concrete encasement, although neglected in strength analysis structural steel frame consisting of moment and braced frames with riveted joints, although encased in cinder concrete, stiffened the frame considerably against wind loads. Measured frequencies of the building have estimated the actual stiffness at 4.8 times the stiffness of the bare frame [7].

3.8 #10: Central Plaza – 374m (Hong Kong)



The frame material is reinforced concrete, and there is a perimeter tube and core constructed from concrete. The external façade frames act as a tube. These comprise columns at 15ft centers and floor edge beams 43” deep. The floor-to-floor height is 11ft. The core carries about 10% of the total wind shear. The tower base structure edge transfer beam is 18ft. deep by 9ft. 2in. wide around the perimeter. This allows alternate columns to be dropped from the façade, thereby opening up the public area at ground level [15].

3.9 #11: Bank of China Tower – 367m (Hong Kong)

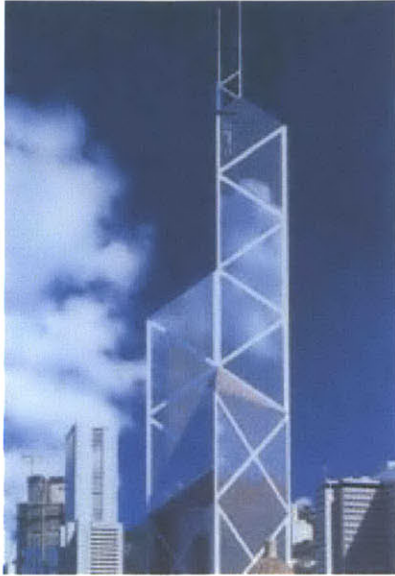

The 76-story building consists of 4 quadrants. Each of them rises to a different height, and only one reaches the full 76 stories. The lateral bracing consists of a space truss spanning between the four corner columns. From the top quadrant down, the gravity loads are systematically transferred out to the building corner columns by truss action. Transverse trusses wrap around the building at selected levels. At the 25th floor, the center column is transferred to the corners by the space truss, providing for an uninterrupted 158-ft clear span at the lobby [7].

3.10 #16: John Hancock Center – 344m (Chicago)

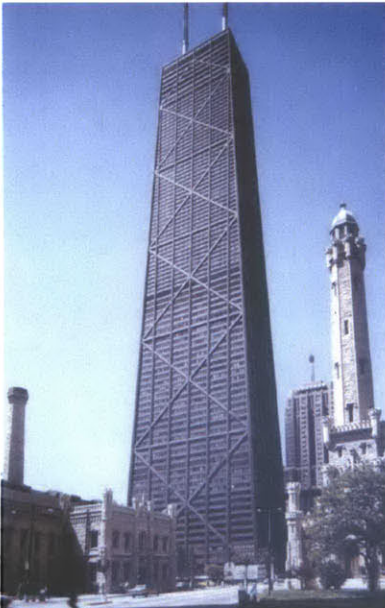

The structural System consists of columns and spandrel beams and diagonal cross bracing, all acting together to form an exterior tube. The requirements of the diagonals imposed a very rigid geometric discipline of the building. The core consists of concrete walls and columns. The lateral load is resisted 80% by cantilever action and 20% by frame action. This is due to the diagonals creating an almost uniform column load distribution across the flange face; there is almost no shear lag.

3.11 New Generation of Skyscrapers

In the early 20th century, high-rise design was focused on strength. Although not accounted for, the heavy masonry cladding and partitions of the time contributed considerable stiffness and damping. As a result, building drifts and accelerations were acceptably small. In the mid-20th century, lightweight curtain wall cladding systems, gypsum board partitions and high strength steels were introduced. Structures would be less damped than before. Designs with different building proportions, framing systems and occupancies make wind performance more challenging. Solutions include stiffness, inherent damping and several types of supplementary damping [14].

A “new generation” of skyscrapers has emerged. Composite elements, use of high-strength concrete for supercolumns, bracing or core walls for lateral stiffness, use of active and passive damping systems and the use of better analytical tools and testing facilities are structural trends which characterize the new structural systems.

However, due to the slenderness and reduction of damping of the structures as the height increases, excessive accelerations in the top floors due to wind induced vibrations can result in human discomfort with many symptoms: nausea, anxiety, stress, dizziness and headaches.

3.12 Human comfort in Tall buildings – Motion Criteria

Oscillation of a structure in wind can rapidly lead to structural failure if the oscillations grow to a large amplitude. However, certain types of oscillation while they are not large enough to cause structural problems may cause problems of human discomfort in tall buildings [24].

For lightweight modern structures, keeping the building motions within acceptable limits can be more of a challenge than ensuring that they have sufficient structural strength. Acceleration has emerged to be the common factor of all motion events. The horizontal force felt on the human body is directly proportional to the horizontal acceleration ($F=ma$). An acceleration of one thousandth of gravity is called a milli-g. People are sensitive to accelerations as small as a few milli-g [24].

Numerous studies have been performed to determine the perception limits. In most cases the studies rely on sinusoidal excitations. Those testing conditions vary with the actual wind conditions, due to numerous reasons: The actual motion of a building due to a wind induced vibration is a narrowband random excitation inducing bi-axial and torsional responses; therefore, just the use of a uni-axial sinusoidal motion could prove to be unrealistic. Additionally, the actual visual environment plays a very significant role: “the absence of visual and audio cues in the test environment neglects critical stimuli, particularly for torsional motions which are infamous for triggering visual stimulus” [26].

The results of the above studies are graphs which indicate how many milli-g's a human can tolerate with, for a particular return period of the excitation: In North America, usually a ten-year return period is used. However, in regions where wind hazards are common phenomena, a much lower return period –one year is used.

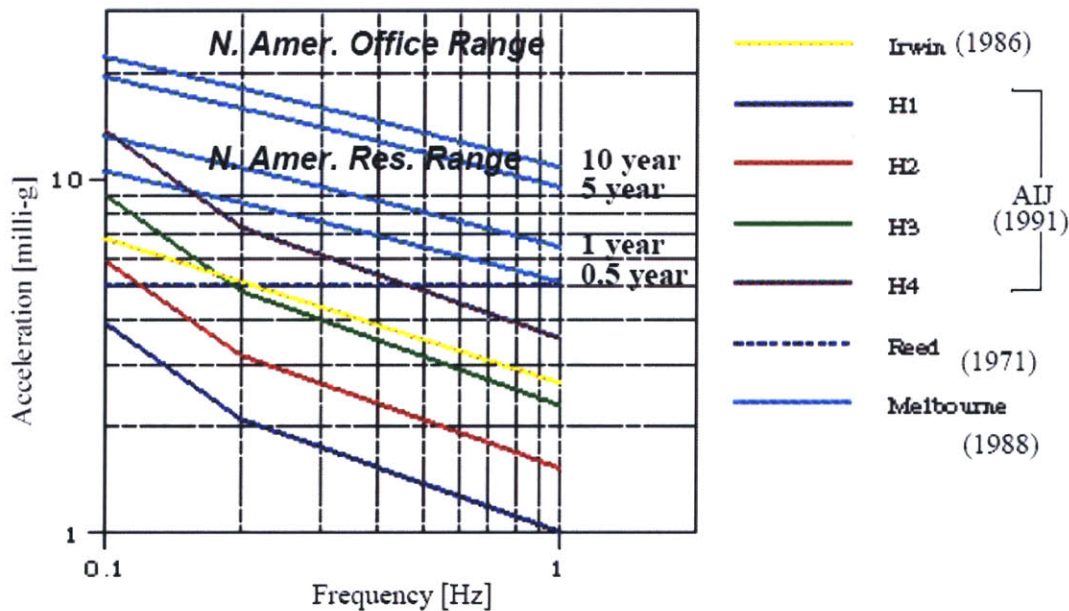

Figure 17: Various perception criteria for occupant comfort [26]

In figure 17, one can observe various perception criteria that are being used: In North America, 10-15 milli-g peak horizontal acceleration at top floor for residential buildings and 20-25 milli-g for office buildings (the difference is due to the fact that the residential buildings are also occupied by residents during the night, as opposed to the office that do not usually operate

during this time), for a ten-year return period. The blue (H1), red (H2), green (H3) and purple (H4) lines indicate the Japanese AIJ standards (AIJ 1991); normally, the H2 is used for residential buildings and H3 for office. The light blue solid line represents the practice in Melbourne.

The following table summarizes general human perception levels due to motion and vibration in the low frequency range of 0-1 Hz which occurs in tall buildings. Several physiological and psychological parameters have been taken into consideration: Occupant's expectancy and experience, their activity, body posture and orientation, visual and acoustic cues, and the amplitude, frequency, and accelerations for both the translational and rotational motions to which the occupant is subjected [35].

LEVEL	ACCELERATION (m / sec ²)	EFFECT
1	< 0.05	Humans cannot perceive motion
2	0.05 - 0.1	a) Sensitive people can perceive motion: b) hanging objects may move slightly
3	0.1 - 0.25	a) Majority of people will perceive motion: b) level of motion may affect desk work: c) long - term exposure may produce motion sickness
4	0.25 - 0.4	a) Desk work becomes difficult or almost impossible: b) ambulation still possible
5	0.4 - 0.5	a) People strongly perceive motion: b) difficult to walk naturally: c) standing people may lose balance.
6	0.5 - 0.6	Most people cannot tolerate motion and are unable to walk naturally
7	0.6 - 0.7	People cannot walk or tolerate motion.
8	> 0.85	Objects begin to fall and people may be injured

Table 2: Human Perception levels [35]

The International Standards Organization (ISO) has published guidelines in terms of the value of the acceleration on the top floor that should not be exceeded more than once in five years on average.

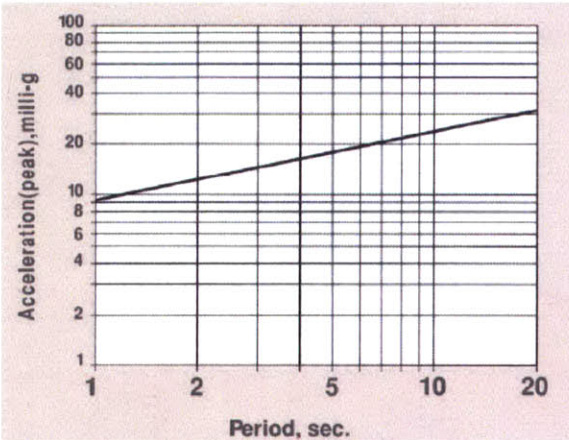

For example, for a building with an eight second period, the five year acceleration not exceeding 22 milli-g is acceptable. These accelerations will be perceived, but if they only occur once every five to ten years, the functioning and commercial viability of the building will not be adversely affected.

Table 3: ISO Guideline for 5 Year Acceleration in Buildings

More recently there has been a trend towards setting the criteria at a shorter return period of one year with values of acceptable acceleration set about 30% lower. This has been prompted by the increasing number of buildings being constructed in hurricane and typhoon areas. Typically, in these areas, there is ample warning of the five or ten year winds caused by these storms. Buildings are usually evacuated before the storm hits, and occupants who stay are not expecting normal comfortable conditions. Therefore, in such areas it is more meaningful to consider the one year wind effect.

The criteria discussed above apply primarily to office buildings since the most data are available for that situation. Target accelerations for residential buildings are often set 20% to 30% lower [24].

4. The need for damping devices in structures

Engineers have learned from building occupants and owners, and from wind tunnel studies, that designing a tall building to meet a given drift limit number under code-specified equivalent static loads is not enough to make occupants comfortable during windstorms. However, they have only limited control over three factors, namely, the height, the shape, and the mass that influence the dynamic response of buildings [7].

Suppression of excessive vibrations can be dealt with limited success in three ways. Firstly, additional stiffness can be provided to reduce the vibration period of a building. Secondly, changes in mass of a building can be effective in reducing excessive wind-induced excitation. Finally, aerodynamic modifications to the building's shape, if agreeable to the building's owner and architect, can result in a "confusion" of the vortex shedding and thus in a reduction of the vibrations caused by wind.

The above traditional methods (change in stiffness, mass or aerodynamic shape) can be implemented only up to a point beyond which the solutions may become unworkable because of other design constraints such as cost, space, or aesthetics. Therefore, to achieve reduction in dynamic response, a practical solution is to supplement the damping of the structure with a mechanical damping system external to the building's structure [7].

Given the desire to build higher buildings, longer bridges and more daring structures, the envelope of what is possible within conventional structural design imposes limitations. Advances in materials, such as high strength steels and efficiencies in structural design through the use of advanced 3-D modeling software, produce designs which may have unexpected deficiencies. Taller and lighter structures tend to be more sensitive to wind-induced vibrations. This has led engineers to turn to the damping of a structure as a means of limiting excessive motions/deflections [25].

A big variety of auxiliary damping devices can be implemented in the structure in order to increase the damping and thus decrease the accelerations which cause human discomfort. In the following table, means to suppress wind-induced responses of buildings are summarized.

Means	Type	Method & Aim	Remarks
Aerodynamic Design	Passive	Improving aerodynamic properties to reduce wind force coefficient	chamfered corners, openings
Structural Design	Passive	Increasing building mass to reduce air/building mass ratio	Increased Material Costs
		Increasing stiffness or natural frequency to reduce non-dimensional windspeed	Bracing Walls, Thick Members
Auxiliary Damping Device	Passive	Addition of materials with energy dissipative properties, increasing building damping ratio	SD, SJD, LD, FD, VED, VD, OD
		Adding auxiliary mass system to increase level of damping	TMD, TLD
	Active	Generating control force using inertia effects to minimize response	AMD, HMD, AGS
		Generating aerodynamic control force to reduce wind force coefficient or minimize response	Rotor, Jet, Aerodynamic Appendages
		Changing stiffness to avoid resonance	AVS

SD: Steel Damper; SJD: Steel Joint Damper; LD: Lead Damper; FD: Friction Damper; VED: Visco-Elastic Damper; VD: Viscous Damper; OD: Oil Damper; TMD: Tuned Mass Damper; TLD: Tuned Liquid Damper; AMD: Active Mass Damper; HMD: Hybrid Mass Damper; AGS: Active Gyro Stabilizer; AVS: Active Variable Stiffness

Table 4: Means to suppress wind-induced responses of buildings [26]

Aerodynamic design improves the aerodynamic properties to reduce the force coefficient. This includes changing in the shape of the building, by either chamfering corners (Figure 19) or adding openings to the structure.

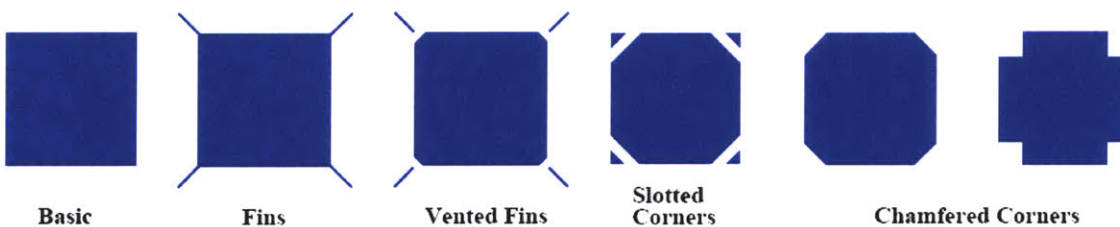

Figure 18: Aerodynamic Modifications to Square Building Shape

The modification of a building's footprint's shape, the change in the cross section with height can reduce building motion, as the vortex shedding can be rapidly reduced. "Such aerodynamic modifications include slotted and chamfered corners, fins, setbacks, buttresses, horizontal and vertical through-building openings, sculpted building tops, tapering, and chamfered corners" [26].



Figure 19: Shanghai WFC opening

Japan has been a pioneer in through-building openings for several years. Nowadays this is being implemented to the world's tallest buildings, as with the case of Shanghai World Financial Center.

A 54m square shaft and diagonal face that is shaved back with the aperture cut off to relieve pressure at this location is the key-structural feature. The opening is 51m in diameter. Moreover, the cross section is decreased with height, essentially tapering in this way the 460m tower.

Modifications in the structural design involve changing the mass or the stiffness of the structure in order to improve the dynamic characteristics and make it less vulnerable to wind excitation. However, there are cost-effective restraints in the amount of material that can be additional used to increase the stiffness. Furthermore, there is also the factor of the aesthetics; design too thick cross members could result in reduced openings (for example in a tube type structure the occupants have limited view from the windows as the columns are spaced 3 feet apart) and ultimately inadequate real estate use of the structure as valuable rentable space is "sacrificed" for the sake of stronger structural elements.

The third way to improve the dynamic performance of the structure is to use an auxiliary device to control passively or actively the response. The current thesis will focus on passive control, and specifically on Tuned Mass Dampers, which are the most common used devices in the building industry [26].

5. Tuned Mass Damper (TMD)

5.1 Introduction

A Tuned Mass Damper (TMD) is a device consisting of a mass, a spring, and a damper that is attached to a structure in order to reduce the dynamic response of it. The frequency of the damper is tuned to a particular structural frequency so that when the frequency is excited, the damper will resonate out of phase with the structural motion. Energy is dissipated by the damper inertia force acting on the structure [17]. The mass of the damper transmits its inertia force to the building in a direction opposite to the motions of the structure itself, thereby reducing the building's oscillations.

The mass itself weighs only a small fraction -0.25 to 0.70%- of the building's total weight, which corresponds to about 1 to 2% of the first modal mass. In addition to the initial tuning when it is first installed, the TMD may be fine-tuned as the building period changes with time. The period may increase as the building occupancy changes, as nonstructural partitions are added, or as elements contributing nonstructural stiffness "loosen up" after initial wind storms [7].

The invention of the TMD as an energy-dissipative vibration absorber is credited to Frahm, who developed the concept in 1909. The theory was later described by Professor Emeritus and former head of the department of Mechanical Engineering in M.I.T. Jacob Den Hartog, in his famous textbook on Mechanical Vibrations (1940). The initial theory was applicable for an undamped SDOF system subjected to a sinusoidal force excitation. Since the wind force-time relationship is not harmonic, the basic ideas developed by Den Hartog have been modified in building applications. Significant contributions were made by Randall et al. (1981), Warburton (1980, 1981, 1982), and Tsai & Lin (1993).

During a major wind storm, the mass of the TMD will move in relation to the building about 2-5ft. The system is activated when a predetermined building lateral acceleration occurs. This motion is monitored with sensors (accelerometers) on the building.

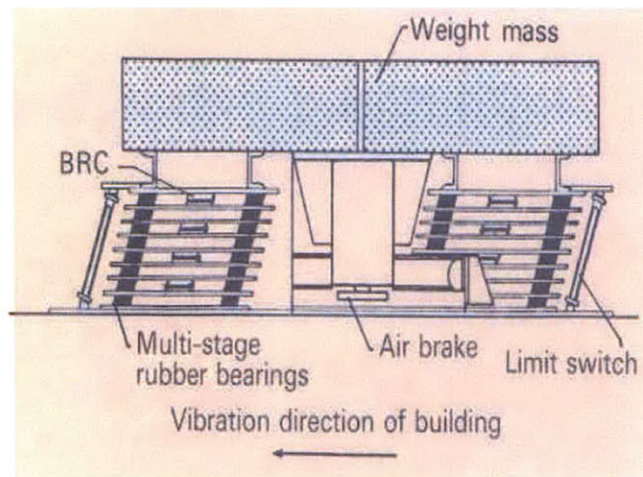

Figure 20: Schematic of a TMD [17]: As the building sways to the left, the TMD moves to the right

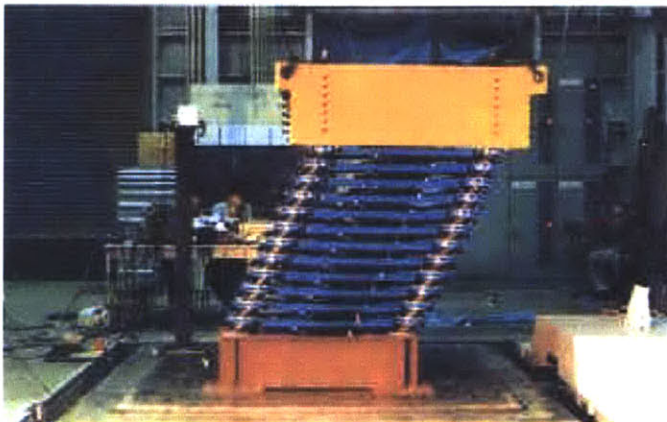

Figure 21: TMD in Motion; Picture courtesy of J.J.Connor

A TMD needs electricity to work, thus all its advantages are no longer applicable in a possible power failure (for example during a heavy windstorm). It is thus recommended to be connected to an emergency power system.

5.2 Active TMD

The effectiveness of a tuned mass damper can be increased by attaching an auxiliary mass and an actuator to the tuned mass and driving the auxiliary mass with the actuator such that its response is out of phase with the response of the tuned mass.

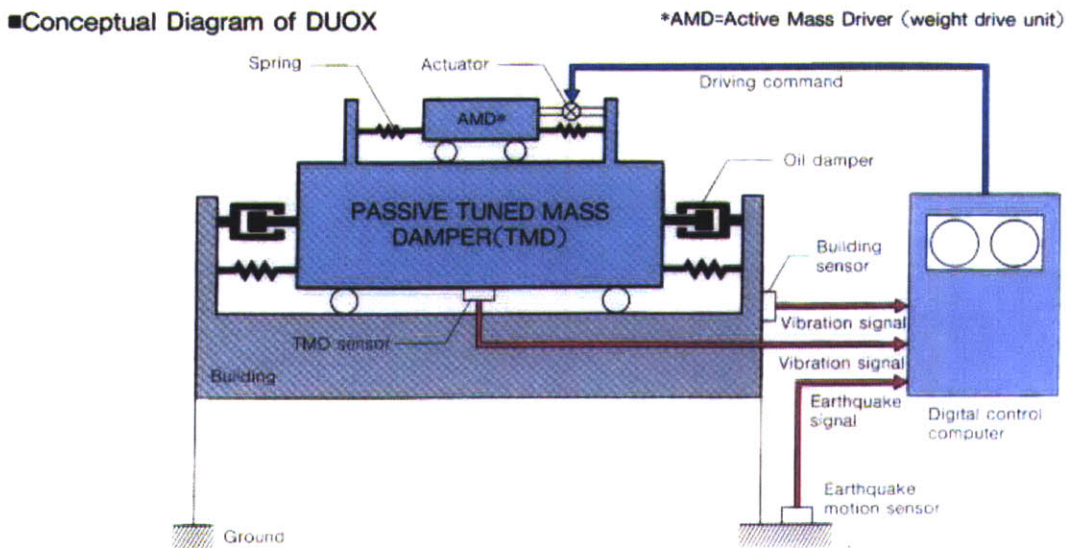

Figure 22: Conceptual Diagram of an Active TMD (Kajima Corporation) [18]

The effect of driving the auxiliary mass is to produce an additional force which complements the force generated by the tuned mass, and therefore increases the equivalent damping ratio of the TMD. (The same behavior can be obtained by attaching the actuator directly to the tuned mass, thereby eliminating the need for an auxiliary mass). Since the actuator requires an external energy source, this system is referred to as an active tuned mass damper.

The author is primarily focusing on passive control. The material presented here is intended to provide background in this subject.

6. Case Studies: Tall buildings with TMD

A review of several tall buildings equipped with a TMD follows. In this way, the reader can get familiarized with the concept, and also some conclusions considering when a TMD is needed can be drawn. The following table contains a list of major installations of Passive Tuned Mass Dampers. In the next pages, the TMD characteristics of a selected number of Tall Buildings are thoroughly investigated and presented:























Name of Structure Height	City/Country	# of TMD	Date	Nat. Frequency/ Damping Mass
John Hancock-241m	Boston 	2	1977	0.14Hz/2x300t
City Corp Center-278m	New York 	1	1978	0.16Hz/370t
Sydney Tower-305m	Sydney 	1	1980	0.1,0.5Hz/220t
Al Khobar 2 chimney-120m	Saudi Arabia 	1	1982	0.44Hz/7t
Deutsche Bundespost tower-278m	Nuernberg 	1	1982	0.67Hz/1.5t
Yanbu Plant Chimney-81m	Saudi Arabia 	1	1984	0.49Hz/10t
Chiba Port Tower-125m	Chiba 	2	1986	0.43-0.44Hz/10,115t
Fukuoka Tower-151m	Fukuoka 	2	1989	0.31-0.33Hz/25,30t
Higashiyame Sky Tower-134m	Nagoya 	1	1989	N/A
Crystal Tower-157m	Osaka 	2	1990	0.24-0.28Hz/180,360t
Huis Ten Bosch Domtoren-105m	Nagasaki 	1	1990	0.65-0.67Hz/7.8t
Hibikiryokuchi Sky Tower-135m	Kitakyushu 	1	1991	N/A
HKW chimney-120m	Frankfurt 	1	1992	0.86Hz/10t
BASF chimney-100m	Antwerp 	1	1992	0.34Hz/8.5t
Siemens Power Station-70m	Killingholme 	1	1992	0.88Hz/7t
Rokko Island P&G-117m	Kobe 	1	1993	0.33-0.62Hz/270t
Chifley Tower-209m	Sydney 	1	1993	400t
Al Taweelah chimney-70m	Abu Dhabi 	1	1993	1.4Hz/1.35t
Akita Tower-112m	Akita 	1	1994	0.41Hz
Canadian National Tower-533m	Toronto 	1	1976	18t
Trump World Tower-262m	New York 	1	2001	600t
Taipei 101-508m	Taipei 	1+2	2004	730t , 2x4.5t

Table 5: High-Rise Structures with Passive TMD; Primary Source: J.D. Holmes[23]

6.1 John Hancock Tower, Boston: two 300-ton TMDs



Two 300-ton TMDs were added to the structure (on the 58th storey, about 67m apart) as an afterthought to prevent occupant discomfort. Each TMD consists of a lead-filled steel box about 5.2m square and 1m deep that rides on a 9m long steel plate. The lead-filled weight, laterally restrained by stiff springs anchored to the interior columns of the building and controlled by servo-hydraulic cylinders, slides back and forth on a hydrostatic bearing consisting of a thin layer of oil forced through holes on the steel plate. Whenever the horizontal acceleration exceed 3 milli-g (0.003g) for two consecutive cycles, the system is automatically activated [17]. They are tuned to a vibration period of approximately 7.5 sec. The total east-west moving mass represents about 1.4% of the building's first-mode generalized mass, while in the twist direction the moving masses represent about 2.1% of the building's generalized torsional inertia [7].

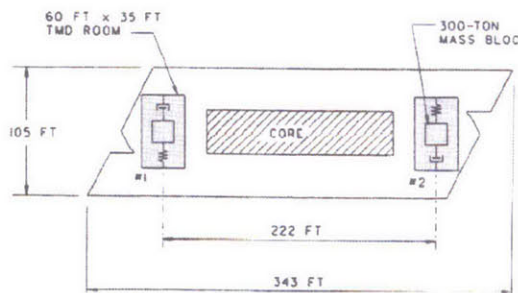

Figure 23: Dual TMD system [7]

The TMDs of the John Hancock Tower are used to assure occupant's comfort. Their beneficial effects in reducing wind-induced dynamic forces are not relied upon for structural integrity under extreme wind loads. The effective damping is increased from about 1% to 4% and the motion is reduced by 50% [7].

6.2 Citicorp Tower, New York City: 400-ton TMD

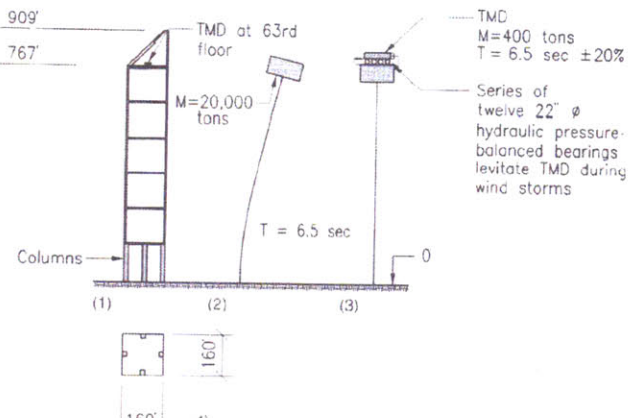

Figure 24: Building elevation, First-mode, TMD at the top [7]

The building has a fundamental period of 6.5s with an inherent damping 1% along its axis. The TMD is located at the 63rd floor and has a mass of 400tons, about 2% of the first modal mass (0.6 to 0.7% of total mass). It is biaxially resonant with a variable operating period of 6.25s +/-20%, adjustable linear damping from 8% to 14%, and peak relative displacement of +/-1.4m. The structural damping is increased to 4%, and thus the sway amplitude by 50%. The damper is activated whenever the horizontal acceleration exceeds 3 milli-g for two consecutive cycles, and will

automatically shut itself down when the building acceleration does not exceed 0.75milli-g in either axis over a 30 minute interval .

The TMD consists of a 400-ton concrete block bearing on a thin film of oil. The structural stiffness of the TMD is aided by pneumatic springs tuned to the frequency of the building. The TMD system is aided by shock absorbers [17][7].

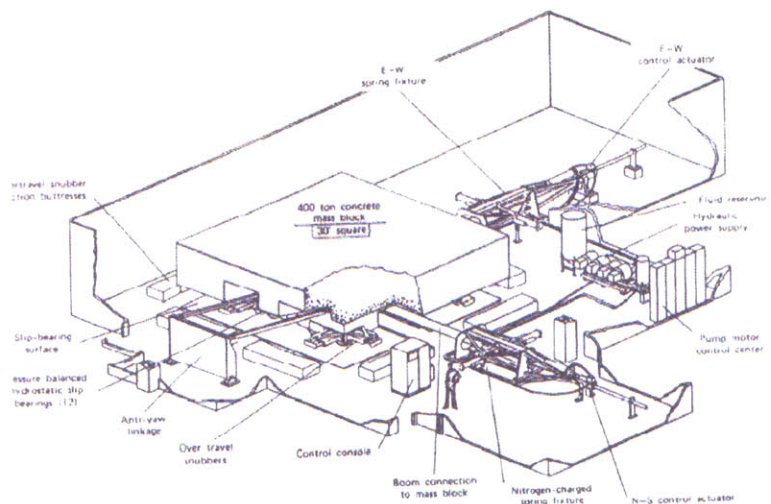

Figure 25: Schematic View of the TMD [7]

6.3 Canadian National Tower: Two 9-ton TMD



The damper system consists of two doughnut shaped steel rings, 35cm wide, 30cm deep, and 2.4 and 3m in diameter, located at elevations 488m and 503m (CN Tower has a height of 553m including the antenna-world Guinness record). Each ring holds about 9 tons of lead and is supported by three steel beams attached to the sides of the antenna mast. Four bearing universal joints that pivot in all directions connect the rings to the beams. In addition, four separate hydraulically activated fluid dampers mounted on the side of the mast and attached to the center of each universal joint dissipate energy. As the lead-weighted rings move back and forth, the hydraulic damper system dissipates the input energy and reduces the tower's response [17].

Figure 26: CN Tower [19]

6.4 Chiba Port Tower: 10-ton TMD

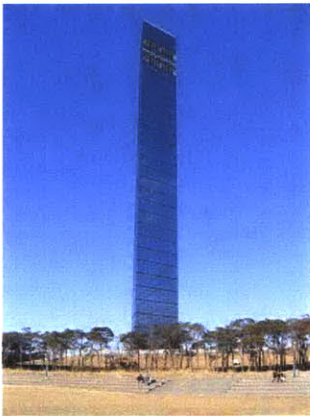

Chiba Port Tower is a structure 125m high, weighting 1950 tons. The first and second mode periods are 2.25s and 0.51s respectively for the X direction and 2.7s and 0.57s for the Y direction. Damping for the fundamental mode is estimated at 0.5%. The purpose of the TMD (which was the first time being installed in a building in Japan) is to increase damping of the first mode for both the X and Y directions [17].



The damper has: mass ratios with respect to the first mode effective weight of the tower (1,200 tons) of about 1/120 (10 tons) in the X direction and 1/80 (15.4 tons) in the Y direction; periods in the X and Y direction are 2.24s and 2.72s respectively; damping ratio 15%. The maximum relative displacement of the TMD is +/-1m, and reductions of about 30%-40% in the displacement of the top floor and 30% in the peak bending moments are expected [17].

Figure 27: TMD of Chiba Port Tower, Japan; Picture courtesy of J.J. Connor

6.5 Crystal Tower, Japan: two TMD

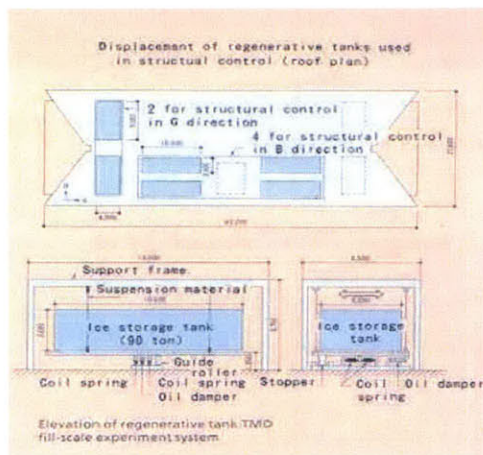

The Tower is 157m high and weights 44,000 tons. Its fundamental period is 4s in the NS direction and 3s in the EW direction. Six of the nine air cooling and heating ice thermal storage tanks (about 90tons each) are hung from the roof top girders and used as a pendulum mass. Four tanks have a pendulum length of 4m and slide in the NS direction; the other two have a pendulum length of about 3, and slide in the EW direction. Oil dampers connected to the pendulums dissipate the pendulum energy.

Figure 28: Layout of the ice-storage tanks that were used as pendulum dampers [17]

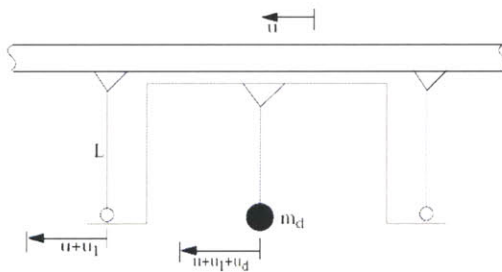

Figure 29: Pendulum Damper (left) and Ice Storage Tank (right) used as the hanging mass; Pictures courtesy of J.J.Connor

6.6 Trump World Tower, New York: 600 ton TMD



A 600 ton TMD is located in the mechanical room at the top of the 90 storey Trump Tower in New York City, the tallest residential building in the world. The TMD provides comfort enhancement for the occupants of the building, reducing the motions caused by winds. The building is rectangular in plan and nearly twice as long as it is wide. The principal direction of the response was across the narrow face. The response to wind was accentuated by the building's slenderness ratio, which is almost eleven [21].

Figure 30: Trump World Tower, NYC: The tallest residential building in the world; Picture courtesy of Motioneering, Inc.



The Trump World Tower's TMD is enclosed in a reinforced-concrete room at the roof level.

Figure 31: TMD of the Tower; Picture courtesy of the Bernstein Associates

6.7 Taipei 101: 730 ton TMD

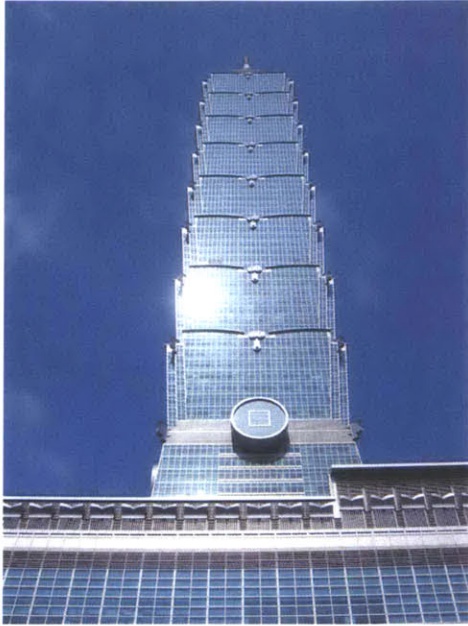

Figure 32: Taipei 101-508m Tall.

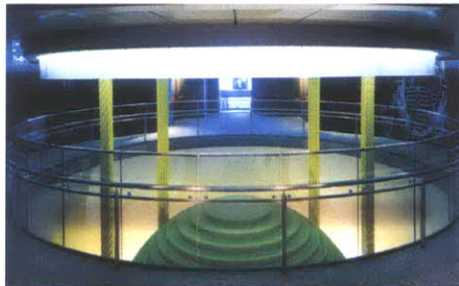

Figure 33: Workers Installing Pinnacle TMDs; Picture courtesy of Motioneering Inc.

. The buildings' first mode period is 7 seconds. The steel frame had an inherent damping close to 1% of critical. Calculated lateral accelerations (caused by 150mph design winds) were not acceptable; therefore the 730 ton TMD was installed. The building TMD is the largest TMD in the world and it is also the first ever constructed as a key architectural and visual element in the building. The 730 ton steel ball (0.26% of the building mass) is suspended as a pendulum and it is surrounded by telescopic dampers. The TMD reduced the peak acceleration of the top occupied floor from 7.0 milli-g to 5.0 milli-g. [22], [20], [14].

The world's largest TMD, a key architectural and visual element, in the world's tallest building (508m) - Taipei 101.

Two additional TMDs reside high in the rooftop spire (pinnacle). Rather than a pendulum, each TMD is a 4.5 ton mass sliding on a tabletop and restrained by springs. They reduce two modes of spire vibration to improve the fatigue of the steel trussed spire backbone [20], [14].

7. Case Study: Taipei 101

Currently it is the world tallest building reaching a height of 508m from ground to pinnacle. Its' features make it a unique structure, often labeled one of the wonders of the modern world. The world biggest Tuned Mass Damper, outriggers, supercolumns, high-strength concrete and steel, moment resisting frame and well optimized aerodynamic shape are the key structural elements that made Taipei 101 a reality, especially for the region of Taiwan, which is very susceptible to catastrophic hurricanes and earthquakes.

Taipei 101 combines an efficient structural system, aerodynamic modifications, and passive control for the guarantee of human comfort and safety. It is the ideal example for the reader to understand all the principles that were discussed in the previous chapters.



Figure 34: Taipei 101 –With a height of 508m it is currently the tallest building to structural top in the world

7.1 Design Development

Several architectural, structural and construction issues have been revisited within the design and construction of the building, in order to maximize and perfect its' performance and beauty.

7.1.1 Architectural Shaping

Architect C.Y. Lee of the company C.Y. Lee & Partners based in Taipei, Taiwan, ingeniously designed the structure in a way that the culture, ambition and vision of the Chinese culture is well represented and expressed with this tremendous achievement: The Chinese Art and Culture, "Stacking upward on luck" and everlasting strength were characteristics well blended into the structure which richly illuminated the sky during the opening ceremony [29].

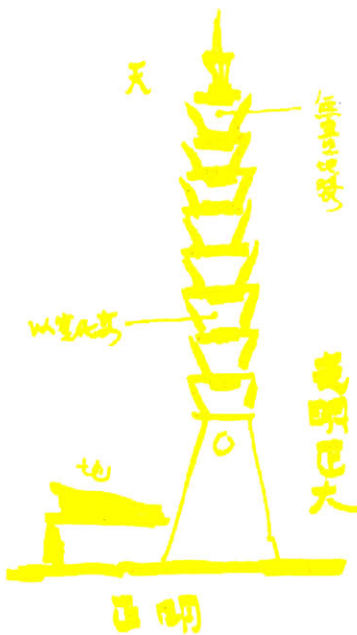

"The Tower rises in 8 canted sections, a design based on the Chinese lucky number "8". It is a homonym for prosperity in Chinese, and the 8 sections of the structure are designed to create rhythm in symmetry, introducing a new style for skyscrapers. The segmented, subtly slanted exterior reduces the effects of wind and emergencies to mega-buildings. 8 floors comprise an independent section, reducing street-level wind caused by high-rises. Plants are laid out to ensure pedestrian safety and comfort. The building is designed to resemble a growing bamboo, a symbol of everlasting strength in Chinese culture." [29]

Figure 35: C.Y. Lee's renderings of Taipei-101

Initial development plans wanted a more commercial construction driven by money and prestige: The same site was planned to contain more towers of lower height, with a result of having the same rentable space at a lower construction cost [26]. However, the investors wanted to lease space in the tallest building. It soon became clear for the owner (Taipei Financial Center Corporation) that a much more pioneering solution should be followed, which

would boost Taipei's prestige and make the building a landmark. C.Y. Lee's logic and ideas were enthusiastically approved and implemented: "The greatest challenge in designing a statement building is not the construction technology involved, but how the building reflects the culture in which it functions. The spirit of architecture lies in the balance between local culture and internationalism [29]."

7.1.2 Exterior symbolism – Feng Shui

Feng Shui is the art and science of positioning objects for eg. furniture, buildings, gardens, waterfalls and even graves. This practice is estimated to be more than 3000 years old.

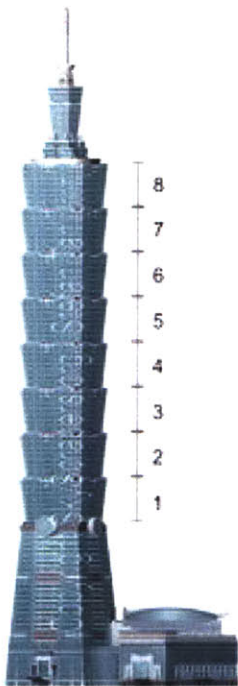

Figure 36: The "8" figure illustration of Taipei 101



Taipei 101 is heavily designed within the practice of Feng Shui. The only Feng Shui problem was a perpendicular road that ran straight into the building's site, which could bring sickness or bad business to the occupants or visitors. The problem was easily solved by adding a fountain to block off the perpendicular road [30].

The tower's aesthetics and design are all based on the number "8", a lucky number in the traditional Chinese culture. One example of the "8" design used in Taipei 101 is counting the number of segments (Body of the Tower) or that represents as Gold Ingots (Image 36). This type of outward tapered design in each of the 8 segments also helps to create a strong impression of a bamboo, which is explained in the next paragraph.

The "8" design is very much used in China. As mentioned before, it is a symbol of wealth, luck and success. An example of a similar structure using the "Number 8" design aesthetics is the Jin Mao Tower in Shanghai [30]. It is well incorporated in Taipei 101: 8 pagodas shaped blocks , 8 supercolumns as a key structural feature, 16 columns comprising the core, 8m length of the Chinese Ru-yi symbol (see next paragraph) .

7.1.3 Native Bamboo Plant analogy

The design is mainly inspired by a Taiwan's native bamboo plant, A bamboo is usually hollow inside. Chinese philosophy teachings about the hollow bamboo symbolizes modesty and humbleness. This makes it easy to relate to this building. This is one of the aesthetic reasons why the building's exterior color is green, the resemblance of a steadily rising bamboo, also reflecting the growing economy of Taiwan [30].

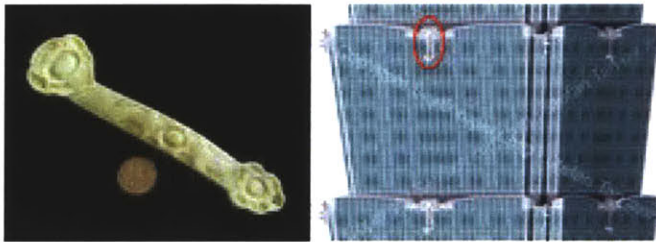

Figure 37: The Chinese Ru-yi symbol (left) being used in Taipei 101



The tower is covered by a wall of green tinted glass that reflects the sky and with traditional Chinese lantern-like figures called "Ru Yi", which are placed on all 4 sides at the top of each of the 8 segments as symbols, symbolizing fulfillment. The Ru Yi symbols symbolize authority and power, these symbols are also used to bring one's career to a higher, better level. It also protects from evil and misfortune happenings. Each of these Ru Yi symbols are 8m high.

"We designed this building based on the philosophy of integrating with nature," said C.P. Wang, architect and project captain. "It's like a plant growing to reach the sky. This is very different from the Western idea of conquering nature [30]."

7.1.4 Leasing

1.8 million sq. feet is the total rentable space of the tower. As one can observe in figure 38, the tower comprises multiple leasing zones: The first three floors are the main lobby, then there is a lower zone up to the first sky lobby at level 36, and then there is the mid and high zone with typical floorplates of 2500-3570 sq. meters. Finally, at level 91 there is an observation deck and restaurant, and in the last 9 floors (92-101) the communication center is located. The tower finishes with a pinnacle, which was an engineering challenge on its own. The structural features are thoroughly presented in the next chapter.



Figure 38: Leasing info [29]

Levels 92-100: Radio transmission, television transmission microwave, emergency rescue system receiving/signaling relay stations; applicable for TV, radio, telecommunication and business tenants.

Levels 85, 86 & 88: Top-level restaurants which are ideal for weddings, anniversaries, fund raisers, award banquets, reunions, charity balls, bar, corporate receptions, meetings and pre-post convention events.

Sky Lobby – Levels 35-36 & 59-60: There are two sky lobby zones which divide Taipei 101 in three zones: The low zone, the mid zone and the high zone. 10 high speed large capacity shuttle lifts bring up the crowds from the lobby and the second floor straight to level 35/36 or 59/60; local lifts can be then used for transfer to designated floors.

7.1.5 Vertical Transportation Scheme

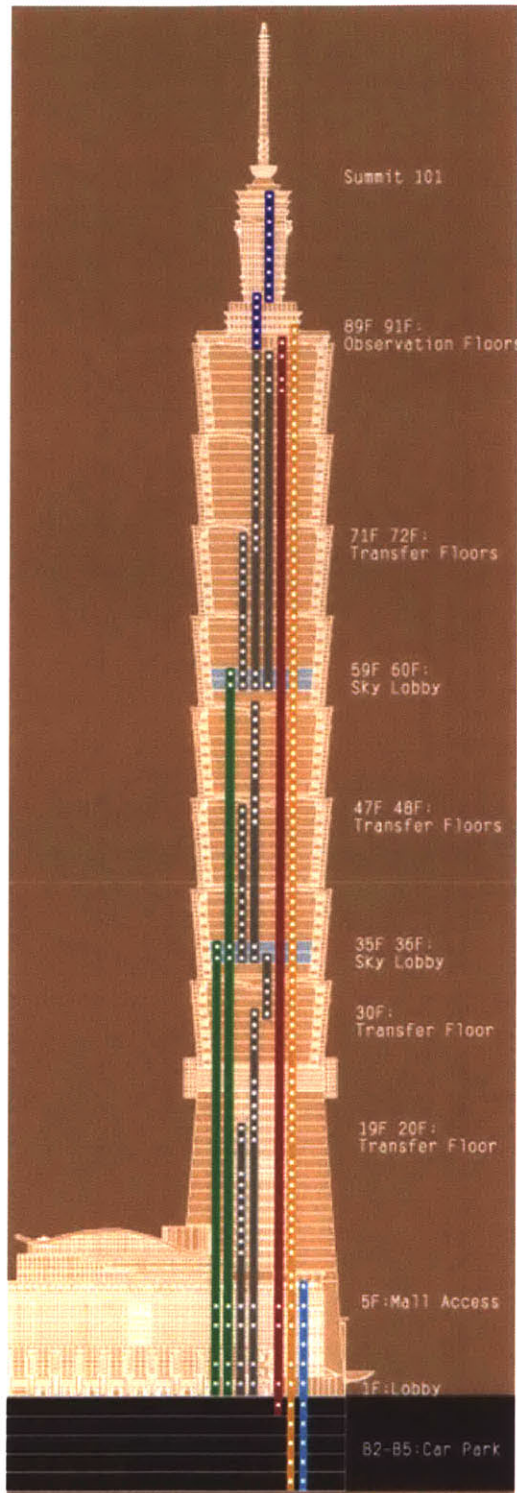

Figure 39: Vertical Transportation Scheme [29]

Taipei 101 possesses the record of the fastest elevator currently worldwide. They were engineered by Toshiba, Japan: "A comfortable, convenient, rapid, intelligent and safe transportation network to meet or exceed tenant and owner requirements" [29].

The red line indicates 2 single-deck, (1600 kg 24 persons) per deck: they are currently the fastest elevators in the world, with aerodynamic pressure controlled cabinets, ascend at 1,010 m/min.

The grey and green line indicate 10 double-deck (2,040kg – 31 persons) per deck elevators serving the transfer floors, 24 double-deck (1,350kg – 20 persons) per deck for access within 6 sub-zones and 3 single deck elevators for various capacities.

The brown line indicates 3 single deck service elevators (2x2,040 kg and 1x4,800 kg).

The blue line indicates car park elevators: 6 single-decks (1,600 kg each).

7.1.6 Structural System

Evergreen Consulting (based in Taipei, Taiwan) was the engineer of the record and Thornton-Tomasetti Engineers (based in New York City) as engineering consultants designed the structural system of the tower.

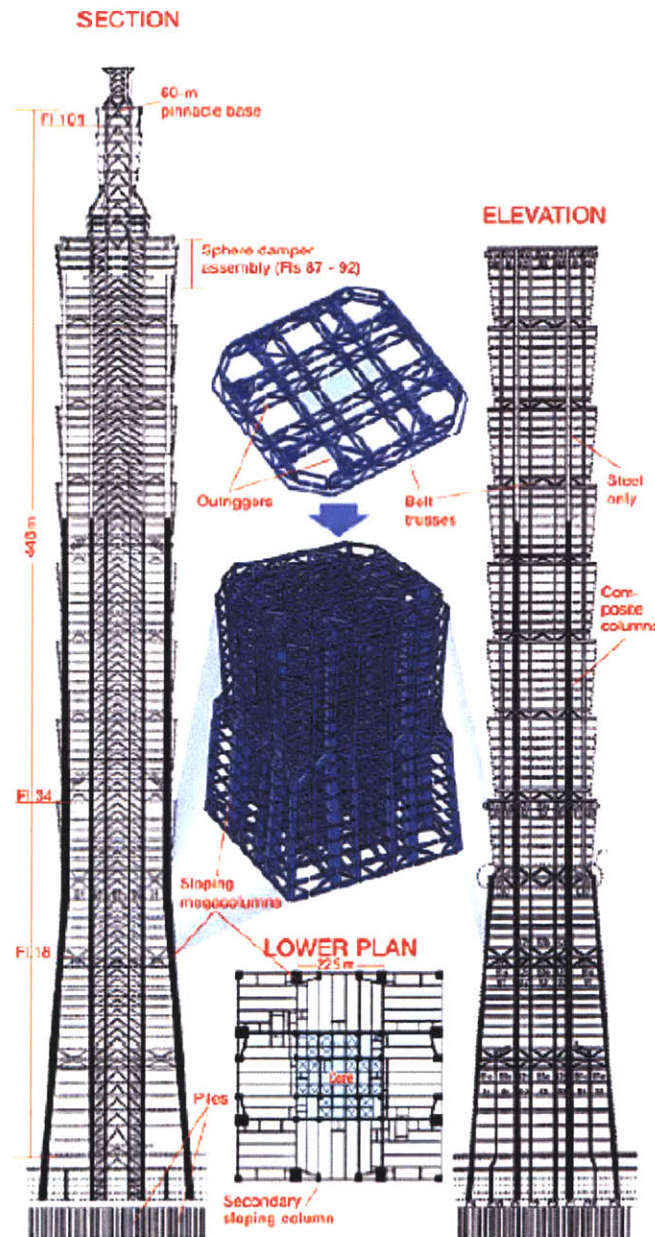

Figure 40: Structural System [27]

The lower 25 storeys are in the shape of a truncated pyramid that has major structural benefits: the wide base to the bottom compared to the upper floors improves the overturning moment resistance, and overall lateral stiffness (compared to a simply solid rectangular box).

The 26th floor is a transition from the pyramidal shaped base to the inverted pyramidal modules (eight in total) gives the building a “waistline”, which is decorated with exterior medallions in the shape of Chinese coins symbolizing wealth [28].

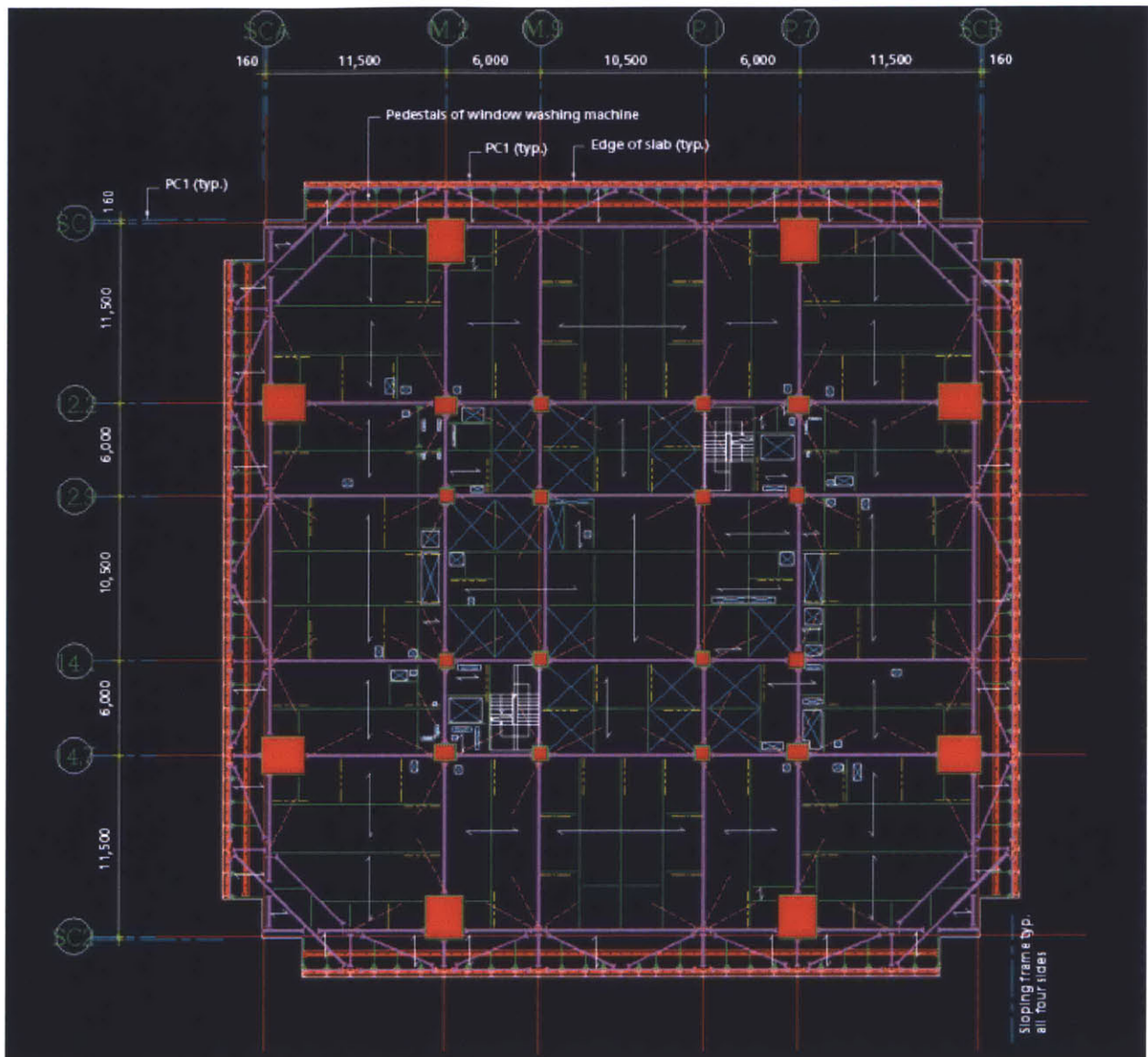

Figure 41: Taipei 101 typical floorplan [28]

Structural engineers examined a variety of solutions before coming to the final structural configuration of Taipei 101. Initially, a framed tube was examined. Such an arrangement would block the wide glass expanses, feature strongly desired by the owners. Furthermore, it would have created indirect transfer-loadings in every of the transition floors (in the eight setbacks). Furthermore, a bundled tube was considered. Although such a solution would have created wider column spacing as compared to a tubular frame, the internal frame lines would create a “picket fence” effect that would subdivide the floors and restrain the use of the floors [28]. A “tube in tube” would mean a central core and a perimeter core, which would again require very close spaced exterior columns.

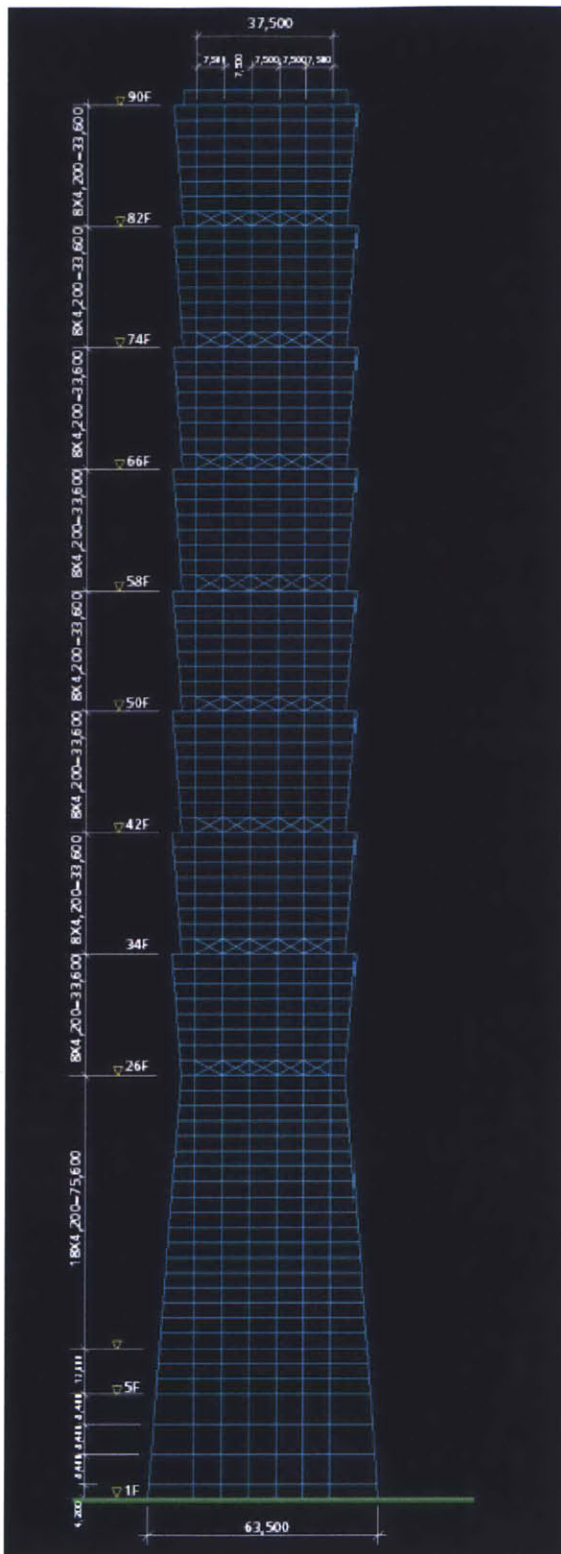

Figure 42: Typical Exterior Moment Frame Elevation [28]

After all the above iterations, the engineers decided to use a mega-frame with a central braced core (figure 40, 41) that is connected to eight super-columns via outriggers (11 in total) which are one to three storey deep. In the 26, 34, 42, 58, 66, 74, 82 floor heights (where the setbacks occur), belt trusses increase the stiffness of the whole system, by transferring the gravity loads from interrupted sloped perimeter columns and delivers them to the external supercolumns.

The above described megafame solution maximizes the view, as the owners wish, and also makes the setbacks feasible structural, as the loads are selectively transferred and directed to specific load paths that optimize the use of the structural elements.

The braced core is encased in concrete walls from the foundation to the eights level. The core columns are compact square and rectangular boxes. They are connected with diagonal and CFB, which allow for the required elevator-shafts openings. See appendix 1 for more frame elevations.

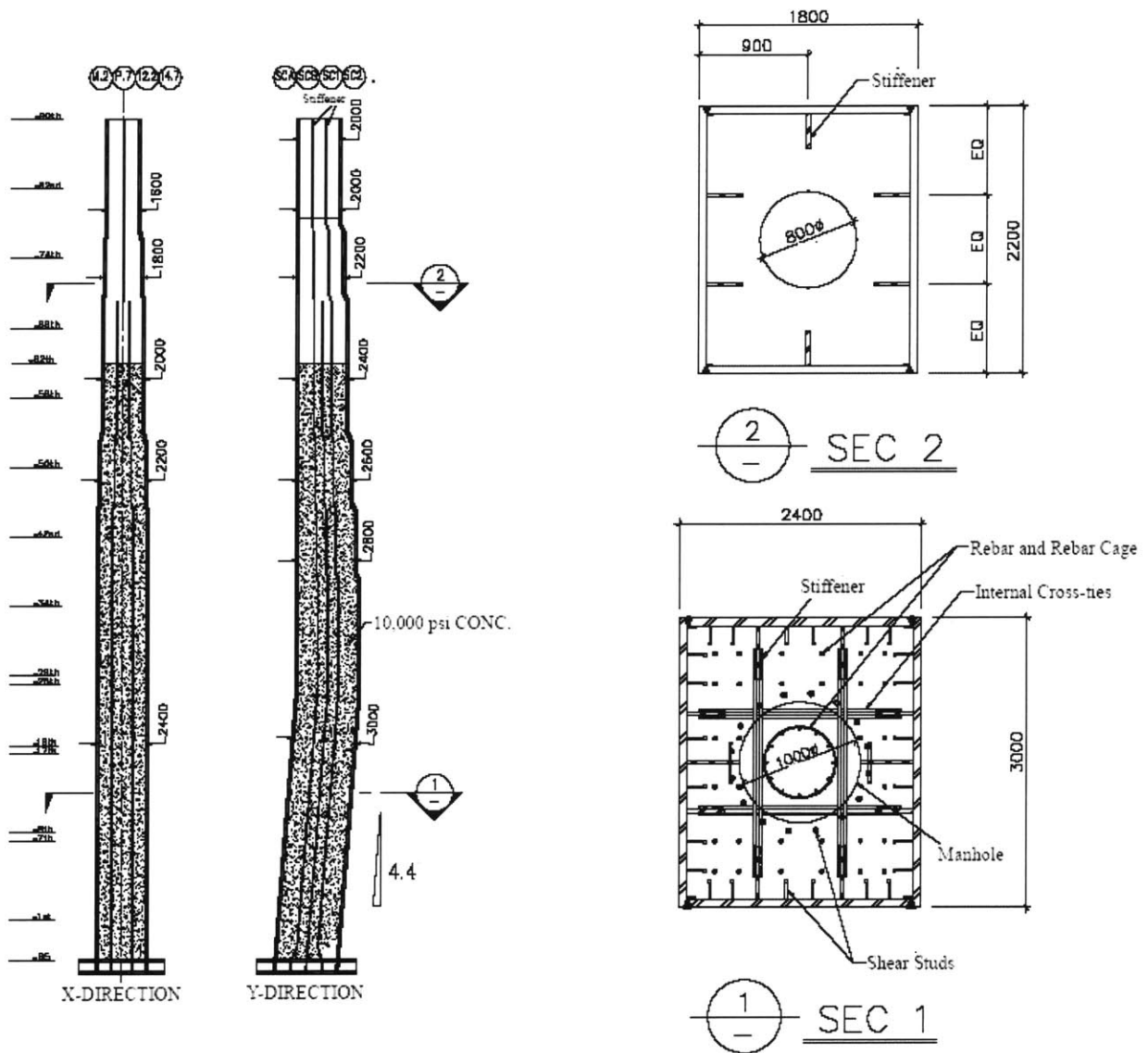

Figure 43: Super-Columns Cross Section [31]

On the perimeter, each of the building faces has two supercolumns, two “sub-supercolumns” (appendix 1) and two corner columns up to level 26. From level 26 and above, the corner columns and the two sub-supercolumns on each face are eliminated. So eight supercolumns in total continue upwards, with a cross section that constantly decreases with height (figure 43). The cross section varies from 3x2.4m in the base to 2x1.8m to the top. They are constructed on site from steel plates of 60ksi yield strength and of a thickness up to 80mm. To provide sufficient structural strength and stiffness, they are filled with high strength concrete (10,000 psi) from level 62 and below.

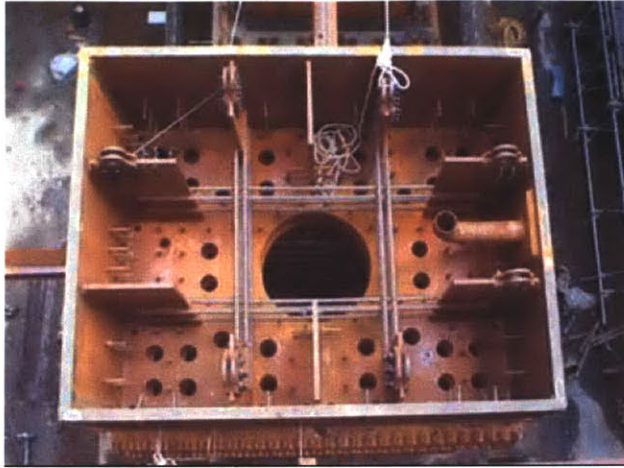

Figure 44: SuperColumn Cross Section [26]

“This steel plate box column construction image shows internal shear studs, holes in diaphragm plates for access and vertical rebar, stiffeners, cross-ties and a “bottom up” concrete fill pipe at the right. Projecting plates at bottom engage a basement concrete slab [26]”.

The shear studs ensure composite action in the supercolumn, and thus a transfer section was used to calculate the capacity. Stress ratios were calculated using the AISC LRFD code. The design maximum factored axial force was 38,000 tons while the maximum factored moment was 4,800 ton-meters [31].

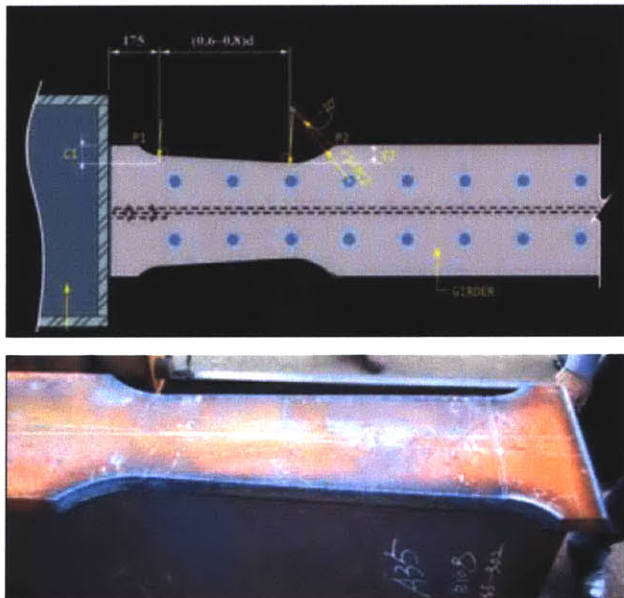

Figure 45: Tapered flange trimming at selected link beams

Another distinctive feature of Taipei 101 is the well-engineered reduced beam sections. In order to ensure “strong columns” behavior, tapered flange trimming at selected link beams creates a “dogbone” condition to improve ductility by locating beam yield zones away from welded joints [26].

7.1.7 Wind Engineering

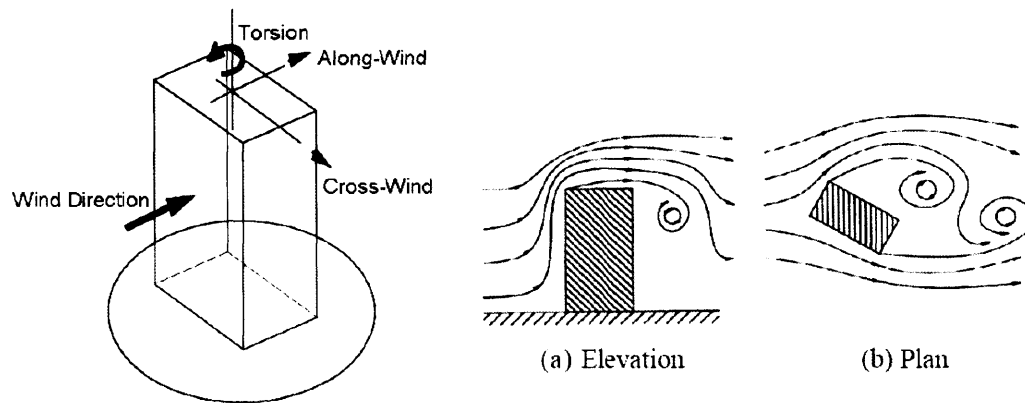

Figure 46: Wind Critical Components and eddies generation [35]

Wind has generally six components: 3 forces and 3 corresponding moments. In structural engineering, the force and moment corresponding to the vertical axis (lift and yawing moment) are not so critical for the building. Therefore, along wind (drag forces) and transverse wind (crosswind) are of major significance. While the maximum lateral wind-loading and deflection is in parallel with the wind (along wind direction), the maximum acceleration which leads to a human perception of motion is in the axis perpendicular to the wind excitation (crosswind) (Figure 46). "There are three main reasons that a building responds in such a way in its' perpendicular to the wind direction: 1) the biaxial displacement induced in the structure because of either asymmetry in geometry or in applied wind loading; 2) the turbulence of wind; and 3) the negative-pressure wake or trail on the building sides" [33]. Usually, the transverse impulses are of the half frequency compared to the along-wind impulses. Those transverse impulses are applied alternatively to the left and to the right, causing a phenomenal so called "vortex shedding". A simple formula that is very widely used to calculate the frequency of the vortex shedding is: $f = (V \times S) / D$; where f = the frequency of vortex shedding, V = the mean wind speed at the top of the building, S = the Strouhal number (a dimensionless parameter for the shape); D = the diameter of the building.

Apart from vortex shedding, phenomena that amplify the dynamic response of a building due to wind are buffeting, galloping and flutter. Buffeting occurs mostly in slender high-rise, in the alongwind direction due to turbulence. Flutter and galloping are usually not critical for common building structures [35].

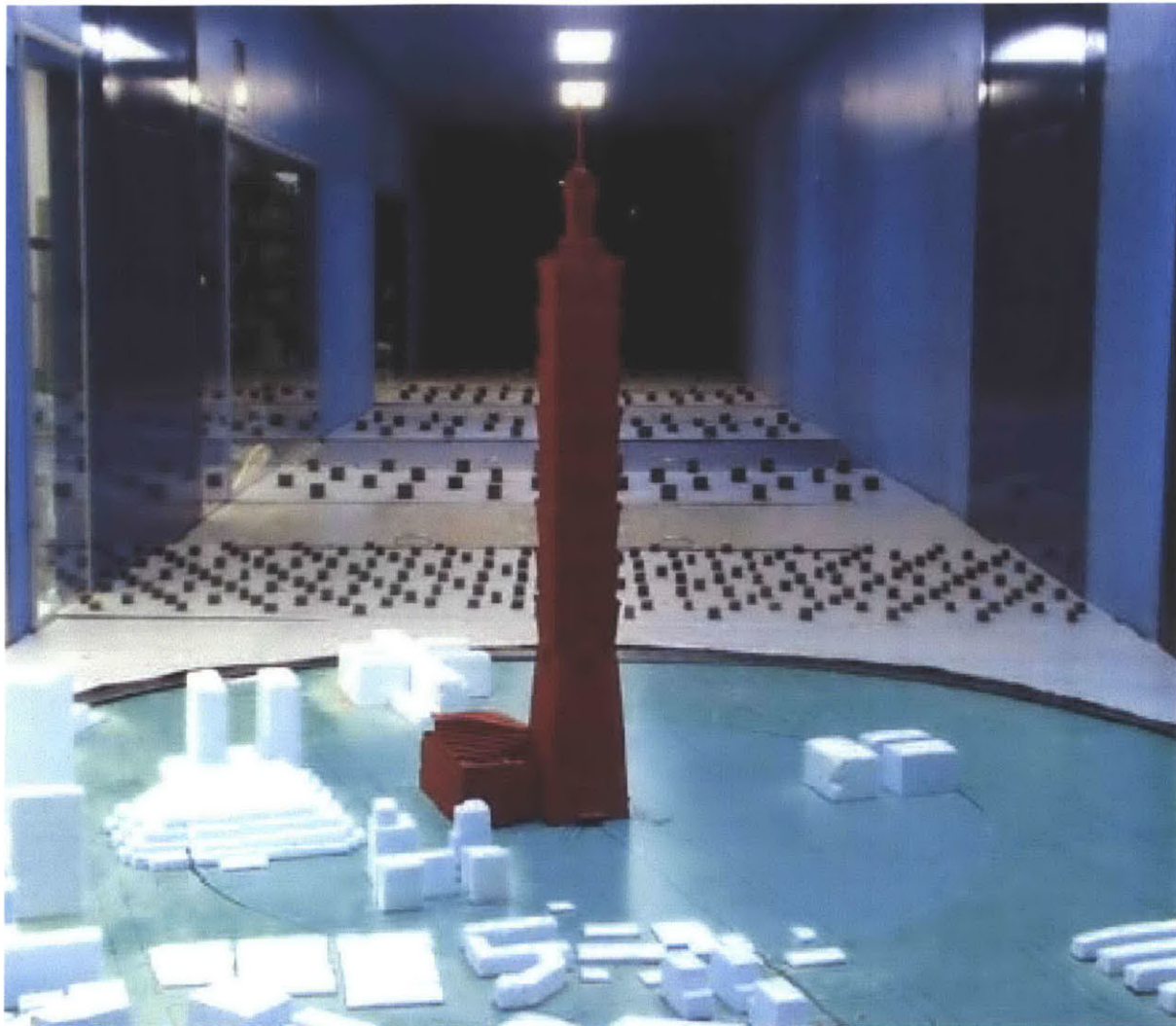

Figure 47: Wind Tunnel Testing of Taipei 101

Several series of wind tunnel tests (figure 47) were conducted by Rowan Williams Davies & Irwin Inc. (RWDI). A wind tunnel testing increases accuracy, takes into account building and site specific conditions (building's shape and orientation, the roughness of the surrounding terrain, local topographic effects, aerodynamic interactions with nearby buildings- characteristics that cannot be simulated by analytical models due to the high complexity and randomness that they affect the structure) [32]. Furthermore, after performing a wind tunnel test, one can decrease the construction cost by minimizing the codes' conservatism (cost savings of \$500,000 or more have resulted), increase safety and have a better understanding of torsional effects [34].

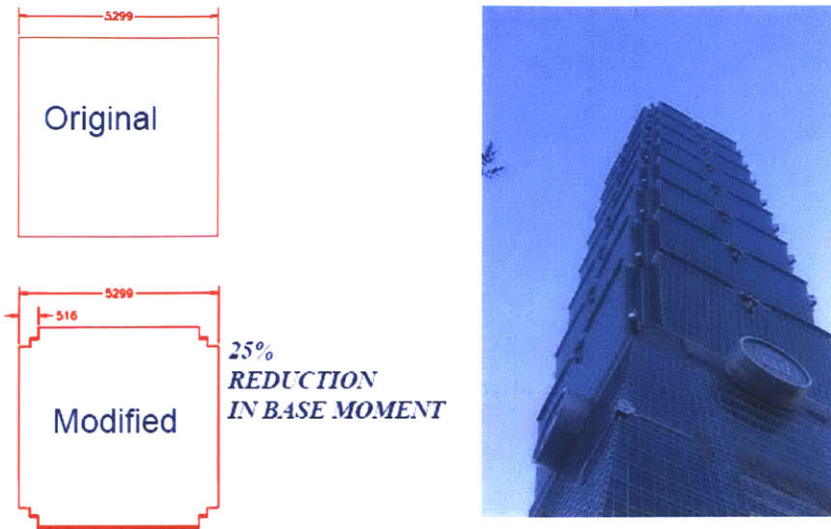
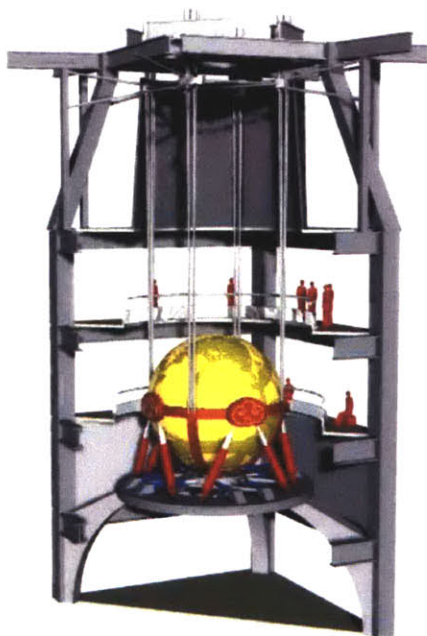

Figure 48: Stepped corners was the result of Taipei 101's aerodynamic shape optimization [34]

In figure 48 one can see the final result of RWDI's work on Taipei 101 optimum aerodynamic behavior. The cross section was rectangular initially, and after a series of testing, the modification was to include stepped corners, which achieved 25% reduction in design base moment.



The wind tunnel tests also revealed that the actual accelerations in the top levels exceed the design accelerations. The solution to this problem was the design of a 730ton Tuned Mass Damper of a pendulum type (as described in page 41), which would counterbalance the swaying of the building and bring the accelerations to an acceptable level. This state-of-the-art system was engineered by Motioneering, a sister company of RWDI. It hangs from the 92-88 floor, with cable lengths of 11.5m (figure 49). The TMD uses the building motion to push and pull dashpots (giant shock absorbers), that convert the motion to heat by forcing fluid through small internal openings.

Figure 49: TMD of Taipei 101, hanging from floor 92; Picture courtesy of Motioneering, Inc.

7.2 Taipei 101 Modeling strategy

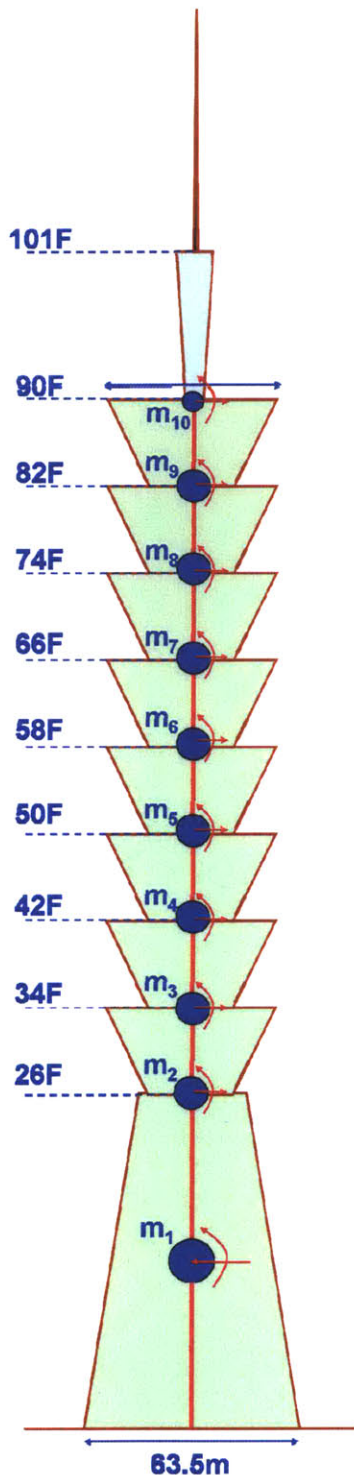

An equivalent 10 Degrees Of Freedom model was modeled in SAP2000. The following assumptions and techniques were followed:

Lumped masses:

The total building weight was calculated considering that the 730ton TMD is 0.26% of the total mass:

$$m_1 = 96,865.38t$$

$$m_2 \text{ through } m_9 = 21,759.62t$$

$$m_{10} = 10,809.62t$$

The masses were lumped according to figure 50, proportionally to the tributary area. Mass m_{10} was deliberately chosen to be in the same floor as the TMD mass is attached.

Properties of Equivalent Beam:

Moments of Inertia I_{xx} and I_{yy} , as well as the rotational moment of inertia J_{zz} were calculated considering two different floorplans (Appendix 1); Furthermore, transfer sections were calculated (up to the height that there is composite action – figure 43), according to the various sizes of the supercolumns along the height of the tower. See Appendix 2 for detailed calculations.

Model Calibration:

As the first mode of the model is known to be 6.8sec, the beam properties were scaled up (using SAP modification factors option) uniformly, until the anticipate frequency was obtained. The calibration takes into account characteristics of the structural system as belt trusses, outriggers, braced core etc., which make the model stiffer than initially assumed.

Figure 50: Equivalent 10-DOF beam model

7.2.1 Modal Analysis

1st Mode: **6.82sec** 2nd Mode: **2.06sec** 3rd Mode: **1.23sec**

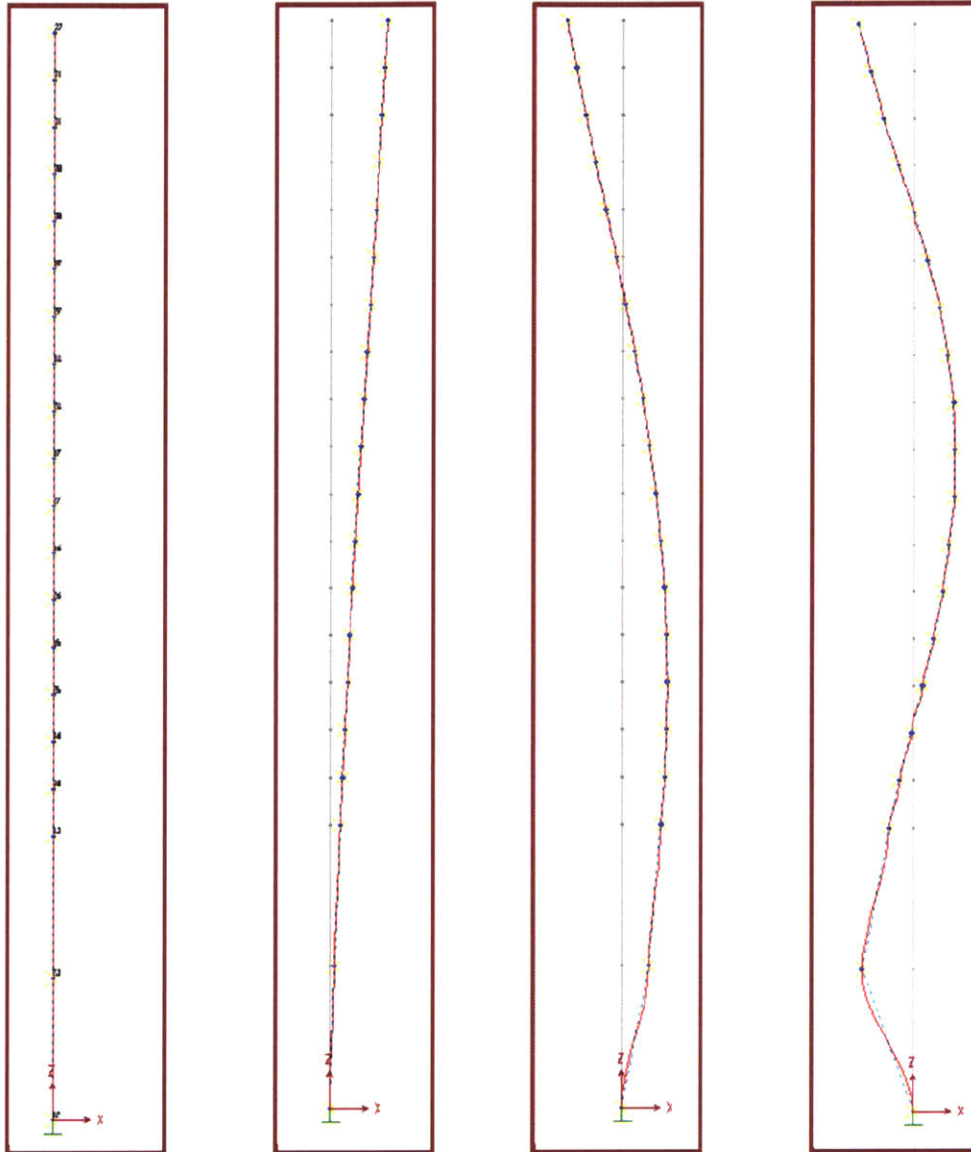

Figure 51: First, Second and Third mode shapes

Both the mode shapes and corresponding Periods results were as anticipated: The first mode is 6.82 sec (the same as the actual building), and its' shape is simply a swaying of the top with no inflection points. The second mode has a period of 2.06 sec. with one inflection point. The third mode has a $T=1.23$ sec and two inflection points.

7.2.2 TMD modeling

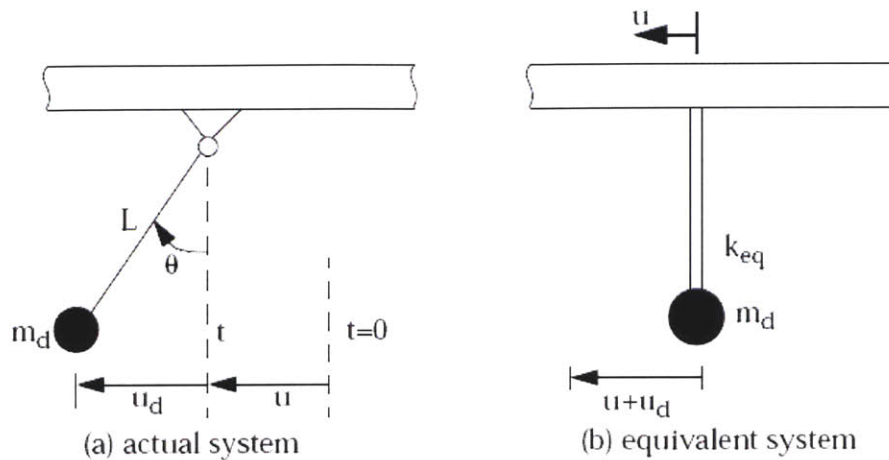
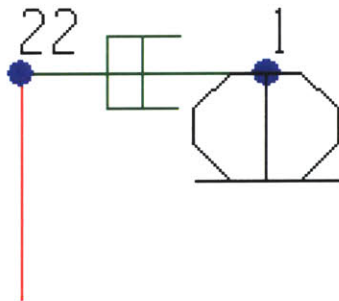

Figure 52: A simple pendulum Tuned Mass Damper [17]



The NLLink option of SAP2000 was used to model the TMD. With the use of simple formulas, the 730-ton steel ball which hangs from floor 92-88 (11.5m), it can be transformed to a mass (which is pinned) attached to the mass of the top floor via a spring of an equivalent stiffness and a dashpot connected in parallel, in order to model the damping of the damper itself.

Figure 53: Modeling the TMD in SAP2000 using the NLLink option

Hence, the natural period of the pendulum is
$$T_d = 2\pi \sqrt{\frac{L}{g}} \quad [17]$$

Using the above formula, once can verify that the TMD is tuned to the first mode with a period of 6.8seconds. The equivalent stiffness of the damper is $K_{eq} = W_d/L$ and the damper coefficient is $c = 2\xi(km)^{1/2}$. The damping of the TMD taken as $\xi = 4.7\%$. This value occurred after several calibrations during the time-history analysis (with the desired acceleration of 5 milli-g as a parameter) which is detailed described in the next chapter.

Assuming that the modal mass is about one third of the total mass, then it can be derived that the TMD is about 1% of the first modal mass. This number is in the lower limit of similar structures; the TMD is already of very big dimensions, so a larger mass would prove to be really challenging to construct.

7.2.3 Time History Analysis

For the TMD to be excited, a sinusoidal excitation with frequency identical to the tower's first frequency was applied. The forcing function was of the form $p = \hat{p} \sin \Omega t$

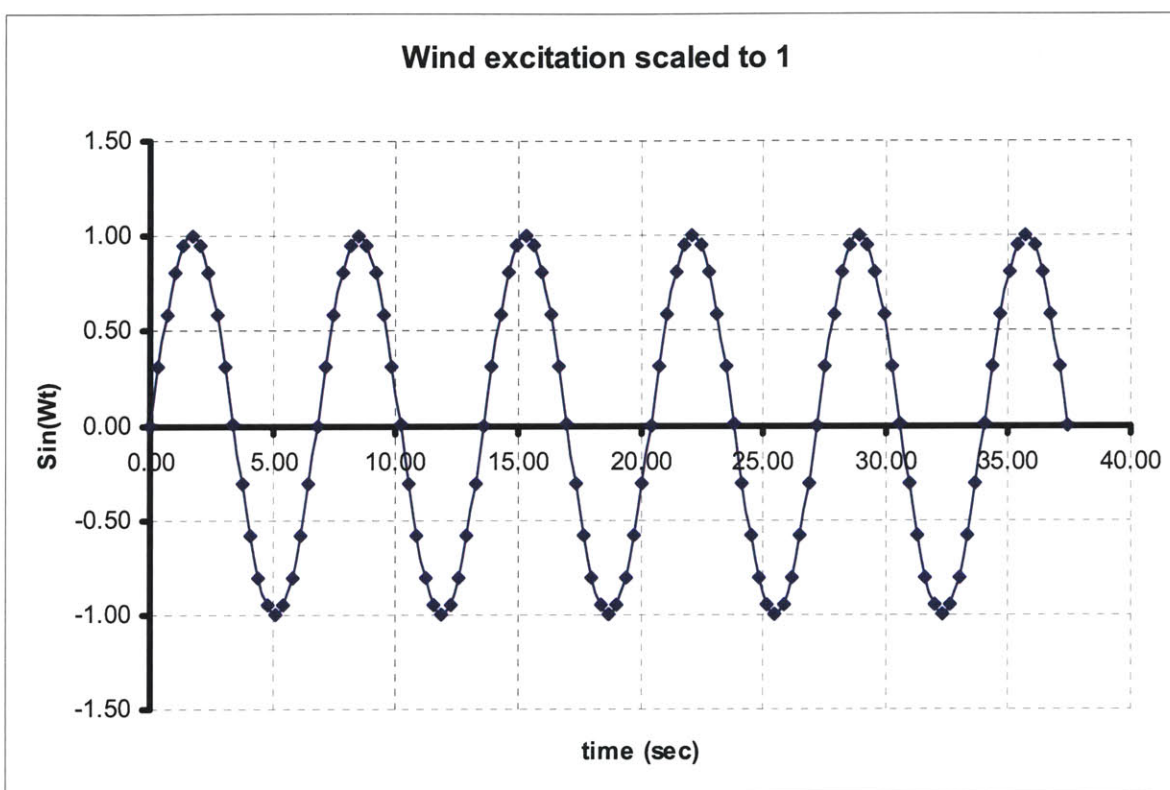

Figure 54: Sinusoidal Wind Excitation, with frequency identical to Taipei 101's first modal frequency

A time range of 35 sec (about 5 circles of 7 seconds each), with 20 time steps each was chosen. The frequency in rad/sec was calculated as $(2\pi)/6.8 = 0.924$ rad/sec.

After defining the time history function in SAP2000, by inserting manually the coordinates of the above function (which was plotted in EXCEL), the two following analyses were performed: The first analysis was the model with TMD at the top; the second was without the TMD at the top but with the same excitation. As the \hat{p} was not known, it was used as a calibration factor, until the target acceleration was reached. The final value was 440kN. It was modeled as a static load triangularly distributed to the top (with an initial value of 1 kN and scaled up with SAP2000's Scale Factor option-figure 55), which was amplified by the sinusoidal function (figure 54).

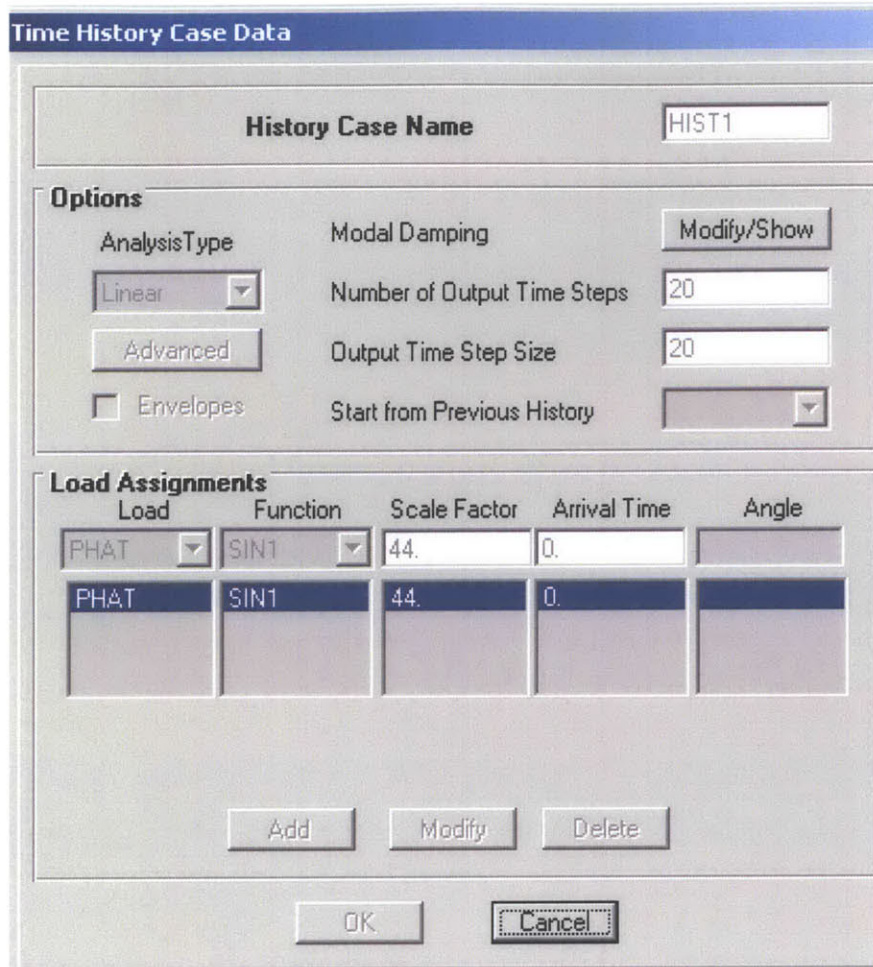

Figure 55: Definition of Time History Case Data in SAP2000

The target acceleration with the TMD was 5.0 milli-g (which is the current acceleration). After removing the TMD, this number increased by ~35%, fact that proves how the TMD worked and substantially decreased the accelerations to a human comfort level. (The current value of 5.0 milli-g's, according to table 2 is so low that human cannot perceive any motion)

In Figures 57 and 58, the time history traces for the top node of the model (joint were the maximum acceleration occurs) are plotted for comparative reasons.

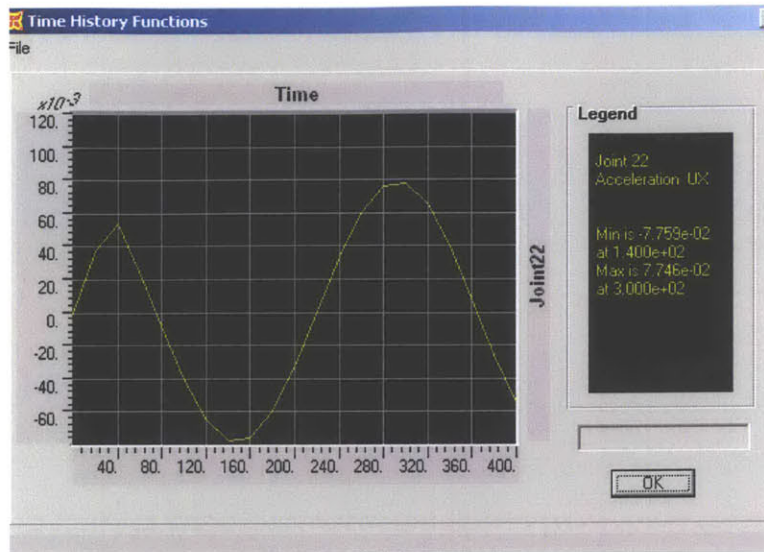

Figure 56: Time History Trace of the top node (Model without TMD)

The absolute maximum acceleration of the model without the TMD (figure 56) is $7.7e-2 \text{ m/s}^2$, which is about 8 milli-g. The same acceleration was obtained with the RWDI's wind tunnel tests and it exceeded the human comfort criteria.

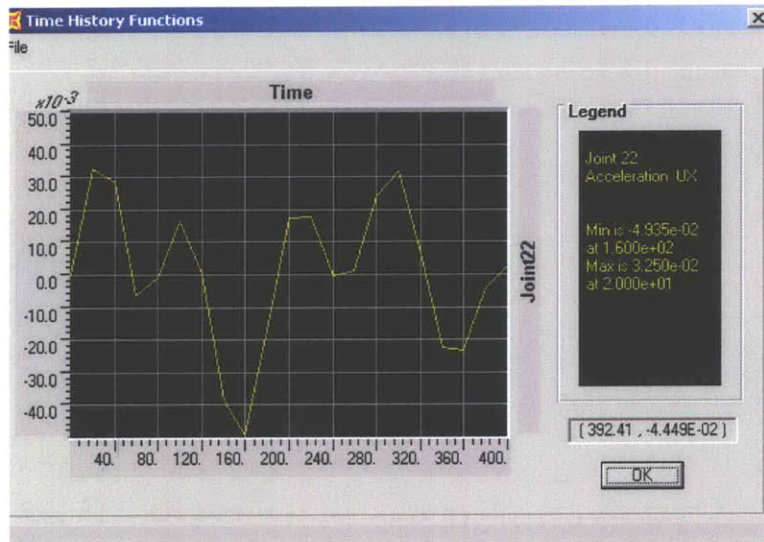

Figure 57: Time History Trace of the top node (Model with TMD)

After including the TMD, the absolute maximum acceleration reduced to $4.935e-2 \text{ m/s}^2$ (~ 35%), about 5 milli-g (figure 57). One can notice the effectiveness of the TMD. It should be also noted that after performing a modal analysis for the model with the TMD, the period was increased from 6.8 to 7 seconds. This slight change was anticipated, as a small fraction of mass was added to the model due to the TMD.

8. Overall Conclusions and Outlook

Structural Systems of Super-Tall Buildings have been examined through various standpoints. It has been proven that due to advances in the computer and material science, more daring solutions can be engineered and thus taller, lighter and more challenging buildings can be designed. A Tuned Mass Damper is a state-of-the-art solution which mitigates the structure's motion due to excessive wind induced vibrations. Like in Taipei 101, the accelerations were reduced by 40% and the TMD proved to be a tremendous engineering achievement: In Year 2005 it was selected to be one of the seven wonders of engineering by the Discovery Channel, and also its' elevators hold the number one place in the Guinness book for their speed. The engineers designed Taipei in an ingenious way, combining old and modern technological achievements in the field of structural, wind and mechanical engineering: outriggers, belt trusses, supercolumns with high-performance concrete, double deck elevators, Tuned Mass Dampers and floorplan aerodynamic optimization through wind tunnel testing are some of the key distinctive features of the tower.

It has been demonstrated that a simple 10-DOF model can very well predict the complicated behavior of the full-scale structure, including the tremendous advantages of a TMD. However, there can be another solution, more efficient than a single TMD, which is the use of multiple distributed Tuned Mass Dampers. In this way, instead of having a huge 730-ton steel ball which occupies valuable rentable space of four floors, one could design a system in which multiple TMDs will be "hidden" into the walls and they will be attached to the structural frame in a way that a similar result in the reduction of the accelerations could be achieved as with a single TMD. In this way the constructability and maintainability is increased, and also if one of the dampers fails to operate, there can be some response from the rest. The author of this thesis strongly recommends further studies in this field.

Appendix 1 – Various floorplans and elevation schematics

Levels 10 and 32 plans: (Notice the super- and “sub-supercolumns” and corner columns for additional stiffness; also notice the setbacks in the corners of the plate at level 32) [31].

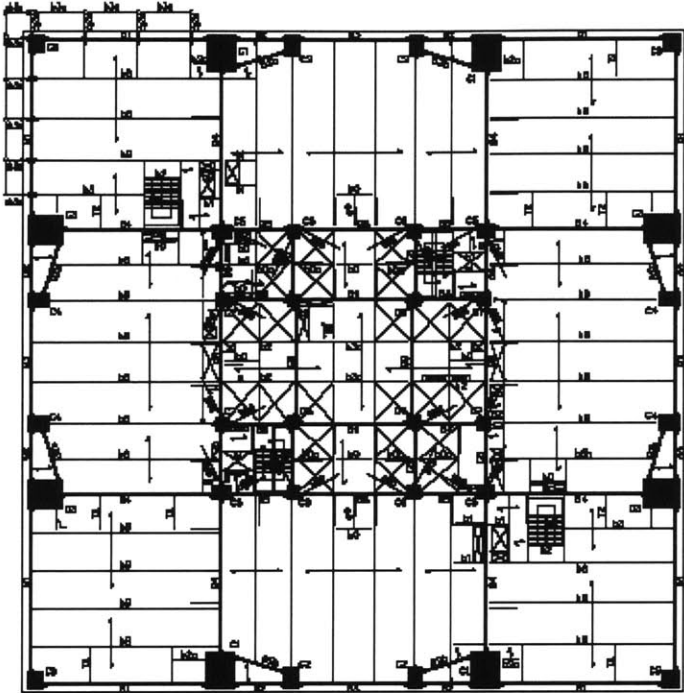

Level 10 - Tower Framing Plan

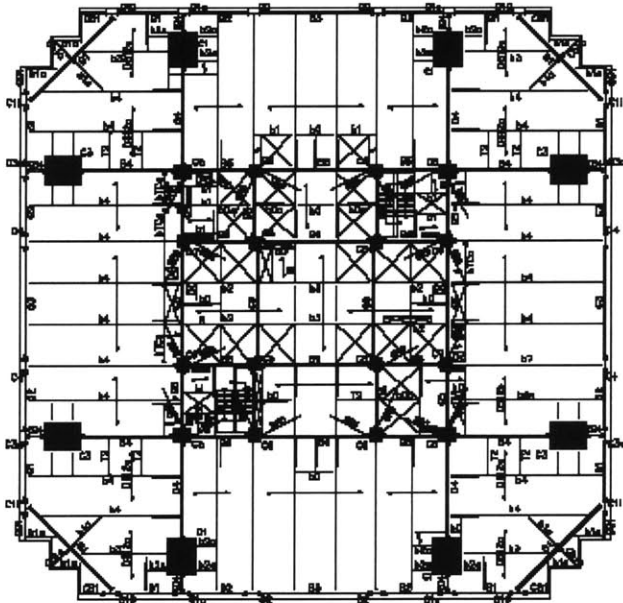

Level 32 - Tower Framing Plan

Frame elevation images: Notice the CBF and diagonally braced core, the outriggers and belt trusses [31].

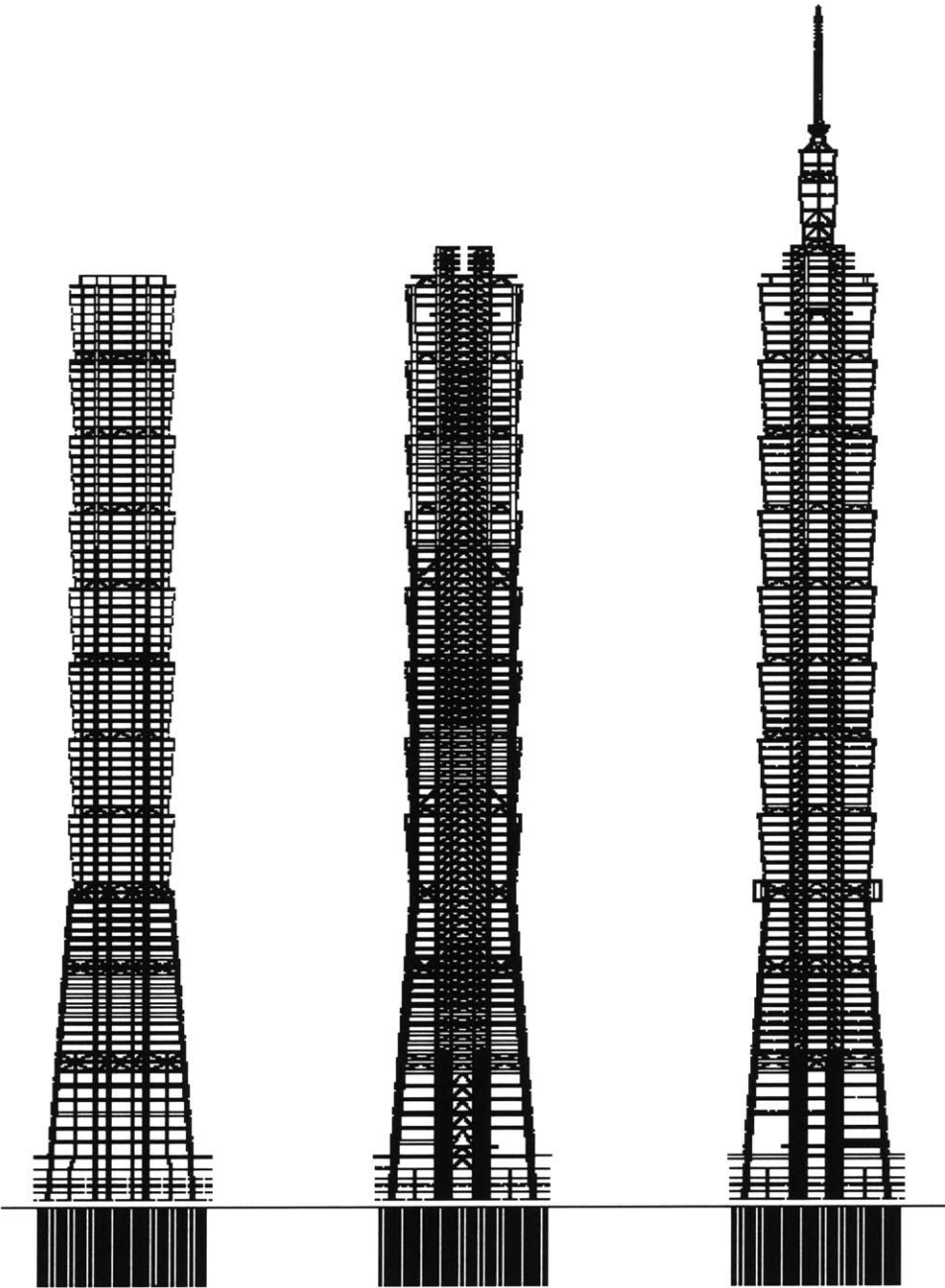

Appendix 2 – Calculations of Equivalent Beam

Steel	Density (t/m ³)	7.8500	Young's Modulus	200.0000
Concrete		2.5000	(Gpa)	40.0000

Sections	Length (m)	Elevations (m) z	SuperColumns (m)		Area (actual)		Mass (t)		Moment of Inertia (m4)			Rotational Moment of Inertia		Area
			x (a)	y (b)	Steel	Concrete	Steel	Concrete	Ixx	Iyy	Jzz (mt ²)	Mass t		
1.0000	100.8000	50.4000	3.0000	2.4000	0.8384	6.3616	729.7501	1,603.1232	1.0600	0.9620	2,869.4341	2,332.8733	2.1107	
2.0000	33.6000	117.6000	3.0000	2.4000	0.8384	6.3616	243.2500	534.3744	1.0600	0.9620	956.4780	777.6244	2.1107	
3.0000	33.6000	151.2000	3.0000	2.4000	0.8384	6.3616	243.2500	534.3744	1.0600	0.9620	956.4780	777.6244	2.1107	
4.0000	33.6000	184.8000	2.8000	2.4000	0.8064	5.9136	233.9657	496.7424	0.9450	0.8577	828.1358	730.7081	1.9891	
5.0000	33.6000	218.4000	2.6000	2.2000	0.7424	4.9776	215.3970	418.1184	0.7430	0.6687	612.3982	633.5154	1.7379	
6.0000	33.6000	252.0000	2.4000	2.0000	0.6784	4.1216	196.8283	346.2144	0.5722	0.5098	441.6747	543.0427	1.5027	
7.0000	33.6000	285.6000	2.4000	2.0000	0.6784		196.8283	0.0000	0.5685	0.5072	160.0870	196.8283	0.6784	
8.0000	33.6000	319.2000	2.2000	1.8000	0.6144		178.2596	0.0000	0.4272	0.3765	120.0281	178.2596	0.6144	
9.0000	33.6000	352.8000	2.2000	1.6000	0.5824		168.9752	0.0000	0.3674	0.3188	104.2014	168.9752	0.5824	
10.0000	16.8000	386.4000	2.0000	1.6000	0.5504		79.8454	0.0000	0.3116	0.2704	43.6488	79.8454	0.5504	
	386.4000													

Sections	Length (m)	Elevations (m) z	Small Columns (m)		Area (transformed)		Mass (t)		Moment of Inertia			Mass Total	Area
			x	y	Steel	Concrete	Steel	Concrete	Ixx/Iyy	Jzz			
1.0000	100.8000	50.4000	1.0000	1.0000	0.0396	0.0400	31.3347	10.0800	0.0067	5.2224	41.4147	0.0796	
2.0000	33.6000	117.6000	1.0000	1.0000	0.0396	0.0400	10.4449	3.3600	0.0067	1.7408	13.8049	0.0796	
3.0000	33.6000	151.2000	1.0000	1.0000	0.0396	0.0400	10.4449	3.3600	0.0067	1.7408	13.8049	0.0796	
4.0000	33.6000	184.8000	1.0000	1.0000	0.0396	0.0400	10.4449	3.3600	0.0067	1.7408	13.8049	0.0796	
5.0000	33.6000	218.4000	1.0000	1.0000	0.0396	0.0400	10.4449	3.3600	0.0067	1.7408	13.8049	0.0796	
6.0000	33.6000	252.0000	1.0000	1.0000	0.0396	0.0400	10.4449	3.3600	0.0067	1.7408	13.8049	0.0796	
7.0000	33.6000	285.6000	1.0000	1.0000	0.0396	0.0400	10.4449	3.3600	0.0067	1.7408	13.8049	0.0796	
8.0000	33.6000	319.2000	1.0000	1.0000	0.0396	0.0400	10.4449	3.3600	0.0067	1.7408	13.8049	0.0796	
9.0000	33.6000	352.8000	1.0000	1.0000	0.0396	0.0400	10.4449	3.3600	0.0067	1.7408	13.8049	0.0796	
10.0000	16.8000	386.4000	1.0000	1.0000	0.0396	0.0400	5.2224	1.6800	0.0067	0.8704	6.9024	0.0796	
	386.4000												

Total Properties for Floorplan				Jzz total : Jzz+md ²				
Sections	Length (m)	Elevations (m) z	Ixx total (Ixx+a ² 2xA)=Iyy		Quarter		Full	Jzz total
			Quarter	Full	Vertical	Slab		
1.0000	100.8000	50.4000	2,012.5647	8,050.2586	151,657.6974	606,630.7895	19,826,354.1667	20,432,984.9562
2.0000	33.6000	117.6000	1,427.3511	5,709.4043	42,057.9452	168,231.7806	2,857,290.0417	3,025,521.8223
3.0000	33.6000	151.2000	1,427.3511	5,709.4043	42,057.9452	168,231.7806	2,857,290.0417	3,025,521.8223
4.0000	33.6000	184.8000	1,348.8061	5,395.2246	39,419.7867	157,679.1467	2,857,290.0417	3,014,969.1884
5.0000	33.6000	218.4000	1,186.6110	4,746.4438	34,054.8098	136,219.2391	2,857,290.0417	2,993,509.2808
6.0000	33.6000	252.0000	1,034.7829	4,139.1317	29,120.9683	116,483.8734	2,857,290.0417	2,973,773.9150
7.0000	33.6000	285.6000	503.8116	2,015.2462	10,983.9500	43,935.7999	2,857,290.0417	2,901,225.8416
8.0000	33.6000	319.2000	462.3156	1,849.2625	9,961.2848	39,845.1392	2,857,290.0417	2,897,135.1808
9.0000	33.6000	352.8000	441.5860	1,766.3441	9,458.3576	37,833.4305	2,857,290.0417	2,895,123.4722
10.0000	16.8000	386.4000	420.8698	1,683.4794	4,476.6383	17,906.5530	2,857,290.0417	2,875,196.5947

References

- [1] Bungale S. Taranath, 1988, *Structural Analysis and Design of Tall Buildings*, McGraw-Hill Book Company, USA.
- [2] Wikipedia, *Tower of Babel*, viewed 5 January 2007, <http://en.wikipedia.org/wiki/Tower_of_Babel>
- [3] Wikipedia, *Colossus of Rhodes*, viewed 5 January 2007, <http://en.wikipedia.org/wiki/Colossus_of_Rhodes>.
- [4] Wikipedia, *Pyramid*, viewed 5 January 2007, <<http://simple.wikipedia.org/wiki/Pyramid>>
- [5] Wikipedia, *Lighthouse of Alexandria*, viewed 5 January 2007, <http://en.wikipedia.org/wiki/Lighthouse_of_Alexandria>.
- [6] Mathew Wells, 2005; *Skyscraper*, Structure and Design, USA.
- [7] P.Jayachandran, 2003; 'Design of Tall Buildings, Preliminary Design and Optimization'; International Conference on Tall buildings and Industrial Structures, PSG College of Technology, Coimbatore, India.
- [8] Bungale S. Taranath, 2005; *Wind and Earthquake Resistant Buildings – Structural Analysis and Design*, McGraw-Hill Book Company, USA.
- [9] John B. Scalzi; 1971, 'The Staggered Truss System-Structural Considerations'; AISC National Engineering Conference, Cleveral, Ohio.
- [10] Kuleuven, viewed 10 January 2007, <<http://www.kuleuven.ac.be/>>.
- [11] 9-11 Research, viewed 10 January 2007, <<http://911research.wtc7.net/mirrors/guardian2/wtc/godfrey.htm>>.
- [12] *John Hancock Center image*, viewed 10 January 2007, : <<http://www.demecanica.com/EstrucArt/images/hancockcenter.jpg>>.
- [13] Emporis Buildings, *Official World's 200 Tallest High-Rise*, viewed 10 January 2007, <www.emporis.com>.
- [14] Aline Brazil, Leonard M. Joseph, Dennis Poon, Thomas Scarangelo, 2006, 'Designing High Rises for Wind Performance ', ASCE 2006, Thornton Tomasetti Engineers, New York.
- [15] Council on Tall Buildings and Urban Habitat, 1995; *Structural Systems for Tall Buildings*; McGraw-Hill, USA.
- [16] Viewed 10 January 2007, <<http://www.istructe.org/thestructuralengineer/>>.
- [17] Jerome J. Connor, 2003, *Introduction to Motion Based Design*, Prentice Hall, New Jersey.
- [18] *Active-passive Composite Tuned Mass Damper*, viewed 15 January 2007, <<http://moment.mit.edu/documentLibrary/Duox/duox.html>>.
- [19] *CN Tower Image*, viewed 15 January 2007, <<http://www.cntower.ca/portal/>>.
- [20] *Motioneering web*, viewed 15 January 2007, <www.motioneering.ca>.
- [21] Brian Breukelman, Trevor Haskett, 2001; 'Good Vibrations'; *Civil Engineering Magazine*, ASCE , vol.71, no 12.

- [22] T. Haskett, B. Breukelman, J. Robinson, J. Kottelenber; 'Tuned Mass Dampers Under Excessive Structural Excitation'; Motioneering Inc.
- [23] J.D. Holmes, 1993; 'Listing of installations'; *Engineering Structures*, vol.17, no 9, pp.676-678.
- [24] Peter Irwin, President of Rowan Williams Davies & Irwin Inc. (RWDI); *RWDI Technotes*, 'Motion Criteria in High Rise Buildings', Issue Number 2c.
- [25] Rowan Williams Davies & Irwin Inc. (RWDI); *RWDI Technotes*, Issue Number 10: Damping Systems; viewed 20 January 2007, <www.rwdi.com>.
- [26] Ahsan Kareem, Tracy Kijewski, Yokio Tamura, 1999, 'Mitigation of Motions of Tall Buildings with Specific Examples of Recent Applications' ; *Journal of Wind and Structures*, vol.2, no 3, pp. 132-184.
- [27] Leonard M. Joseph, Dennis Poon, Shaw-song Shieh, 2006; 'Ingredients of High-Rise Design Taipei 101 – the world's tallest building'; *Structure Magazine*.
- [28] Dennis C.L. Poon, Shaw-song Shieh, Leonard M. Joseph, Ching-Chang, 2004; 'Reaching for the Sky'; *Civil Engineering*.
- [29] *official website of Taipei-101*, viewed 25 April 2007, <<http://www.taipei-101.com.tw>>.
- [30] viewed May 6 2007, <http://www.sky-scrapers.org/Structural_Facts/index.php/Taipei_101:_Aesthetics#Design_Inspirations>.
- [31] Shaw-Song Shieh, Ching-Chang CHANG, Jiun-Hong JONG; 'Structural Design of Composite Super-Columns for the Taipei 101 Tower', Courtesy of Evergreen Consulting Engineering, Inc. Taiwan.
- [32] Peter A. Irwin; President and CEO, RWDI: 'Developing Wind Engineering Techniques to Optimize Design and Reduce Risk'; Courtesy of RWDI.
- [33] Bungale S. Taranath, 1998 ; *Steel, Concrete & Composite design of Tall Buildings – second edition*; Mc Graw-Hill, New York.
- [34] Michael Soligo, RWDI Vice President; 'High-Rise Buildings in Hurricane Areas'; *RWDI Technotes*, Issue No. 2b.
- [35] P. Mendis, T. Ngo, N. Haritos, A. Hira (The Univeristy of Melbourne, Australia), B. Samali (University of Technology Sydney, Australia), J. Cheung (Monash University, Australia); 2007, 'Wind Loading on Tall Buildings'; *EJSE Special Issue: Loading on Structures*.'