

**Supply Chain Packaging – Packaging for Optimal Inter-Region Distribution  
Center Operations and Damage Prevention**

By

Adesunloye Obatoyinbo

B.S. Electrical Engineering, University of South Florida (1999)

M.S. Electrical Engineering, Georgia Institute of Technology (2001)

Submitted to the Sloan School of Management and the Department of Civil and  
Environmental Engineering in Partial Fulfillment of the Requirements for the Degrees of  
Master of Business Administration  
and

Master of Science in Civil and Environmental Engineering

In Conjunction with the Leaders for Manufacturing Program at the  
Massachusetts Institute of Technology  
June 2006

©2006 Massachusetts Institute of Technology. All rights reserved.

Signature of Author \_\_\_\_\_

  
Sloan School of Management  
Department of Civil and Environmental Engineering  
/ May 12, 2006

Certified by \_\_\_\_\_

  
Oral Buyukozturk, Thesis Supervisor  
Professor of Civil and Environmental Engineering

Certified by \_\_\_\_\_

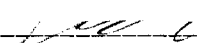
  
Don Rosenfield, Thesis Supervisor  
Director, Leaders For Manufacturing Fellows Program  
Senior Lecturer, Sloan School of Management

Accepted by \_\_\_\_\_

  
Andrew Whittle, Chairman of Committee on Graduate Studies  
Department of Civil & Environmental Engineering

Accepted by \_\_\_\_\_

  
Debbie Berechman, Executive Director of Masters Program  
Sloan School of Management

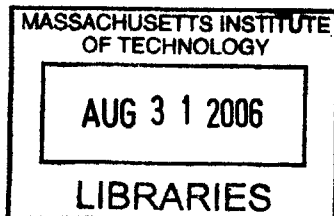

**BARKER**



# **Supply Chain Packaging – Packaging for Optimal Inter-Region Distribution Center Operations and Damage Prevention**

By  
Adesunloye Obatoyinbo

Submitted to the Sloan School of Management and Department of Civil Engineering on May 12, 2006 in partial fulfillment of the Requirements for the Degrees of Master of Business Administration and Master of Science in Civil and Environmental Engineering

## **Abstract**

Honeywell International Corporation is a \$27.5 billion [1] conglomerate with a diverse portfolio of businesses covering Aerospace, Automation and Controls, Specialty Materials and Transportation. Honeywell's Automation and Controls Solutions (ACS) business is the second largest business group with \$9.4 billion in sales in 2005. This business group is further divided into the following strategic business units:

- Security (Facilities)
- Life Safety
- Building Solutions
- Process Solutions
- Sensing and Control
- Environmental and Combustion Controls

The Environmental and Combustion Controls (ECC) business unit of Honeywell ACS maintains a global manufacturing and distribution presence. ECC delivers complex systems that control air, water and combustion for both homes and industrial customers.

Historically, ECC plants in the EMEA (Europe, Middle East and Africa) region have either had their own warehouses or had a captive third party provider that provided warehousing services offsite. However, recent initiatives in the region have culminated in the adoption of a regional distribution center model. Essentially, clusters of plants are grouped into regions that are served by the same warehouse or distribution center. The regional warehouse in Heilbronn Germany (ERD) is the pilot for such a system. Plants in Emmen in the Netherlands, Brno in the Czech Republic, Nagykanisza in Hungary and Schoenaich and Mosbach in Germany, as well as some small Low Risk Distribution (LRD) centers – which stock emergency volumes – in western Europe will all be consolidated and served from the distribution center in Heilbronn. This essentially means that instead of storing their own inventory, all the affected plants will truck all production to the Heilbronn warehouse on a daily basis. The Heilbronn warehouse, which commenced operation in May, 2005 subsequently fulfills all customer orders associated with the locations listed above.

During the consolidation exercise, while planning for receipt of goods from the different plants, it became clear that there were multiple packaging standards in use throughout Europe. There thus arose the need to consolidate the different standards into a coherent well-defined standard to enable the new distribution center established at Heilbronn, Germany, to properly handle goods from the different plants. Additionally, the newly built ERD had a need for an established set of packing guidelines that may include procedural changes or the establishment of new procedures, changes to the physical setup of the outbound lines (freight and parcel), presentation and replenishment of packaging material and suggestions for improvement for the long term. Receiving guidelines have also been newly instituted for products arriving at the ERD, which also creates a case for compliance for goods being shipped from suppliers including a counterpart warehouse – the Louisville Distribution Center (LDC) – in Louisville, Kentucky.

In addition, the LDC had been having difficulty receiving freight from the European plants. The major problems included inadequate labeling, lack of overpacking<sup>1</sup>, inconsistency in packing of mixed pallets and the non-usage of Honeywell 40" X 32" pallets. Since all European plant shipments that formerly shipped directly from each plant would be shipping from ERD in Heilbronn going forward, it became imperative that appropriate packaging standards be developed (in Europe) in order to ensure compliance with receiving guidelines in Louisville at the LDC.

Fulfillment through the distribution centers is what drives customer satisfaction. No matter how efficient the plants may be, transit through the distribution centers is the proverbial "last mile" that delivers all the efforts of the firm to the customers. I have developed and recommended a packaging standard, which outlines the levels to which packaged products must be tested in preparation for safe shipping. I analyzed current packing practice at the ERD showing relevant cost drivers and made recommendations on ways to pack in order to improve service to the downstream distribution center while keeping costs contained. I developed a framework to guide warehouse management with regards to pallet shipping decisions between the ERD and LDC. Finally, I developed a carton<sup>2</sup> replenishment framework for the ERD that can be adopted for other appropriate ECC warehouses.

Thesis Supervisor: Don Rosenfield

Title: Director, Leaders For Manufacturing Fellows Program, Senior Lecturer, Sloan School of Management

Thesis Supervisor: Oral Buyukozturk

Title: Professor of Civil and Environmental Engineering

---

<sup>1</sup> Overpacking is the practice of packing unique part numbers into a larger shipping unit. For example a shipment of 12 thermostats may be packed into a larger box or carton to streamline handling and ensure protection from shipment related damage

<sup>2</sup> The word carton is used in this paper interchangeably with boxes. Here I have defined them as corrugated paper enclosures designed for shipping and/or packaging

## Acknowledgements

*The author wishes to acknowledge the  
Leaders for Manufacturing Program at MIT  
for its support of this work.*

*He would also like to thank various people at Honeywell for their invaluable assistance and advice including but not limited to Jay Fortenberry, Anne Bruggink, Jean-Pierre Lavanchy, Ingo Meckes, Pete Newton, Jeanine Skendzel, Jane Imsorn-Francis, Bill Gibson, Hendrije Carriger, Art Clark, Lynette Whooley, Ken Peter, Andrew Owens and all the staff at the Louisville Distribution Center in Louisville, Kentucky and at the European Distribution Center in Heilbronn, Germany.*

*This page is intentionally left blank*

# Table of Contents

<b>ABSTRACT .....</b>	<b>3</b>
<b>ACKNOWLEDGEMENTS.....</b>	<b>5</b>
<b>TABLE OF CONTENTS.....</b>	<b>7</b>
<b>LIST OF FIGURES .....</b>	<b>9</b>
<b>LIST OF TABLES .....</b>	<b>9</b>
<b>1 INTRODUCTION .....</b>	<b>11</b>
<b>1.1 PACKAGING .....</b>	<b>11</b>
<b>1.2 PACKING .....</b>	<b>11</b>
<b>1.3 THESIS SCOPE AND MOTIVATION .....</b>	<b>11</b>
<b>1.4 THESIS OVERVIEW .....</b>	<b>12</b>
<b>2 THE HONEYWELL ENVIRONMENTAL COMBUSTION AND CONTROL PACKAGING DESIGN PROCESS.....</b>	<b>15</b>
<b>2.1 ECC NORTH AMERICA.....</b>	<b>16</b>
2.1.1 PACKAGING PRACTICE IN ECC NORTH AMERICA .....	16
<b>2.2 ECC EUROPE .....</b>	<b>17</b>
2.2.1 PACKAGING PRACTICE IN ECC EUROPE .....	17
<b>2.3 FUTURE STATE AND RELEVANT STANDARDS .....</b>	<b>18</b>
2.3.1 ASTM, ISTA AND HONEYWELL INTERNAL STANDARDS .....	19
2.3.2 DETAILED PROCEDURE.....	20
2.3.3 EQUIPMENT, PROCESS AND PERSONNEL REQUIREMENTS .....	20
2.3.4 FINANCIAL IMPLICATIONS.....	22
<b>2.4 STACKABILITY .....</b>	<b>24</b>
2.4.1 STACKABILITY MATRIX INPUTS .....	25
2.4.2 STACKABILITY MATRIX – A PRACTICAL EXAMPLE .....	25
2.4.3 HOW TO MAKE IT WORK .....	26
<b>3 PRODUCT PACKING AT THE EUROPEAN DISTRIBUTION CENTER.....</b>	<b>27</b>
<b>3.1 PACKING OVERVIEW OF THE EUROPEAN DISTRIBUTION CENTER, HEILBRONN .....</b>	<b>27</b>
3.1.1 PARCEL PACKING.....	27
3.1.2 FREIGHT PACKING .....	27
<b>3.2 DIFFERENT PACKING STANDARDS .....</b>	<b>28</b>
3.2.1 STANDARD PACKING .....	29
3.2.2 CLASS-A PACKING .....	30
3.2.3 CLASS-B PACKING.....	31
<b>3.3 COMPARISON OF STANDARD, CLASS-A AND CLASS-B PACKING .....</b>	<b>31</b>

3.3.1 CLASS-A VS. STANDARD PACKING .....	32
3.3.2 CLASS-B COST ESTIMATES .....	33

**4 PALLET FLOWS BETWEEN THE EUROPEAN AND LOUISVILLE DISTRIBUTION CENTERS ..... 35**

4.1 HONEYWELL PALLETS .....	35
4.2 WORLDWIDE PALLET USAGE .....	36
4.2.1 NORTH AMERICA STANDARDS .....	36
4.2.2 EUROPE STANDARDS .....	37
4.2.3 HONEYWELL INTERNAL STANDARDS.....	37
4.3 ISPM (INTERNATIONAL STANDARDS FOR PHYTOSANITARY MEASURES) 15 STANDARDS .....	38
4.4 PALLET FLOW BETWEEN ERD AND LDC CURRENT STATE .....	38
4.5 PALLET FLOW ANALYSIS BETWEEN ERD AND LDC .....	39

**5 CARTON REPLENISHMENT ..... 43**

5.1 CARTON TYPES AND USAGE PROFILES .....	43
5.2 SPACE LIMITATIONS ERD, HEILBRONN .....	44
5.3 CURRENT ORDER POLICY .....	44
5.4 PROPOSED FUTURE STATE.....	44

**6 ORGANIZATIONAL LEADERSHIP AND CHANGE ANALYSIS..... 49**

6.1 USING THE THREE PERSPECTIVES ON ORGANIZATIONAL PROCESSES .....	49
6.1.1 STRATEGIC DESIGN .....	49
6.1.2 POLITICAL .....	51
6.1.3 CULTURAL.....	55
6.1.4 SUMMARY OF THE THREE PERSPECTIVES .....	57
6.2 LEADERSHIP OF THE CHANGE PROCESS.....	58
6.3 EVALUATION OF THE CHANGE PROCESS .....	60
6.4 RECOMMENDATIONS FOR CONTINUED SUCCESS.....	61

**7 CONCLUSIONS ..... 63**

**BIBLIOGRAPHY ..... 65**

**APPENDIX A – PACKAGING STANDARD FOR EMEA PLANTS ..... 67**

**APPENDIX B – ASSUMPTIONS FOR CARTON REPLENISHMENT ..... 73**



## List of Figures

FIGURE 1. ECC GLOBAL OPERATIONS	15
FIGURE 2. PACKAGE TEST PROCESS AND COST BREAKDOWN	21
FIGURE 3. PACKAGE TEST PROCESS AND COST BREAKDOWN FOR RECURRING YEARLY COSTS	23
FIGURE 4. STACKABILITY MATRIX	26
FIGURE 5. STANDARD PACKING	29
FIGURE 6. CLASS-A PACKING	30
FIGURE 7. CLASS-B PACKING	31
FIGURE 8. CLASS-A VS. STANDARD PACKING COMPARISON	32
FIGURE 9. CLASS-A, CLASS-B AND STANDARD PACKING RELATIVE COSTS	34
FIGURE 10. A PALLET FROM HONEYWELL'S SAN DIEGO DISTRIBUTION CENTER	35
FIGURE 11. PALLET STANDARDS BY GEOGRAPHY	36
FIGURE 12. THE EURO PALLET	37
FIGURE 13. TOTAL RELEVANT SUPPLY CHAIN PALLET COST	41
FIGURE 14. COSTS AND PALLET SPACES FOR DIFFERENT ORDER FREQUENCIES	47
FIGURE 15. ACS ORGANIZATIONAL MATRIX STRUCTURE	50
FIGURE 16. STAKEHOLDER MAP OF THE LFM THESIS WORK AT HONEYWELL-ECC.	52

## List of Tables

TABLE 1. ECC PLANTS AND PRODUCT PROFILES .....	16
TABLE 2. SUMMARY OF TEST EQUIPMENT .....	20
TABLE 3. FINANCIAL SUMMARY OF TESTING PROGRAM .....	24
TABLE 4. 1-WEEK CARTON USAGE AT THE ERD .....	44
TABLE 5. CARTON 10 ORDER ANALYSIS .....	45
TABLE 6. COST COMPARISON FOR DIFFERENT ORDER FREQUENCIES .....	46
TABLE 7. SUMMARY OF KEY STAKEHOLDERS IN THE LFM THESIS WORK AT HONEYWELL-ECC. ....	53

*This page is intentionally left blank*

# **1 Introduction**

## **1.1 Packaging**

The topic of packaging is one that many manufacturers consider as an afterthought to the development of their latest and greatest products. The mental model is one of “lets create the product and have someone take care of the package.” Although this is a broad generalization, several industries have been at the cutting edge of thinking of package design as integral to their products. Manufacturers of microwave frequency circuits where complex electro-dynamic interactions often require that the package be designed as a part of the product were early converts to the paradigm of a “package-centric” product design model. In the context of a conglomerate that manufactures a wide mix of products from electronic circuits for building controls to 90kg valves that channel water and industrial liquids, packaging can take many forms.

## **1.2 Packing**

Packing on the other hand is the process by which finished products - many of which are already packaged - are prepared for delivery to the end customer. The end customer in this case may be an intermediate distributor, an individual that needs to perform home repairs or even a contractor at a job site responsible for a skyscraper.

Although one may be tempted to consider product packaging and product packing separately, it is essential that a company’s strategy to address each of these areas be an integrated effort. While packaging typically takes place at the point of manufacture, packing may occur elsewhere since distributions centers or warehouses may not be collocated with the corresponding manufacturing site. As we will see, this is the case for the Environmental Combustion and Control (ECC) division of the Automating and Controls Systems business group of Honeywell.

## **1.3 Thesis Scope and Motivation**

Based on the research of Dennis Pascal in his book, *Lean Thinking*, I see supply chains, as being

similar to manufacturing operations in that they are constantly evolving and with every evolution and subsequent stabilization, standardization is necessary to foster an environment conducive to continuous improvement [2].

This thesis seeks to address the key decisions that have to be made in order to accommodate and understand how changes in a supply chain can affect a manufacturing organization's packaging strategy. Relevant examples will be drawn from my experiences at Honeywell's plants and distributions centers all over Western Europe and North America. Furthermore the issues discussed in this thesis will be limited to ECC plants and distributions centers.

## ***1.4 Thesis Overview***

This document is organized as described below:

**Chapter 2, The Honeywell ECC Package Design Process** provides background information as well as the current state of packaging at Honeywell's plants in North America and Europe. Specifically a new packaging standard is defined for certain Honeywell ECC plants in Europe.

**Chapter 3, Product Packing at the European Distribution Center** discusses the definition of packing and the different packing methods currently in use at the ERD in Heilbronn. Suggestions for improvement and a proposed future state are described.

**Chapter 4, Pallet Flows Between the European and Louisville Distribution Centers** provides an analysis of the drivers that affect the decision to source pallets, where to source pallets and which pallets to ship and in which direction.

**Chapter 5, Carton Replenishment** analyses the current state of carton replenishment at ERD, factors in the space requirements with regard to the forecasted increase in volume of products at the warehouse and trades off the availability and cost of delivery of package materials with space required for storage.

**Chapter 6, Organizational Leadership and Change Analysis** examines this thesis work from the three perspectives of organizational processes – strategic design, political, and cultural. This chapter also includes a project leadership assessment, evaluation of the change process, and recommendations for continued success at ECC.

**Chapter 7, Conclusions** ties the results and discussion of the preceding chapters together.

*This page is intentionally left blank*

## 2 The Honeywell Environmental Combustion and Control Packaging Design Process

As outlined in the abstract, Environmental Combustion and Control (ECC) is a strategic business unit within the ACS strategic business group. The worldwide footprint of ECC manufacturing and distribution facilities is far reaching with operations on 3 continents. Figure 1 below shows ECC plants and distribution center locations worldwide.

Figure 1. ECC Global Operations

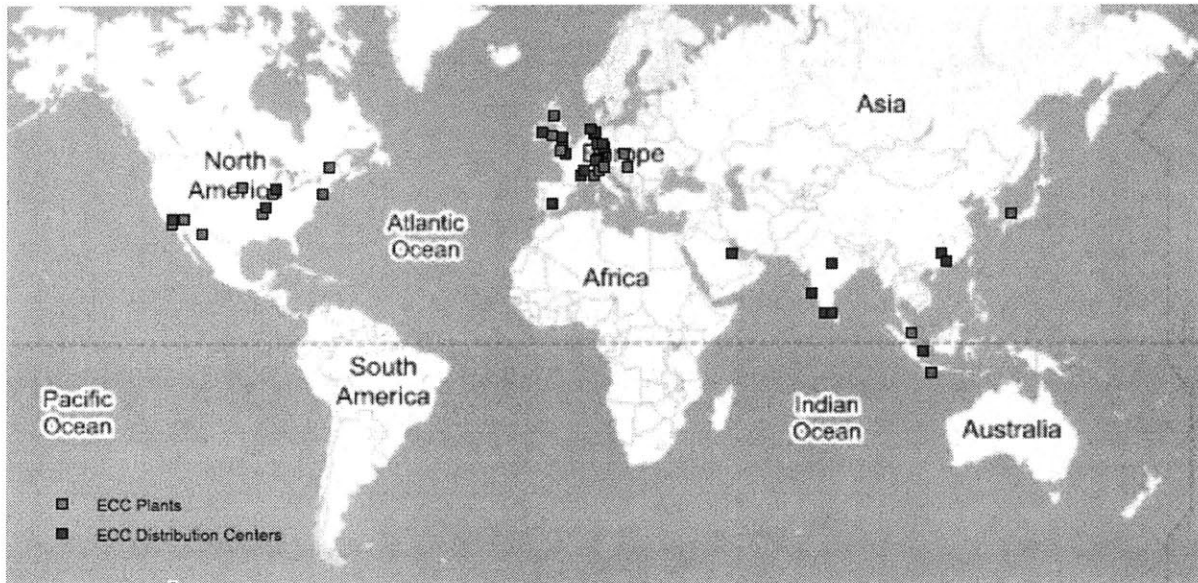

Strategic plans within the Integrated Supply Chain function over the last few years have started to focus on consolidation of plants and distribution centers as part of the cost savings initiative. The future state calls for a smaller and more efficient footprint. Implementation of this plan commenced in Europe with the opening of the ERD, a regional warehouse for continental Europe. It is located in Heilbronn, in the south west of Germany. It is less than 50 miles from two major plants in Germany and also services plants in the Netherlands (Emmen), Hungary (Nagykanizsa) and the Czech Republic (Brno). Since so many plants with different product profiles will be served from a single warehouse, the expected outcome is that outbound shipments can be consolidated to save on outbound shipping costs to the customer. As a result packaging requirements will be different as compared to the situation in which each plant individually shipped its products to the end customer. Obviously the

ERD will not be sufficient to serve all of Europe but rather will serve as a pilot for which other distribution centers can be modeled.

**Table 1. ECC Plants and Product Profiles**

<b>Plant Location</b>	<b>Country</b>	<b>Products (Lines of Business)</b>
1. Emmen	Netherlands	Combustion (Residential), Water products
2. Schoenaich	Germany	Buildings, Homes
3. Mosbach	Germany	Water products, Cooling and refrigeration, Buildings, Homes
4. Nagykanizsa	Hungary	Combustion (Burner boiler controls)
5. Brno	Czech Republic	Homes, Water products

## **2.1 ECC North America**

In North America the ECC organization has locations all over Mexico, the United States and Canada. The largest ECC distribution center in North America is the Louisville Distribution Center (LDC) in Louisville, Kentucky. The LDC is a 300,000 square foot facility that handles inbound shipments from ECC plants all over the world. In addition LDC is able to process 3500 order lines<sup>3</sup> per day of outbound parcels and freight bound for a wide array customers both in the US and abroad.

### **2.1.1 Packaging Practice in ECC North America**

Within ECC in North America, the packaging function is handled in the Golden Valley location, close to Minneapolis, Minnesota. Packaging engineers are responsible for designing new packaging, modifying existing packaging and communicating and documenting their processes. In order to be able to carry out their tasks, packaging engineers interact closely with product engineers to gather requirements in order to understand the performance expected from a package. The requirements may include:

1. The expected load carrying capacity
2. Acceptable levels of damage to either the package or the enclosed product

After requirements gathering, the packaging engineer proceeds with prototyping, final design and implementation. Implementation steps include

---

<sup>3</sup> An order line is an actual line on an order form, which consist of a unique product ID with a quantity of one or more.



1. Document control
2. Ship testing
3. Sourcing of suppliers

## **2.2 ECC Europe**

A new distribution center ERD has been established in Southwest Germany. This 56,500 sq ft facility in Heilbronn, operational since May 2005 will be responsible for taking over the volume formerly associated with 11 factory affiliated warehouses and low risk distributors<sup>4</sup> all over Western and Central Europe. As the new flagship European distribution center it is modern and up to date and utilizes technology to enable efficient operations. It is capable of handling 3068 order lines per day. It is able to do so by utilizing more vertical space than is used in LDC. A standard shelf configuration<sup>5</sup> at the ERD utilizes 9 pallet locations, which can each hold a pallet up to 124cm tall.

### **2.2.1 Packaging Practice in ECC Europe**

Unlike the centralized packaging organization in North America, the packaging organization in Europe is much more disperse. Each factory is uniquely responsible for handling its own packaging needs. The practice in each of the major factories affiliated with the ERD will be briefly discussed below.

#### **Mosbach**

The plant in Mosbach, Germany is 20 miles from the ERD and mainly manufactures products for the water products, cooling and refrigeration building and homes lines of business. Product managers are responsible for designing the packaging for new products.

#### **Schoenaich**

The plant in Schoenaich, Germany is 50 miles from the ERD and manufactures a range of products including electronic modules for the buildings and homes lines of business. Packaging is usually defined within the phase-in process for a new product. It is the responsibility of the product manager together with the warehouse team lead and purchasing to determine the most suitable packaging for a

---

<sup>4</sup> Low risk distributors are small warehouses established to handle local demand within certain countries.

<sup>5</sup> The warehouse shelves are configured differently in certain parts of the warehouse to accommodate different product sizes and to facilitate easy access to high runners.

product. This is usually done based on experience and expertise rather than on any defined standard.

#### **Emmen**

The plant in Emmen, Netherlands manufactures mostly combustion products, which are largely shipped in pallet packs<sup>6</sup>. It also manufactures products for the water line of business and is 336 miles from the ERD. Emmen has a packaging engineer on staff. For several products, returnable packaging is used between the plant and its customers. Sometimes, in order to accommodate a certain customer, these are designed in conjunction with the customer to satisfy the unique need. For certain packages, suppliers are involved in the design process and the standards are determined to conform to the unique circumstance. Otherwise certain Honeywell standards are used to qualify packages as far as prescribed tests are concerned.

#### **Brno**

The plant in Brno, Czech Republic manufactures a lot of the same types of products as the Mosbach plant, specifically for the homes and water products lines of business. It is 523 miles from the ERD. In fact certain products were migrated from Mosbach to the Brno plant. There are no set standards used in determining package design. Packages are usually designed from experience. Some testing equipment is actually available in Brno but is not fully utilized for testing packages.

#### **Nagykanizsa**

The plant in Nagykanizsa, Hungary is unique in that warehouse services such as packaging and distribution are handled by an external logistics provider, Kuhne and Nagel in Gottmadingen, Germany. It is 403 miles from the ERD and manufactures products for the combustion line of business. Products are shipped in quantities and containers that cannot be shipped directly to the end customer. The warehouse in Gottmadingen packages the products based on orders from end customers and handles ongoing shipping to the end customers. Essentially, the packaging function is non-existent in Nagykanizsa.

### ***2.3 Future State and Relevant Standards***

With the migration to the regional warehouse model in ECC, there is a need at Honeywell for a rationalization of packaging standards. Distribution centers will thus be empowered to efficiently

---

<sup>6</sup> Pallet packs are complete pallet loads of a unique product

receive, process and ship products. As has been mentioned before, packaging procedures and processes are stable and have been established for North America. Therefore I devoted considerable time during my internship to establishing relevant standards for particular European factories.

In determining what standards would be appropriate, I consulted various existing standards both within and outside of Honeywell.

### **2.3.1 ASTM, ISTA and Honeywell Internal Standards**

#### ***ASTM***

The ASTM – the American Society for Testing and Materials stated the following as its mission [3]:

*To be the foremost developer and provider of voluntary consensus standards, related technical information, and services having globally recognized quality and applicability that*

- *Promote public health and safety, and the overall quality of life;*
- *Contribute to the reliability of materials, products, systems and services; and*
- *Facilitate international, regional, and national commerce*

The relevant ASTM standards for shipment containers define minimum requirements for packages, to include various combinations of impact, atmospheric conditioning, compression and vibration testing. The ASTM standards for package testing are widely used in industry in the design of packages. They are also used within Honeywell and are widely referenced in Honeywell's own packaging documents.

#### ***ISTA***

The ISTA – International Safe Transit Organization's mission is to:

- *Provide transport information and tools needed to make jobs easier*
- *Help design packages that provide the right amount of product protection; and*
- *Give useful insight and technology that helps lower the total cost of distribution.*

Relevant ISTA standards have been developed to address testing of shipment containers of different weights and dimensions simulating different shipment environments. They are widely used throughout industry.

#### ***Honeywell Internal***

Honeywell's internal Design Analysis standards have also been used in generating a set of packaging

standards for ECC’s European plants. Specifically, DA8.5 [4] addresses environmental test procedures used in Honeywell’s plants in North America.

### 2.3.2 Detailed Procedure

From an examination of the standards listed above in section 2.3.1 as well as consideration for the types of products manufactured in the affected plants, I have generated a new set of standards.

Appendix A contains the relevant standards.

### 2.3.3 Equipment, Process and Personnel Requirements

#### *Equipment*

The equipment requirements for the proposed packaging standard are summarized in Table 2 below.

**Table 2. Summary of Test Equipment**

<b>Test</b>	<b>Cost</b>	<b>Manufacturer</b>	<b>Model</b>
Vibration	\$7926	MRAD	2430(100)TS
Compression	\$34000	Instron	5500
Drop Test	\$12,306	MRAD	3636(200)DT
Atmospheric Conditioning	\$28000	Russell’s Technical Products	G-Series
<i>Total</i>	\$82,232		

#### *Process*

In order to alter the packaging policy, major changes have to be adopted in the internal package design and testing procedures of the individual plants affected by the creation of the ERD. Since the overall product portfolio cannot be addressed at once, I have targeted a certain number of product packages for redesign in the first year. In subsequent years, packaging for a fixed number of products – mainly new products and perhaps some old ones – will be designed or redesigned resulting in a recurring charge. The diagram below clearly shows the sequence of tests and associated costs that would be required to design or redesign product packaging.

Figure 2. Package Test Process and Cost Breakdown

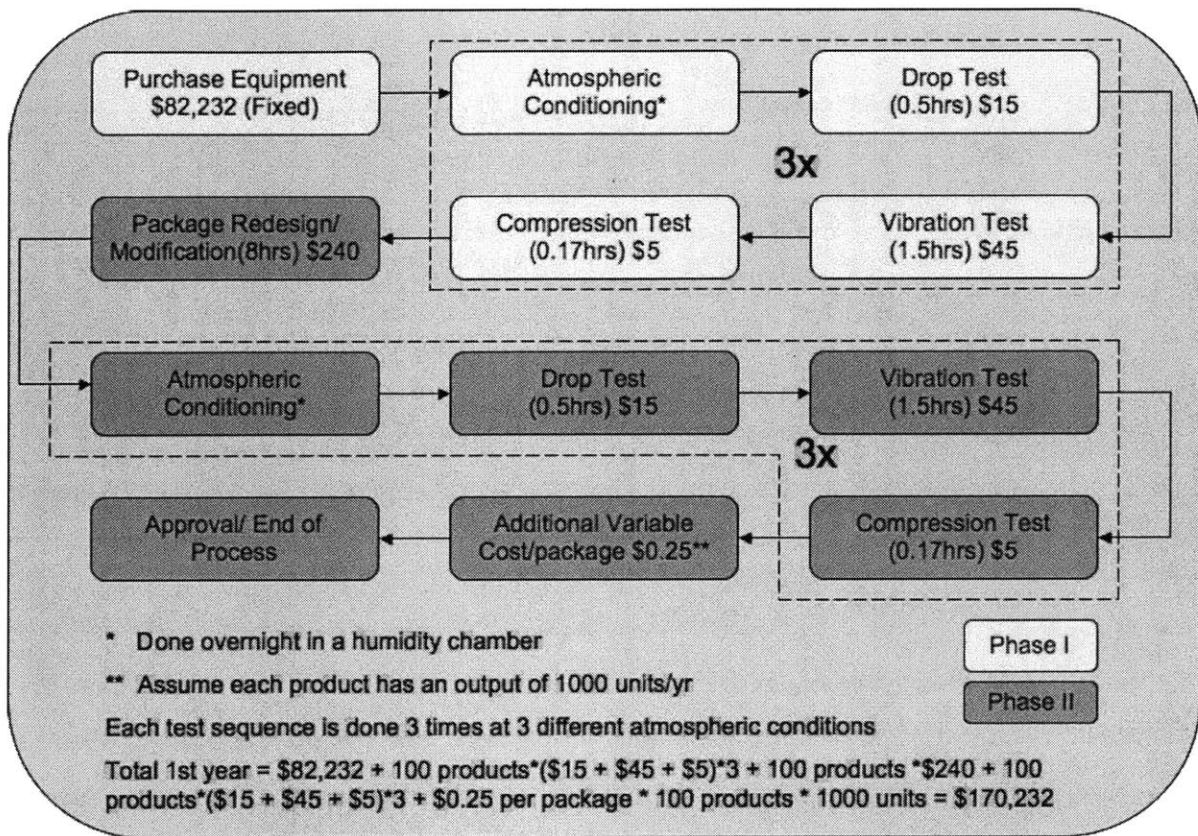

The core process involves atmospheric conditioning in a humidity chamber, drop, vibration and compression testing, a package evaluation and possible redesign based on first phase test results and finally, a second phase of tests resulting in approval. The implicit assumption is that on average two phases of testing will be performed with an intermediate redesign phase. Full financial impact<sup>7</sup> and assumptions are addressed in the next section.

**Personnel**

It is assumed that each plant will have one person on staff capable of performing the requisite tests as outlined in the packaging document.

<sup>7</sup> All numbers associated with test times have been estimated from interviews with actual test engineers within Honeywell as well as external contract test engineers.

### 2.3.4 Financial Implications

Apart from the necessary equipment purchases, certain other assumptions were made in calculating the financial impact of implementing the proposed packaging standard. They are listed below

*Assumptions for first year:*

- Total cost of machines as calculated in Table 2 above is \$82,232
- I have assumed that the total number of unique packages targeted for redesign in the first year of the program is equal to 100
- Many times a package redesign efforts results in reduction of costs because perhaps a product package was designed with no particular shipping environment simulated leading to an overly robust package. In this case due to the generally poor state of packaging observed for many products, a redesign is assumed to *increase* packaging cost per unit by \$0.25/package
- Annual volume for each unique product is 1000
- Engineering Labor cost \$30/hour
- Testing and redesign costs per package are estimated as follows:
  - o Drop test – 0.5 hours (\$15)
  - o Vibration test – 1.5hours (\$45)
  - o Compression test – 0.17hours (\$5)
  - o Redesign – 8 hours (\$240)
- Total first year cash outlay, calculated by adding the total cost of machines to the testing and redesign cost (see Table 3) is \$170,232

*Assumptions after first year:*

- I have assumed that the total number of unique packages targeted for redesign each year after the first year of the program is equal to 10
- Since the package is being designed from scratch, the process flow is as in Figure 3
- Total variable cost per year totals \$13,600

Figure 3. Package Test Process and Cost Breakdown For Recurring Yearly Costs

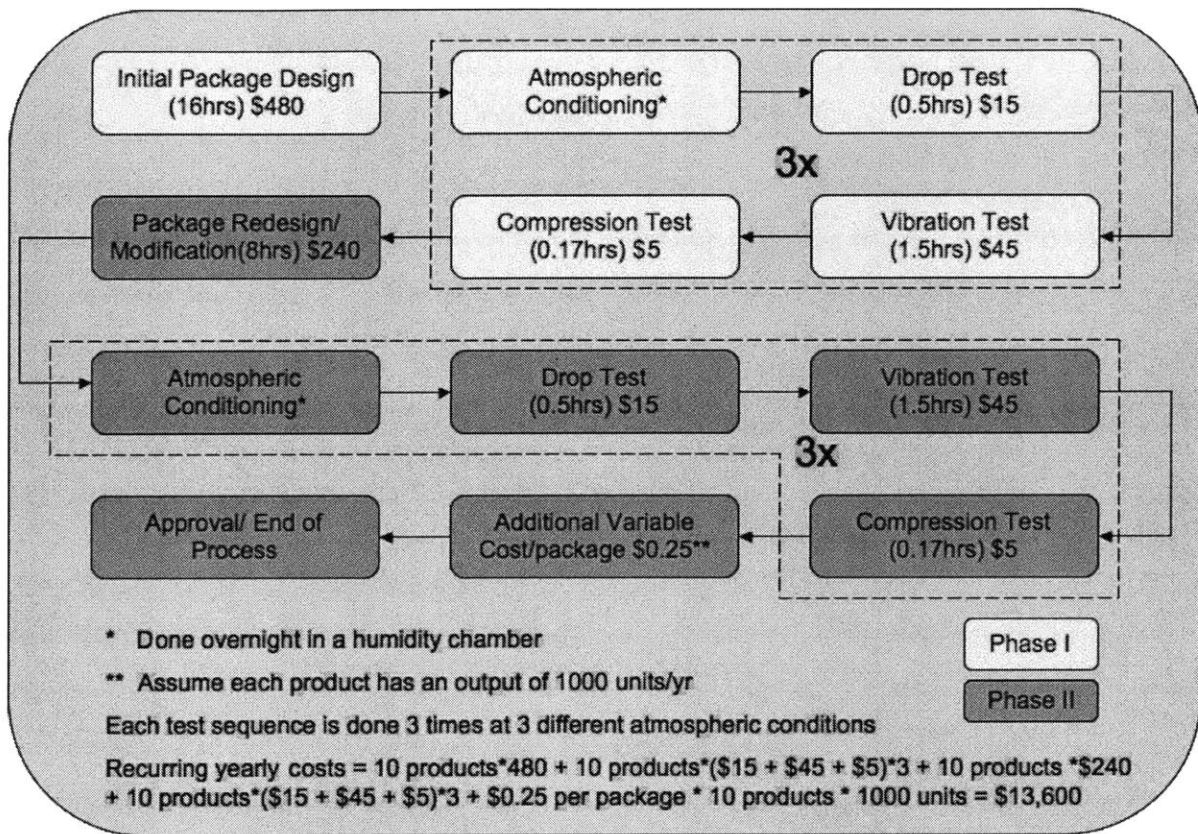

Using a 9% discount rate and evaluating the testing program over a five-year timeframe, the net present value (NPV) of all expenditure is \$203,388. Amortized over five years as an annuity, \$52,289 would be the equivalent annual payment.

The benefits that would accrue from implementation of the program would result in:

- Reduced damage from handling between factory and warehouse
- Reduced warehouse packing cost (material)
- Reduced warehouse packing cost (time)
- Reduced claims from end customer
- Increased Customer satisfaction

Achieving these savings will more than cover the \$52,289.

Table 3. Financial Summary of Testing Program

<b>Total Costs Year 0+1 no discount</b>	<b>\$ 170,232.00</b>	
<b>Recurring costs years 2 - 5</b>	<b>\$ 13,600.00</b>	
<hr/>		
Discount Rate		9%
Summary of costs Yr 0-5		
0	\$ 82,232.00	*
1	\$ 88,000.00	**
2	\$ 13,600.00	***
3	\$ 13,600.00	
4	\$ 13,600.00	
5	\$ 13,600.00	
<hr/>		
<b>NPV expenditures through year 5</b>	<b>\$ 203,388.14</b>	
<b>Yearly savings required to break even</b>	<b>\$52,289.56</b>	year 1 -5
	<b>\$ 13,600.00</b>	break even yr 6 onward
	* Machine cost	
	** Yr 1 initial testing/redesign/variable package	
	*** Yearly variable cost = package, new product introductions, assume as many phase outs as new product introductions	

## 2.4 Stackability

Stackability is a term that is used to describe (in the context of a warehouse operation) which products can be placed on which on a shipment pallet. Although the term is also used to describe the rules for stacking pallets on other pallets within a shipment container, I will use it only in the context of stacking within a pallet in this document. A stackability matrix by extension is a matrix that describes stacking rules on a pallet.

In an environment with an ever-widening list of unique products with different attributes including weight, dimensions and type of product, it is especially useful to have a document to guide packers in the correct way to pack. It may be obvious that heavier products should be placed below lighter ones, however, with each factory producing over 1000 SKUs each, it may be difficult to determine what can be



stacked on what. A stackability matrix serves to ensure that there are no ambiguities surrounding the stacking process.

### **2.4.1 Stackability Matrix Inputs**

In order to develop a comprehensive stackability matrix, it is necessary to have load-bearing data on the products being evaluated. This kind of data would be readily extracted from the result of a compression test (see Appendix A for a full description of such a test). Since package standards that adhere to a clearly defined testing regime were not yet in place in Honeywell's European factories, there was no data indicating the load carrying capacity of any of the packages currently being used. Therefore I have developed a preliminary stackability matrix to illustrate the usefulness of a full stackability matrix that would be developed with all the relevant inputs.

### **2.4.2 Stackability Matrix – A Practical Example**

The stackability matrix is based on package size and weight of the top 53 products that are fulfilled from the ERD. All 53 products were evaluated for surface area of the base as well as weight. I performed a ranking using a measure of pressure in Newtons per square meter to classify products into 6 different categories with break points of 3000, 2000, 1000, 500, 150 Newtons per sq meters. The classification varies from Class A for products for over 3000 Newtons per square meter to Class F for products under 150 Newtons per square meter. Using this type of classification, if two products weigh the same, the smaller one is arranged below the large one. As has been previously discussed, a compression test would allow for a more versatile stackability matrix since accurate calculations could be made which would show if products can be single stacked, double stacked or even triple stacked. Figure 4 below shows the current stackability matrix.

Figure 4. Stackability Matrix

		Stackability Matrix					
		Top Part Class					
B o t t o m  P a r t  C l a s s	Part Class	A	B	C	D	E	F
	A	S	DNS	DNS	DNS	DNS	DNS
	B	S	S	DNS	DNS	DNS	DNS
	C	S	S	S	DNS	DNS	DNS
	D	S	S	S	S	DNS	DNS
	E	S	S	S	S	S	DNS
	F	S	S	S	S	S	S

Legend:  
 S = Stackable  
 DS = Double Stack  
 TS = Triple Stack  
 DNS = Do Not Stack

### 2.4.3 How To Make It Work

A proper stackability matrix would be able to inform as to how many of one product can be stacked on another based on the weight of the stacked (the product on top) product. For example, assume a compression test tells us that product package A is able to withstand up to 100N of force. If product B exerts a force of 30N, product B can triple stacked on product A.

## **3 Product Packing at the European Distribution Center**

### ***3.1 Packing overview of the European Distribution Center, Heilbronn***

Another sub-project of my internship involved investigation of the packing practice at the ERD. Due to significant complaints from downstream customers such as LDC and ISLC (Honeywell distributor in the Netherlands), there has been growing interest in a study of packing at the warehouse.

Packing is the process of preparing a customer order for shipping after a picker<sup>8</sup> delivers it to the packing area. There are two main packing modes defined in the distribution center based on the quantity of goods being shipped and as well as size and weight of the shipment. Smaller shipments are usually shipped as parcels, while larger shipments are shipped as freight.

#### **3.1.1 Parcel Packing**

Parcel packing is the defined packing mode for shipments less than 31.5kg. These shipments are automatically routed using the warehouse management software to the four parcel packing stations located just beyond the storage area of the warehouse. Parcel packing operators guide the pick boxes along rollers to computer stations in which all the picked products are entered either manually or by scanner. This procedure provides a further way in which the accuracy of the quantity and type of outbound products can be verified. The operator places the products in the appropriate size boxes and finishes the packing process by attaching a label and sealing the boxes. At the end of the parcel packing line, bins are available in which the outbound parcels are placed before being pickup by DHL.

#### **3.1.2 Freight Packing**

Freight packing is the defined packing mode for shipments that are not designated as parcels. Typically, these shipments are heavier than 31.5kg and are usually in high quantities that would not

---

<sup>8</sup> A picker is a member of warehouse staff responsible for locating customer orders from a warehouse generated pick list using a motorized vehicle such as a fork lift or otherwise, and assembling them for eventual delivery to the designated packing area.

appropriately fit into individual boxes. The overwhelming majority of outbound freight is shipped on pallets with the exception of some returnable shipping containers. Pallets can be full size EUR pallets or ½ size pallets. Pallets may also be regular or IPPC compliant (See chapter 4 for a full discussion on pallets).

Products always leave the warehouse on pallets and enclosed by a box. On full sized pallets, E-boxes<sup>9</sup> are typically used as the enclosure. Sometimes overcartons<sup>10</sup> with feet are used in place of an E-box to cover products that typically are going out in full pallet quantities. Freight packing operators, pick the appropriate sized pallets and boxes for each shipment based on information contained in the pick list as well as their own experience of what the shipment will require. For example, for a shipment going to the United States, the pick list should call for an IPPC pallet. It is, however, up to the packer to determine how many pallets will be needed and whether to use full pallets only or perhaps some half pallets. As with the parcel line, all parts must be individually counted to verify correctness. The packer must actually sign each line item to indicate that he agrees that the count is correct. The products are appropriately scanned and the relevant shipping labels are automatically generated and affixed to the outer box. Finally the boxes are sealed with tape, strapped, and moved to the outbound staging area to await pickup.

There are some distinctions between the different ways in which freight shipments are handled. There are three freight packing modes defined for the ERD. *Standard* packing, *Class-A* packing and *Class-B* packing. The differences lie in the way the products are arranged in the pallet and the type of documentation that is provided to the customer.

### **3.2 Different Packing Standards**

Packing has typically been done at the Heilbronn warehouse using *Standard* packing practice. I have implemented *Class-A* packing as well as suggested *Class-B* as a middle ground.

---

<sup>9</sup> E-boxes are the largest carton used in the warehouse. They are typically stapled to the pallet and act as extra protection for all enclosed products especially since most product packages in the European plants are not designed as self-shippers.

<sup>10</sup> These are large open bottom enclosures that fit over a pallet. They are usually used for single product shipments that are squared off.

### 3.2.1 Standard Packing

The description given above for the freight packing procedure is typical of standard packing. Essentially, the packer has free reign to determine how the products are arranged in the E-box on the pallet. Packers will typically optimize their packing to try and cram as many products as possible into the fewest pallets possible. In doing so. Most pallets will end up with a mix of different products some of which may have similar packages, which further complicates the receiving process at the customer site. It is also common to have mixed pallets in which the same product is packed with others and spread across multiple pallets. The customer then ends up with the responsibility of sorting through all the products piece by piece in order to separate unique part numbers.

Standard packing, of all three freight packing methods takes the least amount of time and utilizes the fewest packaging materials. Minimal specifications are provide for standard shipments to include:

- *Pallets and Parcels identified*
- *One ship document per shipment, identifying: quantity per product, carton and pallet number*

**Figure 5. Standard Packing**



### 3.2.2 Class-A Packing

In response to customer complaints, Class-A packing has been defined as a way of providing better customer service to certain large customers that are fulfilled from the ERD. Class-A packing has been defined as follows:

- *Packed per product*, which means that each unique product will be packed in individual boxes before being placed in the E-box
- *Customer specific labels* will be provided as requested by the customer
- *Pallets and Parcels identified on the delivery note*
- *One ship document per shipment*, identifying: order, order line, quantity, product, customer number, description, quantity per product, carton number and pallet number
- *EDI – ASN to customers for paperless receipt* essentially provides electronic advanced shipment notices to the customer if their systems are capable of receiving it

I have performed studies on Class-A shipments and in subsequent sections report on how the different methods of packing affects warehouse operations.

**Figure 6. Class-A Packing**



### 3.2.3 Class-B Packing

Due to the differences I have observed between the costs and benefits of Class-A versus Standard packing, I have proposed Class-B packing as a compromise since it sits between the two methods described above from a cost as well as a cycle time perspective. I have defined Class-B as follows:

- *Overpack only products whose largest dimension is smaller than 28cm*
- *Overpack products that are in quantities much lower than a full pallet layer*
- *Label requirements are same as those of Class-A*

**Figure 7. Class-B Packing**



### 3.3 Comparison of Standard, Class-A and Class-B Packing

The ERD currently uses 14 different boxes in order to be able to adequately pack the large variety of unpackaged products from the various factories it serves. The boxes are designed to be shippers<sup>11</sup>.

<sup>11</sup> A shipper is a carton or box designed specifically for shipping purposes.

### 3.3.1 Class-A vs. Standard Packing

I performed an analysis to compare the cost and cycle time effects of packing Class-A compared to Standard packing. This analysis specifically provides information on:

- Cost Comparison between Normal and Class-A packaging
- Shipments within Germany as a case study

The analysis compares five Class-A shipments costs and cycle times to their equivalent Standard shipment costs and cycle times. The shipments were actually packed and shipped as Class-A shipments but the equivalent Standard numbers were estimated based on the experience of the excellent packing staff at the ERD.

In comparing total per pallet costs which included transportation<sup>12</sup>, packaging material (boxes and pallets) and labor, costs increase 220% from: € 23.92 to € 76.61.

- Outbound cycle time increases by 93%
- Inbound cycle time at customer decreases by up to 90%<sup>13</sup>

Figure 8. Class-A vs. Standard Packing Comparison

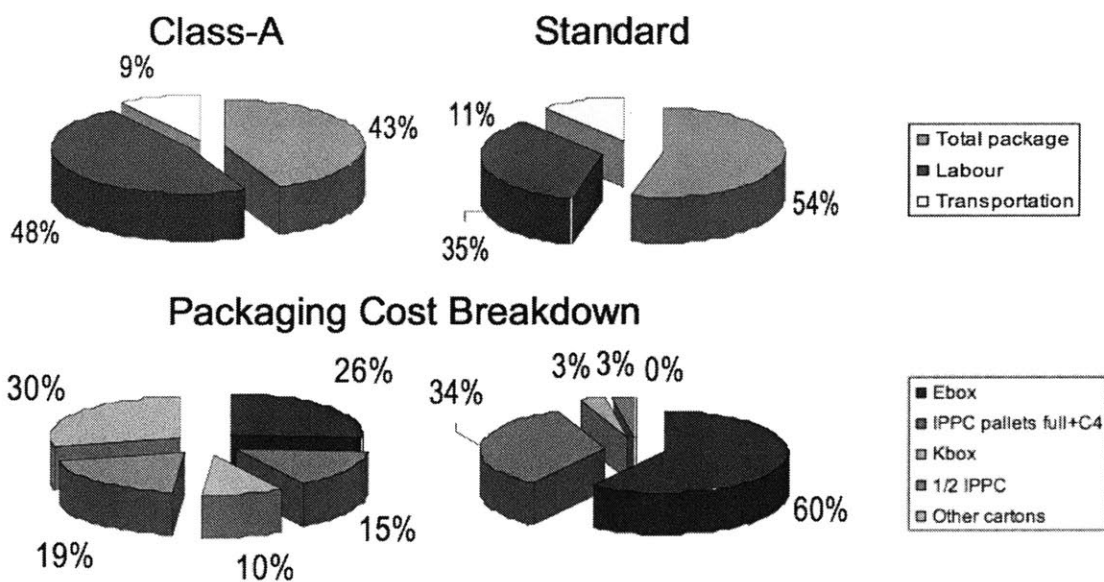

<sup>12</sup> Transportation costs are charged by DHL for shipments within Germany at a rate of €0.165/Kg

<sup>13</sup> Estimates based on actual measurement of a shipment sent from ERD to LDC packed Class-A



### 3.3.2 Class-B Cost Estimates

Although Class-A achieved one of its primary aims of providing a higher level of customer satisfaction due to the ease of receiving Class-A shipments, one unintended consequence was the massive increase in cost as well as outbound cycle time. Even if one could ignore the cost, the increase in outbound cycle time alone is enough of a concern. The fact that cycle time doubles as a result of moving to Class-A means that only half the number of pallets can be shipped each day using the same resources.

I therefore investigated a different way of packing which I designated “Class-B” as an alternative to Class-A packing. I performed an analysis to investigate Class-B packing and found that:

- Class-B results in a total cost increase of 130% above Standard from: € 23.64 to € 54.23
- 56% increase in outbound cycle time
- 68% decrease in inbound cycle time at the customer

I further investigated the effect of packing without the E-box, which constituted 22% of total Class-B costs. Packing without the E-box essentially means that products would be stacked and strapped on a pallet in their original package with no further protection. Packing without the E-box results in a further 26% decrease in total Class-B costs. However, without instituting some kind of standards or testing regime to qualify the product packaged as shippers<sup>14</sup>, discontinuation of the E-box would undoubtedly result in more damage. I therefore am recommending adoption of the standards proposed in chapter 2 before investigating the elimination of the E-box.

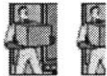
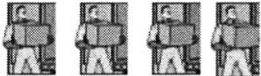





Figure 9 below shows a comparison between the three different shipment modes that have been described in this chapter. The labor cost involved in packing obviously increases as you go from Standard to Class-B to Class-A. Migrating from Standard to Class-B involved spending more time to arrange and separate the products by unique part number. With Class-A this segregation is done per overpack box, which takes even more time. Material costs increase similarly because more material

---

<sup>14</sup> A shipper is a package that has been tested, qualified and approved for shipping without further enclosing or protecting it from the shipping environment. It essentially acts as the interface between the product enclosed inside it and the shipping environment or supply chain.

(namely overpack or enclosure boxes that are arranged into E-boxes or K-boxes and or separating cardboard pieces are used) is used as one migrates from Standard through Class-A packing. Finally transportation costs for European shipments are assessed by weight. As more materials are used, the weight of a shipment increases proportionately. For example a shipment that may fit if packed as a Standard shipment into one palletized E-box could easily require 3 palletized E-boxes when packed Class-A.

**Figure 9. Class-A, Class-B and Standard Packing Relative Costs**

	Standard	Class-B	Class-A
Labor			
Material			
Transportation			

## 4 Pallet Flows Between the European and Louisville

### Distribution Centers

This chapter provides an analysis of the drivers that affect the decision to source pallets. Primarily only pallet flows and shipments between the ERD and the LDC are considered. The goal of the chapter is to determine where to source pallets and which pallets to ship and in which direction – whether from the ERD to LDC or from LDC to ERD.

#### 4.1 Honeywell Pallets

A pallet is a portable platform on which goods can be moved, stacked and sorted, especially with the use of a forklift. They are used extensively in plant or warehouse settings to move and store goods. Although there does not exist a single standard for pallets, there are several standards that have been well established. Although pallets are routinely made of different materials, the most commonly used materials are wood and plastic with wood being overwhelmingly more popular. Although Honeywell uses both types of pallets, wood pallets are by far the majority. Figure 10 below shows an example of one type of pallet used at Honeywell.

**Figure 10. A Pallet from Honeywell's San Diego Distribution Center**



As a global business with manufacturing and distribution sites all over the world, Honeywell and in particular the ECC business unit is faced with a complex supply chain. Further complicating this supply chain is the fact that different types and sizes of pallets are used in different parts of the business and in different parts of the world.

The ISO (international Standards Organization) TC51 Committee established six international pallet size standards (ISO 6780), based on what is commonly used regionally around the world [5]. Of these six sizes, four are metric and two are imperial. They include the 1100 x 1100 mm size used in Asia; the 48 x 40 inch and 42 x 42 inch sizes used in America; and the 800 x 1200 mm, 1200 x 1000 mm and 1140 x 1140 mm sizes used in Europe. Figure 11 below shows the geographic distribution of the most commonly used sizes.

**Figure 11. Pallet Standards by Geography**

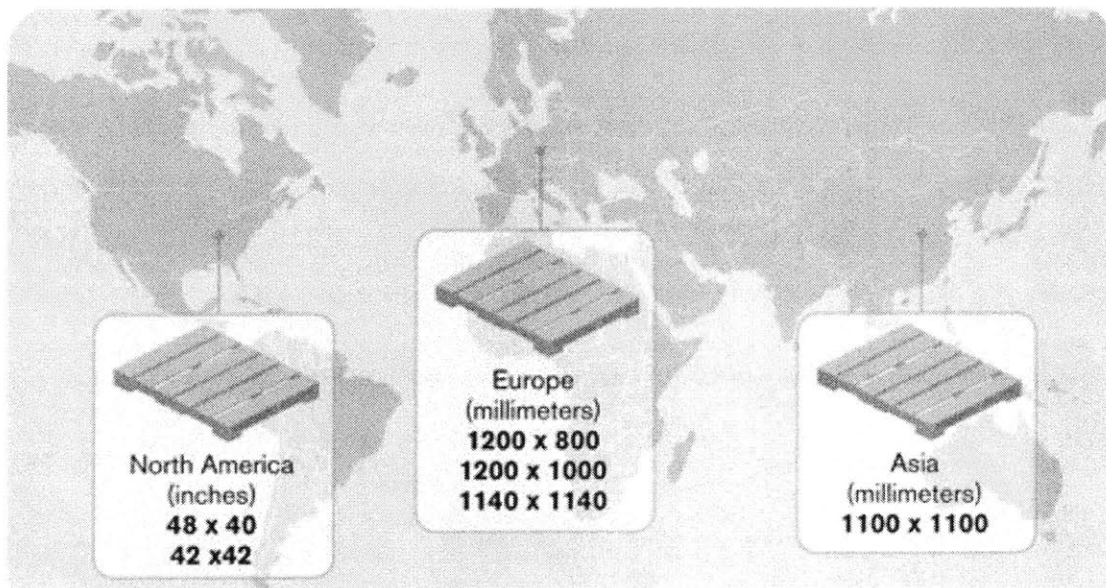

## **4.2 Worldwide Pallet Usage**

The following section addresses the most common sizes used.

### **4.2.1 North America Standards**

The most commonly used pallet size in North America is the 48" X 40". This pallet size is used by one-third of the market in the US and is by far the most commonly used in the country.

## 4.2.2 Europe Standards

### EURO Pallet

In Europe, the most commonly used pallet size is the 1200mm X 800mm. This is the size of the standard “Euro” pallet, which is normally marked with a “EUR” brand. The Euro pallet is a returnable shipment method that is used throughout most of Western Europe. For instance if a factory in Germany ships 40 Euro pallets of freight goods within the usage area, the carrier will in exchange replace those outbound pallets with 40 empty pallets. The specifications for Euro pallets are stringent and well known. The standards are owned and controlled by the UIC, the International Union of Railways. Figure 12 below shows an illustration of a Euro pallet.

Figure 12. The EURO Pallet

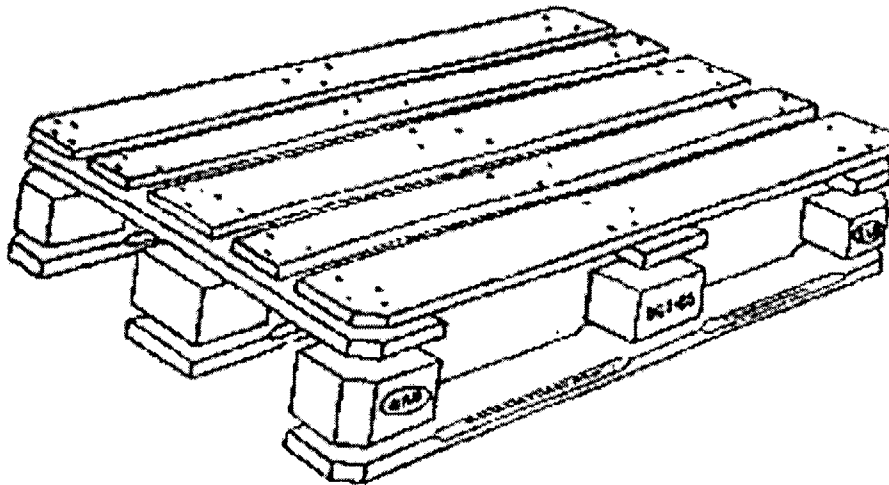

### 1200mm X 1000mm Pallet

The 1200mm X 1000mm pallet is the UK standard, which is somewhat larger than that used in continental Europe (the Euro pallet described above). In fact this size is much closer to the American standard of 48” X 40” which is 1219mm X 1016mm.

## 4.2.3 Honeywell Internal Standards

Adding to the complexity of the Honeywell ECC supply chain is the existence of yet other sizes of pallets. Honeywell’s internal standards call for a 40” X 32” pallet [6] for use within ECC. This is the standard size used in the LDC, which as has been previously mentioned, is the largest ECC

distribution center. Accordingly LDC shelves and layout has been optimized for this pallet size.

Finally, apart from the 40" X 32" pallet and the standard North American size of 48" X 40", which is also used within Honeywell, other pallet sizes have been observed. Specifically, the San Diego distribution center (SDC) regularly ships 85cm(33.5") by 112cm(44") pallets to the ERD.

### **4.3 ISPM (International Standards for Phytosanitary Measures) 15**

#### **Standards**

Added to all the different pallet sizes is the existence of international standards governing treatment of pallets intended to be shipped between countries. The secretariat of the International Plant Protection Convention (IPPC) of the UN Food and Agriculture Organization (FAO) puts forth guidelines for regulating wood packing materials including wood pallets. The standards call for adoption (according to a specified timetable) of IPPC guidelines with the goal of ensuring that virtually all pallets shipped between countries are either heat or chemically treated to reduce the risk of introduction and/or eradication of quarantine pests associated with certain types of wood packaging material [7].

### **4.4 Pallet flow between ERD and LDC Current State**

With all the complexities discussed above, the questions arise as to how to decide which pallets to ship from one location to another. The specific case study under consideration examines shipments between the ERD and LDC.

Some background may help clarify the issue. Currently each distribution center (both LDC and ERD) ships out the kind of pallets used primarily in each of their facilities. ERD ships out only Euro Pallets<sup>15</sup>, while LDC ships out only 40" X 32" pallets. Correspondingly, each distribution center receives from the other essentially the "wrong" type of pallet. According to the kind of pallet used in each of the distribution centers, the overall DC operation is optimized toward that particular pallet

---

<sup>15</sup> Certain accommodations are available under which ERD ships out 1000mm X 800mm pallets which are very close to the LDC required 40" X 32" pallets. This is done for a particular product that is particularly heavy and that would be difficult to restack.

size. For instance, the ERD uses a Euro pallet as its standard pallet. Therefore because the pallet is 1200mm long versus the 40" (1016mm) that is the LDC standard, shelves at the ERD are deeper than those at the LDC. This means that LDC pallets cannot be placed on ERD shelves since LDC pallets would be too small (1016mm) to fit on a standard ERD shelf, which is designed for 1200mm long pallets. The pallets would essentially fall through the shelf! Similarly ERD pallets cannot be placed on LDC shelves even though it is physically possible. The reason being that the overhang would constitute a safety hazard for warehouse staff.

Due to these mismatches between pallets and infrastructure, additional cost is incurred in each distribution center to properly prepare incoming shipments (from its counterpart DC) for shelving. Typically, this involves restacking the inbound products onto a local pallet for eventual placement in the appropriate warehouse location.

#### ***4.5 Pallet flow analysis between ERD and LDC***

Based on the situation described above where each distribution center incurs a cost to receive a pallet from its counterpart DC, there is a need to identify an optimal pallet policy for ECC, which minimizes costs to the organization as a whole. There are various options to consider when formulating a transatlantic pallet policy. These options are listed below:

- i. LDC ships ERD pallets, ERD ships ERD pallets
- ii. LDC ships LDC pallets, ERD ships LDC pallets
- iii. LDC ships LDC pallets, ERD ships ERD pallets (Current State – Neither Comply)
- iv. LDC ships ERD pallets, ERD ships LDC pallets (Both Comply)

There are various relevant cost components associated with each of these scenarios, which shall be quantified in turn. These are:

- a. Total cost of receiving and restacking a pallet in both DC locations.
- b. Sourcing of a foreign pallet for one-way shipment of goods to counterpart DC.
- c. Sourcing of local pallets for one-way shipment of goods to counterpart DC.

- d. Cost of disposal cost of unusable pallets. In the event that each warehouse insists on only using its own pallets for shelving and shipping, non-conforming inbound pallets are disposed of.

### **Assumptions**

Before proceeding with the details of the analysis, it is useful to discuss the assumptions that were made.

1. Pallets are treated as one-way pallets but it is assumed that in the situation where only one type of pallet is used, it can be turned around (reused) only once. For example, assume 40" X 32" pallets are the agreed mode of shipment. They are shipped once from LDC to ERD and one more time from ERD with products bound for LDC. This would constitute a full cycle of the useful life of the pallet. Pallets would likely last through a few more cycles but unlike sturdy Euro pallets, one-way Euro-sized pallets and Honeywell 40" X 32" pallets are not designed for much shorter lifecycles.
2. 100% of pallets are mixed pallets thereby making some product restacking a necessity.
3. It is assumed that 96% of shipped pallets are recycled. In other words, 96% of pallets are suitable for making the return journey.
4. Pallet flow from ERD to LDC is constant at 1820 pallets a year<sup>16</sup>
5. All pallets are appropriately IPPC compliant

### **Data**

Data showing pallet flows from LDC to ERD was difficult to come by. Since pallet flows were known in the other direction, I analyzed the total relevant cost for different pallet volume scenarios flowing from LDC to ERD. The result of the analysis is illustrated in Figure 13 below.

---

<sup>16</sup> This number was calculated based on a very predictable 35 pallets received at LDC (from ERD related factories) weekly 52 weeks a year.



Figure 13. Total Relevant Supply Chain Pallet Cost

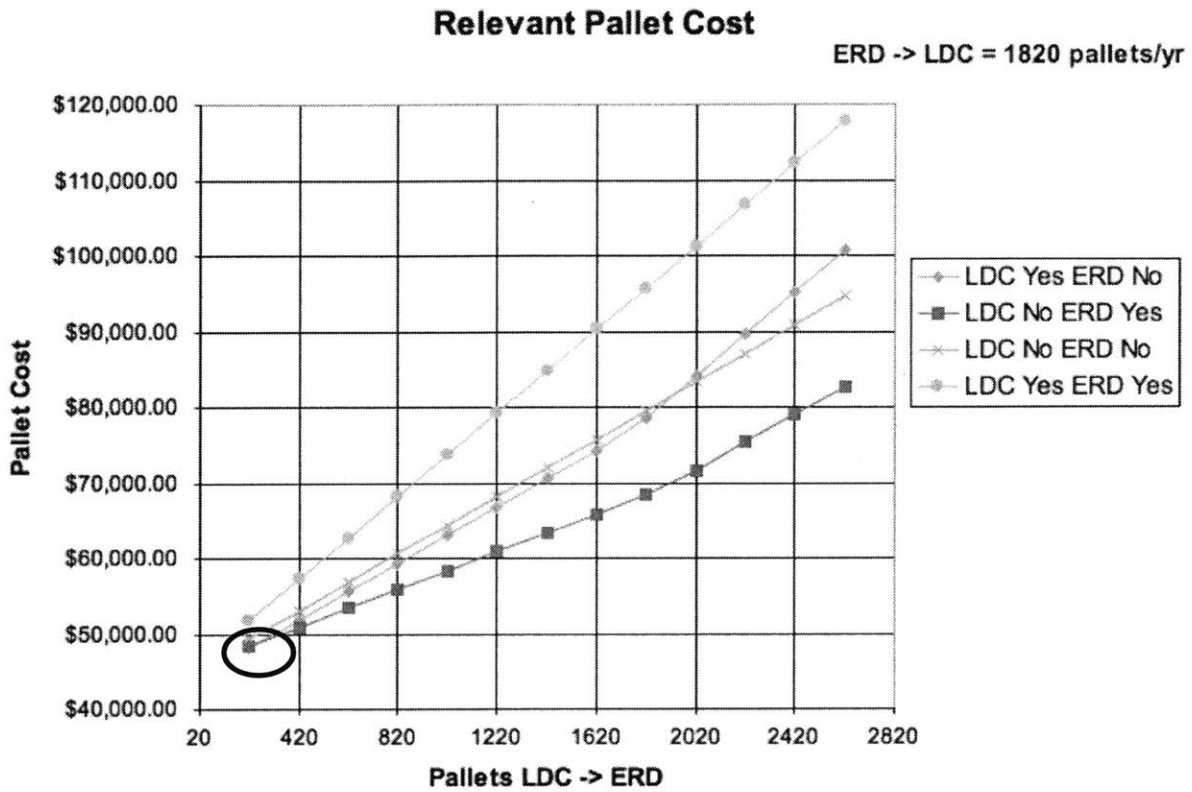

The legend in Figure 13 above corresponds to the shipment options outlined above. The y-axis depicts the total relevant cost, which consists of the total cost of sourcing and receiving pallets at both distribution centers as well as the cost of disposing of pallets where relevant. The scenarios in which one DC complies while the other one does not, results in the lines in the chart that have two distinct slopes. This can be explained by the fact that the relationship between growing volume and cost is not linear since some pallets are recycled. From the chart, the conclusion is for the most part consistent and independent of volume of flow of pallets from LDC to ERD. The “LDC No ERD Yes” solution previously explained above in this section is the most cost effective solution as far as total relevant cost of a shipment cycle from DC to DC is concerned. This however is the case only for shipments above 220. Below that number (the circled part of the graph – though difficult to see) the most cost effective solution is the “LDC Yes ERD No” option. However, because the difference in the solutions at that number is negligible and the fact that it is unlikely that volumes will be that low anyway, I would recommend the initial solution as a robust one.

It is important to note that one of the considerations affecting the analysis is the “free” source of heat treated 40” X 32” pallets at LDC from Canada and Mexico. This essentially comes at no cost to LDC which normally does not source pallets anyway. The cost of the pallets, which has to be borne by the plants in Canada and Mexico in order to ship to LDC is a sunk cost and therefore not considered in the analysis. Also, an initial safety stock of 40” X 32” pallets would have to be provided to smooth out the variation in weekly demand.

## **5 Carton Replenishment**

The establishment of the ERD in Heilbronn presents a unique opportunity to put in place best practices that can be copied at other warehouse locations. With an eye to minimize unnecessary buildup of packing material in the warehouse, I paid special attention to examining the possible scenarios and ordering policies available to the ERD management.

Of primary concern in this analysis were cost and the space requirement with regard to the forecasted increase in volume of products handled at the warehouse. A factor, which made more frequent ordering feasible, is the fact that the supplier of the packing materials is located only 50 kilometers away from the ERD. I present in this chapter, an analysis showing cost and space implications of ordering packing material – primarily cartons – more frequently.

### ***5.1 Carton Types and Usage Profiles***

The ERD ships out a wide variety of cartons and pallet combinations on its outbound freight line and a variety of cartons on its outbound parcel line. Since the products shipped from the warehouse are so diverse, 14 different cartons and three<sup>17</sup> different pallets are commonly used. In fact due to the uniqueness of some products, special cartons have been developed in response to a specific needs. Usage quantities therefore vary widely. An example of usage for one week in the month of August 2005 can be seen below in Table 4.

---

<sup>17</sup> This does not include the plastic pallets, wood crates and 40" X 32" pallets used for certain special shipments.

Table 4. 1-week Carton Usage at the ERD

Package type demand							
PACKAGECODE	Cost	August					Total
		01	02	03	04	05	
EBOX	8.100 €	33	26	8	30	30	127
KBOX	4.565 €	48	85	54	76	108	371
KT10	0.199 €	39	149	135	167	169	659
KT100	0.888 €	9	15	12	17	31	84
KT102	0.895 €	2	3	11	8	9	33
KT120	0.483 €	3	22	19	17	16	77
KT135	0.690 €	49	98	90	146	144	527
KT150	2.690 €	4	13	10	22	21	70
KT201	1.111 €	25	71	51	89	65	301
KT210	1.960 €	7	16	16	31	15	85
KT220	2.080 €		4				4
KT31	0.359 €	33	97	81	131	112	454
KT60	0.499 €	33	94	69	112	81	389
KT90	0.419 €	18	88	47	73	79	305
<b>Grand Total</b>		<b>303</b>	<b>781</b>	<b>603</b>	<b>919</b>	<b>880</b>	<b>3486</b>

## 5.2 Space Limitations ERD, Heilbronn

As has been previously mentioned, the ERD is able to handle 3068 order lines per day. However, shelf space is at a premium. At the point when only three of five warehouse operations of the large European factories had been transitioned to ERD, a large portion of the warehouse had filled up. Another major factor driving the carton replenishment analysis is that there was a need to investigate the potential effects to warehouse operations and cost of more frequent deliveries.

## 5.3 Current Order Policy

The current order policy for packing boxes (cartons) at ERD is to order when stock levels are low. This current policy (based on current usage) also stipulates ordering every two weeks.

## 5.4 Proposed Future State

In order to evaluate the effects of different order policies on the ERD warehouse operations, I calculated the economic order quantity (EOQ) and compared it to the cost of ordering more frequently. Specifically I looked at ordering everyday, every three days and every five days.

Main Assumptions (See appendix B for more detailed assumptions used for the calculations)

- EOQ was calculated (as a basis for comparison)
- Shipping cost was calculated based on shipping rates per loading meter<sup>18</sup>, the required number of loading meters per carton type was calculated based on the known dimensions of the carton and an examination of its usual configuration on a pallet
- One week is equal to five days
- Total relevant costs (TRC) consist of only ordering and holding costs but excludes variable costs of cartons

Using the most frequently used cartons as a case study (carton #10), I calculated the relevant costs associated with ordering in different time intervals. Table 5 below shows that placing orders more frequently increases the order cost. Since order costs in this analysis is a more dominant contributor to total cost, this also increases the total relevant cost. The EOQ as expected is the least costly option.

**Table 5. Carton 10 Order Analysis**

<b>Demand = 37427 units/year</b>	<b>TRC (EOQ) = € 114</b>
<b>EOQ = 2511</b>	<b>TRC (1 day) = € 998</b>
<b>Orders/yr = 15</b>	<b>TRC (3 day) = € 341</b>
<b>Safety Stock = 118</b>	<b>TRC (5 day) = € 215</b>

There are greater opportunities to further reduce order costs. The current replenishment process involves inspecting the stock of cartons, doing a manual count or rough estimate of the current stock and needs, and then placing an order by phone with the supplier. Although there is less overhead when one orders more frequently, this can be further reduced when the ERD information systems are able to keep track of all carton usage and therefore automatically trigger an order when necessary. Such a development would eliminate most of the cost of ordering.

Since order cost currently represents on average, a minimum of 78% of total relevant costs at the

---

<sup>18</sup> A loading meter is a unit of measure defined as the volume occupied by 1m X 2.55m X 2.804m. This represents the standard swap body container used in Europe. There are 7.82 loading meters in a trailer that is 7.82 meters long.

lowest (at 5-days ordering) there is a tremendous opportunity to further streamline and reduce costs as far as the order process is concerned.

To further compare the different scenarios and along the metrics of pallet spaces, Table 5 below shows the average number of pallet spaces occupied per year for all cartons used in the warehouse.

**Table 6. Cost Comparison for Different Order Frequencies**

	<b>Order Frequency</b>			
	<b>1 day</b>	<b>3 day</b>	<b>5 day</b>	<b>EOQ</b>
<b>Average % increase on EOQ</b>	743%	196%	92%	0%
<b>Average \$ increase on EOQ</b>	€782	€ 183	€77	€ 0
<b>Average pallets spaces/yr</b>	13	14	16	25

Figure 14 below shows the average total relevant cost for all cartons used in the warehouse and compares those costs across the different ordering policies evaluated. In addition, the secondary y-axis quantifies the space usage in the warehouse for each order policy. It is clear that going down to orders every five days frees up 12 pallet spaces which can be used for storing the products that generate revenue for the company rather than having those spaces taken up by factors of production which cost the company money. Since a pallet is needed to hold even a small number of cartons, there is a lower limit to the number of pallet spaces that is required for carton storage. Currently, that lower limit is 14, which can be achieved by ordering daily.

This limit can be surmounted by having carton deliveries made to the outbound area as opposed to the stocking shelves. Based on usage, the largest quantity that would be delivered based on a 5-day delivery schedule would be 717 of Carton 10. This represents the largest number of cartons for the 5-day delivery schedule since other 5-day order quantities would be smaller in proportion to the lower annual usage of those cartons. Since this is also the smallest carton, it can be strategically deployed to the 4 – 6 stations in the outbound shipping area without taking too much space. It appears feasible that shelf space can be completely eliminated but further investigation would have to be done to account for all available spaces in the warehouse as well the possibility of making use of more

moveable racks such as those currently used to present packing material to the personnel in the outbound area.

With this analysis, it is now possible to trade-off space in the warehouse based on ordering cartons at different intervals, knowing what it would cost to do so.

**Figure 14. Costs and Pallet Spaces for Different Order Frequencies**

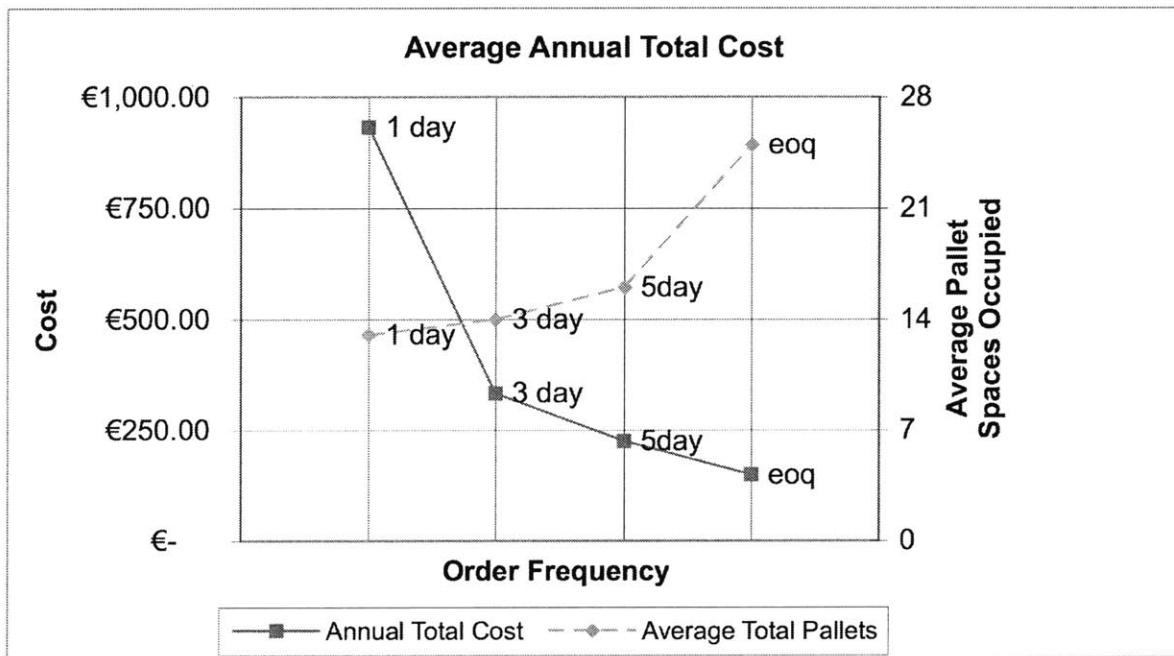

*This page is intentionally left blank*



## **6 Organizational Leadership and Change Analysis**

In this chapter, I present an organizational change and leadership analysis for ECC and Honeywell using the learning from my work on the supply chain packaging project. First, the organization and thesis work is analyzed from the three perspectives of organizational processes for analyzing organizational change. These being the strategic design, political, and cultural. The chapter proceeds by assessing my leadership style. Finally, I conclude the chapter by evaluating the change process and making recommendations regarding future success.

### ***6.1 Using the Three Perspectives on Organizational Processes***

The success of the organizational change brought about in ECC from the supply chain packaging initiative can be evaluated using the three perspectives or lenses framework from the MIT Sloan Organizational Processes (OP) curriculum. These three perspectives – strategic design, political, and cultural – give us a very good insight into Honeywell as specifically ECC as well as the results of the project.

#### **6.1.1 Strategic Design**

The strategic design perspective sees the organizations are a kind of machine that has been designed to achieve goals by carrying out tasks. This perspective is highly rational and analytical and believes organizations are designed with a strategy or purpose based on a rational analysis of capabilities and opportunities. Within this strategic viewpoint, alignment mechanisms are structured to motivate employees towards the organization's common goals.

Honeywell has been able to use a combination of internal growth and acquisitions to fuel growth. The organization has therefore built a strong Integrated Supply Chain (ISC) organization that is tasked with finding the synergies required to make each new acquisition a success. In addition, the ISC function also makes critical decisions regarding sourcing, distribution and logistics.

The current ACS organization is a classic matrix whereby the various business units within ACS such as ECC, Sensing and Controls, Honeywell Process Solutions interact with the functional groups like

ISC. In addition, within each business unit – taking ECC as an example – various sub-organizations exist in order to run the business on a day-to-day basis. In Europe for example there is an organization around “Lines of Business” (LOB) that is separate from the leadership of each manufacturing organization. These LOB leaders may have jurisdiction across multiple products, which are manufactured in different sites.

**Figure 15. ACS Organizational Matrix Structure**

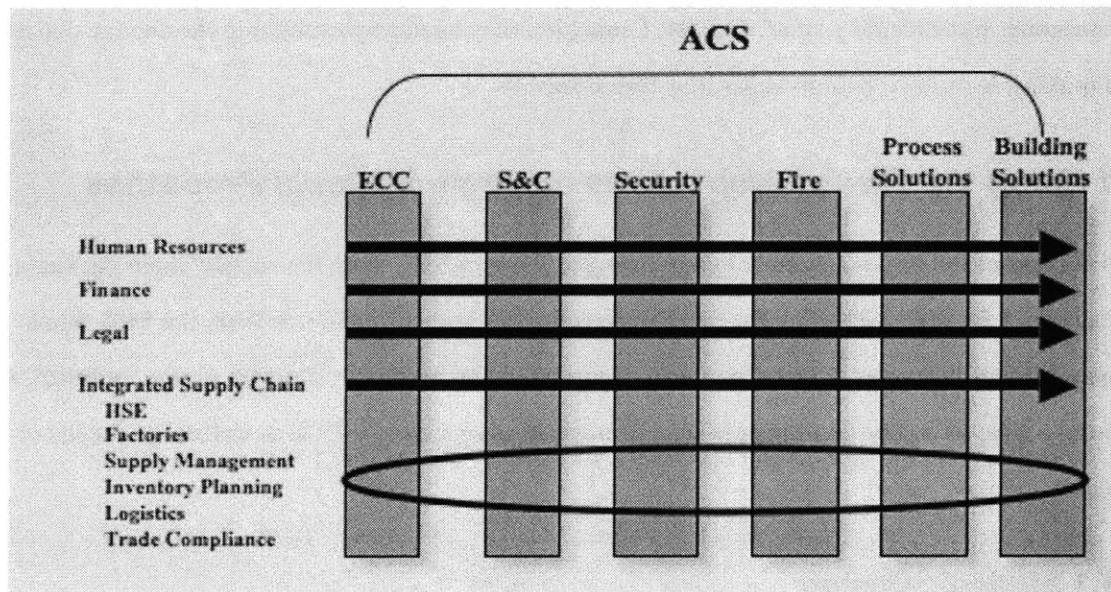

With so many different initiatives, from acquisitions to Lean initiatives to rapid rollout of regional warehouses to installation of new information systems, ACS and ECC are currently very exciting places to work. There especially is a lot of work to be done within ISC and workers (even new hires) are usually given a lot of responsibility very quickly. The scope of my project spanned, ISC, ACS and ECC.

One of the two primary locations where I worked during my research, the LDC in Louisville, Kentucky is the largest ECC warehouse in the world. It is administered by EXEL, a third party logistics provider (3PL). It is headed by an MBA graduate. One priority area for LDC over the course of the last year was the implementation of a warehouse management system (WMS). This initiative was poised to bring the LDC into the 21<sup>st</sup> century by enabling scanning technologies, which had hitherto not been used at the receiving (inbound) docks where every incoming item was manually

counted. Although the employees at LDC were all EXEL employees, they wore Honeywell badges and had Honeywell email addresses.

My second primary location during the research period was the ERD in Heilbronn Germany. The ERD, started operations in May 2005. The relationship that Honeywell already had with Wincanton TransEuropean, a UK based 3PL led to the establishment of a contract to have them operate the new Green field distribution center. Honeywell maintains an open relationship with Wincanton in which Wincanton's margins were clearly known to Honeywell. The relationship was somewhat different from the one I observed between Honeywell and EXEL at the LDC. The employees saw themselves as Wincanton employees and wore Wincanton Badges. During my time in Germany, there was a change of leadership at the warehouse with the appointment of the former warehouse lead from the Mosbach plant. The change did not result in a lot of problems especially since many of the former employees at the Mosbach warehouse moved to Heilbronn to work at ERD. The major initiatives at the ERD were the ongoing transfers of physical inventories from the various European plants and distribution centers to the ERD. Also, Wincanton was constantly updating information systems to enable smooth operation of the DC and minimize interruptions of deliveries to Honeywell's end customers.

Apart from my supervisor and his organization and the DC leadership and staff at LDC and ERD, I also interacted with an array of Honeywell staff in its factories and also within the packaging organization.

### **6.1.2 Political**

The political perspective views the organization as a contested struggle for power among stakeholders with different goals and underlying interests. Different coalitions are formed when people with similar interests get together to advocate their side of important issues. Since organizations are dynamic, power shifts are likely to occur over time.

Within the context of the project, power has come from two main sources at the intersection of factory operations and ISC – recognized technical expertise and positional power. All the players in

the organization that are well respected are technically sound. A case in point being the recently retired EU Logistics Director who was responsible in large part for the tactical realization of the ERD. Another source of power is proximity to the ECC leadership (positional) in St. Louis Park Minnesota. An example of an individual that exercises both sources of power is my internship supervisor and VP of Distribution and Logistics. Throughout my interaction with people at Honeywell, the one recurrent theme I found was that anyone in any position of influence at all was very technically sound. The power structure is reinforced by proximity to the ECC leadership, which sits in St. Louis Park. A visit by anyone from the higher echelons of the ISC organization (housed in St. Louis Park along with ECC leadership) to any related plant or distribution center was always seen as a big deal.

These sources of power among the stakeholders in the supply chain packaging project is apparent from the stakeholder map in Figure 16. Table 7 below lists these stakeholders, their interests, and what each stood to gain or lose from the project.

Figure 16. Stakeholder map of the LFM thesis work at Honeywell-ECC.

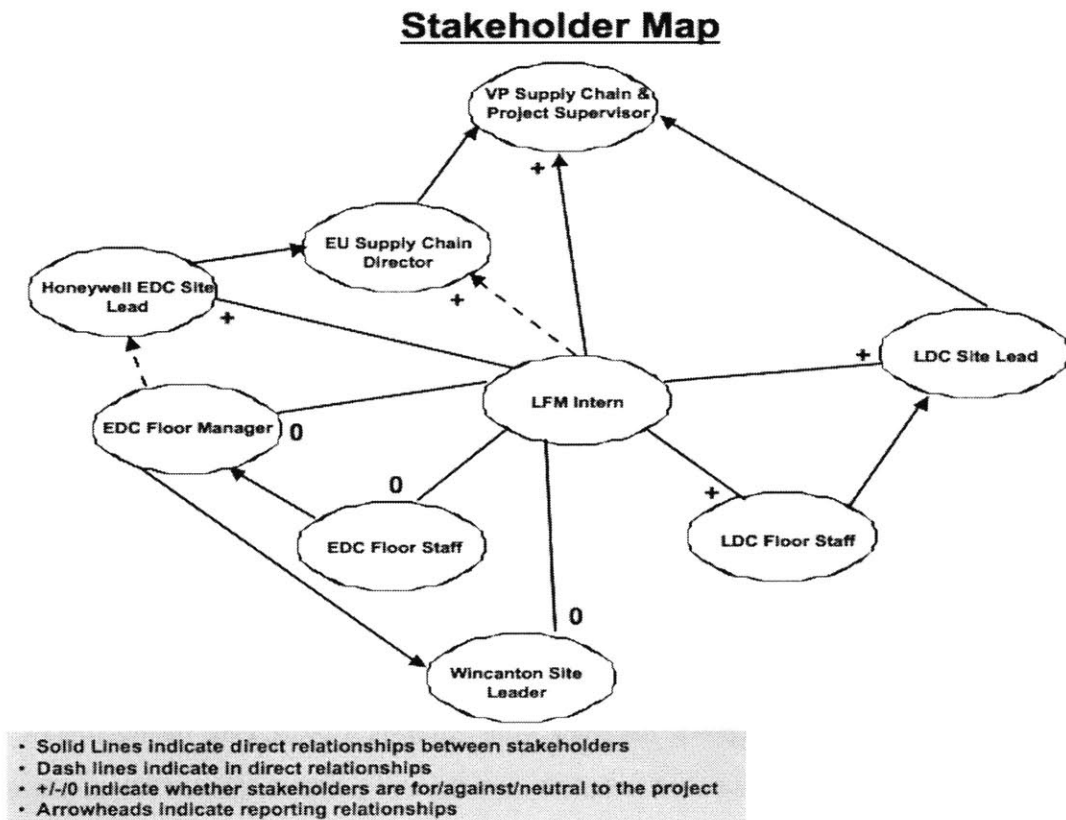

**Table 7. Summary of key stakeholders in the LFM thesis work at Honeywell-ECC.**

<b>Stakeholder</b>	<b>Interests</b>	<b>Gain from Project</b>	<b>Loss from Project</b>	<b>For or Against?</b>
<b>VP Distribution &amp; Logistics and Project Supervisor</b>	<ul style="list-style-type: none"> <li>- Author of project</li> <li>- Lower receiving cycle times at LDC</li> <li>- Replenishment analysis of ERD</li> </ul>	<ul style="list-style-type: none"> <li>- More efficient DC operations</li> </ul>	<ul style="list-style-type: none"> <li>- Project failure would reflect badly</li> </ul>	STRONGLY FOR
<b>EU Director Supply Chain</b>	<ul style="list-style-type: none"> <li>- A Clear Packaging Guideline for EU</li> <li>- Clear Outbound guidelines</li> </ul>	<ul style="list-style-type: none"> <li>- More efficient ERD operations</li> <li>- Better EU supply chain</li> </ul>	<ul style="list-style-type: none"> <li>- None</li> </ul>	STRONGLY FOR
<b>LDC Site Lead</b>	<ul style="list-style-type: none"> <li>- Lower receiving cycle times</li> <li>- Clear direction as to pallet allocation</li> </ul>	<ul style="list-style-type: none"> <li>- Shorter inbound cycle times due to improved packing from ERD</li> </ul>	<ul style="list-style-type: none"> <li>- None</li> </ul>	STRONGLY FOR
<b>ERD Site Lead</b>	<ul style="list-style-type: none"> <li>- Better packaging for inbound goods</li> <li>- Better outbound customer satisfaction</li> </ul>	<ul style="list-style-type: none"> <li>- Shorter inbound cycle times due to improved packaging at EU plants</li> </ul>	<ul style="list-style-type: none"> <li>- None</li> </ul>	FOR
<b>ERD Floor Manager</b>	<ul style="list-style-type: none"> <li>- Stabilized DC operation</li> </ul>	<ul style="list-style-type: none"> <li>- Shorter inbound cycle times due to improved packaging at EU plants</li> </ul>	<ul style="list-style-type: none"> <li>- Initial extra day to day oversight duties for outbound operations</li> </ul>	NEUTRAL
<b>Wincanton Site Leader</b>	<ul style="list-style-type: none"> <li>- Stabilized DC operation</li> </ul>	<ul style="list-style-type: none"> <li>- Shorter inbound cycle times due to improved packaging at EU plants</li> </ul>	<ul style="list-style-type: none"> <li>- Dealing with longer outbound packing cycle times</li> </ul>	NEUTRAL
<b>ERD Floor Staff</b>	<ul style="list-style-type: none"> <li>- Stabilized DC operation</li> <li>- Clear processes</li> </ul>	<ul style="list-style-type: none"> <li>- Shorter inbound cycle times due to improved packaging at EU plants</li> </ul>	<ul style="list-style-type: none"> <li>- Having to learn new processes</li> <li>- Longer outbound packing cycle times</li> </ul>	NEUTRAL
<b>LDC Floor Staff</b>	<ul style="list-style-type: none"> <li>- Lower receiving cycle times</li> </ul>	<ul style="list-style-type: none"> <li>- Better inbound operations due to improved packing from ERD</li> </ul>	<ul style="list-style-type: none"> <li>- None</li> </ul>	STRONGLY FOR
<b>LFM Intern</b>	<ul style="list-style-type: none"> <li>- Successful Implementation</li> <li>- Learn how to work in a world class manufacturing firm</li> </ul>	<ul style="list-style-type: none"> <li>- Recognition</li> <li>- Learning project management</li> <li>- Leadership skills</li> </ul>	<ul style="list-style-type: none"> <li>- Reflect badly if failure</li> </ul>	STRONGLY FOR

The stakeholder analysis table and map above show that most of the interests in the project are fairly compatible. Most of the stakeholders saw value in one or more parts of the project and recognized that it had some benefits that were directly in line with their interests.

In the cases where interests were misaligned, it did not prove to be catastrophic to the project. In one case, I was able to set up a meeting between the site leaders of the ERD and LDC to discuss their mutual objectives and openly discuss their areas of greatest frustration. What emerged from this first of a kind conversation was the realization that they had many goals in common. Although they had never spoken before, this telephone conference established a relationship between them whereby they can communicate directly and on a personal level about inter-distribution center shipments. I also highlighted in the meeting the need for cooperation between them because their one-way shipment relationship (ERD traditionally shipped to LDC with no products going the other way) was to soon change as LDC would start shipping to ERD with the migration of the Nagykanizsa warehouse to ERD.

Where it was not clear what the benefit would be to certain stakeholders I was able to arrange to meet with them to clearly explain the goals of the project. I took pains to explain where I anticipated problems and where I thought the project would add value. For these reasons I was able to create a situation reflected in Table 7 above in which none of the stakeholders are against the project. I should mention here that part of the reason for the lack of resistance is due to the way the project was ably defined by my supervisor and the EU Supply Chain Director as well as the environment in which they placed me.

As the table shows, there was general support both from the top down and from the bottom up. The only neutral elements were the staff at the ERD including the Wincanton site leader, the floor manager and the warehouse staff. There were a few reasons for the lukewarm attitude toward the project. First, the warehouse had just started operation in May of 2005 and the staff was dealing with the near bi-monthly transition of warehouse inventories from other sites to the ERD. As a result the staff were very much focused on fulfilling deliveries to customers with minimum disruptions while

increasing the number of outbound deliveries with each new transition. Second, the outbound packing portion of my project, which would establish processes for better satisfying ERD's end customers also had the potential to increase outbound cycle times thereby leading to a reduction in outbound shipping capacity at the ERD. For these reasons the ERD staff were much more focused on their day-to-day activities and did not necessarily view my project in light of its potential for long-term benefits.

On another note, the packaging standards portion of my project would very much improve the inbound receiving operations at ERD. However, there was little visibility on the part of the warehouse staff into this part of my project since most of the work was done on paper and my final deliverable would be a recommendation and not an actual implementation.

Finally, all the other stakeholders were very clear on the motivation for my project. My supervisor and the EU Logistics Director co-authored the project objectives and therefore were both on board. At times the different authors had different priorities within the project objectives, which at times led to confusion as far as my focus was concerned. But overall there was good support from the higher echelons for the project. The warehouse site leaders likewise supported the project. The LDC warehouse leader was particularly supportive since a successful outcome for her would have meant alleviation of one of her greatest problems – long cycle times for receiving shipments from ERD.

In summary, from the political perspective, the project enjoyed a lot of support both from the top down and from the bottom up. I was able to leverage the respect the overall organization had for the project supervisor and overall ISC and ECC leadership. I was also able to bring people together who had previously not communicated to discuss their problems and propose solutions.

### **6.1.3 Cultural**

The cultural perspective assumes that people in organizations take action as a function of the meanings they assign to situations. Cultures develop over time as organizations solve important problems, pass on their traditions, and develop shared symbols, stories, and experiences. Culture is the

way of life in an organization – it is “what we do around here and why we do it.” Taking this view, organizations are societies in themselves in which people form relationships, live, work and play together. The culture of an organization, much like that of a wider society rewards certain behaviors and punishes others. The meaning therefore that people place on a change initiative is very important and recognizing, shaping and managing that meaning can make or break the initiative.

Honeywell’s website highlights, its six sigma initiative, diversity, learning and continuous improvement as key parts of its culture. In the context of Honeywell and the supply chain packaging project, I found that the organization as a whole rewarded and encouraged people with international experience. It also encouraged people to work hard and to work long hours. In all there was a “lets get things done” attitude that I came away with whether I was working in the Louisville Distribution Center (LDC) or the European Distribution Center (ERD) in Heilbronn.

As far as the supply chain packaging project was concerned, it provides documentary proof to the ISC organization to be able to inform the factories of the need for change in packaging practices in order to fit within the requirements of the work mode of the ERD. At present the ERD is being challenged by the status quo of the packaging process (or lack thereof) at the plant level. In having to deal with inbound loads of very different forms, ERD has a need to enforce some sort of standard in order to stabilize its internal processes. For this reason ISC staff is very keen to publicize and distribute the results of the project.

The project is symbolic from the perspective of ISC since it signals the emphasis that Honeywell as an organization places on integrating its supply chain rather than just treating each manufacturing facility as a standalone entity which holds and manages its own inventory. It serves to reinforce one of the basic tenets of the company, which values continuous improvement and asks the question “how can we do better in our current processes?”

As far as formal communication is concerned, I was initially known as the “packaging guy” a designation I tried hard to dispel. People were told, “Ade is here to help us solve our packaging



problems.” People thought I was a packaging engineer since the MIT name immediately signaled engineering as opposed to management. I constantly had to explain to people that I was not a packaging engineer but rather was focused not only on how to improve the current processes but also assess the business impact of any changes I suggested. Since I interacted with so many different organizations within Honeywell during my time there, I found that I had to constantly remind people what my role was and why I was there. And following the research of Janice Klein, I also had to “learn the whys and wherefores of the existing culture” before attempting to implement any changes [8].

In summary, the Honeywell culture of “getting it done” sometimes interfered with my ability to progress with my project especially since my final deliverable would not be an implementation but rather a set of recommendations based on my time in the organization gathering data and conducting packing experiments. I was able to combat my lack of credibility by delivering insightful analysis to the upper management and with the more junior workers by showing how packaging can be done differently on the warehouse floor to result in greater customer satisfaction or improved inbound (receiving) cycle times.

#### **6.1.4 Summary of the Three Perspectives**

The top three insights from each of the three organizational processes perspectives are summarized below.

##### ***Strategic Design***

- Strategically, the ISC (Integrated Supply Chain) function has been empowered within the organization to consolidate Honeywell’s supply chain
- Organizational structure is somewhat complex but reflects changes within the organization to make it more responsive to Honeywell’s growing business interests
- LFM project fit well with the strategic objectives of the organization

##### ***Political***

- Power in the organization lay in technical expertise as well as an individual’s position within the organization

- Interests of most of the stakeholders were well aligned with the project
- Where areas of misalignment were identified, they were addressed appropriately

### *Cultural*

- Honeywell rewards international experience and expertise
- Honeywell promotes a “get things done” attitude
- Success of the project depended on navigating the culture and delivering timely intermediate results that resulted in continued support from both top and bottom

## **6.2 Leadership of the Change Process**

In this section, I evaluate my leadership role during my research, which led to the recommendations I proposed at the end of the project. Since I did not directly lead a change process during the internship, this section focuses more on what I learned about leadership as well as my leadership style during my time at Honeywell.

I focus on what this experience illustrated about my leadership “change signature.” I was able to start out with a project description, identify the key stakeholders, interface with them to identify the key drivers important to each of them and work to leverage their expertise to determine the best way to address the project goals. At the end, I made my final recommendations to the senior management.

I learned a lot about my leadership style since the position and project were unlike any I had held in the past. The organization was also completely different from any in which I had previously worked. I picked up a few new tools and experiences and offer the following as the leadership behaviors that I learned and as well as those that best characterized my leadership change signature during my time at Honeywell:

- Lead by doing – A leader must demonstrate that she is prepared to do anything she instructs others to do. This demonstrates a strong belief and commitment to her stated goals. On numerous occasions I not only directed receiving operations but also literally rolled up my sleeves and performed the necessary heavy lifting. This helped to illustrate to the team that although my time in the company was temporary and I had an “office” job, I was committed to doing what it took

to make the changes that I felt were important. I was able to work on both the inbound (receiving) and outbound (shipping) lines get in the ERD and the inbound area at the LDC. I believe I gained a lot of credibility in the eyes of the floor workers by getting heavily involved and doing their jobs with them. Prior to his retirement, I observed this behavior in the EU logistics director that was responsible in large measure for bring the ERD online.

- Always preach your message – A leader is responsible for educating others about their cause. At every opportunity, I took pains to highlight the goals of my project with the different stakeholders or other individuals whose assistance was required for successfully completing the project. Whether on the phone with someone halfway around the world or speaking in person with a visiting business group head, I made sure people knew why I was at Honeywell and what I was trying to accomplish. It is said that it does not matter who you know but rather who knows you. By making it clear what I stood for within the organization, it was easy for people to point resources in my direction. Whether it is an alternative source of data or an introduction to an experienced worker, I found that identifying myself in this way helped me get to the information and people I needed. I observed this behavior frequently in my supervisor who constantly spoke at every opportunity about taking Honeywell’s supply chain to world-class status.
- Get to know the people around you – One of the obvious leadership methods is to learn about the people that will influence your professional life. Co-workers, subordinates, superiors and others within and outside of the organization become easier to deal with when one can relate to something about them. Whether learning about the Kentucky Derby in Louisville and the horse industry or picking up the details of how the local handball league works in South West Germany, I found that opening up to people makes it easier to work with them.
- Carefully take advantage of positional leadership and contacts – Although it can be dangerous from a credibility standpoint to exercise positional power, I found that knowing when to call on people in a position of authority to exert the right pressure is critical. Even though I did not achieve my objective to visit a plant on short notice, I determined that having my supervisor personally call to find out if the local plant head was blowing me off or genuinely busy was important. By calling on a higher authority, I was able to push to make sure everything possible had been done to try and accommodate my request.



at LDC, I was unable to execute across the board. Rather I was able to identify the exact drivers that contributed to the current poor situation and quantify the cost of exercising the necessary levers to improve the situation.

- Sustainability of Changes Implemented NOT RELEVANT.  
Since my charter was for the most part to perform analyses and make recommendations, the question of sustainability of changes implemented is moot. As explained in the paragraph above, where an implementation was expected, I was able to run some experimental scenarios and provide numbers as to the impact of making the desired changes.
- Organizational Learning from the Project HIGH.  
This project addressed certain topics that no one had yet tackled. Therefore organizational learning was high as a result of the new information uncovered. I identified key drivers and was able to quantify the effects of my recommendations. Even if not all the recommendations are implemented it is at least clear exactly what is being foregone since there now exists a dollar basis as well as non-dollar basis for evaluating the initiatives in comparison to others.
- Diffusion of Learning to Other Units in the Organization HIGH POTENTIAL.  
Since the results have been delivered to the project supervisor, they can be easily communicated and shared within the organization. Specifically the topic of replenishment of supplies in the warehouse setting was highlighted by the project supervisor as an area with high cross-over potential. Since the analysis has now been delivered, the results are easy to explain to show what kind of impact can be expected in a similar setting at a different facility. Otherwise the learning gleaned from the project is somewhat specific to the organizations involved.

## ***6.4 Recommendations for Continued Success***

My recommendations based on observations during the project are as follows:

- When dealing with multiple managers that are geographically disperse, be sure to set up a formalized process for “checking in” with them and updating them of progress as well as problems. I too often found that there were communication gaps due to infrequent meetings with my immediate superiors who all resided in different cities.
- Always over instead of under-inform. I found that never got into a bind by providing too much

information but rather by providing too little to my superiors. Keeping managers in the know made them comfortable about allowing me the freedom to do what I thought was right.

- For any supply chain initiative, it is important to spend a lot of time hashing out the organization's costs. It can be notoriously difficult to track down certain costs that are critical to a supply chain related calculation but are not tracked by the organization.
- Apart from the raw calculations, it is important to consider the non-numerical parts of a supply chain initiative. Particularly it is important to ask such questions as; "Who performed a certain task in the past and who will do so after the intended change?", "Are there going to be redundancies after implementing this change initiative?", "Which organization processes will need to change when the implementation takes place?"
- In coming up with robust recommendations, it is important to hash out the results of your analysis with the front line workers who deal with the issue on a daily basis. They will be able to provide a sanity check or at least a contrarian's view while verifying assumptions.
- Give some thought to the "what next?" question. It helps to think from the onset of the legacy (if any) that the project should leave on the organization.

## 7 Conclusions

In light of Honeywell's strategy of acquisitions and integration, the integrated supply chain (ISC) function will continue to gain visibility and responsibility in the organization. In fact even without any further acquisitions the group's task remains a daunting and exciting challenge. The supply chain packaging project is but one of the many initiatives going on in within Honeywell and with the proper deployment of resources will result in more successes into the future. I should mention here that even by its own admission, Honeywell is not near best-in-class as far as its supply chain is concerned. However, this to me signals an abundance for opportunity moving forward.

This thesis has sought to pull together many different subprojects that have one unifying theme – packaging. The key learning from the project can be summarized as follows:

- The adoption of a packaging standard in the EMEA region will provide a basis for making continuous improvements in the supply chain that originates in Honeywell's European factories. Such a standard has been highlighted in this thesis with detailed test procedure and financial implications.
- As the ERD continues to grow, more attention needs to be directed at the subject of packing. This thesis has outlined various packing alternatives and proposes a new methodology for achieving greater customer service compared to the current standard method while avoiding the high costs and cycle times of Class-A packing. Class-B packing as I have designated this methodology offers improvements with the potential of solving the ERD's near term packing problems.
- With the rapid consolidation of ECC warehouses in Europe, shipments will become more consolidated between regional warehouses. As such the current one-way shipments, which are the norm will become a two-way flow. A framework for decision making as far as pallet sourcing and sinking has been presented which is robust and able to handle future changes in shipment patterns.
- I have performed an analysis of carton replenishment at the ERD in Heilbronn. I have considered three different scenarios, daily, 3-day and 5-day ordering of shipment cartons and compared the relevant metrics with the EOQ. I have concluded that at current volumes, ordering every five days

would be the optimal order policy.

- Exercising leadership, which has been one of the tenets of the LFM education has also been a core feature of the thesis work. The breadth of learning that took place during the course of my research with Honeywell has given me new insight into my work style and further highlighted some strength as well as areas for improvement.

In closing, I believe that the organization that acted as my host for six months has the opportunity to make vast improvements by using its current successes as a springboard. I hope this thesis work will be able to contribute in a humble way to the overall goal outlined by the organization to “do a great job for our customers every day in delivery, quality, value and technology.”



## Bibliography

- [1] Honeywell Corporation Annual Report 2005.
- [2] Pascal Dennis. Lean Production Simplified. New York: Productivity Press, 2002.
- [3] ASTM Board. "ASTM Mission Statement." October 2005. ASTM. 15 May 2006  
<<http://www.astm.org/cgi-bin/SoftCart.exe/NEWS/Mission2.html?L+mystore+afmx9589+1142741946>>
- [4] Honeywell. "Design Analysis Standards – Environmental Test Procedures." Section DA8.5. Minnesota, 1998.
- [5] "Marshall White on the State of Pallets." 1 March 2006. Modern Materials Handling 15 May 2006 <<http://www.mmh.com/article/CA6314216.html>>
- [6] Honeywell. "Logistics guidebook for ACS ECC."
- [7] United Nations Publication No. 15. Guidelines for Regulating Wood Packaging Materials in International Trade. Rome: Secretariat of the International Plant Protection Convention Food and Agriculture Organization of the United Nations, 2002.
- [8] Klein, Janice A. True Change: How Outsiders on the Inside Get Things Done in Organizations. San Francisco: Jossey-Bass, 2004.

*This page is intentionally left blank*

# **Appendix A – Packaging Standard For EMEA Plants**

## **1. PURPOSE**

Define the tests that are designed and conducted to measure the ability of packed and unpacked devices to withstand damage from the extreme conditions of storage, shipping, handling, and vibration.

## **2. SCOPE**

Applies to all relevant products produced and shipped by Honeywell ECC factories in Mosbach, Schoenaich, Brno and Nagykanizsa. The product manager will be responsible of the applicability of this document to the specific product.

For tests of packed devices, the test units must be packed in the containers that will normally be used. This could be (1) unit pack cartons with single unit overpack, (2) unit cartons with multiple unit overpack, or (3) multiple unit bulk pack. All required accessories must be sealed as they would be for standard shipping.

## **3. POLICY**

Devices are to be tested to per the relevant factory product testing procedure before and after the following tests. Any deviation from specifications must be documented as to approval (or disapproval) status and supporting rationale for that status.

## **4. DEFINITIONS**

### **4.1 ASTM**

American Society for Testing and Materials

### **4.2 TAPPI**

Technical Association for Pulp Paper Industries

### **4.3 NSTA**

National Safe Transit Association

## **5. PROCEDURE**

### **5.1 Storage Test Procedure**

All packed devices must withstand exposure to ambient temperatures of  $-20^{\circ}\text{F}$  to  $+120^{\circ}\text{F}$  without damage, unless otherwise specified in the business plan. The devices need not operate at these temperatures, but must be operable after returning to their normal operating range.

The device must be packed as described above, except an overpack is not required if unit cartons are used. The packs must be exposed to each temperature extreme for eight hours minimum (overnight is preferable) and must be inspected after exposure to each temperature extreme.

Examine items for loosening of parts, freezing of fills, cam locking, leadwire interference, and excessive strain or deformation in elements or other parts.

## 5.2 Handling Test Procedure

The packed devices must not be damaged due to rough handling at normal ambient temperature and at the storage temperature extremes. Unpacked devices must not be damaged due to rough handling at normal ambient temperatures.

### 5.2.1 Fiberboard Containers

#### 5.2.1.1 – Extreme Temperature Considerations

On devices which may be damaged by high or low temperature and humidity ( $-20^{\circ}\text{F}$  or  $+120^{\circ}\text{F}$ ) handling, the package must be exposed to the storage temperature extreme for four hours minimum or until stabilized, and put through the dropping sequence immediately after removing it from the storage temperature. Separate units are to be used for the “Cold” drop, for the “Hot” drop and for the “Tropical Wet” drop ( $100^{\circ}\text{F}$ , 85% RH). Vibration and compression tests will be performed immediately after the drop sequence.

#### 5.2.1.2 – Identification

Facing the end with the manufacturer’s joint on the observer’s right, the top of the box is designated as 1, the right side as 2, the bottom as 3, and the far left side as 4. (**See: Figure 1**). The near end is designated as 5 and the far end as 6. The edges are identified by the number of the faces, which make the edge. For example, 1-2 identifies the edge where the top and right side meet and 2-5 is the edge having the manufacturer’s joint. The corners are identified by the number of the three faces, which meet to form that corner. For example, 1-2-5 identifies the corner where the top, the right side, and the near end meet.

#### 5.2.1.3 – Drop Height

The height of the drop must be adjusted to the appropriate value depending on the weight of the package. Exceptions to this are the following:

- All boxes weighing less than 10 kg – 970mm drop
- All boxes weighing more than 45 kg – 310mm drop

**See: Table 1** to determine drop height for given package weight.

#### 5.2.1.4 – Drop Machine

The drop test machine must be used for all tests. The platform must be adjusted to the correct height, and held by the provided supports. The platform adjusting bolt must be kept tight during operation. For corner and edge drops, the package must be balanced on the platform before dropping. Equipment must comply with ASTM D-775 and/or TAPPI T-802.

- **Description**  
The M/RAD (Drop Test Machine) Model #3636 (200) DT is used for dropping packages. Other machines that conform to ASTM D 5276-98 may also be used. The height of the drop is adjustable over the range from 310mm to 970mm. An air cylinder driven platform supports the package prior to release. When released, the platform is accelerated by the air cylinder away from the bottom of the package and out of its path of fall. Thus, the package is allowed to fall freely.

The platform support travels along a vertical tube and is clamped at the desired height by a bolt through a collar on the tube. A motor driven cable mechanism is used to raise or lower the platform.

- Operating Procedure Using the M/RAD Model #3636 (200) DT

**CAUTION:** Extreme care must be taken to ensure that no person or objects are in the path of swing of the platform.

The air supply valves are located on the wall to the right of the drop test machine. To operate, first move the selector switch to the **Cylinder** position. Then move the **Shut-Off** valve to the **On** position.

The platform is controlled with a foot-operated, floor-mounted switch. This switch pivots either up or down and has a guard to help prevent inadvertent operation. Depressing the lower end of the switch causes the platform to drop. Depressing the upper end of the switch resets the platform into the “**ready**” position. **NOTE:** The operator must ensure that neither persons nor materials are in the path of the arm or severe injury or damage could result.

The height of the drop is adjusted by moving the platform support up or down the vertical tube. If the platform is not in the ready position, operate the foot switch to put the platform into the ready position. Loosen the bolt on the locking collar. Operate the switch on the cord mounted **Up/Down** switch box. A motor driven cable causes the platform to either raise or lower, depending upon which way the switch is moved. Return the switch to the center position and measure the height of the platform.

Adjust the platform up or down, as required for the weight of the package being tested. When at the proper position, lock in place with the locking bolt. Do not operate the **Up/Down** switch when the collar is locked in place. **NOTE:** Do not operate the package platform unless the locking bolt is tightened.

The following shut-down procedure must be conducted before leaving the test area. First, move the air supply valve to the **Off** position. This shuts off the air supply. Second, move the selector switch to the **Exhaust** position. This relieves the pressure from the drop test machine air supply tank, and prevents further operation.

#### 5.2.1.5 – Dropping Sequence

- A corner drop on 1-2-5
- An edge drop on the shortest edge radiating from that corner (usually 2-5)
- An edge drop on the next shortest edge radiating from that corner (usually 1-5)
- An edge drop on the longest edge radiating from that corner (usually 1-2)
- A flatwise drop on one of the smallest faces (usually end 5 or 6)
- A flatwise drop on the opposite smallest face
- A flatwise drop on one of the medium faces (usually 2 or 4)

- A flatwise drop on the opposite medium face
- A flatwise drop on one of the largest faces (usually top 1 or bottom 3)
- A flatwise drop on the opposite large face

### 5.3 Vibration Test Procedures

Devices packed as they would be shipped must withstand one gravity (G) of repetitive shock vibration as could be found in transportation. Testing will be performed per ASTM D999 Method A.

#### 5.3.1 Test Equipment

The test equipment must comply with ASTM D999 Method A. The vibration test machine must have a horizontal platform with a surface of sufficient strength and rigidity such that the applied vibrations are essentially uniform over the entire test surface when loaded with the device under test.

The platform must be supported by a mechanism that vibrates it such that the vertical component of the motion is approximately sinusoidal. Either a rotary motion or a vertical linear motion of the platform is acceptable.

The double amplitude of vibration must be fixed at 25mm, and frequency must be variable down to 5 Hz.

The vibration test machine must be equipped with fences, barricades, or other restraints to retain the test device on the platform.

Step 1: Place the test device on the test machine platform in its normal shipping orientation. (See: Note in Step 3.) Attach restraining devices to the platform to prevent the device from moving off the platform and to prevent excessive rocking. Adjust the restraining means to permit free movement of the test device of approximately 10mm in any horizontal direction from its centered position.

If instrumentation is used to determine vibration level, attach the accelerometer to the platform near the test device, but protected so that it will not be contacted by the device under test.

Step 2: Start the vibration of the platform at the frequency of approximately 5 Hz, and steadily increase the frequency until some portion of the test device repeatedly leaves the platform or until the acceleration of the platform is 1.1 times the acceleration of gravity (measured zero to peak value). This is to ensure that the test specimen receives a continuing series of repetitive shocks.

Step 3: Continue the test at this frequency for a total of 60 minutes. The test may be interrupted momentarily to inspect the device under test for damage.

**NOTE:** If the container could be shipped in any other orientation, use a new test device and repeat Steps 1 through 3 for each additional axis.

Time (in minutes) = 14,200/(60) (X) Hz

**Reference:** ASTM D999 (Method A) and NSTA (Vibration Test).

#### 5.4 Static Compression Test Procedures

The packed device must not be damaged when placed in large stacks while in storage. The pack must be able to withstand the weight of the packs placed above it without damage to the unit. This test will be run at room temperature only. The devices used to run this test will not be the same units used to run the handling tests.

##### 5.4.1 Background

Upon leaving production, most products go to the distribution center where they are placed on pallets for storage. The pallets are placed on metal shelves for the most part, but large bulky devices, may be too large for these shelves.

Products may be stacked on a pallet on top of each other. The weight may or may not be distributed evenly over the pack. For test purposes, the weight must be applied the same way as it would be in storage. The distribution center must be contacted and a determination made as to the method of storage.

Damage has been observed in the past due to inadequate strength of the pack. This Standard is intended to determine if the pack is adequate to protect a device against the stress provided by weight applied during storage.

Background materials used in developing this Standard were the Honeywell Packing Guide and the National Safe Transit Committee pre-shipment test procedures.

##### 5.4.2 Procedure A (Dead Load)

A diagram is printed on the bottom of each shipping container to indicate how the containers are to be stacked on a pallet. Using this information, and the following formula, the load that the container must withstand can be determined.

$$L = W \times (H - D) / D \times F \times 9.8$$

<b>L</b>	<b>(Newtons)</b>	=	The load the packaged product must withstand
<b>W</b>	<b>(Kg)</b>	=	Weight of the individual package under test
<b>H</b>		=	Stacking height above the top of the pallet
<b>D</b>		=	The depth of the container
<b>F</b>		=	4

H and D must be in the same units. F is a compensating factor to allow for the time duration of the test, versus the length of time the device is in storage and humidity conditions. H is determined by the number of layers stacked on one pallet, multiplied by the weight of one packaged unit.

To run the test, place the unit or bulk pack on a wooden pallet and place a piece of plywood on top of the pack. The load, as determined by the above formula, is applied slowly and carefully by placing a weight equal to the load on the plywood. The weight is to be uniformly distributed on the plywood. Allow the weight to remain in place for one hour. Remove the weight and inspect

both the package and units for damage. The device must be free from damage and the package suitable to provide the device adequate protection in shipping.

**5.4.3 Procedure B (Testing Machine)**

**5.4.3.1** – The compression testing machine is to be of accepted design and capacity. If the machine is not equipped with an autograph recording device that records load and deformation, auxiliary equipment must be provided to measure deformation.

**5.4.3.2** – Center the device under test on the bottom platen of the testing machine so as not to incur eccentric loading. Lower the top platen until it comes in contact with the device under test. The upper platen may be either fixed or swiveled for tests where the compressive loads are applied face to face.

Apply the load with a continuous motion of the movable head of the testing machine at a speed of 13mm per minute, until failure and/or maximum load has been reached.

Use same formula in Procedure A to determine the required value for the load the package must withstand.

**TABLE 1: Weight versus Drop Height**

Weight $\geq$ Kg	Weight $>$ Kg	Height mm
0	10	970
10	19	810
19	28	660
28	45	510
18	45	310

**FIGURE 1: Container Identification**

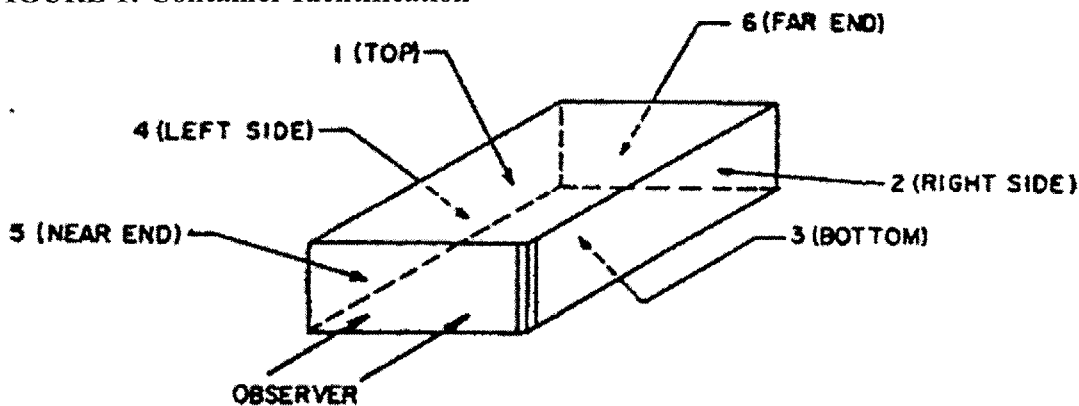



## Appendix B – Assumptions for Carton Replenishment

- Cost per loading meter (transport unit) = €25.26
- # Loading meters per carton is variable between 1/3 – 2
- Variable cost (includes freight varies with size of order and cost of carton) = €0.2 – €13.9
- Fixed order cost is currently estimates to be constant for all types of cartons = 15mins (€3.81)
- Physical Holding = 0.16€/€/yr
- Opportunity Cost = 0.065€/€/yr
- Total Cost = Order cost + Holding cost
- Order cost = time for (inventory counting + calling supplier + receiving). The current numbers are based on estimates gleaned from interviews with warehouse staff.
- EOQ is calculated using the normal EOQ formula -  $\sqrt{\frac{2AD}{vr}}$  where
  - o A – Fixed order cost
  - o D – Annual usage
  - o v – Total variable cost
  - o r – Physical holding cost + opportunity cost
- Total relevant costs are calculated for the three scenarios (1,3 and 5-day ordering) as follows:
  - o Ordering cost = Number of orders per year \* Cost of ordering (A)
  - o Holding cost = Average number of cartons on hand \* variable cost \* opportunity cost