



MIT International Center for Air Transportation

An Analysis of Profit Cycles In the Airline Industry

By

Helen Hong Jiang and R. John Hansman

Report No. ICAT-2004-7

December 2004

Massachusetts Institute of Technology

Cambridge, MA

An Analysis of Profit Cycles in the Airline Industry

by

Helen Hong Jiang and R. John Hansman

ABSTRACT

The objective of this paper is to understand the financial dynamics of the airline industry by identifying profit cycle periods of the industry and their driving factors.

Assuming that the industry profit cycles could be modeled as an undamped second-order system, the fundamental cycle period was identified to be 11.3 years for the U.S. airlines and 10.5 years for the world airlines. Analyses of industry profits reveal that such cycle period is endogenous, neither deregulation nor September 11 have significantly changed it.

Parametric models were developed under the hypothesis that phase lag in the system caused profit oscillations; and two hypotheses, lag in capacity response and lag in cost adjustment were studied. A parametric model was developed by hypothesizing the delay in capacity response caused profit oscillations. For this model, the system stability depends on the delay between aircraft orders and deliveries and the aggressiveness in airplane ordering. Assuming industry profits correlated to capacity shortfall, the delay and gain were calculated and the results were consistent with the observed delay between world aircraft deliveries and net profits. Since the gain in the model has lumped impacts of exogenous factors, exaggerated capacity response was observed in simulation. This indicates capacity shortfall alone cannot fully explain the industry dynamics. The model also indicates reduced delay may help to mitigate system oscillations. Similarly, a parametric model was developed by hypothesizing the delay in cost adjustment caused profit oscillations, and simulation results were consistent with industry profits. A coupled model was developed to study the joint effects of capacity and cost. Simulations indicated that the coupled model explained industry dynamics better than the individual capacity or cost models, indicating that the system behavior is driven by the joint effects of capacity response and cost adjustment. A more sophisticated model including load factor and short-term capacity effects is proposed for future work in an effort to better understand the industry dynamics.

This document is based on the thesis of Helen Hong Jiang submitted to the Department of Aeronautics and Astronautics at the Massachusetts Institute of Technology in partial fulfillment of the requirements for the degree of Master of Science in Aeronautics and Astronautics.

ACKNOWLEDGEMENTS

The authors would like to acknowledge the R. Dixon Speas Fellowship, the MIT Global Airline Industry Program and the Alfred P. Sloan Foundation in supporting this research.

The authors would also like to acknowledge Dr. Peter Belobaba and Professor Steven R. Hall of MIT, Mr. Drew Magill and Dr. William Swan of Boeing Commercial Airplanes, Dr. Christoph Klingenberg and Dr. Alexander Zock of Lufthansa German Airlines, Mr. Stephen K. Welman of The MITRE Corporation, Dr. David W. Peterson of Ventana Systems, Inc., and Professor James M. Lyneis of Worcester Polytechnic Institute for valuable suggestions and feedbacks.

Thanks to Diana Dorinson, Thomas Gorin, Bruno Miller, Liling Ren, Ryan Tam, Emmanuel Carrier, and Phillippe Bonnefoy in the MIT International Center for Air Transportation for valuable discussions related to this research.

TABLE OF CONTENTS

ABSTRACT.....	3
ACKNOWLEDGEMENTS.....	5
TABLE OF CONTENTS.....	7
LIST OF FIGURES.....	9
LIST OF FIGURES.....	12
LIST OF ABBREVIATIONS.....	13
CHAPTER 1: Introduction.....	15
1.1 Objective.....	15
1.2 Motivation.....	15
1.3 Literature Review.....	20
1.4 Methodology.....	21
CHAPTER 2: Methodology for Airline Net Profit Analysis.....	23
2.1 Assumption and Derivation of Airline Net Profit Model.....	23
2.2 Identifying Fundamental Cycle Period of Airline Industry.....	24
2.3 Model Estimation.....	27
CHAPTER 3: Results of Airline Net Profits Analysis.....	29
3.1 U.S. Airline Industry before Deregulation.....	29
3.2 U.S. Airline Industry after Deregulation.....	31
3.2.1 Impact of Deregulation on Profit Cyclicity.....	31
3.2.2 Impact of September 11 on Profit Cyclicity.....	32
3.3 World Airline Industry.....	34
3.4 Assumptions and Limitations of Airline Net Profit Model.....	34
3.5 Summary of Airline Net Profit Analysis.....	35
CHAPTER 4: Parametric Model for Capacity.....	37
4.1 Data Analysis of World Commercial Jet Orders and Deliveries.....	37
4.2 Capacity Hypothesis.....	40
4.3 Parametric Model for Capacity.....	41
4.4 Root Locus Analysis of System Stability.....	42
4.5 Determining Parameters in the Capacity Parametric Model.....	44
4.5.1 Assumptions.....	44
4.5.2 Derivation.....	45
4.5.3 Parameters for the Airline Industry.....	46
4.6 Factors Contributing to Delay and Gain Values.....	47
CHAPTER 5: Simulations of Capacity Parametric Model.....	49
5.1 Capacity Simulations of the U.S. Airlines.....	49
5.2 Revisiting the Assumption – Cost of Adding Capacity.....	51
5.3 Capacity Simulations of the World Airlines.....	51
5.4 Mitigating System Oscillations.....	53
5.5 Summary of Capacity Parametric Model.....	55

CHAPTER 6: Parametric Model for Cost.....	57
6.1 Cost Hypothesis.....	57
6.2 Parametric Model for Cost.....	59
6.3 Unit Net Profit Analysis.....	60
6.4 Determining Parameters in the Cost Parametric Model.....	61
6.5 Simulation Results.....	62
6.6 Summary of Cost Parametric Model.....	65
CHAPTER 7: Coupling Capacity and Cost Effects.....	67
7.1 Coupled Model Combining Capacity and Cost Effects.....	67
7.2 Parameter Values in the Coupled Model.....	69
7.3 Simulation Results.....	72
7.3.1 Simulation 1 – Calibration Simulation.....	72
7.3.2 Simulation 2.....	77
7.3.3 Simulation 3.....	82
7.4 Summary of Coupled Model.....	86
CHAPTER 8: Including Load Factor and Short-term Capacity Effects.....	87
8.1 Model Including Load Factor and Short-term Effects.....	87
8.2 Demand Modeling.....	88
8.2.1 Latent Demand Concept.....	88
8.2.2 Demand Models.....	89
8.3 Revenue Management.....	90
8.4 Capacity Modeling.....	91
8.4.1 Two Capacity Concepts.....	91
8.4.2 Tactical Scheduling Model.....	92
8.4.3 Fleet Planning Model.....	93
8.5 Modeling Cost Factors.....	93
8.6 Summary.....	94
CHAPTER 9: Conclusions.....	95
9.1 Summary of Findings.....	95
REFERENCES.....	97
APPENDIX A: Average Aircraft Utility of the U.S. Airlines.....	99
APPENDIX B: Cost Analysis of the U.S. Major and National Passenger Carriers.....	101
B.1 Introduction and Methodology.....	101
B.2 Cost Analysis.....	103
B.2.1 Labor.....	103
B.2.2 Materials Purchased: Fuel, Food and Maintenance Materials.....	104
B.2.3 Aircraft Ownership and Non-Aircraft Ownership.....	107
B.2.4 Landing Fees.....	108
B.2.5 Services Purchased.....	109
B.2.6 Summary of Cost Analysis.....	113
B.3 Cost Adjustment.....	115

LIST OF FIGURES

Figure	Page
1-1 Annual Traffic and Capacity of the U.S. Airlines of Scheduled Services.....	16
1-2 Annual Operating Revenues and Expenses of the U.S. Airlines of All Services.....	17
1-3 Annual Net Profits of the U.S. Airlines of All Services.....	17
1-4 Unit Net Profits of the U.S. Airlines.....	18
1-5 Annual Traffic and Capacity of the World Airlines.....	19
1-6 Annual Net Profits of the World Airlines.....	20
2-1 DFT Results of the U.S. Airlines Net Profits.....	26
2-2 DFT Results of the World Airlines Net Profits.....	26
3-1 Net Profit Analysis Results of the U.S. Airlines before Deregulation.....	30
3-2 Net Profit Analysis Results of the U.S. Airlines after Deregulation.....	32
3-3 Net Profit Analysis Results of the U.S. Airlines after Deregulation with Data Only before 2001.....	33
3-4 Net Profit Analysis Results of the World Airlines.....	35
4-1 World Commercial Jet Aircraft Orders and Deliveries.....	38
4-2 World Aircraft Orders and World Airlines Net Profits.....	39
4-3 World Aircraft Deliveries and World Airlines Net Profits.....	39
4-4 Asymmetric Effect between World Aircraft Orders and World Airlines Net Profits.....	40
4-5 Block Diagram of a Generic Control System with Phase Lag.....	41
4-6 Block Diagram of Capacity Parametric Model.....	42
4-7 Root Locus of Capacity Parametric Model.....	42
4-8 Relationship between System Stability and Delay/Gain Values.....	44
4-9 System Stability and Delay/Gain Values of the U.S. and World Airlines in Capacity Parametric Model.....	47
5-1 Simulation of Demand and Capacity of the U.S. Airlines.....	50
5-2 Simulation of Capacity Shortfall of the U.S. Airlines and Net Profit Data.....	50
5-3 Simulation of Demand and Capacity of the World Airlines.....	52
5-4 Converted Order Simulation Results of the World Airlines.....	52
5-5 Mitigating Capacity Oscillations of the U.S. Airlines.....	54
5-6 Mitigating Capacity Oscillations of the World Airlines.....	54
6-1 RASM and CASM of the U.S. Major and National Passenger Carriers.....	58
6-2 Unit Operating Expenses and Unit Net Profits of the U.S. Airlines.....	58
6-3 Block Diagram of Cost Parametric Model.....	59
6-4 Unit Net Profit Analysis Results of the U.S. Airlines.....	61
6-5 System Stability and Delay/Gain Values of the U.S. Airlines in Cost Parametric Model.....	62

6-6	Cost/ASM Simulation of the U.S. Airlines.....	63
6-7	Profit/ASM Simulation of the U.S. Airlines.....	63
6-8	Cost/ASM Simulation of the U.S. Airlines with Step RASM Decrease in 2001.....	64
6-9	Profit/ASM Simulation of the U.S. Airlines with Step RASM Decrease in 2001.....	64
7-1	Block Diagram of Coupled Model Combining Capacity and Cost Effects.....	68
7-2	Capacity Simulation of Coupled Model in Simulation 1.....	73
7-3	Fleet Simulation of Coupled Model in Simulation 1.....	73
7-4	CASM Simulation of Coupled Model in Simulation 1.....	74
7-5	Profit Simulation of Coupled Model in Simulation 1.....	74
7-6	Aircraft Order Simulation of Coupled Model in Simulation 1.....	75
7-7	Simulation of Effect of Profitability on Aircraft Orders.....	76
7-8	U.S. Scheduled Monthly Domestic Passenger Traffic and Yield.....	77
7-9	Configuration of Coupled Model for Simulation 2 to Reflect Effects in 2001 on Demand and RASM.....	78
7-10	Capacity Simulation of Coupled Model in Simulation 2.....	78
7-11	Fleet Simulation of Coupled Model in Simulation 2.....	79
7-12	CASM Simulation of Coupled Model in Simulation 2.....	79
7-13	Profit Simulation of Coupled Model in Simulation 2.....	80
7-14	Aircraft Order Simulation of Coupled Model in Simulation 2.....	80
7-15	Stored Aircraft of the U.S. Major, National and Regional Carriers.....	81
7-16	Modified Coupled Model for Simulation 3 to Capture Effects in 2001.....	82
7-17	Capacity Simulation of Modified Coupled Model in Simulation 3.....	83
7-18	Fleet Simulation of Modified Coupled Model in Simulation 3.....	84
7-19	CASM Simulation of Modified Coupled Model in Simulation 3.....	84
7-20	Profit Simulation of Modified Coupled Model in Simulation 3.....	85
7-21	Aircraft Order Simulation of Modified Coupled Model in Simulation 3.....	85
8-1	Proposed Model Including Load Factor and Short-term Capacity Effects.....	88
8-2	Scheduled Passenger Traffic of the U.S. Airlines and GDP.....	89
8-3	Proposed Constant Price Elasticity Demand Model.....	90
8-4	Proposed Simple Linear Demand Model.....	90
8-5	Passenger Load Factors of the U.S. Airlines of Scheduled Services.....	91
A-1	System-wide Aircraft Utility of the U.S. Airlines.....	99
B-1	RASMs and Unit Operating Expenses of the U.S. Major and National Passenger Carriers.....	102
B-2	Unit Labor Costs of the U.S. Major and National Passenger Carriers.....	103
B-3	Unit Fuel Costs of the U.S. Major and National Passenger Carriers.....	104
B-4	Historical Average Jet Fuel Prices of the U.S. Major, National and Large Regional Carriers of All Services and Crude Oil Prices.....	105
B-5	Unit Costs of Food and Beverage of the U.S. Major and National Passenger Carriers.....	106
B-6	Unit Costs of Maintenance Materials of the U.S. Major and National Passenger Carriers.....	106

B-7	Unit Costs of Aircraft Ownership of the U.S. Major and National Passenger Carriers.....	107
B-8	Unit Costs of Non-Aircraft Ownership of the U.S. Major and National Passenger Carriers.....	108
B-9	Unit Costs of Landing Fees of the U.S. Major and National Passenger Carriers.....	109
B-10	Unit Costs of Professional Services of the U.S. Major and National Passenger Carriers.....	110
B-11	Unit Costs of Passenger Commission of the U.S. Major and National Passenger Carriers.....	110
B-12	Unit Costs of Advertising and Promotion of the U.S. Major and National Passenger Carriers.....	111
B-13	Unit Costs of Aircraft Insurance of the U.S. Major and National Passenger Carriers...	112
B-14	Unit Costs of Non-Aircraft Insurance of the U.S. Major and National Passenger Carriers.....	112
B-15	Cost Allocation of the U.S. Major and National Passenger Carriers in 1980.....	113
B-16	Cost Allocation of the U.S. Major and National Passenger Carriers in 2000.....	114
B-17	Cost Allocation of the U.S. Major and National Passenger Carriers in 2003.....	114
B-18	Share of Passenger Revenues in Total Operating Revenues of the U.S. Major and National Passenger Carriers.....	116
B-19	RASM and CASM of the U.S. Major and National Passenger Carriers.....	116

LIST OF TABLES

Table		Page
3-1	Regression Results of Net Profit Analysis of the U.S. Airlines before Deregulation.....	30
3-2	Regression Results of Net Profit Analysis of the U.S. Airlines after Deregulation.....	31
3-3	Regression Results of Net Profit Analysis of the U.S. Airlines after Deregulation with Data Only before 2001.....	33
3-4	Regression Results of Net Profit Analysis of the World Airlines.....	34
4-1	Delay and Gain Estimates of the U.S. and World Airlines under Capacity Hypothesis.....	46
6-1	Delay and Gain Estimates of the U.S. Airlines under Cost Hypothesis	61
7-1	Summary of Variables and Parameters in the Coupled Model.....	69
7-2	Calibration Results of Parameters in the Coupled Model.....	71

LIST OF ABBREVIATIONS

Abbreviation	Description
ATA	Air Transport Association
ATSB	Air Transportation Stabilization Board
ASM	Available seat-miles
ASK	Available seat-kilometers
BEA	Bureau of Economic Analysis, U.S. Department of Commerce
BLS	Bureau of Labor Statistics, U.S. Department of Labor
BTS	Bureau of Transportation Statistics, U.S. Department of Transportation
CAB	Civil Aeronautics Board
CASM	Prorated operating expense per ASM with respect to passenger services
DOT	Department of Transportation
GDP	Gross domestic product
PLF	Passenger load factor, RPMs divided by ASMs
RASM	Revenue per available seat mile
RPM	Revenue passenger-miles
RPK	Revenue passenger-kilometers
September 11	Terrorists attacks on the United States, September 11 th , 2001
Yield	Passenger revenues divided by revenue passenger-miles

Classification of DOT Large Certified Air Carrier

Majors	More than \$1 billion in annual operating revenues
Nationals	Between \$100 million and \$1 billion in annual operating revenues
Large Regionals	Between \$20 million and \$100 million in annual operating revenues
Medium Regionals	Less than \$20 million in annual operating revenues

Large Certified Air Carrier: An air carrier holding a certificate issued under Section 401 of the Federal Aviation Act of 1958, as amended, that: (1) Operates aircraft designed to have a maximum passenger capacity of more than 60 seats or a maximum payload capacity of more than 18,000 pounds, or (2) Conducts operations where one or both terminals of a flight stage are outside the 50 states, the District of Columbia, the Commonwealth of Puerto Rico, and the U.S. Virgin Islands.

CHAPTER 1

Introduction

1.1 Objective

The air transportation in the United States has experienced strong development through the boom-and-bust cycles, particularly since deregulation in 1978. The financial crisis facing the industry in 2001~2003 has highlighted the volatility and oscillation of industry profits as a key issue for the stability of airline industry. The objective of this study is to understand the dynamics of airline industry by identifying the fundamental cycle periods of the U.S. and world airlines as well as the driving factors of the system's financial behavior.

1.2 Motivation

The air transportation system in the United States entered in a new era on October 24, 1978 when the Airline Deregulation Act was approved. Prior to 1978, the airline industry resembled a public utility; the routes each airline flew and the fares they charged were regulated by the Civil Aeronautics Board (CAB) [1]. As the Airline Deregulation Act eliminated CAB's authority over routes and domestic fares, the airline industry transformed into a market-oriented sector, driven by the dynamics between demand and supply.

Deregulation has boosted the development of air transportation system. The rapid growth in air transportation since deregulation has been witnessed by the growths in both traffic and capacity. Figure 1-1 shows the annual traffic measured in terms of Revenue Passenger Miles (RPM), and the annual operating capacity in Available Seat Miles (ASM) of the U.S. airlines for

scheduled services since 1947 [2]. The data, consolidated by ATA based on DOT Form 41 data, reflect the activity of the major, national, and regional passenger and cargo airlines as defined by the U.S. Department of Transportation. Shown by Tam and Hansman, the annual growth of domestic scheduled traffic of the U.S. airlines between 1978 and 2002 averaged at 11.7 million RPMs per year, more than doubled the average growth between 1954 and 1978 that was 5.8 million RPMs per year [3]. Accordingly, the operating capacity of the industry grew on average 4% per year between 1980 and 2000 (Figure 1-1).

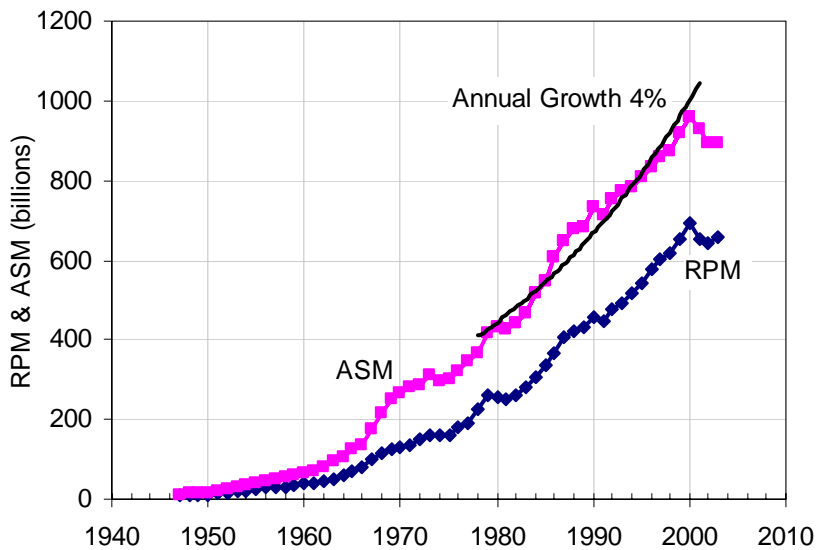

Figure 1-1 Annual Traffic and Capacity of the U.S. Airlines of Scheduled Services [2]

However, the net financial results of the industry had a significant different behavior. The annual operating revenues and expenses of the U.S. major, national and regional passenger and cargo airlines shown in Figure 1-2 have grown with traffic, while the industry profits in Figure 1-3 have oscillated with growing amplitude since deregulation [4]. Again, the financial data were consolidated by ATA based on Form 41 data. It should be noted that data in Figure 1-2 and 1-3 were evaluated in constant 2000 dollars to eliminate the inflation effects. Unless otherwise noted, all financial data in this study is referred to 2000 dollars.

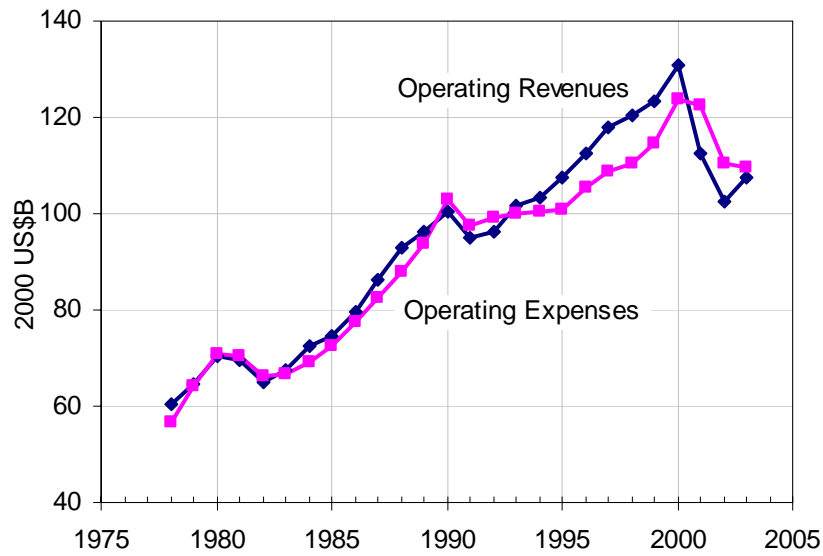

Figure 1-2 Annual Operating Revenues and Expenses of the U.S. Airlines of All Services [4]

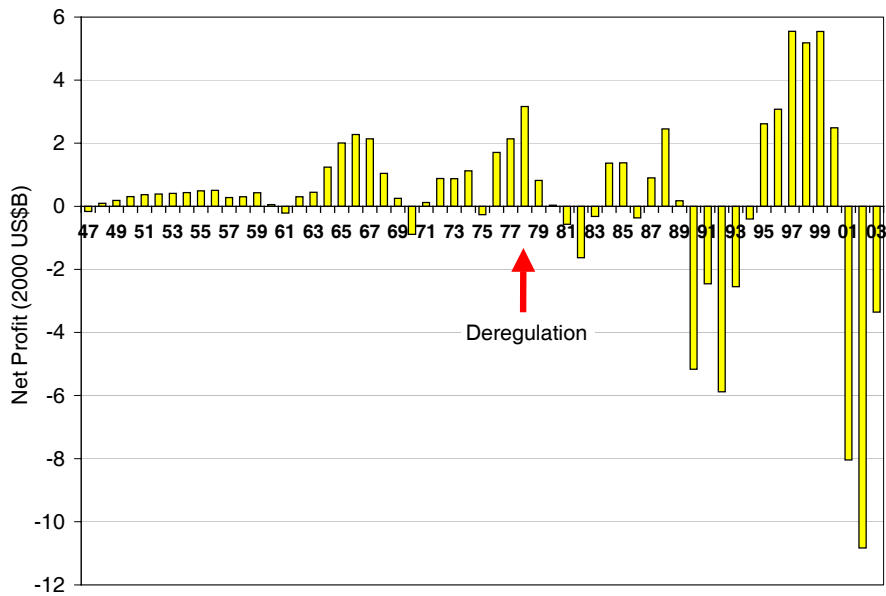

Figure 1-3 Annual Net Profits of the U.S. Airlines of All Services [4]

Figure 1-3 indicates that fundamental changes took place in the industry after deregulation. The industry net profits started to oscillate around zero profit after deregulation and the oscillation amplitude has grown over time. In the current down cycle, the industry has lost over

23 billion dollars accumulatively in 2001, 2002 and 2003, outpacing the total earnings of the past. Many airlines have suffered intense financial losses. As of November 2004, three major airlines, United Airlines, US Airways and ATA Airlines, have filed bankruptcy protection, while several other airlines are teetering at the brink. In contrast, the industry was profitable most of the time before deregulation, even in the down cycle periods (Figure 1-3).

The above trend of growing profit oscillations after deregulation could not be simply explained by traffic or capacity growth. Figure 1-4 depicts the unit profits of the U.S. airlines since deregulation that were derived from ATA traffic and profit data. By normalizing the net profit with respect to ASM of the year, the unit profit eliminated the effect of capacity increase on profit growth. Figure 1-4 shows that the amplitude of oscillating unit profits has grown over the cycles since deregulation. Therefore, it is concluded that certain factors other than traffic or capacity volume has contributed to increasing profit oscillations.

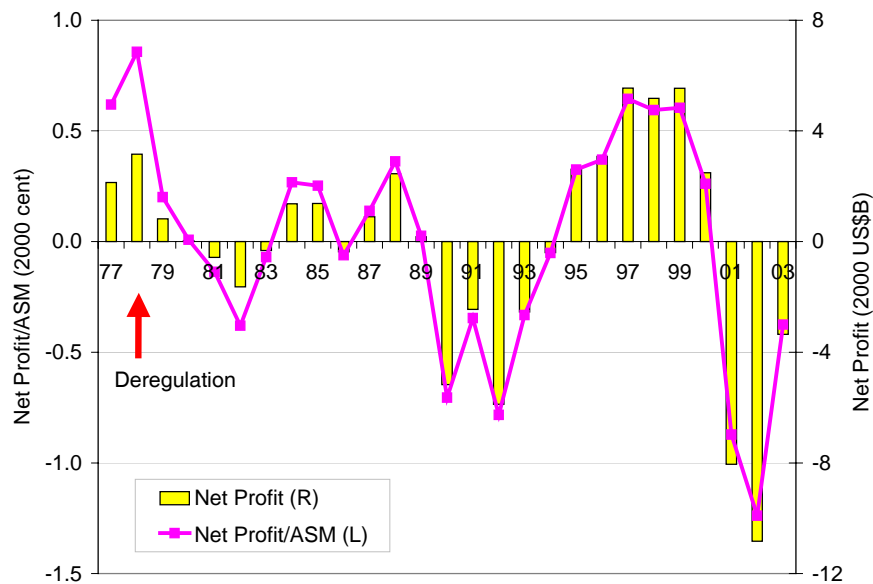

Figure 1-4 Unit Net Profits of the U.S. Airlines

Moreover, the observation of increasing profit oscillation is not unique to the U.S. airline industry. Similar behavior is seen in the world airline industry. As the wave of liberalizing air transportation spreads globally, the world air traffic and capacity have grown rapidly since late 1970s. Figure 1-5 shows the annual traffic (RPK) and operating capacity (ASK) of the world airlines, which reflect the system-wide activity of scheduled passenger and cargo airlines operating worldwide as recorded by ICAO [5]. The annual growth rate of capacity averaged 4.7% during the 1980s and 1990s. On the other hand, according to ICAO records, the net profits of the world airlines again have oscillated with increasing amplitude over the cycles since late 1970s, shown in Figure 1-6 [5].

Therefore, there is a need to study and understand the financial dynamics of the airline industry. The goal of this study is to understand the dynamics of airline industry by identifying the fundamental cycle periods of the U.S. and world airlines as well as the driving factors of the system's financial behavior.

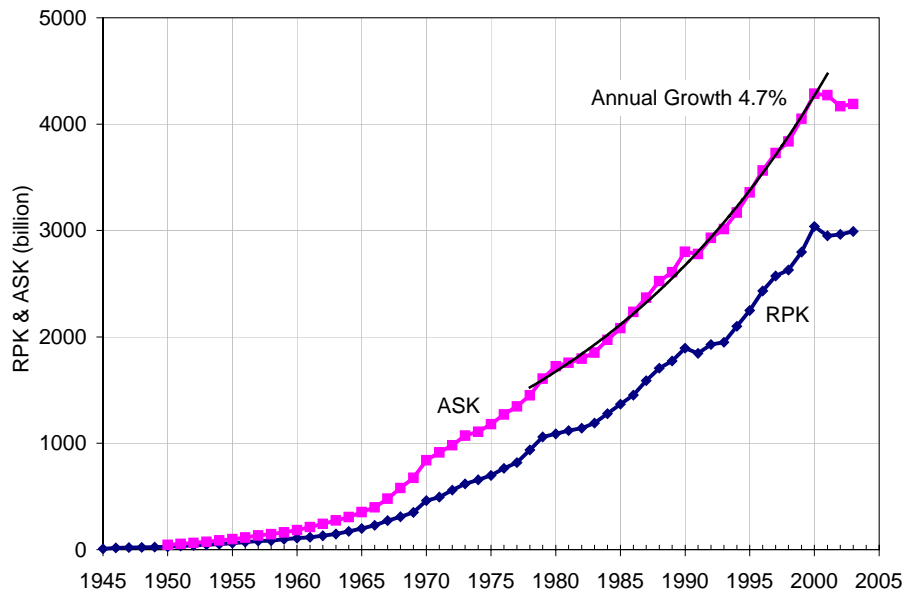

Figure 1-5 Annual Traffic and Capacity of the World Airlines [5]

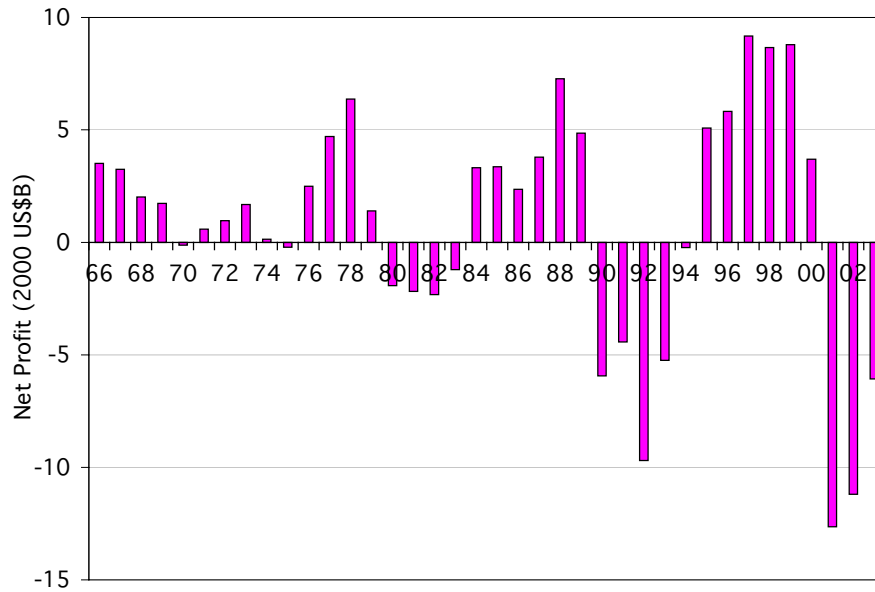

Figure 1-6 Annual Net Profits of the World Airlines [5]

1.3 Literature Review

Although the cyclical behavior in the airline industry has been widely noticed by industry professionals and external financial investors, limited research has been done in identifying the fundamental cycle period of the industry and its causes. According to Liehr et al., one widespread opinion among managers and in literature was that these cycles were the response to the fluctuations in macro economy, i.e., gross domestic product (GDP), and were beyond the industry’s control [6]. Liehr et al. observed the cyclical behavior of the U.S. airlines after deregulation and developed a system dynamics model with the aid of statistical tools to analyze the cycles, with an emphasis on an individual airlines’ perspective particularly airlines’ policies on ordering airplanes.

Other related research by Lyneis focused on the worldwide commercial jet aircraft and parts industry [7]. In the paper, the author discussed the cycles observed in aircraft orders, introduced a system dynamics model developed for a commercial jet aircraft manufacturer, and

demonstrated using the model to forecast worldwide orders of commercial jet aircraft. Little was discussed regarding the profit cycles in the airline industry and its driving factors.

1.4 Methodology

The oscillating profits after deregulation in Figure 1-3 resemble an undamped second-order system. It was assumed that such profit oscillation behavior of the U.S. airline industry could be modeled as a second-order system. A spectrum analysis was conducted in Chapter 2 to identify the fundamental cycle period, followed by detailed analysis on airline profits in Chapter 3 to assess the impact of the fundamental cycle period. The world airline was also studied using the same approach.

It is known that a system having phase lag will oscillate. Two potential sources of phase lag were found through extensive data examination: (1) lag between capacity and profits and (2) lag between costs and profits. The two potential lags were studied first as two separate hypotheses and later jointly.

Based on the hypothesis of phase lag between capacity and profits, a parametric model of a second-order system driven by capacity delay was developed and analyzed in Chapter 4 and 5, including root locus analysis for system stability and simulations of airline industries. Similarly, based on the hypothesis of phase lag between costs and profits, a parametric model of a second-order system driven by cost delay was developed and investigated in Chapter 6.

In Chapter 7, a coupled model was developed to assess the interactions of capacity and cost effects. A more sophisticated model was proposed in Chapter 8 for future research in an effort to better understand the dynamics of the airline industry. The model is based on previous results and includes load factor and short-term response effects.

CHAPTER 2

Methodology for Airline Net Profit Analysis

This chapter presents the analytical background for the airline net profit analysis and identifies the fundamental cycle periods of the U.S. and world airlines via spectrum analysis.

2.1 Assumption and Derivation of Airline Net Profit Model

The profit oscillations of the U.S. airlines after deregulation resembled an undamped second-order system (Figure 1-3). Therefore, a natural deduction was to model the profit cycles as a second-order system. The governing equation for such a system is

$$\ddot{x} + 2\xi\omega_n\dot{x} + \omega_n^2x = 0 \quad (1)$$

where $x(t)$ is the industry profit/loss, and ω_n is the natural frequency of the system.

The parameter ξ is defined as damping ratio. Depending on the value of ξ , the solution of above equation will have different forms and lead to different behaviors. The system can exhibit from exponential decay ($\xi \geq 1$), oscillation ($-1 < \xi < 1$), to exponential growth ($\xi \leq -1$); and in case of oscillation, the amplitude can be decreasing ($0 < \xi < 1$), constant ($\xi = 0$), or exponentially growing ($-1 < \xi < 0$) [8]. The profit oscillations of the U.S. airlines after deregulation shown in Figure 1-3 corresponded to the last case, an undamped system with $-1 < \xi \leq 0$. Such a system oscillates at the damped frequency $\omega_d = \omega_n\sqrt{1 - \xi^2}$.

The analytical solution of equation (1) for $-1 < \xi < 1$ has the general form

$$x(t) = A_0 e^{-\xi\omega_n t} \sin(\omega_d t + \phi) \quad (2)$$

where A_0 , ϕ are determined by initial conditions.

Defining

$$\omega_d = \frac{2\pi}{T}, \quad \tau = -\frac{1}{\xi\omega_n} \quad (3)$$

Above analytical solution can be rewritten as

$$x(t) = Ae^{(t-t_0)/\tau} \sin\left(\frac{2\pi(t-t_0)}{T}\right) \quad (4)$$

where τ is the e-folding time indicating how fast the amplitude grows, T is the fundamental cycle period of the system, t is the chronicle year, and t_0 is the time instant the system crosses zero.

Equation (4) specifies the general form of the airline net profit model to be analyzed in Chapter 3. The methodology of estimating the parameters in above equation is discussed below.

2.2 Identifying Fundamental Cycle Period of Airline Industry

Among the four parameters, A , T , τ , and t_0 in equation (4), the fundamental cycle period T is of most importance and needs to be identified first. The period T characterizes the overall system behavior.

Signal detection methods were used to identify the fundamental cycle period T . Viewing historical airline industry profit data as a set of noisy signals containing information about the system characteristics, a Discrete Fourier transform (DFT) was applied to the profit data to identify the fundamental frequency of the system.

Specifically, the N -point DFT was [9]

$$X[k] = \sum_{n=0}^{N-1} x(n)e^{-2\pi jkn/N} \quad 0 \leq k \leq N-1 \quad (5)$$

where $x(n)$ is the data sample of annual industry profits, and N is the total number of samples.

The relative magnitude of $X[k]$ in decibel was

$$|X[k]|_{\text{dB}} = 20 \log_{10} \frac{|X[k]|}{\max(|X[k]|)} \quad (6)$$

The frequency bin with respect to $X[k]$ was

$$f[k] = \frac{k}{N} F_s \quad 0 \leq k \leq N-1 \quad (7)$$

where F_s is the sampling frequency of input data; and $F_s = 1/\text{year}$ because the data samples were annual profits, or in other words, sampled once per year.

The frequency bin that has the largest magnitude corresponds to the most significant fundamental frequency in the system. Because of limited data samples, the input data series $x(n)$ was zero-padded to $N = 2^{17}$ in the DFT operation. Through zero padding, the frequency bin was narrowed and the resolution of DFT picture (Figure 2-1 and 2-2) was improved.

Annual profits of the U.S. airlines between 1980 and 2002 were analyzed by DFT to detect the fundamental frequency of the industry after deregulation. Shown in Figure 2-1, the fundamental frequency of the U.S. airlines was found to be 0.0938/year. Seen in the figure, the magnitude of the fundamental frequency is relatively 6dB higher than the second frequency; from equation (6), this means that the magnitude of the fundamental frequency is approximately twice of the second frequency. The corresponding fundamental cycle period is therefore 10.7 years, the reciprocal of the fundamental frequency.

Similarly, the world airline industry was modeled as an undamped second-order system as well and annual profits of the industry between 1978 and 2002 were used to identify its fundamental frequency. Shown in Figure 2-2, the fundamental frequency of the world airlines is 0.099/year and its magnitude is relatively 6dB higher than the second frequency. This fundamental frequency corresponds to a 10.1-year cycle.

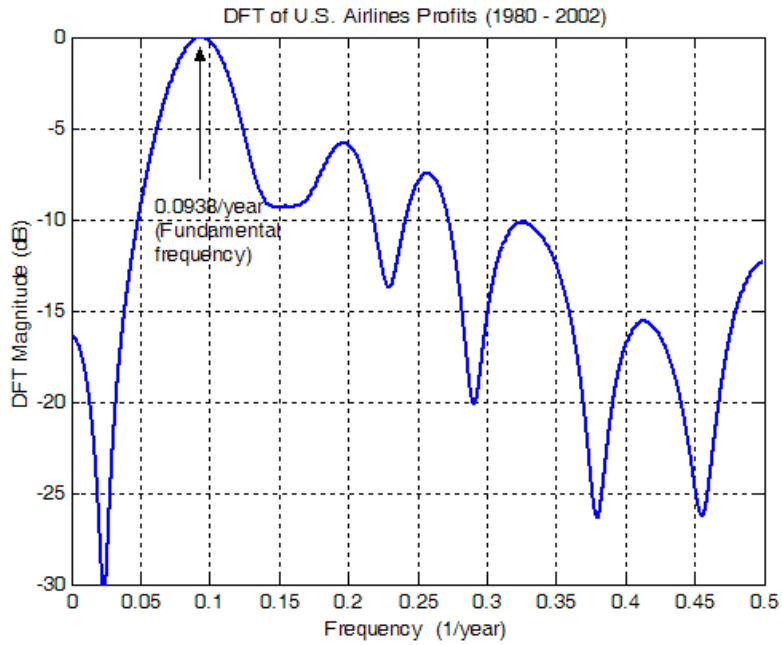

Figure 2-1 DFT Results of the U.S. Airlines Net Profits

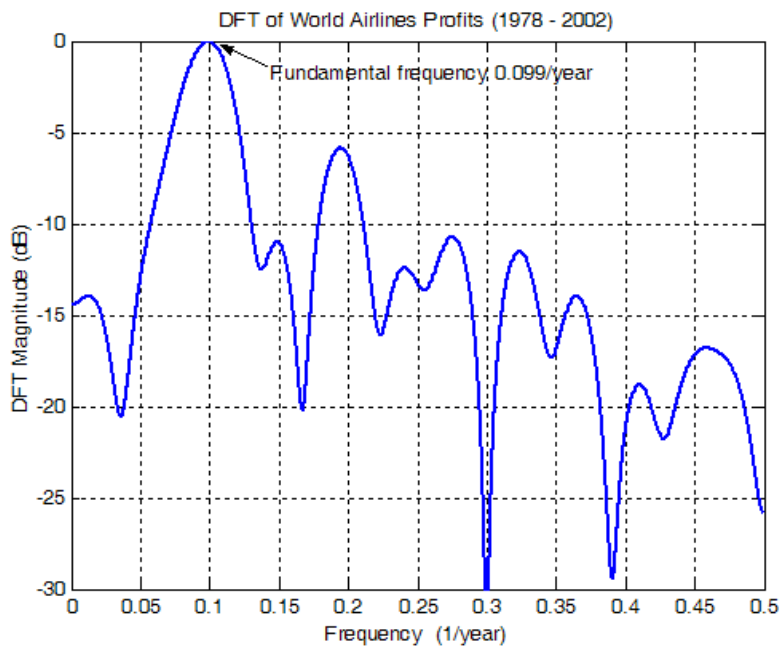

Figure 2-2 DFT Results of the World Airlines Net Profits

2.3 Model Estimation

Nonlinear least square regression was employed to estimate the net profit model specified in equation (4) from industry profit data. The objective function was [10]

$$\text{Minimize } \sum_{i=1}^N (x_i - \hat{x}_i)^2 \quad (8)$$

where x_i is the actual value of $x(t)$ for observation i and corresponds to the industry profit in year i , N is the number of actual observation years, and \hat{x}_i is the fitted or predicted value of x_i and corresponds to the value presented in equation (4) for year i .

The profit data were evaluated in constant 2000 dollars in regression and the best estimation was obtained through iterations. The fundamental cycle periods identified in section 2.2 were served as initial values of T in equation (4) for the U.S. and world airlines respectively to initiate the iteration and assure the solution convergence. The regression statistics of parameter estimates were computed using a program developed by Arthur Jutan [11].

CHAPTER 3

Results of Airline Net Profit Analysis

This chapter summarizes the results of the net profit analyses of the U.S. and world airlines using the methodology discussed in Chapter 2. The U.S. airline industry is analyzed under three scenarios: before deregulation, after deregulation, and after deregulation without impacts of the September 11 event. The assumptions and limitations of the net profit analysis are addressed following the analysis of the world airlines.

3.1 U.S. Airline Industry before Deregulation

To represent the fact that the industry was profitable most of the time before deregulation (Figure 1-3), the net profit model was modified below by adding an intercept to equation (4)

$$x(t) = Ae^{(t-t_0)/\tau} \sin\left(\frac{2\pi(t-t_0)}{T}\right) + C \quad (9)$$

Annual net profits of the U.S. airlines between 1960 and 1979 consolidated by ATA were used to estimate the parameters in above equation. The results are provided in Table 3-1 (first row) including corresponding regression statistics. The correlation coefficient is 0.59. The estimates of all parameters except τ are significant at 5% level of significance. The large τ value implies extremely slow growth in oscillation amplitude and suggests that the exponential term in equation (9) can be removed by letting $\tau = \infty$. The model was estimated again without the exponential term. The results are shown in bold in Table 3-1.

Seen from the table, there are little changes between the two sets of estimates; the maximum difference between the two sets of estimates is about 4% for parameter A . Therefore,

the exponential term in equation (9) can be ignored, and the ultimate net profit model for the U.S. airlines before deregulation is

$$x(t) = -1.06 \sin\left(\frac{2\pi(t - 1957.4)}{11.2}\right) + 0.904 \quad (10)$$

where $x(t)$ is in billions of constant 2000 dollars.

Table 3-1 Regression Results of Net Profit Analysis of the U.S. Airlines before Deregulation

Variable	A	T	t_0	τ	C
Estimate	-1.02	11.2	1957.4	282	0.899
	-1.06	11.2	1957.4	∞	0.904
Standard Error	0.519	0.865	1.05	3071	0.181
t statistics	-1.97	13.0	1857	0.092	4.95

Figure 3-1 shows the best-fit model results as well as industry profits between 1960 and 1990 for comparison.

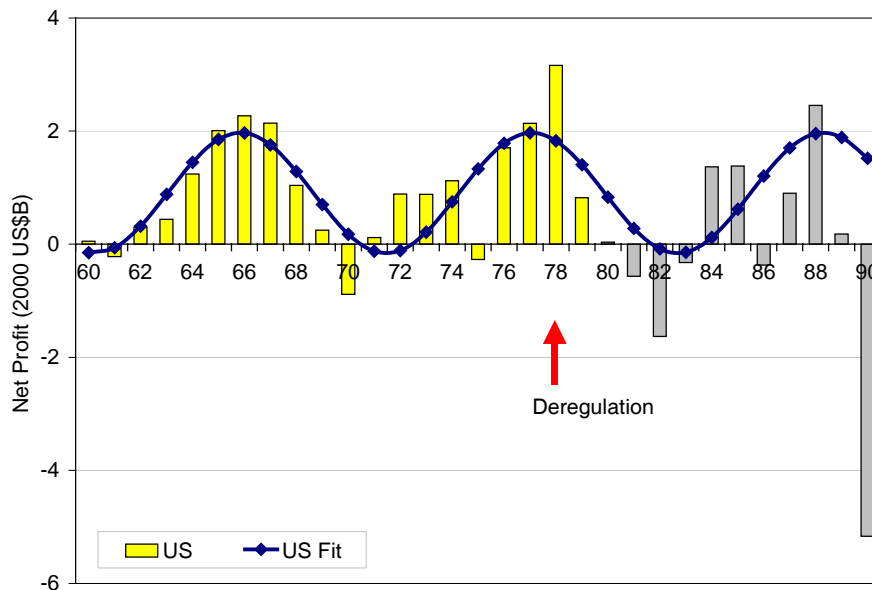

Figure 3-1 Net Profit Analysis Results of the U.S. Airlines before Deregulation

3.2 U.S. Airline Industry after Deregulation

ATA data of annual profits of the U.S. airlines between 1980 and 2002 were used to analyze the industry after deregulation. The estimated model is provided below and the correlation coefficient is 0.88. Seen from Table 3-2, the estimates of T , t_0 and τ are all significant at 5% level of significance except the estimate of A significant at 10% level.

$$x(t) = -0.550e^{(t-1977.4)/7.86} \sin\left(\frac{2\pi(t-1977.4)}{11.3}\right) \quad (11)$$

where $x(t)$ is in billions of constant 2000 dollars.

Figure 3-2 shows the best-fit model results as well as industry profits between 1978 and 2003 and the likely result of 2004 for comparison. Because the study was conducted before the end of 2004, the annual profit of 2004 was estimated by prorating the industry profit in the first half of 2004 using Form 41 data [12].

Table 3-2 Regression Results of Net Profit Analysis of the U.S. Airlines after Deregulation

Variable	A	T	t_0	τ
Estimate	-0.550	11.3	1977.4	7.86
Standard Error	0.287	0.504	0.940	1.43
t statistics	-1.92	22.47	2104	5.48

3.2.1 Impact of Deregulation on Profit Cyclicity

Deregulation in 1978 had a profound influence on the U.S. airline industry. Comparison of above two scenarios indicates that deregulation changed the e-folding time significantly. The pre-deregulation model in equation (10) implies an infinite e-folding time, while this parameter becomes finite in equation (11) for post-deregulation condition. As a result, dramatically different behavior was witnessed before and after deregulation. Figure 3-1 illustrates an

oscillation with constant amplitude while Figure 3-2 projects the industry profit to oscillate with increasing amplitude. Moreover, the order of oscillation amplitude in Figure 3-1 and 3-2 is different in order as well. The amplitude of profit oscillation before deregulation in Figure 3-1 is approximately 1 billion dollars, much lower than the amplitude after deregulation in Figure 3-2.

However, comparisons of the two models reveal that the fundamental cycle periods before and after deregulation were almost identical, approximately 11 years. Therefore, it is concluded that although deregulation influenced the oscillation amplitude, it did not change the fundamental profit cycle period of the U.S. airline industry.

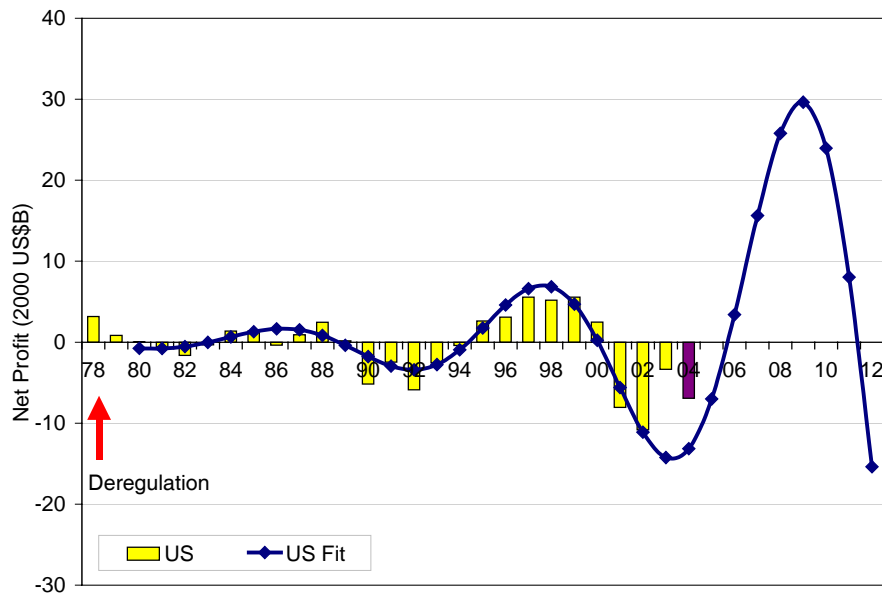

Figure 3-2 Net Profit Analysis Results of the U.S. Airlines after Deregulation

3.2.2 Impact of September 11 on Profit Cyclicity

The September 11 event had severely affected the air transportation system in the United States. To evaluate its impact on profit cyclicity, the net profit model was estimated again in equation (12) using the profit data between 1980 and 2000. The correlation coefficient is 0.83 and the regression results are provided in Table 3-3. The estimates of T , t_0 , and τ are all

significant at 5% level of significance except the estimate of A significant at 10% level. The best-fit model results are shown in Figure 3-3 in comparison with industry profits up to 2003 plus the likely result of 2004.

$$x(t) = -0.728e^{\frac{(t-1976.5)}{9.82}} \sin\left(\frac{2\pi(t-1976.5)}{12.0}\right) \quad (12)$$

where $x(t)$ is in billions of constant 2000 dollars.

Table 3-3 Regression Results of Net Profit Analysis of the U.S. Airlines after Deregulation with Data Only before 2001

Variable	A	T	t_0	τ
Estimate	-0.728	12.0	1976.5	9.82
Standard Error	0.398	0.584	0.962	2.80
t statistics	-1.83	20.6	2054	3.51

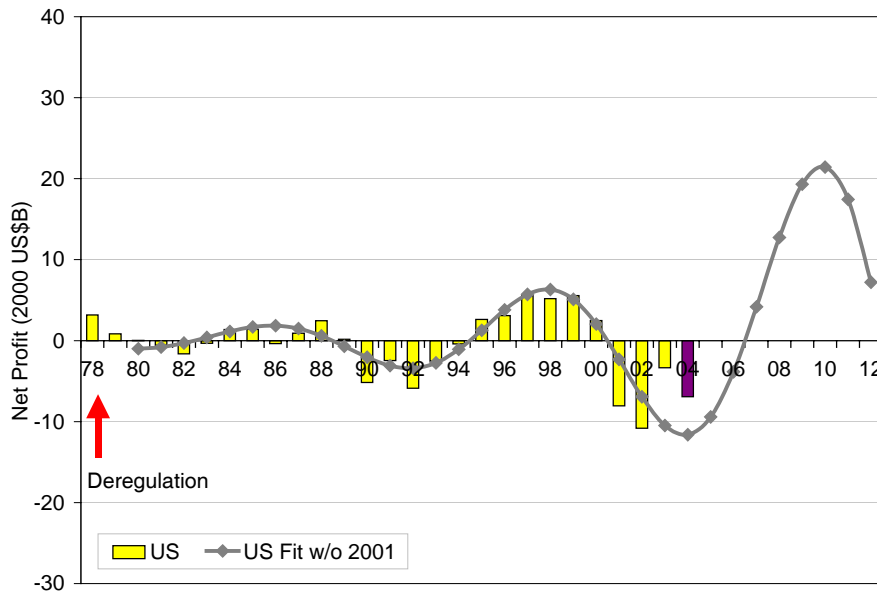

Figure 3-3 Net Profit Analysis Results of the U.S. Airlines after Deregulation with Data Only before 2001

It is interesting to note that the behavior is not highly dependent on the September 11 event. Comparison of amplitudes in Figure 3-2 and 3-3 indicate that the event exacerbated the profit

oscillation. However, close examination of Table 3-1 through 3-3 shows that the cycle period T of industry profits did not vary significantly.

3.3 World Airline Industry

Following the same methodology, the net profit model of the world airlines was estimated in equation (13). Profit data from ICAO between 1978 and 2002, evaluated in constant 2000 U.S. dollars, were used for analysis. The correlation coefficient is 0.84 and the estimates are significant at 5% level shown in Table 3-4. Figure 3-4 shows the best-fit model results in comparison with the world airlines profits between 1978 and 2003.

$$x(t) = -3.00e^{(t-1978.9)/14.9} \sin\left(\frac{2\pi(t-1978.9)}{10.5}\right) \quad (13)$$

where $x(t)$ is in billions of constant 2000 dollars.

Table 3-4 Regression Results of Net Profit Analysis of the World Airlines

Variable	A	T	t_0	τ
Estimate	-3.00	10.5	1978.9	14.9
Standard Error	1.02	0.328	0.548	4.11
t statistics	-2.95	32.1	3612	3.61

3.4 Assumptions and Limitations of Airline Net Profit Model

It is important to note that the net profit model is an extremely simple empirical model that does not address causality or constraints. It is clear that future industry growth will be limited at some point; probably by capital investment as the industry becomes less-appealing to investors due to losses in the down cycle, and/or by capacity and traffic demand as the system reaches the limit of the national aerospace system in the up cycle. Therefore, caution must be taken in applying the models to predict future system behavior and interpreting the projection results.

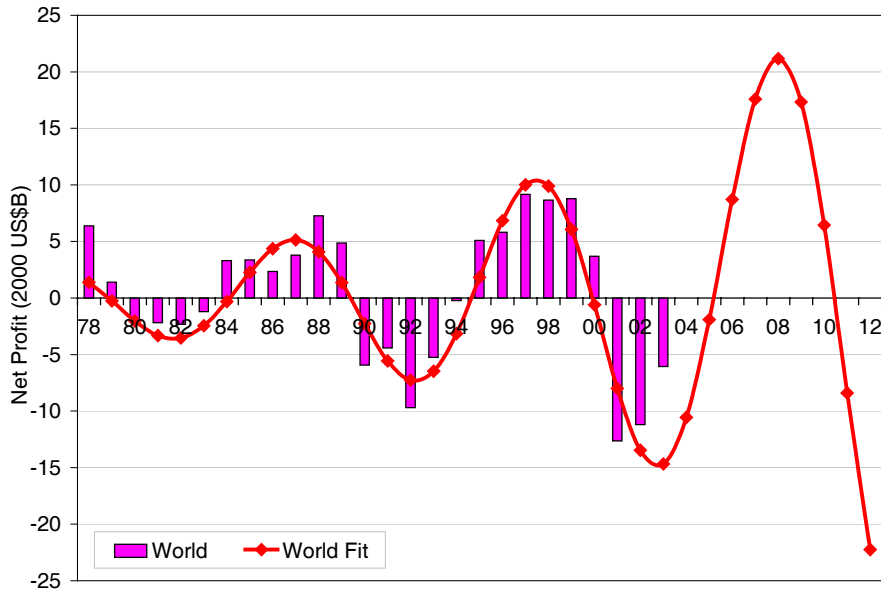

Figure 3-4 Net Profit Analysis Results of the World Airlines

3.5 Summary of Airline Net Profit Analysis

It was found that the fundamental cycle periods of the U.S. and world airlines were 11.2 and 10.5 years respectively. The net profit analysis of the U.S. airlines indicates that the fundamental cycle period of the industry is endogenous and it has existed in the system even before deregulation. Deregulation did not change the fundamental cycle period of industry profits but had a strong influence on the oscillation amplitude. The September 11 event exacerbated the industry financial status however it did not significantly change the cycle period either. The simple empirical net profit model did not address causality or constraints and is subject to constraints in the future. Nevertheless, the model offers insight on the profit cyclicity of airline industry.

CHAPTER 4

Parametric Model for Capacity

It is known that the presence of phase lag or delay in a control system tends to cause oscillations and make the system less stable. Two potential sources of phase lag were observed through extensive data examination: (1) lag between capacity response and profits, and (2) lag between cost adjustment and profits. This chapter analyzes the relationship between capacity and profits, and discusses a parametric model based on the capacity hypothesis. The cost hypothesis will be discussed in Chapter 6.

4.1 Data Analysis of World Commercial Jet Orders and Deliveries

The relationship between industry profits and world commercial jet orders and deliveries is illustrated in Figures 4-1 through 4-4. Figure 4-1 depicts the world commercial jet airplane orders and deliveries to scheduled passenger and cargo airlines operating worldwide as recorded by ICAO [5]; approximately a two-year time shift can be observed between aircraft orders and deliveries. Figure 4-2 shows the world aircraft orders and net profits, and Figure 4-3 describes the relationship between world aircraft deliveries and net profits [5]. Again, the profit data are recorded by ICAO and they reflect the activity of scheduled passenger and cargo airlines worldwide. An apparent time delay of approximately three years is observed in Figure 4-3 between aircraft delivery peaks and profit peaks.

The annual aircraft delivery data were further regressed with respect to annual profits and traffic (RPK) of several years ago to assess the average delay. The best correlation among these three variables was obtained when average 3-year delay was assumed. As shown below, the

delivery in year t has the best correlation with RPK and Profit three years ago, i.e., RPK and Profit in $t-3$ year. The equation is in standard econometric form, where the t -statistics of each estimate is presented in the parenthesis immediately below the estimate. The correlation coefficient is 0.90.

$$\begin{aligned}
 \text{Delivery}_t = & 87 + 0.29 \text{ RPK}_{t-3} + 0.027 \text{ Profit}_{t-3} & (14) \\
 (2.1) & (10.9) & (5.53)
 \end{aligned}$$

where RPK is in billions, $Profit$ in billions of dollars and $Delivery$ in aircraft units. All the estimates are significant at 5% level, according to the t -statistics in the parentheses. The regression results are shown in Figure 4-3 for comparison.

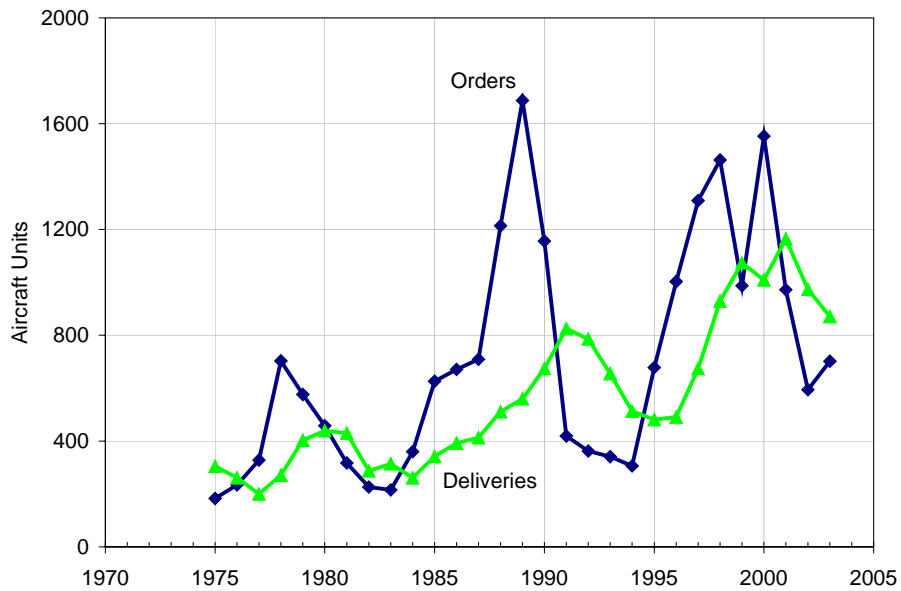

Figure 4-1 World Commercial Jet Aircraft Orders and Deliveries [5]

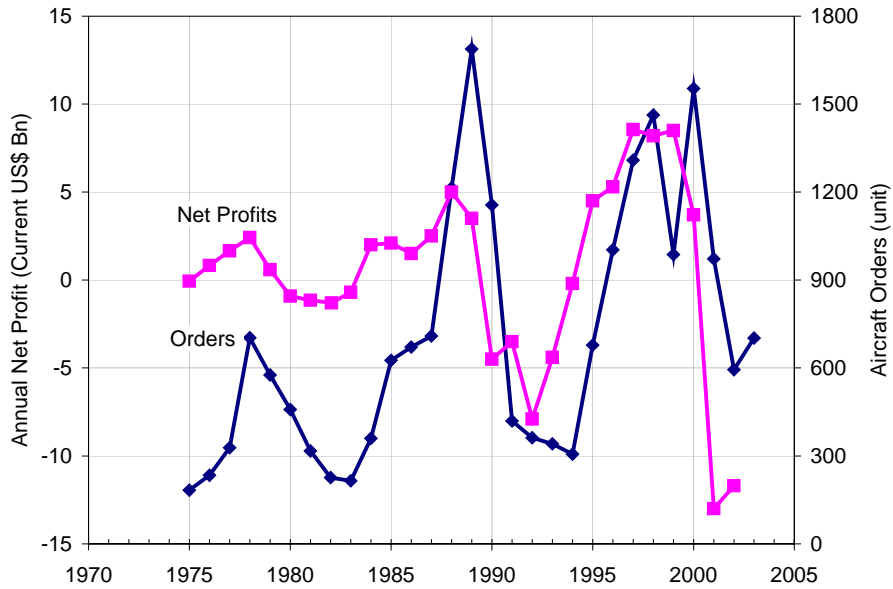

Figure 4-2 World Aircraft Orders and World Airlines Net Profits [5]

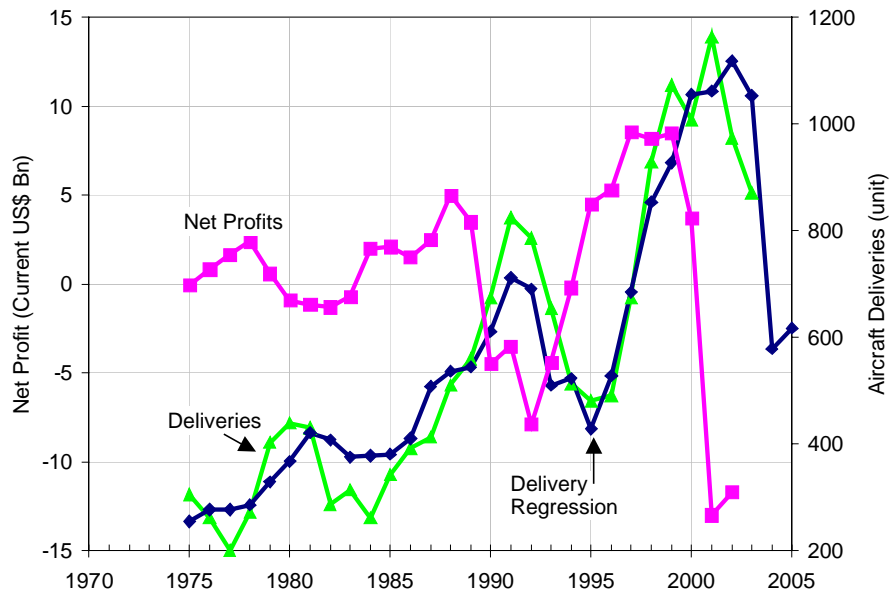

Figure 4-3 World Aircraft Deliveries and World Airlines Net Profits [5]

In addition to the delay observation, an asymmetric effect was found to exist between world aircraft orders and net profits. Shown in Figure 4-4, the world annual aircraft orders are plotted against the profits in the prior year. The figure shows that the aircraft orders either grow

with the profits when the industry is profitable or follow a flat trend otherwise. A first-order approximation of this asymmetric effect indicates that the slope of aircraft orders with respect to prior-year profits is on average about 147 aircraft orders per year for each billion dollars of profits, whereas the flat trend is about 350 aircraft orders per year regardless of the magnitude of losses.

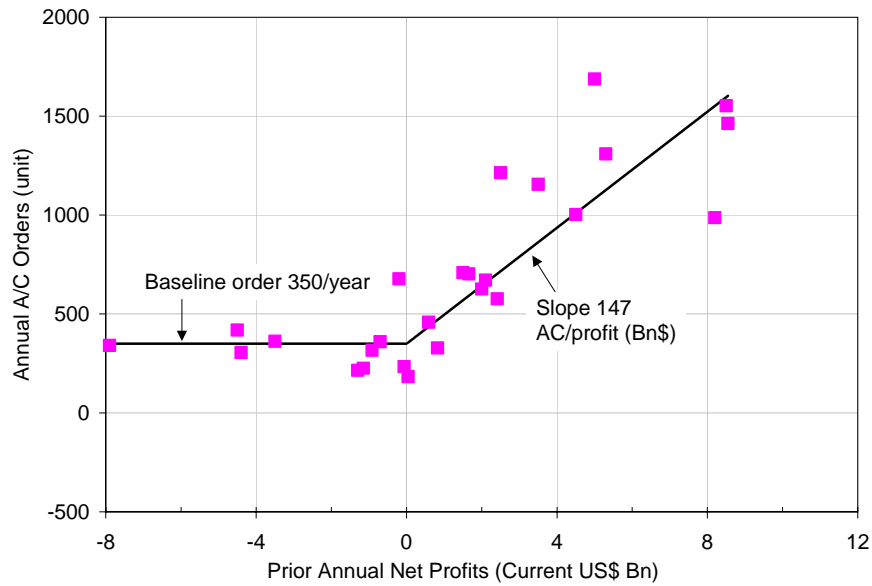

Figure 4-4 Asymmetric Effect between World Aircraft Orders and World Airlines Net Profits

4.2 Capacity Hypothesis

It is known that the presence of phase lag or delay in a control system tends to cause oscillations and make the system less stable. Figure 4-5 presents a generic control system with phase lag that is adopted from Palm's book [13]. The difference between the input and output is the error that needs to be corrected by the system; however, due to the presence of delay D , the correction will not act on the system (Plant $G(s)$) and update the output until D time later. Because of delay, the output of such generic system will oscillate around input and the correction item will oscillate around zero.

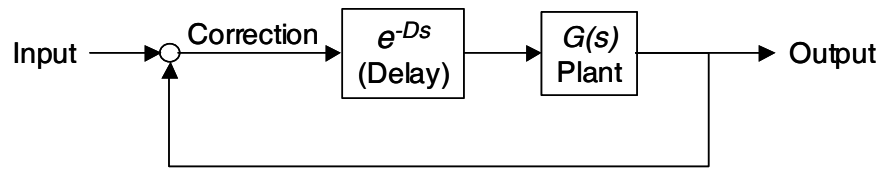

Figure 4-5 Block Diagram of a Generic Control System with Phase Lag
(adopted from Palm's book [13])

From above data analysis, approximately 3-year delay was observed between aircraft deliveries and industry profits. Applying above generic control model to airline industry and assuming capacity as the output, the capacity hypothesis was that the phase lag in capacity response caused system oscillation.

4.3 Parametric Model for Capacity

A parametric model was developed based on the capacity hypothesis and the block diagram is shown in Figure 4-6. Shown in the figure, the output is the capacity offered by the system that has units of available seat-miles (ASM). The input of the system is the demand, which also has units of available seat-miles in order to match the units of capacity. The difference between the demand and the capacity is capacity shortfall, which again has units of available seat-miles. Airlines order airplanes based on the capacity shortfall and their ordering strategies. The control gain K in the model represents the overall aggressiveness in the ordering process, and has units of ASM ordered per year per unit ASM shortfall. The delay D represents the lag between capacity shortfall and deliveries in the system and has units of years. Assuming airlines' pricing activity is based on capacity shortfall, capacity shortfall is correlated with profits through constant C , and the delay D also represents the lag between profits and deliveries. Because of

the delay, the new deliveries will not add into the total capacity until D years later. The closed-loop transfer function of the capacity parametric model is

$$H(s) = \frac{Ke^{-Ds}/s}{1 + Ke^{-Ds}/s} \quad (15)$$

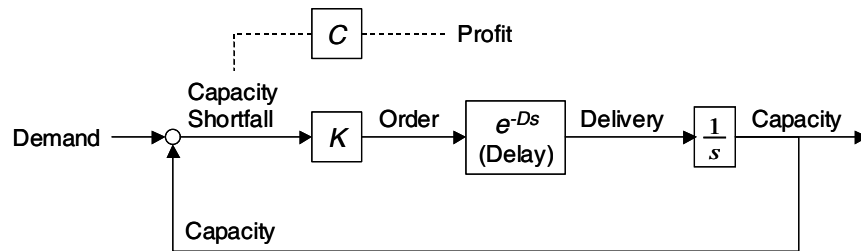

Figure 4-6 Block Diagram of Capacity Parametric Model

4.4 Root Locus Analysis of System Stability

Based on the closed-loop transfer function, a root-locus analysis was performed to analyze the stability of above parametric model and the main branch of root-locus is shown in Figure 4-7.

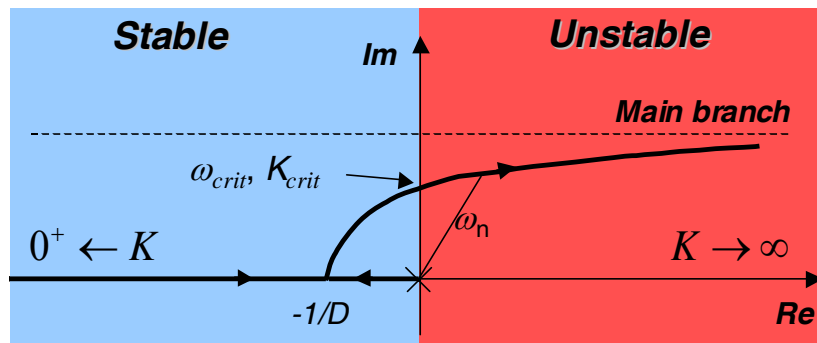

Figure 4-7 Root Locus of Capacity Parametric Model

The equation for root-locus analysis is

$$1 + \frac{Ke^{-Ds}}{s} = 0 \quad (16)$$

At the critical point where the root locus crosses over the imaginary axis

$$s = \omega j \quad (17)$$

Substituting s into equation (16), one obtains

$$\begin{cases} K \cos(\omega D) = 0 \\ \omega - K \sin(\omega D) = 0 \end{cases} \quad (18)$$

Solving for delay D and gain K ($K > 0$)

$$\begin{cases} \omega D = \frac{\pi}{2} + 2n\pi \quad n = 0, 1, 2, \dots \\ K = \frac{\omega}{\sin(\omega D)} = \omega \end{cases} \quad (19)$$

Therefore, at the critical point shown in Figure 4-7, the following relationship holds

$$\begin{cases} \omega_{crit} = \frac{2\pi}{T_{crit}} = \frac{\pi}{2D} \\ T_{crit} = 4D \\ K_{crit} = \omega_{crit} = \frac{\pi}{2D} \end{cases} \quad (20)$$

where ω_{crit} is the critical frequency at which the system oscillates with constant amplitude, T_{crit} is the oscillation cycle period, and K_{crit} is the critical gain corresponding to ω_{crit} .

The relationship between the system stability and the values of delay and gain implied by the root-locus analysis is better illustrated in Figure 4-8. The line in the figure indicates the boundary that maintains the system stable. Systems on the boundary will just oscillate with constant amplitude and have the relationship described in equation (20). Shown in Figure 4-7, the system will become unstable when its poles cross over the imaginary axis and enter into the right-hand side of s -plane, i.e., when $\omega > \omega_{crit}$ and/or $K > K_{crit}$. This corresponds to the area in Figure 4-8 that is above the stability boundary. Systems in this area will oscillate exponentially.

The area below the stability boundary represents the stable region and corresponds to the left-hand side of s -plane in Figure 4-7.

Therefore, the system stability is dependent on the delay and gain values and its location on the map shown in Figure 4-8. To understand the profit stability of airline industry, it is necessary to determine the parameters that represent the U.S. and world airlines and locate them on the map.

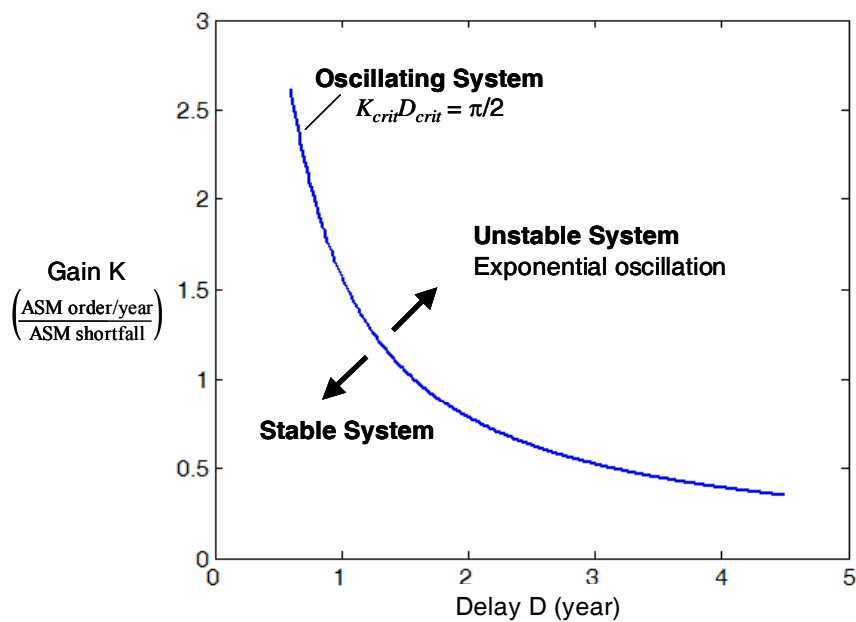

Figure 4-8 Relationship between System Stability and Delay/Gain Values

4.5 Determining Parameters in the Capacity Parametric Model

4.5.1 Assumptions

In order to use profit data to determine the delay and gain values which would correspond to the observed oscillations, it was necessary to assume some relationship between profit and capacity shortfall. A simple assumption was postulated that the aggregate industry profits are proportional to the capacity shortfall, as shown in Figure 4-6

$$\text{Profit} = C (\text{Demand} - \text{Capacity}) \quad (21)$$

Such assumption implies that profit has the same characteristic equation as capacity shortfall that is described in equation (16), and consequently has the same oscillation frequency and damping ratio as capacity shortfall. Therefore, it offers a way to determine the delay and gain values using the results of previous airline net profit analysis. Specifically, the fundamental cycle period T and e-folding time τ found in Chapter 3 for the U.S. and world airlines were used to compute the delay and gain values in the following.

4.5.2 Derivation

In general, the complex conjugate poles in the root-locus can be written in the form

$$s = -\xi\omega_n \pm \omega_d j \quad (22)$$

Substituting s into equation (16), one obtains

$$\begin{cases} -\xi\omega_n + Ke^{D\xi\omega_n} \cos(\omega_d D) = 0 \\ \omega_d - Ke^{D\xi\omega_n} \sin(\omega_d D) = 0 \end{cases} \quad (23)$$

Under above assumption, ω_d and $\xi\omega_n$ in equation (23) are determined from the e-folding time τ and the fundamental cycle period T according to the relationship defined in equation (3), that is, $\omega_d = 2\pi/T$ and $\tau = -1/\xi\omega_n$.

Solving for D and K for the main branch,

$$\begin{cases} \tan(\omega_d D) = \tan(2\pi D/T) = \frac{\omega_d}{\xi\omega_n} = -\frac{2\pi\tau}{T} \\ K = \frac{\omega_d}{e^{D\xi\omega_n} \sin(\omega_d D)} = \frac{2\pi}{Te^{-D/\tau} \sin(2\pi D/T)} \end{cases} \quad (24)$$

4.5.3 Parameters for the Airline Industry

Using equation (24), the delay and gain values for the U.S. and world airlines were computed from the e-folding time τ and fundamental cycle period T that were estimated in Chapter 3 (Table 3-1, 3-2 and 3-4). The results are summarized in Table 4-1, including the critical gain that is calculated with respect to delay according to equation (20).

Seen from the table, the computed delay for the world airlines is 2.8 years. This is consistent with the observed average 3-year delay between the world airlines profits and aircraft deliveries found in section 4.1. This consistency indicates that capacity could influence profits. The gain for the world airlines is 0.73 annual ASM ordered per ASM shortfall, that is, 73% of capacity shortfall is fulfilled annually. The gain is about 30% larger than the critical value, indicating an unstable system.

Table 4-1 Delay and Gain Estimates of the U.S. and World Airlines under Capacity Hypothesis

Airline Industry	T	τ	D	K	K_{crit}
	Year			$\left(\frac{\text{ASM order/year}}{\text{ASM shortfall}}\right)$	
World	10.5	14.9	2.8	0.73	0.56
U.S. before Deregulation	11.2	∞	2.8	0.56	0.56
U.S. after Deregulation	11.3	7.86	3.2	0.86	0.49

Similarly, the computed delays for the U.S. airlines before and after deregulation are consistent or close to the observed average 3-year delay for world aircraft deliveries. However, the gain for the U.S. airlines after deregulation is approximate twice of the critical gain, indicating an even-more unstable system. In contrast, the computed gain for the U.S. airlines before deregulation is equal to the critical value, representing a system that oscillates with constant amplitude.

The delay and gain values determined in Table 4-1 are plotted in Figure 4-9 to illustrate the profit stability of the U.S. and world airlines. Seen in the figure, the U.S. airlines before deregulation is located right on the stability boundary, while the U.S. airlines after deregulation and the world airlines all fall in the unstable region. Moreover, the U.S. airline industry after deregulation is positioned further from the stability boundary than the world airlines, indicating it's more unstable than the latter.

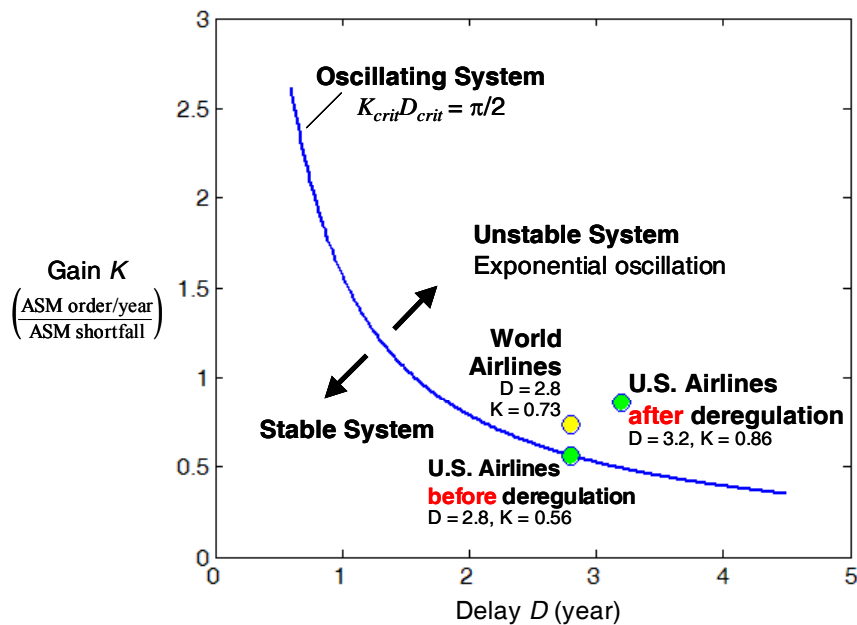

Figure 4-9 System Stability and Delay/Gain Values of the U.S. and World Airlines in Capacity Parametric Model

4.6 Factors Contributing to Delay and Gain Values

Some factors in airline operations have been identified to contribute to the delay and gain values in the capacity parametric model. These factors will be further elaborated in Chapter 8 when a more sophisticated model is proposed.

The delay in the airline industry primarily consists of the decision time in placing orders, order processing time and manufacturing lead-time.

Seen in Figure 4-9, the gains representing the world airlines and the U.S. airlines after deregulation are higher than their corresponding critical values for profit stability. Factors contributing to the high gains may include:

- Optimism in total capacity projection that amplifies the capacity shortfall;
- Collective market share perspective is greater than 100%. The collective market share perspective represents the aggregate effect of individual airlines' projections in market share. For individual airlines, the management usually makes fleet plans based on market share and traffic projections. It is rare for a management to make downward projections of its market share in certain O-D markets and/or across the entire route network of the company. Consequently, the collective market share perspective in each competing O-D market and in total capacity could easily exceed 100%, resulting in significant industry-level over-capacity.
- Aggressiveness when the manufacturers pursue orders. This can happen when a manufacturer offers special deals to particular airlines or markets for the sake of market penetration and/or the market share of the aircraft manufacturer.
- Exogenous factors. Because of the simplicity of the capacity model, the gain has lumped impacts of exogenous factors, such as, the positive impact of high GDP growth on traffic demand and the negative impact of economic recession and war on demand, as well as the influence of fuel price fluctuations on profits.

CHAPTER 5

Simulations of Capacity Parametric Model

The analytical results regarding the delay and gain values determined in Chapter 4 were put into the capacity parametric model for simulation. This chapter summarizes the simulation results with respect to the U.S. and world airlines. The assumption of the dependence of industry profits on capacity shortfall is revisited, and potential approaches to mitigate capacity oscillations are explored.

5.1 Capacity Simulations of the U.S. Airlines

The capacity of the U.S. airlines was simulated by running the capacity parametric model (Figure 4-6) with delay and gain values from the U.S. post-deregulation condition (Table 4-1). The input demand was assumed to grow at 4% per year, based on the average growth rate of the U.S. airlines since deregulation as shown in Figure 1-1. The model was initiated with the industry status in 1980 in terms of profit and associated capacity shortfall, at which time the industry profit was near zero, implying a certain equilibrium achieved between demand and supply.

Figure 5-1 shows the simulation results of demand and capacity in comparison with ATA capacity data. Figure 5-2 shows the results of capacity shortfall plus industry net profits to illustrate the relationship between capacity shortfall and profits. Seen from Figure 5-2, based on the simple capacity model, the industry was approximately 550 billion ASM under-capacity in 1998 while approximately 1000 billion ASM over-capacity in 2003; the capacity shortfall has grown through the cycles. The exponentially oscillating behavior in capacity shortfall is

generally consistent with industry profits. However, the capacity simulation in Figure 5-1 over-predicts the observed variation in capacity data. This indicates that capacity shortfall alone is not sufficient to explain industry profit oscillations.

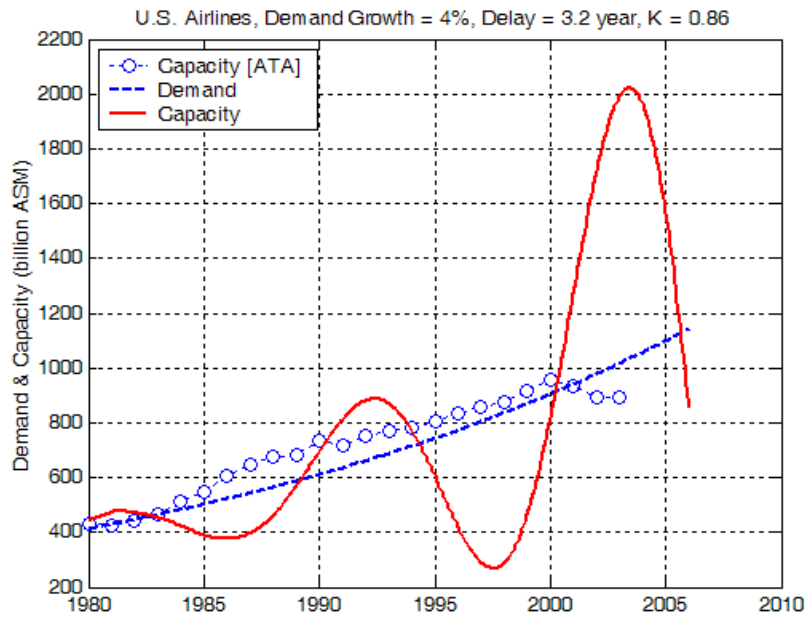

Figure 5-1 Simulation of Demand and Capacity of the U.S. Airlines

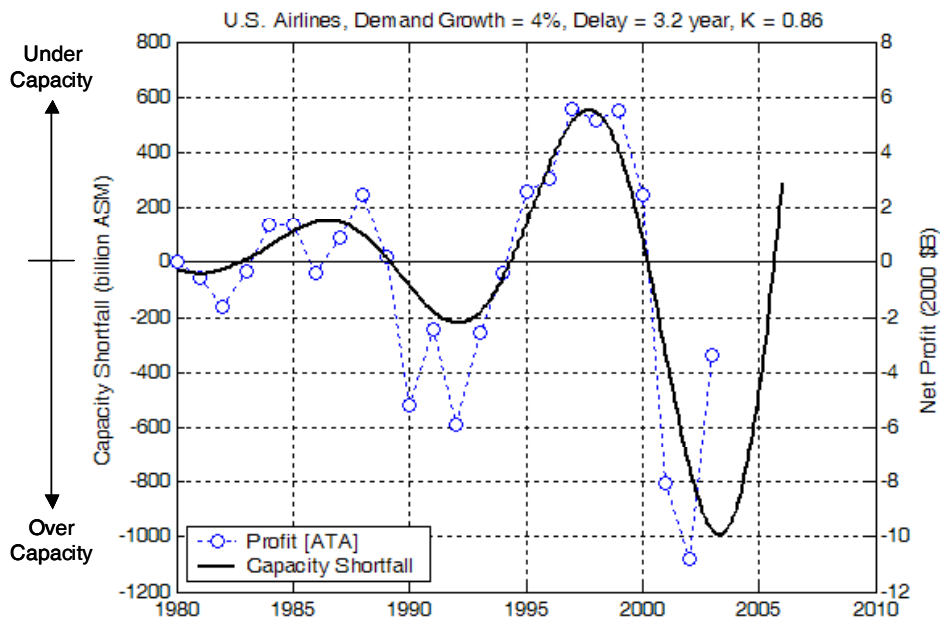

Figure 5-2 Simulation of Capacity Shortfall of the U.S. Airlines and Net Profit Data

5.2 Revisiting the Assumption – Cost of Adding Capacity

Aggregate industry profits were assumed dependent on capacity shortfall as $Profit = C(Demand - Capacity)$ (equation (21) in Chapter 4, repeated here for convenience) in order to determine the delay and gain values in the capacity model. If the behavior were solely due to capacity shortfall, constant C in above equation would have the implication of cost or incentive for adding or removing additional capacity. Based on the model results in Figure 5-2, constant C was estimated by regressing the profit data with respect to capacity shortfall via least-square. The value of constant C was found to be approximate 1 cent (2000\$) per ASM in capacity shortfall, implying that the cost or incentive for adding or removing one available seat-mile to fulfill the capacity shortfall will lead to approximately one cent (2000\$) in profit or loss. Such estimation is preliminary given the simplicity of the model; however, it illustrates the potential interaction between capacity and profit.

5.3 Capacity Simulations of the World Airlines

The capacity of the world airlines was also simulated by similarly setting the delay and gain in the model to the values for the world airlines provided in Table 4-1. The demand growth rate was set to 4.7%, the average worldwide growth rate (Figure 1-5). The model was initiated with the industry status in 1980 in terms of profit and associated capacity shortfall.

Simulation results of demand and capacity of the world airlines are shown in Figure 5-3 in comparison with ICAO capacity data. The model also simulates the aircraft orders in terms of ASM, as shown in the block diagram (Figure 4-6). In order to compare the results with actual order data, the simulated aircraft orders in ASM were converted to aircraft unit orders by dividing the average aircraft utility. The average aircraft utility of the U.S. airlines, that was 190

million ASM per aircraft per year as discussed in Appendix A, was used in the conversion. The converted order simulations are shown in Figure 5-4, in comparison with the world aircraft order data from ICAO and the baseline order that was 350 aircraft per year as shown in Figure 4-4.

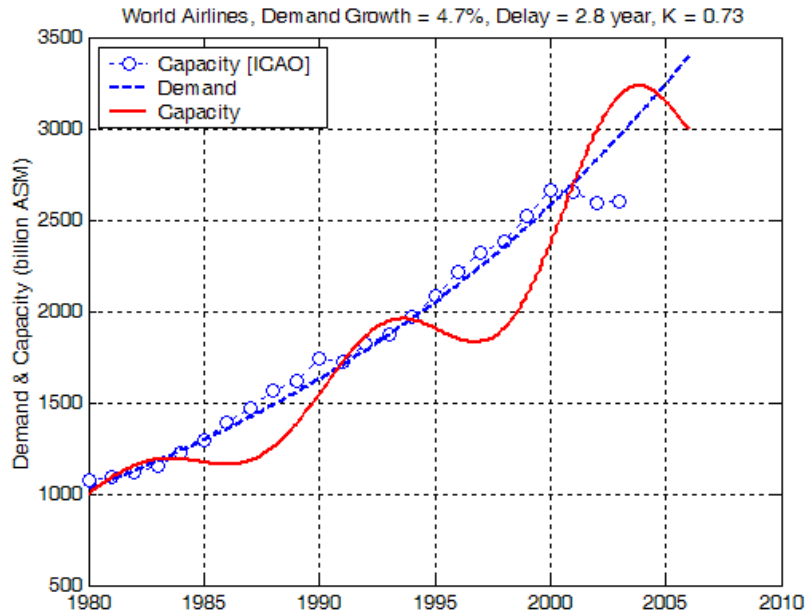

Figure 5-3 Simulation of Demand and Capacity of the World Airlines

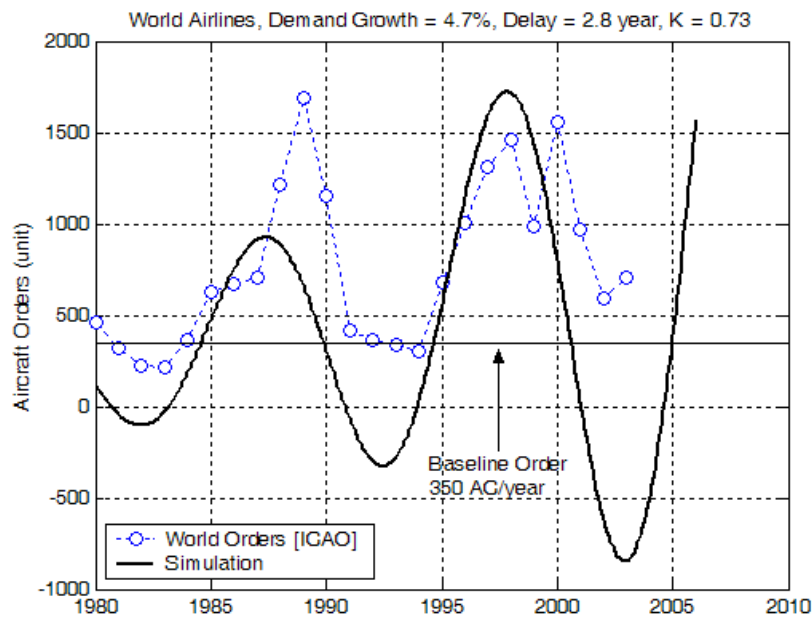

Figure 5-4 Converted Order Simulation Results of the World Airlines

Again, the capacity simulation in Figure 5-3 over-predicts the observed variation in capacity data. Seen from Figure 5-4, the simulation of orders is generally consistent with world aircraft orders. There is a positive offset that the model does not represent and it is consistent with the asymmetric effect between profitability and aircraft orders shown in Figure 4-4. This nonlinear asymmetric effect was not included in the capacity model for simplicity reason. Such effect should not be ignored and is included in a more sophisticated model proposed in Chapter 8 in order to better model the dynamics of airline industry.

Therefore, given the simplicity of the model, it is concluded that the capacity model captures some system behavior. The capacity hypothesis appears valid and capacity response appears to be one potential driving factor of the system behavior. However, simulations indicate that capacity shortfall alone is not sufficient to explain the industry dynamics. There is a need to look at other factors such as cost effects, as to be discussed in Chapter 6.

5.4 Mitigating System Oscillations

Assuming the system stability can be modeled by the simple capacity model, the capacity parametric model was used to explore potential ways to mitigate instability. The stability relationship shown in Figure 4-8 suggests that the system could be stabilized by reducing its delay and gain below the stability boundary.

As an illustration, simulations were performed with different delays while holding the gains unchanged. Figure 5-5 depicts the simulation results with respect to the U.S. airlines for different delay values. Given the condition that the gain is held unchanged, the capacity of the U.S. airlines would become stabilized if the delay were reduced from 3.2 years to 1.8 years.

Similarly, the world capacity would stabilize if the delay were reduced from 2.8 year to 2.2 years, shown in Figure 5-6.

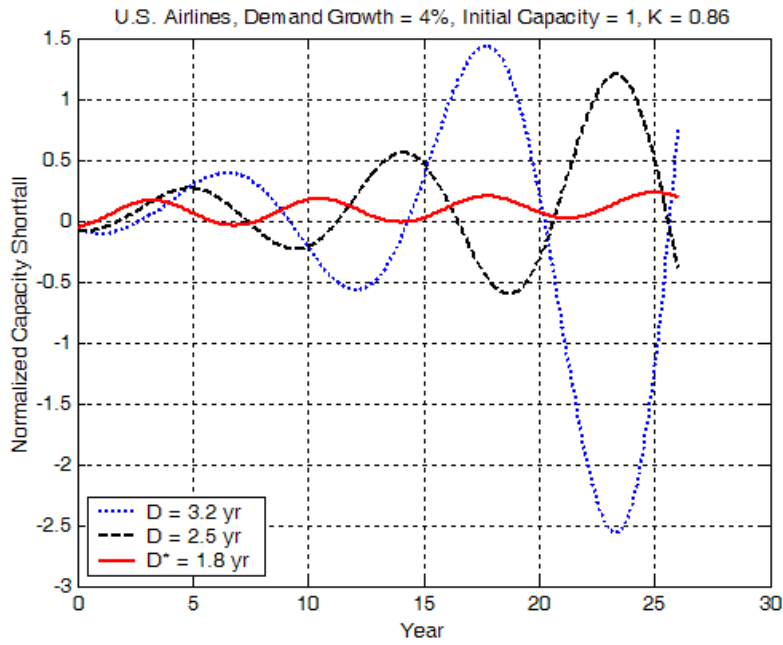

Figure 5-5 Mitigating Capacity Oscillations of the U.S. Airlines

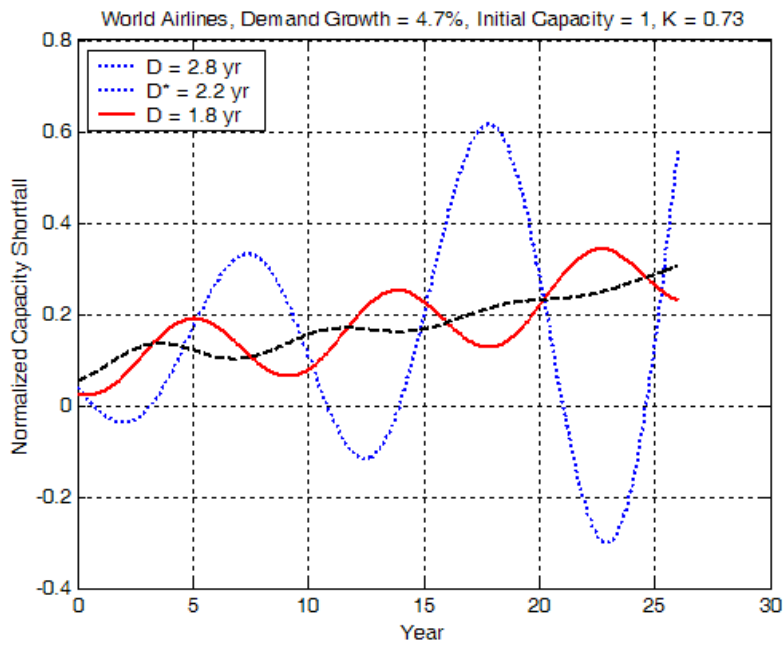

Figure 5-6 Mitigating Capacity Oscillations of the World Airlines

5.5 Summary of Capacity Parametric Model

By hypothesizing the lag in capacity response caused system oscillation, the model identified capacity response as one potential driving factor of the system behavior. For this model, the system stability depends on the delay between aircraft orders and deliveries and the aggressiveness in airplane ordering. Assuming industry profits correlated to capacity shortfall, the delay and gain were calculated and the results were consistent with the observed delay between world aircraft deliveries and net profits. Since the gain in the model has lumped impacts of exogenous factors, exaggerated capacity response was observed in simulation. This indicates capacity shortfall alone cannot fully explain the industry dynamics and there is a need to look at other factors such as cost effects. The model also indicates reduced delay may help to mitigate system oscillations.

CHAPTER 6

Parametric Model for Cost

This chapter develops a parametric model based on the cost hypothesis and summarizes corresponding analytical and simulation results.

6.1 Cost Hypothesis

Figure 6-1 depicts RASM and CASM of the U.S. major and national passenger carriers recorded by DOT and ATA [12, 14]. RASM is the passenger revenue per ASM of the major and national passenger carriers recorded by DOT [12]. CASM, defined as the operating expense per ASM that has been adjusted with respect to passenger services in this study, is based on ATA Airline Cost Index [14]. The methodology of cost adjustment is provided in Appendix B in which the cost structure of the U.S. major and national passenger carriers is analyzed. Both RASM and CASM are evaluated in constant 2000 dollars. According to the DOT classification, majors are the carriers whose annual operating revenues are more than 1 billion dollars; and the nationals are those with revenues between 100 million and 1 billion dollars.

Seen from Figure 6-1, RASM and CASM have both decreased and fluctuated since deregulation. RASM has decreased on average 1.7% per year between 1980 and 2000, while CASM has decreased at 2% annually. The fluctuation in RASM was followed by the fluctuation in CASM with about one year delay. RASM dropped significantly by about 1.3 cent or 14% in 2001 because of the industry crisis in 2001. Correspondingly, CASM dropped by 1 cent or 10% in 2003 from 2001 level.

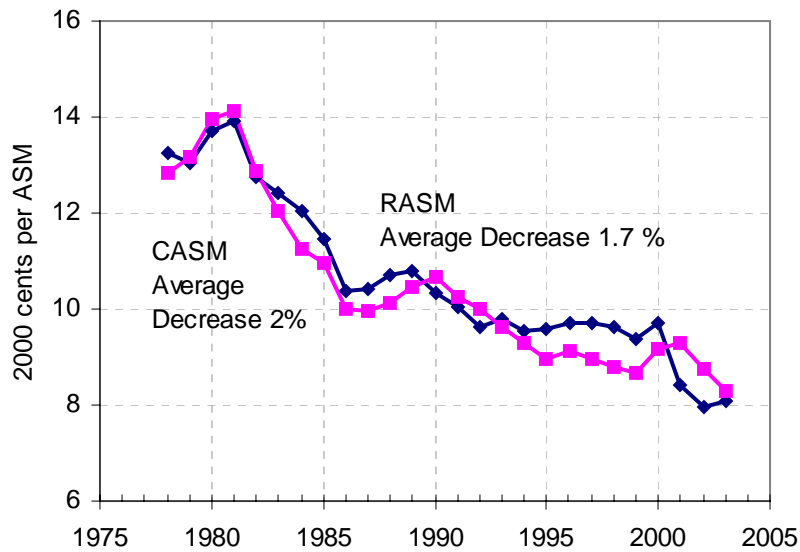

Figure 6-1 RASM and CASM of the U.S. Major and National Passenger Carriers [12, 14]

Figure 6-2 shows the unit operating expenses and unit net profits of all U.S. airlines after deregulation that were based on ATA data [2, 4]. Comparing to Figure 6-1, an apparent delay of approximately three years is observed between the peaks of unit operating expenses and the peaks of unit net profits as well as between the troughs of these two variables.

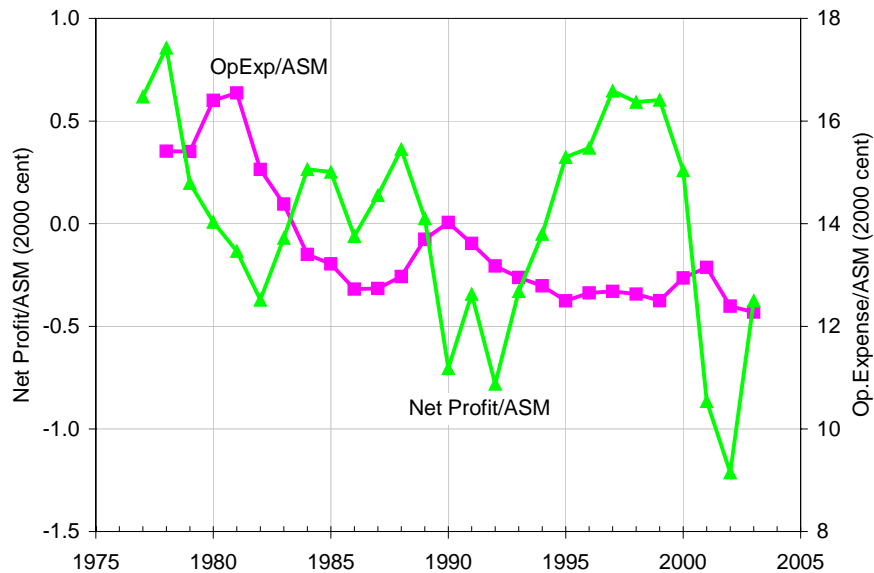

Figure 6-2 Unit Operating Expenses and Unit Net Profits of the U.S. Airlines

It is known that a system having phase lag will oscillate. Applying the generic control model with phase lag shown in Figure 4-5 to airline industry again, the cost hypothesis was that the phase lag between cost adjustment and profits caused system oscillation.

6.2 Parametric Model for Cost

A parametric model was developed based on the cost delay hypothesis and the block diagram is shown in Figure 6-3. As concluded in Appendix B, CASM is split into two components: CASM1 and CASM2; where CASM2 represents the profit-sensitive component of CASM, and CASM1 is less sensitive to profits. The system has two inputs: RASM and CASM1; both having long-term decreasing trends shown in Figure 6-1. The difference between RASM and CASM gives the output – profit per ASM (PASM). Based on PASM, cost adjustment is made due to labor contract negotiation, the competition need, etc. However, due to the presence of delays in the system such as contract negotiation time, such cost adjustment will not take effect immediately but D years later. The control gain K in the model represents the effect of PASM on cost adjustment and has the units of cent/ASM cost adjustment per year per unit cent/ASM profit. The closed-loop transfer function with respect to RASM is

$$H(s) = \frac{1}{1 + Ke^{-Ds}} \cdot \frac{1}{s} \quad (25)$$

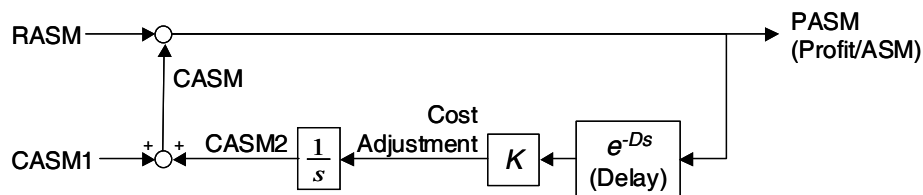

Figure 6-3 Block Diagram of Cost Parametric Model

Following the approach developed in Chapters 2 through 4, the parameters in the cost parametric model were determined below.

6.3 Unit Net Profit Analysis

As discussed in Chapter 1, the unit net profits of the U.S. airlines after deregulation shown in Figure 1-4 resembled an undamped second-order system. Therefore, the oscillation of unit net profits was again modeled as a second-order system, and an analysis on unit net profits was conducted. Equation (4), also provide below for convenience, specified the unit net profit model to be analyzed.

$$x(t) = Ae^{-(t-t_0)/\tau} \sin\left(\frac{2\pi(t-t_0)}{T}\right) \quad (26)$$

where $x(t)$ is the unit net profit or loss, τ is the e-folding time, T is the fundamental cycle period of the system, t is the chronicle year, and t_0 is the time instant the system crosses zero.

Following the procedure introduced in Chapters 2 and 3, the model in equation (26) was estimated via nonlinear least square regression and the best estimation was obtained through iterations. Unit net profits of the U.S. airlines between 1980 and 2002 were used to identify the fundamental cycle period and the finding was used as the initial value of T to assure the iteration convergence. Unit net profits were regressed to estimate the unit net profit model for the U.S. airlines after deregulation

$$x(t) = -0.110e^{-(t-1977.6)/9.78} \sin\left(\frac{2\pi(t-1977.6)}{11.2}\right) \quad (27)$$

where $x(t)$ is in cent/ASM (2000\$). The correlation coefficient is 0.85. Figure 6-4 shows the best-fit model results as well as industry unit net profits up to 2003 for comparison.

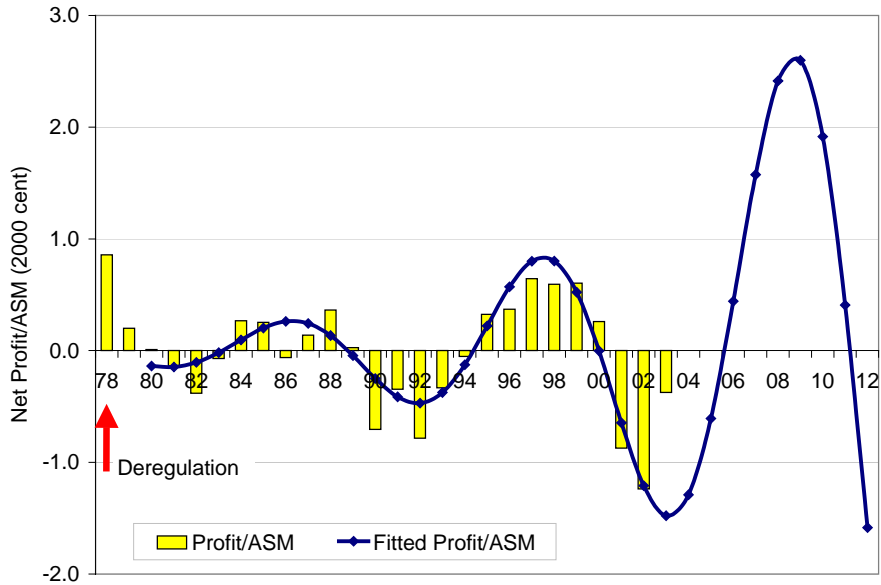

Figure 6-4 Unit Net Profit Analysis Results of the U.S. Airlines

6.4 Determining Parameters in the Cost Parametric Model

Based on the transfer function in equation (25), the equation for root-locus analysis is

$$1 + \frac{Ke^{-Ds}}{s} = 0 \tag{28}$$

The above equation is the same as the root-locus equation (16) for the capacity parametric model in section 4.4. Therefore, the derivation developed in sections 4.4 and 4.5 are applicable to the cost parametric model. Specifically, equation (24) was used again to calculate the delay and gain values in the cost parametric model. The results are summarized in Table 6-1 and plotted in Figure 6-5 to locate the system. Figure 6-5 shows that the U.S. airline industry post-deregulation again falls in the unstable region.

Table 6-1 Delay and Gain Estimates of the U.S. Airlines under Cost Hypothesis

Airline Industry	T	τ	D	K	K_{crit}
	Year			$\left(\frac{\text{Cent/ASM cost/year}}{\text{Cent/ASM profit}} \right)$	
U.S. after Deregulation	11.2	9.78	3.1	0.78	0.50

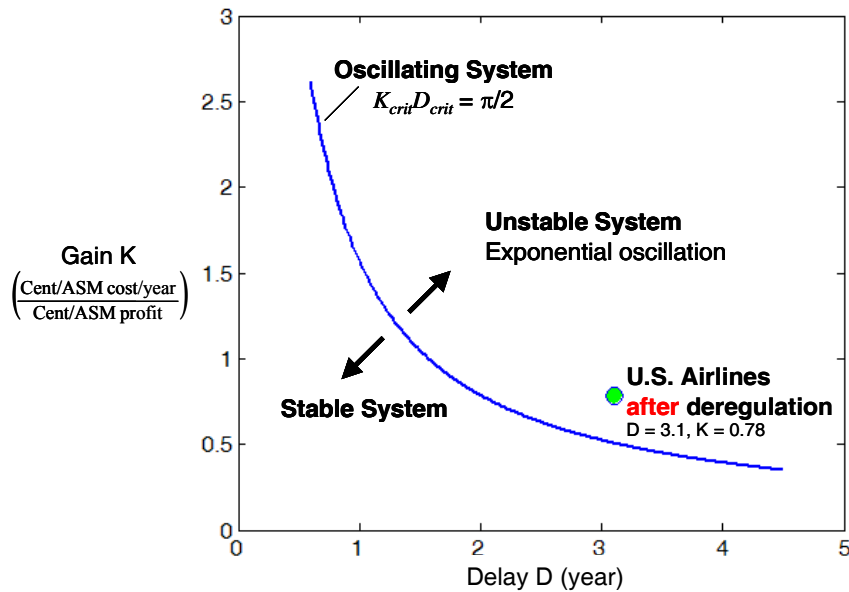

Figure 6-5 System Stability and Delay/Gain Values of the U.S. Airlines in Cost Parametric Model

6.5 Simulation Results

Simulations of the cost parametric model were carried out by running the model with the delay and gain values determined above.

For a first simulation, the inputs RASM and CASM1 were assumed to decrease at 1.7% and 2% per year respectively, based on the average RASM and CASM trends shown in Figure 6-1. The model was initiated with the industry RASM and CASM status in 1980. According to the analysis results in Appendix B, approximately 4% of CASM was used as the initial value of CASM2 and the remaining 96% as the initial value of CASM1. The model was then calibrated to best-fit unit net profits of the U.S. airlines between 1980 and 2000, and the calibrated distribution of CASM is 7% for the initial value of CASM2 and 93% for that of CASM1.

Calibration results of RASM and CASM are shown in Figure 6-6, in comparison with RASM and CASM data of the U.S. airlines by ATA. Figure 6-7 shows the calibration results of

PASM, in comparison with unit net profit data by ATA. Seen from Figure 6-7, the exponentially oscillating behavior in PASM is consistent with industry unit net profits.

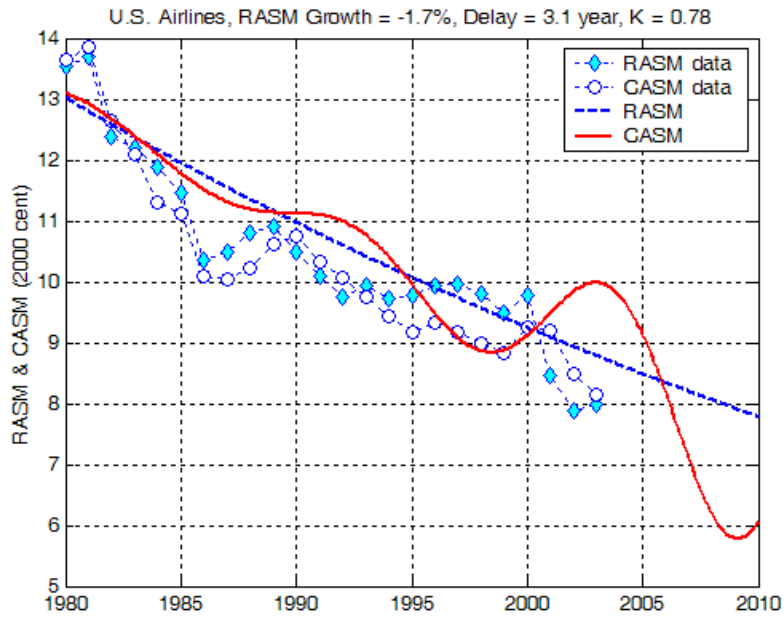

Figure 6-6 Cost/ASM Simulation of the U.S. Airlines

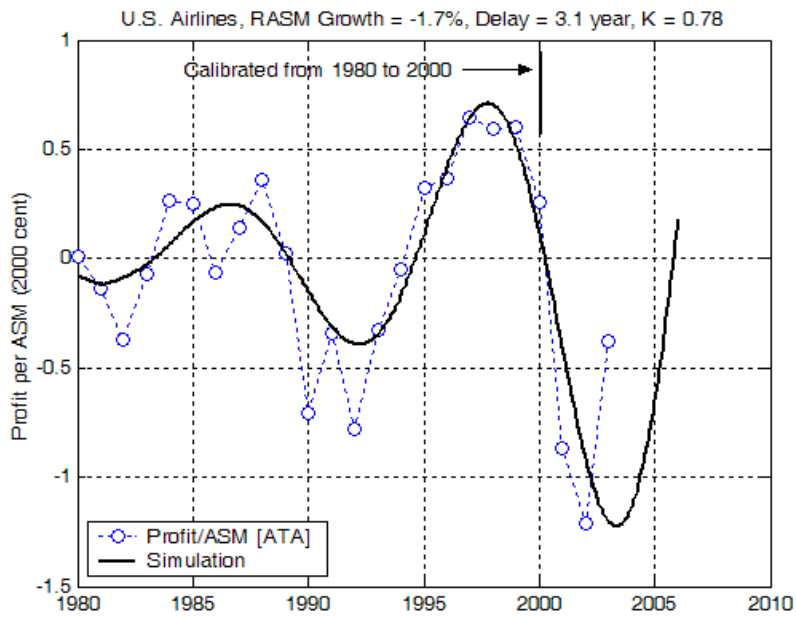

Figure 6-7 Profit/ASM Simulation of the U.S. Airlines

Figure 6-8 and 6-9 summarize another simulation, in which, RASM was further subject to a 14% step decrease in 2001 to simulate the industry crisis in 2001 (section 6.1). Seen from Figure 6-9, the exponentially oscillating behavior in PASM is consistent with industry unit net profits.

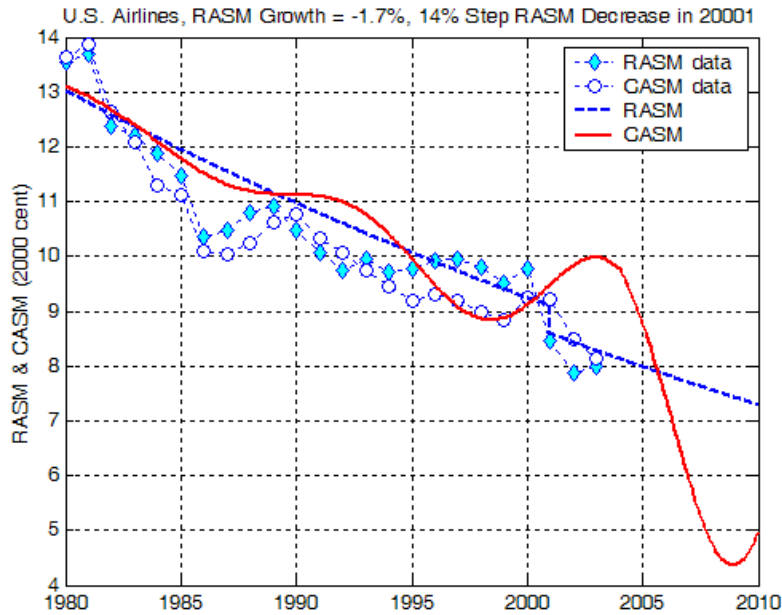

Figure 6-8 Cost/ASM Simulation of the U.S. Airlines with Step RASM Decrease in 2001

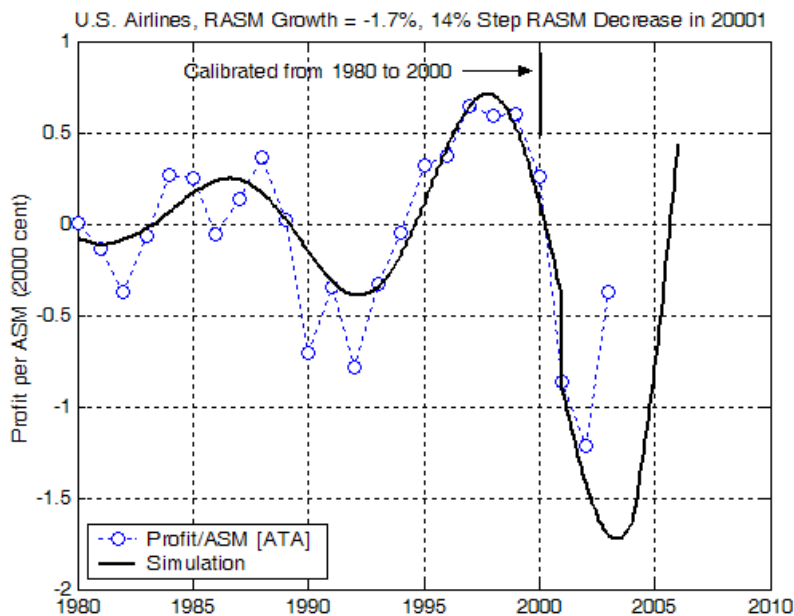

Figure 6-9 Profit/ASM Simulation of the U.S. Airlines with Step RASM Decrease in 2001

6.6 Summary of Cost Parametric Model

It was found that unit profit stability could be modeled by simple cost model. The cost hypothesis hypothesizing the lag between cost adjustment and profit caused system oscillation appears valid. The delay and gain values in the cost model indicate the U.S. airline industry is unstable in terms of exponential oscillation, consistent with the observations and discussions in Chapter 3. Given the simplicity of the model, simulation results showed that the model captures the system behavior reasonably good. The model identified cost adjustment as another potential driving factor of the system behavior, in addition to the capacity factor identified in Chapters 4 and 5.

CHAPTER 7

Coupling Capacity and Cost Effects

Capacity response and cost adjustment were both identified as potential driving factors of the industry profit cyclicity in Chapters 4 through 6. This chapter discusses a coupled model that combines both capacity and cost factors based on previous modeling results.

7.1 Coupled Model Combining Capacity and Cost Effects

The coupled model that combines capacity and cost effects is shown in Figure 7-1. The coupled model was formed by joining the capacity model in Chapter 4 and the cost model in Chapter 6.

The output of the model is the total profit, which is the product of capacity and unit profit (PASM); therefore, it combines both capacity and cost effects. The capacity and cost effects are coupled in the model through two feedbacks from the profit: one fed to the order aggressiveness K_1 and the other fed to CASM2.

First, the total profit is assumed to have an impact on aircraft orders. This impact is seen from the relationship between the world airlines profits and aircraft orders shown in Figure 4-4. Based on profitability, airlines could be aggressive or prudent when placing orders. Therefore, seen in Figure 7-1, a feedback is added by feeding the total profit to orders through gain K_2 after delay D_2 , where D_2 represents the time delay between the profits and the orders driven by the profits. Consequently, K_1 represents the overall aggressiveness in ordering process, and has the following relationship at time instant t

$$K_1(t) = K_0 + K_2 * Profit(t - D_2) \quad (29)$$

where gain K_0 is the baseline order aggressiveness, and K_2 is the order aggressiveness due to profitability. K_0 and K_1 have the units of ASM ordered per year per unit ASM shortfall, while K_2 has the units of ASM ordered per year per ASM shortfall per each billion dollars of profit. The total order is based on capacity shortfall and gain K_1

$$Order(t) = K_1(t) * (Demand(t) - Capacity(t)) \quad (30)$$

Therefore, the added link introduces cost effects into capacity planning.

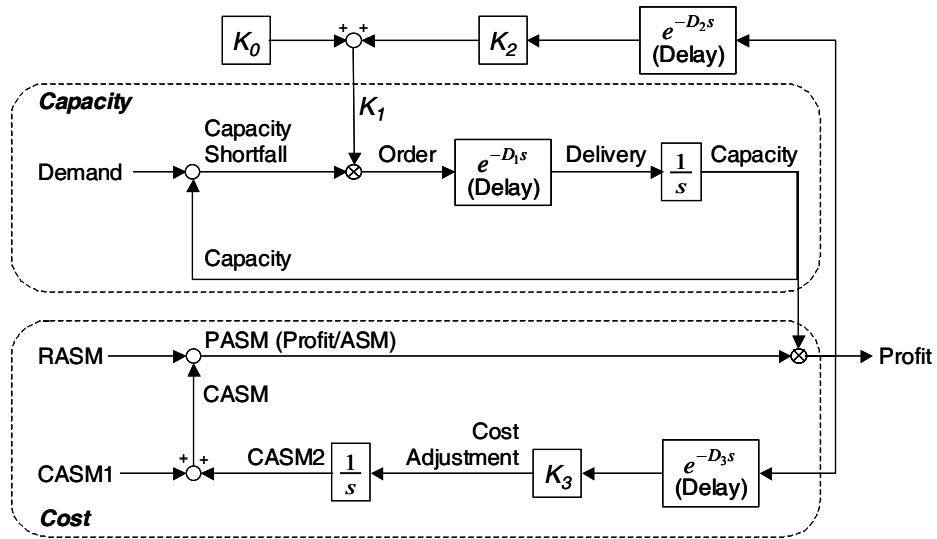

Figure 7-1 Block Diagram of Coupled Model Combining Capacity and Cost Effects

Second, unlike the feedback in the cost model (Figure 6-3) that only feeds PASM back to CASM, gain K_3 in the model interprets the effect of the total profit on CASM2 adjustment and has the units of cent/ASM cost adjustment per year per billion dollars of profit. Again, delay D_3 exists between profit and cost adjustment.

$$\begin{cases} Cost\ Adjustment(t) = K_3 * Profit(t - D_3) \\ Profit(t) = PASM(t) * Capacity(t) \end{cases} \quad (31)$$

Therefore, this feedback feeds capacity effects into unit cost adjustment.

Since the model couples two different factors, capacity and cost, caution must be taken regarding the units of variables and parameters in the model. Table 7-1 summarizes the descriptions and units of variables and parameters in the coupled model.

Table 7-1 Summary of Variables and Parameters in the Coupled Model

Variable	Description	Unit
Capacity	Output of capacity loop	Billion ASM
Demand	Input of traffic volume	Billion ASM
Capacity Shortfall	Demand – Capacity	Billion ASM
Order	New capacity to be added to the fleet	Billion ASM per year
Delivery	New capacity that becomes available	Billion ASM per year
RASM	Revenue per ASM	Cent/ASM
CASM	Cost per ASM	Cent/ASM
CASM1	Component of CASM that is less profit-sensitive	Cent/ASM
CASM2	Profit-sensitive component of CASM	Cent/ASM
PASM	Profit per ASM, RASM – CASM	Cent/ASM
Profit	Model output, PASM*Capacity/(100 cent/\$)	2000 Billion \$
D_1	Delay between orders and deliveries	Year
D_2	Delay between profits and profit-driven orders	Year
D_3	Delay between profits and cost adjustment	Year
K_0	Baseline order aggressiveness	$\frac{\text{ASM order/year}}{\text{ASM shortfall}}$
K_1	Overall order aggressiveness	$\frac{\text{ASM order/year}}{\text{ASM shortfall}}$
K_2	Order aggressiveness due to profitability	$\frac{\text{ASM order/year}}{\text{ASM shortfall}} / \text{Billion \$ profit}$
K_3	Effect of total profits on cost adjustment	$\frac{\text{Cent/ASM cost/year}}{\text{Billion \$ profit}}$

7.2 Parameter Values in the Coupled Model

The parameter values in the coupled model were determined by calibrating the model with respect to the historical capacity, profit, PASM and CASM data between 1980 and 2000. The input setup used in the individual capacity and cost models, such as the initial values for RASM,

CASM1 and CASM2, were used in the coupled model. The parameter values determined in Chapters 4 and 6 provided initial estimates for the gain and delay values in the coupled model wherever possible.

The 3.2-year delay determined in the capacity model (Table 4-1) represents the total delay between profits and deliveries, i.e., D_1 plus D_2 . Assuming approximate 1-year delay between profits and ordering actions for D_2 , the initial estimate for D_1 was 2.2 years. The initial estimate of D_3 was 3.1-year, the delay determined in the cost model (Table 6-1).

The gain for the U.S. airlines after deregulation in the capacity model (Table 4-1) was used as the initial value of K_0 in calibration. Assuming no profit impact on orders at the beginning, the initial value of K_2 was zero. Examination of cost and profit data of the U.S. airlines did not indicate possible K_3 value. Despite of the difference in units, the gain value in the cost model (Table 6-1) was used as the initial value of K_3 .

The calibration effort was first set off to find the possible K_3 value by matching CASM and PASM simulations with CASM and PASM data by ATA respectively. The initial estimate of K_3 was found too large that non-reasonable CASM and PASM results such as negative CASM were generated. As K_3 reduced, CASM and PASM simulations became reasonable and approached to ATA data set. Good matches between CASM and PASM simulations and corresponding ATA data were found when K_3 was around 0.10.

Second, setting K_3 to 0.10, calibration efforts were made to find K_2 by matching the capacity and profit simulations with ATA capacity and profit data. Simulations indicated that the initial estimate of zero K_2 was reasonable and large K_2 generated impossible results such as negative capacity. Slightly increasing K_2 improved the match in capacity and possible K_2 value was found in the range (0.03, 0.1).

During the process of narrowing the range of K_2 , K_0 was allowed to change in order to find the potential optimal set of K_0 and K_2 to match ATA capacity and profit data. The range for K_0 is (0, 1.2), with the initial estimate being the gain in the capacity model that was 0.86 (Table 4-1). Again, it was found that large K_0 generated impossible results such as negative capacity, while small K_0 was not able to generate enough corrections to keep up capacity with demand growth. The range for possible K_0 was found in (0.4, 1.0).

Having found the ranges of gain values, the delays were allowed to change individually. However, the range of possible delay values should be limited because the delays cannot be zero or extremely long. Consequently, D_1 was varied in (1, 4) years, D_3 in (1, 4) years, and D_2 in (1, 3) years, with the objective to match ATA CASM, capacity and profit data.

Last, parameters were optimized in the objective to minimize the sum of square errors with respect to ATA capacity, CASM and profit data, subject to the constraint that K_1 (equation (29)) was non-negative during the time frame. It was found that D_2 values between 1 year and 2 years had almost identical values for objective function. Therefore, the optimal value for D_2 is between 1 and 2 years. The parameter set obtained through calibration is provided in Table 7-2.

Table 7-2 Calibration Results of Parameters in the Coupled Model

Parameter	Description	Value
D_1	Delay between orders and deliveries	2.2 year
D_2	Delay between total profits and profit-driven orders	1 year
D_3	Delay between total profits and cost adjustment	3.1 year
K_0	Baseline order aggressiveness	0.86 $\frac{\text{ASM order/year}}{\text{ASM shortall}}$
K_2	Order aggressiveness due to profitability	0.05 $\frac{\text{ASM order/year}}{\text{ASM shortall}} / \text{Billion \$ profit}$
K_3	Effect of total profits on cost adjustment	0.11 $\frac{\text{Cent/ASM cost/year}}{\text{Billion \$ profit}}$

7.3 Simulation Results

7.3.1 Simulation 1 – Calibration Simulation

Simulation 1, abbreviated as Sim1, is the calibration simulation, in which, the parameters were set to the values shown in Table 7-2. The input setup used in the individual capacity and cost models, such as the initial values for RASM, CASM1 and CASM2, were used in the coupled model. Sim1 assumed the demand grew at 4%, RASM decreased at 1.7%, and CASM1 decreased at 2%, based on the average trends of the U.S. airlines after deregulation (Figures 1-1 and 6-1).

Figure 7-2 shows the simulation results of demand and capacity against industry capacity data by ATA. Figure 7-3 shows the simulation results of the U.S. fleet against Form 41 fleet data. The U.S. fleet simulation was obtained by dividing the capacity by the average aircraft utility of the U.S. airlines (190 million ASM per aircraft per year as discussed in Appendix A). Figure 7-4 plots the simulation results of RASM and CASM, in comparison with RASM and CASM data by ATA, and Figure 7-5 shows the profit simulation and industry profits by ATA.

As can be seen from the figures, the coupled model interprets the industry dynamics reasonably good in terms of capacity trend, fleet size, CASM, and profit. The coupled model captures the industry trends in capacity, cost and profit simultaneously, better than individual capacity or cost models that only reflects system oscillations in industry profits. The simulation results agree with the historical data up to 2000, indicating that coupling capacity and cost effects better explains the system behavior.

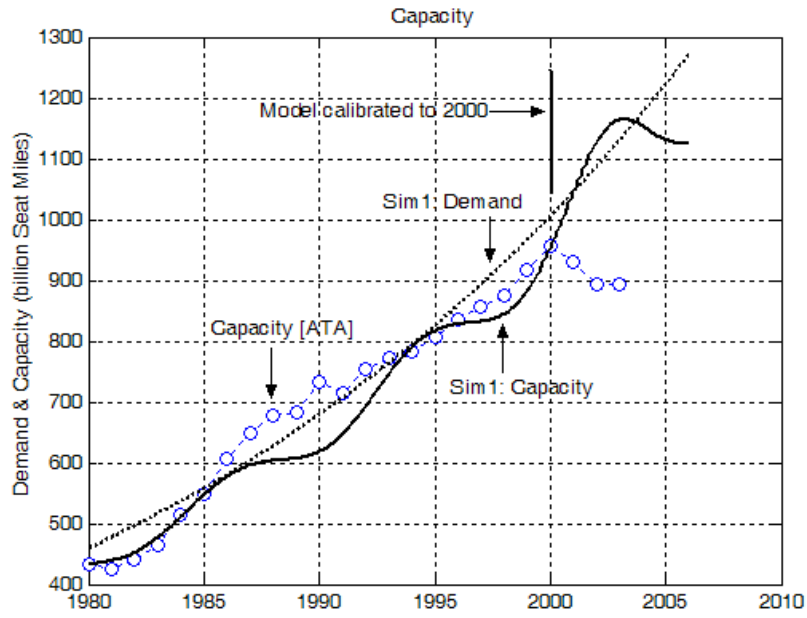

Figure 7-2 Capacity Simulation of Coupled Model in Simulation 1

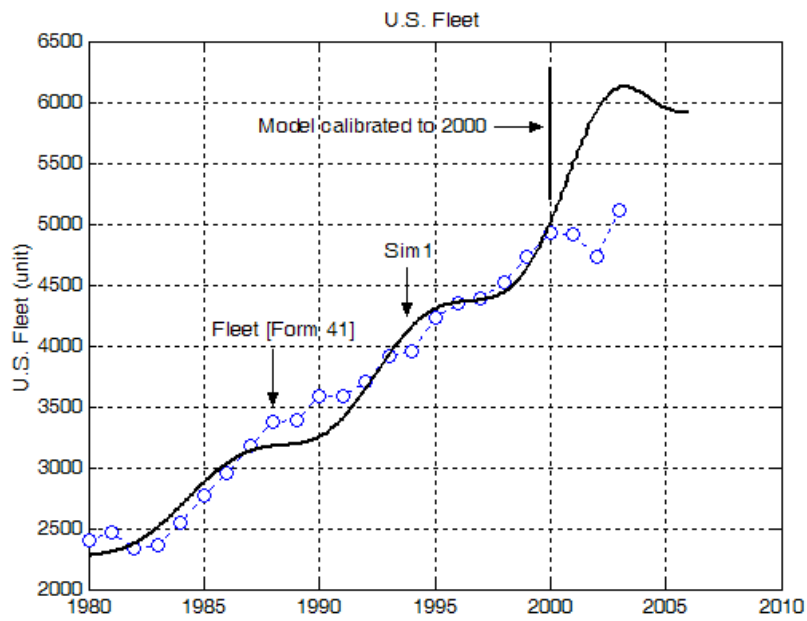

Figure 7-3 Fleet Simulation of Coupled Model in Simulation 1

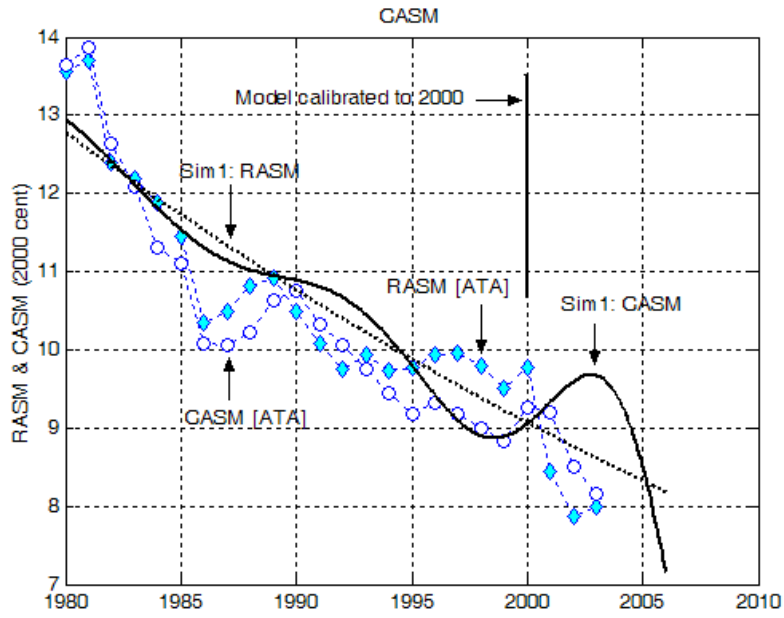

Figure 7-4 CASM Simulation of Coupled Model in Simulation 1

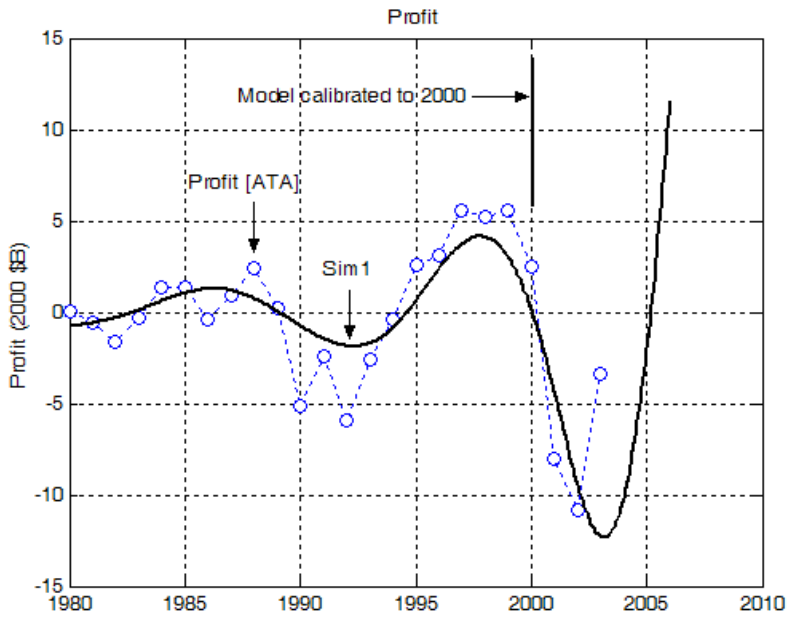

Figure 7-5 Profit Simulation of Coupled Model in Simulation 1

Figure 7-6 shows the order simulations in comparison with 35% of world aircraft orders. Since no immediate data regarding aircraft orders of the U.S. airlines was available to the author, 35% of world aircraft orders were assumed as the U.S. orders. Such ratio was approximated from the forecasts in Boeing Current Market Outlook 2003 [15]. To check the reasonableness of parameter estimates particularly value of K_2 , the assumed U.S. orders (35% of world orders) are further plotted against prior-year profits in Figure 7-7 as well as the simulation results. The figure shows that when the airlines are profitable, the slope of simulated aircraft orders with respect to profits is in the neighborhood of the observed slope from actual data, indicating the estimate of K_2 – effect of profitability on order aggressiveness is in a reasonable range.

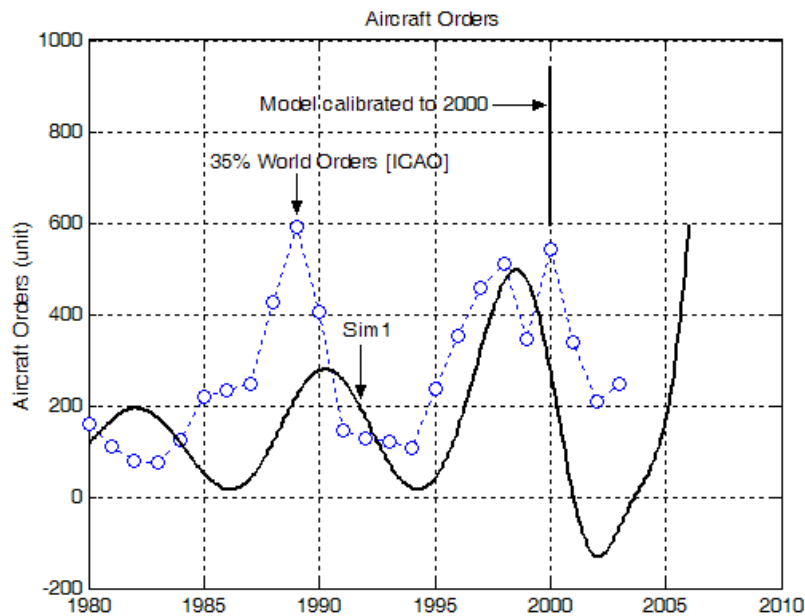

Figure 7-6 Aircraft Order Simulation of Coupled Model in Simulation 1

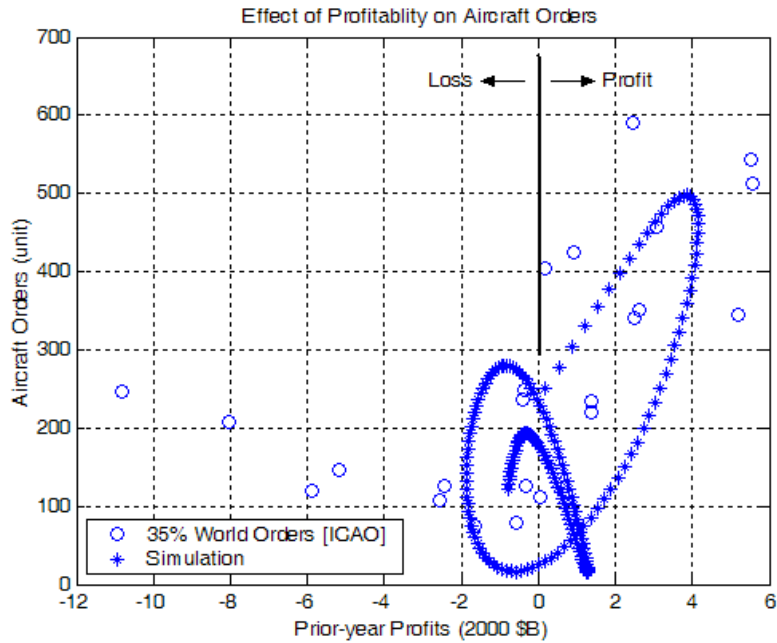

Figure 7-7 Simulation of Effect of Profitability on Aircraft Orders

However, the capacity simulation in Figure 7-2 deviates from the actual data after 2001. So is the CASM simulation in Figure 7-4. Close examinations of simulation set-up found that both demand and RASM inputs did not include the effects of the industry crisis in 2001. Figure 7-8 illustrate the U.S. scheduled domestic passenger traffic and yield between 1995 and 2004, in which aggregate monthly RPM of ATA U.S. member airlines¹ are plotted against the aggregate yield of eight major U.S. airlines² due to data availability [16, 17]. The figure indicates that both demand and yield decreased significantly after the September 11 event and the effects in 2001 should not be ignored.

¹ ATA U.S. member airlines: Aloha, Alaska, America West, American, ATA, Continental, Delta, Hawaiian, JetBlue, Midwest, Northwest, Southwest, United, and US Airways

² Eight major U.S. airlines: Alaska, American, America West, Continental (incl. Micronesia), Delta, Northwest, United, US Airways

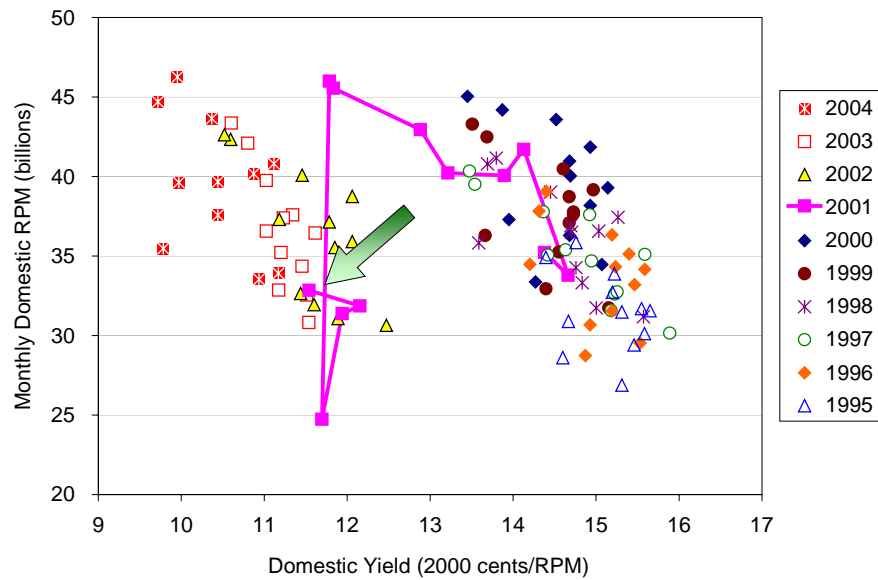

Figure 7-8 U.S. Scheduled Monthly Domestic Passenger Traffic and Yield [16, 17]

7.3.2 Simulation 2

Simulation 2, referred as Sim2 below, had the same parameter setting as Sim1 but different inputs in order to reflect the changes on the input side due to the industry crisis in 2001. In order to simulate the effects in 2001, in addition to the long-term trends for demand, RASM and CASM1 assumed in Sim1, approximately 240 billion ASM drop in demand and 1 cent/ASM decrease in RASM in 2001-02 were added to the model to reflect the changes on demand and RASM. The 240 billion ASM drop in demand was obtained by observing the difference between the long-term demand trend and actual capacity data after 2001 in Figure 7-2; so was the 1 cent/ASM decrease in RASM observed from Figure 7-4. The model setup for Sim2 is shown in Figure 7-9.

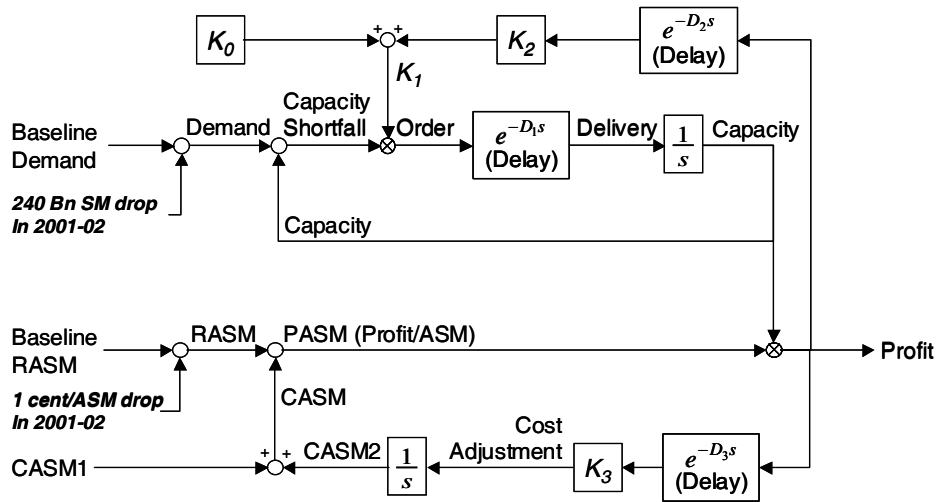

Figure 7-9 Configuration of Coupled Model for Simulation 2 to Reflect Effects in 2001 on Demand and RASM

Figures 7-10 through 7-14 show the simulation results of capacity, fleet size, CASM, profit and aircraft orders for Sim2 in comparison with Sim1 results and industry data respectively.

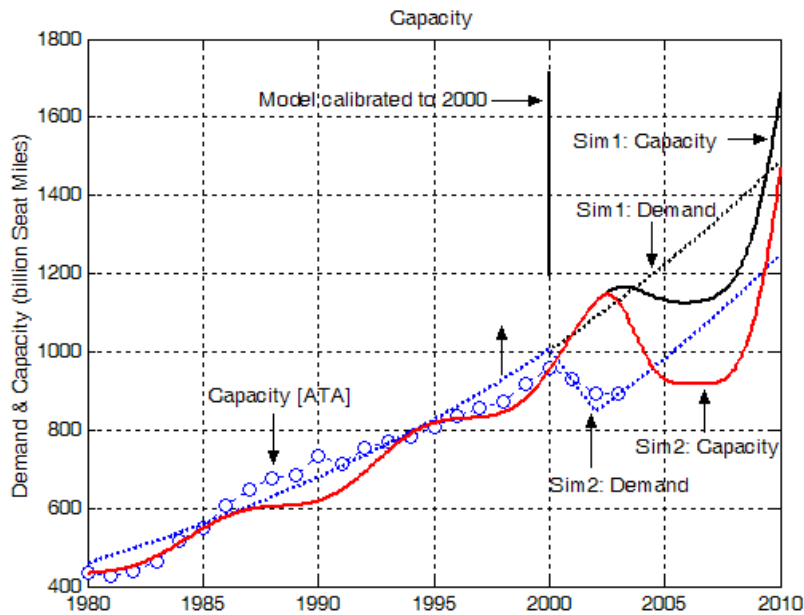

Figure 7-10 Capacity Simulation of Coupled Model in Simulation 2

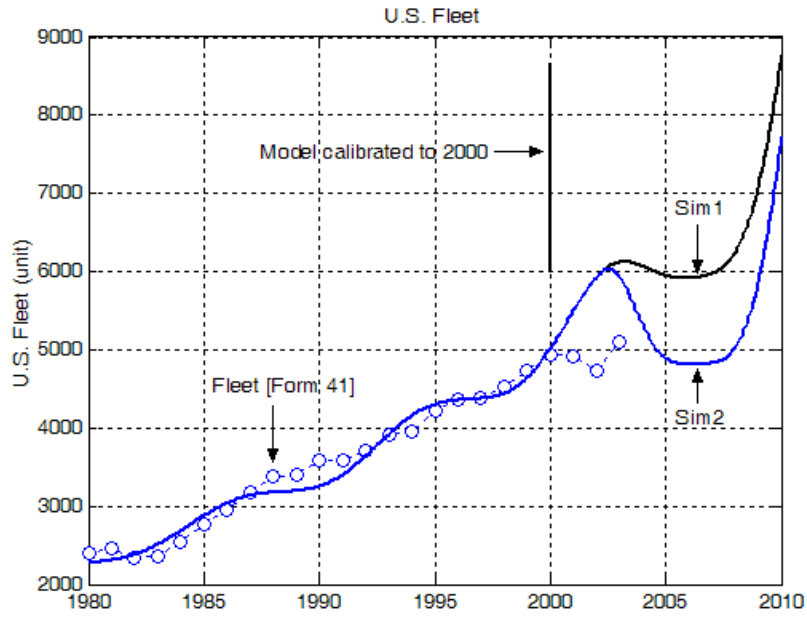

Figure 7-11 Fleet Simulation of Coupled Model in Simulation 2

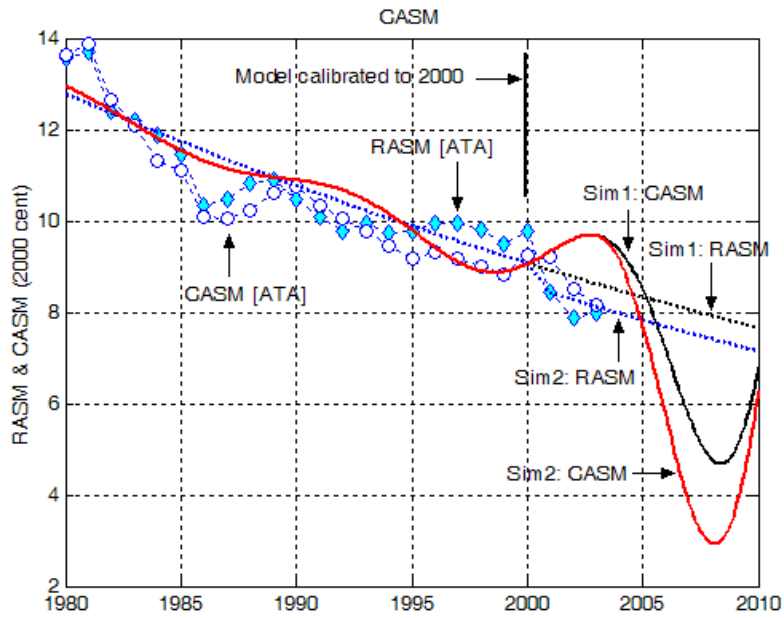

Figure 7-12 CASM Simulation of Coupled Model in Simulation 2

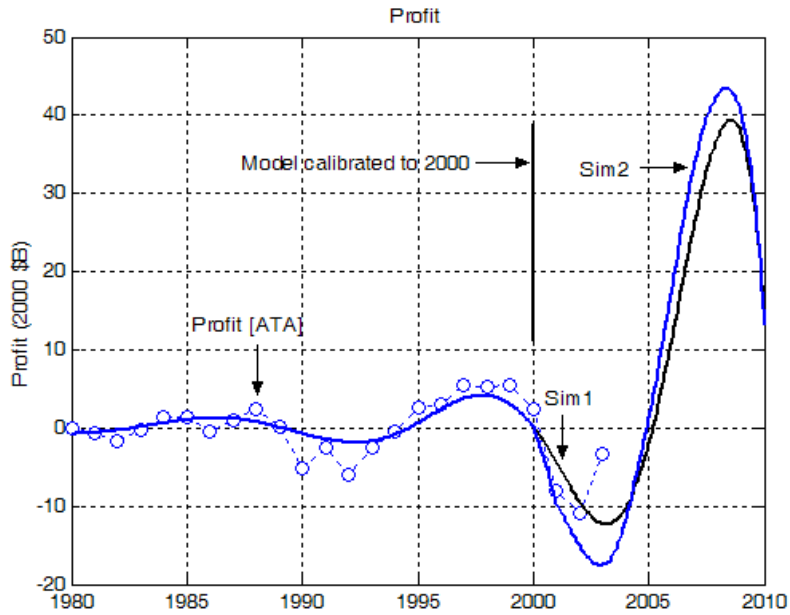

Figure 7-13 Profit Simulation of Coupled Model in Simulation 2

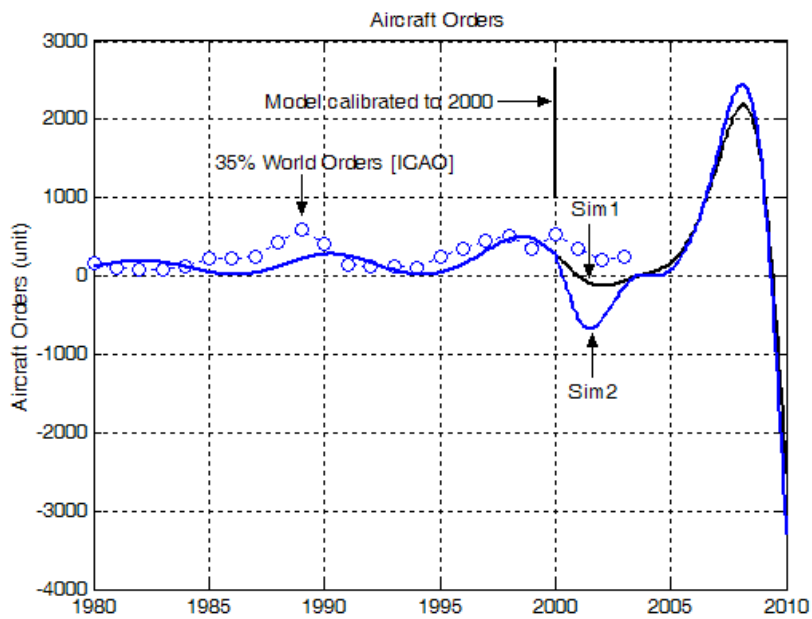

Figure 7-14 Aircraft Order Simulation of Coupled Model in Simulation 2

Shown in Figure 7-10, even after demand correction, the capacity simulation in Sim2 differs dramatically from the actual data in 2001-2003. This indicates that by assuming overall

3-year delay between profits and aircraft deliveries, the coupled model explains the industry growth trend due to airplane orders reasonably well. However, such assumption is not true in terms of explaining the temporary capacity decrease due to emergency, in which the system can respond faster by canceling flights, reducing utilization, parking or retiring aircraft in a short term. Therefore, there exists an asymmetric effect in capacity adjustment, that is, in the up cycle the airlines take years of delay to add capacity while in the down cycle the excess operating capacity can be effectively withdrawn in a short term by parking aircraft and/or reducing utilization. Shown in Figure 7-15, approximately 450 jet aircraft of the U.S. major, national and regional carriers were stored as of May 14, 2003, according to Air Claims data report in Air Transport World, July 2003 issue [18]. Since the coupled model did not take into account the short-term capacity response, it failed to model the system response after 2001.

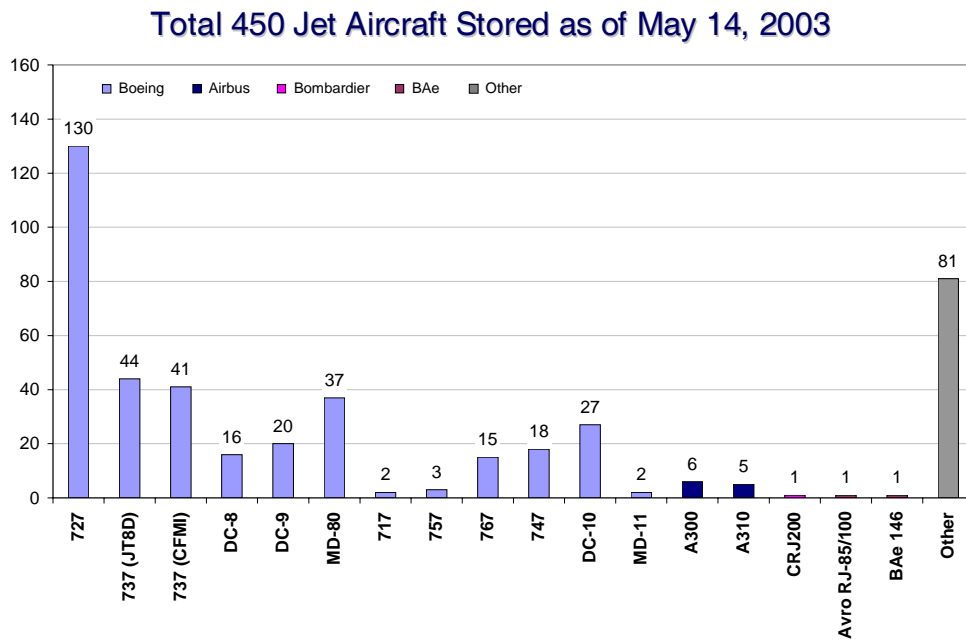

Figure 7-15 Stored Aircraft of the U.S. Major, National and Regional Carriers [18]

Figures 7-17 through 7-21 show the simulation results of capacity, fleet, CASM, profits and aircraft orders of the modified coupled model in comparison with Sim1 and industry data respectively.

Seen from Figure 7-19, by shortening the delay between profits and cost adjustment, the modified coupled model captures the trend in CASM after 2001 regarding the shorter response time in cost adjustment. Figure 7-20 indicates that industry profits will oscillate exponentially if the delay after 2004 kept at the level before 2001.

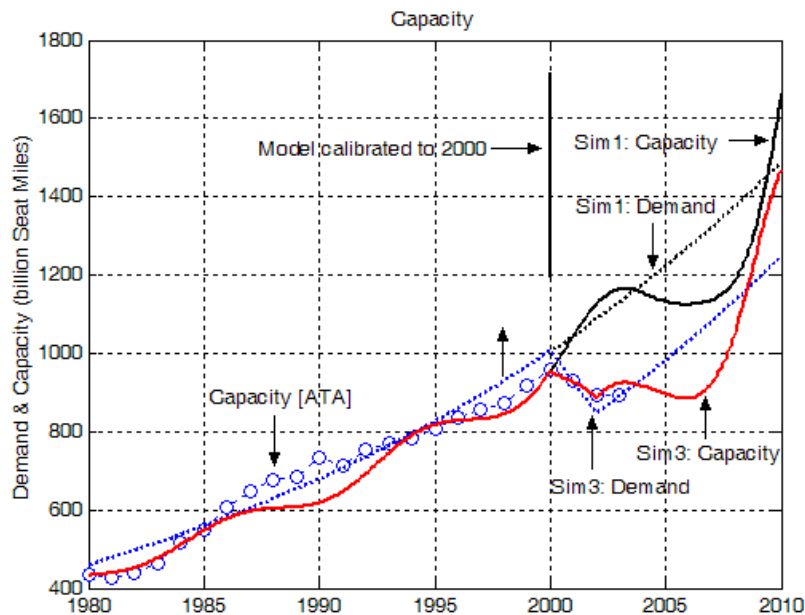

Figure 7-17 Capacity Simulation of Modified Coupled Model in Simulation 3

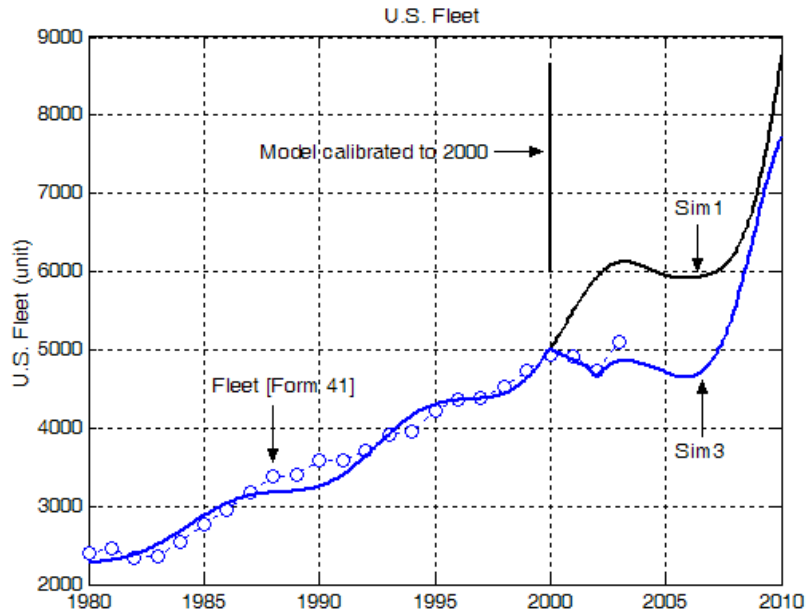

Figure 7-18 Fleet Simulation of Modified Coupled Model in Simulation 3

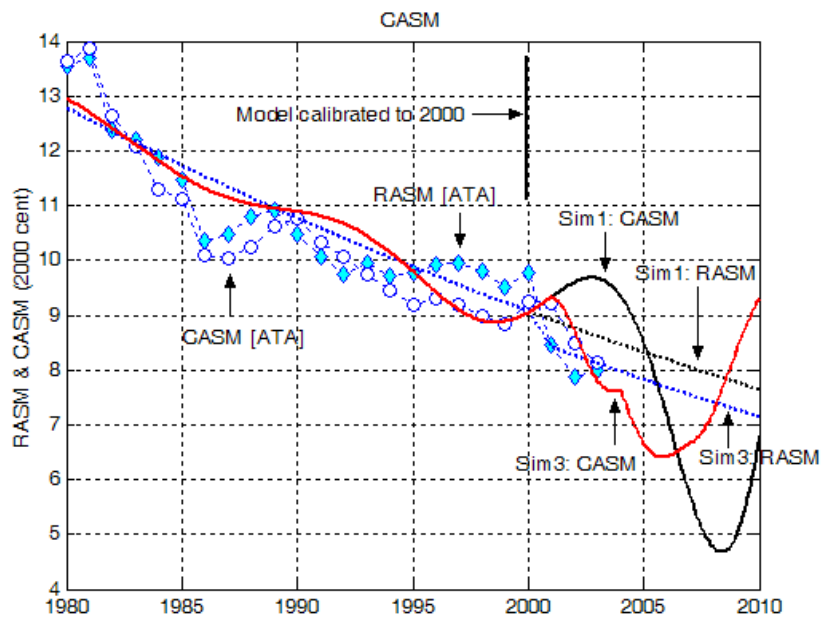

Figure 7-19 CASM Simulation of Modified Coupled Model in Simulation 3

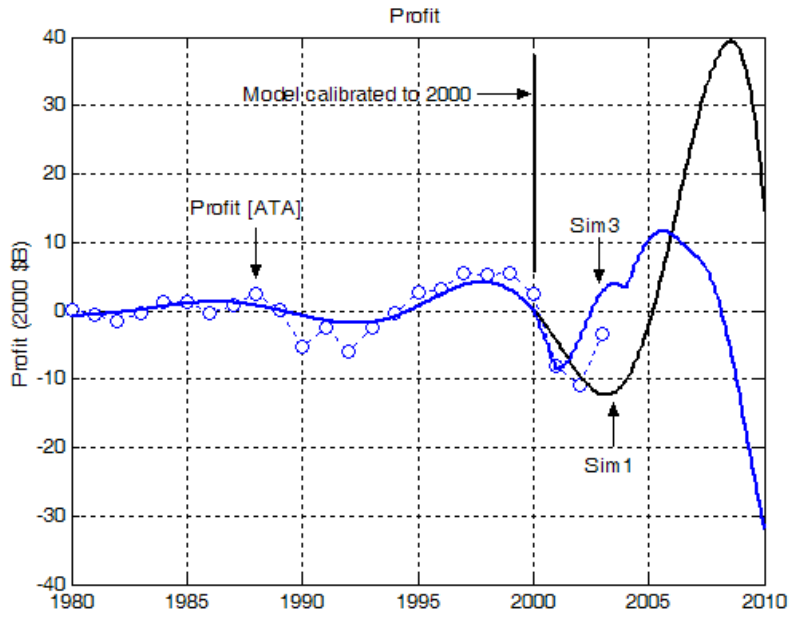

Figure 7-20 Profit Simulation of Modified Coupled Model in Simulation 3

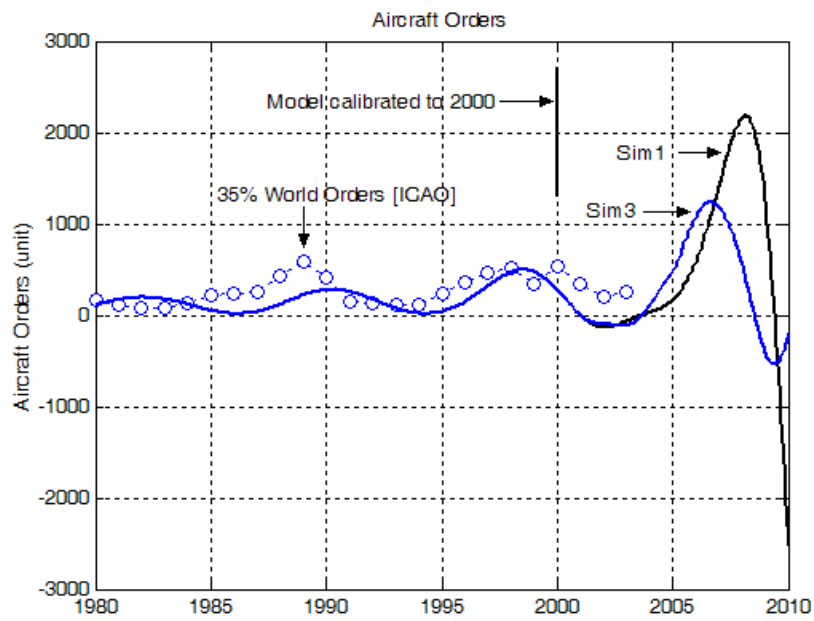

Figure 7-21 Aircraft Order Simulation of Modified Coupled Model in Simulation 3

7.4 Summary of Coupled Model

A coupled model that combines capacity and cost effects was developed based on previous individual capacity and cost models. The parameters in the coupled model were determined from previous results, data examination and calibration. Simulation results indicate that the coupled model captures the long-term industry behavior in profit cyclicity better than the individual capacity or cost models developed previously, indicating that the system oscillation was driven by the joint effects of capacity and cost adjustment. However, the model fails to reflect the industry response after 2001 because of excluding the short-term effect. The simulation results suggest that the short-term asymmetric effect is important and should be included in the model in order to better explain the industry dynamics. By shorten the delay between profits and cost adjustment (D_3) after 2001, the modified coupled model captures the industry response in CASM after 2001.

CHAPTER 8

Including Load Factor and Short-term Capacity Effects

This chapter proposes a more sophisticated model based on previous efforts for future research. The model takes into account effects of price-demand elasticity and load factor on demand and short-term effects on operating capacity in order to better explain the dynamics of airline industry. By including more factors, such model is expected to behave more realistic, however, with a trade-off of model complexity. It should be noted that the model is still under development, and some concepts and/or sub-models are very preliminary and even debatable.

8.1 Model Including Load Factor and Short-term Capacity Effects

Figure 8-1 proposes a model that includes load factor and short-term capacity effects. The model is constructed based on the results from previous discussions, and consists of demand, capacity and revenue management sub-models. The demand model considers traffic demand as an outcome of GDP, social factors and airfare. The capacity model takes into account the long-term fleet planning efforts, short-term tactical scheduling effect, and the asymmetric effect in capacity adjustment. The demand and capacity interacts with each other through the revenue management process to generate the industry profit. Each of these sub-models is to be discussed separately below.

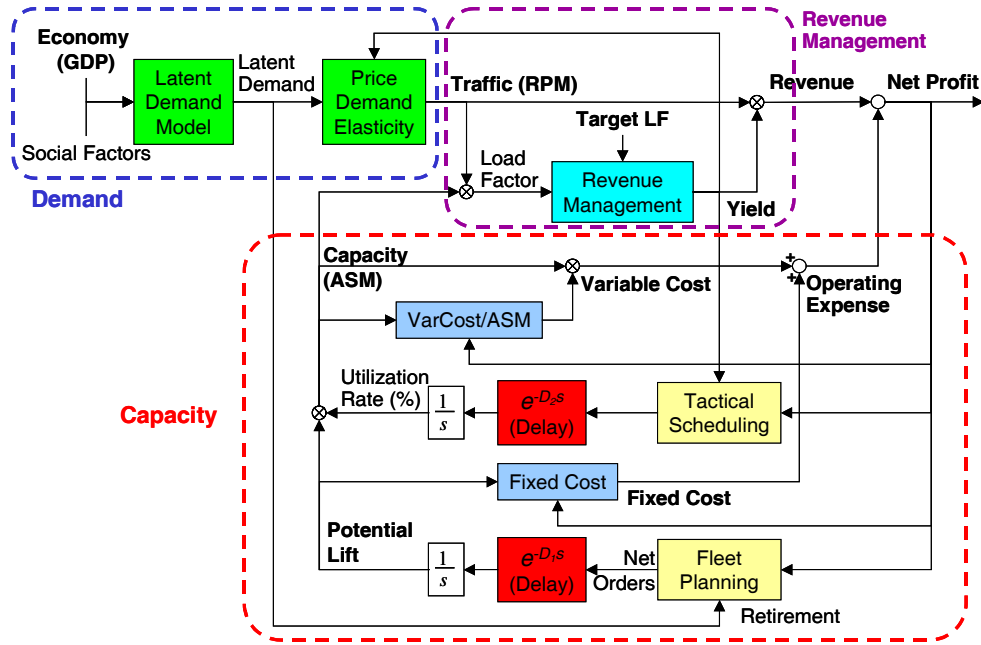

Figure 8-1 Proposed Model Including Load Factor and Short-term Capacity Effects

8.2 Demand Modeling

8.2.1 Latent Demand Concept

A concept of latent demand is proposed in the demand model. The latent demand is the maximum traffic demand that could occur at some price level or free according to current macro economy status and social factors.

Figure 7-8 illustrate the U.S. scheduled domestic passenger traffic and yield between 1995 and 2004 [16, 17]. The figure shows that significant airfare reduction in 2001 did not boost the traffic, indicating that some factors other than yield had determined the maximum demand level at that time. These factors are considered primary due to exogenous macro economy such as GDP growth and social factors such as people's willingness and confidence to air travel. Figure 8-2 shows the passenger traffic of the U.S. airlines versus GDP, indicating there is a decrease in RPM due to the economic recession and September 11 event [2, 19].

Therefore, it is postulated that there exists the latent demand primary driven by the economy and social factors, and price is assumed to have short-term effects on demand.

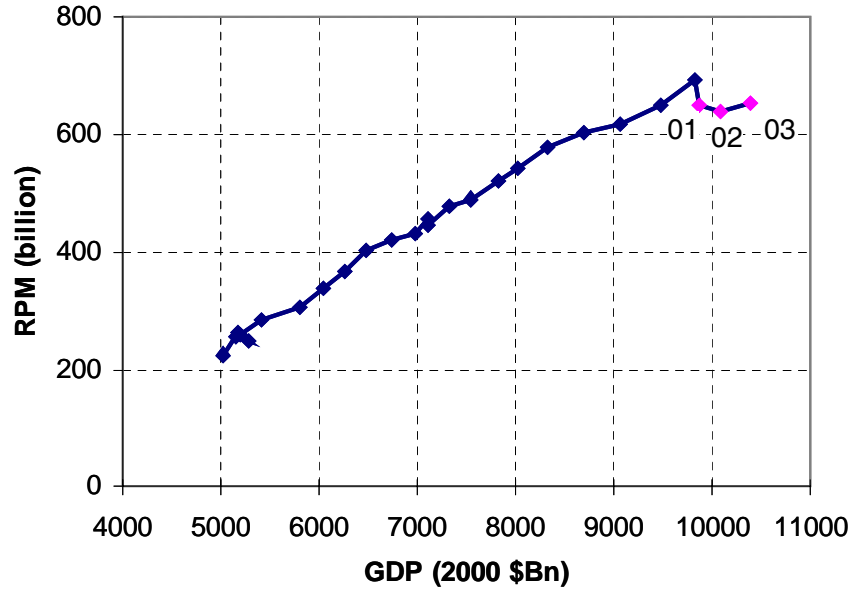

Figure 8-2 Scheduled Passenger Traffic of the U.S. Airlines and GDP [2, 19]

8.2.2 Demand Models

Two preliminary demand models are proposed below based on previous discussions and observations. Figure 8-3 proposes a constant price elasticity demand model, and Figure 8-4 shows a simple linear demand model. As illustrated in the figures, the latent demand determines the overall demand level in a period, and price only has short-term effects on boosting or suppressing the demand in order to materialize demand into traffic.

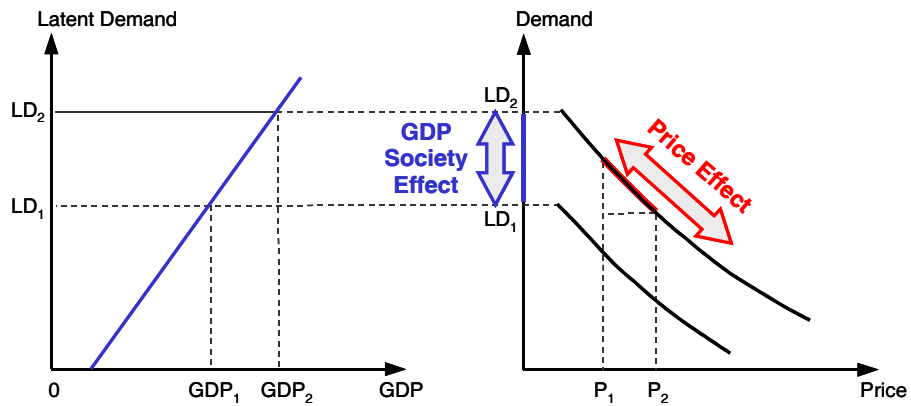

Figure 8-3 Proposed Constant Price Elasticity Demand Model

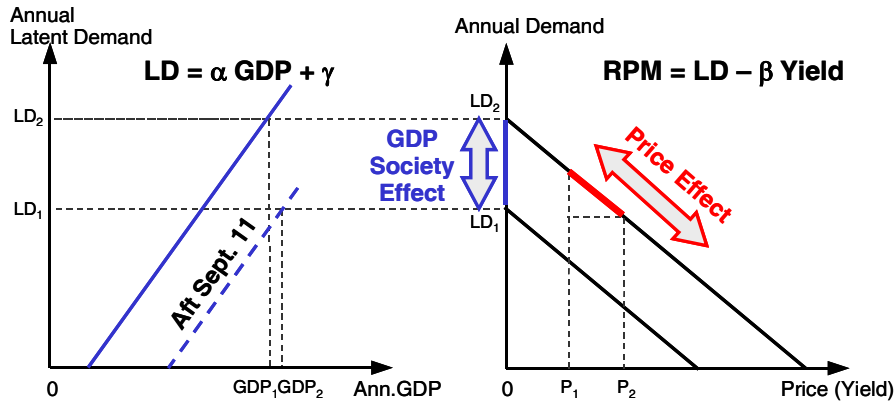

Figure 8-4 Proposed Simple Linear Demand Model

8.3 Revenue Management

The total traffic of the U.S. airline industry in general has grown during the past two decades (Figure 1-1). Figure 8-5 shows ATA data of the average load factor of the U.S. airlines after deregulation, which has gradually increased over the years [2]. However, it is often reported that the traffic demand is ‘weak’ or ‘strong’. This suggests that the ‘weak’ or ‘strong’ traffic demand has to be related to the supply (ASM). Therefore, it is postulated that there exists a target load factor as a threshold in airline’s operation. The traffic is considered ‘weak’ when the actual load factor is below the target load factor, or ‘strong’ when the actual load factor is

above it. Pricing is used as a tool in revenue management to adjust the traffic to achieve the target load factor, shown in Figure 8-1.

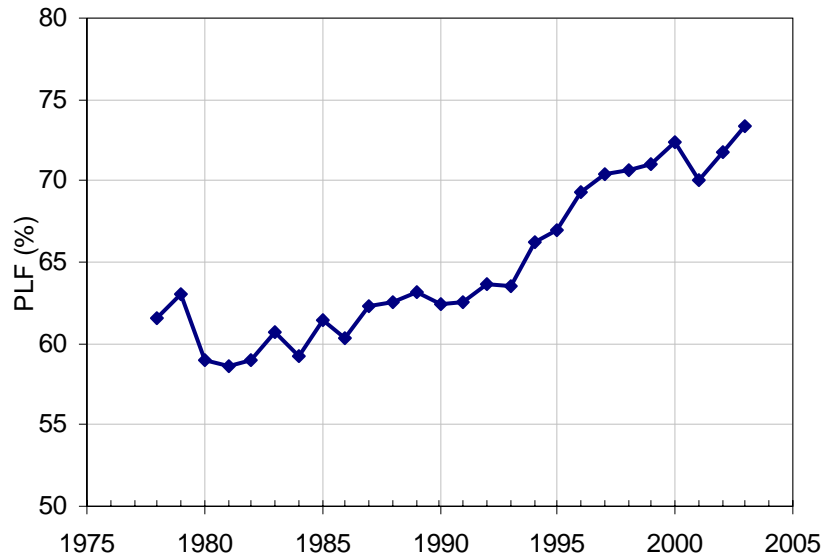

Figure 8-5 Passenger Load Factors of the U.S. Airlines of Scheduled Services [2]

8.4 Capacity Modeling

8.4.1 Two Capacity Concepts

Two capacity concepts are proposed in the model: potential lift and operating capacity (ASM). The potential lift is the maximum capacity that the system could offer at sustainable level. The operating capacity is the capacity in operation, which is part of potential lift. As discussed in Chapter 7, there exists a short-term capacity effect, indicating that there is a difference between the maximum capacity the system could offer and the actual capacity the system operates. Moreover, the short-term capacity effect is often asymmetric in terms of different delay times in adding and removing capacity.

Shown in Figure 8-1, potential lift is considered as the outcome of long-term fleet planning and therefore experience long-time delay due to planning time and manufacturing lead-time.

Operating capacity (ASM) incorporates the short-term scheduling effects and thus is updated at higher frequency and has relatively short delay. The ratio between capacity and potential lift is the utilization rate, indicating the extent to which the potential lift being utilized in operation.

The two capacity concepts have different cost perspectives. As proposed in Figure 8-1, the fixed costs are driven by the potential lift, while the variable costs are driven by the operating capacity.

8.4.2 Tactical Scheduling Model

The short-term tactical scheduling model takes care of temporal changes in operating capacity based on the capacity shortfall in near future. The capacity shortfall is determined based on the mismatch between short-term traffic projection and the capacity that is to be available in the planning horizon. This part of capacity includes current capacity, deliveries and retirements or parking in the planning time frame. Capacity change in scheduling model will take relatively short delay due to schedule and advertising announcement. Profitability may have an impact on scheduling because the operating capacity is related to the variable costs.

It should be pointed out that there's an asymmetric effect in adding and removing capacity, i.e., short-time delay in removing capacity by parking or retiring aircraft versus long-time delay in adding capacity by taking new deliveries. In addition, most capacity in the stored fleet should be considered unlikely to return to services in the U.S. Shown in Figure 7-15, most stored aircraft are old and inefficient aircraft such as B727s and old-generation B737s, indicating that airlines actively use parking aircraft as a way to upgrade their fleets. A concept of Fleet Restorable Ratio is proposed in the scheduling model; such ratio is always less than 1, implying that the stored fleet can not be fully recovered to fulfill the short-term operation need, due to

mismatches across aircraft types, O-D markets and airlines between the stored fleet and the required adjustment. Consequently, this implies the effective way to add capacity is to take new deliveries which requests longer delay time.

8.4.3 Fleet Planning Model

The planning is based on the long-term fleet projection that is driven by demand. The projection offers a base for the desired long-term fleet. A concept of Collective Market Share Perspective Ratio is proposed in constructing the desired fleet; such ratio is always greater than 1, as discussed in section 4.6, due to the optimism in capacity projection, aggregate effects of individual airlines' market share projections, the aggressiveness from manufacturers in promoting the products, and impacts of exogenous factors.

Orders are placed based on the difference between the desired fleet and current operating fleet, plus the incentive of expansion driven by profits which represents the asymmetric effect between profits and orders shown in Figure 4-4.

8.5 Modeling Cost Factors

Proposed in the model, the costs consist of fixed costs and variable cost. The fixed costs is the costs that are related to the size of the fleet or company, such as ownership costs of flight equipment and ground facilities including depreciation and amortization, and general services and administrative costs. This part of costs is not sensitive to daily capacity adjustment, and is not closely related to the status of aircraft, i.e., either in service or storage. It represents the essential costs in terms of owning aircraft and facilities.

The variable costs are the remaining costs that vary with operating capacity, including flight operation costs, maintenance costs, passenger costs, etc. Since this part of costs varies with the operating capacity, it gives airlines flexibility to control the total costs and profits through short-term scheduling efforts.

8.6 Summary

A model including load factor and short-term capacity effects is proposed based on previous efforts in an effort to better model the dynamics of airline industry. The concept of latent demand is proposed in the demand model to interpret impacts of economy and social factors on overall demand level. Effect of revenue management is considered by introducing the target load factor as a threshold in operation and yield as a tool to adjust traffic in short term.

The concepts of potential lift and utilization rate are proposed in the capacity model to represent the capacity limit the industry could offer and the actual capacity the system operates. Scheduling model is proposed to explain the short-term asymmetric capacity effects and offers airlines controllability on the total costs in short time. The concept of Fleet Restorable Ratio is proposed to represent the constraints in recovering massive aircraft from storage. The concept of Collective Market Share Perspective Ratio is proposed in fleet planning model to count the aggregate effects of optimism, aggressiveness of individual airlines and manufacturers, and exogenous factors in developing the system in long term.

The proposed model sets a foundation for future work. By including above factors and effects, the model is expected to better explain the airline industry dynamics.

CHAPTER 9

Conclusions

9.1 Summary of Findings

This study identified the fundamental cycle periods of the U.S. and world airline industries, as well as capacity and cost effects as driving factors of the system behavior.

Assuming that the industry profit cycles could be modeled as an undamped second-order system, the fundamental cycle period was identified to be 11.3 years for the U.S. airlines and 10.5 years for the world airlines. Analyses of industry profits reveal that such cycle period is endogenous, neither deregulation nor September 11 have significantly changed it. The net profit model is an extremely simple empirical model that does not address causality or constraints and offers insight on the profit cyclicity of airline industry; however, care must be taken in applying the model to predict future system behavior.

Parametric models were developed under the hypothesis that phase lag in the system caused profit oscillations; and two hypotheses, lag in capacity response and lag in cost adjustment were studied.

A parametric model was developed by hypothesizing the delay in capacity response caused profit oscillations. For this model, the system stability depends on the delay between aircraft orders and deliveries and the aggressiveness in airplane ordering. Assuming industry profits correlated to capacity shortfall, the delay and gain were calculated and the results were consistent with the observed delay between world aircraft deliveries and net profits. Since the gain in the model has lumped impacts of exogenous factors, exaggerated capacity response was observed in

simulation. This indicates capacity shortfall alone cannot fully explain the industry dynamics. The model also indicates reduced delay may help to mitigate system oscillations.

Similarly, a parametric model was developed by hypothesizing the delay in cost adjustment caused profit oscillations, and simulation results were consistent with industry profits. The model identified cost adjustment as another potential driving factor of the system behavior in addition to capacity response.

A coupled model was developed to study the joint effects of capacity and cost. Simulations indicated that the coupled model explained industry dynamics better than the individual capacity or cost models, indicating that the system behavior is driven by the joint effects of capacity response and cost adjustment. The model also suggests that short-term and asymmetric capacity effects are important and should be included.

Last, a more sophisticated model including load factor and short-term capacity effects is proposed for future work in an effort to better understand the airline industry dynamics.

REFERENCES

- [1] Air Transport Association, 2003, “The Airline Handbook – Online Version,” Chapter 2.
- [2] Air Transport Association, “Annual Traffic and Capacity of U.S. Airlines Scheduled Services,” <http://www.airlines.org/econ/d.aspx?nid=1032>
- [3] Ryan Tam, R. John Hansman, 2003, “Air Transportation and Socioeconomic Connectivity in the United States since Deregulation,” Montreal, 2nd Aviation Management Education and Research Conference.
- [4] Air Transport Association, “Annual Revenue and Earnings of U.S. Airlines All Services,” <http://www.airlines.org/econ/d.aspx?nid=1034>
- [5] ICAO, 1966-2002, “Civil Aviation Statistics of the World: ICAO statistical Yearbook”
- [6] Martin Liehr, Andreas Größler, Martin Klein, and Peter M. Milling, 2001, “Cycles in the sky: Understanding and managing business cycles in the airline market,” *System Dynamics Review*, Vol. 17, December, pp. 311-332.
- [7] James M. Lyneis, 1998, “System Dynamics in Business Forecasting: A Case Study of the Commercial Jet Aircraft Industry,” *Proceedings of the Sixteenth International Conference of the System Dynamics Society: Québec '98 (CD-ROM)*, System Dynamics Society, Québec City, Canada.
- [8] Singiresu S. Rao, 1995, Mechanical Vibrations, 3rd Edition, Reading, Massachusetts, Addison-Wesley Publishing Company.
- [9] B. P. Lathi, 1998, Signal Processing and Linear Systems, Carmichael, California, Berkeley Cambridge Press, Chapters 3, 5 and 10.
- [10] Robert S. Pindyck, Daniel L. Rubinfeld, 1991, Econometric Models and Econometric Forecasts, 3rd Edition, New York, McGraw-Hill, Inc.
- [11] Arthur Jutan, 1999, regdata.m, (a MATLAB® program computing regression statistics from nonlinear least square curve-fit), University of Western Ontario, available at: <http://www.mathworks.com/matlabcentral/fileexchange/download.do?objectId=101&fn=regdata&fe=.m&cid=56068>
- [12] U.S. Department of Transportation, Form 41 data
- [13] William J. Palm III, 1986, Control Systems Engineering, New York, John Wiley & Sons, Inc.

- [14] Air Transport Association, “ATA Quarterly Airline Cost Index of U.S. Major and National Passenger Carriers,” <http://www.airlines.org/econ/d.aspx?nid=1042>
- [15] The Boeing Company, 2003, “Current Market Outlook 2003,” <http://www.boeing.com/commercial/cmo/>
- [16] Air Transport Association, “ATA Monthly Passenger Traffic Report of Scheduled Mainline Services – ATA Member Airlines,” <http://www.airlines.org/econ/d.aspx?nid=1037>
- [17] Air Transport Association, “ATA Monthly Passenger Yield Report of Scheduled Mainline Services – Participating ATA Member Airlines,” <http://www.airlines.org/econ/d.aspx?nid=1041>
- [18] Air Transport World, July 2003, “The World Airline Report”, original data from Air Claims
- [19] Bureau of Economic Analysis, “Gross Domestic Product,” <http://www.bea.gov/>
- [20] Air Transport Association, “ATA Monthly Jet Fuel Report of U.S. Major, National & Large Regional Passenger and Cargo Airlines All Services,” <http://www.airlines.org/econ/d.aspx?nid=5806>
- [21] Bureau of Labor Statistics, “Inflation Calculator,” <http://www.bls.gov/home.htm>

APPENDIX A

Average Aircraft Utility of the U.S. Airlines

The system-wide aircraft utility of the U.S. airlines between 1980 and 2003 recorded by DOT Form 41 is shown in Figure A-1 [12]. The aircraft utility is measured in terms of available seat-miles per aircraft flown per year, and has the average at 190 million ASM per aircraft per year. The average aircraft utility was used in converting the simulated capacity and aircraft orders, both measured in billion ASM in simulation, into fleet size and aircraft orders, measured in aircraft units, respectively.

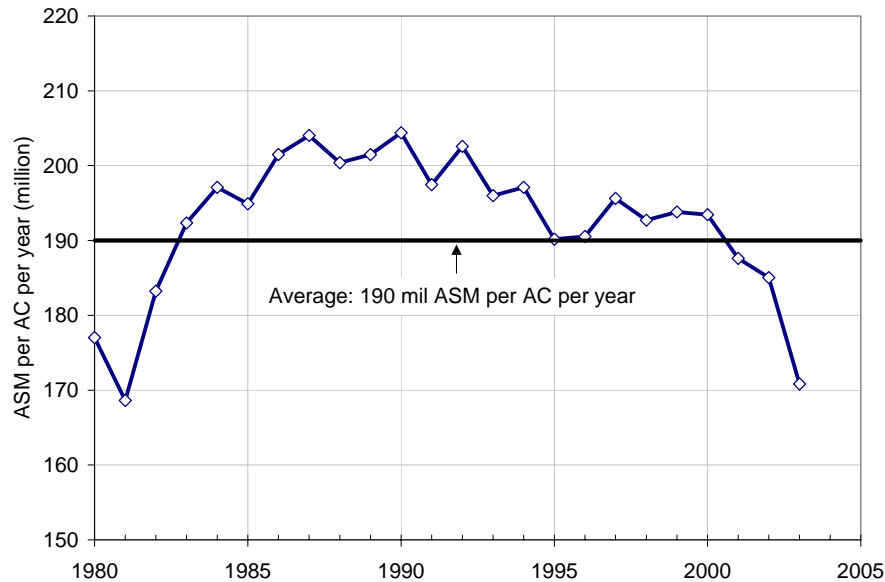

Figure A-1 System-wide Aircraft Utility of the U.S. Airlines [12]

APPENDIX B

Cost Analysis of the U.S. Major and National Passenger Carriers

This section analyzes the cost structure of the U.S. major and national passenger carriers. Conclusions drawn from the analysis provide the foundation for simulations in Chapters 6 and 7.

All revenue and cost items in this chapter are evaluated in constant 2000 dollars and are for the U.S. major and national passenger carriers. According to the Department of Transportation, majors are the carriers whose annual operating revenues are more than 1 billion dollars; and the nationals are those with revenues between 100 million and 1 billion dollars. The passenger revenues of the major and national passenger carriers together accounted for approximately 99% of the total passenger revenues of the U.S. airline industry after 1990, according to author's calculation based on DOT Form 41 data. Therefore, the cost structure of the U.S. major and national passenger carriers is a sound representation of the cost structure of the U.S. passenger services.

B.1 Introduction and Methodology

Figure B-1 depicts unit passenger revenues and unit operating expenses of the U.S. major and national passenger carriers recorded in Form 41 [12]. The unit passenger revenue, abbreviated as RASM, is the passenger revenue per ASM; and the unit operating expense is the operating expense per ASM. Shown in Figure B-1, RASM and unit operating expense have decreased continuously despite of fluctuations. This long-term trend is primarily due to market competition, entrance of low-cost carriers, advance in technology, introduction of better aircraft,

and improvement in operating efficiency. The operating expense consists of many items; and some of them, as shall be discussed below, have weak correlation with the profit. Therefore, it is necessary to examine the cost components closely to determine the extent to which the profit could have impact on.

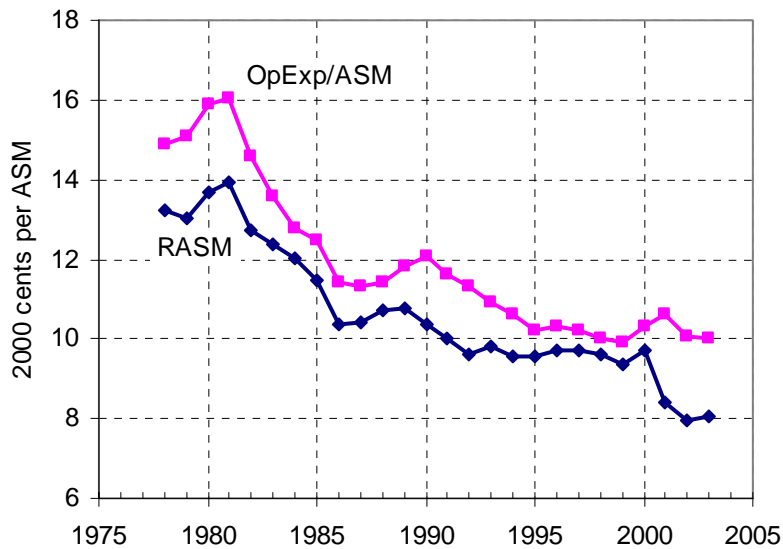

Figure B-1 RASMs and Unit Operating Expenses of the U.S. Major and National Passenger Carriers [12]

The operating expenses were constructed by the objective groupings following the methodology developed by ATA; and corresponding cost breakdown data in ATA Airline Cost Index that were originally from Form 41 were analyzed [14]. Each cost item was carefully examined in terms of real value (2000 \$), share in unit operating expense, driving factors, and its sensitivity to profits. Since the cost is essentially based on the operation need, profitability is considered responsible for the fluctuations of some cost items over the time. Consequently, the cost is classified into two parts: profit-sensitive component and less-profit-sensitive component. The share of annual fluctuations of profit-sensitive cost items in unit operating expense is

considered as an indicator of the impact of profit on cost; and the share of annual fluctuation in 1980 is of particular interest for simulation initiation reasons.

B.2 Cost Analysis

B.2.1 Labor

Labor cost includes salaries, employee benefits and payroll taxes for general management, flight personnel, maintenance labor, aircraft & traffic handling personnel and other personnel. Figure B-2 shows the unit labor cost (labor cost per ASM) and its share in unit operating expense [14].

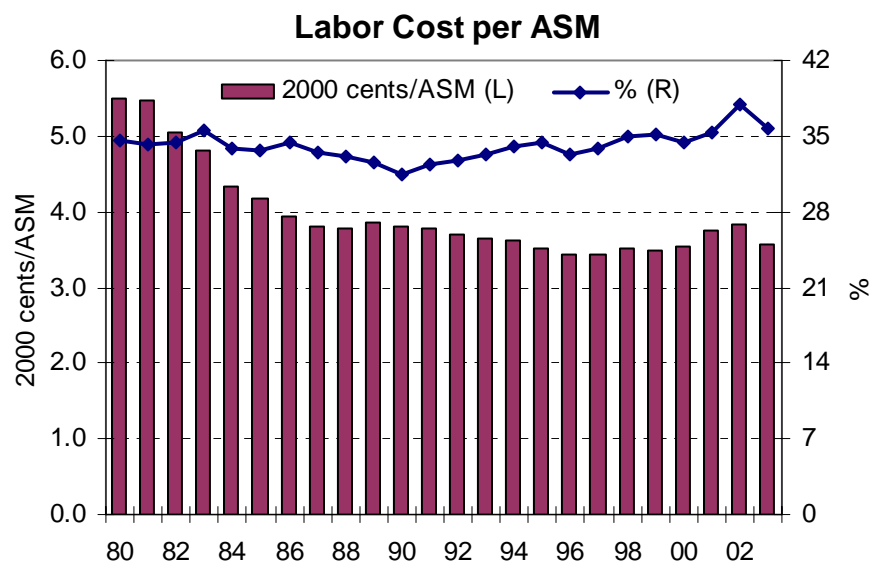

Figure B-2 Unit Labor Costs of the U.S. Majors and Nationals Passenger Carriers [14]

The unit labor cost decreased from 5.5 cents/ASM in 1980 to 3.5 cents/ASM in 2003. However, its share in unit operating expense varied between 32% and 38%, with an average of 34%. Profit contributes to the fluctuations in labor costs through contract negotiation: when the airline is profitable, labor groups would negotiate with the management for wage raise and

benefit improvement; whereas when the airline is in loss, the management would turn to cut the package and headcount. The annual fluctuation in unit labor cost ranged from 0.5-cent/ASM reduction in 1984 to 0.2-cent/ASM increase in 2001, corresponding to 3.9% reduction in unit operating expense in 1984 and 1.9% increase in 2001 respectively. The unit labor cost reduced by 0.2 cent/ASM from 1979 level to 5.5 cents/ASM in 1980, representing a 1.4% reduction in unit operating expense.

B.2.2 Materials Purchased: Fuel, Food and Maintenance Materials

Items in this category include aircraft fuel, passenger food and beverage, maintenance materials, and other materials.

Figure B-3 shows the aircraft fuel cost per ASM and its share in unit operating expense [14]. The unit fuel cost dropped from 4.7 cents/ASM in 1980 to 1.3 cents/ASM in 2003, less than 1/3 of the 1980 level. Correspondingly, the percentage of fuel consumption in unit operating expense reduced from nearly 30% in 1980 to 13% in 2003.

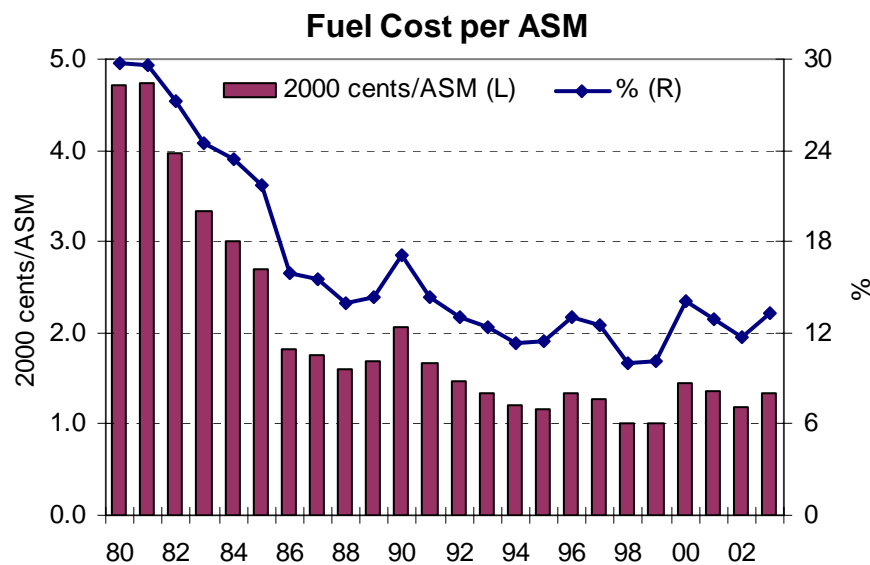

Figure B-3 Unit Fuel Costs of the U.S. Major and National Passenger Carriers [14]

Fuel costs are very sensitive to the jet fuel and crude oil prices. Figure B-4 depicts the historical average jet fuel prices of the U.S. major, national and large regional carriers of all services and the crude oil prices over the period, noticing that the annual average jet fuel prices instead of monthly data during 1980 and 1985 were plotted due to data availability [20]. As can be seen, unit fuel costs in Figure B-3 closely sensed the fluctuations in jet fuel and crude oil prices in Figure B-4. The low fuel prices during the 1990s should be credited to the decreasing unit fuel costs in the same period. Other factors that contributed to the unit fuel cost reduction include introduction of more fuel-efficient aircraft and improvement in operations.

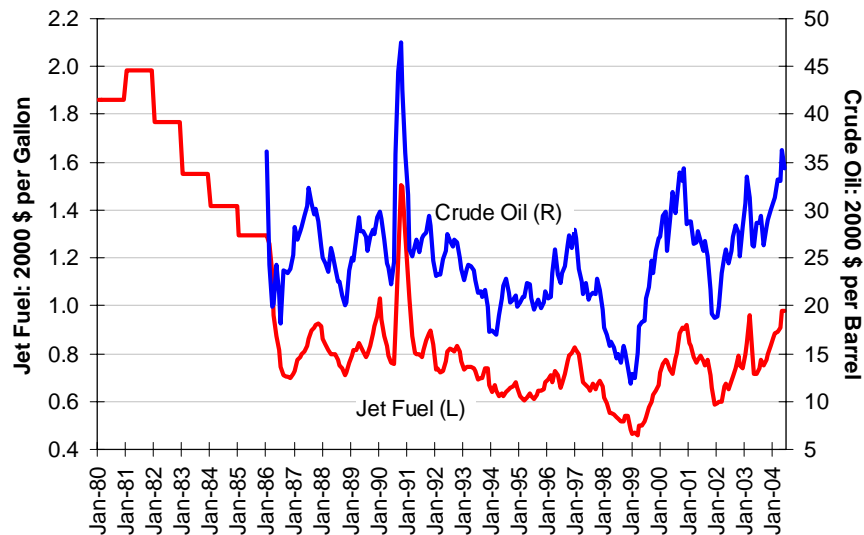

Figure B-4 Historical Average Jet Fuel Prices of the U.S. Major, National and Large Regional Carriers of All Services and Crude Oil Prices [20]

Figure B-5 shows the unit costs of food and beverage [14]. The food costs are driven by the revenue passenger traffic. Starting from the early 1990s, the food costs have been constantly decreasing due to the simplification of catering services abroad and the need to compete with low-cost carriers.

Seen in Figure B-6, the percentage of unit costs of maintenance materials fluctuated between 2% and 3% of unit operating expenses [14]. This part of cost is more relevant to the type of aircraft, age of fleet and aircraft operation hours.

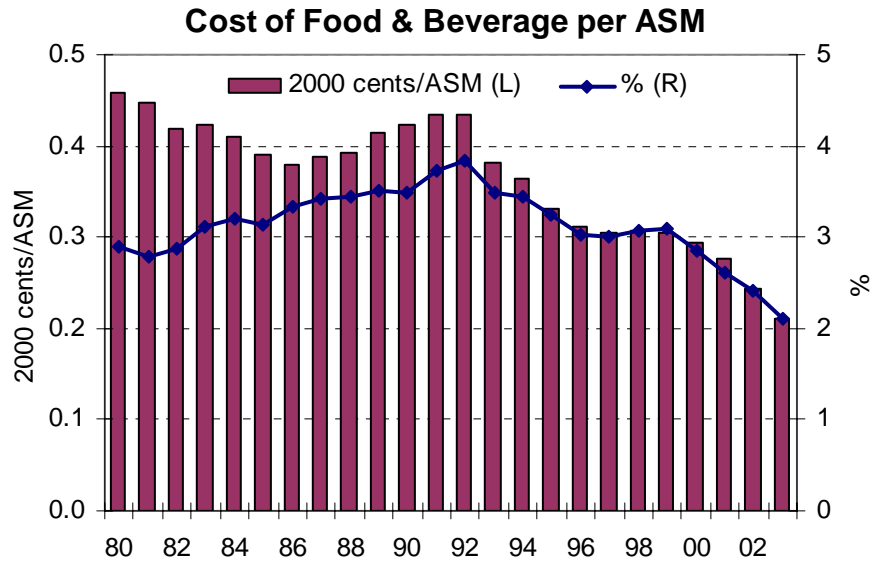

Figure B-5 Unit Costs of Food and Beverage of the U.S. Major and National Passenger Carriers [14]

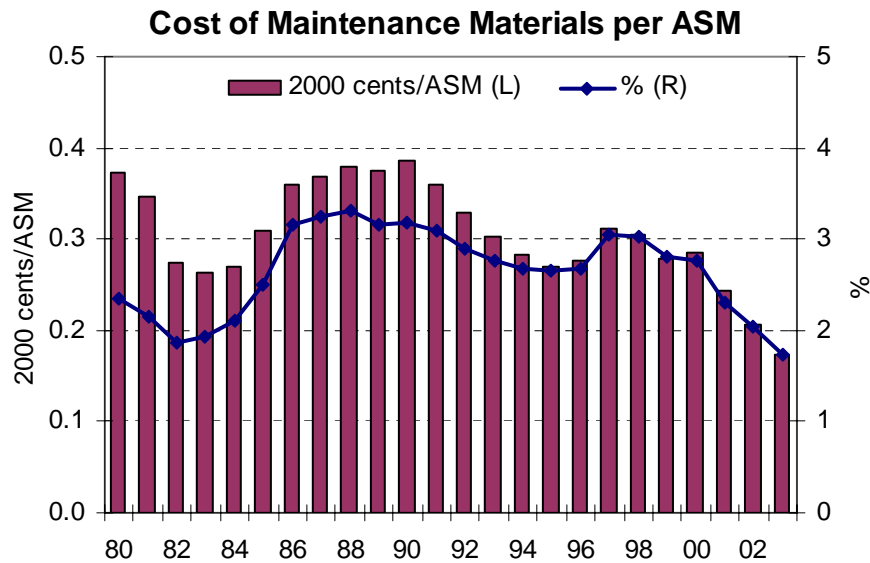

Figure B-6 Unit Costs of Maintenance Materials of the U.S. Major and National Passenger Carriers [14]

Therefore, fuel, food and beverage, and maintenance materials are not considered as cost components that are sensitive to the airline profits.

B.2.3 Aircraft Ownership and Non-Aircraft Ownership

Figure B-7 depicts aircraft ownership costs, which include the costs for aircraft rentals, depreciation of airframes, aircraft engines, airframe parts, aircraft engine parts and other flight equipment, and amortization expenses and capital leases [14]. The share of aircraft ownership cost in operating expense more than doubled over the past two decades, growing from 4.5% in 1980 to 10% in 2003. Figure B-8 shows the non-aircraft ownership costs, which include the rental costs for facilities other than flight equipment and parts plus depreciation and amortization expenses [14]. Again, the share of non-aircraft ownership cost doubled from 2.6% in 1980 to 5.3% in 2003. Collectively, the ownership costs accounted for more than 15% in 2003, twice the level in 1980.

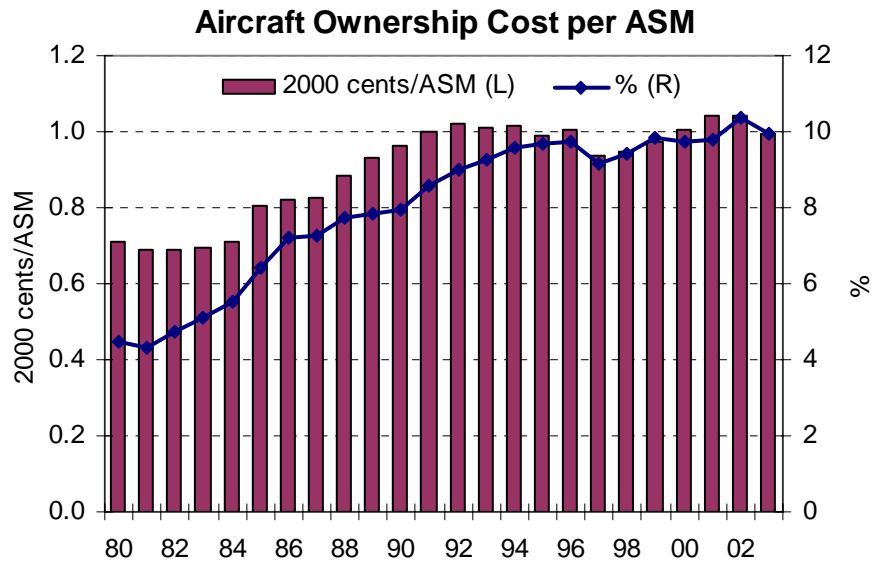

Figure B-7 Unit Costs of Aircraft Ownership of the U.S. Major and National Passenger Carriers [14]

The increasing ownership costs were largely due to airlines' expansion in fleet, network, operations and services, which often came with capacity increase, either fleet or ground facilities. Profits were considered responsible for the increase in ownership costs. The annual fluctuation in ownership costs accounted for 0.42 cent/ASM or 2.7% of unit operating expense in 1980.

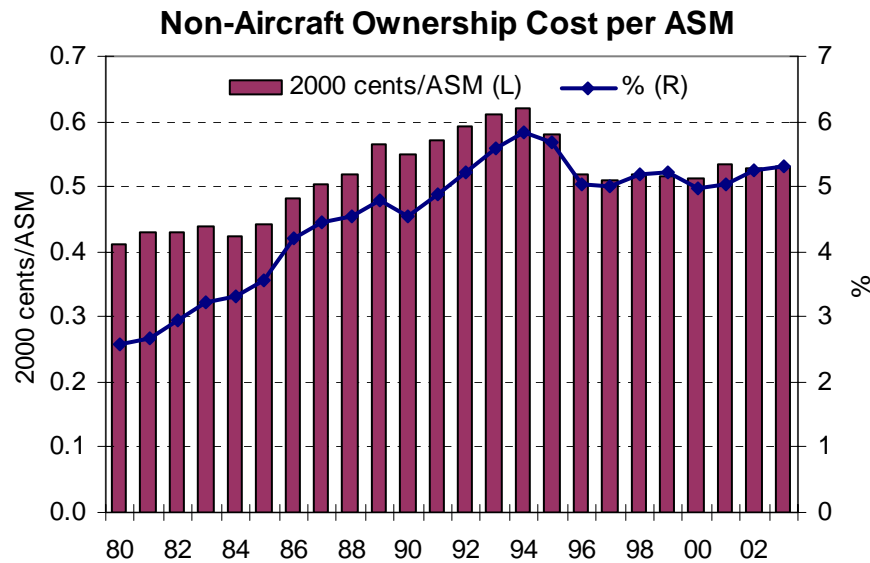

Figure B-8 Unit Costs of Non-Aircraft Ownership of the U.S. Major and National Passenger Carriers [14]

B.2.4 Landing Fees

Seen in Figure B-9, the unit costs of landing fees varied around 2% of unit operating expenses between 1980 and 2003 [14]. The landing fees are charged based on the number of revenue departures and available tons each departure. The annual fluctuation of landing fees varies from -0.1% to 0.1% of unit operating expense during the period analyzed except 2002 which was 0.2%. Therefore, the possible profit impact on landing fees was ignored.

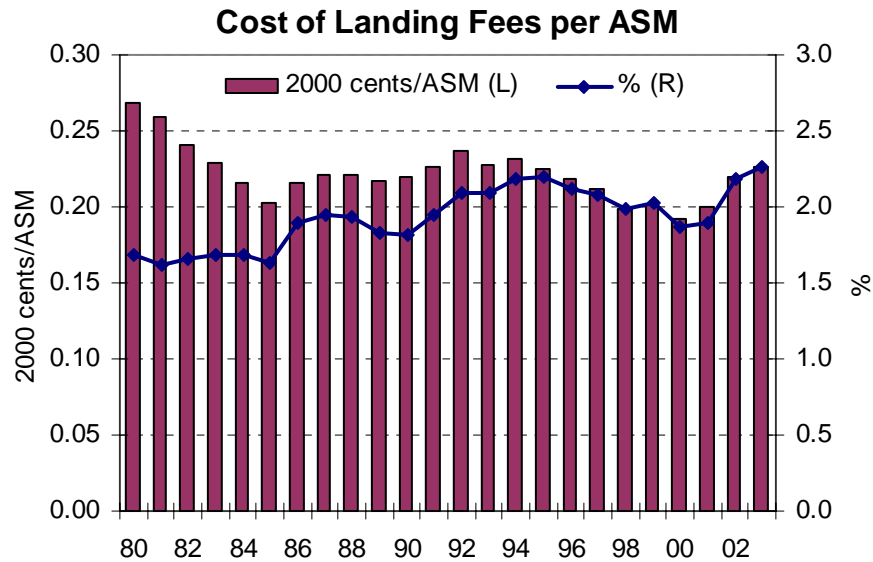

Figure B-9 Unit Costs of Landing Fees of the U.S. Major and National Passenger Carriers [14]

B.2.5 Services Purchased

Cost components in this category include professional services, passenger commission, advertising and promotions, communications, insurance, and other services.

Figure B-10 shows the unit costs of professional services including outside maintenance [14]. The share of professional services increased from less than 2% of operating expense in 1980 to more than 9% in the late 1990s, largely due to the capacity growth and the industrial trend of increasing outsourcing.

Figure B-11 and B-12 illustrate the commission costs and the advertising and promotion costs respectively [14]. Both items are driven by the revenue passenger traffic and have decreasing shares; especially the share of commission cost dropped approximately 9.5% in ten years, from 11.2% in 1993 to 1.7% in 2003. The decreasing commission and promotion costs could attribute to the boom of Internet and the increasing popularity of web-based computer reservation system (CRS) during the period.

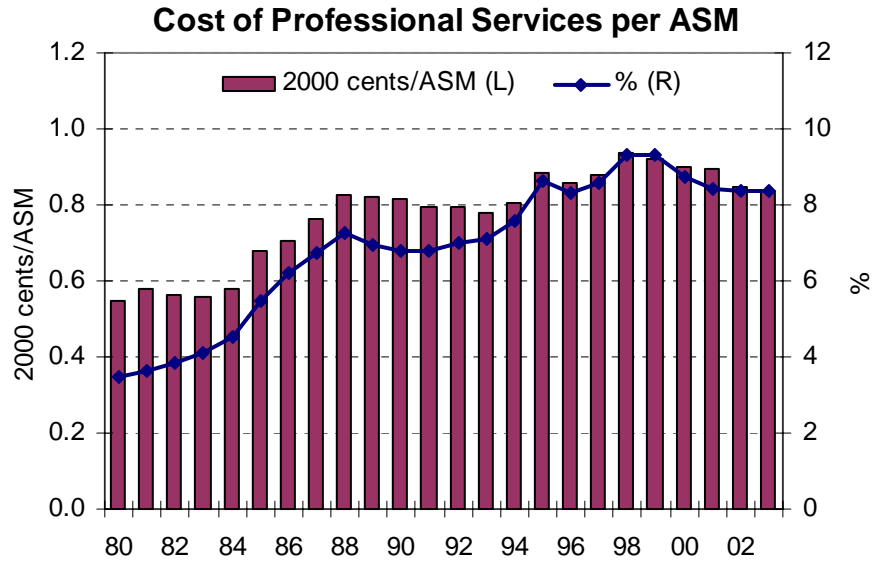

Figure B-10 Unit Costs of Professional Services of the U.S. Major and National Passenger Carriers [14]

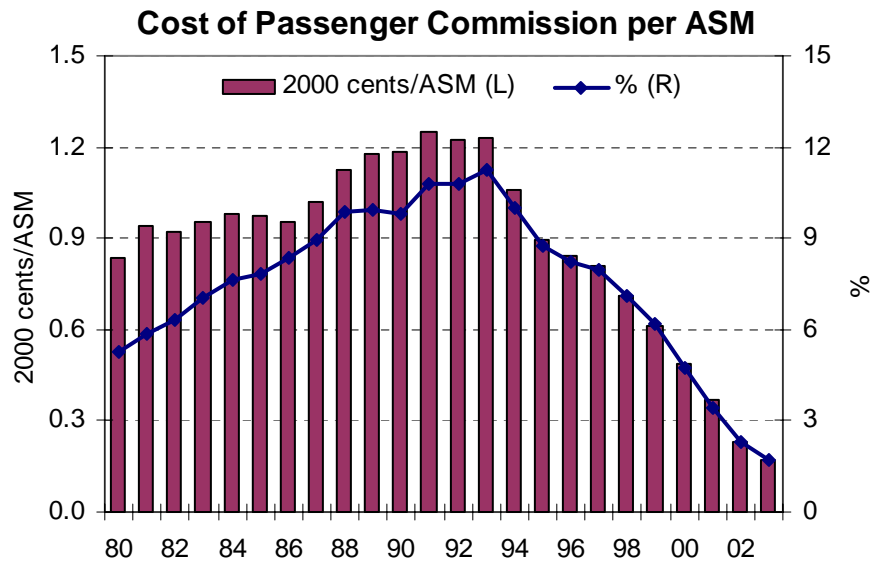

Figure B-11 Unit Costs of Passenger Commission of the U.S. Major and National Passenger Carriers [14]

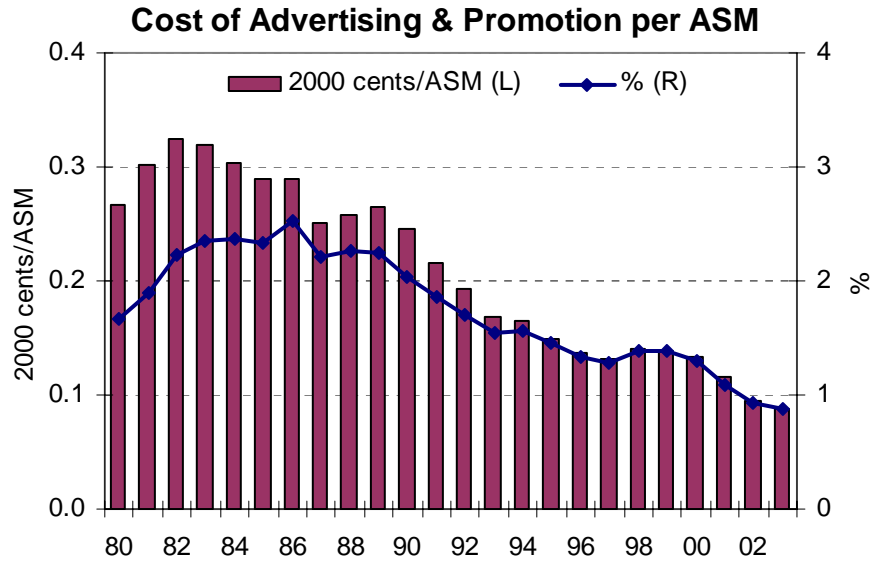

Figure B-12 Unit Costs of Advertising and Promotion of the U.S. Major and National Passenger Carriers [14]

Figure B-13 and B-14 depict the unit costs for aircraft insurance and non-aircraft insurance respectively [14]. The aircraft insurance charge is based on the hull net book value that is related to the fleet age, while the non-aircraft insurance is related to the revenue passenger traffic. Seen in Figure B-14, the non-aircraft insurance increased from 0.4% in 2001 to more than 1% due to changes in insurance policy after the September 11 event. The two insurance components collectively accounted for at most 1.6% of unit operating expense; therefore, profit impact on insurance was ignored.

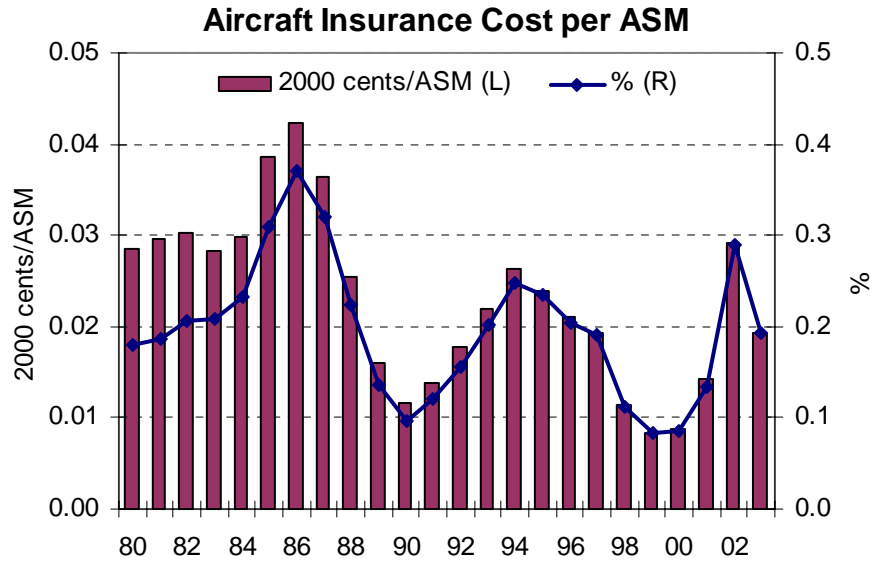

Figure B-13 Unit Costs of Aircraft Insurance of the U.S. Major and National Passenger Carriers [14]

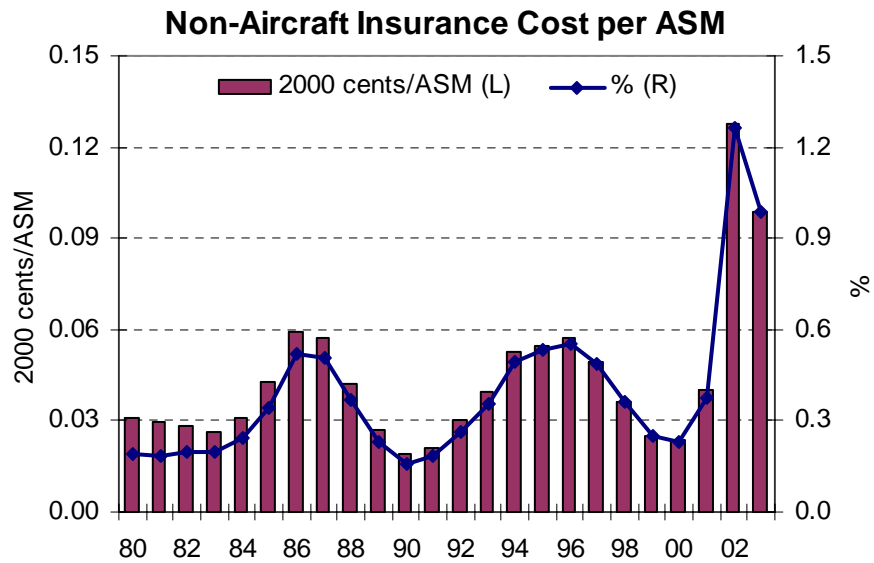

Figure B-14 Unit Costs of Non-Aircraft Insurance of the U.S. Major and National Passenger Carriers [14]

B.2.6 Summary of Cost Analysis

Overall, the unit operating expense has decreased over the period analyzed. This long-term trend is credited to competition, low-cost carrier prosperity, plus improvement in technology and operation. Such long-term decreasing trend is likely to continue in the future.

The cost allocations in 1980, 2000 and 2003 are shown in Figures 7-15 through 7-17 to illustrate the cost structure of the U.S. major and national passenger carriers at the stage of early deregulation, after deregulation and after the effects in 2001 [14]. Seen from the figures, labor remains the largest single cost item through the years, accounting for more than one third of unit operating expense. Fuel and commission costs have been through significant reductions in terms of share distribution over the period, while professional services, aircraft ownership and non-aircraft ownership are among the items experiencing most increases.

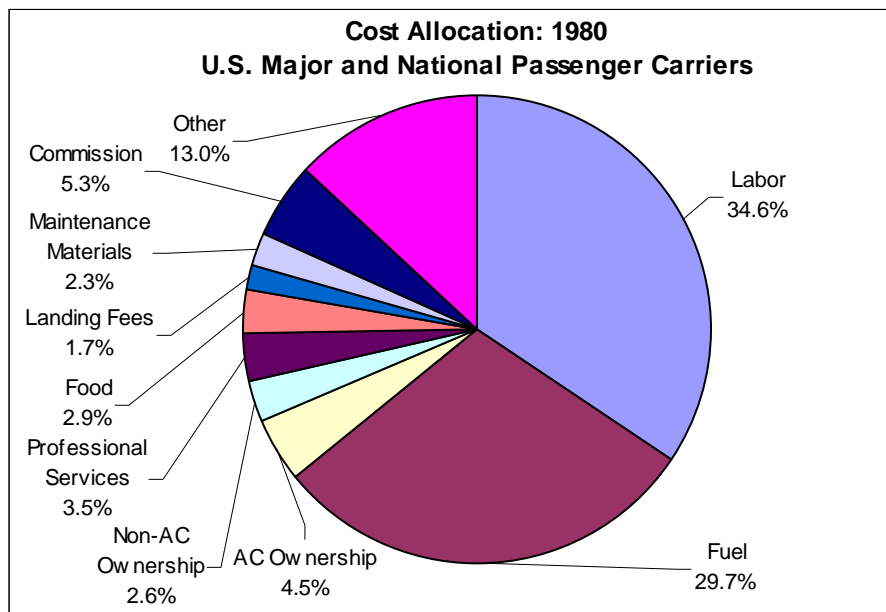

Figure B-15 Cost Allocation of the U.S. Major and National Passenger Carriers in 1980 [14]

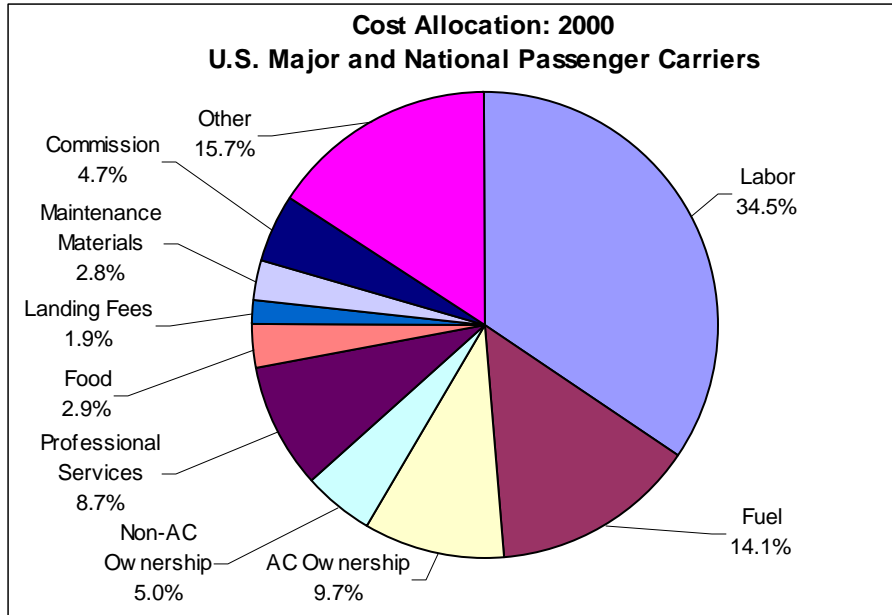

Figure B-16 Cost Allocation of the U.S. Major and National Passenger Carriers in 2000 [14]

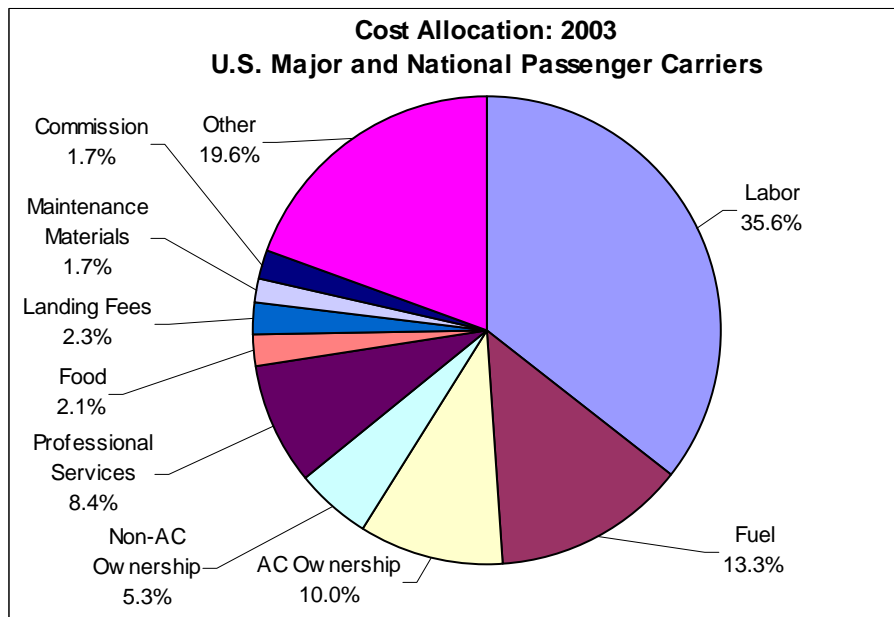

Figure B-17 Cost Allocation of the U.S. Major and National Passenger Carriers in 2003 [14]

Profitability is considered to have impact on the fluctuations in labor, aircraft ownership and non-aircraft ownership costs. The unit costs of labor and aircraft/non-aircraft ownership amount on average 47% of unit operating expense. The annual fluctuations in labor cost and

aircraft/non-aircraft ownership costs accounted for 4.1% of unit operating expense in 1980, of which, 1.7% was due to labor and 2.4% due to ownership. This ratio was used to assess the initial value of CASM2, to be discussed below, for the simulation in Chapter 6.

B.3 Cost Adjustment

Seen in Figure B-1, the unit operating expense is always higher than RASM. This is because the total operating expense combines the expenses within one airline from different operations, such as passenger, cargo and hotel business, whereas RASM is a revenue measurement exclusively for passenger services. Therefore, direct comparison between RASM and unit operating expense is of little sense. Adjustment on unit operating expense is essential in order to make fair comparison between RASM and unit operating expense.

The unit operating expense was adjusted through prorating. Figure B-18 shows the shares of passenger revenues in total operating revenues of the U.S. major and national passenger carriers, based on DOT Form 41 data [12]. The average share was about 88% between 1980 and 2003, despite of 83% in 2003. Assuming operating expenses had the same distribution across the business units as operating revenues, the unit operating expense regarding passenger services was adjusted by prorating. The unit operating expense after adjustment with respect to passenger services is defined as CASM in this study and is shown in Figure B-19 and Figure 6-1.

CASM is split into two components: CASM1 and CASM2; where CASM2 represents the profit-sensitive component of CASM including fluctuations in labor and aircraft/non-aircraft ownership costs, and CASM1 is less sensitive to profits. Based on previous cost analysis results, the initial value of CASM2 was assumed as 4.1% of CASM in 1980 for the simulation in Chapter 6, and the initial value of CASM1 was thus approximately 96% of CASM then.

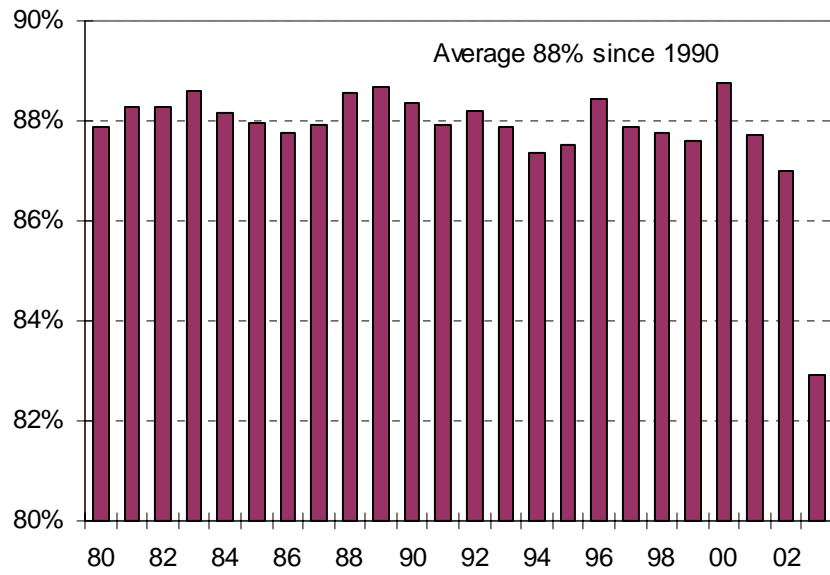

Figure B-18 Share of Passenger Revenues in Total Operating Revenues of the U.S. Major and National Passenger Carriers [12]

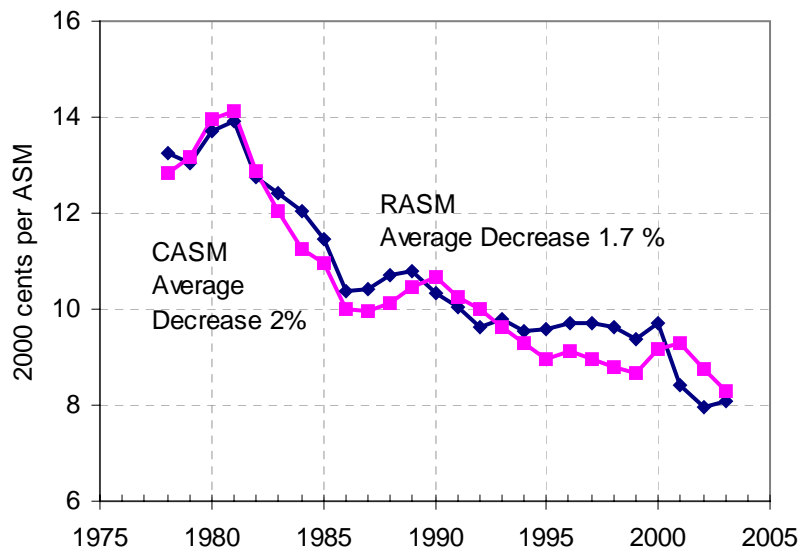

Figure B-19 RASM and CASM of the U.S. Major and National Passenger Carriers