

600

Failsafe

living with man-made disaster and accident

by Saoirse Higgins

M.A Interactive Media (1995) RCA, London.

B.Des Product Design (1987) NCAD, Dublin.

Submitted to the Program in Media Arts and Sciences
School of Architecture and Planning
in partial fulfillment of the requirements of the degree of
Master of Science in Media Arts and Sciences at the
Massachusetts Institute of Technology

September 2004

© 2004 Massachusetts Institute of Technology
All rights reserved

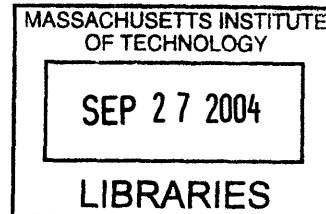

.....
Signature of Author 
May 12, 2004

ROTC

.....
Thesis Advisor
Chris Csikszentmihályi
Assistant Professor of Media Arts and Sciences

.....

Accepted by
Andrew B. Lippman
Chair, Departmental Committee on Graduate Studies
Program in Media Arts and Sciences

Failsafe

living with man-made disaster and accident

by Saoirse Higgins

Submitted to the Program in Media Arts and Sciences
School of Architecture and Planning
in partial fulfillment of the requirements of the degree of
Master of Science in Media Arts and Sciences at the
Massachusetts Institute of Technology

September 2004

1.0 Abstract

"There is no progress with out progress of the catastrophe." Virilio

This thesis project proposes that technological solutions in the design of our systems are not enough to prevent 'man-made' accident. Social, organisational and political means are needed to understand the causes of disaster in the twenty-first century. This project conducts an autopsy on an historic technological disaster case examining the build up to the accident. The object of the experiment (artwork) is to examine the inevitability of accidents, highlight to the viewer that risk is intrinsic to our world, and that technological disaster will be an integral part in our lives in the 21st century.

Thesis supervisor: Chris Csikszentmihalyi
Assistant Professor of Media Arts and Sciences
MIT Media Laboratory

Failsafe

living with man-made disaster and accident

by Saoirse Higgins

M.A Interactive Media (1995) RCA, London.

B.Des Product Design (1987) NCAD, Dublin.

Submitted to the Program in Media Arts and Sciences
School of Architecture and Planning
in partial fulfillment of the requirements of the degree of
Master of Science in Media Arts and Sciences at the
Massachusetts Institute of Technology

September 2004

© 2004 Massachusetts Institute of Technology

All rights reserved



Thesis Reader

John Maeda

Associate Professor of Design and Computation



Thesis Reader

Stefan Helmreich

Assistant Professor of Anthropology

Acknowledgments

I would like to dedicate this thesis to my mother Geraldine. I would also like to dedicate it to: my dad-Tom for his untiring love and support in all that I try to do, bro-Fionan, for trying to get here; Aisling for her sisterly steadfastness and Linn for her two and a half years of wisdom.

I would like to thank all the members of my research group for their support and friendship: Simon for his great collaborations and here's to many more; to Kelly for her machine therapy session; Limor for her coolchick electronics; Tad for his cup cakes; Lira for her sense of design and Elizabeth for her backup help throughout the two years.

I am grateful to Chris for his support and encouragement in pushing me creatively ever further. Also to John Maeda and Stefan Helmreich for their invaluable time and effort with comments for my thesis. To Claire Montgomery for giving me the opportunity to develop this project in the Location One gallery.

To the close friends I have made in my time here, I thank them for keeping me happy: Amanda for next president, Lara for her Brooklyn minibreaks, Hugo for best hugs, Ben for always being there when we need him, Benoit for the french accident translation into perfect English, Sam for fixing my bike, and all the great friends I have made at the media lab who made the two years unforgettable.

Table of Contents

1.0 Abstract

2.0 Introduction

2.1 Motivation

3.0 Background

3.1 History of accident, disaster, technological accident.

3.1.1 introduction

3.1.2 Accident

3.1.3 Disaster

3.1.4 Technological disaster and accident

3.2 Taxonomy of disaster and accident

3.3 Technological theories of accident

3.3.1 Normal accident theory

3.3.2 Externalities of the system

3.3.3 Risk

3.3.3.1 Types of risk

3.4 Technology in an Age of Terror

3.4.1 Misuse of Technology

3.4.1.1 overview

3.4.1.2 Invisible misuse

3.4.1.3 Opaque misuse

3.4.1.4 Suicide bombers

3.4.1.5 Making a terrorist

3.4.2 Attempts to prevent misuse of technology

3.4.2.1 Overview

3.4.2.2 The perfect safe airport

3.4.2.3 Tombstone technology

3.4.2.4 Freedom tower design: future architecture of safety

3.4.2.5 Cultural threat integration

3.5 Dealing with Disaster

3.5.1 Philosophers of disaster

3.5.2 Popular Culture

3.5.2.1 Overview

3.5.2.2 Mary Shelley's Frankenstein

3.5.2.3 Lem's The Cyberiad

3.5.3 film/video

3.5.3.1 Sontag and the essence of science fiction film

3.5.3.2 Film as cause of disaster

3.5.4 Fine Art

3.5.4.1 Overview

4.0 Experiments

4.1 Overview

4.2 Experiment one: The Doom Machine

4.2.1 Influences

4.2.2 Background scene

4.2.3 How it works

4.2.4 The torino scale

4.2.5 The Doom scale

4.2.6 Sound

4.2.6.1 Doomlevel

4.2.6.2 Doomcast

4.2.7 Video

4.2.8 Technical plan

4.2.9 Evaluation

4.3 Experiment two: Mechanism no. 1:War

4.3.1 Introduction

4.3.2 The drummer boy significance

4.3.3 Setting

4.3.4 Interaction

4.3.5 Technical details

4.3.6 Sound

4.3.7 Evaluation of exhibition

4.4 Experiment three: Shuttle demonstration

4.5 Failsafe installation

4.5.1 Installation background

4.5.2 MIT Cryogenics Laboratory

4.5.3 Cryogenics accident report

4.5.4 Approach to the artwork

4.5.5 Cryogenics or cryonics?

4.5.6 Science of cryogenics and what can go wrong.

4.5.7 Handling cryogenic material

4.5.8 Cryonics process

4.5.9 Pompeii influence

- 4.5.9.1 *the pompeii volcano history*
- 4.5.10 *Installation details and layout*
 - 4.5.10.1 *Scale*
 - 4.5.10.1.1 *Ron Mueck and scale*
 - 4.5.10.1.2 *Me and scale*
- 4.5.11 *The accident story*
 - 4.5.11.1.1 *Perspectives*
 - 4.5.11.1.2 *Expert narrative*
 - 4.5.11.1.3 *Operator narrative*
 - 4.5.11.1.4 *Machine narrative*
- 4.5.12 *Sound interaction*
 - 4.5.12.1 *Current systems*
 - 4.5.12.2 *Binaural sound*
- 4.5.13 *Spacial considerations*
- 4.5.14 *The sense of touch*
- 4.5.15 *Making the scientists*
 - 4.5.15.1 *Process background*
 - 4.5.15.2 *3d digitising*
 - 4.5.15.3 *3d model manipulation*
 - 4.5.15.4 *3d printing*
- 4.5.16 *Experiment Objectives*

5.0 Discussion and Analysis

5.1 What do the audience get from the interaction?

5.2 Installation Outcomes

5.3 Audience feedback and evaluation

5.4 Critics comments

5.5 Alternate scenarios in Failsafe

6.0 Conclusions and Future Developments

7.0 Appendix

8.0 Bibliography and References

2.0 Introduction

Large scale, real time failure was a prominent feature of the late twentieth century, and fear of such failure has inaugurated the twenty-first century. The French philosopher Paul Virilio says that a civilization that sets immediacy, ubiquity and instantaneity to work brings accident and disaster into the scene. Perfection is something we strive for in our systems. While we often try to factor in the prospect of an accident, technology can only be as perfect, precise and efficient as the weakest link designing, maintaining, or running the system. This thesis begins with the history of disaster, accident and when accident became technological. I then examine technological theories of disaster and risk. I look at how we are coping with these risks and man-made disaster in this century, looking at the misuses of technology and our attempts to prevent misuse. I explore how we deal with disaster through analysis by sociologists, anthropologists and philosophers, and through popular culture.

In section four I explain my series of experiments examining fear and uncertainty in the world. I describe each experiment and evaluate each one from the perspective of the audience that interacted with them. I then discuss 'Failsafe'-the final installation that focuses on technological accident in particular. This installation depicts a cryogenics accident that froze five scientists in minutes. It is reminiscent of the classic Frankenstein story-but a version for the twenty-first century. The disaster symbolises this current era of invisible threat and preoccupation with security and safety. I discuss the background research, tests and techniques that went into the development of this installation. I write about the evaluation of the installation and draw conclusions for my future research development.

I conclude that to design a technological system for the future a number of factors need to be considered that are not normally highlighted in the design process. We need to acknowledge the invisible threats that we are facing and our new fear and wariness post 9/11. We need to incorporate our imperfect behaviours into the design of a system since we are not, or ever will be, perfect. The social and cultural narratives also need to be examined and applied to the design process.

2.1 Motivation

My thesis project is a reaction to twenty-first century disaster. It is perhaps a less dangerous commentary on the current tenuous situation in the world with

regard to daily global risks than the safety devices put in place after September 11th. It is less dangerous because it examines the wide ranging contributory factors to the build up to disaster. The thesis looks not only at the immediate causes but probes in more depth at the nature of man-made disaster and accident. By discussing and analysing this topic, I would hope to expand the parameters for future critical thinking on dealing with twenty first century disaster. My aim is to highlight how preoccupied we have become with unknown invisible danger, and to make a symbolic representation of our fears of impending threat to our world.

3.0 Background

3.1 History of accident, disaster, technology

3.1.1 Introduction

In this section I will examine the history of the accident and its providential powers in the seventeenth century according to Michael Witmore, a Professor of Literary and Cultural Studies at Carnegie Mellon University. He has studied how accidental events became a privileged means of discovery in the seventeenth century. I will also look at Hans Blumenburg and his escapist model of the sea. Blumenburg is a German anthropologist. His work in the 1960s was significant for his series of considerations of human consciousness. I then move on to discuss political scientist Michael Barkun's definition of disaster in relation to the Millennium, from his essay that he wrote in the 70s 'Disaster in the Millennium.' Barkun has written extensively about millennialism. He related the concept of disaster to a permanent change to the environment and the concept of the accident to a less significant, more temporary change. I then shift to the meaning of technology and look to the German philosopher and phenomenologist Heidegger (from the Frankfurt school, together with Hannah Arendt) for his argument that understanding technology cannot be explained in purely instrumental terms- similar to Witmore's argument that accident is a cultural narrative, a 'prose.' Many complex causation factors contribute to both accident and technology. Having historically defined accident, disaster, and technology I then examine when accident became technological. Rosalind Williams, Professor of Writing and Humanistic study at MIT attributes this change to the development of the railroads which opened up human networks, and as a consequence spread technological accident.

3.1.2 Accident

There was a time when accident was not automatically associated with tech-

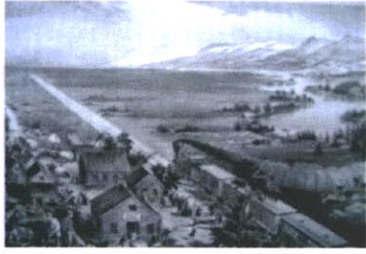

fig 1. Across the continent: westward the course of empire takes its way, 1868 Currier and Ives.

nology. In the sixteenth and seventeenth century accident had the generic meaning of 'event' or 'occurrence.' It had a long standing association with the operations of chance and fortune. Writing in 1603 Francis Bacon said, "accident and experiment require an unusual disposition of circumstances which is what makes both a powerful engine for discovery." (p.112,2001:Witmore) Accidents had the power to change the way people normally looked at events. The change in expectation and attention gave accidents unusual epistemological force in the skeptical context of the seventeenth century. (p.161:Popkin) English providentialists- William Gouge, John Fields and Philip Stubbs thought that "dramatic happenings in the world might persuade wayward individuals to renew their faith, subjecting them to the buried knowledge of God's power."(p.6,2001:Witmore) Accidents blurred the boundary between real and spiritual worlds, acting as an interface between the two. A significant accident in England in Blackfriars church, London in 1623 provides a good example of this interface. Primarily Protestants dominated England at this time and it was virtually forbidden for Catholics to gather and pray openly. On October 25th,1623, while Catholics were praying in Blackfriars church, the floor collapsed killing one hundred of them. This event caused major consternation in the community, as Protestants widely presumed that God was punishing the Catholics for practising their religion. The survivors were urged by many pamphleteers of the time to look at the accident as a sign from God to convert to Protestantism.

In the seventeenth and eighteenth century seafaring was seen as a transgression of natural boundaries that was likely to result in punishment. Man was not content with his natural domain and wanted to cross the borders. Hans Blumenburg saw a persistent escapist model in the sea. "In the modern world we are concerned with mastering nature. Biotech and genetics are seen as somehow driving us into treacherous waters." (p.127,2001:Witmore) Man is still preoccupied with this challenge using technology. According to Michael Witmore in the Culture of Accidents, accidents do not simply happen in a cultural void, but result when certain narrative conventions (a plot) come into contact with communal beliefs about what is likely, valuable or the purpose of the accident. Witmore writes that this is tantamount to saying accident is a narrative artifact, one that draws its power from assumptions about what is usually the case and more important assumptions about value of certain outcomes or events. "What makes accident a powerful focal point for cultural interest in any historical period is the way in which it puts this plural sense of cultural value into play allowing such value to be shifted, contested, or openly debated in either narrative or dialectical form."(p.14,2001:Witmore)

3.1.2 Definition of Disaster

Michael Barkun's study 'Disaster and the Millennium'(1974) describes disaster as being a "long term and fundamental destruction of the primary environment" whereas accidents were "episodes that may severely affect a community but that do not lead to fundamental social change." (p.200,1990:Williams)

According to Barkun, disasters are more severe than accidents - more global than local. Williams says that disaster has long been more associated with nature (the "natural disaster"), accident with man-made or unknown spiritual intervention. Normal nature aided by technology can benefit humanity. Disaster emanates from abnormal nature. Nature intertwined with technology has created abnormal nature, and thus the potential for new forms of disaster. If mankind has created technology and this has developed abnormal nature then mankind has created the new forms of disaster in the twenty first century. I categorise these forms as man-made natural disaster and technological disaster. "In the 20th century our fear is not what nature can do to us, but what we might do to it."(p.190,1990:Williams)

3.1.3 Definition of Technological disaster/accident

The word technology is derived from the Ancient Greek word 'tekhne' meaning art or craft. In modern parlance, the meaning of technology has tended to take on the instrumental aspect implied in the word 'craft', focusing on the 'device' as opposed to both the web of human practices and to the material products of those practices. Heidegger, in his essay 'The Question Concerning Technology' attempts to show that a purely instrumental understanding of technology is a reductive one: it is reductive because if we discuss technology only in instrumental terms we leave out of our account what technology presupposes, and thereby something essential concerning what technology is. Thus, Heidegger is careful to show that "the essence of technology is by no means anything technological." (p.311,1996:Heidegger) In other words, what is essential to technology cannot be accounted for in technological terms. (p.313,1996:Heidegger)

Disaster and accident only became associated with technology in the late nineteenth century. The association developed alongside the building of railroads at this time. As rail crashes began to happen so it increased the sense of the technological disaster. "The connecting links among nations, power grids, information networks began to make possible sharing of benefits but also spread of risk." (p.219,1999:Williams) The railroads and subsequent systems after this, such as electrical power, brought new far reaching risk to the public as well as new benefits.

With the development of new technological systems came new types of accident. In the next section I discuss some of these categories of disaster, particularly important man-made disaster of our time and man-made natural disaster.

3.2 Taxonomy of disaster and accident

From my research on the taxonomy of disaster (fig. 2) I have broken disaster down into three main categories- natural disasters, man-made natural disaster and man-made disaster. Natural disasters are caused by nature and preventing them is beyond our power although we do try to prepare for seasonal disasters, for example, by designing houses to withstand a hurricane, or protecting land from flooding by digging dikes. However, coping with natural disaster is within our possible range. Natural disasters, such as the recent 2003 Bam earthquake in Iran, effect the third world more devastatingly than the first world since there is little or no economic support to improve the situation before or after the crisis. The Bam earthquake killed approximately 30,000 people and injured another 30,000, leaving 75,000 homeless according to the New York Times. ('Deadly Earthquake Jolts City in Southeast Iran' Nazila Fathi: New York Times, December 26th 2003) The seismic intensity was 6.5 on the Richter scale compared to 7.1 on the scale for the 1989 earthquake in San Fransisco. The San Fransisco earthquake killed sixty seven people. It had a tragic effect but most of the modern houses survived. In Bam however, in addition to the fact that most people would have been asleep at the time, officials in Iran attributed the high number of deaths to the mud-brick construction of so many buildings. The houses were not designed to withstand earthquakes although it is known as a natural earthquake region.

Man-made natural disasters are a product of our times. We are dealing with what the media calls 'extreme weather conditions.' Extreme weather, such as flash flooding, is caused by global warming which is directly effected by the ozone hole, which is caused by CFC gases, for which we are responsible. Oil tankard accidents, such as that of the Exxon Valdez disaster, destroys nature. We are also responsible for the transport of oil on board vessels.

Man-made disaster has many categories. The recent power grid black out in Northern America in 2003, for example. The Shuttle disaster and the Concorde disaster are major 'keynote' accidents of our times. The two machines epitomised our former overriding glorification of technology's power in the early twentieth century, and the aftermath of these accidents showed our utter dismay at the 'experts' and technology letting us down.

fig.2 Taxonomy of disaster

1.1 Man-made disaster

- 1.1.1 Structural
 - 1.1.1.1 Bridge
 - 1.1.1.2 Football stadium
- 1.1.2 Explosion
 - 1.1.2.1 Building
 - 1.1.2.2 Machine
- 1.1.3 Black out
 - 1.1.3.1 Economic
 - 1.1.3.2 System
- 1.1.4 Space
- 1.1.5 Transport
 - 1.1.5.1 Land
 - 1.1.5.1.1 Rail
 - 1.1.5.1.2 Car
 - 1.1.5.1.3 Bus
 - 1.1.5.2 Sea
 - 1.1.5.2.1 Ship
 - 1.1.5.2.2 Submarine
 - 1.1.5.3 Air
 - 1.1.5.3.1 Airplane
 - 1.1.5.3.2 Balloon
- 1.1.6 Epidemics
- 1.1.7 Terrorism
 - 1.1.7.1 Bioterrorism
 - 1.1.7.2 chemicalterrorism
 - 1.1.7.3 Suicide bombers
 - 1.1.7.4 Lone bombers(timothymcveigh)
 - 1.1.7.5 Cyberterrorism
 - 1.1.7.6 Hijacking
 - 1.1.7.7 Car bombing
- 1.1.8 Famine
- 1.1.9 Financial
- 1.1.10 Poverty

1.2 Man-made natural disaster

- 1.2.1 Oil spill
- 1.2.2 Nuclear
- 1.2.3 Arson/fire
- 1.2.4 Chemical leak
- 1.2.5 Ozone hole
- 1.2.6 Global warming
- 1.2.7 Acid rain
- 1.2.8 Pollution
- 1.2.9 Dam burst

1.3 Natural disaster

- 1.1.1 tornado
- 1.1.2 hurricane
- 1.1.3 typhoon
- 1.1.4 floods
- 1.1.5 storm
- 1.1.6 earthquake
- 1.1.7 volcano
- 1.1.8 tsunami
- 1.1.10 avalanche
- 1.1.11 meteor
- 1.1.12 drought
- 1.1.13 Fire

3.3 Technological accident theory and risk.

In this section I look at the characteristics of the technological accident based on Charles Perrow's Normal Accident and Ulrich Beck's Risk Society. Perrow is a Professor of Sociology who worked mainly on organisational failure. He first wrote this book about high-risk accident in 1984 with an updated edition in 1999, just before the Y2K crisis. Ulrich Beck, a German sociologist of risk and the environment, wrote Risk Society in 1986. Both wrote within the same time period. Beck was struck by the open ended nature of risk. From his research he believed that industry and social complexity brought with it "manufactured uncertainty." (p.20,1986:Beck)

3.3.1 Perrow's 'Normal' accident theory

Small failures go on continuously in systems, since nothing is perfect, but the safety devices and skills of designers and the experience of operating personnel cope with this. If the system is tightly coupled all the components that make up the system have a tightly working tolerance. Occasionally two or more failures, none of them devastating in themselves in isolation, come together in unexpected ways and defeat the safety devices. This is what Perrow calls "normal accident theory." (p.357, Perrow, 2002) To have an accident, everything has to come together just right. When it does this we have 'negative synergy' in the system. The inevitability of an accident depends on the "interactive complexity" of a system. In the next section I discuss the risk involved in the interactive complexity of a system.

3.3.3 Risk

Ulrich Beck describes the risk faced in the world. He argues that the concept of risk in the time of Columbus, in the fifteenth and sixteenth century was an issue of personal bravery. He says that historically risks were perceptible for example; Paris in the eighteenth century was contaminated with disease and dirt which was an obvious threat to the personal body i.e. urine smelt bad. Now risks are not so perceptible-for example there now exists risks of toxins, GM foods, terrorist threats, anthrax, sarin gas and SARS. These type of risks, he suggests, are more dangerous because they cannot be seen. Risk has become a global problem. The ozone hole which falls into the category of man-made natural disaster, is a global invisible risk with fundamental consequences for future life on the planet.

3.3.3.1 Categories of risk

According to Perrow there are three possible categories of risk analysis: abso-

lute rationality, bounded rationality and social rationality.

Absolute rationality is used when the expert analysts operate on cost-benefit analysis to weigh up the risk factor to industry and to the public in a particular system. (Air accident analysts use this all the time. According to the PBS documentary Crash Site Secrets, TWA spent more on their music system than on safety procedures before the TWA 800 disaster). They stick to known facts and precise goals to make their assessment. Analysis by this means invariably does not work well, as the methods are inflexible to the nuances of human 'imperfect' behaviour. Analysts often insist that the public see the risk level from their expert point of view without allowing them to contribute to the debate. Industry is not good at predicting the public's accepted risk threshold for this reason.

A second category of risk analysis is bounded rationality. Some cognitive psychologists, specifically- Fishoff, Slovic and Lichtenstein, say that we minimize certain dangers and maximize others. (p.320,1999:Perrow-Fishoff). We judge danger by the most recent case we are familiar with and reference our reactions off that experience. For example, nuclear evacuation was treated in a similar manner to any other type of evacuation: During the war children were told to 'duck and hide.' We interchange criteria for both minor and major accidents.

The third category is social rationality, which acknowledges the need for social bonding between humans as a basis for risk assessment. Our world operates with loose tolerances -it is 'loosely coupled.' This means parts can adjust and move depending on changing situations. We operate using approximations and heuristics. Heuristics are defined by this group of psychologists as hunches, intuitions or practical problems and concrete experiences in daily life. It takes us a lot of effort to be precise in a technological world. "Both our predictions about the possibilities of accidents and our explanations of them after they occur are profoundly compromised by our act of social construction."(p.358,2002: Perrow) We use approximations in our decision making. We adapt and deviate from the 'default' to operate a system, dealing with smaller, local errors. The sum accumulation of this 'practical drift' can lead to larger more serious errors that run out of control. An example of this type of risk occurred in the Piper Alpha oil rig disaster in the North Sea, July 6th 1988. Daytime crew were repairing a pump but did not finish it at the end of their shift. They relayed a verbal message about the pump but the night crew did not get the message properly and turned it on anyway. The temporary seal on the pump failed and fire broke open the main risers. Many of the crew were trapped in their quarters with

no escape route. One hundred and sixty seven of the crew died.(p.308,2002: Chiles)

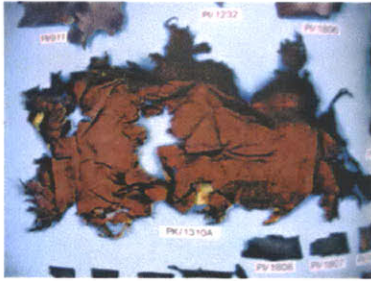

fig.3 TWA crash: metal fragments of the plane.

3.3.2 Externalities of a system

How do we reduce the risk of man-made disaster? Often the answer is in looking at what Perrow calls the 'externalities' to the system. The 'externalities' are the social and cultural costs of an activity (pollution, injury, anxiety), the structural variables in a particular system that do not normally get factored in for consideration. The problem, particularly in America in the twentieth century, was that these 'externalities' of the system were not taken into account. To witness disasters such as that of Chernobyl, Three Mile Island or Bhopal was not part of the 'American Dream.' After September 11th the world moved into an age of terror, urging technology to protect us from harm, but at the same time with a feeling of technological pessimism that Leo Marx associates with late 20th century.



fig.4 TWA 1996 crash reconstruction. New York, November 1997.

3.4 Technology in an age of terror (or terror in an age of technology)

Terror has taken on a more intense stance post-September 11th and palpably more obvious in America than in Europe for the same specific reason. The notion of terror, pre-September 11th, for most Americans and most Europeans, meant something intangible. It was a concept to be read about in the newspaper or on the TV that did not directly effect them. The definition from the dictionary is: "an overwhelming feeling of fear and anxiety." (www.cogsci.princeton.edu/cgi-bin/webwn) The definition seems almost inadequate to describe the type of terror now prevalent, heightened by the media. It is now more closely linked to the notion of 'terrorism' due primarily to September 11th and the subsequent bombing in Madrid. Terror has become inextricably linked to technology. It is linked through the weapons industry, through suicide bombers using commercial planes or military planes, and through hackers infiltrating our computer systems. It is linked to the reactions we have to the 'misuse' of technology. My definition of misuse of technology is the following: technology that is used in a manner that it was not intended by the maker, with detrimental outcome for one or all of humankind. In the case of Sarin gas- the use was as intended- the gas was designed as a weapon, but I would like to highlight that it is one of a number of new invisible threats. The suicide bombers obviously specifically misused technology. I compare and contrast them to the Kamikaze pilots of World War Two, looking at what I believe it means to be a suicide pilot then and now. I also explore the creation of the next form of terrorist and threat to

our wellbeing exactly through our precautionary measures. Machines are being designed to counteract each wave of fresh uncertainty. The perfect airport proposed by Isotec Inc. was designed to counteract future threats. The New York Times article describing the Freedom Tower is examined looking at its safety language of disaster. I also look at the idea of preventative technologies being introduced after the accident has happened- designated as 'tombstone technology' by the engineers on the TWA disaster documentary (PBS:Crash Site Secrets,2004).

3.4.1 Misuse of technology

3.4.1.2 Invisible threat

Terrorists operating as pilots or passengers; computer viruses infiltrating our personal space; software bugs and worms that self-replicate and modify systems; radiation damage; pollution damage; genetically modified foods; genetically modified humans- these are some of the invisible threats currently faced in the world. In September 2001, Anthrax spores were sent by mail to two senators in Washington, killing five people. Anthrax is a bacterial disease that mainly affects animals. The spores produce a powerful toxin (poison) that causes the signs and symptoms of illness. (<http://www.bt.cdc.gov>) Historically, invisible poisonous substances have been sent in letters to unsuspecting lovers. Poisoning was a common subject in newspapers in the 1800s, and arsenic-poisoning cases seemed almost fashionable. One of the well-known cases was the trial of Madeleine Smith for the murder by arsenic letter poisoning of her lover, Emile L'Angelier. It appears the difference in the cases then and now is that these poisonings in the nineteenth century were directed at known individuals- people such as jilted lovers, and had a local effect. What seems to be different is the uncertain scale-what starts off as a local problem has the potential to become global due to our great technological networks that have been built to draw us closer together.

3.4.1.3 Suicide bombers

What is also not new, at least in our imaginations in film, is the concept of a person hiding weapons in objects or clothing. In the James Bond film 'From Russia with Love', embedded in the tips of S.P.E.C.T.R.E. villainess Rosa Klebb's shoes were retractable poison-tipped shoe knives.

In 2002, Richard Reid, a British passenger, managed to board an American Airlines flight on 22nd December, 2001, from Paris to Miami and during the flight was caught trying to light a fuse protruding from his shoe. According to the FBI, packed in the sole of the shoe were enough high explosives to blow a hole

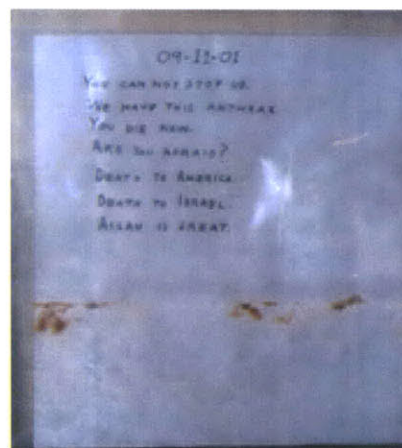

fig.5 Letter with anthrax spores sent to two Washington senators,2001.

in the fuselage of the aircraft. But the attempted bombing was foiled. He did try and pass himself off as a lone nut instead of a London born Islamic convert linked to Al Queda which he is alleged to be, an on-going investigation which is not yet resolved. (Thanassis Cambanis, Boston Globe April 12th, 2003)



fig.6 Kamikaze pilots group photo before a mission.

The suicide bombers of September 11th are a dramatic example of misuse of a technology. They were flying commercial planes not ever designed or intended to be crashed into buildings. The suicide bombers here echo behaviour of the Kamikaze pilots in World War Two. The training for the Kamikaze pilots took just over a week-the suicide bombers took four weeks and much secret meeting and planning. The first Kamikaze attacks took place in the battle for the Philippines in 1944. The Kamikaze pilot aimed the plane at the central elevator on carriers, and the base of the bridge on large warships. The similarities are that the pilots intentionally killed themselves for what they saw as a 'greater cause.' The major difference between the two was that the kamikazes were not using commercial planes or taking innocent people with them on the mission-civilian casualties were not their target. The Japanese government supported the kamikazes whereas the Sept 11th pilots were not supported by any official government and thus were called suicide bombers-responsible for their own death. The intensity of the suicide bombers convictions went beyond the boundaries of normal accepted human control. The suicide bombers manifest themselves as the physical embodiment of the imaginary robots and aliens in films and books that run out of control. The lack of perceptible border is a key issue of terror for the rest of the world. using a quote the Svetlana Aleksievich used for Chernobyl-"The normal layer of culture that protected us was instantaneously shattered."(p.200,2002: Aleksievich and Virilio interview: Unknown Quantity)



fig.7 Waving goodbye to the kamikaze pilots.

3.4.1.5 Making a terrorist

In the film 'Gattaca' the main character passes successfully through a finger print detector using another persons finger skin and hides his true identity using a special iris lens. By imagining these scenarios in the first place, the danger is that we create and convert them into reality. As we place all the more technology in front of us to prevent disaster we create a new form of terrorist built from this imaginary one. It creates the problems Hannah Arendt identified in her book The Human Condition, diminishing human agency and political freedom; the paradox that as human powers increase through technological and humanistic enquiry, we are less equipped to control the consequences of our actions. (p.296, 1958: Arendt)

3.4.1.3 Opaque misuse

Technology can be asymmetric- the positive and the negative sides fluctuate from one to the other depending on the system and circumstances. As Hannah Arendt said, "progress and catastrophe are on the opposite side of the same coin." The flip side of the computer programmer coin is the computer hacker. Hackers breaking into computer systems assume the role of product tester although that is not their official goal. They test the systems to their limit pushing any loopholes out into the public eye. Or they have something to protest. Some are not interested in any of this but do it for pure kicks. Either way hacking does test the system and forces companies to continually develop secure software to deal with it. In 1997, the Pentagon simulated a cyberattack and found that hackers using ordinary computers and widely available software could disrupt military communications, electrical power, and 911 networks in several American cities. (<http://cfrterrorism.org>) Cyberattacks could also involve remotely hijacking control systems, with potentially dire consequences: breaching dams, colliding airplanes and shutting down the power grid. In 2000, hackers working with a former employee of Gazprom, the major Russian energy company, reportedly briefly took control of the computer systems that govern the flow of natural gas through the company's pipelines. Following the April 2001 collision of a U.S. Navy spy plane and a Chinese fighter jet, Chinese hackers launched 'denial of service' attacks against American Web sites. (Ibid) In November 1988, Cornell graduate student Robert Morris released what remains the most devastating Internet worm ever, based on a number of systems shut down - more than 10 percent of the servers online, causing damage of some \$15 million. The Morris worm caused the government to create CERT (Computer Emergency Response Team), and Morris himself was one of the first hackers prosecuted under the Computer Fraud and Abuse Act. He now teaches computer science at MIT.

3.4.2 Attempts to prevent misuse

The strong reactions that America in particular and the rest of the world had to September 11th seems to have had a detrimental effect on the future well being and safety of the world. A colour coded alert system, part of the 'Homeland security' system, was put in place to keep the public and local authorities vigilant to times of heightened danger. Airport security increased radically and rapidly to attempt to counteract terrorist threat. Electronic machines were designed to swab the public's property for electronic equipment and bomb making chemicals. Metal detecting machine sensitivity was increased; new x-ray machines were installed and tested for more invasive body searches; lists were drawn up banning tools including equipment as small as a pair of tweezers.

Many other deterrents have been put in place reacting in a dramatic way to whatever disaster has hit. When 'mad cow disease' spread to Ireland from the UK, disinfectant mats were placed in the airports for people to walk on and disinfect their shoes. It seemed to me as a designer using the system to be a crude safety precaution, relying on human trust, only put in place in one possible entry to the country. This action was a political reaction from the Irish government to the crisis. In my opinion the government had to be seen to be making some effort to protect the public from harm, whether this was a well thought out action or not. It worked as a psychological safety measure. In the next section I look at the hypothetical design of the future perfectly secure airport.

3.4.2.1 *The perfect safe airport*

Isotec Incorporated, a Denver, US-based security systems design firm, engineered an airport that would target terrorists without stopping passenger traffic, as a test case in 2002. In this exercise, money was no object; safety was the only concern. The final design relied heavily on technology, and authentication technology in particular, as the main deterrent. Laser scanners would be used in this airport to detect bomb material. "Officially called laser-induced breakdown spectroscopy (LIBS), this process shoots a beam of light at an object, exciting its molecules. As the molecules relax, they emit a pattern of light, or spectrum, which is unique for every material. This pattern can be checked against a database of known substances. Similar techniques are used to detect carbon in soil, defects in semiconductors, and tooth decay." The major problem seen for designing this secure airport was economic. "It could cost tens of billions of dollars to upgrade existing terminals in all four hundred and twenty nine commercial airports in the U.S.," according to James Gilliland, an airline bond market analyst at Fitch Ratings. That's an enormous amount of money, considering that the nation's airlines earned only two point five billion dollars in 2000, the last year the industry was profitable. (Popular Science Magazine-author Dan Tynan, Feb 19th, 2004)

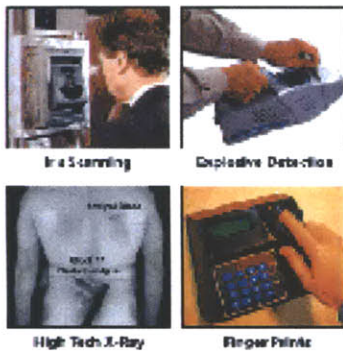

fig.8 Airport security machines.

3.4.2.1 *'Tombstone' technology*

Safety decisions in airplane accidents prevention are often made based on simple cost/benefit analysis-the first of Perrow's three types of risk analysis. The airlines weigh the cost of installing the most effective new safety technologies against what they determine is the cost of a crash and not until a safety feature becomes financially viable are changes implemented. This has been called 'tombstone technology' by some in the industry due to the fact that the technology is put in place after the accident has occurred.

The mysterious loss of three early jetliners prompted the use of the black box,

but pilots and airlines were vehemently opposed to it at first. The demand for cockpit video recorders after the presumed suicide crashes of two flights- a SilkAir 737 in Indonesia and an EgyptAir flight off the coast of Nantucket - was once again resisted by the pilots. The Traffic Alert and Collision Avoidance System (TCAS) was set in place after a mid-air collision over Los Angeles in the 1980s. Terminal Doppler Weather Radar (TDWR), which detects lethal windshear pockets before the pilot hits them and is considered the 'most dramatic' improvement in air safety yet, was not pushed forward until after a number of deadly windshear accidents. A fuel tank inerting system, devised in 1983 but opposed by the industry because it was too heavy, would have prevented the explosion that brought down TWA Flight 800.

The PBS documentary Crash Site Secrets highlights the Assisted Recovery System, which can detect the presence of mountains or buildings like the Twin Towers and override the pilots, preventing them from accidentally or even intentionally steering the plane into harm's way. The pilots, while discussing the proposed 'pilot control' feature, voiced their objection to the new idea. "What you want is an off-switch, a manual override," one of the pilots suggested, to enable the pilot to take the ultimate decisions when flying the plane. (2004, PBS: Crash Site Secrets)

3.4.2.1 Freedom tower design: future architecture of safety

'Designing the safest building in History for the scariest address on earth'
New York Times, Sunday, March 14th 2004.

In the Freedom tower construction the designers were "struggling to master three colossal forces that are at work in the stark empty sky: gravity, wind and perhaps most formidably fear." (March 14th, 2004: New York Times)

The building will have to be visibly solid and safe more than any other building has ever needed to be. This is to convince the public that it is safe to step inside the building considering emotions associated with the address. When referring to the building design the language of the architects and engineers is extra cautious and hesitant about the extra safety features of the design. They use words such as "probably be the safest building in the world..should not result in an immediate collapse." (Ibid) They are aware that anything is possible and are not committing to any definitive statements. The invisible risks of the future are in their minds. One engineer when speaking of their preparations for the design said- "you define attack scenarios.. you say under certain scenarios you might lose an element of the building and you count the redundancy." He also spoke with caution, making sure the reporter is aware he was not directly involved in the design. The designers on the project are using special software

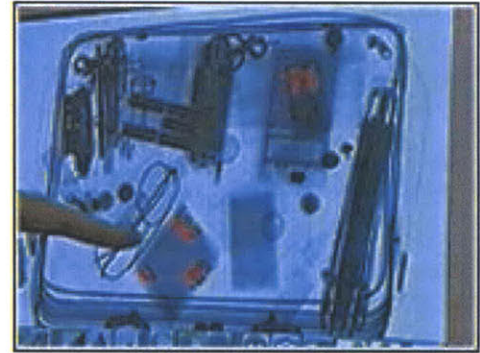

Any potential hazard is highlighted in red by Vivid's machine (CNN)

fig.9 Airport xray machine.

to predict disaster scenarios that could be possible. Simulation programs are being used to test evacuation behaviour of crowds in the building. Technology is dealing with the emotional problems. Nobody is to blame if the predictions don't work out, perhaps the computer program is to blame. It seems as if the designers are distancing themselves from the personal implications of a possible disaster of the future. Who designed the programs and based on what data? Perhaps the next generation of terrorism will be to hack into these types of programs and change this data to make it appear safer.

"Looking preternaturally calm, even disembodied, the swarms of faux-humans make 'decisions' (reporter puts this in parenthesis) about which exits to take...in one such program, the zombie-like people sink through the floor and disappear as they die of smoke inhalation or heat exposure." The language describing the programs makes it cold and distant from human concerns. The writer, is not convinced that these measures will work. Mr. Libeskind, the master planner in the project, talks about the Freedom Tower design as the new skyscraper of the future. He discusses the need for future architecture to be optimistic in the way it is conceived despite the safety precautions. The tower is a monument to 21st century man-made disaster.

3.4.2.2 Cultural threat integration

The SARS epidemic, which started in Hong Kong in 2002, took on a life of its own. A new language developed to deal with the fears the public experienced with the epidemic. People were questioning each other over the availability of the N95, a particularly popular industrial-strength mask. Most people wore the cheap surgical masks, known as '3-ply', while others used a variety of items, among them handkerchiefs, napkins and even plastic files, to cover their mouth and nose. According to reports on the news, barely a day of the health crisis had passed before masks bearing Burberry and Louis Vuitton logos began appearing. Street vendors began selling a range of masks with popular cartoon characters. Pharmacies sold masks for up to five times their usual price and did a brisk trade in disinfectants. (Sarai Reader 2004)



fig.10 SARS mask as fashion statement.

3.5 Dealing with Disaster

3.5.1 The philosophers of disaster

"To invent the airplane is to invent the plane crash." (p.23,2000:Virilio)

Many philosophers and thinkers through the centuries have examined our dealings with disaster and pondered our tenuous relationship with nature. In this part of the thesis I will look at the current thinkers of disaster and the accident. I begin with Paul Virilio who is a French philosopher with a special inter-

est in urbanism and the strategic implications of new technology. Virilio's idea is that once a new technology is released it also releases the disadvantages associated with the design. I then look at Bruno Latour's "actor networks" and the notion that there are different voices and cultural layers in the build up to an accident. Latour is a French philosopher and anthropologist who works in the field studying scientists and engineers at work. I examine Leo Marx's idea of "technological pessimism" in the late twentieth century. Marx is a major historian of American cultural history teaching at MIT. His work examines the relationship between technology and culture in nineteenth and twentieth century America. I move on to Thomas P. Hughes, another major historian and a sociologist of science, and talk of his theory of "technological momentum." Finally I look at Professor Donald McKenzie, a sociologist at Edinburgh university, and his particular studies of computer-related accident.

Paul Virilio

Virilio claims that man-made accident is a product of the "unconscious spirit" of the scientists, and the fruit of Progress and human labor. He says that to deal with accident effectively one must build the prospect of accident into the design of technology. One must acknowledge that accident does happen- e.g design the nuclear facility away from where people live. He suggests that we must study "the virtual velocity of catastrophic surprise" to deal with accident. (p. ff, 2000: Virilio) We must look at what is beneath engineers production consciousness- "the archaeo-technological discovery" or, what comes unexpectedly. (p. ff, 2000: Virilio) Management of fear is something that he suggests will become an important aspect of dealing with disaster. He argues that that the terrorism we are dealing with "is intimately connected with technologization. If the weapons industry stopped there would be no terrorism." (p. 30, 2000: Virilio)

Bruno Latour

Latour examines the "actor networks" involved in technology failure. He talks of the narratives that surround a technological project that does not succeed. "The only way to increase a project's reality is to compromise, to accept sociotechnological compromises." (p. 99, 2002: Latour) There are many layers to consider when designing a technology. Social, technical, human and non-human demands have all to be met to make the project succeed. To deal with accident we must consider all the perspectives involved and be prepared to compromise. He talks of the three key views in a technological accident- that of the operator, the expert and the machine. He wonders who exactly is the 'expert'. He questions the validity of the expert's viewpoint. His views are similar to Perrow

in that they both advocate 'loose couplings' in a project-that humans are not precise and the factors are not so clear and straight forward.

Leo Marx

Marx talks about taking into account the disasters that have occurred in 20th century America. People have had their hopes of the 'American dream' of prosperity and progress dashed, accounting for much of the technological pessimism that abounds. "Americans set themselves up for a fall by idolising technology and prepared the way for an increasingly pessimistic sense of the technological determination of history." (p.237,2002: Marx). He believes this is the state we are in at the present time and this feeling is responsible, or at least a major contributor, to the heightened state of man-made disaster. "The replacement of the impossibly extravagant hopes that had for so long been attached to the idea of 'technology' by more plausible realistic aspirations may in the long run be cause for optimism."(p.238,2002:Marx)

Thomas P.Hughes

Hughes also, writes of the notion of "technological momentum." (p.102,2002: Hughes) What he means by this is that technology breeds more technology. He puts it somewhere between social constructivism and technological determinism. He concludes that the younger, developing technological systems tend to be more open to sociocultural influences while older more mature systems prove to be more independent of outside influences and therefore more deterministic in nature.

Donald Mackenzie

Mackenzie discusses the difficulties of finding the true cause of an accident. He says that unless a researcher can mount a proper investigation the best they can do is get the most 'expert' opinion or report, and that can prove flawed. His argument is similar to Perrow and Latour in that he believes the factors are more complex than solely the result of a system or operator error. Martyn Thomas, a leading commentator on computer systems safety suggests that "the probability of the pilot being blamed for an air crash is more than twice as high if the pilot died in the crash." (p.30,1992:Software engineering notes) Mackenzie talks specifically about computer-related accident. He says the two things that are impossible to recreate consistently are electromagnetic interference and software error. He believes that there are probably far more occurrences of this than are reported since there is no physical evidence to prove it happened.

3.5.2 Popular culture

The theater was a perfect model for the accident-prone world, used as a controlled space in which to plot sudden events and reflect on their causes. Shakespeare used this in many of his plays, notably in Hamlet. He highlighted the circular disaster which “befalls the inventor or engineer hoist with his own petard.” A similar narrative takes place in Mary Shelley’s *Frankenstein* and also in Stanislaw Lem’s *The Cyberiad*.

3.5.2.1 Mary Shelley’s *Frankenstein*

Frankenstein is a story of a ‘robot’ character brought to life by Dr. Frankenstein. “A modern prometheus”- prometheus is described in greek mythology as a man who stole fire from the gods and created humanity from wet earth. The story, first published in 1818 before the author’s twenty-first birthday, proved an immediate hit, although the audience believed the work was written by her husband, Percy Bysshe Shelley. In the book, the horror of the creature he creates prompts Victor (Dr.Frankenstein in the film versions) to swoon and remain unwell for months. The enormity of his action stuns and frightens the young student. Victor has a burning desire to benefit the entire human race. He believes that only by examining death can he re-create life. In Shelley’s work he “discovered the secret of generation and life...and became capable of bestowing animation on lifeless matter.” (p.50) Juxtaposed with his revelation is a warning to Walton as listener ” ..and to the reader as secondary audience: learn from me, if not by my precepts, at least by my example, how dangerous is the acquirement of knowledge, and how much happier that man who believes his native town to be the world, than he who aspires to become greater than his nature will allow.” (p.39) The created ‘monster’ who turns around and does not behave according to the plan of the inventor is a common misgiving of technology in film and theatre. “By the glimmer of the half-extinguished light, I saw the dull yellow eye of the creature open...How can I describe my emotions?...His limbs were in proportion, and I had selected his features as beautiful. Beautiful! Great God! His yellow skin...horrid contrast with watery eyes, shriveled complexion, and straight black lips.” (p.55)

Often when engineers design a system they cannot imagine all the possible outcomes. Usually there are system behaviours that they did not factor in to its future performance. In *Frankenstein*, Victor had not built in any safety controls or procedures. He had not designed any device to assure that only good actions would be performed. The moral of the story is the same in Lem’s *The Cyberiad*.



fig.11 Frankenstein. 1931. Boris Karloff.

2.4.2.2 Stanislaw Lem-The Cyberiad

Lem's The Cyberiad is aptly subtitled 'Fables for the Cybernetic Age', a cycle of tales focusing on the adventures of two intelligent robots, named Trurl and Klapaucius, who are master builders of computers. In one particular section Trurl builds a robot who can construct anything beginning with the letter 'n'. Klapaucius gets the robot to make 'nothing' which he does 'obediently' but stops short of fatally deleting the world. Trurl realises that his construction has developed a mind of its own and that he is not in total control of what this robot can produce anymore. Technological autonomy and its propensity to destroy the world with a will of its own is a common theme in the nineteenth century. Here is an excerpt of this from the story:

'Omigosh!' said Trurl. 'If only nothing bad comes out of all this . . .'
'Don't worry,' said Klapaucius. 'You can see it's not producing Universal Nothingness, but only causing the absence of whatever starts with n. Which is really nothing in the way of nothing, and nothing is what your machine, dear Trurl, is worth!' 'Do not be deceived,' replied the machine. 'I've begun, it's true, with everything in n, but only out of familiarity. To create however is one thing, to destroy, another thing entirely. I can blot out the world for the simple reason that I'm able to do anything and everything - and everything means everything - in n, and consequently Nothingness is child's play for me. In less than a minute now you will cease to have existence, along with everything else, so tell me now, Klapaucius, and quickly, that I am really and truly everything I was programmed to be, before it is too late.'

3.5.4 Film/video

Science fiction films try to help us prepare for disaster. Just as the theatre was used as a control space, disaster film is also used as a virtual accident prone world. Films attempt to play out our worst fears and imaginings of what could happen or might happen in the world. Normally disaster films are very conservative in their approach, using traditional values to gather people together and fight the adversity. In Deep Impact parents choose to die to allow two younger couples (plus baby) to survive the tidal wave at the centre of the film. In earlier science fiction films such as Fritz Lang's Metropolis or King Kong, the city, in particular New York, is shown as being a monument to the machine age. In more recent films such as Armageddon or Independence day, they show graphic destruction of such monuments. In Armageddon the Chrysler building, Grand Central station and the World Trade Centre are all destroyed by a huge meteor.

3.5.3.1 Sontag and the essence of science fiction film

Writer Susan Sontag, in her essay 'the imagination of disaster,' (p.209-25,1966: Sontag) sees the essence of science fiction films as the representation of catastrophe precipitated directly or indirectly by the misuse of science and technology. "Science fiction films invite a dispassionate, aesthetic view of destruction and violence- a technological view." (p.216,1966:Sontag) Scientific advancement, experimentation, with its technological implementation is often the basis of the disaster depicted. For example, in The Fly (1958 director Kurt Neumann) the scientist Andre Delambre becomes obsessed with his latest creation, a matter transporter. He decides to use a human subject, himself, with tragic consequences. During the transference, his atoms become merged with a fly which was accidentally let into the machine. He ends up with the fly's head and one of it's arms, and the fly winds up with Andre's head and arm. Neither Andre, nor the insect, are satisfied with the end result. As a consequence they are not able to live a normal or an enhanced life by the change. The moral: one is not to mess with nature or both human and machine will suffer.

Sontag turns to darker aspects of our engagement with "imagined disasters," in a variety of fears we suffer that are born of "technocratic modernity." In the past, horror fictions often focused on our fears over the loss of our humanity, especially exemplified in Dr. Jekyll and Mr. Hyde. "In the age of technologized modernism, all of our fears of life in the age of machines come together in great anxieties about the fragility of our humanity." (ibid) Sontag is concerned about the dehumanizing, depersonalizing aspects of modernity as is Hannah Arendt in her book The Human Mind. In relation to this global crisis Sontag warns, "What I am suggesting is that the imagery of disaster in science fiction is above all the emblem of an inadequate response." "In this age of extremity, she notes, these films play an essential role. We live under continual threat of two equally fearful, but seemingly opposed, destinies: unremitting banality and inconceivable terror. It is fantasy, served out in large ration by the popular arts, which allows most people to cope with these twin spectres. For one job that fantasy can do is to lift us out of the unbearably humdrum and to distract us from terrors-real or anticipated.." (p.224-5, 1966:Sontag)

3.5.4.1 Film as cause of disaster

The German social critic Siegfried Kracauer was the first to argue, "the films of a nation reflect its mentality." Analyzing the popular movies of the Weimar Republic in the light of the Nazi rise to power, Kracauer wrote that "Germany carried out what had been anticipated by her cinema from its very beginning. It was all as it had been on the screen."

If Die Hard With a Vengeance, released only weeks after the Oklahoma City bombing, was inspired by the first attack on the WTC, it is also possible that the original Die Hard- in which Bruce Willis's NYPD street cop battled international terrorists in an L.A. skyscraper-may have contributed to the 1993 WTC scenario. In the days following September 11th, Warner Brothers postponed Collateral Damage, a film in which Arnold Schwarzenegger plays a firefighter who wreaks vengeance when his wife and child die in a Los Angeles skyscraper blown up by drug-terrorists. It was as though the future might be a safer place if these films did not happen or people did not see them.

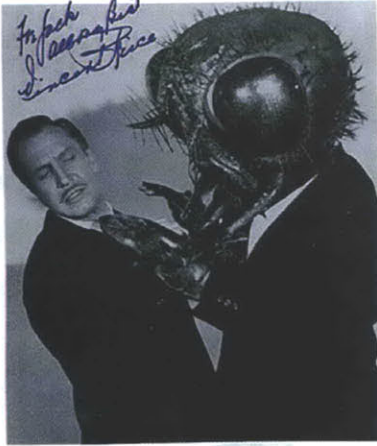

fig.12 The Fly with actor Vincent Price.1958.

After 9/11 the German filmmaker and theorist Alex Kluge remarked that "in the future there will be no more disaster movies." This has already been disproven with the disaster film The Day after Tomorrow due for release on May 28th 2004; a film about the mass destruction of the planet due to man made natural disaster. We need these films to help exorcise our fears of what happened in the past and do a post-mortem on the causes. We need the films to look at alternative endings to disasters without actually having to choose which one and to examine all the dangers we could possibly imagine encountering in our lives or our imagined future. For Hollywood, our unknown threats have been visualized as Euro-terrorists in Die Hard (1988), narco-terrorists in Die Hard 2 (1990), neo-Nazi terrorists in Die Hard With a Vengeance (1995), homegrown American terrorists in Under Siege (1992), 'international' terrorists in Under Siege 2 (1995), extraterrestrial terrorists in Independence Day (1996), micro-organic terrorists in Outbreak (1995), dinosaur-terrorists in The Lost World: Jurassic Park (1997), Russian terrorists in Air Force One (1997), Bosnian terrorists in The Peacemaker (1997), and Islamic terrorists in True Lies (1994), Executive Decision (1996), and The Siege (1998).

All categories of disaster and threat have been dealt with by film to thwart the evil from entering our real lives. For every category of real disaster that has happened, a film has been made to realise all possible scenarios. (See chart for visual representation of the taxonomy). Perhaps the role of the scriptwriter will change in this regard and this job will be officially acknowledged as an important contribution to future safety procedures research.

3.4.5 Fine Art

Another way of to try to deal with disaster and the issues it raises is through creative expression. The architect Lebbeus Wood explores the moment of the fall. He is interested in crisis points and how to create new histories after a disaster. Wolfgang Staehle, a video artist from Germany, and Stephen Vitiello,

a New York sound artist, are both examples of artist dealing with the immediacy of our times. American installation artist Nancy Rubins explores world instability, both natural and man-made in her sculptures. Aernout Mik, a Dutch video artist, develops the idea of the parallel worlds of 'what happened' and 'what might have happened' through the accident. Bill Viola, a key video artist for many years, explores how disasters bring people together in one specific work called "Going Forth Day by Day." I particularly look at artist Eduardo Kac's project-the GFP rabbit 'Alba,' and examine the questions and issues it generated to cope with biotechnology and the prospect of possible genetically engineered humans. I bring in arguments from Hugh Gusterson and Bronislaw Malinowski. Gusterson is a cultural anthropologist. His work has focused on the rise of the anti-nuclear movement and the end of the Cold war. Malinowski founded the field of Social Anthropology known as Functionalism, holding the belief that all components of society interlock to form a well-balanced system. He emphasized characteristics of beliefs, ceremonies, customs, institutions, religion, ritual and sexual taboos.

Lebbeus Wood

The architect Lebbeus Wood is interested in zones of crisis. He wants to build from these sites, believing it erases the memory of the disaster and allows it to cleanly move on to a new history. Lebbeus Wood sees "It should be the purpose of experimental works of art and architecture to explore and reveal what T.S.Eliot called the Shadow that falls between the idea and the act, the obscured realm between cause and effect-the space of the fall itself. The time-space of the fall-too brief to inhabit except in imagination." (p.153,2003:Wood)

Eduardo Kac-genetic art

Eduardo Kac is the artist of the genetic artwork 'Alba the glowing bunny.' He stated that he was not interested in creation of genetic objects but on the invention of transgenic social subjects. He worked with scientists at the Institute National de la Recherche Agronomique (INRA) in France to create a glowing rabbit. Scientists there had been injecting green fluorescent protein into the eggs of albino rabbits since 1998 to trace the action of particular chemicals, the growth of tumours or the workings of genetic diseases. The scientists thought it might be interesting to create such a rabbit for Kac as an artist. They had not considered an entire animal glowing in the dark and also were intrigued at the prospect of involving the public. Kac comments that many molecular biologists do their work in private and pretend it does not have social impact, yet the technologies they develop-such as genetic engineering- will eventually enter the entire society. He attempts to negotiate the "terrain between science and culture"



fig.13 Lebbeus Wood, *The Fall*, 2002. Trajectory paths. (with collaboration of Alexis Rochas.)

through this biotech experiment. Gusterson argues that science is steeped in ritual and myth and is not separated as a special category as Malinowski implies in his work. He describes this particular type of magic as "high-tech ritual." Gusterson gives us various definitions of the effect of ritual by among others - Malinowski. For example: "as a means of allaying anxiety by simulating human control over that which ultimately cannot be controlled-death, disease..." The high-tech ritual is prominent in this case since people trusted the scientist's ritual and proven scientific methods to make the transgenic animal but did not trust the artist's power. The artist had not established a proven set of rituals and rules to create this type of 'life'. The public did not trust him in general-he was seen as a magician of some sorts and not deemed fit to talk about these things.

Kac defined the type of art that includes this glowing bunny as transgenic art- "Transgenic art offers a concept of aesthetics that claims to emphasise the social rather than the formal aspects of life and biodiversity, that aims to challenge notions of genetics purity, incorporates precise work at the genomic level and reveals the fluidity of the concept of species in an ever increasingly transgenic social context." Kac was interested in the whole process of integrating the creation of the bunny, bringing her to society and nurturing her. "It places genetics in a social context in which the relationship between private and public are negotiated. In other words - biotechnology, the private realm of family life, and the social domain of public opinion are discussed in relation to each other." Kac wanted transgenic art to promote awareness of and respect for the spiritual life of the transgenic animal. "Aesthetics in this sense means creation, socialization, domestic integration - a single process. Transgenic art is a rejection of the reductionist view of life. Communication and interaction being the core of life," according to Kac. "Alba is a healthy and gentle mammal. Contrary to popular notions of the alleged monstrosity of genetically engineered organisms, her body shape and colouration are exactly of the same kind we ordinarily find in albino rabbits." Kac's simulation of control in the language of the transgenic bunny attempted to calm the public, although he did not know the exact outcome of the process. He saw successful genetic engineering as altering the human genome to heal or improve living conditions. "Introduction of foreign genetic material into humans is beneficial and welcome if it improves well being."

Having examined the story I believe his viewpoints to be extremely idealistic in terms of the benefits of the experiment and the type of discussion he believed would follow. The rabbit was hardly 'ordinary.' In his efforts to emphasise the

non-grotesque qualities of the transgenic creatures, he glossed over the fact that the creature was actually very different to the norm and that there would be long term consequences of genetic modification in the Alba's glowing future family. He promoted discussion on the social aspects of the project but perhaps to the detriment of the future life of the animal. Could he not have brought these up without creating the glowing rabbit? Probably not-it would not have been as affective. The very notion of what it means to be human is at stake in this technology. Kac regarded being human in the future would mean that the genome is not a limitation but a starting point. He predicted that there will be foreign genetic material in everyone as today there are mechanical and electronic implants. "In other words, we will be transgenic." On the one hand he is using language to calm the public down regarding how normal transgenic animals are, and on the other he is dramatising the future with "foreign genetic material," turning humans into half-monsters. According to Kac it is the social feedback that is the problem in these type of genetic experiments. "Scientists think that 90% of our genes are similar. It is that extra 10% that allows us to keep them in cages." (p.101-131, 2000:Kac)

The key factor in the biotech debate is that DNA is interchangeable between species-the foundation of biotechnology. The French scientists that created the glowing bunny could have used the same technique to make a glowing baby. This is central to the issues of biotechnology and biopower. It frightens the public although it may cure disease. "We have developed a godlike power to redesign life without slowing down to attain the godlike wisdom to use it." (...) All hopes and trust for the future are placed in new technology especially because it promises to make fundamental changes to life as opposed to incremental changes. We entered a fantasy world with magic promises and placed our hopes and desires for eternal life into biotech. The desire versus fear opposition/dichotomy is emphasised in this area- fear of the unknown and the dramatic changes it promises- playing 'God' with the very essence of life and a desire to change life to make it 'better' and live in a perfect peaceful eternal world.

Kac caused heated discussion on whether he actually had the right to do this type of art or whether his claim as an artist was legitimate since the scientists were the ones that actually created the rabbit. Louis Bec, the director of an arts festival in Avignon, approached the Institute National de la Recherche Agronomique (INRA) in France. He wanted Alba for the art festival show. The scientists agreed at first but pulled out last minute and said the bunny was their "research object."

New York art critic Peter Schjeldahl said of transgenic art- "Art like this was a trend that would have a shelf life of milk. Art used to crown civilization, now it skitters through seams and around corners eagerly parasitic." Animal activists were furious- the project was called silly and an 'act of violence.' It fueled existing fears of global genetic mutation and cloning Frankenstein style. Was Alba art? What did she mean? Was she a 'designer pet?' Kac was compared to Duchamp but also criticised for being parasitic. They claimed that he had not actually done anything except attach himself onto the rabbit. Control in this type of experiment is taken away from the 'unpredictable' humans and placed in the laboratories where life can be examined and directed by qualified scientists. Kac is seen as an unpredictable human. There appears to be a desire by mankind in general to adjust nature to make the world more suited to human needs and wants. There has always been a struggle with this blurry distinction between art, life and science. Duchamp was asking the same questions. When was this experiment an art project and when was it science alone? When the artist decides to use it as a piece of work or when the scientists begin the genetic experiment?



fig.14 Eduardo Kac and Alba, the fluorescent bunny.
<http://www.ekac.org>

Photo: Chrystelle Fontaine

Kac says, "If artists ignore the social and ethical issues that Alba raises, if we don't take charge and use these technological media to raise questions about contemporary life- who is going to do that?" It was not the first time genetic art has been censored in the way the French laboratory chose to do. In the 1930's the Museum of Modern Art in New York exhibited plants that had been bred especially for aesthetic beauty. In 1936 they mounted an exhibition of delphiniums bred by the photographer Edward Steichen. The Nazi eugenics movement, the attempt to breed people like plants or animals, put a stop to museum's interest in the use of genetic concepts by artists. They did not want to glorify selective breeding or appear to be endorsing anything like eugenics.

Computer programmer Ellen Ullman, author of Close to the machine, heard Kac speaking about his new project that of a 'glowing dog' at Ars Electronica in 2000. According to the San Francisco Chronicle, she was fascinated at first but then had a growing sense of unease at his arrogance. "How far should we take this new power we are developing to mould other creatures - not to mention ourselves to suit our plans or whims?" The core of the human genome project is the desire to find the secret of life. Searching for this core is intended to foil the most feared elements of our genetic programming-the inevitability of imperfection, deterioration, disease and death. The core of Kac's work was to discuss why the secret of life is a goal for humanity and the effect this would have in the future. David Noble, an English technology historian, discusses new technology as follows: "our culture objectifies technology and sets it apart and

above human affairs..... technology appears to be an external force impinging upon society from outside, determining events to which people must forever adjust." Biopower; the power of the medical establishment in the biotechnology industry; is perpetuated by using the 'autonomous behaviour of technology' argument to maintain control. This establishes the mystery of biotech and keeps the future 'godlike' joy stick in the medical establishment's hands and the debates to the background.

Wolfgang Staehle-Sept 11th

Wolfgang Staehle is an artist from Germany living in New York. He founded 'The Thing' in 1991, an independent media project which became a well known online forum for media arts. His installation 2001 was being shown at the Postmasters gallery when Sept 11th happened. He had originally designed the work so there were three live feeds of images of New York- one of those being the World Trade Centre. Due to this event, the images took on a tragic dimension recording the disaster. It presented immediacy as a form of art of our times.

Nancy Rubins-airplane reconstruction

Nancy Rubins is known for her monumental, gravity-defying, towering sculptures of airplane parts, electrical appliances or mattresses. While Rubins' assemblages are full of compositional ingenuity and beauty, her materials call to mind technological obsolescence and the discarded waste of consumer society. When Rubins experienced an earthquake, her work took a turning point. Struck by the way the concrete walls of her apartment began to undulate, she reflected upon the unstable nature of materials, experimenting in her sculptures with the principles of gravity and movement. Her monumental suspended sculptures are the direct results of these experiences.

Aernout Mik

In Mik's videos he portrayed groups of actors performing carefully constructed fictional scenarios. The characters in his films seemed to move through space like zombies neither communicating with each other nor reacting. Many of his works evoked a scene of disaster, where seemingly shocked survivors occupy that liminal zone just after the tragic event but before help comes. The absence of sound increased that dreamy feel and added to the uncertainty of what was happening. In Reversal Room- everything proceeded in doubles. This produced two separate but parallel realms. These realms might be contiguous or continuous to one another yet somehow they intersected. The behaviour is off but we are not quite sure what it was.



fig.15 Nancy Rubins. *MoMA and Airplane Parts*, 1995. Mixed media.



fig.16 Aernout Mik, *The Elevator*, 2001. Video installation.

Bill Viola

Bill Viola- in his work Going forth day by day talked of the unifying role disaster and tragedies can play in a society and the effect that the human mind and creative imagination can have on the origin and outcome of these forces. He linked fresco paintings to video art in this work. There are five chapters which interpret biblical and mythological themes of the spirit of our times. They were projected directly on the walls similar to Italian frescos. The installation showed a way of life that confronts nature's elements and interacts with humans. One scene displayed a flood happening in a building. "Technology is only a means to an end in his work.." (Deutsche bank-Dr.Rolf Breuer,spokesman for the board of directors) For this piece he researched images of the apocalypse in the Book of Revelations and examined how they had been visualised by artists. His influences were Dante's inferno, Botticelli, the Egyptian Book of the Dead and particularly Italian renaissance painter Luca Signorelli. Signorelli's vision of the end of the world in the Orvieto cathedral fresco cycle of 1499-1504 had a strong effect on Viola. One panel shows a synoptic view of all the various prophecies of the end of time- violent earth quakes, the moon turning red, huge tidal waves, the sun turning black, stars falling from the sky, demons torturing the humans. Viola talks about the end of the world having lots of different scales- losing a favorite object, a job, a home, a friend, an entire culture to war, innocent victims abound.

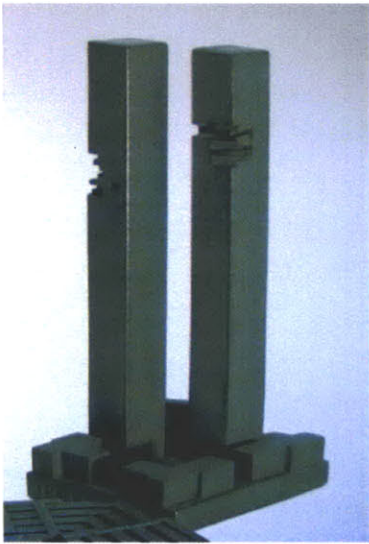

fig.17 Buildings of Disasters: Twin Towers, Boym Design, 2001.

Boym Design associates

Boym associates is a design firm based in New York. It comprises of Lauren Boym and Constantin Boym. Constantin has an architecture background but moved to product design since he believed all ideas that are expressed in architecture could be expressed in objects. Lauren worked as a product designer. In 1997 they began thinking about the upcoming Millennium and decided to mark it with an edition of special souvenirs. They called the collection 'Souvenirs for the End of the Century' and sold them by mail order. They followed this up with a line called 'Buildings of Disaster.' These monuments represented disasters that had occurred around the buildings or inside their walls. Boym stated that the images of destroyed buildings was based on emotional representation rather than scholarly appreciation. The starting point came after the Oklahoma bombing when the Alfred P. Murrah federal building instantly became recognizable all over the world. They then made others to address Chernobyl, Three mile island and some political and government scandal(Watergate, Waco). The most popular building was the Unabomber's cabin- a typical image of an American house that "turned sinister on closer inspection." (p.94,2002:Boym) Their designs were based on newspaper reports and media representation of

the disaster. They allowed for distortion and generalisations to heighten the emotional impact of the objects.

The Boyms had practically stopped selling the disaster buildings when Sept 11th occurred. People began calling them and requesting a souvenir of the building. They decided to go ahead and manufacture the building and give the proceeds to a Sept 11th charity; they received many orders. The transformation of the objects from a cultural commentary on the past to being placed in the midst of a present crisis produced some criticism from the press on the timing and sensitivity. The Boyms saw the emotional need from the people who called and ordered for an object they could hold on to and keep as a reminder. One customer was a former employee in the building, another had survived the disaster.

3.5.7 Sound

Steve Vitiello

Steve Vitiello is a New York sound artist. In 1999 he was awarded a studio in Tower One of the WTC, on the 91st floor. He recorded the cracking noises of the tower swaying after Hurricane Floyd. Although he was trying to show the fallibility of the building that is invisible to the eye, he also became an artist (along with Staehle) who presented us with immediacy as art. For me, this piece of art became a requiem to the building and to the disaster.

Janet Cardiff

Janet Cardiff is a sound artist who has been working since the 70's on sound pieces. I am interested in her particular use of sound to create an emotional build up to her stories. One such piece is a diorama called Cabin Fever. In the diorama there was a dark forest with a small house in the background. The house had some windows that were lit up. It looked like a film set with a nasty ending. When the headphones were put on there was the sound of footsteps running in the wood and then argument and screaming in the house as the lights flashed on and off. There was a sense of tuning in to the middle of a bad scene in the film. Although the diorama worked to an extent, I felt it was distant and was difficult to immerse oneself solely by putting on headphones. I felt the need to put my head all the way into the box, to be surrounded with the images as well as the sound.

4.0 Experiments

Overview

In both the 'Doom machine' project and in 'Mechanism no.1: War' I am looking at our concerns and fears in the world as we embrace technology and its 'powers,' both good and bad. Ultimately we are responsible for technology and how it is used. I am examining the fear factor in the world particularly in these times of uncertainty and paranoia. I am looking at our innate pessimisms and our expectations for the future.

4.1 Experiment one: The Doom Machine

4.1.1 Influences

One of the experimental technologies I have proposed for this era of global risk was a monitoring device called 'The Doom machine.' It takes its influences from Kubrick's 1964 film *Dr. Strangelove*- a wickedly funny satire of deterrence theory where the planet is fatally irradiated by a secret Soviet 'Doom Machine.' It also takes influences from the Doomsday clock of the Bulletin of the Atomic Scientists, started in 1947. The Bulletin clock is a 2d printed image on the cover of the magazine which measures the state of worldwide nuclear danger. The clock, said an editorial in the July 1947 issue of the Bulletin, "represents the state of mind of those whose closeness to the development of atomic energy does not permit them to forget that their lives and those of their children, the security of their country and the survival of civilization, all hang in the balance as long as the spectre of atomic war has not been exorcized." (July,1947: Bulletin of the Atomic Scientist) Every time a dangerous event takes place, e.g a nuclear test, the hand on the clock moves a minute closer to midnight. The clock has moved only seventeen times in fifty-six years, most recently on February 27th, 2002. A group of expert nuclear scientists decide when the hand should move in correlation with worldwide events. The clock was the creation of a Chicago artist known as Martyl, the wife of physicist Alexander Langsdorf, a Bulletin founder. Years later, Martyl said she hit upon the idea "to symbolize urgency." She got that message across by using just the final quadrant of a clock face which suggested to her that the end of time was nigh and placed the hand seven minutes to twelve.

4.1.2 Background Scene

The Doom Machine I proposed takes a daily measure of how close we are to a possible end to the world. One of the versions of the Doom machine I envisioned would stand in the town square, the heart of the town or a city near local government buildings, or at a central meeting place. It would take up a po-



fig.18 The doom machine, front view.

sition similar to the town clock or clockwork automata, a common phenomenon in towns in Europe. In this future setting, public spaces would be re-introduced to American towns and cities. The machine would be the central information dissemination point similar to the war room in Dr. Strangelove. Control rooms breed a feeling of calm and segregate themselves as a space separate from the exterior. My idea was to promote that feeling around the Doom Machine.

One proposal for information for The Doom machine was to take the daily news feed from internet news channels and measure the doomdata on destruction by man and nature. This information would feed the machine's prediction for the day. Novelist Neal Stephenson describes this type of information flow to the machine as "culture reaching in and changing the technology." (p.200,1996: Stephenson) Doom data topics collected could possibly have included questions of nationalism, failed war negotiation and plans, stock market prices, oil spillage, murders, asteroid collisions and natural local and global disaster generally. Local factors could also be introduced to the machine. By this I mean that local culturally important aspects could be added to the index. For example; a local elder or respected chief or mayor's opinion could be added to the vote if the town/city values their input. The idea would be to include a true picture of the community feelings. Thus, the system includes the social and political aspects of the issues, rather than the technological scientific issues in isolation. Perrow says that to prevent disaster or at least in this case to prevent possible doom you must take into consideration the 'externalities' of the system. "The externalities are the social costs of an activity that are not reflected in the price of this activity." Perrow talks about the fact that low-status impoverished operator groups do not succeed in bringing the externalities to public attention with the same success as resource-endowed operator systems with "predictable victims."(p.341,1998:Perrow) This machine would attempt to by-pass this by including these low-status operator groups in the output.

4.1.3 *How it works*

For the first physical version of this machine I designed a website which took the vote from the public on their 'gut feeling' on how the world is doing. It is a representation of our degree of optimism or pessimism about the state of the world. The public act as the filters for the multi-channel news feeds globally instead of me as the designer choosing the sites that I deem important. The machine interprets the data and compiles the average vote via the Doom website - from 0 to 5, 5 being a major catastrophe and 0 being optimistic about the future of the world (with a slight doubt-the machine is not 100% sure). The result is reported hourly to the public by the 'Doomcaster' via the machine's

megaphone and the level is also shown on an analog 'Doomscale' dial. The Doom machine makes it's 'Doomforecast' every day at twelve midday and again at six o'clock in the evening announcing the state of the world to the community. The hour that the machine makes the announcement refers to the religious ritual of the 'angelus' in catholic countries and is also a key time in the day for news to be read on TV and radio.

The Doom machine represents how we live our lives through a mixture of science, religion and magic. Helmreich states in his book *Silicon Second Nature* - "it is commonplace that science today occupies a province once reserved solely for religion. In the secular humanist world, many people turn to science for solid answers to questions of how the world works, how to endure suffering, and how to make wise life choices." (p.182,2000:Helmreich) It attempts to combine the three to give us an assessment of the state of the world both physically and spiritually- a mixture of the "sacred and the profane" (p.17,1948:Malinowski)

4.1.4 The Torino Scale

The scale on the Doom website and the Doom graphic scale of levels on the analog dial is based on the 'Torino scale'. This seemed like the perfect scale to adapt for a Doom machine. The likelihood of a meteor hitting the earth with devastating effect seemed far less improbable than a collection of disasters happening causing harm to the world. The Torino scale is ultimately based on the public's fears and imaginings of disaster more than on a real serious threat.



fig.19 Doomscale. "the end is nigh"

4.1.4.1 Description of Torino scale

The Torino Scale was created by Professor Richard P. Binzel in the Department of Earth, Atmospheric, and Planetary Sciences, at MIT. The first version, called 'A Near-Earth Object Hazard Index,' was presented at a United Nations conference in 1995 and was published by Binzel in the subsequent conference proceedings (Annals of the New York Academy of Sciences, volume 822, 1997.) A revised version of the 'Hazard Index' was presented at a June 1999 international conference on near-Earth objects held in Torino (Turin) Italy. The conference participants voted to adopt the revised version, where they gave it the name 'Torino Scale.' The scale is a 'Richter Scale' for categorizing the Earth's impact hazard associated with newly discovered asteroids and comets. It is intended to serve as a communication tool for astronomers and the public to assess the seriousness of predictions of close encounters by asteroids and comets during the 21st century. The Torino Scale utilizes numbers that range from zero to ten, where zero indicates an object has a zero or negligibly small chance of collision with the Earth. (Zero is also used to categorize any object that is too small to penetrate the Earth's atmosphere intact, in the event that a collision does

occur.) A ten indicates that a collision is certain, and the impacting object is so large that it is capable of precipitating a global climatic disaster. The Torino Scale is color coded from white to yellow to orange to red. White corresponds to category zero and Red means certain collision with the earth with devastating consequences.

4.1.5 *Doom scale*

I edited the Torino scale to suit the tone and subject matter of my project while keeping the apocalyptic nature of the idea. I wanted to keep an 'official' Orwellian feel in the descriptions but use an emergency style language. I choose the same colour level indicator but cut the scale down to six levels-zero to five. The levels are the following:

What is the Doom level today?:

White- 0> 'the world is safe and well.'

Green-1> 'negative events possible with no long term effect.'

Yellow- 2> 'adverse events merit concern.'

Orange- 3> 'events may cause localised destructive impact.'

Red-4> 'events could cause global negative damage.'

Deep red- 5> 'events causing significant global damage.'

4.2.6 *Sound*

4.2.6.1 *Doomlevel sound*

In disaster films, sound is often used to build suspense before something dramatic happens. Bernard Herrmann's theme for Hitchcock's Psycho shower scene used high-pitched string instrument notes with very fast attack to build suspense. (p.363, Darby and Du Bois). The film Jaws used a sinister but very simple double bass which begins in long, heavy notes gradually acquiring a much faster attack (p.534, Darby and Du Bois) . High organic noises can build suspense also. In the Michael Crichton movie Congo, the birds and insects in the jungle create a high ambient whine. A feeling of real anxiety was achieved by playing the insects loudly. (p.83-84, Kenny) I wanted to convey this ominous build up in the Doom machine. I tried to express this with the ambient sound in the piece. As the level on the doomscale increases, the ambient sound gets closer- as if doom is getting closer. Each level is associated with a different volume level which increases as the doomscale moves towards five. The sound is meant to have the rumbling feeling of a large object or machine coming ever nearer. The only difference in the sound content is at level zero where I used a recording of birds singing. I wanted the sound to move from entirely natural, born of nature,

to entirely 'unnatural' machine generated at level five. The machine has a pessimistic outlook and so I added a small amount of doubt into the sound at zero by adding a bee buzzing around. The idea is that 'all is well with the world' but there is that small doubt. The sound constantly loops and plays through the megaphone.

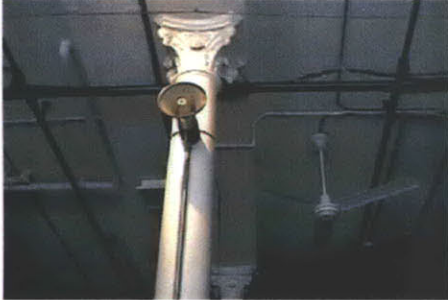

fig.20 Doom Machine megaphone.

4.2.6.2 *Doomcast*

The doom cast announcements were designed to be in the style of a public announcement broadcast or BBC news flash. I choose to use my own 'presenter' voice for this task as opposed to a computer generated voice. I wanted the machine to highlight the human source in the interpretation. Each hour we hear typical 'pips' which indicates an announcement will be made. The Doomcast is announced for approximately two minutes and then goes back to the ambient sound until the next hour's broadcast. The megaphone was used as an output device as it was pertinent to the aesthetic of a public emergency system.



fig.21 Running away from doom. Performance by Jonathen Bachrach.2003

4.2.7 *Video*

On the small 5x6 LCD screen inside the machine there is a looped video. It shows a man running away from impending doom. I directed the actor to imagine that a large rock or wave was rolling towards him. He runs away from this dressed in a dark suit with his tie flying over his shoulder. Every few seconds he takes a look behind him to see how close the 'thing' is. I shot the video in an outdoor factory setting in strong sunlight. His shadow is very black and strong in the video due to the exaggerated light. It evokes the sense of being so scared that you run away from your own shadow. I looped the video to get the idea of an automated machine. I placed the LCD screen and video inside the machine since the doom machine exists through people's fears and through their actions. I made the video part of the machine's internal workings. The public had to peer in through a grid to see what was going on. I wanted to encourage people's fascination with how machines work or at least their curiosity for hidden, secret content or 'extra bonus' content if they look inside. Technology is ultimately built on personalities and emotions and not on the cold hard image we see on the exterior.

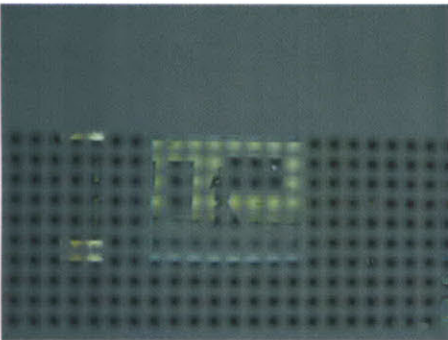

fig.22 'Running away' video on LCD display. Doom Machine 2003.

4.2.8 *Technical plan*

The machine was fixed to the wall or a column in a public space or exhibition area at eye level. The megaphone was placed directly six foot above with the cabling fed through metal tubing. A laptop computer is housed inside the machine running the software and the internet is connected to the machine at all times. Inside there is a microcontroller which talks to the analog dial, and a

tiny LCD screen. There is access to the Doom website for the public on another computer in the space but it is not part of the machine, though can be nearby.

4.2.9 Evaluation

The Doom machine was shown at Location One gallery in Soho last year, 2003. It was also shown at SAT (Societe de Art et Technologie) at the Montreal New Media and Film festival in 2003. One difference in the installation of the piece was that at SAT it was presented in the public café of the building. It was placed on the wall alongside the café tables and blended into the background with the electrical boxes and general equipment. It did this until the doom announcement. As soon as people heard the 'pips' on the hour everyone went silent and paid attention to the machine. This was very effective and exactly the type of reaction I had wanted. For me, it was definitely more successful in a public space rather than a gallery setting. At Location One this 'crowd silencing effect' did not work so well. It had a different type of impact- more of a statement than a future possible product. For an exhibition space I am proposing a second version of the machine which would be free-standing and look like a smaller-scale electric pylon (made of metal pieces bolted together with a larger megaphone on the top). This would be exaggerated in scale and height to accent the drama and be a monument to doom.

Another interesting observation from the two exhibitions in Canada and the other in the USA- The Iraqi war was going on at that time but nothing very different from the normal events had happened either week to prompt a large change in the doom scale. The level was at three/four for most of the month in New York but in Montreal it was much lower and dropped to zero for one of the days of the festival. Perhaps Michael Moore is correct in suggesting that Canadians are more relaxed than Americans (Bowling for Columbine, Michael Moore, 2002).

4.3 Experiment no.two:mechanism no.1:war

Mechanism no.1: war is an interactive video projection which is part of a proposed triptych talking about different aspects of our world in the 21st century. This project began just before the Iraqi war started in 2002 and examines the critical moments leading to war. I was not long in the States, having newly arrived from Europe to the media lab. The paranoia, tension and build up to the war in this country was palpable and something that permeated everywhere in the media. There was a real sense for me that it was too late to stop the inevitability of the war happening and it gave me and many people at the time a sense of helplessness and not being in control. As an artist, I felt it required addressing while I was living here. Mechanism no.1: war was a reaction to this

tension and fear in the world in 2002.

4.3.2 *The significance of the drummer boy*

The project consists of a tin toy drummer boy. From the seventeenth century, the drummer boy announced the beginning of battle through his drumming. He was responsible for playing the correct beatings for the various commands when the battle started on the orders of the captain. The drummer boys were often as young as seven years of age. The toy aspect of the project relates to several ideas:

- The ordinary objects that get left behind in the aftermath of war. Often toys are left behind along with personal belongings in abandoned or damaged houses and villages.
- The concept of playing with something that leads to a serious outcome. The idea that the toy is not part of real life but a representation of it.
- The toy's innocent expression on his face, yet it is slightly uncaring. He is looking out on the world and observing it. It adds to the impact when his expression does not change when the bombs drop.

4.3.3 *Setting*

The piece was designed with a gallery setting in mind. The elements of the installation are: the tin drummer boy toy with wind-up brass key as the interface; a projector suspended from the ceiling with a screen attached with metal reflective sheeting. This is used to give the effect of three dimensions to the projection. The screen is at a 45 degree angle, so the image is projected on the floor. The projector is connected to a computer which is hidden under the plinth. The toy rests on the plinth which has the appearance of a concrete wall. We tried to get the illusion of a military bunker with a concrete floor and concrete wall.

4.3.4 *Interaction*

The interface is the brass wind-up key that is used to mechanically wind the toy up to hit the drum. When the audience begins to wind up the toy they see the doors of a military plane opening to white space. This is a projected animation onto the concrete floor. As soon as the person lets the key go in order for it to unwind, the toy begins hitting the drum. A bomb drops from the sky on each hit of the drum. The bomb image appears to drop away to earth through the floor. The image of the bomb was found on the internet and is two dimensional. The tighter the key is wound, the faster the drum is hit and the faster the bombs drop. The concept being that the more you wind, the closer the consequences. Another important aspect of the toy is the fact that it is



fig.23 Drummer boy corps, 30th Pennsylvania infantry.



fig.24 Mechanism No.1:War, Compton gallery, Boston.



fig.25 Mechanism No.1:War, Drummer boy.

wireless. There are no circuits or wires visible on the toy and it does not feel any heavier than it would normally feel. This adds to the sense of shock and surprise when the audience interacts with it.

4.3.5 Technical

The drummer boy uses a pic 18F chip-the cockroach- which looks at the timing of the hits and talks to Director to animate a 2D bomb image. Two infra red sensors are used to detect whether the arm is raised or lowered. If it is lowered the drum has been hit. A cog was made to attach to the key shaft inside the toy to detect and calculate which way the key was being turned. If the cog is turning one way one of the IR sensors is off while the other one is on and visa versa. This detects whether the key was being wound up or unwinding. The bomb images consists of one sprite called up multiple times in Director and programmed to change position and size as it gets further away. We chose not to put a background on the projection to make it more of a universal idea and not country-specific.

4.3.6 Sound

The sound consists of purely the toy hitting the drum. I decided against using any sound for the bombs dropping as it seemed more powerful to have the natural sound of the drum alone beating out the call to war.

4.3.7 Evaluation

This project was shown in the Compton gallery at MIT as part of the Boston Cyberarts festival 2003. It was also shown in Location one in July 2003. Comparing the spaces- the Compton gallery is a much smaller space and had a lot more installations in the show so the space for the piece was at a minimum. The piece was presented in the middle of the gallery so many people walked across the floor where the projection would happen as other people began interacting. This meant that they sometimes walked across when the bombs began projecting, or 'dropping'. The bombs then had the effect of falling on the person which added an interesting dimension to the work, especially when children crawled across the floor (which actually did happen and was filmed). Many people reacted by trying to step back out of the way and not be involved with the bombs. They were strongly effected by them. The sound of the drum was not so apparent since the space and ceiling was not so big. The Location One gallery had a large empty space surrounding the work and high ceilings. This helped the sound effect as the drum echoed around the room. The toy also looked poignant in the middle of the empty space. The only part that didn't

possibly work as well was the idea of not being able to get away from the projection. It would have been better to tighten up the surrounding space so the person was more enclosed in the bunker wall. As for the interaction, many people felt horrified that their actions could cause bombs to drop. It made them think about responsibility. The review in the Village Voice read that the piece "cleverly addressed responsibility." Others walked around with the toy and watched the bombs drop from afar trying not to draw attention to the fact that they had caused the outcome.

4.4 Experiment three: Shuttle demonstration

(transparent glass of ice water, o-ring in a clamp, small printed label explaining experiment)

Richard Feynman, a famous physicist, conducted an experiment to demonstrate the shuttle o-ring problem. He did the experiment to clarify the link between the cold temperature and loss of resiliency in the rubber-o-rings. "Although the link was obvious for weeks to engineers and those investigating the accident, various officials had camouflaged the issue by testifying to the commission in an obscurantist language of evasive technical jargon."(1992: Gleick) Preparing for the public hearing, where a piece of o-ring would be passed around, he had bought a small clamp from a hardware store in Washington. Feynman described his experiment: "To create a more effective exhibit, the clamped o-ring might well have been placed in a transparent glass of ice water rather than in the opaque cup provided to Feynman. Such a display would then make a visual reference to the extraordinary pre-flight photographs of an ice-covered launch pad, thereby tightening up the link between the ice-water experiment and the Challenger." (p.50,1997:Tufte) He was successful in convincing the public with his strong visual presence and understated 'expert' conclusions - "I believe that has some significance for our problem."(Ibid) This science experiment improvised by the Nobel laureate, became a media sensation appearing on many news broadcasts and on the front page of the New York Times. Feynman had provided a 'news hook' for an inscrutable technical issue in rocket engineering. (p.51,1997:Tufte)

Feynman's experiment cut through the 'experts' jargon and simplified the reasons the Shuttle exploded to a single five minute demo. Professor Feynman chose his words carefully so the journalists would understand what he was trying to prove. Edward Tufte says the experiment was flawed in its parameters, but that it didn't matter as he was renowned as a famous 'expert'. This small artwork is an experimental reconstruction to demonstrate that there is a problem with only taking the expert's view of disaster events. Scientific jargon

is often used deliberately to confuse people's notion of the causes of the accident.

4.5 Failsafe installation

4.5.1 Installation background

'Progress and catastrophe are the opposite faces of the same coin.' (Hannah Arendt, 1965)

This project focuses on our perception of technology as both the source of our vulnerabilities and the answer to all of our problems. Technology can only be as perfect, precise, and efficient as the weakest people who design, maintain, and run a given system. New, improved techniques are often discovered by accident, or upon the failure of an intended process. This project conducts an autopsy on an historic technological disaster case examining the build up to the accident. I made this installation with advise and collaboration from the MIT cryogenics laboratory.

4.5.2 MIT cryogenics Laboratory

The Mit laboratory is run by Professor Joseph Smith. I collaborated with this lab on technical knowledge of the accident and discussed many of the possible scenarios that could have happened. The processes were explained to me in detail and I took my references for the visuals from the many rooms of the lab. The laboratory has many pieces of historical analog equipment involved in the cryogenics process. This gave me inspiration for the physical layout. I also recorded binaural sound around the lab which I will discuss in a later section.

4.5.3 Cryogenics accident report

The technological disaster that I focused on is the Hungarian cryogenics disaster in which the machines appeared to have 'bitten' back, similar to the monster created in Mary Shelley's Frankenstein story. The accident happened in Repcelak in Hungary on 2nd January 1969. According to a French report on the accident, and several books that mention it on the subject of disaster, the accident is thought to have happened as follows: The filling of a tank with carbon dioxide began at 11.50am. The product was liquified and chilled through a refrigerating circuit with ammonia, then stocked in tanks under a pressure of 15 bars, at a temperature of 30°C (roughly). At 2.24pm the liquid carbonic acid storage tank exploded, possibly due to an overfilling of the tank and the gauge freezing. This was followed by another tank exploding. These two explosions pulled the first tank from it's foundations, perforating it with one of its supports, producing a crack ninety cm in its side. The fragments punctured a

third tank, which took off from its base, propelled like a rocket, and smashed into a laboratory. This froze five scientists while they worked at -108 degrees fahrenheit. More pieces of the tank were thrown in every direction which produced the death of four other people and landed 400 meters away. One 1000 kg fragment was propelled more than 250 meters. Fifteen people were wounded altogether. The most probable cause of this incident was an overflow due to a failure of the gauge system (most likely the freezing of the level detector). Moreover, it seems the assembly material of several tanks were not adapted to low temperatures causing a brittle fracture. The technology froze the operators using the same process as cryonically freezing bodies for future science to bring them back to life.

4.5.4 Approach to the artwork

There is very little information about this accident to be found. This is a typical factor in all accidents and disasters unless they have been investigated afterwards. Companies and workers do not want to spread the details of failure especially if they are possibly the cause of the accident. Researching the story of the accident was difficult for this reason. For example, although the MIT cryogenics lab was a great resource for imagery and sound, and the professors there were fascinating to listen to their perspective on the accident and what might have happened; I was not permitted to film a 'before the accident' reconstruction in the cryogenics lab as the professor felt that this would link the lab with accident, or perhaps bad karma. My approach was to base the installation on a mixture of the known facts of this accident and our imagination of what this accident was and how it might have happened. I allowed the influences of popular culture to permeate this piece.

4.5.5 Cryogenics or cryonics?

Most people associate cryogenics with freezing bodies for future medical science to re-awaken them and bring them back to life. This is actually called cryonics. According to Alcor, a cryonics facility in California-, "Cryonics is the process of using very cold temperature to prevent people from dying when ordinary medicine can no longer sustain them. This is done to save their life until a cure for their illness can be found, and means developed to reverse the cryonics process. The technology to reverse the cryonics process is still speculative and far in the future." Cryogenics is the science of freezing materials, whatever they may be, at very low temperatures. When I explain this cryogenics accident to the public they immediately think of the cryonics version which is a point I have taken into account in the depiction and have used this cultural confusion in the interpretation deliberately, being ambiguous about the use of



fig.26 Single body cryonics unit, Alcor.

the tanks and gas in the laboratory to promote the idea that it was used to preserve bodies in this factory.

4.5.6 Science of cryogenics and what can go wrong

Cryogenic's comes from the Greek words 'kryos' which means very cold or freezing and 'genes' meaning created. Cryogenics typically involves a deep freezing process, usually one that takes objects down below 240 degrees Fahrenheit. This deep tempering has an effect of changing the molecular alignment in the object, thus creating new properties and making the material stronger. It seems that when metals are cooled to temperatures approaching -300°F, the structure of the alignment of the molecules in the metal changes from a random type of arrangement known as austenite to a more uniform and refined grain arrangement known as martensite. This martensite arrangement is a lattice type of metallic arrangement, creating a surface that may be stronger and more wear resistant when compared to non-treated materials. The common cryogenic liquids include carbon dioxide, or carbonic acid-the gas that was used in this accident, argon (-302°F), hydrogen (-423°F), nitrogen (-320°F), and oxygen (-297°F). Their cold boil-off vapor rapidly freezes human tissue. Most metals become stronger upon exposure to cold temperatures, but materials such as carbon steel, plastics, and rubber become brittle or even fracture under stress at these temperatures. The material used in the tanks in this accident used cheaper material which caused a brittle fracture. This caused the 90cm tear in the side of the tank.

All cryogenic liquids produce large volumes of gas when they vaporize. Liquid nitrogen will expand 696 times as it vaporizes. The expansion ratio of argon is 847:1, hydrogen is 851:1, and oxygen is 862:1. If these liquids vaporize in a sealed container, they can produce enormous pressures that could rupture the vessel. For this reason, pressurized cryogenic containers are usually protected with multiple pressure relief devices. Primary protection is usually a pressure relief valve; secondary protection is a frangible disc. In the case of this disaster, the gauges froze and so did not detect an overfill. Vaporization of cryogenic liquids (except oxygen) in an enclosed area can cause asphyxiation. Vaporization of liquid oxygen can produce an oxygen-rich atmosphere. Although oxygen is not flammable, it is an oxidant and will support and accelerate the combustion of other materials. Vaporization of liquid hydrogen can form an extremely flammable mixture with air.

4.5.7 Handling Cryogenic material

Most cryogenic liquids are odorless, colorless, and tasteless when vaporized. When cryogenic liquids are exposed to the atmosphere, the cold boil-off gases

condense the moisture in the air, creating a highly visible fog. When spilled on a surface, they tend to cover it completely and, therefore, cool a large area. The vapors from these liquids are also extremely cold and can produce burns and ultimately in this case-freezing of the body. In addition to the hazards of frostbite or flesh sticking to cold materials, objects that are soft and pliable at room temperature, such as rubber or plastic, become hard and brittle and are broken easily at these extremely low temperatures.

4.5.8 Uses of carbonic acid

CO₂ has many commercial uses. It is typically converted into liquid form at approximately 250 to 300 psig (17.6 - 21.1 kg/cm²) for economical storage and transportation. CO₂ vaporizers convert bulk liquid CO₂ to vapor which can be utilized in applications such as the carbonation of beverages (pin point carbonators), increasing the hardness of desalinated water, or the pH adjustment of process or effluent streams. Bulk liquid CO₂ can be utilized as a low temperature heat transfer fluid or as a part of a cascade mechanical refrigeration system. Solid CO₂ or 'dry ice' is often used for food freezing. It is produced by expanding bulk liquid CO₂ to near atmospheric pressure and compacting the resultant solid in a dry ice press. The vapor CO₂ or 'revert gas' produced along with the solid CO₂ when the liquid is expanded is typically recovered in a revert system and returned to the bulk storage tank.



fig.27 Pompeii 600 B.C.

4.5.9 Influence of Pompeii

One of my influences for this work is from the natural disaster of Pompeii. I was fascinated by the expressions on the faces of the people caught unawares. I wanted to express this in the faces of the scientists, since the accident in Hungary was a technological pompeii. I was interested in the fact that the public could get a sense of the fear through a combination of the body posture and face. The volcanic ash did not leave much of the expression but left enough to give us a strong sense of the immediacy of the disaster. It is this balance I was looking for visually in the accident reconstruction.

4.5.9.1 The Pompeii volcano history

The ancient Roman city of Pompeii, located about 20 miles southeast of Naples, was originally founded about 600 BC, and was a prosperous commercial center and resort. At its height, Pompeii reached a population of about 20,000. A sudden eruption of nearby Mount Vesuvius in 79 A.D, however, put an end to the town. When Vesuvius erupted the residents of Pompeii attempted to flee the city or tried to find shelter in their houses, but only some were able to escape. Thousands of residents perished. Several meters of volcanic ash fell on

Pompeii, burying everything except the roofs of some of the taller buildings. After the eruption, the city was abandoned and its location forgotten. In the late 16th century, limited excavations discovered some artifacts at Pompeii, but extensive archeological excavations did not commence until the nineteenth century. The ash that buried the town served to 'freeze' 'mummify' or 'crystallize' the entire city. During the initial excavations of the site, numerous voids in the ash layer were found that contained human remains. Those in charge of the excavations decided to fill the empty spaces with plaster. What emerged were detailed and eerie forms of the bodies of many Pompeiani who failed to escape, in their last moment of life. The expressions of terror and panic can be seen on the faces of many of these bodies.

4.5.10 Physical Installation layout

(3D elements, scale issues full size versus third)

The audience is presented with a laboratory. The laboratory is approximately 20ftx30ft. The audience walks towards the lab door. As they get closer to the door they hear the ambient sounds from inside.

On entering the laboratory they see three full-scale models of the scientists which appear to be frozen 'on the spot'. The idea is to give a feeling of a pompeii scene, frozen in time. There are two exploded tanks with a gauge showing the level of the gas at the time of the accident. Pieces of the tanks are strewn around the floor. The room is very cold and silent. When the audience moves near to the objects he/she will hear pieces of the story of the accident. For example, if the person moves near to the mouth of one of the scientists, the scientist will be speaking in hungarian at the time of the accident. If the person moves near to the tank pieces, the story of the materials, instruments, and cryogenic process will be told. As the audience leaves there is an accident report form on an office table which they may or may not want to fill out and drop in the 'box'. They can write down what they think happened and why.

4.5.10.1 Scale

Scale in an artwork has great power as an aesthetic force. Photo realist sculpture Ron Mueck used scale to great effect in his piece Dead Dad. This piece is diminutive in size, objectifying the moment when the parent becomes the child. It also points to unreliable memory in recalling size of things.

Ron Mueck and scale

Mueck's works are typically made by creating clay models/forms that are then cast in silicone or polyester. The artist often shrinks or inflates the scale of his

figures of babies, children, and men; the image on the left being nearly seven feet high. For Untitled (Big Man), Mueck used an airbrush to apply the final smooth layer of paint, which convincingly resembles human flesh. In addition to being an exploration of anatomy and illusionism, Untitled (Big Man) is a study in color; blue eyes and veins contrast with the yellow undertones of hairless pink skin. Mueck's sculpture, unlike the classical nudes of Ancient Greece and the European Renaissance which celebrate human beauty and proportions, presents the viewer with a monumental yet unidealized version of the human body that emphasizes its physical presence, fleshiness, and weight.

Failsafe scale

Scale can be major consideration in an art installation and is always an important element in my work. Choices can be to make a small object interface have large output consequences, like the drummer boy interface, or larger objects output microscopic changes- e.g the 3D projection for the Streaming installation had a very large projection of a 3D vrml world controlled by a small drawing by the audience in real sand. (Streaming, Saoirse Higgins, Siggraph 2000) In Failsafe, I experimented with having the scale smaller, 1:1, or larger. Having it smaller scale did not fit in with our perceptions of disasters and things that we are afraid of. We imagine things 'larger than life,' more exaggerated than they really are when it comes to disaster and anything we fear. Making it 'larger than life' would have been acceptable, especially when we look at how monsters are treated in horror movies and cartoons, exaggerating the size and elongating the shadows to a much larger scale. Making the installation pieces 1:1 made more sense as I wanted the audience to walk around the room as if they had walked into an accident aftermath. I wanted them to be stepping over objects and walking around the scientists in proportion to their scale so that they could compare their state with the frozen state of the operators.

4.5.11 The accident story

4.5.11.1 Perspectives

The first perspective on the accident in this installation is that of the expert analyst. This is through a piece of equipment that an expert would use in an accident investigation of the time-a 1960s tape player which the audience can rewind and get the expert's notes on the case. The experts version of the accident in this case blames the scientists for not being more aware of the cheap materials of the tanks and not checking the frozen gauge. In this narrative he gives his 'expert' opinion of the causes of the accident.

4.5.11.2 Expert narrative

At 11.50 am the scientists started the process of filling one of the tanks(-tank A) with carbon dioxide. At 2.24, this tank exploded followed a few minutes later by the explosion of another tank-tank B. These two explosions pulled tank A from its foundations perforating it with one of its support legs. This caused a fracture in the metal approximately 90cm² long. The carbon dioxide discharged through the fracture and propelled the tank through the laboratory similar to a rocket effect. The pieces of metal were thrown in all directions, some landing 400 meters away. One 1000- kg fragment was thrown more than 250 meters.

The most probable cause of the accident, in my opinion, was an overflow in the tanks. This could have been due to a failure of the gauging system-possibly because the level detector froze. On examining the fracture in the tanks we can see that it is a brittle fracture which means that the tanks were not made of the correct material for that type of chemical. This was a major mistake on the part of the scientists.

4.5.11.3 Operator narrative

The second is from the perspective of the operators. The audience discovers the operator's perspective on the accident through exploration of the space. When the audience gets close to one of the scientists he/she can hear them speaking about the time of the accident. The closer the person moves to the scientist, the clearer the sound. It is as if they are in cryonic suspension waiting for the audience to wake them up to tell their story. For this I have a narrative of a hungarian operator/scientist giving his side of the story. He blames the equipment and talks about what he remembers before he froze! The narrative is hazy and his memory is not good. He does make sure not to implicate himself in the cause.

We started filling the tank as usual at about 12pm. Then, I think it was at about 2.30pm when we heard a very loud explosion coming from the filling area. I turned around quickly to see what exactly had happened and saw lots of large metal fragments of the tank all over the lab floor. It looked like someone had overfilled the tank or something like that.... Carbon dioxide gas was pouring from tank. It was really bad.....very dangerous situation.....Then.....another one of the tanks exploded and shot across the room like a rocket. It was terrible.....I don't remember anything else.....I think maybe the gauge on the filling tank wasn't working properly and didn't tell us how much carbon dioxide we had in the tank. That would definitely have caused the explosion since we couldn't tell if the tank was full or not.

4.5.11.4 Machine narrative

The third mechanism highlights the system's own viewpoint - "motors, activators, doors, cabins, software and sensors. They too have their conditions; they allow or forbid other alliances. They require, they constrain, they provide." (P.359, 1999:Perrow) This viewpoint is examined through listening to the fragments of the machine for fragments of the story from the machine perspective. For this, the audience receives the ideal way that the equipment should have been handled and was obviously not handled that way. The narrative here talks of the safety precautions required to deal with this gas and procedures for preventing an accident. Implied in this is the machine blaming the operator for mis-handling 'its' parts.

Technical detail for interaction

IR sensors are used to detect the person coming towards an object. When the person is within range the narrative starts softly. The closer the person gets to the object the louder more clear the sound. As the person moves back from the object the sound recedes. The IR sensors are connected to a audio amplification circuit, which controls the volume of the sound which is playing from a CD player. I decided not to use headphones for a number of reasons. Primarily, I felt that the public should be able to walk around the laboratory unencumbered by another layer of equipment. The interface is based on their own natural curiosity and their connection to popular culture and knowledge of disaster movies to discover the story.

Sound interaction

"Scientists say that an extreme bass sound, known as infrasound, can produce emotional effects in people including anxiety, extreme sorrow and chills. In an experiment, inaudible infrasounds were projected on 750 concert attendees without their knowledge. Over 20 percent of the audience reported feeling uneasy or sorrowful, spine chills, revulsion, fear or nervousness." (Wired magazine, Sep 8th, 2003)

Why sound ?

Sound can have the capacity to be more ominous and evocative when one hears voices compared to an image. It is traditionally used in film to build up a dramatic moment as in the film Jaws, for example. I wanted to work on the moments of build up to the accident which can be achieved successfully with audio clues-for example, the alarm, the machine noises, the steam hissing. I wanted to create a tension between the 3d frozen scientists and their live voices recounting the narrative. Audio is used as the key medium in the collection of evidence from suspects in investigative interviews, in airplane accident

blackbox and taped conversations between control tower and airplane. "The topic of death tends to be for radio and not for TV." (p.62,2003:Virilio) It is rare for there to be video footage of the moments of the accident. Normally there are software reconstruction programs that attempt to re-create the conditions for the accident. For example: The TWA 800 accident investigators pieced the plane together like a large puzzle by putting all the fragments of the metal back together again to figure out what went wrong. They also had a piece of audio from the control tower talking to a plane in the area that saw it go down. With the physical pieces, the audio and the experts opinions, they figured out that an electrical spark had caused the accident in the fuel tank.

4.5.12 Sound interaction

Another version of Failsafe would be possible with headphones. The advantage of this is in the individual experience-a private viewing, in other words. The disadvantage is that headphones tend to make the sound feel like it is originating in ones head and not from an external source. It places the sound in another past world along with the accident. Placing the sound open within the space, but not in an intrusive way, brings the accident to the audience. It brings the 3d frozen scientist to life as if they are being re-animated in the true cryonic future sense. It also has associations with old dusty museums (example- the Witch museum, Salem) or funfair shows of the 1960s. It gives the experience a slightly unsettling presence in the room. Headphones would have been yet another layer between the reconstruction and the audience and would feel artificial. I did not want them carrying technology when they were supposed to be thinking about this topic. I wanted to convey an 'accident radio channel' feeling when they get close enough to the objects to 'tune in' to their narrative. Somehow conveying the idea of 'tuning into' their perspective on the accident.

4.5.12.1 Current systems

Current systems for sound interaction in museum type spaces are adequate but not imaginative. There are a variety of systems including Mp3 individual players with wireless headphones; pressing a button on a control panel to get the audio at different stations; reading a printed card with text about the exhibit; wireless and wired phones with numerals related to exhibits; a human guide who takes you around the exhibits or an interactive website with information after or before the show. Having to put on headphones at exhibits is not ideal or comfortable in my experience or from observation of others. A good example of headphones working well is from Keith Haring exhibition at the Sydney Contemporary art gallery. The sounds contained particular music of the 80's, which



fig.28 Headphones from 60's geiger counter.

was associated with each piece of Haring's work. It was a good use of sound, making the link between the artist's music influences and the imagery. It was also particularly appropriate for this artist's work.

4.12.2 Binaural sound

Just as there is a difference in location of the image as seen from the left eye to the right eye so there is a difference in sound between the ears. To recreate the same authentic experience of localised sound I recorded the ambient sound of the cryogenics laboratory using binaural recording technique. By placing two small omnidirectional mikes at the entrance to the ear canals one can record the sound localised to be reconstructed in the installation. Normally an artificial head replicating human features is used (with the ears about 6 to 8 inches apart). This includes even the fleshy ridges of the outer ears which modify the frequency balance of sounds depending on the direction from which they originate. There is no mixing of the two channels as with stereo loudspeaker playback. This gives a more atmospheric, real experience for the audience. It is important to recognize the difference between a stereophonic system and a binaural system. The former system uses loudspeakers but requires an infinite number of channels for perfect reproduction. The latter requires only two channels for perfect reproduction but involves the use of a pair of head receivers [drivers] held tightly to the ears for each listener. All listeners with such a system can be given the illusion of sitting in the best seat in the concert hall. (Harvey Fletcher, SMPTE Journal Vol. 61, September, 1953)

4.5.13 Spacial consideration

The installation is designed for more than one person to use at the same time. The public can walk around and investigate the space. The idea being that they discover the narrative through exploring the space with their normal curious disposition. When one of the public walks closer than ten inches to the scientists, when facing the scientists front, the sound starts. The idea is to give a sense of the scientist telling the story to the person. I imagined the person leaning towards his/her mouth with the ear to listen to a secret. I also wanted to get some sense of when one moves closer to a radio or TV one sometimes acts as a good antenna and gets better reception.

The space is quiet except for the murmur of the narrative to individuals moving around the space and the movement of people around the room. The public has to lean very close to the tank fragments to understand what is being said. The idea is of listening to noises in a pipe. The overall impression is of the public being a team of investigators going about their job gathering the evidence and examining the room. Another key object in the laboratory is a symbolic clock

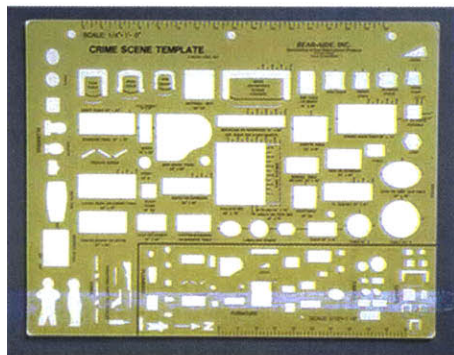

fig.29 Crime scene template.

stopped at the time of the accident with its glass blown away. Equipment on the desk gives us an idea of what the scientists were doing that day, the 'pompeii effect'. When one of the public is listening to the narrative it is possible for another person to come along and overhear the sound. This is a natural way to begin to investigate a story, through pieces of the picture collected from others. There is also a 1960s tape player sitting on the desk which can be played and must be re-wound to play again. This contains the expert's opinion since the expert is not at the scene of the accident but giving the 'news bite' opinion of the cause.

4.5.14 Sense of touch

The sense of touch adds a distinctive contribution to an interactive work. "When the senses conflict touch is usually the ultimate arbiter." (p.359, Perception). Touch is something I have considered an important element in all my installations. For this one, I am making the scientists cold to the touch to get more of a sense of them being frozen. Making the room cold would also contribute to the sense of the cryogenic accident and build up the eeriness. It draws a good comparison with the audience being alive, their breaths showing in the air, while the scientists have none.

4.5.15 Making the scientist

For the construction of the scientists I decided to use a technique that mixes digital and physical. It seemed an appropriate medium to use to capture the moment of the accident in the faces of the scientists. Using the Minolta Viva 910 3D digitizer to do this I could take a 3-dimensional 'snapshot' of the imagined moment in time. This alluded to the 'suspension' of time, similar to the camera tricks in action films spinning around a frozen three dimensional actor. (e.g [The Matrix](#))

4.5.15.1 Background of the process

The Z Corporation 3d printing machine uses a powder technology developed by M.I.T. to build its objects. It lays down material like a laser printer. It builds the positive form with a cellulose (carbohydrate) powder which binds together as it is built up in layers and it fills the negative space with an inert powder that does not fuse. The completed object is then removed from within a cube of the fine dry powder when finished. After printing, the objects can then be soaked with wax or epoxy. When soaked in wax, they can be used in a lost-wax process for investment casting with many materials, including bronze or aluminium. The cellulose and other powders are non-toxic and cost about 65 cents per cu-



fig.30 Laboratory clock stopped at the time of the accident.

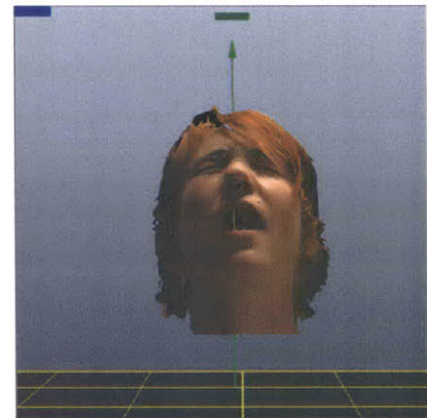

fig.31 3D scan of head. four scans stitched together



fig.32 3d printed face with silicon moulded skin on top.

bic inch. The largest size this machine can print is about eight inches by eight inches by ten inches, built up in layers of one-seven-thousandths of an inch. An interesting result of this process is that there is no time penalty for complexity. A complicated shape with many internal twists and turns is printed in the same time as a solid block of the same size.

Other concept modelers use spray nozzle technology, similar to an ink jet printer, to build up their objects. Because there is no negative space support, these machines must build additional support structures within the objects. The support structure it builds while being constructed is easily broken off of the part. The surface may be very rough and needs a lot of work to finish it, mostly because of the support structure. These machines come with software that is capable of improving the final object by rotating it within the build envelope (the maximum scale for the printer) to minimize 'stair-stepping' of layers, which occurs on diagonal surfaces during the printing. Parts may be also moved, copied, and deleted by the software before printing. Objects may also be scaled by the software. Changing scale has always been a laborious task for sculptors/designers/artists. If scale becomes effortless, it allows artists to consider scale as an aesthetic device in their work.

Issues concerning the speedy reproduction of objects that these machines allow is also intriguing. Without casting, exact reproductions of identical objects can be made as long as one keeps supplying the machines with material. "If you can have 500 identical objects without having to sweat, that opens up a world of possibilities about sculptures that have to do with the idea of sets, sculpture that relies more on the interrelationship among a set of related objects than on the formal properties of a single unitary object."

4.5.15.2 3d digitising

My plan was to 3d scan suitable and willing volunteers to act as the scientists. At first I attempted to scan the whole body in a variety of poses imagined at the point of being frozen. This did not work so well however since the detail I got in the scans was minimal with the lenses available and it was difficult for the person to hold the pose for four to six scans. The other problem was finding a machine large enough to print the entire body full scale. I decided to 3d scan the heads and hands full scale instead and build the bodies out of metal mesh, covering them afterwards with suitable 'scientist-style' clothing.

To 3d scan the person's head I appropriated a rotating metal platform used

normally for pottery. This enabled the person to stay in position while I rotated the platform to each of the four positions for the scans. I experimented with six and more scans but found that four was a good balance between quality of scan and the person being able to hold position. It required that they hold their particular expression I asked them to make for several minutes while I scanned the heads in. Hair was a problem since the scanner does not see black. The darker the hair, the more difficult it was to scan. It also became a big problem to stitch together into a clean model later in the process, so I solved this by placing a white cap on each person. This enabled me to develop good quality scans of the full head and neck. Transparent surfaces did not scan well either as they reflected the laser. Any glasses or watches had to be removed for the process. I scanned the hands separately by raising the arms up and rotating the person around their z-axis to get four scans. It was difficult for them to hold the pose for this, but possible. Putting a black background behind the hands helped since the scanner then did not pick up all the extra detail around the hands, and the scans were easier to clean up later. I could have used a different method to cast the hands and arms but I wanted to keep the materials the same between head and hands so they didn't look like two different bodies.

4.5.15.3 Manipulation of the 3d scans

When the process of the scanning was complete I had a wrp file. I then used software called Geomagic to manipulate the scanned data. The first task was to clean the individual scans up, getting rid of the noise and extra parts that I didn't need. This I did by selecting them all and getting rid of the noise and outliers. I then added points where there was less data at important areas which I knew I would need. The software was quite good at matching the colour also when adding points. Sometimes it did not do it and would add the points in black. This can be a problem if it is a colour print, but I was intending to use the heads white, so this didn't effect me. When I finished cleaning up and adding points I then selected all the scans and manually registered them. This means I selected matching points on each scan to help the software figure out how to put the points together to make a single head. The key to success is matching the points up as close as possible and making sure not to select the inside instead of the outside of a scan. It was hard to tell the inside from the outside since the texture map looked the same on both sides. (Also when selecting points it is a good idea to check that points are not being selected on another plane. If the object is rotated around to check for this it will save a lot of heartache.) Once the scans were stitched together to form one single head it was converted to a polygonal model. This part of the process is where a balance between detail and size matters. I wanted to make sure that I didn't lose



fig.33 3D scan ready for clean up.

the expression on the faces of the scientists. This was very important. I did not reduce the scan data too much before I converted them to polygons.

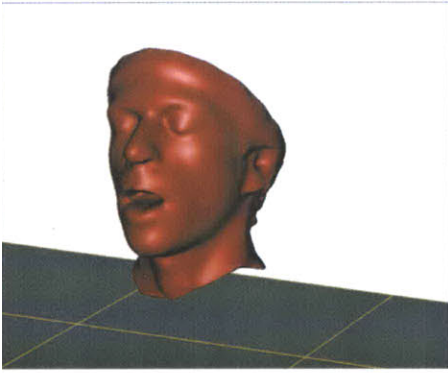

fig.34 Polygonal model of head.

I found that the more angular the face, the better result. Softer expressions and features lost their detail. The more exaggerated the detail to begin with meant that there was more to work with throughout the process. I deliberately kept that in mind with my choices of scientist actors combined with their expression ability and hungarian appeal. The next step was to close any holes in the polygonal model, which can take a long time. The software can calculate the curvature around the hole and can match this. Sometimes it is not able to do this effectively, which means I had to clean the model up around this hole and simplify the edges. When this process was done the model was almost ready to be 3d printed. I shelled my head models so the material would not be wasted and I could fit the electronics on the inside. I then saved the model as an stl file, which printed without colour. The vrm12 format is used to print a colour version. I wanted to test-print many of them and did not use any colour. The white color of the powder looked very similar to a frozen colour therefore I chose to use this feature of the material.

4.5.15 3d printing

The 3d printing took place on the zcorp printer. To print the heads the file is imported into the software and placed in the virtual print area. It matters which way it is placed to reduce contours on the surface. Placing the head face down is better than the other way around-it prints noticeably smoother. Obviously the detail of the polygonal model matters also. For a head which was almost 1:1 it took approximately six hours to print. The printer builds up the layers and makes a shell structure of tightly packed plaster material. The material on the inside of the shell is loosely packed and falls away when the head is finished and taken out of the printer. This leaves a perfect model printed to my specification for wall thickness and size. It is important to leave the model in the machine to cure for several hours. If you pick it up directly after the print it will crumble. After curing the model I then blew out the excess powder and added epoxy to make the material more robust.

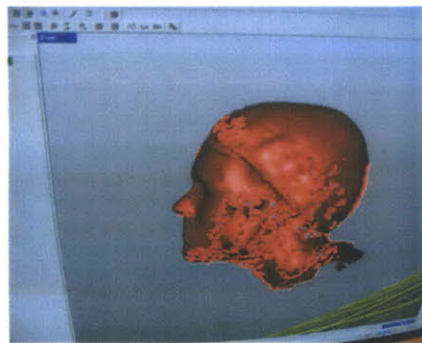

fig.35 Closing the holes in a polygonal model.

5.0 Discussion and Analysis

5.1 What do the audience get from the installation?

The audience begins to understand that risk is intrinsic to our world and thinks about the fact that technological disaster has become integral in our lives in the 21st century. It gives us a moment to pause and realise that technology has two asymmetric sides, one of these sides being failure. Our faith in technology can be deterministic and idealistic, expecting it to solve all our difficult situations, when in fact technology is constantly in a state of dynamism and flux and should be treated accordingly.

5.2 Installation outcomes

The object of the experiment was to examine the evidence of accidents and highlight to the viewer that risk is intrinsic to our world and that technological disaster has become integral in our lives in the 21st century. It offers the audience the case of the accident in order for them to contemplate what happens when a system which is designed to be under control works against this and lets go.

In the two experiments - the 'Doom machine' and in 'Mechanism no.1:War' I examined the question of fear in the world. Through the three experimental artworks I am striving to explore the links between technology and our increasingly apocalyptic vision of the world. Ultimately we are responsible for technology and how it is used with all our human imperfections and 'functional' hiccoughs. In both the Mechanism and Doom machine the output message was so strong and dramatic that the physical elements were not required to be so obvious in highlighting the theme. In fact, part of the impact of the pieces was in the juxtaposition of the physically undramatic 'friendly' interfaces with the message being given. It encouraged people to interact without being afraid and wrapped a serious message in an interface that was easy to handle.

For the 'Failsafe' experiment, the drama of the event is laid bare by the expressions on the faces of the scientists and the metal pieces thrown around the room. The physical interface, in this case, conveys much of its information about what happened. If the audience feels like delving into the accident further, they can receive more information. In other words, the audience does not have to make much effort to discover the interaction. I believe the interface for this should be simple and effortless, considering the subject they have to grasp is quite complex. The objectives of differentiating the operator, expert and machine view is not 'clear cut' in real life scenarios and therefore was not

easy to express in the installation. I resolved this by keeping the same medium of audio but changing the way in which it is presented to the public for each perspective.

For the operator's perspective I made the narrative personal in tone and language. Placing the audio output in the mouth of the models seemed a good option for personal description. Also choosing to use a hungarian speaking heavily accented English made the narrative more authentic. The expert's opinion of the accident is presented on a cassette tape which is placed on the desk. I used the BBC style newcast male voice for this which separated the scene from the expert. It kept the expert in the distance as a global observer. This made it more generic and unemotional to the plight of the operators.

The machine's opinion is a break down of the safety handling, procedures, and properties of the technology, and was fragmented between the pieces of metal and gauge. The audience goes to the various fragments to get the complete version-alluding to the re-construction of physical pieces and analysis of each. Using this as an interface means that the public can focus on the narrative and not be pre-occupied with the technology hanging around their neck or on their ears, especially when my emphasis in the work is that there is more to the accident than just technical explanations-there are the social and cultural aspects.

5.3 Audience feedback and evaluation

The evaluation of audience feedback came from two events. The first event was a critique by the List Arts curator Bill Arning, Professor Stefan Helmreich and Professor Chris Csikszentmihalyi. The second event was an opening evening in which ten people were invited to examine the piece and interact with it for approximately two hours.

Most people are intrigued by the idea of the people freezing instantaneously while they worked. It seems to hit a cultural nerve-the idea of getting caught out by technology when you do not expect it to do that. The slight murmur of the voices worked well in the space which encouraged the audience over to the various pieces. They then could hear the volume changing from soft to loud. The interaction would work better if I had more than one sensor to trigger the sound volume on each piece, as this would enable the audience to approach from more than one main direction to listen to the story. The narrative 'piecing together' of the story needs more refining in order for the audience to understand the sequence of events. Most people wanted to know when the accident

happened and where it happened. They knew about the cryonics process in a vague manner, associating it with a science fiction method of preserving life for future medical advances. They also related easily to the scene of Pompeii and a 21st century Frankenstein story. The audience did explore investigatively in the space. They discovered the interaction narratives by walking close to an object and realising that it effected the sound. They only remained at a point of interaction for approx. 20 seconds getting an impression of the story as opposed to exact detail. This was taken into account when editing the sound.

5.4 Critics comments

Professor Stefan Helmreich discussed the fact that my other projects deal with impending disaster and that this project examines a post-disaster scenario. He suggested that it would be interesting for the audience to leave their opinion of the accident for others to listen to thus building up the audience perception of the scene. This could work well with the piece. Chris suggested the audience as 'forensic investigator' with recording equipment collecting the story, or using taped off areas to highlight the scene of a disaster investigation. Bill Arning talked about the idea of the museum aesthetic and how people represent monumental moments. We discussed the recreation aspect of the disaster and how this could be exaggerated and 'embraced' in the work.

Another idea that was discussed at the second event was that of highlighting the trajectory of the exploding tanks using dashed lines on the ground. This is something I would like to experiment with as I think it might be interesting to link it to the sound narrative.

It was noted that the safety lighting worked well promoting the effect of coldness and that it would help if the temperature in the space was reduced down to below freezing or near there, enhancing the cryogenic effect. Stefan also suggested that the bodies could possibly be designed to thaw out. Bill Arning liked the notion of cryonics prolonging life and the link with this process and the accident at Repcelak.

5.5 Alternate scenarios in Failsafe

A corridor leading to three rooms-one being the time before the accident, the other the time after the accident and the middle room would be the time of the accident. The 'before' room would contain a looped audio tape of the work going on as normal with information about the factory and product on the wall in safety poster style. The 'after' room would contain the scene of the aftermath with three narratives and the middle room would be where the audience decides what actually happened and who was to blame. The 'causality' room. This was abandoned as a plan as I felt that the onus was on the public to work

hard in the piece to get anything out of it. It seemed more like a chore for them. Another set-up was to have a corridor leading out of the laboratory. This corridor would contain pipes running along its sides with no sound apart from a low hissing sound of gas. The public could chose to leave this way or go back the way they came. I felt this was overkill on drama and it was enough to have the laboratory speaking to the public.



fig.35 Exploded tank pieces.



fig.36 Reel-to-reel recorder-expert's opinion.



fig.37 Scientist No.2 Failsafe.



fig.38 Scientist No.1 Failsafe. 3D printed head detail.

6.0 Future developments and conclusions

6.1 Future developments

I will be looking at developing a portable device to capture the accident narratives or to categorise the 'loose couplings' in the disaster. I will also be developing a reflective crisis prediction system that takes into account social and cultural aspects of the story. I would like to examine another key accident-that of the Thetis submarine disaster that happened in the Irish sea. I would like to research the personal narratives more and collect the individual perspectives and where they were coming from. I will be experimenting with the trajectories of the tank pieces and relating this to the narrative.

6.2 Conclusions

Looking at the state of the world today as a contemporary artist, I believe we need to be commenting on the effect that technology is having on the world in this 'age of terror'. I am looking at our concerns and fears as we embrace technology and it's 'powers' both good and bad. My masters thesis is a reaction to the twenty-first century disaster. It is perhaps a less dangerous commentary on the current tenuous situation in the world with regard to daily global risks than some of the safety devices put in place after September 11th . We are increasingly dealing with safety and surveillance systems and it is important to look at evidence of this change in intensity and to react to it as designers, scholars and artists. I would hope to promote more discussion on our 'faith' in technology's power and how we can use digital tools to examine future 'invisible' threats and changing disaster, and aid in more realistic solutions, taking into account all facets of the case. This artwork was designed as a vehicle through which I could explore the fears/hopes, trust/mistrust in human-technology relationships which is embodied in the technological accident. Risk is intrinsic to our world and technological disaster, man-made natural disaster and intentional man-made disaster has become integral in our lives in the 21st century. I believe from my research that systems in the future will have the safety elements visible on the outside but at the same time integrated into the aesthetics of the object, building or technological system. They will no longer ease the safety mechanisms in, placing them in the background, but design the risk into the foreground of the product for all to accept and deal with. The design of a system should acknowledge human imperfection and mix this in, intentionally including the 'domain of magic' along

with science in the design and not try to make the technology a perfect 'tightly coupled' system that has no room for error.(p.89,1998:Perrow)

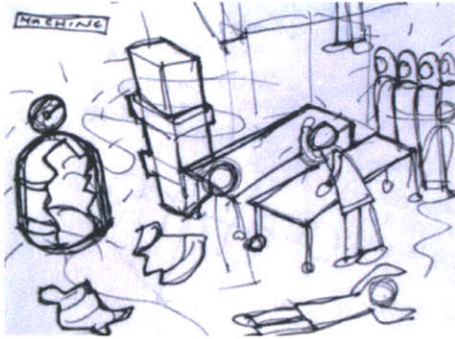

fig.39 Scene of disaster- sketch

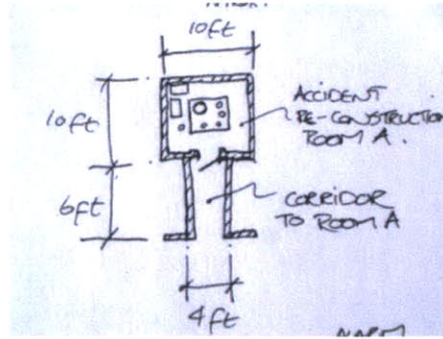

fig.40 Installation plan view.



fig.41 MIT cryogenics lab gauges.



fig.42 Scientist No.3 Failsafe.



fig.43 Scientist No.1 Failsafe.

6.3 Designing future technological systems:

Here I suggest a list of questions that could be incorporated into the design process in order to build a more robust future system tuned to our needs.

- > Examine the multi-narratives in the story.

- > Explore the characters of the user and also that of the maker.

- > What exactly are the design decisions based on-what is the history of the project?

- > Embrace dynamism and fluctuation in a system as a positive feature.

- > Allow for changes in social, environmental and cultural issues.

- > Work with the possible threats and human fears and incorporate them into the design i.e safety features on the outside and not hidden.

- > put human imperfections and character to the foreground of the design.

7.0 Appendices

- 7.1 Article from The Railway Times, 15 August 1840, p. 654
- 7.2 French report on the accident with plan diagram of the space.
- 7.3 Failsafe sound interaction circuit diagram.
- 7.4 Torino scale description
- 7.5 Bam report-christian science report.

8.0 References/Bibliography

- Edwards Paul, Y2K millennial reflections on computers as infrastructure, source
- Adriana Petryna, Life Exposed- Biological citizens after Chernobyl, New York, Princeton Press, 2002.
- Chiles R. James, Inviting Disaster, Lessons from the Edge, Harper Business, 2002.
- DeLillo Don, White Noise, Penguin, 1996.
- Fleck Ludwik, Genesis and Development of a Scientific Fact, Chicago, The University of Chicago Press 1979.
- Geertz Clifford, The Interpretation of Cultures, New York, Basic books, 1973.
- Tenner Edward, Why things bite back, New York, Vintage books, 1997.
- Virilio/Lotringer, Pure War, New York, Semiotext, 1997.
- Latour Bruno, Aramis or The Love of Technology, Cambridge, Harvard University Press, 2002.
- Perrow Charles, Normal Accidents, New York, Princeton Press, 1999.
- Rees Martin, Our Final Hour, New York, Basic Books, 2003.
- Virilio Paul, Unknown Quantity, New York, Thames and Hudson, 2003, Fondation Cartier pour l'Art Contemporain.
- Virilio Paul, Lotringer Sylvere, Crepuscular Dawn, New York, Semiotext, 2002
- Wilson Richard, The Cost of Safety, New Scientist, 30th Oct 1975.
- Marx Leo and Merritt Roe Smith, Does Technology Drive History, Cambridge, MIT

press, 2001.

Kittler Friedrich, Gramophone, Film, Typewriter, Stanford University Press, 1999.

Arendt Hannah, The Human Condition- A study of the central dilemmas facing modern man, Chicago, University of Chicago Press, 1958.

Arendt Hannah, The Life of the Mind Thinking, New York, Harcourt Brace, 1971.

Fortun Kim , Advocacy after Bhopal, Chicago, University of Chicago Press, 2001.

Kraus Karl, In these Great Times, Chicago, University of Chicago Press, 1990.

Whitehead Colson, The Intuitionist, New York, Anchor 1999.

Clarke Lee, Mission Improbable-using Fantasy Documents to Tame Disaster, Chicago, University of Chicago Press, 2001.

Witmore Michael, The Culture of the Accident, Stanford University Press, 2001.

Capek Karl, The War of the Newts, New York, Catbird Press, 1990.

<http://www.swissre.com>

Sigma study

<http://www.humanedgetech.com/guide/emergency.html>

<http://www.ncedr.org/tools/othertools/costbenefit/lead.html>

Tufte Edward, Visual Expectations: Images and Quantities, Evidence and Narrative - Lessons from data analysis from the Challenger, Graphics Press, 1997.

Feynman P.R, Personal Observations on the reliability of the Shuttle.

Paul Slovic, Baruch Fischhoff and Lichtenstein, Facts and Fears: understanding perceived risks in societal risk assessment, ed. Schwing and Albers, New York, Plenum Press, 1980.

<http://science.ksc.nasa.gov/shuttle/missions/51-1/docs/rogers-commission/>

Liotard Francois, The Postmodern Condition, Minnesota, University of Minnesota, 1999.

Heidegger Martin, The Question Concerning Technology, Perennial, 1982.

Mackenzie Donald, Knowing machines-essays on technical change, MIT Press, 1998

Helmreich Stefan, Silicon Second Nature, University of California Press, 2000

Shelley Mary, Frankenstein, Barnes and Noble classic, 2003 (first published in 1818)

Stephenson Neal, The Diamond Age, 2000

Stephenson Neal ,Mother Earth Mother Board,

Lewis Michael, The Future Just Happened, Houdier and Stoughton, 2001

Williams Rosalind, Notes on the Underground, MIT Press, 1990.

Software Engineering Notes, April 1992, p.30.

Curious Boym, Princeton Press, 2002

Perception, Mcgraw Hill publishing, 1990, Sekuler Robert and Blake Randolph. p.345-347.

Sarai Reader, The cities of everyday life and The metropolis and mental strife, Nitin Govil, 2002.

Sontag Susan, Against Interpretation, NY Picador 1966, p.209-25.

Kac Eduardo: Telepresence, Biotelematics, and Transgenic Art (Maribor, Slovenia: Kibla, 2000), pp. 101-131.

<http://www.crime-scene.com/ecpi/tools.shtml>

From The Railway Times, 15 August 1840, p. 654

Full particulars will be found elsewhere of a most melancholy accident, resulting in the violent death of five individuals, and the serious injury of several others, which took place last week on the Hull and Selby Railway. No one can read the evidence given before the Coroner without feeling satisfied that great carelessness must have been displayed in packing the article which led to the lamentable occurrence, although, as usual in such cases, it is difficult to fix the blame upon any particular party. The heavy deodand which has been imposed on the joint Companies will, however, we doubt not, produce a salutary effect upon the Managers of the Selby lines, and if anything were wanting to stimulate other Boards to continued (and, if possible, increased) vigilance, it would be found in the melancholy circumstances connected with this truly mournful affair. That this accident will be easily seized upon by the enemies of railway travelling we are quite prepared to expect. The public, however, will not forget that out of the many millions who have been conveyed on railways in the last 10 years, these five unfortunate individuals in the north are, with but a solitary exception we believe, the only ones who have met with mortal injuries, without any fault of their own; while the absence of minor casualties has been not less remarkable. We venture to assert that for one passenger who has been injured on railways, one hundred have suffered through stage-coaches, steam-boats, sailing vessels, or indeed any other means of locomotion; in fact, there is no greater wonder connected with railway travelling than the extraordinary freedom from mishaps which has hitherto characterised, and will, we trust, long continue to characterise it.

We regret that one of the verdicts in this deplorable case should have been deformed by the introduction of a clause respecting the so-called "violation of the Sabbath," said to be sanctioned by the Directors. "The jury think it consistent [they say] in connection with this awful event," to allude to the Sunday travelling on the line, but where is the consistency, unless they mean to insinuate that the visitation which called them together is to be regarded as a mark of Divine displeasure - in which view of the case is involved, besides other considerations, the injustice of punishing unoffending individuals for the sins of others? This is too serious a matter to be treated with levity, but really the preposterous notions of these Sabbatarians are sufficient to make the scoffer laugh, although they cause the judicious to grieve.

2 EXEMPLES DE BLEVE – RETOUR D'EXPERIENCE

Ce chapitre présente, en premier lieu, divers accidents ayant conduit à des BLEVE en l'absence d'incendie. Dans un second temps, sont exposés des cas ayant impliqué des liquides inflammables et donné matière à l'apparition de boules de feu (C.C.P.S., 1994). Dans une troisième partie enfin, l'INERIS présente les résultats de l'interrogation du BARPI (Bureau d'Analyse des Risques et des Pollutions Industrielles) relativement au phénomène de BLEVE.

2.1 BLEVE SANS BOULE DE FEU

2.1.1 DEFAILLANCE D'UN WAGON CONTENANT DU DIOXYDE DE CARBONE (HALTERN, EX-RFA, 02/09/1976)

Un wagon rempli à 90 %, contenant quelques 231 tonnes de CO₂, a explosé. Le contenu du wagon était à une pression de 7 bar et à une température de -15°C.

Peu avant l'explosion, il aurait été observé que le wagon évacuait du dioxyde de carbone par sa soupape de sécurité. Il n'est pas clairement établi si l'explosion s'est produite avant ou après une collision avec d'autres wagons.

Des fragments du réservoir ont été retrouvés à des distances supérieures à 360 mètres du lieu de l'accident. D'autre part, trois autres wagons vides situés trois voies plus loin ont été soufflés par l'explosion et ont ainsi déraillé. Une personne fut tuée dans l'accident.

L'analyse post-accidentelle d'un fragment aurait indiqué que la rupture de la citerne a été de type fragile.

2.1.2 EXPLOSION D'UN RESERVOIR DE STOCKAGE DE DIOXYDE DE CARBONE LIQUIDE (REPCELAK, HONGRIE, 02/01/1969)

Cet accident s'est produit dans une centrale de production de dioxyde de carbone. Ce produit était liquéfié et refroidi par l'intermédiaire d'un circuit de réfrigération à l'ammoniac puis stocké dans des réservoirs sous une pression de 15 bars et à une température de l'ordre de 30°C.

L'installation comportait trois réservoirs de stockage situés approximativement à 15 mètres du bâtiment de production.

Les conditions de l'accident furent les suivantes (le lecteur se rapportera à la figure 1 ci-après) : à 1h50, le remplissage d'un réservoir (C), avec le dioxyde de carbone produit débute, et à 2h24, pendant le remplissage, le réservoir explose, suivi, quelques instants plus tard, de l'explosion d'un autre réservoir (D). Ces deux explosions produisent l'arrachement du réservoir (A) de ces fondations et sa perforation par l'un de ses supports, provoquant ainsi, dans son flan, une brèche dont la surface fut estimée à environ 90 cm². Le rejet de CO₂ par cette brèche entraîne, par réaction, la mise en mouvement du réservoir à travers l'installation (effet fusée) provoquant ainsi la mort de cinq personnes.

Des fragments, projetés dans toutes les directions, provoquèrent la mort de 4 personnes supplémentaires et atterrirent à plus de 400 mètres.

Un fragment de 1000 kg fut notamment projeté à plus de 250 mètres. Une quinzaine de personnes furent blessées, dont certaines ont subi des gelures partielles.

La cause la plus probable retenue pour cet incident est un sur-remplissage dû à une défaillance du système de jauge (vraisemblablement le gel du détecteur de niveau). Par ailleurs, il semblerait que le matériau de fabrication de plusieurs cuves n'était pas adapté aux faibles températures.

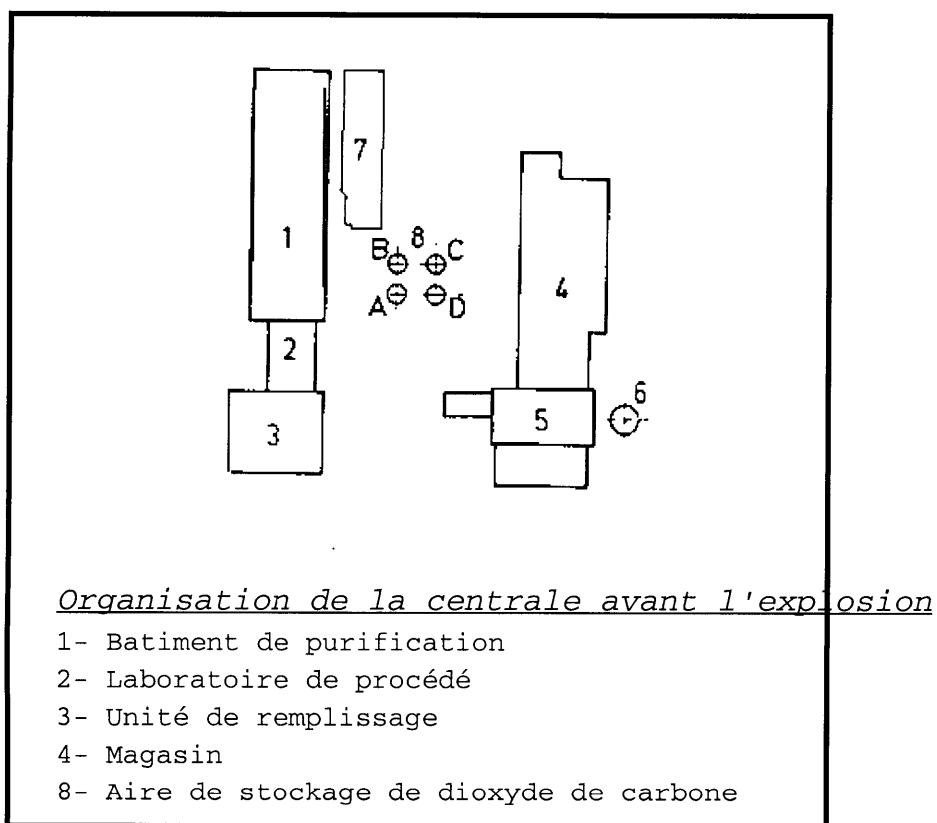
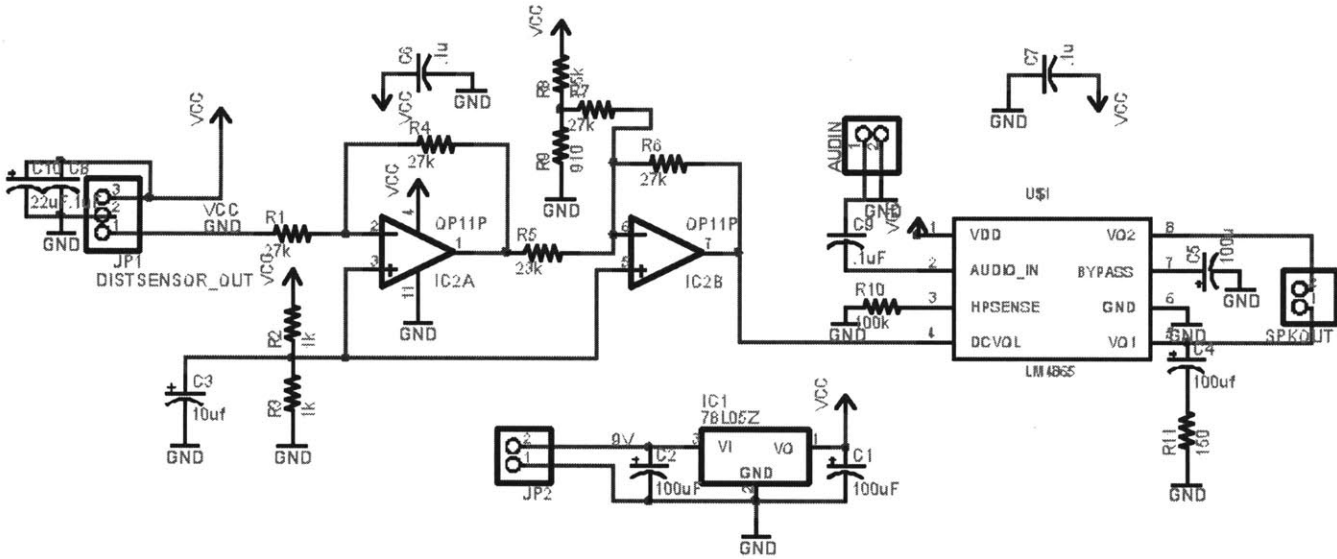

Figure 1 : Site de production de CO₂ de REPCELAK

2.1.3 EXPLOSION D'UN CAMION CITERNE CONTENANT DE L'OXYGENE LIQUIDE (BROOKLYN, NEW YORK, USA, 30/05/1970)

Un camion citerne est rempli de 14 tonnes d'oxygène liquide. Il stationne ainsi chargé pendant toute une nuit, puis, le lendemain, est utilisé pour effectuer une livraison de 1,9 tonnes au réservoir d'un hôpital. Après la livraison le conducteur débranche les tuyaux destinés à la livraison et commence à manœuvrer son camion. La citerne se rompt soudainement et un incendie très violent se développe autour du camion, dans l'atmosphère très enrichie en



THE TORINO SCALE

*Assessing Asteroid and Comet Impact
Hazard Predictions in the 21st Century*

Events Having No Likely Consequences	0	The likelihood of a collision is zero, or well below the chance that a random object of the same size will strike the Earth within the next few decades. This designation also applies to any small object that, in the event of a collision, is unlikely to reach the Earth's surface intact.
Events Meriting Careful Monitoring	1	The chance of collision is extremely unlikely, about the same as a random object of the same size striking the Earth within the next few decades.
	2	A somewhat close, but not unusual encounter. Collision is very unlikely.
Events Meriting Concern	3	A close encounter with 1% or greater chance of a collision capable of causing localized destruction.
	4	A close encounter with 1% or greater chance of a collision capable of causing regional devastation.
	5	A close encounter with a significant threat of a collision capable of causing regional devastation.
Threatening Events	6	A close encounter with a significant threat of a collision capable of causing a global catastrophe.
	7	A close encounter with an extremely significant threat of a collision capable of causing a global catastrophe.
	8	A collision capable of causing localized destruction. Such events occur somewhere on Earth between once per 50 years and once per 1000 years.
Certain Collisions	9	A collision capable of causing regional devastation. Such events occur between once per 1000 years and once per 100,000 years.
	10	A collision capable of causing a global climatic catastrophe. Such events occur once per 100,000 years, or less often.

Iran's quake: Nothing 'natural' about this disaster

By Brendan O'Neill

LONDON –What is the lesson of the terrible earthquake that struck southern Iran last week, which leveled much of the city of Bam and left tens of thousands dead?

For many, it is that man should more closely observe the "rule of nature."

Reporting from the wreckage of Bam, The Sun, Britain's bestselling tabloid, said: "Once again, nature reminds us how puny we really are." Others have said that it was "Mother Nature's fury" that laid Bam to waste, as if nature were some sentient, spiteful force stalking humanity; indeed, one report claimed that "nature remains terrorism's equal ... in tearing lives, property and families to shreds."

This is a strange way to make sense of what happened in Bam. It wasn't man's folly, or the Bam residents' ignorance of the "rule of nature" that allowed the quake to have such devastating consequences. Rather, it is the fact that the people of Bam are forced to live at nature's mercy that leaves them open to such terror. It is the developing world's reliance on nature, rather than its ignorance of nature, that makes it potential prey for this thing we call "Mother Nature's fury."

The lesson of Bam is that the developing world needs to develop - and fast.

For all the post-Bam claims of nature being all-powerful and man being all-puny, in fact humanity has developed the technology and know-how to withstand the effects of many earthquakes.

At the Earthquake Engineering Research Centre at Bristol University here in Britain, scientists devote their energies to understanding quakes. They use sophisticated testing techniques, where a powerful "shaking table" tests new construction materials and components.

Their research on buildings, bridges, and even computer racks (keeping telecommunications systems up and running during earthquakes can be of life-saving importance) has shown how towns and cities can survive major quakes.

When such technology is applied, the impact of quakes is lessened.

The earthquake in Bam reached a magnitude of 6.6 and killed more than 20,000; yet an earthquake in San Francisco in 1989 that measured 7.1 and caused \$10 billion worth of damage, resulted in only 63 deaths.

The earthquake that hit Kobe in Japan in 1995 measured 7.1 and killed around 5,500.

In Kobe, many of the buildings built to new Japanese codes fared quite well, but the quake caused some unexpected problems - its massive vertical component caused buildings to move up and down as well as from side to side.

Again, quake researchers learned from Kobe, and started work on buildings that could withstand both vertical and horizontal movement.

But the most striking contrast with Bam is the quake that rocked California four days earlier. Like the one in Bam, the California quake measured 6.5 and destroyed many buildings, especially in downtown Paso Robles - yet it killed only two people, not thousands. The difference between California and Bam is a difference of development.

In the developed world, advances in technology and construction mean that natural phenomena rarely wreak havoc, except when there are especially bad floods, hurricanes, or quakes. In the developing world, natural phenomena can destroy cities and kill thousands.

Why? Because people have little choice but to live by the arbitrary and reckless "rules" of nature, rather than by the rational rules of man-made development.

That is what Iran and other nations need - development. Many commentators have pointed the finger of blame at the Iranian authorities, for failing to modernize buildings and implement construction codes - and no doubt that is true.

But we also live in a world that is increasingly hostile to all-out development and the application of new technologies. The buzzwords today are "sustainable development" and "appropriate technology," where it is argued that development must happen slowly and "in sync" with nature and the environment.

Yet unless we prioritize human interests over the "rule of nature," there will be little to stop another Bam from happening again.

At times like this, I find myself increasingly uncomfortable with the phrase "natural disaster."

There was nothing "natural" about what happened in southern Iran.

In a world where we can construct buildings to withstand massive earthquakes, the deaths of thousands in Bam is nothing less than perverse.

•*Brendan O'Neill is assistant editor of spiked-online.com*