

Axiomatic System Design:
Chemical Mechanical Polishing
Machine Case Study

by

Jason W Melvin

Submitted to the Department of Mechanical Engineering
in partial fulfillment of the requirements for the degree of

Doctor of Philosophy in Mechanical Engineering

at the

MASSACHUSETTS INSTITUTE OF TECHNOLOGY

February 2003

© Massachusetts Institute of Technology 2003. All rights reserved.

Author
Department of Mechanical Engineering
January 20, 2003

Certified by
Nam P Suh
Ralph E & Eloise F Cross Professor of Mechanical Engineering
Thesis Supervisor

Accepted by
Ain Sonin
Chairman, Department Committee on Graduate Students

**Axiomatic System Design
Chemical Mechanical Polishing
Machine Case Study**

by

Jason W Melvin

Submitted to the Department of Mechanical Engineering
on January 20, 2003, in partial fulfillment of the
requirements for the degree of
Doctor of Philosophy in Mechanical Engineering

Abstract

Axiomatic design is investigated as a design methodology for large or complex system design. Particular considerations of system design are described and the suitability of axiomatic design for such considerations is discussed. Then, tools to enable successful application of axiomatic design to systems are developed. The tools are expressed as theorems for axiomatic system design. The first theorem describes conditions for equivalence of FRs, and helps define the relationships within a design matrix. The second theorem describes a method of using only leaf levels to represent a system, and re-sequencing the design to achieve a decoupled matrix. Therefore, some types of coupling at high levels may be reduced or eliminated. The third theorem defines the decomposition strategy that is necessary to make axiomatic design compatible with object-oriented simulation models that are created starting with the high levels of the decomposition. The fourth and fifth theorems present a new method for considering and increasing system robustness to external noise factors during the conceptual design phase. While techniques for increasing robustness to external noise factors are known, integrating them into axiomatic design has not been shown previously. A case study of the design of a machine tool system for polishing silicon wafers using chemical mechanical polishing (CMP) is presented. The CMP system architecture is decomposed from top level requirements using the principles of axiomatic design, and the theorems developed in this thesis. The CMP system was designed and fabricated at MIT by a team of students, and has demonstrated excellent capability to remove material from the surface of a wafer while offering increased control of the removal profile.

Thesis Supervisor: Nam P Suh

Title: Ralph E & Eloise F Cross Professor of Mechanical Engineering

Committee Members:

Jung-Hoon Chun, Professor of Mechanical Engineering

Daniel Frey, Assistant Professor of Mechanical Engineering

Seth Lloyd, Professor of Mechanical Engineering

Acknowledgments

MIT has become my home over the past nine and a half years, and I have enjoyed most of it. I can not imagine a better place for me to have studied engineering. I was introduced to Professor Nam Suh in the Spring of my final undergraduate year by Professor Alex Slocum, my Bachelor's thesis advisor, thus beginning what has become this thesis and a rich memory of experiences.

Professor Suh has trusted me to a level I consider extraordinary. He encouraged me to lead the design effort for the CMP machine described in this thesis, offering his advice when requested and criticism when required. Such flexibility is rare for a graduate student, particularly when dealing with money and responsibility on that scale. I feel fortunate to have found someone who not only believes in what I am doing, but is also a unique engineer himself. Professor Suh, understanding fundamental engineering principles, accepts nothing as required by convention and pushes forward with vision that is rare. I will miss working and talking with him. He has benefited my life in many ways.

My other committee members have enriched my experience each in their own way. Professor Jung-Hoon Chun was the principle investigator for the CMP project, and thus I have interacted with him nearly as long as Professor Suh. Professor Chun has a knack for homing in on practical aspects of what I do and making sure they are in line, while also providing a welcome source of comic relief. Professor Dan Frey has been particularly helpful with my work on robustness, his area of expertise. He was always willing to meet with me, on short notice, and discuss things from a carefully considered perspective. In particular, helping me refine the theorems proposed in this thesis. Professor Seth Lloyd, my final committee member, has brought an often refreshing external perspective to discussions. He often led me to consider what I was saying in a more general way.

The CMP project was supported by the generous help of Mr. Papken der Torossian, then CEO of Silicon Valley Group. His trust in our work made me feel like we could do anything.

Of course, there have been many students I have worked with at MIT who enriched my experience and helped me through the whole thing. My team members on the CMP project know probably too well what it is like to work with me. Amir Torkaman and Jamie Nam designed the mechanical hardware with me, and Kwangduk (Doug) Lee designed the control systems and also wrote the software to run everything. At the same time, Jiun-Yu Lai kept a polishing process and general scientific tilt to things and made sure we didn't make too many unsafe assumptions.

The students of the axiomatic design group were perhaps the biggest help for this thesis, as I transitioned from design practice to design theory. Tae-Sik Lee has been in the axiomatic design group as long as I, and it was great finding that he thinks similarly to me in some ways, but differently enough to help me work through difficult spots. Hrishikesh Deo joined our group just a year and a half ago, but has been one of my closest friends and academic watchdog at the same time. It is difficult to get something past Hrishi that doesn't make sense; his careful reading of this thesis

helped me tremendously.

Where would I be without family and friends? I suppose nowhere at all, but that's mostly thanks to my parents. I can not imagine having two better parents. I truly hope that I will be able to achieve the type of bond that our family has. My sister Melissa and brother Arron are always ready to laugh at my mistakes and help me through trouble; They are the best. Supportive almost beyond reason, my parents have always encouraged and enabled me to accomplish the things of my dreams. I can't think of a way to express how much I love them.

My friends have been a great help to my sanity during my time at MIT, and helped me divert my attention from engineering. I met Jeremy Smith early in my graduate studies, after most of my school friends had left the Boston area. Jeremy and I have had great fun playing records together, throwing parties and generally making noise.

At some point along the way, I met the most wonderful girl. (I suppose woman is the correct word but I never liked it much.) Either way, Thuy-Anh Nguyen is my fiancée and the best person I have known. She is tremendously supportive of my work with school, always interested in what I am doing, and able to offer constructive ideas. She has helped me make some necessary improvements to myself, and enthusiastically joins me in any endeavor. Thuy-Anh inspires the best things in me and in life. I look forward to a wonderful life together and love her completely.

Contents

1	Introduction	19
1.1	System design	19
1.2	Axiomatic design method	20
1.2.1	General principles	20
1.2.2	The flow diagram	22
2	Axiomatic Design of Systems	23
2.1	The phases of axiomatic system design	23
2.2	The role of experience	23
2.2.1	Customer requirements	24
2.2.2	Technical knowledge	24
2.2.3	Axiomatic design knowledge	25
2.3	Financial considerations	25
2.3.1	Flexibility vs. Specialization	25
2.4	Operational efficiency	27
2.5	Selection of FR subsets – Sequential functions	27
2.6	Time-varying vs. fixed FRs and DPs	27
2.6.1	Fixed FRs	28
2.6.2	Variable FRs	31
2.6.3	Standardized language	35
2.7	Decomposition style	36
2.8	Work distribution	37
2.8.1	Physical interfaces vs. functional decomposition	37

2.8.2	Flow diagram use	37
2.9	Redundant FRs and DPs	38
2.10	Support sub-systems	38
2.11	Software integration	39
2.11.1	Embedded control	39
2.11.2	Operator interface	39
2.12	Summary	40
3	System Decoupling	43
3.1	Full System Matrix	43
3.1.1	Necessary level of detail	44
3.1.2	Uses for the full system matrix	44
3.2	Cross-Hierarchy Influences	45
3.2.1	Constraints	46
3.2.2	Physical co-location	47
3.2.3	Mechanical support	47
3.2.4	Consumable distribution	48
3.2.5	Process loads	48
3.3	System-Wide Re-Sequencing	49
3.3.1	Preferred design element ordering and organization	50
3.4	Summary	51
4	Simulation Within Axiomatic Design	53
4.1	Introduction	53
4.2	Simulation Methods	54
4.2.1	Inside-out versus outside-in decomposition	55
4.2.2	Integration of axiomatic design and simulation environments	58
4.2.3	Block representation	58
4.3	Spindle design example	59
4.4	Diagnostics and Debugging	63

4.5	Summary	64
5	Conceptual Robustness	67
5.1	Robust Design	67
5.1.1	Robustness in axiomatic design	68
5.1.2	Conceptual robustness	68
5.2	Axiomatically Designed Robustness	69
5.2.1	Identification of noise factors	69
5.2.2	General formulation	70
5.2.3	Reducing FR sensitivity to a noise factor	71
5.2.4	Reducing a noise factor	73
5.2.5	Compensate for FR variation due to a noise factor	73
5.2.6	Robustness theorems	74
5.2.7	Mapping to design parameters	75
5.3	Examples	77
5.3.1	CMP pad conditioner	77
5.3.2	CMP pressure application	81
5.3.3	Vehicle design	85
5.4	Summary	86
6	Chemical Mechanical Polishing (CMP) System Design Case	89
6.1	CMP Background	89
6.2	Existing Technology	91
6.3	Axiomatic Design System Architecture for a CMP Machine	93
6.3.1	Top Level Requirements	96
6.3.2	FR/DP1 Maximize value added/ Flexible, integrated processing	98
6.3.3	FR/DP1.1 Process wafer/ Front layer removal	102

6.3.4	FR/DP1.1.1 Remove material/ Abrasive removal processing	105
6.3.5	FR/DP1.1.1.1 Wear surface/ Slurry properties	112
6.3.6	FR/DP1.1.1.2 Control wafer-abrasive relative velocity/ Wafer-pad relative velocity	114
6.3.7	FR/DP1.1.1.2.2 Rotate wafer/ Wafer rotary velocity	117
6.3.8	FR/DP1.1.1.2.2.2 Control wafer rotation speed/ $\Omega_{WAFER-DESIRED}$	119
6.3.9	FR/DP1.1.1.2.3 Control wafer-pad offset/ X-axis position	122
6.3.10	FR/DP1.1.1.3 Maintain wafer position/ Wafer retention	123
6.3.11	FR/DP1.1.1.3.1 Prevent wafer translation/ Retaining ring barrier	124
6.3.12	FR/DP1.1.1.3.1.2 Support friction loads/ Lateral load support chain	127
6.3.13	FR/DP1.1.1.4 Carry abrasive/ Polishing pad surface	129
6.3.14	FR/DP1.1.1.4.2 Maintain uniform pad characteristics/Pad conditioning	130
6.3.15	FR/DP1.1.1.4.2.1 Remove pad surface/ Pad conditioning recipe	132
6.3.16	FR/DP1.1.1.4.2.1.3 Control conditioning pressure/ Conditioning pressure variable	135
6.3.17	FR/DP1.1.1.4.2.1.3.1 Control force applied to conditioner/ Conditioning pressure variable	139
6.3.18	FR/DP1.1.1.4.2.1.4 Control conditioner radial offset/ Conditioner position variable	141

6.3.19	FR/DP1.1.1.4.2.1.5 Control pad rotation/ Pad rotation speed variable (during conditioning)	144
6.3.20	FR/DP1.1.1.4.2.1.6 Control conditioner rotation speed/ Conditioner rotation speed variable	144
6.3.21	FR/DP1.1.1.5 Apply Normal Pressure/ Desired pressure variable	146
6.3.22	FR/DP1.1.1.5.4 Support normal loads/ Normal load support chain	150
6.3.23	FR/DP1.1.2 Enable multi-step processes/ Multiple removal station design	152
6.3.24	FR/DP1.1.4 Exchange wafers/ Wafer exchange sequence	153
6.3.25	FR/DP1.4 Support machine operation/ Support sub-systems	155
6.3.26	FR/DP1.4.1 Enable motion system/ Motion system hardware	159
6.3.27	FR/DP1.4.2 Provide raw materials/ Material supply	160
6.3.28	FR/DP1.4.2.1 Supply slurry/ Slurry distribution	162
6.3.29	FR/DP1.4.2.1.1 Deliver slurry/ Slurry dispensing	163
6.3.30	FR/DP1.4.5 Allow physical access/ Physical configuration	165
6.3.31	FR/DP1.5 Allow user control/ User interface	167
6.3.32	FR/DP2 Minimize Cost of Ownership (COO)/ COO minimization	170
6.3.33	FR/DP2.1 Minimize material costs/ Optimized consumable use	171

6.3.34	FR/DP3 Maximize net wafers per hour/ Maximized output	172
6.3.35	FR/DP3.1a Maximize throughput/ Optimized process cycle time	174
6.3.36	FR/DP3.1b Maximize throughput/ Optimized transport cycle time	175
6.3.37	FR/DP3.2 Maximize yield/ Scrap prevention	176
6.3.38	FR/DP3.2.1 Minimize over-polish percentage/ Uniformity control	177
6.3.39	FR/DP3.2.1.1 Control edge effects/ Retaining ring contact pressure	179
6.3.40	FR/DP3.2.1.2 Control radial polish rate/ Radial pressure distribution	182
6.3.41	System architecture summary	185
6.4	CMP system decoupling	186
6.4.1	Wafer carrier design matrix	186
6.4.2	Full design matrix	191
6.5	Wafer carrier detailed design	191
6.6	CMP System testing & evaluation	194
6.7	Summary	195
7	Conclusions	199
7.1	Summary of work	199
7.2	Suggestions for further research	200
A	Theorems & Corollaries	203
A.1	Theorems	203
A.2	Corollaries	204
	Bibliography	205

List of Figures

1-1	Flow diagram representation	22
4-1	Simple system formulation to demonstrate the effect of decomposition style on topology	56
4-2	Decomposition of the system presented in Figure 4-1	56
4-3	Schematic of spindle decomposition	60
4-4	Flow diagram for the machine spindle.	62
4-5	Full Dymola model of a spindle speed system	63
4-6	Output results from the simulation of a spindle speed system	64
5-1	Robustness of designs ‘A’ and ‘B’ to variation in the DP	69
5-2	Block diagram of a single FR system subject to a noise factor	71
5-3	Block diagram of a feed-forward compensated single FR system subject to a noise factor	75
5-4	Schematic of DP decomposition: Conditioning pressure variable	79
5-5	Schematic of detail from DP decomposition: Conditioning pressure variable	79
5-6	Schematic of DP decomposition: Desired pressure variable	83
6-1	CAD model of the fabricated MIT CMP Platform	94
6-2	Photograph of the fabricated MIT CMP Platform	95
6-3	Schematic of DP1.1.1 decomposition: Abrasive removal process	106
6-4	Schematic of orbital polishing kinematics	115
6-5	Schematic of linear polishing kinematics	115

6-6	Schematic of DP1.1.1.2 decomposition: Wafer-pad relative velocity . .	116
6-7	Schematic of DP1.1.1.3 decomposition: Wafer retention	124
6-8	Schematic of DP1.1.1.3.1 decomposition: Retaining ring barrier . . .	125
6-9	Schematic of DP1.1.1.4.2 decomposition: Pad conditioning	131
6-10	Schematic of DP1.1.1.4.2.1.3 decomposition: Conditioning pressure variable	137
6-11	Schematic of detail from FR/DP1.1.1.4.2.1.3 decomposition	137
6-12	Schematic of DP1.1.1.4.2.1.4 decomposition: Conditioner position . .	142
6-13	Schematic of DP 1.1.1.5 decomposition: Desired pressure variable . .	147
6-14	Schematic of DP3.2.1 decomposition: Uniformity control	178
6-15	Schematic of DP3.2.1.1 decomposition: Retaining ring pressure	181
6-16	Schematic of one alternative for DP3.2.1.2 decomposition	183
6-17	Schematic of DP3.2.1.2 decomposition: Radial pressure distribution .	184
6-18	Matrix of wafer carrier design elements	189
6-19	Re-sequenced matrix of wafer carrier design elements	190
6-20	Full system matrix for the CMP machine, as decomposed	192
6-21	Re-sequenced full system matrix for the CMP machine	193
6-22	CAD assembly drawing of the wafer carrier	194
6-23	Plot of SiO ₂ film thickness after polishing with uniform pressure . . .	196
6-24	Plot of SiO ₂ film thickness after polishing with adjusted pressures . .	197
6-25	Plot of the remaining SiO ₂ thickness after 120 sec. polish at 5 psi. . .	198

List of Tables

2.1	Decomposition of a generalized feedback control system.	32
4.1	Decomposition of FR/DP – Control speed/Desired speed	59
4.2	Decomposition of FR/DP – Control spindle speed/Desired speed . . .	60
5.1	Initial decomposition of DP: Conditioning pressure variable	78
5.2	Decomposition, including robustness FRs/DPs, of DP: Conditioning pressure variable	80
5.3	Initial decomposition of DP: Desired pressure variable	82
5.4	Decomposition, including robustness FRs/DPs, of DP: Desired pres- sure variable	83
6.1	Top level FR/DP for CMP system	96
6.2	Decomposition of DP: CMP system	96
6.3	Decomposition of DP1: Flexible, integrated processing	99
6.4	Constraints for FR/DP 1 decomposition	100
6.5	Decomposition of DP 1.1: Front layer removal	103
6.6	Constraints for FR/DP1.1 decomposition	103
6.7	Decomposition of DP1.1.1: Abrasive removal processing	106
6.8	Constraints for FR/DP1.1.1 decomposition	107
6.9	Decomposition of DP1.1.1.1: Slurry properties	112
6.10	Decomposition of DP1.1.1.2: Wafer-pad relative velocity	115
6.11	Constraints for FR/DP1.1.1.2 decomposition	116
6.12	Decomposition of DP1.1.1.2.2: Wafer rotary velocity	118

6.13	Decomposition of DP1.1.1.2.2.2: $\Omega_{WAFER-DESIRED}$	119
6.14	Decomposition of DP1.1.1.2.3: X-axis position	122
6.15	Decomposition of DP1.1.1.3: Wafer retention	123
6.16	Decomposition of DP1.1.1.3.1: Retaining ring barrier	125
6.17	Constraints for FR/DP1.1.1.3.1 decomposition	125
6.18	Decomposition of DP1.1.1.3.1.2: Lateral load support chain	127
6.19	Decomposition of DP1.1.1.4: Polishing pad surface	129
6.20	Constraints for FR/DP1.1.1.4 decomposition	129
6.21	Decomposition of DP1.1.1.4.2: Pad conditioning	131
6.22	Decomposition of DP1.1.1.4.2.1: Pad conditioning recipe	133
6.23	Decomposition of DP1.1.1.4.2.1.3: Conditioning pressure variable	136
6.24	Decomposition of DP1.1.1.4.2.1.3.1: Conditioning pressure variable	140
6.25	Decomposition of DP1.1.1.4.2.1.4: Conditioner position variable	141
6.26	Constraints for FR/DP1.1.1.4.2.1.4 decomposition	141
6.27	Decomposition of DP1.1.1.4.2.1.6: Conditioner rotation variable	144
6.28	Decomposition of DP 1.1.1.5: Desired pressure variable	146
6.29	Decomposition of DP1.1.1.5.6: Normal load support chain	151
6.30	Decomposition of DP1.1.2: Multiple removal station design	153
6.31	Decomposition of DP1.1.4.1: Wafer exchange sequence	154
6.32	Decomposition of DP1.4: Support sub-systems	156
6.33	Constraints for FR/DP1.4 decomposition	156
6.34	Decomposition of DP1.4.1: Motion system hardware	159
6.35	Decomposition of DP 1.4.2: Material supply	161
6.36	Decomposition of DP1.4.2.1: Slurry distribution	163
6.37	Decomposition of DP1.4.2.1.1: Slurry dispensing	164
6.38	Constraints for FR/DP1.4.2.1.1 decomposition	164
6.39	Decomposition of DP1.4.5: Physical configuration	165
6.40	Decomposition of DP1.5: User interface	167
6.41	Constraints for FR/DP1.5 decomposition	168
6.42	Decomposition of DP2: COO minimization	171

6.43	Decomposition of DP2.1: Optimized consumable use	172
6.44	Decomposition of DP3: Maximized output	173
6.45	Decomposition of DP3.1a: Optimized process cycle time	175
6.46	Decomposition of DP3.1b: Optimized transport cycle time	176
6.47	Decomposition of DP3.2: Scrap prevention	177
6.48	Decomposition of DP3.2.1: Uniformity control	178
6.49	Decomposition of DP3.2.1.1: Retaining ring contact pressure	180
6.50	Decomposition of DP3.2.1.2: Radial pressure distribution	183

Chapter 1

Introduction

1.1 System design

The phrase system design may mean many things to many people. The primary definition of “system” from a dictionary reads: A group of interacting, interrelated, or interdependent elements forming a complex whole. Such a definition applies well to engineering systems; interacting elements characterize a system as opposed to a single part. Often, engineering systems may be described as “large” or “complex,” but a better understanding of metrics used to measure systems is helpful.

A “complex” system is one that does not satisfy its functional requirements reliably, and therefore requires a lot of attention in operation [1]. This is certainly an undesirable state; even more so for engineering systems involving the safety of people. Reduction in system complexity is possible by understanding the system elements and how they work together. By designing a system correctly, it is possible to reduce complexity even without necessarily reducing the number of components or scale of the system.

A “large” system may not be physically large, but contains a large number of functional requirements [1]. Therefore, the engineering difficulty in designing systems increased as the number of necessary functions the system must satisfy increases. As there tends to be interactions between the various elements, a large number of elements results in a large number of interactions. Since a given element may interact

with any other element in the system, there exists at least an N-squared scaling of potential interactions, where N represents the number of functional requirements. With a large number of elements, it is impossible for engineers to predict and track each interaction. Therefore, large systems often have problems during development, due to the large amount of unknown information. The lack of knowledge about interactions leads to poorly designed systems. Since faults are unknown until late in the design process, when resources have been committed, even more expense is incurred in an attempt to make the already designed systems work.

The goal of using axiomatic design for system design is straightforward – to manage and track interactions between elements of the design and functions the design must fulfill. By doing so, the system can be designed in a predictable way, to satisfy the needs it is being created to fill. The structure of the axiomatic design method provides the rigor in managing design information that is required by large systems. One comment occasionally heard when an engineer is introduced to axiomatic design is, “Sure, good designers will do that anyway.” While this may be true, it misses the important point that the axiomatic design method forces careful consideration of functional interactions, rather than relying on an engineer’s intuition. This is particularly beneficial to large or complex systems, where the number of functional requirements makes it essentially impossible for a single engineer to manage the necessary amount of information. Commonly, systems are designed by teams of engineers, therefore requiring communication both within and between teams. In this situation, the documentation created as a natural result of the axiomatic design process will facilitate the communication

1.2 Axiomatic design method

1.2.1 General principles

The axiomatic design process is centered on the satisfaction of functional requirements (FRs). FRs are defined as the minimum set of independent requirements that

characterize the design goals. The design must satisfy the FRs, and this is done by creating a system that uses design parameters (DPs) to affect the behavior such that the FRs are satisfied [1].

Given a set of FRs, the designer conceives of a physical embodiment containing a DP that may be adjusted to satisfy the FR. When embodiments and DPs are selected for the design, they are chosen according to the two design axioms:

Axiom 1 (Independence Axiom) *Maintain the independence of the functional requirements.*

Axiom 2 (Information Axiom) *Minimize the information content of the design.*

The design matrix relates the FR vector to the DP vector. An example design matrix is contained in the following design equation:

$$\begin{Bmatrix} FR1 \\ FR2 \end{Bmatrix} = \begin{bmatrix} A_{11} & 0 \\ A_{21} & A_{22} \end{bmatrix} \begin{Bmatrix} DP1 \\ DP2 \end{Bmatrix} \quad (1.1)$$

where A_{11} denotes the effect of DP1 on FR1, A_{21} denotes the effect of DP1 on FR2, etc. When the design equations represent conceptual levels of the design, it is common for the elements of the matrix, A_{ij} to be represented with an ‘X’ if there is an effect, and an ‘O’ if there is no effect. To satisfy the Independence Axiom, the design matrix must be diagonal or triangular. The triangular matrix in Equation 1.1 represents a decoupled design. For correct implementation of such a design, it is necessary to set the value of DP1 before setting the value of DP2. A diagonal matrix represents an uncoupled design, and the DPs may be set in any order.

Axiomatic design begins with the most general requirements of the system, and decomposes these into sub-requirements. The goal of decomposition is the specification of a set of elements that will result in the parent. As the system is decomposed, it is necessary to specify a set of FRs, move to the physical domain by the conception of a design solution and specification of DPs, and then proceed back to the functional domain as required. This process of moving back and forth between the functional

and physical domains, and progressing from a general to a detailed description, is called zigzagging.

The hierarchical collection of FRs and DPs generated during zigzagging is termed the system architecture. Zigzagging is repeated until it is possible to construct the system from the information contained in the system architecture.

1.2.2 The flow diagram

A key step during the axiomatic design process is the determination of the correct sequence to proceed through the design, if such a sequence exists. Although this information is contained in the design equations, it is useful to represent the system in the form of a flow diagram [2]. The flow diagram shows the interaction between modules. A module is defined as a row of the design equation. When provided with its associated DP, a module produces an FR. If FR1/DP1 from Equation 1.1 are decomposed into an uncoupled combination of two sub-elements, the resulting flow diagram is in Figure 1-1.

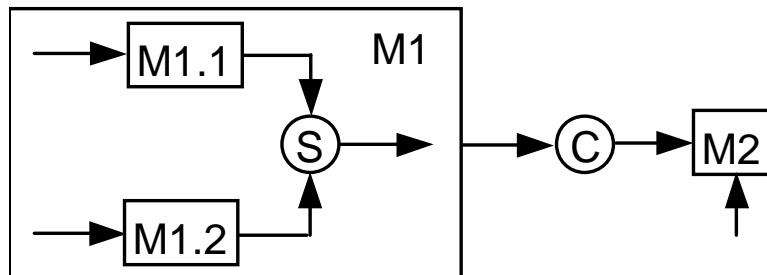

Figure 1-1: Flow diagram representation of Equation 1.1 and further decomposition of FR/DP 1.

All of the arrows in Figure 1-1 without a source represent the DP associated with the module being supplied. The circled 'S' is a sum of inputs, while a 'C' is a combination of elements in a controlled order. The flow diagram will be the link between axiomatic design and simulation.

Chapter 2

Axiomatic Design of Systems

2.1 The phases of axiomatic system design

Current design practice often describes several phases of the design process, beginning with conceptual design, and then moving to configuration design, parameter design, and tolerance design. While these design phases may indicate the increase in resolution of detail in a design, there are many overlapping features. The axiomatic design approach is more continuous in nature, progressing from a necessarily conceptual design to one with sufficient detail to allow creation. It is possible to take a system developed to a certain level with axiomatic design, and proceed with any conventional design method. While this may miss some of the benefits of axiomatic design, it may allow systems to incorporate some of the valuable concepts without supporting the full overhead of the axiomatic design process.

2.2 The role of experience

One of the goals of implementing axiomatic design to create large or complex systems is the decreased reliance on previous experience to guide the design. By making decisions with a strictly defined basis, the design methodology can take the place of previous experience. This can allow engineers to create systems to fulfill roles in which the engineers have not worked, or are not experts. Additionally, without the

constraint of such previous knowledge, it may be possible to create designs with more creativity than might otherwise be possible. While this goal of axiomatic design is of benefit to system designers, there remain tangible benefits to knowledge about the system under consideration. Such knowledge may certainly be obtained through prior experiences.

2.2.1 Customer requirements

The initial step in system design is definition of customer requirements, since systems are created with a customer in mind. Given that understanding the customer is a necessity, experience in this regard is beneficial to the system design process. It may be that team members from areas other than engineering are able to provide information and guidance in developing customer requirements; a common example would be marketing departments who should have a good understanding of the target audience and therefore able to help build requirements that will lead to a successful system. Similarly, upper level management will commonly have strategic goals defined for a company's products, which may influence the definition of customer requirements. It is important to draw from as diverse a pool as possible, to be sure that all important requirements are satisfied. The process of forming functional requirements and constraints from the customer requirements will generally be the duty of the engineering team, and early level reviews must confirm that the top level functional requirements, together with their constraints, are congruous with the customer requirements.

2.2.2 Technical knowledge

Along with customer requirements, experience with a particular industry or process can be hugely beneficial to the system designer. As stated by Suh, "Knowledge & technology define the best possible system." [1] Of course, without the knowledge of what is possible, the maximum capabilities for a system will never be reached.

2.2.3 Axiomatic design knowledge

Suh's Theorem S3 of axiomatic design states that high level decisions that are incorrect can not be changed by decisions at the lower level. Since decisions should be made to be consistent with axiomatic design theory in order to realize the desired system, it is important that the system designer responsible for high level decisions be well versed in axiomatic design theory. It is not sufficient for engineers to understand axiomatic design without the project leader having similar understanding, since the decisions will certainly be made at the top level. The repercussions of poor decisions are huge when the overall development time and costs of the system are large, therefore increasing the motivation to use a method that will ensure consistently good performing results.

2.3 Financial considerations

Since the cost with large or complex systems may be very high, financial considerations are likely to play a large role in the development of such systems. Generally, cost is a key engineering tradeoff, which may be traded against performance metrics in one or more areas of the design [3]. Since cost is involved in so many areas of the system, it is unlikely that specifying cost as a functional requirement will work well when using axiomatic design. More commonly, cost is specified as a constraint, and must be evaluated as system detail is developed, in an iterative process.

2.3.1 Flexibility vs. Specialization

There are certain tradeoffs that may be made when specifying the functional requirements for a system. One of these is that of flexibility versus specialization. One goal of forming the high level sets of functional requirements is to create the minimum set that is necessary to accomplish the task. However, when one considers that the overall goal is to satisfy customer requirements, it becomes less clear what the necessary task is composed of. Certainly, in the area of product design, customers respond to

additional features in a positive manner [4]. The inclusion of features that had not existed previously in choices for the customer may provide the edge that is necessary for a product to succeed.

When other realms of engineering are considered, the motivations for success may be different than those for consumer products. For instance, the capital cost of a machine tool may play a large role in determining its success in the market. In this case, the specialization that occurs by strict definition of the minimum set of functional requirements will allow the designers to reduce the cost of the system.

One caveat here is the integration of previously separate functions. By designing a system that can perform a number of roles that would have been previously separate, it is possible to offer a simpler solution to the customer. An example is the wafer polishing machine discussed in the primary case study later. In early generations of wafer polishing equipment, the wafers were supplied to the machine for polishing which then output a wet wafer contaminated with polishing medium. The wafer was passed to a cleaning machine, cleaned and dried, and then passed to a measurement tool for inspection. In the most recent generation of polishing systems used for semiconductor fabrication, wafers are supplied to the machine in a sealed box, and returned to another sealed box after having been polished, cleaned, and measured within the system. This greatly simplifies the integration of the polishing process with the overall wafer fabrication strategy and eliminates potential sources of contamination to the factory environment by isolating the “dirty” process within an enclosure. By expanding the set of functional requirements for the system, it was possible to add value, and satisfy an enhanced set of functional requirements. It is the duty to the system design team as a whole to identify potential for such performance enhancement that may be obtained by adding functional requirements beyond the minimum set. Certainly, there is an increase in cost associated with the added flexibility provided by the additional functions, but this cost may be offset by the functionality, as was the case with semiconductor polishing machines.

2.4 Operational efficiency

During the operation of any system, resources will be consumed in order to transform the available inputs into the desired output. Likewise, it is possible to define some efficiency of operation for a system, although this efficiency may be in abstract terms, and therefore only relevant for similar systems. The resources may be consumable such as energy or material, and may also be manpower. It is certainly desirable to produce a system of high efficiency, although efficiency is similar to cost in that it is affected by many parts of the system, and therefore generally better handled as a constraint.

2.5 Selection of FR subsets – Sequential functions

There are many instances in a system in which the system must satisfy different sets of functional requirements at different times. Such a system is called a flexible system [1]. An example might be a multi-purpose tool, such as a “Swiss-army” knife. Some flexible systems require time-dependent sequencing of the functional requirements. Such a system might be seen in manufacturing operations. When such a system is designed, it is necessary to incorporate a means for selecting the appropriate set of requirements at any given time. Many issues arise due to selection of functional requirements. One approach is the inclusion of “command and control” elements to coordinate the selection of FR/DP pairs [5]. Current work in axiomatic design theory is addressing the need to provide coordination between different sub-systems, or to distribute a shared resource.

2.6 Time-varying vs. fixed FRs and DPs

Some FRs that are identified during system decomposition will be of a fixed nature. That is, they have a value that is defined during system specification, and will not change during system operation. This type of FR is satisfied during the design and realization processes. The typical realization process for physical sub-systems is man-

ufacturing. For software sub-systems, which often form an integral part of large or complex systems, the realization is the coding process.

During the design process, DPs are assigned to FRs, and details refined through decomposition until it is possible to create the DP and its relationship to the FR. As this final stage, a leaf level, it is necessary to assign values to the DPs. The value assigned to a DP depends on the relationship that has been incorporated into the system and the desired value for the associated FR. The assigning of values is commonly referred to as parameter design in other design methodologies [6]. Therefore, the value of a DP that is mapped to a fixed FR will remain constant during the operation of the system, and is only changed during the realization of the system. The mechanism by which the DP affects the FR may be significantly different than if the FR value changes during the operation of the system. If the value of the FR changes during the operation of the system, the FR is a time-varying FR. A time-varying FR requires a DP that can change value during the operation of the system.

2.6.1 Fixed FRs

The nature of constant FRs permits that a fixed element be included into the system to satisfy the FR. It is of course possible to use a variable element to control a constant FR. In a case where a constant FR is satisfied by a mechanism with a variable DP, there is generally a cost penalty incurred by the change. Therefore, for any given system, some analysis will be necessary to determine the best design solution, given a fixed FR.

The information axiom is a useful metric to determine the most suitable design for a particular application. In the case of a fixed FR that is satisfied by a fixed DP, the variation in the FR value is the key to reducing information. The variation in a single FR or an uncoupled FR from a fixed DP is:

$$\delta FR = A \cdot \delta DP + \delta A \cdot DP \quad (2.1)$$

where δFR is the variation in the FR, δDP is the variation in the DP, and δA is the

variation in the system's response to the DP, the element in the design matrix. If the fixed FR is satisfied by a dynamic DP, and the system is tuned to attain the desired response, then the variation in the single FR is:

$$\delta FR = \varepsilon_{FR} + A \cdot R_{DP} \quad (2.2)$$

where δFR is the variation in the FR satisfied by the dynamic DP, ε_{FR} is the uncertainty in measuring the FR value, A is the element in the system matrix relating the dynamic DP to the FR, and R_{DP} is the resolution in the adjustment of the DP. Here, it is possible to see that the variation of the FR when satisfied by a fixed DP, or by a dynamic DP with a measurement and adjustment stage depends on the configuration of the system. The problem is somewhat more complicated when a multi-FR system is considered. If Equation 2.1 is extended to include multiple DPs in a decoupled or coupled system, the variation in the FR is:

$$\delta FR_i = \sum_{j=1}^n (A_{ij} \cdot \delta DP_j + \delta A_{ij} \cdot DP_j) \quad (2.3)$$

where ij is the index in the design matrix. From Equation 2.3 it is apparent that a decoupled system satisfied by fixed DPs will have greater variation in the FR than an uncoupled or single FR system. However, Equation 2.2 will still represent the variation in an FR of a decoupled system satisfied by a variable DP, when the FRs are adjusted in the correct order. Since the FR is measured, the influences of DPs other than the intended DP are compensated for, and the error does not depend on the number of other FRs and DPs in the system. Such a measure and compensate scheme has been demonstrated to provide increased performance [7].

Another advantage of the measure and compensate approach using a dynamic DP is the freedom from necessary system knowledge. The elements of the design equation determine the effect of DPs on FRs. Using fixed DPs requires accurate knowledge of the design equation, since uncertainty in this knowledge is represented by the δA term of Equations 2.1 and 2.3, leading to increased variation in the FR. Therefore, when the exact relationships within the design equation are unknown, or known only

with a large degree of uncertainty, it benefits the system designer to select dynamic DPs and consider how the system FRs will be measured to allow compensation.

There is one more case where a fixed FR may require a dynamic DP. In the case of a decoupled system, or a redundant system, many DPs affect the FR of interest. In this case, to maintain the fixed value of the FR, a dynamic DP must be used. Here also, a measure and compensate approach must be used.

A coupled system presents much more difficulty for obtaining a satisfactory solution. A coupled system does have a unique solution, and with good knowledge of the system matrix, the solution may be pre-determined to set the DP values. However, the interactions between DPs and FRs result in increased FR variation, due to the increased number of terms in Equation 2.3 above. Using dynamic DPs to satisfy coupled fixed FRs may be possible; however the compensation must be done in an iterative manner, or a system model developed by varying the DPs in turn, and observing the FR outputs. In either case, it may be impossible to achieve the desired range of FR values. A coupled system with dynamic FRs further complicates the issue, resulting in a system with no predefined order for adjusting the DPs as the desired FR values change. Therefore, such a system relies on pre-defined models of system dynamics so a correct solution may be predicted.

A simple example may be drawn from electrical circuits. If one FR of an amplifier circuit is to control the gain of the circuit, then perhaps an operational amplifier is used to provide the gain. In this case, a resistor value may be changed to change the gain of the circuit. Therefore the resistor is the DP. If a particular gain is required for the circuit, and will remain constant during operation, then a resistor may be selected to provide that gain. The resistance value is the DP. However, if the gain of the circuit must be changed during operation, then it is necessary to somehow change the resistance. For the time-varying gain, a potentiometer may be used to provide a variable resistance, and then the position of the potentiometer is the DP that is used to control the overall gain of the circuit. It is apparent from this simple example that the time-varying nature of an FR can have very important effects on the resulting system that is designed to satisfy it.

Borrowing from the example above, the potentiometer may be used to control the gain of the circuit, even if the gain will remain constant. In this case, it may be possible to use parts with larger tolerances, and then trim the circuit to the desired gain by adjusting the potentiometer. If a fixed resistor value is used to set the gain, the tolerances of the discrete components will be more critical, since any variation may not be compensated for by an adjustment of the DP.

The potentiometer is a more costly component than just a resistor. Also, the process of adjustment carries a cost penalty. Some time is required to measure the circuit gain and make the necessary adjustment. Of course, there is a cost benefit to the potentiometer solution – the cost of each fixed resistor in the design may be reduced due to the relaxed tolerances for resistance. Since the circuit will be tuned to meet its requirements, the need for precision parts is reduced.

2.6.2 Variable FRs

With a variable FR, there is less choice in the DP specification. It is necessary to include a mechanism by which the FR value may be changed during system operation. Sometimes, the adjustment may be made by the operator or user, while in other circumstances, a mechanism for updating the DP value may be incorporated into the system. An example of such a system would be a feedback controller. In feedback controllers, an FR is maintained within its desired limits by a compensation subsystem that measures some parameter and changes a DP that will affect the FR. Therefore, a dynamic FR is satisfied by a variable DP without any new input from the user. If a simple, generalized control system is modelled in axiomatic design, the decomposition may look something like the levels shown in Table 2.1 below.

The design equation representing the levels in Table 2.1 is:

$$\begin{Bmatrix} \text{FR1} \\ \text{FR2} \\ \text{FR3} \\ \text{FR4} \end{Bmatrix} = \begin{bmatrix} X & O & O & O \\ X & X & X & X \\ X & X & X & X \\ X & X & X & X \end{bmatrix} \begin{Bmatrix} \text{DP1} \\ \text{DP2} \\ \text{DP3} \\ \text{DP4} \end{Bmatrix} \quad (2.4)$$

Table 2.1: Decomposition of a simple, generalized feedback control system.

	Functional Requirements (FRs)	Design Parameters (DPs)
1	Accept desired output	Input knob position
2	Measure actual output	Sensor output
3	Determine necessary control effort	Difference of measured output from desired output
4	Change actual output	Actuator command

As may be seen by the design equation, Equation 2.4, DP1, the input knob position affects all FRs. The knob position allows the user to communicate with the system and enter the desired output by turning a knob. The element inside the design matrix in Equation 2.4 may be a potentiometer and necessary circuit for the system to register a voltage as an input, or could be an encoder with digital circuitry to measure position; the particular implementation is irrelevant to this example. The input knob position will affect the measurement of actual output because if the knob is turned, the output should change. Similarly, if the input knob is turned, a control effort will be sent through the system, changing the actual output, so DP1 affects all FRs.

DP2 is the sensor output, which is a dynamic element that will automatically represent the actual state of the system in a form that is usable by the control system. Such a sensor could represent a thermocouple and circuitry that converts temperature to a voltage, or might represent a tachometer that converts rotational velocity to voltage, or might be a pressure transducer that converts pressure to voltage or even pressure to a digital word. In any case, the sensor is an element used in the design that allows the system to measure its actual state. The sensor output will affect the measurement of the actual output, since this is the function the parameter is intended to fulfill, and will also affect the control of output, since a change in the sensor output, perhaps from an external disturbance should change the control of output, to maintain the desired value.

DP3 is the difference of the measured output from the desired output. This may be computed electronically, or generated through a physical mechanism. Since the sensed error affects the control effort and therefore the actuator command, it will also change the measured output. DP3 affects FRs 2, 3, and 4.

DP4 is the actuator command – the means for affecting the state of the system as necessary. For the examples given above, if the variable of interest is temperature, the actuator might be a furnace, and the input a voltage telling the furnace to turn on or off. For a rotary velocity, the actuator could be a motor, and the input might be a voltage to the motor amplifier, or the current to the motor. If the variable of interest is pressure, the actuator might be a solenoid valve connecting a pressure source to the system, or venting the system to a pressure sink. The actuator will be chosen to provide a direct influence over the variable of interest. The actuator input will affect the measurement of the actual system output, since a change in the actuator input is designed to change the variable of interest in the system, and therefore the measurement of that variable. The actuator input will also change the control of the output as intended, since the actuator is chosen to affect the output.

From the above example, it is apparent that the design equation, Equation 2.4, is coupled. However, it seems that the nature of feedback control systems is coupled. The measurement of a variable affects the control of the variable itself. Is the system represented in Table 2.1 in violation of Axiom 1? As discussed previously, the FRs are variable FRs. This means that it is necessary to satisfy them over many points in time, and that the values for the FRs may change over time. For example, the user of the example system requires that a change in the desired output be registered. Therefore, it is necessary for the system to measure the desired output more than once. If the desired output is changing slowly, perhaps the rate at which it is measured may be slow. Likewise, the other parameters in the system must be updated to keep up with the dynamics by which they change. The update of parameters should happen over and over, defining either a continuous process or a cycle rate for the system. In the continuous system, all DPs are able to influence their corresponding FR at any point in time. Such would be the case if the system of interest is composed entirely

of analog circuit elements, or physical elements. Many feedback control systems are implemented with digital computers, and therefore operate with well defined loop rates. In this case, the set of FRs/DPs that is managed by the computer are repeated in sequence over and over. There are two extremes that may be useful to determine if the situation created by a feedback control system is acceptable within the definitions of Axiom 1.

If the dynamics of the system are much faster than the dynamics by which the control system affects the system, there will be a problem. For instance, consider a digital control system where the actual output is sampled periodically and the actuator output is updated at the same time. When the sampling rate is much slower than the time it takes the system to change states, there is a delay before a system out of the desired range is corrected. As a simple example, consider a room with a wood stove as the heating furnace. If the goal is to maintain the temperature in the room, and environmental changes influence the room's temperature within a time frame of minutes but an operator enters the room every two hours to check the temperature and change settings on the stove, it is likely that there will be large variations in the temperature of the room. It will be impossible to maintain the output within its intended range, and therefore the system is unacceptable.

On the other hand, the dynamics of the system may be slow compared with the ability to measure and influence the system. Borrowing from the previous example, perhaps a room is fitted with a natural gas furnace and a circulated air system, controlled by a thermostat. Measurements of the room's temperature may be made every second, and the heater output adjusted to maintain the desired temperature. In this system, the room's temperature will be maintained within much stricter requirements than the previous. A coupled system always has a solution, but that solution may be difficult to obtain. In a feedback control system, the solution is iteratively found to maintain the desired state. Therefore, it may be acceptable to use a coupled system if the dynamics for measuring and influencing the system are significantly faster than the dynamics by which the system may change.

Another example of a coupled system with variable FRs and DPs is the commonly

referenced water faucet design [1]. Suppose the FRs for a water faucet are to control temperature and control flow rate. One potential solution is a single spout with a hot water valve and a cold water valve. In this case, the positions of the two valves are the available DPs. Therefore the coupled design equation is:

$$\left\{ \begin{array}{l} FR1 : \textit{Control temperature} \\ FR2 : \textit{Control flowrate} \end{array} \right\} = \begin{bmatrix} X & X \\ X & X \end{bmatrix} \left\{ \begin{array}{l} DP1 : \textit{Hot knob position} \\ DP2 : \textit{Cold knob position} \end{array} \right\} \quad (2.5)$$

Assuming that the system starts in a state where the FRs are satisfied, if either of the FRs change, it will be necessary to change both of the DPs to keep both FR values as they are desired. In this example, the system is well understood by most people, and they are able to make the necessary adjustments with little difficulty, by turning one knob up and one knob down to change only temperature, or by turning the knobs in the same direction to change only flow rate. By using knowledge of the system behavior, it is possible to control a coupled system. However, if the temperature and flow requirements were to change more rapidly, or require more precision, then it is more likely that the system represented by Equation 2.5 is unsatisfactory. The issue of tolerance is paramount. With large tolerances on FRs, the system does not have to be well designed; satisfying strict requirements demands a better system. In this case, a decoupled or uncoupled system is more likely to satisfy the functional requirements.

2.6.3 Standardized language

Since the distinction between fixed and dynamic FRs is critical to the design process, it benefits the system designer to adopt conventions for language describing FRs. If natural language is used to specify FRs then the use of key words may distinguish between the classes of FRs. Words such as ‘control’ or ‘set’ may be used to indicate the dynamic nature of an FR, while ‘maintain’ might indicate a fixed FR.

While natural language is one option for indicating the time-dependent nature of an FR or a DP, it is imprecise due to interpretation. Therefore, it is more reliable for

the system designer using axiomatic design to adopt a standardized notation. In this thesis, dynamic elements are placed in angle brackets. The following design equation is an example:

$$\begin{Bmatrix} \underline{FR1} \\ \langle FR2 \rangle \\ FR3 \end{Bmatrix} = \begin{bmatrix} X & O & O \\ O & X & O \\ O & X & X \end{bmatrix} \begin{Bmatrix} \underline{DP1} \\ \langle DP2 \rangle \\ \langle DP3 \rangle \end{Bmatrix} \quad (2.6)$$

In Equation 2.6, FR/DP1 are leaf level elements, decomposed enough to realize the sub-system. Leaf level elements are shown with an underline. FR2 is a dynamic FR, and has been assigned a dynamic DP. FR3 is a fixed DP, but since it is affected by the dynamic DP2, DP3 must also be dynamic.

2.7 Decomposition style

During the decomposition process, the system architecture is created according to the preferences of the system designer. The system designer's preferences determine how FR/DP pairs will be decomposed into sub-systems. Although the axiomatic design method allows for a large amount of latitude as decomposition proceeds, there are reasons to guide the designer towards particular conventions. The high levels of the design represent conceptual design information that must be enhanced. When sufficient information is contained in a particular FR/DP relationship, the branch of the decomposition is considered finished, and termed a leaf. The system architecture then consists of a number of branches, diverging at various levels, and always ending in leaf levels. The necessary inputs to a system are the leaf level DPs, and none other. With this in mind the question may be asked, "If leaf levels are the DPs that generate inputs to the system, should input parameters be left until the leaf level?"

The goal of axiomatic design is to specify parameters that may be used to achieve functions. Keeping the key parameters until the leaf levels are reached would only hinder the conceptual operation of a system. Therefore, inputs that will be used to control the system may be specified whenever appropriate, and then carried through

the decomposition to a leaf level. The flow diagram representation is useful to illustrate this point.

2.8 Work distribution

Large engineering systems often require engineering effort that must be distributed among individual engineers or groups of engineers. A system that is of sufficient scale to require distributed engineering adds several complexities to the design process. Since no single engineer is responsible for the system, there are boundaries of responsibility and the definition of these boundaries may impact the system design process significantly. When axiomatic design is used to develop a system architecture, it may be necessary for more than one group of engineers to participate in the decomposition process.

2.8.1 Physical interfaces vs. functional decomposition

One approach in systems engineering is to segment the engineering effort into components separated by physical interfaces. If such an intention is to be used along with axiomatic design, it is necessary to complete the system architecture prior to distributing the work effort. The system architecture is segmented by functional requirements, so one particular branch of the system architecture may contain hardware that exists in many locations in the system. Likewise, a particular physical component that is part of a system will likely have design elements from many parts of the system architecture.

2.8.2 Flow diagram use

The flow diagram represents the sequential nature of the system operation; however this should not be confused with the nature of the design process. There is a fine distinction between the two, since fixed DPs are fixed during the design process, while dynamic DPs are fixed during the tuning or operation of the system. Therefore, it

will not be possible to fully define the engineering work flow based on representations of the system architecture such as the flow diagram.

2.9 Redundant FRs and DPs

It is possible that a particular FR will appear in the system architecture more than once. An FR is incorporated in the system architecture to satisfy some parent FR/DP level, so there may be more than one reason for a particular function. If this is the case, it is acceptable to consider the function satisfied and continue with the design. A note or dynamic link should be created in the system architecture document indicating the duplication of a functional requirement.

2.10 Support sub-systems

Sometimes during the decomposition of a system, the selected embodiment and corresponding DP may incur additional requirements in order to be realized. For instance, a particular system may require electrical power, or the supply of raw materials. Both are examples of consumable material distribution. Generally, consumable materials must be used by a system to fulfill its intended functions.

It is possible to treat such needs in two different ways. First is the integrated method, in which the needs of a particular sub-system are added when that sub-system is decomposed. While this method may work, it requires the designer to remember any necessary support functions.

An alternative to the integrated approach for support sub-systems is to explicitly state the need for support. An example is an electrical supply system. The first method of incorporating the supply in the system is at each level to include an FR, “supply electrical power.” The second method is to include a high-level FR, “provide necessary support sub-systems,” which would be decomposed to include, “supply electrical power.” Such an FR is by definition affected by any other DPs at its level, and will come last in the design order. Once the other systems are designed, or during

their design, the necessary support functions are added to the support requirement and mapped to appropriate DPs. This method of identified support levels was used in the design of the wafer polishing machine described as the major case study for this thesis. It proved to be an acceptable method for including necessary functions, while at the same time freeing the main decomposition levels to focus on fulfillment of the critical functions.

2.11 Software integration

2.11.1 Embedded control

As systems are created with more diverse requirements, and larger numbers of requirements, it is likely they will incorporate a blend of physical elements and software elements. When software is used in a system, it serves the same purpose as any other system element – to allow a parameter to be selected as a DP that will provide control of an intended function. When playing the same role as might be by a physical design element, software should be incorporated in a system in the same manner. Therefore, it will be common in system design to find software elements mixed in with physical elements with no clear distinction or boundary between the two. Such embedded software elements will often be in place to enable either feedback or open loop control loops.

2.11.2 Operator interface

Software may also be included into a system to enable an operator interface. If a system is largely controlled by software elements, it is likely that the most efficient interface to the system will be enabled with software. In this case, there is a requirement for an operator to interface with the system for the purposes of control or diagnostics. The specific requirements for such interfacing are likely to vary significantly depending on the intended use of a system. As an example, consider the engine management sub-system for an automobile. In modern vehicles, the engine manage-

ment and control is performed by a computer. During normal operation, there is no need for the user to interface with this software. The engine management computer continues to satisfy its intended functions without any interaction with the driver. However, if there is a problem with the engine and the car is brought in for service, the service technician can plug into the engine management computer and debug what the particular problem is. In this case, the operator interface software is specialized to be used by trained technicians, and may not be built into the engine management computer at all. Since external apparatus is required for any diagnostics, it is possible for the operator interface software to be contained away from the core system. In a system such as this, the diagnostic sub-system is part of the overall system, and may be designed in concurrence.

2.12 Summary

The challenge of axiomatic system design is dealing with many types of requirements and physical systems together. This is the nature of systems, and requires a flexible design process. Axiomatic design is well suited to system design because of the inherent flexibility of axiomatic design. However, with flexibility comes the potential for misuse. It is important to define standards for both notation and usage when dealing with some functional requirements that are fixed, and will not change during system operation, and those that are variable, and require design parameters that are continually adjusted.

Coupled interaction of elements that remain fixed during system operation is not nearly as troubling as interaction of variable elements, since a solution for the fixed elements may be found when there is sufficient time to iterate for the solution, or solve known system relationships to find a solution. The disadvantage of system interactions for fixed elements is one of tolerances - since variation in an FR is caused by more than a single DP, the required tolerance on each DP is tighter, and therefore more difficult to achieve.

Coupled interaction of variable elements leads to a system that is difficult if not

impossible to control. Any change to the desired FR value results in a cycle of iterations that must be completed much faster than the change in FR value.

There are many areas of axiomatic system design that warrant investigation. This chapter has presented a framework of considerations for the engineer creating systems with axiomatic design. Following chapters develop new tools that assist the process of creating large, complex systems with axiomatic design.

Chapter 3

System Decoupling

When systems are designed with axiomatic design, high-level design equations represent conceptual choices made by the designer, and the intent carried with those choices. In order to realize any system, information must be added. Information is added to the system through the decomposition process, which expands FR/DP pairs into sub requirements which are in turn mapped to the physical domain. As this zigzagging process continues, adding information, the decisions must remain consistent with those at higher levels if the original intent is to be maintained. Although this is the goal of the design process, it is not so easily accomplished. Particularly when designing large systems, which must satisfy a large number of functional requirements, it is likely there will be unconsidered influences, or emergent properties that may not be intended, but can not be avoided.

3.1 Full System Matrix

The full system matrix is the collection of all leaf level design elements. Since the leaf levels constitute all upper levels, it is sufficient to realize a design by supplying all leaf level DPs. In essence, the full system matrix is the same as the top level matrix, with all available details about interactions. The top level matrix represents the design intent at the beginning of the design process. Since the full system matrix may only be completed once the system architecture is complete, it is a better representation

of the true relationships in the system. Therefore, the full system matrix is a tool that may be used to evaluate the extent that the design intent was maintained.

When the full system matrix is created of all leaf level design elements, interactions that fall outside of the original design intent may be uncovered, and serve to contradict the original intent. Elements in a design matrix that fall in the upper triangle represent iteration in the design process. While iteration does involve an increase in the design effort, it is often considered inherent to the design process [8]. The conventional solution in axiomatic design would be to rework the design, and develop a set of design parameters that do not result in a coupled system. Such practice would result in a desirable system that avoids all undesirable interactions.

3.1.1 Necessary level of detail

As the system architecture is developed, more detail is added to the system. It may be of use to update and expand the full system matrix as detail is added to the system; this will require considerable effort, so generally the full matrix is formed near the end of the design process. When the full matrix is created, the lowest levels DPs are evaluated against the lowest level FRs to determine if there will be interactions. As the system is further decomposed, the matrix may be expanded. It is the task of the lead engineer or project manager to determine at what point during the design process the full system matrix should be created. Obtaining the information for the full system matrix is a lengthy process and requires the contribution from many people.

3.1.2 Uses for the full system matrix

The full matrix at the completion of the design process represents all necessary elements to implement the system in the desired manner. There are several uses for the information contained in the full matrix. Primarily, it highlights inconsistencies in the system architecture that should be addressed. It may be possible to change the design and eliminate upper triangular elements in the matrix.

Additionally, the full system matrix provides useful information for system integration. It is possible to build and test sub-systems as they are completed. By doing so, any necessary sub-system debugging may be completed in parallel, improving efficiency. However, the potential for trouble remains if there are many off-diagonal terms in the full system matrix that fall outside of the sub-system boundaries. Such terms that fall outside the boundaries of a particular sub-system represent interaction between the sub-systems, and therefore are factors that do not matter until system integration is attempted.

If the full system matrix is triangular, then there is a pre-defined order for integration that must be followed to achieve a predictable system. If the matrix is coupled at all, there are iterative loops that are required for integration. This is a huge motivation for the creation and use of the full system matrix. Eliminating or understanding issues that arise during system integration will benefit system designers tremendously.

Even if the full matrix is a lower triangular matrix, and the design may be integrated satisfactorily, it serves a useful purpose over the extended life of the system. Large or complex systems have a high potential for changes to various sub-systems during the life of the system – this is design evolution [9]. Understanding the repercussions of any changes is a benefit to the design team. Changes to sub-systems will likely involve a small number of design parameters; the full system matrix may be used to predict the influences such changes will have on the rest of the system.

Without *a priori* knowledge of the effects a particular change may have, it may take a large effort to return the system to its desired operating state. By reducing the amount of adjustment that must be made to a system when sub-systems change, the full system matrix is a tool that can improve redesign efficiency.

3.2 Cross-Hierarchy Influences

The full system matrix is a useful tool for highlighting unpredicted system interactions. Therefore, it an understanding of some common off-diagonal interactions

benefits the system designer. This section is a description of some interaction sources that were identified in the case study presented in Chapter 6.

3.2.1 Constraints

Constraints are very closely related to functional requirements. Sometimes, functional requirements are turned into constraints due to their wide reaching effect on the system. Other times, constraints are inextricably linked to functional requirements in order to quantify the FRs. In this case, the effect of a DP on a constraint is very similar to the effect of a DP on the associated FR. Therefore, when DP affects a constraint, matrix elements relating the DP to all FRs affected by the constraint should indicate an interaction. This is based on the following theorem:

Theorem 1 (Equivalence of FRs) *A functional requirement written to contain constraints is equivalent to a functional requirement affected by separate, associated constraints.*

For example, take the functional requirement, “Control temperature to desired value, in a 1000 ft³ volume.” Since a constraint is defined by Suh to be a bound on acceptable solutions, the previous FR statement is the same as an FR saying, “Control temperature” with a constraint “Volume is 1000 ft³.” [1] Therefore, since the particular FR statement will depend on the style of the designer, the resulting design matrix should not depend on the designer. In each case, if a later DP affects the range that the temperature is allowed to vary, this effect should be indicated on the design matrix.

Another example of the effect that a DP may have on constraints and FRs is demonstrated later in Section 6.3.26. The selection of a system for implementing control algorithms affects other FRs at the same level, because the computation hardware selection places a constraint on all other FRs that the solution chosen for them is compatible with the computation hardware.

3.2.2 Physical co-location

The system architecture is a functional decomposition, and therefore is created based on the relationship and necessity of functions. In a particular branch of the system architecture, it is inherent that the functions will be related, since they are included in the branch as a means to satisfy the parent. However, pieces of a branch may be located in different physical areas of the system. Conversely, one particular physical component in a system may contain design parameters that are widely spaced in the system architecture.

Due to the physical proximity or co-location of a pair of parameters in the design, there is potential for interaction. An example of such an interaction is commonly found in electrical systems. Some electrical systems, particularly those with high power or high frequency will tend to generate a large amount of electrical noise. This noise may be transferred through the system either through electrical conductors, or may be radiated from components in the form of electromagnetic waves. These waves have potential to interfere with signals, particularly low-level signals, in adjacent conductors. Common practice in electrical and electromechanical systems is the separation of power conductors and signal conductors, to reduce the potential for interaction due to physical co-location.

If a system designer understands such potential interaction, steps may be taken early in the design process to reduce or avoid it. Such steps will reduce or eliminate the off-diagonal terms in the full system matrix and therefore created fewer problems for system integration.

3.2.3 Mechanical support

Design parameters are generally included into a design by adding some physical sub-system containing the parameter of interest. When the physical sub-system is included into the overall system, there is often a need for mechanical support. This is a support role that must be played in order to realize the desired system. Therefore, the need for support may be stated as a functional requirement. When this is done,

any DP from a sub-system that needs support will affect the support function. Additionally, the embodiments and parameters that are included to satisfy the need for support can have effects on existing systems.

3.2.4 Consumable distribution

Many sub-systems that are included to gain a particular DP will require consumable material to perform their intended role. An example that is common in complex systems is electrical power. The requirements for electrical power may be numerous and distributed throughout a complex system. To implement such sub-systems, it is necessary to run an electrical conductor to each sub-system requiring power, often of different voltages. Since the need for power is set by the sub-system, there is a relationship between the sub-system's DP and the FR to supply electrical power. Due to the means of distributing power to the required components, there will be effects on other sub-systems requiring consideration. It will benefit the designer to consider these effects early in the design process, and make sure that means for distributing consumable materials are planned.

3.2.5 Process loads

By satisfying a particular functional requirement, it is possible that loads in the form of forces and torques are placed on the mechanical system. These loads may be generated from various places in the system, but must be supported. Therefore, the effects of process loads may be spread throughout a system, and should be carefully considered.

Similarly to mechanical loads, there are thermal, electrical, or magnetic loads that may be created in order to enable the system. The effects of such loads may be present in sub-systems that are in close proximity. Such influence is also important for the designer to consider.

3.3 System-Wide Re-Sequencing

While the intent of axiomatic design is to preserve an uncoupled or decoupled system as decomposition proceeds, this is not always feasible. It may take a huge amount of engineering resources to achieve the desired system at each step of decomposition. Interactions, as described, may be inadvertently introduced into the system. Rather than search for a design solution which altogether avoids any of such small scale interactions, it is proposed that it is possible to rearrange the full system matrix, or any subset of leaf level FR/DP pairs beyond the structure that is defined by the hierarchy of decomposition, to reach a design sequence which does not require iteration. This method's benefit is to create a decoupled system, as stated in the following theorem:

Theorem 2 (Re-Sequencing) *A high-level coupled design may be treated as a decoupled design if the full system matrix, consisting of all leaf level design elements, may be re-sequenced to form a triangular matrix.*

The re-sequencing theorem is valid because the full collection of leaf levels defines a system. Therefore, it is possible to use the leaf-level representation of a system as a single matrix, and re-sequence the matrix to a decoupled form. Algorithms for re-sequencing to reach a triangular matrix or keep coupled elements close to the diagonal, where iterative loops are shortest, have been developed [10]. If there is a decoupled sequence possible with the leaf level elements, the system is a decoupled system. Once a system is complete and enters operation, only leaf level DPs are necessary.

Rearrangement of design elements beyond the structure defined at each level of the decomposition process has not been shown within the axiomatic design methodology, and has potential to reduce iteration to the minimum necessary. Another matrix based analysis method, the design structure matrix (DSM), does demonstrate re-sequencing of design elements, but does not generally keep the hierarchal structure once the matrix has been formed [11]. This strength of the DSM method may be incorporated into the axiomatic design method. The DSM method acknowledges

that iteration is going to exist in the design process and attempts to manage the iteration as necessary [12].

The DSM and axiomatic design matrix are very similar, and have been considered identical [13]; however, there are differences. The design matrix of axiomatic design often includes design parameters that are not strictly physical components. This ability to utilize features of components rather than components themselves is a particular strength of axiomatic design. Also, axiomatic design preserves the concept of FRs in the design matrix, assigning a DP to each FR. FRs and DPs are paired together, linking the rows and columns in the design matrix just as in the DSM, but the matrix information may be different. The design matrix represents the effects of DPs on functions, as opposed to the effects of physical components on each other, as in the DSM.

Examples for the utility of system wide rearrangement are drawn from the CMP system design. While the full matrix should be investigated as a whole to insure a properly sequenced design, much may be learned by looking at a smaller subset of FR/DP pairs. This may be useful, for instance, as a way to collect elements that are relevant to a particular piece of hardware. Since the information required to discuss decoupling in context of the CMP system will be developed later, the example of system re-sequencing is given in Section 6.4.

3.3.1 Preferred design element ordering and organization

A matrix may be arranged in a number of ways to satisfy the first axiom, but it is likely that one configuration offers benefits over another. For example, any coupled elements should be located as close together as possible, to reduce the length of an iterative loop that is required. Once the clustered grouping containing a coupled pair is solved, a design may proceed through the rest of the matrix as if it were decoupled or uncoupled.

Additionally, there is a benefit to keeping certain categories of design elements located close to each other during matrix re-sequencing. For example, it may be possible to cluster elements that will be controlled by a organizational group of the

design team, or by a subcontractor for part of the system. Such clustering will make it easier to update the information from a particular organizational group. It may be possible to collapse the group's elements into a single element, and treat it as if it were a single FR and DP. This would be useful only from an organizational perspective, if for instance interaction with the team responsible for the levels is severely limited.

3.4 Summary

As will be shown with the CMP case study in Section 6.4, although design intent may be for a purely uncoupled or decoupled system, details of the implementation can lead to unpredicted interactions. Due to these interactions, iteration is required in the design process. If the full system matrix, or even a subset of it, is rearranged to create the desired lower triangular form, iterations in the design process may be reduced or eliminated. It would be useful in this process to use an algorithm that would efficiently structure the matrix.

An ultimate goal of axiomatic design is the creation of a fully uncoupled system at all levels. While this is a beneficial goal, resulting in a system that is very adaptable and easy to control, the nature of complex systems determines that a fully uncoupled system is not always achievable. A decoupled design is acceptable by Axiom 1 only if the elements are sequenced correctly. Generally, an incorrectly sequenced design is in such a state due to unknown information about system interactions. Once that information is known, Theorem 2 may be used to obtain the correct sequence, reducing iteration.

While the method described here does show promise for improving the design process, it does carry with it some potential issues. By redefining the correct sequence for design, iteration is reduced; however by ignoring the structure of the hierarchy, other useful concepts of axiomatic design are challenged. For instance, the flow diagram representation of system architecture relies on the hierarchal nature of the system architecture to form an efficient representation [2]. The ideal case would be to maintain the uncoupled or decoupled intent of the design as decomposition proceeds, in which

case the method described here need not apply. It is presented as a tool that may be used to help a design where such undesired interactions present themselves.

Chapter 4

Simulation Within Axiomatic Design

4.1 Introduction

To reach a better understanding of system behavior, and therefore eliminate errors in the design, the designer may conduct experimentation. The process of experimentation may be seen as a four step cycle [14]:

1. Design: the experiment is planned to test for the desired outputs.
2. Build: the physical or virtual apparatus necessary to conduct the experiment is constructed.
3. Run: the experiment is carried out to gather data.
4. Analyze: results of the experiment are analyzed.

The apparatus by which an experiment is conducted may be physical or virtual. Simulation is a method by which the system behavior may be modeled virtually using mathematical equations. The equations are solved using numerical methods to estimate the system behavior [15]. By either physical prototyping or simulation, the engineer is able to verify the design and therefore eliminate any potential errors.

Each experimentation mode available to the engineer has strengths and weaknesses. Some simulations are computationally intensive, and take a long time to generate results. Also, physical models offer a greater certainty of the results. An advantage of simulations is the general economy involved with computer-based representations. Because of the tradeoffs involved, there will be a point in the experimentation process at which it is more economical to switch modes from simulation to physical prototyping [14].

Both simulation and physical prototypes are important to the experimentation process. This chapter will concentrate on methods of applying simulation, when axiomatic design is the chosen design method.

4.2 Simulation Methods

Computer-based simulation falls into two general classes: physical modeling and behavioral modeling. Traditional CAD packages are well adapted to physical modeling, and provide the benefits of interference checking and kinematic capabilities [16]. While this helps some types of design problems, it does not satisfy the goal of axiomatic design – functional performance. Since the purpose of using experimentation in design is to speed the design process, and arrive at a better final product, it is desirable to test the part of the system that is relevant to the output behavior. This is the essential problem: what to simulate. The simulation of functional relationships in a design has been investigated. Suzuki et al. call all non-physical information to be “design background information,” and show the need to connect the information with simulation methods [17]. Axiomatic design representation is a method of dealing with such design background information, and the application of simulation will help designers investigate system behavior.

With complex systems, it is necessary to model the behavior of the system as a whole. Interactions of sub-systems may be important to the collective behavior, and are neglected if sub-models are used individually. Lu et al. have presented a “Model Fusion” approach to the system simulation problem, in which various sub-models are

combined as training examples to create a system wide empirical model [18]. When developing simulations for axiomatic design, it is the creation of the initial models that is of interest. The unified nature of axiomatic design should lead to a naturally integrated model. Only fully uncoupled elements may be simulated with independent sub-models.

The general nature of axiomatic design requires a method that is capable of multi-domain models. Modelica is an object-oriented modeling language developed for physical system modeling [19]. Key benefits of Modelica are support for multiple domains and non-causal modeling. By describing component function using declarative equations, once existing components are combined as desired, the simulation software may determine which variables to solve for. This allows for easy reuse of already created components. Modelica uses the concept of ports, or connectors to combine elements and allow communication between them. Physical ports represent energy flow while signal ports transfer only information. In the example presented later in this paper, the relationship between the axiomatic design representation of information flow and simulation methods such as Modelica will be explored.

Dynasim, a Swedish company, sells software to create and solve Modelica models [20]. A group at Carnegie Mellon University proposes so called ‘composable’¹ models, using the object-oriented nature of Modelica to model systems [21]. The composable model method includes a link from the behavioral model to a CAD model, so that as the system is created, certain parameters are supplied directly, and kept updated by the system.

4.2.1 Inside-out versus outside-in decomposition

As decomposition proceeds, detail is added to the system. There are two general manners in which detail is added. Consider the simple system shown in Figure 4-1 below. A single FR is controlled using one of two alternate DPs, x or y . DP x represents an “outside” DP, such that further decomposition determines how the DP

¹‘composable’ models are made up of reusable elements that may be put together based on a CAD model to form the simulation.

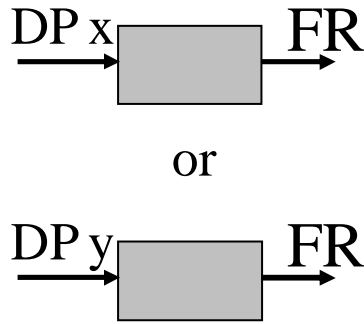

Figure 4-1: Simple system formulation to demonstrate the effect of decomposition style on topology

may be used to change the FR. DP y represents an “inside” DP, such that further decomposition determines how to create the DP. The difference is made more clear by looking at the system from Figure 4-1 after decomposition. The result is shown in Figure 4-2.

In Figure 4-2, it is apparent that DP x, the “outside” DP has remained at the outside of the system flow diagram. Decomposition has added detail to the connection between DP x and FR, but has not changed the structure. If decomposition were to proceed further, existing connections may remain as detail is added in the decomposed elements.

If DP y were used at the top level rather than DP x, decomposition would have added elements to the flow diagram before DP y. To better understand the potential disturbance, consider further decomposition of DP y. If DP y is an “outside” DP, then decomposition will integrate into the existing flow diagram, and add detail to the connection between DP y and FR. However, if DP y is an “inside” DP, then the existing connections will have to be broken to accommodate the decomposition.

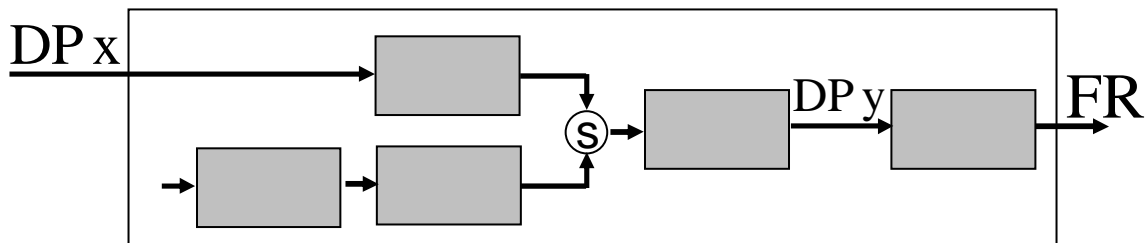

Figure 4-2: Decomposition of the system presented in Figure 4-1, showing the resulting placement of the alternate choices for the top level DP

For a more concrete example, consider a machine spindle system. The FR, “Control speed” might be satisfied by a design parameter “motor torque.” In this case, the resulting task accomplished by decomposition is to determine how the motor torque must be created such that it will control the speed of the spindle. Items will be added to the system before the spindle torque, working backwards towards the user input, which serves as the direct control. Such a decomposition is an ‘inside-out’ decomposition.

The spindle example below demonstrates ‘outside-in’ decomposition. In such a style, the user input is the highest level DP, so at a conceptual level, the user input controls the spindle speed, and further decomposition determines how such action is made possible. The system makes sense at the highest level, and decomposition serves to add the necessary detail to realize the system.

The differences between decomposition styles have large repercussions for simulation. An ‘outside-in’ design is consistent with the representations offered by object-oriented simulation, and maintains the benefits offered by the environment. Therefore, it is possible to define the following theorem:

Theorem 3 (Outside-In Strategy) *To preserve a system’s topology during decomposition², it is necessary to proceed with an outside-in strategy, such that high-level DPs are active inputs used to control FR behavior, and decomposition adds details necessary for implementation.*

Theorem 3 states that system inputs should be stated at a high level. Since a system may be represented in entirety by its leaf level elements, and the inputs used as high level DPs must exist at the leaf level, Theorem 3 precipitates the following Corollary:

Corollary 1 (Repetition of DPs) *An outside-in decomposition strategy requires that high level DPs representing inputs used actively during system operation are repeated as decomposition proceeds to the leaf level.*

²Preserving topology is particularly important when using the system architecture to define a simulation model, since doing so keeps the model connections valid at all levels of the decomposition.

An example of Corollary 1 may be seen in Figure 4-2 above. Since DP x is a DP at the top level, and is required as an input to one of the children elements, DP x must be repeated at the decomposed level.

4.2.2 Integration of axiomatic design and simulation environments

Object-oriented models of system behavior have been shown to be structured similarly with the axiomatic design method. Using the inheritance property of classes, it is possible to construct systems from existing components, while maintaining the ability to extend the level of detail of those components [21]. This is analogous to the decomposition process of axiomatic design. Certainly, axiomatic design does not necessarily result directly in models that fit into a current method of simulation, but does provide the information required to form a system representation. An advantage of using the axiomatic design method as the basis for a simulation model is the answer to the essential question: what to simulate. Axiomatic design describes the essential behavior of a system, and the mechanisms for influencing that behavior. If this behavior is accurately described, and then verified using simulation, there is a high probability that the system will perform as desired.

4.2.3 Block representation

For compatibility with simulation methods such as the Modelica language, it is necessary to represent the system as a collection of blocks, each with inputs and outputs. Only those inputs that change during the operation of the system must communicate through a port of the associated block element. In the axiomatic design method, the flow diagram closely represents a simulation model. Dynamic variables in the flow diagram should connect to ports in the module, enabling them to transfer information across the module boundaries. The example in the next section will show more clearly the transition between axiomatic design representation and a useful simulation model.

Knowing how to connect the elements presents a challenge when building models. With a functional model, the connections represent more than just physical interactions, so there is no clear way of guarantying the correct integration. When axiomatic design is used, and therefore the system architecture exists, there is a clear path towards integration. The hierarchy was developed from the top down, and now all the leaf level elements may be integrated from the bottom up according to the system architecture.

4.3 Spindle design example

As an example of the decomposition process, consider the design of a spindle. The spindle has a top-level functional requirement: ‘Control the rotary velocity of object A.’ This is satisfied using a rotary spindle, where the design parameter is the ‘Desired speed input.’ To decompose, the designer considers the question, ‘How do I realize the desired speed input so that it is possible to control the rotary velocity of object A?’ The result is shown in Table 4.1.

Table 4.1: Decomposition of FR/DP – Control speed/Desired speed

	Functional Requirements (FRs)	Design Parameters (DPs)
X	Allow only rotation	Bearing constraint
Y	<Control spindle speed>	<Desired speed>

In the decomposition of the top level requirements shown in Table 4.1, a bearing is used to define the single degree of freedom the spindle requires, and a feedback control drive system, with the necessary input is used to control the speed. The resulting design equation is:

$$\left\{ \begin{array}{l} FR.X, \theta_R \\ < FR.Y, \Omega > \end{array} \right\} = \begin{bmatrix} X & O \\ O & X \end{bmatrix} \left\{ \begin{array}{l} DP1, \textit{bearing constraint} \\ < DP2, \Omega_d > \end{array} \right\} \quad (4.1)$$

where θ_R is the single rotary degree of freedom, $< \Omega >$ is rotational speed, and $< \Omega_d >$ is the desired speed for the spindle.

Proceeding with the design, it is necessary to decompose FR/DP pair to control speed. The decomposition is shown in Table 4.2, along with a schematic in Figure 4-3. More detailed explanation of the selected system may be found in Section 6.3.8.

Table 4.2: Decomposition of FR/DP – Control spindle speed/Desired speed

	Functional Requirements (FRs)	Design Parameters (DPs)
Y.1	Accept speed input, Ω_{des}	< Ω_d variable entry >
Y.2	Measure actual speed, Ω_{act}	< Spindle encoder count rate >
Y.3	Compute error, ε	< Difference computation >
Y.4	Determine control effort, ψ	< Error value, ε >
Y.5	Output voltage, V	< Control effort value, ψ >
Y.6	Supply torque, T	< Voltage value, V >
Y.7	Set spindle speed, Ω	< Torque value, T >

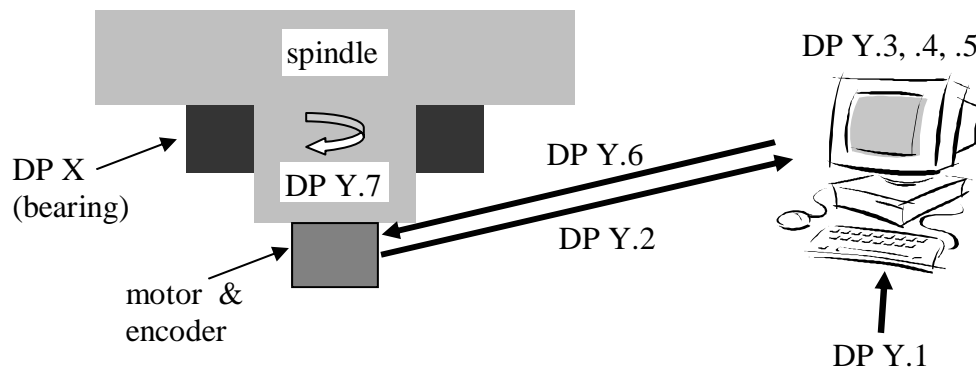

Figure 4-3: Schematic of spindle decomposition

The design matrix for this level is:

$$\begin{pmatrix} \text{FR.Y.1} \\ \text{FR.Y.2} \\ \text{FR.Y.3} \\ \text{FR.Y.4} \\ \text{FR.Y.5} \\ \text{FR.Y.6} \\ \text{FR.Y.7} \end{pmatrix} = \begin{bmatrix} X & O & O & O & O & O & O \\ O & X & O & O & O & O & X \\ X & X & X & O & O & O & O \\ O & O & X & X & O & O & O \\ O & O & O & X & X & O & O \\ O & O & O & O & X & X & O \\ O & O & O & O & O & X & X \end{bmatrix} \begin{pmatrix} \text{DP.Y.1} \\ \text{DP.Y.2} \\ \text{DP.Y.3} \\ \text{DP.Y.4} \\ \text{DP.Y.5} \\ \text{DP.Y.6} \\ \text{DP.Y.7} \end{pmatrix} \quad (4.2)$$

Equation 4.2 indicates the design is partially coupled, and therefore may present a problem. However, Equation 4.2 is very similar to Equation 2.4 from Section 2.6.2. The apparent coupling is managed by the iteration in the control system, and represent the feedback of output state to the input controller. The feedback system is a method to improve the robustness of the spindle speed against noise factors, such as disturbances or modeling errors. Feedback compensation to improve robustness is discussed in greater detail in Section 5.2.5.

The collection of FR/DP pairs in Equation 4.2 is a necessary and sufficient set to create the parent FR/DP pair. It is possible that the parents could have been decomposed into a different combination of children, or certainly that different physical systems (and therefore DPs) could have been chosen to satisfy the FRs.

In Equation 4.2, the determination of error depends on the values for desired and actual speed. The determination of control effort likewise depends on these parameters, along with the computation. All time dependent variables are involved in a sequential structure due to the causal nature of their interaction. Since the goal of the exercise is to understand the interaction of design elements for the purposes of simulation, it is beneficial to construct the flow diagram. A simplified representation of the flow diagram for the elements in Table 4.2 is shown in Figure 4-4.

The flow diagram shows the path of information flow as the spindle operates. As the spindle operates, some values of DPs and FRs are changing. These are the dynamic variables in the system. As operation proceeds, the module must be supplied

with updated values. For module MY.1, the information must cross the module interface. The importance of this will be highlighted in the following section. Those values that remain fixed during the operation of the system may remain isolated within the module structure. They are updated only during design changes.

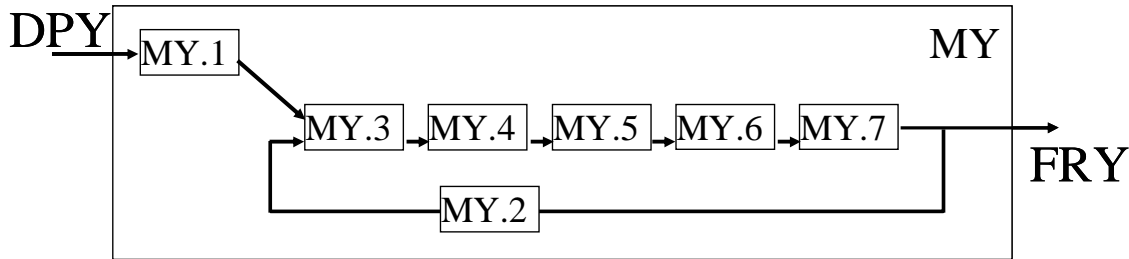

Figure 4-4: Flow diagram for the machine spindle.

If the spindle FR2/DP2 decomposition is represented in a manner that is consistent with the Modelica simulation environment using Dymola, the result is shown in Figure 4-5 [20]. The collection of elements may be called module MY.*x*, because it contains all the sub elements of module MY. The similarities between the flow diagram and the simulation model are apparent, indicating the suitability of the simulation environment. In the simulation model shown, a step input is used to supply the desired speed, so transient behavior may be investigated with the simulation. It is possible to use any desired input function which may more closely represent the intended operation of the system.

For the Dymola model in Figure 4-5, the output variable of interest is the spindle speed. The simulation was run with an initial set of parameters, and the speed recorded over time. To demonstrate a common application of system simulation, the results were used to adjust the control law parameters. By some simple adjustment, it was possible to reduce the amount of overshoot and improve the settling time of the system. The simulation results are shown in Figure 4-6. While the example shown in Figure 4-6 represents a simple adjustment of parameters, it demonstrates the usefulness of a simulation. By modeling the important system behavior, relevant design parameters may be adjusted to satisfy the desired system function.

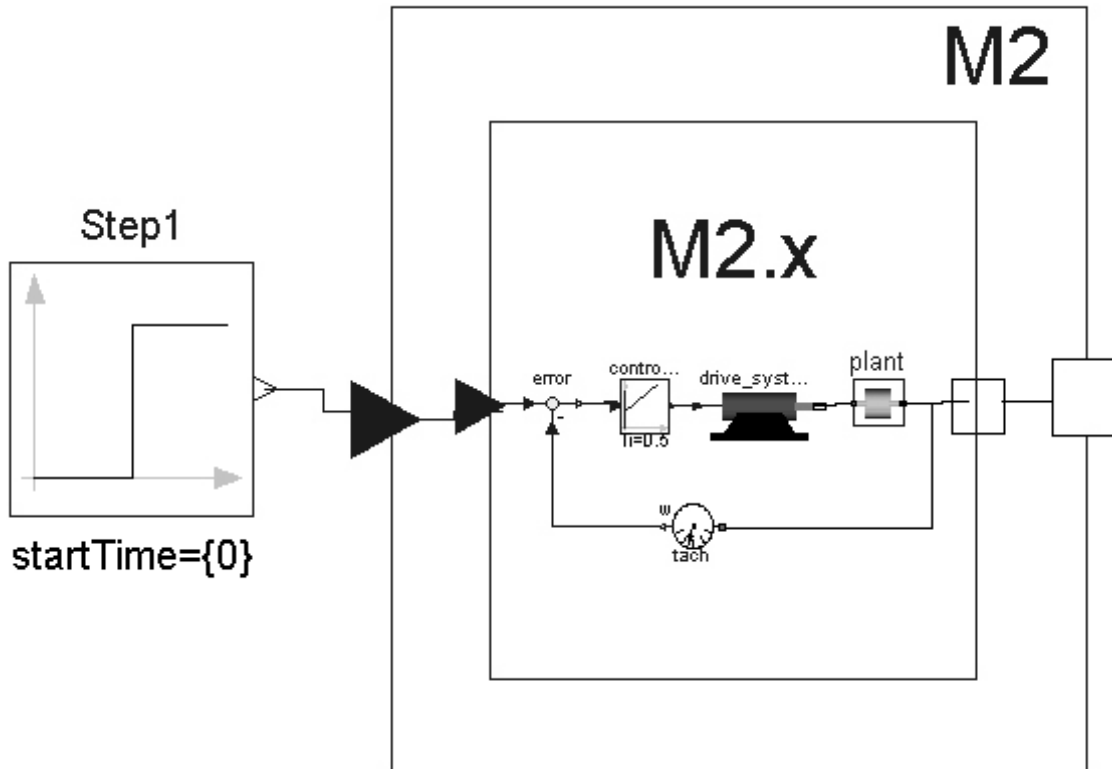

Figure 4-5: Full Dymola model of a spindle speed system

4.4 Diagnostics and Debugging

The formation of simulation models may offer benefits beyond predicting system behavior during the design process. Since a simulation model based on axiomatic design is created to be an analog of the critical system functions, it may be used as a diagnostic tool during system creation and operation. To use a simulation model as a diagnostic tool, the actual inputs from the system are supplied to the simulation. Then, simulation outputs are compared to system outputs. Any discrepancy is an indication of a problem with the system.

Using a simulation model to diagnose problems with a real system requires that errors in the simulation model be less than the desired errors in the real system, since the system can only be made as good as the model, assuming any discrepancy is eliminated by adjusting the system. Therefore, there may be a period in the system initialization during which the simulation model is calibrated to the real system performance. Then, any changes in the system performance will be recognized as

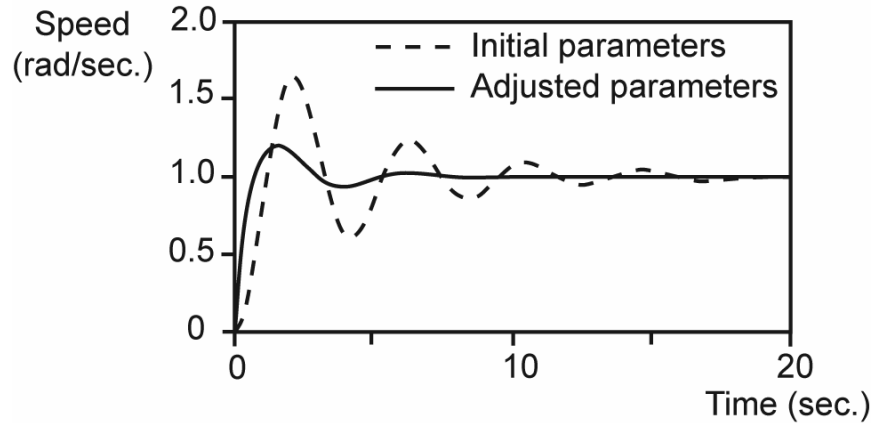

Figure 4-6: Output results from the simulation of a spindle speed system

discrepancy from the simulation model.

One difficulty with using a simulation model as a diagnostic tool during system operation is the speed at which system inputs and outputs change. If real-time diagnostics are required, it will be necessary to have a real-time simulation method. Most simulation methods are not real time, and some models present large computational loads. This is a constraint that will become important as the details of a particular system and simulation model are developed.

During normal operation, high level FRs may be compared between the system and simulation model. When a discrepancy is found, the model can provide more detailed information about where the problem with the system is occurring. By moving down the hierarchy structure, and comparing FRs at each level, the problematic element or interaction in the system may be identified. This is one way the system architecture produced by axiomatic system decomposition may be very useful. By its nature, the system architecture contains all the critical information about a system's functionality.

4.5 Summary

Axiomatic design is a valuable design method that helps create the correct system to meet a set of needs. Expense and lead time involved with building complex systems

results in an increased desire to verify functional performance prior to construction. Similarly, the expense and lead time associated with physical prototypes is motivation to simulate system behavior using virtual models. Integration of simulation is therefore important to any design process. In the context of axiomatic design, current object-oriented simulation environments initially appear most suitable. It is possible to adapt the flow diagram to an appropriate representation for such environments. Either from the top level elements working down the decomposition, or starting from the bottom, leaf levels of the hierarchy, the simulation model is built up. If Theorem 3 is followed, it is possible to work from the top down in an efficient manner. This process has been demonstrated for a simple electromechanical system. Such a system is characteristic of the types of systems that require simulation.

Environments other than the Modelica language may also use a structure that is consistent with the axiomatic design flow diagram. A goal of future research is to generalize the transformations that are necessary to move from the flow diagram to a simulation model, therefore extending the method to all types of systems. A great benefit of generalization would be the automated generation of simulation models from an axiomatic design system architecture. This would facilitate the use of simulation models during the design phase, and also their use as a diagnostic tool.

Chapter 5

Conceptual Robustness

5.1 Robust Design

Robust design is the general term used to describe a process initiated by Taguchi as quality engineering [6]. Taguchi aimed to reduce production variance by creating a quality loss function, and optimizing the product to minimize the loss function. The methods have been expanded and developed, and are commonly termed robust design or Taguchi methods today [22]. The premise of robust design is that product variance is caused by noise factors, which may come from many places, throughout the life of the product, and through experimentation it is possible to make the product and production process less sensitive to sources of variation, so it may always achieve its desired purpose.

Taguchi defines five stages of product and production process design: system selection/design, parameter design, tolerance design, tolerance specifications, and quality management for the production process [23]. While these stages are sometimes expanded, the stages of system design, parameter design, and tolerance design are inherent to robust engineering practice [22]. Unfortunately, little is said of system design – also known as conceptual design – besides mentioning that it is necessary. Taguchi states that the engineer must consider all possible systems to perform the desired functions, and then arrive at a final choice based on judgment and discussions [6, 23]. While this is compatible with the most basic goals of axiomatic design – the

satisfaction of functional requirements, it does not say anything about considering the robustness of a design during the conceptual design stage.

5.1.1 Robustness in axiomatic design

Axiomatic design currently addresses robustness in two areas. By nature of the two design axioms, robustness is improved. The independence axiom results in systems with reduced internal interactions. By designing a system with minimal interaction between elements, one type of internal noise is reduced. Noise that is introduced into one element of the system will not propagate into other areas, therefore improving robustness. This is a feature of axiomatic design that does not need to be separately addressed by the designer to achieve robustness. If the first axiom is followed, and independence is maintained as much as possible, then the system will be as robust as possible to degradation of performance from interactions.

The information axiom also has repercussions for robustness, as discussed by Suh [1]. This may be illustrated as shown in 5-1. Shown are two alternate designs, one with a higher “stiffness” than the other. The tolerance on the allowable FR range and random variation (noise) of the DP is the same for each system. In design A, the stiffer system, it is apparent that the noise-induced variation of the DP causes the FR to move beyond its allowable limits. However, in the case of design B, the same amount of variation allows the system to remain within tolerance. Therefore, axiomatic design is equipped with methods to accommodate variation in the selected design parameters.

5.1.2 Conceptual robustness

Andersson proposes both a qualitative and semi-analytic approach to achieving robustness during conceptual design [24, 25]. His overall idea is that robustness should be considered as early as possible in the product design process, where experimentation is not possible. By setting the stage for parameter design, system design is the key to the possibilities for robustness. A system that is designed to be robust during

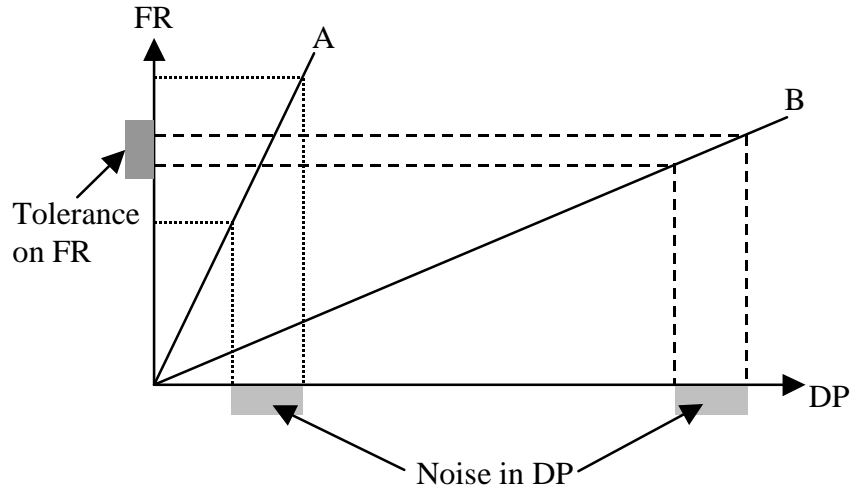

Figure 5-1: Robustness of designs ‘A’ and ‘B’ to variation in the DP

conceptual design will still improve with parameter design – it will improve to a level beyond the system in which robustness was not considered during system design. While Andersson has captured the key idea for conceptual robustness, he does not mention how to go about making sure that the correct ideas are used. He lists many resources of design information that may be applied in the conceptual design phase, and will improve robustness. Ford and Barkan discuss an algorithm for considering robustness during conceptual design, identifying key parameters of the design that lead to a reduction in robustness, and then changing the design to improve robustness [26]. They clearly demonstrate the need for conceptual robustness, and rely on increased consideration to improve robustness. The important step is the ability to identify the need for a particular solution and understand how it can fit into the rest of the system. This is where axiomatic design may be very useful.

5.2 Axiomatically Designed Robustness

5.2.1 Identification of noise factors

While axiomatic design already considers robustness to variation in design parameters and to internal noise, there are many other sources of noise in a system. The current approach of axiomatic design is to consider all the additional noise sources as a single

entity. Then, the allowable variation due to DPs is found by subtracting the sum of the variance due to noise from the total permissible FR variation. This approach may work in many circumstances, but the resulting allowable tolerance of DPs may be expensive or difficult to achieve. This is particularly true when the noise introduced from other sources is very large.

The strategy proposed is to identify major sources of noise, and then specifically target them within the conceptual design of the system. Noise factors may come from several sources; Taguchi defines three types of noise – external, internal, and unit-to-unit [6]. Knowing categories of noise can help the designer predict which may play a factor in the system under consideration. This is an area in which past experience will be important. Information stored as a database may also be used to predict which noise factors are likely to contribute to the behavior of the system.

Once noise factors have been identified, those which are believed to contribute significantly to variation in the desired FR behavior should be selected. For each selected noise factor, one strategy from the list in the following section is used to reduce FR variation.

5.2.2 General formulation

Consider the following design equation describing a single FR system:

$$FR_{intended} = [A] \{DP\} \quad (5.1)$$

when the above system is subject to variation caused by a noise factor, the formulation becomes:

$$FR_{actual} = \left[\begin{array}{cc} A & A_{nf} \end{array} \right] \left\{ \begin{array}{c} DP \\ DP_{nf} \end{array} \right\} \quad (5.2)$$

where DP_{nf} is the noise factor and A_{nf} is the element in the design matrix relating FR response to the noise factor. The noise factor is defined as random deviation from a nominal or desired value. A schematic block diagram of the system is shown in

Figure 5-2. Variation in the FR could be due to variation in the system, variation in the DP, or presence of a noise factor. The effects of these three sources may be expressed as follows:

$$\delta FR = A \cdot \delta DP + \delta A \cdot DP + A_{nf} \cdot DP_{nf} \quad (5.3)$$

where the δ operator is used to indicate variation from the desired value. If the internal variation of the system, represented in Equation 5.3 by the δA term, is assumed to be small, there are three possibilities for reducing the FR's susceptibility to the noise factor. Each strategy for reducing FR variation due to noise factors will be detailed in following sections; they are as follows:

1. Reduce A_{nf}
2. Reduce DP_{nf}
3. Compensate δFR due to DP_{nf}

5.2.3 Reducing FR sensitivity to a noise factor

To reduce the effect that a given noise factor has on an FR, it is necessary to reduce the system response, or stiffness. This is the method generally used by axiomatic design, and works well for variation in both the intended DP and also any noise factors. Since different elements in the design matrix represent the system's response to the two types of variation, it may be necessary to make a number of changes to the system to improve robustness in this manner.

One tool that may be of assistance to the designer is the creation of functional

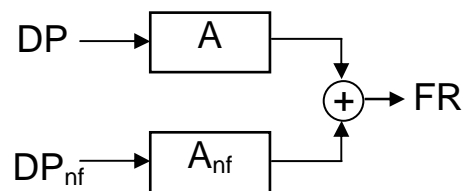

Figure 5-2: Block diagram of a single FR system subject to a noise factor

requirements that address the reduction of matrix elements. By specifying the reduction in system response to a noise factor as a requirement, it may be possible to develop systems or focus the designer's thought in a beneficial way. Also, reducing sensitivity to noise factors may require additional sub-systems to be added. The addition of sub-systems is best handled through the creation of a new FR, thus allowing decomposition.

Given Equation 5.2 as a representation of a single FR subject to a noise factor, consider the goal of reducing system sensitivity to the noise factor. An additional FR to reduce A_{nf} is formulated and added to the system:

$$\begin{Bmatrix} FR \\ FR_{A_{nf}} \end{Bmatrix} = \begin{bmatrix} A & 0 & A_{nf} \\ 0 & A_{A_{nf}} & 0 \end{bmatrix} \begin{Bmatrix} DP \\ DP_{A_{nf}} \\ DP_{nf} \end{Bmatrix} \quad (5.4)$$

where $FR_{A_{nf}} = A_{nf} = A_{A_{nf}} DP_{A_{nf}}$. It is important that the term relating $DP_{A_{nf}}$ to FR is zero, to prevent a double action of $DP_{A_{nf}}$. The formulation in Equation 5.4 is unconventional within axiomatic design, but is essentially a simpler representation of the following:

$$FR = \begin{bmatrix} A & 0 & 0 \end{bmatrix} \begin{Bmatrix} DP \\ DP_{nf} \\ DP_{A_{nf}} \end{Bmatrix} + \begin{Bmatrix} DP & DP_{nf} & DP_{A_{nf}} \end{Bmatrix} \begin{bmatrix} 0 & 0 & 0 \\ 0 & 0 & 0 \\ 0 & A_{A_{nf}} & 0 \end{bmatrix} \begin{Bmatrix} DP \\ DP_{nf} \\ DP_{A_{nf}} \end{Bmatrix} \quad (5.5)$$

where the 3x3 matrix to the right of the equation is a Hessian matrix describing covariance factors. The result of Equation 5.5, and likewise Equation 5.4 is:

$$FR = A \cdot DP + A_{A_{nf}} \cdot DP_{A_{nf}} \cdot DP_{nf} \quad (5.6)$$

The equivalence between Equations 5.4 and 5.5 is possible because of the limited number of covariance terms used from the Hessian matrix in Equation 5.5. Since all the terms are not necessary, Equation 5.4 is the preferred notion, as it fits in with

existing matrices. The utility of stating the sensitivity term as an FR is the use of a DP to control sensitivity. Rather than all the critical information existing buried in a design matrix, a DP directly influencing robustness is defined and controlled.

An example of reducing system sensitivity to noise factors is the addition of a temperature controlled mini-environment that is used to contain a metrology tool, or insulation that is used to isolate acoustic noise. Both of these sub-systems are added to a design to shield from a noise factor, thereby reducing the system sensitivity to the noise factor. From a system-level perspective, the sensitivity to the noise factor is reduced and from a sub-system-level perspective, the observed noise factor variation is reduced. The distinction is only one of scope of consideration, and does not change the approach or results.

One danger involved with adding systems to reduce system sensitivity to noise factors is that of making the system more sensitive to other noise factors. If the overall effect of a change is to cause more variation in the set of FR's, the change is undesirable. Therefore it is important to consider as many noise factors as are known when designing for robustness.

5.2.4 Reducing a noise factor

Reduction of DP_{nf} , the noise factor itself, is an obvious way of reducing system variation, but by definition noise factors are those things that may not be controlled directly. Therefore, the only way to reduce a noise factor is to limit the conditions of use for a system. An example may be to state that a particular automobile tire may only be used in dry conditions, a common qualification for racing tires. Because of the limiting nature of reduction in a noise factor, it is considered unsuitable for general system design practices, although should be remembered as an alternative.

5.2.5 Compensate for FR variation due to a noise factor

The third method for improving system robustness is to compensate for the variation that results from a noise factor. There are two general schemes for compensation.

One is to measure the FR of interest, and change its associated DP to bring the FR within the desired range. This must be done actively, that is repeatedly or continually during system operation, and is what is commonly known in engineering as a feedback controller. Measuring FR performance and making adjustments may also be done only at the start of a system's use, in which case certain noise factors influencing manufacturing may be rejected [7].

The other option for compensation is essentially a feed-forward control scheme, in which the noise factor is measured and a model used to predict the effect the noise factor will have on the FR. The FR is then adjusted accordingly, in an attempt to cancel the undesired effect from the noise factor. The result of the feed-forward compensation scheme is to make the FR's sensitivity to a noise factor, A_{nf} equal to zero, but it is differentiated from methods to reduce sensitivity directly because in a compensation setup, the noise factor still has the same effect on an FR, but that effect is balanced by an opposing effect from the compensator. In this case, the original FR from Equation 5.2 is supplemented with an additional FR. The resulting equation is:

$$\begin{Bmatrix} FR \\ FR' \end{Bmatrix} = \begin{bmatrix} A & A_{nf} \\ 0 & A'_{nf} \end{bmatrix} \begin{Bmatrix} DP \\ DP_{nf} \end{Bmatrix} \quad (5.7)$$

The system is designed so that $A'_{nf} = -A_{nf}$, and when FR and FR' are combined, the result is that the effect of the noise factor, DP_{nf} is cancelled and $FR'' = FR + FR' = A \cdot DP$, as desired. A block diagram schematic of the system is shown in Figure 5-3. An example of such a system is a temperature compensated machine tool, where errors in the axes due to temperature are measured and recorded in a software map [27]. During system operation, temperature sensors are used to measure the machine temperature, and then adjustments made to the positions of the axes to compensate for the thermally induced errors.

5.2.6 Robustness theorems

The following Theorems are proposed:

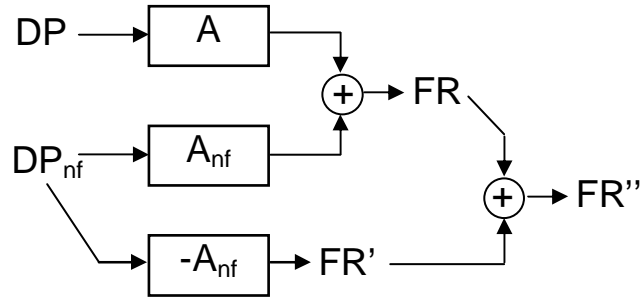

Figure 5-3: Block diagram of a single FR system subject to a noise factor, compensated by a feed-forward method

Theorem 4 (Robustness FRs) *System robustness¹ is increased by augmenting a set of FRs with FRs that reduce sensitivity to noise factors or reduce the observed noise factor variation, provided all FRs are satisfied by appropriate DPs.*

Theorem 5 (Robustness Through Compensation) *System robustness is increased by adding design elements that compensate for changes in noise factors, provided the compensation scheme is real-time and dynamically stable, and measurement uncertainty is significantly less than the desired FR variation.*

With perfect compensation, and no additional errors, it is sufficient for the measurement uncertainty to be less than the desired FR variation.

The important point of utilizing the Robustness FR Theorem is the method of reducing sensitivity to noise factors. While the reduction of sensitivity is consistent with existing axiomatic design theory, stating FRs explicitly forces the designer to focus on the key changes necessary to the system. Often times, the changes involve the addition of sub-systems through further decomposition.

5.2.7 Mapping to design parameters

Once functional requirements that explicitly address sensitivity to noise factors exist, the standard methods of axiomatic design apply. Since there is a design solution to satisfy the fundamental set of FRs, one possibility may be to select some parameter of the existing solution and use that as the DP to control system response to a noise

¹System robustness is defined as the inverse of FR variation due to noise factors

factor. If this is not possible, a new embodiment may be added to the system to provide a parameter that may be used as the DP to control response to the noise factor.

The design solution may be to reduce sensitivity to noise, or to shield the system from the noise. Such an example may be a precision machine tool or measurement tool, where the noise is thermal variation in the environment. Since this is a known source of noise, the design solution may be to create a temperature controlled enclosure in which the machine will operate. On the other hand, if the requirement exists at a lower level of the design, such as a measurement scale, then the design solution may be to use a material with a low coefficient of thermal expansion, and therefore reduce the system sensitivity to the thermal noise.

The need for suitable design parameters to satisfy the newly created functional requirements is significant. While a designer's experience may often allow the specification of appropriate solutions, other sources are useful. This is an area where computer databases of design information may be applied. Work is being done to develop systems with collections of case-based conceptual design information [28]. The information in such a system could be indexed with noise factors, therefore allowing a search to find potential solutions to a particular noise problem.

Often, a design parameter at high levels of the design will require decomposition. For instance, in the case mentioned above, if a thermally controlled enclosure were used, the FR/DP pair would be decomposed into a subsystem to enable the enclosure to be created. This is the natural process of axiomatic design, and moves the system from conceptual design into configuration design and parameter design. In the parameter design stage, when values are set for leaf level DPs, the traditional techniques of Taguchi Methods may be used. Since the system has been designed for robustness from the conceptual stage, it is likely to have the flexibility needed for successful optimization. The control factors to be used for parameter design experiments have already been explicitly placed into the system for the purpose of affecting response to noise.

5.3 Examples

As an example of designing robustness into the system during conceptual design, selected levels from the Chemical Mechanical Polishing (CMP) machine system will be used. The design of the CMP system is detailed in Chapter 6, but elements critical to system robustness are duplicated and highlighted here. Essentially, the CMP system is a machine tool used in the production of integrated circuits, and other devices created on semiconductor wafers. During development, robustness was designed into the concepts of the machine. Examples of robustness FRs will be demonstrated from two subsystems – the pad conditioner and the pressure application to the wafer.

5.3.1 CMP pad conditioner

The pad conditioner is a sub-system that partially satisfies the requirement to maintain a consistent pad surface. As the pad conditioner is decomposed, one requirement is to apply normal force. Table 5.1 shows the original decomposition of the parent pair; FR: Apply normal force and DP: <Conditioning pressure variable>. Figure 5-4 shows an overall schematic of the subsystem, and Figure 5-5 shows a more detailed view of the conditioner head configuration. Further detail about the pad conditioner and its decomposition may be found in Section 6.3.16. Briefly, a software variable representing the desired pressure is used to control the force applied to the conditioner arm through a pair of pneumatic bellows, the load rating of all components in the kinematic chain from the conditioner to the machine base is used to support the applied force, and a compliance is introduced to insure the pressure distribution on the conditioner is uniform.

Table 5.1: Initial decomposition of FR/DP – Control conditioning pressure/Conditioning pressure variable

	Functional Requirements (FRs)	Design Parameters (DPs)
...1	Control force applied to conditioner	<conditioning pressure variable>
...2	Support applied force	Conditioner support chain load rating
...3	Apply uniform pressure distribution	Conditioner gimbal compliance

The design equation for the conditioner force application level, including noise factors, is:

$$\left\{ \begin{array}{l} FR \dots 1 - \text{control F} \\ FR \dots 2 - \text{support F} \\ FR \dots 3 - \text{apply uniform p} \end{array} \right\} = \left[\begin{array}{cccc} X & O & O & A_{F-\mu} \\ X & X & O & O \\ O & X & X & A_{p-\mu} \end{array} \right] \left\{ \begin{array}{l} DP \dots 1 - \langle p_{cond} \rangle \\ DP \dots 2 - \text{cond. support rating} \\ DP \dots 3 - K_{cond-gimbal} \\ DP_{nf} - \mu_{conditioning} \end{array} \right\} \quad (5.8)$$

As a means of reducing the system's sensitivity to friction, the primary noise factor, robustness requirements were added as described by Theorem 4. These robustness FRs are satisfied by selecting DPs from the system. It was not necessary to add any new features to the physical system, but the parameters controlling robustness were selected as DPs. Table 5.2 shows the decomposition of the parent pair once the robustness requirements have been added, and Equation 5.9 is the associated design equation.

The design equation for the conditioner pressure system including robustness requirements and the friction noise factor is:

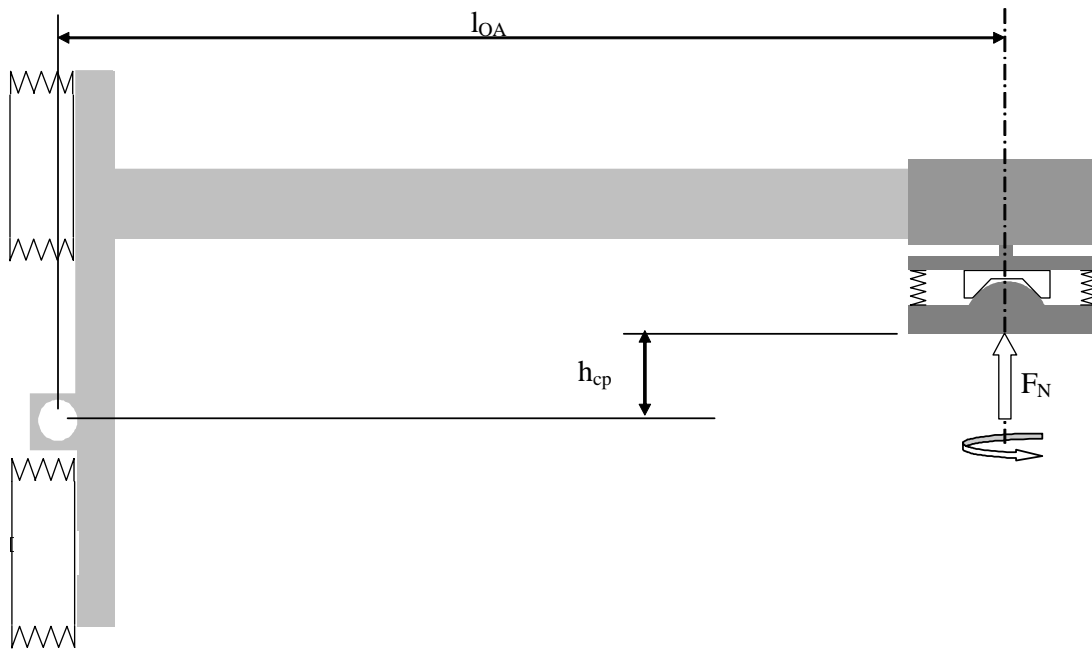

Figure 5-4: Schematic of FR/DP decomposition – Control conditioning pressure/Conditioning pressure variable

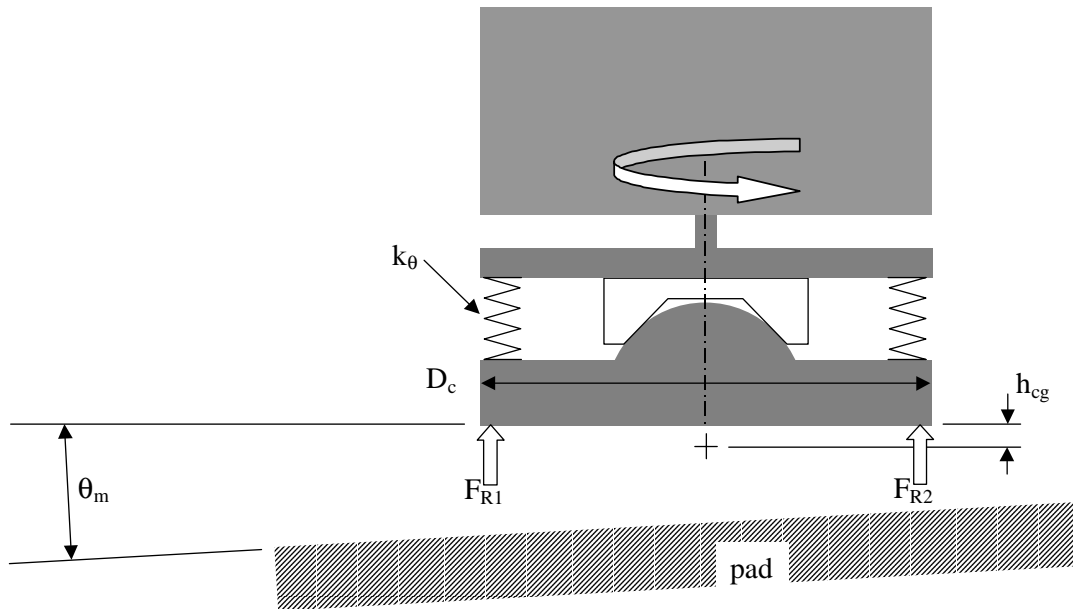

Figure 5-5: Schematic of detail from FR/DP decomposition – Control conditioning pressure/Conditioning pressure variable

Table 5.2: Decomposition, including robustness functions, of FR/DP – Control conditioning pressure/Conditioning pressure variable

	Functional Requirements (FRs)	Design Parameters (DPs)
...1	Control force applied to conditioner	<conditioning pressure variable>
...2	Support applied force	Conditioner support chain load rating
...3	Apply uniform pressure distribution	Conditioner gimbal compliance
...4	Reduce force sensitivity to frictional loads	Vertical offset of pivot point from conditioning point
...5	Reduce pressure distribution sensitivity to frictional loads	Vertical distance between conditioner head pivot and conditioning point

$$\left\{ \begin{array}{l} FR...1 - \text{control F} \\ FR...2 - \text{support F} \\ FR...3 - \text{apply uniform p} \\ FR...4 - \text{Reduce } A_{F-\mu} \\ FR...5 - \text{Reduce } A_{p-\mu} \end{array} \right\} = \left[\begin{array}{cccccc} X & O & O & O & O & A_{F-\mu} \\ X & X & O & O & O & O \\ O & X & X & O & O & A_{p-\mu} \\ O & O & O & L_{OA} & O & O \\ O & O & O & O & \sim \frac{2}{D_c} & O \end{array} \right] \left\{ \begin{array}{l} DP...1 - \langle P_{cond} \rangle \\ DP...2 - \text{cond. support rating} \\ DP...3 - K_{cond-gimbal} \\ DP...4 - h_{cp} - \text{cond. pivot height} \\ DP...5 - h_{cg} - \text{cond. gimbal height} \\ DP_{nf} - \mu_{conditioning} \end{array} \right\} \quad (5.9)$$

DP...4 - conditioner arm pivot height from conditioning point is shown in Figure 5-4. If there is any offset from the point of force application, a moment is created which tends to pivot the arm. The moment will be balanced by a change in the normal force on the conditioner, since the pressure in the bellows is constant. DP...4

would ideally be set near zero, but has been shown with a non-zero value for the purposes of illustration.

DP...5 - conditioner gimbal height from conditioning point is shown in Figure 5-5. If there is any offset from the point of force application, a moment is created in the lower member of the conditioner that must be balanced by a resulting pressure distribution at the surface of contact between the conditioner and pad. DP...5 would ideally be set near zero, but has been shown with a non-zero value for the purposes of illustration.

Through careful selection of the critical parameters and then attention to the parameters during the design process, it is possible to insure that the conditioner pressure system is not sensitive to variations in the coefficient of friction. Variations in the coefficient of friction are likely to happen, as the parameters depends on a number of surface qualities such as pad material and lubrication from water or slurry.

5.3.2 CMP pressure application

Another sub-system of the CMP machine is that to apply pressure to the wafer being polished. The parent FR is ‘Apply normal pressure’ and the DP is ‘Interface pressure’. These are decomposed and explained in detail in Section 6.3.21. As an example of conceptual robustness, the relevant details are presented here. The original decomposition of the parent FR and DP is shown in Table 5.3. A schematic of the system is shown in Figure 5-6. Noise factors that have a strong influence on the application of pressure to the polishing interface are δ , the wafer form error, and ε , misalignment between the wafer chuck and the polishing pad. The design equation, including predicted dominant noise factors, is:

$$\left\{ \begin{array}{l} FR \dots 1 - \text{provide pressure, } p \\ FR \dots 2 - \text{create } \mu m - \text{scale } \Delta p \\ FR \dots 3 - \text{Xmit } p \text{ uniformly} \\ FR \dots 4 - \text{support loads} \end{array} \right\} = \left[\begin{array}{cccccc} X & O & O & O & O & O \\ O & X & O & O & O & O \\ O & O & X & O & A_{p/\delta} & A_{p/\varepsilon} \\ X & O & O & X & O & O \end{array} \right] \left\{ \begin{array}{l} DP \dots 1 - \langle p_{nom} \rangle \\ DP \dots 2 - E_{pad-top} \\ DP \dots 3 - E_{mem} \\ DP \dots 4 - \text{load support} \\ DP_{nf1} - \delta \text{ wafer form} \\ DP_{nf2} - \varepsilon \text{ head-pad} \end{array} \right\} \quad (5.10)$$

Table 5.3: Initial decomposition of FR/DP – Apply normal pressure/Desired pressure variable

	Functional Requirements (FRs)	Design Parameters (DPs)
...1	Provide pressure	<Nominal compartment pressure variable>
...2	Create local (μm -scale) pressure variation	Pad surface modulus; $E_{PAD-TOP}$
...3	Transmit pressure to interface uniformly	Membrane modulus; E_{MEM}
...4	Support applied normal loads	Normal load support chain

To reduce the system's sensitivity to the two identified noise factors, FRs are added to the decomposition and then mapped to the physical domain. The decomposition including the new FRs and DPs is show in Table 5.4. The design equation with the robustness requirements and parameters is Equation 5.11, and shows that the system is decoupled. The FR/DP pairs that were created to improve the system robustness are ...5 and ...6, as described below.

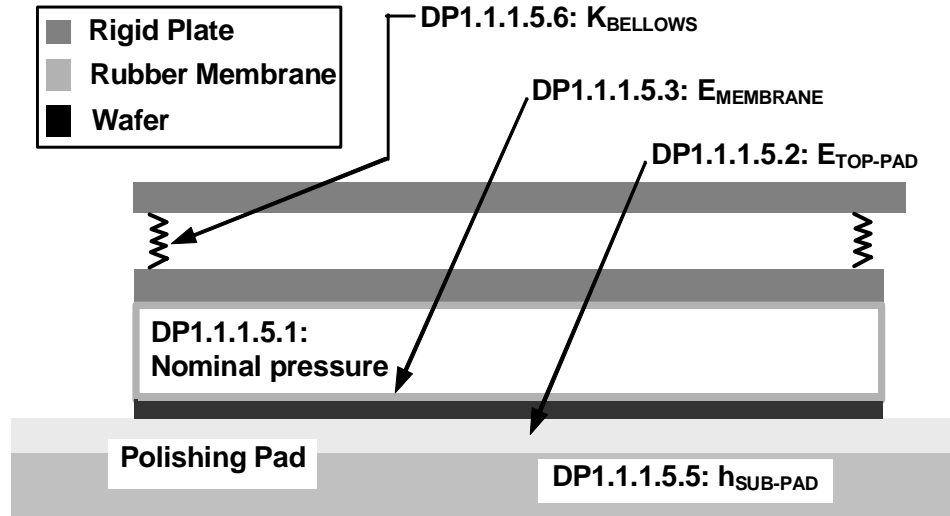

Figure 5-6: Schematic of FR/DP... decomposition – Apply normal pressure/Desired pressure variable

Table 5.4: Decomposition, including robustness FRs/DPs, of FR/DP – Apply normal pressure/Desired pressure variable

	Functional Requirements (FRs)	Design Parameters (DPs)
...1	Provide pressure	<Nominal compartment pressure variable>
...2	Create local (μm -scale) pressure variation	Pad surface modulus; $E_{PAD-TOP}$
...3	Transmit pressure to interface uniformly	Membrane modulus; E_{MEM}
...4	Support applied normal loads	Normal load support chain
...5	Reduce sensitivity to wafer form variation; δ	sub-pad thickness; $h_{SUB-PAD}$
...6	Reduce sensitivity to machine misalignment; ε	Isolation bellows stiffness; $k_{BELLOWS}$

$$\left. \begin{array}{l}
FR \dots 1 - \text{provide pressure, } p \\
FR \dots 2 - \text{create } \mu m - \text{scale } \Delta p \\
FR \dots 3 - \text{Xmit } p \text{ uniformly} \\
FR \dots 4 - \text{support loads} \\
FR \dots 5 - \text{reduce } A_{p/\delta} \\
FR \dots 6 - \text{reduce } A_{p/\varepsilon}
\end{array} \right\} =
\begin{array}{c}
\left[\begin{array}{cccccccc}
X & O & O & O & O & O & O & O \\
O & X & O & O & O & O & O & O \\
O & O & X & O & O & O & A_{p/\delta} & A_{p/\varepsilon} \\
X & O & O & X & O & O & O & O \\
O & X & O & O & X & O & O & O \\
O & X & O & O & X & X & O & O
\end{array} \right]
\left. \begin{array}{l}
DP \dots 1 - \langle p_{nom} \rangle \\
DP \dots 2 - E_{pad-top} \\
DP \dots 3 - E_{mem} \\
DP \dots 4 - \text{load support} \\
DP \dots 5 - h_{sub-pad} \\
DP \dots 6 - k_{bellows} \\
DP_{nf1} - \delta \text{ wafer form} \\
DP_{nf2} - \varepsilon \text{ head-pad}
\end{array} \right\} \quad (5.11)
\end{array}$$

DP...5 – The total stack stiffness of the pad, wafer, and flexible membrane controls how the interface pressure will respond to wafer form variation. A low stiffness will accommodate a large wafer form variation without creating large pressure variation. Due to the high compliance of the membrane used to apply pressure to the wafer, the primary concern here is from the pad side of the wafer. Generally, the pad thickness may be used to control the stack stiffness in a way that will not influence polishing at a local level. Most pads used in commercial processes use a multi-layer stack, so that the surface presented to the wafer is of the desired modulus to satisfy DP...2, and then an additional lower layer may be used to reduce the overall stack stiffness to a value suitable for robustness to incoming wafer variation. Therefore, the height of the soft sub-pad is selected as the design parameter to reduce sensitivity to incoming wafer variation. The sub-pad thickness affects:

- FR...6: high sub-pad thickness (low stiffness) reduces requirements for mis-

alignment, as low pad stiffness creates less pressure variation due to misalignment.

DP...6 – the isolation bellows stiffness is the tip-tilt stiffness of the bellows used to decouple the wafer carrier membrane from the rest of the wafer carrier. Thus, any misalignment in the wafer carrier itself will not translate into a pressure variation on the wafer surface. This decoupling bellows has the benefit of isolating the normal loads on the wafer, i.e. the polishing pressure, from frictional loads that are supported by the wafer carrier. This is a major advantage over some earlier CMP systems, in which a strong coupling exists.

Both of the robustness FR/DP pairs used in the design of the pressure subsystem use an increase in compliance to improve the system robustness. Rather than using parameter design to optimize the values of compliances that might have been part of the design, the compliance was put in the most beneficial position. It is still possible to use parameter design to optimize the values.

5.3.3 Vehicle design

There is a large push for robustness in vehicles. Particularly with vehicles operated on public roads, the conditions of usage vary widely. Many features of robustness have been incorporated into vehicle design as it progressed from generation to generation. For example, the use of detonation sensor, or knock sensor, allows gasoline engines to run on a wide variety of fuel octane content without problems. Detonation, or knock, is a condition where the fuel-air mixture in a cylinder combusts while the piston is still moving upwards to compress the mixture. The pressure force due to early combustion is in opposition to the upward moving cylinder, and therefore creates a loss of power. By sensing detonation in the engine, the sensor provides information to the engine management computer that causes it to retard the ignition timing, therefore allowing the piston to begin moving downward before the mixture is ignited. With the sensor and control system, the engine has been made robust to gasoline variation through the inclusion of a subsystem to change ignition timing. Alternately, high octane fuels

are less prone to pre-ignition, and therefore prevent knock. Requiring a high octane fuel is equivalent to reducing DP_{nf} for the vehicle.

Also, vehicles must be robust with respect to the profile and conditions of the road surface. For instance, undulations in the road surface should not disturb the directional stability of the vehicle. Road undulations cause vertical motion of the suspension relative to the frame of the vehicle; the wheel alignment parameters are a function of the suspension position. For this purpose, the suspension kinematics are carefully designed for the desirable characteristics. The FR in such a case might be as follows: Prevent wheel alignment changes due to road surface undulation, and the DP could be: Suspension kinematics.

Additionally, the tire tread pattern is designed to make the vehicle robust against water or other fluids on the road surface. With the proper tread pattern design, the tire is able to remove water from under the contact patch between the tire and road. Each of these design features, planned during the conceptual design phase of development, directly addresses a known source of noise faced by the system.

5.4 Summary

The need to address robustness during the conceptual design stage has been demonstrated. Parameter design and tolerance design, while useful practices, can only provide as much improvement as allowed by the system as specified in conceptual design. As a design methodology, axiomatic design provides a good framework for performing conceptual design in a structured manner, to insure that necessary functional requirements for a system are met. While axiomatic design does address certain types of robustness, there are likely to be additional noise factors that influence the overall performance of the system. If these can not be dealt with by reducing design parameter variation, another method is needed.

By creating functional requirements for robustness, as described by Theorems 4 and 5, it is possible to directly address individual noise sources with design features. Not only does this provide a system with the increased flexibility that is a benefit to

parameter design, it increases the likelihood that such optimization will be maximally effective. The results of the proposed method are difficult to quantify without a more thorough investigation. The specific benefit of robustness features added during conceptual design could be demonstrated by comparing two systems – one that has no such features, and another that has been designed for conceptual robustness. The system designed for conceptual robustness should show reduced sensitivity to noise factors.

Examples of the proposed method have been shown, such that a number of noise factors could be dealt with. The CMP machine used as an example has been successful in its designed task and performed successfully without the need for careful assembly and debugging, largely due to the robustness built into the system during conceptual design.

Chapter 6

Chemical Mechanical Polishing (CMP) System Design Case

6.1 CMP Background

The CMP process is used by the semiconductor manufacturing industry as a method of smoothing topology and reducing material thickness on the surface of a wafer [29]. The CMP process widely employed uses abrasive particles mixed with a liquid to make polishing slurry, and a porous polishing pad to move the abrasive across the wafer surface. Material is removed from the wafer surface, and the process stopped when suitable planarity has been achieved or when sufficient material has been removed. Because the entire wafer is polished at once, the wafer-scale uniformity of removal is a significant factor in evaluating a CMP process. Also, the trend of the semiconductor industry towards larger wafers places a growing emphasis on uniformity of processing, as the potential for loss increases.

The CMP process is used in inter-level dielectric (ILD) planarization, shallow trench isolation (STI), and metal damascene¹. This research has been focused on one of the primary applications: copper damascene [30]. The requirements for polishing

¹Damascene is an inlaid process, where reliefs (grooves, trenches, or holes) are created in a surface. The surface is covered with a material, and then the bulk material removed such that it remains only in the reliefs

copper in a damascene process are different than those for polishing oxide during ILD planarization.

If one area of the wafer is under-polished, the metal lines will be shorted, resulting in a faulty circuit. As the wafer is polished to insure that there are no under-polished areas, there may be regions of the wafer that polish more quickly and progress past the optimal stopping point, resulting in copper loss at the device level. The performance of a CMP process at the wafer level is quantified by the Within-Wafer-Non-Uniformity (WIWNU). WIWNU is usually expressed as the standard deviation of either removed or remaining thickness divided by the mean value of the measurement. Current process requirements call for less than 5% WIWNU.

WIWNU is the primary factor that may be influenced by machine design. Because the current process uses two- or three-body abrasion, it is an averaging process that tends to smooth over the entire surface. Therefore, there is no mechanism for affecting the process within the area of a single die, let alone within each of the dies individually.

Many attempts have been made to characterize removal of material with the CMP process. Initial models used the Preston Equation [31]:

$$MRR = k_p \cdot P \cdot V \quad (6.1)$$

where MRR is the material removal rate, k_p is the Preston constant, P is the local pressure, and V is the relative velocity between abrasive and pad. The Preston constant is a function of many things, including the interface conditions, slurry distribution, chemistry, etc.

Zhao and Shi have performed analysis and experimentation that shows the Preston equation is not an accurate representation of the CMP process, but rather the removal rate should include a nonlinear relationship with pressure, and that polishing does not take place below a certain threshold pressure [32], [33]. The relationship is expressed as:

$$MRR = K(V) \cdot (P^{2/3} - P_{th}^{2/3}) \quad (6.2)$$

where K is a constant which depends on velocity, V, and P_{th} is now the threshold

pressure. Other people have developed their own relationships for the removal rate, generally finding various dependencies on pressure and velocity [34].

No matter what the exact relationship between the removal rate and process parameters, it is clear that the two primary factors to influence the removal of material from the wafer are the velocity and pressure. Due to the relative difficulty associated with varying the velocity across the wafer surface, the primary approach to removal control is by controlling the pressure at the polishing interface.

Pre-polished wafers may not be flat and may not be of uniform thickness, and there may be misalignment between the wafer and pad axes due to machine misalignment or polishing loads. The ability of CMP equipment to tolerate such disturbances is necessary to insure reliable operation. Increasing compliance of the wafer backing film and the pad contribute to improved uniformity, but a more compliant polishing pad results in inferior die-scale planarity. Therefore, a stiff polishing pad is often stacked on a compliant layer, forming the stacked pad used by the majority of CMP applications today. Although these advances in consumable design have allowed the user a greater range of operating conditions, the design of the polishing tool has a large impact on the pressure distribution at the polishing interface.

6.2 Existing Technology

The CMP systems on the market have progressed through several generations of design. This has allowed the equipment manufacturers to address deficiencies of early machines as well as the evolving demands of the industry.

CMP tools have continually improved the methods used to apply pressure, mostly through a process of trial and error. Early tools used a rigid metal plate to load the wafer against the pad. A soft backing film covering the plate provided compliance to improve wafer scale uniformity. A gimbal, or two degree-of-freedom joint, is used to accommodate misalignment of the wafer and pad. Frictional loads of polishing create a lateral force on the wafer at the pad interface. If the wafer's gimbal point is above the interface, the force will create a moment, causing the wafer to "nose dive" into

the pad.

Other means of providing the compliance of a gimbal joint allow the rotation point near or at the polishing interface. One such method uses a hemispherical surface to define the bearing point. The surface is convex from the wafer carrier such that the center of rotation lies on the polishing interface. Designs of this type have been shown in the intellectual property of Applied Materials, OnTrack, and Obsidian [35, 36, 37].

The reason for frictional forces affecting the wafer's pressure distribution is the coupling from the method to support frictional forces to the function of applying pressure to the wafer. By decoupling the two functions, the effects may be minimized.

Although improvements in wafer carrier gimbal design may isolate the applied pressure from frictional loads, variation in pressure may be caused by wafer thickness variation. To insure even applied pressure on the back of the wafer, several techniques have been employed. One method is the formation of a pocket of water behind the wafer and carrier film, to equalize pressure behind the wafer [38]. This approach evolved into two classes of design: direct fluid pressure and fluid pressure through a membrane.

Direct fluid pressure involves creating a seal around the periphery of the wafer backside, and supplying the resulting cavity with pressurized fluid. This approach offers what may be the ultimate in backside pressure uniformity, but must transfer torque to the wafer through the seal. Therefore, there must be more pressure on the seal area than the rest of the wafer, introducing a source of non-uniformity and performance uncertainty. Direct fluid pressure approaches have been demonstrated by CMP users, but have not been adopted by tool manufacturers [39, 40].

Fluid pressure applied through a membrane separates the wafer from a fluid reservoir. The fluid provides the pressure for polishing, while the membrane surface transmits the necessary torque to the wafer. Because the membrane is highly compliant, the pressure distribution seen on the wafer backside closely follows the uniform pressure in the cavity.

The membrane-style approach has been demonstrated in intellectual property documents from tool manufacturers [41, 42]. One of the limitations is performance at

the wafer edges. The edges of the membrane are coupled to the housing of the wafer carrier, limiting the compliance. It is possible to isolate the membrane from the carrier housing by providing a second pressure source to load the membrane. In effect, the secondary pressure controls the membrane “bias”, or the ratio of sidewall loading to central region loading.

Applied Materials have demonstrated in intellectual property designs of the variable bias type of membrane [43, 44]. One significant advantage of this approach is the ability to control the wafer-level uniformity. The bias type membrane design is capable of adjusting the relative polish rate of the outer periphery and central area of the wafer, and as such offers the user an extended level of control over polishing. Although the bias type membrane design does offer some control of uniformity, its single bias pressure allows only rough adjustment of the radial pressure profile. There are a number of designs that attempt to offer increased spatial resolution when controlling the pressure profile. Both Applied Materials and an independent inventor have protection for concepts that provide a number of pressures [45, 46]. Developed before such patents were issued, the MIT CMP platform wafer carrier has some similarities to these systems; however, there are key advantages to the MIT design that will be discussed subsequently.

6.3 Axiomatic Design System Architecture for a CMP Machine

Axiomatic design was used to develop the requirements for a CMP machine that could address the needs of industry and also extend the state of the art. As a practical determination of the usefulness for axiomatic design in this circumstance, the system was built and tested. The system architecture includes many functions that are necessary for a commercial machine, but impractical for a research machine. Therefore, the system that was built does not include the complete extent defined by the system architecture. Only systems critical to the removal of material from the wafer were

constructed. The machine systems constructed serve as validation of the system design process, and allow for examples of axiomatic system design that highlight critical concepts in the design process. Additionally, the scope of this work is concentrated on the most innovative and critical machine systems. Some branches of the system architecture are terminated when a DP may be specified that is part of a subsystem that has been demonstrated in industry. The DP is considered a leaf level at this point, and will be marked as such with an underline in the decomposition table. A CAD drawing of the completed machine system is shown in Figure 6-1 along with a photograph of the system in Figure 6-2. The general configuration may be useful when following the decomposition. Following is the CMP system architecture that was developed.

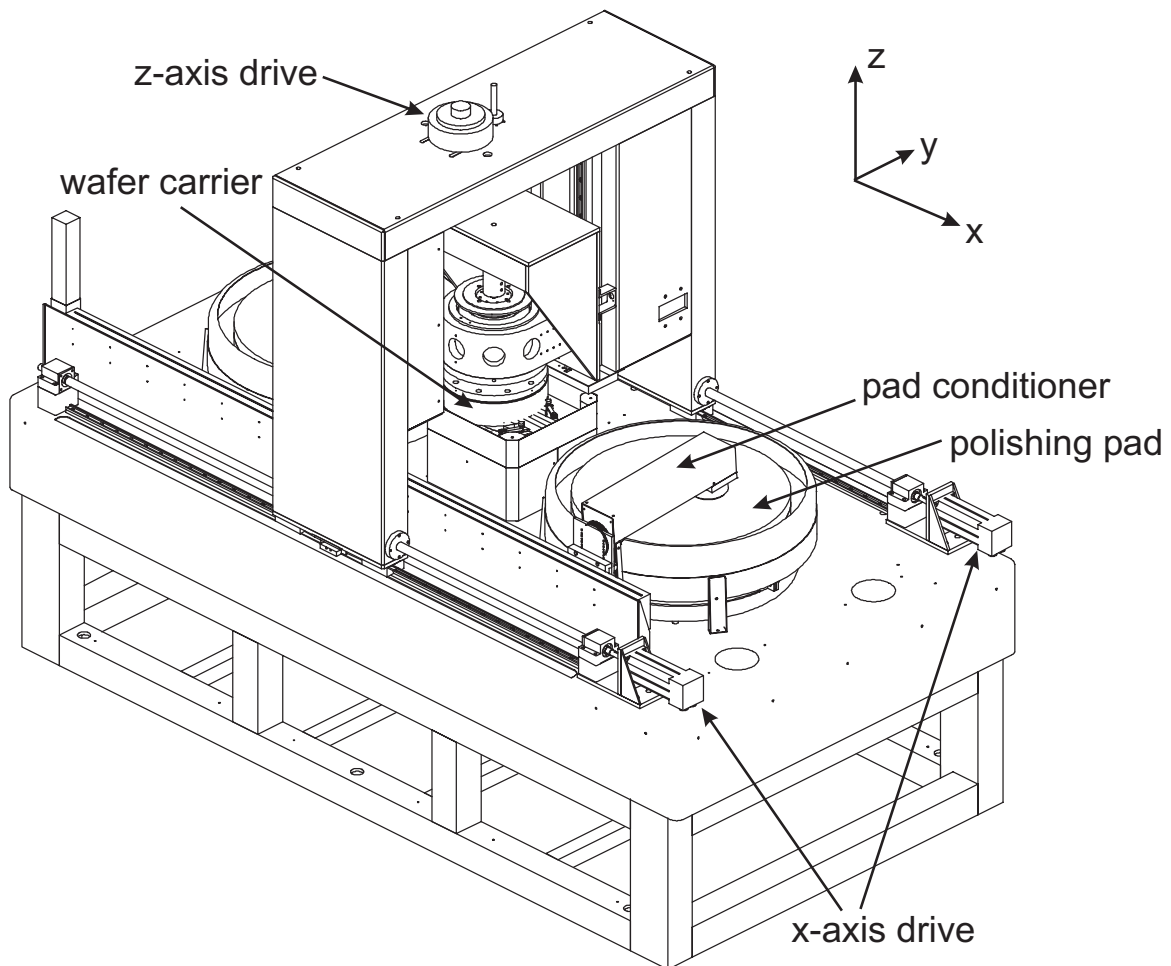

Figure 6-1: CAD model of the fabricated MIT CMP Platform



Figure 6-2: Photograph of the fabricated MIT CMP Platform

6.3.1 Top Level Requirements

The top level FR for the CMP machine is shown in Table 6.1 as follows:

Table 6.1: Top level FR/DP for CMP system

Functional Requirements (FRs)	Design Parameters (DPs)
Remove material from wafer to form a planar surface while maximizing ROI*	<CMP system>

*ROI is Return On Investment

The CMP machine is designed for an industrial customer, who is in the business of producing semiconductor chips to make a profit. Therefore, the general customer requirements are to generate profit as efficiently as possible. To decompose the necessary system, a basic model of the economics is:

$$ROI = (Value\ Added - COO) \cdot (Net\ Wafers\ Per\ Hour) \quad (6.3)$$

Investment must be made in equipment to allow production; therefore the goal of the customer is to maximize the return on this investment. The various components of the return are decomposed into sub requirements, forming the first set of branch FRs which are mapped to DPs according to the Independence Axiom and the Information Axiom. The decomposition is shown below in Table 6.2.

Table 6.2: First branch CMP decomposition of FR/DP – Maximize return-on-investment/CMP system

	Functional Requirements (FRs)	Design Parameters (DPs)
1	Maximize value added	<Flexible, integrated processing>
2	Minimize Cost Of Ownership (COO)	Target COO
3	Maximize wafer production	<Output maximization>

The design equation representing the interaction of top level FRs and DPs from

Table 6.2 is:

$$\begin{Bmatrix} \text{FR1} \\ \text{FR2} \\ \text{FR3} \end{Bmatrix} = \begin{bmatrix} X & O & O \\ X & X & O \\ X & X & X \end{bmatrix} \begin{Bmatrix} \text{DP1} \\ \text{DP2} \\ \text{DP3} \end{Bmatrix} \quad (6.4)$$

DP1 - the value added to the wafer by the CMP process is difficult, if not impossible, to quantify. Therefore, the requirement to maximize value added is satisfied through customer perception. By performing the necessary processing, and therefore enabling the overall manufacturing scheme, the CMP process adds value to the larger system. The current perception of value in CMP tools is the integration of polish, cleaning, and metrology in one station. This allows the CMP process to be combined with existing processes with as little negative impact as possible. By presenting the proposed system as a unified approach, it will be easy to integrate into the overall manufacturing scheme. The unified system affects the following FRs:

- FR2: the cost of ownership that is possible with the machine depends very much on the design of the removal system
- FR3: the production rate of the system will likewise depend on the design of the system itself.

DP2 - target Cost of Ownership is the cost of running the machine system to polish a wafer, expressed in dollars per wafer pass. By taking the system that has been designed to satisfy FR1, and either controlling available parameters or adding additional features to control, it should be possible to influence the consumption of resources that the system will require. Here it should be noted that during the entire design process, it is important to maintain as efficient a system as possible; however through DP2, it is the intention to further increase efficiency by adding and controlling additional parameters. The target COO systems affect:

- FR3: the mechanisms for affecting the cost of ownership may place constraints on the system to maximize output from the machine.

DP3 - to maximize the number of wafers produced, the abstraction is made to create systems for maximized output. This will be decomposed into more concrete levels that enable the CMP system to avoid any waste material while maintaining the highest possible rate of production. The details of all previous systems will be important to those for maximizing output.

The top level requirements have been decomposed and mapped to design parameters, allowing the system architecture to proceed to the next level. Each of the sub levels is decomposed to allow the system to be created. Since the matrix for the decomposition of the top level requirements is decoupled, it is necessary to completely decompose FR/DP1 before FR/DP2 and 3. The decomposition follows.

6.3.2 FR/DP1 Maximize value added/ Flexible, integrated processing

The flexible, integrated processing that is specified to maximize the value added to the wafers must be further decomposed. Here, the constraints defined through the customer requirements are important. To satisfy the needs of the fabrication environment, the CMP system must process wafers and return them to the manufacturing system. Due to contamination requirements, it is important to clean the wafer before returning it to the rest of the manufacturing process. At this level of the design, a utility FR is included to support machine operations. This enables the design to specify and include all sub-systems that are necessary to enable the primary systems. Also, a requirement to allow user control is introduced at this level. While the machine may operate under automatic control by a larger control system, it is important to allow an individual user control of many functions both for processing and for maintenance purposes. The specific requirements are listed in Table 6.3 below. Constraints that govern the mapping from functional requirements to design parameters are shown in Table 6.4.

Table 6.3: Decomposition of FR/DP1 – Maximize value added / Flexible, integrated processing

	Functional Requirements (FRs)	Design Parameters (DPs)
1.1	<Process wafer>	<Front layer removal>
1.2	<Clean wafer>	<Contamination removal>
1.3	<Transport wafers>	<Wafer handling>
1.4	<Support machine operation>	<Sub-system support>
1.5	<Allow user control>	<User interface>

The design equation associated with 6.3 is:

$$\begin{Bmatrix} \text{FR1.1} \\ \text{FR1.2} \\ \text{FR1.3} \\ \text{FR1.4} \\ \text{FR1.5} \end{Bmatrix} = \begin{bmatrix} X & O & O & O & O \\ X & X & O & O & O \\ X & X & X & O & O \\ X & X & X & X & O \\ X & X & X & X & X \end{bmatrix} \begin{Bmatrix} \text{DP1.1} \\ \text{DP1.2} \\ \text{DP1.3} \\ \text{DP1.4} \\ \text{DP1.5} \end{Bmatrix} \quad (6.5)$$

DP1.1 - front layer removal is the key competency of the machine. It enables the process around which the machine is designed, leading to the primary position in the decomposition. The process is defined by other wafer fabrication step requirements as a removal process, therefore there is little choice for a DP at this level; other parameters will be dealt with in the further decomposition. Front layer removal affects the following FRs:

- FR1.2: the removal creates the materials that must be cleaned from the wafer. For example, a change in polishing chemistry will require a change in cleaning chemistry.
- FR1.3: the manner in which the wafer handler interfaces with the removal affects the wafer handler's design.
- FR1.4: any requirements for support sub-systems will be determined by the design of the removal.

Table 6.4: Constraints for FR/DP 1 decomposition

Impacts:	FR.				
Description	1	2	3	4	5
– Critical Performance Specifications –					
Polish output quality	x				
Polish repeatability	x				
Cleaner output quality		x			
– Operational Constraints –					
Allow flexible user interface	x	x	x	x	x
Allow automated operation				x	
– Global Constraints –					
Minimize costs (design, manufacturing, operational, maintenance, etc.)	x	x	x	x	x
Maximize throughput	x	x	x	x	
Do not damage wafers	x	x	x	x	x
Maximize availability / reliability (minimize mean-time-between-maintenance (MTBM) and mean-time-between-failure (MTBF))	x	x	x	x	x
Make tool serviceable (easy access for maintenance)	x	x	x	x	x
Make tool “user-friendly” (ergonomics and software interfaces)	x	x	x	x	x
Minimize footprint	x	x	x	x	x
Conform to industry and safety standards	x	x	x	x	x
Integrate maximum amount of existing technology (minimize redesign of proven components, use off-the-shelf equipment whenever possible)	x	x	x	x	x

- FR1.5: the parameters available for user control and the possible range for control must be determined by the removal.

DP1.2 - cleaning returns the wafers to their pre-process level of contamination. The requirement to clean the wafers is partially created by the choice for removal process. In the MIT CMP platform, wafer cleaning was left as a manual process, since the wafers produced on the machine did not have to undergo any further processing in a cleanroom. Therefore, this branch of the decomposition ends here as a leaf level. Most commercial CMP machines incorporate a 3rd party cleaning system, or allow the customer to install a variety of cleaning systems. The cleaning must meet the minimum throughput defined by the removal. The cleaning affects the following FR's:

- FR1.3: the manner in which the wafer handler interfaces with the cleaning affects the wafer handler's design.
- FR1.4: any requirements for support sub-systems will be determined by the design of the cleaning.
- FR1.5: the parameters available for user control and the possible range for control must be determined by the cleaning.

DP1.3 - the wafer handler is a transport device used to move the wafers from one stage of their processing to the next. It allows the use of multiple removal and cleaning systems to meet a global throughput constraint. Similarly to cleaning the wafer, transport for the MIT CMP platform is not needed, since the machine operates as a stand alone device, and there are no throughput requirements. Therefore, this branch of the decomposition ends here. Wafer handling affects the following FR's:

- FR1.4: any requirements for support sub-systems will be determined by the design of the wafer handler.
- FR1.5: necessary software functions are determined by the wafer handler design.

DP1.4 - the support sub-systems for the machine allow the implementation of the above design parameters. There is a sufficient role in providing those services that are common to multiple parts of the machine to necessitate a separate requirement. Due to the decoupled nature of the design matrix at this level, earlier branches of the system must be decomposed before the support sub-systems. Sub-system support affects:

- FR1.5: necessary software functions are determined by the support sub-systems' design.

DP1.5 - the user interface is the software that is common to all other software modules. This includes any interface with outside information or manual input. It is the normal operating display of the machine interface.

Since the design matrix at this level is decoupled, we will continue to follow the first branch, until completion. Completing the decomposition of the first branch provides information that may be necessary for completion of other branches. The decomposition of FR/DP1.1 follows.

6.3.3 FR/DP1.1 Process wafer/ Front layer removal

To process the wafer, it is necessary to remove a layer from its surface. To accomplish this, the design approach is that of a generally uniform removal process with a controlled duration to control the thickness of the layer removed. It is known that the process must therefore remove material, control the removal time, and be capable of receiving wafers from the machine super-system and returning polished wafers. One requirement that is added at this level is to enable multi-step processes. This requirement was added to the system architecture based on recommendation from a research team focusing on mechanisms of material removal. By allowing multi-step processes, a change in chemistry or physical properties at the surface of the wafer may be effected efficiently.

The addition of the requirement for multi-step processes is partially derived from perceived customer needs, and is supported by Theorem 4. By adding the requirement and mapping to the physical domain, the system’s robustness to process specifications is improved. The decomposition of the front layer removal follows, as shown in Table 6.5. The decomposition is performed to satisfy the constraints shown in Table 6.6.

Table 6.5: Decomposition of FR/DP 1.1 – Process wafer/Front layer removal

	Functional Requirements (FRs)	Design Parameters (DPs)
1.1.1	<Remove surface material>	<Abrasive Removal Processing> (ARP)
1.1.2	Enable multi-step processes	Multiple removal station design
1.1.3	<Control remaining thickness>	<Endpoint signal>
1.1.4	<Exchange wafers>	<Wafer exchange sequence>

Table 6.6: Constraints for FR/DP1.1 decomposition

Impacts:	FR.			
Description	1	2	3	4
– Critical Performance Specifications –				
Uniformity – (WIWNY) – wafer level variation < 5 %	x			
Planarize surface – die scale flatness	x			
Surface quality – scratches & roughness	x			
Wafer-to-wafer variation < 2% - SiO ₂			x	
100% of land area cleared			x	
Minimal overpolish			x	

The design equation for the elements shown in Table 6.5 is:

$$\begin{Bmatrix} \text{FR1.1.1} \\ \text{FR1.1.2} \\ \text{FR1.1.3} \\ \text{FR1.1.4} \end{Bmatrix} = \begin{bmatrix} X & O & O & O \\ X & X & O & O \\ X & X & X & O \\ X & O & O & X \end{bmatrix} \begin{Bmatrix} \text{DP1.1.1} \\ \text{DP1.1.2} \\ \text{DP1.1.3} \\ \text{DP1.1.4} \end{Bmatrix} \quad (6.6)$$

DP1.1.1 - abrasive removal processing (ARP) is a process which removes material in a manner consistent with its constraints. Primary in the constraints is planarization, or the ability of the process to make the surface flat. The flat surface should be created as quickly as possible, to allow for a broader range of remaining thickness. The ratio of the polishing rate of protruding, or “high” features, on the wafer to that for recessed, or “low” features, is called the planarization rate. A high planarization rate is desirable. One of the customer needs identified by the machine development team is compatibility with industry standard processes. Since the semiconductor fabrication industry places a high importance on production stability, radical processes are unlikely to be quickly adopted. Therefore, the MIT CMP platform must be capable of utilizing existing processes. The most widely used removal process in wafer production capable of a high planarization rate is the abrasive removal chosen. A compliant pad is used to carry abrasive particles across the wafer surface, removing material. The ARP will be further decomposed. The removal processing affects the following FR’s:

- FR1.1.2: the ARP determines what is required to enable a multi-step process. This interaction is primarily defined through the constraints of FR1.1.2, as prescribed by Theorem 1; the constraints for enabling a multi-step process are determined by the ARP.
- FR1.1.3: the ARP will determine which parameters are available for control of the remaining thickness, as well as the possible ranges for parameters.
- FR1.1.4: the ARP defines the interface that the wafer must be loaded into and out of.

DP1.1.2 - multiple removal station design is the inclusion of at least two independent pads for polishing. The second pad may enable the use of two step polishing slurries or of a buffing operation after the main polish. This FR/DP pair will be further decomposed to develop the necessary detail. Multiple removal station design affects the following FR's:

- FR1.1.3: to maintain scheduling independence, the endpoint controller must operate on each of the available polishing stations.

DP1.1.3 - the endpoint signal is the output of a process control scheme. It may contain any necessary in-situ/in-process metrology and end-point determination methods. In-situ metrology and determination of the endpoint signal is the subject of another thesis [47].

DP1.1.4 - the exchange sequence is some means of locating the wafer in a known and desired location so that the polishing head may pick it up, and then configuring the polishing head to retain the wafer for transport to the polishing position. This DP is conceptual at this point, and will be decomposed further.

6.3.4 FR/DP1.1.1 Remove material/ Abrasive removal processing

By using abrasive removal processing to remove material from the front of the wafer, the system has been designed to be compatible with existing industrial processes. This was one of the customer needs. Since the semiconductor industry is generally conservative, compatibility with a proven process benefits the system. To remove material, the process is decomposed into sub-requirements as shown in Table 6.7 below. Constraints on the FRs are shown in Table 6.8. To move from the functional domain to the physical domain, the FRs are mapped to DPs as shown in Table 6.7. A schematic of the design is shown in Figure 6-3 below.

Table 6.7: Decomposition of FR/DP1.1.1 – Remove material/
Abrasive removal processing

	Functional Requirements (FRs)	Design Parameters (DPs)
1.1.1.1	Wear surface	Slurry properties
1.1.1.2	<Control abrasive-wafer relative velocity>	<Pad-wafer relative velocity>
1.1.1.3	Maintain wafer position	<Wafer retention>
1.1.1.4	Carry abrasive	<Polishing pad surface>
1.1.1.5	<Control normal pressure>	< Desired pressure>
1.1.1.6	<Control process temperature>	<Slurry temperature>

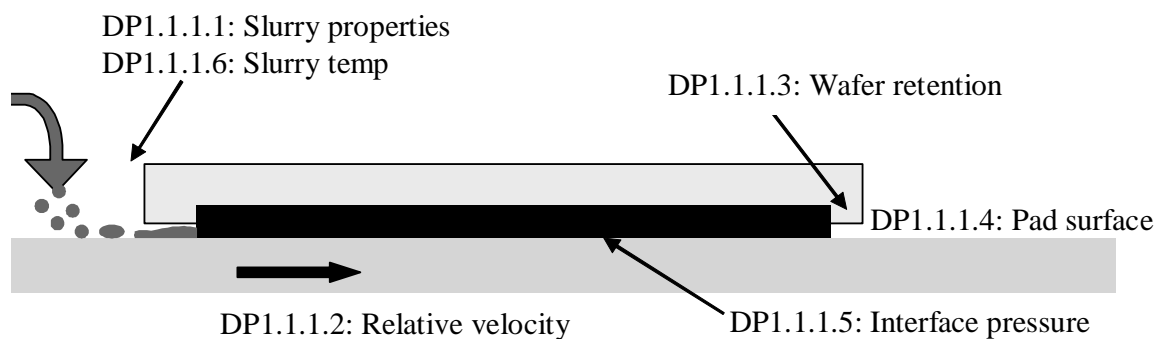

Figure 6-3: Schematic of FR/DP1.1.1 decomposition –
Remove material/Abrasive removal process

Table 6.8: Constraints for FR/DP1.1.1 decomposition

Impacts:	FR.					
Description	1	2	3	4	5	6
– Critical Performance Specifications –						
Uniform velocity profile – this requirement provides three options for motion: rotary, linear, and orbital.	x					
Velocity range – there is some evidence that higher speed polishing leads to some better output characteristics. Therefore, the velocity system must be able to support speeds up to approximately 1000 feet/min.	x					
Do not damage wafer			x			
Hold reliably – releasing the wafer from the carrier unintentionally is a severe hindrance to machine operation, and as such must be minimized			x			
Conform to wafer shape – incoming wafer shape is a variable that should be reduced in sensitivity.			x			
Force range – the force application system must be capable of delivering the necessary loads for polishing. Predictions estimate polishing pressure of up to 10 psi. For a 300mm wafer, the required polishing force would be 1100 lbf.				x		
Force uniformity – the force application to the wafer should nominally be uniform across the wafer surface. This will encourage uniform removal over the wafer surface.				x		
– Operational Constraints –						
Vary velocity orientation with respect to wafer – this is necessary to prevent patterns forming in the polished surface from pad imperfections and a “smearing” tendency in the polishing process		x				
Polishing area – the wafer should use all available pad area to maximize pad life and prevent polishing patterns due to pad non-uniformity		x				
Compatibility – the abrasive system should support the use of commercially available compositions.		x				
Contamination rejection – the wafer carrier should have means for preventing the contamination from polishing slurry. If the slurry is allowed to dry on a surface, it has a tendency to agglomerate and cause problems when released.			x			
Compatibility w/ preceding DP’s – the specific polishing pad must fit on the velocity system selected and be able to use the slurry selected.				x		
Lifetime – the number of wafers possible to polish on a pad affects the machine availability					x	

The decoupled design equation at this level is:

$$\left\{ \begin{array}{l} \text{FR1.1.1.1} \\ \text{FR1.1.1.2} \\ \text{FR1.1.1.3} \\ \text{FR1.1.1.4} \\ \text{FR1.1.1.5} \\ \text{FR1.1.1.6} \end{array} \right\} = \left[\begin{array}{cccccc} X & O & O & O & O & O \\ X & X & O & O & O & O \\ X & X & X & O & O & O \\ X & X & O & X & O & O \\ X & X & X & X & X & O \\ X & X & X & X & X & X \end{array} \right] \left\{ \begin{array}{l} \text{DP1.1.1.1} \\ \text{DP1.1.1.2} \\ \text{DP1.1.1.3} \\ \text{DP1.1.1.4} \\ \text{DP1.1.1.5} \\ \text{DP1.1.1.6} \end{array} \right\} \quad (6.7)$$

DP1.1.1.1 - abrasive slurry, a two phase medium, supplies abrasive to the polishing process, and therefore wears the surface. The properties of the slurry control its ability to wear the surface, and are therefore the selected DP. Due to the constraints described already, the process has been selected to use commercially available consumable materials, leaving little choice for some DPs. The slurry properties will be further decomposed. These properties affect the following FRs:

- FR1.1.1.2: the slurry properties such as viscosity and solid particle content will determine the appropriate velocity for polishing. The effect is primarily on constraints for velocity, although the slurry properties will have some influence on the coefficient of friction between the wafer and pad, effecting the requirement to control the relative velocity between them.
- FR1.1.1.3: the choice of slurry properties will affect the frictional loads during processing, and thus the loads that must be resisted to maintain the wafer position, although again the effect is primarily seen in the constraints of FR1.1.1.3, and may be dealt with rather easily during the design process.
- FR1.1.1.4: the method of carrying abrasive must be compatible with the chemistry and particle content of the slurry; again the slurry properties define constraints on an FR, and therefore affect the FR as described by Theorem 1.
- FR1.1.1.5: the choice of slurry properties, determines the appropriate pressure for processing.

- FR1.1.1.6: the amount of heat generated during the process and the amount of heat removed by the slurry depends on the properties of the slurry. In some processes, chemical action of the slurry contributes to heating at the process interface; there will always be temperature rise due to the mechanical action of the slurry.

DP1.1.1.2 - relative velocity must be applied between the wafer surface and the polishing surface, or pad. The primary constraint in applying velocity to the interface is the uniformity of velocity profile. This may be met in several ways, including rotary, orbital, and linear, as will be described in following decomposition levels. At this level in the decomposition, DP1.1.1.2 represents a software control element, and therefore follows the theory described by Theorem 3 for using an “outside” DP. The software DP provides a great amount of flexibility to the design, allowing either manual or automated control. Most of the machine systems are designed to be operated with software DPs, providing a consistent control interface. The relative velocity affects the following FR’s:

- FR1.1.1.3: the requirements for maintaining the wafer position depend on the configuration of the velocity system, in particular constraints on maintaining the wafer position are determined by the velocity system.
- FR1.1.1.4: the material used for a polishing surface must be compatible with the velocity system.
- FR1.1.1.5: the manner in which the pressure is supported by the polishing surface is affected by the velocity system. A rotary or orbital system may be supporting a large pad while a linear system supports a thin belt.
- FR1.1.1.6: the means for removing heat generated during polishing depend on the configuration of the velocity system.

DP1.1.1.3 - the wafer retention system is the means that holds the wafer for processing. Since this is a high level DP, it is primarily conceptual and will be decomposed to add the necessary detail. Wafer retention affects the following FRs:

- FR1.1.1.5: wafer retention and the means for controlling interface pressure are generally collocated physically, leading to possible functional coupling. As will be seen in further decomposition, the surface of the wafer chuck that applies pressure to the wafer during polishing must also have characteristics that prevent the wafer from slipping during polishing. However, an important feature of the MIT CMP system is the lack of interaction between the sub-branch of wafer retention responsible for supporting friction loads and the pressure at the interface. In a simple CMP wafer carrier, frictional loads may be supported by reaction loads from the pad, rather than the machine frame. In this case, the friction loads induce a pressure distribution on the wafer that change with friction – a significant noise factor. By supporting friction loads with the machine frame, the pressure distribution on the wafer does not change with friction.
- FR1.1.1.6: the ability to add/remove heat through the wafer carrier is determined by the design of the wafer carrier, which is the physical component containing most of the elements for wafer retention.

DP1.1.1.4 - the polishing pad surface is defined as the upper surface of any such pad, that part which makes contact with the wafer surface. Again, given the constraint on process compatibility, there is not much freedom to select a pad radically different from the porous polyurethane currently used. However, if a new pad is found that is capable of carrying abrasive particles, then it is a candidate for DP1.1.1.4. The pad surface must be further decomposed. The pad surface affects the following FRs:

- FR1.1.1.5: the pad surface configuration affects the ability of the pad to create local pressure variation, support the polishing load, etc. Details of these requirements will be apparent in the decomposition of the pressure control branch.
- FR1.1.1.6: The ability to add/remove heat through the pad surface depends on the specifications of the polishing pad, therefore the pad defines constraints on the ability to control process temperature.

DP1.1.1.5 - the interface pressure is the normal load created at the wafer-pad interface to enable removal. This means some manner of loading the wafer and a manner of supporting the polishing pad. The DP selected at this level is a software element providing control of the interface pressure, which will have to be further decomposed to add the necessary detail. A software control element is used, as this allows a variety of interface options from manual to automated control by an additional layer of software. The software element will preserve decomposition topology as described by Theorem 3. The interface pressure affects the following FRs:

- FR1.1.1.6: The ability to add/remove heat through the wafer backside depends on the design of the force application system.

DP1.1.1.6 - the slurry temperature is used to maintain a desired process temperature. At the polishing interface, it is possible to control the temperature of the wafer, the temperature of the pad, or the temperature of the slurry. Controlling the temperature of the wafer is possible, although adds complexity to the design of the wafer carrier, and would be difficult to implement with the elastomer membrane that is used in later decomposition of the pressure control system. Controlling temperature of the pad is difficult because the pad has a large thermal resistance, and so heating or cooling the platen on which the pad is supported is very inefficient. The proposed method is to control the temperature of the slurry before it is introduced into the polishing process, allowing either heating or cooling. A potential downside of using the slurry temperature to control the process temperature is non-uniform distribution of the slurry to the polishing interface. Since the tolerance on controlling process temperature is wide to meet the needs of the MIT CMP research team, controlling the temperature of the slurry will be used if it becomes necessary. Therefore this branch of the decomposition is considered complete; a leaf level.

6.3.5 FR/DP1.1.1.1 Wear surface/

Slurry properties

To wear the surface of the wafer, the slurry properties are controlled. The requirements must meet the strict constraints for polish quality and rate. Since one of the materials of interest as a polishing substrate is silicon dioxide insulator, the surface may be very hard. On the other hand, when polishing copper, the surface is not hard, but will corrode readily. In either case, chemistry may be used to change the properties of the surface being polished. In the case of silicon dioxide, an alkaline slurry is used to soften the surface; for a copper surface, the chemistry passivates the surface to reduce corrosion. The chemically modified surface must be abraded, and then material that is removed must be transported away from the polishing interface along with the polishing particles, to prevent damage from particles that may agglomerate into larger clusters. The requirements are mapped to appropriate parameters as shown in Table 6.9 below.

Table 6.9: Decomposition of FR/DP1.1.1.1 – Wear surface/Slurry properties

	Functional Requirements (FRs)	Design Parameters (DPs)
<u>1.1.1.1.1</u>	Chemically treat wafer surface	Slurry chemistry
<u>1.1.1.1.2</u>	Remove wafer material	Abrasive particles
<u>1.1.1.1.3</u>	Transport particles	Liquid viscosity

The decoupled design equation at this level is:

$$\begin{Bmatrix} \text{FR1.1.1.1.1} \\ \text{FR1.1.1.1.2} \\ \text{FR1.1.1.1.3} \end{Bmatrix} = \begin{bmatrix} X & O & O \\ X & X & O \\ X & X & X \end{bmatrix} \begin{Bmatrix} \text{DP1.1.1.1.1} \\ \text{DP1.1.1.1.2} \\ \text{DP1.1.1.1.3} \end{Bmatrix} \quad (6.8)$$

DP1.1.1.1.1 - the slurry chemistry is the chemical composition of the slurry, used to affect the wafer surface in a desired manner. This may be a high pH during oxide polishing to soften the surface and speed polishing, or it may be a passivation chemical to slow the dishing of copper. Dishing is defined as the undesired removal of copper

from trenches, resulting in reduced remaining thickness. When near the endpoint of polishing a copper wafer, the surface is mostly flat, and there are regions of thick copper interspersed with regions of thin copper on top of an insulator. The object of polishing is to remove the thin copper from the insulator material but keep the thick copper in the trenches. Due to the low hardness of copper, there is the tendency to remove the copper from trench areas faster than that over areas of oxide [48]. The slurry chemistry affects the following FR's:

- FR1.1.1.1.2: the chemistry of the slurry affects how wafer material is removed. It may allow the use of a less aggressive mechanical component, or may require a more aggressive particle if output quality will not suffer.
- FR1.1.1.1.3: the ability to transport particles may be affected by the chemical nature of the slurry. For instance, the slurry pH may affect particle agglomeration; other elements may affect slurry viscosity.

DP1.1.1.1.2 - the abrasive particles used in the slurry make up the third body in the removal process. They are responsible for the mechanical material removal, and may be used to optimize this part of the removal process. Selecting the hardness and size of the abrasive particles strongly influences removal characteristics [48]. The abrasive particles affect the following FR's:

- FR1.1.1.1.3: the ability to transport the particles depends on the particles being transported. The primary particle is the abrasive used for removal. Other particles in the system may be worn pad material and worn wafer coating material. Both have less potential for damaging the wafer as the pad material is very soft and the wafer wear particles will be approximately an order of magnitude smaller than the slurry abrasive particles.

DP1.1.1.1.3 - the liquid viscosity may be used to affect the slurry's ability to transport particles. The viscosity will directly affect the thickness of any fluid film in the polishing interface. It is this fluid film that transports the particles.

6.3.6 FR/DP1.1.1.2 Control wafer-abrasive relative velocity/ Wafer-pad relative velocity

To create a relative velocity between the wafer and abrasive, the relative velocity of the wafer and the polishing pad is controlled. There are several kinematic systems that may achieve the desired result, with some benefits to each. The first is an orbital system. A schematic of orbital kinematics is shown in Figure 6-4. The pad is only slightly larger than the wafer, and does not rotate about its center, but maintains orientation while moving its center on a circular path. The wafer may also rotate slightly, to increase the amount of averaging in the process. Without wafer rotation, there is a uniform relative velocity profile – the desired result. However, since the wafer covers the pad surface almost entirely, distributing slurry to the polishing interface is more difficult. Most orbital systems dispense slurry through holes in the pad and pad support platen.

The second type of polishing kinematic is the linear system, as shown by a schematic in Figure 6-5. Linear polishing systems use a belt containing the pad material to create the dominant relative velocity, and may also rotate the wafer. As with orbital kinematics, without wafer rotation the relative velocity profile is uniform. However, the direction of the relative velocity is not well distributed on the wafer, and may lead to smearing of the surface, particularly when a soft surface is polished. Also, since flat pads are a standard consumable item in the wafer polishing industry, the belt-type pads are difficult to obtain and use.

For the MIT CMP platform, a rotary velocity system is used. A schematic of the system is shown in Figure 6-6. In the rotary system, there is a uniform relative velocity when the rotary speed of the wafer matches that of the pad. Then, the relative velocity may be scaled by changing the offset between the center of the pad and wafer. Both the wafer and the pad are rotated, with planar surfaces in contact, while the offset between the parallel axes of each is controlled. These functions are mapped to DPs very directly as shown in Table 6.10 below, while satisfying the constraints listed in Table 6.11.

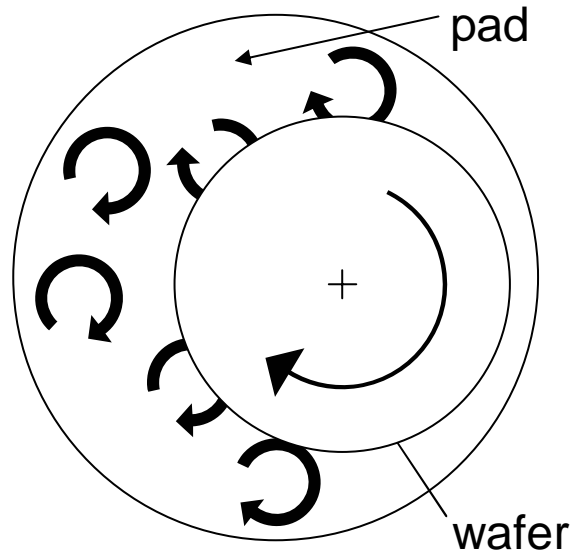

Figure 6-4: Schematic of orbital polishing kinematics

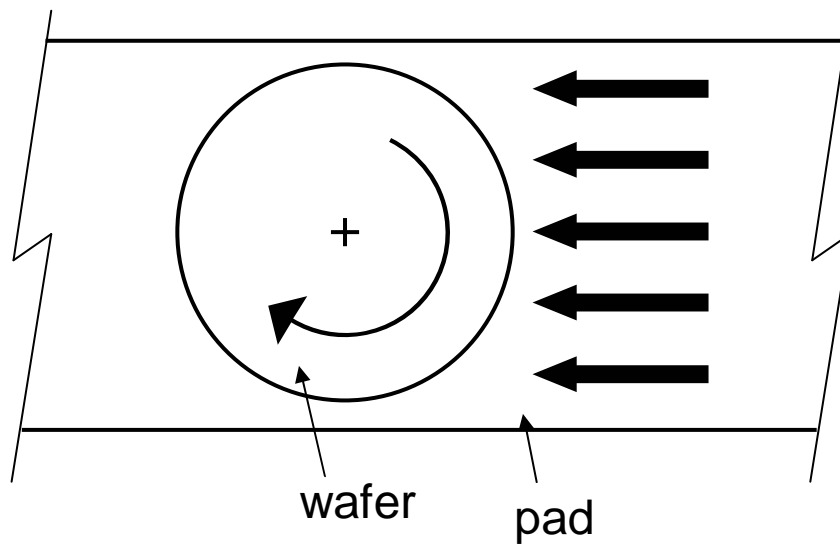

Figure 6-5: Schematic of linear polishing kinematics

Table 6.10: Decomposition of FR/DP1.1.1.2 – Control wafer-abrasive relative velocity/Wafer-pad relative velocity

	Functional Requirements (FRs)	Design Parameters (DPs)
1.1.1.2.1	<Rotate pad>	<Pad rotary velocity>
1.1.1.2.2	<Rotate wafer>	<Wafer rotary velocity>
1.1.1.2.3	<Control offset>	<Pad-wafer offset>

Table 6.11: Constraints for FR/DP1.1.1.2 decomposition

Impacts:	FR.		
Description	1	2	3
– Critical Performance Specifications –			
Acceleration	x	x	x
Velocity	x	x	x
Resolution			x
– Operational Constraints –			
Support vertical load ~1000 lbf.	x	x	x
Support lateral load ~500 lbf.	x	x	x

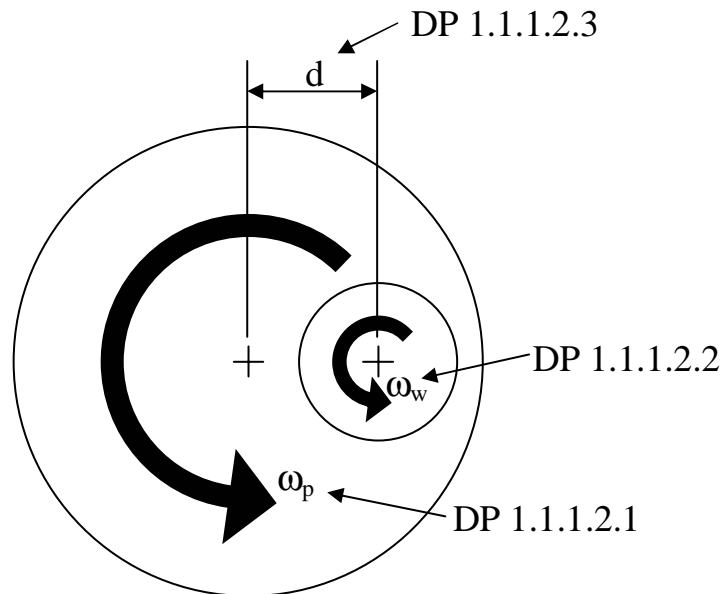

Figure 6-6: Schematic of FR/DP1.1.1.2 decomposition – Control wafer-abrasive relative velocity/Wafer-pad relative velocity

The uncoupled design equation at this level is:

$$\begin{Bmatrix} \text{FR1.1.1.2.1} \\ \text{FR1.1.1.2.2} \\ \text{FR1.1.1.2.3} \end{Bmatrix} = \begin{bmatrix} X & O & O \\ O & X & O \\ O & O & X \end{bmatrix} \begin{Bmatrix} \text{DP1.1.1.2.1} \\ \text{DP1.1.1.2.2} \\ \text{DP1.1.1.2.3} \end{Bmatrix} \quad (6.9)$$

DP 1.1.1.2.1 - the pad rotary velocity is the rotation of the polishing pad relative to the machine frame. The DP at this level is a software element. For the purposes of this system architecture, the method for controlling the rotary velocity of the pad is nearly identical to that for controlling the rotary velocity of the wafer. Therefore, only one of these systems will be decomposed further.

DP 1.1.1.2.2 - the wafer rotary velocity is the rotation of the wafer relative to the machine frame, also controlled with a software element. This branch will be further decomposed.

DP 1.1.1.2.3 - the pad-wafer radial position is the means for relating the rotary velocities of the pad and wafer to the linear relative velocity necessary to polish. In the proposed design, the wafer spindle will move on a line that is a radius of the polishing pad, so the motion of this axis will directly control the offset of the pad and wafer. This branch will be further decomposed.

6.3.7 FR/DP1.1.1.2.2 Rotate wafer/

Wafer rotary velocity

The rotary velocity of the wafer must be controlled. Therefore, the requirements at this level are to constrain the motion of the wafer to one rotary degree of freedom, and then to control the speed of rotation about that degree of freedom. These requirements are mapped to appropriate DPs as shown in Table 6.12 below. The decomposition of this branch has been used previously to illustrate simulation based on axiomatic design in Section 4.3.

Table 6.12: Decomposition of FR/DP1.1.1.2.2 – Rotate wafer/
Wafer rotary velocity

	Functional Requirements (FRs)	Design Parameters (DPs)
<u>1.1.1.2.2.1</u>	Constrain to 1 rotary DOF	Rotary motion bearing
1.1.1.2.2.2	<Control Ω_{WAFER} >	< $\Omega_{WAFER-DESIRED}$ >

The uncoupled design equation for this level is:

$$\begin{Bmatrix} \text{FR1.1.1.2.2.1} \\ \text{FR1.1.1.2.2.2} \end{Bmatrix} = \begin{bmatrix} X & O \\ O & X \end{bmatrix} \begin{Bmatrix} \text{DP1.1.1.2.2.1} \\ \text{DP1.1.1.2.2.2} \end{Bmatrix} \quad (6.10)$$

DP1.1.1.2.2.1 - hydrostatic bearings provide smooth motion that may benefit the polishing process. Also, it is likely that the pocket pressures in a hydrostatic bearing could be used to monitor the loads on the wafer rotation axis, and therefore on the wafer itself. These loads are useful in controlling the polishing process. However, due to constraints on the design team for the MIT CMP platform, rolling element bearings are used to satisfy this function. The selected rolling element bearings are single-piece, crossed roller bearings with an ultra-precision rating to provide less than 2.5 micrometers axial or radial runout. The bearing has large capacity for moment loads, and may be used as a single support for the spindles. Because of the large diameter of the bearing, the loads are located very close to the rolling elements themselves, further improving the moment stiffness.

DP1.1.1.2.2.2 - the desired wafer speed is the rotational speed of the wafer spindle, and exists as a variable in software. The DP has been repeated from the previous level, in accordance with Corollary 1. Further decomposition will be required to demonstrate how the software variable is able to control the rotational speed of the wafer carrier.

6.3.8 FR/DP1.1.1.2.2.2 Control wafer rotation speed/

$$\Omega_{WAFER-DESIRED}$$

To enable the software variable control of the wafer's rotation speed, a closed-loop feedback system is described. Such systems are commonly used in machine tools. The requirements of the system are set the variable's value, and then allow that value to control the speed. Therefore, the actual speed must be measured, and then a control effort computed, and finally the control effort converted into a voltage, torque, and then speed. The decomposition and mapping to DPs is shown in Table 6.13 below.

Table 6.13: Decomposition of FR/DP1.1.1.2.2.2 – Control wafer rotation speed/ $\Omega_{WAFER-DESIRED}$

	Functional Requirements (FRs)	Design Parameters (DPs)
<u>1.1.1.2.2.2.1</u>	Accept speed input $\langle \Omega_{desired} \rangle$	Variable entry $\langle \Omega_d \rangle$
<u>1.1.1.2.2.2.2</u>	Measure actual speed $\langle \Omega_{actual} \rangle$	\langle Spindle encoder count rate \rangle
<u>1.1.1.2.2.2.3</u>	Compute error $\langle \varepsilon \rangle$	\langle Difference computation \rangle
<u>1.1.1.2.2.2.4</u>	Determine control effort $\langle \psi \rangle$	Error value $\langle \varepsilon \rangle$
<u>1.1.1.2.2.2.5</u>	Output voltage $\langle V_c \rangle$	Control effort value $\langle \psi \rangle$
<u>1.1.1.2.2.2.6</u>	Supply torque $\langle T \rangle$	Voltage value $\langle V_c \rangle$
<u>1.1.1.2.2.2.7</u>	Control spindle speed $\langle \Omega_{actual} \rangle$	Torque value $\langle T \rangle$

The design equation for this level is:

$$\left\{ \begin{array}{l} \text{FR1.1.1.2.2.2.1} \\ \text{FR1.1.1.2.2.2.2} \\ \text{FR1.1.1.2.2.2.3} \\ \text{FR1.1.1.2.2.2.4} \\ \text{FR1.1.1.2.2.2.5} \\ \text{FR1.1.1.2.2.2.6} \\ \text{FR1.1.1.2.2.2.7} \end{array} \right\} = \begin{bmatrix} X & O & O & O & O & O & O \\ O & X & O & O & O & O & X \\ X & X & X & O & O & O & O \\ O & O & X & X & O & O & O \\ O & O & O & X & X & O & O \\ O & O & O & O & X & X & O \\ O & O & O & O & O & X & X \end{bmatrix} \left\{ \begin{array}{l} \text{DP1.1.1.2.2.2.1} \\ \text{DP1.1.1.2.2.2.2} \\ \text{DP1.1.1.2.2.2.3} \\ \text{DP1.1.1.2.2.2.4} \\ \text{DP1.1.1.2.2.2.5} \\ \text{DP1.1.1.2.2.2.6} \\ \text{DP1.1.1.2.2.2.7} \end{array} \right\} \quad (6.11)$$

DP1.1.1.2.2.2.1 - variable entry is the software receiving input from the operator of the machine; the operator may be human, manually entering commands, or may be an automated agent running sequences of commands to the machine. The variable entry affects the following FR:

- FR1.1.1.2.2.2.3: the computation of error depends on the value entered for the desired speed. Therefore, the error computation must be performed after the variable is entered. This defines a sequence for the software code.

DP1.1.1.2.2.2.2 - spindle encoder count rate is determined from a rotary position encoder on the spindle. The position is fed into a counter circuit that then allows the software system to differentiate the position with respect to time, and obtain speed. If the count rate is very slow, there may be discontinuous spikes in the computed speed. This will require an algorithm to average the speed over longer time periods. The spindle encoder count rate affects the following FR:

- FR1.1.1.2.2.2.3: the error that is computed will depend on the spindle encoder count rate as described in the following.

DP1.1.1.2.2.2.3 - difference computation is the subtraction that occurs in the software. The speed determined from the spindle encoder count rate is subtracted from the desired speed. The difference computation affects the following FR:

- FR1.1.1.2.2.2.4: the control effort that is computed will depend on the difference computation very directly.

DP1.1.1.2.2.2.4 - the error value that is calculated by the difference computation is used to determine the control effort. Logically, the control effort will depend on the error, such that if the spindle speed is less than the desired value then effort will be positive to increase the actual spindle speed. The mechanism employed is a particular control law, computed to match the dynamics of the spindle and the intended performance of the system. The error value affects the following FR:

- FR1.1.1.2.2.2.5: the voltage is determined in turn based on the control effort, so a change in the error value will change the determination of voltage.

DP1.1.1.2.2.2.5 - control effort value is used to control the voltage output from the machine controller. In this case, there is a proportional scaling such that the control effort directly adjusts the voltage. The mechanism is a digital to analog converter. The control effort value affects the following FR:

- FR1.1.1.2.2.2.6: torque is supplied based on the determination of control effort.

DP1.1.1.2.2.2.6 - voltage value controls the torque that is applied to the spindle through the drive system. An amplifier receives the voltage from the D_iA converter output and in some fashion produces a current in the motor windings proportional to the voltage, allowing the motor to produce a torque that is therefore proportional to the voltage. In a brushed DC motor, this conversion is very straightforward whereas in a brushless DC motor requires computations to account for the rotor-stator relative position. Generally, the motor drive will be a component purchased by the system designer to satisfy the FR/DP relationship with an integrated package. At this level it is also possible to include some transmission mechanism in the design, through further decomposition; in the MIT CMP platform, the drive is an integrated direct drive, brushless DC motor. The voltage value affects the following FR:

- FR1.1.1.2.2.2.7: the spindle speed is controlled based on the voltage that is supplied from the controller.

DP1.1.1.2.2.2.7 - torque value affects the spindle speed through the spindle dynamics. By applying torque to the spindle, its speed may be controlled. The particular dynamics of the coupling will be important to the specification of parts and design of the control law. The torque value affects the following FR:

- FR1.1.1.2.2.2.2: a change in torque causes a change in the spindle speed, and therefore a change in the measured spindle speed.

6.3.9 FR/DP1.1.1.2.3 Control wafer-pad offset/ X-axis position

The wafer-pad offset is controlled by mounting the wafer spindle on a moving structure and then controlling the position of this structure relative to the polishing pad. The wafer is mounted on the structure such that it remains on a line through the center of the polishing pad. Therefore, the position of the structure directly controls the offset between the wafer and the pad. The axis of motion is defined as the X-axis. Control of the X-axis position is decomposed into sub-requirements as shown in Table 6.14. A gantry structure was selected for the moving component, to balance the deflection due to polishing loads. The gantry will be supported on both sides by linear motion bearings and driven by a pair of ballscrew drives. The detailed design of the X-axis is one subject of a related Master's thesis [49] The associated design equation follows, along with an explanation of the selected DPs.

Table 6.14: Decomposition of FR/DP1.1.1.2.3 – Control wafer-pad offset/X-axis position

	Functional Requirements (FRs)	Design Parameters (DPs)
<u>1.1.1.2.3.1</u>	Constrain to 1 linear DOF	Linear motion bearing
<u>1.1.1.2.3.2</u>	<Control position>	< X_{des} >

The uncoupled design equation at this level is:

$$\begin{Bmatrix} \text{FR1.1.1.2.3.1} \\ \text{FR1.1.1.2.3.2} \end{Bmatrix} = \begin{bmatrix} X & O \\ O & X \end{bmatrix} \begin{Bmatrix} \text{DP1.1.1.2.3.1} \\ \text{DP1.1.1.2.3.2} \end{Bmatrix} \quad (6.12)$$

DP1.1.1.2.3.1 - the linear motion bearing is a linear guide commonly used to constrain motion to a single linear degree of freedom. The motion along the X-axis must be capable of supporting the polishing loads.

DP1.1.1.2.3.2 - X_{des} represents the software variable that will control the position of the gantry. Further decomposition defines how the software variable is able to influence the position with the desired accuracy; since such decomposition is suitably similar to the previous decomposition of velocity control, it is not presented here.

6.3.10 FR/DP1.1.1.3 Maintain wafer position/ Wafer retention

To hold the wafer during polishing, it is necessary to prevent undesired translation and rotation. These are the two requirements addressed in the decomposition of FR/DP 1.1.1.3, shown below in Table 6.15. A schematic of the decomposition is shown in Figure 6-7.

Table 6.15: Decomposition of FR/DP1.1.1.3 – Maintain wafer position/Wafer retention

	Functional Requirements (FRs)	Design Parameters (DPs)
1.1.1.3.1	Prevent wafer translation	Retaining ring barrier
<u>1.1.1.3.2</u>	Prevent wafer rotation relative to carrier	Wafer chuck surface

The design equation relating the FRs and DPs of Table 6.15 is:

$$\begin{Bmatrix} \text{FR1.1.1.3.1} \\ \text{FR1.1.1.3.2} \end{Bmatrix} = \begin{bmatrix} X & O \\ O & X \end{bmatrix} \begin{Bmatrix} \text{DP1.1.1.3.1} \\ \text{DP1.1.1.3.2} \end{Bmatrix} \quad (6.13)$$

DP 1.1.1.3.1 - the retaining ring is a means for surrounding the wafer and trapping

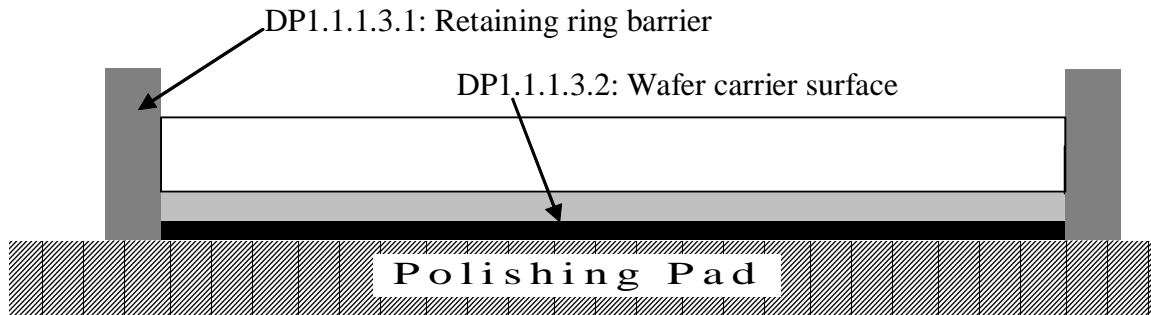

Figure 6-7: Schematic of FR/DP1.1.1.3 decomposition – Maintain wafer position/Wafer retention

it between the polishing pad and the wafer carrier, so that polishing pressure may be applied. This FR/DP pair must be further decomposed to realize it as a physical system.

DP 1.1.1.3.2 - the surface of the wafer carrier that contacts the wafer is designed to provide a high friction with the wafer back surface. This friction will prevent the wafer rotation. Commercially available CMP systems use replaceable compliant pads, called backing films, as the surface that contacts the wafer. If it is necessary to modify the surface of the MIT wafer carrier for this design, it is possible to use such a film. This may not be necessary if it is possible to provide sufficient friction with the native surface of the carrier.

6.3.11 FR/DP1.1.1.3.1 Prevent wafer translation/ Retaining ring barrier

FR1.1.1.3.1 is the requirement to maintain the wafer position during polishing, and is satisfied by surrounding the wafer with a ring, and controlling the position of the ring. If the ring has a good fit around the wafer, the position of the wafer will be directly controlled by the position of the ring. To realize the position of the retaining ring such that it will control the wafer, the ring sub-system must be decomposed. The retaining ring is decomposed as shown in Table 6.16, as guided by the constraints shown in Table 6.17. A schematic of the decomposed system is shown in Figure 6-8. A description of the DPs follows, along with their interactions with the FRs.

Table 6.16: Decomposition of FR/DP1.1.1.3.1 – Maintain wafer position/Retaining ring barrier

	Functional Requirements (FRs)	Design Parameters (DPs)
<u>1.1.1.3.1.1</u>	Provide barrier	Ring ID – compliant
<u>1.1.1.3.1.2</u>	Support friction loads	Lateral load support chain
<u>1.1.1.3.1.3</u>	Maintain barrier contact with pad	Minimum ring contact pressure

Table 6.17: Constraints for FR/DP1.1.1.3.1 decomposition

Impacts:	FR.		
	1	2	3
Description			
The contact pressure should be of sufficient magnitude to prevent the retaining ring lifting off the pad surface enough to allow the wafer to leave the carrier.			x
The contact pressure should be uniform over the contact area of the ring, to prevent any low pressure areas which may allow the wafer to escape			x

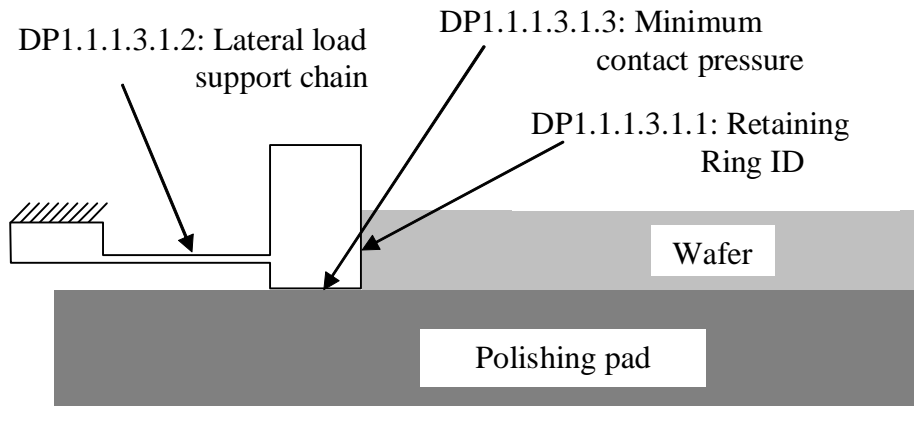

Figure 6-8: Schematic of FR/DP1.1.1.3.1 decomposition – Maintain wafer position/Retaining ring barrier

The design equation at this level is:

$$\begin{Bmatrix} \text{FR 1.1.1.3.1.1} \\ \text{FR 1.1.1.3.1.2} \\ \text{FR 1.1.1.3.1.3} \end{Bmatrix} = \begin{bmatrix} X & O & O \\ O & X & O \\ O & X & X \end{bmatrix} \begin{Bmatrix} \text{DP 1.1.1.3.1.1} \\ \text{DP 1.1.1.3.1.2} \\ \text{DP 1.1.1.3.1.3} \end{Bmatrix} \quad (6.14)$$

DP 1.1.1.3.1.1 - the ring ID is the inner surface of the retaining ring, which contacts the edge of the wafer. It is this surface which provides the support to prevent wafer translation. By controlling the compliance of the inner surface, it is possible to provide a barrier that will not damage the wafer. Here the choice is a material selection issue. The material must be compatible with the chemical and mechanical environment that will be present. Use of a very soft material will result in excessive wear of the retaining ring and therefore frequent maintenance requirements.

DP 1.1.1.3.1.2 - the lateral load support chain is the collection of elements that must support the lateral loads on the wafer. Beginning with the retaining ring, the loads are transferred to the machine base, as will be further decomposed. As discussed previously, transferring the loads from friction to the machine base is an important feature of the MIT CMP platform design, preventing pressure changes or pressure distribution changes due to changes in friction, a significant noise factor. The lateral load support chain affects the following FR:

- FR 1.1.1.3.1.3: external disturbances on the retaining ring may influence its ability to maintain contact with the pad. An easily deflected ring will require a higher minimum pressure to avoid breaking contact with the pad under disturbance.

DP 1.1.1.3.1.3 - the minimum contact pressure is the interface condition around the bottom surface of the ring. To maintain contact with the pad, the contact pressure must be maintained above a certain value. This value is determined experimentally, as the theoretical minimum is just marginally above zero, such that physical proximity is maintained. DP 1.1.1.3.1.3 is a threshold variable, and is satisfied by a range of values. The actual contact pressure of the retaining ring will be set by the requirements for

edge effect control, to pre-compress the polishing pad, as shown later in FR/DP 3.2.1.1.

6.3.12 FR/DP1.1.1.3.1.2 Support friction loads/ Lateral load support chain

Lateral loads on the wafer must be supported at all points along the kinematic chain that circles the point of force generation. There is a frictional force between the wafer and the pad, and this force must be supported by all the components that connect the wafer to the pad. Therefore the decomposition, shown in Table 6.18, includes requirements for all points along the way. It is critical to update these requirements as sub-systems may be added to the machine.

Table 6.18: Decomposition of FR/DP1.1.1.3.1.2 – Support friction loads/Lateral load support chain

	Functional Requirements (FRs)	Design Parameters (DPs)
<u>1.1.1.3.1.2.1</u>	Support Ret.Ring – wafer carrier loads	Retaining ring flexure thickness
<u>1.1.1.3.1.2.2</u>	Support WC – Z-Axis loads	Wafer spindle bearing moment & radial load rating
<u>1.1.1.3.1.2.3</u>	Support Z-Axis – gantry loads	Z-Axis bearing normal load rating
<u>1.1.1.3.1.2.4</u>	Support gantry – frame loads	X-Axis bearing lateral load rating
<u>1.1.1.3.1.2.5</u>	Support Pad spindle – frame loads	Pad spindle bearing radial load rating

The resulting, uncoupled design equation is:

$$\begin{Bmatrix} \text{FR1.1.1.3.1.2.1} \\ \text{FR1.1.1.3.1.2.2} \\ \text{FR1.1.1.3.1.2.3} \\ \text{FR1.1.1.3.1.2.4} \\ \text{FR1.1.1.3.1.2.5} \end{Bmatrix} = \begin{bmatrix} X & O & O & O & O \\ O & X & O & O & O \\ O & O & X & O & O \\ O & O & O & X & O \\ O & O & O & O & X \end{bmatrix} \begin{Bmatrix} \text{DP1.1.1.3.1.2.1} \\ \text{DP1.1.1.3.1.2.2} \\ \text{DP1.1.1.3.1.2.3} \\ \text{DP1.1.1.3.1.2.4} \\ \text{DP1.1.1.3.1.2.5} \end{Bmatrix} \quad (6.15)$$

DP1.1.1.3.1.2.1 - the retaining ring flexure thickness is a mechanical parameter to control the structural strength of the assembly used to support the retaining ring.

DP1.1.1.3.1.2.2 - the wafer spindle bearing moment & radial load rating is the rating of the wafer spindle bearing in the direction that will resist frictional forces. Since the friction force is applied at an axial distance from the center of the wafer spindle bearing, there will be some moment loading on the single bearing. However, the bearing selected for this design is a crossed roller bearing and has significantly more moment load rating than will be applied by the frictional forces of polishing.

DP1.1.1.3.1.2.3 - the Z-Axis bearing normal load rating is the rating on the linear guides that are used to constrain the motion of the wafer spindle to the vertical direction. Since the frictional load from polishing is in the normal direction, and displaced from the center of stiffness of the bearing arrangement, the normal load rating will support the frictional loads that are carried by the spindle.

DP1.1.1.3.1.2.4 - the X-Axis lateral load rating is the rating of the bearing that supports the gantry. The gantry holds the Z-axis and the wafer spindle. Since the frictional loads will be applied perpendicular to the direction of motion for the X-axis, the lateral load rating of the rolling element bearings will support the loads. Since the load is applied at a displacement from the center of stiffness, there will also be some normal loads put on the X-axis bearings due to the frictional force, but this will be sufficiently small to be neglected at this point in the decomposition.

DP1.1.1.3.1.2.5 - the pad spindle bearing radial load rating allows the frictional force on the pad to be carried to the machine frame. The pad spindle bearing is also a crossed roller bearing, of large diameter to support the large pad spindle, so will

have a large excess of maximum load capacity.

6.3.13 FR/DP1.1.1.4 Carry abrasive/ Polishing pad surface

The abrasive that is used in DP1.1.1.1 to wear the surface of the wafer must be moved across the wafer for it to remove material. A compliant polishing pad is used, such that the abrasive particles become embedded in the surface of the pad, and are therefore carried across the polishing interface as the pad moves relative to the wafer. The pad surface must maintain the flow of slurry to allow the particles to effectively wear the surface. Therefore, the pad must maintain the slurry flow in the interface and maintain uniform characteristics, to reduce the variation of the process. The decomposition of the polishing pad surface is shown in Table 6.19, as bounded by the constraints shown in Table 6.20.

Table 6.19: Decomposition of FR/DP1.1.1.4 – Carry abrasive/Polishing pad surface

	Functional Requirements (FRs)	Design Parameters (DPs)
<u>1.1.1.4.1</u>	Maintain slurry flow in polishing interface	Pad voids
<u>1.1.1.4.2</u>	Maintain uniform pad characteristics	<Pad conditioning>

Table 6.20: Constraints for FR/DP1.1.1.4 decomposition

Impacts:	FR.	
Description	1	2
– Critical Performance Specifications –		
Pad life - should not reduce pad life more than is necessary		x

The decoupled design equation at this level is:

$$\begin{Bmatrix} \text{FR1.1.1.4.1} \\ \text{FR1.1.1.4.2} \end{Bmatrix} = \begin{bmatrix} X & O \\ X & X \end{bmatrix} \begin{Bmatrix} \text{DP1.1.1.4.1} \\ \text{DP1.1.1.4.2} \end{Bmatrix} \quad (6.16)$$

DP1.1.1.4.1 - the pad voids are those features used to draw slurry flow into and out of the polishing interface. This flow should reach all parts of the wafer evenly. Generally pad voids may exist on several length scales. There are voids approximately 20-100 μm in diameter relatively evenly dispersed throughout the pad surface material, and also macroscopic features approximately 1 mm in scale. The voids effect the following FR:

- FR 1.1.1.4.2: the means for maintaining the surface of the pad depends on what that surface is. Therefore, any pad conditioning parameters must be selected after the pad surface.

DP1.1.1.4.2 - pad conditioning is the means for controlling the characteristics of the pad. The characteristics that must be maintained are summarized in the constraint table above.

6.3.14 FR/DP1.1.1.4.2 Maintain uniform pad characteristics/Pad conditioning

To maintain uniform characteristics of the pad surface, a pad is used that contains voids through its thickness. Before polishing each wafer, an abrasive disc is used to remove some of the pad material, thus guaranteeing that the initial condition of the pad remains constant. This process of using a fixed abrasive body to remove material from the pad surface is called pad conditioning. The requirements for conditioning the pad surface to keep it uniform are shown in Table 6.21. A schematic of the decomposition is shown in Figure 6-9

Table 6.21: Decomposition of FR/DP1.1.1.4.2 – Maintain uniform pad characteristics/Pad conditioning

	Functional Requirements (FRs)	Design Parameters (DPs)
<u>1.1.1.4.2.1</u>	<Remove pad surface>	<Pad conditioning recipe>
<u>1.1.1.4.2.2</u>	<Control pad wear>	<Wafer offset oscillation>

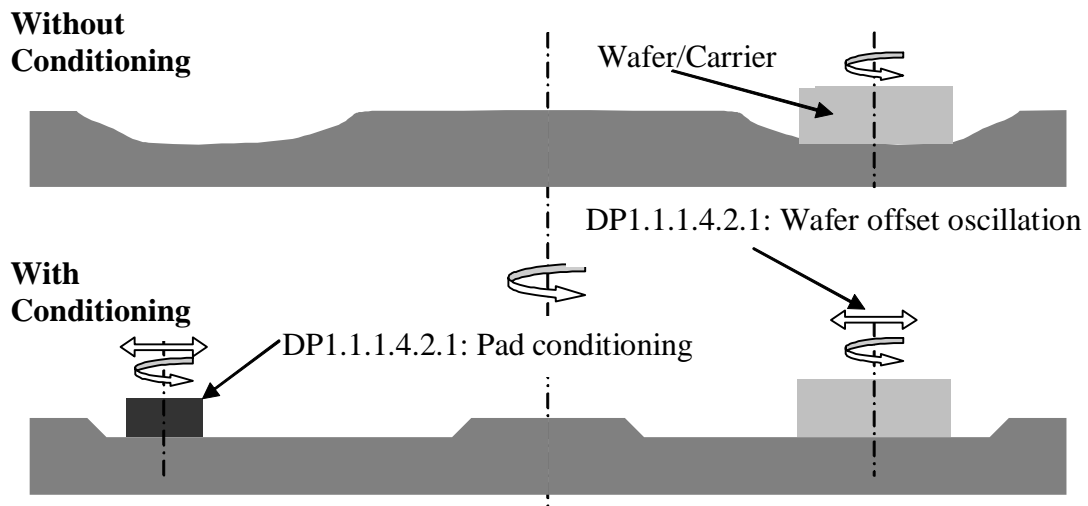

Figure 6-9: Schematic of FR/DP1.1.1.4.2 decomposition – Maintain uniform pad characteristics/Pad conditioning

The design equation at this level is

$$\begin{Bmatrix} \text{FR1.1.1.4.2.1} \\ \text{FR1.1.1.4.2.2} \end{Bmatrix} = \begin{bmatrix} X & O \\ X & X \end{bmatrix} \begin{Bmatrix} \text{DP1.1.1.4.2.1} \\ \text{DP1.1.1.4.2.2} \end{Bmatrix} \quad (6.17)$$

DP1.1.1.4.2.1 – pad conditioning recipe is the sequence of states followed by the pad conditioner, an abrasive mechanism used to roughen up the surface of the pad so it may carry slurry efficiently and consistently. Conditioning is used to correct pad glazing, or plastic deformation of the pad pores resulting in a closed structure. The pad conditioning recipe affects the following FR:

- FR1.1.1.4.2.2: the pad wear shape is significantly influenced by the pad conditioner. As material is removed to maintain the surface, it will have an effect on the wear shape. The wafer offset oscillation may be used to further influence this parameter.

DP1.1.1.4.2.2 - wafer offset oscillation is motion of the wafer in the radial pad direction during polishing. This is done to distribute the wear to a larger area on the pad.

6.3.15 FR/DP1.1.1.4.2.1 Remove pad surface/ Pad conditioning recipe

Removal of the pad surface is accomplished by using a fixed abrasive conditioner that is loaded against the pad surface, with a relative velocity between the two. Most of the dynamic DPs are variables in the software control system that may be changed to control the FR. Decomposition is necessary to enable the sub-systems to function as desired. The removal is decomposed as shown in Table 6.22 below.

Table 6.22: Decomposition of FR/DP1.1.1.4.2.1 – Remove pad surface/Pad conditioning recipe

	Functional Requirements (FRs)	Design Parameters (DPs)
<u>1.1.1.4.2.1.1</u>	Wear pad surface	Conditioner surface texture
<u>1.1.1.4.2.1.2</u>	Allow inter-pad travel	Vertical pad clearance when retracted
<u>1.1.1.4.2.1.3</u>	<Control conditioning pressure>	<Conditioning pressure variable>
<u>1.1.1.4.2.1.4</u>	<Control conditioner - pad radial offset>	<Conditioner position variable>
<u>1.1.1.4.2.1.5</u>	<Control pad rotation speed>	<Pad rotation speed variable> (during conditioning)
<u>1.1.1.4.2.1.6</u>	<Control conditioner rotation speed>	<Conditioner rotation speed variable>

The decoupled design equation at this level is as follows:

$$\begin{pmatrix} \text{FR1.1.1.4.2.1.1} \\ \text{FR1.1.1.4.2.1.2} \\ \text{FR1.1.1.4.2.1.3} \\ \text{FR1.1.1.4.2.1.4} \\ \text{FR1.1.1.4.2.1.5} \\ \text{FR1.1.1.4.2.1.6} \end{pmatrix} = \begin{bmatrix} X & O & O & O & O & O \\ O & X & O & O & O & O \\ X & O & X & O & O & O \\ X & O & O & X & O & O \\ X & O & O & O & X & O \\ X & O & O & O & X & X \end{bmatrix} \begin{pmatrix} \text{DP1.1.1.4.2.1.1} \\ \text{DP1.1.1.4.2.1.2} \\ \text{DP1.1.1.4.2.1.3} \\ \text{DP1.1.1.4.2.1.4} \\ \text{DP1.1.1.4.2.1.5} \\ \text{DP1.1.1.4.2.1.6} \end{pmatrix} \quad (6.18)$$

DP1.1.1.4.2.1.1 - the conditioner surface texture is the face of the conditioning disc that contacts the pad during conditioning. Generally accepted conditioning discs in industry utilize diamond particles that are bonded to the surface of the conditioner with either a nickel coating or a diamond film that is deposited. Downtime is extremely important in the semiconductor fabrication industry due to the large overhead expense associated with the cleanroom space necessary. Therefore, the use of diamond abrasive in the conditioner provides as long a life as possible. Also, if

a diamond particle is released from the conditioner surface, then it may stick on the pad and damage any wafers polished until the pad is changed. Therefore, the conditioner surface texture is an important DP to the success of a commercial CMP system. Generally, there are several sources from 3rd party vendors so a CMP user has a choice about what conditioner surface to use. The conditioner surface texture affects the following FRs:

- FR1.1.1.4.2.1.3: the surface texture of the conditioner determines the removal characteristics of the conditioner and pad, so in order to realize the desired amount of removal, the pressure and velocity of conditioning depend on the texture. A texture with larger grains may require a higher pressure to bring more of the abrasive features in contact with the pad at one time.
- FR1.1.1.4.2.1.4: the radial offset is a dynamic requirement that creates the translational speed of the conditioning disc across the pad surface. If an aggressive abrasive is used in the conditioner, it will be necessary for the radial offset to be controlled in a way that will move the conditioner across the surface of the pad quickly.
- FR1.1.1.4.2.1.5: the pad rotation depends on the conditioner surface texture as described above, in the same way the pressure depends on the surface texture.
- FR1.1.1.4.2.1.6: the conditioner rotation also depends on the surface texture, as described above.

DP1.1.1.4.2.1.2 - the vertical clearance of the conditioner when retracted allows the conditioner to function on more than one pad, or move to a conditioner cleaning station. By insuring that the conditioner will be free to move when retracted, it may leave the pad area.

DP1.1.1.4.2.1.3 - the desired conditioning pressure variable is a software element that sets the necessary parameters to control the pressure between the conditioner and the pad. This variable will be further decomposed to enable the sub-system to be realized.

DP1.1.1.4.2.1.4 - the desired conditioner position variable is a software element that sets the necessary parameters to control the position of the conditioner relative to the pad. This will be further decomposed.

DP1.1.1.4.2.1.5 - the desired pad rotation variable is the same variable that is used as DP1.1.1.2.2.2 to change the necessary parameters to control the rotary speed of the pad. If conditioning is performed at a separate time from polishing, then these two DPs are independent and may be set as desired. However, it may be desirable to condition the pad while polishing a wafer. In this case, the rotation speed of the pad is set for the polishing operation, and must not be changed by the conditioning recipe. The desired pad rotation variable affects the following FR:

- FR1.1.1.4.2.1.6: since the relative velocity between the pad and the conditioner is a function of the rotation speed of the pad and conditioner, along with the radial offset between the two, it is necessary to set up the values as a decoupled sub-system. Since it is possible that the pad velocity is pre-set by polishing requirements, the rotation of the conditioner is determined from the rotation of the pad.

DP1.1.1.4.2.1.6 - the desired conditioner rotation variable is a software element that sets the necessary parameters to control the rotary speed of the conditioning disc.

6.3.16 FR/DP1.1.1.4.2.1.3 Control conditioning pressure/ Conditioning pressure variable

The system to control pressure under the conditioner has only been defined as some system with computer control such that a pressure variable is able to control the pressure between the conditioner and the pad. To realize the system, the FR/DP pair is decomposed as shown in Table 6.23. The requirements are to control the force applied to the conditioner and support that force, along with three requirements to increase the system's robustness. A schematic of the decomposed system is shown in Figure

6-10 along with a more detailed view of the conditioner head in Figure 6-11. The chosen embodiment is an over-arm configuration that is cantilevered from somewhere outside the borders of the polishing pad. Force is applied to the conditioner at the supported end, and creates a torque in the over-arm that is balanced by a reaction force at the conditioner head. The selected configuration was used to occupy as little space on the overall CMP system's footprint as possible. A compliant mechanism at the conditioning end allows the conditioning disc to align with the pad and apply uniform pressure. The mechanism has been designed to place the center of rotation for the conditioner head coincident with the surface of the pad.

Table 6.23: Decomposition of FR/DP1.1.1.4.2.1.3 – Control conditioning pressure/Conditioning pressure variable

	Functional Requirements (FRs)	Design Parameters (DPs)
1.1.1.4.2.1.3.1	Control force applied to conditioner	<conditioning pressure variable>
1.1.1.4.2.1.3.2	Support applied force	Conditioner support chain load rating
1.1.1.4.2.1.3.3	Apply uniform pressure distribution	Conditioner gimbal compliance
1.1.1.4.2.1.3.4	Reduce force sensitivity to frictional loads	Vertical offset of pivot point from conditioning point
1.1.1.4.2.1.3.5	Reduce pressure distribution sensitivity to frictional loads	Vertical distance between conditioner head pivot and conditioning point

Equations describing the relationships between parameters in the above two figures are as follows:

$$\frac{\Delta F_N}{F_N} = \frac{\mu_c h_{cp}}{l_{OA}} \quad (6.19)$$

where $\Delta F_N/F_N$ is the variation in normal force due to frictional force, μ_c is the coefficient of friction between the conditioner and pad, and h_{cp} & l_{OA} are length parameters, as shown in Figure 6-10.

$$\frac{\Delta F_R}{F_N} = \frac{2\mu_c h_{cg}}{D_c} \quad (6.20)$$

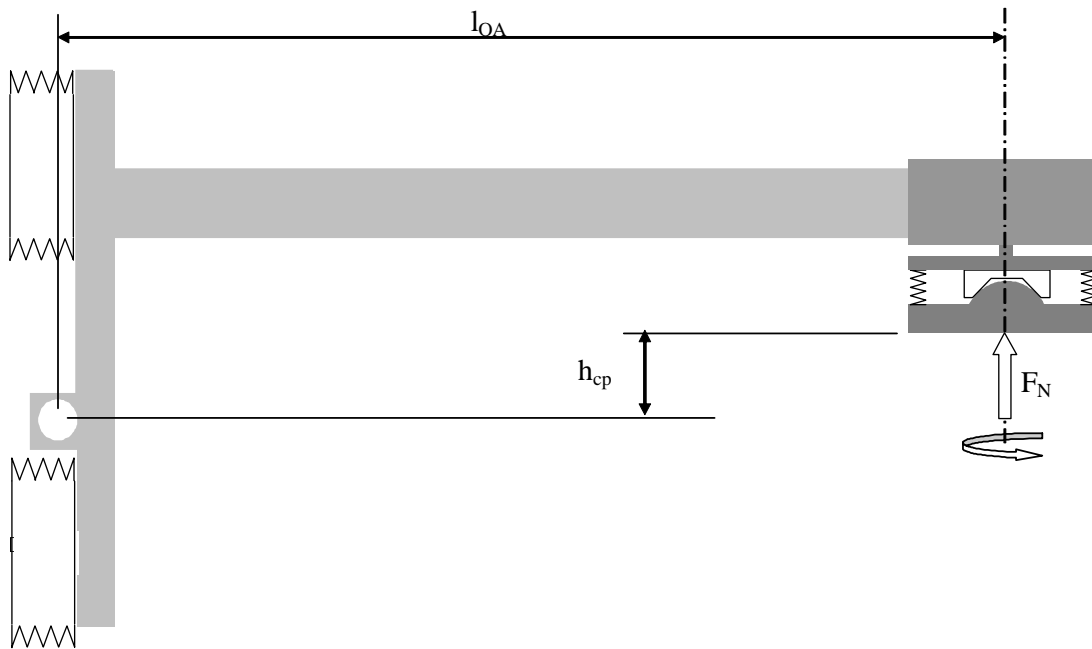

Figure 6-10: Schematic of FR/DP1.1.1.4.2.1.3 decomposition – Control conditioning pressure/Conditioning pressure variable

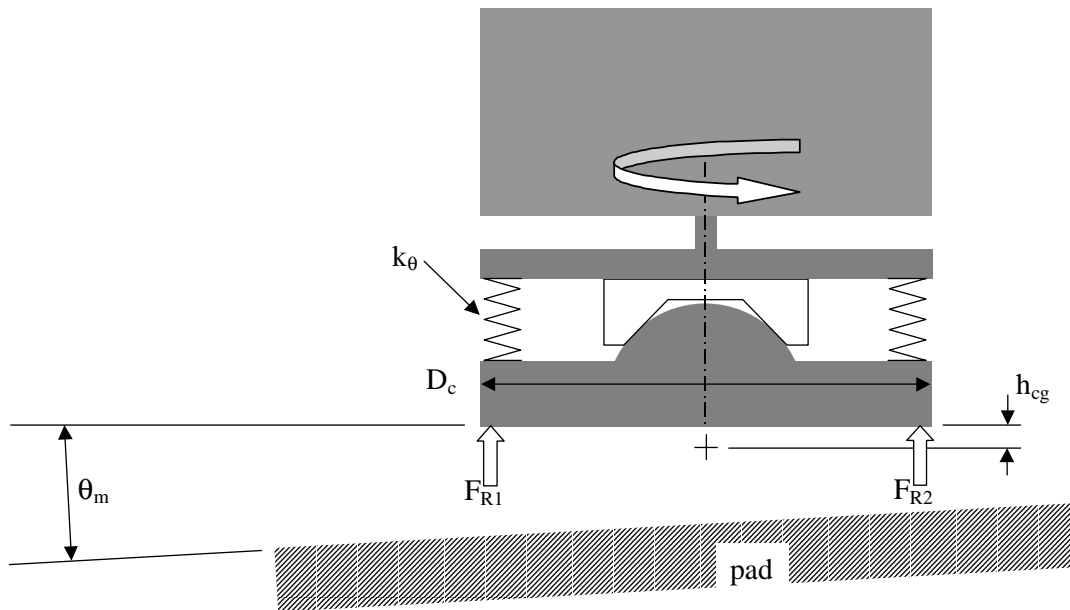

Figure 6-11: Schematic of detail from FR/DP1.1.1.4.2.1.3 decomposition

where $\Delta F_R/F_R$ is the variation in the reaction force between the conditioner and pad (simply modelled to estimate pressure distribution) due to frictional force, and h_{cg} & D_c are length parameters, as shown in Figure 6-11.

$$\frac{\Delta F_R}{\theta_m} = \frac{2k_\theta}{D_c} \quad (6.21)$$

where $\Delta F_R/\theta_m$ is the variation in the reaction force due to misalignment with the pad, k_θ is the angular stiffness of the bellows used in the conditioner head, and D_c is the diameter of the conditioner head.

The design equation for this level is:

$$\left\{ \begin{array}{l} \text{FR1.1.1.4.2.1.3.1} \\ \text{FR1.1.1.4.2.1.3.2} \\ \text{FR1.1.1.4.2.1.3.3} \\ \text{FR1.1.1.4.2.1.3.4} \\ \text{FR1.1.1.4.2.1.3.5} \end{array} \right\} = \left[\begin{array}{cccccc} X & O & O & O & O & A_{F-\mu} \\ X & X & O & O & O & O \\ O & X & X & O & O & A_{p-\mu} \\ O & O & O & L_{OA} & O & O \\ O & O & O & O & \sim \frac{2}{D_c} & O \end{array} \right] \left\{ \begin{array}{l} \text{DP1.1.1.4.2.1.3.1} \\ \text{DP1.1.1.4.2.1.3.2} \\ \text{DP1.1.1.4.2.1.3.3} \\ \text{DP1.1.1.4.2.1.3.4} \\ \text{DP1.1.1.4.2.1.3.5} \\ \text{DP}_{nf} - \mu_{cond.} \end{array} \right\} \quad (6.22)$$

DP1.1.1.4.2.1.3.1 - desired conditioning pressure variable is the software element used to control the pressure between the conditioner and the pad, as carried down from the parent level. Pressure is applied to one of two bellows which pivot the arm up or down, as shown in Figure 6-10. This sub-system will be further decomposed. The conditioning pressure affects:

- FR 1.1.1.4.2.1.3.2: because the amount of force that must be supported is a function of the applied pressure. The basic relationship is one of constraints and may be easily handled early in the design cycle.

DP1.1.1.4.2.1.3.2 - conditioner support chain load rating is the load rating of the components that are selected to support the conditioner, and apply a force to the machine frame. The conditioner support chain load rating affects:

- FR 1.1.1.4.2.1.3.3: the method of equalizing the pressure distribution must meet the requirements of the load rating.

DP1.1.1.4.2.1.3.3 - tip/tilt compliance of conditioner head is also shown as a bellows in Figure 6-11. The bellows provides lateral stiffness to support the conditioner lower member, but allows it to assume the correct orientation to make contact with the pad without a pressure distribution due to misalignment.

DP1.1.1.4.2.1.3.4 - vertical offset of arm pivot from conditioning point is shown in Figure 6-10. If there is any offset from the point of force application, a moment is created which tends to pivot the arm. The moment will be balanced by a change in the normal force on the conditioner, since the pressure in the bellows is constant. DP 1.1.1.4.2.1.3.2 is designed to be zero for maximum robustness, but has been shown with a non-zero value for the purposes of illustration.

DP1.1.1.4.2.1.3.5 - vertical offset of head pivot from conditioning point is shown in Figure 6-11. If there is any offset from the point of force application, a moment is created in the lower member of the conditioner that must be balanced by a resulting pressure distribution at the surface of contact between the conditioner and pad. A special constraint is added to the conditioner disc to define its center of rotation with the bellows. The conditioner disc is rigidly fixed to a member with a convex hemispherical surface. The convex surface has its center of curvature at the conditioner-pad interface, and mates with a cup that is free to slide on the upper member. The bellows connects the upper and lower members. With this constraint, the conditioner disc has a compliance controlled by the bellows and a center of rotation that is coincident with the pad surface, making the value of this DP zero, as desired for maximum robustness.

6.3.17 FR/DP1.1.1.4.2.1.3.1 Control force applied to conditioner/Conditioning pressure variable

The sub-system used to control the force applied to the conditioner based on the desired conditioning pressure variable is decomposed as shown in Table 6.24. A force

is generated by controlling the pressure inside of one of two bellows, to either increase or decrease the force applied to the conditioning disc.

Table 6.24: Decomposition of FR/DP1.1.1.4.2.1.3.1 – Control force applied to conditioner/Conditioning pressure variable

	Functional Requirements (FRs)	Design Parameters (DPs)
<u>1.1.1.4.2.1.3.1.1</u>	Generate force potential	Pneumatic supply pressure
<u>1.1.1.4.2.1.3.1.2</u>	Control bellows pressure	<Conditioning pressure variable>
<u>1.1.1.4.2.1.3.1.3</u>	Select active bellows	<Bellows selection pneumatic valve signal>

The design equation at this level is:

$$\left\{ \begin{array}{l} FR1.1.1.4.2.1.3.1.1 \\ FR1.1.1.4.2.1.3.1.2 \\ FR1.1.1.4.2.1.3.1.3 \end{array} \right\} = \begin{bmatrix} X & O & O \\ O & X & O \\ O & X & X \end{bmatrix} = \left\{ \begin{array}{l} DP1.1.1.4.2.1.3.1.1 \\ DP1.1.1.4.2.1.3.1.2 \\ DP1.1.1.4.2.1.3.1.3 \end{array} \right\} \quad (6.23)$$

DP1.1.1.4.2.1.3.1.1 - the pressure of the pneumatic supply generates the potential for applying force to the conditioner. If more force is necessary when using the full supply pressure, it will be necessary to increase the supply pressure.

DP1.1.1.4.2.1.3.1.2 - the software variable changes an analog output from the control hardware, which is supplied to a V/P, or voltage to pressure valve. The valve outputs a pressure that is proportional to the voltage supplied. This controlled pressure is supplied to the appropriate bellows, as selected by the next DP. The desired conditioning pressure variable affects the following FR:

- FR1.1.1.4.2.1.3.1.3: the bellows that is selected is determined by the desired pressure. The dead weight of the conditioning arm will produce a pressure on the conditioner of several psi. Therefore, to reduce the conditioning pressure, it is necessary to apply pressure to the lower bellows, and vice versa to increase the conditioning pressure.

DP1.1.1.4.2.1.3.1.3 - the bellows selection pneumatic valve signal is the electrical signal that is output from the control hardware and sent to a solenoid valve to direct the output from the pressure regulator controlled by DP1.1.1.4.2.1.3.1.2.

6.3.18 FR/DP1.1.1.4.2.1.4 Control conditioner radial offset/ Conditioner position variable

The system by which the desired position variable will control the conditioner radial offset is decomposed in a similar fashion to other feedback control sub-systems. Details of the selected implementation follow the decomposition shown in Table 6.25. Constraints are shown in Table 6.26.

Table 6.25: Decomposition of FR/DP1.1.1.4.2.1.4 – Control conditioner radial offset/Conditioner position variable

	Functional Requirements (FRs)	Design Parameters (DPs)
<u>1.1.1.4.2.1.4.1</u>	Allow only radial motion with respect to pad	Linear guide constraint
<u>1.1.1.4.2.1.4.2</u>	<Accept desired input>	<Conditioner position variable>
<u>1.1.1.4.2.1.4.3</u>	<Measure actual position>	<Conditioner position rotary encoder signal>
<u>1.1.1.4.2.1.4.4</u>	<Control position>	<Conditioner position error signal>

Table 6.26: Constraints for FR/DP1.1.1.4.2.1.4 decomposition

Impacts:	FR.			
Description	1	2	3	4
– Critical Performance Specifications –				
$T_{max}=76.5$ kgf (max. belt tension) = (max. force)	x			
$V_{max}=1$ m/s			x	

The design equation at this level is:

$$\begin{Bmatrix} FR1.1.1.4.2.1.4.1 \\ FR1.1.1.4.2.1.4.2 \\ FR1.1.1.4.2.1.4.3 \\ FR1.1.1.4.2.1.4.4 \end{Bmatrix} = \begin{bmatrix} X & O & O & O \\ O & X & O & O \\ O & O & X & X \\ O & X & X & X \end{bmatrix} \begin{Bmatrix} DP1.1.1.4.2.1.4.1 \\ DP1.1.1.4.2.1.4.2 \\ DP1.1.1.4.2.1.4.3 \\ DP1.1.1.4.2.1.4.4 \end{Bmatrix} \quad (6.24)$$

Equations showing the derivation of requirements for the components of the system follow. A schematic is shown in Figure 6-12.

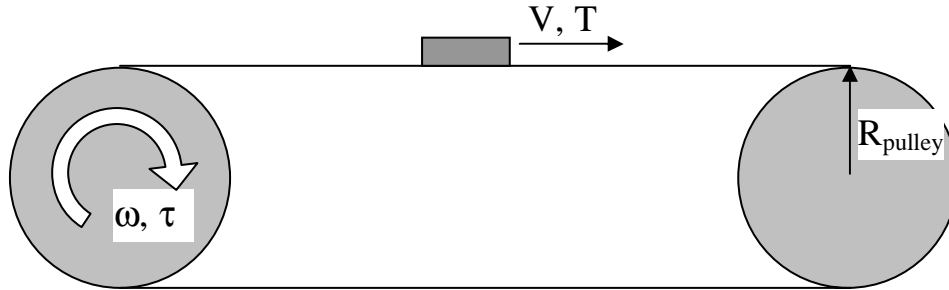

Figure 6-12: Schematic of FR/DP1.1.1.4.2.1.4 decomposition – Control conditioner radial offset/Conditioner position variable

The maximum speed of the motor depends on the maximum desired velocity and the radius of the pulley used to drive the belt:

$$\omega_{max} = V_{max}/R_{pulley} = \frac{1.0[m/s]}{19.1 \times 10^{-3}[m]} = 52 \text{ rad/sec.} = 500 \text{ rpm} \quad (6.25)$$

where ω_{max} is the required maximum speed of the motor output shaft, V_{max} is the required maximum speed of travel for the conditioner carriage, and R_{pulley} is the radius of the pulley used in the belt drive system. The parameters for the belt drive system have been specified by the selection for the bearing constraint in DP1.1.4.2.1.4.1. The maximum torque required for the motor depends on the tension required in the belt and the radius of the pulley. It is important that the motor be sized so that it is limited in torque and will not apply a harmful tension in the pulley. It is better for the conditioner position to accumulate an error than for the belt to break. The

maximum torque is:

$$\tau_{max} = T_{max} \times R_{pulley} = 76.5 \text{ kgf} \times 19.1 \text{ mm} = 14.3 \text{ Nm} \quad (6.26)$$

The preceding two requirements are combined to specify the motor for the conditioner drive. By using a gear reduction, it is possible to find a specification that is available from a standard supply:

$$\text{Motor/gearbox specification : } 1.43 \text{ Nm @ } 5000 \text{ rpm w/ } 10 : 1 \text{ reduction} \quad (6.27)$$

DP1.1.1.4.2.1.4.1 - the linear guide constraint limits the conditioner to travel along a path parallel to the X-axis. The linear guides are located next to the pad spindles, underneath the gantry frame.

DP1.1.1.4.2.1.4.2 - the desired conditioner position variable is carried down from the parent level to provide the input to the control sub-system. Here, a belt drive system is used to control the motion of the carriage along its guides. A belt drive was selected due to the low force and position precision requirements on the conditioner position. The desired position variable affects the following FR:

- FR1.1.1.4.2.1.4.4: the control of position depends on the desired position, as it generates part of the error signal.

DP1.1.1.4.2.1.4.3 - the conditioner position rotary encoder signal is the signal that is interpreted from a rotary encoder placed on the motor driving the conditioner position. While there may be some errors between the encoder and the actual position, the required precision is low enough. The encoder signal affects the following FRs:

FR1.1.1.4.3.1.3.4: the control of position depends on the encoder signal to generate part of the error signal.

DP1.1.1.4.2.1.4.4 - the conditioner position error signal is the difference between the desired position and the measured position. This difference is supplied to the control algorithm which will compute the necessary control effort and supply the effort to the drive system as a voltage. The voltage is converted into a torque by the

amplifier and motor, and then the torque is converted into a force by the belt drive pulley.

**6.3.19 FR/DP1.1.1.4.2.1.5 Control pad rotation/
Pad rotation speed variable (during conditioning)**

The pad rotational speed has been previously decomposed as FR/DP1.1.1.2.1, and will not be repeated here. Since the requirements for conditioning and polishing occur at separate times, there is no conflict. It may be desirable to condition during polishing, at which point the pad velocity will be fixed by the polishing requirements.

**6.3.20 FR/DP1.1.1.4.2.1.6 Control conditioner rotation
speed/Conditioner rotation speed variable**

The conditioner speed is decomposed as shown in Table 6.27. It is similar to other feedback control sub-systems in the design.

Table 6.27: Decomposition of FR/DP1.1.1.4.2.1.6 – Control conditioner rotation speed/Conditioner rotation variable

	Functional Requirements (FRs)	Design Parameters (DPs)
<u>1.1.1.4.2.1.6.1</u>	Allow only rotation	Duplex pair angular contact bearing constraint
<u>1.1.1.4.2.1.6.2</u>	Accept desired speed	<conditioner rotation variable>
<u>1.1.1.4.2.1.6.3</u>	Measure actual speed	<conditioner rotation encoder count rate>
<u>1.1.1.4.2.1.6.4</u>	Control speed	<conditioner rotation error signal>

The decoupled design equation at this level is:

$$\begin{Bmatrix} FR1.1.1.4.2.1.6.1 \\ FR1.1.1.4.2.1.6.2 \\ FR1.1.1.4.2.1.6.3 \\ FR1.1.1.4.2.1.6.4 \end{Bmatrix} = \begin{bmatrix} X & O & O & O \\ O & X & O & O \\ O & O & X & X \\ O & X & X & X \end{bmatrix} \begin{Bmatrix} DP1.1.1.4.2.1.6.1 \\ DP1.1.1.4.2.1.6.2 \\ DP1.1.1.4.2.1.6.3 \\ DP1.1.1.4.2.1.6.4 \end{Bmatrix} \quad (6.28)$$

DP1.1.1.4.2.1.6.1 - the duplex pair angular contact bearing constraint limits the conditioner to rotation about its central axis. Angular contact bearings are used to provide good axial and radial stiffness, along with moment stiffness.

DP1.1.1.4.2.1.6.2 - the conditioner rotation variable is used to set the desired speed for the system. Entered in software, it allows the control system to know the intended speed. The conditioner rotation variable affects the following FR:

- FRP1.1.1.4.2.1.6.4: to control the speed of conditioner rotation, an error signal is computer based partially on the desired speed.

DP1.1.1.4.2.1.6.3 - the conditioner rotation encoder count rate is the rate of change of the encoder on the motor that drives the conditioner rotation. Hardware and software in the control system interprets the encoder pulses and determines a rate and direction of rotation. The conditioner rotation encoder count rate affects the following FR:

- FR1.1.1.4.2.1.6.4: to control the speed of rotation, an error signal is computed based partially on the encoder count rate.

DP1.1.1.4.2.1.6.4 - the conditioner position error signal is computed as the difference between the desired position and the actual position. This is supplied to a control algorithm that computes the desired control effort to bring the error to zero. The control effort is output from the control hardware as a voltage, supplied to the motor drive and converted to a torque to drive the conditioner rotation. The error signal affects the following FR:

- FR1.1.1.4.2.1.6.3: the error signal changes the actual speed of the spindle, and that changes the measured speed.

6.3.21 FR/DP1.1.1.5 Apply Normal Pressure/ Desired pressure variable

Pressure is one of the key variables to influence the removal of material from the wafer surface, and is primarily influenced by the design of the wafer carrier. By using a flexible membrane to form a closed bladder, pneumatic pressure within the bladder guarantees uniform pressure is applied to the wafer, as described previously in Section 6.2. The decomposition of FR/DP 1.1.1.5 is shown in Table 6.28. A schematic of the DPs is shown in Figure 6-13. Following is a description of each of the DPs, and their relationships with other FRs, explaining the off-diagonal elements in the design matrix.

Table 6.28: Decomposition of FR/DP 1.1.1.5 – Apply normal pressure/-
Desired pressure variable

	Functional Requirements (FRs)	Design Parameters (DPs)
<u>1.1.1.5.1</u>	Provide pressure	<Nominal compartment pressure variable>
<u>1.1.1.5.2</u>	Create local (μm -scale) pressure variation	Pad surface modulus; $E_{PAD-TOP}$
<u>1.1.1.5.3</u>	Transmit pressure to interface uniformly	Membrane modulus; E_{MEM}
<u>1.1.1.5.4</u>	Support applied normal loads	Normal load support chain
<u>1.1.1.5.5</u>	Reduce sensitivity to wafer form variation; δ	sub-pad thickness; $h_{SUB-PAD}$
<u>1.1.1.5.6</u>	Reduce sensitivity to machine misalignment; ε	Isolation bellows stiffness; $k_{BELLOWS}$

pressure to the wafer, and relied on compliant pads to create a uniform pressure distribution. Such methods are sensitive to the manufacturing tolerances of the pads as well as incoming wafer variation. With the extremely flexible membrane used in this design, uniform pressure is easily obtained. This branch of the system will not be further decomposed, as valves are available to provide the function. If more precise control of pressure is desired, it would be necessary to decompose the FR/DP pair and design a system to accomplish the pressure control. The selected valves are capable of controlling pressure down to about 2psi. The nominal pressure affects:

- FR1.1.1.5.4: the pressure defines constraints on the support for applied loads. This interaction is minor and easily handled early in the design process. One of the levels in the decomposition of the normal load support chain is an actively variable pressure that must balance the pressure applied to the membrane. Therefore, the decoupled nature of DP1.1.1.5.1 and FR1.1.1.5.4 is very important to the operation of the CMP system. This is more fully explained in the decomposition of the normal load support chain below.

DP1.1.1.5.2 - the pad surface modulus is what creates preferential removal of the high features compared to the low features – the process of planarization. At the length scale of the features being polished (on the order of one micron), macroscopic features of the pad have little effect. The pad appears to be a semi-infinite, elastic solid that supports rigid particles. There are many choices for pad material, and as previously discussed, the MIT CMP platform is designed for compatibility with existing processes. The pad material is a process parameter and may be used to balance the planarization with other effects. The pad surface modulus affects:

- FR1.1.1.5.5: a higher modulus will increase the sensitivity of the system to wafer form variation. This is because the sensitivity to wafer form variation is a function of the compliant stack of the pad, wafer, and pressure membrane. Since the modulus of the pad surface is in this stack, it has an effect.
- FR1.1.1.5.6: similarly to the sensitivity to wafer form variation, the pressure variation caused by misalignment depends on the the stack thickness, and since

the pad surface contributes to the stack thickness, it is an important factor in determining sensitivity.

DP1.1.1.5.3 - membrane modulus is the stiffness of the material that the flexible membrane is made of. By using a highly compliant material, the pressure inside the bladder formed by the membrane and its rigid backing plate is transmitted to the wafer uniformly. One option here is to eliminate the membrane completely and apply pressure directly to the backside of the wafer. However, with such a design, sealing the compartment that contains pressure is an issue. The silicone elastomer used for the MIT CMP platform is resistant to the chemical conditions used in processing, and also straightforward to manufacture as desired using a molding process. Also, by controlling the mixture ratio of two different precursor chemicals, the modulus of the membrane material may be controlled from that of a Shore A 40 durometer to 80 durometer. Therefore, it is possible to tune the modulus of the membrane to the desired value.

DP1.1.1.5.4 - the normal load support chain is the series of machine elements that allows a load to be present at the wafer-pad interface without undue deflection. These are primarily load ratings of the various hardware components used in the mechanical system. This branch will be further decomposed.

DP1.1.1.5.5 - the total stack stiffness of the pad, wafer, and flexible membrane controls how the interface pressure will respond to wafer form variation. A low stiffness will accommodate a large wafer form variation without creating large pressure variation. Due to the high compliance of the membrane used to apply pressure to the wafer, the primary concern here is from the pad side of the wafer. Generally, the pad thickness may be used to control the stack stiffness in a way that will not influence polishing at a local level. Most pads used in commercial processes use a multi-layer stack, so that the surface presented to the wafer is of the desired modulus to satisfy DP...2, and then an additional lower layer may be used to reduce the overall stack stiffness to a value suitable for robustness to incoming wafer variation. Therefore, the height of the soft sub-pad is selected as the design parameter to reduce sensitivity to incoming wafer variation. The sub-pad thickness affects:

- FR1.1.1.5.6: low stiffness reduces requirements for misalignment, as low pad stiffness, as created by a large sub-pad thickness, creates less pressure variation due to misalignment.

DP1.1.1.5.6 - the isolation bellows stiffness is the tip-tilt stiffness of the bellows used to decouple the wafer carrier membrane from the rest of the wafer carrier. Thus, any misalignment in the wafer carrier itself will not translate into a pressure variation on the wafer surface. This decoupling bellows has the benefit of isolating the normal loads on the wafer, i.e. the polishing pressure, from frictional loads that are supported by the wafer carrier. This is a major advantage over some earlier CMP systems, in which a strong coupling exists.

6.3.22 FR/DP1.1.1.5.4 Support normal loads/ Normal load support chain

Normal loads that are applied to the wafer during polishing must be supported at all points along the kinematic chain between the wafer and the membrane that applies pressure to the wafer. Therefore, the chain is decomposed into individual elements as shown in Table 6.29.

The uncoupled design equation at this level is:

$$\left\{ \begin{array}{l} \text{FR1.1.1.5.4.1} \\ \text{FR1.1.1.5.4.2} \\ \text{FR1.1.1.5.4.3} \\ \text{FR1.1.1.5.4.4} \\ \text{FR1.1.1.5.4.5} \\ \text{FR1.1.1.5.4.6} \end{array} \right\} = \left[\begin{array}{cccccc} X & O & O & O & O & O \\ O & X & O & O & O & O \\ O & O & X & O & O & O \\ O & O & O & X & O & O \\ O & O & O & O & X & O \\ O & O & O & O & O & X \end{array} \right] \left\{ \begin{array}{l} \text{DP1.1.1.5.4.1} \\ \text{DP1.1.1.5.4.2} \\ \text{DP1.1.1.5.4.3} \\ \text{DP1.1.1.5.4.4} \\ \text{DP1.1.1.5.4.5} \\ \text{DP1.1.1.5.4.6} \end{array} \right\} \quad (6.30)$$

DP1.1.1.5.4.1 – the bias pressure is a variable in the control system that applies pressure to the cavity above the pressurized membrane. The cavity is contained by the bellows shown in Figure 6-13. Since the purpose of this pressure is to balance the force on the wafer, and the force on the wafer changes as the pressure on the wafer

Table 6.29: Decomposition of FR/DP1.1.1.5.6 – Support normal loads/Normal load support chain

	Functional Requirements (FRs)	Design Parameters (DPs)
<u>1.1.1.5.4.1</u>	Support membrane – par wafer carrier loads	<Bias pressure>
<u>1.1.1.5.4.2</u>	Support wafer carrier – wafer spindle loads	Wafer spindle axial load rating
<u>1.1.1.5.4.3</u>	Support wafer spindle – Z-axis loads	Wafer spindle bracket – Z-Axis attachment
<u>1.1.1.5.4.4</u>	Support Z-Axis – gantry loads	Z-Axis load rating
<u>1.1.1.5.4.5</u>	Support gantry – frame loads	X-Axis normal load rating
<u>1.1.1.5.4.6</u>	Support pad – frame loads	pad spindle bearing axial load rating

changes, it is necessary to make the bias pressure a variable DP. It is automatically adjusted by the machine control system to balance the force applied to the wafer by the membrane. Essentially, the bias pressure controls the amount of force that is supported by the sidewalls of the membrane. If the the bias pressure is too low, then the pressure under the sidewalls will be to low, and if the bias pressure is too high, any excess force will be carried by the sidewalls. Since the distance between the membrane support and the pad support may change due to pad wear or retaining ring wear, controlling the distance between the two members would make it difficult to apply a repeatable pressure to the sidewalls of the membrane. Using the bias pressure makes the pressure on the sidewalls as repeatable as the pressure control valves.

DP1.1.1.5.4.2 - the wafer spindle axial load rating is the rating on the bearings that constrain the wafer spindle to a single rotary degree of motion. Due to the size of the bearing used for this purpose, the load rating is far in excess of any expected loads, so maintains the uncoupled nature of the design matrix.

DP1.1.1.5.4.3 - the wafer spindle bracket is attached to the Z-axis with a bolted

joint, and is capable of easily handling the loads that are placed on it due to the polishing pressure.

DP1.1.1.5.4.4 - the Z-axis load rating is the rating on the drive system that moves the wafer spindle in the vertical direction. Since this moving Z-axis has a large amount of dead weight, it is likely that the weight may be used to support most of the polishing loads. Assuming the 200mm wafer, and a polishing pressure of no more than 10psi, the wafer spindle must apply a force of about 500 lb. The spindle assembly, along with the Z-axis is likely to weigh close to this.

DP1.1.1.5.4.5 - The X-axis normal load rating is the rating on the linear guides used to constrain the X-axis to one linear degree of freedom. Since the pressure will be pushing up on the gantry, any applied polishing load will reduce the loading on the linear guides. Therefore, this function is easily satisfied.

DP1.1.1.5.4.6 - the pad spindle bearing axial load rating guarantees that the pad spindle will be able to support the polishing loads. Since a large diameter crossed-roller bearing has been selected for the pad spindle, its load rating is far in excess of the requirements.

6.3.23 FR/DP1.1.2 Enable multi-step processes/ Multiple removal station design

It is often desirable to run a process with multiple steps, such that the chemistry of the slurry or perhaps the abrasive content of the slurry is different between steps. Most common in the industry is to use a 2-step process; therefore the MIT CMP platform is designed with the ability to accommodate this. Once the need for multiple step processes is introduced, a child requirement is to rinse the wafer between steps. This reduces the amount of cross-contamination between processes. The multiple removal station design is decomposed as shown in Table 6.30.

The decoupled design equation at this level is:

$$\begin{Bmatrix} \text{FR1.1.2.1} \\ \text{FR1.1.2.2} \end{Bmatrix} = \begin{bmatrix} X & O \\ X & X \end{bmatrix} \begin{Bmatrix} \text{DP1.1.2.1} \\ \text{DP1.1.2.2} \end{Bmatrix} \quad (6.31)$$

Table 6.30: Decomposition of FR/DP1.1.2 – Enable multi-step processes/Multiple removal station design

	Functional Requirements (FRs)	Design Parameters (DPs)
<u>1.1.2.1</u>	Provide multiple removal stations	2 nd polishing pad
<u>1.1.2.2</u>	Clean wafer between steps	<Wafer rinsing>

DP1.1.2.1 - the 2nd polishing pad allows the use of multi-step processes, where each of the polishing pads must maintain a separate and different chemistry. For a high-throughput design, there may be more than two polishing tables, and the tables would be allocated according to the processing time of the polishing steps. The 2nd polishing pad affects the following FR:

- FR1.1.2.2: The layout of the 2nd pad determines some constraints on the rinsing, and how the rinsing must be accomplished.

DP1.1.2.2 - wafer rinsing prevents the contamination of polishing stages from earlier stages, rinsing the bulk of slurry particles and chemistry off the wafer.

6.3.24 FR/DP1.1.4 Exchange wafers/ Wafer exchange sequence

To allow the removal process to polish multiple wafers, there must be a method to place a wafer in the polishing apparatus and then remove the wafer once polishing is completed. This is done by interfacing with the existing hardware, and adding required components. Since the wafer fits within the area defined by the retaining ring, it is necessary to locate the wafer fairly precisely. The wafer location must be set within about $\pm 0.5\text{mm}$, the clearance between the wafer and retaining ring. Once the wafer is located, the membrane assumes a configuration for loading, and forms a vacuum seal with the wafer. In a commercial CMP system, it is likely that a wafer handling robot would be used to position the wafer, and therefore it is necessary to allow access to the wafer for the robot. In the MIT CMP platform, wafers are loaded

and unloaded to a central load/washing station where they may be exchanged by hand. The decomposition of the wafer exchange sequence is shown in Table 6.31.

Table 6.31: Decomposition of FR/DP1.1.4.1 – Exchange wafers/Wafer exchange sequence

	Functional Requirements (FRs)	Design Parameters (DPs)
<u>1.1.4.1</u>	<Locate wafer>	<Wafer locating signal>
<u>1.1.4.2</u>	<Load wafer>	<Membrane load configuration signal>
<u>1.1.4.3</u>	<Eject wafer>	<Membrane ejection configuration signal>
<u>1.1.4.4</u>	Allow access to wafer	Wafer carrier vertical clearance when lifted

The uncoupled design equation at this level is:

$$\begin{Bmatrix} \text{FR1.1.4.1} \\ \text{FR1.1.4.2} \\ \text{FR1.1.4.3} \\ \text{FR1.1.4.4} \end{Bmatrix} = \begin{bmatrix} X & O & O & O \\ O & X & O & O \\ O & O & X & O \\ X & O & O & X \end{bmatrix} \begin{Bmatrix} \text{DP1.1.4.1} \\ \text{DP1.1.4.2} \\ \text{DP1.1.4.3} \\ \text{DP1.1.4.4} \end{Bmatrix} \quad (6.32)$$

DP1.1.4.1 - the wafer locating signal is the software element that activates the motion for locating the wafer. This is accomplished with a number of arms that move in the radial direction, and constrain the wafer to the desired position. If the wafer is off-center to begin with, the arms move it to the appropriate position as they close. As discussed, if a robot were used to transport wafers, the locating signal could indicate to the robot to move the wafer into position for loading or unloading. The wafer locating signal affects the following FR:

- FR1.1.4.4: the means by which the locating signal moves the wafer into the desired position has an effect on the physical space around the wafer, and therefore affects the ability to allow access to the wafer.

DP1.1.4.2 - the membrane load configuration signal indicates to the machine control system to configure the membrane for loading. As discussed, a vacuum is applied to the membrane cavity, forming a suction cup with the wafer. This has been experimentally determined to be a reliable way of loading the wafer into the wafer carrier and holding it during transport to the polishing position.

DP1.1.4.3 - the membrane ejection configuration signal, similarly to the load configuration signal, sets up the membrane for releasing the wafer. Releasing the wafer is accomplished by applying a low pressure to the membrane, to create a convex surface and reduce the area of contact with the wafer. The wafer may be held on the membrane surface by the surface tension of the water between the two, so reducing the area by increasing the curvature of the membrane is an effective means to release the wafer.

DP1.1.4.4 - the wafer carrier vertical clearance when lifted is a design parameter that insures there is sufficient room underneath the wafer carrier to access the wafer. It is not particularly important to the MIT CMP platform, as a robot is not used to handle wafers.

6.3.25 FR/DP1.4 Support machine operation/ Support sub-systems

The machine support requirements for the CMP machine were separated from the primary requirements to allow the design team to concentrate on the core of the system. The support requirements were considered to be affected by all other DPs, therefore allowing the support requirements to be developed as the other sub-systems were refined. The requirements for supporting the rest of the machine's operation are shown in Table 6.32, and some constraints for the support systems are shown in Table 6.33.

Table 6.32: Decomposition of FR/DP1.4 – Support machine operation/Support sub-systems

	Functional Requirements (FRs)	Design Parameters (DPs)
1.4.1	Enable motion control system	Motion control hardware
1.4.2	<Provide raw materials>	<Material supply>
1.4.3	Enable user interface	User interface hardware
1.4.4	<Dispose of waste>	<Waste disposal>
1.4.5	Allow physical access	Physical configuration
1.4.6	Provide mechanical support	Machine structure

Table 6.33: Constraints for FR/DP1.4 decomposition

Impacts:	FR.				
Description	1	2	3	4	5
– Operational Constraints –					
The materials used by the machine should be compatible with existing fabrication plant services		x			
Simple operation to allow use by gloved and otherwise physically encumbered operators			x		

The design equation at this level is:

$$\left\{ \begin{array}{l} \text{FR1.4.1} \\ \text{FR1.4.2} \\ \text{FR1.4.3} \\ \text{FR1.4.4} \\ \text{FR1.4.5} \\ \text{FR1.4.6} \end{array} \right\} = \left[\begin{array}{cccccc} X & O & O & O & O & O \\ X & X & O & O & O & O \\ O & O & X & O & O & O \\ O & O & O & X & O & O \\ X & X & X & X & X & O \\ X & X & X & X & X & X \end{array} \right] \left\{ \begin{array}{l} \text{DP1.4.1} \\ \text{DP1.4.2} \\ \text{DP1.4.3} \\ \text{DP1.4.4} \\ \text{DP1.4.5} \\ \text{DP1.4.6} \end{array} \right\} \quad (6.33)$$

DP1.4.1 - the motion control hardware is that hardware which is common to any of the machine motion modules. It will be further decomposed. The motion control hardware affects the following FR's:

- FR1.4.2: raw materials that must be supplied are determined in part by the motion system hardware. These materials may include electrical and fluidic power.
- FR1.4.5: the particular access requirements must be determined by the design of the motion system hardware.
- FR1.4.6: hardware selected for the motion system may place demands on the machine structure for physical space as well as loads.

DP1.4.2 - material supply is the supply of raw material and power needed by any other machine sub-system. This includes electrical, fluidic, and chemical systems. Material supply affects the following FRs:

- FR1.4.5: the particular access requirements must be determined by the design of the material supply systems.
- FR1.4.6: the space required by the supply system must be accounted for in the machine structure.

DP1.4.3 - the operator interface hardware are those devices which are necessary for operator contact with the machine. In the MIT CMP platform, a separate interface

PC is used, due to the ease of software development and obtaining parts. The operator interface hardware affects the following FRs:

- FR1.4.5: the particular access requirements must be determined by the design of user interface hardware.
- FR1.4.6: the user interface hardware requires support for its mass.

DP1.4.4 - the waste disposal system must be capable of maintaining any necessary separation of materials as well as dealing with the abrasive and chemical nature of the materials. Waste disposal affects the following FRs:

- FR1.4.5: the particular access requirements must be determined by the design of the waste disposal system.
- FR1.4.6: the space requirements must be accounted for in the design of the machine structure.

DP1.4.5 - the physical configuration of the machine is defined as the selection and layout of the machine components the operator and factory environment must interface with to facilitate whichever tasks are required. The physical configuration affects the following FRs:

- FR1.4.6: the physical configuration of the machine highly influences the machine structure. The overall shape of the structure is determined by requirements from the physical configuration.

DP1.4.6 - the machine structure is the base of the machine, which supports the various systems of the machine. It needs to support the static loads from gravity as well as process induced loading and dynamic loading. Also included in the machine structure are the major components required to support all the sub-systems that embody design parameters at all levels of the system architecture.

6.3.26 FR/DP1.4.1 Enable motion system/ Motion system hardware

To enable the motion system, some hardware is necessary. The motion system requirements and mapping are shown in Table 6.34. A DSP based real-time control system is chosen to implement the necessary functions. The system used is a modular design allowing necessary functions to be added as necessary.

Table 6.34: Decomposition of FR/DP1.4.1 – Enable motion system/-
Motion system hardware

	Functional Requirements (FRs)	Design Parameters (DPs)
<u>1.4.1.1</u>	Run control software	DSP based architecture
<u>1.4.1.2</u>	Acquire analog signals	Data acquisition board
<u>1.4.1.3</u>	Acquire digital signals	Digital input channels
<u>1.4.1.4</u>	Acquire & interpret encoder signals	Counter input board
<u>1.4.1.5</u>	Output analog command signals	Analog output board
<u>1.4.1.6</u>	Output digital command signals	Digital output channels

The decoupled design equation at this level is:

$$\left\{ \begin{array}{l} \text{FR1.4.1.1} \\ \text{FR1.4.1.2} \\ \text{FR1.4.1.3} \\ \text{FR1.4.1.4} \\ \text{FR1.4.1.5} \\ \text{FR1.4.1.6} \end{array} \right\} = \left[\begin{array}{cccccc} X & O & O & O & O & O \\ X & X & O & O & O & O \\ X & O & X & O & O & O \\ X & O & O & X & O & O \\ X & O & O & O & X & O \\ X & O & O & O & O & X \end{array} \right] \left\{ \begin{array}{l} \text{DP1.4.1.1} \\ \text{DP1.4.1.2} \\ \text{DP1.4.1.3} \\ \text{DP1.4.1.4} \\ \text{DP1.4.1.5} \\ \text{DP1.4.1.6} \end{array} \right\} \quad (6.34)$$

DP1.4.1.1: DSP-based architecture describes the product selected for the control system computer. The product is a Kiethley Metrabyte ADWIN Pro system. The system is a flexible system with slots for various input and output cards. There are many choices for DSP-based motion control systems; the selected hardware offered

the benefit of being easily scalable to meet uncertain needs for software complexity and processing power. DP1.4.1.1 affects all of the other FRs because the selection of the ADWIN system requires the selection of compatible products to integrate with it.

DP1.4.1.2: The data acquisition board is a plug in module designed to sample up to 8 channels at 16 bits with a sample rate up to 100kHz.

DP1.4.1.3: The digital input channels are those channels of the digital interface board which are configured for input. There are a total of 32 digital lines, each of which may be input or output.

DP1.4.1.4: The counter input board is a collection of timers and counters intended to take repetitive digital inputs such as optical encoders and provide position or count information to the central computer.

DP1.4.1.5: The analog output board is a card with 8 channels of 16 bit analog output.

DP1.4.1.6: The digital output channels are those channels of the digital interface board which are configured for output. There are a total of 32 digital lines, each of which may be input or output.

6.3.27 FR/DP1.4.2 Provide raw materials/

Material supply

Supporting the consumable needs for the rest of the machine sub-systems is performed by the material supply sub-systems. The list of required resources is shown in Table 6.35 below.

The decoupled design at this level is:

$$\left\{ \begin{array}{c} \text{FR1.4.2.1} \\ \text{FR1.4.2.2} \\ \text{FR1.4.2.3} \\ \text{FR1.4.2.4} \\ \text{FR1.4.2.5} \end{array} \right\} = \begin{bmatrix} X & O & O & O & O \\ X & X & O & O & O \\ X & X & X & O & O \\ O & O & O & X & O \\ X & O & X & X & X \end{bmatrix} \left\{ \begin{array}{c} \text{DP1.4.2.1} \\ \text{DP1.4.2.2} \\ \text{DP1.4.2.3} \\ \text{DP1.4.2.4} \\ \text{DP1.4.2.5} \end{array} \right\} \quad (6.35)$$

Table 6.35: Decomposition of FR/DP 1.4.2 – Provide raw materials/Material supply

	Functional Requirements (FRs)	Design Parameters (DPs)
1.4.2.1	<Supply abrasive slurry>	<Slurry distribution>
<u>1.4.2.2</u>	<Supply clean water>	<Water filtration and distribution>
<u>1.4.2.3a</u>	<Supply clean pressurized gas>	<Compressed N ₂ distribution>
<u>.3b</u>		<Compressed air distribution>
<u>1.4.2.4</u>	<Supply sub-atmospheric pressure>	<Vacuum distribution>
<u>1.4.2.5</u>	<Supply electrical power>	<Electrical distribution>

DP1.4.2.1 - slurry distribution must handle the machine's interface with external slurry. In a production machine, this would be via bulkhead connectors to the factory distribution service. For the MIT CMP platform, the slurry distribution system should be designed to handle smaller quantities of slurry, with provisions for multiple slurry types and mixes. DP1.4.2.1 affects the following FRs:

- FR1.4.2.2: additional water supply is necessary to clean out the slurry distribution system.
- FR1.4.2.3: pressurized gas is used to activate the slurry distribution valves.
- FR1.4.2.5: electrical power must be supplied to the slurry distribution system to pump slurry.

DP1.4.2.2 - water filtration and distribution must include the connections to a water supply. Depending on the conditions of that supply, the water may have to be filtered and/or pressurized. The distribution to the machine systems should happen through some network of tubing. The axis drive unit handles individual switching, which might be a solenoid valve for water distribution. The water filtration system affects the following FRs:

- FR1.4.2.3: pressurized gas is used to activate the water distribution valves.

DP1.4.2.3a/b - the machine may use compressed nitrogen or air in its pneumatic systems. The use of nitrogen would require the inclusion of a high pressure regulator. Compressed air requires additional filtration to improve the supply quality, if taken from readily available “shop air.” Individual drive units handle control to systems, which may be a proportional pressure valve or a solenoid valve. The pressurized gas distribution system affects the following FR:

- FR1.4.2.5: electrical power must be supplied to the switching network for pressurized gas.

DP1.4.2.4 - vacuum is used in machine systems, and must be distributed for use in a manner similar to the pressure system. The vacuum has the additional requirement of removing any acquired moisture or particle content from the vacuum, to prevent them from entering the main supply system since the flow of material is away from the machine. The vacuum system affects the following FR:

- FR1.4.2.5: The vacuum system requires electrical power to generate vacuum.

DP1.4.2.5 - electrical distribution is the supply of main power to the machine sub-systems, likely a 220VAC supply. It includes the distribution of this power to the machine systems as 220VAC, 110VAC and various voltage levels of DC. The distribution system includes the DC power supplies with enough capability for all necessary sub-systems. The electrical distribution system must also include provisions for cutting machine power through an emergency kill button, and for control of machine power using the software.

6.3.28 FR/DP1.4.2.1 Supply slurry/

Slurry distribution

Slurry distribution is the mechanism for supplying slurry to the polishing process. It is decomposed to the two requirements shown in Table 6.36.

Table 6.36: Decomposition of FR/DP1.4.2.1 – Supply slurry/Slurry distribution

	Functional Requirements (FRs)	Design Parameters (DPs)
1.4.2.1.1	<Deliver slurry>	<Slurry dispensing>
<u>1.4.2.1.2</u>	Prevent slurry accumulation	<Process area rinsing>

The design equation at this level is:

$$\begin{Bmatrix} \text{FR1.4.2.1.1} \\ \text{FR1.4.2.1.2} \end{Bmatrix} = \begin{bmatrix} X & O \\ X & X \end{bmatrix} \begin{Bmatrix} \text{DP1.4.2.1.1} \\ \text{DP1.4.2.1.2} \end{Bmatrix} \quad (6.36)$$

DP1.4.2.1.1 - slurry dispensing is the amount of slurry that is delivered from the storage containers to the point of use at the polishing process. There are several parameters that describe the slurry dispensing, so it is further decomposed. Slurry dispensing affects:

- FR1.4.2.1.2: when slurry is being supplied to the polishing process, there is additional rinsing that may be required to prevent buildup.

DP1.4.2.1.2 - process area rinsing is water supplied to the polishing area, both around the pad when and also onto the pad when not polishing, to prevent slurry from drying. If the slurry dries, it becomes much more difficult to remove, and can agglomerate into larger particles with increased potential to damage wafers during polishing.

6.3.29 FR/DP1.4.2.1.1 Deliver slurry/ Slurry dispensing

Slurry is required at the site of polishing. There are several options for how to best deliver the slurry, and these are selected via design parameter at this level, along with the slurry flow rate. The decomposition of requirements is shown in Table 6.37, along with constraints for slurry dispensing in Table 6.38.

Table 6.37: Decomposition of FR/DP1.4.2.1.1 – Deliver slurry/Slurry dispensing

	Functional Requirements (FRs)	Design Parameters (DPs)
<u>1.4.2.1.1.1</u>	Control flow rate	<Peristaltic pump flow signal>
<u>1.4.2.1.1.2</u>	Position dispensing point	<slurry distribution point signal>
<u>1.4.2.1.1.3</u>	Transport to point-of-use	Slurry distribution plumbing

Table 6.38: Constraints for FR/DP1.4.2.1.1 decomposition

Impacts:	FR.		
Description	1	2	3
– Critical Performance Specifications –			
Flow Rate 50 to 250 mL/min.	x		x
– Operational Constraints –			
Prevent atmospheric exposure	x	x	x
Maintain suspension	x	x	x

The uncoupled design equation at this level is:

$$\begin{Bmatrix} \text{FR1.4.2.1.1.1} \\ \text{FR1.4.2.1.1.2} \\ \text{FR1.4.2.1.1.3} \end{Bmatrix} = \begin{bmatrix} X & O & O \\ O & X & O \\ O & O & X \end{bmatrix} \begin{Bmatrix} \text{DP1.4.2.1.1.1} \\ \text{DP1.4.2.1.1.2} \\ \text{DP1.4.2.1.1.3} \end{Bmatrix} \quad (6.37)$$

DP1.4.2.1.1.1 - a peristaltic pump is used to pump the slurry because the only wetted part with this type of pump is the flexible tubing, which is easily changed. A software variable controls the desired flow rate which is output as a voltage and supplied to the pump, where an internal control system maintains the desired flow rate.

DP1.4.2.1.1.2 - slurry distribution may occur in one of two places. The most common option seen in industry is to drip the slurry on the pad, near the center so it may spread and be dragged under the wafer. Another option is through-the-pad slurry delivery, a mechanism of supplying slurry through a hole in the pad. This delivers

slurry directly to the polishing interface if the wafer overlaps the supply hole. If the wafer does not overlap the supply hole, then this mechanism is essentially the same as conventional over-pad drip. A software element is used to control the dispensing point. The variable is output as a digital signal and supplied to an electro-pneumatic valve where a pressurized gas line controls a fluid valve.

DP1.4.2.1.1.3 - the distribution plumbing is the set of components required to get the slurry where it is needed. The design of the distribution plumbing depends on the selection of a dispensing point. For instance, if through-the-pad dispensing is used, it will require a rotary coupling or open-air coupling to transmit the slurry from the stationary machine frame to the rotating pad.

6.3.30 FR/DP1.4.5 Allow physical access/ Physical configuration

The physical configuration of the machine is what controls how other systems will interact with it. Interacting systems include the factory in which the polishing system operates and a human operator. The specific requirements are shown in Table 6.39 below, along with their mapping to design parameters.

Table 6.39: Decomposition of FR/DP1.4.5 – Allow physical access/Physical configuration

	Functional Requirements (FRs)	Design Parameters (DPs)
<u>1.4.5.1</u>	Provide cassette interface	Front Opening Unified Pod (FOUP) system
<u>1.4.5.2</u>	Allow GUI input	Touch screen
<u>1.4.5.3</u>	Allow data input	Keyboard
<u>1.4.5.4</u>	Supply machine information	Front panel display
<u>1.4.5.5</u>	Allow easy pad change	“Kinematic” platen interchange system

The resulting design equation at this level is:

$$\left\{ \begin{array}{l} \text{FR1.4.5.1} \\ \text{FR1.4.5.2} \\ \text{FR1.4.5.3} \\ \text{FR1.4.5.4} \\ \text{FR1.4.5.5} \end{array} \right\} = \begin{bmatrix} X & O & O & O & O \\ O & X & O & O & O \\ O & O & X & O & O \\ O & X & O & X & O \\ O & O & O & O & X \end{bmatrix} \left\{ \begin{array}{l} \text{DP1.4.5.1} \\ \text{DP1.4.5.2} \\ \text{DP1.4.5.3} \\ \text{DP1.4.5.4} \\ \text{DP1.4.5.5} \end{array} \right\} \quad (6.38)$$

DP1.4.5.1 - a Front Opening Unified Pod (FOUP) system is a standard method of containing and transferring wafers within a production environment. The wafers are contained in a pod which is sealed from the outside environment. When access to the wafers is desired, a door in the front of the pod is open to enable access. Using a FOUP interface is required for modern factory integration of semiconductor processing tools.

DP1.4.5.2 - the touch screen allows a gloved operator to use the machine without the flat horizontal surface necessary for a mouse, and simplifies the operation of the software. The touch screen affects the following FR's:

- FR1.4.5.4: The use of a touch screen requires a compatible display device. Therefore, the touch screen must be selected first, so that improper display selection prevents the use of a touch screen.

DP1.4.5.3 - the keyboard is a common, easy to use data input device.

DP1.4.5.4 - the front panel display is a computer screen to display machine information to the user. This would be a flat panel display in a production machine to help the machine meet footprint requirements, but will be a CRT in the alpha machine to keep costs down.

DP1.4.5.5 - in a rotary system, it may be desirable to use different pads before the pad life has expired. Also, to reduce the time involved with pad change, the procedure may be done off-line on a secondary platen that is just swapped for the removed platen. This is a requirement for a research machine, where the ability to change pads before the pad life has expired may be important.

6.3.31 FR/DP1.5 Allow user control/ User interface

The user interface software allows a human operator to control necessary machine functions. Functions that are defined to be necessary include both automated processing of wafers by implementing ‘process recipes’, or sequences of events to be performed on a wafer, and also full manual control of machine functions. The decomposition of the user interface software is shown in Table 6.40 below; constraints for the software are shown in Table 6.41. The remaining detail for the user interface software was developed by a separate engineering team in the research project. Details may be found in a thesis describing the process [50].

Table 6.40: Decomposition of FR/DP1.5 – Allow user control/User interface

	Functional Requirements (FRs)	Design Parameters (DPs)
<u>1.5.1</u>	<Allow “process recipes”>	<Flexible processing of machine state sequences>
<u>1.5.2</u>	<Interface with measurement data>	<Metrology interface>
<u>1.5.3</u>	<Track wafer processing>	<Wafer database>
<u>1.5.4</u>	<Control sub-system operation>	<Sub-system control interface>
<u>1.5.5</u>	<Allow machine setup/calibration>	<Setup & calibration interface>
<u>1.5.6</u>	<Allow flexible machine operation>	<Machine operation interface>

The design equation at this level is:

$$\left\{ \begin{array}{l} \text{FR1.5.1} \\ \text{FR1.5.2} \\ \text{FR1.5.3} \\ \text{FR1.5.4} \\ \text{FR1.5.5} \\ \text{FR1.5.6} \end{array} \right\} = \begin{bmatrix} X & O & O & O & O & O \\ O & X & O & O & O & O \\ X & X & X & O & O & O \\ O & O & O & X & O & O \\ O & O & O & O & X & O \\ X & X & X & X & X & X \end{bmatrix} \left\{ \begin{array}{l} \text{DP1.5.1} \\ \text{DP1.5.2} \\ \text{DP1.5.3} \\ \text{DP1.5.4} \\ \text{DP1.5.5} \\ \text{DP1.5.6} \end{array} \right\} \quad (6.39)$$

Table 6.41: Constraints for FR/DP1.5 decomposition

Impacts:	FR.					
Description	1	2	3	4	5	6
– Critical Performance Specifications –						
Speed – the sub-system control must be able to process the servo loops as quickly as necessitated by the respective sub-system. This constraint may lead to the use of two computers – one for the user interface and high level machine operations, and one for low-level control loops and algorithms				x		
– Operational Constraints –						
Nova compatibility – due to widespread use of the Nova 210/420 measurement system, compatibility is desired		x				
Parameters to track include the wafer ID number along with any associated wafer metrology and information on any polishing processes that have been run on the wafer			x			
Provide control of all machine functions						x
Display/record all process parameters						x

DP1.5.1 - flexible processing of machine states is the manner in which the software deals with process recipes. To run a particular process on a wafer, the machine must cycle through a series of states, each of which is a combination of machine parameters. Each state may also have a duration associated with it. Flexible processing of machine states affects the following FRs:

- FR1.5.3: the manner in which the machine sequences are created and used will affect how the wafer processing is tracked.
- FR1.5.6: the manner in which the machine sequences are created and used will affect how they are accessed by the machine operation interface.

DP1.5.2 - the metrology interface is responsible for interfacing with any available method for determining wafer coating thickness. This may include a Nova metrology module or off-line metrology data. The metrology module affects the following FR:

- FR1.5.3: the manner in which the metrology module deals with data will affect how that data is tracked by the wafer database.
- FR1.5.6: the manner in which the metrology module deals with data will affect how that data is displayed by the operation interface.

DP1.5.3 - the wafer database is a software module designed to track all parameters relating to an individual wafer. This may include wafer ID number, metrology data, and process data. The wafer database affects the following FR:

- FR1.5.6: the manner in which the database tracks wafer information will affect how this information is displayed in the operation interface.

DP1.5.4 - the sub-system control interface is the layer of software for interface from individual axes to the machine operation interface. It consists of those functions which are common to multiple machine elements, and so may be shared. The sub-system control software affects the following FR:

- FR1.5.6: the parameters available for control and associated value ranges affect the interface to the operation interface.

DP1.5.5 - the setup and calibration interface is a part of the software designed to facilitate tool installation and maintenance. It will allow all software parameters to be adjusted, providing correct scaling and zeroing of sensor values. The setup and calibration interface affects the following FR:

- FR1.5.6: the parameters available for control and available calibration features affect how such information is represented in or accessed from the interface to the operation interface.

DP1.5.6 - the machine operation interface is the screen that the operator has direct contact with. Therefore, it must provide access to all other software modules. The interface must also display all critical machine status information for the operator to review. The interface must enable the use of all other software modules.

6.3.32 FR/DP2 Minimize Cost of Ownership (COO)/ COO minimization

At this point in the decomposition, the first branch is complete, and according to the top-level design equation, the branch for FR/DP2 should be completed. The cost of ownership is defined as the cost of processing one wafer using the CMP system. An early estimate is:

$$COO = Materials + Overhead \quad (6.40)$$

Therefore, each of the major components in the COO is addressed as functional requirements. The decomposition is shown in Table 6.42.

To map the requirements to design parameters, it is important to look at first order effects on the material costs and overhead. These are shown in the following equations:

$$Material\ Cost = Slurry + Pad + DIW + N_2 + Electricity + \dots \quad (6.41)$$

Table 6.42: Decomposition of FR/DP2 – Minimize Cost of Ownership (COO)/COO minimization

	Functional Requirements (FRs)	Design Parameters (DPs)
2.1	Minimize material costs	Optimized consumable use
2.2	Reduce overhead	Reduced footprint design

$$\text{Overhead} = \text{Footprint} + \dots \quad (6.42)$$

Since the material cost has many factors, it is best to further decompose it. The overhead is a strong function of footprint, so footprint may be selected as the leaf level DP. The design equation at this level is:

$$\begin{Bmatrix} \text{FR2.1} \\ \text{FR2.2} \end{Bmatrix} = \begin{bmatrix} X & O \\ O & X \end{bmatrix} \begin{Bmatrix} \text{DP2.1} \\ \text{DP2.2} \end{Bmatrix} \quad (6.43)$$

DP2.1 - optimized consumable use is the method for reducing the consumption of consumable materials during machine operation to the minimum level required to meet performance specifications.

DP2.2 - reduced footprint design provides the smallest possible footprint for the machine.

6.3.33 FR/DP2.1 Minimize material costs/ Optimized consumable use

The materials cost is primarily contained in the polishing pad and slurry, so it is desirable to extend the life of the pad and minimize slurry consumption. Each of these is a key requirement for reducing the consumable use of the machine. The decomposition is shown in Table 6.43.

The design equation at this level is:

$$\begin{Bmatrix} \text{FR2.1.1} \\ \text{FR2.1.2} \end{Bmatrix} = \begin{bmatrix} X & O \\ O & X \end{bmatrix} \begin{Bmatrix} \text{DP2.1.1} \\ \text{DP2.1.2} \end{Bmatrix} \quad (6.44)$$

Table 6.43: Decomposition of FR/DP2.1 – Minimize material costs/-
Optimized consumable use

	Functional Requirements (FRs)	Design Parameters (DPs)
<u>2.1.1</u>	Minimize slurry consumption	Optimized slurry delivery
<u>2.1.2</u>	Minimize pad wear	a) Optimized wafer motion
		b) Optimized conditioning motion

DP2.1.1 - optimized slurry delivery is a dispensing method which allows the highest efficiency of slurry usage. The options that will be explored in this area are supplying slurry directly to the polishing interface, along with the traditional drip above the pad.

DP2.1.2a - optimized wafer motion is the oscillation of the wafer from its nominal offset. This uses a greater fraction of the pad area, extending the pad life.

DP2.1.2b - optimized conditioning motion is the movement of the smaller conditioning disc across the surface of the pad between or during wafer polish cycles. By using the minimum duration of conditioning, it is possible to minimize the pad wear.

6.3.34 FR/DP3 Maximize net wafers per hour/ Maximized output

The third branch of the top-level decomposition is maximized output from the machine. At this point in the design process, a system has been created that is capable of satisfying the basic functional requirements of the process, but in an effort to extend the performance, FR/DP3 are added. The desire in this project was to extend the capabilities of the machine past the current state-of-the-art. A first-order model of the system's output is:

$$Net\ wafers\ per\ hour = Throughput \times Yield \quad (6.45)$$

To maximize the output of the machine, it is necessary to guaranty the maximum throughput of the system and also maximize the yield for the number of wafers that

are put into the system. Throughput may be limited at any part of the required process, so three DPs are used to maximize the throughput. During the course of processing a wafer, these steps happen at different times, so the DPs are not redundant DPs. The decomposition of the maximized output is shown in Table 6.44.

Table 6.44: Decomposition of FR/DP3 – Maximize net wafers per hour/Maximized output

	Functional Requirements (FRs)	Design Parameters (DPs)
3.1a	Maximize throughput	Process cycle time
b		Transport cycle time
c		Cleaning cycle time
3.2	Maximize yield	<Scrap prevention>

To map the requirements to DPs, a first-order model of the requirements is created. The throughput and yield are as follows:

$$Throughput = \frac{60}{\max(t_{process}, t_{transport}, t_{clean})} \quad (6.46)$$

$$Yield = Y_{process} \times Y_{machine} \quad (6.47)$$

The design equation at this level is:

$$\left\{ \begin{array}{l} \text{FR3.1} \\ \text{FR3.2} \end{array} \right\} = \begin{bmatrix} X & X & X & O \\ X & O & O & X \end{bmatrix} \left\{ \begin{array}{l} \text{DP3.1a} \\ \text{DP3.1b} \\ \text{DP3.1c} \\ \text{DP3.2} \end{array} \right\} \quad (6.48)$$

DP3.1a - process cycle time is the net cycle time for processing wafers. It is assumed to be the primary limiting factor in the throughput of the machine, as long as it is greater than DP51b or 51c. The process cycle time affects the following FRs:

- FR3.2: the yield of the process may be influenced by its cycle time.

DP3.1b - the transport cycle time is the net transport time for moving wafers

within the machine. It should be lower than the process cycle time, however dominant FR/DP pairs will be investigated. The process cycle time affects the following FRs:

DP3.1c - the cleaning cycle time is a function of the cleaning module, likely to be supplied by a third party. It should be specified to have a throughput at least as high as the process. The process cycle time affects the following FRs:

DP3.2 - scrap prevention is the method of preventing the machine system from damaging a potential unit of product.

6.3.35 FR/DP3.1a Maximize throughput/ Optimized process cycle time

The process cycle time is the first of the three throughput DPs. A first-order model of the processing time for a single wafer is:

$$T_{process} = \frac{t_{removal} + [t_{2-step\ pad\ change}] + \max(t_{wafer\ change}, t_{ex-situ\ conditioning})}{N_{heads}} \quad (6.49)$$

where $T_{process}$ is the processing time, $t_{removal}$ is the time it takes to remove the necessary material from the surface of the wafer, $t_{2-step\ pad\ change}$ is the time it takes to move the wafer from the first pad to the second pad, if polishing occurs on two separate pads, $\max(t_{wafer\ change}, t_{ex-situ\ conditioning})$ is the maximum of either the wafer exchange sequence or the conditioning sequence, assuming that both of these processes occur simultaneously, and N_{heads} is the number of polishing heads contained on the system.

The decomposition of the optimized process cycle time addressed each of the significant contributions to Equation 6.49 as shown in Table 6.45.

The design equation at this level is:

$$\begin{Bmatrix} \text{FR3.1a.1} \\ \text{FR3.1a.2} \\ \text{FR3.1a.3} \end{Bmatrix} = \begin{bmatrix} X & O & O \\ X & X & O \\ X & O & X \end{bmatrix} \begin{Bmatrix} \text{DP3.1a.1} \\ \text{DP3.1a.2} \\ \text{DP3.1a.3} \end{Bmatrix} \quad (6.50)$$

DP3.1a.1 - the number of polishing heads within a machine directly multiply the

Table 6.45: Decomposition of FR/DP3.1a – Maximize throughput/-
Optimized process cycle time

	Functional Requirements (FRs)	Design Parameters (DPs)
<u>3.1a.1</u>	Maximize number of polishing heads	Number of polishing heads
<u>3.1a.2</u>	Minimize wafer change time	Cached load/unload capability
<u>3.1a.3</u>	Minimize removal time	<Optimized process parameters>

throughput based on process cycle time. The multiple polishing heads affect the following FRs:

- FR3.1a.2: the wafer change time may be influenced by the configuration for multiple heads.
- FR3.1a.3: The removal time may be changed if multiple heads are put on a single pad.

DP3.1a.2 - a cached load/unload station acts as a decoupler between process stages, eliminating any delay between the head unloading a processed wafer and loading a new one.

DP3.1a.3 - optimized process parameters are conditions for removing material from the surface of the wafer as quickly as possible.

6.3.36 FR/DP3.1b Maximize throughput/ Optimized transport cycle time

The second of the throughput design parameters is the transport cycle time. A first-order model of the transport time is:

$$T_{transport} = \bar{V} \cdot X_{net} \quad (6.51)$$

where $T_{transport}$ is the transport time, \bar{V} is the average velocity of transportation, and X_{net} is the net distance of transportation. Therefore, the decomposition of the transport cycle time is shown in Table 6.46.

Table 6.46: Decomposition of FR/DP3.1b – Maximize throughput/-
Optimized transport cycle time

	Functional Requirements (FRs)	Design Parameters (DPs)
<u>3.1b.1</u>	Minimize transport distance	Flow-oriented layout
<u>3.1b.2</u>	Maximize average transport velocity	Optimized motion system

The design equation at this level is:

$$\begin{Bmatrix} \text{FR3.1b.1} \\ \text{FR3.1b.2} \end{Bmatrix} = \begin{bmatrix} X & O \\ O & X \end{bmatrix} \begin{Bmatrix} \text{DP3.1b.1} \\ \text{DP3.1b.2} \end{Bmatrix} \quad (6.52)$$

DP3.1b.1 - product flow oriented layout concerns the layout of machine elements to reduce transport time into and out of the tool as well as part flow within the tool..

DP3.1b.2 - an optimized motion system is the motion control system for the transport device – the wafer handler. By optimizing this system, the transport time may be reduced.

6.3.37 FR/DP3.2 Maximize yield/

Scrap prevention

The scrap prevention mechanisms are used to increase the yield of the machine. A first-order model of the yield is given by:

$$Yield = (1 - \xi) \cdot (1 - \kappa) \quad (6.53)$$

where ξ is the fraction of dies on a wafer that are over-polished, and κ is the fraction of wafers that is broken completely during processing. Since over-polishing is a result

of non-uniform polishing, assuming the overall polishing time is correct (as will be guaranteed by the endpoint sensor system), uniformity control will be used to reduce the number of dies lost to over-polishing. Similarly, the wafer is most likely to be broken if it is released from the wafer carrier during polishing. In this case, a wafer release sensor is located near the wafer carrier to detect the wafer and stop the process before the wafer breaks. The decomposition is shown in Table 6.47.

Table 6.47: Decomposition of FR/DP3.2 – Maximize yield/Scrap prevention

	Functional Requirements (FRs)	Design Parameters (DPs)
3.2.1	Minimize over-polish; ξ (die %)	<Uniformity control>
3.2.2	Minimize breakage; κ (wafer %)	<Wafer release sensing>

The uncoupled design equation at this level is:

$$\begin{Bmatrix} \text{FR3.2.1} \\ \text{FR3.2.2} \end{Bmatrix} = \begin{bmatrix} X & O \\ O & X \end{bmatrix} \begin{Bmatrix} \text{DP3.2.1} \\ \text{DP3.2.2} \end{Bmatrix} \quad (6.54)$$

DP3.2.1 - uniformity control is the means for influencing the polishing uniformity of the wafer. This will insure the highest quality wafers, with a minimal number of overpolished dies.

DP3.2.2 - wafer release sensing is the signal from an optical sensor placed to indicate the release of a wafer from the wafer carrier during polishing, so the machine motions may be stopped before the wafer is broken.

6.3.38 FR/DP3.2.1 Minimize over-polish percentage/ Uniformity control

To minimize the over-polishing of wafers, the only option is to improve uniformity. This decision is made with the assumption that the optimal endpoint is correctly used, meaning that some areas on the wafer are correctly polished, and some are over-

polished. The decomposition of FR/DP 3.2.1 is shown in Table 6.48. A schematic of the elements in Table 6.48 is shown in Figure 6-14. Following is a description of the DPs and their relationships to the FRs, explaining the elements in Equation 6.55.

Table 6.48: Decomposition of FR/DP3.2.1 – Minimize overpolish percentage/Uniformity control

	Functional Requirements (FRs)	Design Parameters (DPs)
3.2.1.1	Control edge effects	<Retaining ring pressure>
3.2.1.2	Control polish rate as a function of radius	<Radial pressure distribution>

The design equation at this level is:

$$\begin{Bmatrix} \text{FR3.2.1.1} \\ \text{FR3.2.1.2} \end{Bmatrix} = \begin{bmatrix} X & O \\ X & X \end{bmatrix} \begin{Bmatrix} \text{DP3.2.1.1} \\ \text{DP3.2.1.2} \end{Bmatrix} \quad (6.55)$$

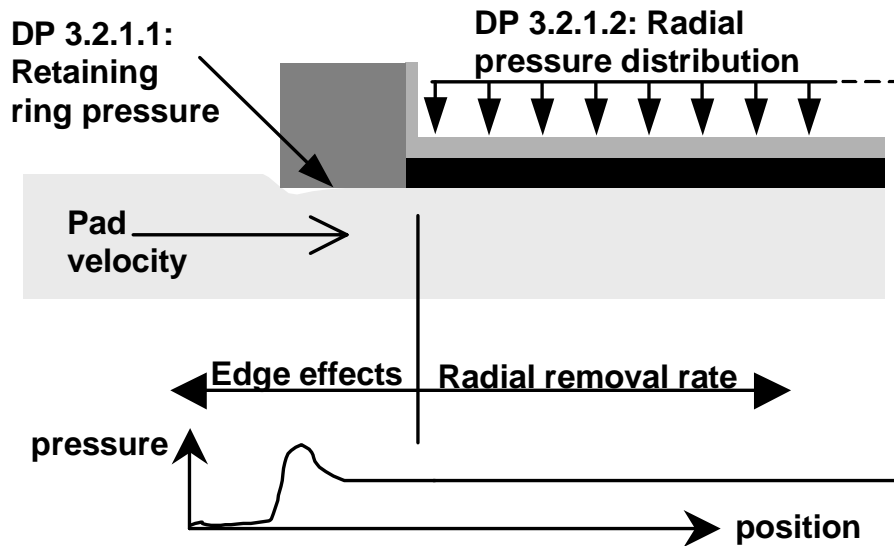

Figure 6-14: Schematic of FR/DP 3.2.1 decomposition – Minimize overpolish percentage/Uniformity control

DP3.2.1.1 - the retaining ring is an element of the machine which originally satisfies the functional requirement to maintain the wafer position during polishing – FR1.1.1.3.1. When the DP for uniformity control mechanisms – DP3.2.1 – is intro-

duced, the existing hardware element of the retaining ring is used to control the edge effects, by controlling the normal pressure against the polishing pad. As long as it remains above the minimum pressure – DP1.1.3.1.3 – this pressure has no effect on the ability of the retaining ring to maintain the wafer position during polishing, so functional independence is maintained. By making the retaining ring pressure approximately equal to the pressure at the polishing interface, the edge effects which would have occurred near the wafer are pushed out onto the retaining ring, a non-critical surface. Since it is not possible to control the pressure under the retaining ring with the existing hardware, it is necessary to further decompose FR/DP3.2.1.1. The retaining ring pressure affects:

- FR3.2.1.2: if the retaining ring pressure is too low or too high, the edge effects influence the wafer, and may be partially compensated by a mechanism to vary the removal rate in the radial direction.

DP3.2.1.2 - the radial pressure distribution directly affects the removal rate on the wafer. Since the wafer is rotating during polishing, the removal tends to be axisymmetric, and control is only needed in the radial direction. As shown in Equations 6.1 and 6.2, pressure and velocity are the primary influences on the removal rate. Due to kinematics, the only effect of changing velocity is to increase the removal rate at the edge of the wafer relative to the center, with a linear transition between the two regions. Therefore, pressure is the parameter selected to control the removal rate. The means of controlling the pressure distribution as a function of wafer radius will be decomposed further.

6.3.39 FR/DP3.2.1.1 Control edge effects/ Retaining ring contact pressure

The pressure under the retaining ring is controlled by connecting the retaining ring to the machine spindle through a flexure. By monitoring the strain in the flexure during polishing, and adjusting the vertical position of the spindle, the force on

the retaining ring may be controlled. Alternatives to the flexure element might be an externally pressurized radial fluid bearing. While this system would satisfy the functional requirements, it involves significantly more complexity than the flexure design. The flexure was chosen for its lack of moving parts and ease of fabrication. The decomposition of FR/DP 3.2.1.1 is show below, in Table 6.49. A schematic of the system is shown in Figure 6-15. Following is a description of the individual DPs, and the interactions they have with the FRs.

Table 6.49: Decomposition of FR/DP3.2.1.1 – Control edge effects/- Retaining ring contact pressure

	Functional Requirements (FRs)	Design Parameters (DPs)
<u>3.2.1.1.1</u>	Reduce sensitivity to head-pad misalignment	Retaining ring flexure O.D.
<u>3.2.1.1.2</u>	Measure force from flexure	<Retaining ring flexure strain>
<u>3.2.1.1.3</u>	Control force from flexure	<Z-axis position during polish>

The design equation at this level is:

$$\begin{Bmatrix} \text{FR3.2.1.1.1} \\ \text{FR3.2.1.1.2} \\ \text{FR3.2.1.1.3} \end{Bmatrix} = \begin{bmatrix} X & O & O \\ X & X & X \\ O & X & X \end{bmatrix} \begin{Bmatrix} \text{DP3.2.1.1.1} \\ \text{DP3.2.1.1.2} \\ \text{DP3.2.1.1.3} \end{Bmatrix} \quad (6.56)$$

DP3.2.1.1.1 - the retaining ring flexure O.D. is the outer diameter of the annular flexure. The inner diameter is constrained to fit the retaining ring, which surrounds the wafer. By controlling the O.D. of the flexure, sufficient tip-tilt compliance can be incorporated to tolerate some misalignment. Since the ring flexure is part of a precision machine, even one degree of misalignment would be a large amount, so the requirement is relatively easy to satisfy. In the MIT CMP platform, the O.D. is 11.150”, and the I.D. is 10.1”. Flexure thickness is 0.025”. The flexure O.D. affects:

- FR3.2.1.1.2: the O.D. changes the relationship between force and strain, and

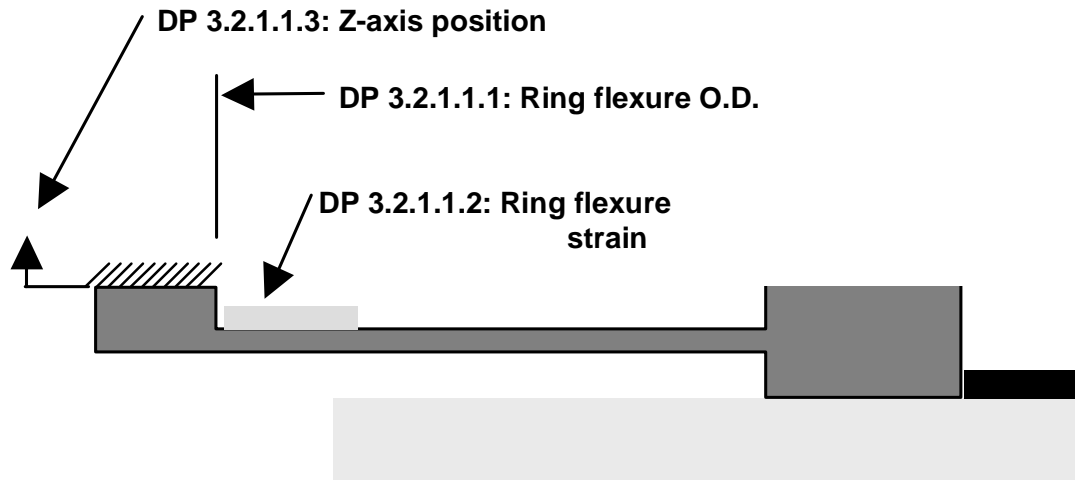

Figure 6-15: Schematic of FR/DP3.2.1.1 decomposition – Control edge effects/Retaining ring contact pressure

therefore must be designed before the appropriate range of strain is known.

DP3.2.1.1.2 - the retaining ring flexure strain is measured using a strain gage applied to the upper surface of the flexure, on the outer perimeter. The gage is temperature compensated for the material it is mounted on to minimize thermal drift, and calibrated before polishing is started, as the ring contacts the pad. The flexure strain affects:

- FR3.2.1.1.3: a change in the strain necessitates a change in the control effort.

DP3.2.1.1.3 - the Z-axis position during polish directly controls the separation of the spindle from the pad, and therefore is used to maintain the desired force on the ring flexure. The Z-axis position influences:

- FR3.2.1.1.2: when the spindle height changes, the strain is a measure of the change. During polishing, the machine software measures the value for strain and adjusts the Z-axis position to compensate for error from the desired value. This forms a servo feedback system, and thus, the apparent coupling in the design is managed.

6.3.40 FR/DP3.2.1.2 Control radial polish rate/ Radial pressure distribution

The other uniformity control mechanism in the decomposition of FR/DP3.2.1 is the radial pressure distribution. The method to satisfy this FR must be compatible with the system to control the interface pressure (FR/DP1.1.1.5). The pressure distribution is controlled by dividing the membrane used in the FR/DP1.1.1.5 decomposition into annular zones, and then controlling the pressure in each of the zones. The flexible membrane that applies pressure is compatible with such an approach allowing integration of the hardware elements. The decomposition of requirements is shown in Table 6.50. In order to vary the pressure as a function of radius, it is necessary to somehow create compartments behind the membrane that pushes on the wafer – this is FR3.2.1.2.1. Here is where design alternatives emerge with significant differences. One possibility that was considered is shown in Figure 6-16. The membrane has been divided into closed compartments separated by walls made of the same elastomer as the membrane. While this is a good starting place, it has significant problems. At each dividing wall, there is a large discontinuity of the pressure applied to the membrane, which will result in difficulty when trying to control the pressure transition between segments (FR3.2.1.2.4).

Rather than the solid dividing walls shown in Figure 6-16, the final design for the MIT CMP platform uses walls with a hollow cross section. This gives the walls a much higher compliance, and allows them to contain an internal pressure. The internal pressure of the dividing walls insures a smooth transition from one segment to the next. By introducing vents that connect the dividing wall with each adjacent segment, the pressure in the dividing wall is automatically maintained at an average of the bordering segments. A schematic of the final design is shown in Figure 6-17. The decomposition of the radial pressure distribution is shown in Table 6.50. Following is a description of the DPs, and their interaction with the FRs.

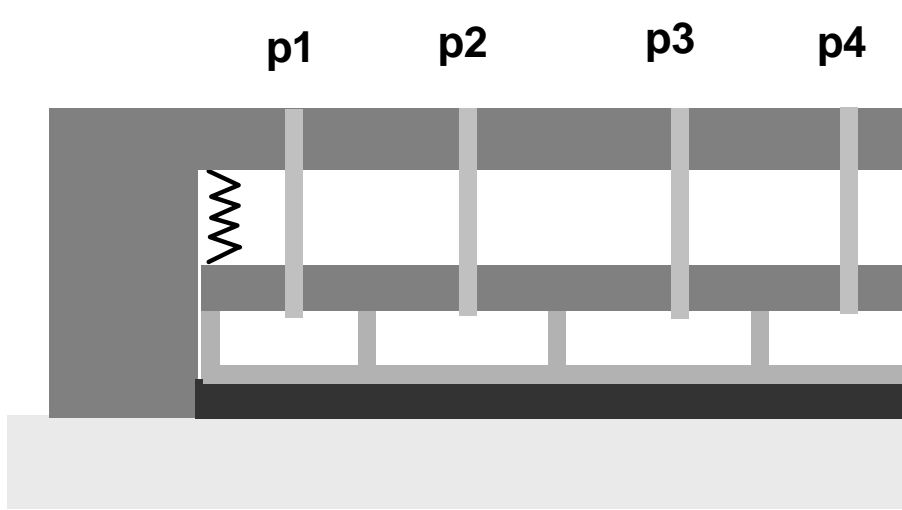

Figure 6-16: Schematic of one alternative for FR/DP 3.2.1.2 decomposition – Control radial polish rate/Radial pressure distribution

Table 6.50: Decomposition of FR/DP3.2.1.2 – Control radial polish rate/Radial pressure distribution

	Functional Requirements (FRs)	Design Parameters (DPs)
<u>3.2.1.2.1</u>	Divide wafer area into segments	Membrane compartment areas
<u>3.2.1.2.2</u>	Control applied pressure profile	<Compartment pressure distribution>
<u>3.2.1.2.3</u>	Smooth applied pressure profile	Membrane thickness; h_{mem}
<u>3.2.1.2.4</u>	Control transition between segments	Compartment divider vent length & I.D.

The design equation at this level is:

$$\begin{Bmatrix} \text{FR3.2.1.2.1} \\ \text{FR3.2.1.2.2} \\ \text{FR3.2.1.2.3} \\ \text{FR3.2.1.2.4} \end{Bmatrix} = \begin{bmatrix} X & O & O & O \\ X & X & O & O \\ O & O & X & O \\ O & X & X & X \end{bmatrix} \begin{Bmatrix} \text{DP3.2.1.2.1} \\ \text{DP3.2.1.2.2} \\ \text{DP3.2.1.2.3} \\ \text{DP3.2.1.2.4} \end{Bmatrix} \quad (6.57)$$

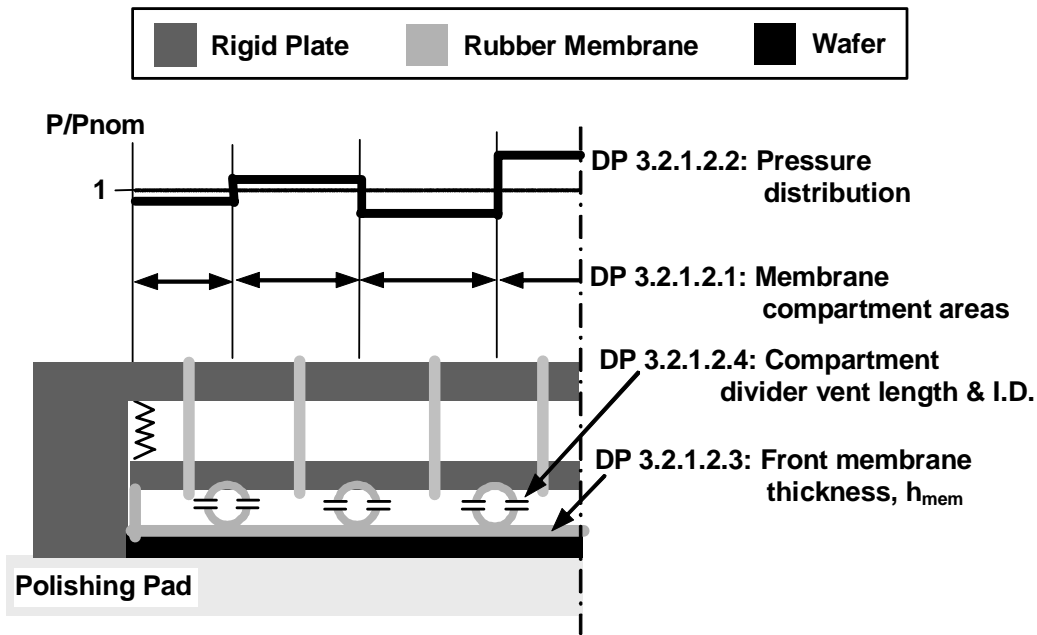

Figure 6-17: Schematic of FR/DP3.2.1.2 decomposition – Control radial polish rate/Radial pressure distribution

DP3.2.1.2.1 - the membrane compartment areas are a means for applying a pattern of displacement in concentric rings to the wafer front surface. With this displacement, the wafer front side will see a variation in normal pressure due to the compression of the polishing pad. The compartments divide the total wafer area into independently controllable regions. Because the variation in removal rate tends to show the highest spatial variability near the edge of the wafer, the outermost compartment has a smaller radial dimension than the others. The membrane compartments affect:

- FR3.2.1.2.2: the way the total area is divided into segments defines how the profile is controlled.

DP3.2.1.2.2 - the compartment pressure distribution is the pressure supplied to a particular membrane compartment to load the respective area of the wafer. Each individual compartment pressure is defined as a ratio to the nominal pressure (DP 1.1.1.5.1). The pressure distribution affects:

- FR3.2.1.2.4: the difference between adjacent compartments determines how much of a transition there is to smooth out, although certain assumptions may be made to complete the design of the wafer carrier.

DP3.2.1.2.3 - the front membrane thickness may be used to smooth the pressure distribution as it is transmitted to the wafer back surface. The front membrane thickness affects:

- FR3.2.1.2.4: the membrane thickness will smooth out the discontinuities of pressure at the dividing walls, and so make the system more tolerant to such discontinuities. The maximum allowed variation across a transition from one compartment to the next is therefore influenced by the membrane thickness.

DP3.2.1.2.4 - the compartment divider vent length & I.D. are the characteristics that define flow through the vents into each compartment divider. The divider is formed of a tubular cross section, and therefore may contain a pressure that is an average of the adjacent compartment. The tubular cross section gives the divider a high compliance, so the pressure within it dominates the pressure applied to the wafer backside.

6.3.41 System architecture summary

At this point, the system architecture has been completed to sufficient detail to allow the detailed design of the machine. Detailed design was performed by a team of three graduate students, and may be referenced in the related theses [49, 47]. The wafer carrier has been identified as a critical component for machine performance, due to its strong influence on polishing pressure. The detailed design of the wafer carrier is presented in Section 6.5, following an example of system decoupling.

6.4 CMP system decoupling

For the following example, the design elements that are relevant to the wafer carrier will be presented. The wafer carrier is the physical component of the machine that holds the wafer during polishing. As will be shown, FR/DP elements from various parts of the decomposition are embodied in the hardware of the wafer carrier. Therefore, the elements for this piece of hardware may be clustered together and then investigated as a part of the whole design. Such clustering is particularly beneficial to the design process, as a single engineer was responsible for the design of the wafer carrier hardware. By collecting all the elements of the matrix relating to the wafer carrier, it was possible for the engineer to see all the locally relevant interactions at one time. Here, the collection of elements will be shown in matrix form, and the benefits of rearranging the matrix demonstrated.

6.4.1 Wafer carrier design matrix

If the leaf elements involved in the wafer carrier hardware are combined into a matrix, the result is shown in Figure 6-18.

As is evident by inspecting the matrix, it is not lower triangular. During each stage of the decomposition, a lower triangular matrix was reached. Therefore, the matrix shown in Figure 6-18 should be lower-triangular. Unfortunately, it was not possible to maintain the intent of the higher level decisions in the strictest sense, resulting in a matrix with some elements in the upper triangle. The off-diagonal elements in the upper triangle represent iteration during the design process, and therefore added time and expense during the design cycle.

Some explanation of the off-diagonal effects observed in Figure 6-18 helps explain the following re-sequencing. The first off-diagonal elements are effects that DP 1.1.1.5.1 – nominal pressure – has on the system. The nominal pressure affects FR 1.1.1.3.1.2 – support wafer frictional loads – and also FR 1.1.1.3.1.3 – maintain retaining ring-pad contact. The FR to support frictional loads is affected because of Theorem 1. Theorem 1 states that if constraints controlling the solution to an FR

are affected, then that is the same as an affect on the FR. The nominal polishing pressure changes the constraints on the support of frictional loads, and so affects FR 1.1.1.3.1.2. This is a relatively trivial example of interaction in the design process, since the required information is easy to obtain early in the process. The other effect of the nominal polishing pressure is not so simple. The nominal polishing pressure also affects FR 1.1.1.3.1.3 because the nominal pressure tends to compress the polishing pad, moving it away from the retaining ring. Therefore, if the nominal pressure increases, it will be necessary to make some change in the retaining ring position to maintain contact with the pad. This is an interaction that may be designed into the software controlling the machine during polishing, either as a check/warning or as an automatically adjusted value. In either case, understanding the correct sequence is important.

The next off diagonal element seen in the wafer carrier matrix of Figure 6-18 is an effect on FR 1.4.6 – provide mechanical support – by DP 3.2.1.1.1 – retaining ring flexure outer diameter. FR 1.4.6 is part of the support sub-systems, created to enable the rest of the machine systems. The design of the support systems is subordinate to most of the rest of the machine. However, since DP 3.2.1 – uniformity control – is introduced to the machine system later in the decomposition, it is necessary to move the mechanical support structure to the end of the design sequence. Unfortunately, while offering benefits to the levels of the wafer carrier, such ordering is insufficient for the rest of the machine systems, as will be shown in the next section. The mechanical structure does affect other FRs in the system outside the wafer carrier.

Beyond the mechanical support structure, there are additional off-diagonal elements in the wafer carrier matrix of Figure 6-18. FR 1.1.4.2 – load wafer – and FR 1.1.4.3 – eject wafer – are both affected by DP 3.2.1.2.1 – membrane compartment areas – and DP 3.2.1.2.3 – membrane front thickness. Since the distribution of membrane compartment areas is designed as part of the uniformity control of DP 3.2.1, it is later in the decomposed design sequence than the load/eject wafer requirements. However, the introduction of the segmented membrane has significant effects on the ability to load/eject wafers. For instance, when multiple chambers are con-

tained within the membrane area, it is possible to pressurize the outermost annular chamber with a positive pressure while applying a negative pressure to the other compartments, forming a sort of suction cup between the wafer and membrane. When ejecting the wafer, multiple membrane compartments require that the compartments be inflated with a positive pressure, and then deflated in a sequence from the outside of the wafer to the center. Such a sequence prevents the suction cup effect, releasing the wafer. Therefore, it is necessary to decide the membrane load and unload configurations after the segmented membrane is fully specified. The last effect in the wafer carrier matrix is an effect of DP 3.2.1.2.3 on FR 1.1.1.5.3 – accommodate wafer form variation. That is because the membrane front thickness has an effect on the overall complaint stack stiffness, and if the bending stiffness of the membrane is too high, the system will not be robust to wafer thickness variation. Because a highly compliant material is used for the membrane material, this effect is relatively weak, but is indicated on the wafer carrier matrix as a potential source of problems.

One important characteristic of the matrix in Figure 6-18 is the nature of leaf level design elements. Since the leaf levels may be combined to make the parent (branch) levels, they are the elements of the design which must be individually set. Once this is accomplished, the structure of the hierarchy may be followed from the bottom of the top to realize the system. Because all the leaf levels must be determined, it is reasonable to consider them as the necessary and sufficient set of information to realize a system.

In the matrix of Figure 6-18, only leaf levels are represented. Therefore, they may be reordered as described by Theorem 2 to reach an appropriate sequence for design. The result of such reordering is shown in Figure 6-19. As may be seen, the matrix is now lower-triangular, to the extent that it can be. There is a fully coupled block that represents the closed loop control system of the retaining ring vertical motion, as discussed above. This is handled with a real time controller that iterates the solution during operation of the machine, guaranteeing FR satisfaction.

	Retaining ring ID surface	Ret. ring flexure thickness	Minimum Ret. Ring pressure	Carrier film surface	Nominal pressure	Device scale pad modulus	Subpad thickness	Membrane modulus	Isolation bellows stiffness	Slurry temperature	Load/U locating device	Membrane load config	Membrane unload config	WC vertical clearance when up	Machine structure	Ret. Ring flexure OD	Ret. Ring flexure strain	Z-Axis position during polish	Membrane compartment areas	Compartment pressure distribution	Membrane front thickness	Compartment divider vent length & O.D.
Prevent wafer translation	X	O	O	O	O	O	O	O	O	O	O	O	O	O	O	O	O	O	O	O	O	O
Support friction loads	O	X	O	O	X	O	O	O	O	O	O	O	O	O	O	O	O	O	O	O	O	O
Maintain ret.ring-pad contact	O	X	X	O	X	O	O	O	O	O	O	O	O	O	O	O	O	O	O	O	O	O
Prevent wafer rotation wrt carrier	O	O	O	X	O	O	O	O	O	O	O	O	O	O	O	O	O	O	O	O	O	O
Provide pressure	O	O	O	O	X	O	O	O	O	O	O	O	O	O	O	O	O	O	O	O	O	O
Create local force variation	O	O	O	O	O	X	O	O	O	O	O	O	O	O	O	O	O	O	O	O	O	O
Reduce sensitivity to wafer form variation	O	O	O	X	X	O	X	O	O	O	O	O	O	O	O	O	O	O	O	O	O	X
Transmit pressure to wafer	O	O	O	O	O	O	O	X	O	O	O	O	O	O	O	O	O	O	O	O	O	O
Reduce sensitivity to wafer-pad alignment	O	O	O	O	X	O	X	X	X	O	O	O	O	O	O	O	O	O	O	O	O	O
Control interface temperature	O	O	O	O	X	O	O	O	O	X	O	O	O	O	O	O	O	O	O	O	O	O
Locate wafer	X	O	O	O	X	O	O	O	O	O	X	X	O	O	O	O	O	O	O	O	O	O
Load wafer	O	O	O	X	O	O	O	X	O	O	O	X	X	O	O	O	O	O	X	O	X	O
Eject wafer	O	O	O	X	O	O	O	X	O	O	O	O	X	O	O	O	O	O	X	O	X	O
Allow access to wafer	O	O	O	O	O	O	O	O	O	O	X	O	O	X	O	O	O	O	O	O	O	O
Provide mechanical support	X	X	O	X	X	O	O	O	X	X	X	O	O	X	X	X	X	X	O	O	O	O
Reduce sensitivity to head-pad alignment	O	X	O	O	O	O	O	O	O	O	O	O	O	O	O	O	X	X	O	O	O	O
Measure force from ring flexure	O	X	O	O	O	O	O	O	O	O	O	O	O	O	O	X	X	X	O	O	O	O
Control force from Z-flexure	O	X	O	O	O	O	X	O	O	O	O	O	O	O	O	X	X	X	O	O	O	O
Divide wafer area into segments	O	O	O	O	O	O	O	X	O	O	O	O	O	O	O	O	O	O	X	X	O	O
Control applied pressure profile	O	O	O	O	O	O	O	O	O	O	O	O	O	O	O	O	X	X	X	X	O	O
Smooth applied pressure profile	O	O	O	X	O	O	O	O	O	O	O	O	O	O	O	O	O	O	X	O	X	X
Control pressure at discontinuities	O	O	O	X	O	O	O	O	O	O	O	O	O	O	O	O	O	O	X	O	X	X

Figure 6-18: Matrix of wafer carrier design elements

	Nominal pressure	Retaining ring ID surface	Ret. ring flexure thickness	Minimum Ret. Ring pressure	Carrier chuck surface	Device scale pad modulus	Membrane modulus	Membrane compartment areas	Compartment pressure distribution	Membrane front thickness	Bias pressure	h-subpad	Isolation bellows stiffness	Slurry temperature	WC vertical clearance when up	Membrane load config	Membrane unload config	Load/U locating device	Ret. Ring flexure OD	Ret. Ring flexure strain	Z-Axis position during polish	Machine structure
Provide pressure	X	O	O	O	O	O	O	O	O	O	O	O	O	O	O	O	O	O	O	O	O	O
Prevent wafer translation	O	X	O	O	O	O	O	O	O	O	O	O	O	O	O	O	O	O	O	O	O	O
Support friction loads	X	O	X	O	O	O	O	O	O	O	O	O	O	O	O	O	O	O	O	O	O	O
Maintain ret.ring-pad contact	X	O	X	X	O	O	O	O	O	O	O	O	O	O	O	O	O	O	O	O	O	O
Prevent wafer rotation wrt carrier	O	O	O	O	X	O	O	O	O	O	O	O	O	O	O	O	O	O	O	O	O	O
Create local force variation	O	O	O	O	O	X	O	O	O	O	O	O	O	O	O	O	O	O	O	O	O	O
Transmit pressure to wafer	O	O	O	O	O	O	X	O	O	O	O	O	O	O	O	O	O	O	O	O	O	O
Divide wafer area into segments	O	O	O	O	O	O	O	X	X	O	O	O	O	O	O	O	O	O	O	O	O	O
Control applied pressure profile	O	O	O	O	O	O	O	X	X	O	O	O	O	O	O	O	O	O	O	O	O	O
Smooth applied pressure profile	O	O	O	O	X	O	O	X	O	X	O	O	O	O	O	O	O	O	O	O	O	O
Control pressure at discontinuities	O	O	O	O	X	O	O	X	O	X	X	O	O	O	O	O	O	O	O	O	O	O
Reduce sensitivity to wafer form variation	X	O	O	O	X	O	O	O	X	O	X	X	O	O	O	O	O	O	O	O	O	O
Reduce sensitivity to wafer-pad alignment	X	O	O	O	O	O	X	O	O	O	O	X	X	O	O	O	O	O	O	O	O	O
Control interface temperature	X	O	O	O	O	O	O	O	O	O	O	O	O	X	O	O	O	O	O	O	O	O
Allow access to wafer	O	O	O	O	O	O	O	O	O	O	O	O	O	O	X	O	O	O	O	O	O	O
Load wafer	O	O	O	O	X	O	X	X	X	X	O	O	O	O	O	X	O	O	O	O	O	O
Eject wafer	O	O	O	O	X	O	X	X	X	X	O	O	O	O	O	O	X	O	O	O	O	O
Locate wafer	X	X	O	O	O	O	O	O	O	O	O	O	O	O	X	O	O	X	O	O	O	O
Reduce sensitivity to head-pad alignment	O	O	X	O	O	O	O	O	O	O	O	O	O	O	O	O	O	O	X	X	O	O
Measure force from ring flexure	O	O	X	O	O	O	O	O	O	O	O	O	O	O	O	O	O	O	X	X	X	O
Control force from Z-flexure	O	O	X	O	O	O	O	O	O	O	X	O	O	O	O	O	O	O	O	X	X	O
Provide mechanical support	X	X	X	O	X	O	O	X	O	X	X	O	X	X	X	X	O	O	X	X	X	X

Figure 6-19: Re-sequenced matrix of wafer carrier design elements

6.4.2 Full design matrix

Similarly to the subset of elements that make up the matrices in Figures 6-18 and 6-19, the entire collection of leaf level elements may be investigated and restructured. The full design matrix created by the decomposition for the CMP machine is shown in Figure 6-20. There are many more effects than in the previous section, which considered on those elements relevant to the wafer carrier hardware. In Figure 6-20, DP 1.4.6 – the mechanical support structure – affects FRs that are involved in moving components, since the design of the mechanical support structure defines inertial elements, and the inertia is a large part of defining requirements for motion systems. Another large source of off-diagonal elements in Figure 6-20 is the decomposition of FR/DP 3.2.1 – uniformity control. Since the uniformity control requirement and parameters were added to the machine systems in a branch of the hierarchy separate from most of the other sub-systems, there is a good bit of re-sequencing that is necessary to achieve the most decoupled system. The uniformity control elements affect earlier functions to provide mechanical support, allow user control, deliver consumable materials/energy, and other functions.

As before, the full matrix is reordered, and the result is shown in Figure 6-21. The matrix in Figure 6-21 represents an improved sequence for the design elements to be set, in a manner that will reduce the iteration required in the design. As may be seen in the figure, some elements remain in the upper triangle of the design matrix. These represent iterative loops that may not be eliminated.

6.5 Wafer carrier detailed design

The MIT CMP platform was designed as a complete system, and includes many elements in order to satisfy its top functional requirements. As the requirements for the CMP system were decomposed, the leaf level DPs were integrated into hardware. Two main branches of the decomposition contain elements that became part of the wafer carrier – the machine element that holds the wafer during polishing. It contains most of the design parameters for the wafer retention system, DP 1.1.1.3, and interface

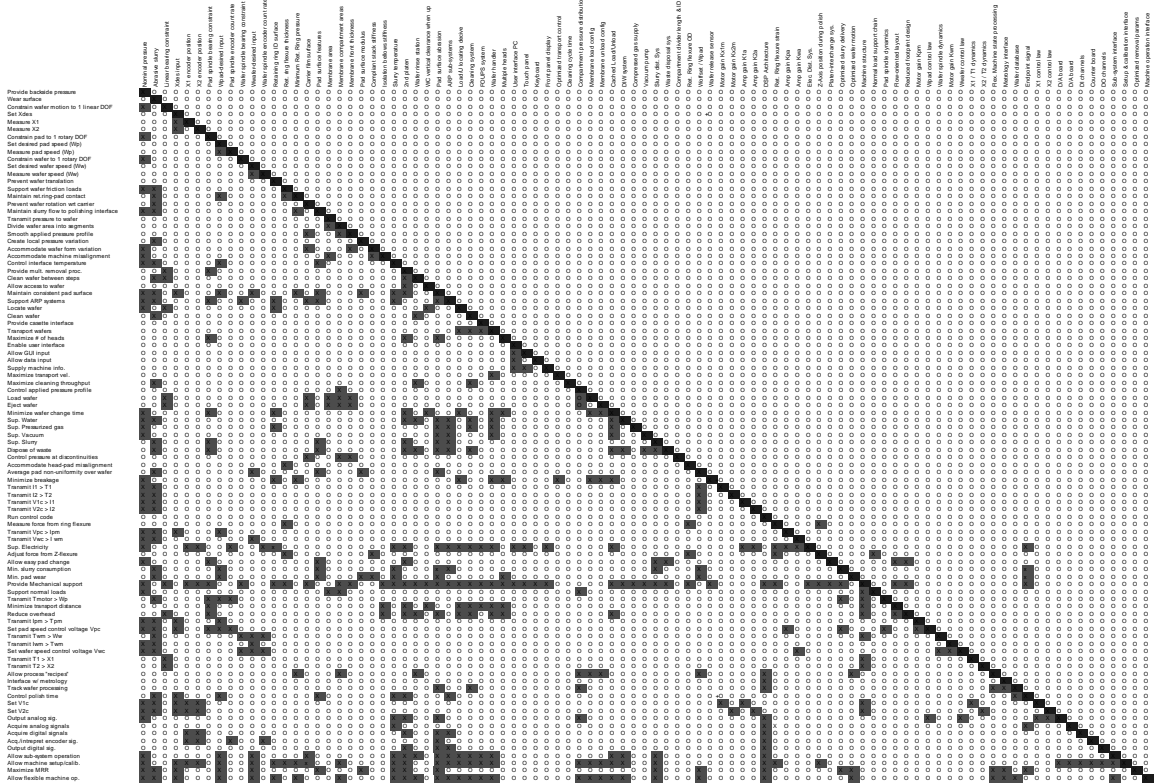

Figure 6-21: Re-sequenced full system matrix for the CMP machine

pressure, DP 1.1.1.5, as well as those for the uniformity control mechanisms, DP 3.2.1.

The wafer carrier elements identified in the system architecture were integrated into hardware elements. The result is shown below in Figure 6-22, a CAD drawing of the assembled system. In Figure 6-22, it is possible to see all the parts that enable the DPs of the sub-systems. Also visible is an outer bellows assembly that was included to support the nominal force applied to the retaining ring for pad compression, had that been necessary. The retaining ring itself is contained on a removable piece, attached to the flexure through screw threads.

All parts of the machine hardware systems were manufactured by external contractors. Most of the parts for the wafer carrier are fabricated of stainless steel. The machine was assembled by the design team.

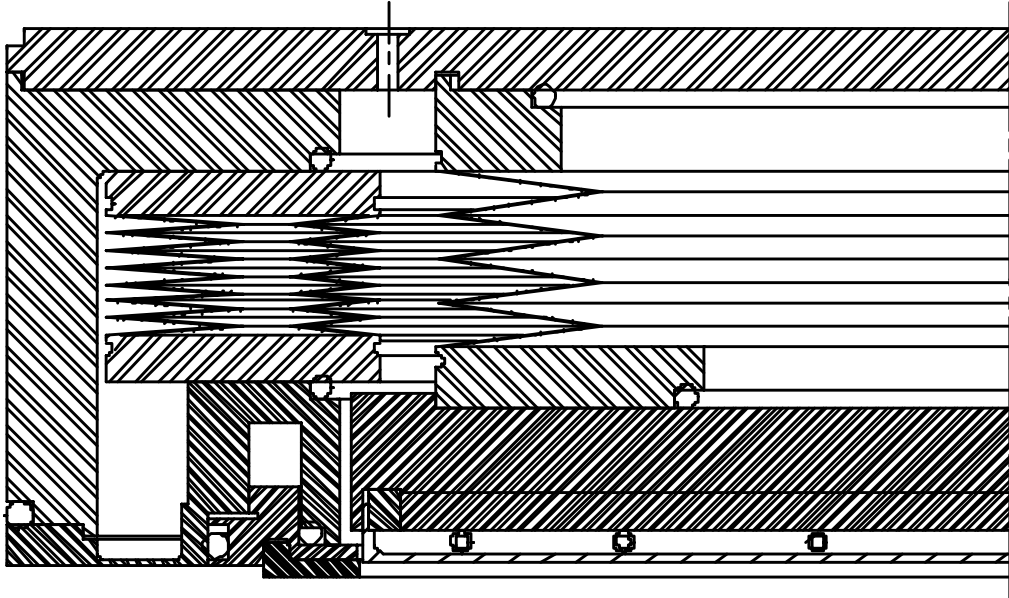

Figure 6-22: CAD assembly drawing of the wafer carrier showing the integration of leaf level DPs

6.6 CMP System testing & evaluation

The MIT CMP platform wafer carrier was evaluated by polishing SiO_2 blanket wafers with industry standard process conditions. The wafers are 200 mm silicon wafers with 1 μm of CVD TEOS oxide. Polishing was done using a Rodel IC-1400 K-groove pad and Rodel Klebosol $\text{\textcircled{R}}$ 1501-50 slurry. Wafers were polished for two minutes at 160 ft/min (0.8 m/sec) relative velocity and 5 psi (34.5 kPa). The pad was conditioned using a diamond abrasive between wafers. Wafers were measured using an optical interferometer to sample 49 points per wafer.

First, wafers were polished using no pressure distribution in the membrane compartments. An equal nominal pressure of 5 psi was applied to each compartment. The removal non-uniformity was 16.9%. The removal was concentrated towards the center of the wafer, as shown in Figure 6-23. To investigate the ability of the segmented membrane to control the removal rate, pressures in the compartments were adjusted to achieve maximum uniformity. The pressure ratios relative to the 5 psi nominal pressure were 1.0, 1.05, 1.10, and 1.25, from the center of the wafer to the edge.

With manual adjustment of the pressures in the compartments, the wafer carrier was able to achieve a removal non-uniformity of 1.7% while maintaining a removal rate of 2,850 Å/min. The resulting oxide thickness is shown in Figure 6-24. A more detailed map of the surface is shown in Figure 6-25.

6.7 Summary

The design presented is a successful approach to a CMP system. Using axiomatic design to develop the system architecture allowed a much faster design process, with fewer uncertainties, than if the design had been started in an ad-hoc manner. It also allowed detailed design to proceed by a design team with little experience in the area of wafer production or machine design. By following the two design axioms, it was possible to conceive of design solutions, with the appropriate DPs, at every level of the decomposition. The system architecture defines the critical functions for the system and specifies how the functions will be satisfied. A great deal more detail is necessary to construct the final CMP system; purchased component specification, engineering drawings, and assembly instructions. However, with the critical information delivered by the system architecture, the development of the remaining detail is greatly simplified.

While the intent for functional independence was expressed at each level of the decomposition, when the full system matrix was completed after decomposition, it was found that some coupling existed in the system. Using Theorem 2 allowed the leaf level elements to be decoupled into a sequence that allowed parameter design – the assigning of values to the DPs – to proceed with a minimum amount of iteration.

Theorem 4 has been used in the design of the CMP system architecture to increase the robustness of the system while still in the conceptual design phase. One of the noise factors considered when planning for conceptual robustness was the alignment of machine features. By considering machine alignment as a noise factor, the system was designed to be easy to assembly, and therefore more likely to function as desired immediately upon activation.

FOCUS Wafer Map

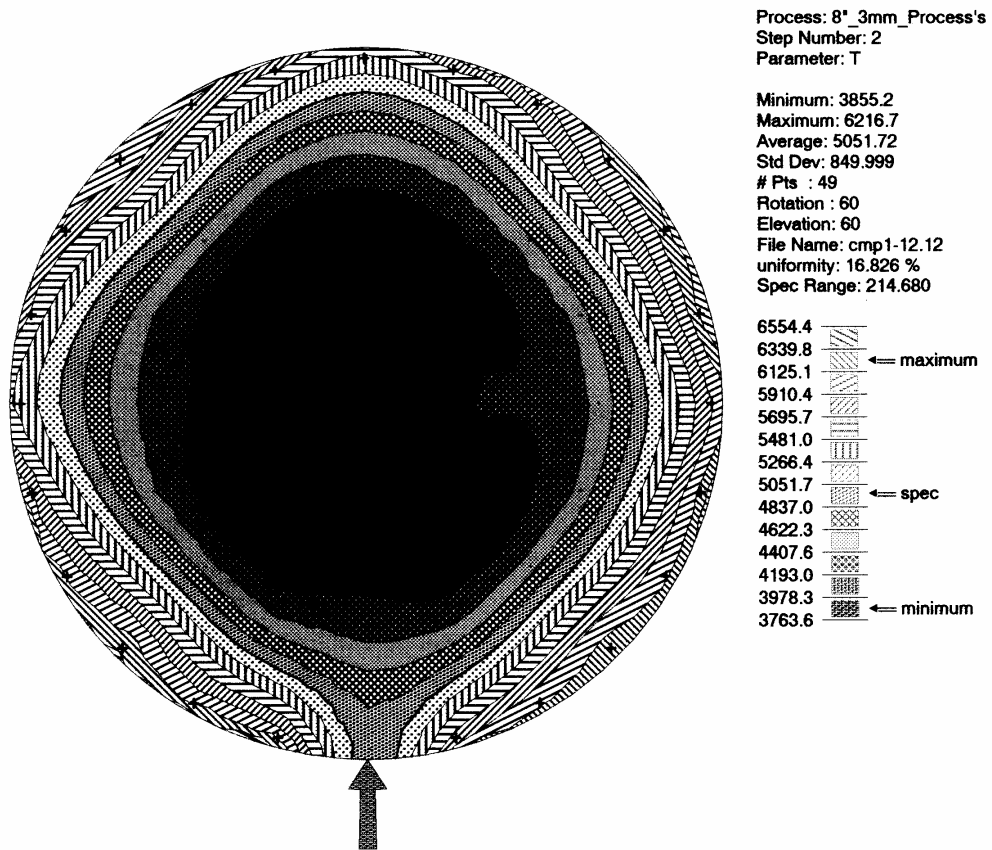

Figure 6-23: Plot of SiO₂ film thickness after polishing with uniform compartment pressure of 5 psi. Removal non-uniformity is 16.8%.

FOCUS Wafer Map

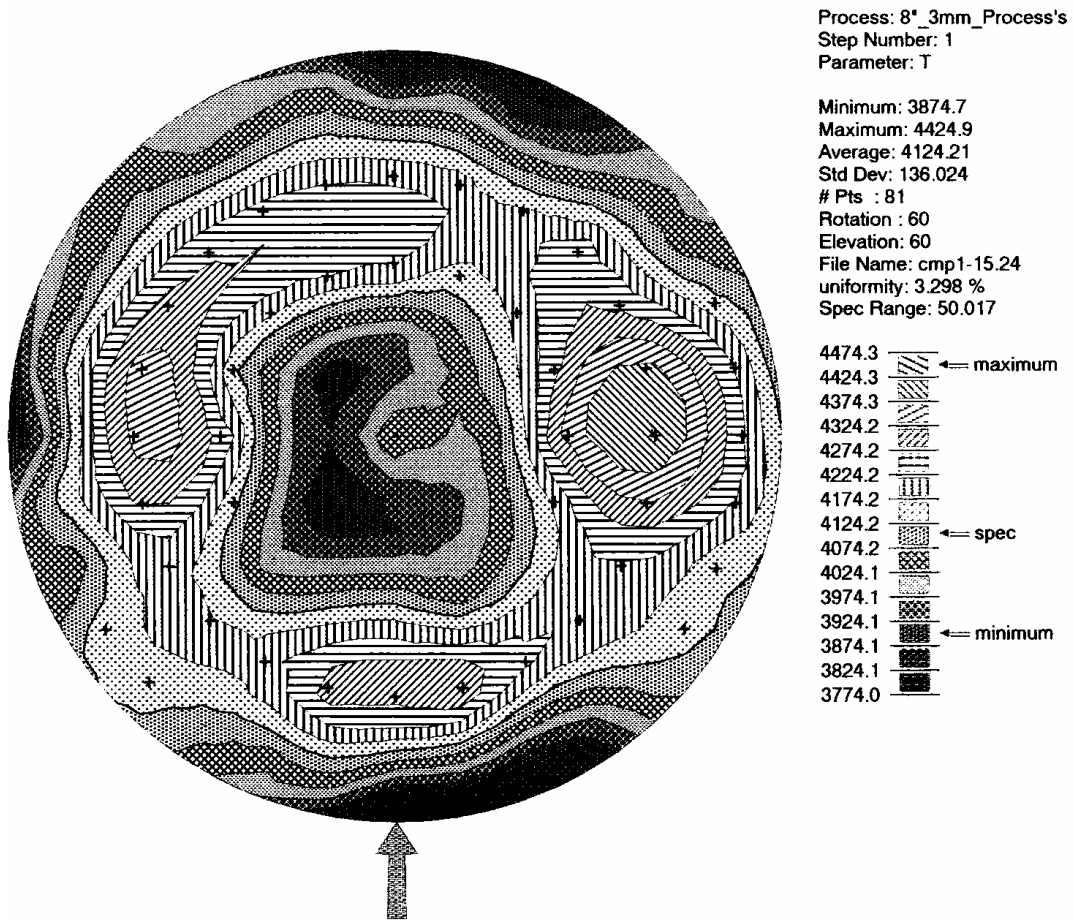

Figure 6-24: Plot of SiO₂ film thickness after polishing with adjusted compartment pressures. Removal non-uniformity is 1.7%.

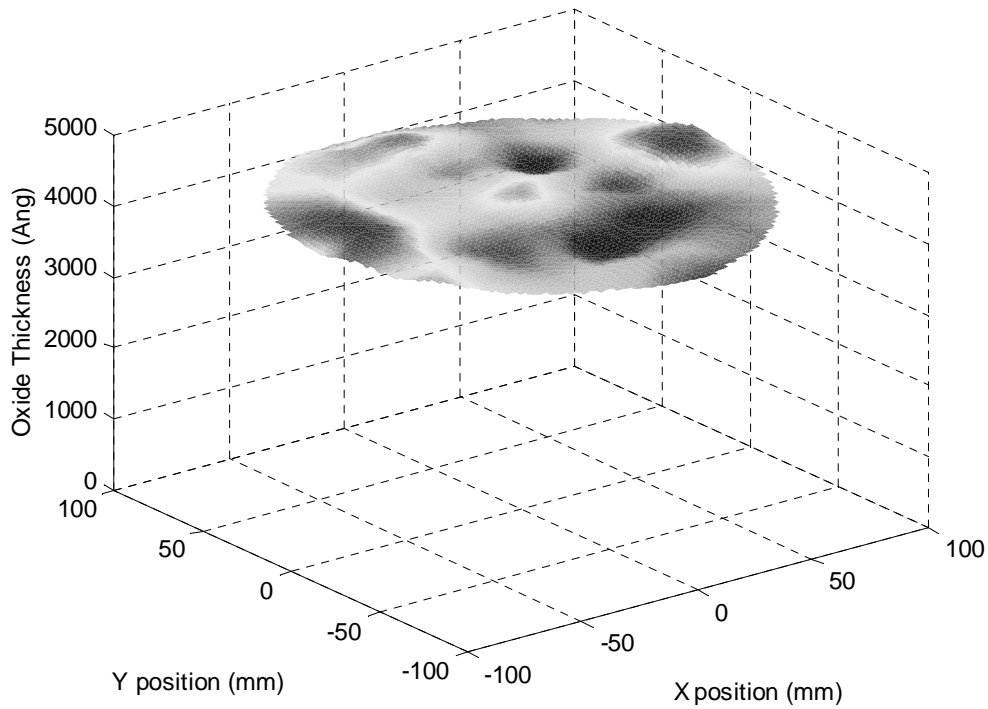

Figure 6-25: Plot of the remaining SiO_2 thickness after 120 sec. polish at 5 psi. Removal non-uniformity is 1.7%.

The sub-system for controlling removal rate allows the MIT CMP platform to produce wafers with excellent non-uniformity, exceeding the demands of the industry at the time of the design. It shows added control of the process as designed, and may be used as part of any CMP system to satisfy the needs of the semiconductor industry. Also, the resolution of the uniformity control mechanism demonstrated on the MIT CMP platform could be increased, to define more than four independent pressure zones on the wafer surface. Certainly as the industry moves to 300mm wafers, there will be a greater need to control the removal rate on the wafer with increasing ability.

Chapter 7

Conclusions

7.1 Summary of work

Several new theorems for axiomatic design have been developed. These theorems have significant implications for the continued application of axiomatic design. They streamline the process of applying axiomatic design to systems, therefore increasing the likelihood that systems will be designed to meet their needs correctly. Decisions made based on the guidelines described by the design axioms are more likely to result in systems that perform in a predictable way, and are easy to control. This can significantly reduce the time and expense spent during the design and operation phase of systems.

Theorem 2, the re-sequencing theorem describes a way by which a system that exhibits some amount of coupling at a high level may be decoupled at the leaf level. If this is the case, and there are no design alternatives that are decoupled at all levels, or such alternatives are too costly, then the correct sequence of the leaf level elements allows for an effectively decoupled design, and should be used.

By guiding the way the systems are decomposed, Theorem 3, the outside-in strategy theorem, makes it easier to create reusable simulation elements, and therefore also data for information-based design systems. Such “expert design systems” are a goal of design methods, such that computerized systems may be used to assist a human designer to a large degree in suggesting possible design alternatives. Only by

developing and applying a consistent method of decomposition will computer-based tools, like simulation and expert design systems, maximize their potential.

System robustness to noise factors is an important consideration, and can be significantly increased during the conceptual design phase. Several strategies for improving system robustness to noise factors were presented, and Theorems 4 and 5 describe how to integrate these strategies into the axiomatic design method. The robustness theorems highlight important features of a design that control sensitivity to noise factors, and therefore help the system designer maintain the desired relationships as a system is developed.

Axiomatic design was used to design a system to polish semiconductor wafers. The system was designed and constructed by a team of designers with limited experience in the fields of semiconductor equipment and machine tools. Despite this, it was possible to create a system with state-of-the-art performance. Much of the success of the project may be attributed to the axiomatic design methodology, which focused the attention of the design team on the important functions and means for accomplishing them. The CMP system is used to demonstrate the application of the theorems presented in preceding chapters, providing tangible evidence of their utility.

7.2 Suggestions for further research

Axiomatic design theory continues to evolve as it is tested in application to various design situations. While this investigation of axiomatic design and system design has achieved success in developing methods for axiomatic system design, the utility of the theorems presented would be greatly enhanced if they are integrated into design tools. Generally, a design tool might take the form of a software package, to help the designer implement concepts and create important documentation. Particularly, application of axiomatic design theory would benefit from implementation of the re-sequencing theorem in software.

The method of simulation based on axiomatic design presented in this thesis is an initial look at the interface of a design method and an analysis tool. While it

seems that the relationships discovered here are valid, a certain amount of testing and application to a multitude of examples will help draw out the true generalizations involved. Once generalizations are possible, the possibility for implementing the simulation methods with software become more real. Such implementation would be a huge benefit to the system designer.

The robustness theorems were applied to the design of a real machine tool, and the tool did demonstrate robustness as intended. However, but to measure the effectiveness of the proposed methods it is necessary to design a system with variable DPs to satisfy the robustness FRs, such that the system's robustness to noise factors may be adjusted and then measured. Such experimentation would provide an evaluation of the methods for conceptual robustness. Another possibility is to design a system both with and without using the robustness theorems and then proceed with a parameter optimization method, such as Taguchi methods. It is the author's belief that the system designed with conceptual robustness will respond more to such optimization, resulting in a system that is more robust to noise factors.

Appendix A

Theorems & Corollaries

A.1 Theorems

Theorem 1 (Equivalence of FRs) *A functional requirement written to contain constraints is equivalent to a functional requirement affected by separate, associated constraints.*

Theorem 2 (Re-Sequencing) *A high-level coupled design may be treated as a decoupled design if the full system matrix, consisting of all leaf level design elements, may be re-sequenced to form a triangular matrix.*

Theorem 3 (Outside-In Strategy) *To preserve a system's topology during decomposition¹, it is necessary to proceed with an outside-in strategy, such that high-level DPs are active inputs used to control FR behavior, and decomposition adds details necessary for implementation.*

Theorem 4 (Robustness FRs) *System robustness² is increased by augmenting a set of FRs with FRs that reduce sensitivity to noise factors or reduce the observed noise factor variation, provided all FRs are satisfied by appropriate DPs.*

¹Preserving topology is particularly important when using the system architecture to define a simulation model, since doing so keeps the model connections valid at all levels of the decomposition.

²System robustness is defined as the inverse of FR variation due to noise factors

Theorem 5 (Robustness Through Compensation) *System robustness is increased by adding design elements that compensate for changes in noise factors, provided the compensation scheme is real-time and dynamically stable, and measurement uncertainty is significantly less than the desired FR variation.*

With perfect compensation, and no additional errors, it is sufficient for the measurement uncertainty to be less than the desired FR variation.

A.2 Corollaries

Corollary 1 (Repetition of DPs) *An outside-in decomposition strategy requires that high level DPs representing inputs used actively during system operation are repeated as decomposition proceeds to the leaf level.*

Bibliography

- [1] Suh NP. *Axiomatic Design: Advances and Applications*. Oxford University Press, New York, NY, 2001.
- [2] Kim SJ, Suh NP, and Kim SG. Design of software systems based on axiomatic design. *Annals of the CIRP*, 40(1):165–170, 1991.
- [3] Moore WL, Louviere JJ, and Verma R. Using conjoint analysis to help design product platforms. *Journal of Product Innovation Management*, 16(1):27–39, 1999.
- [4] Gruca TS, Kumar KR, and Sudharshan D. An equilibrium analysis of defensive responses to entry using a coupled response function model. *Marketing Science*, 11(4):348–358, 1992.
- [5] Hintersteiner JD and Tate D. Command and control in axiomatic design theory: Its role and placement in the system architecture. In *Proceedings of the 2nd International Conference on Engineering Design and Automation*, number 40, pages 165–170, Maui, HI, 1998.
- [6] Taguchi G. *Introduction to Quality Engineering*. Nordica International Limited, Hong Kong, 1986.
- [7] Frey DD, Otto KN, and Taketani S. Manufacturing block diagrams and optimal adjustment procedures. *Journal of Manufacturing Science and Engineering*, 123(1):119–127, 2001.

- [8] Shooter SB, Keirouz WT, Szykman S, and Fenves SJ. A model for the flow of design information in product development. *Engineering with Computers*, 16:178–194, 2000.
- [9] Kayton M. A practitioner’s view of system engineering. *IEEE Transactions on Aerospace and Electronic Systems*, 22(2):579–586, 1997.
- [10] Kisiak A. *Engineering Design: Products, Processes, and Systems*. Academic Press, San Diego, CA, 1999.
- [11] Browning TR. Applying the design structure matrix to system decomposition and integration problems: A review and new directions. *IEEE Transactions on Engineering Management*, 48(3):292–306, 2001.
- [12] Smith RP and Eppinger SD. Identifying controlling features of engineering design iteration. *Management Science*, 43(3):276–293, 1997.
- [13] Dong Q. *Predicting and Managing System Interactions at Early Phase of the Product Development Process*. PhD thesis, Massachusetts Institute of Technology, 2002.
- [14] Thomke SH. Managing experimentation in the design of new products. *Management Science*, 44(6):743–761, 1998.
- [15] Law AM and Kelton WD. *Simulation Modeling and Analysis*. McGraw-Hill.
- [16] Rowell A. Prototyping in a digital world. *Computer Graphics World*, 20(9):55–62, 1997.
- [17] Suzuki H, Kimura F, Moser B, and Yamada T. Modeling information in design background for product development support. *Annals of the CIRP*, 45(1):141–144, 1996.
- [18] Lu SC-Y, Li D, Cheng J, and Wu CL. A model fusion approach to support negotiations during complex engineering system design. *Annals of the CIRP*, 46(1):89–92, 1997.

- [19] Elmqvist H, Mattsson SE, and Otter M. Modelica – a language for physical system modeling, visualization and interaction. In *IEEE Symposium on Computer-Aided Control System Design*, 1999.
- [20] Dymola: A dynamic modeling laboratory. <http://www.dymola.com>.
- [21] Paredis CJ, Diaz-Calderon A, Sinha R, and Khosla PK. Composable models for simulation-based design. *Engineering with Computers*, 17(2):112–128, 2001.
- [22] Park S. *Robust Design and Analysis for Quality Engineering*. Chapman & Hall, London, 1996.
- [23] Taguchi G. *Taguchi on Robust Technology Development*. ASME Press, New York, NY, 1993.
- [24] Andersson P. On robust design in the conceptual design phase: A qualitative approach. *Journal of Engineering Design*, 8(1):75–89, 1997.
- [25] Andersson P. A semi-analytic approach to robust design in the conceptual design phase. *Research in Engineering Design*, 8(4):229–239, 1996.
- [26] Ford R and Barkan P. Beyond parameter design – a methodology addressing product robustness at the concept formation stage. In *ASME Design Engineering Conference - Design for Manufacturability*, volume 81, pages 1–7, Chicago, IL, 1995.
- [27] Donmez MA. *A general methodology for machine tool accuracy enhancement: Theory, application, and implementation*. PhD thesis, Purdue University, 1985.
- [28] Wood W and Agogino A. Case-based conceptual design information server for concurrent engineering. *Computer-Aided Design*, 28(5):361–369, 1996.
- [29] Dejule R. Cmp challenges below a quarter micron. *Semiconductor International*, pages 54–60, Nov. 1997.

- [30] Rosenberg R, Edelstein DC, Hu CK, and Rodbell KP. Copper metallization for high performance silicon technology. *Annual Reviews of Materials Science*, 30:229–262, 2000.
- [31] Preston FW. The theory and design of plate glass polishing machines. *Journal of the Society of Glass Technology*, 11:214–256, 1927.
- [32] Shi F and Zhao B. Modeling of chemical-mechanical polishing with soft pads. *Applied Physics A*, 67:249–252, 1998.
- [33] Zhao B and Shi F. Chemical mechanical polishing: Threshold pressure and mechanism. *Electrochemical and Solid-State Letters*, 3:145–147, 1999.
- [34] Luo J and Dornfeld D. Material removal mechanism in chemical mechanical polishing: Theory and modeling. *IEEE Transactions on Semiconductor Manufacturing*, 14(2):112–133, 2001.
- [35] Talieh et al. Linear polisher and method for semiconductor wafer planarization, 1997. US Patent #5,692,947.
- [36] Zuniga et al. Carrier head design for chemical mechanical polishing apparatus, 1998. US Patent #5,762,544.
- [37] Trojan et al. Low profile, low hysteresis force feedback gimbal system for chemical mechanical polishing, 1999. US Patent #5,899,798.
- [38] Currie et al. Confined water fixture for holding wafers undergoing chemical-mechanical polishing, 1993. US Patent #5,267,418.
- [39] Breivogel et al. Method and apparatus for chemical-mechanical polishing using pneumatic pressure applied to the backside of a substrate, 1997. US Patent #5,635,083.
- [40] Nishio M. Apparatus for holding substrate to be polished and apparatus and method for polishing substrate, 1998. US Patent #5,791,973.

- [41] Strasbaugh A. Wafer carrier for film planarization, 1995. US Patent #5,449,316.
- [42] Shendon N. Chemical mechanical polishing apparatus with improved carrier and method of use, 1997. US Patent #5,624,299.
- [43] Shendon N. Chemical mechanical polishing apparatus with improved polishing control, 1998. US Patent #5,643,053.
- [44] Shendon N. Head for a chemical mechanical polishing apparatus, 1999. US Patent #5,913,718.
- [45] Perlov et al. Carrier head with a flexible membrane for a chemical mechanical polishing system, 1999. US Patent #5,964,653.
- [46] Muller et al. Method and device for polishing semiconductor wafers, 1999. US Patent #5,980,361.
- [47] Nam J. Optical endpoint detection for the chemical mechanical polishing process. Master's thesis, Massachusetts Institute of Technology, 2000.
- [48] Lai J-Y. *Mechanics, mechanisms, and modeling of the chemical mechanical polishing process*. PhD thesis, Massachusetts Institute of Technology, 2001.
- [49] Torkaman A. Design and fabrication of a high precision wafer polishing machine. Master's thesis, Massachusetts Institute of Technology, 2000.
- [50] Lee K. Axiomatic development of a machine control system. Master's thesis, Massachusetts Institute of Technology, 2000.