

Department of Mathematics
University of Fribourg (Switzerland)

New contributions to hyperbolic
polyhedra, reflection groups, and
their commensurability

THESIS

presented to the Faculty of Science of the University of Fribourg
(Switzerland) in consideration for the award of the academic grade of
Doctor scientiarum mathematicarum

by

Matthieu Jacquemet

from

Conthey (VS) & Vétroz (VS)

Thesis No : 1929
e-publi.de
2015

Accepted by the Faculty of Science of the University of Fribourg (Switzerland) upon the recommendation of the jury :

Prof. Dr. Ruth Kellerhals
University of Fribourg (Switzerland), Supervisor

Prof. Dr. John Parker
University of Durham (United Kingdom), Referee

Prof. Dr. John Ratcliffe
University of Vanderbilt (United States of America), Referee

Dr. Pavel Tumarkin
University of Durham (United Kingdom), Referee

Prof. Dr. Jean-Paul Berrut
University of Fribourg (Switzerland), Chair

Fribourg, 15 October 2015

Thesis supervisor

Dean

Prof. Dr. Ruth Kellerhals

Prof. Dr. Fritz Müller

Twenty years from now you will be more disappointed by the things you didn't do than by the ones you did. So throw off the bowlines, sail away from the safe harbour, catch the trade winds in your sails. Explore. Dream. Discover.

Mark Twain

Abstract

Hyperbolic Coxeter groups form an important class of discrete subgroups of $\text{Isom}(\mathbb{H}^n)$: they have a simple presentation, they enjoy nice combinatorial and algebraic properties, and they provide examples of hyperbolic n -orbifolds of small volume. However, they are far from being classified, and a number of their properties remain cryptic. Hence, the study of hyperbolic Coxeter groups and of the related Coxeter polyhedra is a rich and diversified domain, harbouring numerous open problems.

In this work, we solve the three following problems :

- (P1) Find an upper dimensional bound for the existence of hyperbolic Coxeter hypercubes, and classify the ideal Coxeter hypercubes.
- (P2) Find the inradius of a hyperbolic truncated simplex.
- (P3) Classify up to commensurability the hyperbolic Coxeter pyramid groups.

Our results are inspired by previous works respectively of Felikson-Tumarkin [21], Milnor [47], Vinberg [65], Maclachlan [39] and Johnson-Kellerhals-Ratcliffe-Tschantz [31].

Our solution to Problem (P2) has partially been published in [29]. Moreover, the solution to Problem (P3) results from a joint work with Rafael Guglielmetti and Ruth Kellerhals [24].

Résumé

Les groupes de Coxeter hyperboliques forment une classe importante de sous-groupes discrets de $\text{Isom}(\mathbb{H}^n)$: ils ont une présentation simple, satisfont des propriétés combinatoires et algébriques agréables, et fournissent des exemples de n -orbifolds hyperboliques de petit volume. Cependant, ils sont loin d'être classifiés, et plusieurs de leurs propriétés restent cryptiques. Ainsi, l'étude des groupes de Coxeter hyperboliques et des polyèdres de Coxeter correspondants est un domaine riche et diversifié, recelant de nombreux problèmes ouverts.

Dans ce travail, on résout les trois problèmes suivants :

- (P1) Trouver une borne dimensionnelle supérieure pour l'existence d'hypercubes de Coxeter hyperboliques, et classifier les hypercubes de Coxeter idéaux.
- (P2) Trouver le rayon inscrit d'un simplexe tronqué hyperbolique.
- (P3) Classifier à commensurabilité près les groupes de Coxeter hyperboliques pyramidaux.

Nos résultats sont inspirés de travaux précédents respectivement dus à Felikson-Tumarkin [21], Milnor [47], Vinberg [65], Maclachlan [39] et Johnson-Kellerhals-Ratcliffe-Tschantz [31].

Notre solution au problème (P2) a été partiellement publiée dans [29]. De plus, la solution du problème (P3) résulte d'un travail commun avec Rafael Guglielmetti et Ruth Kellerhals [24].

Zusammenfassung

Hyperbolische Coxetergruppen bilden eine wichtige Klasse von diskreten Untergruppen von $\text{Isom}(\mathbb{H}^n)$: sie sind einfach präsentiert, erfüllen schöne kombinatorische und algebraische Eigenschaften, und liefern Beispiele für hyperbolische n -Orbifolds von kleinem Volumen. Sie sind jedoch weit von einer Klassifikation entfernt, und viele ihrer Eigenschaften liegen noch im Dunkeln. Deshalb ist das Studium hyperbolischer Coxetergruppen und der entsprechenden Coxeterpolyeder ein weites und vielfältiges Gebiet.

In dieser Arbeit werden folgende Fragen beantwortet :

- (P1) Finde eine obere Dimensionsschranke für die Existenz hyperbolischer Coxeter-Hyperwürfel, und klassifiziere die idealen Coxeter-Hyperwürfel.
- (P2) Finde den Inballradius eines hyperbolischen abgestumpften Simplexes.
- (P3) Klassifiziere bis auf Kommensurabilität die hyperbolischen pyramidalen Coxetergruppen.

Unsere Resultate wurden inspiriert von Arbeiten von Felikson-Tumarkin [21], Milnor [47], Vinberg [65], Maclachlan [39] und Johnson-Kellerhals-Ratliffe-Tschantz [31].

Unsere Lösung zum Problem (P2) wurde teilweise in [29] veröffentlicht. Ausserdem ist die Lösung zum Problem (P3) das Resultat einer Zusammenarbeit mit Rafael Guglielmetti und Ruth Kellerhals [24].

Acknowledgements

First of all, I would like to thank my supervisor Ruth Kellerhals for having guided me during the past years. Her enthusiasm and her scientific exigencies have been a constant source of inspiration. It has been both an honor and a great pleasure to work with her. Also, I am grateful for the many opportunities she gave me to attend international conferences and meet mathematicians from all around the world.

I would also like to thank the referees : John Parker, John Ratcliffe and Pavel Tumarkin, for having accepted to be members of my thesis jury, for their interest in my work and for their remarks, advices, and helpful comments.

I thank Marston Conder and Dimitri Leemans for their hospitality during my research stay in Auckland, in Spring 2012. This bungy jump of two months in New Zealand has been an incredible opportunity, both on the mathematical and personal level.

I thank also all members from the Department of Mathematics of Fribourg for the nice atmosphere there. I would like to thank the rest of my "geometric family" in Fribourg : Sasha, Jordane and Scott. Another thank goes to my office mates Chrystel and Rafael for their support. Rafael should especially be thanked for his patience and the different motivating projects we worked on. Thank you Michaël for the exciting popularization projects we shared. I really enjoyed to work with students, and they should be thanked for their motivation and their constant quest for knowledge.

I am grateful to the Department of Mathematics, the Faculty of Science and the University of Fribourg, as well as to the CUSO for their diverse financial supports. This work was also partially supported by the Swiss National Science Foundation, project 200020-144438.

Finally, I would like to thank my family for having given me all necessary and sufficient conditions in order to be able to do the job I like, and for their encouragement. I am grateful to all my friends for their support. Last but not least, I would like to thank Laetitia for being there in the good and bad times, and for her constant care. I am lucky to be part of her team.

Contents

1	Introduction	1
2	Preliminaries	3
2.1	Polyhedra in the model geometric spaces	3
2.1.1	Model geometric spaces	3
2.1.2	Hyperplanes and polyhedra	5
2.1.3	Hyperbolic polyhedra	8
2.1.4	Examples	11
2.2	Coxeter groups	12
2.2.1	Coxeter polyhedra and Coxeter groups	12
2.2.2	Classification of geometric Coxeter groups	14
2.3	Invariants	16
2.3.1	Inradius	16
2.3.2	Volume	17
2.3.3	Commensurability	19
2.3.4	Arithmeticity	20
3	Hyperbolic Coxeter n-cubes	23
3.1	Hyperbolic n -cubes	23
3.2	Ideal Coxeter squares and 3-cubes	26
3.2.1	Ideal Coxeter squares	26
3.2.2	Ideal Coxeter 3-cubes	27
3.3	Absence of ideal Coxeter n -cubes in $\overline{\mathcal{H}^n}$, $n \geq 4$	30
3.4	Volume and inradius of ideal Coxeter n -cubes, $n = 2, 3$	35
4	The inradius of hyperbolic truncated simplices	39
4.1	Hyperbolic truncated simplices	39
4.1.1	Examples	41
4.1.2	The reduced Gram matrix of a hyperbolic truncated simplex	43
4.2	The inradius of a hyperbolic truncated simplex	45
4.2.1	The inball of a total simplex	46
4.2.2	The inball of a hyperbolic truncated simplex	52

4.2.3	Inradius monotonicity	53
4.3	Applications	54
4.3.1	Some explicit values	54
4.3.2	Extremal fundamental polygons	56
5	Commensurability of hyperbolic Coxeter pyramids	66
5.1	Methods	66
5.1.1	General tools	66
5.1.2	Maclachlan's criteria for arithmetic Coxeter groups . .	74
5.2	Hyperbolic Coxeter pyramid groups	80
5.3	Commensurability classes	82
5.3.1	The classification	83
5.3.2	Summary	93
5.4	Commensurability classes of ideal Coxeter 3-cubes	95
	Bibliography	96

Chapter 1

Introduction

Let $\mathbb{X}^n \in \{\mathbb{S}^n, \mathbb{E}^n, \mathbb{H}^n\}$ be either the spherical space \mathbb{S}^n , the Euclidean space \mathbb{E}^n or the hyperbolic space \mathbb{H}^n . A *Coxeter polyhedron* $\mathcal{P} \subset \mathbb{X}^n$ is a convex polyhedron whose dihedral angles are of the form $\frac{\pi}{k}$, $k \geq 2$. The reflections in the facets of \mathcal{P} generate a discrete group $W = W(\mathcal{P}) < \text{Isom}(\mathbb{X}^n)$, a so-called *geometric Coxeter group*.

While spherical and Euclidean Coxeter groups exist in any dimension and are completely classified, hyperbolic Coxeter groups do not exist any more if $n \geq 996$ and are far from being classified. Examples are available only for $n \leq 21$ in the cofinite noncompact case, and for $n \leq 8$ in the compact case. Moreover, complete classifications are only available for hyperbolic Coxeter groups of small rank, for example with rank $n + 1$ (simplicial case) and $n + 2$ (prismatic and pyramidal cases). The simplex case is the only case so far where all volumes and commensurability classes are available.

In this work, we contribute to the theory of hyperbolic Coxeter polyhedra and Coxeter groups in the three following ways.

First, we study hyperbolic Coxeter polyhedra having the combinatorial type of an n -cube. We show that such *hyperbolic Coxeter n -cubes* do not exist in dimensions $n \geq 10$, and that *ideal Coxeter n -cubes* exist only for $n = 2$ and 3 . We show that ideal Coxeter squares form a one-parameter family, and that there are only 7 ideal hyperbolic Coxeter 3-cubes. The methods used are of combinatorial nature. They exploit the fact that such polyhedra are simple, that the figure of a vertex of a hyperbolic polyhedron is a spherical or a Euclidean polyhedron, and that the graph of a hyperbolic Coxeter polyhedron cannot contain disconnected hyperbolic subgraphs. These ideas have been successfully used by Felikson-Tumarkin [21] in the context of simple ideal hyperbolic polyhedra.

As a byproduct, we provide the volume of all ideal hyperbolic Coxeter

squares and 3-cubes, as well as the inradius of the *regular* ideal Coxeter 3-cube and the local density of the inball packing induced by a tessellation of \mathbb{H}^3 by isometric copies of it.

Secondly, we study so-called *hyperbolic truncated simplices*, that is, hyperbolic polyhedra arising as finite-volume truncated part of an arrangement of $n + 1$ hyperplanes in \mathbb{H}^n . This class of polyhedra includes several important Coxeter polyhedra related to small volume orbifolds.

We provide a criterion in order to decide whether such an arrangement admits an inball. As a consequence, we provide a formula for the inradius of a hyperbolic truncated simplex in terms of the determinant and cofactors of the associated *reduced Gram matrix*. We use the vector space approach initiated by Milnor and Vinberg, Gram matrix theory, and geometric bisection properties in order to provide an explicit description of the center of the inball. Direct consequences include formulas for the circumradius of compact hyperbolic simplices, the in- and circumradii of spherical simplices, as well as inradius monotonicity.

As an application, we determine the local densities of inball packings resulting from tessellations of \mathbb{H}^n by certain small volume hyperbolic Coxeter polyhedra. This part has already been published in [29]. Moreover, we use Poincaré's ideas in the context of planar tessellations in order to provide an alternative proof of Siegel's result on the minimal co-area discrete subgroup of $\text{Isom}(\mathbb{H}^2)$. This proof allows us to determine the fundamental N -gons of minimal area for $3 \leq N \leq 6$, and to show that amongst all fundamental triangles, the Coxeter triangle [3, 7] has the smallest inradius.

Finally, we determine the commensurability classes of *hyperbolic Coxeter pyramid groups*, that is, cofinite Coxeter groups whose fundamental Coxeter polyhedron is a noncompact pyramid based on the product of two simplices of positive dimensions. In the arithmetic case, we use algebraic methods developed by Maclachlan [39] involving quadratic forms, their related Hasse-Witt invariants and their ramification sets. We compare this classification with the commensurability classes of simplicial Coxeter groups due to Johnson-Kellerhals-Ratcliffe-Tschantz [31], whenever possible. In the non-arithmetic case, we use and develop tools coming from the theory of abstract Coxeter groups, free products with amalgamation, fields generated by traces of Coxeter elements, the geometry of Euclidean lattices, as well as dissection properties.

This part is a joint work with R. Guglielmetti and R. Kellerhals [24].

In order to close the loop, we finish this work by determining the commensurability classes of the 7 ideal hyperbolic Coxeter 3-cubes.

Chapter 2

Preliminaries

2.1 Polyhedra in the model geometric spaces

In this section, we remind the reader about the notions of a polyhedron in the spherical, Euclidean and hyperbolic spaces and its Gram matrix, and we discuss their existence, with a focus on hyperbolic polyhedra. Standard references in this context are [51, 65].

2.1.1 Model geometric spaces

By a *model geometric space*, we mean one of the three simply connected Riemannian manifolds of constant sectional curvature 1, 0 and -1 : the spherical space \mathbb{S}^n , the Euclidean space \mathbb{E}^n , and the hyperbolic space \mathbb{H}^n , respectively. They can be modelled as follows.

For $\varepsilon \in \{-1, 0, 1\}$, let the bilinear form $\langle \cdot, \cdot \rangle_\varepsilon$ be given by

$$\langle x, y \rangle_\varepsilon := \sum_{i=1}^n x_i y_i + \varepsilon \cdot x_{n+1} y_{n+1}$$

for two vectors $x = (x_1, \dots, x_{n+1})$ and $y = (y_1, \dots, y_{n+1})$ in \mathbb{R}^{n+1} . In particular, $\langle \cdot, \cdot \rangle_{-1}$ is of signature $(n, 1)$ and $\langle \cdot, \cdot \rangle_1$ is positive definite.

Furthermore, for $\rho \in \mathbb{R}$, let

$$\mathcal{S}_\varepsilon(\rho) = \{x \in \mathbb{R}^{n+1} \mid \langle x, x \rangle_\varepsilon = \rho\}$$

be the (pseudo-)sphere of radius ρ with respect to $\langle \cdot, \cdot \rangle_\varepsilon$.

This general setting allows us a simultaneous definition of the three model geometric spaces as follows.

Definition 2.1. • The *spherical space* \mathbb{S}^n is the sphere

$$\mathbb{S}^n = \{x \in \mathbb{R}^{n+1} \mid \langle x, x \rangle_1 = 1\}$$

together with the spherical metric given by

$$d_S(x, y) = \arccos \langle x, y \rangle_1$$

for any $x, y \in \mathbb{S}^n$.

- The *Euclidean space* \mathbb{E}^n can be identified with the hyperplane

$$\mathbb{E}^n = \{x \in \mathbb{R}^{n+1} \mid x_{n+1} = 0\},$$

equipped with the Euclidean metric given by

$$d_E(x, y) = \sqrt{\langle x - y, x - y \rangle_1},$$

for any $x, y \in \mathbb{E}^n$.

- The *hyperbolic space* \mathbb{H}^n can be modelled by means of the upper shell of the hyperboloid, i.e.

$$\mathcal{H}^n = \{x \in \mathbb{R}^{n+1} \mid \langle x, x \rangle_{-1} = -1, x_{n+1} > 0\},$$

equipped with the hyperbolic metric given by

$$d_{\mathcal{H}}(x, y) = \operatorname{arcosh}(-\langle x, y \rangle_{-1}),$$

for any $x, y \in \mathcal{H}^n$.

Its boundary $\partial\mathcal{H}^n$ consisting of points at infinity of \mathcal{H}^n can be described, up to the choice of a representative, by

$$\partial\mathcal{H}^n = \{x \in \mathcal{S}_{-1}(0) \cap \mathcal{S}_1(1) \mid x_{n+1} \geq 0\}.$$

Then, the closure $\overline{\mathcal{H}^n}$ is the union $\mathcal{H}^n \cup \partial\mathcal{H}^n$.

Notice that \mathbb{S}^n coincides with $\mathcal{S}_1(1)$ and that \mathcal{H}^n is the upper connected component of $\mathcal{S}_{-1}(-1)$. In the sequel, we will denote by $\mathbb{M}^n(\varepsilon)$ the simply connected Riemannian manifold of dimension n and constant sectional curvature equal to ε , with $\varepsilon \in \{-1, 0, 1\}$, i.e. $\mathbb{M}^n(1) = \mathbb{S}^n$, $\mathbb{M}^n(0) = \mathbb{E}^n$, and $\mathbb{M}^n(-1) = \mathcal{H}^n$. Moreover, we set $\mathcal{S}_0(1) := \mathbb{S}^{n-1}$.

Remark 2.1. There are other models for \mathbb{H}^n . The most important ones are Klein's projective model $\mathcal{K}^n \subset \mathbb{R}P^n$ and Poincaré's models in the upper half-space $\mathcal{U}^n \subset \mathbb{R}^{n+1}$ and in the unit ball $\mathcal{B}^n \subset \mathbb{R}^{n+1}$. All models have their own advantages :

- The vector space model \mathcal{H}^n is particularly convenient when considering hyperplanes given by their normal vectors, and the Gram matrix of a system of vectors. For this reason, it will be our reference model.

- The non-conformal projective model \mathcal{K}^n can be used in order to study the relative position of hyperplanes and the combinatorial structure of such arrangements.
- Poincaré's upper half-space model \mathcal{U}^n is especially designed for the study of hyperbolic isometries and their representation by Clifford matrices, via the identification $\text{Isom}(\mathcal{U}^n) \cong \text{PSL}_2(C_{n-2})$, where C_{n-2} is the Clifford algebra with $n - 2$ non-trivial generators (in particular, $C_0 = \mathbb{R}$ and $C_1 = \mathbb{C}$).
- Poincaré's ball model \mathcal{B}^n is conformal and provides a visualization of the points at infinity.

2.1.2 Hyperplanes and polyhedra

For $\varepsilon = 0$, i.e. $\mathbb{M}^n(\varepsilon) = \mathbb{E}^n$ is the Euclidean space, a hyperplane is of the form

$$H_{u,a} = \{x \in \mathbb{R}^n \mid \langle x, u \rangle_1 = 0\} + a,$$

for a *normal vector* $u \in \mathbb{S}^{n-1}$, and a translational vector $a \in \mathbb{R}^n$.

Let us consider now the case where $\varepsilon \in \{-1, 1\}$. For vector $u \in \mathcal{S}_\varepsilon(1)$, the orthogonal complement \widehat{H}_u of u is given by

$$\widehat{H}_u := u^\perp = \{x \in \mathbb{R}^{n+1} \mid \langle x, u \rangle_\varepsilon = 0\}.$$

Then, the intersection $H_u \subset \mathbb{M}^n(\varepsilon)$ given by

$$H_u = \widehat{H}_u \cap \mathbb{M}^n(\varepsilon)$$

is a hyperplane in $\mathbb{M}^n(\varepsilon)$ with *normal vector* $u \in \mathcal{S}_\varepsilon(1)$. Conversely, for any hyperplane $H \subset \mathbb{M}^n(\varepsilon)$, there is a vector $u \in \mathcal{S}_\varepsilon(1)$ such that $H = u^\perp \cap \mathbb{M}^n(\varepsilon)$.

The relative position of two hyperplanes $H_u, H_v \subset \mathbb{M}^n(\varepsilon)$ with normal vectors $u, v \in \mathcal{S}_\varepsilon(1)$, can be determined by looking at the product $\langle u, v \rangle_\varepsilon$ as follows [51, Chapters 1.3, 2.2 and 3.2]

- If $\mathbb{M}^n(\varepsilon) = \mathbb{E}^n$, $u, v \in \mathbb{S}^{n-1}$, $a, b \in \mathbb{R}^n$, then $H_{u,a}$ and $H_{v,b}$ properly intersect in \mathbb{E}^n if and only if $|\langle u, v \rangle_1| \neq 1$, and their dihedral angle $\angle(H_{u,a}, H_{v,b})$ is given by

$$\cos \angle(H_{u,a}, H_{v,b}) = -\langle u, v \rangle_1. \quad (2.1)$$

If $|\langle u, v \rangle_1| = 1$, then they are *parallel*, and their intersection angle is 0.

- If $\mathbb{M}^n(\varepsilon) = \mathbb{S}^n$, $u, v \in \mathcal{S}_1(1)$, then H_u and H_v always intersect in \mathbb{S}^n , and their dihedral angle $\angle(H_u, H_v)$ is given by

$$\cos \angle(H_u, H_v) = -\langle u, v \rangle_1. \quad (2.2)$$

- If $\mathbb{M}^n(\varepsilon) = \mathcal{H}^n$, $u, v \in \mathcal{S}_{-1}(1)$, then

- H_u and H_v intersect in \mathcal{H}^n if and only if $|\langle u, v \rangle_{-1}| < 1$. Then, their dihedral angle $\angle(H_u, H_v)$ is given by

$$\cos \angle(H_u, H_v) = -\langle u, v \rangle_{-1}. \quad (2.3)$$

- H_u and H_v intersect in $\partial\mathcal{H}^n$ if and only if $|\langle u, v \rangle_{-1}| = 1$. They are called *parallel*, and their intersection angle is 0.
- H_u and H_v do not intersect in $\overline{\mathcal{H}^n}$ if and only if $|\langle u, v \rangle_{-1}| > 1$. They are called *ultra-parallel*, and the distance $d(H_u, H_v)$ is given by

$$\cosh d(H_u, H_v) = |\langle u, v \rangle_{-1}|. \quad (2.4)$$

Furthermore, if L is the hyperbolic line orthogonal to H_u and H_v , then $\langle u, v \rangle_{-1} < 0$ if and only if u and v are oppositely oriented tangent vectors to L .

For $\varepsilon \in \{-1, 1\}$, let $H_u \subset \mathbb{M}^n(\varepsilon)$ be a hyperplane with normal vector $u \in \mathcal{S}_\varepsilon(1)$. Then, the (closed) *half-space* bounded by H_u with normal vector u pointing outwards is given by

$$H_u^- = \{x \in \mathbb{M}^n(\varepsilon) \mid \langle x, u \rangle_\varepsilon \leq 0\}.$$

A similar construction holds in the Euclidean case.

Definition 2.2. A *polyhedron* $\mathcal{P} \subset \mathbb{M}^n(\varepsilon)$ is the intersection, with nonempty interior, of finitely many half-spaces in $\mathbb{M}^n(\varepsilon)$, that is,

$$\mathcal{P} = \bigcap_{i=1}^N H_i^- \subset \mathbb{M}^n(\varepsilon),$$

with $N \geq n+1$. We require that the hyperplanes H_1, \dots, H_N form a minimal family of hyperplanes bounding \mathcal{P} . Moreover, we write $H_i =: H_{u_i}$, with *normal vectors* $u_i \in \mathcal{S}_\varepsilon(1)$. By construction, \mathcal{P} is convex. Up to isometry, \mathcal{P} is entirely determined by its normal vectors u_1, \dots, u_N . If $N = n+1$, then \mathcal{P} is a (n -)simplex in $\mathbb{M}^n(\varepsilon)$.

Remark 2.2. For the rest of this work, we will assume that any polyhedron $\mathcal{P} \subset \overline{\mathcal{H}^n}$ is of finite volume, unless otherwise specified.

Definition 2.3. The *facet* (or $(n - 1)$ -*face*) F_i of \mathcal{P} is the intersection

$$F_i = \mathcal{P} \cap H_{u_i}, \quad 1 \leq i \leq N.$$

If two facets F_i and F_j intersect, their *dihedral angle* is given by $\angle(H_{u_i}, H_{u_j})$ according to (2.2)-(2.4). A polyhedron is called *acute-angled* if any pair of its facets is either disjoint or intersects under a dihedral angle not greater than $\frac{\pi}{2}$.

Definition 2.4. For $0 \leq k \leq n$, a k -*face* of \mathcal{P} is a facet of a $(k + 1)$ -face of \mathcal{P} . A 0-face of \mathcal{P} is called a *vertex*, and a 1-face of \mathcal{P} is called an *edge*.

Definition 2.5. For $k \in \{0, \dots, n\}$, let $f_k(\mathcal{P})$ be the number of k -faces of \mathcal{P} . The vector

$$f(\mathcal{P}) := (f_0(\mathcal{P}), \dots, f_{n-1}(\mathcal{P}), 1) \in \mathbb{R}^{n+1}$$

is called the *f-vector* of \mathcal{P} .

Definition 2.6. The *figure* (or *link*) of a vertex v of \mathcal{P} is the intersection

$$L(v) = \mathcal{P} \cap \mathfrak{S}_\rho(v),$$

where $\mathfrak{S}_\rho(v)$ is a sphere with center v and radius $\rho > 0$ not containing any other vertex of \mathcal{P} and not intersecting any facet not incident to v .

Definition 2.7. A polyhedron in $\mathbb{M}^n(\varepsilon)$ is said to be *simple* if any of its k -dimensional faces is the intersection of exactly $n - k$ facets.

Definition 2.8. The *Gram matrix* of \mathcal{P} is the matrix $G = G(\mathcal{P}) = (g_{ij})_{1 \leq i, j \leq N}$ given by

$$g_{ij} = \langle u_i, u_j \rangle_\varepsilon, \quad i, j = 1, \dots, N.$$

In particular, G is real symmetric with $g_{ii} = 1$ for all $i = 1, \dots, N$. The relations (2.2) to (2.4) provide a geometric interpretation of the entries of G . Furthermore, if \mathcal{P} is acute-angled, the rank and the signature of G enjoy the following properties [65, Chapter 6.1.1].

- If $\mathcal{P} \subset \mathbb{S}^n$ is a spherical polyhedron, then G has rank $n + 1$ and is positive definite.
- If $\mathcal{P} \subset \mathbb{E}^n$ is a Euclidean polyhedron, then G has rank n and is positive semidefinite.
- If $\mathcal{P} \subset \mathcal{H}^n$ is a hyperbolic polyhedron, then G has rank $n + 1$ and signature $(n, 1)$.

For a matrix $M \in \text{Mat}(n, \mathbb{R})$, let $\text{cof}_{i,j}(M)$ be the (i, j) -th *cofactor* of M . The following result is due to Milnor and shows that there is one-to-one correspondence between Gram matrices of a certain type and simplices in $\mathbb{M}^n(\varepsilon)$.

Theorem 2.1 (Milnor [47]). *Let $n \in \mathbb{N}$ and let $G = (g_{ij})_{1 \leq i, j \leq n+1} \in \text{Mat}(n+1, \mathbb{R})$ be symmetric and such that $g_{ii} = 1$ for $i = 1, \dots, n+1$ and $g_{ij} \in [-1, 0]$ for $1 \leq i, j \leq n+1$. Then,*

- *If $g_{ij} \neq -1$ for $1 \leq i, j \leq n+1$ and G is positive definite, then G is the Gram matrix of a spherical simplex in \mathbb{S}^n which is unique up to isometry. Its dihedral angles can be determined by using (2.2).*
- *If G is positive semidefinite of rank n such that for $i, j \in \{1, \dots, n+1\}$, the cofactor $\text{cof}_{ij}(G)$ is positive, then G is the Gram matrix of a Euclidean simplex in \mathbb{E}^n which is unique up to isometry. Its dihedral angles can be determined by using (2.1).*
- *If G is of signature $(n, 1)$ such that for all $i, j \in \{1, \dots, n+1\}$, the cofactor $\text{cof}_{ij}(G)$ is positive, then G is the Gram matrix of a hyperbolic simplex in \mathcal{H}^n which is unique up to isometry. Its dihedral angles can be determined by using (2.3).*

The main idea of the proof is the following. Let $J_\varepsilon = \text{Diag}(1, \dots, 1, \varepsilon)$ be the matrix associated to the quadratic form $\langle \cdot, \cdot \rangle_\varepsilon$ on \mathbb{R}^{n+1} . Then, since G is symmetric, there exists a matrix $U \in \text{GL}(n+1, \mathbb{R})$ such that $G = U^t J_\varepsilon U$. By writing $U = (u_1 | \dots | u_{n+1})$ as a matrix of column vectors, the condition on the cofactors ensures that the vectors u_1, \dots, u_{n+1} can be interpreted as normal vectors of a simplex \mathcal{P} in $\mathbb{M}^n(\varepsilon)$. We shall come back and elaborate this construction in Section 4.1 for hyperbolic truncated simplices.

2.1.3 Hyperbolic polyhedra

In this section, we shall review some general facts about hyperbolic polyhedra. We first extend the discussion of the hyperbolic space \mathcal{H}^n .

Definition 2.9. For $k \geq 1$, a k -dimensional vector subspace $V \subset \mathbb{R}^{n+1}$ is *hyperbolic* if it has a nonempty intersection with \mathcal{H}^n , and the intersection $V \cap \mathcal{H}^n$ is a *hyperbolic $(k-1)$ -plane*. It is *elliptic* if $V \cap \overline{\mathcal{H}^n}$ is empty. In the remaining case, V is called *parabolic*.

In particular, the orthogonal complement

$$V^\perp = \{x \in \mathbb{R}^{n+1} \mid \langle v, x \rangle_{-1} = 0, \forall v \in V\}$$

is elliptic if and only if V is hyperbolic [51, Chapter 3.2].

Recall that we shall always assume that $\mathcal{P} \subset \overline{\mathcal{H}^n}$ is of finite volume, i.e. $\text{vol}_n(\mathcal{P}) < \infty$. Moreover, if all vertices of \mathcal{P} lie on $\partial\mathcal{H}^n$, then \mathcal{P} is called *ideal*.

The following result gives a complete characterization of hyperbolic polygons of finite area (see [65, Chapter 3.2], for example).

Theorem 2.2. Let $N \geq 3$ be an integer and $0 \leq \alpha_1, \dots, \alpha_N < \pi$ be non-negative real numbers such that

$$\alpha_1 + \dots + \alpha_N < (N - 2) \cdot \pi. \quad (2.5)$$

Then, there exists a hyperbolic N -gon $\mathcal{P} \subset \overline{\mathcal{H}^2}$ with angles $\alpha_1, \dots, \alpha_N$. Conversely, if $0 \leq \alpha_1, \dots, \alpha_N < \pi$ are the angles of an N -gon $\mathcal{P} \subset \overline{\mathcal{H}^2}$, then they satisfy (2.5).

Moreover, the area of \mathcal{P} is given by the angle defect $(N - 2)\pi - \sum_{i=1}^N \alpha_i$.

In $\overline{\mathcal{H}^n}$, $n \geq 2$, we can say even more. First, compact acute-angled hyperbolic polyhedra satisfy the following combinatorial property [65, Section 6.1.2, Theorem 1.8].

Theorem 2.3 (Vinberg). Let $\mathcal{P} \subset \mathcal{H}^n$ be a compact acute-angled polyhedron. Then \mathcal{P} is simple.

Moreover, if $\mathcal{P} \subset \overline{\mathcal{H}^n}$ is an acute-angled polyhedron and if v is a vertex of \mathcal{P} , then $v \in \partial\mathcal{H}^n$ if and only if its figure $L(v)$ is a Euclidean polyhedron, and $v \in \mathcal{H}^n$ if and only if $L(v)$ is a spherical polyhedron (see [65, Chapter 6]).

Definition 2.10. A *prismatic k -circuit* of a polyhedron $\mathcal{P} \subset \overline{\mathcal{H}^3}$ is a sequence of k facets F_1, \dots, F_k of \mathcal{P} such that F_1 intersects only F_k and F_2 , F_k intersects only F_{k-1} and F_1 , and F_i intersects only F_{i-1} and F_{i+1} for $i = 2, \dots, k - 1$, and all corresponding edges are disjoint.

Next, we introduce the notion of an *abstract polyhedron* in order to discuss existence properties.

Definition 2.11. Let $(P, <)$ be a partially ordered set. We call *faces* the elements of P .

Let $Q \subseteq P$ be a subset of P . A face $F \in Q$ is called *the greatest face of Q* if $G < F$ for all $G \in Q \setminus \{F\}$, and it is called *the smallest face of Q* if $F < G$ for all $G \in Q \setminus \{F\}$.

A *chain of P* is a totally ordered subset of P .

Remark 2.3. In general, a subset $Q \subseteq P$ has no greatest or smallest face. However, if Q is a chain, then it has a greatest and a smallest face.

If $Q = \{F\}$, then F is both the greatest and the smallest face of Q .

Definition 2.12. Let $(P, <)$ be a partially ordered set. The *rank* $\text{rk}(F)$ of a face $F \in P$ is given by $\text{rk}(F) = m - 2$, where m is the maximal number of faces in any chain of P whose greatest face is F .

A face of P of rank k , $-1 \leq k \leq \infty$, is called a *k -face of P* .

If a subset $Q \subseteq P$ has a greatest face, say F , then its *rank* $\text{rk}(Q)$ is the rank of F .

Definition 2.13. Let $(P, <)$ be a partially ordered set, and $F, G \in P$ be two faces of P such that $F < G$. The set $G/F := \{K \in P \mid F < K < G\} \subset P$ is called a *section* of P .

Definition 2.14. Let $n \geq 0$. An *abstract n -polyhedron* is a partially ordered set $(P, <)$ satisfying the following axioms :

- (1) It has a greatest face (of rank n) and a least face.
- (2) All maximal chains (so-called *flags*) of P contain the same number of faces.
- (3) It is strongly connected (i.e. all sections of P are connected).
- (4) Every section of rank 1 of P is a line segment (i.e. is has a greatest face, exactly two 0-faces, and a least face).

For more details about abstract polyhedra, see for example [45, Part 2A]. The following result due to Andreev has been fully proved by Roeder [53].

Theorem 2.4 (Andreev [1]). *Let $\mathcal{P} \subset \mathcal{H}^3$ be a compact acute-angled polyhedron with $N \geq 5$ facets and $M \geq 5$ edges with corresponding dihedral angles $\alpha_1, \dots, \alpha_M \leq \frac{\pi}{2}$. Then,*

- (1) For all $i = 1, \dots, M$, $\alpha_i > 0$.
- (2) If three edges e_i, e_j, e_k meet at a vertex, then $\alpha_i + \alpha_j + \alpha_k > \pi$.
- (3) For any prismatic 3-circuit with intersecting edges e_i, e_j, e_k , one has $\alpha_i + \alpha_j + \alpha_k < \pi$.
- (4) For any prismatic 4-circuit with intersecting edges e_i, e_j, e_k, e_l , one has $\alpha_i + \alpha_j + \alpha_k + \alpha_l < 2\pi$.
- (5) For any quadrilateral facet F bounded successively by edges e_i, e_j, e_k, e_l such that $e_{ij}, e_{jk}, e_{kl}, e_{li}$ are the remaining edges of \mathcal{P} based at the vertices of F (e_{pq} is based at the intersection of e_p and e_q), then

$$\alpha_i + \alpha_k + \alpha_{ij} + \alpha_{jk} + \alpha_{kl} + \alpha_{li} < 3\pi$$

and

$$\alpha_j + \alpha_l + \alpha_{ij} + \alpha_{jk} + \alpha_{kl} + \alpha_{li} < 3\pi.$$

Furthermore, the converse holds, i.e. any abstract 3-polyhedron satisfying the conditions above can be realized as a compact acute-angled hyperbolic 3-polyhedron.

Andreev's result has been generalized to ideal hyperbolic 3-polyhedra by Rivin. Let us recall that the *dual* of a polyhedron $\mathcal{P} \subset \overline{\mathcal{H}^3}$ is the polyhedron \mathcal{P}^* such that the set of vertices of \mathcal{P} is in bijection with the set of facets of \mathcal{P}^* , and vice-versa. Furthermore, for any edge e of \mathcal{P} associated to a dihedral angle α , the corresponding edge e^* of \mathcal{P}^* supports a dihedral angle α^* given by $\alpha^* = \pi - \alpha$. The result reads as follows.

Theorem 2.5 (Rivin [52]). *Let $\mathcal{P} \subset \overline{\mathcal{H}^3}$ be an ideal polyhedron. Then, its dual $\mathcal{P}^* \subset \overline{\mathcal{H}^3}$ satisfies the following conditions.*

- (1) *For any dihedral angle α^* of \mathcal{P}^* , one has $0 < \alpha^* < \pi$.*
- (2) *If the edges e_1^*, \dots, e_k^* with associated dihedral angles $\alpha_1^*, \dots, \alpha_k^*$ form the boundary of a facet of \mathcal{P}^* , then*

$$\sum_{i=1}^k \alpha_i^* = 2\pi.$$

- (3) *If the edges e_1^*, \dots, e_k^* with associated dihedral angles $\alpha_1^*, \dots, \alpha_k^*$ form a closed circuit in \mathcal{P}^* but do not bound a facet, then*

$$\sum_{i=1}^k \alpha_i^* > 2\pi.$$

Moreover, any polyhedron $\mathcal{P}^* \subset \overline{\mathcal{H}^n}$ satisfying the above conditions (1) – (3) is the dual of some ideal polyhedron $\mathcal{P} \subset \overline{\mathcal{H}^n}$, which is unique up to isometry.

2.1.4 Examples

- (1) Let \mathcal{C} be an abstract 3-cube with angles $\alpha, \beta, \gamma \in]0, \pi/2[$ as depicted in Figure 2.1, and with all other angles being right angles.

Then, one can check that all conditions of Andreev's Theorem are satisfied, so that \mathcal{C} can be realized as a compact hyperbolic cube in \mathcal{H}^3 .

Such a polyhedron is called a *Lambert cube* (see also Section 4.1.1, (2)).

- (2) For a parameter $\alpha \in \mathbb{R}_{\geq 0}$, consider the matrix $G(\alpha)$ given by

$$G(\alpha) = \begin{pmatrix} 1 & -1/2 & 0 \\ -1/2 & 1 & -\cos \alpha \\ 0 & -\cos \alpha & 1 \end{pmatrix}.$$

Its characteristic polynomial $\chi = \chi_{G(\alpha)}$ is given by

$$\chi(\lambda) = (1 - \lambda) \left(\lambda^2 - 2\lambda + \frac{3}{4} - \cos^2 \alpha \right), \quad \lambda \in \mathbb{R}.$$

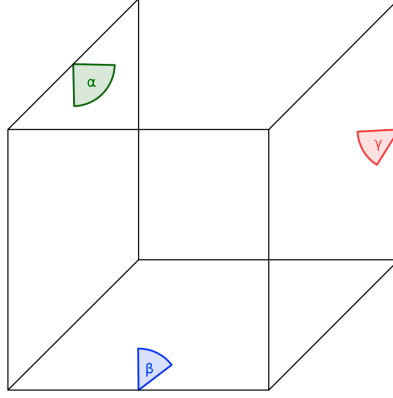

Figure 2.1

Hence, the eigenvalues $\lambda_1, \lambda_2, \lambda_3$ of $G(\alpha)$ are given by

$$\lambda_1 = 1, \quad \lambda_2 = 1 + \sqrt{\frac{1}{4} + \cos^2 \alpha}, \quad \lambda_3 = 1 - \sqrt{\frac{1}{4} + \cos^2 \alpha}.$$

For all $\alpha \in \mathbb{R}_{\geq 0}$, the eigenvalues λ_1 and λ_2 are positive. The eigenvalue λ_3 is negative (respectively zero, positive) if and only if $\alpha > \frac{\pi}{6}$ (respectively $= \frac{\pi}{6}, < \frac{\pi}{6}$). Hence, by Theorem 2.1, $G(\alpha)$ is the Gram matrix of a spherical (respectively Euclidean, hyperbolic) triangle $T(\alpha)$ of angles $\frac{\pi}{2}, \frac{\pi}{3}$ and α if and only if $\alpha > \frac{\pi}{6}$ (respectively $= \frac{\pi}{6}, < \frac{\pi}{6}$).

In particular, for an integer $k \geq 2$, the triangle $T(\frac{\pi}{k})$ is spherical if and only if $k = 2, 3, 4, 5$, Euclidean if and only if $k = 6$, and hyperbolic if and only if $k \geq 7$.

2.2 Coxeter groups

The aim of this section is to present Coxeter polyhedra and Coxeter groups, and to review some of their geometric and combinatorial properties, as well as existence and classification results. References for this section are [7, 28, 65].

2.2.1 Coxeter polyhedra and Coxeter groups

Definition 2.15. A *Coxeter polyhedron* in $\mathbb{M}^n(\varepsilon)$ is a polyhedron $\mathcal{P} \subset \mathbb{M}^n(\varepsilon)$ whose dihedral angles are of the form $\frac{\pi}{k}$ for $k \in \{2, 3, \dots, \infty\}$.

If \mathcal{P} is of finite volume, then it is bounded by finitely many hyperplanes, say H_1, \dots, H_N . For a polyhedron, we denote by $s_1, \dots, s_N \in \text{Isom}(\mathbb{M}^n(\varepsilon))$ the reflections with respect to the hyperplanes H_1, \dots, H_N , respectively. Since

the dihedral angles of \mathcal{P} are integral submultiples of π , the relations between the reflections s_1, \dots, s_N can be deduced from the geometry of \mathcal{P} in the following way.

- Since s_1, \dots, s_N are reflections, one has $s_i^2 = 1$ for $i = 1, \dots, N$.
- If the hyperplanes H_i and H_j intersect in $\mathbb{M}^n(\varepsilon)$ under an angle $\frac{\pi}{k_{ij}}$, $k \geq 2$, then $(s_i s_j)^{k_{ij}} = 1$.
- If the hyperplanes H_i and H_j are parallel (in the Euclidean or hyperbolic sense) or ultra-parallel, then the reflections s_i and s_j have no relation, i.e. the product $s_i s_j$ is of infinite order in $\text{Isom}(\mathbb{M}^n(\varepsilon))$.

In particular, the product of two reflections in the facets of a spherical polyhedron is always of finite order.

Definition 2.16. The group $W < \text{Isom}(\mathbb{M}^n(\varepsilon))$ with set of generators $S = \{s_1, \dots, s_N\}$ satisfying the relations above is the *Coxeter group associated to* \mathcal{P} . It is finitely presented, with presentation

$$W = \langle s_1, \dots, s_N \mid (s_i s_j)^{k_{ij}} \rangle,$$

with $k_{ii} = 1$ and $k_{ij} = k_{ji} \in \{2, \dots, \infty\}$ for $1 \leq i, j \leq N$, $i \neq j$. The pair (W, S) is a *Coxeter system*, and the number $N = |S|$ of generators of W is the *rank of* W . The group W is a discrete subgroup of $\text{Isom}(\mathbb{M}^n(\varepsilon))$, with fundamental polyhedron \mathcal{P} . It is called *cocompact* if and only if $\mathcal{P} \subset \mathbb{M}^n(\varepsilon)$ is compact, and *cofinite* if and only if $\mathcal{P} \subset \mathbb{M}^n(\varepsilon)$ is of finite volume.

Definition 2.17. A Coxeter polyhedron $\mathcal{P} \subset \mathbb{M}^n(\varepsilon)$ and its Coxeter group $W < \text{Isom}(\mathbb{M}^n(\varepsilon))$ are often described by their *Coxeter graph* $\Gamma = \Gamma(\mathcal{P}) = \Gamma(W)$ of rank N as follows. A node i in Γ represents the bounding hyperplane H_i of \mathcal{P} (or the generator s_i of W). Two nodes i and j are joined by an edge with weight $k_{ij} \geq 2$ if H_i and H_j intersect in $\mathbb{M}^n(\varepsilon)$ with angle $\frac{\pi}{k_{ij}}$, and with weight ∞ if H_i and H_j are parallel. If the hyperplanes H_i and H_j have a common perpendicular in \mathcal{H}^n , the nodes i and j are joined by a dotted edge. In practice, an edge of weight 2 is omitted, an edge of weight 3 is written without label, and an edge of weight ∞ is denoted by a bold edge.

Definition 2.18. Coxeter groups with linear graphs of rank $r + 1 \geq 2$ with weights $k_1 = k_{1,2}, \dots, k_r = k_{r,r+1}$, called *Coxeter orthoschemes*, are often denoted by the Coxeter symbol $[k_1, \dots, k_r]$.

The notion of Coxeter group appears in the context of finitely presented abstract groups (see [28], for example). In fact, a Coxeter group $W = \langle S, R \rangle$ with set of generators S and set of relations R is called *elliptic* (or

finite), parabolic (or affine) or hyperbolic, respectively, if it is isomorphic to a subgroup of $\text{Isom}(\mathbb{S}^n)$, $\text{Isom}(\mathbb{E}^n)$ or $\text{Isom}(\mathbb{H}^n)$, respectively, and the Coxeter graph $\Gamma = \Gamma(W)$ is the graph of respectively a spherical, Euclidean or hyperbolic polyhedron \mathcal{P} . In particular, elliptic Coxeter groups are finite, and parabolic and hyperbolic Coxeter groups are infinite.

2.2.2 Classification of geometric Coxeter groups

Definition 2.19. By a *geometric Coxeter group*, we mean a Coxeter group which is isomorphic to some subgroup of $\text{Isom}(\mathbb{M}^n(\varepsilon))$, $\varepsilon \in \{-1, 0, 1\}$ (see Section 2.2.1).

Elliptic and parabolic Coxeter groups (and therefore the corresponding spherical and Euclidean Coxeter polyhedra) are well understood and completely classified. They exist in any dimension $n \geq 1$, and if we restrict to irreducible groups, they are described by a graph with one connected component only. One has the following finite lists (containing both infinite and finite families).

Theorem 2.6 (Coxeter [11]). *Let W be an elliptic (finite) Coxeter group with connected Coxeter graph $\Gamma(W)$. Then, $\Gamma(W)$ is isomorphic to one of the graphs on Figure 2.2.*

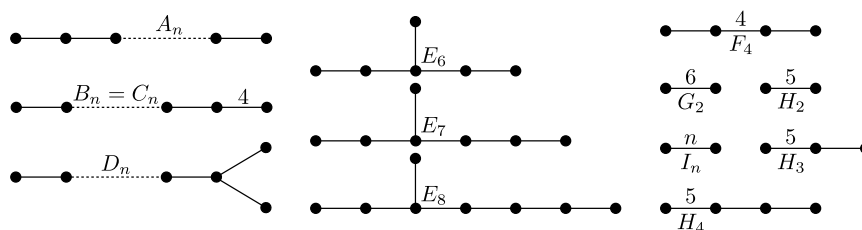

Figure 2.2: Graphs of the irreducible elliptic Coxeter groups

Theorem 2.7 (Coxeter [11]). *Let W be a parabolic (affine) Coxeter group with connected Coxeter graph $\Gamma(W)$. Then, $\Gamma(W)$ is isomorphic to one of the graphs on Figure 2.3.*

The situation is radically different for cofinite hyperbolic Coxeter groups and polyhedra : they do not exist any more in high dimensions and their classification is far from being completed ! We give an overview of the situation. Let us start with the upper dimensional bounds.

Theorem 2.8 (Prokhorov-Khovanskij [50]). *There are no cofinite hyperbolic Coxeter groups $W < \text{Isom}(\mathcal{H}^n)$ for $n \geq 996$.*

Theorem 2.9 (Vinberg [64]). *There are no cocompact hyperbolic Coxeter groups $W < \text{Isom}(\mathcal{H}^n)$ for $n \geq 30$.*

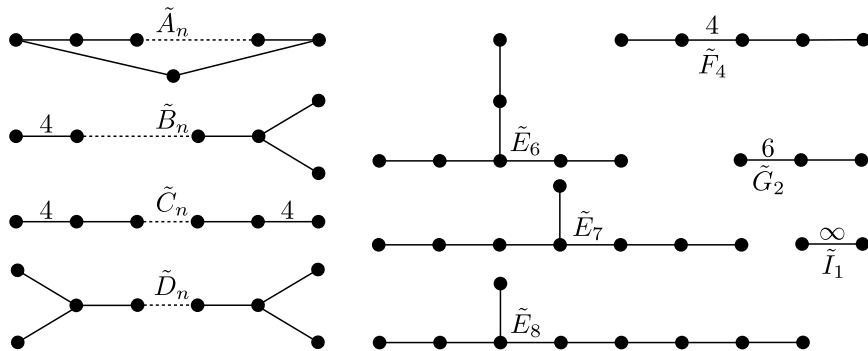

Figure 2.3: Graphs of the irreducible parabolic Coxeter groups

Notice that the greatest n for which we have examples of hyperbolic Coxeter groups is $n = 21$ (Borcherds [5], finite-volume case), respectively $n = 8$ (Bugaenko [8], compact case).

The classification of Coxeter polygons as well as compact, resp. ideal, Coxeter polyhedra in $\overline{\mathcal{H}^3}$ can be directly deduced from Theorems 2.2, 2.4 and 2.5 stated above. Hyperbolic Coxeter polyhedra of fixed rank $N \geq n + 1$ in $\overline{\mathcal{H}^n}$ are classified only for small N .

The hyperbolic Coxeter simplices ($N = n + 1$) have been classified by Lannér and Koszul. The corresponding Coxeter graphs are often called *Lannér* (compact case), resp. *quasi-Lannér* (noncompact case) graphs. Tables are given in [65, pp. 205-208] for example.

Notice that the class of hyperbolic simplices is the only class where all volumes are known [30] and which has been split further into commensurability classes [31].

A complete classification for $N = n + 2$ has been performed by Kaplinskaya [32] (prisms), Esselmann [18] (compact polyhedra which are not prisms) and Tumarkin [59] (noncompact polyhedra which are not prisms). Moreover, Tumarkin showed that, up to one exception, all noncompact hyperbolic Coxeter polyhedra with $n + 2$ facets are pyramids.

Definition 2.20. For $N \geq n + 2$, a *rank N hyperbolic Coxeter pyramid group* is the discrete group generated by the reflections in the facets of a finite volume Coxeter polyhedron with N facets in $\overline{\mathcal{H}^n}$ which has the combinatorial type of a pyramid.

Remark 2.4. For the rest of this work, we will simply call *hyperbolic Coxeter pyramid group* a rank $n + 2$ hyperbolic Coxeter pyramid group. The fundamental polyhedron of such a group has the combinatorial type of a

pyramid over the product of two simplices of positive dimensions.

Esselmann [17] and Tumarkin [60] provided a complete classification of compact hyperbolic Coxeter polyhedra with $n+3$ facets. Felikson-Tumarkin [20] showed that there are no compact hyperbolic Coxeter polyhedra in $\overline{\mathcal{H}^n}$ for $n \geq 8$ and classified all such polyhedra in $\overline{\mathcal{H}^7}$. Their different approaches essentially use Gale diagrams in order to perform a case exhaustion.

A classification for $N \geq n+5$ seems to be out of reach for the moment.

By Theorem 2.3, we know that all compact Coxeter polyhedra are simple. Felikson and Tumarkin gave a similar result in the context of ideal Coxeter polyhedra :

Theorem 2.10 (Felikson-Tumarkin [21]). *There is no finite-volume simple ideal Coxeter polyhedron in $\overline{\mathcal{H}^n}$ for $n > 8$.*

Their proof uses a technical result due to Nikulin, which gives an upper bound on the average number of k -dimensional faces in any l -dimensional face of a polyhedron $\mathcal{P} \subset \overline{\mathcal{H}^n}$ with $N \geq n+1$ facets, $1 \leq k \leq l \leq N$.

2.3 Invariants

Coxeter polyhedra and Coxeter groups are fairly simple to describe and enjoy nice algebraic and metric properties. In this section we shall review some important invariants of hyperbolic Coxeter polyhedra. In particular, volume, arithmeticity and commensurability are also invariants of the associated hyperbolic quotient spaces, so-called *n-orbifolds*. The study of these invariants illustrates the particular role of hyperbolic Coxeter groups in the context of extremal hyperbolic *n-orbifolds*.

2.3.1 Inradius

Definition 2.21. The *inradius* of a finite-volume polyhedron $\mathcal{P} \subset \mathbb{M}^n(\varepsilon)$ is the radius of the greatest ball contained in \mathcal{P} .

In the hyperbolic case ($\varepsilon = -1$), explicit formulas have been given only for triangles (see [2]), certain special polygons, and certain particular polyhedra, such as regular simplices (see [35]).

As for orbifolds, Fanoni [19] has proved that the minimal inradius amongst all *orientable* hyperbolic 2-orbifolds is related to the group of orientation-preserving isometries of the Coxeter triangle group [3, 7].

2.3.2 Volume

Volume formulas

Let (W, S) be a hyperbolic Coxeter system. The (orbifold) Euler characteristic $\chi(W)$ of W is given by

$$\chi(W) = \sum_{T \in \mathcal{F}} \frac{(-1)^{|T|}}{f_T(1)},$$

where $\mathcal{F} = \{T \subset S \mid \langle T \rangle < W \text{ is finite}\}$ is in bijection with the finite subgroups of W , and f_T is the growth series of $\langle T \rangle$ (see [37] for details).

In even dimensions $n = 2m$, $m \geq 1$, the covolume of W is known to be proportional to its Euler characteristic, thanks to a result of Heckman [25] (which is in fact a special case of the Gauss-Bonnet Theorem). The explicit expression reads as follows.

Theorem 2.11 (Heckman). *For $m \geq 1$, let $\mathcal{P} \subset \overline{\mathcal{H}^{2m}}$ be a Coxeter polyhedron with Coxeter group $W < \text{Isom}(\mathcal{H}^{2m})$. Then,*

$$\text{vol}(\mathcal{P}) = \text{covol}(W) = \frac{(2\pi)^m}{1 \cdot 3 \cdot \dots \cdot (4m - 1)} \cdot |\chi(W)|. \quad (2.6)$$

For $m = 1$, this expression coincides with the general defect formula given by (see also Theorem 2.2)

Theorem 2.12 (Poincaré). *Let $\mathcal{P} \subset \overline{\mathcal{H}^2}$ be an N -gon (not necessarily of Coxeter type) with angles $\alpha_1, \dots, \alpha_N$, $N \geq 3$. Then,*

$$\text{vol}(\mathcal{P}) = (N - 2)\pi - \sum_{i=1}^N \alpha_i.$$

Formulas *à la Heckman* do not hold for odd dimensions $n = 2m + 1$, $m \geq 1$, since one has $\chi(W) = 0$ for all $W < \text{Isom}(\mathcal{H}^{2m+1})$. In dimension 3, volumes of hyperbolic (Coxeter and non-Coxeter) polyhedra are expressed by means of the *Lobachevsky function* $\mathbb{J} : \mathbb{R} \rightarrow \mathbb{R}$ given by

$$\mathbb{J}(x) := - \int_0^x \log|2 \sin t| dt = \frac{1}{2} \sum_{k=1}^{\infty} \frac{\sin 2kx}{k^2}.$$

The function \mathbb{J} is π -periodic, odd, and satisfies the *distribution law* given by

$$\mathbb{J}(nx) = n \sum_{k=0}^{n-1} \mathbb{J}\left(x + \frac{k\pi}{n}\right), \quad \text{for all } n \in \mathbb{N}^*, \quad (2.7)$$

(see [58, Chapter 7] and [65, Part I, Chapter 7.3] for example).

Minimal volume hyperbolic orbifolds

It is known that there is a unique compact hyperbolic n -orbifold \mathcal{H}^n/H of minimal volume for $n = 2$ and for $n = 3$. The two corresponding groups are given in Table 2.1. There, for $H < \text{Isom}(\mathcal{H}^n)$, we denote by $\mathbb{Z}_2 \rtimes H$ the \mathbb{Z}_2 -extension of H . For $n \geq 4$, the compact hyperbolic n -orbifolds of minimal volume are still unknown.

n	Group	Reference
2		Siegel [55]
3	$\mathbb{Z}_2 \rtimes$ 	Gehring-Marshall-Martin [22, 42]

Table 2.1: Fundamental groups of the minimal volume compact hyperbolic n -orbifolds

The noncompact hyperbolic n -orbifolds of minimal volume are known for $2 \leq n \leq 9$. These spaces have exactly one cusp and are closely related to quotients by hyperbolic Coxeter simplex groups. They are summarized in Table 2.2.



n	Group	Reference
2		Siegel [55]
3		Meyerhoff [46]
4		Hild-Kellerhals [27]
5		Hild [26]
6		Hild [26]
7		Hild [26]
8		Hild [26]
9		Hild [26]

Table 2.2: Fundamental groups of the minimal volume noncompact hyperbolic n -orbifolds

Observe that the fundamental groups listed in Tables 2.1 and 2.2 are Coxeter

groups or \mathbb{Z}_2 -extensions of Coxeter groups.

2.3.3 Commensurability

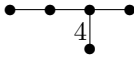
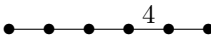
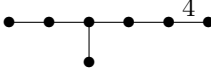
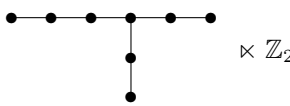
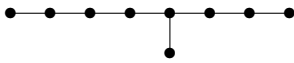
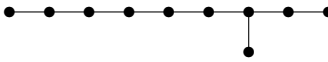
The notion of commensurability is an important tool for the classification of hyperbolic n -orbifolds and n -manifolds.

Definition 2.22. Let H be an arbitrary group. Two subgroups $H_1, H_2 < H$ are said to be *commensurable* if and only if their intersection $H_1 \cap H_2$ has finite index in both H_1 and H_2 (notice that the indices need not coincide). Moreover, H_1 and H_2 are said to be *commensurable in the wide sense* if and only if there is a $h \in H$ such that H_1 is commensurable with $h^{-1}H_2h$.

The notion of commensurability can be directly transported to hyperbolic n -orbifolds by considering the respective fundamental groups. Then, commensurable hyperbolic n -orbifolds admit a finite-sheeted common covering n -orbifold.

We will be interested in the case $H = \text{Isom}(\mathcal{H}^n)$ and where H_1, H_2 are discrete subgroups of H (in particular, Coxeter groups). For $\gamma \in \text{Isom}(\mathcal{H}^n)$, let $\gamma^{-1}H_1\gamma$ be the conjugate of H_1 by γ . Then, the orbifolds \mathcal{H}^n/H_1 and $\mathcal{H}^n/\gamma^{-1}H_1\gamma$ are isometric. Hence, it is sufficient for us to study wide commensurability. For the rest of this work, we will only write "commensurable" for "commensurable in the wide sense", and "commensurability" for "wide commensurability".

Commensurable groups enjoy the following interesting properties (see [31], for example).

Proposition 2.1. *Let $G_1, G_2 < \text{Isom}(\mathcal{H}^n)$ be commensurable.*

- (a) *If G_1 is discrete, then G_2 is discrete (and vice-versa).*
- (b) *The covolumes $\text{covol}(G_1)$ and $\text{covol}(G_2)$ are commensurable (as real numbers), i.e. they differ only by a rational factor.*
- (c) *If G_1 is cofinite, then G_2 is cofinite (and vice-versa).*
- (d) *If G_1 is cocompact, then G_2 is cocompact (and vice-versa).*
- (e) *If G_1 is arithmetic, then G_2 is arithmetic (and vice-versa).*

Notice that the converse of part (b) does not hold in general (for n even, this is an immediate consequence of (2.6)). The notion of arithmeticity appearing in (e) will be discussed in the next section.

The commensurability classes of hyperbolic Coxeter simplex groups have been determined by Johnson, Kellerhals, Ratcliffe and Tschantz [31]. They made a particular use of the fact that the Gram matrix of a simplex group is invertible, beside other algebraic tools.

2.3.4 Arithmeticity

Arithmetic groups of the simplest type and Vinberg's criterion

There are different approaches to the concept of arithmetic groups. We will only introduce the notion of *arithmetic group of the simplest type*, which is particularly convenient when working with noncompact Coxeter groups and their Gram matrices (see [39] and [65], for example).

To this end, equip the space \mathbb{R}^{n+1} with the quadratic form q_{-1} of signature $(n, 1)$ given by $q_{-1}(x) = \langle x, x \rangle_{-1}$ for all $x \in \mathbb{R}^{n+1}$, such that \mathcal{H}^n is the upper sheet of $\{x \in \mathbb{R}^{n+1} \mid q_{-1}(x) = -1\}$ (see Section 2.1). That is, the group $\text{Isom}(\mathcal{H}^n)$ is isomorphic to

$$\text{PO}(n, 1) = \{T \in \text{GL}(n+1, \mathbb{R}) \mid q_{-1}(Tx) = q_{-1}(x) \forall x \in \mathbb{R}^{n+1}, T(\mathcal{H}^n) = \mathcal{H}^n\},$$

the group of isometries of the quadratic space $(\mathbb{R}^{n+1}, q_{-1})$ preserving \mathcal{H}^n .

Consider a totally real number field $k \subset \mathbb{R}$, that is, for each embedding $\iota : k \hookrightarrow \mathbb{C}$, one has $\iota(k) \subset \mathbb{R}$. Let V be a k -vector space with $\dim_k V = n+1$, equipped with a quadratic form q of signature $(n, 1)$, such that for any nonidentity embedding $\sigma : k \rightarrow \mathbb{R}$, the quadratic space (V^σ, q^σ) induced by σ is positive definite. Then, the quadratic forms q_{-1} and q are *equivalent over* \mathbb{R} , i.e. there exists $S \in \text{GL}(n+1, \mathbb{R})$ such that $q(Sx) = q_{-1}(x)$ for all $x \in \mathbb{R}^{n+1} \cong V \otimes \mathbb{R}$ [39, Section 2]. Moreover, for

$$\text{O}(V, q) = \{U \in \text{GL}(n+1, \mathbb{R}) \mid q(Ux) = q(x) \forall x \in V \otimes \mathbb{R}\},$$

one has $S^{-1}\text{PO}(n, 1)S = \text{PO}(V, q)$.

For \mathcal{O}_k the ring of integers of k , let $L \subset V$ be an \mathcal{O}_k -lattice (i.e. L as an \mathcal{O}_k -module is a subgroup of rank $n+1$ of V , and $V = \text{span}_k L$) and let $\text{O}(L) < \text{PO}(V, q) \cap \text{GL}(n+1, k)$ be the group of transformations with coefficients in k that preserves L . Then, by a result of Borel and Harish-Chandra, $\text{O}(L)$ is discrete in $\text{PO}(V, q)$, and has finite covolume.

Definition 2.23. A subgroup $G < \text{PO}(n, 1)$ is called *arithmetic of the simplest type* if there is a transformation $S \in \text{GL}(n+1, \mathbb{R})$ and an \mathcal{O}_k -lattice $L \subset V$ such that $S^{-1}GS$ is commensurable to $\text{O}(L)$ in $\text{PO}(V, q) \cap \text{GL}(n+1, k)$.

Remark 2.5. (1) It is known that for n even, any discrete arithmetic subgroup of $\text{Isom}(\mathcal{H}^n)$ is of the simplest type. If n is odd, then there are arithmetic groups which are not of the simplest type (see [65, Part II, Chapter 6] for details).

(2) Moreover, if $W < \text{Isom}(\mathcal{H}^n)$, $n \geq 4$, is a noncompact arithmetic Coxeter group, then it is of the simplest type, with $k = \mathbb{Q}$ [39, Theorem 8.1]. Since we will be interested in hyperbolic Coxeter pyramid groups

which are noncocompact, we do not discuss the notion of arithmeticity in the general sense (this can be found in [41], for example).

In [63], Vinberg developed a general criterion in order to decide whether a Coxeter group $W < \text{Isom}(\mathcal{H}^n)$ is arithmetic or not :

We use the following terminology : for a matrix $M \in \text{Mat}(r, \mathbb{C})$, $M = (m_{ij})_{1 \leq i, j \leq r}$, a *cyclic product in M of length l* is a product of the form

$$m_{i_1, i_2} \cdot m_{i_2, i_3} \cdot \dots \cdot m_{i_l, i_1}, \quad i_1, \dots, i_l \in \{1, \dots, r\}.$$

A cyclic product is said to be *irreducible* if the indices i_1, \dots, i_r are distinct. Any matrix M gives rise to finitely many irreducible cycles. Moreover, it is not hard to see that any cyclic product in M is a product of irreducible cyclic products in M . The following result can be found in [65, Part II, Chapter 6.3].

Theorem 2.13 (Vinberg). *Let $W < \text{Isom}(\mathcal{H}^n)$ be a cofinite Coxeter group of rank $N \geq n + 1$ with Gram matrix $G = G(W) = (g_{ij})_{1 \leq i, j \leq N}$. Let K be the field generated by the entries of G , and $k \subset K$ the field generated by its cyclic products. Then, W is arithmetic if and only if*

- (1) *the field K is a totally real number field,*
- (2) *for any embedding $\sigma : K \rightarrow \mathbb{R}$ which is not the identity on k , the matrix $G^\sigma := (\sigma(g_{ij}))_{1 \leq i, j \leq N}$ is positive semidefinite,*
- (3) *the cyclic products of the matrix $2G$ are integers in K .*

If W is arithmetic, then its field of definition is K .

This criterion can be used as follows in order to directly decide about the arithmeticity of a noncocompact cofinite hyperbolic Coxeter group W given by a graph *without dotted edges* (see [23], for example).

Corollary 2.1. *Let $W < \text{Isom}(\mathcal{H}^n)$ be a noncocompact cofinite Coxeter group with Gram matrix $G = G(W)$ and graph $\Gamma = \Gamma(W)$ such that Γ has no dotted edge. Then W is arithmetic if and only if*

- (1) *the graph Γ has only edges of weight 2, 3, 4, 6 or ∞ ,*
- (2) *the irreducible cycle in $2G$ corresponding to any simple closed path in Γ lies in \mathbb{Z} .*

For arithmetic Coxeter groups in \mathcal{H}^n , the dimensional bound of Prokhorov-Khovanskij (see Theorem 2.8) can be drastically decreased :

Theorem 2.14 (Vinberg). *There are no arithmetic hyperbolic Coxeter groups in dimensions $n \geq 30$.*

Minimal volume arithmetic hyperbolic orbifolds

With the help of heavy algebraic tools involving Prasad's volume formula, Belolipetsky [3] (n even) and Emery [15] (n odd) determined the explicit minimal values ν_n in the set of all $\text{vol}(\mathcal{O}^n)$, where \mathcal{O}^n is an *orientable arithmetic hyperbolic n -orbifold* (either compact or of finite volume), i.e. $\mathcal{O}^n = \mathcal{H}^n/H$, with $H < \text{Isom}^+(\mathcal{H}^n)$ a discrete arithmetic group (not necessarily of Coxeter type).

Having these explicit minimal values ν_n in all dimensions for both compact and noncompact cases, it remains to detect n -orbifolds \mathcal{O}^n such that $\text{vol}(\mathcal{O}^n) = \nu_n$. This is not an easy task in general, but it has been achieved for several cases. It turns out that in these cases, the group which is responsible for minimal volume is related to a certain Coxeter group. Furthermore, Emery [16] showed that amongst all orientable arithmetic hyperbolic n -orbifolds, the orbifold with fundamental group the Coxeter group W_{17} with graph

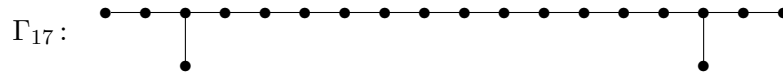

has minimal volume amongst all orientable hyperbolic arithmetic n -orbifolds in any dimension. We refer to the survey [36] for details and references about extremal arithmetic orbifolds.

Chapter 3

Hyperbolic Coxeter n -cubes

As mentioned in Section 2.2.2, hyperbolic Coxeter simplices are completely classified. They exist in $\overline{\mathcal{H}^n}$ for $n \leq 9$. These polyhedra are simple and simplicial (i.e. all their facets are simplices themselves). In this chapter, we shall study and partially classified hyperbolic Coxeter cubes, which are simple and cubical (i.e. all their facets are cubes themselves) polyhedra. They are defined as follows.

Definition 3.1. A hyperbolic n -cube, $n \geq 2$, is a polyhedron $\mathcal{C} \subset \overline{\mathcal{H}^n}$ which is combinatorially equivalent to the standard cube $[0, 1]^n \subset \mathbb{R}^n$.

In particular, the k -th component of the f -vector $f(\mathcal{C})$ is given by

$$f_k(\mathcal{C}) = 2^{n-k} \binom{n}{k}, \quad 0 \leq k \leq n.$$

Moreover, an n -cube has 2^n vertices, it is bounded by n pairs of mutually disjoint hyperplanes, and all its k -faces are k -cubes, $2 \leq k \leq n$.

The set of n -cubes form an important class of polyhedra which, in contrast to simplices, are characterized by the absence of simplex faces. We will show that there is no hyperbolic Coxeter n -cube for $n \geq 9$, and no *ideal* hyperbolic Coxeter n -cube for $4 \leq n \leq 8$. The absence of ideal hyperbolic Coxeter n -cubes for $n \geq 9$ follows directly from Felikson-Tumarkin's result stated in Theorem 2.10.

3.1 Hyperbolic n -cubes

For $n \geq 2$, let $\mathcal{C} \subset \overline{\mathcal{H}^n}$ be an n -cube bounded by hyperplanes H_1, \dots, H_{2n} such that the hyperplane H_i intersects all hyperplanes except H_{2n-i+1} for $i = 1, \dots, 2n$. The set $\mathfrak{H} = \{H_1, \dots, H_{2n}\}$ can be partitioned in 2 families of n concurrent hyperplanes in 2^n different ways. Let $\mathfrak{H} = \mathfrak{H}_1 \sqcup \mathfrak{H}_2$ be such a partition. Then, for $i = 1, 2$, the hyperplanes in \mathfrak{H}_i form a simplicial cone in

$\overline{\mathcal{H}^n}$ based at a vertex of \mathcal{C} , say \mathfrak{v}_i . The vertices \mathfrak{v}_1 and \mathfrak{v}_2 lie on a (spatial) diagonal of \mathcal{C} . We say that they are *opposite* in \mathcal{C} . In this way, we can label the vertices p_1, \dots, p_{2^n} of \mathcal{C} such that p_i and p_{2^n-i+1} are opposite in \mathcal{C} , $i = 1, \dots, 2^n$. For example, one can write

$$p_1 = \bigcap_{i=1}^n H_i \quad \text{and} \quad p_{2^n} = \bigcap_{i=n+1}^{2n} H_i.$$

Theorem 3.1. *There are no Coxeter n -cubes in $\overline{\mathcal{H}^n}$ for $n \geq 10$.*

Proof. Let $\mathcal{C} \subset \overline{\mathcal{H}^n}$ be a Coxeter n -cube with graph $\Gamma = \Gamma(\mathcal{C})$. Let $V = V(\Gamma)$ be the set of vertices and $E = E(\Gamma)$ the set of edges of Γ . Then, $|V| = 2^n$ and $|E| \leq n(2^n - 1)$. Let e be the number of edges of Γ which are *not* dotted edges. Then $e \leq 2^n(n - 1)$, since Γ contains exactly n dotted edges.

Because the associated Gram matrix $G = G(\mathcal{C}) = G(\Gamma)$ has signature $(n, 1)$, it follows that any pair of dotted edges in Γ is connected in Γ (see also [21, p. 116]). Hence, one must have

$$\frac{n(n-1)}{2} \leq e. \quad (3.1)$$

Moreover, the graph of the figure of any of the 2^n vertices of \mathcal{C} is a subgraph of Γ of rank n which is either elliptic or parabolic. Observe that any non-dotted edge of Γ belongs to the graph of precisely $2^n/4$ vertex figures. Since any elliptic or parabolic Coxeter graph of rank n has at most n edges, one deduces that

$$e \leq \frac{2^n n}{2^{n-2}} = 4n. \quad (3.2)$$

From (3.1) and (3.2), one deduces that one must have

$$\frac{n(n-1)}{2} \leq 4n.$$

This inequality holds only for $n \leq 9$. □

Notice that there are no ideal Coxeter n -cubes in $\overline{\mathcal{H}^n}$ for $n \geq 9$ because of Theorem 2.10.

Corollary 3.1. *There are no compact Coxeter n -cubes in \mathcal{H}^n for $n \geq 9$.*

Proof. The vertex figure of an ordinary vertex is a spherical Coxeter $(n-1)$ -simplex. Since the graph of such a polyhedron has at most $n-1$ vertices, the equation (3.2) in the proof of Proposition 3.1 has to be replaced by $e \leq 4(n-1)$. □

Remark 3.1. If \mathcal{C} is an ideal n -cube in $\overline{\mathcal{H}^n}$, then all its vertex figures are Euclidean simplices. The graph of any such polyhedron is a connected parabolic Coxeter graph of rank n , with n edges, if it is isomorphic to \widetilde{A}_{n-1} , or with $n-1$ edges, in all other cases (see Tables 2.2 and 2.3). Hence, the number e of edges of Γ which are not dotted edges satisfies $4(n-1) \leq e \leq 4n$.

For the rest of the chapter, we focus on the class of all *ideal* Coxeter n -cubes in $\overline{\mathcal{H}^n}$.

Let $\Gamma = (V, E)$ be a graph with set of vertices $V = \{v_1, \dots, v_{2n}\}$ and set of edges $E = \{(v_i, v_j) \mid 1 \leq i < j \leq 2n\}$ such that the edges of the form (v_i, v_{2n-i+1}) , $i = 1, \dots, n$ are represented by dotted edges of Γ . To each dotted edge (v_i, v_{2n-i+1}) we assign a weight $l_i := l_{i, 2n-i+1} \in \mathbb{R}_{>0}$, and each non-dotted edge (v_i, v_j) is decorated with an integer weight $m_{ij} \geq 3$. The *Schläfli matrix* $S = S(\Gamma)$ of Γ is the symmetric matrix $S = (s_{ij})_{1 \leq i, j \leq 2n} \in \text{Mat}(2n \times 2n, \mathbb{R})$ given by

$$s_{ij} = \begin{cases} 1 & , j = i \\ -\cosh l_i & , j = 2n - i + 1 \\ -\cos \frac{\pi}{m_{ij}} & , (v_i, v_j) \in E, j \neq i, 2n - i + 1 \\ 0 & , \text{otherwise.} \end{cases}$$

Notice that alternatively, any entry of S of the form $s_{ij} = 0$ can be associated to an edge (v_i, v_j) of Γ with weight $m_{ij} = 2$.

If S is of signature $(n, 1)$, then S can be interpreted as the Gram matrix $G(\mathcal{C})$ of an ideal Coxeter n -cube $\mathcal{C} \subset \overline{\mathcal{H}^n}$ (see [64, Section I, Chapter 6.2], for example). More precisely, in such a case, any vertex $v_i \in V$ corresponds to a facet F_i of \mathcal{C} , the facets F_i and F_{2n-i+1} , have a common perpendicular of length l_i , $i = 1, \dots, n$, and the angle between the facets F_i and F_j , $j \neq 2n - i + 1$, is equal to $\frac{\pi}{m_{ij}}$ if $(v_i, v_j) \in E$ and to $\frac{\pi}{2}$ otherwise.

Let Γ be a graph as above, with Schläfli matrix $S = S(\Gamma)$ such that $S = G(\mathcal{C})$ for an ideal Coxeter n -cube $\mathcal{C} \subset \overline{\mathcal{H}^n}$. Then, Γ must satisfy the following conditions (see [21], for example).

- (1) The signature of S equals $(n, 1)$.
- (2) Any subgraph of Γ corresponding to the figure of a vertex of \mathcal{C} is a connected parabolic Coxeter graph.
- (3) Let Γ_1 and Γ_2 be two *indefinite* subgraphs of Γ (i.e. Γ_i contains at least one connected component which is neither elliptic nor parabolic, $i = 1, 2$). Then, Γ_1 and Γ_2 are connected in Γ .

In the sequel, we call Condition (2) *parabolicity* and Condition (3) *signature obstruction*. Notice that for n -cubes, Condition (3) is equivalent to

- (3') Every two dotted edges are connected in Γ .

Our approach is the following. We first focus on Condition (2). Start with a graph $\Gamma^{(0)}$ with $2n$ vertices, say v_1, \dots, v_{2n} , such that the vertices v_i and v_{2n-i+1} , $i = 1, \dots, n$, are connected by a dotted edge, and such that $\Gamma^{(0)}$ has

no other edge (which is equivalent to supposing that the remaining edges of $\Gamma^{(0)}$ have weight 2). Let $\sigma^{(0)} := \langle v_1, \dots, v_n \rangle \subset \Gamma$ be the subgraph of $\Gamma^{(0)}$ spanned by the vertices v_1, \dots, v_n . Add $n - 1$ or n edges to $\Gamma^{(0)}$ so that $\sigma^{(0)}$ turns into a connected parabolic Coxeter graph, say $\Sigma^{(0)}$. Denote by $\Gamma^{(1)}$ the graph obtained from $\Gamma^{(0)}$ by replacing $\sigma^{(0)}$ by $\Sigma^{(0)}$. Next, take a subgraph $\sigma^{(1)} \subset \Gamma^{(1)}$, $\sigma^{(1)} \neq \Sigma^{(0)}$, containing no dotted edge, and add edges to $\Gamma^{(1)}$ so that $\sigma^{(1)}$ turns into a connected parabolic Coxeter graph, say $\Sigma^{(2)}$. This leads a graph $\Gamma^{(2)}$. After at most 2^n steps, this procedure either yields a graph Γ satisfying Condition (2), or allows us to claim that such a graph does not exist. At this stage, Condition (3) may help in order to restrain the list of graphs.

Let Γ be a graph obtained by the procedure described in the previous paragraph, and satisfying Conditions (2) and (3). The weights of all edges of Γ are fixed, except those of its dotted edges. Finally, we look at Condition (1). Let χ_S be the characteristic polynomial of S . Then, one has

$$\chi_S(t) = \sum_{i=0}^{2n} a_i t^i \in \mathbb{R}[t], \quad (3.3)$$

where the coefficients a_0, \dots, a_{2n} depend on l_1, \dots, l_n . Furthermore, the condition $\text{sign}(S) = (n, 1)$ implies that

$$a_0 = \dots = a_{n-2} = 0. \quad (3.4)$$

The equations (3.3) and (3.4) provide a system of $n - 1$ equations with respect to the unknowns l_1, \dots, l_n , which can be solved in order to decide about the realizability of Γ as the graph of an ideal Coxeter n -cube in $\overline{\mathcal{H}^n}$. This will be worked out in the next sections.

3.2 Ideal Coxeter squares and 3-cubes

As a warm-up, we classify all ideal Coxeter squares and 3-cubes. Let us recall that such polyhedra can be entirely described by using Theorem 2.2 and Rivin's Theorem 2.5.

In this section, the *signature of a graph* Γ will denote the signature of the associated Gram matrix $G(\Gamma)$.

3.2.1 Ideal Coxeter squares

Recall that there is only one parabolic Coxeter graph of rank 2 : \widetilde{A}_1 . By Section 3.1, if $\mathcal{C} \subset \overline{\mathcal{H}^2}$ is an ideal Coxeter square, then its graph Γ can only be of the following type :

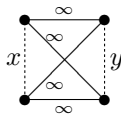

where the weights x and y correspond to the respective lengths between the two pairs of ultra-parallel sides of \mathcal{C} . The Schläfli matrix S of Γ is given by

$$S = \begin{pmatrix} 1 & -1 & -1 & -\cosh x \\ -1 & 1 & -\cosh y & -1 \\ -1 & -\cosh y & 1 & -1 \\ -\cosh x & -1 & -1 & 1 \end{pmatrix}.$$

Since S must be of signature $(2, 1)$, it admits the eigenvalue $\lambda_1 = 0$ of multiplicity 1. Since $x, y > 0$, the condition $\det(S) = 0$ is equivalent to

$$-3 - \cosh x - \cosh y + \cosh x \cosh y = 0,$$

which leads to the identity $\cosh y = 1 + \frac{4}{-1 + \cosh x}$. From this, it follows that the eigenvalues of S are given by

$$\lambda_1 = 0, \quad \lambda_2 = 2 \coth^2 \frac{x}{2}, \quad \lambda_3 = 1 + \cosh x, \quad \lambda_4 = 1 - \cosh x - \frac{2}{\sinh^2 \frac{x}{2}}.$$

Hence, ideal hyperbolic Coxeter squares form a one-parameter family $\mathcal{C}(x)$, $x > 0$, of polygons in $\overline{\mathcal{H}^2}$ whose lengths between the two pairs of non-intersecting sides are given by

$$l_1 = x \quad \text{and} \quad \cosh l_2 = 1 + \frac{4}{-1 + \cosh x}.$$

3.2.2 Ideal Coxeter 3-cubes

Let Γ be the graph of an ideal Coxeter 3-cube $\mathcal{C} \subset \overline{\mathcal{H}^3}$. Then, Γ has 6 vertices, say v_1, \dots, v_6 , corresponding to the hyperplanes bounding \mathcal{C} , as well as 3 dotted edges (between the vertices v_1 and v_6 , v_2 and v_5 , and v_3 and v_4) corresponding to the 3 pairs of ultra-parallel faces of \mathcal{C} . The vertex figures of \mathcal{C} correspond to those subgraphs of Γ of rank 3 which do not contain any dotted edge. There are 3 different parabolic Coxeter graphs of rank 3: \widetilde{A}_2 , \widetilde{B}_2 and \widetilde{G}_2 .

By applying the procedure described in Section 3.1, one finds the 11 potential graphs enlisted on Figure 3.1.

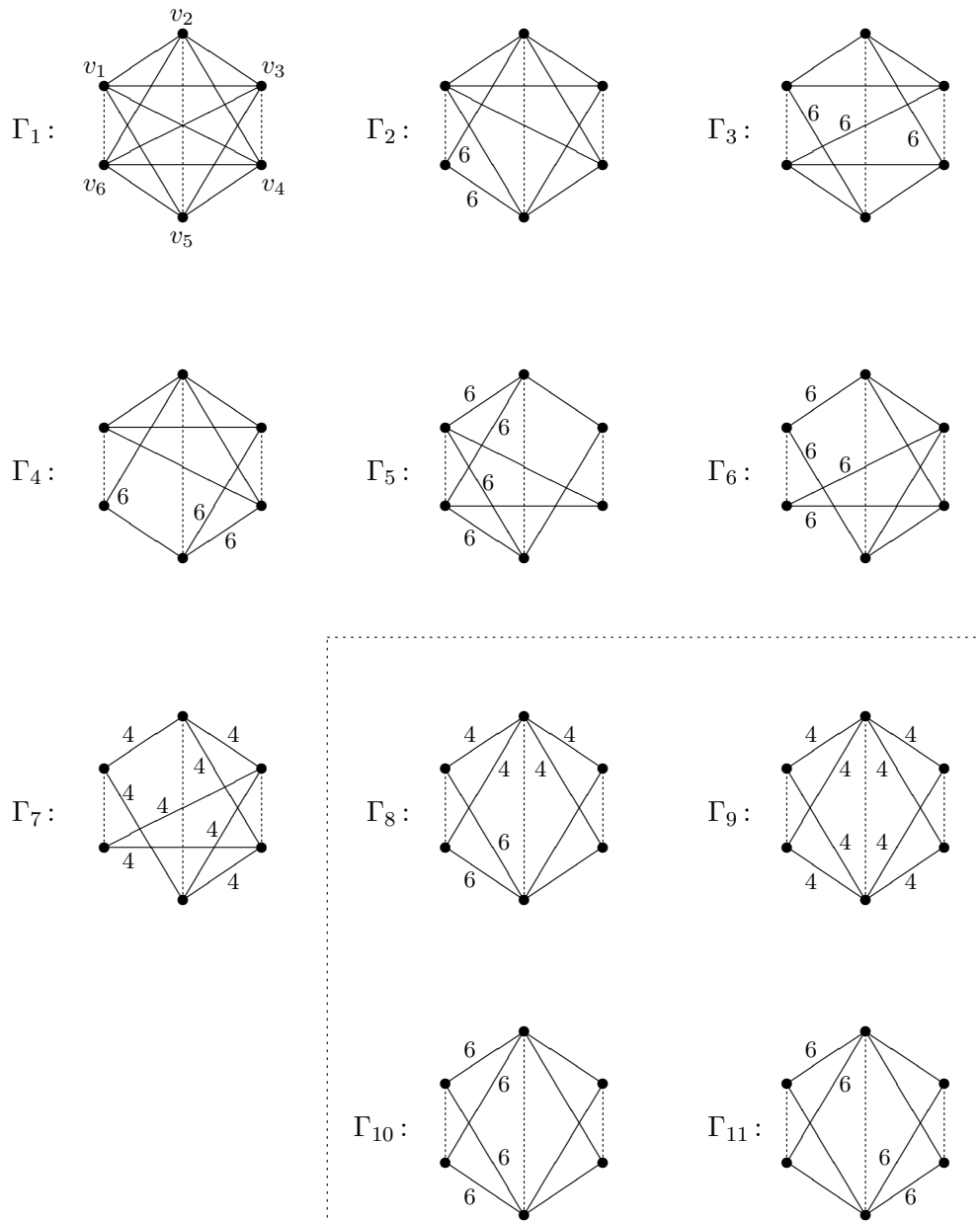

Figure 3.1: Potential graphs of ideal hyperbolic Coxeter cubes

The graphs $\Gamma_8, \Gamma_9, \Gamma_{10}$ and Γ_{11} contain each a subgraph which is the product of two Lannér graphs of order 2. Hence, they have to be removed from the list due to the signature obstruction.

Let us consider the graph Γ_1 . Its Schläfli matrix $S_1 = S(\Gamma_1)$ is given by

$$S_1 = \begin{pmatrix} 1 & -\frac{1}{2} & -\frac{1}{2} & -\frac{1}{2} & -\frac{1}{2} & a \\ -\frac{1}{2} & 1 & -\frac{1}{2} & -\frac{1}{2} & b & -\frac{1}{2} \\ -\frac{1}{2} & -\frac{1}{2} & 1 & c & -\frac{1}{2} & -\frac{1}{2} \\ -\frac{1}{2} & -\frac{1}{2} & c & 1 & -\frac{1}{2} & -\frac{1}{2} \\ -\frac{1}{2} & b & -\frac{1}{2} & -\frac{1}{2} & 1 & -\frac{1}{2} \\ a & -\frac{1}{2} & -\frac{1}{2} & -\frac{1}{2} & -\frac{1}{2} & 1 \end{pmatrix},$$

where $a = -\cosh l_1$, $b = -\cosh l_2$ and $c = -\cosh l_3$ depend on the weights l_1 , l_2 and l_3 of the dotted edges of Γ_1 .

In order to be the Gram matrix of a hyperbolic polyhedron in $\overline{\mathcal{H}^3}$, S_1 has to have signature $(3, 1)$. In particular, it has to have the eigenvalue $\lambda_1 = 0$ with multiplicity 2. The characteristic polynomial $\chi_1 = \chi_{S_1}$ is given by

$$\begin{aligned} \chi_1(t) = & -(t + a - 1)(t + b - 1)(t + c - 1)(-4 + ab + ac + bc + abc \\ & - t(2a + 2b + 2c + ab + ac + bc) + t^2(3 + a + b + c) - t^3), \end{aligned}$$

for $t \in \mathbb{R}$. Since $a, b, c < -1$, the eigenvalue $\lambda_1 = 0$ must be a root of the factor

$$-4 + ab + ac + bc + abc - t(2a + 2b + 2c + ab + ac + bc) + t^2(3 + a + b + c) - t^3,$$

which yields the system

$$\begin{cases} -4 + ab + ac + bc + abc & = 0 \\ 2a + 2b + 2c + ab + ac + bc & = 0 \end{cases}.$$

Since $a, b, c < -1$, this system admits the unique solution $a = b = c = -2$. One can check that the matrix obtained by replacing the coefficients a, b, c by -2 in S_1 has signature $(3, 1)$. As an outcome, one deduces that the graph Γ_1 is the graph of an ideal hyperbolic Coxeter cube \mathcal{C}_1 with $l_1 = l_2 = l_3 = \operatorname{arcosh} 2$.

Similar computations with the remaining graphs show that the graphs Γ_1 to Γ_7 are the graphs of the ideal Coxeter 3-cubes in $\overline{\mathcal{H}^3}$. The corresponding values of $\cosh l_1$, $\cosh l_2$ and $\cosh l_3$ are provided in Table 3.1.

Graph	$\cosh l_1$	$\cosh l_2$	$\cosh l_3$
Γ_1	2	2	2
Γ_2	$\sqrt{3}$	$\frac{7}{2}$	$\frac{5}{4}$
Γ_3	$\sqrt{3}$	$\sqrt{3}$	$\sqrt{3}$
Γ_4	$\frac{3\sqrt{3}}{4}$	$2\sqrt{3}$	$\frac{3}{2}$
Γ_5	$\frac{5}{2}$	$\frac{5}{2}$	$\frac{2\sqrt{3}}{3}$
Γ_6	2	$\frac{3}{2}$	$\frac{3}{2}$
Γ_7	$\sqrt{2}$	2	2

Table 3.1: Weights of the dotted edges in the graphs $\Gamma_1, \dots, \Gamma_7$

3.3 Absence of ideal Coxeter n -cubes in $\overline{\mathcal{H}^n}$, $n \geq 4$

This section is devoted to the proof of the following result.

Theorem 3.2. *There are no ideal Coxeter n -cubes in $\overline{\mathcal{H}^n}$, $n \geq 4$.*

Proof. By Theorem 2.10, it suffices to prove the assertion for $4 \leq n \leq 8$ only. We will proceed dimension by dimension, by using the notation and the procedure described in Section 3.1. Recall that all connected parabolic Coxeter graphs are collected in Table 2.3.

Dimension 4

Let Γ be the graph of an ideal 4-cube $\mathcal{C} \subset \overline{\mathcal{H}^4}$, with vertices v_1, \dots, v_8 and dotted edges (v_1, v_8) , (v_2, v_7) , (v_3, v_6) and (v_4, v_5) . Then, Γ must satisfy the conditions (1) – (3) described in Section 3.1. As for Condition (2), notice that there are 3 connected parabolic Coxeter graphs of rank 4 which may appear as subgraphs $\langle v_i, v_j, v_k, v_l \rangle \subset \Gamma$: \widetilde{A}_3 , \widetilde{B}_3 and \widetilde{C}_3 .

First, suppose that Γ has a subgraph isomorphic to \widetilde{B}_3 , say $\langle v_1, v_2, v_3, v_4 \rangle$. Without loss of generality, we can suppose that $m_{12} = m_{23} = 3$, $m_{24} = 4$, and $m_{13} = m_{14} = m_{34} = 2$. Then, by considering the subgraph $\langle v_1, v_2, v_3, v_5 \rangle$, one deduces that one must have either $m_{25} = 4$ and $m_{15} = m_{35} = 2$ (so that $\langle v_1, v_2, v_3, v_5 \rangle$ is isomorphic to \widetilde{B}_3), or $m_{15} = m_{35} = 3$ and $m_{25} = 2$ (so that $\langle v_1, v_2, v_3, v_5 \rangle$ is isomorphic to \widetilde{A}_3).

- 1) Suppose that $m_{25} = 4$ and $m_{15} = m_{35} = 2$. Then, by parabolicity, one deduces by considering the subgraph $\langle v_2, v_3, v_4, v_8 \rangle$ that one must have $m_{48} = 2$. In the same way, the subgraph $\langle v_2, v_3, v_5, v_8 \rangle$ cannot be parabolic unless $m_{58} = 2$.

Since $m_{14} = m_{15} = m_{48} = m_{58} = 2$, the dotted edges (v_1, v_8) and (v_4, v_5)

will be disconnected. Hence, by the signature obstruction, the graph Γ cannot describe an ideal hyperbolic 4-cube.

2) Suppose that $m_{15} = m_{35} = 3$ and $m_{25} = 2$. Then, by parabolicity, we have the following dichotomy for the subgraph $\langle v_1, v_2, v_5, v_6 \rangle$:

2.1) If $m_{16} = 4$ and $m_{26} = m_{25} = 2$, then we have two possibilities coming from the subgraph $\langle v_1, v_3, v_4, v_7 \rangle$:

2.1.1) If $m_{17} = 3 = m_{37}$ and $m_{47} = 4$, then by considering the subgraphs $\langle v_1, v_4, v_6, v_7 \rangle$ and $\langle v_1, v_5, v_6, v_7 \rangle$, we deduce by parabolicity that one must have $m_{7,6} = 2 = m_{7,5}$. Moreover, by parabolicity again, the subgraph $\langle v_2, v_3, v_5, v_8 \rangle$ leads to $m_{28} = m_{58} = 3$ and $m_{38} = 2$, and the subgraph $\langle v_3, v_4, v_7, v_8 \rangle$ to $m_{78} = 3$ and $m_{38} = m_{48} = 2$. Finally, for the subgraph $\langle v_5, v_6, v_7, v_8 \rangle$, parabolicity forces $m_{68} = 4$, so that we obtain the following graph Γ_1 :

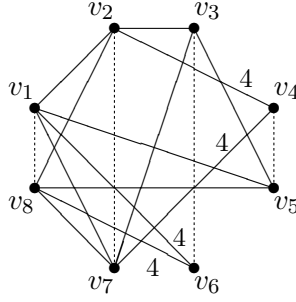

2.2.2) If $m_{17} = 4$ or $m_{37} = 4$, then the subgraph $\langle v_1, v_3, v_5, v_7 \rangle$ is not parabolic, which contradicts Condition (2).

2.2) If $m_{16} = 2$ and $m_{26} = 3 = m_{56}$, then we have two possibilities in order to have a parabolic subgraph $\langle v_2, v_3, v_4, v_8 \rangle$:

2.2.1) If $m_{28} = 3$ and $m_{38} = m_{48} = 2$, then, the parabolicity of the subgraph $\langle v_2, v_4, v_6, v_8 \rangle$ forces $m_{68} = 2$. Then, the dotted edges (v_1, v_8) and (v_3, v_6) are disconnected, which contradicts the signature obstruction.

2.2.2) If $m_{28} = m_{48} = 2$ and $m_{38} = 4$, then one can easily determine the remaining edge weights and get the following graph Γ_2 :

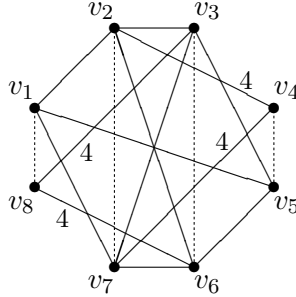

Next, suppose that Γ has a subgraph which is isomorphic to \widetilde{A}_3 , say $\langle v_1, v_2, v_3, v_4 \rangle$, but no subgraph isomorphic to \widetilde{B}_3 . We can suppose that $m_{12} = m_{23} = m_{34} = m_{14} = 3$ and $m_{13} = m_{24} = 2$. Then, the parabolicity of the subgraph $\langle v_1, v_2, v_3, v_5 \rangle$ implies that $m_{25} = 2$ and $m_{15} = m_{35} = 3$, and the parabolicity of the subgraph $\langle v_1, v_3, v_4, v_7 \rangle$ forces $m_{17} = m_{37} = 3$ and $m_{47} = 2$. The subgraph $\langle v_1, v_3, v_5, v_7 \rangle$ also has to be parabolic, so that $m_{57} = 2$, which implies that the dotted edges (v_2, v_7) and (v_4, v_5) are disconnected. By the signature obstruction, this implies that Γ has no subgraph isomorphic to \widetilde{A}_3 .

Finally, suppose that all parabolic rank 4 subgraphs of Γ are isomorphic to \widetilde{C}_3 . We start by supposing that $m_{23} = 3$, $m_{12} = m_{34} = 4$ and $m_{13} = m_{14} = m_{24} = 2$. Then, by parabolicity, the subgraphs $\langle v_1, v_2, v_3, v_5 \rangle$ and $\langle v_2, v_3, v_4, v_8 \rangle$ lead to $m_{35} = m_{28} = 4$ and $m_{15} = m_{25} = 2 = m_{38} = m_{48}$, so that by considering the subgraph $\langle v_2, v_3, v_5, v_8 \rangle$, we deduce $m_{58} = 2$. Hence, the dotted edges (v_1, v_8) and (v_4, v_5) are disconnected, which violates the signature obstruction.

It remains to consider more closely the graphs Γ_1 and Γ_2 obtained above and satisfying Conditions (2) and (3) from Section 3.1. In view of Condition (1), we have to determine the weights of the various dotted edges in these graphs. To this end, one first computes the respective characteristic polynomials and then the coefficients of their constant, linear and quadratic terms (see (3.3) and (3.4)). In contrast with the case of dimension 3 (see Section 3.2.2), the resulting systems of equations with respect to the weights of the dotted edges turn out to have no solution. Hence, there is no ideal 4-cube in $\widetilde{\mathcal{H}}^4$.

Dimension 5

Consider the graph Γ of an ideal Coxeter 5-cube, with vertices v_1, \dots, v_{10} and with dotted edges $(v_1, v_{10}), (v_2, v_9), (v_3, v_8), (v_4, v_7)$ and (v_5, v_6) . Any rank 5 subgraph of Γ *not* containing any dotted edge has to be parabolic, i.e. it has to be isomorphic to $\widetilde{A}_4, \widetilde{B}_4, \widetilde{C}_4, \widetilde{D}_4$ or \widetilde{F}_4 . The strategy here is similar to the one we have used for dimension 4, but quite longer, since we have to deal with 5 possible parabolic graphs. Therefore, we only give the main steps of the non-existence proof.

First, suppose that Γ contains a subgraph which is isomorphic to \widetilde{A}_4 , say $\langle v_1, v_2, v_3, v_4, v_5 \rangle$. Without loss of generality, we can suppose that $m_{12} = m_{23} = m_{34} = m_{45} = m_{15} = 3$ and that $m_{13} = m_{14} = m_{24} = m_{25} = m_{35} = 2$. Then, by successively considering the subgraphs obtained from $\langle v_1, v_2, v_3, v_4, v_5 \rangle$ by replacing the vertex v_i by the vertex v_{10-i} , $i = 1, \dots, 5$, one deduces that $m_{16} = m_{46} = m_{37} = m_{57} = m_{28} = m_{46} = m_{19} = m_{39} = m_{2,10} = m_{5,10} = 3$. By performing a similar substitution with the 5 pairs of vertices connected by an edge in $\langle v_1, v_2, v_3, v_4, v_5 \rangle$, one can determine 10 further edges of Γ . At this stage, we have found 30 non-dotted edges of the

graph Γ . By (3.2), we deduce that Γ contains no further edge, so that the dotted edges (v_1, v_{10}) and (v_3, v_8) are disconnected. Hence, by the signature obstruction, no ideal Coxeter 5-cube has a graph with a subgraph isomorphic to \widetilde{A}_4 .

Secondly, suppose that Γ has a subgraph isomorphic to \widetilde{C}_4 , say $\langle v_1, v_2, v_3, v_4, v_5 \rangle$, and no subgraph isomorphic to \widetilde{A}_4 . Without loss of generality, we can suppose that $m_{12} = m_{45} = 4$, $m_{23} = m_{34} = 3$, and that all remaining weights of edges of $\langle v_1, v_2, v_3, v_4, v_5 \rangle$ equal 2. Then, up to re-labelling the vertices, we can also suppose that the subgraph $\langle v_1, v_2, v_8, v_4, v_5 \rangle$ is such that $m_{28} = m_{48} = 3$ (and $m_{18} = m_{58} = 2$).

Consider now the subgraph $\langle v_{10}, v_2, v_3, v_4, v_5 \rangle$. It is isomorphic to a parabolic graph only in the following 3 cases :

- 1) \widetilde{B}_4 : set $m_{3,10} = 3$, $m_{2,10} = m_{4,10} = m_{5,10} = 2$.
- 2) \widetilde{C}_4 : set $m_{2,10} = 4$, $m_{3,10} = m_{4,10} = m_{5,10} = 2$.
- 3) \widetilde{F}_4 : set $m_{2,10} = m_{3,10} = m_{4,10} = 2$.

Cases 2) and 3) turn out to be impossible, since it would imply that $m_{8,10} = 2$, so that the dotted edges (v_1, v_{10}) and (v_3, v_8) are disconnected.

Case 1) splits further into 3 cases which also lead to disconnected dotted edges. Hence, we see that Γ cannot contain a rank 5 parabolic subgraph isomorphic to \widetilde{C}_4 .

Third of all, suppose that Γ has no subgraph isomorphic to \widetilde{A}_4 or \widetilde{C}_4 , but a subgraph isomorphic to \widetilde{D}_4 , say $\langle v_1, v_2, v_3, v_4, v_5 \rangle$. Without loss of generality, we can suppose that $m_{13} = m_{23} = m_{34} = m_{35} = 3$. Then, by considering the subgraph $\langle v_1, v_2, v_8, v_4, v_5 \rangle$, we see that one must have $m_{18} = m_{28} = m_{48} = m_{58} = 3$. Next, consider the graph $\langle v_{10}, v_2, v_3, v_4, v_5 \rangle$. It is isomorphic to a parabolic graph only in the following 2 cases :

- 1) \widetilde{B}_4 : set $m_{2,10} = 4$ and $m_{3,10} = m_{4,10} = m_{5,10} = 2$.
- 2) \widetilde{D}_4 : set $m_{3,10} = 3$ and $m_{2,10} = m_{4,10} = m_{5,10} = 2$.

Consider case 2). Then, by looking at the subgraph $\langle v_{10}, v_2, v_8, v_4, v_5 \rangle$, one deduces that $m_{8,10} = 3$. Moreover, the subgraph $\langle v_1, v_2, v_3, v_4, v_6 \rangle$ yields $m_{16} = 4$ and $m_{26} = m_{36} = m_{46} = 2$, so that $m_{6,10} = 4$. Furthermore, the subgraph $\langle v_1, v_2, v_3, v_7, v_5 \rangle$ yields $m_{17} = 4$ and $m_{27} = m_{37} = m_{57} = 2$, which forces $m_{7,10} = 4$. At this stage, we know 14 non-dotted edges of Γ and their weights. By Remark 3.1 and since no subgraph can be isomorphic to \widetilde{A}_4 , Γ can only have 2 additional edges. This implies that the dotted edges (v_2, v_9) , (v_4, v_7) and (v_5, v_6) cannot be mutually connected in Γ , which contradicts the signature obstruction.

Case 1) splits further into 2 subcases, both resulting in graphs containing

disconnected dotted edges. As a consequence, Γ does not contain any rank 5 subgraph isomorphic to \widetilde{D}_4 either.

In a very similar way, the two remaining steps (Γ contains a subgraph isomorphic to \widetilde{F}_4 , respectively all subgraphs of Γ are isomorphic to \widetilde{B}_4) also lead to graphs containing at least one pair of disconnected dotted edges. Hence, there is no ideal Coxeter 5-cube.

Dimensions 6, 7 and 8

Let $\mathcal{C} \subset \overline{\mathcal{H}}^n$ be an ideal Coxeter n -cube, $n \geq 2$. Then, for $2 \leq k \leq n$, any k -face of \mathcal{C} is an ideal k -cube. The following property is a consequence of an observation due to Borchers [6, Example 5.6] and will be useful in order to determine when a k -face of \mathcal{C} is a Coxeter polyhedron : if the graph Γ of \mathcal{C} has an elliptic subgraph Γ' of rank $n - k$ with no component of type A_l , $l \geq 1$, or D_5 , then the k -face $F \subset \mathcal{C}$ corresponding to Γ' is a Coxeter polyhedron itself.

The parabolic graphs \widetilde{B}_{n-1} and \widetilde{C}_{n-1} , $n = 6, 7, 8$, contain an elliptic subgraph of type $I_2(4)$, B_3 and B_4 , respectively. Since, as we have seen, there is no ideal hyperbolic Coxeter 4-cube, the above observation allows us to deduce that the graphs \widetilde{B}_{n-1} and \widetilde{C}_{n-1} , $n = 6, 7, 8$ cannot occur as parabolic subgraphs of the graph of an ideal Coxeter n -cube in $\overline{\mathcal{H}}^n$, $n = 6, 7, 8$. Hence, for $n = 6$, the only possible rank 6 parabolic subgraphs are \widetilde{A}_5 and \widetilde{D}_5 , for $n = 7$, the only possible rank 7 parabolic subgraphs are \widetilde{A}_6 , \widetilde{D}_6 and \widetilde{E}_6 , and for $n = 8$, the only possible rank 8 parabolic subgraphs are \widetilde{A}_7 , \widetilde{D}_7 and \widetilde{E}_7 .

The different subgraph chasings in these cases are much shorter than for dimensions 4 and 5. Because of the high proportion of edges of weight 2 in parabolic graphs of higher rank, the parabolicity condition (2) of Section 3.1 already suffices in order to proceed, as in the case of dimension 5.

As an illustration, we give the proof in the case where $n = 6$. Let Γ be the graph of an ideal hyperbolic Coxeter 6-cube, with vertices v_1, \dots, v_{12} and dotted edges (v_i, v_{13-i}) , $i = 1, \dots, 6$. Then, any rank 6 parabolic subgraph of Γ is isomorphic either to \widetilde{A}_5 or to \widetilde{D}_5 .

We start by supposing that Γ has a subgraph isomorphic to \widetilde{A}_5 , say $\langle v_1, v_2, v_3, v_4, v_5, v_6 \rangle$. Then, we can suppose that $m_{12} = m_{23} = m_{34} = m_{45} = m_{56} = m_{16} = 3$ and $m_{13} = m_{14} = m_{15} = m_{24} = m_{25} = m_{26} = m_{35} = m_{36} = m_{46} = 2$. By successively considering the subgraphs obtained from $\langle v_1, v_2, v_3, v_4, v_5, v_6 \rangle$ by replacing the vertex v_i by the vertex v_{13-i} , $i = 1, \dots, 6$, we can determine 12 further edges of Γ , by the parabolicity condition. A similar substitution for each the 6 pairs of vertices connected by an edge in $\langle v_1, v_2, v_3, v_4, v_5, v_6 \rangle$ lead to 6 more edges of Γ . Hence, by (3.2), Γ contains no further non-dotted edge. We observe that the dotted edges

(v_1, v_{12}) and (v_5, v_8) are disconnected in Γ , contradicting the signature obstruction. Hence, Γ contains no subgraph isomorphic to \widetilde{A}_5 .

Hence, we can suppose that all rank 6 parabolic subgraphs of Γ are isomorphic to \widetilde{D}_5 . Without loss of generality, we can set $m_{12} = m_{23} = m_{25} = m_{45} = m_{56} = 3$ and $m_{13} = m_{14} = m_{16} = m_{24} = m_{26} = m_{34} = m_{35} = m_{36} = m_{46} = 2$. Then, by considering the subgraphs obtained from $\langle v_1, v_2, v_3, v_4, v_5, v_6 \rangle$ by replacing the vertex v_i by the vertex v_{13-i} , $i = 1, \dots, 6$, we can determine 10 further edges of Γ , due to the parabolicity condition. By successively considering the parabolicity condition for the subgraphs $\langle v_4, v_5, v_6, v_{10}, v_{11}, v_{12} \rangle$, $\langle v_1, v_2, v_3, v_7, v_8, v_9 \rangle$ and $\langle v_7, v_8, v_9, v_{10}, v_{11}, v_{12} \rangle$, we deduce 5 further edges of Γ , so that we have determined 20 edges of Γ so far. By the proof of Corollary 3.1, Γ must have exactly 20 edges, so that Γ has no further edge. By observing that the dotted edges (v_1, v_{12}) and (v_3, v_{10}) are disconnected in Γ , the signature obstruction allows us to deduce that there is no ideal hyperbolic 6-cube.

As mentioned before, the cases where $n = 7$ and $n = 8$ are very similar to the cases $n = 5$ and $n = 6$ and straightforward. \square

3.4 Volume and inradius of ideal Coxeter n -cubes, $n = 2, 3$

We end this chapter by computing the volume and inradius of the hyperbolic Coxeter n -cubes, $n = 2, 3$, classified in Section 3.2.

Ideal Coxeter squares

Let $\mathcal{C}(x)$, $x > 0$, be an ideal Coxeter square in $\overline{\mathcal{H}^2}$ (see Section 3.2.1). Then, by Theorem 2.12,

$$\text{area}(\mathcal{C}(x)) = 2\pi.$$

Moreover, by Section 3.2.1, the inradius $r(\mathcal{C}(x))$ is given by

$$r(\mathcal{C}(x)) = \min_{x>0} \left\{ \frac{x}{2}, \frac{1}{2} \operatorname{arcosh} \left(1 + \frac{4}{-1 + \cosh x} \right) \right\}.$$

Direct computations show that

$$r(\mathcal{C}(x)) = \begin{cases} x/2 & , \quad 0 < x \leq \operatorname{arcosh} 3 \\ \frac{1}{2} \operatorname{arcosh} \left(1 + \frac{4}{-1 + \cosh x} \right) & , \quad \operatorname{arcosh} 3 \leq x \end{cases},$$

and that

$$\max_{x>0} \{r(\mathcal{C}(x))\} = \frac{\operatorname{arcosh} 3}{2},$$

i.e. the ideal Coxeter square of maximal inradius is $\mathcal{C}(\operatorname{arcosh} 3)$, the regular ideal square.

Recall that the area of a hyperbolic disk $\mathcal{B}_2(r)$ of radius r is given by $\operatorname{area}(\mathcal{B}_2(r)) = 2\pi(\cosh r - 1)$. Hence, the maximal local density δ_{max}^\square of periodic (in)disk packings resulting of tessellations of the hyperbolic plane by ideal Coxeter squares is

$$\delta_{max}^\square = \frac{2\pi(\cosh \frac{\operatorname{arcosh} 3}{2} - 1)}{2\pi} = \sqrt{2} - 1 \approx 0.41421.$$

This is greater than the local density δ_2^Δ of the periodic (in)disk packing induced by the tessellation of \mathcal{H}^2 by regular ideal triangles, which is known to be $\delta_2^\Delta = 2\left(\frac{2\sqrt{3}}{3} - 1\right) \approx 0.30940$ (see [35], for example). However, δ_{max}^\square is smaller than the local density δ_2 of the periodic (in)disk packing induced by the tessellation of \mathcal{H}^2 by copies of the (compact) Coxeter triangle [3, 7] (see Section 4.3.1).

Ideal Coxeter 3-cubes

The volume of an ideal 3-cube can be computed as follows.

Lemma 3.1. *Let $\mathcal{C} \subset \overline{\mathcal{H}^3}$ be an ideal hyperbolic 3-cube with faces F_i , $i = 1, \dots, 6$, such that F_i is opposite to F_{6-i+1} in \mathcal{C} , $i = 1, \dots, 3$. Let α_{ij} , $1 \leq i < j \leq 6$, $i + j \neq 6$, denote the dihedral angles of \mathcal{C} . Then, the volume of \mathcal{C} is given by*

$$\operatorname{vol}(\mathcal{C}) = \sum_{\substack{1 \leq i < j \leq 6 \\ i+j \neq 7}} \mathcal{L}(\alpha_{ij}) - \sum_{\substack{i \in \{1,2\} \\ j \in \{2,3,4,5\} \\ i \neq j, i+j \neq 7}} \mathcal{L}(\alpha_{ij} + \alpha_{7-i,7-j}). \quad (3.5)$$

Proof. The cube \mathcal{C} can be dissected into 5 ideal tetrahedra as in Figure 3.2.

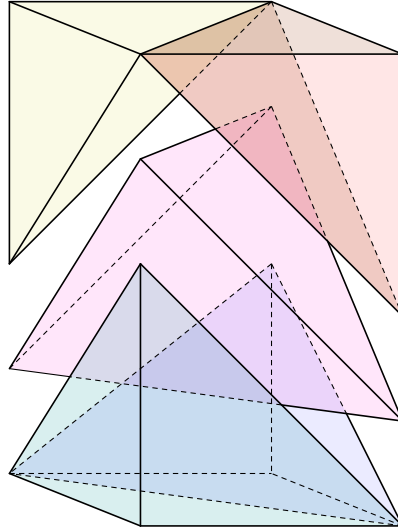

Figure 3.2

Recall that in an ideal tetrahedron, the dihedral angles corresponding to opposite edges are equal. The 4 tetrahedra having bounding hyperplanes in common with \mathcal{C} have dihedral angles $\alpha_{12}, \alpha_{13}, \alpha_{23}$; $\alpha_{14}, \alpha_{15}, \alpha_{45}$; $\alpha_{24}, \alpha_{26}, \alpha_{46}$ and $\alpha_{35}, \alpha_{36}, \alpha_{56}$, respectively. The remaining tetrahedron, sharing no edge with \mathcal{C} , has dihedral angles $\pi - \alpha_{12} - \alpha_{56}$, $\pi - \alpha_{13} - \alpha_{46}$, and $\pi - \alpha_{14} - \alpha_{36}$. The volume of an ideal tetrahedron \mathcal{T} of dihedral angles α, β, γ is given by (see [65, Part I, Chapter 7.3.4])

$$\text{vol}(\mathcal{T}) = \mathcal{J}(\alpha) + \mathcal{J}(\beta) + \mathcal{J}(\gamma).$$

Since the Lobachevsky function \mathcal{J} is odd and π -periodic, the formula (3.5) follows. \square

Let $\mathcal{C}_1, \dots, \mathcal{C}_7$ be the ideal Coxeter 3-cubes described in Section 3.2.2 (see Table 3.1). By using (3.5) and the distribution law (2.7), one finds the volumes listed in Table 3.2.

i	1	2	3	4	5	6	7
$\text{vol } \mathcal{C}_i$	$12\mathcal{J}(\frac{\pi}{3})$	$11\mathcal{J}(\frac{\pi}{3})$	$\frac{23}{2}\mathcal{J}(\frac{\pi}{3})$	$\frac{19}{2}\mathcal{J}(\frac{\pi}{3})$	$10\mathcal{J}(\frac{\pi}{3})$	$10\mathcal{J}(\frac{\pi}{3})$	$8\mathcal{J}(\frac{\pi}{4})$

Table 3.2: Volumes of the ideal hyperbolic Coxeter 3-cubes $\mathcal{C}_1, \dots, \mathcal{C}_7$

Observe that the *regular* ideal 3-cube \mathcal{C}_1 has maximal volume amongst the ideal hyperbolic Coxeter 3-cubes. Moreover, its inradius $r_1 = r(\mathcal{C}_1)$ is given

by half the distance between two of its nonintersecting facets. It can be directly read off from Table 3.1, and we have $r_1 = \frac{1}{2}\operatorname{arcosh} 2$.

Remark 3.2. Amongst all ideal simplices in $\overline{\mathcal{H}^n}$, $n \geq 2$, the regular one is of maximal covolume as well (see [48], for example). Moreover, it is of maximal inradius (by inradius monotonicity, see Section 4.2.3).

Recall that the volume of a hyperbolic ball $\mathcal{B}_3(r) \subset \mathcal{H}^3$ of radius $r > 0$ is given by $\operatorname{vol}(\mathcal{B}_3(r)) = \pi(\sinh 2r - 2r)$. Hence, the local density δ_1^\square of the periodic (in)ball packing induced by a tessellation of $\overline{\mathcal{H}^3}$ by isometric copies of \mathcal{C}_1 is given by

$$\delta_1^\square = \frac{\pi(\sqrt{\cosh^2 2r_1 - 1} - 2r_1)}{\operatorname{vol} \mathcal{C}_1} \approx 0.32121.$$

As for dimension 2, this density is greater than the local density δ_3^\triangle of the periodic (in)ball packing induced by a tessellation of the hyperbolic 3-space by isometric copies of the regular ideal simplex with angle $\frac{\pi}{3}$, which is given by $\delta_3^\triangle = \frac{\pi/4(3-4\log 2)}{3\mathbb{I}(\pi/3)} \approx 0.17598$ (see [10], for example).

Chapter 4

The inradius of hyperbolic truncated simplices

The content of this chapter has already been published in large parts in [29]. From now on, we shall denote $\langle \cdot, \cdot \rangle_{-1}$ simply by $\langle \cdot, \cdot \rangle$ only.

4.1 Hyperbolic truncated simplices

Let us recall that a *simplex* $\mathcal{P} \subset \overline{\mathcal{H}^n}$ is the convex hull of $n + 1$ points $v_1, \dots, v_{n+1} \in \overline{\mathcal{H}^n}$ which form a basis of \mathbb{R}^{n+1} and are called *vertices*. Every vertex v_i is given by

$$v_i = \bigcap_{\substack{j=1 \\ j \neq i}}^{n+1} H_j, \quad (4.1)$$

where H_1, \dots, H_{n+1} are hyperplanes such that H_i lies opposite to the vertex v_i in \mathcal{P} .

In the sequel, we extend the concept of a hyperbolic simplex to a wider class of polyhedra. Let $u_1, \dots, u_{n+1} \in \mathcal{S}_{-1}(1)$ be a basis of \mathbb{R}^{n+1} such that $\langle u_i, u_j \rangle < 1$ for $i \neq j$, and let \widehat{H}_i be the vector subspace of \mathbb{R}^{n+1} such that $H_i = \widehat{H}_i \cap \overline{\mathcal{H}^n}$. Then, the intersection

$$\Theta := \bigcap_{i=1}^{n+1} \widehat{H}_i^- \quad (4.2)$$

is a simplicial n -cone in \mathbb{R}^{n+1} of apex $\mathbf{o} = (0, \dots, 0)$ (see also [13]). In particular, for every i , the intersection

$$\widehat{v}_i := \bigcap_{\substack{j=1 \\ j \neq i}}^{n+1} \widehat{H}_j$$

is a line passing through \mathbf{o} .

It is easy to see that every line \widehat{v}_i contains a point v_i such that

$$\begin{cases} v_i = \widehat{v}_i \cap (\overline{\mathcal{H}^n} \cup \mathcal{S}_{-1}(1)) \\ \langle u_i, v_i \rangle < 0 \end{cases}. \quad (4.3)$$

Definition 4.1. The set

$$\widehat{\mathcal{T}} := \Theta \cap (\overline{\mathcal{H}^n} \cup \mathcal{S}_{-1}(1)) \subset \mathbb{R}^{n+1}$$

with vertices v_1, \dots, v_{n+1} satisfying (4.3) is called the *total simplex* associated to u_1, \dots, u_{n+1} .

Remark 4.1. By passing to the Klein-Beltrami model \mathcal{K}^n of \mathbb{H}^n (see [51, Chapter 6.1] for example), $\widehat{\mathcal{T}}$ is a simplex in the real projective space \mathbb{RP}^n intersecting \mathcal{K}^n non-trivially.

Let $p, q \geq 0$ be integers such that $p + q \leq n + 1$.

Definition 4.2. A total simplex $\widehat{\mathcal{T}}$ is said to be of *type* (p, q) if p of its vertices lie in $\mathcal{S}_{-1}(1)$, q vertices are in $\partial\mathcal{H}^n$, and the remaining ones belong to \mathcal{H}^n .

The vertices lying in \mathcal{H}^n are called *ordinary* vertices, the ones lying in $\partial\mathcal{H}^n$ *ideal*, and the ones lying in $\mathcal{S}_{-1}(1)$ *ultra-ideal* vertices of $\widehat{\mathcal{T}}$.

The set of the ordinary vertices of $\widehat{\mathcal{T}}$ is denoted by \mathcal{V}_- , the set of the ideal vertices \mathcal{V}_0 , and the set of the ultra-ideal vertices \mathcal{V}_+ .

With these definitions, a total simplex $\widehat{\mathcal{T}}$ of type $(0, q)$, $0 \leq q \leq n + 1$, is a hyperbolic simplex. If $q = 0$, it is compact, and if $q = n + 1$, $\widehat{\mathcal{T}}$ is a totally ideal hyperbolic simplex.

Let us now consider a total simplex $\widehat{\mathcal{T}} \subset \mathbb{R}^{n+1}$ of type (p, q) , $p > 0$, with associated cone $\Theta = \bigcap_{i=1}^{n+1} \widehat{H}_i^-$.

Then each ultra-ideal vertex v_i gives rise to the hyperbolic hyperplane $H_{v_i} = v_i^\perp$ which intersects $\widehat{\mathcal{T}}$ non-trivially. More specifically, by (4.1), H_{v_i} intersects each H_j , $j \neq i$ orthogonally.

Let $k \in \{1, \dots, p\}$ be an integer, and let $v_1, \dots, v_k \in \mathcal{V}_+$ be ultra-ideal vertices of $\widehat{\mathcal{T}}$ such that the set

$$\mathcal{T} := \bigcap_{i=1}^{n+1} H_i^- \cap \bigcap_{j=1}^k H_{v_j}^- \subset \overline{\mathcal{H}^n} \quad (4.4)$$

is nonempty and has positive finite volume.

Definition 4.3. The set \mathcal{T} is called the *hyperbolic k -truncated simplex* (of type (p, q)) associated to $\widehat{\mathcal{T}}$ with respect to the vertices v_1, \dots, v_k of $\widehat{\mathcal{T}}$.

Remark 4.2. By analogy with projective geometry of quadratic forms, for an ultra-ideal vertex $v_i \in \mathcal{S}_{-1}(1)$, we call H_{v_i} *polar hyperplane*, and write H_i^* . By (4.1), we have $\angle(H_i^*, H_j) = \frac{\pi}{2}$ for $i \neq j$. Let $F_i^* = \widehat{\mathcal{T}} \cap H_i^*$ be the corresponding facet of \mathcal{T} .

4.1.1 Examples

Before going any further, we give several examples showing that the class of truncated simplices contains different types of polyhedra, and more specifically, many known examples of Coxeter polyhedra can be interpreted in this way.

(1) Truncated triangles are characterized as follows.

Lemma 4.1. *Let $\mathcal{T} \subset \overline{\mathcal{H}^2}$ be a truncated triangle. Then, \mathcal{T} is either a triangle, or a quadrilateral with at least 2 adjacent right angles, or a pentagon with at least 4 right angles, or a totally rectangular hexagon, and conversely.*

Proof. Let $\widehat{\mathcal{T}} \subset \mathbb{R}^{2,1}$ be a total triangle of type (p, q) , $p, q \in \{0, 1, 2, 3\}$, $p + q \leq 3$, with associated truncated triangle $\mathcal{T} \subset \overline{\mathcal{H}^2}$. Then, one has the following cases.

- If $p = 0$, then $\widehat{\mathcal{T}} = \mathcal{T}$ is a triangle. It is compact if and only if $q = 0$.
- If $p = 1$, then \mathcal{T} is a quadrilateral with two consecutive right angles arising from the truncation. It is compact if and only if $q = 0$.
- If $p = 2$, then \mathcal{T} is a pentagon with two pairs of two consecutive right angles arising from the truncations. It is compact if and only if $q = 0$.
- If $p = 3$, then \mathcal{T} is a totally rectangular hexagon.

Conversely, consider a quadrilateral \mathcal{Q} with two consecutive right angles which is bounded by lines H_1, H_2, H_3 and H_4 , such that H_4 intersects H_2 and H_3 orthogonally. Since H_2 and H_3 do not intersect in $\overline{\mathcal{H}^2}$, they have a common perpendicular, which is nothing but H_4 . Hence H_4 is the polar line coming from the ultra-ideal intersection of H_2 and H_3 . Therefore, the lines H_1, H_2 and H_3 bound the hyperbolic part of a total simplex $\widehat{\mathcal{T}}$ with associated truncated simplex \mathcal{Q} .

Because of the uniqueness of the common perpendicular between two disjoint lines in $\overline{\mathcal{H}^2}$, this argument can be extended to pentagons with at least four right angles and totally rectangular hexagons. \square

In particular, any totally right-angled pentagon is the truncated part of 5 different total triangles of type $(2, 0)$ (each of them being uniquely determined by the choice of a vertex of the pentagon as ordinary vertex of the total simplex), and any totally right-angled hexagon is the truncated part of 2 different total simplices of type $(3, 0)$.

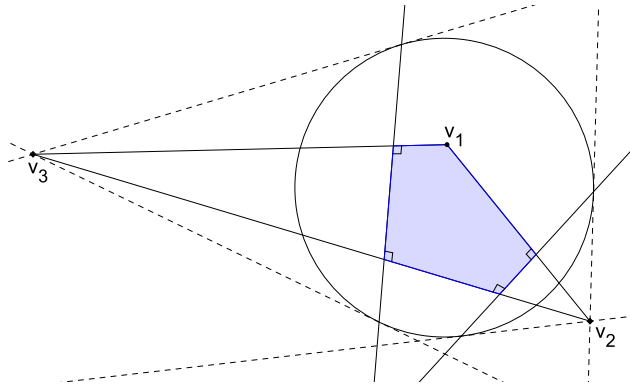
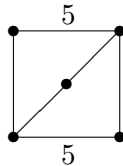

Figure 4.1: Any pentagon with 4 right angles is a 2-truncated triangle

- (2) Lambert cubes are hyperbolic 2-truncated 3-simplices (cf. [34]).
- (3) Straight simplicial prisms are hyperbolic 1-truncated simplices.
- (4) Consider the following Coxeter graph with 5 nodes.



By Vinberg's existence criterion (see [64]), this graph describes a Coxeter polyhedron $\mathcal{P} \subset \overline{\mathcal{H}^4}$ of infinite volume. Moreover, it can be interpreted as hyperbolic part of a total simplex of type $(5, 0)$ whose associated 5-truncated simplex is a compact Coxeter polyhedron. For more details, see [61].

- (5) The following linear graphs encode compact hyperbolic Coxeter k -orthoschemes in $\overline{\mathcal{H}^k}$, $k = 2, 3, 4$, respectively.

$$\Gamma_2: \bullet \text{---} 7 \text{---} \bullet \qquad \Gamma_3: \bullet \text{---} 5 \text{---} \bullet \text{---} \bullet \qquad \Gamma_4: \bullet \text{---} 5 \text{---} \bullet \text{---} \bullet \text{---} \bullet$$

Moreover, the graph Γ_5 given by

$$\Gamma_5: \bullet \text{---} 5 \text{---} \bullet \text{---} \bullet \text{---} \bullet \text{---} \bullet \text{---} \bullet \text{---} \circ$$

yields a compact 1-truncated orthoscheme in \mathcal{H}^5 . The truncating polar hyperplane corresponds to the white node of Γ_5 .

- (6) Bugaenko [8], [9] showed that the following graphs give rise to compact arithmetic Coxeter polyhedra in $\overline{\mathcal{H}^k}$, $k = 6, 7, 8$, respectively.

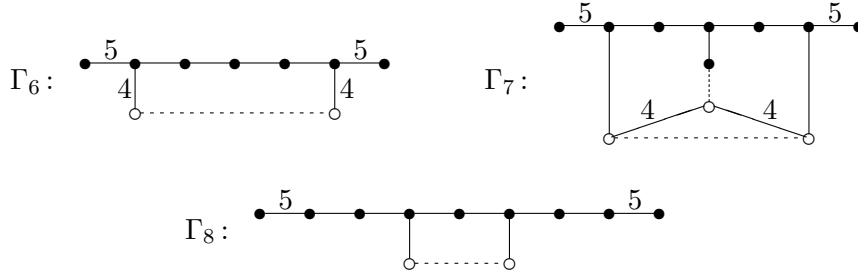

By using the approach described above, one sees that Γ_6 and Γ_8 can be interpreted as 2-truncated orthoschemes, and Γ_7 describes a 3-truncated simplex. As in Example (5), the truncating polar hyperplanes are represented by white nodes.

- (7) The following graph represents a non-compact Coxeter polyhedron in $\overline{\mathcal{H}^{17}}$, which is combinatorially a pyramid over the product of two simplices (see Section 5.2).

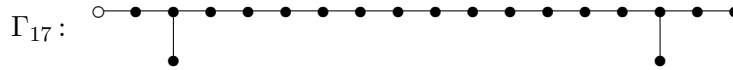

One can interpret Γ_{17} as the graph of a 1-truncated simplex. For example, identify the truncating polar hyperplane by the white node as indicated. The volume of this polyhedron is equal to the minimal value amongst all volumes of orientable hyperbolic arithmetic n -orbifolds (see Section 2.3.4).

4.1.2 The reduced Gram matrix of a hyperbolic truncated simplex

For a $k \times k$ matrix M and $i, j \in \{1, \dots, k\}$, we denote by M_{ij} the $(k-1) \times (k-1)$ matrix obtained by removing the i -th row and j -th column from M . The matrix $M_i := M_{ii}$ is the i -th principal submatrix, and the (i, j) -th cofactor $\text{cof}_{ij}(M)$ of M is given by $(-1)^{i+j} \det(M_{ij})$, as usual.

Recall that, for M invertible, the coefficients of M^{-1} can be expressed according to

$$[M^{-1}]_{ij} = \frac{1}{\det(M)} \text{cof}_{ji}(M), \quad 1 \leq i, j \leq k.$$

After these preliminaries, consider a hyperbolic polyhedron $\mathcal{P} \subset \mathcal{H}^n$ with normal vectors $u_1, \dots, u_N \in \mathcal{S}_{-1}(1)$.

The *Gram matrix* $G(\mathcal{P}) =: G = (g_{ij})_{1 \leq i, j \leq N}$ of \mathcal{P} is given by

$$g_{ij} = \langle u_i, u_j \rangle, \quad i, j = 1, \dots, N. \quad (4.5)$$

It is clear that G is real symmetric with $g_{ii} = 1$ for all $i = 1, \dots, N$. By (2.3) and (2.4), we get the geometric interpretation

$$g_{ij} = \begin{cases} -\cos \angle(H_i, H_j) & \Leftrightarrow |\langle u_i, u_j \rangle| \leq 1 \\ -\cosh d(H_i, H_j) & \Leftrightarrow |\langle u_i, u_j \rangle| > 1 \end{cases} \quad (4.6)$$

A crucial fact is that if \mathcal{P} is a hyperbolic simplex, then the matrix $G(\mathcal{P}) = (\langle u_i, u_j \rangle)_{1 \leq i, j \leq N}$ is invertible and of signature $(n, 1)$ (cf. [64]).

In the sequel, we consider a total simplex $\widehat{\mathcal{T}}$ of type (p, q) , $p \geq 0$, with associated cone $\Theta = \bigcap_{i=1}^{n+1} \widehat{H}_{u_i}^-$, $u_i \in \mathcal{S}_{-1}(1)$, and associated hyperbolic k -truncated simplex \mathcal{T} . Since $k \geq 1$, the Gram matrix $G = G(\mathcal{T})$ is singular of size $(n+k+1) \times (n+k+1)$. This motivates the following

Definition. The *reduced Gram matrix* of \mathcal{T} is defined by $\widehat{G} := G(\widehat{\mathcal{T}})$.

In other words, we consider in the singular matrix $G(\mathcal{T})$ the invertible principal submatrix \widehat{G} of identical signature $(n, 1)$.

Vice-versa, consider a symmetric matrix $A = (a_{ij})_{1 \leq i, j \leq n+1} \in GL(n+1, \mathbb{R})$ of signature $(n, 1)$ with $a_{ii} = 1$ and $a_{i,j} < 1$ for $1 \leq i, j \leq n+1$. In fact, A can be interpreted as the Gram matrix of a total simplex $\widehat{\mathcal{T}}$ with cone $\Theta = \bigcap_{i=1}^{n+1} \widehat{H}_{u_i}^-$ bounded by hyperbolic hyperplanes in \mathbb{R}^{n+1} as follows.

Since A is invertible of signature $(n, 1)$, there exists a matrix $U \in GL(n+1)$ such that $A = U^t J U$, where $J = \text{Diag}(1, \dots, 1, -1)$ is the matrix associated to the standard quadratic form $\langle \cdot, \cdot \rangle$ on $\mathbb{R}^{n,1}$. Write $U = (u_1 | \dots | u_{n+1})$, with well-defined vectors $u_i \in \mathcal{S}(1)$. It follows that $A = G(\widehat{\mathcal{T}}) = \widehat{G}$, for a total simplex $\widehat{\mathcal{T}}$ with cone $\Theta := \bigcap_{i=1}^{n+1} \widehat{H}_{u_i}^- \subset \mathbb{R}^{n+1}$, as required.

The next goal is to construct explicitly vertex vectors for $\widehat{\mathcal{T}}$ which are vectors v_1, \dots, v_{n+1} satisfying (4.3).

Inspired by [47], we put, for $i = 1, \dots, n+1$,

$$v_i := \begin{cases} \frac{\sum_{k=1}^{n+1} \text{cof}_{ik}(\widehat{G}) u_k}{\sqrt{|\text{cof}_{ii}(\widehat{G}) \det(\widehat{G})|}} & \text{if } \text{cof}_{ii}(\widehat{G}) \neq 0 \\ \sum_{k=1}^{n+1} \text{cof}_{ik}(\widehat{G}) u_k & \text{if } \text{cof}_{ii}(\widehat{G}) = 0 \end{cases}. \quad (4.7)$$

A straightforward computation using the identity

$$\sum_{k=1}^{n+1} g_{ik} \operatorname{cof}_{kj}(\widehat{G}) = \det(\widehat{G}) \sum_{k=1}^{n+1} g_{ik} [\widehat{G}^{-1}]_{kj} = \det(\widehat{G}) \delta_{ij}$$

for $1 \leq i, j \leq n+1$ shows that

$$\langle v_i, u_j \rangle = \begin{cases} -\delta_{ij} \sqrt{\left| \frac{\det(\widehat{G})}{\operatorname{cof}_{ii}(\widehat{G})} \right|} & \operatorname{cof}_{ii}(\widehat{G}) \neq 0 \\ \delta_{ij} \det(\widehat{G}) & \operatorname{cof}_{ii}(\widehat{G}) = 0 \end{cases}. \quad (4.8)$$

This can be used to deduce the useful identities

$$\langle v_i, v_j \rangle = \begin{cases} \frac{-\operatorname{cof}_{ij}(\widehat{G})}{\sqrt{|\operatorname{cof}_{ii}(\widehat{G}) \operatorname{cof}_{jj}(\widehat{G})|}} & \operatorname{cof}_{ii}(\widehat{G}), \operatorname{cof}_{jj}(\widehat{G}) \neq 0 \\ -\operatorname{cof}_{ij}(\widehat{G}) \sqrt{\left| \frac{\det(\widehat{G})}{\operatorname{cof}_{jj}(\widehat{G})} \right|} & \operatorname{cof}_{ii}(\widehat{G}) = 0, \operatorname{cof}_{jj}(\widehat{G}) \neq 0 \\ \operatorname{cof}_{ij}(\widehat{G}) \det(\widehat{G}) & \operatorname{cof}_{ii}(\widehat{G}), \operatorname{cof}_{jj}(\widehat{G}) = 0 \end{cases} \quad (4.9)$$

For $j = i$, one gets then

$$\langle v_i, v_i \rangle = \begin{cases} -1 & \Leftrightarrow \operatorname{cof}_{ii}(\widehat{G}) > 0 \\ 0 & \Leftrightarrow \operatorname{cof}_{ii}(\widehat{G}) = 0 \\ 1 & \Leftrightarrow \operatorname{cof}_{ii}(\widehat{G}) < 0 \end{cases} \quad (4.10)$$

Then, if p (resp. q) denotes the number of ultra-ideal (ideal) vertices of $\widehat{\mathcal{T}}$ and if for $k \leq p$ the intersection $\mathcal{T} = \bigcap_{i=1}^{n+1} H_{u_i}^- \cap \bigcap_{i=1}^k H_{v_i}^-$ is nonempty and of finite volume, then modulo a change of indices \mathcal{T} is the hyperbolic k -truncated simplex of type (p, q) associated to $\widehat{\mathcal{T}}$ with respect to the ultra-ideal vertices $v_1, \dots, v_k \in \mathcal{V}_+$, with reduced Gram matrix \widehat{G} .

4.2 The inradius of a hyperbolic truncated simplex

Let $\widehat{\mathcal{T}} \subset \mathbb{R}^{n+1}$ be a total simplex of type (p, q) with simplicial cone $\Theta = \bigcap_{i=1}^{n+1} \widehat{H}_i^-$, and let $\mathcal{T} \subset \overline{\mathcal{H}^n}$ be an associated hyperbolic k -truncated simplex with respect to ultra-ideal vertices $v_1, \dots, v_k \in \mathcal{V}_+$, $1 \leq k \leq p$.

Furthermore, let $u_i \in \mathcal{S}_{-1}(1)$ be the oriented normal vector related to the hyperbolic hyperplane \widehat{H}_i of Θ .

Denote by F_1, \dots, F_{n+1} the facets of \mathcal{T} associated to u_1, \dots, u_{n+1} , and by F_1^*, \dots, F_k^* those associated to v_1, \dots, v_k , all together forming the facet complex of \mathcal{T} . This will be our setting for the rest of the chapter.

Let us denote by $\mathcal{B} = B(\mathcal{T})$ the ball of maximal radius embedded in \mathcal{T} which is the *inball* of \mathcal{T} . The goal of this chapter is to determine the *inradius* $r := r(\mathcal{B})$ of \mathcal{T} .

4.2.1 The inball of a total simplex

For $i, j \in \{1, \dots, n+1\}$, $i \neq j$, let H_{ij} be the hyperbolic hyperplane given by

$$H_{ij} := (u_i - u_j)^\perp.$$

Geometrically, we will see that H_{ij} is the hyperbolic hyperplane intersecting the interior of $\widehat{\mathcal{T}}$ which is midway to the hyperplanes H_i and H_j . More precisely, if H_i and H_j intersect, then H_{ij} is the hyperplane bisecting the dihedral angle α_{ij} . If H_i and H_j are ultra-parallel, then H_{ij} is the hyperplane equidistant to H_i and H_j . If H_i and H_j are parallel, then H_{ij} is the hyperplane determined by horospherical bisector associated to H_i and H_j .

Let us define the vectors

$$b_i := u_i - u_{i+1}, \quad 1 \leq i \leq n. \quad (4.11)$$

Then, by (4.7) and (4.10), we get that for all $i \in \{1, \dots, n\}$

$$\|b_i\|^2 = \langle u_i - u_{i+1}, u_i - u_{i+1} \rangle = 2 - 2\langle u_i, u_{i+1} \rangle = 2 - 2g_{i,i+1} > 0.$$

Now, we normalize and suppose that $b_i \in \mathcal{S}_{-1}(1)$, $i = 1, \dots, n+1$.

In view of (4.6), we deduce

$$H_{b_i} = H_{i,i+1}, \quad i = 1, \dots, n. \quad (4.12)$$

One notices that b_1, \dots, b_n are linearly independent. Hence, the intersection

$$\mathcal{L} := \bigcap_{i=1}^n H_{b_i} \quad (4.13)$$

is nonempty. In view of (4.12) and since Θ is a simplicial cone, \mathcal{L} is a line in \mathbb{R}^{n+1} . In particular, each $x \in \mathcal{L}$ satisfies

$$0 = \langle x, b_i \rangle = \langle x, u_i \rangle - \langle x, u_{i+1} \rangle, \quad 1 \leq i \leq n,$$

and

$$0 = \langle x, b_{n+1} \rangle = \langle x, u_{n+1} \rangle = \langle x, u_1 \rangle.$$

Hence, for each $x \in \mathcal{L}$, one has

$$\langle x, u_i \rangle = \langle x, u_j \rangle, \quad 1 \leq i, j \leq n+1, \quad i \neq j, \quad (4.14)$$

so that

$$\mathcal{L} = \bigcap_{1 \leq i < j \leq n+1} H_{ij}. \quad (4.15)$$

In particular, any hyperplane of the form H_{ij} is midway to the hyperplanes H_i and H_j . Notice that this construction can be generalized as follows.

Lemma 4.2. *Let H_u and H_v be two hyperplanes intersecting in \mathcal{H}^n , with normal vectors $u, v \in \mathcal{S}_{-1}(1)$ and let α be the angle $\angle(H_u, H_v)$. For $\beta \in [0, \alpha]$, we set*

$$w := -\frac{\sin(\alpha - \beta)}{\sin \alpha} u + \frac{\sin \beta}{\sin \alpha} v.$$

Then, the hyperplane H_w is the hyperplane such that $\angle(H_w, H_u) = \beta$ and $\angle(H_w, H_v) = \alpha - \beta$.

Proof. Direct computations using trigonometric identities show that $w \in \mathcal{S}_{-1}(1)$ and that $\langle u, -w \rangle = -\cos(\alpha - \beta)$ and $\langle v, w \rangle = -\cos \beta$. \square

In a similar way, one can prove the following corresponding result for ultra-parallel hyperplanes.

Lemma 4.3. *Let H_u and H_v be two hyperplanes not intersecting in $\overline{\mathcal{H}^n}$, with normal vectors $u, v \in \mathcal{S}_{-1}(1)$ and let l be the distance $d(H_u, H_v)$. For $l' \in [0, l]$, we set*

$$w := -\frac{\sinh(l - l')}{\sinh l} u + \frac{\sinh l'}{\sinh l} v.$$

Then, the hyperplane H_w is the hyperplane such that $d(H_u, H_w) = l'$ and $d(H_v, H_w) = l - l'$.

Let us come back to the line \mathcal{L} .

Lemma 4.4. *The line \mathcal{L} is hyperbolic (respectively parabolic, elliptic) if and only if $\sum_{i,j=1}^{n+1} \text{cof}_{ij}(\widehat{G})$ is strictly positive (respectively zero, strictly negative).*

Proof. In order to facilitate notation, suppose that v_1, \dots, v_q are the ideal vertices of $\widehat{\mathcal{T}}$, such that, by (4.10),

$$\begin{cases} \text{cof}_{11}(\widehat{G}) = \dots = \text{cof}_{qq}(\widehat{G}) = 0 \\ \text{cof}_{ii}(\widehat{G}) \neq 0 \quad \text{for all } i = q+1, \dots, n+1 \end{cases}.$$

Let $b_1, \dots, b_n \in \mathcal{S}(1)$ be the vectors given in (4.11). Then, any nonzero point $x \in \mathcal{L}$ satisfies the conditions

$$\langle x, b_i \rangle = 0, \quad i = 1, \dots, n. \quad (4.16)$$

Since the vectors v_1, \dots, v_{n+1} form a basis of \mathbb{R}^{n+1} , any nonzero $x \in \mathcal{L}$ can be represented as

$$x = \sum_{i=1}^{n+1} \lambda_i v_i, \quad \lambda_i \in \mathbb{R}. \quad (4.17)$$

By (4.8) and (4.11), the n equations $\langle x, b_i \rangle = 0$ have the obvious solution

$$\begin{cases} \lambda_1 = \dots = \lambda_q = \kappa \frac{1}{\sqrt{|\det(\widehat{G})|}} \\ \lambda_i = \kappa \sqrt{|\operatorname{cof}_{ii}(\widehat{G})|}, \quad i = q+1, \dots, n+1 \end{cases}, \quad \kappa \in \mathbb{R} \setminus \{0\}.$$

For

$$\mu_i := \begin{cases} \frac{1}{\sqrt{|\det(\widehat{G})|}} & i = 1, \dots, q \\ \sqrt{|\operatorname{cof}_{ii}(\widehat{G})|} & i = q+1, \dots, n+1 \end{cases}, \quad (4.18)$$

one has for each $x \in \mathcal{L}$ nonzero

$$x = \kappa \sum_{i=1}^{n+1} \mu_i v_i. \quad (4.19)$$

Then, one has for any $x \in \mathcal{L} \setminus \{0\}$

$$\langle x, x \rangle = \kappa^2 \sum_{i,j=1}^{n+1} \mu_i \mu_j \langle v_i, v_j \rangle. \quad (4.20)$$

By (4.9) and (4.18) we obtain

$$\mu_i \mu_j \langle v_i, v_j \rangle = -\operatorname{cof}_{ij}(\widehat{G}) \text{ for all } i, j = 1, \dots, n+1,$$

that is

$$\langle x, x \rangle = -\kappa^2 \sum_{i,j=1}^{n+1} \operatorname{cof}_{ij}(\widehat{G}), \text{ for all } x \in \mathcal{L} \setminus \{0\}. \quad (4.21)$$

Hence, \mathcal{L} is a hyperbolic (respectively parabolic, elliptic) line if and only if $\sum_{i,j=1}^{n+1} \operatorname{cof}_{ij}(\widehat{G}) > 0$ (respectively $= 0, < 0$). \square

Definition 4.4. Let $\widehat{\mathcal{T}}$ be a total simplex. A *tangent inball* of $\widehat{\mathcal{T}}$ is a ball $B(\widehat{\mathcal{T}}) \subset \widehat{\mathcal{T}} \cap \mathcal{H}^n$ which is tangent to all the hyperplanes bounding $\widehat{\mathcal{T}}$.

Corollary 4.1. A total hyperbolic simplex $\widehat{\mathcal{T}}$ with Gram matrix \widehat{G} has a tangent inball if and only if $\sum_{i,j=1}^{n+1} \operatorname{cof}_{ij}(\widehat{G}) > 0$.

Proof. Suppose that $\widehat{\mathcal{T}}$ has a tangent inball $B(\widehat{\mathcal{T}})$. Since $B(\widehat{\mathcal{T}})$ is tangent to all hyperplanes H_1, \dots, H_{n+1} bounding $\widehat{\mathcal{T}}$, the proof of Lemma 4.4 shows that the line \mathcal{L} defined in (4.15) is hyperbolic, since it contains the center of $B(\widehat{\mathcal{T}})$. Therefore $\sum_{i,j=1}^{n+1} \operatorname{cof}_{ij}(\widehat{G}) > 0$.

Suppose that $\sum_{i,j=1}^{n+1} \text{cof}_{ij}(\widehat{G}) > 0$. Then, the line \mathcal{L} is hyperbolic. Hence, by (4.14), the point $\widehat{b} = \mathcal{L} \cap \mathcal{H}^n$ is the center of $B(\widehat{\mathcal{T}})$, and the radius $r(B(\widehat{\mathcal{T}}))$ is given by $d(\widehat{b}, H_i)$ for any $1 \leq i \leq n+1$. In particular, this radius is finite. \square

Remark 4.3. The Corollary can be completed as follows.

1. If $\sum_{i,j=1}^{n+1} \text{cof}_{ij}(\widehat{G}) = 0$, by a continuity argument, the ball $B(\widehat{\mathcal{T}})$ is a horoball tangent to the hyperplanes bounding $\widehat{\mathcal{T}}$.
2. If $\sum_{i,j=1}^{n+1} \text{cof}_{ij}(\widehat{G}) < 0$, then any hyperbolic ball embedded in $\widehat{\mathcal{T}}$ is tangent to at most n hyperplanes bounding $\widehat{\mathcal{T}}$, as the proof above shows.

Remark 4.4. If $\widehat{\mathcal{T}}$ has ultra-ideal vertices, then the tangent inball $B(\widehat{\mathcal{T}})$ is *locally maximal* in the following sense. Suppose that $v_i \in \mathcal{V}_+$ is an ultra-ideal vertex of $\widehat{\mathcal{T}}$. Let $s_i \in \text{Isom}(\mathcal{H}^n)$ be the reflection in the hyperplane H_{v_i} . Then, for $1 \leq j \leq n+1$, $j \neq i$, one has $s_i(H_j) = H_j$. Let \widehat{b} be the center of $B(\widehat{\mathcal{T}})$, and \widehat{r} its radius. Then, $s_i(B(\widehat{\mathcal{T}}))$ is contained in $\widehat{\mathcal{T}} \cap \mathcal{H}^n$, and satisfies $\widehat{r} = r(s_i(B(\widehat{\mathcal{T}})))$. Let L be the geodesic line containing \widehat{b} and $s_i(\widehat{b})$. By moving $s_i(\widehat{b})$ on L away from H_{v_i} , one can construct hyperbolic balls contained in $\widehat{\mathcal{T}}$ and with arbitrarily large radii. On the other hand, the radius of any ball centred at points belonging to the geodesic segment $[\widehat{b}, s_i(\widehat{b})]$ is smaller than \widehat{r} .

However, since we are interested in (polarly) truncated simplices, it is sufficient to consider tangent inballs of total simplices (see Section 4.2.2 below).

In the sequel, if $\widehat{\mathcal{T}}$ has a tangent inball in \mathcal{H}^n , we denote it by $\widehat{\mathcal{B}} = B(\widehat{\mathcal{T}})$ and we call it *the inball of $\widehat{\mathcal{T}}$* . Moreover, we call the radius $\widehat{r} := r(\widehat{\mathcal{B}})$ the *inradius of $\widehat{\mathcal{T}}$* .

Example 4.1. For $a < -1$, the matrix

$$\widehat{G}(a) = \begin{pmatrix} 1 & -\frac{1}{2} & 0 \\ -\frac{1}{2} & 1 & a \\ 0 & a & 1 \end{pmatrix}$$

is the Gram matrix of a total triangle $\widehat{\mathcal{T}}(a)$ of type $(1, 0)$ in $\mathbb{R}^{2,1}$. Since

$$\sum_{i,j=1}^3 \text{cof}_{ij}(\widehat{G}(a)) = - \left(a^2 + 3a - \frac{15}{4} \right),$$

one deduces that $\widehat{\mathcal{T}}(a)$ has an inball $\widehat{\mathcal{B}} = B(a)$ in \mathcal{H}^2 if and only if $-\frac{3}{2} - \sqrt{6} < a < -1$. In the limiting case $a_0 = -\frac{3}{2} - \sqrt{6}$, $B(a_0)$ is a horoball tangent to the 3 sides of $\widehat{\mathcal{T}}(a_0)$ (cf. Remark 4.3, 1.).

Theorem 4.1. Let $\widehat{G} = G(\widehat{\mathcal{T}})$ be the Gram matrix of a total simplex $\widehat{\mathcal{T}}$ with inball $\widehat{\mathcal{B}} \subset \mathcal{H}^n$. Then, the inradius $\widehat{r} = r(\widehat{\mathcal{B}})$ is given by

$$\widehat{r} = \operatorname{arsinh} \sqrt{\frac{-\det(\widehat{G})}{\sum_{i,j=1}^{n+1} \operatorname{cof}_{ij}(\widehat{G})}}. \quad (4.22)$$

Proof. As in the proof of the Corollary, let $\widehat{b} = \mathcal{L} \cap \mathcal{H}^n$ be the center of $\widehat{\mathcal{B}}$. Then, by writing

$$\widehat{b} = \sum_{i=1}^{n+1} \lambda_i v_i$$

as in (4.17), the condition

$$\langle \widehat{b}, \widehat{b} \rangle = -1$$

together with (4.21), leads to

$$\kappa = \frac{1}{\sqrt{\sum_{i,j=1}^{n+1} \operatorname{cof}_{ij}(\widehat{G})}}.$$

Observe that $\widehat{\mathcal{T}}$ can always be moved such that the vectors v_i satisfy $[v_i]_{n+1} > 0$, ensuring that $[\widehat{b}]_{n+1} > 0$ by (4.18). Then, (4.21) becomes

$$\widehat{b} = \frac{\sum_{i=1}^{n+1} \mu_i v_i}{\sqrt{\sum_{i,j=1}^{n+1} \operatorname{cof}_{ij}(\widehat{G})}}. \quad (4.23)$$

Then, we have

$$\widehat{r} = d(\widehat{b}, H_i) = \operatorname{arsinh} |\langle \widehat{b}, u_i \rangle|, \quad i = 1, \dots, n+1.$$

A direct and easy computation using (4.8), (4.14), (4.18) and (4.23) finishes the proof. \square

Remark. If $p = 0$, then $\mathcal{T} = \widehat{\mathcal{T}}$ is a compact simplex or a simplex of finite volume with q ideal vertices, $1 \leq q \leq n+1$, whose inradius $r = r(\mathcal{T})$ equals \widehat{r} . In particular, for $n = 2$, we get the inradius formula for triangles given by Beardon [2, Theorem 7.14.2].

Furthermore, by adapting the setting to the Euclidean case, we can get the following analogous result for spherical simplices.

Remark. Let $\mathcal{T} \subset \mathbb{S}^n$ be a spherical n -simplex with Gram matrix G . Then, its inradius $r = r(\mathcal{T})$ is given by

$$r = \arcsin \sqrt{\frac{\det(G)}{\sum_{i,j=1}^{n+1} \operatorname{cof}_{ij}(G)}}. \quad (4.24)$$

If $p = q = 0$, let \mathcal{C} denote the *circumball* of $\mathcal{T} = \widehat{\mathcal{T}}$, with radius $R := r(\mathcal{C})$.

Proposition 4.1. *Let $\mathcal{T} \subset \mathcal{H}^n$ be a compact hyperbolic simplex with Gram matrix G . Then the circumradius R of \mathcal{T} is given by*

$$R = \operatorname{arcosh} \sqrt{\frac{\det(G)}{\sum_{i,j=1}^{n+1} g_{ij} \sqrt{\operatorname{cof}_{ii}(G) \operatorname{cof}_{jj}(G)}}}. \quad (4.25)$$

Proof. We follow a similar strategy as in the proof of the Theorem. Let $c \in \mathcal{H}^n$ denote the center of \mathcal{C} . Then, c satisfies the conditions

$$\begin{cases} \langle c, v_i \rangle = \langle c, v_j \rangle, & 1 \leq i < j \leq n+1 \\ \|c\|^2 = -1 \\ [c]_{n+1} > 0 \end{cases}. \quad (4.26)$$

Since u_1, \dots, u_{n+1} is a basis of \mathbb{R}^{n+1} , we represent c as

$$c = \sum_{i=1}^{n+1} \sigma_i u_i.$$

Then, a direct computation using (4.8) shows that the system of equations (4.26) admits the unique solution

$$c = \sum_{i=1}^{n+1} \sqrt{\frac{\operatorname{cof}_{ii}(G)}{-\sum_{l,m=1}^{n+1} g_{lm} \sqrt{\operatorname{cof}_{ll}(G) \operatorname{cof}_{mm}(G)}}} u_i. \quad (4.27)$$

Since

$$R = d(c, v_i) = \operatorname{arcosh} |\langle c, v_i \rangle|, \quad i = 1, \dots, n+1,$$

the use of (4.8) and (4.27) allows us to finish the proof. \square

As for the inradius, a proof similar to the one of Proposition 4.1 allows us to deduce the following properties.

Remark. Let G be the Gram matrix of a compact hyperbolic n -simplex $\mathcal{T} \subset \mathcal{H}^n$. The entries and the cofactors of G satisfy the condition

$$\sum_{i,j=1}^{n+1} g_{ij} \sqrt{\operatorname{cof}_{ii}(G) \operatorname{cof}_{jj}(G)} < 0.$$

Remark. Let $\mathcal{T} \subset \mathcal{S}^n$ be a spherical n -simplex with Gram matrix G . Then the circumradius R of \mathcal{T} is given by

$$R = \arccos \sqrt{\frac{\det(G)}{\sum_{i,j=1}^{n+1} g_{ij} \sqrt{\operatorname{cof}_{ii}(G) \operatorname{cof}_{jj}(G)}}}. \quad (4.28)$$

4.2.2 The inball of a hyperbolic truncated simplex

Consider a total simplex $\widehat{\mathcal{T}}$ of type (p, q) with $p \geq 1$, with (tangent) inball $\widehat{\mathcal{B}}$ in \mathcal{H}^n . Then every ultra-ideal vertex v_i comes with its polar hyperplane H_i^* which may intersect the inball $\widehat{\mathcal{B}}$ of $\widehat{\mathcal{T}}$ or not. The following result gives a precise criterion.

Proposition 4.2. *Let $\widehat{\mathcal{T}}$ be a total simplex of type (p, q) , $p \geq 1$, with Gram matrix \widehat{G} , such that $\widehat{\mathcal{T}}$ has an inball $\widehat{\mathcal{B}} \subset \mathcal{H}^n$. Let \widehat{r} be the radius of $\widehat{\mathcal{B}}$. Denote by $\mathcal{T} \subset \overline{\mathcal{H}^n}$ its associated hyperbolic k -truncated simplex with respect to the ultra-ideal vertices $v_1, \dots, v_k \in \mathcal{V}_+$ of $\widehat{\mathcal{T}}$, $1 \leq k \leq p$. Let r be the inradius of \mathcal{T} .*

Then, $r = \widehat{r}$ if and only if

$$\frac{\sum_{j=1}^{n+1} \operatorname{cof}_{ij}(\widehat{G})}{\sqrt{\det(\widehat{G}) \operatorname{cof}_{ii}(\widehat{G})}} \geq 1 \quad \text{for all } i = 1, \dots, k. \quad (4.29)$$

Proof. Let $\widehat{b} \in \mathcal{H}^n$ be the center of $\widehat{\mathcal{B}}$ as in the proof of Theorem (see Section 4.1). For $i = 1, \dots, k$, we set

$$d_i := d(\widehat{b}, H_i^*).$$

Since $v_i \in \mathcal{S}(1)$ for $i \in \{1, \dots, k\}$ as usual (see (4.3)), we can use (4.18) and (4.23) to deduce that

$$d_i = \operatorname{arsinh} \frac{\sum_{j=1}^{n+1} \operatorname{cof}_{ij}(\widehat{G})}{\sqrt{\sum_{l,m=1}^{n+1} \operatorname{cof}_{lm}(\widehat{G})} \sqrt{-\operatorname{cof}_{ii}(\widehat{G})}}. \quad (4.30)$$

Then, by (4.22) and (4.30), we get that $\widehat{r} \leq d_i$ if and only if

$$\frac{\sum_{j=1}^{n+1} \operatorname{cof}_{ij}(\widehat{G})}{\sqrt{\det(\widehat{G}) \operatorname{cof}_{ii}(\widehat{G})}} \geq 1. \quad (4.31)$$

If (4.31) holds for all $i = 1, \dots, k$, then $\widehat{\mathcal{B}}$ is contained in $\bigcap_{i=1}^k (H_i^*)^-$ in such a way that $\widehat{\mathcal{B}}$ is embedded in \mathcal{T} . This completes the proof. \square

Suppose that, in the proof above, one has $\widehat{\mathcal{B}} \not\subseteq (H_i^*)^-$ for at least one $i \in \{1, \dots, k\}$. Then, the inradius $r = r(\mathcal{B})$ can - roughly - be determined as follows.

First, observe that \mathcal{B} must be tangent to at least $n + 1$ of the hyperplanes bounding \mathcal{T} . Next, fix a configuration ω of $n + 1$ hyperplanes bounding \mathcal{T} . The set ω gives rise to a total simplex $\widehat{\mathcal{T}}_\omega$ of type (p_ω, q_ω) , with Gram matrix \widehat{G}_ω , say.

Suppose that $\widehat{\mathcal{T}}_\omega$ has an inball $\widehat{\mathcal{B}}_\omega$ in \mathcal{H}^n , with center \widehat{b}_ω and radius \widehat{r}_ω . Let

H be a hyperplane bounding \mathcal{T} but not $\widehat{\mathcal{T}}_\omega$ (in general, H does not coincide with a polar hyperplane associated to $\widehat{\mathcal{T}}_\omega$). Then, $\widehat{\mathcal{B}}_\omega$ is embedded in \mathcal{T} if and only if for each such H , one has

$$d(\widehat{b}_\omega, H) \geq \widehat{r}_\omega.$$

This condition can be checked by using the corresponding expressions (4.23) and (4.18) for \widehat{G}_ω (or by using (4.31) if H coincides with a polar hyperplane for $\widehat{\mathcal{T}}_\omega$).

Let Ω be the set of all configurations ω of $n + 1$ hyperplanes bounding \mathcal{T} , and, motivated by the Corollary, define

$$\Omega_+ := \left\{ \omega \in \Omega \mid \sum_{i,j=1}^{n+1} \text{cof}_{ij}(\widehat{G}_\omega) > 0 \right\} \subset \Omega.$$

By the above, one sees that $1 \leq \text{card } \Omega_+ \leq \binom{n+k+1}{n+1}$. In this way, the inradius r of \mathcal{T} is given by

$$r = \max_{\omega \in \Omega_+} \left\{ \widehat{r}_\omega \mid \widehat{\mathcal{B}}_\omega \text{ is embedded in } \mathcal{T} \right\}.$$

4.2.3 Inradius monotonicity

In the sequel, we investigate the behavior of the inradius $r = r(\mathcal{T})$ of a spherical or hyperbolic simplex \mathcal{T} with respect to a dihedral angle variation. To this end, we adapt the idea of Vinberg in the proof of Schläfli's differential formula for the volume of a non-Euclidean convex polyhedron (see [65, pp.119-120]). More concretely, let $\mathcal{X}^n = \mathbb{S}^n$ or $\overline{\mathcal{H}}^n$, and let

$$\mathcal{T} = \bigcap_{i=1}^{n+1} H_i^- \subset \mathcal{X}^n$$

be a simplex as usual. Consider the simplicial cone

$$\mathcal{K} := \bigcap_{i=1}^n H_i^-$$

in \mathcal{X}^n . For $\mathcal{X}^n = \mathbb{S}^n$ (respectively $\overline{\mathcal{H}}^n$), the volume of $\mathcal{T} = \mathcal{K} \cap H_{n+1}^-$ is a strictly increasing (respectively decreasing) function with respect to the dihedral angle

$$\alpha := \angle(H_n, H_{n+1}).$$

More precisely, there is an infinitesimal displacement of H_{n+1} into a hyperplane H'_{n+1} such that the intersection

$$\mathcal{T}' = \mathcal{K} \cap (H'_{n+1})^-$$

is a simplex having the same dihedral angles as \mathcal{T} except for

$$\alpha' = \alpha + d\alpha > \alpha,$$

and such that

$$\begin{cases} \mathcal{T} \subset \mathcal{T}' & \text{if } \mathcal{X}^n = \mathbb{S}^n \\ \mathcal{T}' \subset \mathcal{T} & \text{if } \mathcal{X}^n = \overline{\mathcal{H}^n} \end{cases} . \quad (4.32)$$

By convexity, we deduce from (4.32) that the inradius $r = r(\alpha)$ of a spherical (respectively finite volume hyperbolic) simplex \mathcal{T} is strictly increasing (respectively decreasing). Therefore we have proven the following result.

Proposition 4.3. *Let $\mathcal{T} \subset \mathbb{S}^n$ (respectively $\overline{\mathcal{H}^n}$) be a spherical (respectively compact or ideal hyperbolic) simplex. Then, the inradius r of \mathcal{T} is a strictly increasing (respectively decreasing) function with respect to each dihedral angle of \mathcal{T} .*

Notice that, by continuity, Proposition 4.3 remains valid for hyperbolic k -truncated simplices.

4.3 Applications

4.3.1 Some explicit values

Hyperbolic (truncated) simplices are not only distinguished by their particularly nice combinatorial structure, but appear also as fundamental polyhedra of hyperbolic orbifolds and manifolds of small characteristic invariants such as volume. More specifically, such orbifolds are often quotient spaces of hyperbolic space by arithmetic discrete reflection groups related to (truncated) Coxeter simplices. A famous example is Siegel's orbifold of minimal area $\pi/42$ which is related to the $[3, 7]$ -triangle group defined over the field $\mathbb{Q}(2 \cos(\pi/7))$ (cf. [55]). For details concerning volumes of arithmetic hyperbolic orbifolds, see for example [4, Section 2]. A good survey about hyperbolic orbifolds of small volume is [36].

It is an interesting fact that the total simplices given in Section 4.1.1 have (tangent) inballs, which, by criterion (4.29), coincide with the inballs of the corresponding hyperbolic truncated simplices.

Each Coxeter polyhedron $\mathcal{P} \subset \mathcal{H}^n$ yields a tessellation by the action of the associated Coxeter group. Therefore, the inball \mathcal{B} of \mathcal{P} gives rise to an infinite ball packing whose *local density* (see [10]) is defined by

$$\delta(\mathcal{P}) = \frac{\text{vol}_n(\mathcal{B})}{\text{vol}_n(\mathcal{P})} < 1, \quad (4.33)$$

where the volume of \mathcal{B} is given by

$$\text{vol}_n(\mathcal{B}) = \frac{2\pi^{\frac{n}{2}}}{\Gamma(\frac{n}{2})} \int_0^r \sinh^{n-1}(t) dt.$$

By (4.33), we notice that small volume hyperbolic Coxeter polyhedra are closely related to ball packings of large local density (see [56], for example). Observe that the Coxeter polyhedra given in Section 4.1.1, (5) – (6) – (7), are known to give rise to hyperbolic orbifolds of very small volume (see [36]). In the sequel, we shall apply Theorem 4.1 (see Section 4.2.2) to these polyhedra in order to provide a list of geometric quantities including volume, inradius, and local density.

Consider the graphs Γ_n which describe Coxeter (truncated) simplices $\mathcal{T}_n \subset \mathcal{H}^n$, $n = 2, \dots, 8, 17$, as explained in Section 4.1.1, (5) – (6) – (7). Write $v_n = \text{vol}_n(\mathcal{T}_n)$, $r_n = r(\mathcal{T}_n)$ and $\delta_n = \delta(\mathcal{T}_n)$.

Table 4.1 lists the graphs Γ_n and their volumes v_n , $n = 2, \dots, 8, 17$. In this table, k_0 is the field $\mathbb{Q}(\sqrt{5})$, while l_0 is the number field $\mathbb{Q}[x]/(x^4 - x^3 + 3x - 1)$. Furthermore, ζ_k is the Dedekind zeta function associated to the field k , and $L_{l/k} = \zeta_l/\zeta_k$ is the L -function corresponding to a quadratic extension l/k . Notice that the volume of the Coxeter truncated simplex with graph Γ_7 is still unknown !

n	Γ_n	v_n
2		$\frac{\pi}{42} \simeq 7.480 \cdot 10^{-2}$
3		$\frac{275^{3/2}}{8\pi^2} \zeta_{k_0}(2) \simeq 3.905 \cdot 10^{-2}$
4		$\frac{\pi^2}{10800} \simeq 9.139 \cdot 10^{-4}$
5		$\frac{9\sqrt{5}^{15}}{(2\pi)^{15}} \zeta_{k_0}(2) \zeta_{k_0}(4) L_{l_0/k_0}(3) \simeq 7.673 \cdot 10^{-4}$
6		$\frac{67\pi^3}{1080000} \simeq 1.924 \cdot 10^{-3}$
7		?
8		$\frac{24187\pi^4}{5715360000} \simeq 4.122 \cdot 10^{-5}$
17		$\frac{691 \cdot 3617}{2^{38} \cdot 3^{10} \cdot 5^{11} \cdot 7^2 \cdot 11 \cdot 13 \cdot 17} \zeta(9) \simeq 2.072 \cdot 10^{-18}$

Table 4.1: Graphs and volumes of the Coxeter (truncated) n -simplices \mathcal{T}_n

Table 4.2 collects the *exact* values of $\sinh^2 r_n$, as well as approximative values for r_n and for δ_n . By the (non-)truncation criterion (4.29), the inradii r_n could be obtained directly from formula (4.22).

n	$\sinh^2 r_n$	$r_n \simeq$	$\delta_n \simeq$
2	$\frac{-461+324 \cos \frac{\pi}{7}+240 \cos^2 \frac{\pi}{7}}{2351}$	$1.044 \cdot 10^{-1}$	$4.585 \cdot 10^{-1}$
3	$\frac{-17+19\sqrt{5}}{232}$	$1.158 \cdot 10^{-1}$	$1.670 \cdot 10^{-1}$
4	$\frac{-2+\sqrt{5}}{85}$	$5.268 \cdot 10^{-2}$	$4.161 \cdot 10^{-2}$
5	$\frac{-577+345\sqrt{5}}{47672}$	$6.382 \cdot 10^{-2}$	$7.278 \cdot 10^{-3}$
6	$\frac{-47+37\sqrt{5}}{4636}$	$8.768 \cdot 10^{-2}$	$1.227 \cdot 10^{-3}$
7	$\frac{61+65\sqrt{5}}{17404}$	$1.087 \cdot 10^{-1}$?
8	$\frac{-58+65\sqrt{5}}{17761}$	$7.007 \cdot 10^{-2}$	$5.747 \cdot 10^{-5}$
17	$\frac{1}{1240}$	$2.839 \cdot 10^{-2}$	$3.455 \cdot 10^{-10}$

Table 4.2: Inradii and local densities of the Coxeter (truncated) simplices \mathcal{T}_n

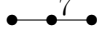
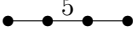
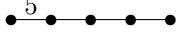
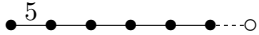
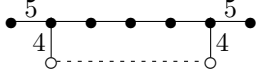
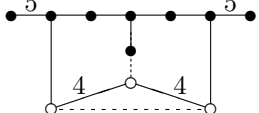
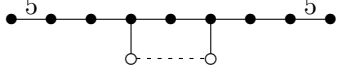
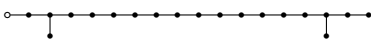
4.3.2 Extremal fundamental polygons

For the end of this chapter, we focus on the 2-dimensional case and polygons tessellating the plane $\overline{\mathcal{H}^2}$. In particular, we give an alternative proof of the following celebrated result of Siegel.

Theorem 4.2 (Siegel [55]). *Let $H \subset \text{Isom}(\mathcal{H}^2)$ be a discrete group, and let $[3, 7]$ be the Coxeter group generated by the reflections in the sides of the triangle with angles $\frac{\pi}{2}$, $\frac{\pi}{3}$ and $\frac{\pi}{7}$. Then, $\text{covol}(H) \geq \frac{\pi}{42} = \text{covol}([3, 7])$, with equality if and only if H is conjugated to $[3, 7]$ in $\text{Isom}(\mathcal{H}^2)$.*

Our approach is based on Poincaré’s description of periodic tessellations of $\overline{\mathcal{H}^2}$ resulting from a discrete group action. In particular, we will study angular conditions for fundamental polygons tessellating the hyperbolic plane. This approach will allow us to determine the minimal area hyperbolic fundamental N -gons, $3 \leq N \leq 6$, and to show that the Coxeter triangle $[3, 7]$ has the minimal inradius amongst all hyperbolic fundamental triangles.

Alternative proof of Siegel’s Theorem

We follow ideas developed by Poincaré [49] (see also [43]) in order to determine conditions for a polygon to be the fundamental domain of a discrete

group $H < \text{Isom}(\mathcal{H}^2)$. For $N \geq 3$, let $\mathcal{P} \subset \overline{\mathcal{H}^2}$ be a finite area N -gon tessellating $\overline{\mathcal{H}^2}$, with vertices v_1, \dots, v_N and corresponding angles $\alpha_1, \dots, \alpha_N$. Let a_1, \dots, a_N be the sides of \mathcal{P} such that a_i connects the vertices v_i and v_{i+1} , $i = 1, \dots, N-1$, and a_N connects v_N and v_1 .

The plane $\overline{\mathcal{H}^2}$ is tessellated by copies of \mathcal{P} through (isometric) identifications of the sides of \mathcal{P} (any side is identified either with itself, or with a unique other side). This induces a partition of the set of vertices of \mathcal{P} into cycles of identified vertices, and therefore a partition of the set $\{1, \dots, N\}$ of indices into subsets J_1, \dots, J_r , $r \geq 1$. We also get a partition of the set of angles into cycles of angles around any vertex in the tessellation. Since the angles around each vertex sum up to 2π , this leads us to the so-called *angle conditions*

$$\sum_{j \in J_k} \alpha_j = \frac{2\pi}{m_k}, \quad k = 1, \dots, r, \quad \text{for integers } m_k \in \mathbb{N}^*. \quad (4.34)$$

For any angle cycle $\mathcal{C}_k = \mathcal{C}(J_k)$, let

$$\mu_k = \frac{1}{|J_k|} \cdot \frac{2\pi}{m_k}$$

be the *mean angle* associated to the cycle \mathcal{C}_k . Since $\alpha_i \in [0, \pi[$ for $i = 1, \dots, N$, (4.34) implies the following :

- If $|J_k| = 1$, then $m_k \geq 3$, and $\mu_k \leq \frac{2\pi}{3}$.
- If $|J_k| = 2$, then $m_k \geq 2$, and $\mu_k \leq \frac{\pi}{2}$.
- If $|J_k| = 3$, then $m_k \geq 1$, and $\mu_k \leq \frac{2\pi}{3}$.
- If $|J_k| \geq 4$, then $m_k \geq 1$, and $\mu_k \leq \frac{2\pi}{|J_k|} < \frac{2\pi}{3}$.

Hence, since the J_k 's form a partition of $\{1, \dots, N\}$, one can write

$$\sum_{k=1}^r \mu_k \cdot |J_k| \leq \sum_{k=1}^r \frac{2\pi}{3} \cdot |J_k| = \frac{2\pi}{3} N. \quad (4.35)$$

Moreover, the area of \mathcal{P} is given by (see Theorem 2.12)

$$\text{area}(\mathcal{P}) = (N-2)\pi - \sum_{i=1}^N \alpha_i.$$

By (4.34) and (4.35), one has the following bound :

$$\sum_{i=1}^N \alpha_i = \sum_{k=1}^r \sum_{j \in J_k} \alpha_j = \sum_{k=1}^r \mu_k \cdot |J_k| \leq \frac{2\pi}{3} N,$$

which implies

$$\text{area}(\mathcal{P}) \geq (N - 2)\pi - \frac{2\pi}{3}N = \frac{\pi}{3}(N - 6).$$

In particular, for $N \geq 7$, one has $\text{area}(\mathcal{P}) \geq \frac{\pi}{3} > \frac{\pi}{42} = \text{area}([3, 7])$. Hence, it remains to consider the cases $N = 3, 4, 5, 6$, for which we will need to look more closely at the nature of the identifications of the sides of \mathcal{P} . Observe that a side of a polygon can be identified with itself only by a reflection in the line containing it, or by a rotation of angle π around its midpoint (see Figure 4.2).

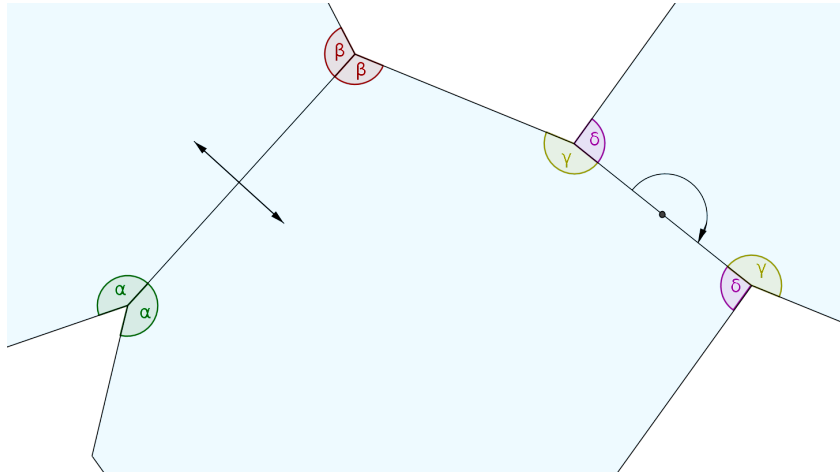

Figure 4.2

We start with $N = 3$, i.e. \mathcal{P} is a triangle tessellating $\overline{\mathcal{H}^2}$. Then, one has only 2 possible configurations :

- (1) Each side a_i of \mathcal{P} is identified with itself by an isometry $h_i \in \text{Isom}(\mathcal{H}^2)$, $i = 1, 2, 3$. Each h_i is either a reflection in the line containing a_i , or a rotation of angle π around the midpoint of a_i . Then, one has 4 possibilities for the nature of h_1, h_2 and h_3 :
 - (i) The isometries h_1, h_2 and h_3 are rotations. Then, the vertices v_1, v_2 and v_3 are mutually identified, so that the angles α_1, α_2 and α_3 belong to the same cycle. Hence, the corresponding angle condition (4.34) is of the form $\alpha_1 + \alpha_2 + \alpha_3 = \frac{2\pi}{m}$, $m \geq 1$.
 - (ii) There is 1 reflection, say h_1 . As in (i), the angles of \mathcal{P} belong to the same cycle, and the corresponding angle condition is of the form $2\alpha_1 + 2\alpha_2 + 2\alpha_3 = \frac{2\pi}{m}$, $m \geq 1$, i.e. $\alpha_1 + \alpha_2 + \alpha_3 = \frac{\pi}{m}$, $m \geq 1$.
 - (iii) There are 2 reflections, say h_2 and h_3 . Then, the vertices v_1 and v_2 are mutually identified, while the vertex v_3 is identified only with itself. The angles of \mathcal{P} split into two cycles, say $\mathcal{C}_1 = \{\alpha_1, \alpha_2\}$ and

$\mathcal{C}_2 = \{\alpha_3\}$. The corresponding angle conditions are of the form $\alpha_1 + \alpha_2 = \frac{\pi}{m_1}$, $\alpha_3 = \frac{\pi}{m_2}$, $m_1 \geq 1$, $m_2 \geq 2$.

(iv) The isometries h_1, h_2 and h_3 are reflections. Then, the vertices of \mathcal{P} are identified only with themselves, so that we have the 3 angle cycles $\mathcal{C}_i = \{\alpha_i\}$, $i = 1, 2, 3$. The corresponding angle conditions are of the form $\alpha_1 = \frac{\pi}{m_1}$, $\alpha_2 = \frac{\pi}{m_2}$, $\alpha_3 = \frac{\pi}{m_3}$, $m_1, m_2, m_3 \geq 2$.

(2) The triangle \mathcal{P} has at least two isometric sides, say a_1 and a_3 , which are identified with each other by the isometries h_1 and $h_3 = h_1^{-1}$ (such that $h_1(v_1) = v_1$ or $h_1(v_1) = v_3$). The remaining side a_2 is identified with itself by $h_2 \in \text{Isom}(\mathcal{H}^2)$, where h_2 is either a reflection or a rotation as in (1). Then, one has $\alpha_2 = \alpha_3$. There are again 4 cases :

- (i) One has $h_1(v_1) = v_1$ and h_2 is a rotation. Then, the corresponding angle conditions are of the form $\alpha_1 = \frac{2\pi}{m_1}$, $\alpha_2 = \alpha_3 = \frac{\pi}{m_2}$, $m_1 \geq 3$, $m_2 \geq 2$.
- (ii) One has $h_1(v_1) = v_1$ and h_2 is a reflection. Then, the corresponding angle conditions are of the form $\alpha_1 = \frac{2\pi}{m_1}$, $\alpha_2 = \alpha_3 = \frac{\pi}{2m_2}$, $m_1 \geq 3$, $m_2 \geq 2$.
- (iii) One has $h_1(v_1) = v_3$ and h_2 is a rotation. Then, the corresponding angle condition is of the form $\alpha_1 + \alpha_2 + \alpha_3 = \frac{2\pi}{m}$, $m \geq 1$.
- (iv) One has $h_1(v_1) = v_3$ and h_2 is a reflection. Then, the corresponding angle condition is of the form $\alpha_1 + \alpha_2 + \alpha_3 = \frac{\pi}{m}$, $m \geq 1$.

The above conditions combined with $\alpha_1 + \alpha_2 + \alpha_3 < \pi$ lead to a lower bound on $\text{area}(\mathcal{P})$ in each case.

As an example, consider the case (1)(iv). There, we have to minimize the expression $\pi - (\frac{\pi}{m_1} + \frac{\pi}{m_2} + \frac{\pi}{m_3})$ with respect to $m_1, m_2, m_3 \geq 2$. Suppose without loss of generality that we have $2 \leq m_1 \leq m_2 \leq m_3$. If $m_1 \geq 4$, then $\pi - (\frac{\pi}{m_1} + \frac{\pi}{m_2} + \frac{\pi}{m_3}) \geq \frac{\pi}{4}$. If $m_1 = 3$, then $\pi - (\frac{\pi}{m_1} + \frac{\pi}{m_2} + \frac{\pi}{m_3}) \geq \frac{2\pi}{3} - (\frac{\pi}{3} + \frac{\pi}{4}) = \frac{\pi}{12}$. Finally, if $m_1 = 2$, then $\pi - (\frac{\pi}{m_1} + \frac{\pi}{m_2} + \frac{\pi}{m_3}) \geq \frac{\pi}{2} - (\frac{\pi}{3} + \frac{\pi}{7}) = \frac{\pi}{42}$. Hence, $\pi - (\frac{\pi}{m_1} + \frac{\pi}{m_2} + \frac{\pi}{m_3})$ is minimal if and only if $m_1 = 2$, $m_2 = 3$ and $m_3 = 7$, which is the unique possibility for this case.

Table 4.3 summarizes the minimal area which can be obtained for any of the configurations described above.

	(i)	(ii)	(iii)	(iv)
(1)	$\pi/3$	$\pi/2$	$\pi/6$	$\pi/42$
(2)	$\pi/21$	$\pi/6$	$\pi/2$	$\pi/2$

Table 4.3: Minimal values of $\text{area}(\mathcal{P})$ if \mathcal{P} is a fundamental triangle

Hence, the minimal possible triangle area is $\frac{\pi}{42}$. It is realized by a triangle \triangle with sides identifications described in case (1)(iv). This corresponds to the

Coxeter triangle of angles $\frac{\pi}{2}, \frac{\pi}{3}, \frac{\pi}{7}$. Since, in this case, the side identifications h_1, h_2 and h_3 are reflections in the sides of Δ , we deduce that the associated discrete group H is conjugate to the Coxeter group $[3, 7]$ in $\text{Isom}(\mathcal{H}^2)$.

The same procedure can be performed for $N = 4, 5, 6$. For $N = 4$, it turns out that the area minimizer is the quadrilateral \mathcal{Q} obtained by doubling the Coxeter triangle Δ along its long side. The corresponding discrete group $H < \text{Isom}(\mathcal{H}^2)$ is the index 2 rotational subgroup of the Coxeter group $[3, 7]$. Hence, if \mathcal{P} is a fundamental quadrilateral, then $\text{area}(\mathcal{P}) \geq \frac{\pi}{21}$, with equality if and only if \mathcal{P} is isometric to \mathcal{Q} .

Let us consider the case $N = 5$, i.e. \mathcal{P} is a pentagon with vertices v_1, \dots, v_5 , sides a_1, \dots, a_5 and angles $\alpha_1, \dots, \alpha_5$. The case distinction can be summarized as follows.

- (1) Each side of \mathcal{P} is identified with itself.
- (2) One pair of sides of \mathcal{P} consists in mutually identified sides, and each remaining side is identified with itself. This case splits in the 2 following cases.
 - (i) The mutually identified sides are adjacent.
 - (ii) The mutually identified sides are not adjacent.
- (3) Two pairs of sides of \mathcal{P} consist in mutually identified sides, and the remaining side is identified with itself. This case splits in the 3 following cases.
 - (i) The pairs of mutually identified sides are mutually adjacent.
 - (ii) One pair of mutually identified sides consists in adjacent sides, the other one consists in non-adjacent sides.
 - (iii) Both pairs of mutually identified sides consist in non-adjacent sides.

Each of the above cases splits further in sub-cases corresponding to the different possible natures of the side identifications h_1, \dots, h_5 . As an illustration, we explicit the procedure for the case (3)(i). Suppose that amongst the sides of the pentagon \mathcal{P} , the sides a_1 and a_2 are mutually identified by an isometry $h_1 \in \text{Isom}(\mathcal{H}^2)$, the sides a_3 and a_4 are mutually identified by an isometry $h_3 \in \text{Isom}(\mathcal{H}^2)$, and the side a_5 is identified with itself by an isometry $h_5 \in \text{Isom}(\mathcal{H}^2)$. Then, we have 6 possibilities depending on the nature of h_1, h_3 and h_5 (the case where $h_1(v_2) \neq v_2$ and $h_3(v_4) = v_4$ is similar to the case where $h_1(v_2) = v_2$ and $h_3(v_4) \neq v_4$) :

- (a) If $h_1(v_2) = v_2, h_3(v_4) = v_4$ and h_5 is a reflection, then the angular conditions are given by $\alpha_1 + \alpha_3 + \alpha_5 = \frac{\pi}{m_1}, m_1 \geq 1, \alpha_2 = \frac{2\pi}{m_2}, m_2 \geq 3$, and $\alpha_4 = \frac{2\pi}{m_3}, m_3 \geq 3$.

- (b) If $h_1(v_2) = v_2$, $h_3(v_4) = v_4$ and h_5 is not a reflection, then the angular conditions are given by $\alpha_1 + \alpha_3 + \alpha_5 = \frac{2\pi}{m_1}$, $m_1 \geq 1$, $\alpha_2 = \frac{2\pi}{m_2}$, $m_2 \geq 3$, and $\alpha_4 = \frac{2\pi}{m_3}$, $m_3 \geq 3$.
- (c) If $h_1(v_2) = v_2$, $h_3(v_4) \neq v_4$ and h_5 is a reflection, then the angular conditions are given by $\alpha_1 + \alpha_3 + \alpha_4 + \alpha_5 = \frac{\pi}{m_1}$, $m_1 \geq 1$, $\alpha_2 = \frac{2\pi}{m_2}$, $m_2 \geq 3$.
- (d) If $h_1(v_2) = v_2$, $h_3(v_4) \neq v_4$ and h_5 is not a reflection, then the angular conditions are given by $\alpha_1 + \alpha_3 + \alpha_4 + \alpha_5 = \frac{2\pi}{m_1}$, $m_1 \geq 1$, $\alpha_2 = \frac{2\pi}{m_2}$, $m_2 \geq 3$.
- (e) If $h_1(v_2) \neq v_2$, $h_3(v_4) \neq v_4$ and h_5 is a reflection, then the angular condition is given by $\alpha_1 + \alpha_2 + \alpha_3 + \alpha_4 + \alpha_5 = \frac{\pi}{m_1}$, $m_1 \geq 1$.
- (f) If $h_1(v_2) \neq v_2$, $h_3(v_4) \neq v_4$ and h_5 is not a reflection, then the angular condition is given by $\alpha_1 + \alpha_2 + \alpha_3 + \alpha_4 + \alpha_5 = \frac{2\pi}{m_1}$, $m_1 \geq 1$.

Since \mathcal{P} is a pentagon, we have $\text{area}(\mathcal{P}) = 3\pi - (\alpha_1 + \alpha_2 + \alpha_3 + \alpha_4 + \alpha_5)$. As for the triangular case, the angular conditions and $\alpha_1 + \alpha_2 + \alpha_3 + \alpha_4 + \alpha_5 < 3\pi$ allow us to determine the minimal possible area for each of the cases (a)–(f). For example, in case (b), the minimal area is reached for $m_1 = 1$, $m_2 = 3$ and $m_3 = 7$ (or $m_2 = 7$ and $m_3 = 3$). The corresponding minimal values of $\text{area}(\mathcal{P})$ are given in Table 4.4.

(a)	(b)	(c)	(d)	(e)	(f)
$2\pi/3$	$\pi/21$	$4\pi/3$	$\pi/3$	2π	π

Table 4.4: Minimal values of $\text{area}(\mathcal{P})$ for the configurations (a) – (f)

Hence, the minimal possible area in case (3)(i) is $\frac{\pi}{21}$ and is realizable only in the configuration (b) above. By following the same strategy, one can determine the minimal values of $\text{area}(\mathcal{P})$ in all cases (1) – (2) – (3) above. They are listed in Table 4.5.

(1)	(2)(i)	(2)(ii)	(3)(i)	(3)(ii)	(3)(iii)
$\pi/2$	$\pi/3$	$\pi/3$	$\pi/21$	$\pi/3$	$\pi/3$

Table 4.5: Minimal values of $\text{area}(\mathcal{P})$ for \mathcal{P} a fundamental pentagon

Hence, the fundamental pentagon with minimal area is a pentagon Π with angles α_1 , $2\pi/3$, α_3 , $2\pi/7$ and α_5 satisfying $\alpha_1 + \alpha_3 + \alpha_5 = 2\pi$. Moreover, the sides of Π are identified as follows : a_1 is identified with a_2 by a rotation ρ_1 of angle $2\pi/3$ around v_2 , a_3 is identified with a_4 by a rotation ρ_2 of angle

$2\pi/7$ around v_4 , and a_5 is identified with itself by a rotation ρ_3 of angle π around its midpoint. By Poincaré's Fundamental Polyhedron Theorem (see [43] for example), the corresponding discrete group $H < \text{Isom}(\mathcal{H}^2)$ is given by

$$H_{\Pi} = \langle r_1, r_2, r_3 \mid \rho_1^7 = \rho_2^3 = \rho_3^2 = \rho_1\rho_2\rho_3 \rangle.$$

From the relations $\rho_3^2 = \rho_1\rho_2\rho_3 = 1$ one deduces $\rho_1\rho_2 = \rho_3$. Hence, $H_{\Pi} = \langle \rho_1, \rho_2 \mid \rho_1^7 = \rho_2^3 = (\rho_1\rho_2)^2 = 1 \rangle$, i.e. H_{Π} is isomorphic to the index 2 rotational subgroup of the Coxeter groups [3, 7]. In particular, the fundamental quadrilateral and the fundamental pentagon of minimal area are fundamental polygons of the same group.

For $N = 6$, the same procedure leads to the bound $\text{area}(\mathcal{P}) \geq \frac{\pi}{6}$, with equality if and only if \mathcal{P} is the hexagon Θ with angles $\alpha_1, 2\pi/3, \alpha_3, 2\pi/3, \alpha_5, \pi/2$ (in the given order), satisfying $\alpha_1 + \alpha_3 + \alpha_5 = 2\pi$. Moreover, the sides of Θ are identified as follows : a_1 is identified with a_2 by a rotation of angle $2\pi/3$ around v_2 , a_3 is identified with a_4 by a rotation of angle $2\pi/3$ around v_4 , and a_5 is identified with a_6 by a rotation of angle $\pi/2$ around v_6 .

Finally, one deduces that if \mathcal{P} is a fundamental polygon for a discrete subgroup of $\text{Isom}(\mathcal{H}^2)$, then $\text{area}(\mathcal{P}) \geq \frac{\pi}{42}$, with equality if and only if \mathcal{P} is the Coxeter triangle [3, 7].

Remark 4.5. This proof, based on Poincaré's ideas, reveals the minimal area of a fundamental N -gon for fixed N , $3 \leq N \leq 6$ and the corresponding discrete subgroups of $\text{Isom}(\mathcal{H}^2)$. The method can be extended for $N \geq 7$, but the case-by-case analysis becomes heavier as N grows.

Let us summarize some byproducts of the above proof.

Corollary 4.2. *For $N \geq 3$, let $\mathcal{P} \subset \overline{\mathcal{H}^2}$ be a fundamental N -gon for a discrete subgroup of $\text{Isom}(\mathcal{H}^2)$. Then*

$$\text{area}(\mathcal{P}) \geq \frac{\pi}{3}(N - 6).$$

Corollary 4.3. *The fundamental quadrilateral and the fundamental pentagon in $\overline{\mathcal{H}^2}$ with minimal area are fundamental polygons for the same group : $[3, 7]^+$, the index 2 rotational subgroup of [3, 7], of coarea $\pi/21$.*

Corollary 4.4. *The fundamental hexagon in $\overline{\mathcal{H}^2}$ with minimal area is a fundamental polygon for the group $H = \langle \rho_1, \rho_2, \rho_3 \mid \rho_1^3 = \rho_2^3 = \rho_3^4 = \rho_1\rho_2\rho_3 \rangle$ of coarea $\pi/6$.*

Fundamental triangles of minimal inradius

We end this chapter by proving the following result.

Proposition 4.4. *Let $\mathcal{T} \subset \overline{\mathcal{H}^2}$ be a fundamental triangle of some cofinite discrete group $H < \text{Isom}(\mathcal{H}^2)$ and let $r(\mathcal{T})$ be the inradius of \mathcal{T} . Then,*

$$r(\mathcal{T}) \geq r_0 := \text{arsinh} \sqrt{\frac{-3/4 + \cos^2(\pi/7)}{15/4 + 3 \cos(\pi/7) - \cos^2(\pi/7)}} \approx 0.10443,$$

with equality if and only if \mathcal{T} is isometric to the Coxeter triangle [3, 7].

Proof. Let \mathcal{T} be a fundamental triangle with angles $\alpha, \beta, \gamma \geq 0$, $\alpha + \beta + \gamma < \pi$. By the above proof of Siegel's Theorem, α, β and γ must satisfy one of the following conditions :

- (1) $\alpha + \beta + \gamma = \frac{2\pi}{k}$, $k \geq 3$.
- (2) $\alpha + \beta + \gamma = \frac{\pi}{k}$, $k \geq 2$.
- (3) $\alpha + \beta = \frac{\pi}{k}$, $k \geq 2$ and $\gamma = \frac{\pi}{l}$, $l \geq 2$.
- (4) $\alpha = \frac{2\pi}{k}$, $k \geq 3$, and $\beta = \gamma = \frac{\pi}{2l}$, $l \geq 2$.
- (5) $\alpha = \frac{\pi}{k}$, $k \geq 2$, $\beta = \frac{\pi}{l}$, $l \geq 2$, and $\gamma = \frac{\pi}{m}$, $m \geq 2$.

Let $r(\mathcal{T}) = r(\alpha, \beta, \gamma)$ be the inradius of \mathcal{T} (see (4.22)). We consider successively each of the cases (1) – (5).

Ad (1) : We assume without loss of generality that $\alpha \geq \beta \geq \gamma$.

Suppose first that $k \geq 5$, i.e. if $\alpha + \beta + \gamma \leq \frac{2\pi}{5}$. Then, one has $\gamma < \frac{\pi}{7}$ (since otherwise one would have $\alpha + \beta + \gamma \geq \frac{3\pi}{7} > \frac{2\pi}{5}$), $\beta < \frac{\pi}{3}$ (since otherwise one would have $\alpha + \beta + \gamma \geq \frac{2\pi}{3} > \frac{2\pi}{5}$), and $\alpha < \frac{\pi}{2}$ (since otherwise we would have $\alpha + \beta + \gamma \geq \frac{\pi}{2} > \frac{2\pi}{5}$). Hence, by inradius monotonicity (see Proposition 4.3), one has $r(\alpha, \beta, \gamma) > r_0$.

Next, suppose that $k = 4$, i.e. $\alpha + \beta + \gamma = \frac{\pi}{2}$. Then, $\frac{\pi}{6} \leq \alpha \leq \frac{\pi}{2}$, $0 \leq \beta \leq \frac{\pi}{4}$, and $0 \leq \gamma \leq \frac{\pi}{6}$. If $\gamma \leq \frac{\pi}{7}$, then a similar argument as above leads to $r(\alpha, \beta, \gamma) > r_0$. Moreover, we observe that $r(\frac{\pi}{6}, \frac{\pi}{6}, \frac{\pi}{6}) > r_0$, so that we can suppose $\frac{\pi}{7} < \gamma < \frac{\pi}{6}$. Hence, one must have $\beta \leq \frac{5\pi}{28}$ and $\alpha \leq \frac{3\pi}{14}$. By inradius monotonicity, one deduces that $r(\alpha, \beta, \gamma) \geq r(\frac{3\pi}{14}, \frac{5\pi}{28}, \frac{\pi}{7}) > r_0$.

Finally, suppose that $k = 3$, i.e. $\alpha + \beta + \gamma = \frac{2\pi}{3}$. If $\alpha \geq \frac{\pi}{2}$, then $\beta \leq \frac{\pi}{6}$ and $\gamma \leq \frac{\pi}{12}$. Inradius monotonicity and a direct computation show that $r(\alpha, \beta, \gamma) \geq r(\frac{2\pi}{3}, \frac{\pi}{6}, \frac{\pi}{12}) > r_0$. It remains to consider the case $\alpha < \frac{\pi}{2}$. We have $\beta \leq \frac{2\pi}{3}$, so that if $\gamma \leq \frac{\pi}{7}$, then $r(\alpha, \beta, \gamma) > r_0$ by inradius monotonicity. Hence, we suppose $\gamma > \frac{\pi}{7}$. Then, we have the following bounds for α, β, γ :

$\alpha \leq \frac{8\pi}{21} = \frac{2\pi}{3} - 2 \cdot \frac{\pi}{7}$, $\beta \leq \frac{11\pi}{42} = \frac{1}{2}(\frac{2\pi}{3} - \frac{\pi}{7})$, and $\gamma \leq \frac{2\pi}{9} = \frac{1}{3} \cdot \frac{2\pi}{3}$. Inradius monotonicity and a direct computation show that $r(\alpha, \beta, \gamma) \geq r(\frac{8\pi}{21}, \frac{11\pi}{42}, \frac{2\pi}{9}) > r_0$.

Hence, if $\alpha + \beta + \gamma = \frac{2\pi}{k}$, $k \geq 3$, then $r(\alpha, \beta, \gamma) > r_0$.

Ad (2) : This is case (1) for $k = 2l$, $k \geq 4$.

Ad (3) : First, suppose that $\alpha + \beta = \frac{\pi}{2}$, i.e. $\beta = \frac{\pi}{2} - \alpha$. Then, $\gamma \leq \frac{\pi}{3}$, $r(\alpha, \beta, \gamma) = r(\alpha, \gamma)$, and (4.22) shows that $\sinh r^2(\alpha, \gamma) = f(\alpha, \gamma)$, with

$$f(\alpha, \gamma) = \frac{-\cos \gamma(\cos \gamma + \sin 2\alpha)}{-3 + \cos^2 \alpha - 2 \cos \gamma + (\cos \gamma - \sin \alpha)^2 - 2 \sin \alpha - 2 \cos \alpha(1 + \cos \beta + \sin \alpha)}.$$

The partial derivative $\frac{\partial}{\partial \gamma} f(\alpha, \gamma)$ equals

$$-\frac{\sin \gamma(1 + \sin \alpha + \cos \alpha)^2(1 + 2 \sin 2\alpha + 4 \cos \gamma + \cos 2\gamma)}{2(-3 + \cos^2 \alpha - 2 \cos \gamma + (\cos \gamma - \sin \alpha)^2 - 2 \sin \alpha - 2 \cos \alpha(1 + \cos \beta + \sin \alpha))^2},$$

and its sign is the same as the sign of the function

$$\nu(\alpha, \gamma) := -\sin \gamma(1 + \sin \alpha + \cos \alpha)^2(1 + 2 \sin 2\alpha + 4 \cos \gamma + \cos 2\gamma).$$

Since $0 \leq 2\alpha \leq \pi$ and $0 < \gamma \leq \frac{\pi}{3}$, one sees that $\nu(\alpha, \gamma) < 0$, so that $f(\alpha, \gamma)$ is strictly decreasing as a function of γ , i.e. $f(\alpha, \frac{\pi}{3}) < f(\alpha, \gamma)$ for all $\gamma \in [0, \frac{\pi}{3}]$. One has

$$f(\alpha, \frac{\pi}{3}) = f(\alpha) = \frac{1 + 2 \sin 2\alpha}{11 + 12 \sin \alpha + 4 \cos \alpha(3 + 2 \sin \alpha)}.$$

Observe that $f(\frac{\pi}{2} - \alpha) = f(\alpha)$ for all $\alpha \in [0, \frac{\pi}{2}]$, so that it is sufficient to study $f(\alpha)$ for $\alpha \in [0, \frac{\pi}{4}]$. Furthermore,

$$f'(\alpha) = \frac{12(2 \cos \alpha + 3 \cos 2\alpha + \cos 3\alpha - 2 \sin \alpha + \sin 3\alpha)}{(11 + 12 \sin \alpha + 4 \cos \alpha(3 + 2 \sin \alpha))^2}.$$

For all $\alpha \in [0, \frac{\pi}{4}]$, one has $2 \cos \alpha - 2 \sin \alpha \geq 0$, $\cos 3\alpha + \sin 3\alpha \geq 0$, and $3 \cos 2\alpha \geq 0$, so that $f'(\alpha) \geq 0$ for all $\alpha \in [0, \frac{\pi}{4}]$, with equality if and only if $\alpha = \frac{\pi}{4}$. Hence, the function f is strictly increasing in α for $\alpha \in [0, \frac{\pi}{4}]$, has a maximum in $\alpha = \frac{\pi}{4}$, and is strictly decreasing for $\alpha \in [\frac{\pi}{4}, \frac{\pi}{2}]$.

As a consequence, one has $f(\alpha, \gamma) \geq f(0, \frac{\pi}{3}) = f(\frac{\pi}{2}, \frac{\pi}{3})$. Hence, $r(\alpha, \beta, \gamma) \geq r(0, \frac{\pi}{2}, \frac{\pi}{3})$, so that $r(\alpha, \beta, \gamma) > r_0$ if $\alpha + \beta = \frac{\pi}{2}$ and $\gamma = \frac{\pi}{3}$, $l \geq 3$.

Now, suppose that $\alpha + \beta \leq \frac{\pi}{3}$. By inradius monotonicity, $r(\alpha, \beta, \frac{\pi}{2}) \leq r(\alpha, \beta, \gamma)$ for all $\gamma \in]0, \frac{\pi}{2}]$. Moreover, a procedure similar to the procedure used in the case $\alpha + \beta = \frac{\pi}{2}$ shows that $r(\alpha, \beta, \frac{\pi}{2})$ is minimal for $\alpha = \frac{\pi}{3}$ and $\beta = 0$ (or vice-versa), so that $r(\alpha, \beta, \frac{\pi}{2}) \geq r(\frac{\pi}{3}, 0, \frac{\pi}{2})$. Hence, $r(\alpha, \beta, \gamma) > r_0$ if $\alpha + \beta = \frac{\pi}{k}$, $k \geq 3$, and $\gamma = \frac{\pi}{l}$, $l \geq 2$.

Ad (4) : If $\alpha = \frac{2\pi}{k}$, $k \geq 3$ and $\beta = \gamma = \frac{\pi}{2l}$, $l \geq 2$, then $r(\alpha, \beta, \gamma) = r(\alpha, \beta)$, is given by

$$r(\alpha, \beta) = \operatorname{arsinh} \sqrt{\frac{\cos \alpha + \cos 2\beta}{3 - \cos \alpha + 4 \cos \beta}}.$$

Let $f(\alpha, \beta) = \sinh r^2(\alpha, \beta)$. Then,

$$\frac{\partial}{\partial \alpha} f(\alpha, \beta) = \frac{-\cos^4 \frac{\beta}{2} \sin \alpha}{(3 - \cos \alpha + 4 \cos \beta)^2}.$$

In particular, for any $\beta \in]0, \frac{\pi}{4}]$, the function $f(\alpha, \beta)$ is strictly decreasing with respect to α . Hence, $f(\frac{2\pi}{3}, \beta) \leq f(\alpha, \beta)$ for all $\alpha \in]0, \frac{2\pi}{3}]$, $\beta \in]0, \frac{\pi}{4}]$. Since $\alpha + 2\beta < \pi$, we have the following cases :

- Suppose that $\alpha = \frac{2\pi}{3}$ and $\beta = \frac{\pi}{2k}$, $k \geq 4$. Then inradius monotonicity and a direct computation yield $r(\frac{2\pi}{3}, \beta) \geq r(\frac{2\pi}{3}, \frac{\pi}{8}) > r_0$.
- Suppose that $\alpha = \frac{\pi}{2}$ and $\beta = \frac{\pi}{6}$. Then, a direct computation shows that $r(\frac{\pi}{2}, \frac{\pi}{6}) > r_0$.
- Suppose that $\alpha \leq \frac{2\pi}{5}$ and $\beta = \frac{\pi}{4}$. Then, the above discussion, inradius monotonicity and a direct computation show $r(\alpha, \beta) \geq r(\frac{2\pi}{5}, \frac{\pi}{4}) > r_0$.

Hence, if $\alpha = \frac{2\pi}{k}$, $k \geq 3$ and $\beta = \gamma = \frac{\pi}{2l}$, $l \geq 2$, then $r(\alpha, \beta, \gamma) > r_0$.

Ad (5) : Suppose that $\alpha = \frac{\pi}{k}$, $\beta = \frac{\pi}{l}$, $\gamma = \frac{\pi}{m}$, $k, l, m \geq 2$, $\alpha + \beta + \gamma < \pi$. Write $r(k, l, m) = r(\frac{\pi}{k}, \frac{\pi}{l}, \frac{\pi}{m})$, and suppose without loss of generality that $\alpha \geq \beta \geq \gamma$, i.e. $k \leq l \leq m$.

First, if $k \geq 2$, $l \geq 3$ and $m \geq 7$, then inradius monotonicity implies that $r(k, l, m) \geq r_0$, with equality if and only if $k = 2$, $l = 3$, $m = 7$.

Next, let $\mathcal{D} \subset \mathbb{N}^3$ be the set of triples (k, l, m) such that $2 \leq k \leq l \leq m < 7$ and $\frac{1}{k} + \frac{1}{l} + \frac{1}{m} < 1$. Then, one has

$$\begin{aligned} \mathcal{D} = \{ & (2, 4, 5), (2, 4, 6), (2, 5, 5), (2, 5, 6), (2, 6, 6), (3, 3, 4), (3, 3, 5), (3, 3, 6), \\ & (3, 4, 4), (3, 4, 5), (3, 4, 6), (3, 5, 5), (3, 5, 6), (3, 6, 6), (4, 4, 4), (4, 4, 5), \\ & (4, 4, 6), (4, 5, 5), (4, 5, 6), (4, 6, 6), (5, 5, 5), (5, 5, 6), (5, 6, 6), (6, 6, 6) \}. \end{aligned}$$

Direct computations using (4.22) show that for any triple $(k, l, m) \in \mathcal{D}$, one has $r(k, l, m) > r_0$.

As a consequence of the above case distinction, one sees that $r(\alpha, \beta, \gamma) \geq r_0$ for all angles α, β, γ satisfying one of the conditions (1) – (5), with equality only if $\alpha = \frac{\pi}{2}$, $\beta = \frac{\pi}{3}$ and $\gamma = \frac{\pi}{7}$ in the setting of case (5), i.e. the triangle \mathcal{T} is the fundamental triangle of the Coxeter group [3, 7]. \square

Chapter 5

Commensurability of hyperbolic Coxeter pyramids

This chapter is based on a joint work with Rafael Guglielmetti and Ruth Kellerhals [24].

As mentioned in Section 2.3.3, the commensurability classes (in the wide sense) of hyperbolic Coxeter simplex groups (of rank $n+1$) have already been determined [31]. In this section, we determine commensurability classes (in the wide sense) of *hyperbolic Coxeter pyramid groups* (of rank $n+2$). Recall that their associated Coxeter polyhedron is bounded by $n+2$ hyperplanes in $\overline{\mathcal{H}^n}$, it is noncompact, and it has the combinatorial type of a pyramid over the product of two simplices of positive dimensions (see Definition 2.20 and Remark 2.4). In the sequel, commensurability will always be meant in the wide sense.

5.1 Methods

In this section, we present the different methods which we are going to use. For brevity, we do not give all details of the proofs, but we always indicate at least one corresponding reference. We illustrate each method with one or several examples. Notice that these methods are general, in the sense that they can be applied to many other cofinite noncompact hyperbolic Coxeter groups of arbitrary rank $N \geq n+1$.

5.1.1 General tools

Subgroup relations

Any two groups G_1, G_2 such that $G_1 < G_2$ with finite index are commensurable. Hence, looking for subgroup relations is a natural first step towards classification. Finite index Coxeter subgroups of Coxeter groups are not easy

to detect in general. There are, however, some results about Coxeter subgroups of *abstract* Coxeter groups (see [12, 28], for example). The following specific property will be useful in the sequel.

Theorem 5.1 (Maxwell [44]). *Let W be a Coxeter group with set of generators S and whose graph Γ is a union $\Gamma_1 \cup \Gamma_2$ such that*

- (1) $\Gamma_1 = \{s_1, \dots, s_{l-1}\}$, $l \leq |S|$, is of type A_{l-1} , $l \geq 2$.
- (2) There is exactly one edge between the vertices s_{l-1} of Γ_1 and s_l of Γ_2 , and there is no other edge connecting Γ_1 and Γ_2 .
- (3) The weight $m(s_{l-1}, s_l)$ is an even number, say $2M \geq 4$.

Let S' be the set obtained from S by replacing s_k by

$$s'_k = s_k s_{k+1} \dots s_{l-1} s_l s_{l-1} \dots s_{k+1} s_k,$$

for some k such that $1 \leq k \leq l-1$.

Let Γ'_1 be the graph obtained from Γ_1 by replacing s_k with s'_k and joining s'_k to s_{k-1} (if $k > 1$) with an edge of weight $2M$, and to s_l with an edge of weight M (if $M > 2$), and let $\Gamma' = \Gamma'_1 \cup \Gamma_2$ be such that any vertex s of Γ_2 joined to s_l with an edge of weight $m(s, s_l)$ is also joined to s'_k with an edge of the same weight.

Then, the group W' generated by S' is a Coxeter subgroup of W of index $\binom{l}{k}$.

Example 5.1. We show that the parabolic Coxeter group \widetilde{B}_4 is a subgroup of index 3 in the parabolic Coxeter group \widetilde{F}_4 . Let $\{s_1, \dots, s_5\}$ be a set of generators of \widetilde{F}_4 according to the following graph :

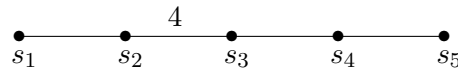

We are in the setting of Theorem 5.1 for $l = 3$ and $p = 2$. By choosing $k = 1$, we can replace s_1 by $s'_1 = s_1 s_2 s_3 s_2 s_1$. Then, by Theorem 5.1, we have $m(s'_1, s_2) = 2$, $m(s'_1, s_3) = 2$, $m(s'_1, s_4) = 3$ and $m(s'_1, s_5) = 2$ so that the Coxeter group generated by $\{s'_1, s_2, s_3, s_4, s_5\}$ is represented by the graph

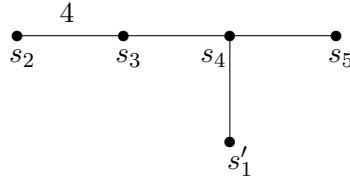

It is isomorphic to \widetilde{B}_4 , and, by Theorem 5.1, it is a subgroup of index 3 in \widetilde{F}_4 . Notice that choosing $k = 2$ yields the same outcome.

Remark 5.1. Maxwell [44, Theorem 3.2] proved a similar result for the case where the unique edge between the two components of the graph of W is of the form $3M$, $M \geq 2$.

The following geometric approach is very direct. Let $P_1, P_2 \subset \overline{\mathcal{H}^n}$ be two hyperbolic Coxeter polyhedra with corresponding Coxeter groups $W_1, W_2 < \text{Isom}(\mathcal{H}^n)$. If P_1 can be dissected into a finite number of isometric copies of P_2 , then W_1 is isomorphic to a finite index subgroup of W_2 .

Example 5.2. Let $\mathcal{P} \subset \overline{\mathcal{H}^n}$ be a hyperbolic Coxeter polyhedron whose graph $\Gamma = \Gamma_\times \cup \Delta$ is given by

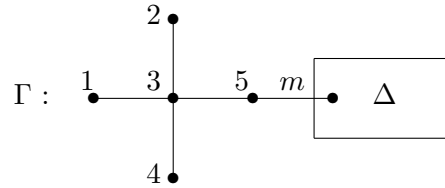

Here, the vertex 5 of the subgraph Γ_\times is connected to the subgraph Δ with a unique edge of weight $m \geq 3$. For $i = 1, \dots, 5$, let H_i be the hyperplane corresponding to the vertex i of Γ_\times , and let $u_i \in \mathcal{S}_1(1)$ be the normal vector to H_i pointing outside of \mathcal{P} . Let $H_{1,2}$ be the hyperplane bisecting the dihedral angle between H_1 and H_2 , with normal vector $u_{1,2} \in \mathcal{S}_1(1)$ given by $u_{1,2} = \frac{1}{\sqrt{2}}(u_2 - u_1)$ (see also Section 4.2.1). The products $\langle u_{1,2}, u_i \rangle_{-1}$, $i = 1, \dots, 5$, can be directly computed by using the weights in Γ_\times . It follows that the polyhedron \mathcal{P} can be dissected into two copies of the polyhedron \mathcal{P}' whose graph $\Gamma' = \Gamma_< \cup \Delta$ is given by

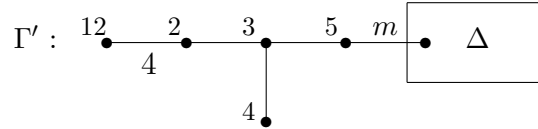

Here, the subgraph $\Gamma_<$ is connected to the subgraph Δ by a unique edge of the same weight m as for \mathcal{P} . In particular, if W and W' are the Coxeter groups with graphs Γ and Γ' respectively, then W is an index 2 subgroup of W' .

Translational length

In certain cases, non-commensurability can be detected with the help of geometric arguments. We start with the following general fact, which is proved in [24].

Proposition 5.1. *Let $W = [p_1, \dots, p_n, \infty] < \text{Isom}(\mathcal{H}^n)$, $p_1 = \infty$ if $n = 3$, be a Coxeter group with fundamental polyhedron $\mathcal{P} \subset \overline{\mathcal{H}^n}$ (\mathcal{P} is a truncated*

orthoscheme which is combinatorially a pyramid over the product of two Euclidean orthoschemes). Denote by $q \in \partial\mathcal{H}^n$ the apex of \mathcal{P} . Then, the stabilizer $W_q < \text{Isom}(\mathbb{E}^{n-1})$ of q contains a translation of translational length $l_q = 2 \cos \frac{\pi}{p_n}$.

Definition 5.1. Let $\widehat{\mathcal{T}} \subset \mathbb{R}^{n+1}$ be a hyperbolic total simplex (see Section 4.1). The Coxeter group $\widehat{W} < \text{Isom}(\mathcal{H}^n)$ generated by the reflections in the facets of $\widehat{\mathcal{T}}$ is called a *Coxeter total simplex group*.

Remark 5.2. (1) If $\widehat{\mathcal{T}} = \mathcal{T}$ is a hyperbolic Coxeter simplex, then the group $\widehat{W} = W$ is a Coxeter simplex group as usual (see [30]).

(2) If $\widehat{\mathcal{T}}$ gives rise to a hyperbolic 1-truncated simplex \mathcal{T} which is a hyperbolic Coxeter pyramid, then the Coxeter group W associated to \mathcal{T} is a Coxeter pyramid group.

with the help of Proposition 5.1, we can deduce the following result, which is proved in [24, Proposition 1].

Proposition 5.2. *Let $W \subset \text{Isom}(\mathcal{H}^n)$ be a Coxeter pyramid group. Suppose that $W = \widehat{W}_1 \star_{\Omega} \widehat{W}_2$, where $\widehat{W}_1 = [p_1, \dots, p_{n-1}, q_1]$, $\widehat{W}_2 = [p_1, \dots, p_{n-1}, q_2]$ and $\Omega = [p_1, \dots, p_{n-1}]$, with $p_1 = \infty$ if $n = 3$. Let $W_1 = [p_1, \dots, p_{n-1}, q_1, \infty]$ and $W_2 = [p_1, \dots, p_{n-1}, q_2, \infty]$ be the Coxeter pyramid groups associated to the Coxeter total simplex groups \widehat{W}_1 and \widehat{W}_2 . Suppose furthermore that the associated orbifold \mathcal{H}^n/W has only one cusp. Then, the following dichotomy holds.*

(1) If $q_1 = q_2$, then W is a subgroup of index 2 in $W_1 = W_2$.

(2) If $q_1 \neq q_2$, then W is not commensurable to both W_1 and W_2 .

Example 5.3. Consider the graphs Γ_1 and Γ_2 given by

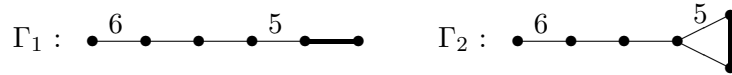

and let W_1 and W_2 be the corresponding Coxeter pyramid groups. Both associated polyhedra are noncompact pyramids in $\overline{\mathcal{H}^4}$ with 6 facets and a single ideal vertex. We are in the setting of Proposition 5.2, since $W_2 = \widehat{W}_1 \star_{\Omega} \widehat{W}_3$, with $W_3 = [6, 3, 3, 3, \infty]$ and $\Omega = [6, 3, 3]$. Hence, W_1 and W_2 are incommensurable in $\text{Isom}(\mathcal{H}^4)$.

A more general setting is when the gluing of two (not necessarily isometric) Coxeter polyhedra along a common *Coxeter facet* yields again a Coxeter polyhedron (see [66]).

Definition 5.2. Let $P_1, P_2 \subset \overline{\mathcal{H}^n}$ be two Coxeter polyhedra having a common isometric Coxeter facet F , and let $W_1, W_2 < \text{Isom}(\mathcal{H}^n)$ and $\Omega < \text{Isom}(\mathcal{H}^{n-1})$ be the corresponding Coxeter groups. Furthermore, suppose that the gluing P of P_1 and P_2 along F is again a Coxeter polyhedron. For $i = 1, 2$, denote by \widehat{W}_i the Coxeter group obtained from W_i by removing the generator corresponding to the hyperplane containing F . Then, the Coxeter group W associated to P is the free product $\widehat{W}_1 \star_{\Omega} \widehat{W}_2 < \text{Isom}(\mathcal{H}^n)$ of \widehat{W}_1 and \widehat{W}_2 amalgamated over their subgroup Ω . It is called the (*Gromov - Piatetski-Shapiro*) mixture of W_1 and W_2 .

The following result will be applied to this situation.

Theorem 5.2 (Karrass-Solitar [33]). *Let G_1 and G_2 be two groups containing a subgroup $\Omega < G_1, G_2$. Let $G = G_1 \star_{\Omega} G_2$ be the free product of G_1 and G_2 amalgamated over Ω . Let $H < G$ be a finitely generated subgroup containing a normal subgroup $N \triangleleft G$ such that $N \not\leq \Omega$. Then H is of finite index in G if and only if the intersection of Ω with each conjugate of H is of finite index in Ω .*

Example 5.4. Consider the graphs Γ_1 and Γ_2 given by



and let W_1 and W_2 be the corresponding Coxeter groups. One has $W_1, W_2 < \text{Isom}(\mathcal{H}^4)$, and by Section 2.3.4, W_1 and W_2 are non-arithmetic. Algebraically, W_1 is the free product of the Coxeter total simplex groups $\widehat{W}_{1,1} := [4, 4, 3, 4]$ and $\widehat{W}_{1,2} := [4, 4, 3, 3]$ amalgamated over the common Coxeter subgroup $\Omega_1 := [4, 4, 3]$. Similarly, the group W_2 is the free product of the Coxeter total simplex groups $\widehat{W}_{2,1} := [6, 3, 3, 4]$ and $\widehat{W}_{2,2} := [6, 3, 3, 3]$ amalgamated over the common Coxeter subgroup $\Omega_2 := [6, 3, 3]$.

Suppose that W_1 and W_2 are commensurable, i.e. there exists an isometry $\gamma \in \text{Isom}(\mathcal{H}^4)$ such that the intersection $K := W_1 \cap \gamma W_2 \gamma^{-1}$ is of finite index in both W_1 and $\gamma W_2 \gamma^{-1}$. Write $W'_2 = \gamma W_2 \gamma^{-1}$, and denote by Ω'_2 the image of Ω_2 in W'_2 . Then, K is finitely generated, since W_1 is finitely generated. Consider the *normal core* $K_{W_1} = \bigcap_{w \in W_1} w K w^{-1}$ of K in W_1 . It is a normal subgroup of W_1 of finite index, and we have $K_{W_1} < K$. Since the index of Ω_1 in W_1 is infinite, one has $K_{W_1} \not\leq \Omega_1$. A similar argument shows that K also contains the normal subgroup $K_{W'_2} \triangleleft W'_2$ with $K_{W'_2} \not\leq \Omega'_2$. Hence, by Karrass-Solitar's Theorem 5.2, the intersection $K_1 := K \cap \Omega_1$ is of finite index in Ω_1 , and the intersection $K_2 := K \cap \Omega'_2$ is of finite index in Ω'_2 .

The second part of the argument is of geometric nature. By observing that the groups $[4, 4]$ and $[6, 3]$ are inequivalent as crystallographic groups and by using Bieberbach's result about the existence of full rank translational

lattices in crystallographic groups of $\text{Isom}(\mathbb{E}^2)$, one can use Proposition 5.1 in order to deduce a contradiction (see [24, Lemma 3] for details). Hence, the Coxeter pyramid groups W_1 and W_2 are incommensurable.

Trace field and Coxeter elements

The trace of an element in $\text{PO}(n, 1) \subset \text{GL}(n + 1, \mathbb{R})$ is invariant by conjugation. For $H < \text{PO}(n, 1)$, the (ordinary) trace field $\text{Tr}(H) \subset \mathbb{R}$ is the field generated by the traces of the elements of H . It has been exploited in [31] as follows. First, let (W, S) be a Coxeter system of rank r with generating set $S = \{s_1, \dots, s_r\}$. Then, a Coxeter element $c = c(S)$ of W is given by $c = s_1 \cdot \dots \cdot s_r$. If $H < W$ is a finite-index subgroup, then H must contain some power of c . Now, one has the following criterion (see [31, p. 132]) : let $W_1, W_2 < \text{Isom}(\mathcal{H}^n)$ be Coxeter simplex groups with Coxeter elements c_1 and c_2 , and let $T_i^k = \mathbb{Q}(\text{tr}(c_i^k)) \subset \text{Tr}(W_i)$, $i = 1, 2$, $k \in \mathbb{N}^*$, be the fields generated by the traces of the k -th powers of c_1 and c_2 , $k \in \mathbb{N}^*$. If

$$T_1^k \not\subset \text{Tr}(W_2) \text{ for all } k \in \mathbb{N}^* \text{ or } T_2^l \not\subset \text{Tr}(W_1) \text{ for all } l \in \mathbb{N}^*, \quad (5.1)$$

then W_1 and W_2 are not commensurable. This property can be extended to Coxeter pyramid groups as follows.

Let $W_1, W_2 < \text{Isom}(\mathcal{H}^n)$ be Coxeter pyramid groups. Recall that each of them can be identified, up to finite index, with a polarly truncated Coxeter simplex group (see Definitions 4.2 and 4.3 in Section 4.1.1, and Remark 5.2,(2)). Let $\mathcal{P}_1 = \bigcap_{i=1}^{n+2} H_i^- \subset \overline{\mathcal{H}^n}$ be a fundamental Coxeter pyramid for W_1 , and let $S_1 = \{s_1, \dots, s_{n+2}\}$ be the set of generators of W_1 such that each s_i is a reflection in the hyperplane $H_i \subset \mathcal{H}^n$ with normal vector $u_i \in \mathcal{S}_{-1}(1)$ pointing outward from \mathcal{P}_1 , say. Associated to W_1 is a Coxeter total simplex group \widehat{W}_1 . Without loss of generality, we can suppose that \widehat{W}_1 is generated by the reflections s_1, \dots, s_{n+1} , so that the vectors u_1, \dots, u_{n+1} are linearly independent (see Section 4.1.2). Let \widehat{G}_1 and G_1 be the respective Gram matrices of \widehat{W}_1 and W_1 . The matrix \widehat{G}_1 is the top left principal submatrix of size $n + 1$ in G_1 . Now, for $i = 1, \dots, n + 1$, the matrix of s_i with respect to the canonical basis of \mathbb{R}^{n+1} is $R_{1,i} := I - 2A_{1,i}$, where $A_{1,i}$ is obtained by replacing the i -th line of the zero matrix of size $n + 1$ by the i -th line of \widehat{G}_1 . Moreover, the vector u_{n+2} normal to the polar hyperplane is given by

$$u_{n+2} = \frac{\sum_{j=1}^{n+1} \text{cof}_{j,n+1}(\widehat{G}_1) u_j}{\sqrt{\det(\widehat{G}_1) \text{cof}_{n+1,n+1}(\widehat{G}_1)}}, \quad (5.2)$$

(see (4.7) ; notice u_{n+2} can be interpreted as a ultra-ideal vertex, say v_{n+1} , of the total simplex associated to \widehat{W}_1 as described in Section 4.1.2). It follows that the matrix of s_{n+2} with respect to the canonical basis of \mathbb{R}^{n+1} is $R_{1,n+2} := I - 2B_1$, where B_1 is given by $[B_1]_{i,j} = 0$ if $j \neq n + 1$ and

$$[B_1]_{i,n+1} = \frac{\text{cof}_{i,n+1}(\widehat{G}_1)}{\text{cof}_{n+1,n+1}(\widehat{G}_1)}, \quad 1 \leq i \leq n+1.$$

Let $U := (u_1 | \dots | u_{n+1}) \in \text{GL}(n+1, \mathbb{R})$ be the matrix whose i -th column is u_i , $i = 1, \dots, n+1$. Then, $UR_{1,i}U^{-1} \in \text{O}(n, 1)$ for $1 \leq i \leq n+2$. The group generated by $R_{1,1}, \dots, R_{1,n+2}$ is a matrix representation of W_1 in $\text{GL}(n+1, \mathbb{Q}(\widehat{W}_1))$, with Coxeter element $C_1 := \prod_{i=1}^{n+2} R_{1,i}$.

Similarly, one obtains a matrix representation of W_2 in $\text{GL}(n+1, \mathbb{Q}(\widehat{W}_2))$ with Coxeter element $C_2 = \prod_{i=1}^{n+2} R_{2,i}$. Then, if the corresponding condition (5.1) is satisfied, the groups W_1 and W_2 are incommensurable (as subgroups of $\text{GL}(n+1, \mathbb{R})$).

Example 5.5. Consider the graphs Γ_1, Γ_2 and Γ_3 given by

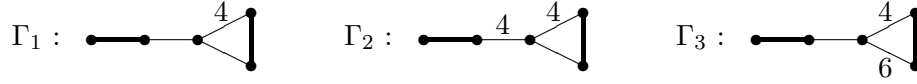

and let W_1, W_2 and W_3 be the corresponding Coxeter pyramid groups. By removing the first node on the left of Γ_i , one obtains the Coxeter graph of the Coxeter total simplex group \widehat{W}_i associated to W_i . Let G_i be the Gram matrix of W_i , and \widehat{G}_i be the Gram matrix of \widehat{W}_i , $i = 1, 2, 3$. For $i = 1, 2, 3$ and $j = 1, \dots, 5$, we compute the matrix representations $R_{i,j}$ as above. In particular, the product $C_i := \prod_{j=1}^5 R_{i,j} \in \text{GL}(4, \mathbb{Q}(\widehat{G}_i))$ is a matrix representation for a Coxeter element of W_i . The characteristic polynomial $\chi_i = \chi(C_i)$ is of the form

$$\chi_i(t) = (t-1)(t+1)(t^2 - 2\alpha_i t + 1),$$

where the coefficients α_i , $i = 1, 2, 3$, are given by the following table

i	1	2	3
α_i	$3 + \sqrt{2}$	$7/2 + \sqrt{2}$	$4 + \sqrt{6}$

Then, the eigenvalues $\lambda_{i,k}$, $k = 1, \dots, 4$, of C_i are given by

$$\lambda_{i,1} = 1, \quad \lambda_{i,2} = -1, \quad \lambda_{i,3} = \alpha_i + \sqrt{\alpha_i^2 - 1}, \quad \lambda_{i,4} = \alpha_i - \sqrt{\alpha_i^2 - 1}.$$

Hence, the trace $\text{tr}(C_i^k)$ is given for $k \geq 0$ by

$$\begin{aligned} \sum_{l=1}^4 \lambda_{i,l}^k &= 1 + (-1)^k + \sum_{m=0}^k \binom{k}{m} (1 + (-1)^m) \alpha_i^{k-m} \left(\sqrt{\alpha_i^2 - 1} \right)^m \\ &= 1 + (-1)^k + 2 \sum_{\substack{m=0 \\ m \text{ even}}}^k \binom{k}{m} \alpha_i^{k-m} \left(\sqrt{\alpha_i^2 - 1} \right)^m \\ &= 1 + (-1)^k + 2 \sum_{\substack{m=0 \\ m \text{ even}}}^k \binom{k}{m} \alpha_i^{k-m} (\alpha_i^2 - 1)^{m/2} \end{aligned}$$

Since $\alpha_i^2 - 1 > 0$ for $i = 1, 2, 3$, each term of the sum consists of a product of (powers of) algebraic numbers of positive rational part and positive coefficients on $\sqrt{2}$ and $\sqrt{6}$, respectively, so that we obtain the following fields for the groups W_1, W_2 and W_3 :

$$T_1^k = \mathbb{Q}(\sqrt{2}), \quad T_2^k = \mathbb{Q}(\sqrt{2}), \quad T_3^k = \mathbb{Q}(\sqrt{6}), \quad \text{for all } k \in \mathbb{N}^*.$$

For $i = 1, 2, 3$, let $\mathbb{Q}(G_i)$ be the field generated by the coefficients of the Gram matrix G_i . Observe that $\text{Tr}(W_1), \text{Tr}(W_2) \subset \mathbb{Q}(\widehat{G}_1) = \mathbb{Q}(\widehat{G}_2) = \mathbb{Q}(\sqrt{2})$ and that $\text{Tr}(W_3) \subset \mathbb{Q}(\widehat{G}_3) = \mathbb{Q}(\sqrt{2}, \sqrt{3})$. Then, by (5.1), the group W_3 is incommensurable to W_1 and to W_2 . Moreover, commensurability between W_1 and W_2 cannot be decided by this mean.

Kleinian groups

Let us consider the hyperbolic 3-space \mathcal{H}^3 . A *Kleinian group* is a discrete group of $\text{Isom}^+(\mathcal{H}^3) \cong \text{PSL}(2, \mathbb{C})$. Commensurability properties of Kleinian groups have been studied by Maclachlan-Reid [40] and Neumann-Reid [14], for example. In this context, we have the following commensurability invariants. Let H be a Kleinian group (not necessarily arithmetic), and let $H^{(2)} := \langle \{h^2 \mid h \in H\} \rangle$. Then, the set $kH := \mathbb{Q}(\text{Tr}(H^{(2)})) \subset \mathbb{R}$ is called the *invariant trace field* of H . If $H < \text{PSL}(2, \mathbb{C})$ is the rotational subgroup of a Coxeter group acting on \mathcal{H}^3 , we have the relation

$$kH = K(G)(\sqrt{d}), \quad (5.3)$$

where $K(G)$ is the field generated by the cycles in $2G$, for G the Gram matrix associated to H (see Section 2.3.4), and d is the discriminant of the underlying quadratic space (more details about these notions are given in next section). Further properties and proofs can be found in [40, 41].

Example 5.6. Consider the graphs Γ_1, Γ_2 and Γ_3 given by

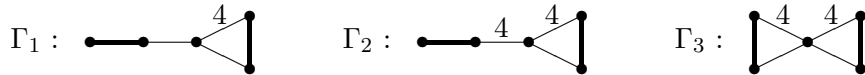

and let W_1, W_2 and W_3 be the corresponding Coxeter groups.

A direct computation using the Gram matrices G_i^+ of the rotational subgroups $W_i^+ < W_i$, $i = 1, 2, 3$, shows that $K(G_1^+) = K(G_2^+) = K(G_3^+) = \mathbb{Q}(\sqrt{2})$, and that the associated discriminants d_i , $i = 1, 2, 3$, are given by $d_1 = d_2 = -1$ and $d_3 = -\frac{3}{2} - \sqrt{2}$. Hence, the invariant trace fields kW_i^+ , $i = 1, 2, 3$, are the following :

$$kW_1^+ = \mathbb{Q}(\sqrt{2}, i) = kW_2^+, \quad kW_3^+ = \mathbb{Q}\left(\sqrt{2}, \sqrt{-3/2 - \sqrt{2}}\right).$$

Since the invariant trace field is a commensurability invariant, one deduces that the group W_3 is incommensurable to both groups W_1 and W_2 . The commensurability between W_1 and W_2 cannot be decided by using this tool.

5.1.2 Maclachlan's criteria for arithmetic Coxeter groups

In the particular case of *arithmetic* subgroups of $\text{Isom}(\mathcal{H}^n)$, more sophisticated algebraic tools can be used, in particular quaternion algebras. Recall that discrete cofinite noncocompact arithmetic subgroups of $\text{Isom}(\mathcal{H}^n)$ are all of the simplest type and defined over \mathbb{Q} (see Section 2.3.4). Hence, we formulate the results for this field only. Moreover, we will summarize the necessary tools for a computational use, and not provide the whole theory of central simple algebras and the Brauer group. For details and for the general results, we refer to [38, 41, 54, 62].

Algebraic background

For $a, b \in \mathbb{Q}^*$, let $Q = \mathbb{Q} \cdot 1 \oplus \mathbb{Q} \cdot i \oplus \mathbb{Q} \cdot j \oplus \mathbb{Q} \cdot (ij)$ be the \mathbb{Q} -vector space of base $1, i, j, ij$. If we require that $i^2 = a$, $j^2 = b$ and $ij = -ji$, we can equip Q with an associative \mathbb{Q} -bilinear multiplication. Then, one can check that Q is a central simple algebra (over \mathbb{Q}) of dimension 4, a so-called *quaternion algebra (over \mathbb{Q})*. It is convenient to denote it by $(a, b)_{\mathbb{Q}}$, or simply by (a, b) since the context is clear.

It is a consequence of Wedderburn's theorem (see [38] for example) that for any central simple algebra A , there is a unique (up to isomorphism) division algebra D and a unique natural number m such that $A \cong M_m(D)$, the matrix algebra of dimension m over D . Then, two central simple algebras $A_1 \cong M_{m_1}(D_1)$ and $A_2 \cong M_{m_2}(D_2)$ are said to be *equivalent* if and only if $D_1 \cong D_2$. In particular, one can see that two central simple algebras of the same dimension are equivalent if and only if they are isomorphic. This allows us to provide the set of all isomorphism classes of central simple algebras (over \mathbb{Q}) with a group structure. The resulting group is called the *Brauer group* $\text{Br}(\mathbb{Q})$. The group law is given by $[A_1] \cdot [A_2] := [A_1 \otimes_{\mathbb{Q}} A_2]$, and the neutral element is $[\mathbb{Q}] = [(1, 1)] = [M_1(\mathbb{Q})]$. For a central simple algebra A , let A^{op} be the central simple algebra built from the same vector space as A , and such that the multiplication in A^{op} is the multiplication in A in the reverse order. Then, one can check that $[A]^{-1} = [A^{op}]$.

In the sequel, we will be interested only in the subgroup of $\text{Br}(\mathbb{Q})$ generated by isomorphism classes of quaternion algebras (a proof that isomorphism classes of quaternion algebras generate a subgroup of $\text{Br}(\mathbb{Q})$ can be found in [62, Théorème 2.9]). We have the following computational properties [38, Chapter III.1].

Proposition 5.3. *Let $a, b, c \in \mathbb{Q}^*$. Then, one has*

- | | |
|--|--|
| (1) $[(a, 1)] = [(a, -a)] = [(1, 1)].$ | (4) $[(a, b)] = [(b, a)].$ |
| (2) $[(a, 1 - a)] = [(1, 1)]$ if $a \neq 1.$ | (5) $[(a, b)] = [(c^2 a, b)].$ |
| (3) $[(a, a)] = [(a, -1)].$ | (6) $[(a, b)] \cdot [(a, c)] = [(a, bc)].$ |

Proposition 5.3 may not be sufficient to decide about the (non-)isomorphism of quaternion algebras. However, it is known (see [39], for example), that any two quaternion algebras (over \mathbb{Q}) are isomorphic if and only if their so-called *ramification sets* are equal. Let \mathbb{P} be the set of prime numbers, and write $\mathbb{Q}_\infty = \mathbb{R}$. The ramification set $\text{Ram}(Q) \subset \mathbb{P} \cup \{\infty\}$ of a quaternion algebra Q is defined as follows : $p \in \mathbb{P} \cup \{\infty\}$ belongs to $\text{Ram}(Q)$ if and only if $Q \otimes_{\mathbb{Q}} \mathbb{Q}_p$ is a division algebra. As before, we will only summarize computational properties of ramification sets. For more details, we refer to [54], for example.

One can check that $\text{Ram}(1, 1) = \emptyset$ for all $a \in \mathbb{Q}^*$, and that $\text{Ram}(-1, -1) = \{2, \infty\}$. Moreover, the ramification set of the tensor product of two quaternion algebras Q_1, Q_2 can be computed according to

$$\text{Ram}(Q_1 \otimes_{\mathbb{Q}} Q_2) = (\text{Ram}(Q_1) \cup \text{Ram}(Q_2)) \setminus (\text{Ram}(Q_1) \cap \text{Ram}(Q_2)), \quad (5.4)$$

see [39]. Hence, ramification sets can be determined by using Proposition 5.3 and (5.4) together with the following result, whose proof is presented in [24].

Proposition 5.4. *We have $\text{Ram}(-1, 2) = \emptyset$ and $\text{Ram}(-1, -2) = \{2, \infty\}$. If $q \in \mathbb{P} \setminus \{2\}$, then we have the following ramification sets :*

	$q \equiv 1 \pmod{8}$	$q \equiv 3 \pmod{8}$	$q \equiv 5 \pmod{8}$	$q \equiv 7 \pmod{8}$
$(-1, q)$	\emptyset	$\{2, q\}$	\emptyset	$\{2, q\}$
$(-1, -q)$	$\{2, \infty\}$	$\{q, \infty\}$	$\{2, \infty\}$	$\{q, \infty\}$
$(2, -q)$	\emptyset	$\{2, q\}$	$\{2, q\}$	\emptyset
$(-2, q)$	\emptyset	\emptyset	$\{2, q\}$	$\{2, q\}$

If $q_1, q_2 \in \mathbb{P} \setminus \{2\}$ are distinct, then the ramification set of the quaternion algebra $(-q_1, q_2)$ is given as follows.

	$q_2 \equiv 1 \pmod{4}$	$q_2 \equiv 3 \pmod{4}$
$q_1 \equiv 1 \pmod{4}$	$\{q_1, q_2\}$ if $\left(\frac{q_1}{q_2}\right) = -1$ \emptyset otherwise	$\{2, q_1\}$ if $\left(\frac{q_1}{q_2}\right) = -1$ $\{2, q_2\}$ otherwise
$q_1 \equiv 3 \pmod{4}$	$\{q_1, q_2\}$ if $\left(\frac{q_1}{q_2}\right) = -1$ \emptyset otherwise	$\{q_1, q_2\}$ if $\left(\frac{q_1}{q_2}\right) = 1$ \emptyset otherwise

where $\left(\frac{a}{b}\right)$ denotes the Legendre symbol of a and b .

Finally, we will need the following two invariants of quadratic spaces. Let (V, q) be a quadratic space of signature $(n, 1)$ (see Section 2.3.4). Suppose that, with respect to a suitable basis of V , q is given in a diagonal form,

denoted by $\langle a_1, \dots, a_{n+1} \rangle$, $a_i \in \mathbb{Q}^*$, $i = 1, \dots, n+1$. Then, the *Hasse invariant* of q , denoted by $s(q)$, is given by the class

$$s(q) = \left[\bigotimes_{i < j} (a_i, a_j) \right] \in \text{Br}(\mathbb{Q}). \quad (5.5)$$

The *Witt invariant* of q , denoted by $c(q)$, is given by

$$c(q) = \begin{cases} s(q) & , \text{ if } n+1 \equiv 1, 2 \pmod{8} \\ s(q) \cdot [(-1, -\det(q))] & , \text{ if } n+1 \equiv 3, 4 \pmod{8} \\ s(q) \cdot [(-1, -1)] & , \text{ if } n+1 \equiv 5, 6 \pmod{8} \\ s(q) \cdot [(-1, \det(q))] & , \text{ if } n+1 \equiv 7, 8 \pmod{8} \end{cases}. \quad (5.6)$$

The proof that $s(q)$ and $c(q)$ are invariants of the quadratic form q , as well as the related theoretical background, can be found in [38, Chapter V.3], for example.

Maclachlan's results for arithmetic groups

In [39], Maclachlan gives a complete solution to the problem of classifying up to commensurability discrete arithmetic subgroups of $\text{Isom}(\mathcal{H}^n)$ of the simplest type for $n \geq 4$. The corresponding problem for $n = 2$ and $n = 3$ was solved by Takeuchi [57] and Maclachlan-Reid [40], respectively.

In Sections 8 and 9 of [39] the particular cases of cofinite noncocompact discrete groups, in particular Coxeter groups, are investigated. Since we are going to be interested in noncocompact Coxeter groups only, we formulate Maclachlan's results for this much simpler setting only.

Theorem 5.3 (Maclachlan). *When n is even, the commensurability classes of cofinite noncocompact arithmetic discrete subgroups of $\text{Isom}(\mathcal{H}^n)$ are in one-to-one correspondence with the isomorphism classes of quaternion algebras over \mathbb{Q} .*

In order to formulate the corresponding result for n odd, let us recall that for $p \in \mathbb{P} \cup \{\infty\}$, a prime ideal $\mathfrak{p} = (p)$ in \mathbb{Q} splits in $\mathbb{Q}(\sqrt{\delta})$ if and only if one has in $\mathbb{Q}(\sqrt{\delta})$ a factorization of the type $\mathfrak{p} = \mathfrak{p}_1 \cdot \mathfrak{p}_2$, where \mathfrak{p}_1 and \mathfrak{p}_2 are distinct ideals in $\mathbb{Q}(\sqrt{\delta})$.

Theorem 5.4 (Maclachlan). *When n is odd, the commensurability classes of cofinite noncocompact arithmetic discrete subgroups $H < \text{Isom}(\mathcal{H}^n)$ of the simplest type are parametrized by the pairs $(\delta, \{p_1, \dots, p_s\})$, where*

- *the number δ is the signed determinant of the quadratic form q associated to H , and*
- *the prime numbers p_1, \dots, p_s are the elements of $\text{Ram}_f(c(q))$ such that the ideals $(p_1), \dots, (p_s)$ are prime ideals in \mathbb{Q} which split in $\mathbb{Q}(\sqrt{\delta})$,*

together with, if $n \equiv 1 \pmod{4}$, the sets $\{p_1, \dots, p_r\}$, such that p_1, \dots, p_r are rational primes and r satisfies

$$\begin{cases} r \equiv 0 \pmod{2} & \text{if } n \equiv 1 \pmod{8} \\ r \equiv 1 \pmod{2} & \text{if } n \equiv 5 \pmod{8} \end{cases} .$$

In order to determine Maclachlan's invariants in the context of Coxeter groups, there is a direct procedure due to Vinberg which is based on Theorem 2.13 (see [39] and [65, Part II, Chapter 6]). Let $W < \text{Isom}(\mathcal{H}^n)$ be a cofinite noncocompact arithmetic Coxeter group of rank $r \geq n + 1$, with Coxeter polyhedron $\mathcal{P} \subset \overline{\mathcal{H}^r}$ and Gram matrix G , and recall that \mathbb{Q} is the field generated by the cyclic products of $2G$. For $\{e_1, \dots, e_r\}$ the set of normal vectors of \mathcal{P} , and any subset $\{i_1, \dots, i_l\}$ of $\{1, \dots, r\}$, $1 \leq l \leq r$, let

$$v_{i_1, \dots, i_l} := a_{1, i_1} a_{i_1, i_2} \dots a_{i_{l-1}, i_l} e_{i_l}. \quad (5.7)$$

Then, the \mathbb{Q} -span of all vectors of type (5.7) is a \mathbb{Q} -vector space V of dimension $n + 1$, with basis \mathcal{B} , say, such that the quadratic form q_G associated to G is equivalent to the diagonal form $q = \langle a_1, \dots, a_{n+1} \rangle$, $a_i \in \mathbb{Q}^*$.

Thanks to this simple correspondence, Maclachlan deduces the following procedure in order to compute the invariants of W :

1. Compute the Gram matrix $G \in \text{GL}(r, \mathbb{R})$ of W .
2. Determine the field k generated the cyclic products of G . In our setting, we will always have $k = \mathbb{Q}$.
3. Determine all vectors of the type described in (5.7).
4. Let V be the \mathbb{Q} -span of all such vectors. Determine a \mathbb{Q} -basis \mathcal{B} of V .
5. Compute the diagonal form $q = \langle a_1, \dots, a_{n+1} \rangle$ of G in the basis \mathcal{B} .
6. with the help of q , compute the Hasse and Witt invariants, $s(q)$ and $c(q)$.
7. Compute the ramification sets of the Hasse and Witt invariants, as well as, if needed and if n is odd, the relevant complete invariants.

Example 5.7. We shall illustrate the above procedure and Theorems 5.3 and 5.4 in dimensions 6 and 7 respectively. For an element $[(a, b)]$ of the Brauer group, we shall simply write (a, b) .

- (1) We consider the arithmetic Coxeter groups $W_1, \dots, W_5 < \text{Isom}(\mathcal{H}^6)$ given by the corresponding Coxeter graphs $\Gamma_1, \dots, \Gamma_5$ as follows.

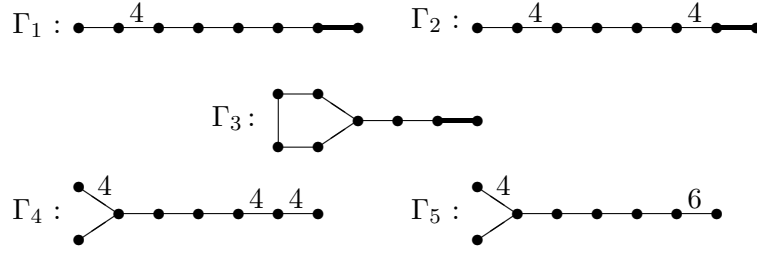

Then, one can compute the respective Gram matrix G_i , and verify that the field k_i generated by the cyclic products of G_i is indeed \mathbb{Q} for $i = 1, \dots, 5$. A direct computation using (5.7) yields the diagonal forms q_i^6 , $i = 1, \dots, 5$ collected in Table 5.1.

i	q_i^6
1	$\langle 1, 1, 2, 2, 3, 6, -1 \rangle$
2	$\langle 1, 1, 1, 2, 3, 6, -1 \rangle$
3	$\langle 1, 1, 3, 6, 10, 15, -15 \rangle$
4	$\langle 1, 1, 2, 2, 2, 2, -1 \rangle$
5	$\langle 1, 1, 2, 2, 2, 6, -1 \rangle$

Table 5.1

Moreover, let $W_6 = [4, 3^2, 3^{2,1}]$ and $W_7 = [3, 3^{[6]}]$ be representatives for the two commensurability classes of cofinite noncocompact arithmetic Coxeter 6-simplex groups (see [31, p. 139]). Then, the corresponding diagonal forms are $q_6^6 = \langle 1, 3, 6, 6, 10, 10, -6 \rangle$ and $q_7^6 = \langle 1, 3, 6, 10, 15, 21, -21 \rangle$. with the help of (5.5), (5.6), and Proposition 5.3, and then Proposition 5.4, we deduce Table 5.2 for the Witt invariants $c(q_i^6)$, and their ramification sets $\text{Ram}(c(q_i^6))$, $i = 1, \dots, 7$.

i	$c(q_i^6)$	$\text{Ram}(c(q_i^6))$
1	$(-1, -1)$	$\{2, \infty\}$
2	$(-1, -1)$	$\{2, \infty\}$
3	$(5, -2) \otimes (-1, -1)$	$\{5, \infty\}$
4	$(-1, -1)$	$\{2, \infty\}$
5	$(-1, -3)$	$\{3, \infty\}$
6	$(-5, -1)$	$\{2, \infty\}$
7	$(-15, -1)$	$\{3, \infty\}$

Table 5.2

Hence, by Theorem 5.3, the groups W_1, \dots, W_7 fall into 3 commensurability classes : $\{W_1, W_2, W_4, W_6\}$, $\{W_5, W_7\}$ and $\{W_3\}$.

- (2) Consider the arithmetic Coxeter groups $W_1, \dots, W_6 < \text{Isom}(\mathcal{H}^7)$ given by the following graphs $\Gamma_1, \dots, \Gamma_6$:

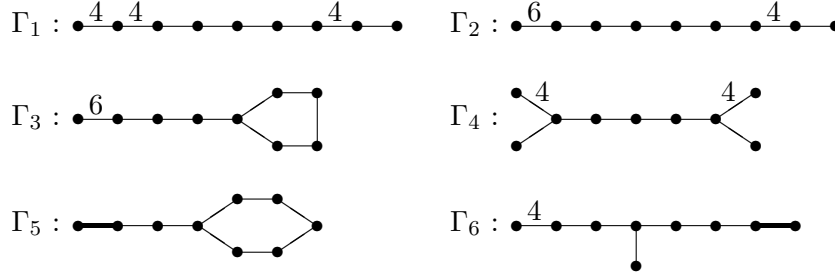

Then, for each group W_i , $i = 1, \dots, 6$, one can determine the associated Gram matrix G_i , and deduce that the field k_i generated by the cyclic products of G_i is \mathbb{Q} for $i = 1, \dots, 6$. The use of (5.7) allows us to determine the associated quadratic forms q_i^7 , $i = 1, \dots, 6$. Let $W_7 = [3^{3,2,2}]$, $W_8 = [4, 3^3, 3^{2,1}]$ and $W_9 = [3, 3^{[7]}]$ be representatives of the commensurability classes of the cofinite noncompact arithmetic Coxeter 7-simplex groups (see [31, p. 140]) and let q_i^7 , $i = 7, 8, 9$. Furthermore, let δ_i , $i = 1, \dots, 9$, be the corresponding signed determinants. They are collected in Table 5.3.

i	q_i^7	δ_i
1	$\langle 1, 1, 1, 2, 2, 3, 6, -2 \rangle$	-1
2	$\langle 1, 1, 2, 3, 3, 6, 6, -6 \rangle$	-3
3	$\langle 1, 1, 2, 3, 3, 6, 30, -6 \rangle$	-15
4	$\langle 1, 1, 2, 2, 2, 3, 6, -1 \rangle$	-1
5	$\langle 1, 1, 3, 6, 6, 10, 15, -6 \rangle$	-3
6	$\langle 1, 1, 1, 1, 1, 1, 2, -1 \rangle$	-2
7	$\langle 1, 3, 6, 7, 10, 15, 21, -3 \rangle$	-3
8	$\langle 1, 1, 1, 1, 1, 1, 1, -1 \rangle$	-1
9	$\langle 1, 3, 6, 7, 10, 15, 21, -7 \rangle$	-7

Table 5.3

Since the signed determinant is a commensurability invariant by Theorem 5.4, we can already say that the groups W_1, \dots, W_9 fall into at least 5 commensurability classes. In particular, the groups W_3 , W_6 and W_9 are pairwise incommensurable, and incommensurable to the other

groups as well. In order to distinguish between the remaining groups, we make use of (5.5), (5.6), and Proposition 5.3, so that we can obtain the Witt invariants $c(q_i^7)$. They are summarized in Table 5.4.

i	$c(q_i^7)$
1	$(-1, -1)$
4	$(-1, -1)$
8	$(-1, -1)$
2	$(-1, -1)$
5	$(-15, -6)$
7	$(-15, -1) \otimes (2, -7)$

Table 5.4

This allows us to say that the groups W_1 , W_4 and W_8 are commensurable, since they have the same Witt invariants. As for the groups W_2 , W_5 and W_7 , computations using basic number theoretical properties show that $\mathbb{P} \cap \text{Ram}(c(q_i^7)) = \{2\}$ if $i = 2$, respectively $\{3\}$ if $i = 5, 7$. Since the ideals (2) and (3) do not split in $\mathbb{Q}(\sqrt{-3})$, the groups W_2 , W_5 and W_7 are commensurable.

5.2 Hyperbolic Coxeter pyramid groups

The graphs of all hyperbolic Coxeter pyramid groups are given in Tables 5.5, 5.6 and 5.7 (see also [59]).

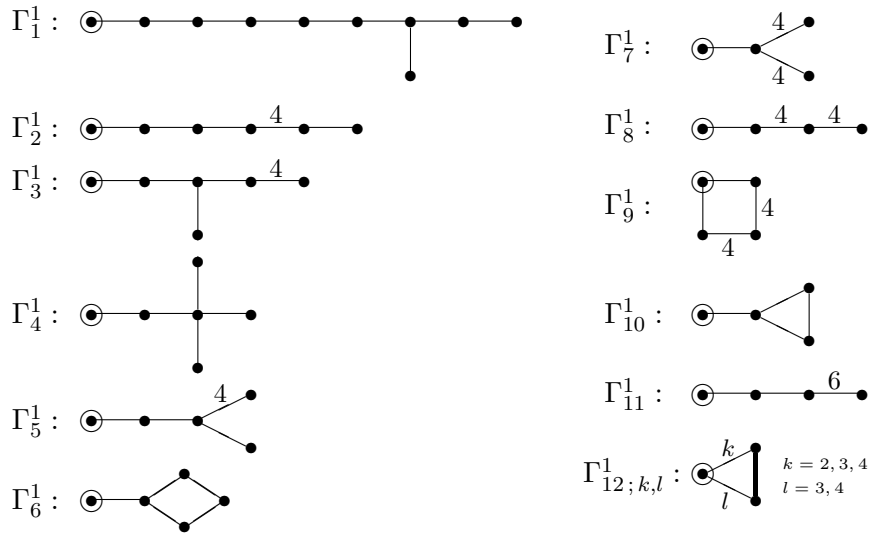

Table 5.5: Gluing together any two diagrams by the encircled vertices yields the Coxeter diagram of a hyperbolic Coxeter pyramid group

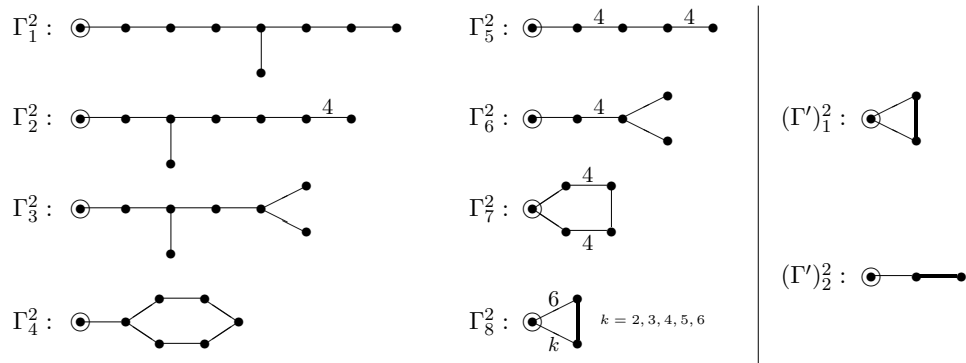

Table 5.6: Gluing together any diagram from the left column with any diagram from the right column by the encircled vertices yields the Coxeter diagram of a hyperbolic Coxeter pyramid group

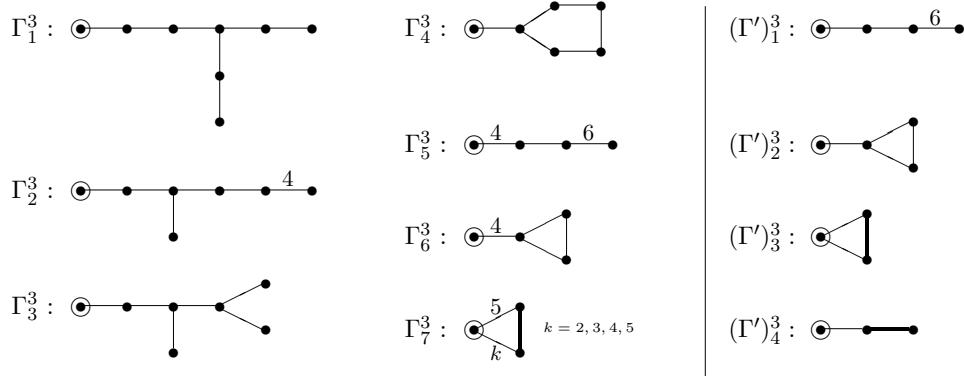

Table 5.7: Gluing together any diagram from the left column with any diagram from the right column by the encircled vertices yields the Coxeter diagram of a hyperbolic Coxeter pyramid group

5.3 Commensurability classes

We aim to classify up to commensurability all 200 Coxeter pyramid groups in $\text{Isom}(\mathcal{H}^n)$, $n \geq 3$.

Notation. In the sequel, we shall refer to a graph in Tables 5.($N + 4$), $N = 1, 2, 3$, as Γ_M^N , where M is the position of the graph in the table, starting from top left and enumerating column by column (see Section 5.2).

- The graphs constructed from Table 5.5 are written as follows. The graph $\Gamma_{M_1, M_2; k_1, l_1, k_2, l_2}^1$ denotes the gluing of the graph $\Gamma_{M_1; k_1, l_1}^1$ (with parameters k_1, l_1 , if any) with the graph $\Gamma_{M_2; k_2, l_2}^1$ (with parameters k_2, l_2 , if any) by the encircled vertices.
- For the graphs coming from Tables 5.($N + 4$), $N = 2, 3$, we adopt the following notation. The graph $\Gamma_{M_1, M_2; k, l}^N$ will denote the gluing of the graphs $\Gamma_{M_1; k, l}^N$ (with parameters k, l , if any) of the left column with the graph $(\Gamma')_{M_2}^N$ from the right column by the encircled vertices.

The *Coxeter symbol* of a Coxeter group $W < \text{Isom}(\mathcal{H}^n)$ is a particularly convenient way of describing it. It is constructed by using the following basic conventions.

- For $l \geq 1$, the symbol $[m_1, \dots, m_l]$ is the Coxeter symbol of the Coxeter group with linear graph of rank $l + 1$ with consecutive labels $m_1, \dots, m_l \geq 3$. If $m_1 = \dots = m_l =: m$, we write simply $[m^l]$.
- For $l \geq 1$, the symbol $[(m_1, \dots, m_l)]$ is the Coxeter symbol of the Coxeter group with cyclic graph of rank l with consecutive labels $m_1, \dots, m_l \geq 3$. If $m_1 = \dots = m_l =: m$, we write simply $[m^{[l]}]$.

- For $l \geq 1$ and $m \geq 3$, the symbol $[m^{i_1, \dots, i_l}]$ is the Coxeter symbol of the Coxeter graph with l strings of Coxeter symbols $[m^{i_k}]$, $k = 1, \dots, l$, emanating from a common vertex.

The three Coxeter symbols described above can be combined in order to describe more elaborated Coxeter graphs.

For the sake of brevity, we will use the same letter Γ for the Coxeter graph, the related Coxeter group and the Coxeter polyhedron.

5.3.1 The classification

We shall use the methods described in Section 5.1 in order to classify the groups described in Section 5.2 In the arithmetic case, we shall determine representatives given by cofinite Coxeter simplex groups (see [31]), whenever possible. Recall that for most of these graphs, (non-)arithmeticity can be read off from the graph thanks to Corollary 2.1 (see Section 2.3.4). The results outlined in the sequel can be found in [24].

Dimension 3

There are 33 Coxeter pyramid groups in $\text{Isom}(\mathcal{H}^3)$. They are given by the graphs $\Gamma_{12,12;k_1,l_1,k_2,l_2}^1$, $k_1, k_2 = 2, 3, 4$, $l_1, l_2 = 3, 4$, $\Gamma_{8,i;r}^2$, $i = 1, 2$, $r = 2, \dots, 6$, and $\Gamma_{7,j;s}^3$, $j = 3, 4$, $s = 2, 3, 4, 5$. The groups $\Gamma_{12,12;k_1,l_1,3,4}^1$, $k_1 = 2, 3, 4$, $l_1 = 3, 4$, $\Gamma_{8,i;r}^2$, $i = 1, 2$, $r = 3, 4, 5$ and $\Gamma_{7,j;s}^3$, $j = 3, 4$, $s = 2, 3, 4, 5$ are the only non-arithmetic ones amongst them.

Dissection arguments according to Section 5.1.1 yield the following subgroup relations :

- One has $\Gamma_{12,12;3,3,3,3}^1 < \Gamma_{12,12;2,3,3,3}^1 < \Gamma_{12,12;2,3,2,3}^1$, each time with index 2.
- The groups $\Gamma_{12,12;k_1,3,k_2,4}^1$, for $k_1 = 2, 3$ and $k_2 = 2, 4$ are finite index subgroups of $\Gamma_{12,12;2,3,2,4}^1$.
- One has $\Gamma_{12,12;4,4,4,4}^1 < \Gamma_{12,12;2,4,4,4}^1 < \Gamma_{12,12;2,4,2,4}^1$, each time with index 2.
- The groups $\Gamma_{8,j;r}^2$, for $j = 1, 2$ and $r = 2, 6$, are finite index subgroups of $\Gamma_{8,2;2}^2$.
- One has $\Gamma_{12,12;k,k,3,4}^1 < \Gamma_{12,12;2,k,3,4}^1$ with index 2, for $k = 3, 4$. Let $W_1 := \Gamma_{12,12;2,3,3,4}^1$ and $W_2 := \Gamma_{12,12;2,4,3,4}^1$.
- One has $\Gamma_{8,1;r}^2 < \Gamma_{8,2;r}^2$, for $r = 3, 4, 5$. Let $W_r := \Gamma_{8,2;r}^2$, $r = 3, 4, 5$.
- The groups $\Gamma_{7,j;s}^3$, for $j = 3, 4$ and $s = 2, 5$, are finite index subgroups of $\Gamma_{7,4;2}^3 =: W_6$.

- One has $\Gamma_{7,3;s}^3 < \Gamma_{7,4;s}^3$ with index 2, for $s = 3, 4$. Let $W_7 := \Gamma_{7,4;3}^3$ and $W_8 := \Gamma_{7,4;4}^3$.

Dissection arguments also show that the group $\Gamma_{12,12;2,3,2,3}^1$ is a subgroup of index 2 in the simplex group $[3, 4, 4]$, and that the group $\Gamma_{12,12;2,4,2,4}^1$ is an index 2 subgroup of the simplex group $[4, 4, 4]$. Since the group $[4, 4, 4]$ is an index 3 subgroup of the group $[3, 4, 4]$ (see [31]), one deduces that the groups $\Gamma_{12,12;2,3,2,3}^1$ and $\Gamma_{12,12;2,4,2,4}^1$ are commensurable.

The group $[3, 4, 4]$ is arithmetic and is associated to the diagonal form $\langle 1, 3, 6, -2 \rangle$ of signed determinant $\delta_1 = -1$. Moreover, the group $\Gamma_{12,12;2,3,2,4}^1$ corresponds to the diagonal form $\langle 1, 3, 6, -1 \rangle$ of signed determinant $\delta_2 = -2$, the group $\Gamma_{8,2;2}^2$ to the diagonal form $\langle 1, 3, 3, -3 \rangle$ of signed determinant $\delta_3 = -3$, and the simplex group $[3, 3, 6]$ to the diagonal form $\langle 1, 3, 6, -6 \rangle$ of signed determinant $\delta_4 = -3$. By Section 5.1, this implies that the *arithmetic* Coxeter pyramid groups in $\text{Isom}(\mathcal{H}^3)$ fall into three commensurability classes, and that the commensurability classes of the groups $\Gamma_{8,2;2}^2$ and $[3, 3, 6]$ coincide.

Let $W_9 := \Gamma_{12,12;3,4,3,4}^1$. In order to distinguish between the commensurability classes of the *non-arithmetic* pyramid groups W_i , $i = 1, \dots, 9$, we first determine the associated fields T_i^k of suitable matrix representations, $k \geq 1$ (see Example 5.5). One observes that $T_i^k = T_i^l$ for all $k, l \geq 1$ and all $i = 1, \dots, 9$. Hence, we simply write $T_i := \tilde{T}_i^k$. These fields are collected in Table 5.8.

i	W_i	Coxeter symbol	T_i
1	$\Gamma_{12,12;2,3,3,4}^1$	$[\infty, 3, (3, \infty, 4)]$	$\mathbb{Q}(\sqrt{2})$
2	$\Gamma_{12,12;2,4,3,4}^1$	$[\infty, 4, (3, \infty, 4)]$	$\mathbb{Q}(\sqrt{2})$
3	$\Gamma_{8,2;3}^2$	$[\infty, 3, (3, \infty, 6)]$	$\mathbb{Q}(\sqrt{3})$
4	$\Gamma_{8,2;4}^2$	$[\infty, 3, (4, \infty, 6)]$	$\mathbb{Q}(\sqrt{6})$
5	$\Gamma_{8,2;5}^2$	$[\infty, 3, (5, \infty, 6)]$	$\mathbb{Q}(\sqrt{3}, \sqrt{5})$
6	$\Gamma_{7,4;2}^3$	$[\infty, 3, 5, \infty]$	$\mathbb{Q}(\sqrt{5})$
7	$\Gamma_{7,4;3}^3$	$[\infty, 3, (3, \infty, 5)]$	$\mathbb{Q}(\sqrt{5})$
8	$\Gamma_{7,4;4}^3$	$[\infty, 3, (4, \infty, 5)]$	$\mathbb{Q}(\sqrt{2}, \sqrt{5})$
9	$\Gamma_{12,12;3,4,3,4}^1$	$[(3, \infty, 4), (3, \infty, 4)]$	$\mathbb{Q}(\sqrt{2})$

Table 5.8

Hence, by (5.1), we only have to study the commensurability problem for the groups W_1 , W_2 and W_9 , and for the groups W_6 and W_7 , the other ones being pairwise incommensurable. By Proposition 5.1 (see Example 5.3), the

groups W_6 and W_7 are incommensurable. By Example 5.6, the group W_9 is not commensurable with the groups W_1 and W_2 .

Remark 5.3. The procedures above fail to decide about the commensurability of the groups W_1 and W_2 with Coxeter symbols $[\infty, 3, (3, \infty, 4)]$ and $[\infty, 4, (3, \infty, 4)]$. This question can be related to a conjecture of Milnor about certain values of the Lobachevsky function as follows.

In [65, Part I, Section 7,3.5], Vinberg gives a formula for the volume of an N -sided hyperbolic pyramid $\mathcal{P} \subset \overline{\mathcal{H}^3}$ whose apex lies in $\partial\mathcal{H}^3$ (his formula contains some minor sign errors). The formula in terms of the Lobachevsky function \mathbb{J} is the following :

$$\begin{aligned} \text{vol}(\mathcal{P}) = \frac{1}{2} \sum_{i=1}^N & \left[\mathbb{J}(\gamma_i) + \mathbb{J}\left(\frac{1}{2}(\pi + \alpha_i + \alpha_{i+1} - \gamma_i)\right) + \mathbb{J}\left(\frac{1}{2}(\pi + \alpha_i - \alpha_{i+1} - \gamma_i)\right) \right. \\ & \left. + \mathbb{J}\left(\frac{1}{2}(\pi - \alpha_i + \alpha_{i+1} - \gamma_i)\right) - \mathbb{J}\left(\frac{1}{2}(\alpha_i + \alpha_{i+1} + \gamma_i - \pi)\right) \right], \end{aligned}$$

where $\alpha_1, \dots, \alpha_N$ are the dihedral angles at the base of \mathcal{P} , and $\gamma_1, \dots, \gamma_N$ are the dihedral angles at the edges of \mathcal{P} meeting at its apex.

In our setting, $N = 4$ and $\gamma_i = \frac{\pi}{2}$ for $i = 1, \dots, N$, so that the covolumes of $[\infty, 3, (3, \infty, 4)]$ and $[\infty, 4, (3, \infty, 4)]$ are given by

$$\begin{aligned} \text{covol}([\infty, 3, (3, \infty, 4)]) &= \frac{1}{3}\mathbb{J}(\pi/4) + \frac{1}{8}\mathbb{J}(\pi/6) + \mathbb{J}(5\pi/24) - \mathbb{J}(\pi/24), \\ \text{covol}([\infty, 4, (3, \infty, 4)]) &= \mathbb{J}(\pi/4) + \frac{1}{8}\mathbb{J}(\pi/6) + \mathbb{J}(5\pi/24) - \mathbb{J}(\pi/24). \end{aligned} \quad (5.8)$$

Let us write

$$\alpha := \frac{\text{covol}([\infty, 3, (3, \infty, 4)])}{\text{covol}([\infty, 4, (3, \infty, 4)])} \quad \text{and} \quad \beta := \frac{2}{3(1 - \alpha)}. \quad (5.9)$$

By using the functional properties of the Lobachevsky function \mathbb{J} (see Section 2.3.2), it can be shown that (5.8) and (5.9) yield

$$\mathbb{J}(\pi/8) = \frac{6\beta - 5}{4}\mathbb{J}(\pi/4). \quad (5.10)$$

Suppose now that the groups $[\infty, 3, (3, \infty, 4)]$ and $[\infty, 4, (3, \infty, 4)]$ are commensurable. Then, α is rational, as well as β . By (5.10), $\mathbb{J}(\pi/8)$ and $\mathbb{J}(\pi/4)$ are therefore linearly dependent over \mathbb{Q} . This would imply that $\mathbb{J}(\pi/8)$ and $\mathbb{J}(3\pi/8)$ are linearly dependent over \mathbb{Q} , contradicting the following conjecture due to Milnor [58, Chapter 7].

Conjecture (Milnor). Fixing some integer denominator $M \geq 3$, the real numbers $\mathbb{J}(k\pi/M)$, with k relatively prime to M and $0 < k < M/2$, are linearly independent over the rationals.

Remark 5.4. In [24], we provide a proof of the incommensurability of W_1 and W_2 based on (5.9), a numerical estimation of α , and an argument related to the so-called *commensurator* of a subgroup.

Dimension 4

There are 27 Coxeter pyramid groups of rank 6 in $\text{Isom}(\mathcal{H}^4)$: $\Gamma_{i,12;k,l}^1$, $i = 7, \dots, 11$, $k = 2, 3, 4$, $l = 3, 4$, $\Gamma_{7,j;m}^3$, $j = 1, 2$, $m = 2, 3, 4, 5$, and $\Gamma_{r,s}^3$, $r = 3, 4$, $s = 5, 6$. The groups $\Gamma_{i,12;3,4}^1$, $i = 7, \dots, 11$ and $\Gamma_{7,j;m}^3$, $j = 1, 2$, $m = 2, 3, 4, 5$, are the non-arithmetic ones amongst them.

Moreover, there is one further cofinite noncocompact rank 6 Coxeter group $\Gamma^* < \text{Isom}(\mathcal{H}^4)$ whose Coxeter polyhedron is neither a prism nor a pyramid. It has the graph

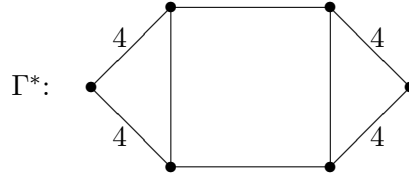

and is arithmetic. Combinatorially, the polyhedron Γ^* is the product of two triangles (see [59]). Let $W_1 := \Gamma^*$.

Dissection arguments lead to the following subgroup relations :

- The groups $\Gamma_{i,12;k,3}^1$, $i = 7, 8, 9$, $k = 2, 3$, are finite index subgroups of $\Gamma_{8,12;2,3}^1 =: W_2$.
- The groups $\Gamma_{i,12;k,4}^1$, $i = 7, 8, 9$, $k = 2, 3$, are finite index subgroups of $\Gamma_{8,12;2,4}^1 =: W_3$.
- The groups $\Gamma_{i,12;k,3}^1$, $i = 10, 11$, $k = 2, 3$, are finite index subgroups of $\Gamma_{11,12;2,3}^1 =: W_4$.
- The groups $\Gamma_{i,12;k,4}^1$, $i = 10, 11$, $k = 2, 3$, are finite index subgroups of $\Gamma_{11,12;2,4}^1 =: W_5$.
- The groups $\Gamma_{r,s}^3$, $r = 5, 6$, $s = 3, 4$, are finite index subgroups of $\Gamma_{5,4}^3 =: W_6$.
- One has $\Gamma_{9,12;3,4}^1 < \Gamma_{7,12;3,4}^1 < \Gamma_{8,12;3,4}^1 =: W_8$. Both subgroup relations are of index 2.
- One has $\Gamma_{10,12;3,4}^1 < \Gamma_{11,12;3,4}^1 =: W_9$ with index 2.
- The groups $\Gamma_{7,1;5}^3$, $\Gamma_{7,2;5}^3$ and $\Gamma_{7,2;2}^3$ are finite index subgroups of $\Gamma_{7,1;2}^3 =: W_{10}$.
- One has $\Gamma_{7,2;3}^3 < \Gamma_{7,1;3}^3 := W_{11}$, and $\Gamma_{7,2;4}^3 < \Gamma_{7,1;4}^3 =: W_{12}$, both with index 2.

Let W_7 be the arithmetic simplex group $[3, 4, 3, 4]$. In Table 5.9, we provide the *arithmetic* groups W_i , $i = 1, \dots, 7$, the associated diagonal quadratic forms q_i^4 , the Witt invariants $c(q_i^4)$, and the ramification sets $\text{Ram}(c(q_i^4))$, $i = 1, \dots, 7$. The simplex group W_7 is a representative of the (unique) commensurability class of arithmetic Coxeter 4-simplex groups (see [31]).

i	W_i	Coxeter symbol	q_i^4	$c(q_i^4)$	$\text{Ram}(c(q_i^4))$
1	Γ^*		$\langle 1, 1, 1, 3, -3 \rangle$	$(-1, -1)$	$\{2, \infty\}$
2	$\Gamma_{8,12;2,3}^1$	$[4^2, 3^2, \infty]$	$\langle 1, 1, 1, 2, -2 \rangle$	$(-1, -1)$	$\{2, \infty\}$
3	$\Gamma_{8,12;2,4}^1$	$[4^2, 3, 4, \infty]$	$\langle 1, 1, 2, 2, -2 \rangle$	$(-1, -1)$	$\{2, \infty\}$
4	$\Gamma_{11,12;2,3}^1$	$[6, 3^3, \infty]$	$\langle 1, 3, 3, 6, -6 \rangle$	$(-1, -3)$	$\{3, \infty\}$
5	$\Gamma_{11,12;2,4}^1$	$[6, 3^2, 4, \infty]$	$\langle 1, 3, 6, 6, -6 \rangle$	$(-1, -1)$	$\{2, \infty\}$
6	$\Gamma_{5,4}^3$	$[6, 3, 4, 3, \infty]$	$\langle 1, 3, 3, 6, -3 \rangle$	$(-1, -1)$	$\{2, \infty\}$
7		$[3, 4, 3, 4]$	$\langle 1, 2, 3, 6, -1 \rangle$	$(-1, -1)$	$\{2, \infty\}$

Table 5.9

Hence, by Theorem 5.3, all the above arithmetic non-cocompact Coxeter groups of rank at most 6 in $\text{Isom}(\mathcal{H}^4)$ fall into two commensurability classes, represented by the groups $[3, 4, 3, 4]$ and $\Gamma_{11,12;2,3}^1$, for example.

It remains to determine the commensurability classes of the *non-arithmetic* groups W_i , $i = 8, \dots, 12$. We start by considering the fields T_i^k , $k \geq 1$, generated by the trace of the k -power of a matrix representation of a Coxeter element of the group W_i as in Example 5.5. Computations similar to the ones of Example 5.5 show that $T_i^k = T_i^l =: T_i$ for all $k, l \geq 1$. They are collected in Table 5.10.

i	W_i	Coxeter symbol	T_i
8	$\Gamma_{8,12;3,4}^1$	$[4^2, 3, (3, \infty, 4)]$	$\mathbb{Q}(\sqrt{2})$
9	$\Gamma_{11,12;3,4}^1$	$[6, 3^2, (3, \infty, 4)]$	$\mathbb{Q}(\sqrt{2})$
10	$\Gamma_{7,1;2}^3$	$[6, 3^2, 5, \infty]$	$\mathbb{Q}(\sqrt{5})$
11	$\Gamma_{7,1;3}^3$	$[6, 3^2, (3, \infty, 5)]$	$\mathbb{Q}(\sqrt{5})$
12	$\Gamma_{7,1;4}^3$	$[6, 3^2, (4, \infty, 5)]$	$\mathbb{Q}(\sqrt{2}, \sqrt{5})$

Table 5.10

Notice that the associated total simplex groups \widehat{W}_8 and \widehat{W}_9 are defined over $\mathbb{Q}(\sqrt{2})$, the groups \widehat{W}_{10} and \widehat{W}_{11} over $\mathbb{Q}(\sqrt{5})$, and the group \widehat{W}_{12} over

$\mathbb{Q}(\sqrt{2}, \sqrt{5})$. Hence, we only have to study the commensurability between W_8 and W_9 , and between W_{10} and W_{11} , respectively, since other commensurability relations are impossible by (5.1). By Theorem 5.2 and Proposition 5.1, these groups are pairwise incommensurable (see Examples 5.4 and 5.3). As a consequence, there are 5 commensurability classes of non-arithmetic Coxeter pyramid groups in $\text{Isom}(\mathcal{H}^4)$.

Dimension 5

There are 35 cofinite Coxeter pyramid groups in $\text{Isom}(\mathcal{H}^5)$ $\Gamma_{i,j}^1$, $i, j = 7, \dots, 11$, $\Gamma_{p,12;k,l}^1$, $p = 5, 6$, $k = 2, 3, 4$, $l = 3, 4$, $\Gamma_{r,s}^2$, $r = 5, 6, 7$, $s = 1, 2$, $\Gamma_{t,u}^3$, $t = 5, 6$, $u = 1, 2$. Amongst them, the groups $\Gamma_{5,12;3,4}^1$ and $\Gamma_{6,12;3,4}^1$ are the only non-arithmetic ones.

Dissection arguments lead to the following subgroup relations :

- The groups $\Gamma_{r,12;k,3}^1$, $r = 5, 6$, $k = 2, 3$, are finite index subgroups of $\Gamma_{5,12;2,3}^1 =: W_1$.
- The groups $\Gamma_{r,12;k,4}^1$, $r = 5, 6$, $k = 2, 4$, are finite index subgroups of $\Gamma_{5,12;2,4}^1 =: W_2$.
- The groups $\Gamma_{i,j}^1$, $i, j = 7, 8, 9$, are finite index subgroups of $\Gamma_{8,8}^1 =: W_3$.
- The groups $\Gamma_{i,j}^1$, $i = 7, 8, 9$, $j = 10, 11$, are finite index subgroups of $\Gamma_{8,11}^1 =: W_4$.
- One has $\Gamma_{10,10}^1 < \Gamma_{10,11}^1 < \Gamma_{11,11}^1 =: W_5$, each time with index 2.
- The groups $\Gamma_{r,s}^2$, $r = 5, 6$, $s = 1, 2$, are finite index subgroups of $\Gamma_{5,2}^2 =: W_6$.
- One has $\Gamma_{7,2}^2 < \Gamma_{7,1}^2 =: W_7$ with index 2.
- The groups $\Gamma_{r,s}^3$, $r = 5, 6$, $s = 1, 2$, are finite index subgroups of $\Gamma_{5,1}^3 =: W_8$.
- One has $\Gamma_{6,12;3,4}^1 < \Gamma_{5,12;3,4}^1$ with index 2.

Let W_9 be the arithmetic simplex group $[3, 3, 3, 4, 3]$ and W_{10} be the arithmetic simplex group $[3, 3^{[5]}]$. Table 5.11 collects the diagonal quadratic forms q_i^5 associated to the groups W_i , $i = 1, \dots, 10$, as well as their signed determinants δ_i .

i	W_i	Coxeter symbol	q_i^5	δ_i
1	$\Gamma_{5,12;2,3}^1$	$[4, 3^{1,3}, \infty]$	$\langle 1, 1, 2, 2, 2, -1 \rangle$	2
2	$\Gamma_{5,12;2,4}^1$	$[4, 3^{1,2}, 4, \infty]$	$\langle 1, 1, 1, 2, 2, -1 \rangle$	1
3	$\Gamma_{8,8}^1$	$[4^2, 3^2, 4^2]$	$\langle 1, 1, 1, 1, 2, -2 \rangle$	1
4	$\Gamma_{8,11}^1$	$[4^2, 3^3, 6]$	$\langle 1, 1, 1, 2, 3, -2 \rangle$	3
5	$\Gamma_{11,11}^1$	$[6, 4^4, 6]$	$\langle 1, 1, 3, 3, 6, -6 \rangle$	1
6	$\Gamma_{5,2}^2$	$[4, 3, 4, 3^2, \infty]$	$= q_3^5$	1
7	$\Gamma_{7,1}^2$	$[\infty, 3, (3, 4, 3, 4, 3)]$	$= q_3^5$	1
8	$\Gamma_{5,1}^3$	$[6, 3, 4, 3^2, 6]$	$\langle 1, 2, 3, 3, 6, -3 \rangle$	1
9		$[3, 3, 3, 4, 3]$	$\langle 1, 3, 6, 10, 10, -2 \rangle$	1
10		$[3, 3^{[5]}]$	$\langle 1, 3, 6, 10, 15, -15 \rangle$	5

Table 5.11

Since no prime ideal splits in \mathbb{Q} , we deduce from Theorem 5.4 that the above arithmetic cofinite noncocompact Coxeter groups of rank at most 7 in $\text{Isom}(\mathcal{H}^5)$ fall into 4 commensurability classes. They are represented by the groups $[3, 3, 3, 4, 3]$, $[4, 3^{1,3}, \infty]$, $[4^2, 3^3, 6]$ and $[3, 3^{[5]}]$, for example.

Dimension 6

There are 27 cofinite Coxeter pyramid groups in $\text{Isom}(\mathcal{H}^6) : \Gamma_{i,j}^1, i = 5, 6, j = 7, \dots, 11, \Gamma_{r,12;k,l}^1, r = 2, 3, 4, k = 2, 3, 4, l = 3, 4, \Gamma_{4,3}^3$ and $\Gamma_{4,4}^3$. The groups $\Gamma_{r,12;3,4}^1 \cong \Gamma_{r,12;4,3}^1, r = 2, 3, 4$, are the only non-arithmetic groups amongst them. By dissection arguments and Maxwell's Theorem (see Theorem 5.1), the groups $\Gamma_{r,12;3,4}^1, r = 2, 3, 4$, are finite index subgroups of $\Gamma_{2,12;3,4}^1$, the groups $\Gamma_{r,12;k,3}^1, r = 2, 3, 4, k = 2, 3$ are finite index subgroups of $\Gamma_{2,12;2,3}^1$, and the groups $\Gamma_{r,12;k,3}^1, r = 2, 3, 4, k = 2, 4$ are finite index subgroups of $\Gamma_{2,12;2,4}^1$. Moreover, dissection arguments also show that the groups $\Gamma_{i,j}^1, i = 5, 6, j = 7, 8, 9$, are finite index subgroups of $\Gamma_{5,8}^1$, that the groups $\Gamma_{i,j}^1, i = 5, 6, j = 10, 11$ are finite index subgroups of $\Gamma_{5,11}^1$, and that $\Gamma_{4,3}^3 < \Gamma_{4,4}^3$ (with index 2).

Hence, there is a unique commensurability class of *non-arithmetic* Coxeter pyramid groups in $\text{Isom}(\mathcal{H}^6)$, represented by the group $\Gamma_{2,12;3,4}^1$, for example.

As for the *arithmetic* case, by Example 5.7, (1), there are 3 commensurability classes of arithmetic Coxeter pyramid groups in $\text{Isom}(\mathcal{H}^6)$, represented by the 3 groups $\Gamma_{5,8}^1, \Gamma_{5,11}^1$ and $\Gamma_{4,4}^3$, for example.

Dimension 7

There are 26 Coxeter pyramid groups in $\text{Isom}(\mathcal{H}^7) : \Gamma_{i,j}^1, i = 2, 3, 4, j = 7, \dots, 11, \Gamma_{5,5}^1, \Gamma_{5,6}^1, \Gamma_{6,6}^1, \Gamma_{4,1}^2, \Gamma_{4,1}^2, \Gamma_{2,3}^3, \Gamma_{2,4}^3, \Gamma_{3,3}^3, \Gamma_{3,4}^3, \Gamma_{4,1}^3$ and $\Gamma_{4,2}^3$. All are arithmetic. Dissection arguments and Maxwell's Theorem show that all groups of the form $\Gamma_{i,j}^1, i = 2, 3, 4, j = 7, 8, 9$ are finite index subgroups of $\Gamma_{2,8}^1$, and that all groups of the form $\Gamma_{i,j}^1, i = 2, 3, 4, j = 10, 11$, are finite index subgroups of $\Gamma_{2,11}^1$. Moreover, dissection arguments show that $\Gamma_{5,5}^1 < \Gamma_{5,6}^1 < \Gamma_{6,6}^1$ (each time with index 2), $\Gamma_{4,1}^2 < \Gamma_{4,2}^2$ (with index 2), $\Gamma_{4,2}^3 < \Gamma_{4,1}^3$ (with index 2), and that $\Gamma_{2,3}^3, \Gamma_{3,3}^3$ and $\Gamma_{3,4}^3$ are finite index subgroups of $\Gamma_{2,4}^3$.

By Example 5.7, (2), one has 5 commensurability classes of cofinite non-cocompact Coxeter groups of rank at most 9 in $\text{Isom}(\mathcal{H}^7)$, with respective representatives $\Gamma_{2,8}^1, \Gamma_{2,4}^3, \Gamma_{2,11}^1, \Gamma_{4,2}^2$, and the simplex group with Coxeter symbol $[3, 3^{[7]}]$, for example.

Dimension 8

There are 16 Coxeter pyramid groups in $\text{Isom}(\mathcal{H}^8) : \Gamma_{i,j}^1, i = 2, 3, 4, j = 5, 6, \Gamma_{2,1}^2, \Gamma_{2,2}^2, \Gamma_{3,1}^2, \Gamma_{3,2}^2, \Gamma_{1,3}^3, \Gamma_{1,4}^3, \Gamma_{2,1}^3, \Gamma_{2,2}^3, \Gamma_{3,1}^3, \Gamma_{3,2}^3$. All are arithmetic. Dissection arguments and Maxwell's Theorem show that the groups of the form $\Gamma_{i,j}^1, i = 2, 3, 4, j = 5, 6$ are finite index subgroups of $\Gamma_{2,5}^1$, that $\Gamma_{2,2}^2, \Gamma_{3,1}^2$ and $\Gamma_{3,2}^2$ are finite index subgroups of $\Gamma_{2,1}^2$, that $\Gamma_{2,2}^3, \Gamma_{3,1}^3$ and $\Gamma_{3,2}^3$ are finite index subgroups of $\Gamma_{2,1}^3$, and that $\Gamma_{1,3}^3 < \Gamma_{1,4}^3$ (with index 2).

The group $\Gamma_{2,5}^1$ is associated to the diagonal form

$$q_1^8 = \langle 1, 1, 1, 2, 2, 2, 6, 12, -1 \rangle,$$

the group $\Gamma_{2,1}^2$ to the diagonal form

$$q_2^8 = \langle 1, 1, 1, 1, 1, 1, 1, 2, -1 \rangle,$$

the group $\Gamma_{2,1}^3$ to the diagonal form

$$q_3^8 = \langle 1, 2, 3, 3, 6, 6, 6, 9, -6 \rangle,$$

and the group $\Gamma_{1,4}^3$ to the diagonal form

$$q_4^8 = \langle 1, 1, 1, 2, 3, 6, 10, 15, -2 \rangle.$$

Futhermore, by [31, Theorem 8], all Coxeter simplex groups in $\text{Isom}(\mathcal{H}^8)$ are arithmetic and commensurable with the group \overline{T}_8 of Coxeter symbol $[3^{4,3,1}]$, associated to the diagonal form

$$q_5^8 = \langle 1, 1, 2, 3, 3, 6, 10, 15, -2 \rangle.$$

By computing the respective Witt invariants and using Propositions 5.3 and 5.4, one sees that $\text{Ram}(c(q_i^8)) = \emptyset$, $i = 1, \dots, 5$. Therefore, by Theorem 5.3, the Coxeter simplex groups and the Coxeter pyramid groups in $\text{Isom}(\mathcal{H}^8)$ belong to the same commensurability class.

Dimension 9

There are 10 Coxeter pyramid groups in $\text{Isom}(\mathcal{H}^9)$: $\Gamma_{2,2}^1, \Gamma_{2,3}^1, \Gamma_{2,4}^1, \Gamma_{3,3}^1, \Gamma_{3,4}^1, \Gamma_{4,4}^1, \Gamma_{1,1}^2, \Gamma_{1,2}^2, \Gamma_{1,1}^3$ and $\Gamma_{1,2}^3$. All are arithmetic. Dissection arguments and Maxwell's Theorem show that the groups of the form $\Gamma_{i,j}^1$, $i, j = 2, 3, 4$ are all finite index subgroups of $\Gamma_{2,2}^1$, that $\Gamma_{1,1}^2 < \Gamma_{1,2}^2$ (with index 2), and that $\Gamma_{1,2}^3 < \Gamma_{1,1}^3$ (with index 2).

The group $\Gamma_{2,2}^1$ is associated to the diagonal form

$$q_1^9 = \langle 1, 1, 1, 2, 2, 3, 3, 6, 6, -1 \rangle,$$

the groups $\Gamma_{1,2}^2$ and $\Gamma_{1,1}^3$ to the diagonal form

$$q_2^9 = \langle 1, 1, 1, 2, 3, 3, 6, 10, 15, -2 \rangle.$$

Both forms have signed discriminant $\delta_1 = \delta_2 = 1$, so that for both groups, the field $\mathbb{Q}(\sqrt{\delta})$ of Theorem 5.4 is \mathbb{Q} . Since no prime ideal of \mathbb{Q} splits in \mathbb{Q} , one deduces that both groups have the same invariant : $\{\mathbb{Q}, 1, \emptyset\}$. By Theorem 5.4, one deduces that there is only one commensurability class of Coxeter pyramid groups in $\text{Isom}(\mathcal{H}^9)$.

Moreover, by [31, Theorem 9], there is only one commensurability class of Coxeter simplex groups in $\text{Isom}(\mathcal{H}^9)$, represented by the arithmetic group \bar{T}_9 of Coxeter symbol $[3^{6,2,1}]$, for example. This group is associated to the quadratic form

$$q_3^9 = \langle 1, 1, 2, 3, 4, 7, 10, 15, 21, -2 \rangle,$$

of signed determinant $\delta_3 = 1$. By Theorem 5.4 one deduces that the commensurability class of \bar{T}_9 coincides with the one of $\Gamma_{2,2}^1$.

Dimension 10

There are 5 Coxeter pyramid groups in $\text{Isom}(\mathcal{H}^{10})$: $\Gamma_{1,12;2,3}^1, \Gamma_{1,12;2,4}^1, \Gamma_{1,12;3,3}^1, \Gamma_{1,12;3,4}^1$ and $\Gamma_{1,12;3,4}^1$. The group $\Gamma_{1,12;3,4}^1$ is the only non-arithmetic one and forms a single commensurability class (observe that this group is algebraically a Gromov - Piatetski-Shapiro mixture, see [66]). Moreover, dissection arguments show that $\Gamma_{1,12;3,3}^1 < \Gamma_{1,12;2,3}^1$ and $\Gamma_{1,12;4,4}^1 < \Gamma_{1,12;2,4}^1$ (each time with index 2).

The group $\Gamma_{1,12;2,3}^1$ is related to the diagonal quadratic form

$$q_1^{10} = \langle 1, 1, 1, 2, 3, 3, 6, 6, 10, 10, -2 \rangle,$$

and the group $\Gamma_{1,12;2,4}^1$ to the diagonal quadratic form

$$q_2^{10} = \langle 1, 1, 2, 2, 3, 3, 6, 6, 10, 10, -2 \rangle,$$

of respective Witt invariants $c(q_1^{10}) = (5, -1)$ and $c(q_2^{10}) = (2, -1)$. By Proposition 5.4, one deduces that $\text{Ram}(c(q_1^{10})) = \text{Ram}(c(q_2^{10})) = \emptyset$. Hence, by Theorem 5.3, the arithmetic Coxeter pyramid groups in $\text{Isom}(\mathcal{H}^{10})$ form a single commensurability class.

Dimension 11

There are 5 Coxeter pyramid groups in $\text{Isom}(\mathcal{H}^{11})$: $\Gamma_{1,i}^1$, $i = 7, \dots, 11$. All are arithmetic, and dissection arguments show that $\Gamma_{1,9}^1 < \Gamma_{1,7}^1 < \Gamma_{1,8}^1$ (each time with index 2) and $\Gamma_{1,10}^1 < \Gamma_{1,11}^1$ (with index 2).

The group $\Gamma_{1,8}^1$ is related to the diagonal quadratic form

$$q_1^{11} = \langle 1, 1, 1, 1, 2, 3, 3, 6, 6, 10, 10, -1 \rangle,$$

and the group $\Gamma_{1,11}^1$ to the diagonal quadratic form

$$q_2^{11} = \langle 1, 1, 1, 2, 3, 3, 3, 6, 6, 10, 10, -2 \rangle.$$

The corresponding (squarefree) signed determinants are $\delta_1 = -2$ and $\delta_2 = -3$, respectively. Hence, by Theorem 5.4, one can already deduce that the groups $\Gamma_{1,8}^1$ and $\Gamma_{1,11}^1$ are not commensurable, so that there are only two such commensurability classes in $\text{Isom}(\mathcal{H}^{11})$.

Dimension 12

The Coxeter pyramid groups $\Gamma_{1,5}^1$ and $\Gamma_{1,6}^1$ are the only Coxeter groups in $\text{Isom}(\mathcal{H}^{12})$. Both are arithmetic. By a dissection argument, one has $\Gamma_{1,6}^1 < \Gamma_{1,5}^1$ (with index 2). Hence, there is a single commensurability class of such groups.

Dimension 13

There are exactly 3 Coxeter pyramid groups in $\text{Isom}(\mathcal{H}^{13})$: $\Gamma_{1,2}^1$, $\Gamma_{1,3}^1$ and $\Gamma_{1,4}^1$. They are all arithmetic. By Maxwell's Theorem one has $\Gamma_{1,3}^1 < \Gamma_{1,2}^1$ (with index 3), and by a dissection argument, one can see that $\Gamma_{1,4}^1 < \Gamma_{1,3}^1$ (with index 2). Hence, all the 3 groups are commensurable.

Dimension 17

The pyramid group $\Gamma_{1,1}^1$ is the unique such group in $\text{Isom}(\mathcal{H}^{17})$. It is therefore the only commensurability class in this dimension. It is arithmetic, and plays an eminent role in the context of minimal volume orientable arithmetic n -orbifolds, $n \geq 2$ (see Section 2.3.4).

5.3.2 Summary

Theorem 5.5 ([24]). *The commensurability classes of non-arithmetic Coxeter pyramid groups in $\text{Isom}(\mathcal{H}^n)$ are characterized in Table 5.12.*

n	Representative	Coxeter symbol	Cardinality
3	$\Gamma_{12,12;2,3,3,4}^1$	$[\infty, 3, (3, \infty, 4)]$	2
	$\Gamma_{12,12;2,4,3,4}^1$	$[\infty, 4, (3, \infty, 4)]$	2
	$\Gamma_{12,12;3,4,3,4}^1$	$[(3, \infty, 4), (3, \infty, 4)]$	1
	$\Gamma_{8,2;3}^2$	$[\infty, 3, (3, \infty, 6)]$	2
	$\Gamma_{8,2;4}^2$	$[\infty, 3, (4, \infty, 4)]$	2
	$\Gamma_{8,2;5}^2$	$[\infty, 3, (3, \infty, 5)]$	2
	$\Gamma_{7,4;2}^3$	$[\infty, 3, 5, \infty]$	4
	$\Gamma_{7,4;3}^3$	$[\infty, 3, (3, \infty, 5)]$	2
	$\Gamma_{7,4;4}^3$	$[\infty, 3, (4, \infty, 5)]$	2
	4	$\Gamma_{8,12;3,4}^1$	$[4^2, 3, (3, \infty, 4)]$
$\Gamma_{11,12;3,4}^1$		$[6, 3^2, (3, \infty, 4)]$	2
$\Gamma_{7,1;2}^3$		$[6, 3^2, 5, \infty]$	4
$\Gamma_{7,1;3}^3$		$[6, 3^2, (3, \infty, 5)]$	2
$\Gamma_{7,1;4}^3$		$[6, 3^2, (4, \infty, 5)]$	2
5	$\Gamma_{5,12;3,4}^1$	$[4, 3^{1,2}, (3, \infty, 4)]$	2
6	$\Gamma_{2,12;3,4}^1$	$[3, 4, 3^3, (3, \infty, 4)]$	3
10	$\Gamma_{1,12;3,4}^1$	$[3^{2,1}, 3^6, (3, \infty, 4)]$	1

Table 5.12

Theorem 5.6 ([24]). *The commensurability classes of arithmetic Coxeter pyramid groups in $\text{Isom}(\mathcal{H}^n)$ are given in Table 5.13.*

n	Representative	Coxeter symbol	Cardinality	Simplex representative
3	$\Gamma_{12,12;2,3,2,3}^1$	$[\infty, 3, 3, \infty]$	6	$[3, 4, 4]$
	$\Gamma_{8,2;2}^2$	$[\infty, 3, 6, \infty]$	4	$[3, 3, 6]$
	$\Gamma_{12,12;2,3,2,4}^1$	$[\infty, 3, 4, \infty]$	4	-
4	$\Gamma_{8,12;2,3}^1$	$[4^2, 3^2, \infty]$	21	$[3, 4, 3, 4]$
	$\Gamma_{11,12;2,3}^1$	$[6, 3^3, \infty]$	4	-
5	$\Gamma_{8,8}^1$	$[4^2, 3^2, 4^2]$	23	$[3, 3, 3, 4, 3]$
	$\Gamma_{5,12;2,3}^1$	$[4, 3^{1,3}, \infty]$	4	-
	$\Gamma_{8,11}^1$	$[4^2, 3^3, 6]$	6	-
6	$\Gamma_{2,12;2,3}^1$	$[3, 4, 3^4, \infty]$	18	$[4, 3^2, 3^{2,1}]$
	$\Gamma_{5,11}^1$	$[4, 3^{1,4}, 6]$	4	$[3, 3^{[6]}]$
	$\Gamma_{4,4}^3$	$[\infty, 3^2, 3^{[5]}]$	2	-
7	$\Gamma_{2,8}^1$	$[4^2, 3^4, 4, 3]$	12	$[4, 3^3, 3^{2,1}]$
	$\Gamma_{2,11}^1$	$[6, 3^5, 4, 3]$	8	$[3^{2,2,2}]$
	$\Gamma_{2,4}^3$	$[4, 3^2, 3^{1,3}, \infty]$	4	-
	$\Gamma_{4,1}^3$	$[6, 3^3, 3^{[5]}]$	2	-
8	$\Gamma_{2,5}^1$	$[4, 3^{1,5}, 4, 3]$	16	$[3^{4,3,1}]$
9	$\Gamma_{2,2}^1$	$[3, 4, 3^6, 4, 3]$	8	$[3^{6,2,1}]$
10	$\Gamma_{1,12;2,3}^1$	$[3^{2,1}, 3^7, \infty]$	4	-
11	$\Gamma_{1,8}^1$	$[3^{2,1}, 3^7, 4^2]$	3	-
	$\Gamma_{1,11}^1$	$[3^{2,1}, 3^8, 6]$	2	-
12	$\Gamma_{1,5}^1$	$[4, 3^{1,8}, 3^{1,2}]$	2	-
13	$\Gamma_{1,2}^1$	$[3^{2,1}, 3^9, 4, 3]$	3	-
17	$\Gamma_{1,1}^1$	$[3^{2,1}, 3^{12}, 3^{1,2}]$	1	-

Table 5.13

Remark 5.5. Table 5.13 includes the "bow tie" Coxeter group $\Gamma^* < \text{Isom}(\mathcal{H}^4)$.

5.4 Commensurability classes of ideal Coxeter 3-cubes

In this section, we study the commensurability problem for the 7 ideal Coxeter 3-cubes described in Section 3.2.2. Recall that their graphs $\Gamma_1, \dots, \Gamma_7$ are given in Figure 3.1, the weights of their dotted edges in Table 3.1, and their volumes in Table 3.2. For $i = 1, \dots, 7$, let $\mathcal{C}_i \subset \overline{\mathcal{H}^3}$ be the ideal Coxeter 3-cube of graph Γ_i , with Coxeter group $W_i < \text{Isom}(\overline{\mathcal{H}^3})$.

By Vinberg's criterion stated in Theorem 2.13, the groups W_1, W_3, W_6 and W_7 are arithmetic (over \mathbb{Q}), while the groups W_2, W_4 and W_5 are non-arithmetic.

The invariants of the *arithmetic* groups can be computed by using Section 5.1.2. Consider for instance the cube \mathcal{C}_3 . It is not hard to show that the rows e_1, \dots, e_6 of the matrix M_3 given by

$$M_3 = \begin{pmatrix} 1 & 0 & 0 & 0 \\ -\frac{1}{2} & -\frac{\sqrt{3}}{2} & 0 & 0 \\ -\frac{1}{2} & \frac{\sqrt{3}}{2} & -3\sqrt{3} & 3\sqrt{3} \\ 0 & 1 & \frac{1}{4} & \frac{1}{4} \\ -\frac{\sqrt{3}}{2} & \frac{5}{2} & -\frac{23}{4} & \frac{25}{4} \\ -\sqrt{3} & 1 & -\frac{11}{4} & \frac{13}{4} \end{pmatrix}$$

are normal vectors for \mathcal{C}_3 . Then, the vectors described by (5.7) are given by

$$v_1 = e_1, \quad v_2 = e_2, \quad v_3 = e_3, \quad v_4 = \sqrt{3}e_4, \quad v_5 = \sqrt{3}e_5, \quad v_6 = \sqrt{3}e_6.$$

One can check that $\{v_1, \dots, v_4\}$ is a basis of \mathbb{R}^4 , leading to the diagonal form $q_3 = \langle 1, 3, 6, -6 \rangle$ of signed determinant $\delta_3 = -3$. Hence, by Section 5.3.1, the group W_3 is commensurable to the simplex group $[3, 3, 6]$.

A similar procedure shows that the groups W_1 and W_6 are also commensurable to the simplex group $[3, 3, 6]$, while the group W_7 is commensurable to the simplex group $[3, 4, 4]$.

As for the *non-arithmetic* groups W_2, W_4 and W_5 , we observe that none of the methods described in Section 5.1.1 allows us to decide about their commensurability relations. Moreover, since their volumes are rational multiples of $\mathbb{I}(\pi/3)$, nothing can be deduced from a volume comparison.

Direct computations using (5.3) show that the invariant trace fields of the respective rotational subgroups W_2^+, W_4^+ and W_5^+ are given by

$$kW_2^+ = \mathbb{Q}(\sqrt{3}, \sqrt{3}i) = kW_4^+ = kW_5^+.$$

Hence, by Example 5.6 and Table 5.12 (see Section 5.1), these groups are incommensurable with the non-arithmetic pyramid groups in $\text{Isom}(\overline{\mathcal{H}^3})$.

Bibliography

- [1] E. M. Andreev. Convex polyhedra in Lobacevskii spaces. *Mat. Sb. (N.S.)*, 81 (123):445–478, 1970.
- [2] A. F. Beardon. *The Geometry of Discrete Groups*. Springer, 1983.
- [3] M. Belolipetsky. On volumes of arithmetic quotients of $SO(1, n)$. *Annali della Scuola Normale Superiore di Pisa. Classe di Scienze. Serie V*, 3(4):749–770, 2004.
- [4] M. Belolipetsky and V. Emery. On volumes of arithmetic quotients of $PO(n, 1)^\circ$, n odd. *Proceedings of the London Mathematical Society*, 105:541–570, 2012.
- [5] R. Borcherds. Automorphism groups of Lorentzian lattices. *Journal of Algebra*, 111:133–153, 1987.
- [6] R. Borcherds. Coxeter groups, Lorentzian lattices, and $K3$ surfaces. *Internat. Math. Res. Notices*, (19):1011–1031, 1998.
- [7] N. Bourbaki. *Éléments de mathématique*. Masson, Paris, 1981. Groupes et algèbres de Lie. Chapitres 4, 5 et 6.
- [8] V. O. Bugaenko. Groups of automorphisms of unimodular hyperbolic quadratic forms over the ring $\mathbb{Z}[(\sqrt{5} + 1)/2]$. *Moskow University Mathematics Bulletin*, 5:6–14, 1984.
- [9] V. O. Bugaenko. Arithmetic crystallographic groups generated by reflections, and reflective hyperbolic lattices. In *Lie groups, their discrete subgroups, and invariant theory*, volume 8 of *Advances in Soviet Mathematics*, pages 33–55. AMS, 1992.
- [10] K. Böröczky. Packings of spheres in spaces of constant curvature. *Acta Mathematica Academiae Scientiarum Hungaricae*, 32(3-4):243–261, 1978.
- [11] H. S. M. Coxeter. Discrete groups generated by reflections. *Ann. of Math. (2)*, 35(3):588–621, 1934.

- [12] M. W. Davis. *The geometry and topology of Coxeter groups*, volume 32 of *London Mathematical Society Monographs Series*. Princeton University Press, Princeton, NJ, 2008.
- [13] R. Diaz. A characterization of Gram matrices of polytopes. *Discrete & Computational Geometry*, 21:581–601, 1999.
- [14] W. D. Neumann and A. W. Reid. Arithmetic of hyperbolic manifolds. In *Topology '90 (Columbus, OH, 1990)*, volume 1 of *Ohio State Univ. Math. Res. Inst. Publ.*, pages 273–310. de Gruyter, Berlin, 1992.
- [15] V. Emery. Du volume des quotients arithmétiques de l'espace hyperbolique. Thèse 1648, Université de Fribourg, Suisse, 2009.
- [16] V. Emery. Even unimodular Lorentzian lattices and hyperbolic volume. *Journal für die Reine und Angewandte Mathematik*, 690:173–177, 2014.
- [17] F. Esselmann. Ueber kompakte hyperbolische Coxeter-Polytope mit wenigen facetten. *SFB 343 Fakultät für Mathematik, Universität Bielefeld*, 1994.
- [18] F. Esselmann. The classification of compact hyperbolic Coxeter d -polytopes with $d + 2$ facets. *Commentarii Mathematici Helvetici*, 71(2):229–242, 1996.
- [19] F. Fanoni. The maximum injectivity radius of hyperbolic orbifolds. *Geom. Dedicata*, 175:281–307, 2015.
- [20] A. Felikson and P. Tumarkin. On bounded hyperbolic d -dimensional Coxeter polytopes with $d + 4$ hyperfaces. *Tr. Mosk. Mat. Obs.*, 69:126–181, 2008.
- [21] A. Felikson and P. Tumarkin. On simple ideal hyperbolic Coxeter polytopes. *Izv. Ross. Akad. Nauk Ser. Mat.*, 72(1):123–136, 2008.
- [22] F. W. Gehring and G. J. Martin. Minimal co-volume hyperbolic lattices, I : The spherical points of a Kleinian group. *Annals of Mathematics*, 170(1):123–161, 2009.
- [23] R. Guglielmetti. CoxIter - computing invariants of hyperbolic Coxeter groups. To appear in *LMS Journal of Computation and Mathematics*, 2015.
- [24] R. Guglielmetti, M. Jacquemet, and R. Kellerhals. On commensurable hyperbolic Coxeter groups. Submitted preprint, 2015.
- [25] G. J. Heckman. The volume of hyperbolic Coxeter polytopes of even dimension. *Indagationes Mathematicae NS*, 6:189–196, 1995.

- [26] T. Hild. Cusped hyperbolic orbifolds of minimal volume in dimensions less than ten. *Journal of Algebra*, 313(1):208–222, 2007.
- [27] T. Hild and R. Kellerhals. The FCC lattice and the cusped hyperbolic 4-orbifold of minimal volume. 75(3):677–689, 2007.
- [28] J. E. Humphreys. *Reflection groups and Coxeter groups*, volume 29 of *Cambridge Studies in Advanced Mathematics*. Cambridge University Press, Cambridge, 1990.
- [29] M. Jacquemet. The inradius of a hyperbolic truncated n -simplex. *Discrete & Computational Geometry*, 51(4):997–1016, 2014.
- [30] N. W. Johnson, R. Kellerhals, J. G. Ratcliffe, and S. T. Tschantz. The size of a hyperbolic Coxeter simplex. *Transformation Groups*, 4(4):329–353, 1999.
- [31] N. W. Johnson, R. Kellerhals, J. G. Ratcliffe, and S. T. Tschantz. Commensurability classes of hyperbolic Coxeter groups. *Linear Algebra and its Applications*, 345:119–147, 2002.
- [32] I. Kaplinskaja. The discrete groups that are generated by reflections in the faces of simplicial prisms in Lobačevskiĭ spaces. *Mat. Zametki*, 15:159–164, 1974.
- [33] A. Karrass and D. Solitar. The subgroups of a free product of two groups with an amalgamated subgroup. *Trans. Amer. Math. Soc.*, 150:227–255, 1970.
- [34] R. Kellerhals. On the volume of hyperbolic polyhedra. *Mathematische Annalen*, 285:541–569, 1989.
- [35] R. Kellerhals. Regular simplices and lower volume bounds for hyperbolic n -manifolds. *Annals of Global Analysis and Geometry*, 13:377–392, 1995.
- [36] R. Kellerhals. Hyperbolic orbifolds of minimal volume. *Computational Methods and Function Theory*, 14(2-3):465–481, 2014.
- [37] R. Kellerhals and G. Perren. On the growth of cocompact hyperbolic Coxeter groups. *European J. Combin.*, 32(8):1299–1316, 2011.
- [38] T. Y. Lam. *Introduction to quadratic forms over fields*, volume 67 of *Graduate Studies in Mathematics*. American Mathematical Society, Providence, RI, 2005.
- [39] C. Maclachlan. Commensurability classes of discrete arithmetic hyperbolic groups. *Groups, Geometry, and Dynamics*, 5(4), 2011.

- [40] C. Maclachlan and A. W. Reid. Invariant trace-fields and quaternion algebras of polyhedral groups. *J. London Math. Soc. (2)*, 58(3):709–722, 1998.
- [41] C. Maclachlan and A. W. Reid. *The arithmetic of hyperbolic 3-manifolds*, volume 219 of *Graduate Texts in Mathematics*. Springer-Verlag, New York, 2003.
- [42] T. H. Marshall and G. J. Martin. Minimal co-volume hyperbolic lattices, II : Simple torsion in a Kleinian group. *Annals of Mathematics*, 176(2):261–301, 2012.
- [43] B. Maskit. *Kleinian groups*. Springer, 1988.
- [44] G. Maxwell. Euler characteristics and imbeddings of hyperbolic Coxeter groups. *J. Austral. Math. Soc. Ser. A*, 64(2):149–161, 1998.
- [45] P. McMullen and E. Schulte. *Abstract regular polytopes*, volume 92 of *Encyclopedia of Mathematics and its Applications*. Cambridge University Press, Cambridge, 2002.
- [46] R. Meyerhoff. Sphere-packing and volume in hyperbolic 3-space. *Commentarii Mathematici Helvetici*, 61(2):271–278, 1986.
- [47] J. Milnor. The Schläfli differential equality. In *John Milnor Collected Papers*, volume 1, pages 281–295. Publish or Perish, 1994.
- [48] N. Peyerimhoff. Simplices of maximal volume or minimal total edge length in hyperbolic space. *J. London Math. Soc. (2)*, 66(3):753–768, 2002.
- [49] H. Poincaré. Sur la théorie des groupes fuchsien. *Acta Mathematica*, 1:1–62, 1882.
- [50] M. Prokhorov. Absence of discrete reflection groups with non-compact fundamental polyhedron of finite volume in Lobachevskij spaces of large dimension. *Mathematics of the USSR-Izvestiya*, 28:401–411, 1987.
- [51] J. G. Ratcliffe. *Foundations of Hyperbolic Manifolds*. Springer, 1994.
- [52] I. Rivin. A characterization of ideal polyhedra in hyperbolic 3-space. *Annals of Mathematics (2)*, 143(1):51–70, 1996.
- [53] R. K. W. Roeder. Andreev’s classification of hyperbolic polyhedra. PhD Thesis, Université de Provence, Marseille, 2004.
- [54] J.-P. Serre. *A course in arithmetic*. Springer-Verlag, New York-Heidelberg, 1973. Translated from the French, Graduate Texts in Mathematics, No. 7.

- [55] C. L. Siegel. Some remarks on discontinuous groups. *Annals of Mathematics*, 46(4):708–718, 1945.
- [56] J. Szirmai. The regular prism tilings and their optimal hyperball packings in the hyperbolic n -space. *Publicationes Mathematicae Debrecen*, 69(1-2):195–207, 2006.
- [57] K. Takeuchi. Commensurability classes of arithmetic triangle groups. *J. Fac. Sci. Univ. Tokyo Sect. IA Math.*, 24(1):201–212, 1977.
- [58] W. Thurston. *The Geometry and Topology of 3-manifolds*. Princeton, 1979.
- [59] P. Tumarkin. Hyperbolic Coxeter n -polytopes with $n + 2$ facets. *Mathematical Notes*, 75:909–916, 2004.
- [60] P. Tumarkin. Compact hyperbolic Coxeter n -polytopes with $n + 3$ facets. *Electronic Journal of Combinatorics*, 1:36, 2007.
- [61] Y. Umemoto. The growth function of Coxeter dominoes and 2-Salem numbers. *Algebraic & Geometric Topology*, 14(5):2721–2746, 2014.
- [62] M.-F. Vignéras. *Arithmétique des algèbres de quaternions*, volume 800 of *Lecture Notes in Mathematics*. Springer, Berlin, 1980.
- [63] E. B. Vinberg. Discrete groups generated by reflections in Lobachevskii spaces. *Mathematics of the USSR-Sbornik*, 1:429–444, 1967.
- [64] E. B. Vinberg. Hyperbolic reflection groups. *Russian Mathematical Surveys*, 40(1):31–75, 1985.
- [65] E. B. Vinberg, editor. *Geometry II - Spaces of Constant Curvature*. Springer, 1993.
- [66] E. B. Vinberg. Non-arithmetic hyperbolic reflection groups in higher dimensions. Univ. Bielefeld Preprint 14047, 2014.

Matthieu Jacquemet

Personal Data

Birth : 01.07.1986 in Sion, Switzerland
Citizenship : Swiss
Marital Status : Married

Education

- 10.2010-10.2015 **PhD Studies in Mathematics**, *University of Fribourg*.
Advisor : Prof. Dr. Ruth Kellerhals
- 09.2008-09.2010 **Master of Science in Mathematics**, *University of Fribourg*.
Master Thesis "The discovery of hyperbolization of a knot complement". Advisor : Prof. Dr. Ruth Kellerhals
- 09.2005-09.2008 **Bachelor of Science in Mathematics**, *University of Fribourg*.
Minor in Philosophy

Current Position

From 10.2010 **PhD Student and Graduate Assistant**, *University of Fribourg*.

Invited Talks

- 23.07.2015 **Hyperbolic truncated simplices and reflection groups**.
Lie Groups and Algebraic Groups, University of Bielefeld.
- 27.06.2015 **Commensurability of hyperbolic Coxeter polyhedra with $n + 2$ facets**.
Intuitive Geometry, László Fejes Tóth Centennial, University of Budapest.
- 27.11.2014 **Groupes et polyèdres de Coxeter hyperboliques : invariants et commensurabilité**.
Paroles aux jeunes chercheurs en géométrie et dynamique, GDR Platon, University of Bordeaux.
- 12.11.2014 **Invariants et commensurabilité des groupes de Coxeter hyperboliques**.
Oberseminar Geometrie, University of Fribourg.
- 06.03.2013 **The inner radius of a hyperbolic n -simplex**.
Oberseminar Geometrie, University of Fribourg.
- 07.12.2012 **Hyperbolic volume, estimates, and simplices**.
Seminar Algebra & Geometry, University of Basel.
- 18.06.2012 **The inradius of a compact hyperbolic simplex**.
9-th Graduate Colloquium of the Swiss Doctoral School in Mathematics, Neuchâtel.
- 23./30.03.2012 **The discovery of hyperbolization of a knot complement, (2 Parts)**.
Topology Seminar, University of Auckland, NZ.

Award

- 19.06.2012 **Prize for the best talk**.
9-th Graduate Colloquium of the Swiss Doctoral School in Mathematics, Neuchâtel.

Research Stays

- 09.2013 **Semester Program on Low-Dimensional Topology, Geometry and Dynamics**.
(2 weeks) Long-Term Participant, ICERM, Providence RI.
- 02-04.2012 **University of Auckland**.
(7 weeks) Host: Prof. Dr. Marston Conder.

Publications, Preprints, Posters

On commensurable hyperbolic Coxeter groups, with R. Guglielmetti and R. Kellerhals.
Submitted, 2015.

Polyhedra and commensurability, with R. Guglielmetti.
Snapshots of Modern Mathematics, MFO Oberwolfach. Submitted, 2015.

The inradius of a hyperbolic truncated n -simplex.
Discrete and Computational Geometry 51 (4), 997-1016 (2014).

The inradius of a hyperbolic truncated simplex, *Poster*.
Poster Session of the Workshop Exotic Geometric Structures, ICERM, Providence RI, 2013.

Popularization of Mathematics

- 12.05.2015 **(M)hasta siempre**, *Talk*.
Mathematikòn, University of Fribourg.
- 28.04.2015 **Parfois, la taille compte aussi !**, *Workshop*, with R. Guglielmetti.
TecDays@Madame-de-Staël, Collège Madame-de-Staël, Carouge.
- 10.10.2014 **Parfois, la taille compte aussi !**, *Workshop*, with R. Guglielmetti.
TecDays@Beaulieu, Gymnase de Beaulieu, Lausanne.
- 30.09.2014 **Didon, comment on va ranger ces livres ?**, *Talk*.
Mathematikòn, University of Fribourg.
- 18.03.2014 **Ludwig Schläfli, un Bernois d'(au moins) une autre dimension**, *Talk*.
Mathematikòn, University of Fribourg.
- 15.04.2013 **Napoléon aurait-il pu gagner à Waterloo ?**, *Talk*.
Mathematikòn, University of Fribourg.
- 11.10.2010 **Promenade entre algèbre et géométrie**, *Talk*.
Mathematikòn, University of Fribourg.
- 08.2010 **Quand les mathématiciens font de l'épicerie**, *Poster*.
Exposition "Plantes, spirales et nombres", University of Fribourg.