

Low-Complexity SOCPBFSK-OOK Interface Between PLC and VLC Channels for Low Data Rate Transmission Applications

A. R. Ndjiongue, H. C. Ferreira, K. Ouahada and A. J. Han Vinck[‡].

Department of Electrical and Electronic Engineering Science, University of Johannesburg,
P.O. Box 524, Auckland Park, 2006, Johannesburg, South Africa.

[‡]Institute of Experimental Mathematics, University of Duisburg-Essen,
Ellernstr. 29, 45326 Essen, Germany.

Email: {alainn, hcferreira, kouahada}@uj.ac.za, vinck@iem.uni-due.de

Abstract—This paper studies and proposes a low cost low complexity interface between power line communications (PLC) and visible light communications (VLC) for low data rate transmission applications. The discussion presents the performance of a spread orthogonal continuous phase binary frequency shift keying (SOCPBFSK) receiver combined with an on-off keying (OOK) modulator to relay low data transmission between PLC and VLC channels. The characteristics of the interface are presented. The results of an experimental test using the proposed interface over the European Committee for Electrotechnical Standardization (CENELEC) bands C and D are presented. The eye diagrams of the combined error are presented as well.

I. INTRODUCTION

Power line communications (PLC) has reached a point where it competes with other communication technologies for low and high bits transmission. For cost and reliability purpose, in certain applications, PLC is to be combined with other emerging technologies such as visible light communications (VLC). Some applications are common for PLC and VLC. Some of those common applications are: Inter building communication, street lighting, point to point applications, signboards, vehicle safety lighting, traffic lighting, inter-vehicle communications and remote controls.

Visible light communications transmits data via modulating light emitting diodes (LEDs). LEDs offer many advantages in lighting in which we have: Very good reliability, very high brightness, very low power consumption, very long lifetime and they offers very good scalability of the flowing current. IEEE 802.15.7 is the standard for short-range optical communications using visible light. IEEE 802.15.7 is summarized and presented in [1]. It shows that on-off keying (OOK) and variable pulse position modulations (VPPM) are suitable for low bits transmission over VLC channel. The interface presented in Section IV complies with the IEEE 802.15.7 standards. OOK is a special binary amplitude shift keying (BASK) in which the second amplitude is null. On-off keying is one of the lowest complexity digital modulations used. Besides, OOK is one of the most used modulation scheme in optical wireless communications [2]. the low cost and low complexity criteria stated early in this paper do not allow the use of OOK-RZ, because of the waist of energy during the return to zero for the consecutive binary ones. The OOK-NRZ is then used.

Frequency shift keying is a modulation scheme in which a NRZ data stream convoluts the carrier signal the way that each symbol corresponds to one frequency. The next consecutive symbol will be represented by another frequency up until the total number of frequencies is used. In binary frequency shift keying (BFSK), two frequencies are used. The zeros are mapped to the space frequency and the ones correspond to the mark frequency. Spread frequency shift keying (S-FSK) is the version of FSK adapted to PLC channel [3]. The spreading principle adjusts the shift between frequencies to make it greater than 10 kHz. Receiver side, the demodulator is assumed to detect whether at least one of the frequencies is disturbed [3]. Spread frequency shift keying groups in one modulation scheme some advantages provided by the spread spectrum (SS) modulation and those provided by the frequency shift keying; respectively, SS modulation provides immunity and robustness against non-Gaussian noise such as narrowband interference and impulses, knowing that short time disturbers are the typical causes of impairments of PLC [4]; and FSK is a very low complexity modulation scheme [5].

Combining power line communications and visible light communications is not a new idea. Many propositions were made through research outputs. In [6], the authors proposed an integrated system of white LED visible light communications and power line communications using a single carrier binary phase shift keying (SC-BPSK), some results of the simulations and the demonstration model were proposed. In [7], P. Amirshahi and M. Kavehrad proposed a broadband access over medium and low voltage power lines and the use of white light emitting diodes for indoor communications. Their work describes the medium, the low voltage power line channel and the VLC channels. In [8], the authors focused on the integration of indoor visible light and the power line communications systems. The orthogonal frequency division multiplexing (OFDM) was highlighted with an emphasis on multiple inputs and multiple outputs (MIMO). Other modulation schemes such as OOK-NRZ, pulse position modulation (PPM) and pulse width modulation (PWM) where introduced. In this paper, we propose a low cost low complexity SOCPBFSK-OOK interface for combining PLC channel and VLC channel for low data rate transmission applications.

EN 50065-1 is the regulation proposed by the CENELEC organization. It gives the general requirements, frequency range and

electromagnetic disturbances for the transmission over power lines between 3 kHz and 148.5 kHz [9]. the hardware presented in Section IV and the experimental tests presented in Section V comply with the recommendations and exigences of EN 50065-1.

The rest of the paper is organized as it follows: An overview of FSK and OOK is presented in Section II, a quick view of both channels is given in section III, followed by the implementation concept in Section IV. A complete transmission over PLC and VLC channels, as well the results are presented in Section V. Some applications and the conclusion are given in Section VI.

II. OVERVIEW OF SOCPBFSK AND OOK MODULATIONS

A. Overview of SOCPBFSK

Orthogonal continuous phase binary FSK (OCPBFSK) is a binary version of orthogonal continuous phase FSK. For the flow of explanation, some definitions are first to be made. R_b is the bit rate in bits per second, the baud rate (in symbols per second) is defined by $f_b = R_b/N$, where N is the number of bits per symbol. The modulation level is $M = 2^N$. $m(t)$ is the base band message signal and the carrier signal is $c_{FSK}(t)$. T is the bit period. The symbol duration is defined by $T_b = NT = 1/f_b$; f_c is the apparent carrier frequency and f_d represents the frequency deviation. It is also to be defined the frequency sensitivity λ representing the amount of frequency change in the carrier frequency per unit amplitude variation in the message signal. In general, in FSK, each symbol is represented by one of the M frequencies selected in the set defined by f_n as follows:

$$f_n = f_c + f_d[2N - (M - 1)] \quad (1)$$

The symbols form a function $\delta(n, t)$ defined by:

$$\delta(n, t) = D(n)S_y(t - nT_b) \quad (2)$$

where $D(n) = f_d[2k_n - (M - 1)]$ represents the possible deviation between frequencies, k_n being the decimal value of the binary input and $S_y(t)$ is defined as follows [10]:

$$S_y(t) = \begin{cases} 1 & \text{for } nT_b < t < (n+1)T_b, \\ 0 & \text{elsewhere} \end{cases} \quad (3)$$

The baseband message signal defined in (4) is the sum over infinity of $\delta(n, t)$.

$$m(t) = \sum_{n=0}^{\infty} \delta(n, t) = \sum_{n=0}^{\infty} D(n)S_y(t - nT_b) \quad (4)$$

The baseband message signal $m(t)$ is then modulated, resulting in a carrier signal $c_{FSK}(t)$. The general expression of the carrier signal in FSK modulation is then given as it follows [10]:

$$c_{FSK}(t) = A_{FSK} \cos[2\pi f_c t + \lambda \int_0^t m(\tau) d\tau + \varphi_0] \quad (5)$$

In the case of this study, $M = 2$ and $N = 1$ (binary FSK), then $T = T_b$. To ensure phase continuity, (assuming $\lambda = 1$) the carrier signal can be represented as follows:

$$c_{FSK}(t) = A_{FSK} \cos[2\pi f_c t + (\frac{\pi h a_n(t - nT)}{T}) + \pi h \sum_{i=0}^{n-1} a_i], nT \leq t \leq (n+1)T. \quad (6)$$

In (6), the quantity $\frac{\pi h a_n(t - nT)}{T}$ represents the phase and $\pi h \sum_{i=0}^{n-1} a_i$ represents the accumulated phase. $a_i = \pm 1$ is the n^{th} bit (1 is mapped to +1 and 0 to -1). The deviation Δf defining the phase continuity can be calculated as the derivative of the phase as follows:

$$\Delta f = \frac{d[\pi h a_n(t - nT)]}{2\pi dt} = \frac{h}{2T}, \quad (7)$$

then the modulation index is given by $h = \frac{2\Delta f}{R_b}$. Since $M = 2$, the two signals can be expressed as:

$$s_1 = A_{FSK} \cos(2\pi f_1 t + \varphi) \quad (8)$$

$$s_2 = A_{FSK} \cos(2\pi f_2 t + \varphi) \quad (9)$$

s_1 and s_2 are orthogonal if $[\int_{NT}^{(N+1)T} s_1(t)s_2(t)dt = 0]$ is satisfied. This requires that $2\pi(f_1 + f_2)T = 2\alpha\pi$ and $2\pi(f_1 - f_2)T = 2\beta\pi$ where α and β are integer. Then the two frequencies can be expressed as it follows:

$$f_1 = \frac{2\alpha + \beta}{4T} \quad (10)$$

$$f_2 = \frac{2\alpha - \beta}{4T} \quad (11)$$

This means that the frequencies f_1 and f_2 must be an integer multiple of $1/4T$, and the apparent carrier frequency $f_c = \frac{f_1 + f_2}{2}$ must be an integer multiple of $1/2T$. The minimum shift between the two frequencies must be $1/2T$. For the FSK to be wide band, $[2\Delta f > R_b]$ must be satisfied. Spread FSK is a special wide band FSK characterized by $(f_1 - f_2) \geq 10kHz$ and $\frac{1}{2T} \geq 10kHz$.

On the demodulator side, the technique adapted to wide band FSK and low SNR is the phase locked loop (PLL) [11]. PLL generates an output signal whose phase is related to the phase of an input signal.

B. Overview of OOK

On-off keying is a special case of amplitude shift keying (ASK) modulation using two different voltage levels, where the second amplitude is null. ASK is the modulation scheme in which different symbols are represented by $M = 2^N$ voltage levels of M different signals. The signals have the same phase and the same frequency. Let A be the maximum possible amplitude, then the voltage level for the symbol s is given by:

$$V_s = \frac{2A}{M-1}N - A \quad (12)$$

where $N = 0, 1, \dots, M-1$ and the carrier signal can be represented by

$$c_{ASK}(t) = \sum_{n=-\infty}^{+\infty} v[n]S_y(t - nT_b) \quad (13)$$

where $v[n]$ represents the voltage level function and S_y is a unit height pulse of the duration T_b representing the symbols. In binary ASK, $N = 1$ and $M = 2$, then $V_s = A(2N - 1)$. In OOK, only the amplitude representing the logic "1" is used ($V_1 = A$) since the second amplitude is null.

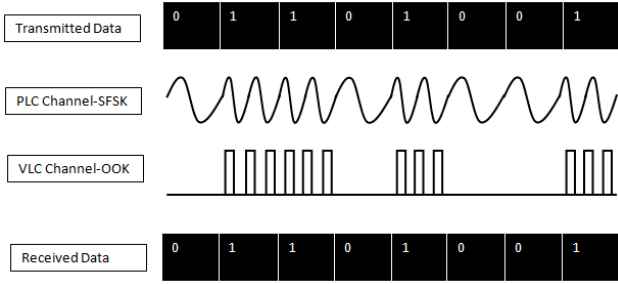

Fig. 1. Description of the transmission carriers continuous S-BFSK - OOK showing two different carrier signals for the two different channels.

C. BSK - OOK mapping

The mark frequency (BFSK) is mapped to A (OOK) while the space frequency (BFSK) is mapped to 0 (OOK).

$$\begin{cases} f_1 \Rightarrow A, \\ f_2 \Rightarrow 0 \end{cases} \quad (14)$$

A is the amplitude of a periodic function $a(t)$, with period T_a and frequency f_a . In optical communications and especially in visible light communications, a square wave is more indicated, then $a(t)$ is defined as it follows:

$$\begin{cases} a(t) = A & \text{for the ones} \\ a(t) = 0 & \text{for the zeros} \end{cases} \quad (15)$$

(15) is achieved by using the same unit height symbol function S_y in FSK and in OOK. This makes the OOK modulator to see at its output exactly what is going out from the SOCPBFSK demodulator output and then the global system will be seen as one block using the unit height symbol function S_y . Fig. 1 illustrates the transmission wave forms for the two different channels. The FSK signal is sent over PLC channel while the OOK carrier signal is sent over VLC channel.

III. PLC CHANNEL VERSUS VLC CHANNEL

A. PLC channel

The medium in power line communications is the existing wires used for electrical purpose. To characterize this medium and use it as communications infrastructure, many parameters are to be studied: The bandwidth, the impedance, noise, the variability of the electrical grid. The noise spectrum in the PLC channel presents very high amplitude in low frequencies [12]. The decomposition of the PLC noise in the range of frequencies between 0 and 120 kHz into short time disturbers such as narrow band interference and impulses, and into non-impulsive noise is showed in Fig. 2, as studied and proposed in [12]. This subserves the use of a frequency spreading modulation technique in narrow band PLC and justifies the use of spread OCPBFSK in our case. The model of PLC channel presented in [13] integrates all types of noise present over PLC channel; it gives the output signal as a function of the input signal added to the sum of disturbances in the channel.

B. VLC channel

The most important source of interference in visible light communications is the other sources of light. Among them,

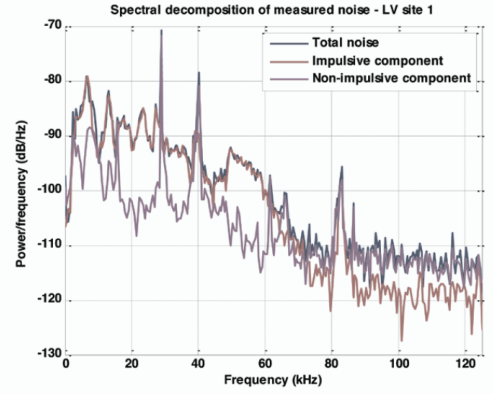

Fig. 2. Decomposition of PLC noise over the frequency range [0-120 kHz], highlighting the presence of short time disturbers [12].

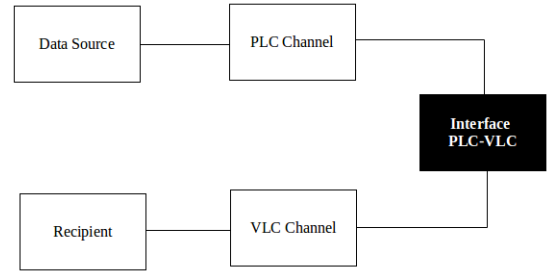

Fig. 3. Explanatory blocks of the system including the interface PLC-VLC for low data rate transmission.

we denote the sunlight, the incandescent light, the fluorescent light. Multi-path fading is also to be taken into account. In certain applications the need of a line of side is predominant. the VLC channel present a very high bandwidth. More than 3.2×10^{14} is available for data transmission.

IV. HARDWARE IMPLEMENTATION

The block diagram of the system fitting the interface is presented in Fig. 3. For the experimental test, a full PLC communication system is implemented. The interface includes a band pass filter to take out the 50 Hz, A S-FSK - OOK bridge, and the power supply. The exploded diagram of the interface is showed in Fig.4. The scanning covers the range of frequencies between 125 kHz and 153 kHz, which corresponds to C and D bands of CENELEC standards. By fixing the space frequency at 125 kHz, the design provides large variation of the mark frequency between 131.41 kHz and 153 kHz. The chosen values of the mark frequency are 131.41 kHz, 139.54 kHz, 145.27 kHz and 152.77 kHz. Table 1 summarizes the frequencies (in kHz) and modulation index for 1200, 2400 and 4800 baud rates adapted to the proposed bridge.

The S-FSK-OOK interface detects the S-FSK signal at the output of the band pass filter (coupler) and produces a square wave corresponding to the message. This is used to convolute the supply of the LEDs and consequently, the photo-transistor (VLC receiver) receives the on-off keying message which is converted into data. It is to mentioned that the VLC receiver is not studied in this paper, therefore, the reader is referred

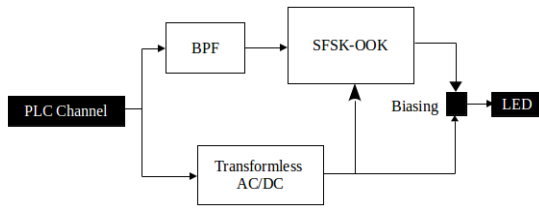

Fig. 4. Exploded proposed PLC-VLC interface showing the different main blocks (BPF, BFSK-OOK, Power supply).

TABLE I. PLC TRANSMISSION FREQUENCIES, Δf , f_c AND h

f_2 (kHz)	125	125	125	125
f_1 (kHz)	131.41	139.54	145.27	152.77
Δf (kHz)	6.41	14.54	20.27	27.77
f_c (kHz)	128.205	132.27	135.135	138.888
h_{1200}	10.68	24.23	33.78	46.3
h_{2400}	5.34	12.11	16.89	23.14
h_{4800}	//	6.058	8.445	11.57

to [14-16] for more information about VLC receivers. For the VLC channel, the space frequency (FSK) is mapped to nothing (OOK) while the mark frequency (FSK) is mapped to a high frequency square wave (OOK). In the interface discussed in this paper, an efficient transform-less coupler is used. A third order T-shaped band pass filter arrangement proposed by the authors of [17] is adapted to this design. The schematic diagram of the T-shaped third order filter is presented in Fig.5. The transfer function given in Fig.6 shows a bandwidth large enough to pass all the frequencies (125 kHz to 153 kHz) planned to be demodulated and relayed by the bridge.

V. EXPERIMENTAL TEST AND PERFORMANCES

A. The SOCPBFSK PLC-VLC bridge

The bridge between PLC and VLC presented in this paper is a very low cost and very low complexity system. It integrates a FSK demodulator, an OOK modulator, a PLC transform-less coupler and a power supply. The demodulator uses a very low consumption monolithic voltage control oscillator (VCO). The frequency range of the VCO is between 1 Hz and 300 kHz and its maximum current supply of 7 mA. At 8 V DC supply, the chip consumes about 56 mW power. The OOK is composed by using the output signal of the demodulator to bias a LED driver. The LED driver used is an extremely low power consumption chip. The inside switch of the driver is controlled with a 1.2 mA current. The maximum supply

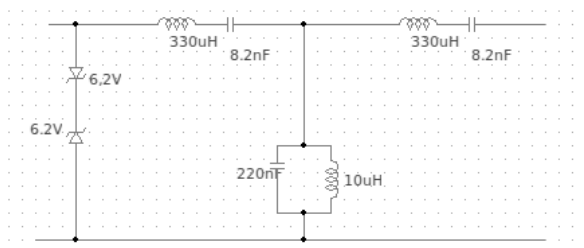

Fig. 5. Third order T-shaped transformless band pass filter schematic diagram studied and presented in [17].

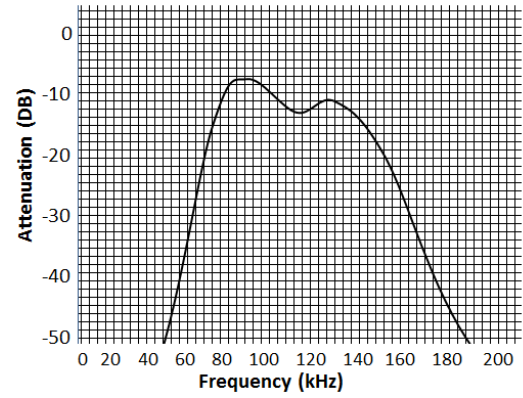

Fig. 6. Response of the transformless band pass filter used, showing the availability of the bandwidth to pass the frequencies between 80 kHz and 160 kHz with less attenuation [12].

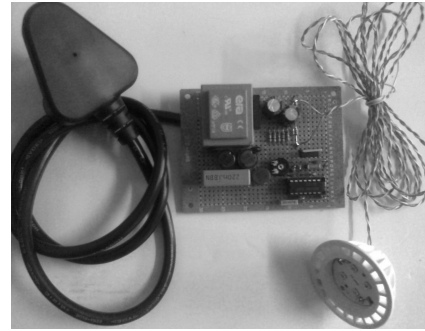

Fig. 7. Prototype of the SOCPBFSK-OOK bridge for relaying low data transmission between PLC and VLC channel.

voltage (24V) of the driver corresponds to the supply voltage of the two blocks of LEDs in series; to make it, a block of resistors is inserted in series to the two blocks of LEDs and its role is to polarize the LEDs and limit the forward current. Four white LEDs are used, two parallels of two diodes in series. Each LED need 0.175 A under 8 V to produce the total quantity light needed. For two branches of two LEDs in parallel, a total consumption of 8.4 W is to be produced by the power supply. The power supply itself consumes about 0.2W, which give a total consumption of 8.6 W. In regards to this information, the bridge can fit in a very small casing. Fig. 7 shows the photograph of the bridge built on a veroboard. For the experimental test, the four LEDs are suspended at 2 meters above the VLC receiver. Manufacturers can also use other low consumption small chips to realize the bridge and make it more smaller so that it can fit in any chosen LED bulb casing. The use of a transform-less power supply is suggested. The experimental setup is presented in Fig. 8 showing a signal generator, an oscilloscope, the FSK modulator, the FSK-OOK bridge and the VLC receiver.

B. Performance in communication

Fig. 9 represents the modulated signal to be sent through the PLC channel. The ones and zeros are respectively represented by f_1 (139 kHz) and f_0 (139 kHz), and the phase continuity is highlighted. Fig. 10 shows the OOK signal received by the end user. The FSK transmitter is connected

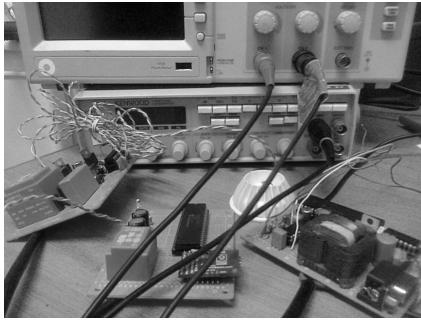

Fig. 8. Experimental setup used to characterize the bridge (TDS1001B oscilloscope, FG273 function generator, FSK modulator+ PLC coupler, SOCPBFSK-OOK bridge, VLC receiver).

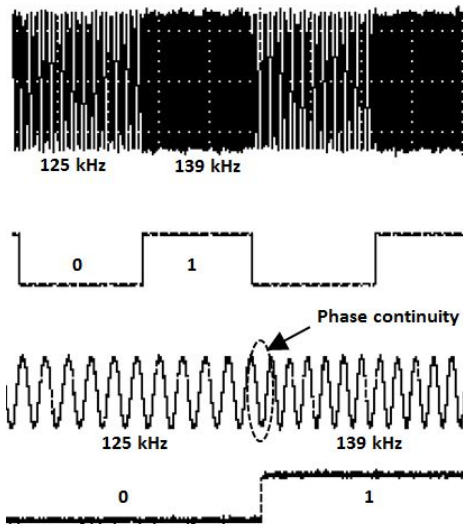

Fig. 9. Modulator at the input of the PLC channel highlighting the phase continuity between the two frequencies.

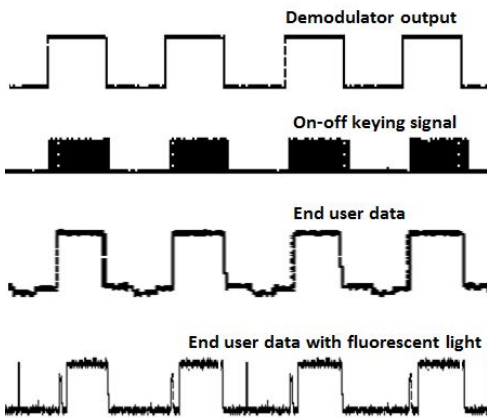

Fig. 10. End user data stream compared to the bridge demodulator output for no interference and when the fluorescent light are on.

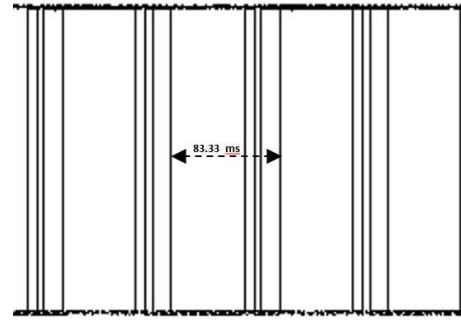

Fig. 11. Eye diagram of the VLC receiver input data stream.

at one meter from the bridge. The first test is performed while the two room fluorescent lights are off, the second one is done under the influence of two fluorescent light and the sunlight. The impact of the interference provoked by the fluorescent source of light is noticeable but the bridge will still performing. As presented in Fig. 10. The performance of the bridge is evaluated for double transmission (PLC channel and VLC channel) but the result is given for both combined channel. A good method to bound the number of ones and zeros in a waveform is to use 8b/10b encoding. 8b/10b is a line code that maps 8 bit symbols to 10 bit symbols to provide DC balance for the waveform and also provide enough state changes to allow reasonable clock recovery; which is not studied in this paper, but as showed in Fig. 8, a pulse generator is required to generate a random bit stream and an oscilloscope is used to display the input and the output data streams. To compare the input data to the output, we use an experimental method called eye diagram. For a baud rate of 1200, we compare the input data to what is received. This method permits us to easily compare the received ones and zeros to the sent ones and zeros, by using the amplitude of the eye diagrams. The received eye width should match with the width of the send data to ensure that the bit period is maintained. The received bits affected by noise present a very high rise/fall time, and the presence of jitter in the system is also detected. The error rate in the system globally is detected by the eye closure. Fig. 11 and 12 are the eye diagrams representing the input data stream from the data source and from the end user receiver. In Fig. 11, we have perfect data coming in the system free of distortions, it represents the perfect ideal eye diagram. Fig. 12, 13 and 14 represent respectively three different situations where the bridge is used to relay transmission: As it happens, when the transmission is in the darkness, no others sources of light are present; when the fluorescent light is on but no interference from the sunlight and when the system is facing the fluorescent and the sunlight interference simultaneously. The sunlight penetrate the room through the windows (which is not quantified). A look at Fig. 14, the eye tends to close, indicating the huge rate of noise. It is important to mention that the impacts of the PLC noise is noticeable, but not on the amplitude of the received signal because the bridge demodulator rectifies the errors and produces new squares for the next channel. PLC noise is going to impact on the global throughput which is not studied in this paper. It is to notice that in Fig. 11, 12, 13 and 14, the width of the eyes is respectively the same, showing the bit period sender and receiver side.

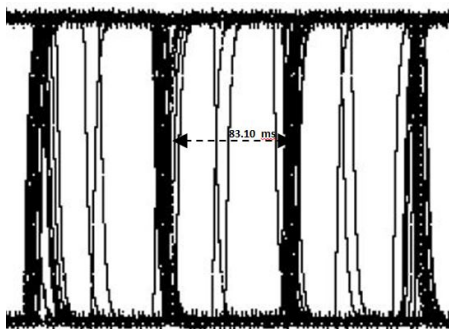

Fig. 12. Eye diagram of the VLC receiver output with fluorescent light off and window closed.

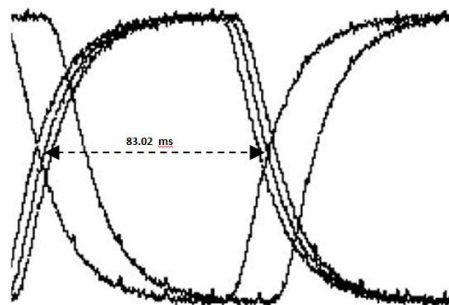

Fig. 13. Eye diagram of the VLC receiver output with fluorescent light on and window closed.

VI. CONCLUSION AND APPLICATIONS

A. Applications

The proposed interface between PLC channel and VLC channel finds its application in peer to peer communications, in any application where PLC and VLC can be combined for low data rate transmission. Near field communications is growing and proposes a solution for access control. Visible light communications is good solution of communication technology to be used in near field communications. The combined PLC-VLC system is then welcomed to reduce implementation cost. Many other applications are to be studied and presented.

B. Conclusion

This paper presented a SOCPBFSK-OOK bridge between power line communications channel and visible light commu-

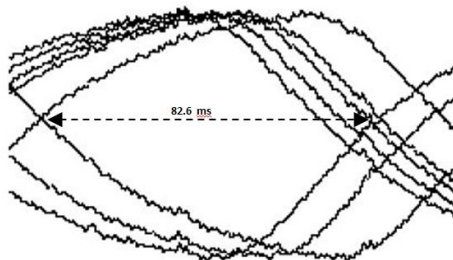

Fig. 14. Eye diagram of the VLC receiver output with fluorescent light off and window opened.

nications channel to relay low data rate transmission. It uses a spread orthogonal continuous phase binary shift keying and the on-off keying modulation techniques. Some characteristics of the interface were presented and the error rate is presented using eye diagrams.

REFERENCES

- [1] R. D. Roberts, S. Tajagopal, and Sang-Kyu Lim, "IEEE 802.15.7 Physical Layer Summary", 2nd IEEE workshop on Optical Wireless Communication, pp. 772-776, 5-9 Dec. 2011, Houston, TX, USA.
- [2] Qi Lu, Qingchongliu, Gregody S. Mitchell, "Performance Analysis for Optical Wireless Communication Systems Using Subcarrier PSK Intensity Modulation Through Turbulent Atmospheric Channel", IEEE Global Telecommunications Conference, vol. 3, pp. 1872-1875, 29 Nov.-03 dec. 2004.
- [3] A. J. Han Vinck and Jurger Haring, "Coding and Modulation for Power Line Communications", IEEE International Symposium on Power Line Communications and its Applications.
- [4] H. C. Ferreira, L. Lampe, J. Newbury, and Theo G. Swart, "Power Line Communications: Theory and Applications for Narrowbands and Broadband Communications over Power Lines", WILEY 2010.
- [5] RT. Scaub, "Spread Frequency Shift Keying", IEEE Transaction on communications. vol. 42, n0. 234, pp. 1056-1064, Feb./Mar./Apr. 1994.
- [6] T. Komine and M. Nakagawa, "Integrated System of White LED Visible Light Communications and Power Line Communications", IEEE Transaction on consumer Electronics, vol. 49, no. 1, pp. 71-79, Feb. 2003.
- [7] P. Amirshahi and M. Kaverhrad, "Broadband Access Over Medium and Low Voltage Power Lines and use of White Light Emitting Diodes for Indoor Communications" 3rd IEEE Conference on Consumer Communications and Networking (CCNC), vol. 2, pp. 897-901, 8-10 Jan. 2006.
- [8] Hao Ma, Lutz Lampe and Steve Hranilovic, "Integration of Indoor Visible Light and Power Line Communication Systems" 17th International Symposium on Power Line Communications and its Applications (ISPLC), pp. 291-296, 24-27 March 2003, Johannesburg, South Africa.
- [9] CENELEC, "Signaling on Low Voltage Installations in Frequency Range 3 kHz to 148.5 kHz-Part 1, General requirements, Frequency-bands and Electromagnetic Disturbance" IHS, CENELEC FPREN 50056-1, Sep 2010B. Boraboi, "Narrow Band Power Line Communication, Applications and Challenges" Ariane Controls Inc.
- [10] R. W. Lucky, J. Salz, and E. J. Weldon, "Principle of data Communications", McGraw-Hill 1968, pp. 203-208 and 242-246.
- [11] Richard D. Gitlin, Jeremiah F. Hayes, and Stephen B. Weinstein, "Data Communications Principle", 1992 Plenum Press, New York, pp. 357-371.
- [12] Il Han Kim, Anand Dabak, David Rieken and Gordon Gregg, "Evaluating the low-frequency power-line communications channel in rural North America", White Paper, TEXAS INSTRUMENT
- [13] Olaf G. Hooijen, and A.J.Han Vinck, "On the Channel Capacity of a European-style Residential Power Circuit" IEEE Communications letters, Vol. 2, n0 10, October 1998.
- [14] M. Biagi, T. Borogovac, and T. Little, "Adaptive Receiver for Indoor Visible Light Communications", J. Lightwave Technol. 31, 3676-3686 (2013).
- [15] H. Le Minh, D. C. OBrien, G. Faulkner, L. Zeng, K. Lee, D. Jung and Y. Oh, "100-Mbit/s NRZ Visible Light Communications Using a Post-Equalized White LED", IEEE Photonics Technology Letters, Vol.21, No.15, pp.1063-1065, 2009
- [16] M. Biagi, and A.M. Vegni, "Enabling High Data Rate VLC via MIMO-LEDs PPM", accepted to Proc. of 4th IEEE Globecom 2013 Workshop on Optical Wireless Communications (OWC), December 9, 2013, Atlanta GA, USA.
- [17] M. P. Sibanda, P. A. Janse van Rensburg, and Hendrik C. Ferreira, "Passive, Transformless Coupling Circuitry for Narrow-Band Power Line Communications" 13th International Symposium on Power Line Communications and its Applications (ISPLC), pp. 125-130, 29 March - 01 April 2009, Dresden, Germany.