

YOU DON'T HAVE TO LOVE IT

Exploring the mechanisms of exercise motivation using self-determination theory in a digital context

KARIN WEMAN JOSEFSSON

DEPARTMENT OF PSYCHOLOGY



UNIVERSITY OF
GOTHENBURG



Photo: Mikael Evard

Karin Weman Josefsson

Karin's personal relationship to exercise motivation started in the aftermaths of a traffic accident in the mid 90's when she was prescribed an early prototype of exercise on prescription* as a part of her rehabilitation process. Slowly discovering and internalizing the benefits and enjoyment of being physically active, exercise became a natural part of her daily life routines. Over a few years' time, Karin became increasingly involved in the local fitness club as a trained exercise instructor and member of the club board. This journey sparked a growing interest in exercise motivation and aspirations to facilitate similar experiences for others, and in 2001, at 25 years of age, she started her studies in sport and exercise psychology at Halmstad University. Shortly after finishing her Master's degree she started teaching exercise psychology and, in 2011, initiated part time PhD studies. Parallel to her doctoral studies, Karin has continued to teach and develop exercise psychology courses; she initiated an interdisciplinary research project on digital innovations for exercise and motivation [Project GoDIS] and has also authored course literature. Karin lives in Halmstad on the west coast of Sweden and in her leisure time she likes to exercise at the gym, take long runs, and go horseback riding. She also enjoys nice food and good laughs with family and friends.

** Today, physical activity on prescription (FaR®) is a renowned and regularly used method for preventive medicine in Swedish health care.*

ISBN: 978-91-628-9776-5 (print)

ISBN: 978-91-628-9777-2 (pdf)

ISRN GU/PSYK/AVH--336--SE

gupealänk <http://hdl.handle.net/2077/42217>

ISSN 1101-718X Avhandling/Göteborgs universitet, Psykologiska inst.

You don't have to love it

Exploring the mechanisms of exercise motivation using
self-determination theory in a digital context

Karin Weman Josefsson

You don't have to love it

Exploring the mechanisms of exercise motivation using
self-determination theory in a digital context

Karin Weman Josefsson

Department of Psychology



UNIVERSITY OF GOTHENBURG

Doctoral Dissertation in Psychology
Department of Psychology
University of Gothenburg
April 29 2016

© Karin Weman Josefsson Karin.Weman@hh.se
Cover illustration: Lee Partridge Studios
Printed by Ineko AB, Gothenburg, Sweden, 2016

ISBN: 978-91-628-9776-5 (print)
ISBN: 978-91-628-9777-2 (pdf)

ISSN: 1101-718X Avhandling/Göteborgs universitet, Psykologiska inst.
ISRN: GU/PSYK/AVH--336—SE

Electronic version of this thesis available at <http://hdl.handle.net/2077/42217>

*In loving memory of
Aira and Bertil*

Abstract

Most Western countries have developed guidelines and programs to inform and promote regular physical activity and exercise behaviours in order to gain desired health benefits for the population. Unfortunately, health statistics show that many people do not reach these recommended activity levels. Research has also demonstrated that approximately half of those who actually try fail to maintain regular exercise habits. Theoretical understanding of the mechanisms of motivation is of great importance for how to enhance the knowledge of how interventions promoting sustainable exercise motivation and behaviour can be designed. The overall aim of this thesis was to explore the motivational processes behind physical activity and exercise behaviours, with the self-determination theory as a guiding framework. Previous research and practice have generated ample knowledge of what works in exercise and physical activity promotion on a general level, but less is known about why it works, that is, the underlying mechanisms. Because interventions operate through mediating processes, the study of indirect effects and motivational mechanisms may forward mean level research and has the potential to provide knowledge of how observed intervention effects could be interpreted and understood. A key finding of this thesis was that analyses of Study I and IV showed patterns of need satisfaction, motivational regulations, and exercise differing across age and gender, indicating that motivational mechanisms could vary (qualitatively) in different subgroups. These findings support the idea that a generic method will not be successful in all situations and for all participants (i.e., one size does not fit all). Based on the results of Study II and IV, a second key finding is that the mediating mechanisms of the process model can be manipulated in an intervention by, for example, creating need-supportive environments facilitating internalization and subsequent exercise behaviour. In line with previous research, both Study I and II demonstrated identified regulation as playing a prominent role in the motivational processes, supporting the significance of internalizing the values behind a certain behaviour for the regulation of potentially challenging activities such as exercise. This is also why *you don't have to love it* as long as it suits your life routines and feels valuable to you. A third key finding is related to the findings of Study III, which provide preliminary support for the notions behind “motivational soup” by showing motivational profiles based on person-centred analyses. Finally, in Study IV, amotivation was involved in significant main (time) effects and also played an unexpected role in the motivational processes of younger adults.

Keywords: exercise, digital intervention, LGCM, mediation, RCT, self-determination theory.

Svensk populärvetenskaplig sammanfattning

De flesta människor vet att det är hälsosamt att röra på sig, men många som försökt att förändra sin livsstil vet att ibland är varken kunskap eller uppmuntran tillräckligt för att lyckas förändra ett beteende. Ofta räcker inte ens goda intentioner eller god vilja till. För många människor räcker inte heller tillgången till rabatterade träningskort, motion på recept, en träningskamrat eller glada tillrop från familj, vänner och kollegor. Dessutom tenderar vi att överskatta den ansträngning som krävs för att få effekter. Dessa höga förväntningar gör att många går ut alldeles för hårt, vilket kan ha negativ inverkan på motivationen eftersom det kan bli svårt att leva upp till kraven. Förväntningarna kan även påverka motivationen negativt genom att minska tilltron till den egna förmågan att lyckas, vilket gör att många kanske inte ens försöker. Dessutom har forskning under många år visat att hälften av dem som ändå börjar motionera slutar inom tre till sex månader. En av de största utmaningarna är därmed inte bara att stimulera människor att bli mer fysiskt aktiva, utan även att skapa hållbara beteendeförändringar som människor förmår upprätthålla över tid.

Motivation är drivkraften bakom allt vi gör eller inte gör en given dag, det gäller stordåd likväl som till synes obetydliga handlingar. Det är därför en klok strategi att fokusera på att påverka människors motivation när man designar interventioner, policyer och program för att främja hälsobeteenden som fysisk aktivitet och motion, istället för att enbart fokusera på själva beteendet som ett slutmål. Det har visat sig vara viktigt att särskilja motivationens kvantitet och kvalitet, dvs. inte bara värdera motivation utifrån frågan *hur mycket* utan även ställa frågan *varför* någon är motiverad (eller inte) för att förstå vilka faktorer som påverkar beteendet. Självbestämmandeteorin är en motivationsteori med fokus på motivationens kvalitet som de senaste decennierna har nått en framstående position i såväl forskning som tillämpning. Teorin är en organismisk teori, vilket innebär att den har sin grund i ett antal antaganden om hur människor fungerar, bland annat att människor antas vara proaktiva och naturligt nyfikna problemlösare med en benägenhet att vilja påverka sin omgivning. Teorin bygger på kognitiv och humanistisk teoribildning, dvs. att människor varken är passiva eller automatiska till sin natur utan att självmedvetenheten (*självet*) har betydelse för deras handlingar. Grundantagandet i självbestämmandeteorin är i linje med andra humanistiska och klientcentrerade perspektiv som adresserar frågan om hur man på bästa sätt kan engagera en människas självmedvetenhet (t ex Rogeriansk terapi). Självmedvetenhet är viktigt för att planera och sätta upp mål och för att motivera beteenden över tid, särskilt sådana beteenden som kanske inte är tilltalande i sig själva men som har en

adaptiv funktion. Genom att betona människans medfödda tendens att vilja styra sitt eget liv åskådliggör självbestämmandeteorin även begrepp som fri vilja och självreglering och kan därmed fungera som en brygga mellan experimentell psykologi och nutidens populära självhjälpböcker. Ur det perspektivet bygger självförverkligande på idén att endast en gynnsam atmosfär står emellan oss och vår potential att växa och utvecklas. Detta skiljer sig från traditionella förhållningssätt där en ojämlig rollrelation mellan givare (t ex läkare, coach, lärare) och mottagare (t ex patient, klient, elev) präglas av auktoritet och där mottagarens självförverkligande och personliga utveckling sällan tas tillvara.

Tendensen att vilja påverka sin omgivning och klara av att hantera uppgifter definieras inom självbestämmandeteorin som ett grundläggande psykologiskt behov att känna sig kompetent, trygg och effektiv i de situationer man möter. Vidare relaterar människor inte bara till sig själva utan försöker även integrera självet med den sociala omgivningen i kontakten med andra människor. Att människor har ett djupt rotat behov av att känna kontakt och gemenskap med andra människor definieras i självbestämmandeteorin som ett grundläggande psykologiskt behov av tillhörighet. Ett tredje grundläggande psykologiskt behov handlar om att själv kunna reglera sitt beteende, dvs. att kunna välja och ha kontroll över vad man gör. Detta definieras som behovet av autonomi. Motsatsen till autonomi är att känna sig kontrollerad av sin omgivning, t ex för att få en belöning eller för att undvika negativa konsekvenser. Mellan dessa ytterligheter rymms allt ifrån att följa sina innersta värderingar till att styras av yttre tvång och övertalning eller inre tvång och dåligt samvete. Enligt självbestämmandeteorin är de tre grundläggande psykologiska behoven nödvändiga för att förstå vad målet innehåller och varför människor eftersträvar ett givet mål. Olika beteenden kan dessutom styras av olika drivkrafter/regleringar samtidigt (den s.k. *motivationssoppan*). Detta beror bland annat på att människor har flera olika "själv" som samexisterar och som kan ha helt skilda mål och självuppfattning, vilket innebär att de kan konkurrera med varandra och variera i betydelse i olika situationer. För att förklara hur dessa drivkrafter påverkar motivationen bakom val och prioriteringar erbjuder självbestämmandeteorin en nyanserad bild av motivationens regleringar (dvs. motivations kvalitet) genom att illustrera i vilken utsträckning de har integrerats i personens självuppfattning. Denna centrala process kallas för internalisering. Beteenden som är fullt internaliserade upplevs som självreglerade och motivationen är då i hög grad självbestämmande, vilket kan relateras till begreppet inre motivation. Beteenden som drivs av inre motivation grundas i tillfredsställelse av de grundläggande psykologiska behoven och känslan av självbestämmande. Dessa beteenden upplevs som

intressanta i sig själva och kräver ingen separat förstärkning. Yttre motivation är däremot beroende av olika former av förstärkning (t ex belöningar, bestraffningar, social bekräftelse, självkänsla, skam, skuld osv) och anses vara kontrollerande eftersom den bara fungerar som en drivkraft så länge förstärkningen är närvarande. Amotivation är en form av "icke-reglering" som står i kontrast till både inre och yttre motivation eftersom den inte bara saknar båda typerna av reglering utan även saknar självbestämmande och upplevd kompetens. Amotiverade personer känner inte att de kan påverka eller kontrollera situationen, känner inte att beteendet kommer bidra med något och ser ingen mening med att delta i aktiviteten (det finns därmed tydliga paralleller mellan amotivation och det så kallade *förnekelsestadiet* i den transteoretiska modellen för beteendeförändring, även kallad stegbaserad teori). Amotivation både grundas i och förstärker effekten av underminerad behovstillfredsställelse, dvs. brist på autonomi, kompetens och/eller tillhörighet. Amotiverade personer är ofta svåra att nå med kampanjer eller interventioner eftersom de av naturliga skäl sällan söker sig till hälsofrämjande aktiviteter och kan vara obenägna att ta till sig den typen av information.

Den digitala världen har inneburit ett närmast revolutionerande skifte i hur människor kommunicerar och inhämtar information. Människor har numera betydligt större egenmakt genom en nästintill obegränsad tillgång till information, service och sociala nätverk som dessutom varken är begränsade av tid eller plats på samma sätt som tidigare. Dessa förändringar har även skapat en ny arena för hälso- och sjukvården och nya möjligheter för människor att kunna vara delaktiga i densamma. Samtidigt blir många tjänster i samhället också alltmer rationaliserade, speciellt inom de områden som innebär fysiska möten (inte minst vårdsektorn) och här finns sedan länge ett behov av att hushålla med knappa resurser och finna kostnadseffektiva lösningar. Ett fält som växt fram i takt med dessa omständigheter är olika digitala lösningar, så kallad e-hälsa. Dagens digitala teknologi innebär lovande möjligheter att skapa nya modeller som kan ha en betydande inverkan på folkhälsan. En sådan modell är att människan (klienten, patienten) har en central roll och får möjlighet att själv definiera och forma sjuk- frisk- och egenvård utifrån sina behov och förutsättningar, istället för tvärtom. Digital teknologi ger även möjlighet till annan samordning av hälso- och sjukvården, inte minst genom att avlasta hårt pressad personal. Personlig rådgivning för att främja fysisk aktivitet och motion är ofta en kostsam lösning och e-hälsa erbjuder inte bara kostnadseffektiva alternativ, utan även andra fördelar som standardisering och bättre möjligheter att utvärdera effekterna samt möjlighet att nå ett stort antal personer. Det behövs därmed mer kunskap och förståelse kring hur olika verktyg och tjänster ska utformas,

kombineras och koordineras, samt hur klyftan mellan specialister inom de olika kunskapsfälten (t ex informationsteknologi och beteendevetenskap) kan överbryggas genom samproduktion och samarbete mellan discipliner. Framförallt behövs en ökad kunskap om de psykologiska och sociala processer som kan förklara varför en lösning fungerar eller inte. Betydelsen av att basera hälsointerventioner i adekvata teoretiska modeller framhålls i internationell forskning som en viktig framgångsfaktor och är speciellt relevant för e-hälsa eftersom det ofta innebär ett komplext upplägg med avancerade interaktioner mellan mottagaren och det aktuella systemet. Eftersom interventioner verkar genom *medierande processer* (dvs. effekten av variabel på en annan går via en tredje variabel) är studiet av dessa indirekta effekter och motivationens mekanismer ett naturligt steg för att avancera och utveckla tidigare forskning genom att bidra med kunskap om hur interventionseffekter kan tolkas och förstås – det vill säga inte bara vad som fungerar, utan även hur, för vem och varför.

Det övergripande syftet med den här avhandlingen var därför att utforska bakomliggande motivationsprocesser till fysisk aktivitet och motion baserat på självbestämmandeteorin för att därigenom kunna bidra med praktiska råd för hur sådan kunskap kan främja hållbara motionsvanor, även i digitala kontexter. Ett antal fynd kan framhållas som särskilt intressanta. För det första visade resultaten i Studie I att mönstren för sambanden mellan de grundläggande psykologiska behoven, motivationsregleringar och motionsbeteende skilde sig åt i olika åldrar och mellan könen, vilket indikerar att motivationsmekanismerna kan variera (kvalitativt) i olika grupper. Detta kan kanske anses föga förvånande, men det är förhållandevis få studier som undersökt detta med adekvata analysmetoder och det har därför hittills funnits relativt svaga bevis för sådana antaganden. Resultaten ger därmed stöd åt tanken att det inte finns någon universalmetod som är effektiv för alla människor i alla situationer utan att insatser bör anpassas till olika målgrupper. För det andra visar resultaten i Studierna II och IV att de medierande mekanismerna i självbestämmandeteorin kan manipuleras genom interventioner, t ex genom att skapa autonomistödande miljöer som främjar internalisering, vilket i sin tur kan påverka motionsbeteende i termer av mängd och intensitet. För det tredje visar både Studie I och Studie II att motivationens kvalitet spelar en framträdande roll i motivationsprocessen, vilket är i linje med teoretiska förväntningar och tidigare forskning och understryker betydelsen av att internalisera det bakomliggande värdet av beteendet för att reglera motionsbeteenden. Detta är anledningen till varför man inte behöver älska ett beteende för att ägna sig åt det (*you don't have to love it*) så länge det känns meningsfullt. För det fjärde visar Studie III preliminärt stöd för idén bakom motivationssoppan genom att identifiera

olika typer av motivationsprofiler, vilka i sin tur kan kopplas till motionsbeteende. Dessa resultat kan bidra med värdefull kunskap om hur motivationens kvalitet kan samspela och variera både inom och mellan personer. Slutligen visade Studie IV att den digitala interventionen minskade graden av amotivation och att denna minskning i sin tur hade en positiv inverkan på motionsbeteendet. Studie IV visade även att den digitala interventionen hade bäst effekt på de deltagare som hade låga värden på självbestämmande motivation och de som ägnade sig främst åt motionsaktiviteter med låg intensitet vid starten, vilket indikerar att den verkar ha haft bäst effekt på dem som behövde det som mest.

Studie IV genomfördes som ett fristående forskningsprojekt (GoDIS: Go Digital Innovations in Self-determined exercise motivation) som skapades i syfte att utveckla ny kunskap om hur hållbara motionsvanor kan främjas med hjälp av professionellt utformade, vetenskapligt förankrade och kostadseffektiva digitala verktyg. Projektet är ett svar på Forskningspropositionens (2012-2016) uppmaning till samverkansprojekt som möter samhällsutmaningarna inom hälsopromotion genom effektiva förebyggande och hälsofrämjande metoder som kan bidra till att stimulera människor att engagera sig i sin egen hälsa. Nyckeln i GoDIS är ett tydligt fokus på de motivationsteoretiska fundament som utgörs av självbestämmandeteorin. För att skapa goda förutsättningar för att de digitala lösningarna i projektet ska generera hälsofrämjande effekter och främja hållbara motionsbeteenden är projektet tvärvetenskapligt och syftar därmed till att utveckla ett interaktivt verktyg baserat på adekvat beteendeforskning i kombination med informationsteknologisk och innovationsvetenskaplig forskningsexpertis med utgångspunkt i användarvänlighet och behoven inom e-hälsoindustrin.

Förutom arenor som exempelvis företagshälsovård, hälsorådgivning, gymverksamhet och skolämnet Idrott & Hälsa är vård och omsorg ett potentiellt implikationsområde för resultaten i denna avhandling, inte minst med anledning av intresseorganisationen Sveriges kommuner och landstings (SKL) beslut att verka nationellt för den personcentrerade vården. Värdegrunden i självbestämmandeteorin har många gemensamma nämnare med filosofin bakom personcentrerad vård (dvs. personalismen). Bland annat är personens subjektiva upplevelser centrala i båda perspektiven, personen betraktas som en aktiv, tänkande och kapabel resurs och delaktighet i planering, diskussioner, problemlösning och beslutsfattande uppmuntras i båda perspektiven. Personcentrerad vård kännetecknas av relationer (i motsats till patient- eller individperspektivet) vilket motsvaras av begreppet autonomistöd i självbestämmandeteorin, och som illustrerar omgivningens betydelse för självbestämmande och välbefinnande. Autonomibegreppet ska inte förväxlas med individbaserad självständighet eller oberoende, utan

kopplas till relationen mellan personen och den omgivande sociala miljön och kan även förstås utifrån de engelska begreppen *volition* och *interest* som är centrala i personcentrerad vård. Eftersom autonomistöd kan förväntas främja personcentrering och vice versa finns det goda skäl att integrera principerna för autonomistöd i den praktiska tillämpningen av personcentrerad vård. En synergi mellan dessa båda ansatser skulle inte bara kunna vara gynnsamt för forskningen utan även för tillämpat arbete genom att utbilda vårdpersonal med förskrivningsrätt i autonomistödjande metodik och förhållningssätt, till exempel inom ramen för fysisk aktivitet på recept (Far®). Inom forskningen skulle självbestämmandeteorin kunna bidra med förklaringsmodeller för vilka mekanismer som är verksamma i de effekter som observerats inom personcentrerad vård och därmed öka förståelsen för vad som fungerar, hur, varför och för vem (se Weman Josefsson, 2016 för en mer utförlig diskussion).

Som avslutning kan det vara på sin plats med några praktiska tips. Du som jobbar med människor kan försöka tillämpa en värdegrund som bygger på att människor kan bli självreglerande och inte behöver luras eller tvingas att ta hand om sin hälsa. Undvik tvingande och skuldbeläggande ord som *måste* och *borde* i samtalet, prata istället om vad som känns meningsfullt och genomförbart för den personen. Försök även att basera ditt arbetssätt i adekvat teoribildning, det kommer inte bara förenkla och systematisera själva arbetet utan även uppföljning och utvärdering. Du som själv vill bli mer fysiskt aktiv rekommenderar jag att börja med små förändringar i vardagen som känns enkla att ta till sig och som du orkar genomföra regelbundet över tid istället för att kasta dig in i ”ditt nya liv” med ambitiöst träningschema, förbud och måsten. Försök hitta någon aktivitet som känns genomförbar och gärna något som känns roligt, men du behöver inte älska det för att lyckas. Gör det som känns meningsfullt och som funkar för dig i din vardag så ökar chansen att det en vacker dag kommer kännas så bra att det känns naturligt och går av sig själv. Glöm inte att förlåta dig själv om det inte blir som du har tänkt, det är naturligt att tappa sugen ibland och det spelar ju ingen större roll i ett livslångt perspektiv så länge du tar upp tråden igen. Oregelbundna motionsvanor är bättre än inga alls.

List of papers

This thesis consists of a summary and the following four papers, which are referred to by their roman numerals:

- I Weman-Josefsson, A. K., Lindwall, M., & Ivarsson, A. (2015). Psychological need satisfaction, motivational regulations and exercise. Moderation and mediation effects. *International Journal of Behavioral Nutrition and Physical Activity*. 12:67 doi:10.1186/s12966-015-0226-0
- II Weman-Josefsson, K., Fröberg, K., Karlsson, S., & Lindwall, M. (2015). Mechanisms in self-determined exercise motivation: Effects of a theory informed pilot intervention. *Current Psychology*, 1-11. doi: 10.1007/s12144-015-9388-9
- III Lindwall, M., Weman-Josefsson, K., Jonsson, L., Ivarsson, A., Ntoumanis, N., Patrick, H., Thøgersen-Ntoumani, C., Markland, D (2015). Stirring in the motivational soup: Within-person latent profiles of motivation in exercise. Submitted manuscript.
- IV Weman-Josefsson, A. K., Johnson, U. & Lindwall, M. Zooming in on the effects: A randomized controlled trial on motivation and exercise behaviour in a digital context. Submitted manuscript.

Contents

Introduction	1
Theoretical perspectives on exercise motivation	4
Self-determination theory (SDT)	5
Organismic integration theory (OIT)	6
Basic needs theory (BNT)	10
The SDT process model	13
Mediation and moderation	14
SDT applications and interventions	17
Combining SDT with other theories and methods	18
Digital interventions	20
Summary	25
Purpose	27
Methods	29
Participants	29
Study I	29
Study II	29
Study III	29
Study IV	30
Measures	30
Psychological need satisfaction	30
Behavioural regulations	30
Self-reported exercise	31
Procedure	32
Study I and Study III	32
Study II	32
Intervention Study II	33
Study IV	34
Intervention Study IV	35
Data analyses	37
Study I	37
Study II and IV	37
Study III	38
Results	41
Study I	41
Study II	42
Post-intervention differences	42
Mediating effects	43
Study III	43
Best-fitting profile solution in Sample A	43
Best-fitting profile solution in Sample B	44

Profile relations to needs, motivation and exercise behavior	45
Study IV	46
Post-intervention differences between groups	46
Mediation (indirect) effects	46
Moderating effects of the intervention.....	47
Moderating effects of gender on exercise	48
Moderating effects of age on exercise	48
Discussion	51
Psychological needs and behavioural regulations	53
Psychological needs, behavioural regulations and exercise behaviour	56
Moderating effects of gender and age.....	59
Gender as a moderator	59
Age as a moderator	60
Intervention effects	63
General effects.....	63
Intervention design	64
Moderating and mediating effects	66
The digital intervention context.....	68
Motivational soup	71
From theory to practice.....	73
Enhancing self-determined exercise motivation	75
Practical implications and future directions.....	79
Strengths and limitations	83
Study I	83
Study II.....	84
Study III.....	84
Study IV	85
Conclusions & contributions.....	86
References	91

Figures and tables

Figure 1 Continuum of self-determination	7
Figure 2. The SDT process model.....	14
Figure 3. Basic mediation model outline.....	15
Figure 4. A model for effects of e-health	24
Figure 5. Intervention design Study II.....	33
Figure 6. Intervention design Study IV	35
Figure 7. Indirect effects of behavioral regulations.....	42
Figure 8. Motivational profiles in best fitting model (6 profiles) in Sample A	44
Figure 9. Motivational profiles in best fitting model (6 profiles) in Sample B	45
Figure 10. Indirect effects of the intervention between T2 and T3	47
Table 1. Design overview.....	39
Table 2. Thesis overview.....	88

Abbreviations

AMA	American medical association
ACSM	American college of sports medicine
ANCOVA	Analyses of covariance
BLRT	Bootstrapped likelihood ratio test
BNT	Basic needs theory
BPNES	Basic psychological needs in exercise scale
BREQ-2	Behavioural regulations in exercise questionnaire-2
CBT	Cognitive behavioural therapy
CHES	Comprehensive health enhancement support system
CFI	Bentler comparative fit index
CI	Confidence interval
CONSORT	Consolidated standards of reporting trials
DALY	Disability adjusted life years
FIML	Full information maximum likelihood
HCI	Human-computer interaction
IL	Intervention leader
IPAQ	International physical activity questionnaire
LGCM	Latent growth curve model
LPA	Latent profile analysis
LTEQ	Leisure time exercise questionnaire
LMR	Lo-Mendell-Rubin likelihood test
MET	Metabolic equivalent of exercise
MI	Motivational interviewing
MLR	Robust maximum likelihood
MVA	Mediating variable analysis
OIT	Organismic integration theory
PNSE	Psychological needs in exercise scale
RAI	Relative autonomy index
RCT	Randomized controlled trial
RMSEA	Root mean square error of approximation
RPM	Relapse prevention model
SBU	The Swedish council on medical assessment
SEM	Structural equation modelling
SPSS	Statistical package for social sciences
SDT	Self-determination theory
TAI	Treated as intended
TTM	Transtheoretical model of behaviour change
WHO	World health organization
YFA	Professional associations for physical activity, Sweden

You don't have to love it

Acknowledgements

I am deeply grateful for all the generous and kind support I have received in completing this task. This includes past and present teachers, fellow students and colleagues, university staff, reviewers, supporters, friends, family, and all the kind people participating in my studies. Although only a few of you can be mentioned here, I pledge my sincere appreciation to one and all who, in any way have contributed to my endeavour.

I wish to thank Professor Magnus Lindwall for the excellent supervision during the whole process; your great experience and knowledge, combined with an immovable calm, sharp sense of humour and autonomy-supportive approach have been invaluable. Thanks also to my co-supervisor, Boo Johansson, for your unruffled and professional answers to all my questions along the way.

My deepest thanks go to my colleagues at Halmstad University. Being part of such a supportive environment is truly a blessing. I would especially like to thank Andreas Ivarsson, Alina Frank, Linette Thörnqvist and Rasmus Tornberg for chatting, fika and pranking. Special thanks also goes to Professor Urban Johnson for welcoming me into the academic world and supporting my ideas to become real projects, and to Professor Natalia Stambulova for being a great role model and sharing your wisdom. I also like to thank Anders Nelson and Mattias Nilsson for supporting me in the challenge of having dual employments during PhD studies.

I would like to thank my Tasmanian friends, Jeffrey Armstrong and Mark Andersen, for excellent (and sometimes hilarious) proofreading services. Thanks also to Ann Backlund at University of Gothenburg for superhuman support in PhD administration.

I also want to acknowledge the SDT community and all the interesting and nice encounters with professionals within this field. Special thanks to Professors Edward Deci and Richard Ryan for your devoted work on Self-determination theory, thereby providing the world with an appealing way to understand human motivation, to Professor Geoffrey Williams for taking time to meet me when visiting Stockholm and for all your kind and generous advice, to Professor Michelle Fortier for reviewing this manuscript, and of course, many thanks to Professor Pedro Teixeira for honouring me by coming to Sweden and chat about my thesis.

This task could not have been done without financial support and I am sincerely grateful to the Centre for Person-Centred Care and the Department of Psychology at the University of Gothenburg, Halmstad University and Health Technology Centre Halland, the European Regional Development Fund and the Knowledge Foundation. Special thanks also go to Tappa Service and the HPI Health Profile Institute for believing in, and financially supporting, the GoDIS project, and to Mats Olsson at Kairos Future for helping me raise the bets and aim higher.

From the bottom of my heart, I would like to give my warmest thanks to my family and dear friends for giving me constant encouragement, love, and understanding. I am especially thankful for the loving support from my handsome, clever, amusing and caring husband, Rickard Weman. A very special thanks also goes to all of you who sparked my exercise motivation a long time ago, I think you know who you are. Finally, I am deeply grateful for my power of will and the forces of motivation that got me all this way.

Karin Weman Josefsson
Halmstad 2016

Introduction

A considerable number of publications, such as the European Health Reports (World Health Organization (WHO), 2009a, 2013) and Physical Activity in the Prevention and Treatment of Disease (YFA, 2010), confirm the beneficial effects of physical activity and exercise. Also, there are many warnings about the risks of physical inactivity and sedentary behaviour. According to the WHO (2009b, 2010), physical inactivity constitutes the fourth leading risk factor for global mortality and risk factors for burden of disease, equivalent even to smoking (Lee et al., 2012). Although the differentiation between physical activity and exercise is important in research, both concepts could be addressed simultaneously (but not interchangeably) in terms of active behaviours (as will be the case in this thesis). It is, on the other hand, more important to differentiate between a sedentary lifestyle (e.g., a sedentary job situation and/or leisure time) and physical inactivity or non-exercise, as they are considered to be two separate behaviours. Recent research shows that a sedentary lifestyle increases the risks of premature death and a number of common diseases regardless of exercise level (Healy et al., 2012; Katzmarzyk, 2010), suggesting a need for public health strategies aimed at increasing physical activity and exercise levels and at reducing sitting time (Ekblom-Bak, Hellenius, & Ekblom, 2010). Current health recommendations for physical activity levels are to be physically active at a moderate intensity for at least 30 minutes five days a week, or to work out at a higher intensity for a minimum of 20 minutes, three times a week (Haskell et al., 2007). According to Haskell and colleagues, due to the dose-response relationship between physical activity and health, exceeding the minimum recommendations will increase fitness and health benefits. It is essential to study how sustainable and cost-effective physical activity-promoting interventions could be fashioned (WHO, 2009b) and already ten years ago, WHO stated that two million deaths and 20 million DALYs (disability adjusted life years) could be prevented globally through interventions successfully promoting a more physically active lifestyle in the population (Bull et al., 2004). Physical inactivity entails societal costs (Kohl et al., 2012; Bolin & Lindgren, 2005), therefore, besides potential health economy benefits, there are significant benefits for well-being, quality of life and perceived health status (Elley, Kerse, Arrol, & Robinson, 2003; Vuillemin et al., 2005). For instance, physical activity could be used to prevent and treat diseases such as metabolic syndrome (Carroll & Dudfield, 2004), coronary heart disease, obesity, diabetes, and insulin resistance (Frank et al., 2005; YFA, 2010) and depression (Josefsson, Lindwall, & Archer,

2013; Mammen & Faulkner, 2013; Rimer et al., 2012). Further, physical activity has been shown to increase our ability to cope with stress (Georgiades et al., 2000; Traustadottir, Bosch, & Matt, 2005), to have an “anti-ageing effect” on our cell structure by lengthening the protecting telomeres (Cherkas et al., 2008) and even, according to experiments on mice, to potentially influence neurogenesis in the brain (Brene et al., 2007; Onksen, Briand, Galante, Pack, & Blendy, 2012).

Despite all these recognized benefits, humans have probably never been as sedentary as we are today. According to the World Health Organization (2011), approximately 44% of Swedish citizens were insufficiently physically active in 2008, which is fairly comparable to other Western countries (Hallal et al., 2012). Furthermore, these reports should be interpreted with caution because they are based on self-reports; studies using more reliable objective measures indicate self-reports to be overestimated (Hagströmer, Oja & Sjöström, 2007) and that the correct numbers might even be as low as 7% (Ekblom-Bak et al., 2015). The reasons why so many people (at least in Western societies) do not regularly engage in physical activity and exercise behaviours are undeniably complex. Considering human nature and ecological conditions, modern humans are not typically exposed to the physical demands they are genetically designed to manage. Due to escalating technical development, most people are no longer forced into daily physical exertion for survival. The *palaeolithic rhythm* coded in human genes (Booth, Chakravarthy, Gordon, & Spangenburg, 2002) means that in the same way people are programmed to use their bodies to hunt for and gather food, they are also programmed to rest when possible to save energy (Åstrand, 1992). This is a highly adaptable human instinct when living under hunter-gatherer conditions (i.e., the conditions during approximately 99.9% of human history), but during the past century muscle power has become virtually unnecessary through uncountable clever inventions of machines and instruments, diminishing physical activity in our working lives (robots, computers, transports, communication), our homes (vacuum cleaners, dishwashers, lawnmowers) and our leisure-time activities (TV, smartphones, video games). Thanks to all these time- and effort-saving gadgets it is possible for most people to almost completely avoid physical exertion. This means that people often have to make an active choice to be physically active outside the demands and societal expectations of their daily lives (e.g., using hidden stairs instead of escalators). In addition, personal beliefs, values and priorities engender different inclinations to engage in physical activity behaviours, and personal, environmental, psychological, social and cultural factors interact and affect behavioural regulations. To understand multifaceted behaviours such as physical activity and exercise, multiple and

interacting mechanisms need to be examined (Nigg & Geller, 2012; Spence & Lee, 2003; Bauman et al., 2012).

In spite of the amount and variety of health information available today, apparently many people do not lead as healthy lives as they could, or sometimes, would even like to. Generally, people are most likely aware that regular physical activity and exercise are beneficial from a health perspective, but apparently this knowledge is not enough to incorporate the behaviour into their daily lifestyle routines. Furthermore, studies clearly support beneficial effects on health and quality of life from getting physical activity on prescription (PaP) in Sweden (e.g., Olsson et al., 2015), but approximately 50% of those who get PaP fail to increase their activity level (Kallings et al., 2009; Leijon, Bendtsen, Nilsen, Festin, & Stahle, 2009). To support this, exercise research during the past 30 years has steadily shown that as much as 50% of exercise initiators drop out within three to six months (Buckworth, Dishman, & Tomporowski, 2013; Lox, Martin Ginis, & Petruzzello, 2010; Nigg, Borelli, Maddock, & Dishman, 2008). Even knowledge, good intentions and initiated behaviour changes seem to be insufficient for people to adhere to exercise and physical activity behaviours. Consequently, adherence is a considerable challenge in promoting exercise (Patrick & Canavello, 2011; Portnoy, Scott-Sheldon, Johnson, & Carey, 2008).

In conclusion, involvement in physical activity and exercise behaviour is multifaceted, and it seems overwhelming to take into account all the plausible factors suggested by the theoretical models (e.g., Spence & Lee, 2003). One interesting way to narrow the understanding of human behaviour and “why we do what we do” would be to use a motivational perspective (Deci & Flaste, 1996). An established definition of motivation is “...the internal and/or external forces that produce the initiation, direction, intensity, and persistence of behaviour” (Vallerand, 2004 p. 428). Because adherence is closely related to motivational aspects, it is important to understand exercise motivation and its relationship to adherence in order to construct effective interventions and methods promoting sustainable exercise behaviours. Most of the diseases involved in early mortality are related to lifestyle factors; adding adherence to only one of the five health recommendations for smoking, alcohol intake, physical activity, waist circumference or diet will have a considerable protective effect on mortality risk (Petersen et al., 2015). Lack of adherence in a large proportion of the population is most likely an indication that society has not managed to convey information in a way that people could internalize, which is, in turn, probably due to a lack of understanding of how human motivation operates (Sheldon, Williams, & Joiner, 2003). For that reason, the overall aim of this thesis is to adopt a motivational perspective enhancing the understanding of the psychological

processes behind exercise behaviours for the promotion of behaviour change, adherence, and maintenance.

Theoretical perspectives on exercise motivation

Motivation has been one of the most popular research topics for more than a century, and it would be sensible to start by narrowing the focus to exercise-specific theories of motivation. Biddle and Mutrie (2008) made a simple classification for theories of exercise behaviour, differentiating between *competence-based* (e.g., self-efficacy theory), *stage-based* (e.g., transtheoretical model of behaviour change) and *control-based* (e.g., self-determination theory) frameworks. There are numerous ways of defining theory foundations, but regardless of how frameworks are categorized, they should not be viewed as antagonists but, rather, as complementary efforts to understand and predict exercise behaviour. When behaviour change is the aim, a polytheoretical approach could improve the predictive value and facilitate the effectiveness of interventions (Baranowski, Anderson, & Carmack, 1998). Theoretical usage could be advanced by combining different theoretical approaches or models (Ntoumanis, 2012; Sallis et al., 2008).

Basing interventions on sound theoretical foundations to stimulate behaviour change and enhance physical activity and exercise motivation is strongly advocated (e.g., Biddle, Brehm, Verheijden, & Hopman-Rock, 2012; Fortier, Duda, Guérin, & Teixeira, 2012; Nigg & Geller, 2012). In a Swedish literature review, it was proposed that theory-based interventions have the potential to increase physical activity by 10-15% compared with standard care (SBU, 2007; see also Biddle, Mutrie, Gorely, & Blamey, 2012). Theory-based work enables a deeper analysis of the underlying processes, providing a more profound understanding of why some behaviour changes are successful and some are not. It also generates structure, content and adequate evaluation systems for the intervention and enables the identification and classification of contributing factors (Bauman, Sallis, Dzewaltowski, & Owen, 2002; Bauman et al., 2012; Cerin & Mackinnon, 2009). These aspects are important for face-to-face programs, and in other settings such as how tools and services in e-health are designed, placing high demands on the ability to apply theory to practice. Theory could be helpful in tailoring personalized programs, tools, and services in interventions by identifying stages of change (transtheoretical model of behaviour change/stages of change, Prochaska, DiClemente, & Norcross, 1992; Prochaska & Velicer, 1997), managing barriers and drop-out (relapse prevention model, Larimer, Palmer, & Marlatt, 1999; Marlatt & Gordon, 1985), promoting perceived ability (self-efficacy theory, Bandura, 1977; 1986; Bandura, 1997), or

facilitating motivational climate and autonomy support (self-determination theory, Deci & Ryan, 1985; Deci & Ryan, 2000; Deci & Ryan, 2012; Ryan & Deci, 2002 and motivational interviewing, Miller & Rollnick, 2002; Miller & Rollnick, 2012). This thesis will be focused primarily on theory and method concerning motivational climate and autonomy support.

Self-determination theory (SDT)

SDT (Deci & Ryan, 1985; Deci & Ryan, 2000; Ryan & Deci, 2002) is a multidimensional theory grounded in both cognitive and humanistic psychology. From a SDT perspective, humans are neither passive nor automatic, and our self (personhood) plays a significant role in our actions (Sheldon et al., 2003). In that way, SDT is in line with modern philosophy (e.g., personalism, see Smith, 2010) and other humanistic and client-centred perspectives focusing on how to engage the human self (e.g., Rogerian therapy, see Casemore, 2011). Self-awareness has several important functions (e.g., goal setting and planning) (Sheldon, Elliot, & Kasser, 2001), but is most important for motivating behaviours that are not enjoyable in themselves, but have adaptive functions, such as many health behaviours (Deci & Ryan, 2000). The emphasis of SDT is on social context and its ability to facilitate or thwart optimal motivation, and on the extent to which behaviours are generally self-determined or controlled in nature, capturing both situational and personality-related aspects of motivation. In recent decades, SDT has reached a prominent position and is a popular framework in both research (Lindahl, Stenling, Colliander, & Lindwall, 2014) and practice (Cheon, Reeve, & Moon, 2012; Fortier et al., 2012; Ng et al., 2012). SDT is an organismic theory founded on a number of assumptions about human functioning. Humans are, for example, proposed to have a natural tendency to explore and master their environment (Ryan & Deci, 2002). This innate (or intrinsic) drive motivating behaviour is contrary to behaviouristic motivation perspectives which build on the claim that drives are governed by external factors. Intrinsically motivated behaviours are volitional and spontaneous, concurring with our inner interests (i.e., not for achieving separate consequences), and hence represent the prototype for self-determined behaviours (Deci, 1975).

Deci and Ryan (2000) highlight the distinction between goal content (*what*) and the regulation processes by which goals are pursued (*why*), arguing that motivation quality has a significant impact on human behaviour. This “Copernican turn in motivational thinking” (Deci & Ryan, 2013) represents a paradigm shift from traditional views of motivated behaviour. The quantity of motivation a person has regarding a certain behaviour can be linked to social-cognitive theories such as self-efficacy theory (Bandura,

1986; Bandura, 1997) or the concept of intention (see e.g., Hagger, Chatzisarantis, & Biddle, 2002; Webb & Sheeran, 2006), representing motivation magnitude or level. The quality of motivation concerns different types of motivation. According to SDT, specific types of motivation generate different consequences (e.g., relation to health and well-being) regardless of motivation quantity (Deci & Ryan, 2000). Consequently, the main focus in SDT is on the quality of motivation in different situations and how the environment could stimulate or hamper the above-mentioned innate behavioural drive towards certain activities. For example, if the environment is perceived as hindering and/or controlling, natural engagement is assumed to deteriorate (Deci & Ryan, 2000). By also focusing on how motivation can be thwarted, SDT provides a broad range of questions related to many health behaviours (Sheldon et al., 2003). The theoretical framework of SDT contains a number of sub-theories that share the same philosophical foundations (Ryan & Deci, 2002) and in this thesis two of them will be regarded – organismic integration theory and basic needs theory.

Organismic integration theory (OIT)

An essential ingredient of SDT is the sub-theory OIT which defines (qualitatively) different dimensions of motivation on a continuum (Deci & Ryan, 2000). The quality dimensions are relative to the degree of the behaviour being regulated by self-determined versus controlled aspects (see Figure 1). The continuum stretches from highly controlled non-regulation (amotivation), through four types of gradually more autonomous regulations (extrinsic motivation), to fully self-determined regulation (intrinsic motivation). The continuum depicts how activities and behaviours vary in the degree of self-determination through the process of *internalization* and integration of regulations. Internalization is a central aspect of human motivation, whereby people integrate values and behaviours of significant others (or a given culture) into the self (Ryan & Deci, 2002). In this manner, initially uninteresting, boring, or strenuous activities could become more self-regulated and allow people (to various degrees) to feel self-determined or autonomous even when doing extrinsically motivated activities. By integrating and transforming external regulations through internalization, one is able to be more autonomous in executing the behaviour. For example, integrated regulation signifies an optimal internalization process through which social regulations are fully accepted as our own, while introjection denotes values and regulations that remain external or only partially internalized (Ryan & Deci, 2002). With increased internalization, the motivation becomes more self-determined and enhances persistence and adherence (Deci & Ryan, 2000). In this perspective, even extrinsic

motivation can be self-determined and people may engage in exercise behaviours not exclusively for intrinsic reasons, but also to achieve internalized outcomes (Hagger & Chatzisarantis, 2008).

Figure 1 Continuum of self-determination

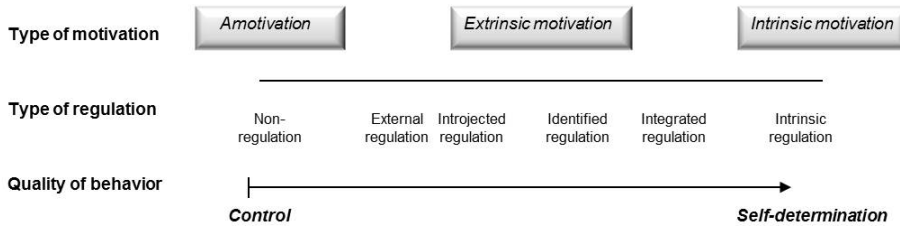

(from Ryan & Deci, 2002, p. 16)

At the far end of the continuum we have *amotivation* (Ryan & Deci, 2002; Deci & Ryan, 2000), which stems from feeling incompetent and helpless (e.g., “It’s impossible” or “It’s not worth it”), representing non-regulation and non-intentional behaviour. Due to the absence of both intrinsic and extrinsic motivation, it contains no self-determination or feelings of competence. Amotivation both springs from, and amplifies, psychological need-thwarting (Deci & Ryan, 2000) and amotivated people have been found to have low adherence to health behaviours (Thøgersen-Ntoumani & Ntoumanis, 2006). As approximately one third of the population lacks intentions towards health behaviours such as physical activity (Rhodes & deBruijn, 2013), they are unlikely to appear in physical activity and exercise contexts (Teixeira, Carraca, Markland, Silva, & Ryan, 2012), hence, amotivation constitutes a significant challenge in health behaviour promotion (Hardcastle et al., 2015; Miller & Rollnick, 2013; Peters, Rutter, & Kok, 2013). *Externally regulated* behaviours are pursued to achieve external rewards or avoid punishment, signified by the classic “carrot and stick” metaphor. This highly controlled form of motivation reduces intrinsic motivation, and because it is contingency-dependent, externally regulated behaviours are assumed to be maintained only as long as the rewards remain present, hence, it has low predictive value regarding adherence. *Introjected regulation* is a slightly less controlled motivation in which the contingent rewards or punishments are delivered by oneself through feelings such as pride, shame, or guilt (e.g., “I should” or “I ought to”) or to maintain self-worth. The internalization process is then initiated, and this type of motivation is hypothesized to have a stronger influence on behavioural maintenance than external regulation, albeit not integrated with the self. Introjected values are not self-determined,

but directed by an “ought-self”, pushing us to act. *Identified regulation* represents what happens if the internalization proceeds further and the behaviour becomes increasingly important, valued, and volitional (e.g., one exercises because the expected health benefits are important), but it is more self-determined and could be expected to yield higher levels of commitment and maintenance. It could also be related to a level of maturity in which people have learned to take ownership of their externally regulated behaviours (Sheldon et al 2003). *Integrated regulation* represents the most self-determined form of extrinsic motivation; it is optimally internalized and stems from values and beliefs consistent with one’s identity and integrated with other aspects of the self (Ryan & Deci, 2002; Deci & Ryan, 2000). In this dimension, external regulation has become self-regulated and volitional (e.g., “Exercise and healthy living is part of who I am”), and the activity also supports other important behaviours or life goals. Nevertheless, even if these features make integrated regulation closely related to intrinsic motivation, the behaviour is still instrumental to some degree and, therefore, is also still extrinsic by definition. *Intrinsic regulation*, on the other hand, is completely self-determined and characterized by enjoyment, curiosity and passion; the inherent pleasure of performing the activity in itself (e.g., “I exercise because it’s fun and exciting”). When self-determined one experiences volition, self-regulation and autonomy; as long as the activity is interesting, stimulating, and optimally challenging, it can be expected the behaviour will be self-maintained. Self-determined motivation has, therefore, a strong predictive value for behavioural maintenance (Ryan & Deci, 2002; Deci & Ryan, 2000).

The most important contribution of OIT is the provision of a plausible explanation for how people become motivated to engage in all the behaviours (e.g., tedious, uninteresting or exhausting) that are not energized by intrinsic motivation. It is suggested that internalization is especially important for the regulation and maintenance of potentially demanding or non-enjoyable behaviours such as exercise (Deci & Ryan, 2000). For instance, identified regulation has been shown to predict strenuous exercise activity, which implies that the valuing of the activity due to factors such as potential health benefits is significant (Edmunds, Ntoumanis, & Duda, 2006). Teixeira and colleagues (2012) even suggested that identified regulation might be “the single best correlate of exercise” (p. 22), perhaps even more salient than intrinsic motivation. It is likely that motivation, which is considered to be dynamic (Ryan & Deci, 2002), is a combination of different regulations that could be operative simultaneously in a given domain (Patrick, 2014). Motivational regulations are strongly linked to goals and motives. Several motives (intrinsic and extrinsic) can operate simultaneously so that any given behaviour contains portions of different types of motivation (e.g., both “I

ought to” and “It’s fun”), a phenomenon that has been referred to as the *motivational soup* (Patrick 2014). These multiple reasons can also vary in strength from day to day, but taken together, regulations behind the given behaviour are typically assumed to add up to a more or less controlled, or autonomously oriented, profile. It has been suggested that people could be high in both controlled and autonomous forms, as well as high autonomous/low controlled or low autonomous/high controlled forms of motivation (Vansteenkiste, Sierens, Soenens, Luyckx, & Lens, 2009). Gillison, Osborn, Standage, and Skevington (2009) found that introjected regulation (without apparent negative effects) coexisted with more self-determined forms of motivation, and was also associated with higher levels of physical activity. Although it is argued that introjected motivation might play an important role in the internalization process (Gillison et al., 2009; Vansteenkiste, Simons, Soenens, & Lens, 2004) and may serve motivational purposes initially or in the shorter term, even if controlled processes can motivate behaviour, being regulated by feelings of guilt or shame can also have negative effects in the long run (Deci & Ryan, 2000).

In a recent debate regarding OIT and the continuum, Chemolli and Gagné (2014) question the continuum, arguing the regulatory styles to be more properly described as *contiguous* multidimensional constructs adjacent to each other and differing in kind rather than degree. Besides clarifying misconceptions on the theoretical approach used to support the continuum structure (Guttman’s radex theory) in favour of the more suitable Rasch analysis, the main arguments are based on the facts that people often hold multiple reasons for exercise at the same time and that different regulations could yield different outcomes. For these reasons, Chemolli and Gagné (2014) also strongly advise against using the relative autonomy index (RAI) and other unidimensional conceptualizations of motivation. In a recent review on changes and dynamics in behavioural regulations over time in the context of exercise, Wasserkampf and Kleinert (2015) found different forms of regulations to change simultaneously in exercise contexts (i.e., identified and introjected regulations). They also found interesting differences in the timing of patterns of change in autonomous and controlled regulations, adding to the understanding of how (and when) regulations are internalized. Autonomous motivation, for example, increased at the earlier stages of intervention (the first weeks), lasting for up to a year after intervention, while controlled motivation was mainly stable (non-changing) or with observed changes at the earliest six weeks after baseline (Wasserkampf & Kleinert, 2015). Such empirical trends add to the theoretical understanding of how to operationalize the regulations and how internalization occurs. In support of OIT arguments, there is also neuropsychological empirical evidence for the

idea that different regulations produce different outcomes (Lee, Reeve, Xue, & Xiong, 2012) and that self-determined behaviour seems to be more personally agentic than controlled behaviours (Lee & Reeve, 2013).

Considering the dynamics of motivation addressed above, a person-centred approach might complement the traditional variable-centred approach by configuring subgroups characterized by different motivational profiles (Ratelle, Guay, Vallerand, Larose, & Senécal, 2007; Vansteenkiste et al., 2009), and accounting for within-person interactions of motivation and regulations instead of only between-person variances (Bergman & Andersson, 2010). A person-centred methodology may allow for a more profound understanding of how motivational regulations interact within a person, which is valuable for better tailoring of interventions to specific groups (Guerin & Fortier, 2012) that could then be identified in moderation analyses (see page 14). Although attention has recently been drawn to examine the nature of motivational profiles via person-centred approaches, only a small amount of studies have focused on adults' physical activity behaviour (Friederichs, Bolman, Oenema, & Lechner, 2015; Guerin & Fortier, 2012; Matsumoto & Takenaka, 2004). Two of these studies (Friederich et al., 2015; Matsumoto & Takenaka, 2004) found three clusters of motivational profiles: an *autonomous motivation profile* (high scores on autonomous motivation and low scores on controlled motivation), a *controlled motivation profile* (high scores on controlled motivation and low scores on autonomous motivation), and a *low motivation profile* (low scores on both autonomous and controlled motivation). Guerin and Fortier (2012) also found three clusters, but unlike the other two studies, theirs constituted a *self-determined profile* (high scores on autonomous motivation and low scores on controlled motivation), a *motivated profile* (moderate scores on autonomous motivation and high scores on controlled motivation), and a *low motivation profile* (high autonomous motivation scores, but high controlled motivation scores). These three studies, however, have included deductive methods of analysis (i.e., cluster analysis) instead of more recently recommended inductive approaches (Hardcastle & Hagger, 2016), such as latent profile analyses (LPA; Marsh, Lüdtke, & Trautwein, 2009; Pastor, Barron, Miller, & Davis, 2007).

Basic needs theory (BNT)

In gaining a more comprehensive understanding of the foundations empowering different regulations, some basic elements affecting motivation quality should be considered, that is, human needs. According to SDT, self-determined motivation and psychological well-being will be promoted when certain basic psychological needs are satisfied, as described in the sub-theory

BNT (Deci & Ryan, 2000; Ryan & Deci, 2002). BNT posits that self-determined motivation is based on the satisfaction of three basic psychological needs: competence, relatedness, and autonomy. The need for competence reflects a feeling of effectiveness when interacting with other people and obtaining desired outcomes (Deci & Ryan, 2000). This is similar to the concept of self-efficacy (Bandura, 1977; 1997), a situation-specific cognitive mechanism and part of social cognitive theory (Bandura, 1986), and is based on the argument that the strongest force in behaviour change is a personal conviction that one is able to successfully perform the change. An important discrepancy between the need for competence and self-efficacy is that the latter does not distinguish between intrinsic and extrinsic motivation (Deci & Ryan, 2000), claiming that all behaviours are motivated merely by desired objectives and the feeling of being capable of reaching these goals or aspirations.

The need to belong is considered to be a fundamental human need (Baumeister & Leary, 1995) and the need for relatedness in SDT involves the need to feel connected to other people, to be part of a social context, to care and feel cared for by other people. The need for autonomy contains feelings of volition and choice, to be the agent of our own actions. SDT stipulates that people seek out need-supportive settings (e.g., objectives and relations), that self-determined motivation and psychological well-being will be promoted when the three needs are satisfied, and that these needs are essential for understanding the what (content), and why (process), of human objectives and behaviours. Basic psychological needs are defined as “innate psychological nutriments that are essential for on-going psychological growth, integrity and well-being” (Ryan & Deci, 2002, p. 229) and are based on inborn, lifelong propensities to pursue effectance, (to feel effective through mastery and skill development; see White, 1959) coherence, and affiliation. Placing this in an evolutionary perspective, the adaptable human would naturally be interested in socializing, practicing abilities, and integrating experiences, making basic psychological needs fundamental for motivating action and effectance in social relations (Deci & Ryan, 2000).

Deci and Ryan (2000) also suggest that just as peoples’ physical needs can vary, psychological need significance can be expected to vary between individuals, (i.e., that the three needs would naturally differ in strength between people). They argue that the focus of SDT is not need satisfaction magnitude, and that the study of variations in motivational orientation and goal content is far more informative and useful in the understanding of human behaviour (Deci & Ryan, 2000). As stated above, numerous behaviours are not inherently interesting and enjoyable, and the energy motivating these behaviours is fuelled by psychological need satisfaction.

The satisfaction of basic psychological needs constitutes the fuel necessary for intrinsic motivation and the internalization of extrinsic motivation to arise and, thus, for well-being and optimal development (Deci & Ryan, 2002). The psychological needs tend to be thwarted when authorities ignore their perspective, remove options, and fail to explain reasons behind demands (Sheldon et al., 2003). Threats, surveillance, deadlines, and evaluation also undermine intrinsic motivation, probably due to increased feelings of being controlled. Persuasion or force by authority is also likely to cause negative effects and often results in behaviour fading when the authority is no longer present (Sheldon et al., 2003). People also tends to feel controlled when given external rewards (e.g., money) for intrinsically regulated behaviours, which could result in the intrinsic motivation turning into more external regulations (Deci, Koestner, & Ryan, 1999). It is postulated that if need satisfaction is thwarted, negative consequences such as overly external aspirations (e.g., for social recognition), risky health behaviours (e.g., smoking) and forestalled internalization could follow. In the long term, controlled motivation and amotivation are thought to cause negative conditions such as learned helplessness and other self-protective behaviours (Ryan & Deci, 2002).

Because internalization is a natural but not an automatic process, it requires nutriment (e.g., feeling capable or affiliated) to progress; all three needs are considered important for optimal development and for self-determined motivation to occur (Deci & Ryan, 2000). For example, competence is regarded as essential in all forms of motivation, although autonomy is required for intrinsic motivation. Relatedness is perceived as essential for the maintenance of intrinsic motivation, but because even solitary activities can be driven by intrinsic motivation, perhaps this need has a more “distal role” than the others (Deci & Ryan, 2000). In support of this view, previous studies have found competence and autonomy need satisfaction to be more strongly endorsed than relatedness in exercise settings (Wilson, Longley, Muon, Rodgers, & Murray, 2006; Wilson, Rodgers, & Fraser, 2002), discussing differences in contexts and degree of internalization as possibly influencing the impact of the need for relatedness. Not surprisingly then, the role of relatedness in exercise settings has been debated (e.g., McDonough & Crocker, 2007; Wilson et al., 2002) and the findings are mixed (Teixeira et al., 2012). Another common trend in previous work is the strong inter-correlations between the needs, particularly competence and autonomy (e.g., Markland & Tobin, 2010), suggesting that the three needs may be captured by an underlying unidimensional factor. This is supported by Hagger, Chatzisarantis, and Harris (2006), who found that a single global need satisfaction factor could explain latent variables representing autonomy, competence and relatedness.

BMT and OIT are linked together, the former constituting a map of the origins of self-determined regulations in motivation and the latter seeking to explain how externally regulated behaviours can become incorporated in a person's self-determined way of life for satisfying basic needs (Hagger & Chatzisarantis, 2008). Hence, people's interest in (motivation to perform) a given activity will vary in relation to the degree of need satisfaction when doing it, and as long as the nutrimental needs are achievable, the organismic tendency to engage in activities supporting vitality, integration and health will be sustained (Deci & Ryan, 2000). Edmunds, Ntoumanis, and Duda (2008) found that need satisfaction increased both self-determined motivation towards exercise and attendance rates. Another study by Edmunds, Ntoumanis, and Duda (2007) found that an increase in relatedness satisfaction also corresponded to greater adherence.

The SDT process model

The understanding of the prerequisites for psychological need satisfaction (or thwarting) generates practical implications for constructing autonomy-supportive social environments, facilitating self-determined motivation and improving psychological well-being (Deci & Ryan, 2000). Given that autonomous motivation can be modified through interventions (e.g., Fortier, Sweet, O'Sullivan, & Williams, 2007) as described in comprehensive process models involving motivational regulations (OIT) and behavioural outcomes (e.g., Williams et al., 2006; Pingree et al., 2010; Fortier et al., 2012), it is possible to study motivational sequence and specific mechanisms behind these processes, creating a stronger platform for tailoring successful interventions (e.g., Fortier et al., 2011).

In line with these propositions, this thesis is guided by a process model (Figure 2), illustrating the motivational sequence proposed by SDT. The model describes the hypothesized causal mechanisms behind maintained health behaviour change and psychological well-being (Fortier et al., 2012) and the value of utilizing the SDT process model has substantial support (e.g., Williams et al., 2006; Williams et al., 2002; Fortier et al., 2012; Pingree et al., 2010; Silva et al., 2011). The SDT process model postulates that if an intervention (Steps 1 & 2) increases psychological need satisfaction (Step 3), self-determined motivation will increase (Step 4), which, in turn, will predict the final steps into positive behavioural and psychological outcomes.

Figure 2. The SDT process model

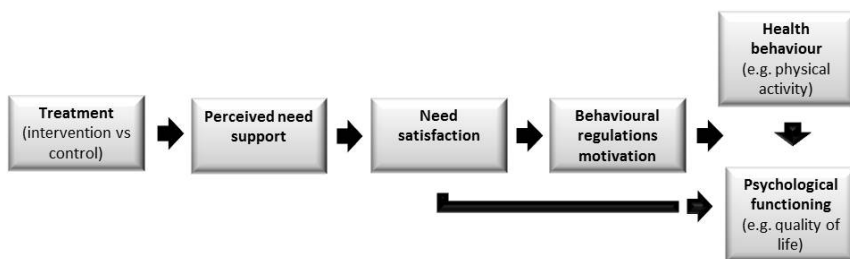

(from Fortier et al., 2012, p 3)

Mediation and moderation

As mentioned above, a substantial amount of research strongly advocates adequate application of theory to explore and understand the mechanisms of intervention efficacy (e.g., Baranowski et al., 1998; Bauman et al., 2002; Cerin & Mackinnon, 2009; Lubans, Foster, & Biddle, 2008; Noar & Zimmerman, 2005), or simply put – clarify why any given intervention succeeds or fails in changing behavioural outcomes. Such knowledge would provide a recipe for how to construct interventions that will bring about changes in behaviour, which turns the query into a matter of causality (Bauman et al., 2002). When discussing cause and effect, it is important to note that all human behaviour involves multi-causal influences and reciprocal determinism (i.e., bidirectional correlations). The relationship between the dependent (outcome) and independent (intervention) variables could, hypothetically, be affected by such factors, forming the warranted mechanisms. This process is based on the assumption of *mediation effects* (Cerin & MacKinnon, 2009), also called mediators of change (Rhodes & Pfaeffli, 2010), and tested by mediation analyses (MacKinnon, Fairchild, & Fritz, 2007), also known as mediating variable analysis (MVA; Cerin & MacKinnon, 2009). With adequate study design and proper analysis, MVA can inform practice by displaying whether an intervention changes the suggested mediators (the alpha-coefficient, or *a*-path), and evaluate theory efficacy by demonstrating conceptual theory links (the beta-coefficient, or *b*-path), such as whether a change in mediators also changes outcomes (MacKinnon et al., 2007; Cerin & MacKinnon, 2008). In other words, mediated effects is a result of a concurrent test of action theory links (the effect of the independent variable on the mediator) and conceptual theory links (the effect of the mediator on the dependent variable) (Cerin, Barnett, & Baranowski, 2009) and action and conceptual theory links should therefore be considered in mediation analyses (Cerin & Mackinnon, 2009). These links are, however, rarely reported in intervention studies. In their review, Rhodes

and Pfaeffli (2010) concluded that although action theory links are reported more often than conceptual theory links, interventions often failed to affect the desired outcome according to action theory relations. The basic mediation model (see Figure 3) also contains the *c*-path, depicting the direct effect between the dependent and independent variables. The gold standard for testing these processes is randomized controlled trials (RCT; Kramer, Wilson, Fairburn, & Agras, 2002), but mediators can also be observed in other designs (even in cross-sectional studies, see MacKinnon et al., 2007; Kline, 1998) albeit with weaker values of evidence due to, for example, factors of temporal and controlling character (Shadish, Cook, & Campbell, 2002). Mediators are variables required for an independent variable (*x*) to cause an effect in the dependent variable (*y*), and this relationship (indirect effects) can in turn be affected by a third variable called *moderators* (Hayes, 2009). As an example, an intervention effect, and the effect of the mediator in this intervention effect, could be stronger or weaker in different age groups. Moderating analysis might uncover how the impact of different intervention structures differ in diverse subgroups, enabling optimized adaptation in the tailoring of effective interventions (van Stralen, de Vries, Bolman, & Lechner, 2010).

Figure 3. Basic mediation model outline

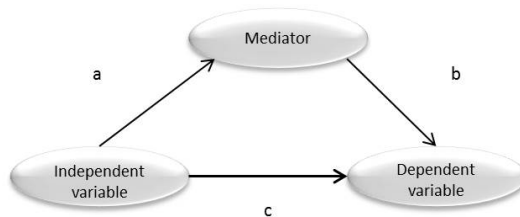

An avenue less studied is the possibility that the key associations in the SDT process model differ on the basis of demographical factors. Due to natural variations in personal values, health, and goals, the individual motives for exercise and physical activity will possibly change at various points in life (Miller & Iris, 2002; Owen, Smith, & Lubans, 2014). For example, Wilson and colleagues (2006) found that psychological need satisfaction in an exercise setting and gender differences in the association between need satisfaction and well-being changed over time. Brunet and Sabiston (2011) found that controlled motivation correlated with physical activity among younger adults, but older adults seemed to be more internally regulated in terms of physical activity behaviour. Qualitative studies have suggested older adults participate in physical activity for autonomous reasons such as valued

and enjoyed activities (Beck, Gillison, & Standage, 2010). Regarding gender differences in behavioural regulation level, exercise motivation has been found to differ between women and men (e.g., Daley & Duda, 2006; Hamilton, Cox, & White, 2012; Kilpatrick, Hebert, & Bartholomew, 2005; Li, 1999), but a meta-analysis concluded current findings on gender differences to be trivial (Guérin, Bales, Fortier, & Sweet, 2012). Due to the somewhat inconsistent findings of gender and age mean-level differences, it seems reasonable to progress by exploring these features through more sophisticated analyses of mediation and moderation. Previous research has called for a more thorough exploration of the potential moderating effects of gender and age (Guerin et al., 2012; Teixeira et al., 2012; Owen et al., 2014). Extending this even further, moderated mediation (i.e., that the mediation effect between x and y varies as a function of a third variable), could also affect the strength of the relationship in different groups (Cerin, 2010). Taken together, recognizing such differences as potential moderators in the pathways between psychological need satisfaction, motivational regulations, and outcomes might serve to improve exercise interventions for specific subgroups (Nigg & Geller, 2012). Potential subgroups could be identified by demographic or behavioural patterns, or preferably, by psychographic profiling based on motives, preferences, and needs (Hardcastle & Hagger, 2016). As no factor can guarantee a behavioural outcome, only those assumed to increase the probability of behavioural outcomes can be considered for study, and potential *confounders* (i.e., biasing factors that hinder discovery of the true level of observed effects) should be recognized to improve interpretation (Bauman et al., 2002).

In conclusion, it is suggested that the deficiency of proper MVA studies is an important reason numerous exercise and physical activity interventions fail to change targeted behaviours (Baranowski et al., 1998; Baranowski & Jago, 2005; Rhodes & Pfaeffli, 2010). Bauman and colleagues (2002; 2012) have stated that public health can be systematically improved only by understanding why interventions succeed or not. MVA provides a systematic evaluation of how theory works in an intervention, and reveals and explains the contribution of mediating and moderating factors, allowing a focus on effective mechanisms and – perhaps more importantly – the removal of ineffective components (Baranowski et al., 1998; Cerin & MacKinnon, 2009). In SDT research, this will entail a beneficial progression from dealing with first-generation research questions (whether need satisfaction is related to motivation and exercise behaviour), to second- (whether relationships between need satisfaction, motivation, and exercise are stronger or weaker in different subgroups) and third-generation questions (what mechanisms can explain and/or predict the relationship between need satisfaction and

exercise) (Zanna & Fazio, 1982). If mediation is not examined, it will remain uncertain whether or not theoretical constructs have caused observed intervention outcomes, and the potential to understand behaviour change will be restrained (Lubans et al., 2008). Even small-scale studies can yield knowledge for effective intervention designs if proper MVA is used, diminishing the practical limitations of large and expensive interventions and programs (Cerin, Taylor, Leslie, & Owen, 2006). By focusing on changing mediators rather than behaviours, intervention magnitude (e.g., time, participants) could be condensed and yield more cost-effective programs. In this way, successful and economically sound intervention design for behaviour change could be facilitated (Baranowski et al., 1998; Cerin & MacKinnon, 2009).

SDT applications and interventions

There is a considerable amount of research supporting SDT notions in health behaviour change (Ng et al., 2012; Williams et al., 2006; Sheldon, Williams, & Joiner, 2003) and in the physical activity and exercise field (Silva et al., 2011; Silva et al., 2008; Silva et al., 2010; Teixeira et al., 2012; Fortier et al., 2012; Hagger & Chatzisarantis, 2008). There is also emergent empirical evidence for its application in specific domains such as exercise adherence (Patrick & Canavello, 2011; Williams, Niemiec, Patrick, & Deci, 2009) and in e-health (Friederichs et al., 2015; Pingree et al., 2010; Webber, Tate, Ward, & Bowling, 2010).

By applying *autonomy support* in interventions, the SDT framework has proven to be a promising compass tool in intervention design (e.g., Ng et al., 2012; Cheon et al., 2012). Autonomy support is an interpersonal style that practitioners (e.g., teachers, counsellors, coaches, health-care providers or health professionals) can learn (Reeve & Halusic, 2009; Su & Reeve, 2010; Sheldon et al., 2003; Ntoumanis, 2012), and details what should be said and done to facilitate a person's locus of causality, volition, and perceived options (Reeve, Nix, & Hamm, 2003). This is accomplished by creating an environment promoting autonomy, competence, and relatedness need satisfaction, facilitating internalization and minimizing control and pressure (Sheldon et al., 2003). Autonomy-supportive strategies include providing a *meaningful rationale* (explaining usage and value of the target behaviour), *acknowledging negative feelings* (demonstrating empathy and understanding), *using non-controlling language* (avoiding terms such as "must" and "should"), *offering choice* (informing about options), and *encouraging inner motivational resources* (stimulating interest, enjoyment and curiosity) (Fortier et al., 2011; Su & Reeve, 2011). The provision of *structure* (clear guidelines, optimal challenge and informational feedback)

and interpersonal *involvement* (emotional warmth and care) will complement autonomy support and facilitate the interaction and psychological need support (Ntoumanis, 2012).

Autonomy support could be valuable in any interpersonal relation, but perhaps especially in situations where there is some sort of power imbalance and authority involved, such as between children/adults, employer/employee or counsellor/client (Sheldon et al., 2003). By displaying sympathy for feelings of aversion towards a given behaviour, explaining ambivalence to be normal, and the possibility of performing the behaviour in spite of these feelings, an autonomy supportive counsellor could relieve tensions in such situations (Su & Reeve, 2011). Explaining how such self-regulation could be beneficial for the client, offering choices and sympathizing with negative feelings could engender positive effects by supporting feelings of autonomy and control. This includes encouraging a person in making their own choices, finding alternatives, discovering what they might consider meaningful, interesting, enjoyable and possible, creating an inventory of potential expectations and values, and delivering information about facilitating factors. The communication style should be based on minimizing pressuring language, avoiding criticism and judgements, and having a flexible approach (Su & Reeve, 2011). Autonomy support is based on the assumption that people will not need to be “forced” to embrace positive health behaviours as long as the social contexts support satisfaction of the basic psychological needs (Sheldon et al., 2003). One important issue with health behaviours is however that they involve performing activities that will not lead to an ultimate goal closure, but are about repeating something positive even when struggling (e.g., effort, dullness). For instance, a constant maintenance is needed to reap the beneficial health effects from physical activity and exercise. Because motivation is all about the energy driving human pursuits, it seems to be obvious why motivation can be considered a cardinal component in health behaviour promotion (Sheldon et al., 2003).

Combining SDT with other theories and methods

A growing amount of research also highlights the practical implications of the commonalities of SDT and the use of the clinical method motivational interviewing (MI; Miller & Rollnick, 2013) as a means of delivering autonomy support for successful health behaviour change (Deci & Ryan, 2012; Patrick & Williams, 2012), suggesting that an applied combination of the two frameworks could be an improvement in intervention design. MI is a method developed from practice in treating addictive behaviours and is defined as a “collaborative, person-centred form of guiding to elicit and strengthen motivation for change” (Miller & Rollnick, 2009 p. 137). MI aims

to change a certain behaviour by exploring and solving ambivalence (Miller & Rollnick, 2013), through, for example, rapport building and considering readiness for change (Burke, Arkowitz, & Menchola, 2003) using four basic principles: a) expressing empathy, b) developing discrepancy, c) rolling with resistance, and d) supporting self-efficacy (Miller & Rollnick, 2013). MI is receiving growing empirical support for promoting health behaviour change (Burke et al., 2003; Lundahl, Kunz, Brownell, Tollefson, & Burke, 2010; Miller & Rollnick, 2012) in the physical activity domain as well (e.g., van Keulen et al., 2011). The main weakness of MI however, is that because it is a “bottom-up” model developed from practice, it lacks coherent theoretical foundations and the behavioural effects of MI-based interventions might therefore be difficult to explain (Patrick & Williams, 2012). There seems to be a natural fit between the model of MI and the theoretical frame of SDT (e.g., Deci & Ryan, 2012; Markland, Ryan, Tobin, & Rollnick, 2005; Vansteenkiste & Sheldon, 2006); it has been suggested that SDT could back up the theory deficiency in MI, and MI could provide SDT with guidelines in terms of practical implications and methods (e.g., Patrick & Williams, 2012). Supporting autonomy and volition are fundamental in both MI and SDT, and they share a person-centred approach and a human needs awareness (Miller & Rollnick, 2012; Deci & Ryan, 2012). Also, both SDT and MI are process-oriented (Teixeira, Palmeira, & Vansteenkiste, 2012) and the needs of BNT are an essential part of MI (Miller & Rollnick, 2012).

Current research also recommends interventions combining SDT with other frameworks of health behaviour, such as the transtheoretical model of behaviour change (see Fortier & Kowal, 2007) and the relapse prevention model (see Gustafson et al., 2011). The transtheoretical model of behaviour change (TTM; Marcus & Simkin, 1994; Prochaska et al., 1992; Prochaska & Velicer, 1997) integrates cognitive theory (e.g., self-efficacy theory and the relapse prevention model) and behavioural strategies. It describes and explains the gradual process by which people change their behaviour through various stages of attitudes, motivation, and behaviour, and how behaviour maintenance can be promoted. The basic idea in applying the model is timing, that is, providing the accurate advice at the right moment based on the stage in the model at which the target person is located. The proposed stages in TTM are; *precontemplation*, *contemplation*, *preparation*, *action* and *maintenance* (Prochaska et al., 1992; 1997). Similarly to SDT, the precontemplation stage has been related to the concept of amotivation (Thøgersen-Ntoumani & Ntoumanis, 2006) and the early stages in TTM have been found to be related to more controlled motivation, while the later steps have been connected to more autonomous motivation to physical activity and exercise (Daley & Duda, 2006; Landry & Solmon, 2004; Rose, Parfitt, &

Williams, 2005). A difference between SDT and TTM is however that the latter represents a quantitative approach on motivation (i.e., more motivation in later stages), while the former, as mentioned above, is focused on a qualitative approach.

The relapse prevention model (RPM, Marlatt & Gordon, 1985; Larimer et al., 1999) involves cognitive and behavioural strategies for effective coping in certain high-risk situations that could tempt people to regress and return to an earlier stage of change. Like other health behaviours, exercise adherence entails embarking on a journey for life; maintenance cannot be expected to be a linear process, and slips, lapses and relapses are a natural part of the journey (Stetson et al., 2005). The capacity to effectively cope with such barriers could be related to both competence and autonomy need satisfaction according to SDT tenets. As an example of TTM and RPM usage, reviews have demonstrated that physical activity intervention programs personally customized to readiness for change (Kahn et al., 2002; Ogilvie et al., 2007) and containing goal setting and relapse-prevention strategies (Kahn et al. 2002) are useful and effective.

Digital interventions

The digital world (and especially internet interactivity) has resulted in almost revolutionary changes in how we communicate and retrieve information (Hesse, 2008). The vast access to information, services, and social networks without time or location limitations, provides us with significantly more personal power than before. These changes have generated a new arena for health care services and novel opportunities for people to participate in their own health care. A large proportion of the population is constantly online with the internet being available via smartphones, tablets and computers. People shop, work and socialize digitally. At the same time, modern health care has become more and more rationalized and slimmed, highlighting an increasing need for cost-effective solutions. The use of technology in health care could lessen costs for clinical contact and carries the potential to reach more people than traditional care (Williams et al., 2014). Also, numerous digital solutions have emerged, and various forms of so-called e-health are now fact and not fiction. In Sweden, for example, the government has established a national e-Health Agency, aiming to enhance public health and healthcare by developing and innovating the Swedish e-health infrastructure. Modern technology carries thriving potential for new models influencing public health, including one in which the person (client/patient) has a central role with opportunity to personally define and shape the care and services based on his or her own needs, instead of the opposite (Marsch & Gustafson, 2013). This could involve sensors or

applications measuring physical (e.g., blood pressure), psychological (e.g., motivation) or behavioural (e.g., exercise) data in real time. It could also be self-administered education modules and support tools, or for functions such as social networking and sharing, providing autonomy and personalization for the individual. These functions have a great potential for quality enhancement, coordination, and influence in healthcare. Today's information and communication technology provides opportunities to tailor and personalize programs and interventions, and also enables change monitoring and regulation of services and functions over time based on observed patterns of change. Personal counselling promoting physical activity and exercise is often an expensive solution (Garrett et al., 2011; Wu, Cohen, Shi, Pearson, & Sturm, 2011); e-health offers cost-effective alternatives and other benefits such as standardization and better opportunities for evaluations of potential effects (Patrick & Canavello, 2011) and the potential to reach a broader population (Broekhuizen, Kroeze, van Poppel, Oenema, & Brug, 2012; del Hoyo-Barbolla, Kukafka, Arredondo, & Ortega, 2006; Lustria et al., 2013; Peels et al., 2012). The amount of internet based interventions for physical activity and exercise has grown (Norman et al., 2007; Vandelanotte, Spathonis, Eakin, & Owen, 2007) and several reviews have been published concerning the effects of these types of interventions (e.g., Davies, Spence, Vandelanotte, Caperchione, & Mummery, 2012; Van den Berg, Schoones, & Vliet Vlieland, 2007). A common conclusion in these reviews is that digital interventions for physical activity show positive effects in the short term, but small, or even zero, effects in the long term. Davies and colleagues (2012) hold that the question whether or not internet based interventions are capable of stimulating sustainable behaviour change remains unanswered.

More knowledge is needed regarding how different tools and services should be designed, combined, and coordinated and how the gap between specialists within the different fields (e.g., information and communication technology vs. behavioural and health sciences) could be bridged through coproduction and cooperation across disciplines (Marsch & Gustafson, 2013). Above all, there is a need for increased understanding of the psychological and social processes explaining why some models/solutions work and other do not, which means we need to firmly base our interventions in adequate theory (Pingree et al., 2010). This is particularly true for e-health because it involves complex interactions between user, provider, and the system itself (Epstein & Street, 2007). Some years ago, Doshi, Patrick, Sallis, and Calfas (2003) and Evers and colleagues (2003) concluded that only a few websites with interventions promoting physical activity used theory based strategies or basic structures for behaviour change. In a recent review, Vandelanotte and colleagues (2014) showed that the majority of similar

(freely accessible) web sites still lack basic components for effective behaviour change such as self-surveillance, goal setting, and connection to social media. A study by Middelweerd, Mollee, van der Wal, Brug, and te Velde (2014) also showed that, even though app-manufacturers seem to be trying to use behaviour change theory, the majority of the apps studied included only a few basic techniques for behaviour change. These studies used a taxonomy for behaviour change techniques developed to identify useful intervention techniques (also for physical activity), such as prompts, feedback, goal setting, self-surveillance and social functions (see Abraham & Michie, 2008).

Although using digital tools holds great potential, stimulating health behaviour change via the internet might be a greater challenge than previously expected (Marshall, Leslie, Bauman, Marcus, & Owen, 2003). It has, for example, proven difficult to attract, engage, and keep participants in web based interventions (Kohl, Crutzen, & De Vries, 2013; Vandelanotte et al., 2007); there are usually high drop-out rates (Elfeddali, Bolman, Candel, Wiers, & de Vries, 2012; Peels et al., 2013), which likely contributes to the modest and short term effects that are often documented (Davies et al., 2012; Joseph, Durant, Benitez, & Pekmez, 2014; Norman et al., 2007; Van den Berg et al., 2007; van den Berg et al., 2007; Webb, Joseph, Yardley, & Michie, 2010).

In addition to theory-based work, it is also a good idea to focus on general strategies already shown to have positive health effects in web based interventions and programs (Vandelanotte et al., 2014). Examples of such strategies are: (a) keeping regular contact with the participants in different ways, such as using e-mail and smartphone functions (Brouwer et al., 2011; Kirwan, Duncan, Vandelanotte, & Mummery, 2012; Morrison, Yardley, Powell, & Michie, 2012; Plotnikoff, McCargar, Wilson, & Loucaides, 2005; Vandelanotte et al., 2007; Webb et al., 2010); (b) updating the web site regularly with high interactivity (Brouwer et al., 2011; Hurling, Fairley, & Dias, 2006; Leslie, Marshall, Owen, & Bauman, 2005) (c) to offer tailored feedback (Kohl et al., 2013; Morrison et al., 2012; Pingree et al., 2010; Webb et al., 2010); and (d) using tools that inspire self-surveillance, goal setting and social support (Brouwer et al., 2011; Kohl et al., 2013; Morrison et al., 2012; Tate et al., 2003; Tate, Jackvony, & Wing, 2003; Webb et al., 2010; Winett, Anderson, Wojcik, Winett, & Bowden, 2007). Previous research has also shown personally adapted feedback and counselling to be more effective than general information on physical activity, both in printed material (Kreuter, Strecher, & Glassman, 1999) and in web based interventions (Lustria et al., 2013; van den Berg et al., 2007). Interaction in social media (e.g., Twitter, Facebook, YouTube, Wikipedia) is rapidly increasing; consideration of why

it has been such a success could help integrate these strategies in our web solutions (Hesse, 2008). Probable causes behind social medias' popularity are that they are flexible and dynamic, meaning the content is continuously changing by allowing the users to create and change the content together (Kaplan & Haenlein, 2010), and makes the users both inventors and consumers (Schein, Wilson, & Keelan, 2010).

The majority of SDT-based intervention studies are based on face-to-face programs, but the process model of SDT also allows for the potential to increase the understanding of intervention effects in e-health (i.e., not only what works, but also why it works) (Rhodes & Pfaeffli, 2010). SDT-based interventions also have (through enhanced psychological need satisfaction) the potential to help create e-health systems that generate a better quality of life (Pingree et al., 2010). The numbered arrows in Figure 4 below illustrate the outline of the hypothetical processes of an intervention program based on SDT (in this case CHES: Comprehensive Health Enhancement Support System). Pingree et al., (2010) explains the model as follows: 1) the system (CHES or similar systems) gives proximal effects in factors such as knowledge, social relations, skills; 2) by actively processing and integrating new (health) information in relation to previous experience and knowledge (contrasted to passively receiving mass communication), the impact on the proximal effects increases; and 3) the system is interactive and encourage personal engagement (make choices, navigate, explore): 4) the proximal effects contribute to satisfaction of the psychological needs autonomy, competence and relatedness, internalisation of self-regulation; 5) the proximal effects have a direct effect on behaviour; 6) autonomy, competence and relatedness affect quality of life, though it is unclear if it is a direct effect or if the effect runs via the behaviour; 7) the behaviour affects quality of life, because positive health behaviours (self-regulation, compliance and adherence to health recommendations and prescriptions, social relations, coping skills, etc.) improve both quality of life and the experience of it.

The process in the model is not, however, necessarily linear, so changes in the parts to the right could cause changes in the parts to the left. For example, increases in autonomy and competence could lead to higher levels of system interaction because there is a distinct connection between changes related to behaviour and the three psychological needs (a reversed effect of link 6). This model is mainly aimed at stimulating research and variance testing in systems such as CHES, which will contribute to the improvement of e-health interventions. Such research could, among other things, study what the effective ingredients are, what proximal effects these ingredients will produce and if there are patterns between the ingredients and potential effects (Pingree et al, 2010). In a RCT using CHES for cancer patients (Hawkins, Pingree,

Shaw, & al., 2008), autonomy, competence and relatedness for example mediated the intervention effect on quality of life after only six weeks of intervention. In another program (iMOVE; Friederichs, Oenema, Bolman, & Lechner, 2015), the intervention effects were moderated by age, gender, and civil status, showing the effects were stronger for male participants, for participants under the age of 47, and for those who were single.

Figure 4. A model for effects of e-health

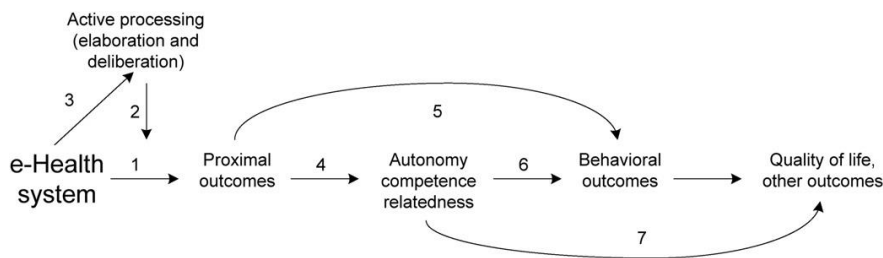

(from Pingree et al., 2010, p. 105)

Most types of e-health could be adjusted to be autonomy supportive by offering theory based goal setting tools, self-regulation tools, relapse prevention, expert panels, and so on. In healthcare, SDT based interventions could support the need for competence by providing facts and information on diseases, treatment, and recovery; support the need for autonomy by providing choice and information on options for action; and support the need for relatedness by providing social connection alternatives and advice on how to handle and preserve existing relations during situations such as a long/tough time of illness (Pingree et al., 2010). Hesse (2008) also presents a compilation of how different types of e-health tools can affect operationalisations within SDT. Besides structures such as self-help tools and health portals with relevant information he also highlights different forms of *ubiquitous health care* (i.e., constantly available health care) and the importance of the ability to handle one's own health registers. Such structures could be connected to the discussion about the freedom in not having to walk to the bank and is transferable to a majority of health care situations and services. To recapitulate, there are reasons for suggesting SDT may be a useful framework for effective design and evaluation of digital interventions in physical activity and exercise, (e.g., integration of structures based on the psychological mechanisms described in the SDT process model and in the model for effects on e-health). In future research, it would be relevant to examine how SDT components could be implemented in digital services

using modern interaction design and computer engineering. In addition, a commentary in the Lancet's physical activity series (Hallal et al., 2012) stated that "more of the same is not enough" (p. 2) and current approaches in both research and practice in physical activity and exercise promotion need to be revised and made a global health priority. In that same series, Heath and colleagues (2012) also recommend that policy approaches for increased physical activity should include environmental matters such as urban design and planning, which might be related to a relatively new line of research concerning the combination of smart and healthy cities (see Kamel Boulos & Al-Shorbaji, 2014; Rydin et al., 2012; Kamel Boulos, Tsouros, & Holopainen, 2015 for a description) that embraces a holistic approach to building a sustainable society based on economic, health, and environmental factors, and also considering the citizens' quality of life.

Summary

The physical and psychological health benefits of regular physical activity and exercise will be reaped when the behaviour is performed according to recommendations. Establishing sustainable exercise routines have proven to be challenging, but understanding the motivational prerequisites of exercise and physical activity behaviour could help disentangle the complex foundations of exercise and physical activity engagement. SDT has received substantive support for its application in both research and practice. Based on previous research, further advancement in the knowledge of motivational foundations, conditions, and mechanisms seems promising. Improvements in the practical applications for successful and cost-effective intervention design, promoting exercise adherence and long-term maintenance in both face-to-face interventions and in the digital arena could provide better and longer lasting health benefits.

Purpose

The main purpose of this thesis was to explore the motivational processes underlying exercise behaviours, using self-determination theory as a guiding framework. This was done in four studies:

The aim of Study I was to examine: (a) the relationships between the latent constructs of psychological needs, self-determined motivation and the manifest variable of exercise behaviour; (b) the mediational role of self-determined motivation in the association of psychological needs with exercise behaviour; and (c) and moderating effects of gender and age in the aforementioned associations.

The aim of Study II was to examine the effects of an exercise intervention, informed by SDT with added elements of CBT, MI, and relapse prevention strategies, regarding: (a) exercise level; (b) motivation quality, (c) need satisfaction in autonomy and competence; (d) testing indirect (mediating) effects of self-determined motivation and need satisfaction on the effect of the intervention on exercise behaviour.

The aim of Study III was to: (a) identify different motivational profiles, based on the different behavioural regulations for exercise in two samples of adults using latent profile analyses; and (b) examine differences in satisfaction of basic psychological needs (competence, autonomy, and relatedness) and exercise behaviour across the different latent motivational profiles.

The aim of Study IV was to design a digital intervention and use a randomized controlled trial to examine different paths in the SDT process model by testing: (a) if the intervention would affect exercise level and intensity, (b) if the intervention would affect psychological need satisfaction and motivation quality, (c) if potential intervention effects would be mediated according to the SDT process model, and (d) if gender and age would operate as moderators in potential relations between psychological need satisfaction, motivation quality and exercise behaviour.

Methods

An overview of the methodological approaches applied in the four studies is depicted in Table 1 on page 39. The table covers participants, measures, design, and data analyses.

Participants

Study I

The participants ($N = 1091$) – 286 men and 805 women, aged 18-78 years ($M = 45.0$; $SD = 11.7$) – were all active members of an internet-based physical activity and exercise program provided by a Swedish e-health company offering health care services in the private sector. Because customers could join the web service either by purchasing a private membership ($n = 251$) or by joining a group package provided by their employer ($n = 840$), the sample was expected to be diverse in aspects such as fitness and activity levels, age and gender, and motivational aspects.

Study II

The participants were 64 undergraduate university students (49 women and 15 men) aged 19-49 years ($M = 27.3$; $SD = 7.4$). The inclusion criterion for this convenience sample was that the participants were not currently engaging in exercise activities more than once a week.

Study III

The participants of this study comprised two samples. Sample A involved 1084 (279 men and 805 women) adults who were active members of an internet-based physical activity and exercise program provided by a Swedish e-health company offering health care services in the private sector. The mean age was 45.0 years ($SD = 11.7$), and the mean levels of activity in Sample A were 3.7 light exercise ($SD = 3.3$), moderate exercise 3.5 ($SD = 2.9$), and strenuous exercise 1.9 ($SD = 1.7$). The total exercise score (MET) for Sample A was 44.2 ($SD = 25.1$). Sample B consisted of 511 university students (226 men and 285 women) with a mean age of 22 years ($SD = 3.3$). The mean levels of activity were 2.9 ($SD = 2.0$) for light exercise, 2.4 ($SD = 2.7$) for moderate exercise, and 2.3 ($SD = 2.0$) for strenuous exercise. The MET score for Sample B was 41.0 ($SD = 26.0$).

Study IV

A total of 542 participants consented to join the study, in which 318 actively participated in two or more measure points whereof 187 participated in all three measure points. The participants were adult women ($n = 278$) and men ($n = 40$), aged 23-67 years ($M = 46.7$; $SD = 9.4$), who participated in a digital step contest provided by their employers and were recruited from different companies from all over Sweden; hence, they were expected to vary in both demographic variables (e.g., type of profession, gender, age) and geographic locations. Participants were assigned to either a control ($n = 152$) or an experimental ($n = 166$) group. Eighty-five of the 166 individuals assigned to the experimental group logged in to the digital intervention platform on at least one occasion and were therefore treated as intended (TAI). Drop-out analyses showed participants with high amotivation levels at T2 were more likely to drop-out from the study.

Measures

Psychological need satisfaction

Several SDT-driven instruments have been developed to assess psychological needs in exercise, and two different measures were used in this thesis. In Study I, the Basic Psychological Needs in Exercise Scale (BPNES; Vlachopoulos, 2008) was used to measure satisfaction of the three needs: autonomy, competence, and relatedness. It consists of 12 items and a five-point Likert scale, from 1 (*I don't agree at all*), to 5 (*I completely agree*). Cronbach's alpha for the BPNES ranged from 0.81 to 0.92 in Study I, III and IV. The BPNES has been successfully validated as supporting the theoretically based three-factor model and the needs hypothesis of SDT (Vlachopoulos & Michailidou, 2006). It has also demonstrated gender invariance (Vlachopoulos, 2008) and cross-cultural validity (Vlachopoulos, Ntoumanis, & Smith, 2010). In Study II, 12 items representing the factors of autonomy and competence in the Psychological Needs in Exercise Scale (PNES; Wilson, Rogers, Rodgers, & Wild, 2006) were used to measure psychological need satisfaction through statements assessed on a six-point Likert scale ranging from 1 (*false*) to 6 (*true*). Cronbach's alpha for the PNES ranged from .89 to .91 in Study II. The PNES scale has supporting evidence of structural and convergent validity (Wilson et al., 2006): higher scores on PNES are associated with more internalized exercise motivation (Wilson & Rogers, 2008).

Behavioural regulations

The most widely used measure of behavioural regulations in the exercise domain is the Behavioural Regulations in Exercise Questionnaire-2 (BREQ-

2; Markland & Tobin, 2004). It has been validated in several studies and has been found to be psychometrically robust in a number of translated versions (Moustaka, Vlachopoulos, Vazou, Kaperoni, & Markland, 2010; Murcia, Gimeno, & Camacho, 2007; Palmeira, Teixeira, Silva, & Markland, 2007). The scale contains 19 items on a five-point Likert scale, from 0 (*not true for me*) to 4 (*very true for me*). Study I and III applied a four-pointed Likert scale with the same anchors, that is, 1 (*not true for me*) and 4 (*very true for me*). Unlike the original BREQ scale (Mullan, Markland, & Ingledew, 1997), the BREQ-2 measures amotivation in addition to external, introjected, identified, and intrinsic regulations. Variables representing controlled and autonomous motivation were created by averaging scores on external and introjected regulation for controlled motivation, and on identified and intrinsic regulation for autonomous motivation. Alternatively, for the separate regulation scores, an overall score (RAI-score, relative autonomy index) for motivation quality can also be constructed by weighting and combining the different regulations. Higher RAI scores (over zero) denote more self-determined motivation. Using the RAI scores has previously been recommended (Vallerand & Ratelle, 2002), providing an overall index of the degree of self-determination which was used in Study II only. Cronbach's alpha for the BREQ-2 ranged from .73 to .86 across all four studies.

The BPNES, PNES, and BREQ-2 were translated from English into Swedish according to the back-translation method (Brislin, 1986). A bilingual (English and Swedish) expert first translated the tests from English into Swedish, and then another bilingual expert translated them back into English. Differences in the translated versions and the originals were discussed in the research group and formed the foundation of the final versions. A pilot study was then conducted in which ten persons, selected through convenience sample, tested the comprehension and design of the test battery using the think-aloud method (Ericsson & Simon, 1993). The pilot study resulted in the clarification and remodelling of parts of the test battery for the final version.

Self-reported exercise

All four studies used items from the Leisure Time Exercise Questionnaire (LTEQ; Godin & Shephard, 1985; Godin & Shephard, 1997) to measure self-reported exercise. The LTEQ contains four questions; three of them measure the frequency of performing different levels of exercise (strenuous, moderate and light) during a regular week. By multiplying the scores of strenuous exercise by 9, the scores of moderate exercise by 5 and the scores of light exercise by 3, the total exercise score is calculated and transformed into scores of metabolic equivalent of exercise (MET). The main interest in these studies was in MET scores; therefore, the fourth item in LTEQ (measuring

how often, during a typical week, a person engages in any regular activity long enough to work up a sweat and rapid heartbeats) was excluded. The LTEQ is a frequently used self-reported measure of exercise, has sound test-retest reliability (Godin & Shepherd, 1985; Jacobs, Ainsworth, Hartman, & Leon, 1993) and construct validity (Wilson et al., 2010), and its scores have a confirmed relation to accelerometer motion scores (e.g., Jacobs et al., 1993). The rationale for using the LTEQ instead of other popular and more detailed self-report measures (e.g., the IPAQ), is that it is user-friendly while also providing useful information, and due to its frequent use in previous research, study comparisons are possible.

Procedure

Study I and Study III

After obtaining a list of members provided by the e-health service company, potential participants for Study I and III (Sample A) were contacted by e-mail, with information on the aim of the study, ethical concerns and practical issues. When logging in to the questionnaire, the participants were required to tick a box regarding informed consent to access the questionnaire. For Sample B, the data was collected during the students' classes at two different universities in southern Sweden. The collected data from both samples were stored in a secure web account accessible only by the researchers. No personal register was created because participation was anonymous, and no personal data were requested. Studies I and III were approved (as one) by the regional ethical board (Dnr. Etik:H15 2010/94).

Study II

Participants, chosen by a convenience sample, were initially informed of the study's aim and procedure. After completing baseline measures, the 64 voluntary participants were randomly assigned to either an experimental group ($n = 32$) or a control group ($n = 32$). Members of the experimental group were contacted by telephone to schedule a time for the intervention. The intervention was implemented individually following a semi-structured intervention template. Mid-intervention (after three weeks), members of the experimental group received a follow-up telephone call and were offered support and exercise goal modification, if needed. Control group members received no intervention. Six weeks after the intervention, both the experimental and the control group were assembled to complete the post-intervention measures. All participants received cinema tickets (value approx. €10). The study was conducted according to the guidelines of the regional ethics board. An outline of the intervention is depicted in Figure 5.

Intervention Study II

The intervention in Study II was led by trained psychologists and consisted of a selection of MI, cognitive behavioural therapy (CBT), and RPM strategies relating to exercise-related participant narratives, decision balance, health-related exercise rationale, exercise-barrier identification, chain analyses, and goal setting. According to recommendations from previous research on SDT (e.g., Fortier et al., 2012; Sheldon et al., 2003; Su & Reeve, 2011) and research that was conducted with SDT in combination with MI (e.g., Patrick & Williams, 2012; Markland et al., 2005), the intervention was conducted in an autonomy-supportive manner, using non-controlling language and conveying an empathic and non-judgmental approach, allowing participants to decide on potential behaviour change themselves without attempting to force any decisions. The intervention provided vital elements of the SDT-informed interpersonal style with structure and involvement. To allow personalized support and counselling, the intervention leaders (IL) met all experimental group members individually.

Figure 5. Intervention design Study II

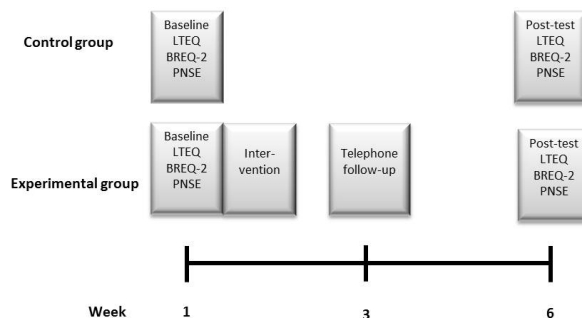

Initially, each participant's current relation to exercise and previous experiences was discussed, followed by a decision balance procedure in which participants listed exercise pros and cons. The listings were transferred to a whiteboard, where pros and cons could be compared, to display whether one outweighed the other. Then the IL provided a CBT-based rationale for the potential positive effects of exercise on physical and mental health (see Robertson, 2010; O'Donohue & Fisher, 2012). The rationale was followed by an inventory of experienced exercise-barriers and potential approaches to overcome such barriers using relapse-prevention strategies (Marlatt & Gordon, 1985; Larimer et al., 1999), and discussing potential drop-out situations and prevention strategies respectively. The IL described the

differences between a slip, lapse, relapse, and collapse, emphasizing the importance of participants not being self-judgmental when facing these difficulties, but instead to try to regain their exercise routines. CBT-based barrier chain analysis was conducted to increase awareness of the long- and short-term consequences of different actions; the participant was instructed to reflect on possible factors that facilitated exercise (see Linton & Flink, 2011; Lukens & Mc Farlane, 2004; Sudak, 2011). Next, a basic description of SDT was presented through CBT-based psychoeducation. Finally, potential interest in exercise initiation and prospective exercise activities were discussed based on the initial narrative. After the appropriate activities were established, participants were guided in exercise goal setting by employing specific, realistic, and challenging goals based on CBT guidelines and SDT-informed intrinsic goal orientation. The agreed-on goal formulation was compiled and distributed to each participant after the meeting. Three weeks after the first meeting, members of the experimental group were contacted by telephone for a follow-up aimed to support participants by giving them an opportunity to discuss their exercise progress or any additional need for support in exercise initiation, ask questions, or to modify their goals, if needed.

Study IV

The intervention outline is presented in Figure 6. Participants were invited to the study via the web company's regular information systems (e-mail, notification, and web site bulletin boards); they were provided with study information (aims, ethical concerns, and practicalities) and a web link to an informed consent check, repeating the same information package, a tick-in-the-box, and an e-mail registration procedure. After informed consent was received, participants were informed they would be contacted the following week with a link to the web survey. The registered e-mail addresses of the voluntarily enrolled participants were then transformed into anonymous ID numbers using customized software, enabling cross-reference for the three measure points to each individual case without personal identification, and providing a longitudinal reference for the data. The list connecting e-mail addresses to the ID numbers was stored separately from the collected data in accordance with local university IT-regulations, and was accessible only by the responsible researcher. No personal data except e-mail addresses was asked for. The participants were then stratified on age and gender and randomly assigned to the experimental or the control group. Both groups received three automatically generated e-mails (based on the e-mail addresses provided at registration/consent), repeating the information package and containing a web link to the survey. This was delivered in three-week

intervals over six weeks (T1: baseline; T2: post intervention; and T3: follow-up). For each delivery, the participants signed in with the same e-mail address as a user name and a freely selected password. The e-mail service system was connected to the web survey system, and one week after each of the three survey deliveries, the system automatically dispatched a reminder to those who had not yet filled out the web form.

Figure 6. Intervention design Study IV

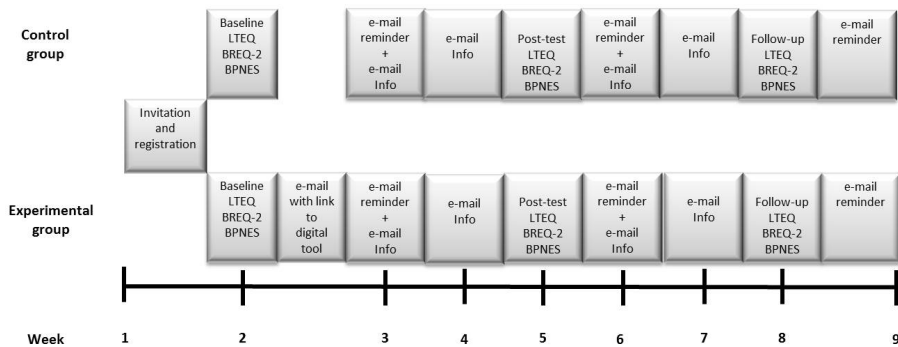

The experimental group was invited and granted access to the intervention application after completion of T1 (via e-mail) and was sent a weekly reminder of this invitation. The control group received weekly e-mails with general health information and health related web links. The first ten participants (from experimental and control group collectively) to complete all three measure points (time was logged by the system) received an activity bracelet (worth approximately 50€). An e-mail announcement asked winners to send their contact details and postal address to the responsible researcher because these were not known or registered. The process spanned over nine weeks in total, from February to April 2015. The intervention trial was approved by the regional ethics board (Dnr. Etik 2014/336) and guided by the CONSORT checklist (Schulz, Altman, & Moher, 2010).

Intervention Study IV

The intervention took place in parallel with a workplace step contest. Because participants could not be invited until after they had registered for the step contest, baseline measures took place approximately one week after the contest had started. The step contest finished two weeks after T2 (post-intervention). In addition to the regular web service available for all step contestants, the experimental group also had access to the intervention (a digital platform adaptable to tablet/smartphone) for three weeks. From a SDT

perspective, the underlying intention was to influence participants' exercise behaviours by manipulating the suggested causal mechanisms described in the process model (see Figure 2), that is, facilitate internalization by providing digital autonomy support, structure and involvement. This was done by constructing a digital intervention package based on approaches for web based interventions recommended in previous research, including goal setting support (Abraham & Michie, 2008; Pingree et al., 2010), regular contact with the participants using e-mail (Brouwer et al., 2011; Plotnikoff, McCargar, Wilson, & Loucaides, 2005), prompts and social functions (Abraham & Michie, 2008), and health literacy (Pingree et al., 2010), see also Vandelanotte and colleagues (2014). In line with the phases proposed by Sallis, Owen and Fotheringham (2000), experiences and results from Study I and II were considered in the intervention design, such as regarding the potential significance of identified regulation and inclusion of RPM and TTM strategies. All CBT and MI influences from Study II were excluded from Study IV, in part because the trained psychologists from Study II (who possessed these specific skills in practice) were not involved in this study, and in part, due to the apparent inconsistencies between CBT and SDT values. Due to practical limitations, the moderating effects of gender and age observed in Study I could not be addressed in this intervention package, but will be considered in future versions.

During their initial login, the participants answered four questions to determine their current status in the TTM and then were automatically sent a number of articles with exercise and physical activity related information tailored to this stage. The prototype did not include possibilities for interactions with professionals (e.g., tailored feedback or advice); autonomy- and competence-need support was provided by exercise and health literacy articles organized in four categories (health, lifestyle changes, inspiration, and tips & facts). The aim was to provide meaningful rationale, while also acknowledging negative feelings, using non-controlling language, offering choice, and encouraging inner motivational resources, as recommended for face-to-face interventions (Su & Reeves, 2011; Fortier et al., 2011). Other provisions included motivational readiness/stage based support in adequate goal-setting/modification, exercise-barrier identification, relapse prevention and health-related exercise rationales (see e.g., Larimer et al., 1999; Stetson et al., 2005; Kahn et al., 2002; Ogilvie et al., 2007). The need for relatedness was covered, primarily, by allowing participants to voluntarily share and view posts (logged activities) from other participants, and to read real life role model stories written and shared for this purpose (Inspiration category).

Data analyses

Study I

Independent sample *t*-tests were conducted to examine differences in psychological need satisfaction and motivation across gender and age groups. In the main analyses, structural equation modelling (SEM) and mediation and moderation analysis using a bootstrapping resampling approach (Preacher & Hayes, 2008; Cerin, 2010) were used, enabling the examination of measurement-error-free associations between constructs and more robust mediational paths. Mplus version 7.1 (Muthen & Muthen, 1998–2009) was used to analyse the data (mediation and moderation) with the robust maximum likelihood (MLR) estimator. For the invariance and moderation analyses, mean age (45.0) was used to create two age groups: a younger (18–45 years) and an older (46–78 years) one. In the invariance testing, we used the recommendations of Cheung and Rensvold (2002). As the Chi-square difference test is sensitive to the sample size, they recommend using a decline in the CFI of 0.01 or less as indicative of invariance. Missing data were handled using a full maximum likelihood (FIML) estimator, which is the default in Mplus. Data from all participants ($N = 1091$), including those who had missing data on some items or variables, were used in the Mplus analyses.

Study II and IV

In the intervention studies, independent sample *t*-tests were performed using the LTEQ (MET, strenuous, moderate, and light exercise), the BREQ-2 (amotivation, external, introjected, identified and intrinsic regulation, and controlled and autonomous motivation computations), the PNES (Study II), and the BPNES (Study IV) to detect any differences between the two groups from the baseline measurements. In Study IV, paired samples *t*-tests were performed for post-intervention and follow-up scores. Instrument reliability was tested using Cronbach's alpha. According to recommendations (Cole & Maxwell, 2003; Senn, 2006), intervention effects were tested through analyses of covariance (ANCOVA); the post-intervention scores (and in Study IV, the follow up scores also) on exercise, need satisfaction and motivational quality were compared in the control and intervention groups, controlling for baseline scores. The significance level for all tests was set to $p < .05$. To test indirect effects, we used multiple mediator models with a bootstrapping resampling approach to calculate product-of-coefficients and an asymmetric 95% confidence interval based on 5000 resamples (Preacher & Hayes, 2004; 2008). All mediation and moderation analyses were performed through the SPSS macro PROCESS, as recommended by Hayes (2013).

Study III

Descriptive statistics were obtained using SPSS version 20. Mplus software (version 7.1; Muthén & Muthén, 1998-2012) was used to perform latent profile analysis (LPA). Model parameters were calculated using maximum likelihood (ML) estimation. Latent profile analysis was performed with the five BREQ-2 subscales (amotivation, external regulation, introjected regulation, identified regulation, and intrinsic motivation) as input variables. A sequence of nested models, starting with one profile and increasing the number from there, were compared to examine if more complex models (with more profiles) fit the data better than more parsimonious models with less profiles. In the present study, models with one to seven profiles were tested to identify the optimal number of profiles. Profiles were added iteratively to identify the best model fit. Based on recommendations from previous research (e.g., Nylund, Asparouhov, & Muthén, 2007), a number of different criteria were used to determine the optimal number of profiles. The Bayesian information criterion (BIC; Henson, Reise, & Kim, 2007) and the sample-size adjusted BIC (SSA-BIC; Yang, 2006) were inspected, with lower values indicating better model fit. The Lo-Mendell-Rubin likelihood test (LMR; Lo, Mendell, & Rubin, 2001) and the bootstrapped likelihood ratio test (BLRT; Arminger, Stein, & Wittenberg, 1999) were used to compare the fit of two competing models. Statistically significant LMR and BLRT tests ($p < .05$) indicate that the target profile solution fits better with the data than a profile solution with one less profile. The entropy criterion, which indicates how accurately people are slotted into their respective profiles, with higher values indicating a better fit for a given solution, was also examined (Aldridge & Roesch, 2008). In addition to the fit criteria, interpretability, theoretical meaningfulness, and parsimony were taken into account when deciding upon the best solution. To support the interpretation of the best-fitting solution, z -scores of the observed variables were used. To examine how the different latent profiles differed in terms of other relevant variables, the three basic psychological needs and exercise behaviour were included in the model as auxiliary variables (Asparouhov & Muthén, 2014). Mplus computes an overall test of association using Wald's test, as well as pairwise profile comparisons between the auxiliary variable means and probabilities.

Table 1. Design overview

	Study I	Study II	Study III	Study IV
Design	Cross-sectional	RCT/Intervention	Cross-sectional	RCT/Intervention
Participants	1091 adult men ($n = 286$) and women ($n = 805$), aged 18-78 years ($M = 45.0$; $SD = 11.7$), all were active members of a web based Swedish exercise program.	64 Swedish undergraduate university students (women $n = 49$ and men $n = 15$) aged 19-49 years ($M = 27.3$; $SD = 7.4$).	Sample A: $N = 1084$, web-based exercise service members, mean age 45 ($SD = 11.7$). Sample B: $N = 511$ university students with a mean age of 22 years ($SD = 3.3$).	318 adult women ($n = 279$) and men ($n = 40$) aged 23-67 years ($M = 46.7$; $SD = 9.4$) participating in a digital step contest provided by their employer
Measures	Basic Psychological Needs in Exercise scale (BPNES) Behavioural Regulations in Exercise Questionnaire-2 (BREQ-2), Leisure Lime Exercise Questionnaire (L-TEQ)	Psychological Needs in Exercise Scale (PNES), Behavioural Regulations in Exercise Questionnaire-2 (BREQ-2), Leisure Time Exercise Questionnaire (L-TEQ)	Basic Psychological Needs in Exercise scale (BPNES) Behavioural Regulations in Exercise Questionnaire-2 (BREQ-2), Leisure Lime Exercise Questionnaire (L-TEQ)	Basic Psychological Needs in Exercise scale (BPNES) Behavioural Regulations in Exercise Questionnaire-2 (BREQ-2), Leisure Lime Exercise Questionnaire (L-TEQ)
Analyses	Structural equation modeling (SEM), mediation and moderation variable analysis (MVA)	Analysis of covariance (ANCOVA), mediation variable analysis	Latent profile analysis (LPA)	Analysis of covariance (ANCOVA), mediation and moderation variable analysis (MVA)

Results

Study I

The theoretical a-priori models displayed good to adequate fits with the data. For the BPNES, the theoretical a-priori three-factor model demonstrated a good fit with data, $\chi^2 = 246.45$ (51 *df*), $CFI = 0.96$; RMSEA: 0.059 (0.052-0.067). The five-factor model of the BREQ-2 demonstrated an acceptable fit to the data ($\chi^2 = 408.60$ (142 *df*), $CFI = 0.94$; RMSEA: 0.044 (0.039-0.049). All standardized factor loadings were statistically significant and, generally over .60. The three factor model of the BPNES displayed strict invariance across gender and age because the CFI did not decrease more than .01 in model fit when constraining factor loadings, intercepts, and residuals to be equal across gender groups (men and women) and the two age-groups. The BREQ-2 demonstrated strong invariance across gender and weak invariance (equal factor loadings) across age-groups.

When using the three need-satisfaction factors simultaneously to predict motivation in the analyses, we found that competence and relatedness predicted autonomous motivation in expected positive directions ($\beta = .89$, $p < .01$ and $\beta = .15$, $p < .01$ respectively) but the path between autonomy need satisfaction and autonomous motivation, which was negative and statistically significant ($\beta = -.33$, $p < .01$), was unexpected. Given that the correlations between autonomy and the latent factors of the BREQ-2 were according to expectations (i.e., positive correlations with identified and intrinsic regulation but negative correlations with amotivation and external regulation), the negative path displayed in the model between autonomy and autonomous motivation most probably signals a suppressor effect rather than a conceptually meaningful result. Because the latent factors of competence, autonomy, and relatedness correlated moderately to strongly, the three psychological need satisfaction factors were collapsed into one total psychological need factor, using a second-order (higher-order) model.

Analyses showed total psychological need satisfaction to positively predict autonomous motivation ($\beta = .68$, $p < .01$) and to negatively predict controlled motivation ($\beta = -.26$, $p < .01$) for the entire sample. For the regulations (see Figure 7), total need satisfaction negatively predicted amotivation ($\beta = -.44$, $p < .01$) and external regulation ($\beta = -.26$, $p < .01$), but had positive statistically significant relations to identified regulation ($\beta = .79$, $p < .01$) and intrinsic motivation ($\beta = .81$, $p < .01$), while only identified

RESULTS

regulation ($\beta = .30, p < .01$) also predicted total exercise (MET) in a full mediation model ($\alpha\beta 6.52; 95\% CI = 3.85-9.19$).

Figure 7. Indirect effects of behavioral regulations

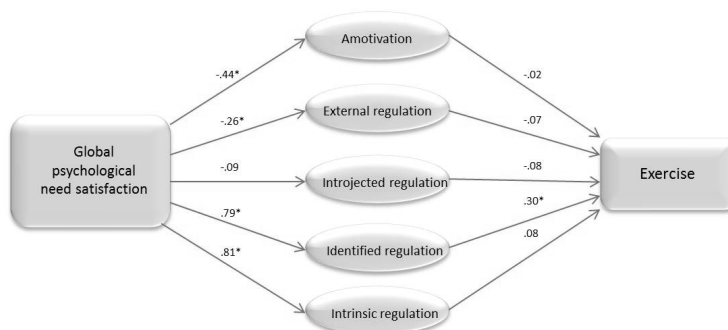

Moderation analyses showed that identified regulation was a strong predictor of exercise for women ($\beta = .40, p < .01$) but not for men, whereas introjected ($\beta = .26, p < .01$) and external ($\beta = .26, p < .01$) regulations positively predicted total exercise (MET) in men, but not in women. The path between total need satisfaction and introjected regulation was positive and statistically significant for men ($\beta = .41, p < .01$) but negative and non-significant for women, and total need satisfaction was more strongly related to identified regulation for men ($\beta = .88, p < .01$) than for women ($\beta = .75, p < .01$). The path between identified regulation and exercise was stronger and statistically significant for the younger age group ($\beta = .52, p < .01$) than for the older one, whereas the path between intrinsic motivation and exercise was positive and statistically significant ($\beta = .24, p < .05$) for the older one and negative and non-significant for the younger group.

Study II

Post-intervention differences

The experimental group reported statistically significant higher total exercise $F(1,58) = 12.4, p < .001$ (η^2 partial = 0.17) post-intervention than the control group. They also showed statistically significant higher levels of strenuous exercise $F(1,58) = 13.66, p = .040$ (η^2 partial = 0.19) post-intervention than participants in the control group, whereas the control group displayed statistically significant more external regulation post-intervention $F(1,58) = 4.41, p = .040$ (η^2 partial = 0.12) than members of the experimental

group. For partial eta-squared in ANCOVA, effect sizes were medium to large, according to Cohen (1988).

Mediating effects

The total effect (c' -path) of the intervention on exercise post-test was statistically significant $c' = 12.77$, $SE: 5.06$, $p < .05$; the total RAI score and identified regulation post-test mediated the effect of the intervention on exercise post-test. The 95% confidence intervals did not include zero, and ranged between 0.30 and 6.57. When considering all the BREQ-2 variables as mediators in the same model, the only statistically significant indirect effect found was for identified regulation, with the bootstrap 95% confidence intervals estimated to be between 0.12 and 11.58. The experimental group had higher RAI scores ($p < .05$) and identified regulation in post-tests (b -path); higher RAI scores and identified regulation were related to higher exercise scores. The indirect effects of the other BREQ-2 variables and of the needs competence and autonomy were not statistically significant, indicated by the fact that zero was included in the 95% confidence bootstrap intervals for these variables.

Study III

Best-fitting profile solution in Sample A

In Sample A, profile 1 ($n = 194$, 17.8%) is characterized by low scores on all variables, in particular on introjected regulation ($z = -0.78$, $p < .01$) and identified regulation ($z = -0.92$, $p < .01$). Consequently profile 1 may be labelled a *low motivation profile*. In contrast to profile 1, individuals in profile 2 ($n = 230$, 21.1%) reported high scores on amotivation ($z = 1.03$, $p < .01$) and external regulation ($z = 1.05$, $p < .01$) but low scores on identified regulation ($z = -0.76$, $p < .01$) and intrinsic motivation ($z = -0.85$, $p < .01$). Profile 2 is, consequently, labelled an *amotivated and controlled motivation profile*. Individuals in profile 3 ($n = 263$, 24.1%) depicted a quite different motivational pattern. This profile is characterized, primarily, by a relatively high introjected regulation ($z = 0.56$, $p < .01$) in combination with slightly above mean scores on identified regulation ($z = 0.21$, $p < .01$) and slightly below mean scores on amotivation ($z = -0.29$, $p < .01$). This profile is named an *introjected and identified motivation profile*. Profile 4 ($n = 115$, 10.5%) shows below average amotivation ($z = -0.33$, $p < .01$) and external regulation ($z = -0.44$, $p < .01$), about average introjected regulation ($z = 0.16$, $p < .01$), and is almost a standard deviation above the mean in identified regulation ($z = 0.95$, $p < .01$) and intrinsic motivation ($z = 0.87$, $p < .01$).

Figure 8. Motivational profiles in best fitting model (6 profiles) in Sample A

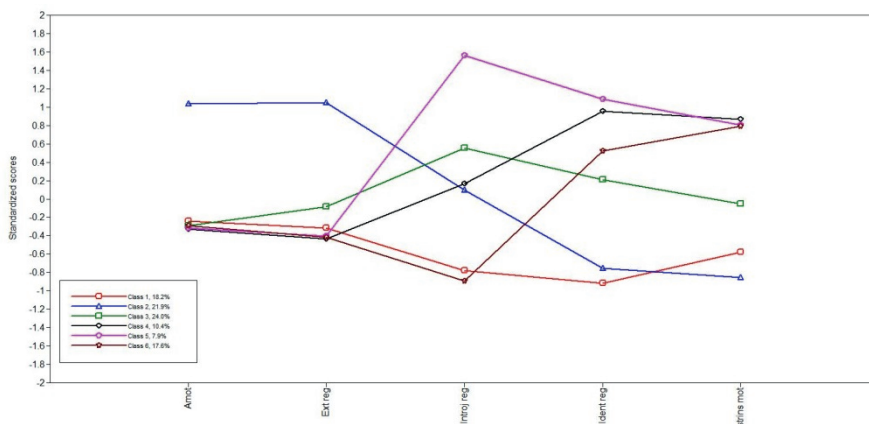

Overall, profile 4 mirrors a *self-determined profile*. Profile 5 ($n = 87$, 8.0%) resembles the overall pattern of profile 4, with low scores on amotivation and external regulation and high scores on identified regulation and intrinsic motivation. Contrary to the average levels of introjected regulation in profile 4, individuals in profile 5 reported very high levels of introjected regulation ($z = 1.56$, $p < .01$). This profile seems to be a *self-determined and introjected profile*. Finally, profile 6 ($n = 200$, 18.4%) resembles profile 4 regarding low scores on amotivation ($z = -0.29$, $p < .01$) and external regulation ($z = -0.41$, $p < .01$), and high scores on intrinsic motivation ($z = 0.79$, $p < .01$). In contrast to profile 4, profile 6 is characterized by lower scores on identified regulation ($z = 0.53$, $p < .01$). More importantly, contrary to the average scores on introjected regulation for individuals in profile 4, individuals in profile 6 reported very low scores on introjected regulation ($z = -0.89$, $p < .01$). Profile 6 is, therefore, labelled a *self-determined and low introjected profile*.

Best-fitting profile solution in Sample B

In Sample B, profile 1 ($n = 140$, 27.4%) has below average scores on all variables, making it a *low motivation profile*. Individuals in profile 2 ($n = 90$, 17.6%) reported average scores on amotivation and intrinsic motivation, but very high scores on external regulation ($z = 1.50$, $p < .01$), high scores on introjected regulation ($z = 0.77$, $p < .01$), and above mean scores on identified regulation ($z = 0.35$, $p < .01$); this profile seems to be an *extrinsic motivation profile*. The very small profile 3 ($n = 21$, 4.1%) is described by low levels of amotivation ($z = -0.53$, $p < .01$) and external regulation ($z = -0.65$, $p < .01$), average levels of introjected regulation ($z = -0.09$, $p > .05$), and very high

identified regulation ($z = 1.22, p < .01$) and intrinsic motivation ($z = 1.12, p < .01$). Profile 3 could clearly be described as a *self-determined profile*. Profile 4 ($n = 75, 14.7\%$) is similar to profile 3 in its low scores on amotivation ($z = -0.45, p < .01$), external regulation ($z = -0.52, p < .01$), and above mean scores (albeit not so very high as in profile 3) on identified regulation ($z = 0.58, p < .01$), and intrinsic motivation ($z = 0.79, p < .01$).

Figure 9. Motivational profiles in best fitting model (6 profiles) in sample B

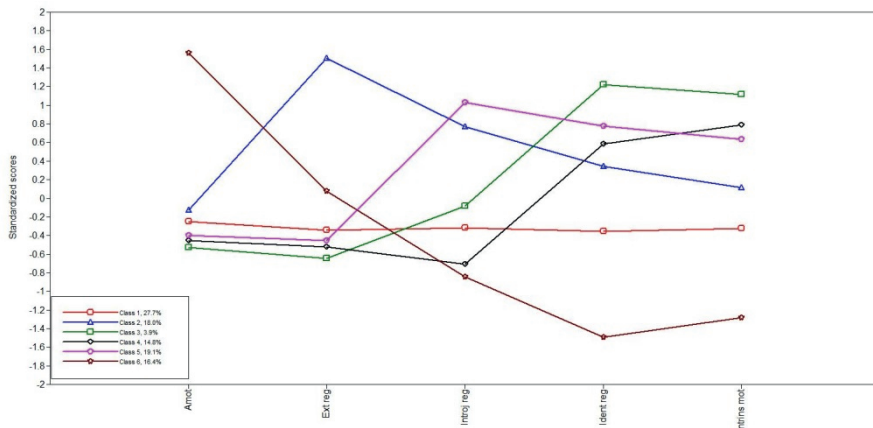

Profile 4 distinguishes itself from profile 3 with low scores on introjected regulation ($z = -0.71, p < .01$). Profile 4 is labelled a *self-determined and low introjected profile*. The members of profile 5 ($n = 101, 19.8\%$) showed similarly low scores on amotivation ($z = -0.40, p < .01$) and external regulation ($z = -0.45, p < .01$) as in profile 3 and 4. They also demonstrated similarly high scores on identified regulation ($z = 0.77, p < .01$) and intrinsic motivation ($z = 0.63, p < .01$) as profile 4. Contrary to profile 3 and 4, profile 5 members also showed very high scores ($z = 1.03, p < .01$) on introjected regulation, describing the total profile as a *self-determined and high introjected profile*. Finally profile 6 ($n = 84, 16.4\%$), is labelled an *amotivated profile* with very high scores on amotivation ($z = 1.56, p < .01$) and low to very low scores on introjected regulation ($z = -0.84, p < .01$), identified regulation ($z = -1.49, p < .01$), and intrinsic motivation ($z = -1.28, p < .01$).

Profile relations to needs, motivation and exercise behaviour

In Sample A, the overall test of equality of means was statistically significant for competence $\chi^2(5) = 124.06, p < .001$, autonomy $\chi^2(5) = 69.18, p < .001$, relatedness $\chi^2(5) = 55.84, p < .001$, and exercise behaviour χ^2

(5) = 16.11, $p < .01$. Similar results were found in Sample B, with the overall equality test being statistically significant for competence $\chi^2(5) = 113.32$, $p < .001$, autonomy $\chi^2(5) = 101.04$, $p < .001$, relatedness $\chi^2(5) = 72.64$, $p < .001$, and exercise behaviour $\chi^2(5) = 41.03$, $p < .01$. More specifically, in Sample A, profiles 4, 5, and 6 demonstrated higher satisfaction in terms of all three psychological needs (competence, autonomy, and relatedness) compared to profiles 1, 2, and 3 ($ps < .05$). Profile 3 showed higher competence and relatedness satisfaction compared to profiles 1 and 2 and higher autonomy compared to profile 2 ($ps < .05$). Regarding exercise behaviour, profiles 3-6 reported exercising more than profiles 1 and 2 ($ps < .05$). Profile 6 also exercised more than profiles 1, 2, and 3.

In Sample B, profiles 3, 4, and 5 reported higher need satisfaction regarding competence, autonomy, and relatedness, and reported greater levels of exercise compared to profiles 1, 2 and 6 ($ps < .05$). Profile 2 had higher competence and autonomy scores compared to profiles 1 and 6, and profile 1 reported higher competence and autonomy compared to profile 6 ($ps < .05$). Profiles 1 and 2 also scored higher on relatedness and exercise levels compared to profile 6 ($ps < .05$).

Study IV

Post-intervention differences between groups

The group treated as intended (TAI group) reported statistically significant lower levels of external regulation $F(1,84) = 16.91$, $p = .000$ (η^2 partial = .04) and controlled motivation $F(1,84) = 9.90$, $p < .001$ (η^2 partial = .05) post-intervention than participants in the control group. Regarding exercise behaviour, participants in the TAI group displayed, post-intervention, statistically significant higher total exercise (MET) $F(1,84) = 6.45$, $p = .012$ (η^2 partial = .03), strenuous exercise $F(1,84) = 4.29$, $p = .039$ (η^2 partial = .08), and light exercise $F(1,84) = 5.01$, $p = .026$ (η^2 partial = .02) than members of the control group. The TAI group also showed statistically significant higher autonomy need satisfaction $F(1,84) = 32.87$, $p = .001$ (η^2 partial = .15) and total need satisfaction $F(1,84) = 7.99$, $p = .005$ (η^2 partial = .04), but lower amotivation $F(1,84) = 5.85$, $p = .017$ (η^2 partial = .03) than the control group in the follow-up measures. Except for the large effect size for autonomy need satisfaction (.15), the partial eta-squared were medium sized (.03-.08) for ANCOVA analyses (Cohen, 1988).

Mediation (indirect) effects

When examining mediation effects of regulations and psychological needs on exercise, only one mediation effect was found. There was an indirect

effect of amotivation post-intervention ($a\beta$ 1.40; 95% $CI = 0.37- 2.94$) in the effect of the intervention on total exercise (MET) at follow-up. Both the a -path (β -0.11; 95% $CI = -0.21- -0.01$) as well as the b -path (β -12.55; 95% $CI = -22.86- -2.25$) were statistically significant. The TAI group reported lower amotivation level post-intervention, which in turn predicted higher exercise score at follow-up. For the other examined variables, there were statistically significant a -paths between T2 and T3 for external regulation (β -0.27; 95% $CI = -0.44- -0.09$) and controlled motivation (β -0.21; 95% $CI = -0.39- -0.03$) and statistically significant b -paths in intrinsic motivation (β 4.35; 95% $CI = 0.38-8.23$), and autonomous motivation (β 2.29; 95% $CI = 0.08-4.51$).

Figure 10. Indirect effects of the intervention between T2 and T3

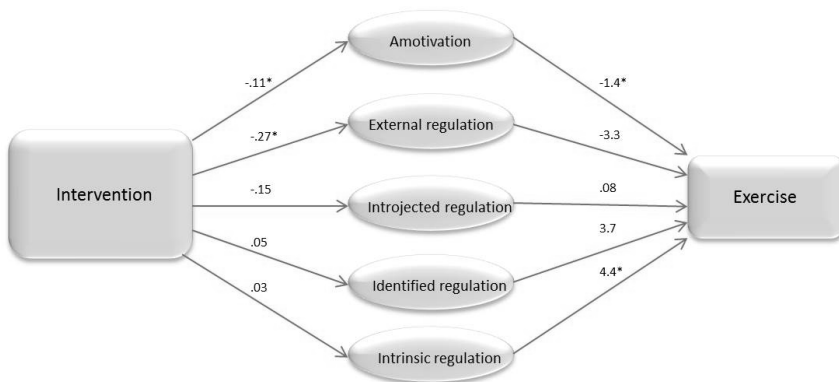

Testing a model using psychological need satisfaction as mediating variables between intervention and exercise, statistically significant a -paths were found between autonomy need satisfaction (β 6.67; 95% $CI = -3.19- -10.16$), competence need satisfaction (β 7.03; 95% $CI = 2.27-10.69$), relatedness need satisfaction (β 3.53; 95% $CI = 0.39-6.67$) and total need satisfaction (β 2.53; 95% $CI = 1.21-3.85$) between post-intervention (T2) and exercise at follow-up (T3).

Moderating effects of the intervention

Moderation analyses showed that the effect of the intervention on light exercise post-intervention was stronger for those with moderate ($\beta = 3.31, p < .01$), or high levels ($\beta = 8.81, p < .01$), of light exercise at baseline; the intervention effect on identified regulation at follow-up was stronger for those with low levels of identified regulation ($\beta = 0.39, p < .05$) at baseline. Explained variance ranged between r^2 .33 to .58.

Moderating effects of gender on exercise

No moderating effects of gender were detected in terms of intervention effects, but gender moderated the general effects of motivation on exercise in the full sample. The path between external motivation at baseline and total exercise at baseline was negative and statistically significant for women ($\beta = -7.19, p < .05$), but positive and non-significant for men. Similarly, external regulation post-intervention predicted total exercise at follow-up for men in a positive direction ($\beta = 11.29, p < .01$), but was negative and non-significant for women. Identified regulation post-intervention had a negative statistically significant relation to strenuous exercise at the same time-point for men ($\beta = -16.52, p < .01$), but had a positive and non-significant relation in women.

Gender was also found to moderate the general relationships between motivational regulations and exercise and also between motivational regulations and psychological need satisfaction. Intrinsic regulation post-intervention positively predicted relatedness need satisfaction for women at that time-point ($\beta = 0.47, p < .05$), but this path was negative and non-significant for men. Additionally, relatedness need satisfaction at post-intervention was positively associated with identified regulation in women at the same time-point ($\beta = 0.37, p < .05$), but was not related to motivation in men. Relatedness need satisfaction post-intervention had a negative relation to external regulation at that time-point in women ($\beta = -0.13, p < .05$), but not in men. Finally, intrinsic motivation post-intervention was more strongly related to autonomy need satisfaction at follow-up for women ($\beta = 0.78, p < .05$), than for men ($\beta = 0.28, p < .05$). Except for identified regulation ($r^2 .13$), explained variances were small ($r^2 .03$)

Moderating effects of age on exercise

Similarly to the effects of gender, no moderating effects of age were detected in terms of intervention effects; age was, however, found to moderate the general relationships between motivational regulations and exercise in the full sample. A negative association between external regulation post-intervention and strenuous exercise at follow-up was stronger and statistically significant for older adults ($\beta = -8.90, p < .01$) compared to middle-aged adults and was positive (but non-significant) for younger adults. The paths between amotivation at baseline and light exercise at baseline ($\beta = 3.59, p < .05$) and T2 ($\beta = 3.45, p < .05$) were positive and statistically significant for younger adults, but weaker and non-significant for middle-aged adults, and negative and non-significant for older adults. Similarly, the effect of amotivation at baseline on light exercise post-intervention was positive and statistically significant for younger adults ($\beta = 3.45, p < .05$), but weaker and non-significant for middle-aged adults, and negative and non-

significant for older adults. Additionally, there was a statistically significant and positive path between autonomy need satisfaction at follow-up and moderate exercise at follow-up; it was stronger for older ($\beta = 4.38, p < .05$) and middle-aged adults ($\beta = 1.41, p < .05$) than for younger adults. Competence need satisfaction ($\beta = 4.13, p < .05$) and total need satisfaction ($\beta = 1.50, p < .05$) at follow-up positively predicted moderate exercise at that time-point for older adults, but not for middle-aged adults. These paths were negative and non-significant for younger adults. Explained variance ranged from $r^2 .03$ to $.07$.

Discussion

Enhancing the knowledge of how interventions promoting sustainable exercise motivation and behaviour can be designed has strong implications for the theoretical understanding of the mechanisms of motivation. The overall aim of this thesis was to explore the motivational processes behind exercise behaviours, with the self-determination theory (SDT) as a guiding framework. First, the most essential results of all four studies will be addressed; then a more detailed discussion will be held, followed by a general discussion with future directions, limitations and conclusions. A brief summary of the contributions of the included studies is presented in Table 2 (page 88).

As initially outlined, contemporary literature offers considerable evidence on the potential health benefits of regular physical activity and exercise (e.g., WHO, 2013; YFA, 2010; Petersen et al., 2015), but because modern society places little or no physical demands on people for survival, and because the palaeolithic rhythm has encoded humans to take any opportunity to rest and save energy (Booth et al., 2002; Åstrand, 1992), people often have to take deliberate action regarding physical activity and exercise behaviours. Most Western countries have developed guidelines and programs to inform and promote physical activity and exercise behaviours for the population to gain desired health benefits. As mentioned before, health statistics show that many people do not reach these recommended activity levels (Hallal et al., 2012; WHO, 2011). Research has also demonstrated that approximately half of those who actually try, fail to maintain regular exercise habits (e.g., Nigg et al., 2008), and that approximately half of those getting physical activity on prescription do not actually increase their physical activity level (Kallings et al., 2009; Leijon et al., 2009). Apparently, few programs generate sustainable changes in the long term (Cerin, 2010; Baranowski et al., 1998; Bauman et al., 2002; Bauman et al., 2012), and because the targeted behaviours rely on multifaceted and complex relationships between various factors (e.g., Baranowski et al., 1998; Bauman et al., 2002; Nigg & Geller, 2012) there is a need for guidance on how to properly design successful programs along with acceptance of new approaches in research and practice (Hallal et al., 2012). Because interventions operate through mediating processes, the study of indirect effects and clarifying mechanisms through MVA adds to the knowledge of how observed intervention effects could be interpreted and understood (MacKinnon et al., 2007). This could also endorse the evaluation

of theory capacity and conceptual theory links (Cerin & MacKinnon, 2008), a progression in this line of research (Nigg & Geller, 2012). Targeting the proposed mediators of behaviour change by focusing on moderating variables could be of assistance in adjusting the interventions for different groups/individuals or situations and could help create effective interventions (Cerin, 2010). Focusing on known factors and mechanisms assumed to increase behavioural outcomes, in this case physical activity and exercise, allows for systematic improvement and an understanding of how theory operates in successful interventions (Bauman et al., 2002; 2012). In turn, this allows for possible improvement by including effective components while removing ineffective ones, facilitating the design of more cost-effective programs (Baranowski et al., 1998; Cerin & MacKinnon, 2008).

Previous research and practice have generated ample knowledge of what works in exercise and physical activity promotion on a general level, but less is known about why it works, more specifically, the underlying mechanisms (Cerin & Mackinnon, 2008). Although several studies have supported the different individual paths of the proposed mediating model of SDT, few have fully tested the key assumption that autonomous motivation will mediate the association between need satisfaction and exercise outcome, especially considering possible moderating factors. By adding some new pieces to the puzzle, this thesis contributes to the understanding of how autonomy-supportive conditions facilitate autonomous motivation and subsequent outcomes regarding exercise behaviour. Such knowledge constitutes a foundation for creating effective interventions and methods in public health programs as well as in specific domains such as schools, fitness centres and workplaces, or for instance addressing the attrition rates reported in physical activity on prescription (PaP; see Kallings et al., 2009; Leijon et al., 2009).

Overall, the results of the four studies in this thesis correspond to the predictions from an SDT perspective and support the key assumption that a higher degree of psychological need satisfaction will be associated with increased exercise via more autonomous motivation (e.g., Deci & Ryan, 2000; Hagger & Chatzisarantis, 2008; Fortier et al., 2012; Vallerand & Losier, 1999) Williams et al., 2006). By studying the motivational processes through mediation and moderation effects instead of focusing on direct or mean-level effects, this thesis represents a requested extension of previous studies in the field of exercise and physical activity (e.g., Biddle et al., 2012; Nigg & Geller, 2012; Bauman et al., 2002; Fortier et al., 2012; Teixeira et al., 2012; Cerin, 2010; Pingree et al., 2010). A key finding of this thesis is that patterns of need satisfaction, motivational regulations, and exercise differed across age and gender, proposing that mechanisms in the SDT process model possibly could vary (qualitatively) in different subgroups. Although gender

and age did not significantly moderate the indirect effects of autonomous motivation on the associations between psychological need satisfaction and exercise in Study I, the findings of gender and age in full sample analyses of Study I and IV highlight the need to further address these matters in future studies by means of moderated mediation and mediated moderation analyses (see Fortier et al., 2011). Gallagher and colleagues (2012) proposed that “one size may not fit all” and the current findings support the idea that a generic method will not be successful in all situations and for all participants. It seems that one important key to success is personalization and timing, that is, doing the right thing for the right person at the right time. Based on the results of Study II and IV, a second key finding of this thesis is the that the mediating mechanisms of the process model can be manipulated in an intervention, by, for example, creating need-supportive environments facilitating internalization and subsequent exercise behaviour. In following suggestions for further research made by Teixeira and colleagues (2012); and Edmunds and colleagues (2006), both Study I and II demonstrated that identified regulation plays a prominent role in the motivational processes, and supports the significance of internalizing the values behind a behaviour for the regulation of challenging activities such as exercise (Deci & Ryan, 2000). A third key finding is related to Study III and the preliminary support of the notions behind the motivational soup by presenting motivational profiles based on person-centred analyses. Fourth, amotivation was involved in statistically significant main (time) effects and also played an unexpected role in the motivational processes of younger adults in Study IV. Finally, the prospective value of combining SDT with other theoretical approaches and methods also constitutes a valuable outcome of this thesis. Implications of these findings will be addressed below.

Psychological needs and behavioural regulations

To begin with, the translated versions of the BPNES (Vlachopoulos & Michailidou, 2006) and the BREQ-2 (Markland & Tobin, 2004) displayed acceptable factorial validity, reflected by a good fit between data and theoretical a-priori models (BNT and OIT) in the confirmatory factor analyses. It seems proper to suggest that these instruments constitute robust and valid measurements of psychological needs and autonomous motivation, not only in their original language versions, but also in translated versions across languages and cultural contexts (Vlachopoulos, Ntoumanis, & Smith, 2010). Study I was the only study in this thesis where the latent constructs of psychological need satisfaction and motivation were examined, reducing the

DISCUSSION

bias of measurement error. The respective satisfaction of the three psychological needs was, as expected, strongly and positively associated, generally supporting the trends in previous works (Hagger & Chatzisarantis, 2008; Wilson & Rodgers, 2008). Regarding the specific pattern of associations between the needs, strong correlations were found between autonomy and competence, followed by the correlation between relatedness and competence, and between relatedness and autonomy. The stronger association between competence and autonomy could be a probable cause of the observed suppressor effect in Study I. The suppressor effect exposed a negative association between autonomy need satisfaction and autonomous motivation, which is inconsistent with expectations from an SDT perspective. Nevertheless, previous studies (Hagger et al., 2006; Markland & Tobin, 2010) have found that a single global need satisfaction factor explains latent variables representing autonomy, competence, and relatedness. Collapsing the three needs into one total latent need satisfaction factor proved to fit the present data well. Because the respective satisfaction of the three needs is suggested to be complementary (Deci & Ryan, 2002; Wilson & Rodgers, 2007), the global or total need factor seems to be a reasonable solution. Altogether, this might indicate that the observed suppression is not caused by conceptual theory or mediator measurement problems, issues suggested as probable causes of this particular phenomenon (Cerin and MacKinnon, 2008).

The slightly weaker correlation between the need for relatedness and the other two needs has been noted in several previous studies (Wilson & Rodgers, 2007; Wilson et al., 2006; Wilson et al., 2002). Inconsistencies regarding the role of relatedness in exercise settings are well-known and could in part be attributed to measurement differences and operationalization (Markland & Tobin, 2010; Teixeira et al., 2012). Markland and Tobin (2010) suggested that relatedness might be more properly measured by distinguishing between general (broader social and cultural relations) and specific dimensions (intimate relations with significant others). Another possibility could be that relatedness support may have a somewhat different bearing in different relationships (e.g., friends and family versus health professionals or exercise instructors) and may originate from multiple sources. This would be especially true in solitary activities, which also makes the use of BPNES slightly problematic because most items tapping social aspects in exercise motivation concern the relation to other exercisers. For example, some people exercise alone because they prefer to exercise alone, muddling the importance of relatedness in these activities and making it harder to comprehend.

Taken together, these inconsistencies resulted in the choice to exclude the relatedness dimension from the measures in Study II, and also, to use another instrument to measure psychological need satisfaction (PNES) in that study. Potential issues with this decision are further discussed on page 67. In Study I, autonomy, competence, and relatedness need satisfaction all had a statistically significant positive relation to autonomous motivation (identified and intrinsic regulation) and a statistically significant negative relation to external regulation and amotivation, which is consistent with theory (Deci & Ryan, 1985; 2000) and previous research (Wilson & Rodgers, 2004; McDonough & Crocker, 2007; Teixeira et al., 2012; Hagger & Chatzisarantis, 2008). The findings of Study I are also supported by Study III, where the motivational profiles that were characterised by high autonomous motivation also demonstrated higher psychological need satisfaction compared to profiles with more mixed or controlled motivational patterns. This is perhaps not surprising, because one of the samples in Study III (Sample A) was the same as in Study I; but it is still noteworthy that the results are consistent also in terms of motivational profiles and within-person analyses. Relatedness was a relatively strong predictor of autonomous motivation, also in a comparable study (employing similar modern recommended analyses) on adult dragon boaters by McDonough and Crocker (2007), highlighting the potential importance of relatedness in motivational processes. As dragon boating is a team activity likely to entail group support and cohesion, and as most of the participants in Study I took part in a step contest as teams, both settings clearly tap the relatedness dimension. In Study IV (applied in the same type of workplace related step-contest as in Study I), it was further explored whether psychological need associations would be dependent on personal or demographic circumstances. Moderation analyses for the full sample in Study IV revealed that intrinsic regulation positively predicted relatedness need satisfaction for women, but this path was negative and non-significant for men. Additionally, relatedness need satisfaction positively predicted identified regulation in women, and had a negative relation to external regulation in women, but was not at all related to motivation in men. These results contradict the speculation by Wilson and colleagues (2002), who proposed that relatedness could perhaps be more important in extrinsic than intrinsic regulations, and emphasize the question raised by McDonough and Crocker (2007) regarding the need for further exploration of what circumstances under which relatedness is most prominent. The endorsement of relatedness in Study I and IV could be linked to the specific web service conditions regarding the team-based competitive components in workplace settings. This could be an example of how competition is need-supportive, rather than thwarting, by facilitating strong

group cohesion, and thereby also increasing the magnitude of relatedness satisfaction. Again, this is partly supported by Study III, where relatedness was also positively associated with autonomous profiles of motivation in Sample A (the same sample as Study I).

SDT postulates that one has to feel both competent and related (or at least a desire for relatedness) to be introjected (Ryan & Deci, 2007), but in Study I, introjected regulation had non-significant relations to both competence and relatedness. To sum up, future studies examine the relatedness dimension in exercise more thoroughly, especially contextual and personal circumstances such as type of activity, group versus solitary activities, age and gender, stage of change, and so forth. Because different dimensions and sources of relatedness are not captured in the current measures, measurement refinement would be a relevant avenue for progressive research.

Psychological needs, behavioural regulations and exercise behaviour

The construct of light exercise in the LTEQ is mainly operationalized as lifestyle activities (e.g., walking, fishing, golfing) with low exertion, perhaps more equivalent to definitions of physical activity than exercise per se, which makes a cross-reference to other physical activity interventions more suitable. In support of this assumption, Sweet, Fortier and Blanchard (2014) have actually used the LTEQ to measure physical activity. Following the recommendations of previous research (e.g., Rhodes & Pfaeffli, 2010; Cerin & MacKinnon, 2009; Baranowski et al., 1998) Study I, II and IV examined relationships between psychological needs, autonomous motivation and exercise behaviour according to the related steps of the process model. In Study I the main analyses in the full sample showed that higher total need satisfaction predicted a more autonomous motivation, which in turn predicts behavioural outcomes in terms of more exercise. More in detail, total need satisfaction especially predicted identified regulation, which in turn also predicted total exercise, thereby supporting the last three steps of the SDT process model (see Figure 2). Although the recommended analyses for cross-sectional data (MacKinnon, 2008; Kline 1998) were used, causal inference in cross sectional data is limited and the reciprocal influences assumed to be present in the process model remain elusive. Study designs containing repeated measures provide better insight into mediational processes by adding a temporal aspect, allowing for sequential observation (Cerin, 2010). In Study II an important step was added by including an intervention representing the first step of the described process model. The results from Study I were recurring in Study II, showing the intervention effect to be

mediated by identified regulation. The potential value of identified regulation for demanding activities such as physical activity and exercise is thereby reinforced, along with the suggestion that identified regulation could be the most salient regulation in exercise behaviour (Teixeira et al., 2012). Results from Study I and II support the general suggestions that more internalized regulations have a strong influence on behaviours that are not necessarily inherently rewarding or enjoyable (e.g., Deci & Ryan, 2000; Edmunds et al., 2006). Also Study III supports this assumption, because participants in the more autonomously motivated profiles were exercising more regularly, especially compared with controlled motivation profiles; this finding aligns with similar studies of person-centred analysis which have demonstrated that people who exhibit more self-determined profiles find exercise more enjoyable (Friederichs et al., 2015; Guerin & Fortier, 2012) and are more physically active (Friederichs et al., 2015). The experiences from Study I and II were considered when tailoring the content of the digital intervention in Study IV by, for example, highlighting the values behind engagement in active behaviours.

The mediating effects outlined above are in agreement with SDT postulations (Deci & Ryan, 2000; Ryan & Deci, 2002) and previous research (Sweet et al., 2014; Fortier et al., 2012; Teixeira et al., 2012), adding to the substantial body of research confirming associations between autonomous motivation and positive behavioural outcomes such as physical activity and exercise. The findings on identified regulation were not repeated in Study IV. In this study, a more intriguing result was found, showing that the participants who were treated as intended (TAI group) reported lower amotivation level post-intervention than the control group, and that amotivation level post-intervention in turn predicted higher total exercise score at follow-up. Although it is consistent with SDT tenets, this mediational path is rarely observed and might be interesting for several reasons. Considering the well-known risks of physical inactivity and sedentary behaviour (WHO, 2009b, 2010; Lee et al., 2012; Healy et al., 2012; Katzmarzyk, 2010) combined with the reported poor uptake of sufficient physical activity and exercise in Western countries (Hallal, 2012; WHO, 2011), and the well-known drop-out rates for those trying to adopt these behaviours (Kallings et al., 2009; Leijon et al., 2009; Buckworth et al., 2013; Lox, et al., 2010; Nigg, et al., 2008), the issue of “motivating the unmotivated” is acknowledged as a key challenge in health promotion (Hardcastle & Hagger, 2015; Miller & Rollnick, 2013; Peters et al., 2013). Amotivated people have low intentions and adherence towards exercise related behaviours (Thøgersen-Ntoumanis & Ntoumani, 2006); it has been suggested that approximately 30% of the population lack the intention to

exercise (Rhodes & DeBruijn, 2013). According to Sheldon and colleagues (2003), one reason for the low uptake rates could be that society has a poor understanding of motivation, which could mean that health promotion is not communicated in ways that promote internalization. The findings of Study IV could, therefore, be considered promising regarding the digital intervention's capability to affect a construct as critical as amotivation, which, in turn, influences exercise behaviour. The motivational sequences displayed in Studies I, II, and IV support previous research showing the value of using the SDT process model (e.g., Williams et al., 2006; Williams et al., 2002; Fortier et al., 2012; Pingree et al., 2010; Silva et al., 2011) and contribute to the understanding of how theory works in interventions (Baranowski et al., 1998; Cerin & MacKinnon, 2009) as well as to the understanding of behaviour change (Lubans et al., 2008). The observation of a negative (statistically significant) action theory link between the intervention and amotivation supports the assumed efficacy of the intervention; the negative (statistically significant) conceptual theory link confirms SDT stipulations by suggesting that changes in exercise were induced by changes in amotivation (Cerin et al., 2009). This indicates that work-place programs might be a good spot to reach a target group that is as hard, but highly relevant, to reach as the amotivated ones.

It seems unlikely to find amotivated people in exercise contexts (Teixeira et al., 2012), but the workplace related step-contest might provide some explanation. The competition was provided (and payed for) by the employer and, even though participation was voluntary, some employees might have joined reluctantly or felt obliged to participate for different reasons such as group induced pressures or fear of negative job-related consequences. Such inclinations would primarily be associated with controlled motivation, but because external regulation was shown to be a positive predictor of exercise in some moderation analyses (see below), it might not be too farfetched to suggest that amotivation and external regulation overlap or, at least coincide here, possibly in line with the arguments behind the motivational soup (Patrick, 2014). In addition, for Sample A in Study III, profile 2 was labelled amotivated and controlled motivation profile, and showed high scores on amotivation and external regulation (but low scores on identified regulation and intrinsic motivation), that might confirm this assumption. The motivational soup is further discussed below (page 71).

Moderating effects of gender and age

Gender as a moderator

Based on SDT stipulations, the connection between psychological needs and motivation would be universal across populations, but it could be assumed that the relationship between motivation and behaviour might differ between subgroups (Deci & Ryan, 2000). Because factors such as age, gender, and culture could influence how basic psychological needs are met (Ryan & Deci, 2002), such factors could also be expected to have an impact on the development of behavioural regulations. This would be especially true considering the importance of social contexts in SDT. Bearing in mind that exercise-related values and goals are likely to differ between people in different demographic groups (e.g., gender, age, culture), the mechanisms within the SDT process model are also likely to vary as a function of such influences. This research topic does not necessarily contradict the proposed universality of SDT constructs (Guérin et al., 2012) and previous research has strongly advocated the examination of age and gender differences instead of grouping these data together to focus on general associations (Guerin et al., 2012; Teixeira et al 2012; Owen, et al., 2014). By extending previous research, Study I revealed autonomous motivation as a stronger predictor of exercise for women than for men. More specifically, identified regulation was found to mediate the relation between need satisfaction and exercise in women, and external regulation served as the corresponding mediator only for men. These findings were, in essence, recurring in moderation analyses of the full sample (treating participants from experimental and control groups as one group) in Study IV. External regulation post-intervention predicted total exercise at follow-up for men in a positive direction, but this path was negative (however non-significant) for women. Instead, external motivation at baseline negatively predicted total exercise for women at the same time point, whereas this path was positive and non-significant for men. Identified regulation post-intervention, on the other hand, had a negative relation to strenuous exercise at the same time point for men, but was positive and non-significant for women. As described above, Study IV examined yet another step in the process model regarding the patterns between relatedness and motivation described above, in which the relations between relatedness and autonomous motivation followed SDT expectations for women, but not for men. It seems that the stipulated mechanisms between exercise, motivation and psychological need satisfaction in Studies I and IV are clearly more active for women than for men. The reversed paths, even though some of them were not statistically significant, are particularly noteworthy, such as identified regulation having a negative effect on exercise in men and extrinsic regulation having a negative effect on exercise for women, and vice versa.

Although gender did not moderate intervention effects, these circumstances confirm the points of direction for the differences in gender associations found here and give us reason to believe that they might, actually, reflect true directions in this specific sample.

The present results might have been affected by the sample constitution of both studies (mainly women) and the tendency that women seem to be more prone than men to join web-based health programs (see Brouwer et al., 2010; Dawson, Tracey, & Berry, 2008; Napolitano et al., 2003), and therefore they could be expected to be more self-determined participants of the step-contest (which is delivered as a web-based service). Women may, to a greater extent than men, also participate for social reasons, an idea supported by the discovery of links between autonomous motivation and relatedness need satisfaction, appearing in Studies I and III on a general level, and the specific findings for relatedness need satisfaction in the association to motivation for women in Study IV. It is, however, harder to explain differences in prediction than differences in level. Furthermore, because competition can generally be expected to have extrinsic connotations, the predictive value of external regulation of men's exercise behaviour could be referred to the competitive context. It is possible that the men in these two studies are more regulated than the women by the external rewards (i.e., winning). Some of the limitations of these studies is that Study I is of cross-sectional design and that Study IV only spanned over a few weeks. This means that the findings regarding men and controlled motivation could reflect the concept that controlled motivation might work in the short term (Deci & Ryan, 1985), and the findings say nothing about the stability of these associations over a longer period of time.

Age as a moderator

In Study I, mean age (45 years) was used to split the sample into two age groups: younger adults (18-45 years) and older adults (46-78 years). In Study IV, the sample was split into three age groups: younger adults (23-34), middle-aged adults (35-54) and older adults (55-67) to provide more detailed information. It should be noted though, that when splitting the sample in Study I into three age groups (younger, middle-aged, and older adults) the findings on age differences remained essentially similar to those based on two age groups. The distribution of gender was similar across the different age groups in both studies. The analyses in Study I showed that identified regulation mediated the relation between need satisfaction and exercise behaviour for younger adults only, whereas intrinsic motivation mediated this link for older adults. In Study IV, a negative association between external regulation post-intervention and strenuous exercise at follow-up was stronger

and statistically significant for older adults compared to middle-aged adults, but was positive (and non-significant) for younger adults. These findings could be related to previous mean-level research showing older adults to have more autonomous goals and motives (Beck et al., 2010) and younger adults to be affected by more controlled motivational foundations (Brunet & Sabiston, 2011). Unlike Study I, Study IV also showed that age moderated relations of psychological need satisfaction and exercise. There was a positive path between autonomy need satisfaction at follow-up and moderate exercise at the same time-point, and it was stronger for older and middle-aged adults than for younger adults. Furthermore, competence need satisfaction and total need satisfaction at follow-up also positively predicted moderate exercise at that time-point for older adults, but not for middle-aged adults, and these paths were negative and non-significant for younger adults. An unexpected finding was that the paths between amotivation at baseline and light exercise post-intervention was positive and statistically significant for young adults, but weaker and non-significant for middle-aged adults and negative and non-significant for older adults. The same pattern was shown in the path between amotivation at baseline and light exercise at the same time-point. Such a link could be considered to be quite exceptional (see e.g., Teixeira et al., 2012; Hardcastle et al., 2015) and could challenge theoretical expectations from a SDT point of view (Deci & Ryan, 2002). Although it seems possible to participate in exercise activities (at least in light activities) even when amotivated, engagement is still likely to be non-volitional, and, referring to previous discussions, the competition context is a probable reason, also possibly due to work-place related forces.

Overall, the results for middle-aged and older adults are consistent with SDT expectations. It makes sense that psychological need satisfaction was positively associated with exercise and the negative path between strenuous exercise and external regulation follow the same logic. Conversely, the reversed paths for younger adults (although not all of them statistically significant) are more challenging to explain from a SDT perspective. Even if they might be considered to be in agreement with Study I, the associations are in this case likely to have underpinnings in the social environmental context and might be clarified by the same arguments as for the findings of gender moderations. Generally, previous research has however shown that older adults have more intrinsically oriented exercise goals and motives (Beck et al., 2010), while younger adults tend to have less autonomous ones (Brunet & Sabiston, 2011) and similar patterns have also been observed in studies on work-related motives (Kooij, De Lange, Jansen, Kanfer & Dikkers (2011), indicating these results actually might reflect a more general phenomenon rather than a context specific occurrence. This may contribute to

the explanation of why older adults could be expected, generally, to be more autonomously regulated and younger adults to be more controlled in Studies I and IV. It could show that older adults, at least in these samples, might have more internalized goals, related more to aspects of health and less to appearance, a suggestion for future research to examine.

Collectively, the results on gender and age differences in Studies I and IV can be considered to advance the knowledge of mediating and moderating factors and possible mechanisms between hypothesized SDT constructs and exercise behaviour. The findings highlight the value of examining potential moderators to identify what causes effect in an intervention and for whom (Hayes, 2009; van Stralen, 2010; Hardcastle & Hagger, 2016) even though the effects of gender and age were only found for the full sample in Study IV, and not in analyses with intervention as an independent variable. When interpreting the moderation results of gender and age, the literature on gender differences in motivational regulations is inconsistent (see e.g., Daley & Duda, 2006; Hamilton et al., 2012; Guérin, Bales, Fortier, & Sweet, 2012) and mainly concerns mean levels of motivation or direct effects, not (as in these two studies) indirect effects and moderation. The literature on moderation concerning age in behavioural regulations is as scarce as in gender. Even though earlier findings on mean levels for different age groups are more consistent than those regarding gender, rational interpretations of the current results still appear rather complicated. At this stage, it is clearly challenging (and probably premature) to generate sensible explanations for these mechanisms. To extend these exploratory analyses, the investigation of cross-study differences in SDT-related relationships regarding gender, age, and other potential moderating factors highlighted in previous research (Guérin et al., 2012; Teixeira et al., 2012), along with analyses of moderated mediation and mediated moderation (Fortier, 2011), needs to be addressed in future studies.

Given the proposed universality within the SDT framework, an explanation in line with theory would be that observed differences of gender and age could be influenced by the extent to which the social context supports (or thwarts) need satisfaction for a given subgroup, such as in competitive and/or in digital contexts. Although in a different context, Gillison and colleagues (2009) concluded that gender differences in adolescents' exercise motivation was attributed to (practically opposite to each other) influence of social environment variances, which might support this assumption. If the social context is part of the explanation it carries positive outlooks for interventions targeted at tailoring environmental structures, not only at personal or group levels but also for meta-structures such as city or landscape planning and architectural strategies (i.e., stepping

away from “doing more of the same”). The observed mechanisms may also be partly explained by the general (stereotypic) gym culture; social context at fitness clubs might generate different opportunities for optimal psychological need fulfilment for men and women, as well as at different stages of life. Furthermore, older adults could be assumed to have more leisure time and better opportunities to choose interesting and stimulating exercise activities and/or be more prone to engage in and seek out a need supportive context. It is also possible that these particular samples of older adults are different than the archetypal/general person in this age group, regarding, for instance, their use of web-based exercise services.

Intervention effects

General effects

Results from Study II demonstrated that the intervention had a positive effect on exercise behaviour and internalization. The results displayed intervention effects on exercise level, exercise intensity and motivation quality, as well as mediating effects of identified regulation in relation to exercise behaviour. The experimental group also demonstrated statistically significant lower levels of extrinsic motivation than the control group post-intervention. In Study IV, the intervention had positive effects on exercise level and intensity between the baseline and post-intervention time-points for the participants exposed to the digital tool (the TAI group). Also, the TAI group reported lower scores on external regulation and controlled motivation post-intervention, and had lower levels of amotivation, but higher autonomy need satisfaction and total need satisfaction at follow up measures. In the TAI group, post-intervention amotivation mediated the effects on exercise behaviour at follow-up, with both a negative *a*-path and *b*-path. The results from both Studies I and IV support the tenets of SDT (Deci & Ryan, 2000; Ryan & Deci, 2002) and the related steps of the process model by demonstrating (a) that autonomous motivation (i.e., identified regulation) mediates the link between psychological need fulfilment and exercise behaviour and (b) that a decrease in amotivation mediates the intervention effect on exercise behaviour. In confirming these links, this study contributes to the growing amount of evidence for the efficacy of SDT (Sweet et al., 2014; Ng et al., 2012; Teixeira et al., 2012; Fortier et al., 2012). Because physical activity and exercise interventions in general have been shown to be ineffective in changing both proposed mediators and behaviour, and few studies have demonstrated that a change in the mediators changes behavioural outcome (Rhodes & Pfaeffli, 2010), the results of both studies support SDT tenets and capacity. Additionally, Study IV provided both

action and conceptual theory links equally supporting intervention and theory capacity, which has been called for in previous research (Rhodes & Pfaeffli, 2010; Cerin et al., 2009).

Intervention design

Because physical activity and exercise behaviour have been suggested to be multifaceted behaviours that are difficult to cover with one specific theory (Bauman et al., 2002; 2012), and polytheoretical approaches are advocated (Baranowski et al., 1998; Ntoumanis, 2012), both Study II and IV combined a SDT-based intervention with other methods and frameworks that had previously been applied in this kind of work. In Study II elements of motivational interviewing (MI; Miller & Rollnick, 2013; 2009), cognitive behavioural theory (CBT; see Linton & Flink, 2011; Lukens & McFarlane, 2004; Sudak, 2011), and relapse prevention model (RPM; Larimer, Palmer, & Marlatt, 1999; Marlatt & Gordon, 1985) were included and used as intervention methods to apply and deliver the SDT-informed content in a structured manner. In Study IV, SDT was complemented by the transtheoretical model of behaviour change (TTM; Prochaska, DiClemente, & Norcross, 1992; Prochaska & Velicer, 1997) and the RPM to provide motivational readiness-, stage-based support for adequate goal setting and goal modification, exercise-barrier identification, relapse prevention, and health-related exercise rationale (see e.g., Larimer et al., 1999; Stetson et al., 2005; Kahn et al., 2002; Ogilvie et al., 2007). These techniques were mainly used to support the need-satisfaction for autonomy and competence. From a SDT perspective, the overall aim with both trials was to provide meaningful rationales while also acknowledging negative feelings, using non-controlling language, offering choice, and encouraging inner motivational resources, as recommended for face-to-face interventions (Su & Reeves, 2011; Fortier et al., 2011). The underlying intention was to affect participants' exercise behaviour by manipulating the suggested causal mechanisms described in the process model (Williams et al., 2004; Fortier et al., 2012), that is, to facilitate internalization through an interpersonal style that provides autonomy support, structure, and involvement (see e.g., Sheldon et al., 2003; Ntoumanis, 2012).

In this thesis, this approach provided support for previously suggested combinations of SDT with MI (Patrick & Williams, 2012; Markland et al., 2005; Vansteenkiste & Sheldon, 2006; Deci & Ryan, 2012; Friederichs et al., 2015), CBT (Khazaal et al., 2008), RPM (Gustafson et al., 2011) and TTM (Friederichs et al., 2015). The results show the potential value of using polytheoretical approaches in exercise interventions. The intervention effects on exercise behaviour in Study II may indicate support for using MI guidelines in applying the theoretical foundations of SDT as encouraged by,

among others, Patrick and Williams (2012). Besides providing structure, elements such as goal setting and chain analyses from CBT, along with the relapse prevention strategies such as managing barriers, may have supported participants' feelings of control and self-regulation. In Study IV, the inclusion of relapse prevention strategies and the articles tailored for the different stages of change might have contributed to the positive effects on low quality motivation and psychological need satisfaction. Amotivation has been related to the precontemplation stage (Thøgersen-Ntoumani & Ntoumanis, 2006); it is possible amotivation levels were diminished thanks to the articles tailored for precontemplators, and improved capacity to effectively cope with exercise related barriers related to relapse prevention. Together with the overall ambition to convey an autonomy-supportive approach, the application of multiple methods may have facilitated internalization and diminished the prominence of external regulations and amotivation, which may have, in turn, contributed to increased exercise level and intensity. Nevertheless, because the added frameworks were not measured as outcomes, interpretations of how the mediating effects of SDT-related constructs relate to specific constructs of MI, CBT, RPM, or TTM cannot be made.

Mixing theories in interventions has been questioned (Prestwich, Webb, & Conner, 2015); although combinations have been supported by previous research (e.g., Friederichs et al., 2015), there are some important discrepancies between the frameworks used in Studies II and IV and SDT. Above all, the foundation of CBT (i.e., behaviourism) does not fit naturally with the organismic tenets of SDT and the values behind self-determination and autonomy. The CBT-based strategies (e.g., goal-setting and chain analysis) have therefore been carefully used as mere methods, and were delivered by trained psychologists in an autonomy-supportive manner. The most important difference between MI and SDT is that the former has a bottom-up approach and is atheoretical, while the latter is top-down with a strong theoretical foundation backed up by empirical evidence (Patrick & Williams, 2012; Deci & Ryan, 2012; Miller & Rollnick, 2012). MI is also focused on moving clients toward change and influencing choice, (Miller & Rollnick, 2012) without concern for the quality of motivation that is prominent in SDT (Deci & Ryan, 2002). Also TTM differs with SDT. In face-to-face interventions, TTM could involve controlling elements (e.g., confrontational feedback and reinforcements), but this was easily avoided in the digital intervention of Study IV because this tool only contained written information.

Moderating and mediating effects

In line with recommendations (e.g., Hayes, 2009; Hardcastle & Hagger, 2016; van Stralen et al., 2010), Study IV extended Study II by the application of moderation analyses for the effects of the intervention. The intervention effects on light exercise post-intervention were stronger for those with moderate or high levels of light exercise at baseline, which means that the intervention had a stronger effect on exercise behaviour in participants engaging in light activities (as mentioned above, light exercise in LTEQ is mainly operationalized as lifestyle activities) to some degree. Perhaps those engaged in more vigorous activities already had a solid foundation for their engagement and were not as affected by the intervention (or the step-contest) as those engaging in lighter activities. The digital intervention in Study IV was primarily designed to promote internalization to support exercise initiation and maintenance, and was not adjusted for experienced and more committed exercisers who might have different needs and preferences. Regarding motivational regulations, intervention effects on identified regulation at follow-up were stronger for participants with low levels of identified regulation at baseline. It also affected exercise level for those engaging primarily in low intensity activities. These results are in accordance with the fundamental principles of motivation quality and behaviour within the SDT process model (Fortier et al., 2012; Pingree et al., 2010; Williams, 2004) and theoretical tenets (Deci & Ryan, 2000). The more experienced and already autonomous participants engaging in strenuous exercise activities may have different preferences and perhaps find other ways to fulfil their needs. Therefore, the intervention seems best fitted to those who might be considered to gain the most benefit, especially for amotivated participants and for those with poorer motivation quality. The implications of this research on the future design and development of this platform are that it may provide better possibilities for positive effects in targeted populations. For example, upcoming versions applied in similar populations will concentrate on keeping and developing features related to adoption, barrier management and relapse prevention, and supportive structures related to the earlier stages of change, but will put less focus on elaborated appliances that might attract more experienced exercisers. Another finding was that both interventions affected controlled motivation (primarily external regulation) and, in Study IV, the changes appeared as early as three weeks after baseline. This differs from findings in the review by Wasserkampff and Kleinert (2015), who found controlled motivation to be mainly stable (i.e., non-changing) or that changes were observed at the earliest six weeks after baseline. This further underscores the importance of context, and it would be interesting to find out what features of Studies II and IV are responsible for the diminishing effects

on controlled motivation and amotivation because such effects have rarely been observed in previous research.

The lack of statistically significant main and indirect effects of psychological need satisfaction in Study II suggest that the mechanisms of autonomous motivation could be operative and may generate an increased exercise outcome even in the absence of statistically significant mechanisms of need satisfaction. This does not necessarily rule out the impact of psychological need satisfaction on participants' autonomous motivation, and the associations may have been undetectable due to for example threshold or ceiling effects. Furthermore, many SDT studies differ in terms of the number of needs assessed (Teixeira et al., 2012), and the decision to exclude the relatedness dimension from PNES was based on its supposedly more distal (Deci & Ryan, 2000) and, in exercise settings, debated role (McDonough & Crocker, 2007; Wilson et al., 2002; Wilson et al., 2006) predisposing the interpretation that feeling related to others might not be as essential in exercise settings as is feeling autonomous and efficacious. But because the three needs are considered interdependent and highly interrelated on a general level (Deci & Ryan, 2000), as was also the case in Study I, the inclusion of relatedness in Study II might have generated more interpretable results in relation to theory. This is supported by the discovered gender differences in the association of relatedness need satisfaction and motivation in Study IV. It is recommended that future studies include all three needs to make adequate interpretations of the mechanisms between psychological needs and behavioural regulations in exercise settings. Also, although it has been previously recommended, (Vallerand & Ratelle, 2002), using the RAI has been questioned in recent research (e.g., Chemolli & Gagné, 2014), which is why the results on RAI from Study II will be disregarded in this discussion. This critique is the main reason the RAI was not used in Study I and IV and was influential in implementing the person-centred LPA design in Study III. Also, Study II could be considered an efficacy (rather than effectiveness) trial (see Biddle et al., 2012); due to aspects such as the sample of convenience, results are not easily generalized to various samples and settings. Although Study IV has a more rigorous design, these results are also somewhat difficult to generalize to other populations due to the specificity of the sample, but are on the other hand of value for similar contexts.

The general decrease in levels of many of the variables examined between post-intervention and follow-up in Study IV could be logically explained by the step contest setting, and that the competition ended between these two measure points. In spite of this decline, statistically significant intervention effects and mechanisms in several paths of the process model were discovered, supporting the argument for intervention tool efficacy and

usefulness in this particular context. This discovery may buffer potential adverse (need thwarting) effects of competitive settings for certain subgroups (e.g., women and older adults). Study IV especially adds current literature by showing how autonomous exercise motivation might differ in different groups (e.g., older, younger, male, female), and could facilitate the process of influencing positive behavioural change (i.e., increased level and intensity of exercise) in different ways. The discovery of mediating and moderating variables sheds some light on SDT efficacy and the potential specific processes underlying intervention effects. The most surprising discoveries in Study IV were related to amotivation. As discussed above, promoting internalization in amotivated people and represent a significant challenge in health promotion (Hardcastle & Hagger, 2015; Miller & Rollnick 2013; Peters et al., 2013); the current results might carry implications for practical use and future intervention construction.

The digital intervention context

The application of behavioural theory in digital physical activity interventions is limited (Doshi et al, 2003; Evers et al., 2003). A majority of freely accessible web sites has been found to lack basic components for effective behaviour change (Vandelanotte et al, 2014); a majority of the apps studied by Middelweerd and colleagues (2014) included only a few basic techniques for behaviour change. Because e-health involves complex interactions between user, provider and the system itself (Epstein & Street, 2007), the digital intervention tool in Study IV was developed through an interdisciplinary project where researchers from psychology, interaction design, computer engineering, and innovation science collaborated with companies in the e-health industry, the latter providing expertise and access to digital infrastructure and ecosystems. As requested by previous research (e.g., Pingree et al., 2010), the project is based on the judicious and thorough use of sound theory to inform practice, product development, and program implementation (see brief project description in Weman-Josefsson et al., 2014). The project also answered the call for increased knowledge of how different tools and services should be designed, combined, and coordinated, and how the gap between specialists within the different fields (in this case, information technology, business model innovation, and psychology) could be bridged through coproduction and cooperation across disciplines (Marsch & Gustafson, 2013). In combination with a firm SDT foundation, the inclusion of customer- and user-experience design methods and techniques (see e.g., Bødker, Kensing, & Simonsen, 2004; Zimmerman, Forlizzi, & Evenson, 2004) in the project will enable studies on how to deliver meaningful experiences in the exercise and physical activity domains to

support sustainable exercise behaviours. The potential for producing new knowledge regarding methods and techniques for the design, and the evaluation of IT-supported self-determined motivation to exercise is substantial, and can provide valuable understanding for the human-computer interaction research community. Furthermore, the inclusion of business model innovation will increase the understanding of how (e-health) companies can communicate strategic choices, and to capture and create value (e.g., Zott & Amit, 2010).

The potential of using of technology in health care is considerable (e.g., Williams et al., 2014; Hesse, 2008; Pingree, 2010; Marsch & Gustafson, 2013), but might constitute a greater challenge than expected (Marshall et al., 2003), due to problems such as attracting, engaging and keeping participants, (Kohl et al., 2013; Vandelanotte et al., 2007), and high drop-out rates (Elfeddali et al., 2012; Peels et al., 2013). These issues were also noticed in Study IV. The intervention tool contained general strategies that have previously been shown to have positive effects in web based interventions and programs, such as (a) keeping in regular contact with the participants (Morrison et al., 2012; Vandelanotte et al., 2007) through the use of e-mail (Brouwer et al., 2011; Plotnikoff et al., 2005) and smartphone functions (Kirwan et al., 2012; Webb et al., 2010), (b) updating the web site regularly (Brouwer et al., 2011), (c) providing goal setting tools and goal setting support (Kohl et al., 2013; Webb et al., 2010), and (d) providing social support (Brouwer et al., 2011; Morrison et al., 2012; Tate et al., 2003; Winett et al., 2007). Nevertheless, structures for interactivity (Hurling et al., 2006; Kohl et al., 2013; Leslie et al., 2005; Pingree et al., 2010) and tailored feedback (Kohl et al., 2013; Morrison et al., 2012; Webb et al., 2010) have also been shown to have positive effects in these settings, but the digital tool was a prototype platform and interacting artefacts for communication and feedback was not yet included, representing a substantial discrepancy compared to more interactive digital tools (or to face-to-face interventions with personal counselling), which might have contributed to attrition rates. Given that interaction in social media (e.g., Twitter, Facebook, YouTube, Wikipedia) is rapidly increasing (Hesse, 2008), elements of social media will be integrated in future versions of the intervention tool. Also, although Study IV is in line with previous research showing short-term positive effects of digital interventions for physical activity (Davies et al., 2012; Norman et al., 2007; Van den Berg et al., 2007), this RCT has not answered the question of whether or not it is capable of stimulating sustainable behaviour change. The tool is therefore being tested in a six-month intervention with follow-up after three months to examine potential long-term effects; a more extensive one-

year trial with a one-year follow-up is also planned for, along with qualitative and ethnographic evaluations.

In comparing the digital intervention in Study IV to the e-health model described by Pingree and colleagues (2010, see Figure 4), some parallels can be drawn. The intervention content (e.g., health literacy, the ability to anonymously share with others, articles tailored to stages of change, strategies for relapse prevention and behavioural change, inspirational stories) may have caused proximal effects on skills and knowledge (step 1), and these proximal effects might have increased while participants actively integrated this in relation to previous skills and knowledge (step 2). Although this digital system was not interactive through personal feedback, it still contained interactive features likely to encourage personal engagement in terms of making choices, using goal-setting structures, and navigating and exploring the different parts of the platform (step 3). The results show that the system (plausibly via the proximal effects) has facilitated psychological need satisfaction and internalization (step 4), and mediation analyses showed amotivation to influence exercise behaviour (step 5). No evidence was found that psychological need satisfaction (via *b*-paths) directly influenced exercise behaviour (step 6) and, because measuring quality of life was out of the scope of this study, relations to the next phases (steps 7 and 8) cannot be made. Even so, this guiding model for e-health interventions seems promising for helping to improve intervention development and inspiring research advancements in the area.

To summarize, Studies II and IV denote decent attempts to uncover the dynamics of exercise motivation in interventions, but future studies would benefit by addressing motivational mechanisms more thoroughly to provide more comprehensive information and explanations. Regardless of what is considered to be the most plausible explanation for observed age and gender differences in the full samples of Study I and IV (e.g., whether differences are related to different motivational/need-support preferences, or that these age and gender differences are instead based on different opportunities in the social context), it could be beneficial to consider other intervention designs tailored for these subgroups. Even though no intervention effects in Study IV differed based on gender, perhaps such tailoring could provide valuable information contributing to sensible explanations and deeper knowledge on motivational mechanisms in future studies. Given that the population of older adults is growing, identifying and understanding the preferences of this group could be essential for facilitating the maintenance of physical health as well as mental capacities during a long life.

Motivational soup

The arguments behind motivational soup, suggesting that different regulations are likely to be simultaneously operative in a given domain (Patrick 2014), are based on the proposed dynamic nature of motivation which was forwarded by Deci and Ryan (2002). The motivational soup thereby refers to the occurrence of several motives (intrinsic and extrinsic) being held simultaneously so that a given behaviour could contain portions of different types of motivation (e.g., “I need to”, “It’s meaningful to me”) at the same time. Considering these dynamics, a person-centred methodology could allow for a more profound understanding of how motivational regulations interact within a person, and could complement the traditional variable-centred approach by revealing subgroups of different motivational profiles (Ratelle et al., 2007; Vansteenkiste et al., 2009; Fortier et al., 2012). Current research on this area of motivation is limited (Friederichs et al., 2015) and the few studies that have focused on adults’ physical activity behaviour (Matsumoto & Takenaka, 2004; Friederichs et al., 2015; Guerin & Fortier, 2012) used cluster analysis instead of more recently recommended inductive approaches (Hardcastle & Hagger, 2016), such as latent profile analyses (LPA; Marsh et al., 2009; Pastor et al., 2007). Besides making a contribution to the mapping of person-centred motivational profiles, Study III therefore also provides a methodological advancement in the area. This study also addresses the critique recently raised against the motivational continuum and use of unidimensional conceptualizations such as the RAI (Chemolli & Gagné, 2014) by employing more appropriate analyses for constructs more likely to be contiguous than continuous. Furthermore, Study III examined two different samples with slightly different demographical characteristics, offering a more solid foundation for interpretation.

Study III revealed six distinct profiles of motivational regulations in exercise across both samples. Three of these were similarly shaped profiles, presumably representing more stable and consistent subgroups of motivational regulations. These subgroups included: a) a low motivation profile (below average scores on all regulations); b) a self-determined profile (high scores on identified and intrinsic, low scores on amotivation and external); and c) a self-determined profile with high introjection (high scores on intrinsic, identified, and introjected, and low scores on external and amotivation). These findings could be linked to previous work in the field of physical activity (e.g., Friederichs et al., 2015; Guérin & Fortier, 2012; Matsumoto & Takenaka, 2004) where groups (clusters) similar to the self-determined profiles have been identified, although these studies used notably different (i.e., less active) samples compared to Study III. The fact that self-determined profiles are replicated across samples and studies would not be

surprising, because such a profile has robust theoretical underpinnings in SDT. Approximately 40% of the participants in both samples of Study III belonged to these good-quality or sustainably-beneficial profiles with high autonomous motivation as a motivational platform. Other profiles discovered in Study III seem to be less prevalent, and these profiles may even provide a more important theoretical insight than the others, because they signify a complex result of within-person effects of different regulations interacting. For example, the self-determined profile with high introjection has not been as prominent in previous work, although clusters with high autonomous motivation in combination with moderate introjection have been noted (e.g., Friederichs et al., 2015; Guerin & Fortier, 2012; Matsumoto & Takenaka, 2004). These more uncommon profiles reflect the rich and dynamic qualities of motivation, showing multiple ways that motivation quality can manifest. In support of the findings regarding autonomous motivation and introjection, Vansteenkiste and colleagues (2008) suggested that people could be high in both controlled and autonomous forms at the same time, as well as be high autonomous/low controlled or low autonomous/high controlled forms of motivation. In a qualitative study of adolescents, Gillison, Osborn, Standage and Skevington (2009) found introjected regulation coexisting with autonomous motivation (identified regulation) in female adolescents, besides being associated with higher levels of physical activity, and without obvious negative effects. In their review, Teixeira and colleagues (2012) concluded that findings on the association between introjection and physical activity were mixed, and the findings in this thesis confirm these inconsistencies. Introjection was not found to be involved in any statistically significant effects in Study II or IV. In Study I, however, total need satisfaction negatively predicted controlled motivation (i.e., introjected and external regulations), and introjected and external regulations separately, and also positively predicted total exercise in men but not in women. In Study III, introjection was the most obvious difference between some profiles that were otherwise quite similar in terms of the regulation patterns. These circumstances highlight the value of scrutinizing motivational regulations from different perspectives and using various analyses. Introjection, especially, seems to have a more complex role than formerly stated in SDT, and it is possible that the division in autonomous and controlled motivation compounds will not explain it fully. This is in line with the arguments against the continuum structure forwarded by Chemolli and Gagné (2014) and the suggestion that introjection seems to be placed in between autonomous and controlled motivation rather than being purely controlled in nature. When introjection denote a step into internalization of external regulation, it can be considered a valuable form of motivation in the short term, but it is not

expected to translate into maintenance (Deci et al., 1994), and because internalization is a dynamic process, cross-sectional studies will not provide as rich information as when studied over periods of change (Gillison et al., 2009). The motivational soup is likely to be multifaceted and divergent for different groups, but, when using suitable methodological and analytical glasses, patterns can be detected. Taken together, research on motivation will benefit from examining the motivational soup more thoroughly, preferably using recommended person-centred analyses in longitudinal studies.

From theory to practice

When the aim is to facilitate motivation and engagement, involvement, which can be described as the extent to which participants are involved in the processes and decisions concerning their health in a bottom-up manner, rather than receiving the traditional (more hierarchical) top-down approach, constitutes a fundamental element. The bottom-up involvement approach represents the spirit of autonomy support in SDT (Deci & Ryan, 2000; Reeve et al., 2003; Sheldon et al., 2003) constituting an important philosophical foundation forming the attitudinal value systems applied in research and practice.

The SDT assumption of people as organismic, dialectic individuals having an innate intrinsic motivational drive towards well-being (Deci & Ryan, 1985; 2000) is a belief that shapes interactions with clients and patients. Essentially, this means that practitioners will not (and should not) have to force people to change, which is also mostly in line with the fundamentals of MI practice (Miller & Rollnick, 2013; 2012) and represents a shift from traditional approaches involving more controlling and persuasive (or even threatening) interpersonal communication. Markedly, this also highlights a choice to not change, or not prioritize health as autonomous and fully acceptable. It is easy to presume that people see health as their first priority and would like to change, but the reality might look slightly different. Projecting personal values on others (e.g., stating that “Health is important”, “This person should change”, “I’m the expert here”, “This person has a problem”) and regarding no change as a personal failure are common traps in health counselling (Mason & Butler, 2010). Although many people have a desire to improve their health and/or feel better in general, health is not always their first priority. Overlooking such an essential precondition could create an imbalance impeding the autonomy-supportive conditions of SDT. Volition (i.e., personal desires, goals, meaning) is considered a key capacity and a powerful human phenomenon in SDT, and is expected to have an impact on the emotional experience of behaviour as well as the subsequent

behaviour itself. Being volitional (or autonomous), a person is able to feel creative and efficient in causing one's own actions (Deci & Ryan, 2000; Ryan & Deci, 2002), and because this normally takes place within some social context, the social predispositions (e.g., value systems, interpersonal communication) are essential for the person to feel volitional. It would therefore seem fruitful for all involved parties (from policy-makers to researchers and practitioners) to truthfully question prevailing perceptions of human capacity to apply a more adaptable philosophical foundation. The culture and atmosphere conveyed through the adopted value system could likely influence whether or not reaching out and stimulating motivation and engagement are successful. Autonomy support could be a valuable tool, being an approach that could have a positive influence on the motivation and engagement for sustainable behaviour change and the subsequent self-regulation in different domains. This could be true not only for face-to-face interactions, but also in designing digital tools and services in e-health domains, placing high demands on practical application and highlighting the need for an adequate theory base.

Moving all of this to a higher level, this approach also carries implications for policy-making. It is not unusual that health policies include controlling approaches, with pressures based on what people "should" do, or even regular threats (such as warning texts on cigarette packages). As stated previously by SDT related research, the use of coercion and control could have negative consequences for maintenance and for well-being, and is likely to be less effective than an autonomy supportive approach. Autonomy support and facilitation of internalization of the targeted behaviour's value could increase the influence of health policy interventions and help people make their own choices based on meaningful information and structure, without manipulation (Moller, Ryan, & Deci, 2006). Also, such approaches are less demanding in terms of monitoring and reinforcement and could be expected to generate sustainable effects in the long term. Furthermore, and quoting the commentary from the Lancet's physical activity series (Hallal et al., 2012) "more of the same is not enough" (p. 2), there seems to be a salient need to revise current (research and practice) approaches to physical activity and exercise promotion and also to make it a global health priority. Perhaps we should shift focus away from individual counselling and also view these matters from a different angle. According to Heath and colleagues (2012) behavioural and social approaches have yielded effective outcomes but they also recommend that environmental and policy approaches for increased physical activity should comprise actions for availability and community-scale urban design and planning. This corresponds to the suggestion to combine smart and healthy cities (see Kamel Boulos & Al-Shorbaji, 2014;

Rydin et al., 2012; Kamel Boulos et al., 2015 for a description) to create a sustainable society from a holistic point of view. Such approaches might benefit from the application of behavioural theory and autonomy supportive structures in architecture, city and landscape planning and so forth, to create eco-friendly, sustainable environments with the potential to improve the health and well-being of local populations.

Enhancing self-determined exercise motivation

The implementation of regular exercise behaviour could be considered to be demanding in several ways. Obviously, it requires physical exertion to some degree, but it also requires mental effort involving things such as planning and prioritizing (i.e., replacing other valued activities with exercise), reasoning with oneself in the face of boredom or stagnation, and sometimes even reasoning with others (perhaps questioning the new habit or feeling neglected in the process), and so on. Besides consciously planning logistic features (e.g., time, place, priorities), people also need to use cognitive and behavioural strategies to overcome perceived barriers that are both psychological (e.g., lack of time, energy, motivation, social support) and physical (e.g., somatic limitations such as pain, being overweight, fitness level, perceived exertion) in nature. In addition, practical skills and knowledge (e.g., adequate techniques, suitable exercise dosage, appropriate goal setting), and matters of facility proximity and access, resources, and equipment need to be handled. Exercise initiation and maintenance can be quite challenging and, for most people, will most likely not happen automatically or through pure will power. When dealing with exercise promotion and policy-making, practitioners and researchers need to not only recognize these challenges (and acknowledge the effort and ambivalence involved in persevering to them), but also to consider the different pieces of the puzzle mentioned above, such as the multifaceted origins of exercise engagement and mechanisms of motivational processes (i.e., the “why”) and – perhaps most importantly – to consider the value system employed as discussed above. Associations between exercise and physical activity correlates are likely to be bidirectional (Bauman et al., 2002; 2012) and because no particular factor by itself can guarantee a desired outcome, a holistic view of exercise behaviour is of particular importance.

Bearing in mind that exercise adoption and adherence have the potential to generate substantial health effects (Lee et al., 2012) and reduce mortality risk (Petersen et al., 2015), there is a great deal to be won from creating successful exercise interventions based on the processes of motivation and engagement at both an individual and a (global) public health level. But general activity aims are perhaps too high, making people feel there is no use

trying (amotivation) or experience pressures related to external and introjected regulations. Perceptions of *no pain-no gain* are commonly accepted, inflating the beliefs regarding the effort needed to gain desired benefits. Perhaps it could be stressed more clearly that the dose-response recommendations should be viewed in regard to the desired effects. That is, recommendations should differentiate more clearly between health and performance enhancement, because they denote quite different demands in terms of the time and effort needed. The positive (hedonic) experience of exercise and physical activity depends on how one thinks and feels about the activity; a positive change in affective response during exercise is related to future physical activity behaviour (Rhodes & Kates, 2015). Hedonic feelings could be related to experiencing competence and autonomy; eudaimonic feelings such as freedom, safety, happiness, fulfilment and contentment; and to relatedness in terms of feeling respected, understood, cared for and safe. People who are physically inactive and/or inexperienced may feel incompetent due both to physical limitations and to perceptions (imagined or real) of not being able to perform. Dosage and perceived exertion can be considered critical for the exercise and physical activity experience, and starting at too high of a level could result in the inability to maintain ambitions, which, in turn, could have negative effects on feelings of competence (cf. effectance; White, 1959), thereby affecting motivation and increasing the risk for drop-out. Linking this to the tenets of relapse prevention (see Marlatt & Gordon, 1985; Larimer et al., 1999; Stetson et al., 2005), high initial ambitions would result in slips and lapses in the face of barriers, putting the person at risk of experiencing inconsequence between ambition and action (i.e., cognitive dissonance), generating feelings such as guilt, failure, and loss of control (thwarting the need for competence), which in turn leads to drop-out. In speculation, these arguments could contribute to explaining the stable drop-out rates observed in previous research (see Buckworth et al., 2013; Nigg et al., 2008; Lox et al., 2010) and the challenge of adherence (see Patrick & Canavello, 2011; Portnoy et al., 2008), as well as physical activity attrition rates in physical activity on prescription (see Kallings et al., 2009; Leijon et al., 2009). It is possible that both health professionals and people in general hold idealistic expectations regarding (particularly the initial) dosage recommendations, hampering motivation for, and engagement in, exercise and physical activity behaviour by thwarting psychological need satisfaction and forestalling internalization.

The importance of low-intensity physical activity is often neglected, and considering that this constitutes the main part of regular physical activity for most people (e.g., daily housework, short-distance walking), these everyday activities could have a greater impact on health than jogging or going to the

gym three times a week. In fact, focusing on merely reducing daily sitting time (e.g., watching TV, working at the computer) could prompt substantial positive health effects (Eklund-Bak et al., 2010), or even by simply taking short breaks (i.e., standing up) from sitting down (Healy et al., 2010). In view of this, the quite low effort needed for relatively large health benefits, is a concept quite contrary to the no pain-no gain idea. People do not actually need to start a jogging or gym routine, take their bike to work, or even take brisk walks at lunch. This might sound nearly immoral to health professionals devoted to stimulating their clients/patients to improve their health by engaging in these behaviours. Quite the contrary, this should be considered highly encouraging. First of all, it opens up numerous options for people to be physically active outside the conventional (and for many people dreadful) exercise activities such as jogging, working out, doing aerobics, cycling, and so on. Second, it allows people to feel more confident in trying, virtually regardless of fitness level, weight or other (perceived or real) somatic barriers, at least as long as one is able to stand up for a few minutes. Consequently, discouragement from anticipated physical exertion will be minimized. Third, it also allows people to find time to actually do it. Numerous studies have shown that the perception of lack of time is one of the most prominent barriers to physical activity and exercise (e.g., Buckworth et al., 2013; Lox et al., 2010); considering this, just regularly standing up during the TV commercials might sound like a much more attainable goal to a reluctant exercise initiator than going to spinning class. Accomplishing such small steps could increase feelings of competence and create a foundation for autonomous progression. At the same time, it should not be forgotten that participants hold the key to change. Some people are really motivated to go from zero activity right into that spinning class, and some of them actually succeed in “starting their new life”, turning a more or less sedentary lifestyle into regular exercise behaviour in this way (underscoring the value of also considering other frameworks such as stages of change). Being true to the values of SDT, all motivational sparks should be professionally supported by the exploration of choice and motivational aspirations. The social context and competing motives and values should also be considered, because these aspects are believed to affect a person’s motivation for behaviour change. In this case, a caring and supportive environment would be especially important.

In predicting behaviour more accurately, it is essential that processes of what and why in motivation and goal orientations are separated (Deci & Ryan, 2000). Why a certain goal is pursued (e.g., intrinsic aspirations such as affiliation versus extrinsic ones like image) is vital, because autonomous regulations involve higher need satisfaction. The effects of the goal content (e.g., in terms of well-being) could also be affected by why it is being

pursued, making the regulation process more important than the goal itself. When psychological need satisfaction is supported, internalization and self-determination will be promoted, which in turn is believed to encourage goals and aspirations involving need satisfaction. Focusing on individual differences in motivational orientations and goal content could provide valuable knowledge about human behaviour (Deci & Ryan, 2000). The degree of self-determination could be captured by asking for whom the behaviour is carried out, why it is pursued and how it feels when being performed. If the answer encompasses experiences such as curiosity and feelings of enjoyment and pleasure, the behaviour is likely intrinsically regulated, which, according to SDT, represents completely autonomous (self-determined) motivation. Due to their volitional and self-regulated nature, intrinsically motivated behaviours are expected to be self-maintained and therefore have a strong predictive value for adherence and maintenance (Ryan & Deci, 2002; Deci & Ryan, 2000).

Not all behaviours, however, denote pleasure and enjoyment, and for any given behaviour there are most likely pieces of different types of motivation and goals, in line with arguments of motivational soup (Patrick, 2014). People might want to work out to improve their fitness and lose weight, and they can feel, simultaneously, both that it is fun and that they ought to do it. Bearing in mind the potential effort needed to adopt and maintain regular exercise behaviours, intrinsic motivation may not be the most salient drive in this motivational soup in exercise settings, compared to more integrated or identified values. Identified regulation denotes partial internalization, whereby expected outcomes of pursuing the behaviour are highly valued even if the activity itself is not enjoyable (Ryan & Deci, 2000). In this case, internalization maintains the behaviour through perceived importance, even in the absence of intrinsic appeal (Ryan, 1995), and this is why extrinsic motivation does not necessarily have to generate negative consequences. If a person identifies with the values and expected outcomes of the activity (or has integrated them into the self), he or she can feel autonomous and self-determined. This means that promoting identified (and integrated) regulation along with intrinsic motivation could be advantageous in exercise settings (Edmunds et al., 2006; Teixeira et al., 2012), a belief visibly supported by the results of this thesis and the discussions above.

Identified regulation could be expected to help people exert effort in pursuing exercise activities, while intrinsic motivation could help them focus on enjoyment and well-being. It should be kept in mind that intrinsic motivation is more than just fun; it is also about mastery, challenge, learning, and creativity, which places the focus on the experience as an outcome. As Rhodes and Pfaeffli (2010) suggested, focusing on altering the behavioural

experience in challenging behaviours such as exercise has the potential to improve intervention adherence and to have a positive effect on proposed mediators. This could also be linked to the discussion above regarding exercise dosage and perceived exertion, highlighting the potential power of personalizing programs. Furthermore, focusing on the experience could be signified by the feelings afterwards, such as smiling, relief, accomplishment, as well as feeling related to others in the process. In the exercise and physical activity domain, relatedness most likely centres on connecting with other people. Even when people exercise alone they can have support from peers, either directly, when exercising close to other people (e.g., relating with others in spinning classes due to shared suffering, the music energy, connecting with the instructor), or more distally, when interacting via social media (posting exercise-related achievements on Facebook, tweeting on Twitter, participating in forum discussions, etc.). The significance of the need for relatedness in Studies I, III and IV is therefore an interesting finding, highlighted by the obvious problems interpreting the results of Study II facing the lack of data in the relatedness dimension.

Practical implications and future directions

Taken together, the results and arguments discussed above can readily be tied to the tenets of psychological need satisfaction, autonomy support, and the internalization process. The suggestion to start on a smaller scale, with activities easy to incorporate into our daily routine without demanding too much sacrifice or prioritization, and with a low potential for inconvenience in terms of physical exertion or discomfort, has the potential to have a positive impact on our feelings of competence and autonomy. This will also improve the chances of having a positive affect and a hedonic experience. The potential in connecting (distally or proximally) with others will fuel the need for relatedness, which in programs and interventions can also be fuelled by a counsellor or health professional conveying involvement and acknowledging feelings (e.g., resignation or amotivation due to previous failure in exercise adoption) during the process. Embracing the proposition to nurture all three needs (i.e., to feel capable, volitional and affiliated) in these ways has the potential to facilitate internalization, optimize development and autonomous motivation in the people we work with, and simultaneously enhance psychological well-being and health related quality of life. Tending to the quality of motivation (i.e., the “why”) will increase the understanding of factors influencing behaviour and how people become more autonomous by internalizing extrinsic motives, which is assumed to have a positive impact on maintenance of and commitment to the behaviour. Interventions that successfully satisfy the three psychological needs could then be expected to

foster internalization and subsequent behaviour change and maintenance. As outlined above, there is reason to believe that the key associations in the hypothesized SDT process model, linking need satisfaction to behavioural and affective outcomes via autonomous motivation, might not be the same across gender, age, and psychographic or social contexts. One size will probably not fit all and interventions addressing these observed mechanisms seem to play an essential role in the motivational processes. This thesis also offers preliminary support for successful outcomes in combining the basic outlines of SDT with other theories and methods such as motivational interviewing, relapse-prevention, and stages of change. For example, because people can be expected to pay attention to different types of messages and supportive approaches depending on which stage they are at (Prochaska et al, 1992), the intervention literacy tailored for precontemplators in Study IV might have facilitated the positive effects on amotivation and extrinsic motivation, and the mediating effect on light exercise behaviour. It is also possible that the efforts to facilitate identified regulation (based on the findings in Study I and II) contributed to these effects. These effects are rarely observed in previous research and might be of practical importance for several reasons, not the least of which is that amotivated people (akin to precontemplators) are a highly relevant, but rarely reached target group in the promotion of exercise and physical activity.

The motivational strategies presented in this thesis could be applied within several areas of expertise. One relevant area is the practice of physical activity on prescription (PaP), providing structure, support and evaluation tools (also cost-effective digital ones) to help patients adopt and maintain sustainable exercise behaviours. This would not only apply within the Swedish health care system, it is also in line with the global health initiative Exercise is Medicine® which was started by the American Medical Association (AMA) and the American College of Sports Medicine (ACSM) in 2007 and currently available in 43 countries worldwide. In line with the benefits of combining SDT with other methods, the results of this thesis might also be applicable within in the area of person centred care (see Weman Josefsson, 2016). The apparent commonalities of SDT and person-centred care regarding value systems and practical implications could entail interesting advancement in both fields. Person-centred care can be expected to promote autonomy and vice versa, and the solid framework of SDT could strengthen person-centred care research and practice by illuminating some of the mechanisms behind effective person-centred interventions.

Another relevant, and in many ways, broader area, is the fitness industry with its countless personal trainers (PT), exercise instructors, health coaches, and so on, offering their services to committed as well as reluctant exercisers

all over the world. Just like most profitable industries it attracts some high quality, scientifically based actors along with services of poor quality or even “quacks”. Several PT academies operating in Sweden provide good quality educations on health, diet and physical training, but most of them lack adequate expertise in behavioural sciences. As a consequence, many trained PTs often do not have sufficed skills in communication, motivation and behaviour change, skills that could aid their professional efficacy and help promote client achievements. The ability to listen, understand, care for, and adapt to your client is an important key to success for both parties. The application of autonomy support, structure, and involvement, according to SDT tenets, would probably be highly beneficial for clients who are not already committed or experienced exercisers, and perhaps consult PTs for external/introjected reasons. It would therefore be very interesting to study the effects of including autonomy supportive structures compared to the usual practice in PT settings.

Looking forward for future research, one of the main things omitted in current research is an assessment of psychological need-support from multiple sources such as tapping different dimensions of the needs (particularly relatedness) and separating need support given by health professionals (physicians, instructors, health educators, etc.) from the need support given by significant others (friends, family, colleagues). In view of this, it would also be interesting to investigate whether the source of the support might matter as much, or even more, than the psychological need itself. It would also be interesting to study whether having a need-supportive personal sphere (e.g., friends or family) might compensate for having a controlling health professional, that is, whether there would be a statistical interaction between psychological need support (or perhaps thwarting) from the health professional and the psychological need support from family and friends.

Three of the four studies in this thesis (i.e., I, III and IV) were conducted in digital contexts. These digital contexts also contained a distinct feature in terms of the work-place step-contest (i.e., a web-based program) that might be considered a type of intervention in itself. Digital interventions are an important new direction for health promotion and intervention, but in the rapid advancement of the e-health industry regarding accessibility, quality and variety, the fundamentals of human needs and behaviour seem to have gotten lost somewhere. With a few exceptions, common digital services (e.g., apps, platforms, programs) are rarely founded in behavioural theory and many popular gadgets (e.g., wristbands) seem to be based instead on short-term principles of maximizing turnover and consumer appeal. For example, extrinsic rewards, pressuring introjects, controlling measures or ratings, and

so on could, from an SDT perspective, result in undermining effects (e.g., decrease in intrinsic motivation, need thwarting) and limit positive effect to the short-term. Designing e-health services is generally done for good reasons, but because controlled processes can have negative consequences on personal growth and well-being, besides having little or no effect in the long term, they potentially risk harming people. It would probably be advantageous for future digital health promotion services to apply professionally devised services providing opportunities for autonomy support, structure and involvement. This could be accomplished through providing educational health information along with a variety of options, instruments and tools; emphasizing volition, optimal goal orientation, and values; facilitating feelings of connection, coherence and meaningful relationships, and so forth. Based on the arguments above, embracing SDT in e-health design could be expected to facilitate positive effects regarding targeted health behaviour outcomes and well-being. In this way, there would be potential to generate a win-win situation for both users and producers.

The current results also highlight the possible implications of incorporating age and gender perspectives when designing effective exercise interventions. Given the observed female greater likelihood of using web-based exercise and physical activity programs, this might be even more important in internet-based interventions and programs. Future research can benefit the practical applications by more thoroughly examining these concepts (especially mediating and moderating effects) to make adequate recommendations for how to address age and gender issues in digital intervention designs.

The possibilities offered by personalized interventions regarding aspects such as motivational soup and subgroups based on different exercise activities or environments, along with longitudinal within-/between-group changes in these dimensions, would also be interesting objectives for study to better understand the elusive foundations of exercise and physical activity behaviour. It has been suggested that moving away from the traditional between-subject design in RCT studies and test so called single-patient (N-of-1) trials may shed some light on how a specific client will respond to a certain treatment (Davidson, Peacock, Kronish & Edmondson) and thereby take us closer to knowing what will work for whom, when and why.

Finally, it seems beneficial to critically consider whether or not more health information and counselling relying on reasoned actions is the ultimate solution for the promotion of physical activity and exercise behaviours. In line with the statement that “more of the same is not enough”, other strategies might complement these traditional approaches, along with the inclusion of more holistic approaches related to policy making and environmental design

(e.g., smart and healthy cities). Of course, the purpose should never be stealthy about nudging an “ignorant mass”, but should use organismic values and autonomy support to design motivating environments (e.g., restructure cities in such a way that it is easier to make good choices such as taking the stairs, walking and biking; create attractive outdoor recreation areas and so on) instead of focusing only on the person, as traditionally has been done.

Strengths and limitations

Some limitations concern all four studies, such as the use of self-reported exercise measures. Self-reported measures are problematic, even when using comparatively well-documented instruments such as the LTEQ (Jacobs et al., 1993; Wilson et al., 2010), because they are subject to biases such as social desirability, and the potential overestimation of recalled activity and of measurement error (Gillison et al., 2014). Including a direct measure of exercise in all four studies would therefore have been ideal to permit the cross-referencing of subjective and objective measures. Interpretation should also consider the specific samples of Studies I, III and IV, consisting mainly of middle-aged women, the majority of whom had joined the web-based exercise service via step-contest packages provided by an employer, which are factors that may have influenced the measured concepts. The samples of Studies I, III and IV are quite specific and may not generalize to the common population, but bearing in mind the overall purpose was to examine motivational mechanisms in a digital context, these samples can be considered adequate. In addition, because most participants in these samples were involved in a step contest via their employer, it is likely to have engaged previously inactive employees as well as regular exercisers, a speculation supported by the intervention effects on amotivation in Study IV.

Study I

Due to the cross-sectional design restraining causal inferences, the outcomes of this study should be interpreted with caution, but having used the recommended proper and modern mediation variable analyses (Hayes, 2009; Cerin & MacKinnon, 2008), the results could still be considered useful in informing practical application (MacKinnon, 2008; Kline, 1998). Study I also contributes to previous studies by providing a large e-health-based sample of middle-aged adults with assumed variance in studied variables, and the use of latent variables also reduced measurement error.

Study II

Despite the small sample, the use of statistical methods with high power allows inferences of the mediating mechanisms influencing exercise behaviour (Cerin et al., 2006). The use of reliable measures for motivational constructs (Teixeira et al., 2012; Rhodes & Pfaeffli, 2010), random assignment, and theory-informed intervention design are all strengths that make Study II a potentially valuable contribution to the field. The use of matching and multivariate analyses could also, to some extent, have reduced confounder bias incidence. Moreover, as the intervention was conducted in the participants' real-world setting (i.e., not in a restricted or controlled environment), its expected practical application regarding resources in terms of time, facilities and staff is widespread. The intervention in Study II has the potential to be applied to almost any context (e.g., gyms, workplaces, schools, digital settings). Many previous studies have involved very specific samples, such as clinical settings and overweight/obese women (Fortier et al. 2012), making this sample a valuable contribution in spite of its population. An additional measure point would have strengthened the study, allowing tests for within-person temporal change (Cole & Maxwell, 2003), and a post-intervention follow-up would have provided valuable information regarding maintenance and adherence; these concerns, however, as well as applying CONSORT guidelines and measuring intervention fidelity, were beyond the scope of this brief study. Finally, using the RAI has been questioned in recent research (see e.g., Chemolli & Gagné, 2014), therefore most of the attention should be focused on the results of the separate regulations instead of on the ones based on the RAI.

Study III

Identifying complex interactions such as those in Study III would probably be futile in traditional variable-centred analyses, and, if identified statistically, the interpretation of these five-way interactions could be cumbersome. The value of using a person-centred analysis, such as LPA, aside from providing a complementary and alternative picture of associations, may primarily be to offer researchers the possibility of closer examination of the important SDT-related assumption regarding multiple regulations/driving forces pushing and pulling the individual towards behaviour; a theoretical assumption that has been largely neglected, or only touched upon on the surface, in previous empirical work. As in Study I, the cross-sectional design of Study III is one apparent weakness. For example, no causal direction can be implied by the associations between the associations in profiles, need satisfaction and exercise behaviour. Also, although the data displayed substantial variation regarding most of the BREQ-2 input variables, the

variance was trivial, and low overall scores in amotivation, which may have provided a different overall pattern if the samples had included more people being less active and scoring high on amotivation.

Study IV

As people spend more and more time in digital worlds, more knowledge about how to facilitate motivation in digital contexts would be increasingly valuable across domains. The main strengths of Study IV were the randomized controlled design with three wave measurements, the use of modern, recommended mediation analyses with documentation of action theory links and conceptual theory links in the relation between the intervention and targeted variables, and the implementation of moderation analyses. Nevertheless, some limitations need to be addressed. No unexpected disparities were found in drop-out analyses, and high drop-out is common in this type of study (Elfeddali et al., 2012; Peels et al., 2013; Eysenbach et al., 2005; Friederichs et al., 2015), but because only half of the original experimental group actually logged on to the intervention tool, this drop-out might have had an effect on power and analyses precision. The time frame for the intervention was limited due to the project structure being divided into separate phases as a result of the logistic arrangements. To date, this first phase has been followed by a second one, where the same prototype is tested in a 9-month RCT, potentially adding more profound information of the studied effects and mechanisms. Being a small-scale and short-term trial, all process analyses might not have had appropriate power and some interpretations could be of more practical or clinical importance in the real world of exercise and physical activity than having statistical significance (Ivarsson et al., 2013). Because there are numerous exercise correlates influencing behaviour (Bauman et al., 2012; Bauman et al., 2002); also a small percentage of variance explained in exercise level and intensity might be of importance for health related costs/benefits on a population level. For example, a small difference between groups in energy expenditure (MET) might spawn weight loss that have positive health effects (i.e., lower risk of diabetes, colon cancer and so on, see e.g., YFA, 2010; Petersen et al., 2015). When it comes to improvements in motivation quality (e.g., decrease in amotivation and controlled motivation) this could be considered highly valuable if sustained, not only for potential influence on future behaviour, but according to SDT stipulates also for increased quality of life. Furthermore, the significance of finding out how to motivate the unmotivated has also been stressed (Hardcastle & Hagger, 2016) and adding adherence to physical activity behaviours would have considerable protective effects on mortality risk (Petersen et al., 2015). In the context of a step-contest as a part of work-

place health promotion, lower amotivation and controlled motivation levels for only a few employees would be meaningful in terms of the significance for potential outcomes of such an investment.

As in most intervention studies there might be difficulty in knowing what features of the intervention content caused the effects. This is especially true for multicomponent programs such as this one and can be addressed in future studies by including complementary measures. Intervention fidelity can be considered based on the five aspects of Dane and Schneider (1998), regarding: a) the components of the intervention were delivered and adapted to the digital contexts according to recommendations in previous research; b) the program content was available for all participants, but in this version of the digital tool, no frequencies of personal delivery could be tracked; c) the content was delivered according to the theory based ideal which was adapted to the digital context; d) participant responsiveness could not be measured on a personal level, only in terms of article ratings, collective amount of views/visits etc.; and e) program differentiation of critical components was not identified at this stage. Finally, the intervention was a prototype platform and interacting artefacts for communication and feedback were not yet included, representing a substantial discrepancy compared to more interactive digital tools or to face-to-face interventions in personal counselling.

Conclusions & contributions

The results are generally in line with the theoretical expectations concerning the mechanisms in the SDT process model, demonstrating that autonomous motivation is promoted by need satisfaction and that autonomous motivation, in turn, can translate into increased levels of exercise. Furthermore, the results of the second and fourth study provide evidence that these mechanisms can be manipulated in an intervention, for example by creating need-supportive environments facilitating internalization and subsequent exercise behaviour. Showing that theory may be able to predict behaviour by understanding mediating effects allows a refinement of the intervention construction to increase its effectiveness.

This thesis also extends previous research by exploring the sequential steps proposed by SDT in different mediation models. Two of the studies demonstrated that identified regulation plays a prominent role in the motivational processes, supporting the significance of promoting internalization in exercise. In this way, intervention efficacy could be systematically improved and more cost-effective and more successful program tailoring could be facilitated. The statement, *you don't have to love it*, is based on the significance of identified regulation found in Study I and II, along with the moderation analyses in Study IV which showed that the digital

intervention had the best effects for the ones with low scores on identified regulation and that those engaging in predominantly light activities increased their exercise level the most. These results indicate that the ambition to facilitate identified regulation in tailoring the digital intervention had potential. Moderation analyses provided a better understanding of what worked and for whom, and the moderating effects of gender and age in the full samples of Study I and IV revealed complex patterns in the associations between SDT concepts and exercise, which propose that motivational mechanisms can vary depending on subgroup. This represents an indication that intervention design might benefit from slightly different approaches for different subgroups based on age and gender, and perhaps also based on contextual influences likely to modify vital prerequisites of certain subgroups. Although some preliminary interpretations have been made here, the purpose has been to explore the presence of these mechanisms rather than to explain them. Recommendations for future studies include further examining the moderating effects of gender and age to provide comprehensive and elaborate explanations for informing practical applications. In such research, it would also be advisable to address the motivational soup and person-centred analyses to create psychographic profiles that could complement demographics.

Another interesting discovery in this thesis was related to amotivation, which was involved in statistically significant main (time) effects, as well as in mediating the intervention effects in Study IV. Amotivation was also moderated by age in the general moderation analyses for the full sample, predicting light exercise for younger adults. Finally, the potential value of using a polytheoretical approach in exercise promotion was discussed regarding the potential outcomes from combining SDT with other theories and methods.

Table 2. Thesis overview

	Study I	Study II	Study III	Study IV
Design	Cross-sectional	Two-wave RCT intervention	Cross-sectional	Three-wave RCT intervention
Theoretical foundation	SDT	SDT, MI, RPM CBT	SDT	SDT, RPM, TTM
Participants	1091 adult men ($n = 286$) and women ($n = 805$), aged 18-78 years ($M = 45.0$; $SD = 11.7$), all were active members of a web based Swedish exercise program.	64 Swedish undergraduate university students (women $n = 49$ and men $n = 15$) aged 19-49 years ($M = 27.3$; $SD = 7.4$).	Sample A: $N = 1084$, web-based exercise service members, mean age 45 ($SD = 11.7$). Sample B: $N = 511$ university students with a mean age of 22 years ($SD = 3.3$).	318 adult women ($n = 279$) and men ($n = 40$) aged 23-67 years ($M = 46.7$; $SD = 9.4$) participating in a digital step contest provided by their employer
Measures	BPNES, BREQ-2, LTEQ SEM, MVA	PNES, BREQ-2, LTEQ ANCOVA, MVA	BPNES, BREQ-2, LTEQ LPA	BPNES, BREQ-2, LTEQ ANCOVA, MVA
Analyses				
Results	Self-determined exercise motivation (identified regulation) mediated the relationship between basic psychological need satisfaction and exercise in the full sample. Moderations of gender and age were also found.	Post-intervention effects showed increased levels of total and strenuous exercise, and this effect was mediated by self-determined motivation (identified regulation).	Six profiles were found in both samples. Some profiles were found in both samples whereas others were unique to each sample. More self-determined profiles demonstrated higher scores on need satisfaction and exercise	The intervention increased levels of total, strenuous and light exercise and predicted mediators in terms of motivational quality. Moderations of gender and age were also found.

Limitations	Cross-sectional design, sample constitution (mainly women, high mean age) and self-reported exercise.	Small sample of convenience, self-reported exercise, exclusion of the relatedness need dimension and only having two measure points.	Cross-sectional design, sample constitution (mainly women, high mean age) and self-reported exercise.	High drop-out, sample constitution (mainly women, high mean age), self-reported exercise.
Contributions	Validation of Swedish translations of BPNES and BREQ-2 Employing a large sample of middle-aged adults in an e-health context Using SEM and advanced and modern recommended MVA Generating a full mediation model of steps 3-5 in the SDT process model along with moderating effects of gender and age, hence not only examining general relationships between variables but also when, for whom, and why they are associated.	Short-term exercise intervention Applying polytheoretical intervention tailoring Operating in a real-world setting Using advanced and modern recommended MVA	Support for the motivational soup, i.e., that motivation is a multidimensional construct and that people have different, sometimes competing, reasons for engaging in exercise. Using person-oriented analyses to examine within-person interactions of motivation and different regulations	Short term exercise intervention in a digital context. Amotivation was involved in statistically significant main (time) effects, as well as in mediating the intervention effects. The intervention decreased controlled motivation (external regulation) and amotivation. Results of moderation analyses suggest that the stipulated mechanisms between exercise, motivation and psychological need satisfaction in this study hold for women, but not for men, and for older, but not for younger adults.

References

- Abraham, C., & Michie, S. (2008). A taxonomy of behavior change techniques used in interventions. *Health Psychology, 27*, 379–387. doi: 10.1037/0278-6133.27.3.379
- Aldridge, A. A., & Roesch, S. C. (2008). Developing coping typologies of minority adolescents: a latent profile analysis. *Journal of Adolescence, 31*(4), 499-517. doi:0.1016/j.adolescence.2007.08.005
- Arminger, G., Stein, P., & Wittenberg, J. (1999). Mixtures of conditional mean- and covariance-structure models. *Psychometrika, 64*(4), 475-494.
- Asparouhov, T., & Muthén, B. (2014). Auxiliary variables in mixture modeling: Three-step approaches using Mplus. *Structural Equation Modeling, 21*(3), 329-341.
- Bandura, A. (1977). Self-efficacy: Toward a unifying theory of behavioral change. *Psychological Review, 84*(2), 191-215.
- Bandura, A. (1986). *Social foundations of thought and action: A social cognitive theory*. Englewood Cliffs, NJ: Prentice Hall.
- Bandura, A. (1997). *Self-Efficacy, the exercise of control*. New York; NY: W. H. Freeman & Company.
- Baranowski, T., Anderson, C., & Carmack, C. (1998). Mediating variable framework in physical activity interventions: How are we doing? How might we do better? *American Journal of Preventive Medicine, 15*, 266-297. doi:10.1016/S0749-3797(98)00080-4
- Baranowski, T., & Jago, R. (2005). Understanding the mechanisms of change in children's physical activity programs. *Exercise and Sport Sciences Reviews, 33*(4), 163-168.
- Bauman, A. E., Sallis, J. S., Dzewaltowski, D. A., & Owen, N. (2002). Toward a better understanding of the influences on physical activity. *American Journal of Preventive Medicine, 23*(Suppl. 2), 5-14. doi:10.1016/S0749-3797(02)00469-5
- Bauman, A. E., Reis, R. S., Sallis, J. F., Wells, J. C., Loos, R. J. F., & Martin, B. W. (2012). Correlates of physical activity: Why are some people physically active and others not? *The Lancet, 380*(9838), 258 - 271. doi:10.1016/S0140-6736(12)60735-1
- Baumeister, R. F., & Leary, R. L. (1995). Need to belong: Desire for interpersonal attachments as a fundamental human emotion. *Psychological Bulletin, 117*(3), 497-529.

REFERENCES

- Beck, F., Gillison, F., & Standage, M. (2010). A theoretical investigation of the development of physical activity habits in retirement. *British Journal of Health Psychology*, 15, 663-679. doi:10.1348/135910709X479096
- Bergman, L. R., & Andersson, H. (2010). The person and the variable in developmental psychology. *Journal of Psychology*, 218(3), 155-165. doi: 10.1027/0044-3409/a000025
- Biddle, S. H. J., & Mutrie, N. (2008). *Psychology of physical activity. Determinants, well-being and interventions*. (2:nd ed). New York, NY: Routledge.
- Biddle, S. H. J., Mutrie, N., Gorely, T., & Blamey, A. A. (2012). *Interventions for physical activity and sedentary behavior*. In G. C. Roberts & D. C. Treasure (Eds.). *Advances in motivation in sport and exercise* (3:rd ed.). Champaign, IL: Human Kinetics.
- Biddle, S. J. H., Brehm, W., Verheijden, M., & Hopman-Rock, M. (2012). Population physical activity behaviour change: A review for the European College of Sport Science. *European Journal of Sport Science*, 12(4), 367-383. doi: 10.1080/17461391.2011.635700
- Bolin, K., & Lindgren, B. (2005). *Fysisk inaktivitet - produktionsbortfall och sjukvårdskostnader*. Stockholm, Sweden: FRISAM.
- Booth, F. W., Chakravarthy, M. V., Gordon, S. E., & Spangenburg, E. E. (2002). Waging war on physical inactivity: Using modern molecular ammunition against an ancient enemy. *Journal of Applied Physiology* [8750-7587], 93(1), 3-30. doi: 10.1152/jappphysiol.00073.2002
- Brene, S., Bjornebekk, A., Aberg, E., Mathe, A. A., Olson, L., & Werme, M. (2007). Running is rewarding and antidepressive. *Physiology and Behavior*, 92, 136-140. doi: 10.1016/j.physbeh.2007.05.015
- Brislin, R. W. (Ed.). (1986). *The wording and translation of research instruments* (137-164). Thousand Oaks, CA: Sage.
- Broekhuizen, K., Kroeze, W., van Poppel, M., Oenema, A., & Brug, J. (2012). A systematic review of randomized controlled trials on the effectiveness of computertailored physical activity and dietary behavior promotion programs: an update. *Annals of Behavioral Medicine*, 44, 259-286.
- Brouwer, W., Kroeze, W., Crutzen, R., De Nooijer, J., De Vries, N., Brug, J., & Oenema, A. (2011). Which intervention characteristics are related to more exposure to internet-delivered healthy lifestyle promotion interventions? A systematic review. *Journal of Medical Internet Research*, 13, e2. doi:10.2196/jmir.1639
- Brouwer, W., Oenema, A., Raat, H., Crutzen, R., de Nooijer, J., de Vries, N., & Brug, J. (2010). Characteristics of visitors and revisitors to an Internet delivered computer-tailored lifestyle intervention

- implemented for use by the general public. *Health Education Research*, 25, 585-595. doi:10.1093/her/cyp063
- Brunet, J., & Sabiston, C. M. (2011). Exploring motivation for physical activity across the adult lifespan. *Psychology of Sport and Exercise*, 12, 99-105. doi:10.1016/j.psychsport.2010.09.006
- Buckworth, J., (Ed) Dishman, R. K., & Tomporowski, P. (2013). *Exercise psychology* (2:nd ed.). Champaign, Ill: Human Kinetics.
- Bull, F. C., Armstrong, T. P., Dixon, T., Ham, S., Nieman, A., & Pratt, M. (2004). *Comparative quantification of health risks global and regional burden of disease attributable to selected major risk factors* Geneva, Switzerland: World Health Organization.
- Burke, B. L., Arkowitz, H., & Menchola, M. (2003). The efficacy of motivational interviewing: a meta-analysis of controlled clinical trials. *Journal of Consulting and Clinical Psychology*, 71(5), 843-861. doi: 10.1037/0022-006X.71.5.843
- Bødker, K., Kensing, F., & Simonsen, J. (2004). *Participatory IT design: Designing for business and workplace realities*. Cambridge, MA: MIT Press.
- Carroll, S., & Dudfield, M. (2004). What is the relationship between exercise and metabolic abnormalities? A review of the metabolic syndrome. *Sports Medicine*, 34(6), 371-418.
- Casemore, R. (2011). *Person-centred counselling in a nutshell* (2 ed.). Warwick, England: Sage Publications Ltd.
- Cerin, E. (2010). Ways of unraveling how and why physical activity influences mental health through statistical mediation analyses. *Mental Health and Physical Activity*, 3, 51-60. doi 10.1016/j.mhpa.2010.06.002
- Cerin, E., Barnett, A., & Baranowski, T. (2009). Testing theories of dietary behavior change in youth using the mediating variable model with intervention programs. *Journal of Nutrition Education and Behavior*, 41, 309-318. doi: 0.1016/j.jneb.2009.03.129.
- Cerin, E., & Mackinnon, D. P. (2009). A commentary on current practice in mediating variable analyses in behavioural nutrition and physical activity. *Public Health Nutrition*, 12, 1182-1188. doi:10.1017/S1368980008003649
- Cerin, E., Taylor, L. M., Leslie, E., & Owen, N. (2006). Small-scale randomized controlled trials need more powerful methods of mediational analysis than the Baron-Kenny method. *Journal of Clinical Epidemiology*, 59, 457-464. doi:10.1016/j.jclinepi.2005.11.008
- Chemolli, E., & Gagné, M. (2014). Evidence against the continuum structure underlying motivation measures derived from self-determination

REFERENCES

- theory. *Psychological Assessment*, 26(2), 575 - 585. doi: 10.1037/a0036212
- Cheon, S. H., Reeve, J., & Moon, I. S. (2012). Experimentally based, longitudinally designed, teacher-focused intervention to help physical education teachers be more autonomy supportive toward their students. *Journal of Sport & Exercise psychology*, 34(3), 365-396.
- Cherkas, L. F., Hunkin, J. L., Kato, B. S. J., Richards, B., Gardner, J. P. S., G. L. Kimura, M., . . . Aviv, A. (2008). The association between physical activity in leisure time and leukocyte telomere length. *Archives of Internal Medicine*, 168(2), 154-158. doi: 10.1001/archinternmed.2007.39.
- Cohen, J. (1988). *Statistical power analysis for the behavioral sciences* (2 ed.). Hillsdale, NJ: Erlbaum.
- Cole, D. A., & Maxwell, S. E. (2003). Testing mediational models with longitudinal data: Questions and tips in the use of structural equation modeling. *Journal of Abnormal Psychology*, 112, 558-577. doi: 10.1037/0021-843X.112.4.558
- Dane, A. V., & Schneider, B. H. (1998). Program integrity in primary and early secondary prevention: Are implementation effects out of control? *Clinical Psychology Review*, 18, 23-45. doi: 10.1016/S0272-7358(97)00043-3.
- Daley, A. J., & Duda, J. L. (2006). Self-determination, stage of readiness to change for exercise, and frequency of physical activity in young people. *European Journal of Sport Science*, 6(4), 231-243. doi: 10.1080/17461390601012637
- Davies, C., Spence, J., Vandelanotte, C., Caperchione, C., & Mummery, W. (2012). Meta-analysis of internet-delivered interventions to increase physical activity levels. *International Journal of Behavioral Nutrition and Physical Activity*, 9, 52. doi:10.1186/1479-5868-9-52
- Davidson, K. W., Peacock, J., Kronish, I. M., & Edmondson, D. (2014). Personalizing behavioral interventions through single-patient (N-of-1) trials. *Social and Personality Psychology Compass*, 8(8), 408-421. doi: 10.1111/spc3.12121
- Dawson, K. A., Tracey, J., & Berry, T. (2008). Evaluation of work place group and internet based physical activity interventions on psychological variables associated with exercise behaviour change. *Journal of Sports Science and Medicine*, 7, 537-543. doi 10.4278/ajhp.120404-LIT-18
- Deci, E. (1975). *Intrinsic motivation*. New York, NY: Plenum.
- Deci, E. L., & Flaste, R. (1996). *Why we do what we do. Understanding Self-Motivation* New York, NY: Penguin Books.

- Deci, E. L., Koestner, R., & Ryan, R. M. (1999). A meta-analytic review of experiments examining the effects of extrinsic rewards on intrinsic motivation. *Psychological Bulletin*, *125*, 627-668.
- Deci, E. L., & Ryan, R. M. (1985). *Intrinsic motivation and self-determination in human behavior*. New York, NY: Plenum Press.
- Deci, E. L., & Ryan, R. M. (2000). The “what” and “why” of goal pursuits: Human needs and the self-determination of behavior. *Psychological Inquiry*, *4*, 227-268. doi: 10.1207/S15327965PLI1104_01
- Deci, E. L., & Ryan, R. M. (2012). Self-determination theory in health care and its relations to motivational interviewing: A few comments. *International Journal of Behavioral Nutrition and Physical Activity*, *9*, 24. doi:10.1186/1479-5868-9-24
- Deci, E. L., & Ryan, R. M. (2013, June). *Facilitating development, motivation, performance and wellness: an overview of Self-Determination Theory*. 5th Self-determination theory conference, Rochester NY. 2013-06-28
- del Hoyo-Barbolla, E., Kukafka, R., Arredondo, M., & Ortega, M. (2006). A new perspective in the promotion of e-health. *Studies in Health Technology and Informatics*, *124*, 404-412. doi: 10.3233/978-1-58603-647-8-404
- Doshi, A., Patrick, K., Sallis, J., & Calfas, K. (2003). Evaluation of physical activity Web sites for use of behavior change theories. *Annals of Behavioural Medicine*, *25*, 105-111. doi: 10.1207/S15324796ABM2502_06
- Edmunds, J., Ntoumanis, N., & Duda, J. L. (2006). Examining exercise dependence symptomatology from a self-determination perspective. *Journal of Health Psychology*, *11*, 887-903. doi:10.1177/1359105306069091
- Edmunds, J., Ntoumanis, N., & Duda, J. L. (2007). Adherence and well-being in overweight and obese patients referred to an exercise on prescription scheme: A self-determination theory perspective. *Psychology of Sport and Exercise*, *8*(5), 722-740. doi: 10.1016/j.psychsport.2006.07.006
- Edmunds, J., Ntoumanis, N., & Duda, J. L. (2008). Testing a self-determination theory-based teaching style intervention in the exercise domain. *European Journal of Social Psychology*, *38*, 375-388. doi:10.1002/ejsp.463
- Eklom-Bak, E., Hellenius, M.-L., & Eklom, B. (2010). Are we facing a new paradigm of inactivity physiology? *British Journal of Sports Medicine*, *44*(12), 834-835. doi: 10.1136/bjism.2009.067702
- Eklom-Bak, E., Olsson, G., Eklom, O., Eklom, B., Bergstrom, G., & Borjesson, M. (2015). The daily movement pattern and fulfilment of physical activity recommendations in Swedish middle-aged adults:

REFERENCES

- The SCAPIS pilot study. *PloS one*, 10(5), e0126336. doi: 10.1371/journal.pone.0126336
- Elfeddali, I., Bolman, C., Candel, M., Wiers, R., & de Vries, H. J. (2012). Preventing smoking relapse via Web-based computer-tailored feedback: A randomized controlled trial. *Journal of Medical Internet Research*, 14, e109. doi: 10.2196/jmir.2057
- Elley, C. R., Kerse, N., Arrol, B., & Robinson, E. (2003). Effectiveness of counseling patients on physical activity in general practice: Cluster randomized controlled trial. *British Medical Journal*, 326, 793-796. doi: 10.1136/bmj.326.7393.793
- Epstein, R., & Street, R. (2007). *Patient-centered communication in cancer care: Promoting healing and reducing suffering*. Bethesda, MD: National Institutes of Health.
- Ericsson, K., & Simon, H. (1993). *Protocol analysis: Verbal reports as data* (2 ed.). Boston, MA: MIT Press.
- Evers, K., Prochaska, J., Prochaska, J., Driskell, M., Cummins, C., & Velicer, W. (2003). Strengths and weaknesses of health behavior change programs on the Internet. *Journal of Health Psychology*, 8(63-70). doi: 10.1177/1359105303008001435
- Fortier, M., & Kowal, J. (2007). *The flow state and physical activity behaviour change as motivational outcomes. A self-determination theory perspective*. Champaign Ill: Human Kinetics.
- Fortier, M. S., Duda, J. L., Guérin, E., & Teixeira, P. J. (2012). Promoting physical activity: development and testing of self-determination theory-based interventions. *International Journal of Behavioral Nutrition and Physical Activity*, 9, 20. doi:10.1186/1479-5868-9-20
- Fortier, M. S., Sweet, S. N., O'Sullivan, T. L., & Williams, G. C. (2007). A self-determination process model of physical activity adoption in the context of a randomized controlled trial. *Psychology of Sport and Exercise*, 8, 741-757. doi:10.1016/j.psychsport.2006.10.006
- Fortier, M. S., Wiseman, E., Sweet, S. N., O'Sullivan, T. L., Blanchard, C. M., Sigal, R. J., & Hogg, W. (2011). A moderated mediation of motivation on physical activity in the context of the physical activity counseling randomized control trial. *Psychology of Sport and Exercise*, 12, 71-78. doi:10.1016/j.psychsport.2010.08.001
- Frank, L. L., Sorensen, B. E., Yasui, Y., Tworoger, S. S., Schwartz, R. S., Ulrich, C. M., . . . McTiernan, A. (2005). Effects of exercise on metabolic risk variables in overweight postmenopausal women: a randomized clinical trial. *Obesity Research*, 13(3), 615-625. doi: 10.1038/oby.2005.66
- Friederichs, S. A., Oenema, A., Bolman, C., & Lechner, L. (2015). Long term effects of self-determination theory and motivational interviewing in a web-based physical activity intervention: Randomized controlled

- trial. *International Journal of Behavioral Nutrition and Physical Activity*, 12, 101. doi:10.1186/s12966-015-0262-9
- Friederichs, S. A. H., Bolman, C., Oenema, A., & Lechner, L. (2015). Profiling physical activity motivation based on self-determination theory: A cluster analysis approach. *Psychology*, 3(1). doi: 10.1186/s40359-015-0059-2
- Gallagher, P., Yancy, W. S., Jr., Swartout, K., Denissen, J. J., Kuhnel, A., & Voils, C. I. (2012). Age and sex differences in prospective effects of health goals and motivations on daily leisure-time physical activity. *Preventive Medicine*, 55, 322-324. doi:10.1016/j.ypmed.2012.07.017
- Garrett, S., Elley, C. R., Rose, S. B., O'Dea, D., Lawton, B. A., & Dowell, A. C. (2011). Are physical activity interventions in primary care and the community cost-effective? A systematic review of the evidence. *British Journal of General Practice*, 61(584), e125-133. doi: 10.3399/bjgp11X561249
- Georgiades, A., Sherwood, A., Gullette, E. C. D., Babyak, M. A., Hinderliter, A., Waugh, R., & Blumenthal, J. A. (2000). Effects of Exercise and Weight Loss on Mental Stress-Induced Cardiovascular Responses in Individuals With High Blood Pressure. *Hypertension*, 36(2), 171-176. doi: 10.1161/01.hyp.36.2.171
- Gillison, F., Osborn, M., Standage, M., & Skevington, S. (2009). Exploring the experience of introjected regulation for exercise across gender in exercise. *Psychology of Sport and Exercise Special Issue: Advances in self-determination theory research in sport and exercise*, 10, 309-319. doi: 10.1016/j.psychsport.2008.10.004
- Godin, G., & Shephard, R. J. (1985). A simple method to assess exercise behavior in the community. *Canadian Journal of Applied Sport Sciences/ Journal Canadien des Sciences Appliquees Au Sport*, 10, 141-146.
- Godin, G., & Shephard, R. J. (1997). Godin Leisure-Time Exercise Questionnaire. *Medicine and Science in Sports and Exercise*, 29(Suppl.) 36-38.
- Guérin, E., Bales, E., Fortier, M. S., & Sweet, S. (2012). A meta-analysis of the influence of gender on self-determination theory's motivational regulations for physical activity. *Canadian Psychology/Psychologie Canadienne*, 53, 291-300. doi:10.1037/a0030215
- Guerin, E., & Fortier, M. (2012). Motivational profiles for physical activity: Cluster analysis and links with enjoyment. *RevuephénEPS/PHEnex Journal*, 4(2), 1-21.
- Gustafson, D. H., Shaw, B. R., Isham, A., Baker, T., Boyle, M. G., & Levy, M. (2011). Explicating an evidence-based, theoretically informed, mobile technology-based system to improve outcomes for people in

REFERENCES

- recovery for alcohol dependence. *Substance Use and Misuse*, 46, 96-111. doi:10.3109/10826084.2011.521413
- Hagger, M. S., Chatzisarantis, N. L., & Biddle, S. J. (2002). The influence of autonomous and controlling motives on physical activity intentions within the theory of planned behaviour. *British Journal of Health Psychology*, 7(Part 3), 283-297. doi: 10.1348/135910702760213689
- Hagger, M. S., & Chatzisarantis, N. L. D. (2008). Self-determination theory and the psychology of exercise. *International Review of Sport and Exercise Psychology*, 1(1), 79-103. doi:10.1080/17509840701827437
- Hagger, M. S., Chatzisarantis, N. L. D., & Harris, J. (2006). From psychological need satisfaction to intentional behavior: Testing a motivational sequence in two behavioral contexts. *Personality and Social Psychology Bulletin*, 32, 131-138. doi: 10.1177/0146167205279905
- Hagstromer, M., Oja, P., & Sjostrom, M. (2007). Physical activity and inactivity in an adult population assessed by accelerometry. *Medicine and Science in Sports and Exercise*, 39(9), 1502-1508. doi: 10.1249/mss.0b013e3180a76de5
- Hallal, P. C., Andersen, L. B., Bull, F. C., Guthold, R., Haskell, W., & Ekelund, U. (2012). Global physical activity levels: Surveillance progress, pitfalls, and prospects. *The Lancet*, 380(9838), 247 - 257. doi:10.1016/S0140-6736(12)60646-1
- Hamilton, K., Cox, S., & White, K. M. (2012). Testing a model of physical activity among mothers and fathers of young children: Integrating self-determined motivation, planning, and the theory of planned behavior. *Journal of Sport & Exercise Psychology*, 34, 124-145.
- Hardcastle, S. J., & Hagger, M. S. (2016). Psychographic profiling for effective health behavior change interventions. *Frontiers in Psychology*, 6, 1-2. doi:10.3389/fpsyg.2015.01988
- Hardcastle, S. J., Hancox, J., Hattar, A., Maxwell-Smith, C., Thøgersen-Ntoumani, C., & Hagger, M. S. (2015). Motivating the unmotivated: How can health behavior be changed in those unwilling to change? *Frontiers in Psychology*, 6, 835. doi:10.3389/fpsyg.2015.00835
- Haskell, W. L., Lee, I. M., Pate, R. R., Powell, K. E., Blair, S. N., Franklin, B. A., Bauman, A. (2007). Physical activity and public health: updated recommendation for adults from the American College of Sports Medicine and the American Heart Association. *Medicine and Science in Sports and Exercise*, 39(8), 1423-1434. doi: 10.1249/mss.0b013e3180616b27
- Hawkins, R., Pingree, S., Shaw, B., & (2008, May). *Mediating processes of effects of two communication interventions*. Paper presented at the Annual meeting of the International Communication Association, Montreal, Canada.

- Hayes, A. F. (2009). Beyond Baron and Kenny: Statistical mediation analysis in the new millennium. *Communication Monographs*, 76, 408-420. doi:10.1080/03637750903310360
- Hayes, A. F. (2013). *Introduction to mediation, moderation, and conditional process analysis: A regression-based approach*. New York, NY: Guilford Press.
- Healy, G., Lawler, S., Thorp, A., Neuhaus, M., Robson, E., Owen, N., & Dunstan, D. (2012). *Reducing prolonged sitting in the workplace. An evidence review: full report*. Victorian Health Promotion Foundation, Melbourne, Australia.
- Heath, G. W., Parra, D. C., Sarmiento, O. L., Andersen, L. B., Owen, N., Goenka, S., Brownson, R. C. (2012). Evidence-based intervention in physical activity: Lessons from around the world. *The Lancet*, 380(9838), 272 - 281. doi: 10.1016/S0140-6736(12)60816-2
- Henson, J. M., Reise, S. P., & Kim, K. H. (2007). Detecting mixtures from structural model differences using latent variable mixture modeling: A comparison of relative model-fit statistics. *Structural Equation Modeling*, 14, 202-226. doi: 10.1080/10705510709336744
- Hesse, B. W. (2008). *Enhancing consumer involvement in health care*. In J. C. Parker & E. Thorson (Eds.), *Healthcare communication in the new media landscape*. New York, NY: Springer.
- Hurling, R., Fairley, B., & Dias, M. (2006). Internet-based exercise intervention systems: Are more interactive designs better? *Psychology & health*, 21, 757-772. doi: 10.2196/jmir.9.2.e7
- Jacobs, D. T. R., Ainsworth, B. E., Hartman, T. J., & Leon, A. S. (1993). A simultaneous evaluation of 10 commonly used physical activity questionnaires. *Medicine and Science in Sports and Exercise*, 25, 81-91. doi 10.1249/00005768-199301000-00012
- Josefsson, T., Lindwall, M., & Archer, T. (2013). Physical exercise intervention in depressive disorders: Meta-analysis and systematic review. *Scandinavian Journal of Medicine & Science in Sports*. doi: 10.1111/sms.12050
- Joseph, R., Durant, N., Benitez, T., & Pekmez, i. D. (2014). Internet-based physical activity interventions. *American Journal of Lifestyle Medicine*, 8, 42-68. doi: 10.1177/1559827613498059
- Kahn, E. B., Ramsey, L. T., Brownson, R. C., Heath, G. W., Howze, E. H., & Powell, K. E., (2002). The effectiveness of interventions to increase physical activity: a systematic review. *American Journal of Preventive Medicine*, 22(4, Suppl. 1), 73-107. doi 10.1016/S0749-3797(02)00434-8
- Kallings, L. V., Sierra Johnson, J., Fisher, R. M., de Faire, U., Stahle, A., Hemmingsson, E., & Hellénus, M. L. (2009). Beneficial effects of individualized physical activity on prescription on body composition

REFERENCES

- and cardiometabolic risk factors: Results from a randomized controlled trial. *European Journal of Cardiovascular Prevention & Rehabilitation*, 16(1), 80-84. doi: 10.1097/HJR.0b013e32831e953a
- Kamel Boulos, M. N., & Al-Shorbaji, N. M. (2014). On the Internet of things, smart cities and the WHO Healthy Cities. *International Journal of Health Geographics*, 13(10). doi: 10.1186/1476-072X-13-10
- Kaplan, A., & Haenlein, M. (2010). Users of the world, unite! The challenges and opportunities of social media. *Business Horizons*, 53, 59-68. doi:10.1016/j.bushor.2009.09.003
- Katzmarzyk, P. T. (2010). Physical activity, sedentary behavior, and health: paradigm paralysis or paradigm shift? *Diabetes*, 59(11), 2717-2725. doi: 10.2337/db10-0822
- Khazaal, Y., Richard, C., Matthieu-Darekar, S., Qument, B., Kramer, U., & Preisig, M. (2008). Advance directives in bipolar disorder, a cognitive behavioural conceptualization. *International Journal of Law and Psychiatry*, 31(1), 1-8. doi: S0160-2527(07)00098-2 [pii]10.1016/j.ijlp.2007.11.001
- Kilpatrick, M., Hebert, E., & Bartholomew, J. (2005). College students' motivation for physical activity: Differentiating men's and women's motives for sport participation and exercise. *Journal of American College Health Affairs*, 54, 87-94. doi:10.3200/JACH.54.2.87-94
- Kirwan, M., Duncan, M., Vandelanotte, C., & Mummery, W. (2012). Using smartphone technology to monitor physical activity in the 10,000 Steps program: a matched case-control trial. *Journal of Medical Internet Research*, 14, e55.
- Kline, R. B. (1998). *Principles and practice of structural equation modeling*. New York, NY: Guilford Press.
- Kohl, L., Crutzen, R., & De Vries, N. (2013). Online prevention aimed at lifestyle behaviors: a systematic review of reviews. *Journal of Medical Internet Research*, 15(7), e146. doi: 10.2196/jmir.2665
- Kohl, H. W., Craig, C. L., Lambert, V. L., Inoue, S., Alkandari, J. M., Leetongin, G., & Kahlmeier, S. (2012). The pandemic of physical inactivity: global action for public health. *The Lancet*, 380(9838), 67-78. doi: /10.1016/S0140-6736(12)60898-8
- Kooij, D. T. A. M., De Lange, A. H., Jansen, P. G. W., & Kanfer & Dikkers, J. S. E. (2011). Age and work-related motives: Results of a meta-analysis. *Journal of Organizational Behavior*. 32, 197-225.
- Kramer, H. C., Wilson, G. T., Fairburn, C. G., & Agras, W. S. (2002). Mediators and moderators of treatment effects in randomized controlled trials. *Archives of General Psychiatry*, 59, 877-883. doi: 10.1001/archpsyc.59.10.877.

- Kreuter, M., Strecher, V., & Glassman, B. (1999). One size does not fit all: the case for tailoring print materials. *Annals of Behavioral Medicine, 21*, 276-283.
- Landry, J. B., & Solmon, M. A. (2004). African American women's self-determination across the stages of change for exercise. *Journal of Sport and Exercise Psychology, 26*, 457-469.
- Larimer, M. E., Palmer, R. S., & Marlatt, G. A. (1999). Relapse prevention. An overview of Marlatt's cognitive-behavioral model. *Alcohol Research and Health, 23*, 151-160.
- Lee, I.-M., Shiroma, E. J., Lobelo, F., Puska, P., Blair, S. N., & Katzmarzyk, P. T. (2012). Effect of physical inactivity on major non-communicable diseases worldwide: An analysis of burden of disease and life expectancy. *The Lancet, 380*(9838), 219-229. doi:10.1016/S0140-6736(12)61031-9
- Lee, W., & Reeve, J. (2013). Self-determined, but not non-self-determined, motivation predicts activations in the anterior insular cortex: An fMRI study of personal agency. *Social, Cognitive, and Affective Neuroscience*(8), 538-545. doi: 10.1093/scan/nss029
- Lee, W., Reeve, J., Xue, Y., & Xiong, J. (2012). Neural differences between intrinsic reasons for doing versus extrinsic reasons for doing: An fMRI study. *Neuroscience Research, 73*, 68-72. doi: 10.1016/j.neures.2012.02.010
- Leijon, M. E., Bendtsen, P., Nilsen, P., Festin, K., & Stahle, A. (2009). Does a physical activity referral scheme improve the physical activity among routine primary health care patients? *Scandinavian Journal of Medicine & Science in Sports, 19*(5), 627-636. doi: 10.1111/j.1600-0838.2008.00820.x.
- Leslie, E., Marshall, A., Owen, N., & Bauman, A. (2005). Engagement and retention of participants in a physical activity website. *Preventive Medicine, 40*, 54-59. doi: 10.1016/j.ypmed.2004.05.002
- Li, F. (1999). The Exercise Motivation Scale: Its multifaceted structure and construct validity. *Journal of Applied Sport Psychology, 11*, 97-115. doi:10.1080/10413209908402953
- Lindahl, J., Stenling, A., Colliander, C., & Lindwall, M. (2014). Trends and knowledge base in sport and exercise psychology research: a bibliometric review study. *International Review of Sport and Exercise Psychology, 8*(1), 71-94. doi: 10.1080/1750984X.2015.1019540
- Linton, S. J., & Flink, I. (2011). *12 verktyg i KBT: från teori till färdighet*. Stockholm, Sweden: Natur & kultur.
- Lo, Y., Mendell, N., & Rubin, D. (2001). Testing the number of components in a normal mixture. *Biometrika, 88*, 767-778. doi: 10.1093/biomet/88.3.767

REFERENCES

- Lox, C., Martin Ginis, K. A., & Petruzzello, S. J. (2010). *The psychology of exercise: Integrating theory and practice* (3 ed.). Scottsdale, AZ: Holcomb Hathaway.
- Lubans, D. R., Foster, C., & Biddle, S. J. (2008). A review of mediators of behavior in interventions to promote physical activity among children and adolescents. *Preventive Medicine, 47*, 463-470. doi:10.1016/j.ypmed.2008.07.011
- Lukens, E., & McFarlane, W. R. (2004). Psychoeducation as evidence-based practice: Considerations for practice, research, and policy. *Brief Treatment and Crisis Intervention, 4* (3), 205. doi: 10.1093/brief-treatment/mhh019
- Lundahl, B. W., Kunz, C., Brownell, C., Tollefson, D., & Burke, B. L. (2010). A Meta-analysis of motivational interviewing: Twenty-five years of empirical studies. *Research on Social Work Practice, 20*(2), 137-160. doi: 10.1177/1049731509347850
- Lustria, M., Noar, S., Cortese, J., Van Stee, S., Glueckauf, R., & Lee, J. (2013). A meta-analysis of web-delivered tailored health behavior change interventions. *Journal of Health Communication, 18*, 1039-1069. doi: 10.1080/10810730.2013.768727
- MacKinnon, D. P., Fairchild, A. J., & Fritz, M. S. (2007). Mediation analysis. *Annual Review of Psychology, 58*, 593-614. doi: 10.1146/annurev.psych.58.110405.085542
- Mammen, G., & Faulkner, G. (2013). Physical activity and the prevention of depression: A systematic review of prospective studies. *American Journal of Preventive Medicine, 45*(5), 649-657. doi: 10.1016/j.amepre.2013.08.001.
- Marcus, B. H., & Simkin, L. R. (1994). The transtheoretical model - applications to exercise behavior. *Medicine and Science in Sports and Exercise, 26*, 1400 - 1404.
- Markland, D., Ryan, R. M., Tobin, V. J., & Rollnick, S. (2005). Motivational interviewing and self-determination theory. *Journal of Social and Clinical Psychology, 24*, (6), 811-831.
- Markland, D., & Tobin, V. J. (2004). A modification of the Behavioral Regulation in Exercise Questionnaire to include an assesment of amotivation. *Journal of Sport and Exercise, 26*, 191-196.
- Markland, D., & Tobin, V. J. (2010). Need support and behavioural regulations for exercise among exercise referral scheme clients: The mediating role of psychological need satisfaction. *Psychology of Sport and Exercise, 11*, 91-99. doi: 10.1016/j.psychsport.2009.07.001
- Marlatt, G. A., & Gordon, J. R. (1985). *Relapse prevention: maintenance strategies in the treatment of addictive behaviors*. New York, NY: Guilford Press.

- Marsch, L. A., & Gustafson, D. H. (2013). The role of technology in health care innovation: A commentary. *Journal of Dual Diagnosis, 9*(1), 101-103. doi: 10.1080/15504263.2012.750105
- Marsh, H., Luedtke, O., & Trautwein, U. (2009). Classical latent profile analysis of academic self-concept dimensions: Synergy of person- and variable-centered approaches to theoretical models of self-concept. *Structural Equation Modeling, 16*(2), 191-225. doi: 10.1080/10705510902751010
- Marshall, A., Leslie, E., Bauman, A., Marcus, B., & Owen, N. (2003). Print versus website physical activity programs - A randomized trial. *American Journal of Preventive Medicine, 25*, 88-94. doi 10.1016/S0749-3797(03)00111-9
- Mason, P., & Butler, C. (2010). *Health behavior change: A guide for practitioners* (2 ed.). Edinburgh, Scotland: Churchill Livingstone.
- Matsumoto, H., & Takenaka, K. (2004). Motivational profiles and stages of exercise behavior change. *International Journal of Sport and Health Science, 2*, 89-96.
- McDonough, M. H., & Crocker, P. R. E. (2007). Testing self-determination as a mediator of the relationship between psychological needs and affective and behavioral outcomes. *Journal of Sport & Exercise psychology, 29*, 645-663. doi:10.1016/j.psychsport.2013.03.007
- Middelweerd, A., Mollee, S. M., van der Wal, C. N., Brug, J., & te Velde, S. J. (2014). Apps to promote physical activity among adults: a review and content analysis. *International Journal of Behavioral Nutrition and Physical Activity, 11*(97), 1-9. doi: 10.1186/s12966-014-0091-9
- Miller, A. M., & Iris, M. (2002). Health promotion attitudes and strategies in older adults. *Health Education and Behavior, 29*, 249-267. doi: 10.1177/1090198102029002009
- Miller, A. M., & Rollnick, S. (2009). Ten things that motivational interviewing is not. *Behavioural and Cognitive Psychotherapy, 37*, 129-140. doi: 10.1017/S1352465809005128
- Miller, W. R., & Rollnick, S. (2002). *Motivational interviewing: Preparing people to change addictive behavior* (2:nd ed.). New York, NY: Guilford Press.
- Miller, W. R., & Rollnick, S. (2012). Meeting in the middle: motivational interviewing and self-determination theory. *International Journal of Behavioral Nutrition and Physical Activity, 9*(1), 25. doi: 10.1186/1479-5868-9-25
- Miller, W. R., & Rollnick, S. (2013). *Motivational Interviewing: Preparing People for Change* (3:rd ed.). New York; NY: Guildford Press.
- Moller, A., Ryan, R., & Deci, E. (2006). Self-determination theory and public policy: Improving the quality of consumer decisions without using

REFERENCES

- coercion. *American Marketing Association*, 25, 104-116. doi: 10.1509/jppm.25.1.104
- Morrison, L., Yardley, L., Powell, J., & Michie, S. (2012). What design features are used in effective e-health interventions? A review using techniques from critical interpretive synthesis. *Telemedicine Journal and e-Health*, 18, 137-144. doi: 10.1089/tmj.2011.0062.
- Moustaka, F. C., Vlachopoulos, S. P., Vazou, S., Kaperoni, M., & Markland, D. A. (2010). Initial validity evidence for the Behavioral Regulation in Exercise Questionnaire-2 among Greek exercise participants. *European Journal of Psychological Assessment* (26), 269-276. 10.1027/1015-5759/a000036
- Mullan, E., Markland, D., & Ingledew, D. K. (1997). A graded conceptualization of self-determination in the regulation of exercise behaviour: development of a measure using confirmatory factor analytic procedures. *Personality and Individual Differences*, 23(5), 745-752.
- Murayama, K., Matsumoto, M., Izuma, K., & Matsumoto, K. (2010). Neural basis of the undermining effect of monetary reward on intrinsic motivation. *Proceedings of the National Academy of Sciences* , 7(107), 49e. doi: 10.1073/pnas.1013305107
- Murcia, J. A., Gimeno, E. C., & Camacho, A. M. (2007). Measuring self-determination motivation in a physical fitness setting: Validation of the Behavioral Regulation in Exercise Questionnaire-2 (BREQ-2) in a Spanish sample. *The Journal of Sports Medicine and Physical Fitness*, 47(3), 366-374.
- Napolitano, M. A., Fotheringham, M., Tate, D., Sciamanna, C., Leslie, E., Owen, N., Marcus, B. (2003). Evaluation of an internet-based physical activity intention: A preliminary intervention. *Annals of Behavioral Medicine*, 25(92-99). doi: 10.1207/S15324796ABM2502_04
- Ng, J. Y. Y., Ntoumanis, N., Thøgersen-Ntoumani, C., Deci, E. L., Ryan, R. M., Duda, J. L., & Williams, G. C. (2012). Self-determination theory applied to health contexts: A meta-analysis. *Perspectives on Psychological Science*, 7(4), 325-340. doi: 10.1177/1745691612447309
- Nigg, C. R., Borelli, B., Maddock, J., & Dishman, R. K. (2008). A theory of physical activity maintenance. *Applied Psychology: An international review*, 57 (4), 544-560.
- Nigg, C. R., & Geller, K. S. (2012). *Theoretical approaches to physical activity intervention*. New York, NY: Oxford University Press.
- Noar, S. M., & Zimmerman, R. S. (2005). Health behavior theory and cumulative knowledge regarding health behaviors: Are we moving in

- the right direction? *Health Education Research*, 20(3), 275-290. doi: 10.1093/her/cyg113
- Norman, G., Zabinski, M., Adams, M., Rosenberg, D., Yaroch, A., & Atienza, A. (2007). A review of eHealth interventions for physical activity and dietary behavior change. *American Journal of Preventive Medicine*, 33, 336-345 e316. doi: 10.1016/j.amepre.2007.05.007
- Ntoumanis, N. (2012). *A self-determination perspective on motivation and Physical education*. (3 ed.). Champaign Ill: Human Kinetics.
- Nylund, K. L., Asparouhov, T., & Muthén, B. (2007). Deciding on the number of classes in latent class analysis and growth mixture modeling: A Monte Carlo simulation study. *Structural Equation Modeling*, 14, 535-569.
- O'Donohue, W. T., & Fisher, J. E. (Ed) (2012). *Cognitive behavior therapy: Core principles for practice*. Hoboken NJ: Wiley & Sons.
- Ogilvie, D., Foster, C. E., Rothnie, H., Cavill, N., Hamilton, V., & Fitzsimons, C. F., (2007). Interventions to promote walking: Systematic review. *British Medical Journal*, 334. doi:10.1136/bmj.39198.722720.BE
- Olsson, S. J., Borjesson, M., Ekblom-Bak, E., Hemmingsson, E., Hellenius, M. L., & Kallings, L. V. (2015). Effects of the Swedish physical activity on prescription model on health-related quality of life in overweight older adults: a randomised controlled trial. *Public Health*, 15, 687. doi: 10.1186/s12889-015-2036-3
- Onksen, J. L., Briand, L. A., Galante, R. J., Pack, A. I., & Blendy, J. A. (2012). Running-induced anxiety is dependent on increases in hippocampal neurogenesis. *Genes, Brain and Behavior*, 11(5), 529-538. doi: 10.1111/j.1601-183X.2012.00788.x
- Owen, K. B., Smith, J., & Lubans, D. R. (2014). Self-determined motivation and physical activity in children and adolescents: A systematic review and meta-analysis. *Preventive Medicine*, 67, 270-279. doi:10.1016/j.ypmed.2014.07.033
- Palmeira, A., Teixeira, P., Silva, M., & Markland, D. (2007, June). *Confirmatory factor analysis of the Behavioural Regulation in Exercise Questionnaire - Portuguese version*. Paper presented at the 12th European Congress of Sport Psychology, Halkidiki, Greece.
- Pastor, D. A., Barron, K. E., Miller, B. J., & Davis, S. L. (2007). A latent profile analysis of college students' achievement goal orientation. *Contemporary Educational Psychology*, 32(1), 8-47. doi: 10.1016/j.cedpsych.2006.10.003
- Patrick, H. (2014). Ascending mount maslow with oxygen to spare: A self-determination theory perspective. *Psychological Inquiry*, 25(1), 101-107. doi: 10.1080/1047840x.2014.878682

REFERENCES

- Patrick, H., & Canavello, A. (2011). Methodological overview of a self-determination theory based computerized intervention to promote leisure-time physical activity. *Psychology of Sport and Exercise*, 12, 13-19. doi:10.1016/j.psychsport.2010.04.011
- Patrick, H., & Williams, G. C. (2012). Self-determination theory: its application to health behavior and complementarity with motivational interviewing. *International Journal of Behavioral Nutrition and Physical Activity*, 9, 18. doi:10.1186/1479-5868-9-18
- Peels, D., Bolman, C., Golsteijn, R., De Vries, H., Mudde, A., van Stralen, M., & al., e. (2012). Differences in reach and attrition between Web-based and printdelivered tailored interventions among adults over 50 years of age: A clustered randomized trial. *Journal of Medical Internet Research*, 14, e179. doi: 10.2196/jmir.2229
- Peels, D. A., Bolman, C., Golsteijn, R. H., de Vries, H., Mudde, A. N., van Stralen, M. M., & Lechner, L. (2013). Long-term efficacy of a printed or a Web-based tailored physical activity intervention among older adults. *International Journal of Behavioral Nutrition and Physical Activity*, 10, 104. doi: 10.1186/1479-5868-10-104
- Peters, G.-J. Y., Ruiter, R. A. C., & Kok, G. (2013). Threatening communication: A critical re-analysis and a revised meta-analytic test of fear appeal theory. *Health Psychology Review*, 7, 8-31. doi: 10.1080/17437199.2012.703527
- Petersen, K. E. N., Johnsen, N. F., Olsen, A., Albieri, V., Olsen, L. K. H., Dragsted, L. O., & Egeberg, R. (2015). The combined impact of adherence to five lifestyle factors on all-cause, cancer and cardiovascular mortality: a prospective cohort study among Danish men and women. *The British Journal of Nutrition*, 113, 849-858. doi:10.1017/S0007114515000070
- Pingree, S., Hawkins, R., Baker, T., duBenske, L., Roberts, L. J., & Gustafson, D. H. (2010). The value of theory for enhancing and understanding e-health interventions. *American Journal of Preventive Medicine*, 38, 103-109. doi:10.1016/j.amepre.2009.09.035
- Plotnikoff, R., McCargar, L., Wilson, P., & Loucaides, C. (2005). Efficacy of an e-mail intervention for the promotion of physical activity and nutrition behavior in the workplace context. *American Journal of Health Promotion*, 19, 422-429. doi 10.4278/0890-1171-19.6.422
- Portnoy, D. B., Scott-Sheldon, L. A. J., Johnson, B. T., & Carey, M. P. (2008). Computer delivered interventions for health promotion and behavioral risk reduction: A metaanalysis of 75 randomized controlled trials, 1988-2007. *Preventive Medicine*, 47, 3-16. doi: 10.1016/j.ypmed.2008.02.014.

- Preacher, K. J., & Hayes, A. F. (2004). SPSS and SAS procedures for estimating indirect effects in simple mediation models. *Behavior Research Methods*, *36*(4), 717-731.
- Preacher, K. J., & Hayes, A. F. (2008). Asymptotic and resampling strategies for assessing and comparing indirect effects in multiple mediator models. *Behavior Research Methods*, *40*(3), 879-891. doi: 10.3758/brm.40.3.879
- Prestwich, A., Webb, T. L., & Conner, M. (2015). Using theory to develop and test interventions to promote changes in health behaviour: evidence, issues, and recommendations. *Current Opinion in Psychology*, *5*, 1-5. doi: 10.1016/j.copsyc.2015.02.011
- Prochaska, J. O., DiClemente, C. C., & Norcross, J. C. (1992). In search of how people change: Applications to addictive behaviors. *American Psychologist*, *47*(9), 1102-1114.
- Prochaska, J. O., & Velicer, W. F. (1997). The transtheoretical model of health behavior change. *American Journal of Health Promotion*, *12*, 38 - 48.
- Ratelle, C. F., Guay, F., Vallerand, R. J., Larose, S., & Senécal, C. (2007). Autonomous, controlled, and amotivated types of academic motivation: a person-oriented analysis. *Journal of Educational Psychology*, *99*, 734-746. doi: 10.1037/0022-0663.99.4.734
- Reeve, J., & Halusic, M. (2009). How K-12 teachers can put self-determination theory principles into practice. *Theory and Research in Education*, *7*(2), 145-154. doi: 10.1177/1477878509104319
- Reeve, J., Nix, G., & Hamm, D. (2003). Testing models of the experience of self-determination in intrinsic motivation and the conundrum of choice. *Journal of Educational Psychology*(95), 375-392. doi: doi:10.1037/0022-0663.95.2.375.
- Rhodes, R. E., & deBruijn, G. J. (2013). How big is the physical activity intention-behaviour gap? A meta-analysis using the action control framework. *British Journal of Health Psychology*, *18*, 296-309. doi:10.1111/bjhp.12032
- Rhodes, R. E., & Pfaeffli, L. A. (2010). Mediators of physical activity behaviour change among adult non-clinical populations: A review update. *International Journal of Behavioral Nutrition and Physical Activity*, *7*, 37. doi:10.1186/1479-5868-7-37
- Rhodes, R. E., & Kates, A. (2015). Can the affective response to exercise predict future motives and physical activity behavior? A systematic review of published evidence. *Annals of Behavioral Medicine*, *49*(5), 715-731. doi: 10.1007/s12160-015-9704-5
- Rimer, J., Dwan, K., Lawlor, D. A., Greig, C. A., McMurdo, M., Morley, W., & Mead, G. E. (2012). Exercise for depression. *Cochrane Database Systematic Review*, *7*, doi: 10.1002/14651858.CD004366.pub5

REFERENCES

- Robertson, D. (2010). *The philosophy of cognitive-behavioural therapy (CBT): Stoic philosophy as rational and cognitive psychotherapy*. London, England: Karnak Books
- Rose, E. A., Parfitt, G., & Williams, S. (2005). Exercise causality orientations, behavioural regulation for exercise and stage of change for exercise: Exploring their relationships. *Psychology of Sport and Exercise*, 6(4), 399-414. doi: 10.1016/j.psychsport.2004.07.002
- Ryan, R. M., & Deci, E. L. (2002). *Overview of self-determination theory: An organismic dialectical perspective*. Rochester, NY: University of Rochester Press.
- Ryan, R. M., & Deci, E. L. (2007). *Active human nature: Self-determination theory and the promotion and maintenance of sport, exercise, and health*. Champaign, IL: Human Kinetics.
- Sallis, J. F., Owen, N., & Fotheringham, M. J. (2000). Behavioral epidemiology: A systematic framework to classify phases of research on health promotion and disease prevention. *Annals of Behavioural Medicine*, 22(4), 294-298.
- Sallis, J. F., Owen, N., & Fisher, E. B. (2008). *Ecological models of health behavior*. In K. Glanz, B. K. Rimer & K. Viswanath (Eds.), *Health behavior and health education: theory, research, and practice* (4 ed., pp. 465–486.). San Francisco, CA: Jossey-Bass.
- Schein, R., Wilson, K., & Keelan, J. (2010). Literature review on effectiveness of the use of social media: a report for Peel Public Health. Retrieved October 1st 2015, from <https://www.peelregion.ca/health/resources/pdf/socialmedia.pdf>
- Schulz, K. F., Altman, D. G., & Moher, D. (2010). CONSORT 2010 statement: Updated guidelines for reporting parallel group randomized trials. *Annals of Internal Medicine*, 152, 726-732. doi:10.7326/0003-4819-152-11-201006010-00232
- Senn, S. (2006). Change from baseline and analysis of covariance revisited. *Statistics in Medicine*, 25, 4334-4344. doi:10.1002/sim.268
- Shadish, W. R., Cook, T. D., & Campbell, D. T. (2002). *Experimental and quasi-experimental designs for generalized causal inference*. Boston, MA: Houghton Mifflin.
- Sheldon, K. M., Elliot, A. J., Kim, Y., & Kasser, T. (2001). What is satisfying about satisfying events? Testing 10 candidate psychological needs. *Journal of Personality and Social Psychology Quarterly*, 89, 325-339. doi: 10.1037/0022-3514.80.2.325
- Sheldon, K. M., Williams, G., & Joiner, T. (2003). *Self-determination theory in the clinic: Motivating physical and mental health*. New Haven, CT: Yale University Press.
- Silva, M. N., Markland, D., Carraca, E. V., Vieira, P. N., Coutinho, S. R., Minderico, C. S., & Teixeira, P. J. (2011). Exercise autonomous

- motivation predicts 3-yr weight loss in women. *Medicine and Science in Sports and Exercise*, 43, 728-737.
doi:10.1249/MSS.0b013e3181f3818f
- Silva, M. N., Markland, D., Minderico, C. S., Vieira, P. N., Castro, M. M., Coutinho, S. R., . . . Teixeira, P. J. (2008). A randomized controlled trial to evaluate self-determination theory for exercise adherence and weight control: Rationale and intervention description. *Public Health*, 8, 234. doi:10.1186/1471-2458-8-234
- Silva, M. N., Vieira, P. N., Coutinho, S. R., Minderico, C. S., Matos, M. G., Sardinha, L. B., & Teixeira, P. J. (2010). Using self-determination theory to promote physical activity and weight control: A randomized controlled trial in women. *Journal of Behavioral Medicine*, 33, 110-122. doi:10.1007/s10865-009-9239-y
- Smith, C. (2010). *What is a person?: Rethinking humanity, social life, and the moral good from the person up*. Chicago Ill: University of Chicago Press.
- Spence, J. C., & Lee, R. E. (2003). Toward a comprehensive model of physical activity. *Psychology of Sport and Exercise*, 4, 7-24. doi: 10.1016/S1469-0292(02)00014-6
- Stetson, B. A., Beacham, A. O., Frommelt, K. N., Cole, J. D., Ziegler, C. H., & Looney, S. W. (2005). Exercise slips in high risk situations and activity patterns in long-term exercises: An application of the relapse prevention model. *Annals of Behavioral Medicine*, 30, 25-35. doi 10.1207/s15324796abm3001_4
- Su, Y.-L., & Reeve, J. (2011). A meta-analysis of the effectiveness of intervention programs designed to support autonomy. *Educational Psychology Review*, 23, 159-188. doi:10.1007/s10648-010-9142-7
- Sudak, D. M. (2011). *Combining CBT and medication: An evidence-based approach*. Hoboken, NJ: John Wiley & Sons, Inc. doi: 10.1002/9781118093368.refs
- Sweet, S. N., Fortier, M. S., & Blanchard, C. M. (2014). Investigating motivational regulations and physical activity over 25 weeks. *Journal of Physical Activity and Health*, 11(5), 1052-1056. doi: 10.1123/jpah.2012-0057
- Tate, D., Jackvony, E., & Wing, R. (2003). Effects of Internet behavioral counseling on weight loss in adults at risk for type 2 diabetes - A randomized trial. *Journal of the American Medical Association*, 289, 1833-1836. doi:10.1001/jama.289.14.1833.
- Teixeira, P. J., Carraca, E. V., Markland, D., Silva, M. N., & Ryan, R. M. (2012). Exercise, physical activity, and self-determination theory: A systematic review. *International Journal of Behavioral Nutrition and Physical Activity*, 9, 78. doi:10.1186/1479-5868-9-78

REFERENCES

- Teixeira, P. J., Palmeira, A. L., & Vansteenkiste, M. (2012). The role of self-determination theory and motivational interviewing in behavioral nutrition, physical activity, and health: an introduction to the IJBNPA special series. *International Journal of Behavioral Nutrition and Physical Activity*, *9*(1), 17. doi: 10.1186/1479-5868-9-17
- Thøgersen-Ntoumani, C., & Ntoumanis, N. (2006). The role of self-determined motivation in the understanding of exercise-related behaviours, cognitions and physical self-evaluations. *Journal of Sports Sciences*, *24*, 393-404. doi: 10.1080/02640410500131670
- Traustadottir, T., Bosch, P. R., & Matt, K. S. (2005). The HPA axis response to stress in women: effects of aging and fitness. *Psychoneuroendocrinology*, *30*(4), 392-402. doi: 10.1016/j.psyneuen.2004.11.002
- Vallerand, R. (2004). Intrinsic and extrinsic motivation in sport. *Encyclopedia of Applied Psychology*, *2*, 427-435.
- Vallerand, R. J., & Losier, G. F. (1999). An integrative analysis of intrinsic and extrinsic motivation. *Journal of Applied Sport Psychology*, *11*, 142-169. doi: 10.1080/10413209908402956
- Vallerand, R. J., & Ratelle, C. F. (2002). *Intrinsic and extrinsic motivation: A hierarchical model*. Rochester, NY: University of Rochester Press.
- van den Berg, M., Schoones, J., & Vliet Vlieland, T. (2007). Internet-based physical activity interventions: A systematic review of the literature. *Journal of Medical Internet Research*, *9*, e26. doi: 10.2196/jmir.9.3.e26
- van den Berg, M. H., Runday, H. K., Peeters, A. J., Voogt-van der Harst, E. M., Munneke, M., Breedveld, F. C., & Vliet Vlieland, T. P. M. (2007). Engagement and satisfaction with an Internet-based physical activity intervention in patients with rheumatoid arthritis. *Rheumatology and Physical Medicine*, *46*, 545-552. doi: 10.1093/rheumatology/kel341
- van Keulen, H. M., Mesters, I., Ausems, M., van Breukelen, G., Campbell, M., Resnicow, K., . . . de Vries, H. (2011). Tailored print communication and telephone motivational interviewing are equally successful in improving multiple lifestyle behaviors in a randomized controlled trial. *Annals of Behavioral Medicine*, *41*(1), 104-118. doi: 10.1007/s12160-010-9231-3
- van Stralen, M. M., de Vries, H., Bolman, C., N., M. A., & Lechner, L. (2010). Exploring the efficacy and moderators of two computer-tailored physical activity interventions for older adults: A randomized controlled trial. *Annals of Behavioral Medicine*, *39*, 139-150. doi: 10.1007/s12160-010-9166-8
- Vandelanotte, C., Kirwan, M., Rebar, A., Alley, S., Short, C., Fallon, L., & Duncan, M. (2014). Examining the use of evidence-based and social

- media supported tools in freely accessible physical activity intervention websites. *International Journal of Behavioral Nutrition and Physical Activity*, 11, 105. doi:10.1186/s12966-014-0105-0
- Vandelanotte, C., Spathonis, K., Eakin, E., & Owen, N. (2007). Website-delivered physical activity interventions. A review of the literature. *American Journal of Preventive Medicine*, 33, 54–64. doi: 10.1016/j.amepre.2007.02.041
- Vansteenkiste, M., & Sheldon, K. M. (2006). There's nothing more practical than a good theory: Integrating motivational interviewing and self-determination theory. *British Journal of Clinical Psychology*, 45(1), 63-82. doi: 10.1348/014466505x34192
- Vansteenkiste, M., Sierens, E., Soenens, B., Luyckx, K., & Lens, W. (2009). Motivational profiles from a self-determination perspective: The quality of motivation matters. *Journal of Educational Psychology*, 101(3), 671-688. doi: 10.1037/a0015083
- Vansteenkiste, M., Simons, J., Soenens, B., & Lens, W. (2004). How to become a persevering exerciser? Providing a clear, future intrinsic goal in an autonomy-supportive way. *Journal of Sport and Exercise Psychology*, 26, 232-249
- Wasserkampf, A., & Kleinert, J. (2015). Organismic integration as a dynamic process: A systematic review of empirical studies on change in behavioral regulations in exercise in adults. *International Review of Sport and Exercise Psychology*, 9(1), 65-95. doi: 10.1080/1750984x.2015.1119873
- Webb, T., Joseph, J., Yardley, L., & Michie, S. (2010). Using the Internet to promote health behavior change: A systematic review and meta-analysis of the impact of theoretical basis, use of behavior change techniques, and mode of delivery on efficacy. *Journal of Medical Internet Research*, 12(e4.). doi: 10.2196/jmir.1376
- Webb, T., & Sheeran, P. (2006). Does changing behavioral intentions engender behavior change? A meta-analysis of the experimental evidence. *Psychological Bulletin*, 132(2), 249-268. doi: 10.1037/0033-2909.132.2.249
- Webber, K. H., Tate, D. F., Ward, D. S., & Bowling, J. M. (2010). Motivation and its relationship to adherence to self-monitoring and weight loss in a 16-week Internet behavioral weight loss intervention. *Journal of Nutrition Education and Behavior*, 42(3), 161-167. doi: 10.1016/j.jneb.2009.03.001
- Weman-Josefsson, A. K., Halila F., Johnson U., Lindwall M., Wickström M., & P., W. (2014, April). *Digital innovations and self-determined exercise motivation: A person-centred perspective*. Paper presented at the VITALIS - Nordens ledande eHälsomöte; 2014, Göteborg, Sweden.

REFERENCES

- Weman Josefsson, K. (2016). Suggesting a synergy between self-determination theory and person-centred care. *Jacobs Journal of Physical Rehabilitation and Medicine*, 2(1), e024.
- White, R. (1959). Motivation Reconsidered. The concept of competence. *Psychological Review*, 66(5), 297-333.
- Williams, G. C., McGregor, H., A., Sharp, D., Levesque, C., Kouides, R., W., Ryan, R., M., & Deci, E., L. (2006). Testing a self-determination theory intervention for motivating tobacco cessation: Supporting autonomy and competence in a clinical trial. *Health psychology*, 25(1), 91-101. doi: 10.1037/0278-6133.25.1.91.
- Williams, G. C., Minicucci, D. S., Kouides, R. W., Levesque, C. S., Chirkov, V. I., Ryan, R. M., & Deci, E. L. (2002). Self-determination, smoking, diet and health. *Health Education Research*, 17(5), 512-521. doi: 10.1093/her/17.5.512
- Williams, G. C., Niemiec, C. P., Elliot, A. J., LaGuardia, J. G., Gorin, A. A., & Rigby, C. S. (2014). Virtual Look AHEAD program: initial support for a partly virtualized intensive lifestyle intervention in type 2 diabetes. *Diabetes Care*, 37(8), e169-170. doi: 10.2337/dc14-0831
- Williams, G. C., Niemiec, C. P., Patrick, H., Ryan, R. M., & Deci, E. L. (2009). The importance of supporting autonomy in facilitating long-term tobacco abstinence. *Annals of Behavioral Medicine*, 37, 315-324. doi: 10.1007/s12160-009-9090-y
- Wilson, P. M., Longley, K., Muon, S., Rodgers, W. M., & Murray, T. C. (2006). Examining the contributions of perceived psychological need satisfaction to well-being in exercise. *Journal of Applied Biobehavioral Research*, 11 (3-4), 243-264. 4. doi: 10.1111/j.1751-9861.2007.00008.x
- Wilson, P. M., Rodgers, W. M., & Fraser, S. N. (2002). Examining the psychometric properties of the behavioral regulation in exercise questionnaire. *Measurement in Physical Education and Exercise Science*, 6, 1-21. doi:10.1207/s15327841mpee0601_1
- Wilson, P. M., & Rogers, T. W. (2008). Examining relationships between perceived psychological need satisfaction and behavioral regulation in exercise. *Journal of Applied Biobehavioral Research*, 13, 119-142. doi: 10.1111/j.1751-9861.2008.00031.x.
- Wilson, P. M., Rogers, W. T., Rodgers, W. M., & Wild, T. C. (2006). The psychological need satisfaction in exercise scale. *Journal of Sport & Exercise Psychology*, 28, 231-251.
- Winett, R., Anderson, E., Wojcik, J., Winett, S., & Bowden, T. (2007). Guide to health: nutrition and physical activity outcomes of a group randomised trial of an internet-based intervention in churches. *Annals of Behavioral Medicine*, 33, 251-261.

- Vlachopoulos, S. P. (2008). The Basic Psychological Needs in Exercise Scale: Measurement invariance over gender. *Structural Equation Modeling*, 15, 114-135. doi:10.1080/10705510701758398
- Vlachopoulos, S. P., Ntoumanis, N., & Smith, A. L. (2010). The Basic Psychological Needs in Exercise Scale: Translation and evidence for cross-cultural validity. *International Journal of Sport and Exercise Psychology*, 8, 394-412. doi:10.1080/1612197X.2010.9671960
- World Health Organization. (2009a). *Global Health Risks*. Copenhagen, Denmark: Author, Regional Office for Europe.
- World Health Organization. (2009b). *Interventions on diet and physical activity: what works. Summary report*. Geneva, Switzerland: Author, Regional Office for Europe.
- World Health Organization. (2010). *Global recommendations on physical activity for health*. Geneva, Switzerland: Author, Regional Office for Europe.
- World Health Organization. (2011). *Insufficient physical activity 2008. Prevalence of insufficient physical activity, ages 15+, both ages*. Copenhagen; Denmark: Author, Regional Office for Europe.
- World Health Organization. (2013). *The European Health Report 2012*. Copenhagen; Denmark: Author, Regional Office for Europe.
- Wu, S., Cohen, D., Shi, Y., Pearson, M., & Sturm, R. (2011). Economic analysis of physical activity interventions. *American Journal of Preventive medicine*, 40, 149-158. doi: 10.1016/j.amepre.2010.10.029
- Vuillemin, A., Boini, S., Bertrais, S., Tessier, S., Oppert, J.-M., Hercberg, S., . . . Briancon, S. (2005). Leisure time physical activity and health related quality of life. *Preventive Medicine*, 41, 562-569. doi:10.1016/j.ypmed.2005.01.006
- Yang, C.-C. (2006). Evaluating latent class analysis models in qualitative phenotype identification. *Computational Statistics & Data Analysis*, 50, 1090-1104. doi: 10.1016/j.csda.2004.11.004
- YFA. (2010). Yrkesföreningar för fysisk aktivitet - Professional associations for physical activity, *Physical activity in the prevention and treatment of disease*. Stockholm, Sweden.
- Zanna, M. P., & Fazio, R. H. (1982). *The attitude-behaviour relation: Moving toward a third generation of research*. Hillsdale NJ: Erlbaum.
- Zimmerman, J., Forlizzi, J., & Evenson, S. (2004, November). *Taxonomy for extracting design knowledge from research conducted during design cases*. Proceedings of Futureground04, available on CD-rom.
- Zott, C., & Amit, R. (2010). Designing your future business model: An activity system perspective. *Long Range Planning*, 43, 216-226. doi: 10.2139/ssrn.135651

REFERENCES

Åstrand, P. O. (1992). J. B. Wolffe memorial lecture: 'Why exercise?'.
Medical Science and Sports Exercise., 24, 153-162.