

Technical University of Denmark



## Introduction to Pinch Technology

**Rokni, Masoud**

*Publication date:*  
2016

*Document Version*  
Peer reviewed version

[Link back to DTU Orbit](#)

*Citation (APA):*  
Rokni, M. (2016). Introduction to Pinch Technology. Kgs. Lyngby: Technical University of Denmark (DTU).

## DTU Library

Technical Information Center of Denmark

---

### General rights

Copyright and moral rights for the publications made accessible in the public portal are retained by the authors and/or other copyright owners and it is a condition of accessing publications that users recognise and abide by the legal requirements associated with these rights.

- Users may download and print one copy of any publication from the public portal for the purpose of private study or research.
- You may not further distribute the material or use it for any profit-making activity or commercial gain
- You may freely distribute the URL identifying the publication in the public portal

If you believe that this document breaches copyright please contact us providing details, and we will remove access to the work immediately and investigate your claim.

# **Introduction to Pinch Technology**

Division of Energy Section  
Technical University of Denmark  
DTU Building 402, 1<sup>st</sup> Floor  
DK-2800 KGS, Lyngby

July 2006  
Revised April 2016

Masoud Rokni  
[MR@mek.dtu.dk](mailto:MR@mek.dtu.dk)



# Introduction to Pinch Technology

## 1. Introduction

The demand for effective usage of energy processes is increasing and nowadays every process engineer is facing the challenge to seek answers to the questions related to their process energy patterns. Below the questions that frequently may be asked are listed:

- Is the existing process as energy efficient as it should be?
- How can new projects be evaluated with respect to their energy requirements?
- What changes can be made to increase the energy efficiency without incurring any cost?
- What investments can be made to improve energy efficiency?
- What is the most appropriate utility mix for the process?
- How to put energy efficiency and other targets like reducing emissions, increasing plant capacities, improve product qualities etc, into a one coherent strategic plan for the overall site?

All these questions and more can be answered with a full understanding of *Pinch Technology* and an awareness of the available tools for applying it in a practical way. The aim here is to provide the basic knowledge of pinch technology concept and how it can be applied across a wide range of process industries. The pinch technology was proposed firstly for optimization of heat exchangers and therefore it is introduced / described below for such devices. Heat exchange equipments encounter in many industries for at least two reasons; a) it is often necessary as part of the process to change the thermal condition and b) it is the ambition to minimize the energy consumption of the given process. With other words the idea is to *maximize the energy recovery within the process* or to *minimize the use of external energy sources*. Figs 1 and 2 illustrate this meaning.

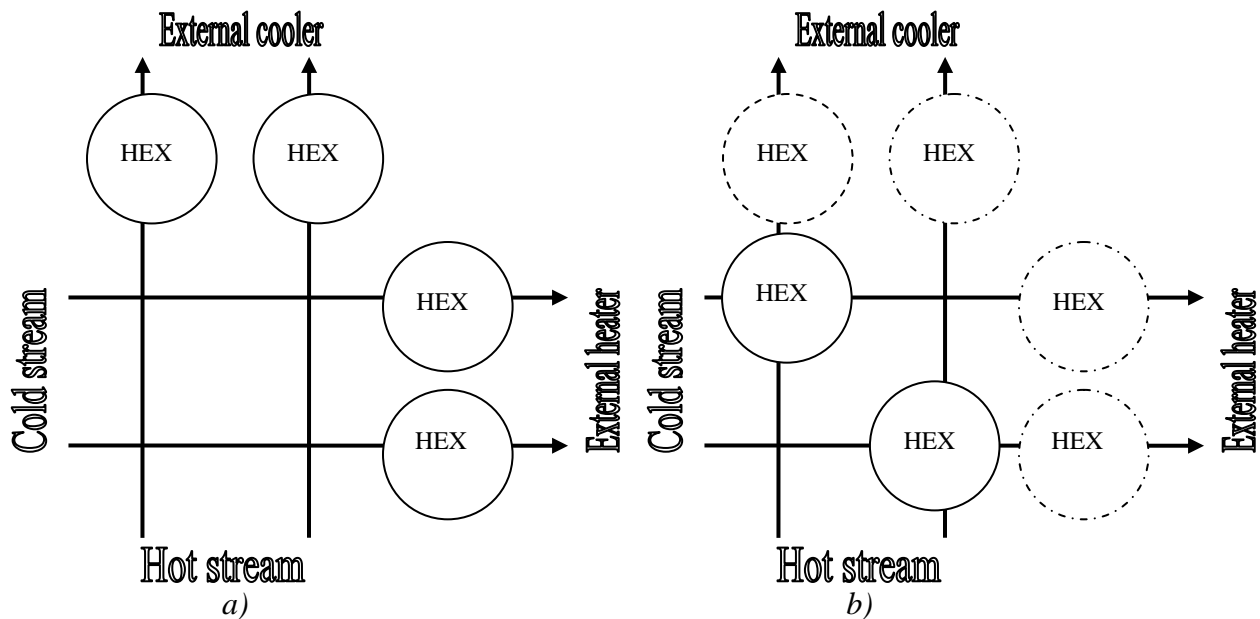

Figure 1. a) Process with only external energy sources and b) Process with internal and external energy sources.

In Fig. 1a heat is added or removed only with external sources (heaters and coolers) while the same process can be improved by using internal heat exchanges under the condition of an overlap in the temperature intervals, see Fig 1b. The need of external energy sources can be reduced by using internal heat exchanges between cold and hot streams and a more energy efficient process can thus be achieved. However, it does not mean that the total cost is reduced since the use of internal heat exchange results in increased capital cost through bigger or more heat exchanger units. Fig. 2 shows how heat can be recovered in a simple process scheme by using internal heat exchange.

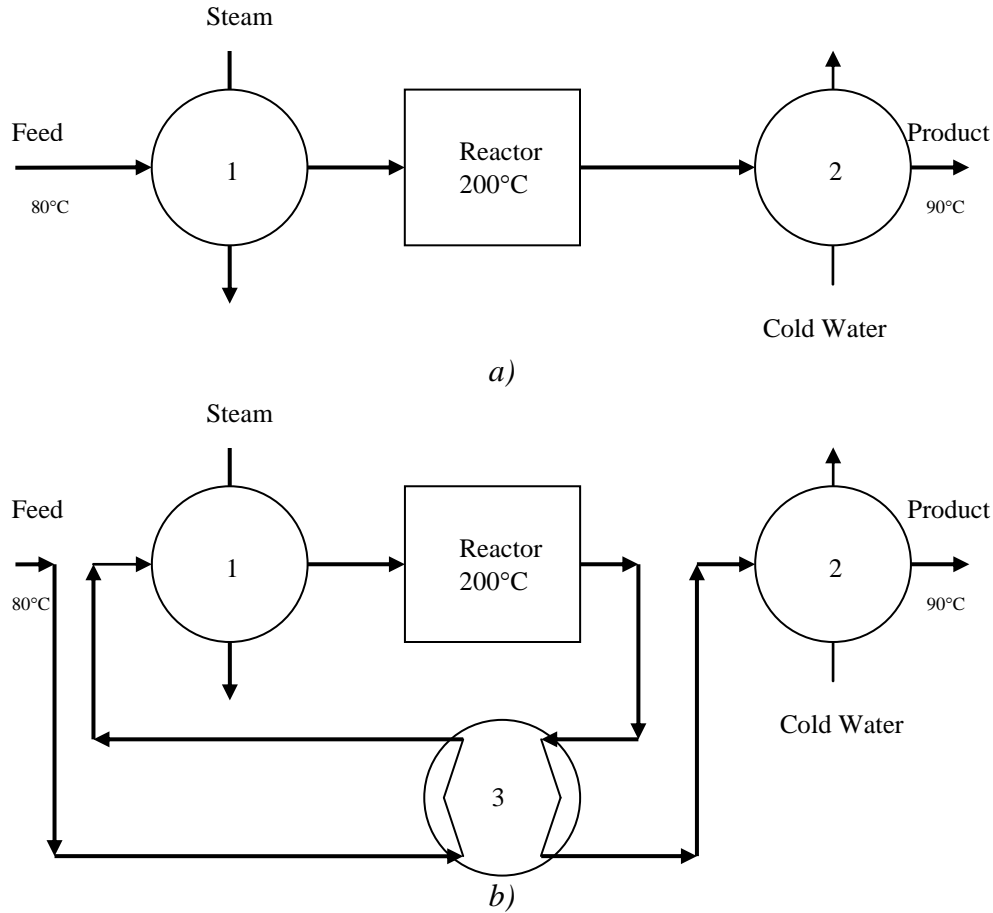

Figure 2. A simple process a) with external energy sources only and b) with internal and external energy sources.

The application of such optimization method is referred as “Pinch Technology” that guarantee minimum energy levels in design of heat exchanger network in a process.

## 2. Problem Statement

A typical industrial process may consist of several numbers of hot and cold process streams which may demand cooling and heating respectively. Heat exchangers can be used to recover some of the heat demand while external heaters and coolers can be used to achieve the temperature demand of the process streams. Suppose an industrial plant with hot and cold process

streams as shown in table 1. Heat capacity rate is defined as mass flow rate times heat capacity  $\dot{m}C_p$ .

Table 1. Process streams in an industrial plant.

Process stream Nr / Type	Inlet Temp. [°C]	Outlet Temp. [°C]	Heat capacity rate [kW/K]	$\dot{Q}$ [kW]
1. cold	90	420	10	3300
2. cold	170	350	32	5760
3. cold	200	390	29	5510
4. hot	440	140	27	8100
5. hot	510	300	24	5040

The task is to find the optimal network of heat exchangers, external coolers and external heaters with respect to the capital and annual operating cost. The maximum heat that can be transferred in a heat exchanger is limited by the minimum allowed temperature difference between hot and cold streams, called as  $\Delta T_{\min}$ . The temperature level at which  $\Delta T_{\min}$  is observed is called as “pinch point” and the analysis to find this temperature with respect to the laws of thermodynamic is called as “Pinch Analysis” or “Pinch Technology”. Capital costs depend mainly on the number of heaters, coolers, heat exchangers and their sizes (area) while operating cost is mainly dominated by the need for external energy supplied such as heating and cooling. Thus the main objective of pinch analysis is to achieve financial savings by better process heat integration (maximizing the process heat recovery and reducing the external utility loads).

In table 1, the heating effect and cooling effect under steady state condition (constant heat capacities and temperatures) are

$$Q_{\text{heat}} = 10 \times (420 - 90) + 32 \times (350 - 170) + 29 \times (390 - 200) = 14570 \text{ kW}$$

$$Q_{\text{cool}} = 27 \times (510 - 300) + 2.0 \times (440 - 140) = 13140 \text{ kW}$$

which must be supplied by external heater and cooler such as steam water and cold water. The idea is now to find the lowest possible  $Q_{\text{heat}}$  for this particular problem.

### 3. The Pinch Method

The pinch method consists of two steps. In the first step the maximum energy recovery in the system should be calculated which in turn reduces the external energy needed to a minimum level.

Consider the process streams and its temperatures in table 1. Figure 3 shows the process streams and the temperature intervals for the plant. The inlet and outlet temperatures can now be divided into temperature intervals where the first temperature interval is between the largest temperature and the second largest temperature. The next interval is between the second largest temperature and the third largest temperature, etc. Such temperature intervals results are shown in table 2.

For a given interval, one may calculate the amount of heat to be supplied to the plant (called as  $Q_{\text{heat}}$ ) and how much heat must be taken from the plant (called as  $Q_{\text{cool}}$ ). The relationship between these external cooling and heating can be written as

$$\Delta \dot{Q} = \dot{Q}_{\text{cool}} - \dot{Q}_{\text{heat}} \quad (1)$$

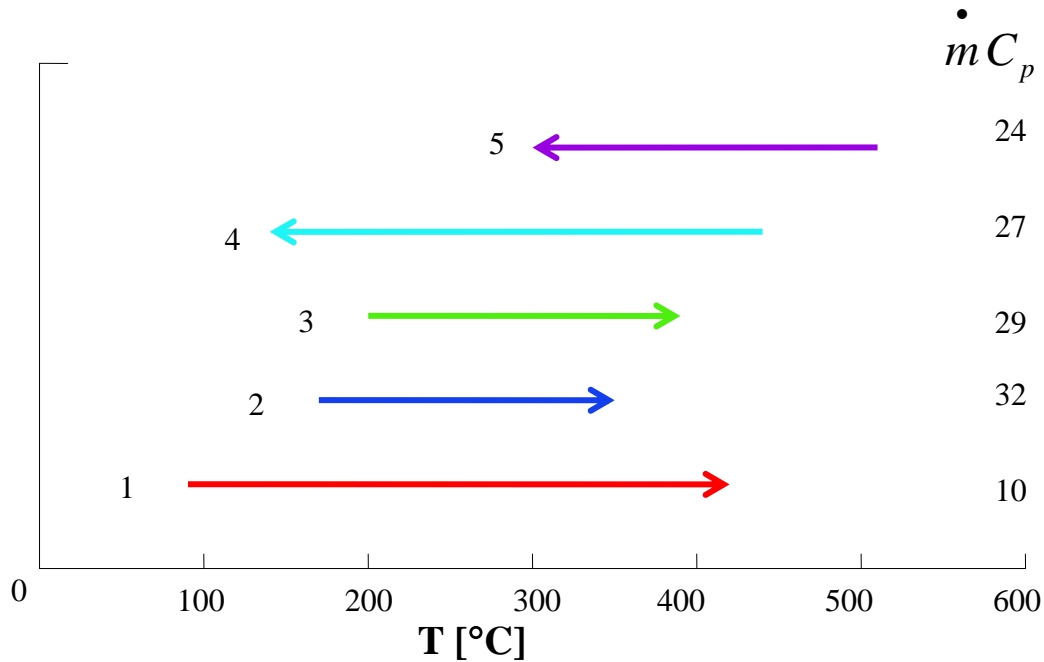

Figure 3. Temperatures of the process streams.

Table 2. Temperature interval and external heating and cooling effects.

Interval Number	Temperature interval [°C]	Stream Numbers	$\dot{Q}_{cool}$ [kW]	$\dot{Q}_{heat}$ [kW]	$\Delta\dot{Q}$ [kW]
1	510 – 440	5	1680	0	1680
2	440 – 420	4 + 5	1020	0	1020
3	420 – 390	1 + 4 + 5	1530	300	1230
4	390 – 350	1 + 3 + 4 + 5	2040	1560	480
5	350 – 300	1 + 2 + 3 + 4 + 5	2550	3550	- 1000
6	300 – 200	1 + 2 + 3 + 4	2700	7100	- 4400
7	200 – 170	1 + 2 + 4	810	1260	- 450
8	170 – 140	1 + 4	810	300	510
9	140 – 90	1	0	500	- 500

For example in interval 4 where the temperature interval is between 390°C to 350°C, the cooling and heating demands are:

$$Q_{heat} = 10 \times (390 - 350) + 29 \times (390 - 350) = 1560 \text{ kW}$$

$$Q_{cool} = 27 \times (390 - 350) + 24 \times (390 - 350) = 2040 \text{ kW}$$

$$\Delta Q = Q_{cool} - Q_{heat} = 2040 - 1560 = 480 \text{ kW}$$

It means that a cooling effect of 480 kW must be supplied to the interval 4 so that the process stream can deliver the lowest needed temperature which is 350°C.

Another important conclusion from table 2 is that in interval 6 the need for external heating is – 4400 kW which is the largest heating demand and must be supplied by external heating to the process. In pinch method this external heating must be first supplied to the system at the respective temperature interval and then all other temperature intervals must be updated according to this heating demand.

There are two major methods to calculate the pinch point, *table method* and *composite curve method*. The table method will be discussed next. However, in between the importance of  $\Delta T_{\min}$  is going to be discussed first.

### 3.1 The meaning of $\Delta T_{\min}$

The interval and calculated heat transfer in table 2 requires an ideal heat transfer within a heat exchanger that cool the hot stream down to the minimum temperature difference of  $\Delta T_{\min} = 0$ . It means that the heat exchanger area (size) is infinite,

$$\Delta T_{\min} \rightarrow 0 \Rightarrow \text{heat exchanger size and price} \rightarrow \infty.$$

This of course is not possible in practical applications and  $\Delta T_{\min} \neq 0$  is always valid. In order to decrease the size of heat exchanger to an acceptable level with reasonable price it is assumed that there always exists a temperature difference, preferably  $\Delta T_{\min} = 10^\circ\text{C}$ . This  $10^\circ\text{C}$  can be treated in three different ways. It can be added to the cold streams, which means that the cold streams are warmed with  $10^\circ\text{C}$ . Or, it can be divided between cold and streams which mean that the cold stream will be warmer by  $5^\circ\text{C}$  and the hot streams will be cooler by  $5^\circ\text{C}$ . Finally, it can be decreased from hot streams which in turn mean that the hot stream will be cooled by  $10^\circ\text{C}$ . Suppose that we choose the last option, although the hot streams cannot be fully warmed and they will be cooler by  $10^\circ\text{C}$ . A new temperature interval can thus be calculated which is specified in table 3.

Table 3. Temperature interval for  $\Delta T_{\min} = 10^\circ\text{C}$ .

Interval Number	Temperature interval [ $^\circ\text{C}$ ]	Stream Numbers	$\dot{Q}_{cool}$ [kW]	$\dot{Q}_{heat}$ [kW]	$\Delta\dot{Q}$ [kW]
1	500 – 430	5	1680	0	1680
2	430 – 420	4 + 5	510	0	510
3	420 – 390	1 + 4 + 5	1530	300	1230
4	390 – 350	1 + 3 + 4 + 5	2040	1560	480
5	350 – 290	1 + 2 + 3 + 4 + 5	3060	4260	-1200
6	290 – 200	1 + 2 + 3 + 4	2430	6390	-3960
7	200 – 170	1 + 2 + 4	810	1260	-450
8	170 – 130	1 + 4	1080	400	680
9	130 – 90	1	0	400	-400

### 3.2 The Problem Table Algorithm (PTA)

In this method the temperature intervals can be described as thermal blocks connected to each other in series which is illustrated in Fig. 4. Every temperature interval can be regarded as a



network (or sub-network) that could be optimized with respect to the maximum energy recovery within the process. Such coupling is also called as *cascade* coupling.

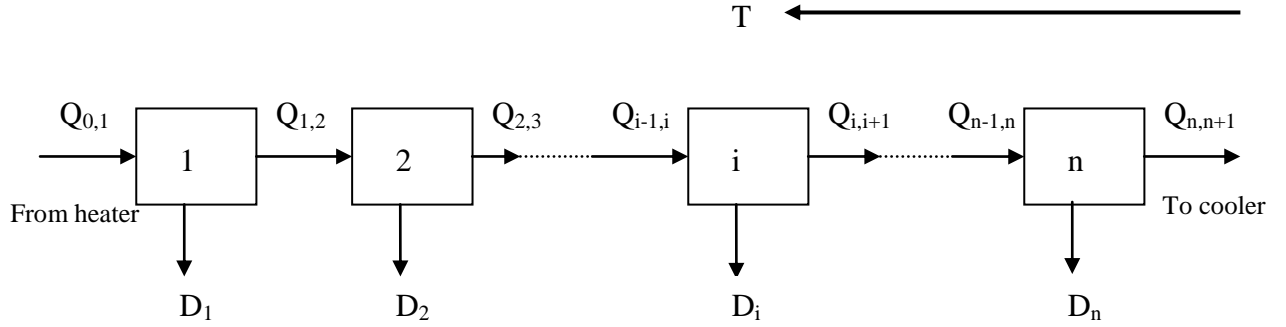

Figure 4. Illustration of serial network connection.

The excess energy, which is usually called as deficit, for an arbitrary sub-network  $i$  can be obtained from

$$D_i = (T_i - T_{i+1}) \left[ \sum \left( \dot{m} C_p \right)_{cold} - \sum \left( \dot{m} C_p \right)_{hot} \right] \quad (2)$$

where  $T_i$  and  $T_{i+1}$  corresponds to upper and lower temperatures in the arbitrary temperature interval  $i$ . The important following condition is thus valid

$$\begin{aligned} D_i < 0 &\Rightarrow \text{need for cooling} \\ D_i > 0 &\Rightarrow \text{need for heating} \end{aligned}$$

The energy balance for the arbitrary block  $i$  can be calculated by

$$\dot{Q}_{i,i+1} = \dot{Q}_{i-1,i} - D_i \quad (3)$$

where  $Q_{i-1,i}$  and  $Q_{i,i+1}$  are the supplied heat and removed heat respectively for each block. Table 4 shows the calculated supplied and removed heat for each temperature interval (block) as given in table 1 and figure 3. Initially the supplied heat  $Q_{0,1}$  for block 1 is set to  $Q_{0,1} = 0$ .

The supplied heat  $Q_{i-1,i}$  and the removal heat  $Q_{i,i+1}$  for any interval  $i$  are usually called as *sequential balance*, which is illustrated in table 4. From table 4 it can be seen that  $Q_{6,7}$ ,  $Q_{7,8}$ ,  $Q_{8,9}$  and  $Q_{9,10}$  have negative values. These values are unreasonable because it would mean that heat is moving from a lower temperature to a higher temperature. In order to create a reasonable network, first the highest negative value must be found and then all the sequential balance values must be added with this highest negative value (mathematically the lowest value). In the table, we shall see that the highest negative value is  $-1710$  kW and this value must now be added to the sequential balance values of  $Q_{i-1,i}$  and  $Q_{i,i+1}$ . The updated results are shown in the same table (table 4) and are called as *max table* which refers to the last two columns at table 4. Table 4 is usually called as *cascade table*.

From the last two columns of the table (Max table) three important values can be read. First, the minimum external heat supply to enable the network working is read as 1710 kW. Second, the minimum external cooling is 280 kW. Third, there exists a point where the heat flow between the points is zero. This point is called the “pinch point” of the system.

Table 4. Sequential balance problem for the case in table 1 with  $\Delta T_{min} = 10\text{ }^{\circ}\text{C}$ .

Interval	Temp. limits	$D_i$	Sequential Balance		Max Table	
			$\dot{Q}_{i-1,i}$	$\dot{Q}_{i,i+1}$	$\dot{Q}_{i-1,i}$	$\dot{Q}_{i,i+1}$
1	500 – 430	-1680	0	1680	<b>1710</b>	3390
2	430 – 420	-510	1680	2190	3390	3900
3	420 – 390	-1230	2190	3420	3900	5130
4	390 – 350	-480	3420	3900	5130	5610
5	350 – 290	1200	3900	2700	5610	4410
6	290 – 200	3960	2700	-1260	4410	450
7	200 – 170	450	-1260	-1710	450	<b>0</b>
8	170 – 130	-680	-1710	-1030	<b>0</b>	680
9	130 – 90	400	-1030	-1430	680	<b>280</b>

### 3.3 Importance of Pinch Point

Identification of the pinch point is very important when the process system consist of several heat exchangers, coolers and heaters, in order to recover energy within the system with maximum results and decrease the need for the external heating and cooling energy. Thus energy target can be realized by designing an appreciate heat recovery network. The following rules immediately are valid

- External coolers cannot be used above the pinch point (otherwise they should be heated again)
- External heaters cannot be used below the pinch point (otherwise they should be cooled again)
- Heat exchanger cannot be used across the pinch point because otherwise all heat flows must be increased with this heat transferred.

*Violation of any above rules results in higher energy requirements than the minimum requirements theoretically possible. These rules are often called as pinch rules.*

The pinch point divides the process into two separate systems which means that the areas below and above the pinch point should be designed separately, when designing the process network. Violation of any rules mentioned above results in higher energy requirements than the minimum energy requirements that theoretically would be possible. Furthermore the following conditions should be fulfilled at design closest to the pinch point

$$- \left( \dot{m} C_p \right)_{hot} \leq \left( \dot{m} C_p \right)_{cold} \quad \text{immediate above the pinch point} \quad (4a)$$

$$- \left( \dot{m} C_p \right)_{hot} \geq \left( \dot{m} C_p \right)_{cold} \quad \text{immediate below the pinch point} \quad (4b)$$

Due to several reasons such as safety reasons, corrosive media, pressure level, etc. some heat exchangers cannot be used for some streams. Such limitations must be overcome with special treatment, which are out of the scope of here and will not be further discussed.

### 3.4 Importance of $\Delta T_{\min}$

The driving force for heat transfer in a heat exchange is the average temperature difference  $\Delta T_{\min}$  through  $Q = UA\Delta T_{\min}$ , where  $A$  is the heat exchanger area and  $U$  is the heat transfer coefficient. For a given heat transfer coefficient the need for heat transfer area decreases with increasing  $\Delta T_{\min}$ . For example, a heat exchanger with  $\Delta T_{\min} = 10^\circ\text{C}$  is about 90% smaller than a heat exchanger with  $\Delta T_{\min} = 1^\circ\text{C}$ . Further, for  $\Delta T_{\min} = 20^\circ\text{C}$  the cost for external energy will increase while the capital cost decreases. In addition, a balance between capital cost (heat transfer area) and energy cost (external  $Q_{\text{heat}}$  and  $Q_{\text{cool}}$ ) decides the optimum  $\Delta T_{\min}$ , as shown in Fig. 5.

The capital cost for heat exchangers may have the form of a  $b + c$  while the energy cost may be approximated as linear function of  $d(Q_{\text{heat}}) + e(Q_{\text{cool}})$  which is a function for cost applied to annual cost.

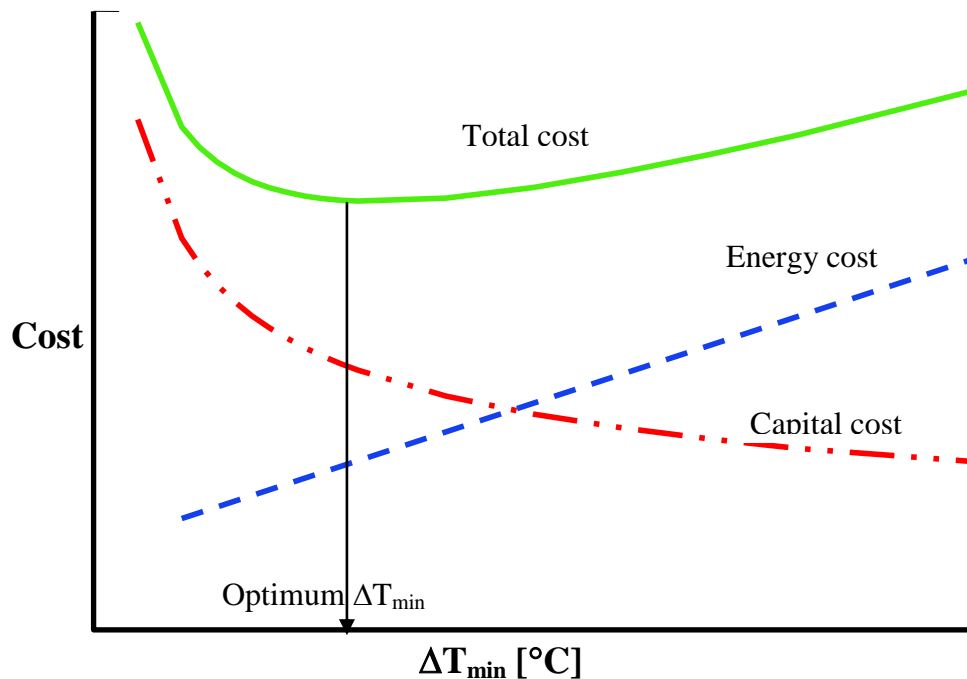

Figure 5. Different cost as function of  $\Delta T_{\min}$ .

Note that an increase of  $\Delta T_{\min}$  does not necessarily give the same relative increase in temperature difference between the streams everywhere. The biggest relative increase is obtained close to the pinch point while the relative increase may be marginal away from this optimum point.

### 3.5 Composite Curves

The problem with energy recovery within the system can also be illustrated graphically by plotting the temperature – enthalpy curves. In order to do that the cold and hot streams shall be

treated separately and the temperature intervals may be decided similar to the problem table algorithm method. Consider the streams for the process defined in table 1. The temperature interval for the hot stream can be illustrated as shown in Fig. 6. Suppose that the temperature interval is beginning from the lowest temperature to the highest temperature. The temperature intervals with respective streams, heat capacity rates and enthalpy are also shown in table 5. Three temperature intervals are found.

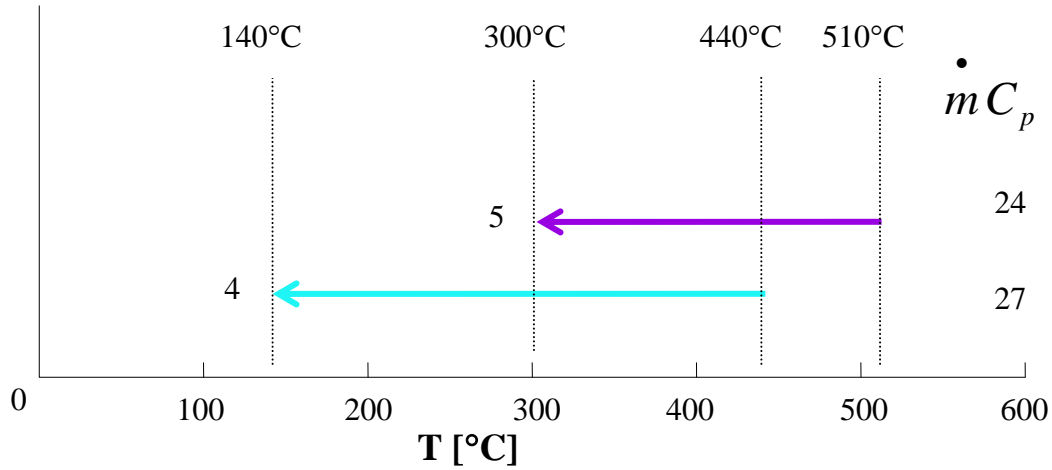

Figure 6. Temperature intervals for the hot streams from table 1.

Table 5. Temperature intervals and enthalpy flow rates for hot streams only.

Interval Number	Temperature interval [°C]	Stream Numbers	$\sum \dot{m} C_p$ [kW/K]	$\Delta \dot{H} = \Delta T \sum \dot{m} C_p$ [kW]	$\sum \Delta \dot{H}$ [kW]
1	140 – 300	4	27	4320	4320
2	300 – 440	4 + 5	51	7140	11460
3	440 – 510	5	24	1680	13140

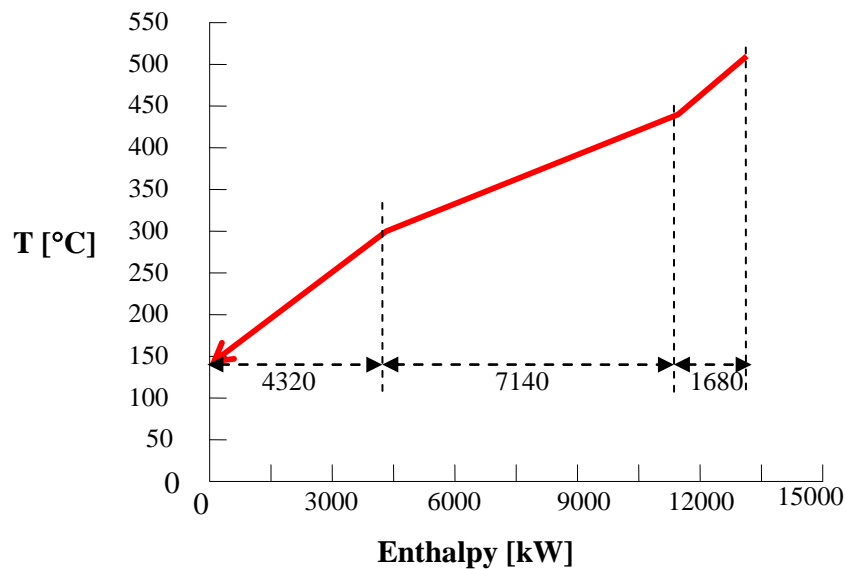

Figure 7. Composite curve for hot streams.

In table 5, the enthalpy flow for any temperature interval can be calculated as the product of the temperature difference and the sum of the heat capacity rates. Now the composite curve for hot streams indicating the enthalpy – temperature diagram can be drawn for each temperature. Since enthalpy is a relative value then the enthalpy for the first point ( $T = 140^{\circ}\text{C}$ ) can be assumed to be zero. Of course any other values can also be assumed. The results are shown in Fig. 7.

The cold streams can also be treated in the same way, see below. The illustration of the temperature interval for the cold streams can be found in Fig. 8. The temperature interval for the cold streams including the heat capacity rates and enthalpy are show in table 6. Five intervals are found and for each temperature interval the enthalpy is the sum of all enthalpy for the previous enthalpies.

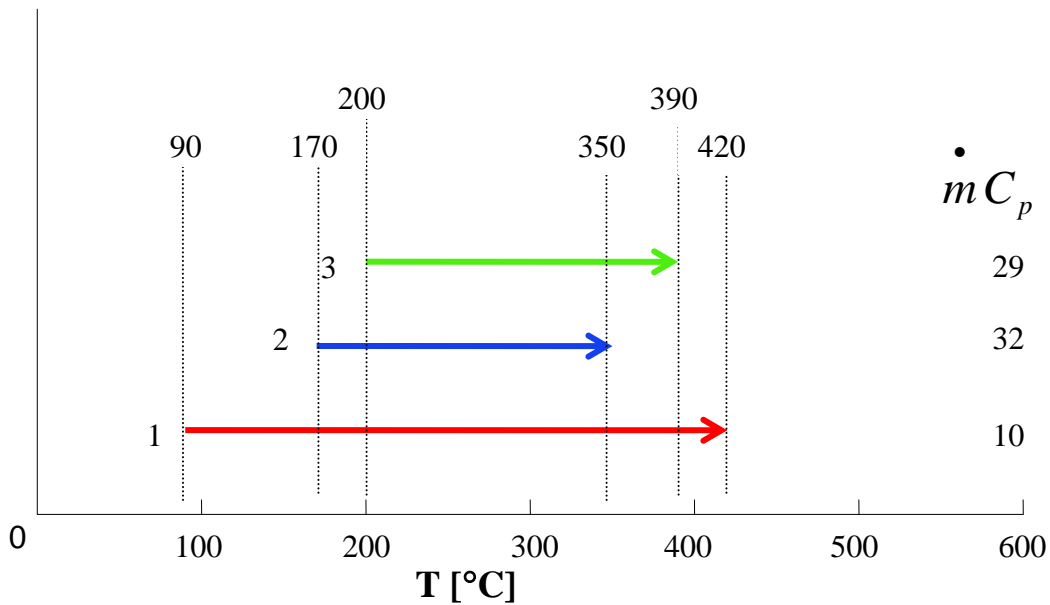

Figure 8. Temperature intervals for the cold streams from table 1.

Table 6. Temperature intervals and enthalpy flow rates for cold streams only.

Interval Number	Temperature interval [ $^{\circ}\text{C}$ ]	Stream Numbers	$\sum \dot{m} C_p$ [kW/K]	$\Delta \dot{H} = \Delta T \sum \dot{m} C_p$ [kW]	$\sum \Delta \dot{H}$ [kW]
1	90 – 170	1	10	800	280 – 1080
2	170 – 200	1 + 2	42	1260	1080 – 2340
3	200 – 350	1 + 2 + 3	71	10650	2340 – 12990
4	350 – 390	1 + 3	39	1560	12990 – 14550
5	390 – 420	1	10	300	14550 – 14850

The temperature – enthalpy diagram can now be included in composite curve of the hot streams. The results are shown in Fig. 9. Note that from table method the external cooling was determined to be

$$\dot{Q}_{cool} = 280 \text{ kW}$$

which is also the starting value (enthalpy) for the cold stream at 90°C.

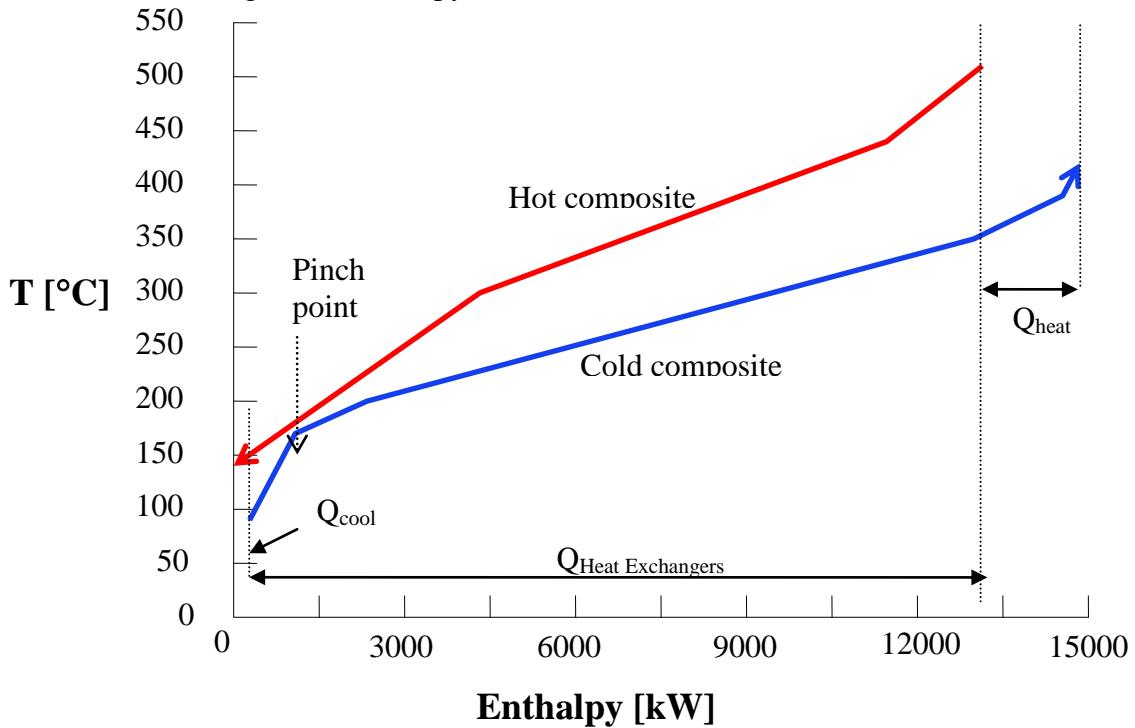

Figure 9. Composite curves for hot and cold streams.

The pinch point in the composite curve is the point where the smallest temperature difference ( $\Delta T_{\min}$ ) between the hot composite and cold composite curves as indicated in Fig. 9. The external cooling and external heating are the difference between the curves under and above pinch point respectively. The overlapping area between the hot composite and cold composite curves is the heat duty which is transferred in the heat recovery heat exchangers. The placement of the cold composite curve is determined by the magnitude of the  $\Delta T_{\min}$ . Increasing the  $\Delta T_{\min}$  means that the cold composite curve is shifted sideways in the enthalpy direction, see Fig. 10.

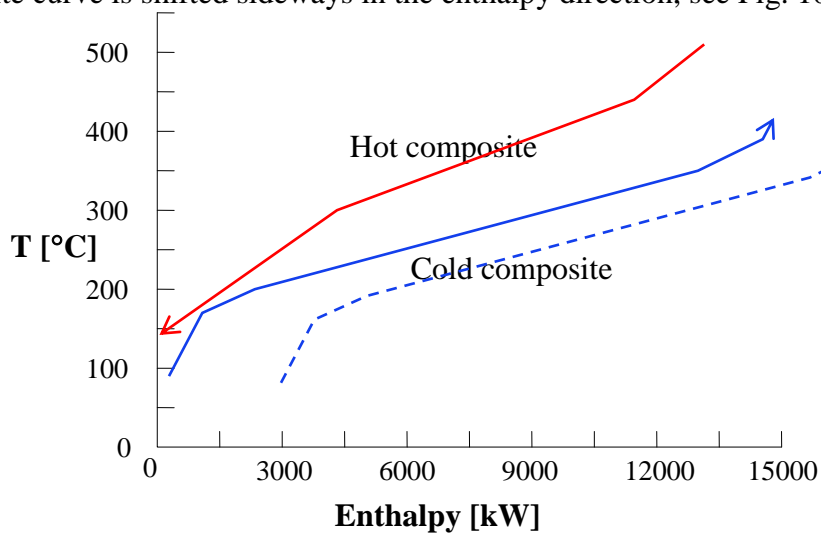

Figure 10. Composite curves when the  $\Delta T_{\min}$  increasing.

### 3.6 Grand Composite Curve (GCC)

The cascade coupling of the heat flows shown in Fig. 4 can graphically be illustrated in a temperature – heat flow (or enthalpy) diagram where each heat flow can be drawn against its respective temperature interval as shown in Fig 10. This Grand Composite curve is drawn for  $\Delta T_{\min} = 10^{\circ}\text{C}$  as was assumed in table 3 previously. The results for table 4 are graphically shown in this figure. The GCC gives more detailed information about the process streams, external heater and cooler utilities, etc. compared to the composite curves.

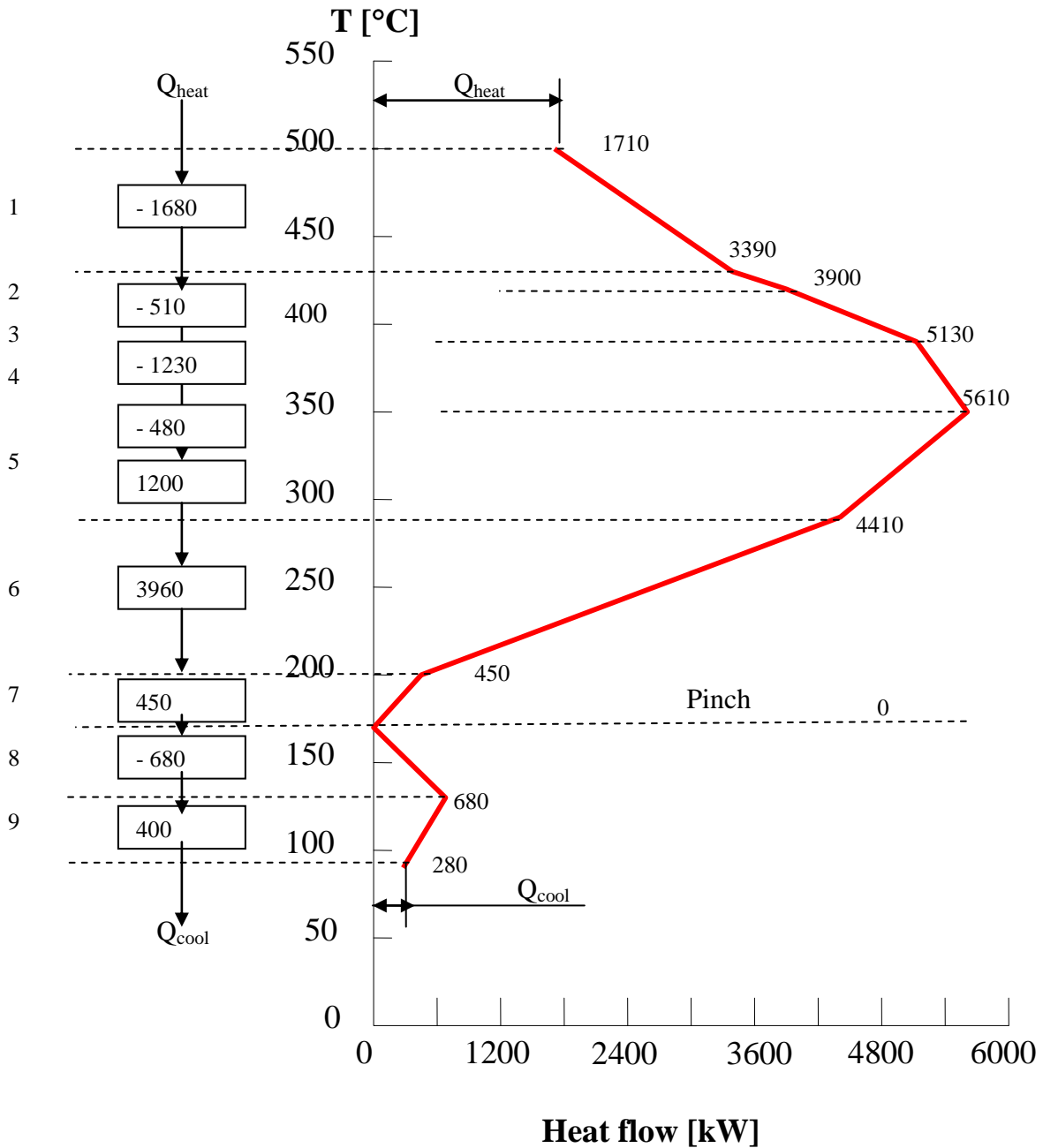

Figure 11. "Grand Composite" curve.

#### 4. Design of Heat Exchanger Network (HEN)

The design of new heat exchanger networks can be best executed by using the pinch method. Using the pinch method incorporates two important features: a) it recognizes that the most constrained part of the problem is the pinch region and b) designers are allowed to choose between the match options. The designer examines which hot streams can be matched to the cold stream by heat recovery. Every match brings one stream to its target temperature and the pinch separates the heat exchanger systems into two thermally independent regions, heat exchange networks above and below pinch temperature. When the heat recovery is maximized the remaining thermal needs are supplied by external heat utility.

There is not any clear method in designing the HEN and therefore the designer shall try different networks and finally find the optimal one. However, it is important to remember some rules when designing the HEN

- The network above and below the pinch shall be designed separately (independently)
- Start with placing a heat exchanger close to the pinch point and continue outwards
- Allow the heat exchangers transfer heat as much as possible
- The need of heat load for hot streams shall be satisfied above the pinch point
- The criteria (4a) and (4b) mentioned previously are fulfilled

Sometimes it is necessary to split one stream in order to match some loads. The following diagram may help in splitting the streams. Suppose  $N_{hot}$  and  $N_{cold}$  are the number of hot and cold streams respectively.

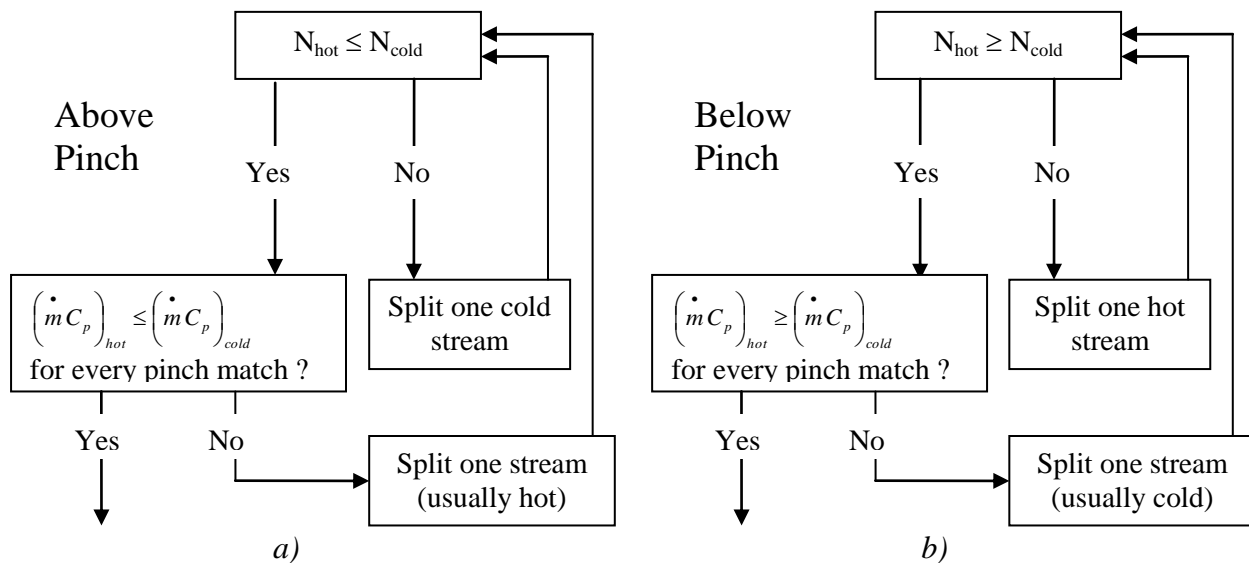

Figure 12. Flow diagram for splitting of streams a) above the pinch b) below the pinch.

In order to design the HEN for the example above it is useful to create tables in which the streams specifications above and below the pinch temperature are shown, see tables 7 and 8. Note that the pinch temperature was  $170^{\circ}\text{C}$ , therefore, above the pinch the cold streams shall be heated from  $170^{\circ}\text{C}$  while the hot streams must be cooled to  $180^{\circ}\text{C}$  (if  $\Delta T_{min} = 10^{\circ}\text{C}$ ). In these tables such aspects are also taken into account. As shown in the table there exist only one cold stream and one hot stream below the pinch point (streams number 1 and 4).



Table 7. Process streams above the pinch with  $\Delta T_{min} = 10^\circ\text{C}$ .

Process stream Nr / Type	Inlet Temp. [°C]	Outlet Temp. [°C]	Heat capacity rate [kW/K]	$\dot{Q}$ [kW]
1. cold	170	420	10	2500
2. cold	170	350	32	5760
3. cold	200	390	29	5510
4. hot	440	180	27	7020
5. hot	510	300	24	5040

Table 8. Process streams below the pinch with  $\Delta T_{min} = 10^\circ\text{C}$ .

Process stream Nr / Type	Inlet Temp. [°C]	Outlet Temp. [°C]	Heat capacity rate [kW/K]	$\dot{Q}$ [kW]
1. cold	90	170	10	800
2. cold	–	–	–	–
3. cold	–	–	–	–
4. hot	180	140	27	1080
5. hot	–	–	–	–

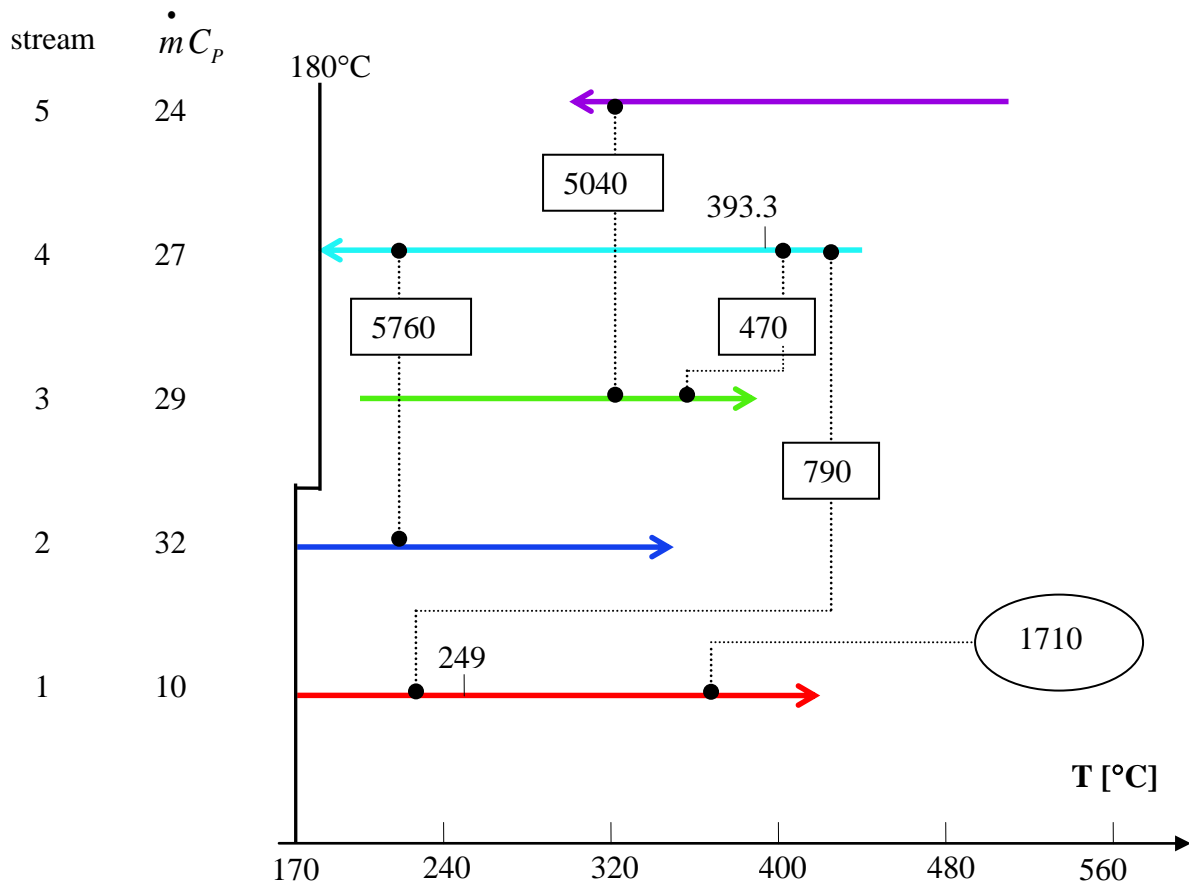

Figure 13. Grid diagram above the pinch point.

Immediate above the pinch point, streams 4 and 2 fulfill the condition (4a), and table 7 shows that the heat available from hot stream 4 can satisfy the needed heat for cold stream 2. The rest of 1260 kW ( $7020 - 5760 = 1260$  kW) can be used for heat supply to other cold streams. An energy balance provides the breaking temperature for stream 4,

$$5670 \times 10^3 = 27 \times 10^3 (T - 180) \Rightarrow T = 393.33^\circ\text{C}$$

These temperatures are far away from the pinch point and the condition (4a) is not in use any more. Therefore, the rest heat of 1260kW can be used for any other cold streams. The hot stream 5 can provide 5040 kW needed heat for cold stream 3. Again, temperature  $300^\circ\text{C}$  for stream 5 is far away from pinch and the condition (3a) is not valid any longer. Now the cold stream 3 needed 470 kW ( $5510 - 5040 = 470$ ) which can be taken from rest of stream 4. After this, stream 4 has 790 kW left ( $1260 - 470 = 790$ ) which can be given to the cold stream 1. The breaking temperature for stream 1 can be calculated by

$$790 \times 10^3 = 10 \times 10^3 (T - 170) \Rightarrow T = 249^\circ\text{C}$$

The cold stream 1 needed now 1710 kW ( $2500 - 790 = 1710$ ), which can be provided by external heating. No split for any streams was needed since the conditions (4a) and (4b) were fulfilled completely. The external heating is the same as was calculated previously. The results are graphically illustrated in Fig. 13 which is usually called as *Grid Diagram*.

A similar treatment can also be done for stream below the pinch point, which is illustrated in Fig. 14. The cold stream 4 needs 800 kW which can be provided by the hot stream 1 due to the fact that the condition (4b) is fulfilled. The breaking temperature can be calculated through energy balance equation as

$$800 \times 10^3 = 27 \times 10^3 (180 - T) \Rightarrow T = 150.37^\circ\text{C}$$

The hot stream 4 needs now 280 kW ( $1080 - 800$ ) which can be supplied by the external cooling utility.

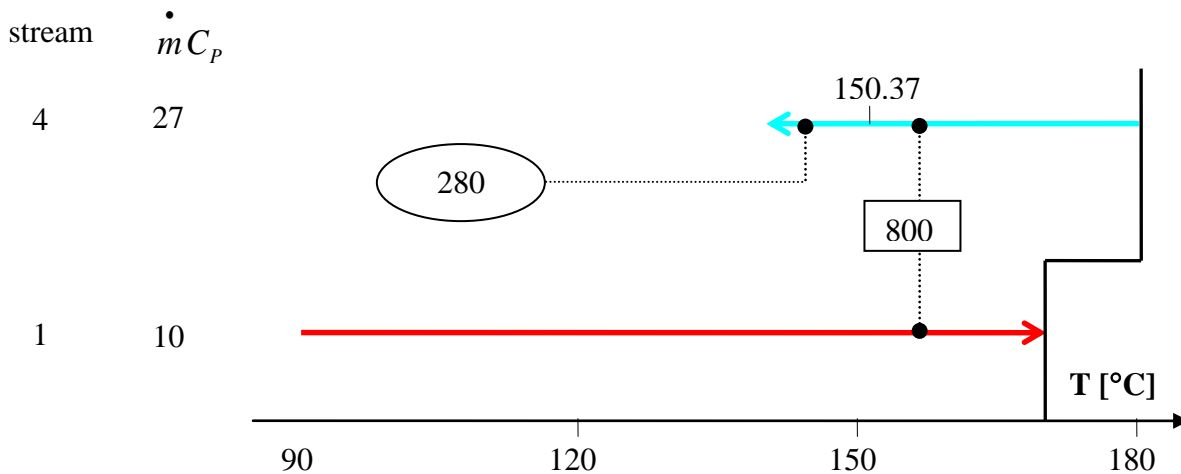

Figure 14. Grid diagram below the pinch point.

Now if grid diagrams in Figs. 13 and 14 are connected then the whole network can be graphically shown in Fig. 15. Note that it is always useful to show the breaking points for the respective stream in the grid diagrams in order to more exactly specify where the considered heat exchangers are place. Another advantage is that by showing these breaking temperatures the designer can easily realize how far these temperatures in comparison to the pinch point are place and thus to understand whether the conditions (4a) and (4b) are relevant. Note that these conditions are only valid immediately above or below the pinch point, not every where else.

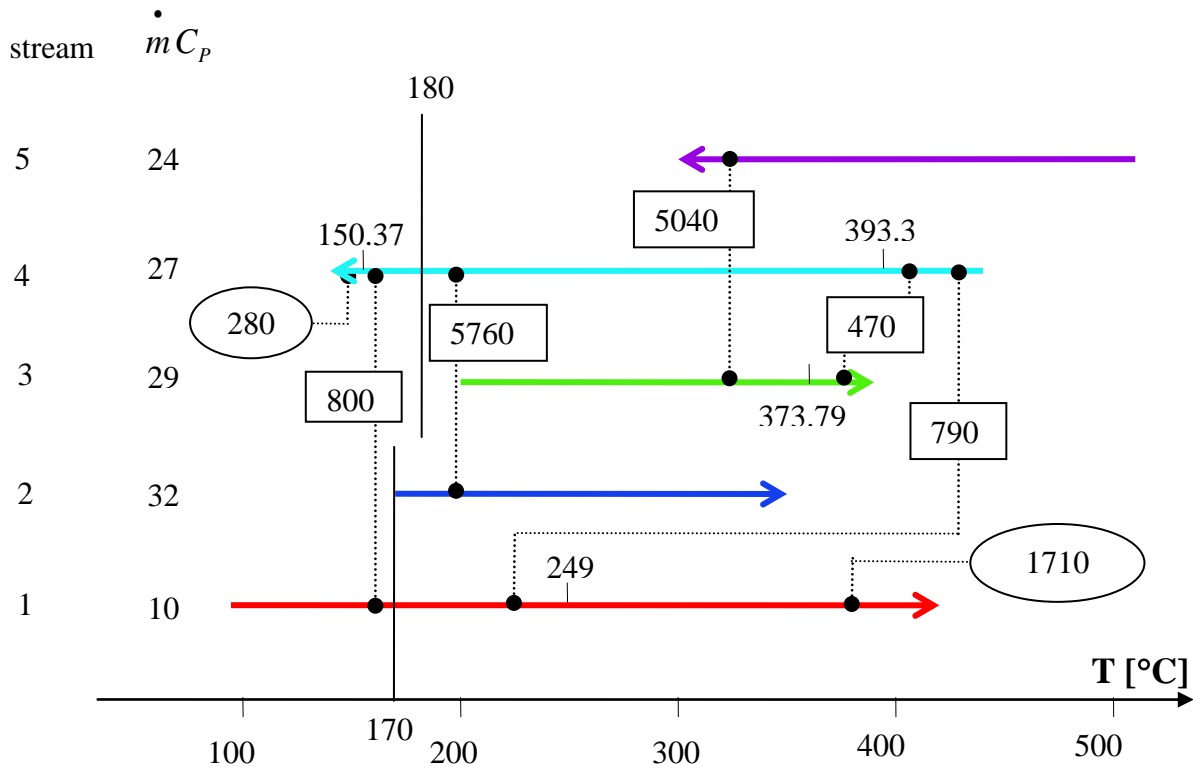

Figure 15. Resulting grid diagram for the network.

#### 4.1 Minimum Number of Heat Exchangers

At this point it might be interesting to mention the minimum number of heat exchangers units that can be used in HEN designing. Below the pinch point the heat exchangers load is chosen so that the cold streams are satisfied while above the pinch point the heat exchangers load is chosen so that the hot streams are satisfied. As mentioned previously, to fulfill these conditions it is sometime necessary to split some streams. Further, no heat transfer is allowed across the pinch point in designing the Minimum Energy Requirement (often called as MER). Therefore, a realistic target for the minimum number of units ( $U_{targetMER}$ ) would be the sum of targets evaluated at both above and below the pinch point separately as (Euler's theory),

$$U_{targetMER} = (N_{hot} + N_{cold} + N_{utility} - 1)_{AbovePinch} + (N_{hot} + N_{cold} + N_{utility} - 1)_{BelowPinch} \quad (5)$$

where  $N_{hot}$ ,  $N_{cold}$  and  $N_{utility}$  are number of hot streams, number of cold streams and number of utilities (heaters and coolers) respectively. For the example above, below the pinch there are 2 streams and 1 heater, thus the minimum number of heat exchangers would be  $2 + 1 - 1 = 2$  which is also used in this HEN. Above the pinch, there are 5 streams (3 cold plus 2 hot) and 1 cooler which results in  $5 + 1 - 1 = 5$  which is the minimum HEN and also is used in this solution HEN. Note that the external cooling (1710 kW) and heating (280 kW) shall also be provided by heat exchangers.

Moreover, the cost of heat exchangers should be in balance compared to other solution methods such the need for more external heating and cooling. The target for minimum heat transfer area and minimum number of heat exchanger units can be combined with the heat

exchanger cost method to determine the target for the HEN capital cost. Note that the minimum of units is of more interest in respect for cost of pipelines, fundamentals, maintenance, etc.

## 5. Pinch Technology and Additional Points

As pointed out before the pinch technology offers a novel approach on designing a process with maximal energy recovery network and thus minimizing the capital and maintenance cost. Here some additional points will be pointed out which the designer shall be think.

### 5.1 Pinch Technology and Traditional Approach

In traditional designing approach, the core of process is designed with fixed flow rates and temperatures so that the heat and mass balance of the process is satisfied. The design of heat recovery systems are provided afterwards and the remaining duties are completed by using the external utilities. In pinch technology approach integration of heat recovery systems is considered together with process designing. A simple map in Fig. 16 shows clearly the differences.

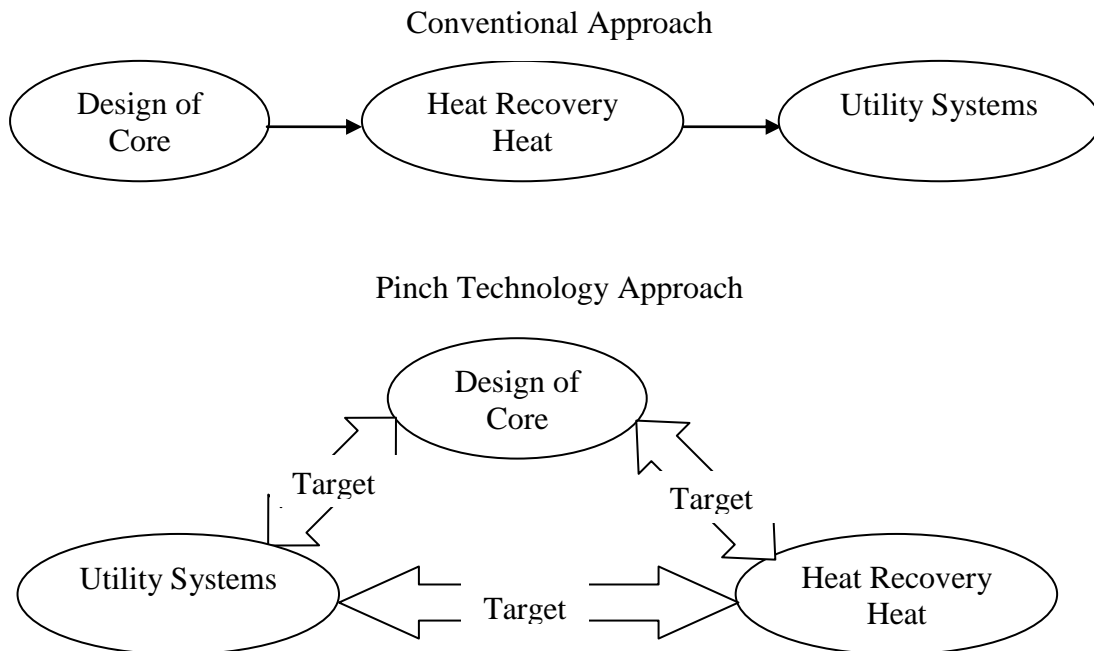

Figure 16. Traditional design approach versus pinch design approach.

### 5.2 Guidelines on Deciding the Magnitude of $\Delta T_{\min}$

In case information lack, the table below shows some guidelines on preliminary assumption of  $\Delta T_{\min}$  for some different industrial processes.

Table 9. Some typical values for  $\Delta T_{\min}$  in industrial sectors.

Industrial Sector	Typical values for $\Delta T_{\min}$
Low Temperature Process	3 – 5 °C
Chemical	10 – 20 °C
Petrochemical	10 – 20 °C
Oil Refinery	20 – 40 °C

Note that the  $\Delta T_{\min}$  should be highly dependent on the flow type, heat exchanger type, sector to be used, etc. For example, in oil refinery fouling is problem in the heat exchangers and therefore  $\Delta T_{\min}$  would be large. Or power requirement for refrigeration process is very expensive and therefore low value for  $\Delta T_{\min}$  is desired.

### 5.3 Steps of Pinch Analysis

A well defined stepwise procedure shall be followed in any pinch analysis problem, whether it is a new project or it is retrofit situation (existing project to be updated). Note that it might be necessary to iterate between some steps before continuing. Re-simulation and data modification may also be useful in many situations.

- Identification of the cold streams, hot streams and utilities
- Thermal data extraction for the streams and utilities
- $\Delta T_{\min}$  value selection
- Composite curves and grand composite curve construction
- Minimum energy cost target estimation
- Capital cost target estimation
- Optimum  $\Delta T_{\min}$  value estimation
- Practical targets for HEN design estimation
- HEN design

### 5.4 Benefits and Application Areas of Pinch Technology

Maybe one of the main advantages of the pinch technology over the traditional methods is the ability of the pinch technology to set capital cost and energy recovery targets for a sub-process or entire process ahead of design. Also, before designing any process the scope of energy savings and investment requirements are known in advanced. In addition, the following process improvements are among many that the pinch technology helps the process engineers to achieve.

- Updating/modifying the existing process flow diagram. It shows the areas that process changes reduce the overall energy target.
- Process simulation studies. Old energy studies can be replaced by pinch technology simulations so that information can be easily updated. It helps to avoid unnecessary capital cost before the projects are implemented.
- Practical targets settings. Theoretical targets can be modified by taking into account practical restrictions (safety, difficult handling fluids, temperature limit, pressure limit, etc.).
- Determination of opportunities for Combined Heat and Power (CHP) process. Power cost reduces significantly with a well designed CHP system. Pinch technology shows the best possible CHP system that matches the thermodynamic targets on the site.
- Deciding what can be done with the low-grade waste heat. Pinch technology shows which waste heat streams can be recovered effectively.

## 6. Pinch Method with Active Components of Heat Engines and Heat Pumps

Heat engines and heat pumps are the key components for the process utility systems. The idea would therefore be the principles of placing these components into the process, or appropriate integration of such devices into the process. Figure 17 shows the principle working mechanism

of heat engines and heat pumps. A heat engine receives heat from a high temperature source and produces work while emitting heat to a lower temperature source. A heat pump (refrigeration mechanism) takes heat from a lower temperature reservoir by supplied work and rejects heat to a high temperature source. The following relation is valid

$$\dot{W} = \dot{Q}_1 - \dot{Q}_2 \quad (6)$$

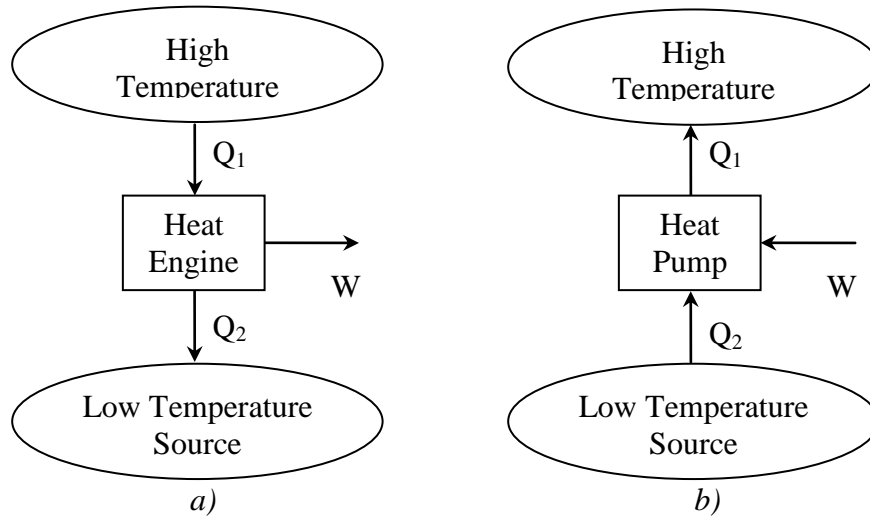

Figure 17. Principles mechanism of a) heat engines and b) heat pumps (refrigeration).

### 6.1 Heat Engine (HE)

A heat engine in a process has two main objectives, supplying process heat demand and generating power. An appropriate integration of heat engines into a process is important on providing the most energy efficient combination of these objectives. By integration it means that a heat exchange link is provided between the heat engine and the process. The integration of heat engines into a process can be done on three different ways, above the pinch, below the pinch and across the pinch. These integration possibilities are shown in Fig. 18.

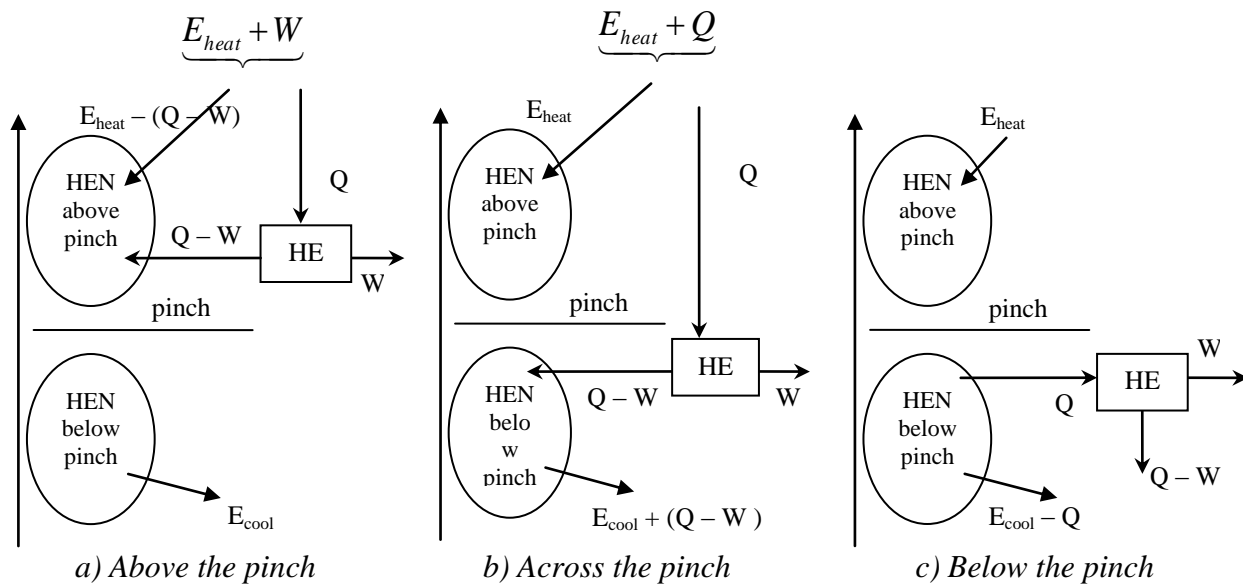

Figure 18. Different integration possibilities of heat engines in a network.

If the heat engine is integrated so that it rejects heat to the network above the pinch temperature (Fig. 18a), then heat will be transferred to the process heat sink. Therefore, network hot utility demand will be reduced slightly and overall hot utility requirement is only increased by engine shaft-work  $W$ . Such placement is appropriate because it implies 100% efficient heat engine.

If the heat engine is placed so that it takes energy from the network below the pinch temperature (Fig. 18c) then heat will be taken from overall process heat sources. It means that the heat engine is running on free of fuel cost and overall cold utility requirement will be decreased by engine shaft-work of  $W$ . Therefore, the heat engine is integrated appropriately.

If the heat engine is placed across the pinch temperature then both overall heat requirement and overall cold requirement will be increased, as shown in Fig. 18b. Therefore, the heat engine is integrated inappropriately.

To summarize, a heat engine placed either above the pinch or below the pinch are appropriated, while a heat engine placed across the pinch is not appropriated.

## 6.2 Heat Pump (HP)

As pointed before a heat pump receives heat at a lower temperature and by using a mechanical power rejects the heat at a higher temperature. The rejected heat is thus the sum of input heat and the mechanical power. Key design parameters for heat pumps can be decided by pinch analysis technology. Again, integration possibilities for heat pumps into a network process can be done in three ways which are called as above the pinch, below the pinch and across the pinch, see Fig. 19.

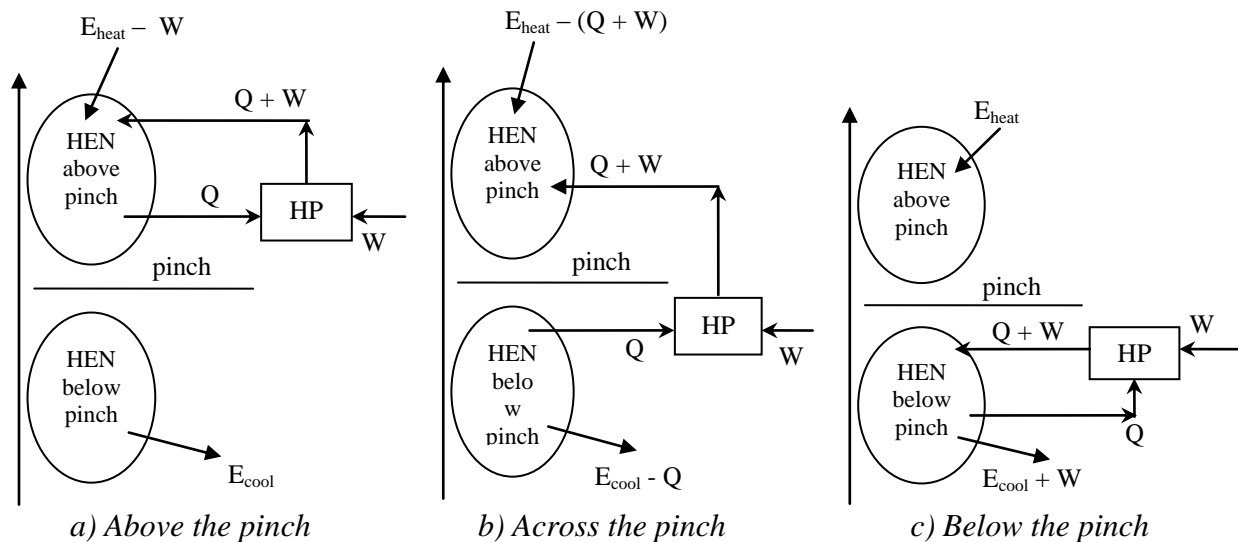

Figure 19. Different integration possibilities of heat pumps in a network.

A heat pump can be placed so that it takes energy from the network above the pinch point and reject heat to a higher temperature also above the pinch, see Fig. 19a. This integration possibility decreases the overall heat demand by pump shaft-work  $W$  in expense of an equal input power. Therefore, such integration is inappropriate since the input power is more expensive than gained heat.

In the second option, a heat pump can be integrated so that it takes energy from the network below the pinch temperature and rejects heat to the temperature above the pinch, see Fig. 19b. Such heat pump placement decreases the overall heating demand and overall cooling demand.

The reduced overall heating and cooling demands is much bigger than the provided work to the pump. Thus such integration possibility is appropriated.

The third option is that the heat pump is placed so that it takes energy from a point below the pinch and rejects heat to a higher temperature which is also below the pinch, Fig. 19c. Such integration increases the cooling demand with a value equal to the pump shaft-work  $W$ . This is done in expense of an equal power provided for pump. Again, since the power is more expensive than heat then such placement possibility is not appropriated.

To summarize, the only appropriate way to integrate a pump into a process is to place it across the pinch. However, it is important to remind that the overall economic of a heat pump depends on the heat saving when it is compared with the cost of input power, heat pump capital cost and associated heat exchangers.

## 7. Process Modification by Plus – Minus Principle

In order to further decrease the overall energy requirement in a process, one needs to study the composite curves (beside the process parameters such as operating pressure, operating temperatures, reactor conversions, etc.). Since the composite curves strongly depend on the heat and material balance of process, thus any changes in these parameters affect the composite curves. Therefore, by applying the pinch rules mentioned above, one can easily identify the changes in process parameter that have favorable impact on energy consumption.

The following rules are thus useful on studying the composite curves.

- The hot utility target reduces by:
  - Any increase (+) in hot streams duty above the pinch
  - Any decrease (–) in cold streams duty above the pinch
- The cold utility target reduces by:
  - Any increase (+) in cold streams duty below the pinch
  - Any decrease (–) in hot streams duty below the pinch

These simple rules are often called as “*plus – minus principle*” (+ / – *principle*) and are regarded as guidelines for adjustment of a single heat duty. However, it is often possible to change process temperature rather than its duty. The beneficial target for shifting the temperature can easily be summarized as

- Shift hot streams from below the pinch to above the pinch
- Shift cold streams from above the pinch to below the pinch

These are in agreement with the general idea that it is beneficial to increase the hot streams temperature (easier to extract energy) and reduce the cold streams temperature.

## 8. Pinch Technology and Future Possibilities

In late 1970s, the development of Pinch Technology started and it has found its place in energy conversation applications. However, new developments for Pinch Analysis have been done in other areas such as water use minimization, waste minimization, hydrogen management, plastics manufacturing, etc. Below, some key research areas are pointed out.

- *Water Pinch*: In view of rising fresh water costs and more stringent discharge regulations, Pinch Analysis may help companies to systematically minimize freshwater consumption and wastewater volumes. Water Pinch is a technique that can be used for analyzing water networks and reducing water costs for processes.



- *Hydrogen Pinch*: Hydrogen Pinch is the pinch technology approach which applies to hydrogen management technique. Using Hydrogen Pinch, a designer may be able to set targets for the minimum hydrogen production from the plant or hydrogen imports without the need for any process design. Hydrogen Pinch may also help for effective use of hydrogen purification units.
- *Top Level Analysis*: Sometimes, it is very difficult to collect the required data in large industrial areas. Which utilities are worth for saving can be determined by using a Top Level Analysis with only efficiencies and constraints of the utility systems. Then data can be gathered from those processes or units that use these utilities. Finally, a pinch analysis can be performed on these equipment only.
- *Total Site Analysis*: Refinery and petrochemical processes operate usually as part of large factories or sites. These sites have several processes which are serviced by a centralized utility system. Via the main steam supplement, there might be both consumption and recovery of the steam for different processes. In such large sites, different departments usually control the individual process and the central services. These departments usually operate independently. To improve integration of total site infrastructure, a simultaneous approach to consider individual process issues and entire site utility planning is sometimes necessary. Pinch Technology can therefore be used to calculate energy targets for the entire site.
- *Regional Energy Analysis*: By studying the net energy demands of several companies together (combined), the potential for sharing heat between these companies can be identified. Such analyses may give insight into the amount of waste heat from these industrial areas that might be available for export. Depending on the temperature level of waste heat, it can also be used for power generation or district heating.

## Assignments

**Problem 1:** In a process site the following process streams are given. Suppose  $\Delta T_{\min} = 0^\circ\text{C}$ .

Process stream Nr / Type	Inlet Temp. [°C]	Outlet Temp. [°C]	Heat capacity rate [kW/K]
1. cold	20	135	2.0
2. cold	80	140	6.0
4. hot	170	60	3.0
5. hot	150	30	1.5

- Perform the temperature interval.
- Perform the sequential and max table.
- Find out the external heating and cooling demands.
- What is the pinch temperature?

(Answer:  $Q_{\text{heat}} = 95 \text{ kW}$   
 $Q_{\text{cool}} = 15 \text{ kW}$   
 $T_{\text{pinch}} = 80^\circ\text{C}$ )

**Problem 2:** A chemical site is going to be designed based on the following process streams. It is also desired to recover maximum amount of heat through a network of heat exchangers.

Process stream Nr / Type	Inlet Temp. [°C]	Outlet Temp. [°C]	Heat capacity rate [kW/K]
1. cold	100	430	16.0
2. cold	180	360	32.4
3. cold	200	400	29.7
4. cold	260	400	22.4
5. hot	440	150	28.0
6. hot	520	300	23.8
7. hot	390	150	33.6

Assume  $\Delta T_{\min} = 10^\circ\text{C}$  for the heat exchangers.

- Find out the temperature interval.
- Perform the cascade table.
- What are the minimal external and cooling effects?
- What is the pinch temperature?
- Draw the composite curves.
- Draw the grand composite curve.
- Draw the grid diagram.

(Answer:  $Q_{\text{heat}} = 216 \text{ kW}$   
 $Q_{\text{cool}} = 1448 \text{ kW}$   
 $T_{\text{pinch}} = 200^\circ\text{C}$ )

**Problem 3:** Due to energy prices, a refinery is going to be modernized and at the same time recover maximum energy in the site by using a complex network of heat exchangers.

Process stream Nr / Type	Inlet Temp. [°C]	Outlet Temp. [°C]	Heat capacity rate [kW/K]
1. cold	95	205	8.0
2. cold	40	220	8.0
3. cold	150	205	12.0
4. cold	65	140	20.0
5. hot	310	205	8.0
6. hot	245	95	13.0
7. hot	280	65	6.0

Answer to the following questions if  $\Delta T_{\min}$  for the heat exchangers is 10°C. (Theoretical MER is valid.)

- Find out the temperature interval.
- Draw the composite curves.
- Perform the cascade table.
- What are the minimal external and cooling effects?
- What is the pinch temperature?
- Draw the grid diagram for the heat exchangers.
- Draw the grand composite curve.

(Answer:  $Q_{\text{heat}} = 400 \text{ kW}$   
 $Q_{\text{cool}} = 0 \text{ kW}$   
 $T_{\text{pinch}} = 40^\circ\text{C}$ )