

## **Adaptive Assessment of Future Scenarios and Mapping of Observability Needs. Deliverable D5.1**

WP 5: Increased Observability

**Morch, Andrei Z. ; Visscher, Klaas; Jakobsen, Sigurd Hofsmo; Marinelli, Mattia; Obusevs, Artjoms;  
Uytterhoeven, Stijn; Prostejovsky, Alexander Maria; Pertl, Michael; Nadar, Abdullah; Dag, Bülent**

*Publication date:*  
2015

*Document Version*  
Publisher's PDF, also known as Version of record

[Link back to DTU Orbit](#)

*Citation (APA):*  
Morch, A. Z., Visscher, K., Jakobsen, S. H., Marinelli, M., Obusevs, A., Uytterhoeven, S., ... Dag, B. (2015). Adaptive Assessment of Future Scenarios and Mapping of Observability Needs. Deliverable D5.1: WP 5: Increased Observability. ELECTRA Consortium.

## **DTU Library** Technical Information Center of Denmark

---

### **General rights**

Copyright and moral rights for the publications made accessible in the public portal are retained by the authors and/or other copyright owners and it is a condition of accessing publications that users recognise and abide by the legal requirements associated with these rights.

- Users may download and print one copy of any publication from the public portal for the purpose of private study or research.
- You may not further distribute the material or use it for any profit-making activity or commercial gain
- You may freely distribute the URL identifying the publication in the public portal

If you believe that this document breaches copyright please contact us providing details, and we will remove access to the work immediately and investigate your claim.

Project No. 609687  
FP7-ENERGY-2013-IRP

# **ELECTRA**

## **European Liaison on Electricity Committed Towards long-term Research Activities for Smart Grids**



## **WP5**

### **Increased Observability**

### **Deliverable D5.1**

## **Adaptive Assessment of Future Scenarios and Mapping of Observability Needs**

19/01/2015

<b>ID&amp;Title</b>	D5.1 “Adaptive Assessment of Future Scenarios and Mapping of Observability Needs”	<b>Number of pages:</b>	114
<b>Short description (Max. 50 words):</b>			
<p>Task T5.1 is the first of five tasks in WP5 "Increased Observability". The task defines the scope and main ground rules for the succeeding tasks. Accordingly the main objectives of this report are threefold:</p> <ul style="list-style-type: none"> <li>• Narrow the scope of the research for the succeeding tasks in WP5</li> <li>• Analyse the scenarios and settings regarding operation of the future power system from WP3 “Scenarios and case studies for future power system operation”</li> </ul> <p>Derive particular observability needs required by the future power system</p>			
<b>Version</b>			
<b>Date</b>			
<b>Modification's nature</b>			
V 0.1	24/06/2014	Creation of the document	
V 0.2	17/08/2014	Revision of the ToC	
V 0.3	01/09/2014	Section 4.1 added	
V 0.4	01/10/2014	Started writing on the information exchanges part	
V 0.5-0.8	07/11/2014	Addition of several new sections	
V 0.9	26/11/2014	Finalization of observable practices	
V 1.0	18/12/2014	The document is issued for Internal Review	
V 1.1	16/01/2015	Comments from the Internal Review implemented.	
V 2.0	19/01/2015	The document is issued	
<b>Accessibility</b>			
<input checked="" type="checkbox"/> PU, Public			
<input type="checkbox"/> PP, Restricted to other program participants (including the Commission Services)			
<input type="checkbox"/> RE, Restricted to other a group specified by the consortium (including the Commission Services)			
<input type="checkbox"/> CO, Confidential, only for members of the consortium (including the Commission Services)			
<b>If restricted, please specify here the group:</b>			
<b>Owner / Main responsible:</b>			
WP5 Leader	Andrei Z. Morch, SINTEF		

<b>Reviewed by:</b>		
WP8 Leader	Henrik Bindner, DTU	14/01/2015
WP4 Leader	Chris Caerts, VITO	
<b>Final Approval by:</b>		
ELECTRA Technical Committee TOQA appointed Reviewer:	-	19/01/2015

## Authors

Name	Last Name	Organization	Country
Andrei	Morch	SINTEF	Norway
Klaas	Visscher	TNO	The Netherlands
Sigurd Hofsmo	Jakobsen	SINTEF	Norway
Mattia	Marinelli	DTU	Denmark
Artjoms	Obusevs	IPE	Latvia
Stijn	Uytterhoeven	LABORELEC	Belgium
Alexander	Prostejovsky	DTU	Denmark
Michael	Pertl	DTU	Denmark
Abdullah	Nadar	TUBITAK	Turkey
Bülent	Dag	TUBITAK	Turkey
Irina	Oleinikova	IPE	Latvia

## Copyright

@ Copyright 2013-2016 The ELECTRA Consortium

Consisting of:

<b>Coordinator</b>	
Ricerca Sul Sistema Energetico – (RSE)	Italy
<b>Participants</b>	
Austrian Institute of Technology GmbH - (AIT)	Austria
Vlaamse Instelling Voor Technologisch Onderzoek N.V. - (VITO)	Belgium
Belgisch Laboratorium Van De Elektriciteitsindustrie - (LABORELEC)	Belgium
Danmarks Tekniske Universitet - (DTU)	Denmark
Teknologian Tutkimuskeskus - (VTT)	Finland
Commissariat A L'Energie Atomique Et Aux Energies Alternatives - (CEA)	France
Fraunhofer-Gesellschaft Zur Förderung Der Angewandten Forschung E.V – (IWES)	Germany
Centre For Renewable Energy Sources And Saving - (CRES)	Greece
Agenzia Nazionale per Le Nuove Tecnologie, L'Energia E Lo Sviluppo Economico Sostenibile - (ENEA)	Italy
Fizikalas Energetikas Instituts - (IPE)	Latvia
SINTEF Energi AS - (SINTEF)	Norway
Instytut Energetyki - (IEN)	Poland
Instituto De Engenharia De Sistemas E Computadores Do Porto - (INESC_P)	Portugal
Fundacion Tecnalia Research & Innovation - (TECNALIA)	Spain
Joint Research Centre European Commission - (JRC)	Belgium
Nederlandse Organisatie Voor Toegepast Natuurwetenschappelijk Onderzoek – (TNO)	Netherlands
Turkiye Bilimsel Ve Teknolojik Arastirma Kurumu - (TUBITAK)	Turkey
University Of Strathclyde - (USTRATH)	UK
European Distributed Energy Resources Laboratories (DERlab)	Germany
Institute for Information Technology at University of Oldenburg (OFFIS)	Germany

**This document may not be copied, reproduced, or modified in whole or in part for any purpose without written permission from the ELECTRA Consortium. In addition to such written permission to copy, reproduce, or modify this document in whole or part, an acknowledgment of the authors of the document and all applicable portions of the copyright notice must be clearly referenced.**

All rights reserved.

This document may change without notice.

## Executive summary

The present goals of achieving European environmental targets of 20/20/20 and the 2050 decarbonisation roadmap require a major transfer from conventional generation to Renewable Energy Sources (RES) on different power levels, from offshore wind farms to small-scale photovoltaic (PV) panels, feeding into networks on various voltage levels. Following the same goals, electrification of transport (EVs) and increased use of heat pumps for space heating will contribute to changes on the consumption side. Accommodation of intermittent generation and coincident loads into the network and assuring its reliable operation requires a gradual evolution of the network structure and in particular improvement of its monitoring or observing.

In the future grid, a shift is expected from central synchronous generators at transmission level to intermittent production units (PV panels, Wind turbines) at distribution level, which cannot participate directly in central balancing by the TSO and do not provide inertial response power for instantaneous balancing. Furthermore, coincident non-intermittent loads like EV battery charging stations and heat pumps may cause temporary overloads in LV and MV substations. These factors decrease the reliability of grid control by TSO's and DSO's.

Task T5.1 is the first of five tasks in WP5 "Increased Observability". The task defines the scope and main ground rules for the succeeding tasks. Accordingly the main objectives of this report are threefold:

- Narrow the scope of the research for the succeeding tasks in WP5
- Analyse the scenarios and settings regarding operation of the future power system from WP3 "Scenarios and case studies for future power system operation"
- Derive particular observability needs required by the future power system

The present task is closely interrelated with several other tasks in the project and in particular with WP3, which provides scenarios and a high level functional architecture for the future power system operation.

In order to set the main ground rules and principles for the whole workpackage several key concepts and definitions have been made. An observable herewith is a uniquely valued function of a number of measurable quantities in a physical system. An observable can either be a scalar or vector ("State Vector") that relates to measured (observed) values in the present or past. The main working concept in the task is the control triple concept, consisting of a set of three elements:

- Control Aim
- Observable
- System input signal

Based on this, a comprehensive survey of the existing and experimental control triples inventory has been conducted, which collected more than 20 control triples differentiated according to their transition times. Introduction and description of control triples is expected to be the main conceptual cornerstone for WP5. In addition to this, another important concept of a single reference power system has been defined in order to simplify and straightforward modelling of the observables in the workpackage.

According to the project's description of work (DoW) the present deliverable is essentially based on results and conclusions from T3.1 of ELECTRA in the form of the internal report R3.1(M6) [6] providing the problem description of voltage and frequency control residing on more traditional centralised system architecture. The succeeding task T3.2 developed and proposed a novel

architecture concept for the future power system, coined web-of-cells, which was documented in D3.1 [11]. Following this, the future European power grid will be decomposed into a new structure - web-of-cells, where the cells are defined as a group of interconnected loads, distributed energy resources and storage units within well-defined electrical boundaries corresponding to a physical portion of the grid and corresponding to a delimited geographical area. What is more interesting is that the web-of-cells architecture does not strictly follow division into traditional control levels (primary-secondary-tertiary), especially when it comes to voltage regulation. This can be done due to limited size of individual cells and efficient utilisation of new technologies, which make some of the existing control schemes redundant.

The main question is what information should be available to the controllers and operators to assess the state of the system and decide what the relevant control actions are. Therefore in order to explore differences between these two alternative approaches, especially with regard to observability, a comparative evaluation of information exchanges in different control schemes has been reviewed. For the centralised architecture originating from R3.1 an additional set of information exchange tables were developed, based on Intelligrid's Use Case Methodology. This was compared with the information exchanges developed in D3.1. One of the main conclusions is that the observables derived from similar control schemes in these two architectures are quite similar, probably due to the fact that it is high level use cases that are not very much concerned with the components involved. This evaluation did create a solid starting point in the study, but did not however provide an exhaustive answer for the expected observability needs.

In order to define a present status and establish a common reference for observing practices, a limited survey of the observability practices was conducted. The survey covered eight participating countries and differentiated the practices according to TSO/DSO operations. Several important conclusions have been made after this survey:

- Practices for Observing of the Transmission Networks are quite similar (most likely due to compliance with ENTSO-E's requirements) with very little variation among countries.
- Observing of the Distribution Network varies from country to country and in general is limited i.e. it appears that observability today is lower in Distribution Networks than in Transmission Networks
- DSOs seem to be most concerned what happens at HV/MV connection points and connection of big customers.
- Most participating countries plan to improve the observability of the distribution grid

After conducting the survey it became even more obvious that the present practices for observing both Transmission and especially Distribution networks are not adequate for the expected transformation of the power sector in order to meet the European 20/20/20 goals.

Several technical and non-technical requirements have been defined for more specific description of the observability needs. Following results of the first comparative evaluation of information exchanges, the study made a new additional and deeper qualitative approach aligning observability needs with technical challenges in the new control schemes and defined set of technical requirements for each observability need.



# 1 Terminologies

## 1.1 Definitions

In general ELECTRA project has a commonly coordinated strategy related to use of terms and definitions within the project. In WP4 “Interoperable Systems” it has been created ELECTRA Glossary activity, which collects and validates specific terms and definitions. The Electra Glossary is available for the projects' participants in the file repository at [www.electrairp.eu](http://www.electrairp.eu) and will not be repeated in the present document.

Furthermore, the document complies with the main definitions of ENTSO-E's documents and their supporting documents and in particular with network codes (NCs) related to Operation:

- Operational Security (NC-OS)
- Operational Planning and Scheduling (NC-OPS)
- Load-Frequency Control and Reserves (NC-LFCR) [7]
- Emergency and Restoration (NC-E&R)

and Market:

- Capacity Allocation & Congestion Management (NC-CACM)
- ENTSO-E Network Code on Electricity Balancing (NC-EB) [4]

Additionally the document introduces several new terms and definitions, which have been specifically developed in T5.1 for the scope of ELECTRA project (see Section 4.1) or/and have meaning, which may differ from the commonly used. The text below shows a selection of the key definitions:

- **Observable:** An observable is a uniquely valued function of a number of measurable quantities in a physical system. An observable can either be a scalar or vector (“State Vector”) that relates to measured (observed) values in the present or past.
- **Transition time:** Time to complete the transition from a stationary system state to the next stationary one, after a switching event occurs
- **Dead time:** Time difference between switching event and noticeable system response.
- **Time resolution:** Maximum sample duration in order to capture a response to a switching event in ample details.
- **Control triple:** every working control loop must have a set of three elements:
  1. Control Aim
  2. Observable
  3. System input signal

In the scope of the present project this set will be called “Control triple”.

- **Cells:** grid units, that each are responsible for local balancing and voltage control and consist of interconnected loads, distributed energy resources and storage units within well-defined electrical boundaries corresponding to a physical portion of the grid and corresponding to a delimited geographical area [11].
- **Cell Operator:** a new role, which is responsible for establishing and maintaining automatic and manual control mechanisms as well as procuring sufficient reserves and contributing to a stable and secure system operation.

## 1.2 Abbreviations

Abbreviation	Meaning
AVR	Automatic Voltage Regulator
BRC	Balance Restoration Control
BRP	Balance Responsible Party
BSC	Balance Steering Control
BSC	Balance Steering Control
BSP	Balancing Service Provider
BSR	Balance Steering Reserve
CCPP	Cell Controller Pilot Project
CHP	Combined Heat And Power
CIGRE	International Council On Large Electric Systems
CPU	Central Processing Unit
CSC	Current Source Converter
DER	Distributed Energy Resources
DG	Distributed Generation
DN	Distribution Network
DNO	Distribution Network Operator
DOW	Description Of Work
DR	Demand Response
DSO	Distribution System Operator
DVC	Digital Voltage Control
EDSO	European Distribution System Operators
ELECTRA	European Liaison On Electricity Committed Towards Long-Term Research Activity
ENTSO-E	European Network Of Transmission System Operators For Electricity
EV	Electric Vehicle
FACTS	Flexible Alternating Current Transmission System
FCC	Frequency Containment Control
FCR	Frequency Containment Reserves
FRR	Frequency Restoration Reserves
GPU	Graphical Processing Unit

Abbreviation	Meaning
HV	High Voltage
HVDC	High-voltage Direct Current
ICT	Information And Communication Technology
IEEE	Institute Of Electrical And Electronics Engineers
IFC	Inertia Frequency Control
ISGT	Innovative Smart Grid Technologies
LV	Low Voltage
MS	Milestone
MV	Medium Voltage
MW	Megawatt
NC	Network Codes
NC- EB	Network Code On Electricity Balancing
NC-CACM	Network Code On Capacity Allocation And Congestion Management
NC-LFCR	Network Code On Load Frequency Control And Reserves
NC-OPS	Network Code On Operation Planning And Scheduling
NC-OS	Network Code On Operational Security
OPF	Optimal Power Flow
PAS	Publicly Available Specification
PCC	Point Of Common Coupling
PFC	Primary Frequency Control
PLL	Phase-locked Loop
PMU	Phasor Measurement Unit
PPVC	Post-Primary Voltage Control
PV	Photovoltaic
PVC	Primary Voltage Control
PWM	Pulse-width Modulation
RES	Renewable Energy Sources
RMS	Root Mean Square
ROCOF	Rate Of Change Of Frequency
RR	Replacement Reserves
SCADA	Supervisory Control And Data Acquisition

Abbreviation	Meaning
SFC	Secondary Frequency Control
SGAM	Smart Grid Architecture Model
SGS	Speed Governing System
SOC	State Of Charge
SRPS	Single Reference Power System
STATCOM	Static compensator
SVR	Secondary Voltage Regulator
TFC	Tertiary Frequency Control
TN	Transmission Network
TSO	Transmission System Operator
TVC	Tertiary Voltage Control
VSC	Voltage Source Converter
VSG	Virtual Synchronous Generator
VSYNC	Frequency support and stabilisation by Virtual Synchronous Generators

## Table of contents

Executive summary.....	6
1 Terminologies.....	8
1.1 Definitions.....	8
1.2 Abbreviations.....	9
2 Introduction and scope.....	18
2.1 WP5 “Increased Observability” .....	18
2.2 Objective of this report.....	19
2.3 Relation to other tasks .....	19
2.4 Assumptions and Limitations of the Study.....	20
2.5 Outline of the report / Reading Guide.....	20
3 Methodology .....	21
4 Observability Fundamentals.....	22
4.1 Definition of Observables in grid control context .....	22
4.2 Basic definitions.....	22
4.2.1 Physical System .....	22
4.2.2 System State .....	23
4.2.3 Observable .....	23
4.2.4 Forecast (“Prediction”) .....	23
4.2.5 Measurement (“Observation”).....	23
4.3 Working definitions for quality parameters .....	23
4.3.1 Observability.....	23
4.3.2 Predictability .....	24
4.3.3 Controllability .....	24
4.3.4 Frequency Control Example.....	25
4.4 Observables Inventory Survey .....	26
4.4.1 Basic Control System.....	26
4.4.2 Control Triples .....	27
4.4.3 Control Levels.....	28
4.4.4 Workflow of the Survey .....	29
4.4.5 Resulting Control Triples.....	30
5 Single Reference Power System.....	33

5.1	Challenges in power system description .....	33
5.2	Single Reference Power System (SRPS).....	33
5.3	SRPS description examples.....	34
5.3.1	CIGRE .....	34
5.3.2	IEEE .....	35
5.4	Advantages.....	35
6	Selection and Development of Use Cases .....	36
6.1	Summary and interpretation of the main findings in ELECTRA R3.1 and D3.1 reports....	36
6.1.1	Existing practices and future challenges .....	36
6.1.2	Introduction of the ELECTRA scenario .....	37
6.1.3	Main finding in D3.1: Introduction of cell-based architecture .....	39
6.2	Architectures and ancillary services for future networks.....	40
6.2.1	Conclusions and interpretation of results .....	42
6.3	Information Exchanges in the Future Control Schemes .....	43
6.3.1	Information Exchanges in the Future Control Schemes based on centralised architecture.....	43
6.3.2	Information Exchanges in the Future Control Schemes based on decentralised architecture.....	56
6.3.3	Summary of conclusions drawn from Use Cases in R3.1 and D3.1 .....	70
7	Identification of observability needs .....	71
7.1	Principal requirements for the Power System .....	71
7.2	The existing observability practices (Survey) .....	71
7.3	Limitations of the existing practices.....	74
8	Observables and their parameters .....	75
8.1	Physical requirements for the observables.....	75
8.2	Descriptive observable parameters.....	76
8.3	Mapping of observability needs to physical requirements .....	76
8.4	Mapping of observability needs and requirements .....	78
8.4.1	Primary frequency control .....	78
8.4.2	Primary voltage control .....	79
8.4.3	Secondary frequency control .....	81
8.4.4	Secondary voltage control .....	82
8.4.5	Tertiary frequency control .....	83
8.4.6	Tertiary voltage control .....	86

8.5 Conclusions drawn from mapping of observability needs and requirements ..... 89

9 Conclusions ..... 90

9.1 The main concepts for the succeeding activities in WP5..... 90

9.2 Similar observables in two different functional architectures ..... 90

9.3 Present observability practices are not adequate for the expected transformation of the power sector..... 90

9.4 Growth of RES and use of DR schemes create new observability needs..... 91

9.5 Summary of observables identified in the different studies..... 91

10 References..... 93

11 Annex I Observability Fundamentals ..... 95

11.1 Print of Observables spreadsheet..... 95

11.2 Observables Inventory spreadsheet..... 96

11.3 Webinar-Observables Inventory Survey..... 96

12 Annex II Overview over relevant projects ..... 97

12.1 EcoGrid EU..... 97

12.1.1 Full project name ..... 97

12.1.2 Description..... 97

12.1.3 Work specifically relevant for WP5..... 98

12.1.4 References and Relevant Documents..... 98

12.2 SYNC Project..... 98

12.2.1 Full project name ..... 98

12.2.2 Description..... 98

12.2.3 Work specifically relevant for WP5..... 102

12.2.4 References and Relevant Documents..... 102

12.3 Demand as frequency controlled reserve..... 104

12.3.1 Full project name ..... 104

12.3.2 Description..... 104

12.3.3 Work specifically relevant for WP5..... 105

12.3.4 References and Relevant Documents..... 105

12.4 CCPP ..... 105

12.4.1 Full project name ..... 105

12.4.2 Description..... 105

12.4.3 Work specifically relevant for WP5..... 106

12.4.4 References and Relevant Documents..... 106

12.5	STRONGrid .....	106
12.5.1	Full project name .....	106
12.5.2	Description.....	107
12.5.3	Work specifically relevant for WP5.....	107
12.5.4	References and Relevant Documents.....	107
12.6	Nikola .....	108
12.6.1	Full project name .....	108
12.6.2	Description.....	108
12.6.3	Work specifically relevant for WP5.....	109
12.6.4	References and Relevant Documents.....	109
12.7	ESVM .....	109
12.7.1	Full project namehttp:///h .....	109
12.7.2	Descriptionhttp:///h.....	110
12.7.3	Work specifically relevant for WP5http:///h.....	110
12.7.4	References and Relevant Documentshttp:///hhttp:///h .....	110
12.8	OPTIMATE .....	111
12.8.1	Full project name .....	111
12.8.2	Description.....	111
12.8.3	Work specifically relevant for WP5.....	111
12.8.4	References and Relevant Documents.....	111
13	Annex III ENTSO-E frequency control requirements.....	112
14	Disclaimer .....	114



## List of figures

Figure 4-1 Relation between input signal and observable signal for a basic physical system model. Please note that the division in collections of potential states is not a spatial division, but a Venn diagram of collections. ....	22
Figure 4-2 Example of a basic frequency control system .....	25
Figure 4-3 Basic control system in the electric grid. A grid will contain multiple basic control systems. ....	27
Figure 4-4 Workflow of the Survey .....	30
Figure 5-1 Single Reference Power System and its potential representation formats.....	34
Figure 5-2 Hierarchy for identifying DER integration benchmarks (From: CIGRE report reference [12]) .....	34
Figure 6-1 ELECTRA vision of the decentralized electricity network. Source: [6] .....	37
Figure 6-2 Operation vertical integration. Source: [6] .....	38
Figure 6-3 Decentralized local control. Source: [6] .....	39
Figure 6-4 Example of cell architecture: Source D3.1 [6].....	40
Figure 6-5 Sequence diagram for frequency containment control. Source: [6] .....	44
Figure 6-6 Sequence diagram for secondary frequency control. Source: [6] .....	46
Figure 6-7 Sequence diagram tertiary frequency control. Source: [6] .....	48
Figure 6-8 Sequence diagram primary voltage control. Source: [6] .....	50
Figure 6-9 Sequence diagram tertiary voltage control. Source: [6] .....	53
Figure 6-10 Comparison of observables for different controls .....	56
Figure 6-11 Inertia control cell. Source: [11].....	58
Figure 6-12 Activate inertia. Source: [11] .....	59
Figure 6-13 Optimize inertia control cell. Source: [11] .....	60
Figure 6-14 Inertia control plant. Source: [11] .....	60
Figure 6-15 Inertia control unit. Source: [11] .....	61
Figure 6-16 FCC control cell. Source: [11] .....	62
Figure 6-17 posFCC activation. Source: [11].....	63
Figure 6-18 FCC unit. Source: [11] .....	63
Figure 6-19 Comparison of observables for different decentralised control types.....	70
Figure 8-1 Observables for different control types.....	89
Figure 9-1 Overview of observables from the different studies.....	92
Figure 12-1 EcoGrid EU New real-time market concept within the existing timeline. Source: EcoGrid EU.....	97
Figure 12-2 VSG operating principle. ....	99

---

Figure 12-3 Power histogram of a 10 kW ideally frequency-following VSG, calculated for 10 April 2008 (24 hrs, sample time 4s).....	99
Figure 12-4 Frequency oscillations 35kW generator, a) without VSG, b) With VSG only inertia emulation operational.....	101
Figure 12-5 Set-up and preliminary results – island operating mode, running the VSG algorithm, frequency reference: 50 Hz.....	101
Figure 12-6 Topology of the Cell.....	106
Figure 12-7 Categories of services in the Nikola project.....	108
Figure 12-8 Reference network of the iPower project.....	110

## 2 Introduction and scope

The European Union has defined several ambitious climate and energy targets including 20-20-20 [14]:

- A 20% reduction in EU greenhouse gas emissions from 1990 levels
- Raising the share of EU energy consumption produced from renewable resources to 20%
- A 20% improvement in the EU's energy efficiency and the 2050 decarbonisation roadmap [15].

Achieving these goals will require a major transfer from conventional generation to Renewable Energy Sources (RES) on different scales, from offshore wind farms to small-scale PVs, feeding into networks on various voltage levels.

### 2.1 WP5 “Increased Observability”

Great challenges are anticipated for the secure operation of the future power system, in connection with the foreseen transition from centralised to decentralised generation. Implementation of novel control strategies will enhance flexibility of the power system enabling it to accommodate a broad spectrum of decentralised and intermittent (renewable) energy sources in order to provide sustainable and economical supply of electricity. Description of energy mix futures scenarios in Europe was provided in [6]. Accommodation of intermittent generation into the network and its reliable operation requires a gradual evolution of the network structure and in particular improvement of its control, monitoring or observing. Adequate observability of the system operating state is a requirement for a reliable and secure supply of electricity.

Monitoring of the electricity network in the past was limited both by the lack of capable ICT technologies in combination with the fact that operation of the conventional vertical "downfall" power system did not necessarily require excessive monitoring, especially in the distribution network. Development of ICTs and integration of these as a new layer into the electricity network, also known as smart grids, will diminish the technical limitations and improve the system observability.

As an input, these control strategies will require a whole new class of system observables in order to suffice the required awareness needed for future system operation and control. To take into consideration the investment cost of the IT infrastructure, the flow and the amount of data to be exchanged and their practical implementation having clearly defined which parameters exactly need to be observed and measured.

The main objective of WP5 "Increased Observability" is therefore to develop and implement adequate concepts and methods for sufficiently observing the state of the future power system for the three axes:

- Pan-European
- Vertically integrated
- Local (Horizontal/ Distributed)

The suggested observability schemes will be implemented in a generic lab platform programmable in an advanced language (Matlab, SciLab or similar). The concrete programming environment will be defined and harmonised among the partners in course of the IRP.

WP5 includes the following tasks:

- T5.1: Adaptive assessment of future scenarios and mapping of observability needs
- T5.2: Observables for Distributed Local Control Schemes
- T5.3: Observables for Vertical Control Schemes
- T5.4: Observables for Pan-European Control Schemes
- T5.5: Comparative analysis and enabling global level design

The present report is the result of T5.1. The design and implementation of the various monitoring systems will be done in the succeeding tasks T5.2, T5.3 and T5.4.

## 2.2 Objective of this report

WP5 “Increased Observability” deepens on the concept of observability of the power system with the main aim of increasing the power network control. T5.1 is the first task in WP5, which is meant to:

- Analyse the scenarios and settings regarding operation of the future power system from WP3 “Scenarios and case studies for future power system operation”
- Narrow the scope of the research for the succeeding tasks in WP5
- Derive particular observability needs required by the future power system

At this stage the task does not specifically consider spatial limitations of the scope i.e. how deep into power system the measurements should be done. This will be defined later in the WP, based on quantifiable definition of technical requirements for the observability needs.

## 2.3 Relation to other tasks

According to the project's Description of Work (DoW) T5.1 has several interactions with other tasks during its course. The main inputs, which have been used during development of the present report, are presented in the next Table 2-1.

**Table 2-1 Inputs for Task 5.1 from other tasks**

Task info	Delivery Month	Content of interest for T5.1
T3.1 Futures identification and analysis of requirements	M6 (R3.1) May 2014	R3.1 Problem Description: specification of the requirements for the overall Smart Grid voltage and frequency control.
T3.2 Functional specification for future power system operation	M12 (D3.1) Dec 2014	D3.1 Specification of Smart Grids high level functional architecture for frequency and voltage control  (business layer descriptions of the proposed solutions)
T3.3 (IPE) Market Design	M04 >>	Functional specification of e-market environment Assessment of different e-market models  E-market design for ancillary services to provide market-based management and operation of local and global system parameters

Task info	Delivery Month	Content of interest for T5.1
T4.1 (RSE) Definition of methodology for the specification of functional architectures	M12 (R4.1) Dec 2014	R4.1 Description of the SGAM methodology Task 4.1 is meant to describe this methodology, educate the various partners about the use of it and agree on the overall methodology to follow during the detailed specification phase.
Task 4.2 (VITO) Specification of the functional architecture of systems of the smart grid stakeholders by interworking with WP3, WP5, WP6	M05 >>	T4.2.2: Interworking with WP5 and WP6 for monitoring and control functions specification WP4 will give methodological support to WP5 and WP6 in the definition of use cases for the improvement of observability and controllability of the power system.

## 2.4 Assumptions and Limitations of the Study

The overall objective of the ELECTRA project in a nutshell is to develop radically new control solutions towards 2035 and beyond. Expectations and scenarios for a future with so remote time horizon will inevitably contain a substantial share of uncertainty. Even though the task has tried to mitigate the overall uncertainty relating to the publically available roadmaps for the close future, as for example [5] it is still necessary to make several assumptions in order to handle the future uncertainties. With reference to the future time scale and in order to point out the uncertainties, the following main assumptions have been made:

- **The identified observability needs may not all be met in the project.** This means that the present report will not be limited, by identifying observability needs, which are obviously achievable. Some of the identified observability needs may not be met in the course of the project but nonetheless are expected to be achievable in due time.
- **Technology limitations are not important.** Considering rapid development during the recent years in technologies such as communication or computation and the long time horizon, the task decided to consider, but not to limit itself, to the present technologic limitations.
- **Cost limitations are not important.** Technological advancement normally leads to significant cost reductions. Therefore the task has chosen to consider, but not limit itself, to the present costs limitations (at least within reasonable limits).
- **Potential conflicts between different control schemes are not important.** These are planned to be addressed more specifically in WP6 "Controllable Flexibility" according to the project's DOW. Therefore the present task does not omit any control schemes due to potential conflicts between these.

## 2.5 Outline of the report / Reading Guide

The document starts with a short introduction of report's scope, main objectives and questions to be addressed in Sections 2.1 and 2.2.

In order to give a better understanding of the task's approach, the document explains in Section 2.3 relation to other tasks in the project and more specifically refers to documents, which are used

as input to this study. It is reasonable to expect that scenarios for a future with so remote (2035-2050) time horizon will inevitably contain a substantial share of uncertainty. Several important assumptions were made in Section 2.4 in order to mitigate this uncertainty.

Two succeeding Sections 4 and 5 introduce concepts and definitions, which are essential for the course of whole WP5 "Increased Observability". More specifically, Section 4 "Observability Fundamentals" presents the key formal definitions and concepts for observability and control triples. Following these definitions, the chapter further presents results of the Inventory Survey, which identified more than 20 existing and experimental control triples. Section 5 introduces a concept of Single Reference Power System and its advantages.

Section 6 in the report summarises and interprets two main inputs to the document from WP3. These outputs describe high level functional architecture for the future centralised and decentralised control systems.

The following Section 7 reminds principal requirements for the future power system and proceeds to overview of the existing observability practices, based on a limited survey, which was conducted in eight European countries. The section makes several conclusions pointing out that the existing observability practices are not sufficient in meeting needs of the future power system.

Finally Section 8 proposes a set of physical requirements, which are applicable for the observables and proceeds to a new additional and deeper qualitative evaluation resulting in a set of observability needs with corresponding technical requirements.

### 3 Methodology

In the scope of the present task use of the methodologies has been twofold:

- The major part of the report is based on classical electrical engineering as for example [2] and [16].
- The second part of this report is based upon the use-case methodology as described in reference [8]. The activity has further used methodology, specifications and guidelines for power system domain experts, which is explained in Intelligrid's Publicly Available Specification (PAS) [9]
- The study also includes a simple questionnaire-based survey in order to collect information about the present observability practices.

## 4 Observability Fundamentals

In this chapter guidelines are described for choosing well defined observables that in practice can be used to serve control aims in the future electric grid.

The work in this chapter is to be continued, used and improved in the next WP5 tasks. It is a first start, and by no means meant as a final project result.

### 4.1 Definition of Observables in grid control context

In this paragraph some basic definitions for observables in a physical (electric) system are given. Based on that, a few working definitions for quality parameters of observables are defined.

These are to be used as guidelines to choose well defined observables for the electric system that are of practical use.

### 4.2 Basic definitions

#### 4.2.1 Physical System

In the next figure the basic relation between input signal and observable signal for a physical system is depicted. The next system description is based on a physical model to be chosen appropriately for the grid control problems to be solved.

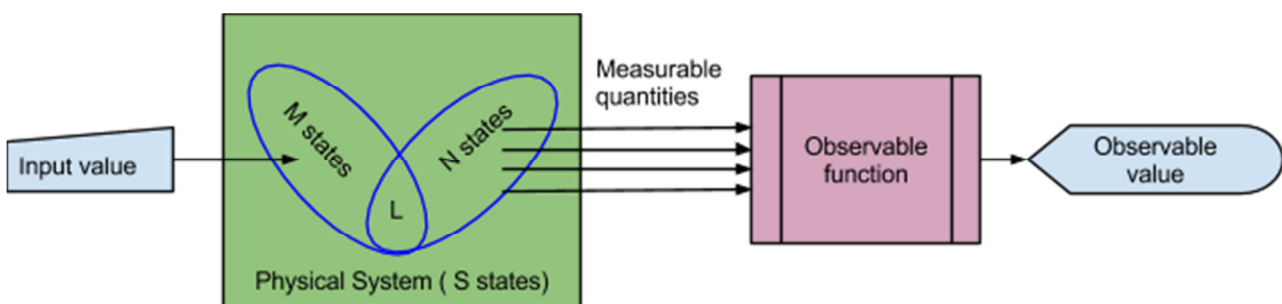

**Figure 4-1 Relation between input signal and observable signal for a basic physical system model. Please note that the division in collections of potential states is not a spatial division, but a Venn diagram of collections.**

Explanation of the diagram:

- A certain physical system model contains S states.
- A certain input value to the system model influences M system states.
- The observable function is a calculated function of a number of measurable quantities, which in turn depend on N system model states.
- The cross section of the collections of M states and N states contains L system states. These L states are both influenced by the input value, and contribute to the observable value.

## 4.2.2 System State

A system state is defined as a collection of numbers completely describing the system model at a certain time (“snapshot”).

- The actual system state is one element of the collection of S possible states.

## 4.2.3 Observable

An observable is a uniquely valued function of a number of measurable quantities in a physical system model.

- An observable can either be a scalar or vector (“State Vector”) that relates to measured (observed) values in the present or past.
- An observable is calculated from measurements in the system.

*Example:*

*The RMS value of an AC voltage is an observable., and so is the complex representation of an AC voltage. Both are computed or derived from an actual measured voltage as a function of time. The RMS voltage is a scalar, and the complex voltage is a vector.*

With “**actual value**” of an **observable** we mean "derived from a time interval ranging from a certain time in the past till now".

To be precise, "actual value" does not exist in its exact sense. When we use the word that moment has already passed and the value may differ.

## 4.2.4 Forecast (“Prediction”)

- Forecasts can be used to improve existing feedback control loops (“Predictive Control”)

## 4.2.5 Measurement (“Observation”)

Source: IEEE Standards Dictionary [10]

*The raw data acquired by executing a test procedure.*

*It represents the:*

- *observed characteristics of a specific signal (e.g., the voltage peak of a sinusoid waveform),*
- *the observed characteristics of the environment (e.g., the ambient temperature),*
- *or the derived value of product characteristics (e.g., the measured value of gain).*

A “test procedure” could also be named “measurement”.

## 4.3 Working definitions for quality parameters

Quality parameters can be used to make an assessment of the quality of observables, system input signals, and the extent to which a system input signal can influence an observable in order to serve a control aim (set point for the observable). These can be based on the basic definitions in the previous paragraph.

### 4.3.1 Observability

- N is the number of possible states of a physical system model that corresponds to one observable value at a certain time.



Then the observability  $O$  is the inverse of  $N$ :

#### Equation 1 Observability

$$O = \frac{1}{N}$$

*In case one observable value corresponds to very many system states  $N$ , then we do not know anything about the actual state of the system model, and  $O$  approaches zero.*

*In case one observable correspond to exactly one system state, then we know everything about the system model and  $O$  is one.*

*In reference [22] the notion of [mathematical observability](#) is defined as the system being either “completely observable” or “unobservable” (0 or 1) with nothing in between.*

*As this is not suitable for a quality parameter, we try here to make a working definition that gives a quality parameter ranging from 0 to 1 (or: 0% to 100%).*

*Other ways to form an observability definition in a range instead of “completely observable” or “unobservable” will be explored in the follow-up tasks of the project.*

#### 4.3.2 Predictability

- $M$  is the number of possible states of a physical system model that corresponds to one physical input value at a certain time.

Then the predictability  $P$  is the inverse of  $M$ :

#### Equation 2 Predictability

$$P = \frac{1}{M}$$

*In case one physical input value corresponds to very many system states  $M$ , then we cannot predict anything about the actual state of the system, and  $P$  approaches zero.*

*In case one physical input value corresponds to exactly one system state, we know the exact system state and  $P$  is one.*

#### 4.3.3 Controllability

- $L$  is the number of possible states that the collections of  $M$  and  $N$  have in common.

Then the controllability  $C$  is the fraction of states that the collections of  $M$  and  $N$  together have in common:

#### Equation 3 Controllability

$$C = \frac{L}{M + N - L}$$

*In order to make a closed control loop, there must be a fraction of system states that the physical input value and the observable have in common.*

When this fraction is zero, the physical input signal cannot influence the observable and the system cannot be controlled.

When this fraction is one, the physical input value has a one-to-one relationship with the observable value, and the system can be controlled without any deviation.

### 4.3.4 Frequency Control Example

In order to clarify the System States approach for the physical grid, in the next Figure 4-2 a practical example of a basic frequency control system is depicted.

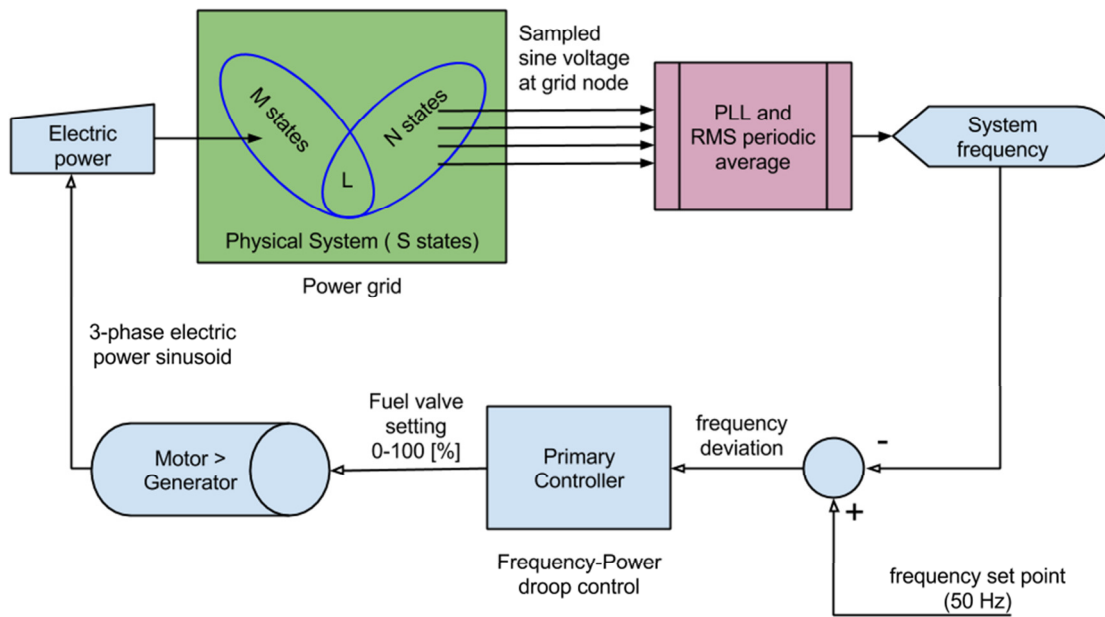

**Figure 4-2 Example of a basic frequency control system**

We consider constant generator voltage. Now the electric power of the 3-phase generator influences voltage level, current level, and sine wave frequency at all branches and nodes.

- The measurement is the sampled sine wave voltage at the connection point<sup>1</sup> of the generator.
- The observable derived from this voltage is the system frequency.
- The preserved relation between the input electric power from the motor/generator and the output sinusoidal voltage is that the frequency of the electric power sine wave in each electrical phase is twice that of the voltage sine wave. This holds for all possible stationary system states, so  $M=L=N \gg 1$ . That leaves  $(S-M)$  possible non-stationary states that do not show sinusoidal waveforms.

Next we can make an assessment for Observability, Predictability and Controllability in Table 4-1.

<sup>1</sup> The voltages of many grid nodes are available, of which only this one is used.

**Table 4-1 Assessment for Observability, Predictability and Controllability**

<b>Output:</b>	Observability	$O=1/M \ll 1$	The output system frequency does not give us reliable information about the actual system state (collection of actual voltages, currents at system frequency).
<b>Input:</b>	Predictability	$P=1/M \ll 1$	The frequency of the electric power input does not determine in a reliable way the actual system state (collection of actual voltages, currents at system frequency).
<b>Throughput:</b>	Controllability	$C= 1$	But the system frequency is fully known and controllable.

While the system state is not observable from frequency, and not predictable from power input, the system frequency is highly controllable because frequency is a conserved property.

## 4.4 Observables Inventory Survey

In the next paragraphs a short description of the structure and outcome is given of a survey on existing and potential observables in the electric grid.

### 4.4.1 Basic Control System

In the next figure a basic control system in the electric grid is depicted. In general a grid will contain a number of basic control systems that work automatically or are used by system operators in a control room.

Voltages, currents and temperatures are measured in a grid and stored temporarily for data collection. By processing the data with some algorithm an observable is calculated, that is a measure for a certain property (“Observable”) of the grid considered.

Now this property can be controlled by feeding the difference of a set point for that property and the observed one to a controller. The controller transfers this difference to a system input signal that drives a change in the measured values, and hence the observable. The transfer function of the controller is to be chosen such that in a limited time a near-zero difference is reached where the observed value equals the set point.

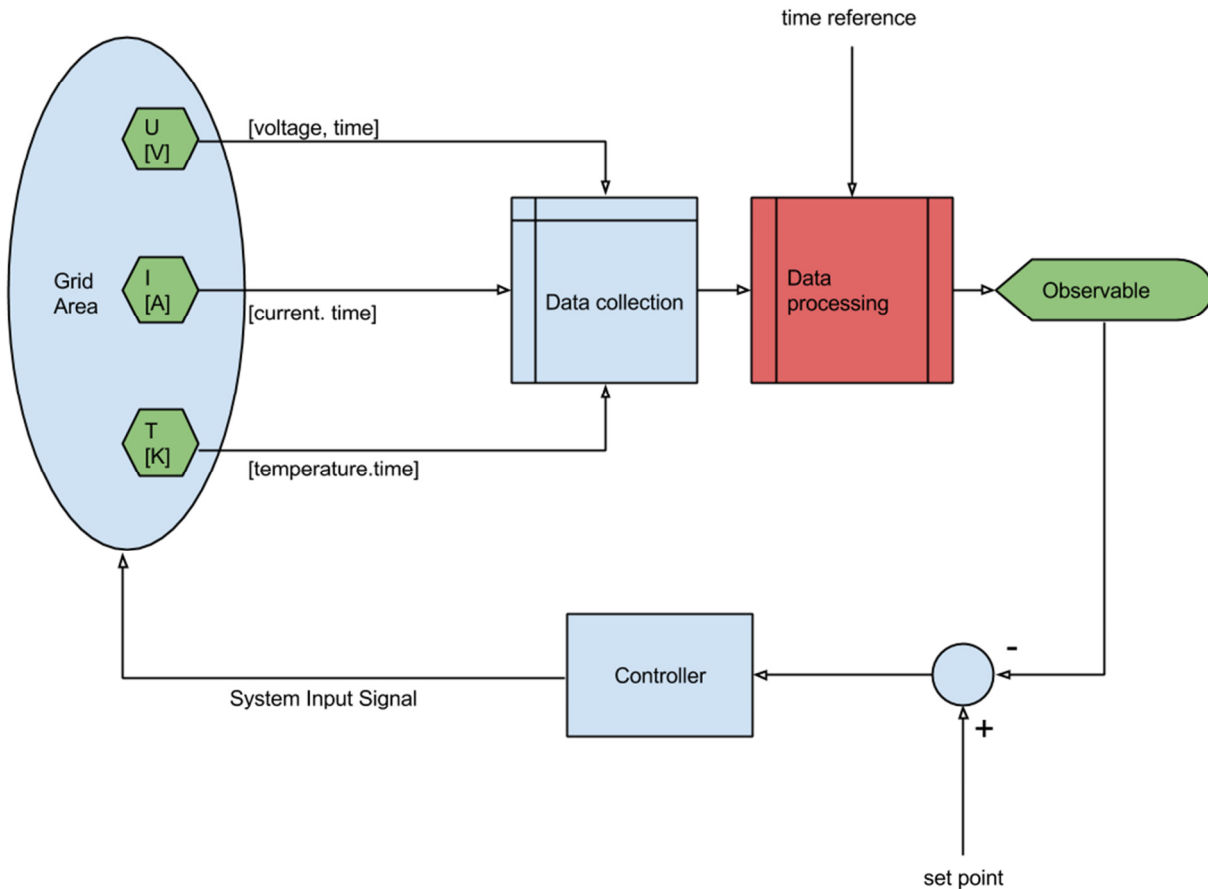

**Figure 4-3 Basic control system in the electric grid. A grid will contain multiple basic control systems.**

### 4.4.2 Control Triples

The Survey is built around the notion that every working control loop must have a set of three elements:

1. Control Aim
2. Observable
3. System input signal

In the remainder such a set is called a “**Control Triple**”.

In the following project Tasks the algorithm for calculating an observable will be added to the set, as this is necessary to make a control loop that can be implemented and tested, thereby expanding a certain Control Triple to a number of potential quadruples.

This is not covered in the work of this Deliverable, as we only make a first inventory by Control Triples. However, the existence of such algorithms is included in the definition of the Observable in the previous paragraph. It is not specified in detail and not mentioned explicitly here, because we want to keep open the possibility of calculating one and the same observable in different ways in the follow-up tasks.

The aim of the Survey is then to find as many Control Triples as possible for an electric system.

These Control Triples are to be used later as a reference to fulfil the Control Aims that are defined by Use Cases defined in the project.

### 4.4.3 Control Levels

In an effective control loop the elements of its control triple must work together on the same characteristic timescale. Therefore a classification of control triples can be made that is based on timescale.

In the classical grid already a division by timescale is made in the so-called primary, secondary and tertiary control of system frequency. This division is derived from the system deployment time of its response and its control loops to switching events. This deployment time is further called the **Transition Time**, which is defined here as:

<b>Transition time:</b>	"Time for system response or system control loops to complete the transition from a stationary system state to the next stationary one, after a switching event occurs."
-------------------------	--

A "switching event" refers to any electrical connection in the system being opened or closed, either planned, deliberate (device on/off) or involuntary (short-circuit), thereby putting the system in an unbalanced state for power, frequency and voltage.

Next the system response of and the control loops in the system determine how long it takes to restore the balanced state power, frequency and voltage, as well as to optimise the use of system resources.

In order to make a division that is compatible with the classical grid frequency control loops, the Control Levels<sup>2</sup> in the next table are chosen by Transition Time.

**Table 4-2 Transition times and control levels**

Control Level	Transition time [s]	Corresponding Classical Control Level
<b>0.System response</b>	5	0.Inertial response
<b>1.Primary Level</b>	30	1.Primary control
<b>2.Secondary Level</b>	120	2.Secondary control
<b>3.Tertiary Level</b>	900	3.Tertiary control

For the purpose of this project, a summary of definitions of relevant time quantities is given in the next table.

---

<sup>2</sup> Although, some voltage controls, like the automatic voltage regulator on generators, generally act on a faster time scale than the frequency controls, we classify the voltage controls according to the same control levels. The rationale being that the transition times are an upper bound.

**Table 4-3 Definitions of time quantities**

<b>Transition time</b>	Time for system response or system control loops to complete the transition from a stationary system state to the next stationary one, after a switching event occurs.
<b>Dead time</b>	Time difference between switching event and noticeable system response or system control loop response.
<b>Time resolution</b>	Maximum sample duration in order to capture a response to a switching event in ample details.

#### 4.4.4 Workflow of the Survey

The workflow of the Survey is depicted in the next figure.

It starts by making separate lists for known and potential control aims, observables and system input signals. So these have no relation yet.

Next each of the lists are divided according to Control Level. So for each Control Level there are three independent lists of potential control aims, observables and system input signals

In the last step, for each Control Level, meaningful Control Triples are chosen from the three independent lists of control aims, observables and system input signals.

Now for each Control Level a set of meaningful Control Triples results.

In order to correct the initial independent lists of control aims, observables and system input signals where necessary, two feedback loops are integrated in the process:

1. A review by Control Level, where a check is done whether all known control aims, observables and system input signals are listed and are compatible with the transition time by which the Control Level is defined.
2. A review by Control Level, where a check is done whether all known Control Triples are listed that can be formed from the independent lists of control aims, observables and system input signals.

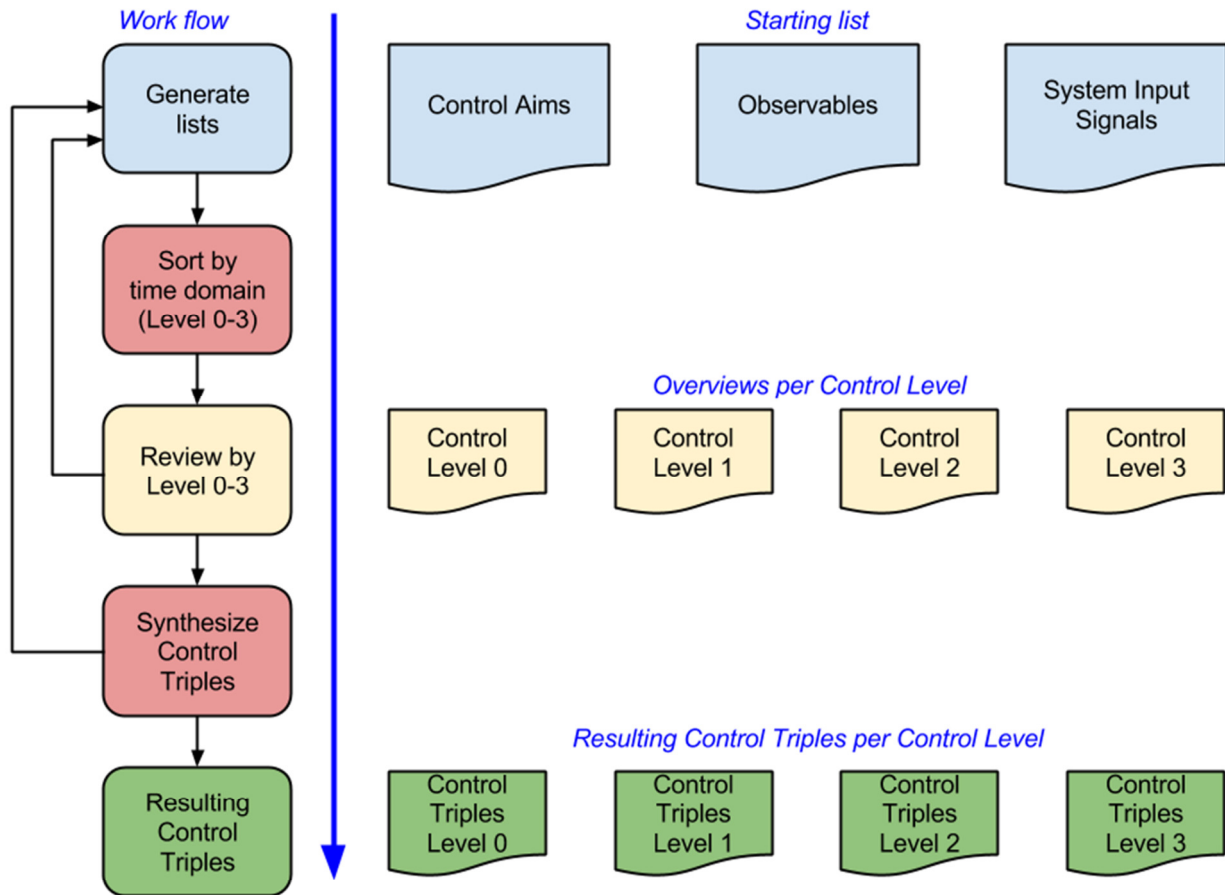

**Figure 4-4 Workflow of the Survey**

#### 4.4.5 Resulting Control Triples

In order to smooth the process, the workflow shown is used in an automated spreadsheet. A printout of this spreadsheet is shown in “Annex I, Observability Fundamentals.”

In the next tables, the preliminary results are shown for the four Control Levels:

1. System response
2. Primary Level
3. Secondary Level
4. Tertiary Level

The Control Triples have been chosen from existing practice or result from research projects referred to in the spreadsheet. In the next tables, the exact measurement and calculation method for the observable is not specified as this can be done in multiple ways, that will be worked out by the following project Tasks with an "open mind".

**Table 4-4 Control Level Summary - 0.System response (5 s)**

Control Triples - 0.System response (5 s)			
Nr.	Control Aim	Observable [unit]	System Input Signal [unit]
1	Minimise current distortion [A]	Actual branch current [A]	Injected current [A]
2	Minimise (stationary) frequency fluctuations [Hz]	Actual node voltage [V]	Inertia response power [W]
3	Minimise (stationary) voltage fluctuations [V]	Actual node voltage [V]	Injected current [A]
4	Secure transient frequency stability [Hz]	Actual branch current [A]	Inertia response power [W]

**Table 4-5 Control Level Summary - 1.Primary Level (30 s)**

Control Triples - 1.Primary Level (30 s)			
Nr.	Control Aim	Observable [unit]	System Input Signal [unit]
1	Minimise current deviations [A]	Branch current phasor [A]	Fast storage active and reactive power [VA]
2	Minimise frequency deviations [Hz]	Frequency [Hz]	Active power of Synchronous Generator [W]
3	Minimise reactive current [A]	Complex power [VA]	Capacitor storage reactive power [VA]
4	Minimise voltage deviations [V]	Node voltage phasor [V]	Reactive power of Synchronous Generator [VA]
5	Secure power transmission [W]	Node voltage phasor [V]	Reactive power of Synchronous Generator [VA]
6	Minimise frequency deviations [Hz]	Frequency [Hz]	On off signal of electrical appliances [0/1]
7	Optimise microgrid energy production with storage devices [Wh]	Real Power [W]	Active power of non-rotating generator [W]

**Table 4-6 Control Level Summary - 2.Secondary Level (120 s)**

Control Triples - 2.Secondary Level (120 s)			
Nr.	Control Aim	Observable [unit]	System Input Signal [unit]
1	Bring frequency back to its set point [Hz]	Frequency [Hz]	Active power set point of generators participating in secondary control [W]
2	Enhance voltage stability [V]	Voltage error at pilot nodes [V]	Set point of AVR's of generators [V]
3	Secure power balance by generation [W]	Tie line power flows [VA]	Active power set point of generators participating in



Control Triples - 2.Secondary Level (120 s)			
Nr.	Control Aim	Observable [unit]	System Input Signal [unit]
			secondary control [W]
4	MV-LV transformer and lines overloads mitigation [W]	Current flowing in the MV-LV transformer [A]	P,Q setpoint to DER [W,VA]
5	LV network phase balancing via controllable DER connected through a PWM inverter [1,2,3]	Current flowing in the MV-LV transformer [A]	P,Q setpoint to DER [W,VA]
6	LV overvoltages management via reactive dispatch of DER in LV network [VA]	1 min averaged voltage at the end of the feeder [V]	P,Q setpoint to DER [W,VA]
7	LV network phase balancing via EV [1,2,3]	1 min averaged voltage at the customer premises [V]	EV charging phase number [1,2,3]
8	LV overvoltages management via OLTC MV-LV trafo [V]	1 min averaged voltage at the end of the feeder [V]	OLTC setpoint [0-9]

**Table 4-7 Control Level Summary -3.Tertiary Level (900 s)**

Control Triples - 3.Tertiary Level (900 s)			
Nr.	Control Aim	Observable [unit]	System Input Signal [unit]
1	Follow day-ahead generation profile [W]	Secondary reserve power [W]	Start-up of generators participating in tertiary control [0/1]
2	Prevent over-heating of lines or cables (limit temperate) [K]	Core temperature of line or cable [K]	Switch off industrial loads participating in tertiary control [0/1]
3	Reduce deviation from forecasted optimal voltage values [V]	Estimated voltage at pilot nodes [V]	Set point of SVRs (Secondary Voltage Regulator) [V]
4	Prevent over-heating of transformers (limit temperate) [K]	Core temperature of transformer [K]	Switch off distribution station fields [0/1]

## 5 Single Reference Power System

Often in a grid project a power system model is chosen to test some theory or to check some field test result. In order to work efficiently with such a power system model, inconsistent or obsolete information has to be avoided and validation checks should be meaningful.

### 5.1 Challenges in power system description

When one wants to describe a power system that is used in a system study, then next three challenges are faced:

- 1) Keep power system description consistent over different:
  - a) reporting formats
  - b) software implementations
- 2) Multiple reporting formats for each software implementation
  - a) Topology schematic
  - b) Parameter listing
  - c) Readable text
  - d) et cetera
- 3) Problematic translations of specific software implementations to other software
  - a) Powerfactory
  - b) SimPowerSystems (Matlab)
  - c) PSCAD
  - d) NEPLAN
  - e) et cetera

Most of the problems mentioned arise from trying to keep the information content one type of information about the system exactly the same as any other type of informations. This implies that one can translate information between representations of the power system in both directions. And this in general is not feasible, as the information content can range from generic to very specific and even contradicting in different representations.

In this chapter a way to resolve these problems is proposed.

### 5.2 Single Reference Power System (SRPS)

In the next picture a unidirectional workflow is shown where all information presented in some format is derived from one and the same generic description of the power system at hand.

The aim is to avoid contradicting or obsolete information in:

- Reporting formats
- Software implementations

Examples of these are:

1. inconsistent reporting formats
2. incompatible translation between different software implementations of the same physical power system

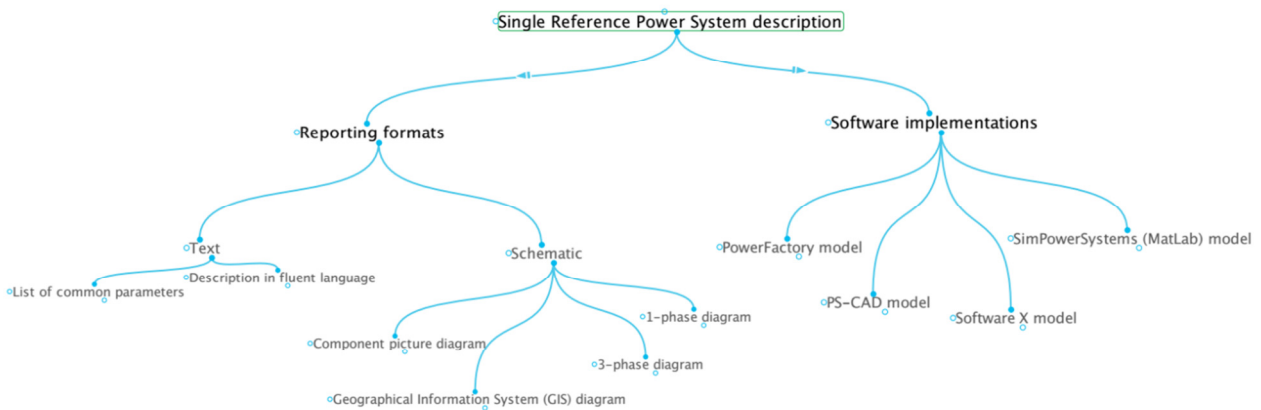

**Figure 5-1 Single Reference Power System and its potential representation formats.**

The unidirectional workflow proposed resolves most of the challenges mentioned in the previous paragraph.

### 5.3 SRPS description examples

#### 5.3.1 CIGRE

CIGRE has made a publication named “Benchmark Systems for Network Integration of Renewable and Distributed Energy Resources” [12]. This benchmark system:

- Test systems that facilitate the analysis and validation of developed methods and techniques.
- An electric power system is described by its underlying network structure and the resources connected to its nodes.
- Benchmarks for DER integration with HV Transmission, MV Distribution and LV Distribution are considered.
- Each benchmark is distinguished between European and North American versions.

The system is based on the hierarchy in system elements portrayed in the next picture.

The underlined items indicate the benchmarks:

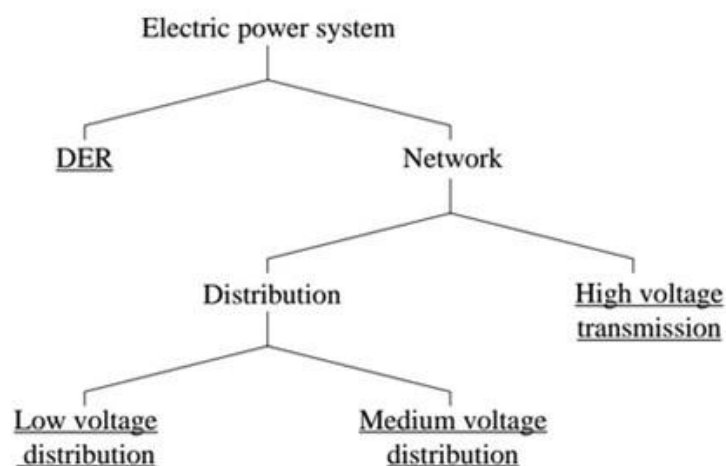

**Figure 5-2 Hierarchy for identifying DER integration benchmarks (From: CIGRE report reference [12])**

As the key driver of this benchmark is distributed energy resource (DER), first a division is made between the network and DER connected to it. So the conventional synchronous generators, OLTC, network breakers, et cetera are all considered to be part of the “Network”.

Next the network is divided in the classical way according to Distribution and Transmission. Finally distribution is divided into its voltage levels MV and LV.

Only the network benchmark options are covered in the figure. So one could add either a local or a coordinated control structure to a specific benchmark.

### 5.3.2 IEEE

IEEE PES has posted several examples of Distribution Test Feeders online [23], among which:

- Radial Distribution Test Feeders [25]
- n-bus feeders (several)
- EPRI test circuits
- EPRI Distribution System Simulator
- et cetera

## 5.4 Advantages

The advantages of a unidirectional information flow are as follows:

- The SRPS has only to be made once for a chosen power system model
- Easier implementation for each software chosen.
- No problematic software translations
- Partners do not have to use the same software.
  - Simulation results must compare, however
- For each reporting format only one document.
  - Customised reports for the Project Officer

In this concept a set of common definitions and rules for power system description and simulation can be established that enables all partners to cooperate effectively while avoiding redundancies and ambiguities.

The SPRS concept is to be developed further to a framework that is common to all technical work packages in ELECTRA.

## 6 Selection and Development of Use Cases

This chapter outlines the findings from the ELECTRA reports R3.1 [6] and D3.1 [11].

According to the project's description of work (DoW) and as it was mentioned in Table 2-1, the present deliverable is essentially based on results and conclusions from T3.1 "Futures Identification and Analysis of Requirements" of ELECTRA in the form of the internal report R3.1 (M6) [6] providing the problem description of voltage and frequency control residing on more traditional centralised system architecture. The timeline of the project provided a considerable overlap between these two tasks, and therefore R3.1 was the key input to the present report.

The succeeding task T3.2 "Functional Specification for Future Power System Operation" developed and proposed a novel architecture concept for the future power system, coined web-of-cells, which was documented in D3.1 [11]. The major part of the present tasks was done before the high level shaping of the new concept was achieved, and principal selection of the future concept to be pursued in ELECTRA was made. However, several important inputs from D3.1 were included into the document in order to avoid deviations from the new functional architecture.

Furthermore at the present stage of work, changes in the high level architecture does not influence neither the basic definitions of observability nor identified observability needs, since the overall premise i.e. the problem description remains the same. As the web-of-cells architecture will mature in the dedicated task T4.2 "Detailed Specification of the Functional Architecture" it will be accordingly implemented in the succeeding tasks T5.2-T5.4 (see Section 2.1).

### 6.1 Summary and interpretation of the main findings in ELECTRA R3.1 and D3.1 reports

According to formulations in the DOW the present task is intended to be mainly based on results and conclusions from WP3 in the form of two documents:

- The internal report R3.1 (M6), which was planned to provide the problem description of voltage and frequency control.
- The public report D3.1 (M12), which was planned to describe in the form of Use Cases the functionality of the future voltage and frequency control and interactions between the different stakeholders, which have being worked out in T3.2.

The present chapter summarises the main results from the above mentioned deliverables. Furthermore the task has interpreted some of the findings in R3.1 and D3.1 in order to meet the scope of WP5 "Increased Observability".

#### 6.1.1 Existing practices and future challenges

R3.1 report outlines a scenario for the future network towards 2050 in compliance with the European energy strategy and describes a set of requirements, which have to be met in order to meet the great challenges caused by increased deployment of RES feeding into the distribution network by 2050.

R3.1 report takes a systematic approach considering several factors, studies and trends in order to build up their conclusions. The document considers the existing practices in the European power sector, including the existing roles and responsibilities of different actors and power businesses in provision of the ancillary services (frequency and voltage control).

In order to justify and if necessary adjust the predictions related to the future challenges in the power system and design of the control concepts, which are necessary to meet these, the (R3.1) study looks at preliminary conclusions from the eHighway 2050 project [5]. This project is one of the few fully transparent bottom-up studies, which are available at the writing moment. The project in a rather pragmatic way chooses a set of boundary scenarios, which envelope all equally possible ways to achieve the 2050 targets. Therefore, it is reasonable to assume that any development path for achievement of the 2050 goals will be within the defined envelope.

### 6.1.2 Introduction of the ELECTRA scenario

In the next step the reports describe the ELECTRA scenario. The document specifically points out that **ELECTRA does not present itself a unique scenario, but focuses on effort in designing control strategies** that will facilitate the integration of the European transmission networks and at the same time allow the use of decentralised and intermittent generation, connected at all levels within the electrical network. The requirement to use resources connected at low and medium voltage levels for ancillary services provision implies the need to control the behaviour of those resources to provide responses similar to the conventional power plants, which means providing inertia, frequency reserves and voltage reserves. The combination of these factors provides a vision, which is depicted in Figure 6-1.

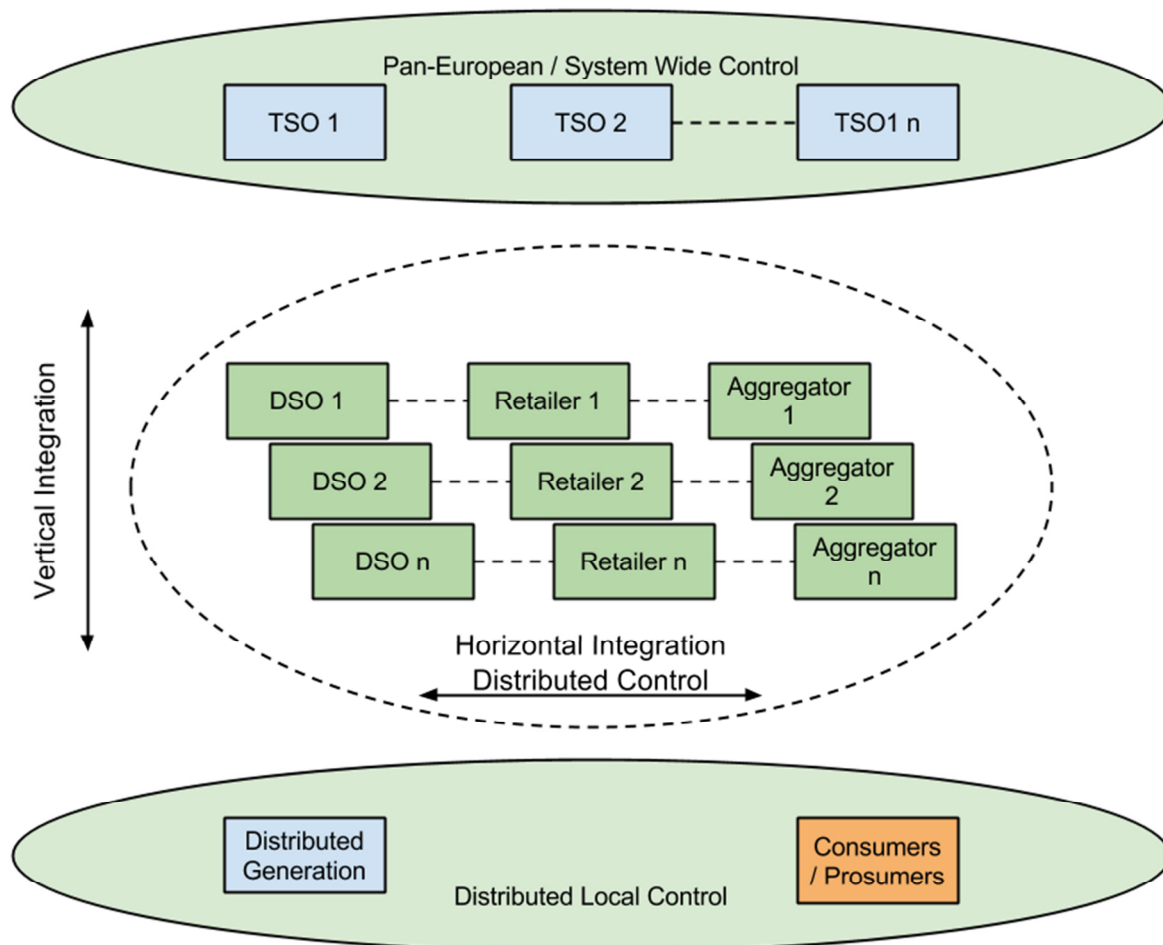
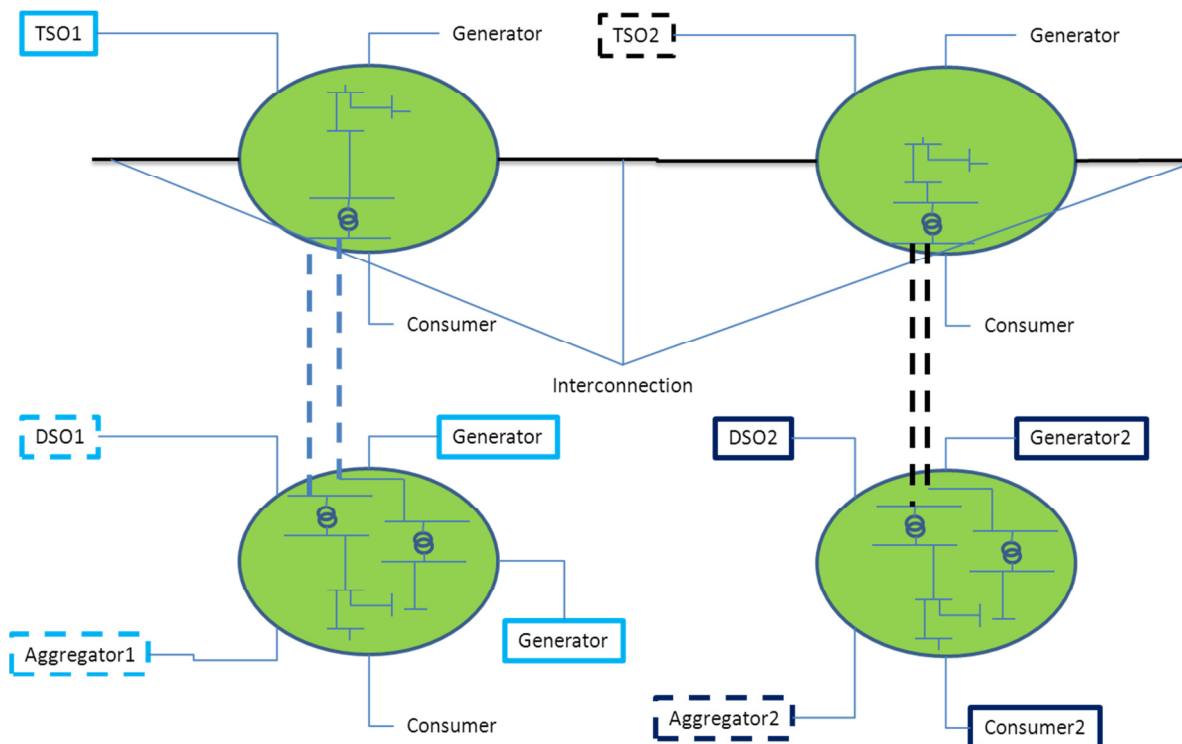

Figure 6-1 ELECTRA vision of the decentralized electricity network. Source: [6]

The picture shows the Pan-European electricity network at the upper layer, and at the lower layers the distributed resources providing the power to manage the system wide network under consideration of local system operation needs within the distribution networks.

The deliverables further define the Pan-European transmission network, which can be interpreted as a transfer from the present standard **TSO-TSO** model (applied for exchange of balancing services exclusively by TSOs) to **TSO-BSP** type of model. TSO-BSP model is intended for exchange of balancing capacity or balancing energy, where the contracting TSO has an agreement with a Balancing Service Provider (BSP) (see description of the models in [4]). It is necessary to comment that a multilateral TSO-TSO model with a common merit order lists is defined by ENTSO-E as a key part of the European Integration model for replacement reserves, while TSO-BSP in the writing moment is an exemption from it, and has to be specifically requested.

The operation of the foreseen vertical integration (middle layer in Figure 6-1) is presented in Figure 6-2. Detailed explanation can be found in R.1 Section 3.2.2 [6]. For the scope of the present document the most interesting conclusion is that operation of this model requires a more active role (-s) for DSOs including highly increased level of **control and automation of the distribution network** and taking into consideration that other stakeholders are requesting services (balancing and others) provided by resources connected to its network.



**Figure 6-2 Operation vertical integration. Source: [6]**

This lower layer in Figure 6-1 shows how resources connected to the distribution network use local and distributed control schemes to be able to provide an aggregated behaviour necessary for supporting the operation of the network. This is exemplified by a situation of decentralized/local control at a low voltage network.

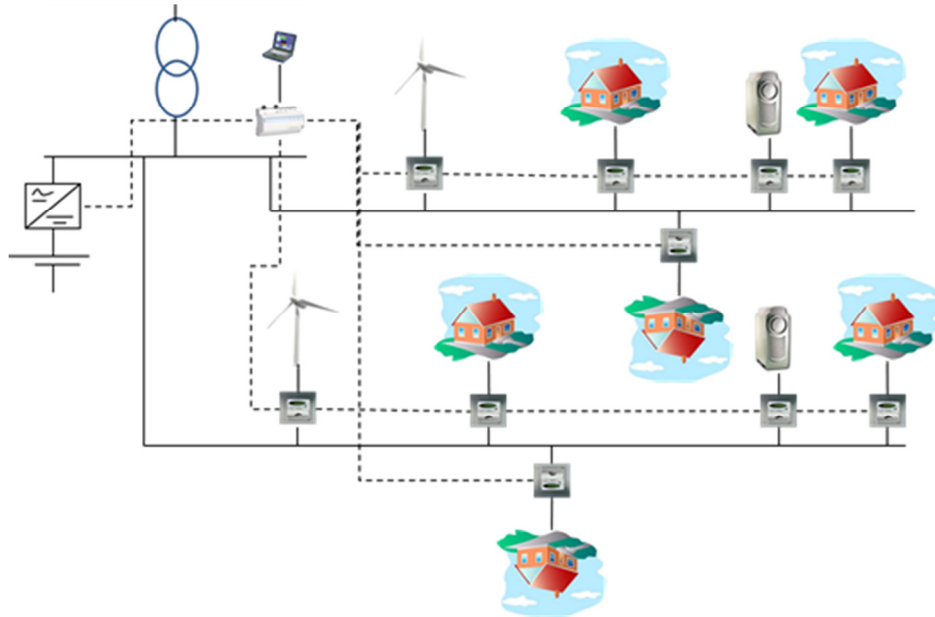

**Figure 6-3 Decentralized local control. Source: [6]**

In this case the controller is at the substation and it has as resources a capacitor, some connected wind mills, some CHP generators and some prosumers. The controller located at the substation would request **measurements from the field**. Most likely this controller has to be coordinated with other controllers and thus can be considered as a central controller for the subgrid or as an element in a hierarchical control system. Based on that information and the voltage profile that has to be maintained it would calculate the reactive consumption/generation that each resource would need to keep. The orders would be sent to each resource until the next period of data gathering and verification.

### 6.1.3 Main finding in D3.1: Introduction of cell-based architecture

The Decentralised Local Control Architecture suggested in R3.1 (see Figure 6-3) has been further elaborated in D3.1 and evolved into a novel concept of decentralized managed future power system.

In this concept the power system is divided into grid units, called **cells**, that each are responsible for local balancing and voltage control. Following this, the future European power grid will be decomposed into a new structure, coined **web-of-cells** by ELECTRA, where the cells are defined as follows (working definitions):

- a group of interconnected loads, distributed energy resources and storage units within well-defined electrical boundaries corresponding to a physical portion of the grid and corresponding to a delimited geographical area.
- cells have adequate monitoring infrastructure installed, as well as local reserves capacity enabling them to resolve voltage and cell balancing problems locally
  - but there is no expectation that cells must be able to operate in islanded mode, i.e. they can rely on structural imports or exports for their local Balance Responsible Party (BRP) market-based balancing (micro-grid capabilities are optional and out of scope)
  - only for the real-time resolving of local residual imbalances or local voltage regulation, it is expected that sufficient local reserve capacity is available. Cells are dimensioned accordingly (possibly dedicated reserves capacities like local storage)



are added). The procurement of reserves capacity is out of scope for this document, but it is proposed that guidelines, similar to those currently employed at Control Area level, are used to define the type and amount of reserves capacity required for each cell

- cells are connected to neighbouring cells via inter-cell physical tie lines; there can be multiple physical tie-lines between any two cells, and at a given moment of time, any connection can be open or closed.

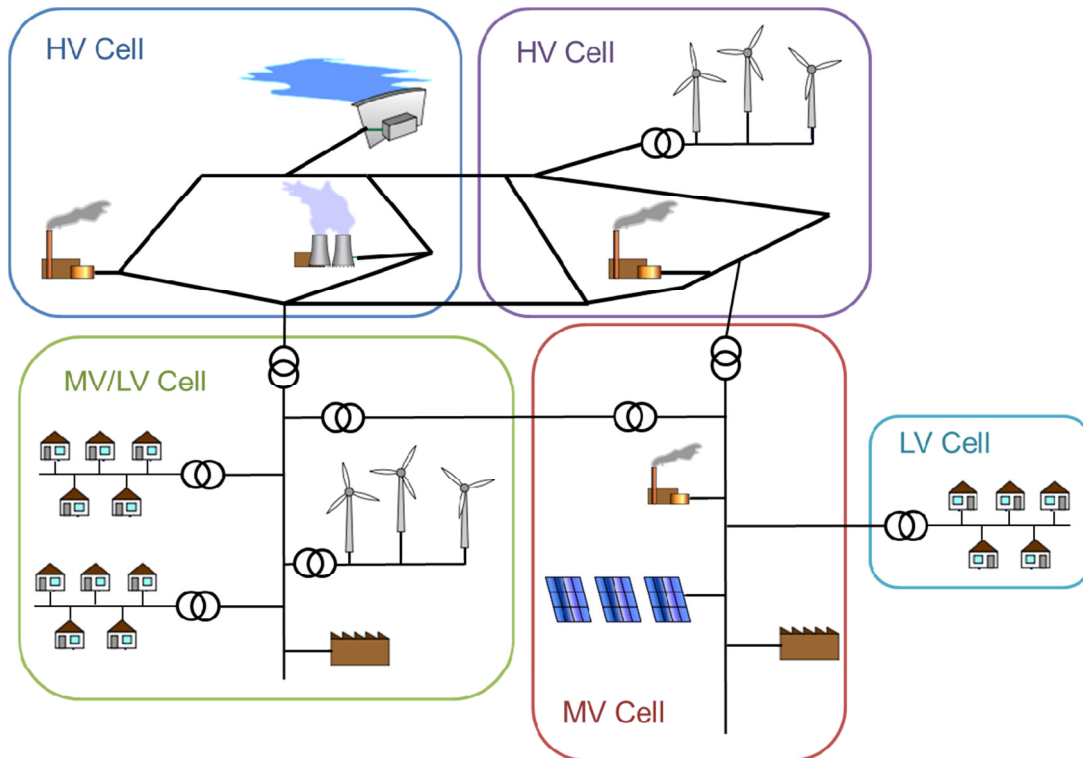

**Figure 6-4 Example of cell architecture: Source D3.1 [6]**

The key principle behind cell-based architecture is a ‘solve local problems locally’ approach.

Operation of a cell requires a new role – Cell Operator, which is responsible for establishing and maintaining automatic control mechanisms as well as procuring sufficient reserves and contributing to a stable and secure system operation.

## 6.2 Architectures and ancillary services for future networks

The framework described in the previous subsection sets boundaries for the outlook for two future architectures:

- Centrally managed future, where frequency and voltage controls are managed by the TSO who controls reserves located at distribution grid level as well as those located at transmission grid level.
- Decentralized managed future, where the power system is divided in grid units, called cells, that each is responsible for local balancing and voltage control.

These two future architectures are foreseen to comprise the following two sets of types of control:

**Table 6-1 Summary of the control schemes identified for two types of architectures.**

Centralised architecture (R3.1)	Decentralised web-of-cell architecture (D3.1)
<b>Frequency control</b>	
<p><b>Primary frequency control</b> uses new resources as frequency-controlled demand from distributed loads and distributed control/MicroGrids</p> <p><b>Secondary frequency control</b> includes an increased involvement of Non-programmable RES with centralized and local dispatching. The latter entails DSO to be responsible for the services towards TSO, participating in the ancillary service market.</p> <p><b>Tertiary frequency control</b> includes a number of potential resources at both transmission and distribution levels: consumers at LV distribution level, Distributed Generators as wind and PV, centralised storage as pumped hydro and distributed storage as EVs.</p>	<p><b>Inertia frequency control (IFC)</b>, where each unit, involved in inertia control, automatically changes its level of inertia power response (synthetic inertia) depending on certain predefined characteristics.</p> <p><b>Frequency containment control (FCC)</b> will not be fundamentally changed compared to today's schemes, except that the resources providing containment reserves will be different: generating units (in the broadest sense) as well as loads and storage distributed across the power grid (within each cell).</p> <p><b>Balance restoration control (BRC)</b> initiates the restoration of the cell balance and load flows based on local information. It is assumed that (almost) all prosumers, that are connected through public communication infrastructure, will be able to offer fast FRR capacity, e.g. through their flexible loads, and possibly local storage.</p> <p><b>Balance steering control (BSC)</b> will replace the BRC in a more economic manner if this can be done safely or adjust the balance set points. It can as well have pro-active activation based on prognoses. This control deploys resources not only within the cell but also from neighbouring cells.</p>
<b>Voltage control</b>	
<p><b>Primary voltage control</b> is a process that is performed locally by each network element which has voltage control capability. The future schemes in addition to the conventional power plants are expected to include RES and Microgrids.</p> <p>The <b>secondary voltage control</b> in future grids can cover both the regional control within a certain zone of the TSO's control area and the voltage control at the distribution system level. The secondary voltage and reactive power control at the transmission grid controls the <b>reactive power at certain pilot-nodes</b> in the transmission grid. Each pilot-node is representative for the voltage within a certain zone. The secondary controller changes the reactive power provided by the devices (power plants or reactive power equipment of the TSO (e.g. capacitors banks) or reactive Power provided by distribution grids)</p>	<p><b>Primary voltage control</b> is not expected to have fundamental changes compared to today's primary voltage control, except that the resources used will be different: generating units (in the broadest sense) as well as loads, storage devices and FACTS. These resources will be procured within every cell, and will thus be distributed over different voltage levels.</p> <p><b>Post-primary voltage control (PPVC)</b> has the commitment to bring the voltage levels in the nodes of the power system back to nominal values while optimizing the reactive (and active) power flows in order to reduce the losses in the network.</p> <p>Each cell is responsible for its own voltage control while a close coordination between neighbouring cells guarantees the provision of PPVC service between</p>

<p>within this zone until the voltage at the pilot-node is at the desired level. The secondary voltage and reactive power control of the distribution grid controls the reactive power at certain pilot-nodes in the medium voltage network of the distribution grid. The reactive power requested by the DSO can be provided by one or more aggregators which send the reactive power request to their devices which are present in the zone of a certain MV pilot-node or can be directly controlled by the DSO himself.</p> <p><b>Tertiary voltage control</b> is a process that acts on a system wide scale and in a time range of about 10 to 30 minutes. The objective of tertiary voltage is to optimize the operation of the network by maintaining the required voltage quality and the substitution of reactive reserves.</p>	<p>neighbouring cells.</p>
---	----------------------------

## 6.2.1 Conclusions and interpretation of results

### General Conclusions:

- The future power system will combine increased RES injection at distribution grid level with reduced share of central power plants
- As the ratio between inverter-connected generation and synchronous generators increases, the time constant of the system decreases and the stability margins worsen.
- Many distributed loads and generators can contribute to offering ancillary services, and combined can react with low inertia (matching reduced inertia of grid).
- Different control schemes have been designed for centralised and decentralised architectures. The main principles will however be unchanged since the physics do not change. These principles will however be applied on different levels: Cell or Control Area. This may require new observables and control architectures.
- The future control schemes will strongly rely on provision of services by Distribution Networks, which are most likely to be involved in all levels of control.
- Provision of services by DNs and in particular potential disturbances and local congestions will require radically improved information about status of the DNs
- The future control schemes will involve both consumers and intermittent RES generation as consistent part of cells or as separate units. The latter will depend on specific market implementation schemes.
- Several control schemes suggest participation of cells in provision of the resources. This complies with the suggested decentralised load control operation.

### Evolution of the roles and actors:

- Provision of services from Distribution Networks will require more active role of DSOs being responsible for provision of services towards TSOs.
- Several of the new services will require introduction of Aggregators or DSOs acting as Aggregators.
- Introduction of cell concept will lead to creation of a new role – Cell Operator, which can be assigned to one of the existing or new actors

## 6.3 Information Exchanges in the Future Control Schemes

This section is based upon the use case descriptions from both R3.1 [6] and D3.1 [11]. R3.1 was the first input to WP5 and the first iteration of work was done based on R3.1. Even though in the writing moment D3.1 is still a working document, it does provide a complete use case description. However, instead of updating the initial work with the information from D3.1 we chose to keep one separate section for R3.1 and D3.1. The reason for this is twofold:

- First of all, R3.1 allowed for a wider interpretation, resulting in some interesting thoughts on the observability in future power systems.
- Furthermore, it also documents the work done within the present task and allows for comparing some aspects related to observability from R3.1 and D3.1.

It is, however, worth noting that the view on how the power system is going to be organized is different from R3.1 and D3.1, since they consider two different architectures: centralised and decentralised (see Section 6). D3.1 will be the basis for the rest of the project, which means that some of the conclusions drawn here may be reconsidered and elaborated further in the later tasks.

There are many ways to derive observables, and ideally we should have descriptions of control loops. However, we decided to use high level descriptions in this first iteration. The alternative would be to not do any work on the observables until after some control loops had been developed. It was found more reasonable to start working with the observables earlier to start the thought process on how to proceed, and also get an idea on where to put further efforts.

### 6.3.1 Information Exchanges in the Future Control Schemes based on centralised architecture

*This sub section is meant to document the first iteration of work done on refining the use cases, as well as providing a broader discussion and is entirely based upon the work performed in R3.1 [6].*

One of the tasks of T5.1 is to refine and systematically combine a selected set of use cases provided by [6]. To accomplish this task, the draft high level functional requirement described in R3.1 for the 2030+ European power system was investigated. The procedure chosen was to fill out the "Information Exchanged" table, from the use case template defined in [8] based upon the high level description in [6]. To be precise, the tables are based upon the sequence of actions as described in Chapter 5 of [6]. The idea being that a sequence of action describes the interaction between a system and the relevant actors. Consequently, there should be an information exchanged related to each sequence of action.

To systematically develop full use cases based upon the description in [6] is outside the scope of this work. However, for the work in T5.1 it is necessary to have a firm grasp on the proposed functional requirements. The development of the information exchanged tables was not only a start on refining the description. It also served as a validation of the first version of the use cases and a useful mental exercise aiding the work to follow.

While performing the task it was evident that the functional specification provided in [6] is not a full use case description. Of course it is possible to create a functional specification without adhering to the strict formalism required by the use case methodology. And it is also not necessary to describe a system according to the use case methodology to identify observability needs. However, one cannot further refine a set of use cases if they are not already completed.

In the tables the obvious information elements are made **bold**. The rest are information elements that are necessary for the use case to fulfil its goal.

**6.3.1.1 Specific Assumptions and Limitations**

In addition to the global assumptions defined in Section 2.4 the following assumptions were used for performing the work in this section:

- Time horizon 30 + years
- High level
- No specific technology limitations

Due to the fact that the functional specification in [6] is not a complete use case description certain assumptions have to be made concerning what can be considered an information exchange. Ideally an information exchange is information exchanged between the system performing the use case and external actors. However, the functional requirement in [6] does not clearly specify pre and post-conditions and system boundaries. For this reason it is sometimes ambiguous what is information exchanges pre or post-conditions. To circumvent this issue it was assumed that all information found in the sequence of action that would have to be exchanged could be considered information exchanged. For the purpose of studying observability this is a reasonable assumption. However, one should be aware that this implies that what has been identified as information exchanged for primary frequency control in this task, might be identified as something else in later tasks. For instance frequency deviation might be identified as information exchanged in this task, but as a pre-condition in later tasks. Other information exchanges might also be considered, as relevant for separate use cases or use cases in sub systems in later tasks. Once again it should be stressed that these subtleties are not important for the present discussion.

**6.3.1.2 Information Exchanges Frequency Control**

In this subsection the information exchanged identified for the different time horizons for frequency control are presented.

The frequency containment control is responsible for minimizing frequency deviations. How it is envisioned in the centralised future is depicted in the figure below.

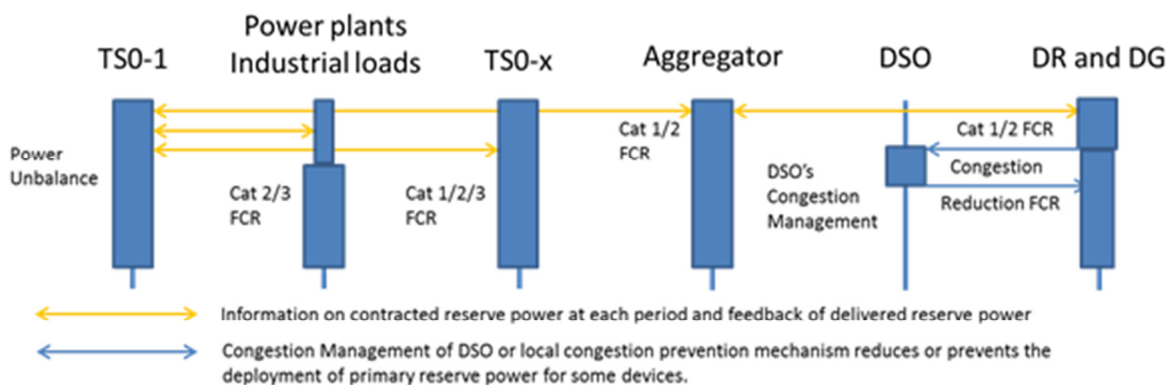

**Figure 6-5 Sequence diagram for frequency containment control. Source: [6]**

**Table 6-2 Information exchanges primary frequency control**

Information Exchanged			Comments: missing descriptions, need for improvements, need for new observables
Name of Information (ID)	Description of Information Exchanged	Requirements to information data	
<b>Reference frequency measurement</b>	Central frequency measurement to act as the master value in monitoring and contract settlement.		
<b>Real-time frequency measurement (local)</b>	Local power frequency measurement (Hz) as input to local FCR control circuit	Requirements (accuracy, time delay etc.) according to flex product specifications.	
<b>Power frequency response of unit</b>	Power frequency response of every unit participating in FCR market to monitor the delivery according to FCR contract	Measurement requirements according to flex product specification.  Accuracy of time stamp	
Required amount of FCR	Required volume of FCR by area and category per unit of time (hour), based on forecast or market signals. Information is input to the market for procurement of the reserves.		
Available amount of FCR	Available volume of FCR by area and category per unit of time, based on forecast or market signals.	Reserve capacity from TSO, through aggregators, MV, LV and DSO.	Overview of the rate of change in the power output used for primary control, which must be sufficient for control purposes.
Available cross-border transmission capacity for FCR	The available cross-border transmission capacity for FCR in MW with certain resolution (hour)		It is not defined in high level requirements when this should be handled. Reserved capacity in the day-ahead market? Or spare capacity after energy market is "done". Or a real-time monitoring?
Reason for flex product not delivered (Refers to high level)	If the reason for not delivering according to contract is of relevance to the remuneration/fine, it must be registered, e.g. local voltage		

Information Exchanged			Comments: missing descriptions, need for improvements, need for new observables
Name of Information (ID)	Description of Information Exchanged	Requirements to information data	
requirement Exception 1)	restriction		
Change of FCR availability (Partly addresses Exception 2)	Units/aggregators/DSOs that are hindered from delivering according to contract reports this prior to the operation time.		It is not necessarily optimal to compensate within the same DN. A near-to-real-time exchange (5-15 minutes) could be an alternative to handle last minute changes.

In Table 6-2: Information exchanges primary frequency control the only entry that can be seen as a direct result of the ELECTRA future scenarios are "Reason for flex product not delivered". The other information exchanges only reflect the new scenario in their description. In other words, it can merely be viewed as an incremental update to existing practices.

“Secondary frequency control is a centralised control aimed to control the Frequency Error towards zero and restore power exchanges between TSOs to their set point.” [6]. The sequence diagram of the secondary frequency control is depicted in the figure below.

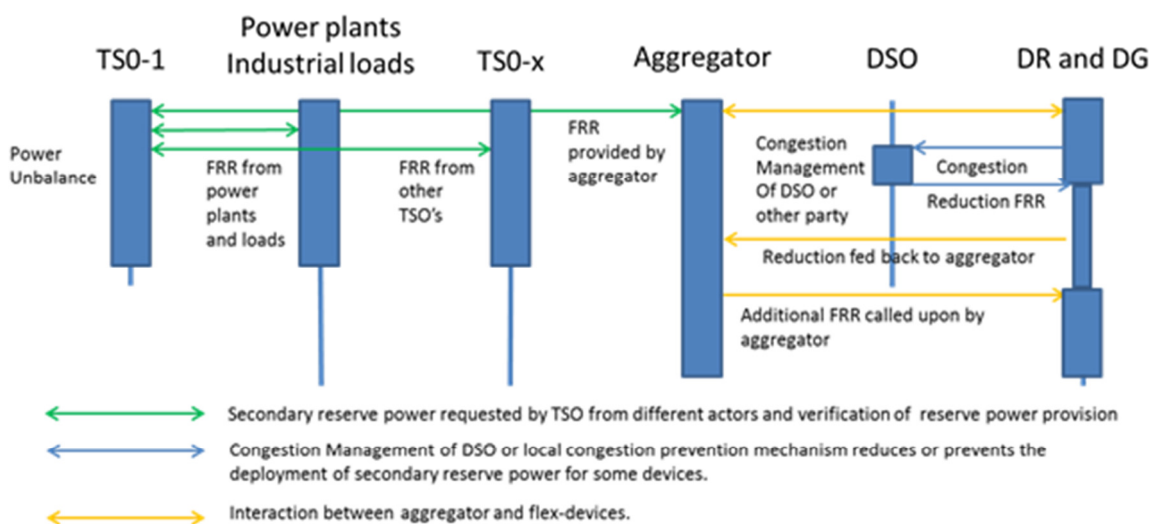

Figure 6-6 Sequence diagram for secondary frequency control. Source: [6]

**Table 6-3 Information exchanges secondary frequency control.**

Information Exchanged			Comments: missing descriptions, need for improvements, need for new observables
Name of Information (ID)	Description of Information Exchanged	Requirements to information data	
<b>Reference frequency measurement</b>	Frequency as measured by the TSO in the control center. Used to determine if secondary control should be activated		
<b>Real-time frequency measurement</b>	Local power frequency measurement as input to local FRR control circuit	Requirements according to flex product specification. Accuracy of time stamp.	Power balance within control area/block and restores the power exchange with other control area/blocks.
<b>Available cross-border transmission capacity for FRR</b>	The available cross-border transmission capacity for FRR in MW with certain resolution between TSOs and DSOs.	Available capacity from TSO, through aggregators, MV, LV and DSO with requirements to accuracy, time delay etc.	Including max reliability and efficiency for sufficient control purposes. It is not defined in high level requirements when this should be handled.
<b>Required amount of FRR</b>	Required volume of FRR by area and category per unit of time, based on forecast or market signals. Information is input to the market for procurement of the reserves.	Measurement requirements according to flex product specification. Accuracy of time stamp.	Is taken based on minimal costs. Incl. max reliability and efficiency. L- agent activation order?
<b>Available amount of FRR</b>	Available volume of FRR by area and category per unit of time, based on forecast or market signals.	Reserve capacity from TSO, through aggregators, MV, LV and DSO.	Overview of the rate of change in the power output used for secondary control, which must be sufficient for control purposes.
<b>Change of FRR availability</b>	TSO needs to verify whether or not sufficient secondary reserve capacity is available		Request to the flex device can be intercepted by the congestion prevention mechanism – can reduce/ cancel power request. (refer to except. 1,2)



In this Table there is nothing new compared to present practices.

Tertiary frequency control is defined as any change of generator set-points, which allows for restoration of secondary reserves [6]. The sequence diagram for tertiary frequency control is depicted in the figure below.

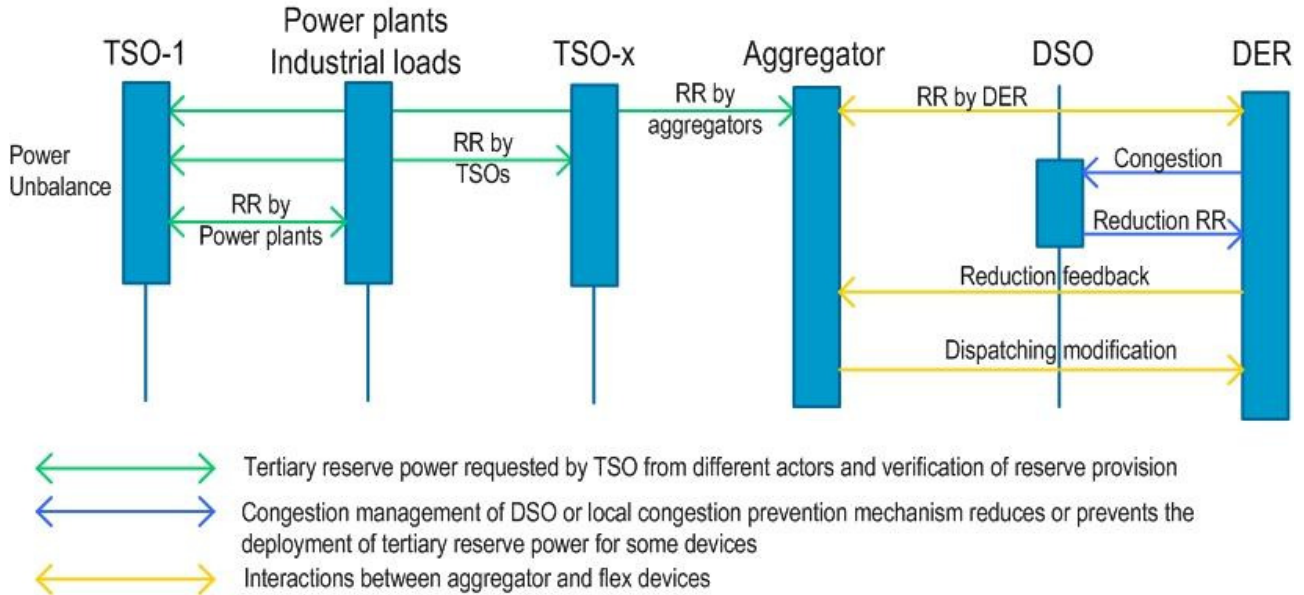

Figure 6-7 Sequence diagram tertiary frequency control. Source: [6]

Table 6-4 Information exchanges tertiary frequency control

Information Exchanged			Comments: missing descriptions, need for improvements, need for new observables
Name of Information (ID)	Description of Information Exchanged	Requirements to information data	
<b>Activation order for RR by TSO</b>	Activation orders for replacement reserve to adjacent TSOs, directly connected generation, industrial loads and aggregators/DSO's.	Exact mixture of resources to be used will have to be a combination of optimisation problem solving and operating constraints regarding voltage and congestion of lines.	
<b>Power imbalance (TSO)</b>	Measurement of power imbalance in the area as input to the operator or algorithm controlling the tertiary control		The main driver is to free the secondary frequency control reserves, or to find an optimal working condition between secondary and tertiary. Yet it is not specified how exactly these choices are made.
<b>Activation order for RR</b>	Communicating of TSO requests among agents below		It is not specified how priorities are set for the

Information Exchanged			Comments: missing descriptions, need for improvements, need for new observables
Name of Information (ID)	Description of Information Exchanged	Requirements to information data	
by L3 – agents	(MV and distribution level)		activation of the different agents ? Which are the key-parameters ?
Modification of provided power (violation 1)	Maintaining the voltage at the connection point within specific limits by the local controller		
Active response of an RR-unit (violation 1)	Monitored by the aggregator to fine-tune its schedule.		
Constraint signals to DER units (violation 1)	Sent by the DSO in order to avoid congestion problems by the selected dispatching schedule to modify the output power		
Price signal influence	When the DER – unit response differs from the requested RRs, because of economic benefits for the DER owner, the aggregator must monitor the response of the units and modifies the schedule to achieve the target.		

This far this Table through the inclusion of new actors represent the biggest change compared to the present practices.

### 6.3.1.3 Information Exchanges Voltage Controls

The primary voltage control aims at maintaining the voltage locally. The sequence diagram is depicted below.

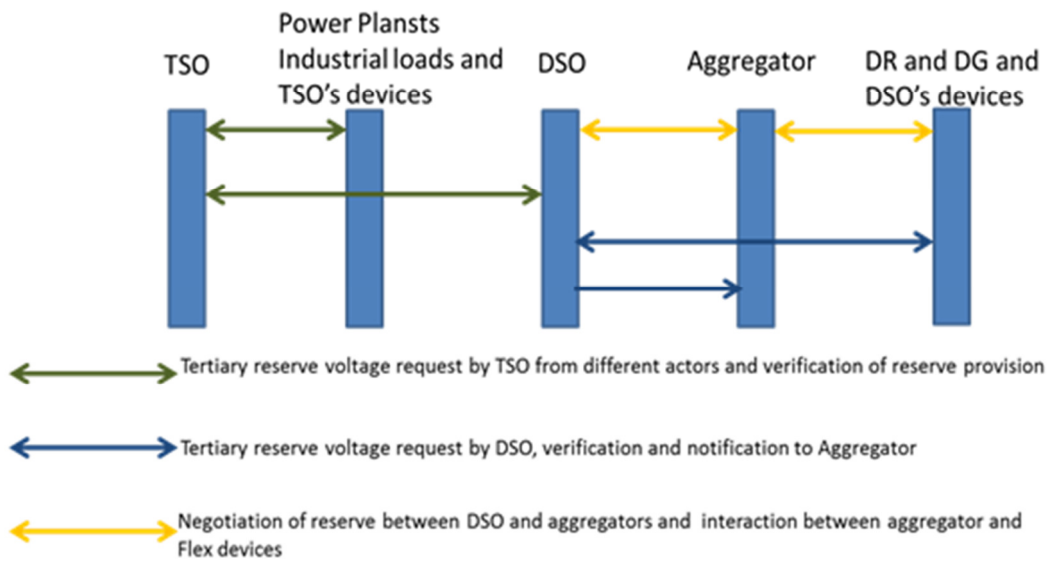

Figure 6-8 Sequence diagram primary voltage control. Source: [6]

Table 6-5 Information exchanges primary voltage control

Information Exchanged			Comments: missing descriptions, need for improvements, need for new observables
Name of Information (ID)	Description of Information Exchanged	Requirements to information data	
<b>Node voltage</b>	Voltage at the terminal of the unit participating in voltage control. This information is used locally by the controller		
<b>Grid's code on reactive power-voltage droop characteristics</b>	Information on how much reactive power each MV and HV devices are to provide according to the grid's code on reactive voltage droop characteristics.		How is the grid's code on voltage droop characteristics determined? Voltage control mode and set-point should be according to grid operator control signal.

Information Exchanged			Comments: missing descriptions, need for improvements, need for new observables
Name of Information (ID)	Description of Information Exchanged	Requirements to information data	
<b>Active Power</b>	Active measured power at node used to determine if load curtailment is necessary.		Observable for voltage stability is needed. A stability margin has to be defined, for instance what is the maximum allowed loading with respect to the theoretical maximum allowed loading. The maximum allowed loading could also be one observable, as it can be either determined from analysis or measured online. The latter case being more precise.
<b>Voltage droop characteristics</b>	Voltage droop characteristics used for load curtailment		This is active power control.
<b>Maximum active power at voltage stability limit</b>	The maximum power that can be delivered to a node before voltage instability occurs		

Table 6-5 indicates that there is an expected greater collaboration between DSOs and TSO to perform primary voltage control. However, the list of actors provided in chapter four is extensive enough to indicate that there should be more information exchanges.

The secondary voltage control is supervisory to the primary control and acts by maintaining the voltage at selected pilot nodes. The sequences of actions are quoted below.

- “Voltage deviation is detected by the voltage measurement module of the device.
- HV and MV devices: Reactive power is provided according to the grid’s code reactive power–voltage droop characteristics.
- In low voltage grids the active power is also taken into account and curtailment will occur according to a predefined voltage-droop characteristic. When the voltage is near its nominal value and taking into account some hysteresis (to avoid oscillations), the active power can be restored to its set-point value” [6].

**Table 6-6 Information exchanges secondary voltage control**

Information Exchanged			Comments: missing descriptions, need for improvements, need for new observables
Name of Information (ID)	Description of Information Exchanged	Requirements to information data	
<b>Pilot node voltage</b>	Voltage at the terminal of the unit participating in voltage control in <b>designated region. Information from controller at TN, DN.</b>	Measurements data to the central controller.	Internal/local congestion control measurements in a hierarchical way.
<b>Reactive power</b>	Reactive power <b>information exchange</b> between TN and DN to controller.	Requirements (accuracy, time delay etc.)	Depending on the size of distribution grid section and amount/types of connected generation/loads, it could be decided in a DN region not include secondary reactive power control (rely on the primary and tertiary reactive power control).
<b>Active Power</b>	Active power <b>information exchange</b> between TSO, DSO and Aggregator.	Requirements (accuracy, time delay etc.)	Online control measurements and information exchange between TSO, DSO and Aggregator.
<b>Available reserves capacity for SVC</b>	Request to reserve supplier in a hierarchical way to DR. If sufficient reserve capacity available and there is no congestion at the lowest level, report this up. If redispatch fails, and insufficient reserves are available, alerts are sent ->activation of tertiary reserves.		Additional observables can be taken into account for allocation available reserves: Weather condition (Wind speed, Solar irradiation, Temperature etc.)
<b>Position of switches (topology of the grid)</b>	The position of switches is monitored to coordinate dispatch of reactive power.		
<b>Tap-changer position (DSO and TSO)</b>	The tap-position of the transformer is monitored to participate in the secondary voltage regulation.		

Information Exchanged			Comments: missing descriptions, need for improvements, need for new observables
Name of Information (ID)	Description of Information Exchanged	Requirements to information data	
<b>Set points of Flexible Alternating Current Transmission System</b>	The set points of the FACTS are monitored to participate in the secondary voltage regulation.		

Just as the previous table, Table 6-6 indicates greater collaboration between TSOs and DSOs, but the table is still rather conservative.

The aim of the tertiary control in the centralised architecture is “to optimize the operation of the network by maintaining the required voltage quality and the substitution of reactive reserves” [6]. A sequence diagram depicting how this is done is given below.

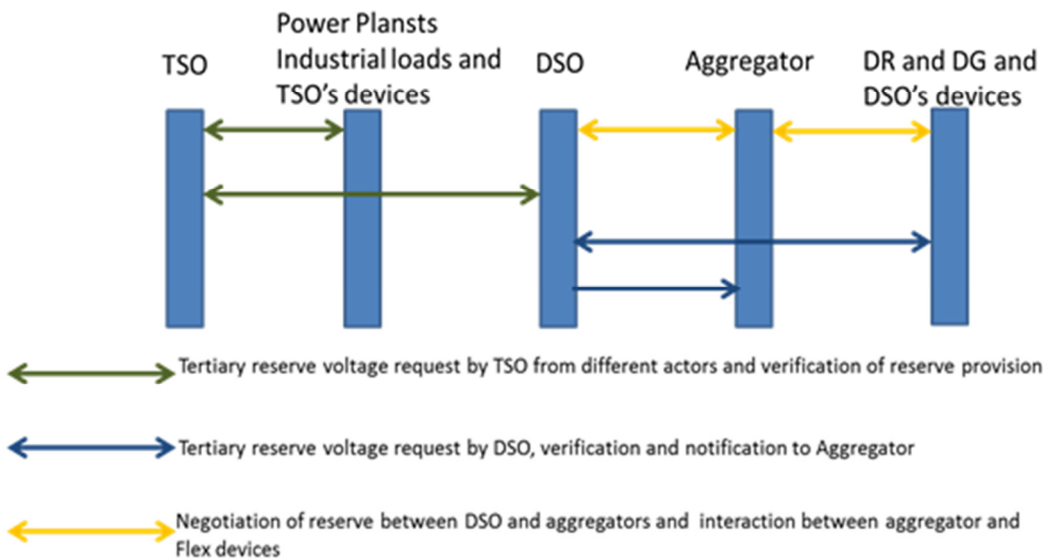

Figure 6-9 Sequence diagram tertiary voltage control. Source: [6]

**Table 6-7 Information exchanges tertiary voltage control**

Information Exchanged			Comments: missing descriptions, need for improvements, need for new observables
Name of Information (ID)	Description of Information Exchanged	Requirements to information data	
<b>Voltage (TSO-nodes)</b>	The voltage measured at the connection of different units participating in the tertiary voltage control	Time – scale 15 min values	
<b>Reactive power (TSO-nodes)</b>	The reactive power flow in and out of a node is measured to regulate the optimal settings of the available devices. Such nodes can be for example power plants or big customers directly connected to the transmission system, but also aggregated power plants, renewable generation parks, or capacitor battery banks and voltage regulators.	Time – scale 15 min values	Optimal reactive power flow can have different objectives for TSO and DSO. While the TSO is particularly interested in optimizing the grid losses and keeping the grid stable, the DSO could be more interested to achieve the more optimal configuration for the DG installed in the MV-grid. This can lead to a conflict between TSO and DSO reactive power flow controllers.
<b>Transformer Tap-changer settings (TSO)</b>	The tap-position of the transformer is monitored to participate in the tertiary voltage regulation.	Time – scale 15 min values	This information should also be presented to the DSO, at MV-injections. And could thus be incorporated in the DSO control algorithms.
<b>Reactive power (DSO)</b>	Measurement of inflow of reactive power from the transmission grid at the injection points (transformers).	Time – scale 15 min values	Voltage on the MV – busbar is controlled by the TSO (by HV/MV tapchanger).
<b>Control signal towards DG, capacitor banks for voltage regulation</b>	Signals to be sent to MV-grid connected devices (distributed generation, capacitor banks, and voltage regulators) in	Time – scale 15 min values	Voltage control is a local issue, and cannot always be controlled by the devices alone. Local active power curtailment should be also considered (where the

Information Exchanged			Comments: missing descriptions, need for improvements, need for new observables
Name of Information (ID)	Description of Information Exchanged	Requirements to information data	
	order to produce or consume reactive power for voltage regulation purposes.		grid is to weak). This should be done at the LV-level.

**6.3.1.4 Conclusions drawn based upon the Information Exchanged Tables**

From the information exchanged tables it is possible to identify numerous observables. Most of these observables are already in use; however, some new observables were identified. Furthermore, observables already in use were identified as relevant for new controls where they are not currently in use.

As can be seen from the next figure, the voltage and frequency observables identified from the sequence of action list are not expected to be the same. Generally it seems that the frequency observables are of a more centralized nature than the voltage observables. This is natural given the fact that frequency is a system wide parameter, and that voltage is a local parameter.

This Figure also shows that it is not possible to extract the whole observability picture from the information exchanged tables. The only level three observable for the frequency control is power imbalance. However, from the description in R3.1 it seems that the control would need to have information from a state estimator to perform its function.



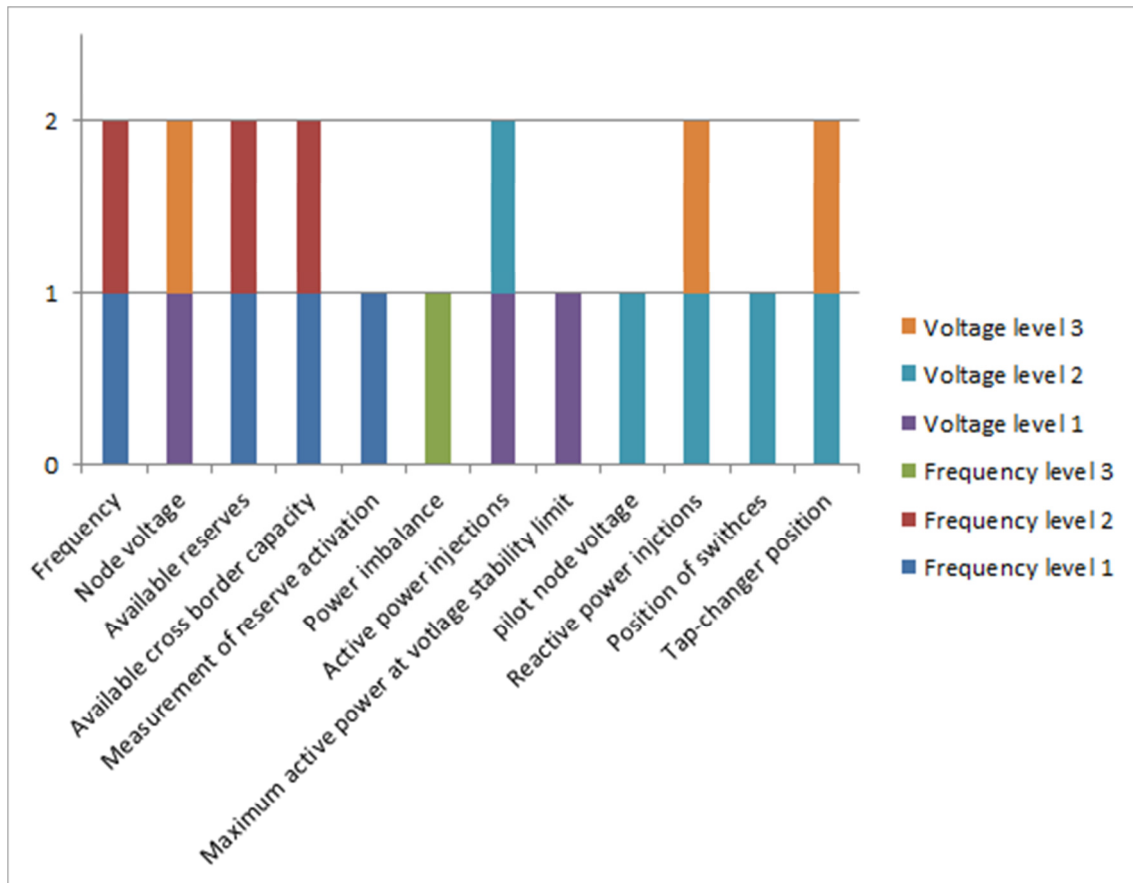

**Figure 6-10 Comparison of observables for different controls**

Even though it is possible to identify relevant information exchanges based upon [6], it will be necessary to continue the work when more detailed descriptions of the control solutions are available.

As shown above one is certain to end up with inconsistent and ambiguous results if one solely bases the observability needs discussion on the information exchanged tables. However, the tables can be used as complementary information and as feedback on some of the present functional specifications shortcomings. Finally it should be pointed out that the functional specification is at a draft stage, and is expected to improve. Furthermore the narrative description is in a much more complete state and should serve as the main input to the identification of observability needs.

### 6.3.2 Information Exchanges in the Future Control Schemes based on decentralised architecture

Even though, D3.1 in the writing moment is still a working document it does provide a rather complete use case description of the future control schemes. Most interesting for the work done in this task is that it provides complete information exchanges tables. This allows for comparing the information exchanges tables developed based upon R3.1 with the ones from D3.1. Furthermore, it is possible to go one step further and identify observables based upon the tables. It is also worth noting that the control types and their names have changed since R3.1

The information exchange tables from D3.1 have been slightly modified in this report. Instead of having an empty column for requirement IDs it has been replaced with a column called observable.

In this column suggestions for observables will be made. In some cases where no information exchange table are available, a sequence diagram is used to derive the observables.

For the convenience of the readers not familiar with [11] each use case is introduced before the information exchanges tables are presented. The introductions consist of the short use case descriptions found in [11].

### ***6.3.2.1 Specific Assumptions and Limitations***

The assumptions remain more or less the same as for the work done based on R3.1 with the following assumptions remaining the same.

In addition to the global assumptions defined in Section 1.4 the following assumptions were used for performing the work in this section:

- Time horizon 30 + years
- High level
- No specific technology limitations

For the work based upon R3.1 it was necessary to make some assumptions regarding what can be considered an information exchange. This is no longer necessary, due to the fact that D3.1 already provides the information exchanged tables. For this reason, the new assumption made is that observables can be identified using the information exchanged tables.

### ***6.3.2.2 Future Inertia Control***

“In future power systems the share of converter-coupled generation/load increases. This leads to reduced stored kinetic energy in the power system since converter-coupled generation/load does not inherently contribute to inertia control. Comparable active power changes would result in higher frequency gradients. In order to assure that integration and use of converter-coupled generation/load has not to be limited due to frequency stability issues, new concepts for power system control have to be introduced on plant (especially for converter-coupled generation/load) as well as on power system level” [11].

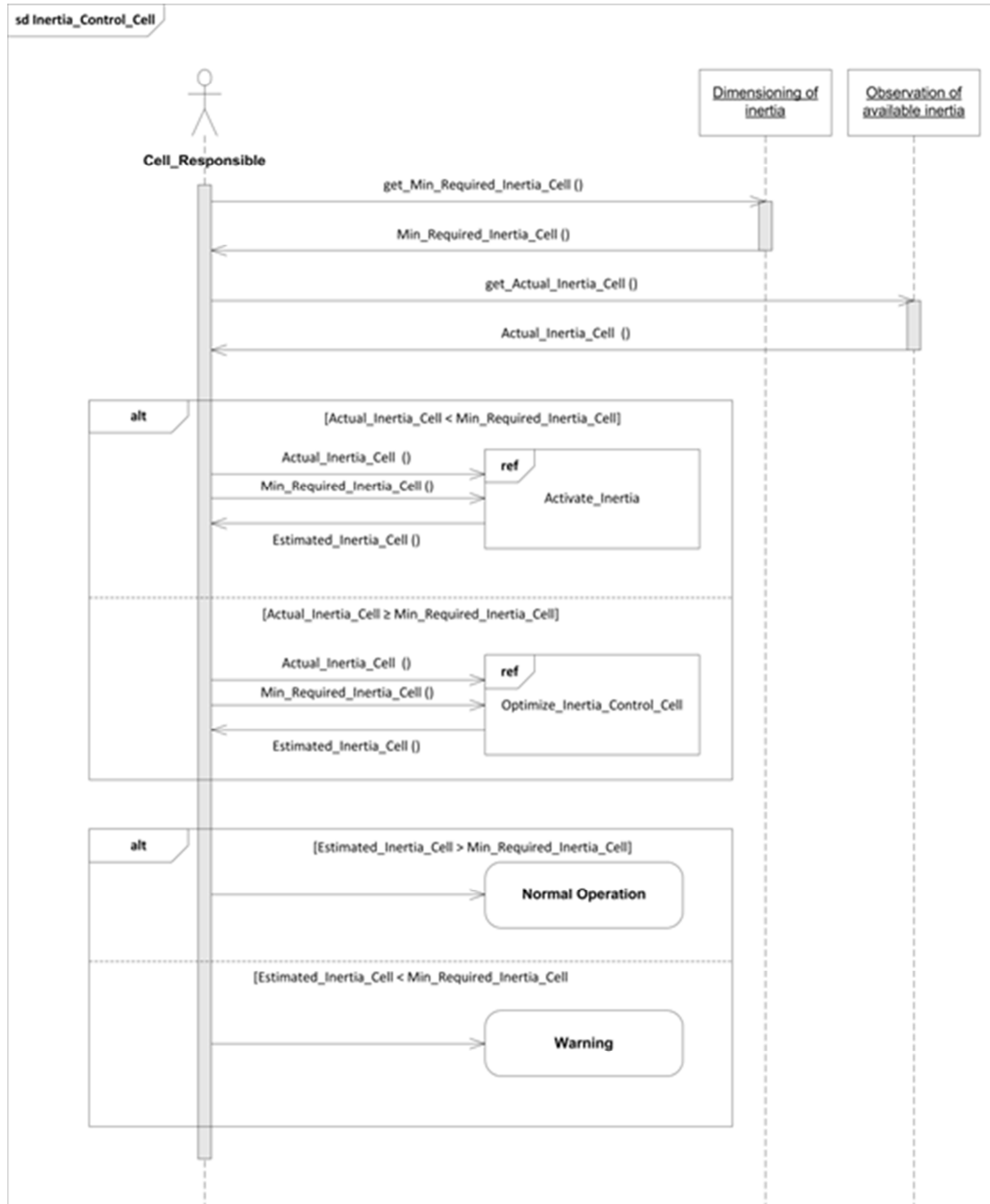

Figure 6-11 Inertia control cell. Source: [11]

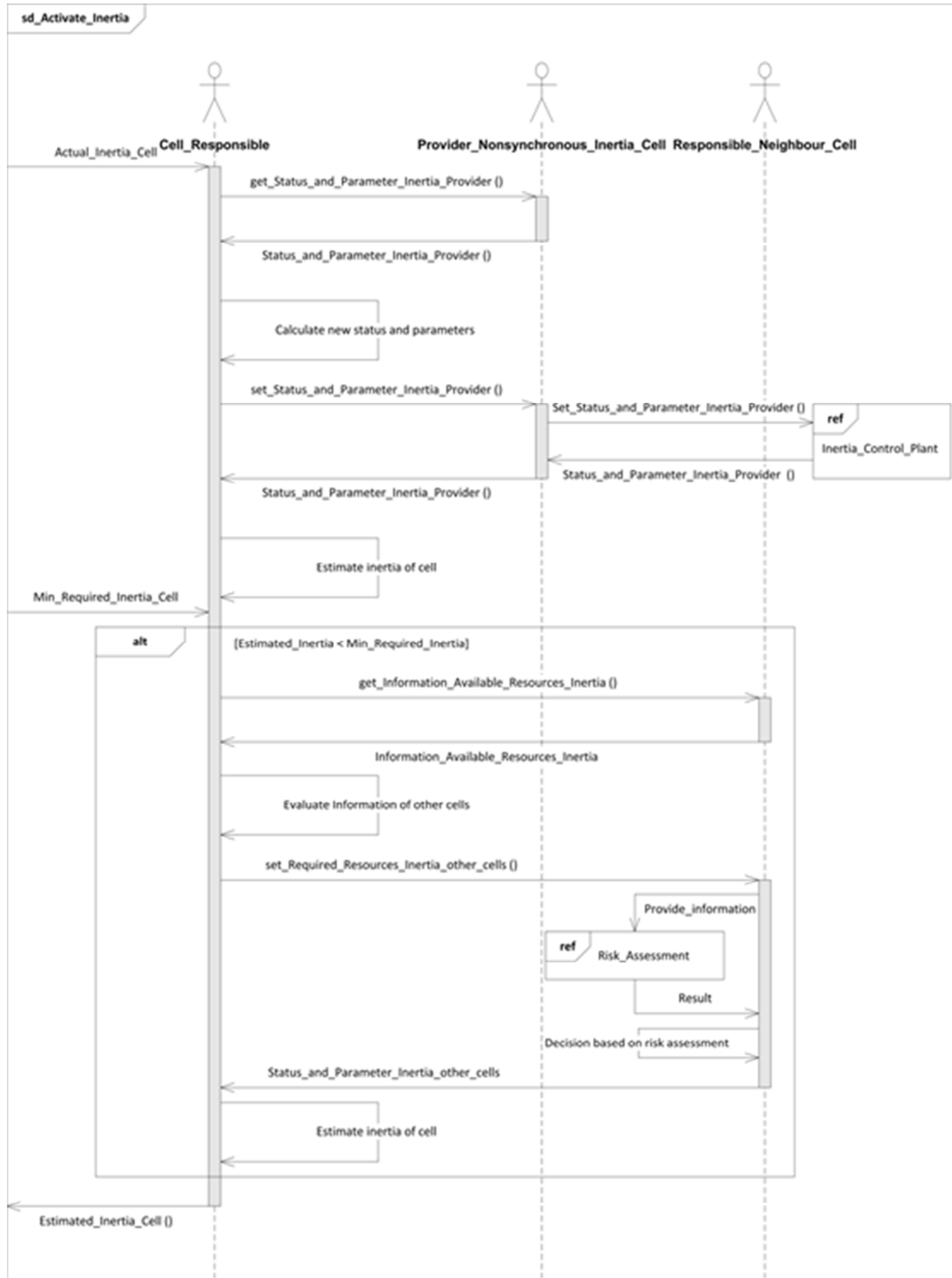

Figure 6-12 Activate inertia. Source: [11]

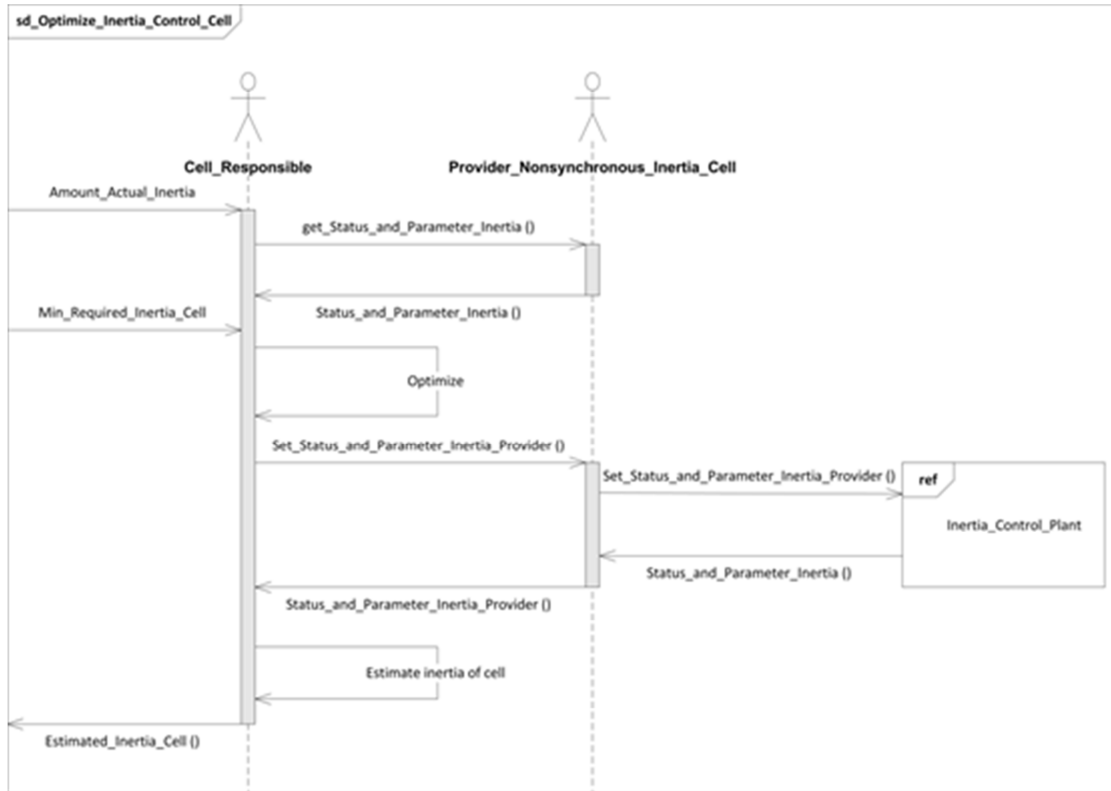

Figure 6-13 Optimize inertia control cell. Source: [11]

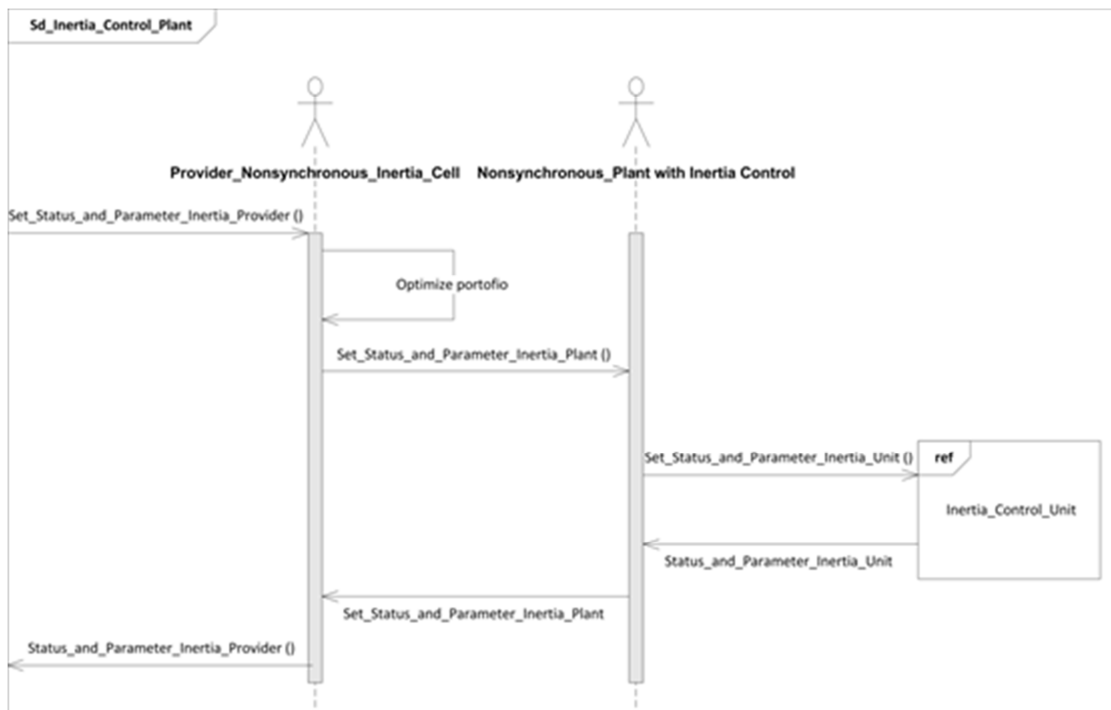
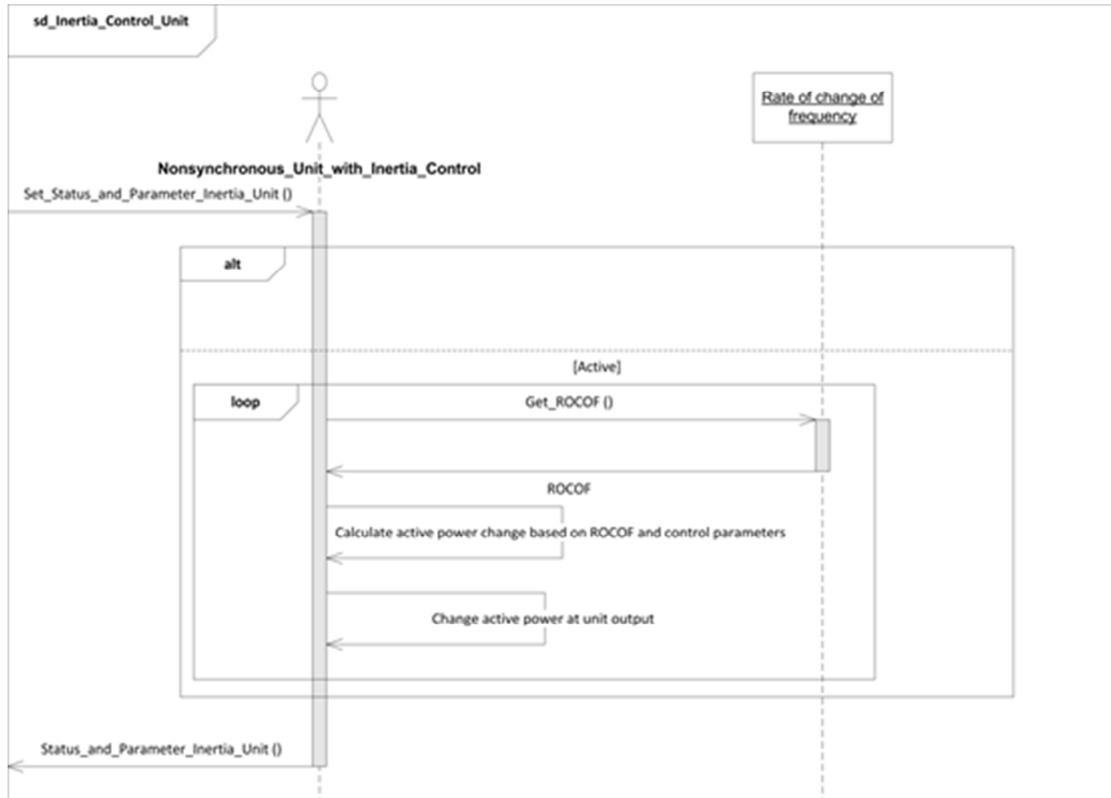

Figure 6-14 Inertia control plant. Source: [11]



**Figure 6-15 Inertia control unit. Source: [11]**

From the sequence diagrams of the inertia control three observables can be identified, namely:

1. Cell inertia
2. Available inertia providing resources
3. ROCOF

### 6.3.2.3 Future Frequency Containment Control

“In future power systems the share of converter-coupled generation/load increases as well as the generation mix changes more frequently. Therefore a flexible Frequency Containment Control (FCC) is required. The FCC has to be designed in a way every unit can bring in its strengths based on its technology.

The basic requirements for FCC are:

- Be sufficiently fast in order to support Inertia response power Control
- Provide sufficient power reserves to cover power imbalance and ensure  $\Delta f_{dyn,static}$
- Provide sufficient energy reserves to ensure  $\Delta f_{dyn,static}$  until FRR/RR restore frequency” [11]

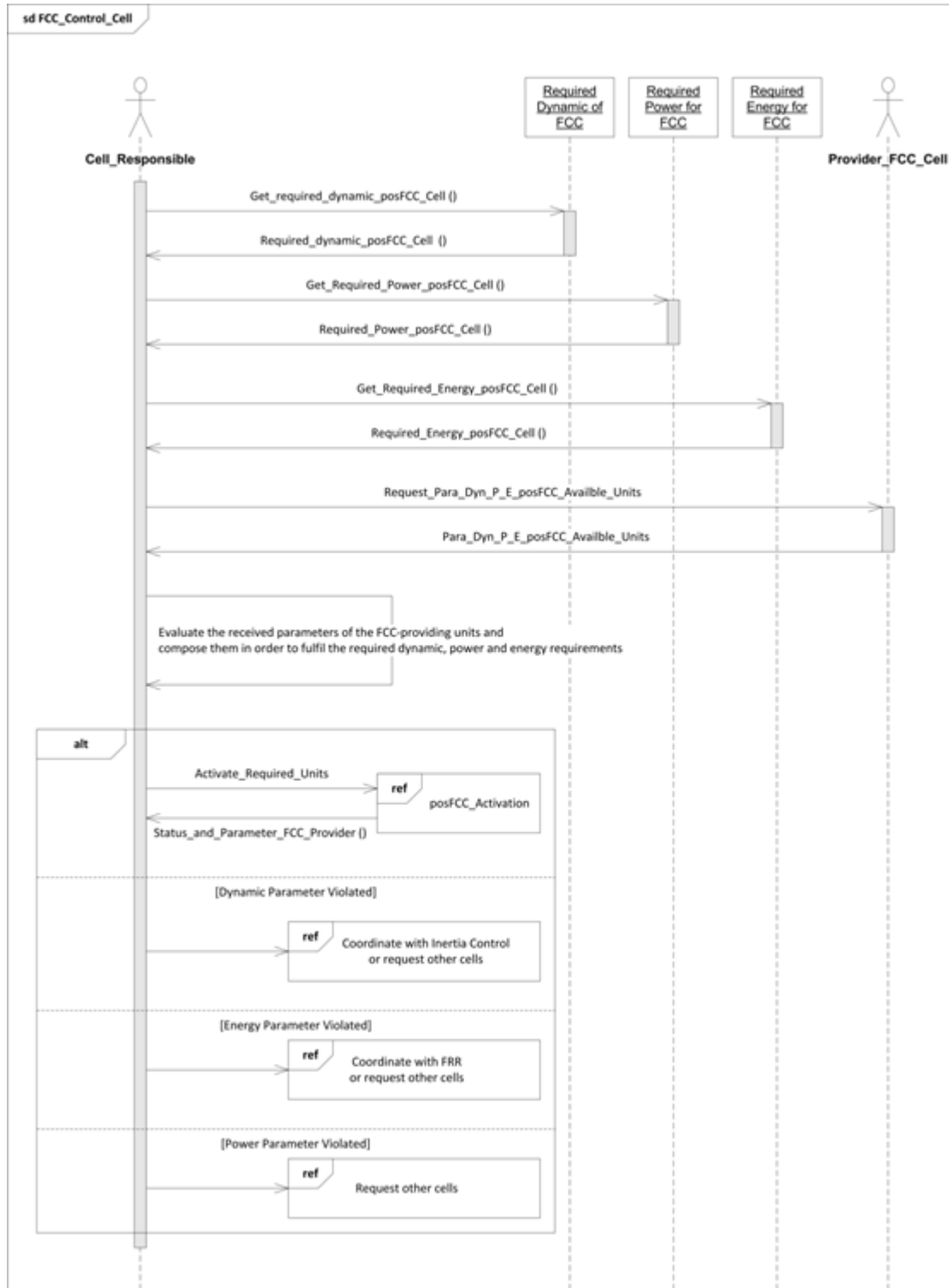
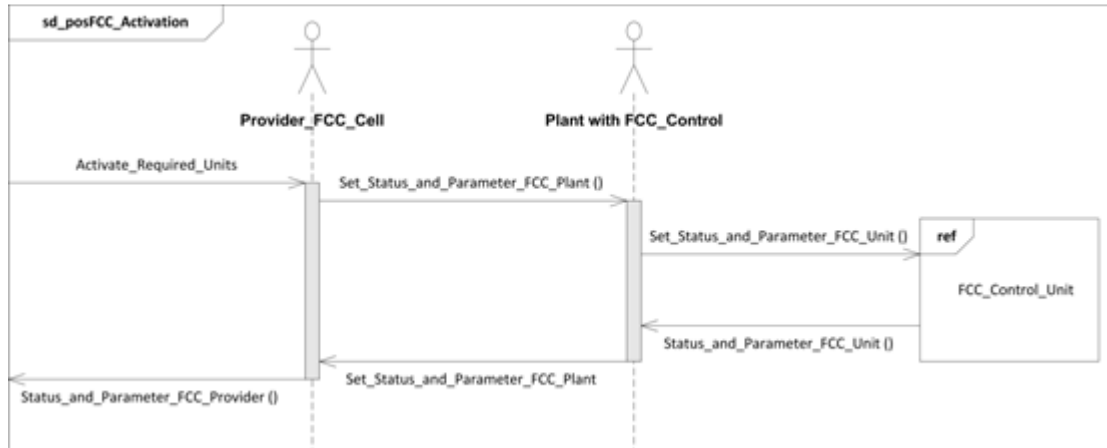
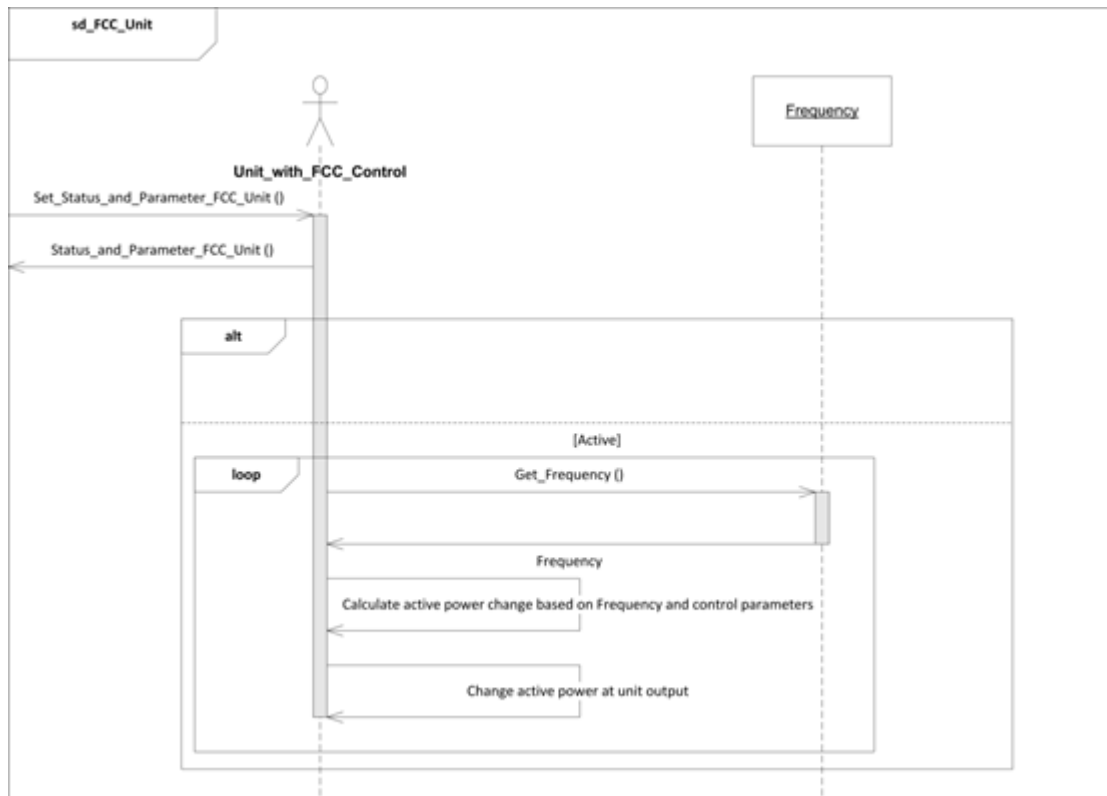

Figure 6-16 FCC control cell. Source: [11]



**Figure 6-17 posFCC activation. Source: [11]**



**Figure 6-18 FCC unit. Source: [11]**

In the sequence diagrams the only observable explicitly mentioned is the frequency. Some parameters are also mentioned, but there are not details for any conclusions to be drawn.

#### 6.3.2.4 Future Balance Restoration Process

“In the future Electra scenario, the system operator within each “cell” will contract Balance Restoration Reserves, offered by a Restoration Reserve Provider. Based on the difference between scheduled power flow and measured/actual power flow across the cell borders (= Balance Restoration control error), Balance Restoration reserves (available within the cell) are activated.



Balance Restoration Process

- a. Detection of Balance Restoration error
- b. Determination of state of control cell
- c. Definition of restoration reserves merit order
- d. Determination of activation orders
- e. Sending of activation orders to restoration reserve providers
- f. Activation and monitoring of reserves

Source:[11]

**Table 6-8 Information Exchanged future balance restoration process. Source: [11]**

Information Exchanged			
Information Exchanged ID	Name of Information	Description of Information Exchanged	Observable
IE_01	restoration reserve bid	Restoration reserve bids indicate the volume (per quarter hour) that is available for restoration reserve, as well as an activation price. The volumes bid must be in agreement with the contract the reserve provider has with the Control Cell Operator.	
IE_02	Balance Restoration error	difference between scheduled power flow and measured/actual power flow across the cell borders	Balance restoration error
IE_03	Cell system State	Measured or estimated cell system state, i.e. power flows through lines, voltages on busses of cell system.	Cell system state
I_04	Restoration Reserve Activation Order	Control signal to active restoration reserve unit, contains: <ul style="list-style-type: none"> <li>• Restoration Reserve Provider ID</li> <li>• Power [MW]</li> <li>• activation time [min]</li> </ul>	
I_05	Measurements of reserve activation	Measurements of reserve activation enabling ex-post handling and remuneration.	Measurement of reserve activation

For the balance restoration process the following observables could be deduced from the information exchanged table:

- 1. Balance restoration error
- 2. Cell system state
- 3. Measurement of reserve activation

### 6.3.2.5 Future Balance Steering control

“The use of BSC can be distinguished into two main modes, all of which ensure a specific system balance and, hence, an indirect frequency containment within predefined boundaries. The future cell-centric Balance Steering Control strategy addresses two major operation issues, such as prevention of potential contingencies by proactive coverage of residual imbalances and support/substitution of secondary frequency reserves (namely BRRs) by Replacement Reserves (RRs) in order to make the former available to tackle potential future contingencies” [11].

**Table 6-9 Information Exchanged future balance steering control. Source: [11]**

Information Exchanged			
Information Exchanged ID	Name of Information	Description of Information Exchanged	Observable
IE_01	System and BRRs state	Active Power flows and FRRs power/state	
IE_02	System and BRRs state	Active Power flows and FRRs power/state, Frequency deviation	
IE_03	Schedule/activation of Cell interchange	Active Power set-point schedule/dispatching, Cost estimation	
IE_04	Schedule/activation of BSRs (Balance Steering Reserve)	Active Power set-point schedule/dispatching	
IE_05	Acceptance/modification	Acknowledgement Message, Active Power set-point schedule/dispatching	
IE_06	Schedule/activation of BSRs within and between cells	Active Power set-point schedule/dispatching	
IE_07	Acceptance/modification	Acknowledgement Message, Active Power set-point schedule/dispatching	
IE_08	Schedule/activation of BSRs within cells	Active Power set-point schedule/dispatching, Active Power flows forecasts, Cost estimation	
IE_09	Schedule/activation of BSRs within cells	Active Power set-point	
IE_10	State/Active Power	State signal,	

Information Exchanged			
Information Exchanged ID	Name of Information	Description of Information Exchanged	Observable
		Active Power	
IE_11	Observables	Active Power flows, Frequency	
IE_12	KPIs/Constraints	Active Power flows, Operating costs, Frequency	

For the BSC the information exchanged table sufficiently explained the relevant observables, so the column for observables was not needed. The identified observables where:

1. Active Power at nodes
2. Active power flows
3. Frequency
4. System state

The system state is particularly important to determine whether or not residual power flows can be accepted to optimize the overall system.

#### 6.3.2.6 Future Primary Voltage Control

“Primary voltage control utilizes reactive power capabilities of grid connected generating units to maintain voltage level in an interconnection point. Active power control can also be required to achieve the desired voltage level in a low voltage grids where the line resistance is greater than the line reactance ( $R > X$ ).

The generating unit voltage set point can be set by Control Cell Operator or it’s system that perform post-primary voltage control” [11].

**Table 6-10 Information Exchanged future primary voltage control. Source: [11]**

Information Exchanged			
Information Exchanged ID	Name of Information	Description of Information Exchanged	Observable
IE_01	Output Voltage	Voltage measured at generator terminals or in interconnection point ( $V_O$ ).	Voltage at generator terminals and voltage at interconnection points
IE_02	Output Active Power	Active power measured at generator terminals or in interconnection point ( $P_O$ ).	Active power at generator terminals, and active power in interconnection points
IE_03	Output Reactive Power	Reactive power measured at generator terminals or in interconnection point ( $Q_O$ ).	Reactive power at generator terminals and interconnection point.

Information Exchanged			
Information Exchanged ID	Name of Information	Description of Information Exchanged	Observable
IE_04	Voltage Setpoint	Present value of voltage setpoint that is used in control process ( $V_{setp}$ ).	
IE_05	New Voltage Setpoint	New value of voltage setpoint received from Cell Operator. After authorisation and value checking it becomes a present setpoint IE_04 ( $V_{setp}$ ).	
IE_06	Generating Unit Active Power Adjustment	Information representing a signal that change generating unit output active power.	
IE_07	Generating Unit Reactive Power Adjustment	Information representing a signal that change generating unit output reactive power.	
IE_08	Voltage Control Status	Aggregated information containing present measurements, voltage setpoint, available active and reactive power range, status signals and alarms.	

The relevant observables for the primary voltage control are summarized below:

1. Voltages at generator terminals and interconnection
2. Active power at generator terminals and interconnections
3. Reactive power at terminals and interconnections

### 6.3.2.7 Future Post-Primary Voltage Control

“The post-primary voltage control has the commitment to bring the voltage levels in the nodes of the power system back to nominal values while optimizing the reactive power flows in order to reduce, to the extent possible, the losses in the network. In the future cell-based grid structure, the PPVC is intended to replace the present secondary (local) and tertiary voltage control (global) schemes existing in power grids by a decentralized control, located a cell level. Each cell is responsible for its own voltage control while a close coordination between cells guarantees the provision of PPVC service between neighbouring cells” [11].

**Table 6-11 Information Exchanged future post-primary voltage control. Source: [11]**

Information Exchanged			
Information Exchanged ID	Name of Information	Description of Information Exchanged	Observable
I_01	OPF information	PPVC reserves information (contract, location, responsibility) Cell topology Generation and consumption	Cell topology, voltages, currents, active power and reactive power.

Information Exchanged			
Information Exchanged ID	Name of Information	Description of Information Exchanged	Observable
		forecast Measurements of controllable devices (voltages, currents, active and reactive power) Voltage and reactive power limits	
I_02	Real-time measurements to monitoring system	Voltage measurements Reactive power outputs and flows	*
I_03	Real-time measurements to Control system	Voltage measurements Reactive power outputs and flows	
I_04	Real-time measurements receipt by Control system	Confirmation message Status signal	
I_05	Error calculation	Voltage set-points Voltage measurements	
I_06	Availability check	Availability signal	
I_07	Availability status	Status signal	
I_08	Availability check	Congestion signal Availability signal	
I_09	Availability status	Status signal	
I_10	Select PPVC providers	Available PPVC resources PPVC reserves information (contract, location, responsibility)	
I_11	Re-dispatch	PPVC reserves information (contract, location, responsibility) Cell topology Generation and consumption forecast Measurements of controllable devices (voltages, currents,	

Information Exchanged			
Information Exchanged ID	Name of Information	Description of Information Exchanged	Observable
		active and reactive power) Voltage and reactive power limits Congestion constraints	
I_12	Activation of PPVC reserves	Voltage set-points	
I_13	PPVC provision	Confirmation message	
I_14	Activation of PPVC reserves	Voltage set-points	
I_15	PPVC provision	Confirmation message	
I_16	Select PPVC providers	Available PPVC resources PPVC reserves information (contract, location, responsibility)	
I_17	Re-dispatch	PPVC reserves information (contract, location, responsibility) Cell topology Generation and consumption forecast Measurements of controllable devices (voltages, currents, active and reactive power) Voltage and reactive power limits Congestion constraints	
I_18	Activation of PPVC reserves	Voltage set-points	
I_19	PPVC provision	Confirmation message	

*\* In the table there are many information exchanges that are seemingly identical, and some that are a subset of others. What they have in common is that they can be obtained from a state estimator. In summary the post primary voltage control uses observables obtained from a state estimator.*

### 6.3.2.8 Conclusions drawn from D3.1

Generally, D3.1 presents the use cases in a structured manner, making it relatively simple to derive observables from the proposed control schemes. However, in comparison to present practices the observables remain mostly the same. This is most likely due to the fact that it is high level use cases that are not very much concerned with the components involved. It is believed that further observability needs will be discovered in subsequent tasks where one is more concerned with specific implementations. In particular one would expect that some work is needed to calculate the availability of all the intermittent resources introduced to the system. Furthermore, one can say that the observables are defined based on the services so if the services are similar the observables will be similar.

The next figure shows the identified observables for the different control types. It is worth noting that most of the control types do not use the same observables. There may be different reasons for this; one reason may be that the use cases are written at somewhat different levels of detail.

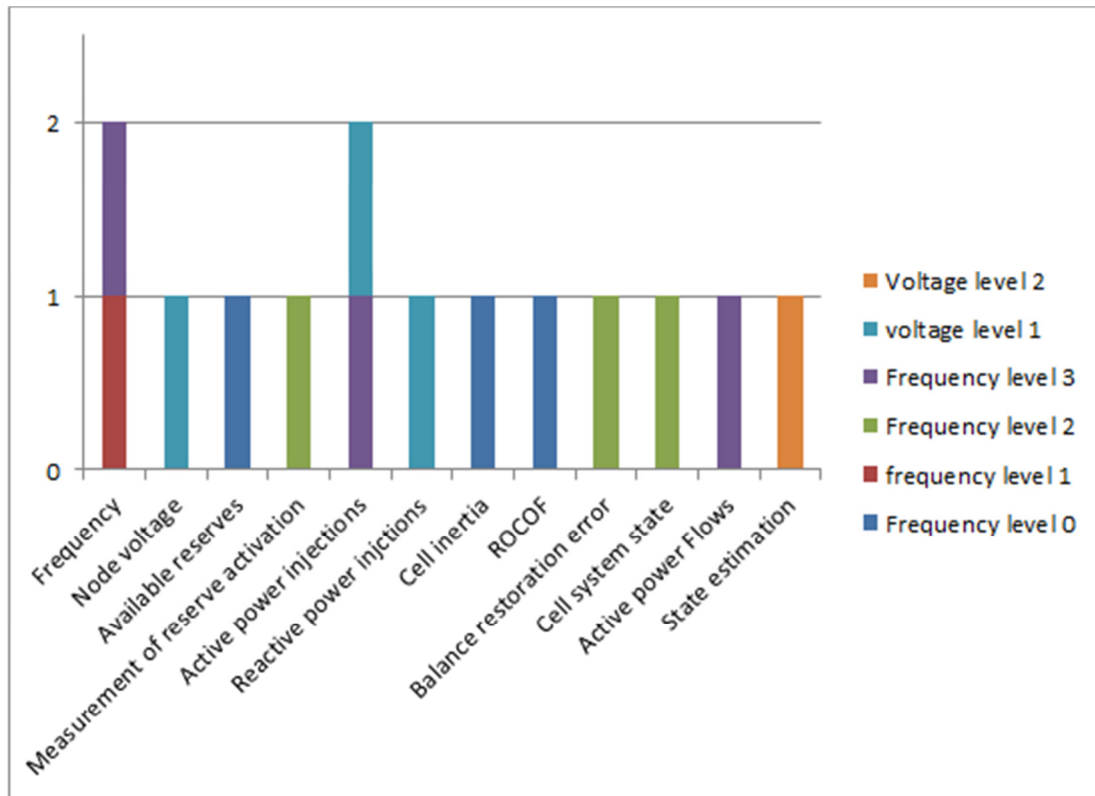

Figure 6-19 Comparison of observables for different decentralised control types.

### 6.3.3 Summary of conclusions drawn from Use Cases in R3.1 and D3.1

Even though, R3.1 and D3.1 suggest different architectures the identified observables are more or less the same. The reason for this is most likely the fact that they are both dependent on the same future scenario. This means that they are two answers to the same challenges. Consequently, one cannot expect to derive fundamentally different observables from the high level descriptions. This point is further emphasized in the summary where the observables identified in the different chapters of this report are compared.

## 7 Identification of observability needs

### 7.1 Principal requirements for the Power System

To determine the observability needs in future power systems. It might be useful to consider the requirements for power systems. These requirements are met through elaborate control schemes, which rely on the system observability. Consequently, the power system requirements can aid in deciding if expected changes in the future power system implies new observability needs. Below are stated the power system requirements [2].

- The system must be able to meet the continually changing load demand for active and reactive power.
- The system should supply energy at minimum cost and with minimum ecological impact.
- The “quality” of power system supply must meet certain minimum standards with regard to the following factors:
  - constancy of frequency
  - constancy of voltage
  - level of reliability

Even though the requirements on the level of quality of power system supply might change in future power systems, the different classes of power system requirements are not expected to change. One example is that many components can only tolerate a certain deviation in frequency or voltage. The tolerance may change in the future; however, this aspect is expected to remain.

### 7.2 The existing observability practices (Survey)

To get an overview of the observables in use today it was decided to conduct a short survey among participants of the ELECTRA project. The idea was not to make a detailed and comprehensive overview, but to get a broader reference picture of what is in use today and to aid the work on deciding future needs.

The survey was conducted by distributing a simple questionnaire, which project partners were requested to fill out. Different partners chose different approaches to fill out the tables. Some chose to fill out the tables based upon own experiences, and others used industry contacts.

In total eight partners responded. This is not enough to draw general conclusions on existing observability practices throughout Europe. However, it is more than enough to conclude that a certain observable is in regular use at least in one or some countries. This is also in line with the rationale behind this simple survey.

**Table 7-1 Observables in use today in distribution networks**

Observable	Comment
Current MV-level	Most respondents responded that current is measured at the MV level, both at HV/MV transformers and MV/LV transformers. Some countries also measure the current at connection points for industrial customers. It varies from country to country whether or not it is a three phase measurement or if the power factor is measured.



Observable	Comment
Voltage MV-level	Mostly measured at HV/MV transformers, and MV/LV transformers. Just as with the current it varies whether or not all the three phases are measured. Some also report that voltage is measured at points of special interest.
Active power MV-level	This is mainly measured at HV/MV transformers. When it is measured at MV/LV transformers it is mainly used for billing purposes. It is also measured for distributed generation resources. In addition to using power measurements for billing purposes they are also used as input for load and generation forecasts.
Reactive power MV-level	Reactive power is mostly reported to be measured at HV/MV transformers, and at connected distributed generation units.
Reactive power compensation of capacitor banks	Some countries report that reactive power compensation is measured at LV level and at primary substations
Position of switches	Most respondents reported that the position of switches are measured at both LV and MV level
State of fuses	One respondent reported that the state of the fuses at LV level is measured
Current LV level	Half of the respondents reported that the current is measured at LV level, some of them reported that these measurements were available for some busbars and substations
Voltage LV level	Two respondent reported that voltages are measured for some points at LV level, but that extensive use is planned
Frequency	One respondent reported that frequency is measured

From the results on the present observability practices in distribution networks it is clear that the **observability decreases as the voltage level decreases**. Defining reasons for this was not the intention of the survey, but one can assume that the distribution grid has been designed so it doesn't need a lot of measurements for its operation (design case is estimated maximum load plus some margin) and that it is mainly passive operated as open loops. The DSOs seem to be most concerned with what happens at the HV/MV connection points as well as where power plants or large customers are connected.

**Table 7-2 Future observables for distribution networks**

Observable	Comment
Voltage, active and reactive power flows at LV transformers	These measurements are to some extent in use, but only in test pilots.
Rate of change of frequency (ROCOF) at (Point of Common Coupling) PCC	Can be used for islanding detection in microgrids

Observable	Comment
Voltage for batteries/Pressure for Hydrogen tanks	SOC (state of charge) estimation for possible storage units

As could be expected from the table reporting observables in use in today's distribution system, the observability at lower voltage levels are expected to increase. In addition some observables for microgrids and storage units are expected. The observables that most often were reported as possible, but not in use are position of taps in tap-changing transformers and position of switches.

**Table 7-3 Observables in use today in transmission networks**

Observable	Comments
HV/MV at key nodes	To make sure that the voltage is within its limits
Active and Reactive Power flows at key intersections	To identify if there are network congestions or if the system is N-1 secure the power flows in lines need to be known
Transformer tap changer position	To regulate the voltage by using tap changers
Generation active and reactive power	The state estimator needs to know the power injections to estimate the system state
Water inflow and level	For water inflow forecasting, HPP/CHP production optimization, and reserves estimation
State of reactive power compensators (shunt capacitors and reactors)	For HV level regulation
Position of switches and disconnectors	For grid topology estimation and monitoring
Transformer oil humidity and gas concentration	Monitor the status of the transformers
Wind speed and direction	WPP production forecasting
The outdoor temperature	For electric and heat consumption forecasting, production optimization (CHP)
Frequency	To make sure that the frequency is within its range in the future

For the transmission system most respondents reported similar practices. One reason for this might be that the TSOs have to apply to grid codes developed by ENTSO-E. With respect to future observability practices some TSOs reported that they are testing PMUs, which might be part of future observability practices.

### 7.3 Limitations of the existing practices

Even though one should refrain from drawing too general conclusions from such a small survey, it is evident that there are some general traits among the countries involved in the ELECTRA project. The most obvious trait is that **the observability increases with the voltage level**. This may, however, change in the future. As were pointed out by most of the respondents, most countries have plans for increasing the observability at lower voltage levels.

## 8 Observables and their parameters

To aid the work in identifying relevant observables, to meet the observability needs, as well as to help distinguishing observables from each other, it is useful to define some physical parameters for the observables. These will be used to map observables and observability needs as well as to provide guidance for the requirements of the observables that will have to be developed.

### 8.1 Physical requirements for the observables

Physical requirements for the observables define more specifically quantifiable physical attributes, which are necessary in order to meet the observability needs. The following physical requirements have been identified:

- **Required time resolution (sampling frequency):** number of samples obtained in one second. This requirement can be described as a min value.
- **Maximum latency allowed:** for data or data transfer from source to destination. This requirement can be described as max possible period of time. Several observability needs have to be met within a certain time period and may become worthless if not.
- **Reference location according to the network's voltage level (HV; MV; LV or more specific).** The reference location, where the observability has to be met. It does not necessarily mean that the actual measurements have to be done in the same place. The observability can be derived based on measurements in other places or/and calculations. This applies to local observables and may be irrelevant in case of global observables as for example frequency.
- **Reference location to the network's topology** (specific network components). It does not necessarily mean that the actual measurements have to be done in the same place. The observability can be derived based on measurements in other places or/and calculations. This applies to local observables and may be irrelevant in case of global observables as for example frequency.
- **Time stamp:** For many observables it is important to know with ample detail when they were observed.
- **Accuracy:** the closeness of computations or estimates to the exact or true values [13]. Inaccuracies of measuring the “true” variable values due to the fallibility of the measuring instrument, data entry errors or respondents error are defined by measurement error value [17].
- **Reliability:** extent to which a variable or a set of variables is consistent in what it is intended to measure. If multiple measurements are taken, the reliable measures will all be very consistent with in their values.[17]

Additional physical requirements for the defined observability needs have been identified. Meeting these requirements however can be optional since these are not directly related to operation.

- **Requirements to the communication channel** which would be necessary to meet, including:
  - requirements of bandwidth and latency
  - communication privacy
  - availability of the communication

- **Where to be used:** weak or strong grid and specific topology characteristics

## 8.2 Descriptive observable parameters

Descriptive parameters of the observables are non-quantifiable attributes of the observables.

- There are several possible ways to define levels of development and deployment of different technologies or observables in this context. For the sake of simplicity the study suggests using standard well-defined Technology Readiness Levels (1-9) [19].
- Unique measurement value / Calculated values
  - Term “Unique measurement value” in the present context refers to observables, which are solely based on measurements without computations as for example DC voltage.
  - Term “Calculated values” in the present context refers to observables, which are based on computation of one or several several measurements, based on a given function (-s).
- Relation to control aim (ref. [20] Observables inventory survey)

## 8.3 Mapping of observability needs to physical requirements

To get an overview of what the requirements on the future observables are, a mapping of observability needs to physical requirements were conducted. This was done in a process consisting of two steps:

- First, the relationship between the control levels defined in Section 4 Observability Fundamentals and the control types in R3.1 and D3.1 are explained. By doing this, some general conclusions on the requirements on the future observables can be drawn.
- Second, the identified observability needs are translated into observables and relevant requirements. This also provides a link between the control triples, observability practices and observability needs.

In the next table the relation between the control levels, the relevant times and the control types are provided. Definitions for the transition time, dead time and time resolution for the purpose of this project are given in Table 4-3 “Definitions of time quantities”. The dead time and the time resolution can be seen as general upper bounds for observables within the same control level. There may be individual differences for observables within the same control level; however, these will have to be determined through testing later on in the project. The dead time, which gives the time from a switching event to a noticeable change in the power system state, provides a logical upper bound for the time latency. The rationale being that if the latency is so high that the system state changes before the observable is delivered, then the observable is already invalid. The time resolution is merely the inverse of the required sampling frequency and provides its general bound.

**Table 8-1 Time requirements for different control types.**

Control level	Transition time	Dead time	Time resolution	Control types	
				Centralised architecture (R3.1)	Decentralised web-of-cell architecture (D3.1)
0.System response	5 s	1 ms	1 ms	System inertia response	Total inertia response
1.Primary Level	30 s	10 s	1 s	Inertia Control	Cell inertia support
				Primary frequency control	Frequency containment control
				Primary voltage control	Primary voltage control
2.Secondary Level	120 s	30 s	10 s	Inertia restoration	Cell inertia restoration
				Secondary frequency control	Balance restoration control
				Secondary voltage control	Post primary voltage control
3.Tertiary Level	900	5 min	1 min	Inertia scheduling	Cell inertia scheduling
				Tertiary frequency control	Balance steering control

ENTSO-E also enforces some requirements on the frequency control both with respect to the observing and controlling the system. The requirements from the Load-Frequency Control and Performance Policy [18].

**Table 8-2 ENTSO-E requirements for frequency control. Source: [18].**

Control type	Accuracy	Time resolution
Primary frequency control	10 mHz	1 second (strongly recommended) to at most 10
Secondary frequency control	between 1.0 mHz and 1.5 mHz	10 seconds
Tertiary frequency control	-	-

The policy also specifies more requirements not covered in the present study.

As earlier mentioned the control levels classification only provides an upper bound for the observable requirements. It is outside the scope of this task to precisely specify these requirements. However, a guidance on which requirements to study further is given. The approach used is to investigate the identified observability needs for future power systems. These contain needs that can be interpreted as:

- needs for new observables or
- modifications of requirements on existing observables.

The results are presented using the tables from Section 6, additional columns for suggested observable and most relevant requirements.

## 8.4 Mapping of observability needs and requirements

As it was explained in the beginning of Section 6, the following mapping is essentially based on results of R3.1 and will be further elaborated in the succeeding tasks.

### 8.4.1 Primary frequency control

Observability needs for primary frequency control

The primary frequency control corresponds to local, automatic control action that adjust the active power output of the responsible generating units in direct response to measured frequency variations and with the indirect impact of restoring balance between load and generation. In order to secure safe system operation the system operator must have adequate reserve at its disposal. The reserve to be utilized by the primary control should be uniformly distributed around the system to prevent overloading tie-lines between cells and/or transmission corridors. An interconnected system requires coordination so the requirements regarding primary control are subject to the agreements between partners cooperating in a given interconnected network. Coordination of primary reserve control for existing networks is under the responsibility of TSOs. Due to large scale integration of Distributed Generation Sources (DGs) expected in future electrical networks DSOs will be assumed to be responsible from primary frequency control as well.

**Table 8-3 Observability needs for TSOs.**

Observability needs	Challenges	Observable	Requirements
1. Availability and location of spinning reserves	Synchronous generating units are capable of controlling their active power output according to the frequency deviations. Total primary frequency reserve capacity of synchronous generating units are larger than the primary frequency control reserve need of a power system.	Availability: -Available locations -Available active and reactive powers	Sampling frequency, time latency, physical location
2. Monitorable primary frequency control	Total primary frequency control reserve need may be distributed to synchronous generating units which are in service. In this case, primary frequency control reserve is so small that monitoring of primary frequency control is difficult. To monitor the primary frequency control, primary frequency control reserve of a generating unit must be larger; hence, some of the generating units can participate in primary frequency control.	-Frequency deviation -Available locations -primary frequency control reserve of generating units	

**Table 8-4 Observability needs for DSOs.**

Observability needs	Challenges	Observable	Requirements
Availability and location of active power reserves	Some sort of DGs cannot provide reserve since they are operated at maximum power available such as PV sources. Although wind turbines are also operated at their maximum power their limited spin reserve can be available for primary control. Other DGs such as microturbines, fuel cells and storage units can provide reserve but their speed of response need to be analysed for conformity as primary reserve sources.	Availability: -Available locations -Available active powers	Physical location, sampling frequency, time resolution

### 8.4.2 Primary voltage control

The task of the primary voltage control (automatic voltage control) is to control the reactive output from a device to prevent voltage collapse and is achieved by automatic and fast control, so that the voltage magnitude is kept at or close to the set value of the controller. Usually the node of the controlled voltage is at the same or very close to the node of the reactive device, since reactive power is a fairly local quantity. The set values for the voltage controllers are selected so that the desired voltage profile of the system is obtained. Balancing the reactive power via AVRs and other devices can be considered a local control action. Hence in case of a disturbance, the devices



electrically nearby will try to compensate the reactive power needs. This may result in unacceptable voltage values and an uneven reactive power distribution over the generators. This creates the need of a coordinated adjustment of the set points of the reactive power suppliers [16].

It is assumed that primary voltage control operation will be carried out by both TSO and DSO in the future operation.

**Table 8-5 Observability needs and requirements with respect to TSOs.**

Observability needs	Challenges	Observable	Requirement
1.Availability of primary voltage control	To estimate reactive power output capacity from devices (static and dynamic reactive power sources which are controlled by the TSO).	Status, power output of the resource and availability of reactive power	Reference location to the network's topology, sampling frequency and latency
2.System state	To estimate generated reactive power from transmission lines and for short term transient voltage stability analysis.	Status of switches and line flows	Reference location to the network's topology, time stamp
3.HVDC (VSC and CSC), FACTS (SVC and STATCOM) operational states	Track the position of these devices and their operating points to estimate the margin left for these devices.	Operating points of HVDC and FACTS devices	Physical location, sampling frequency, and latency, time stamp
4.New technology flexibility	Significant growth of information and data exchanges increase needs in data centers/servers/hubs. Such kind of consumption can bring new possibility of regulation and provide local ancillary services with fast response.  Track the position of consumption and their operating points to estimate the up/down margin	Consumption load and flexibility	Physical location, sampling frequency, latency, time stamp

**Table 8-6 Observability needs and requirements with respect to DSO's**

Observability needs	Challenges	Observable	Requirement
1. Availability of primary voltage control	To estimate reactive power output capacity from devices receive information about location and available capacity from aggregators, distributed generators, RES, consumers who have the voltage control ability.	Status, power output of the resource and availability of reactive power	Reference location to the network's topology, sampling frequency and latency

Observability needs	Challenges	Observable	Requirement
2. System state	To estimate generated reactive power from cable line significant reactive power generation with/without compensation devices	Status of switches and line flows	Reference location to the network's topology, time stamp

### 8.4.3 Secondary frequency control

Traditionally, the secondary frequency control, aiming to restore within a few minutes the system frequency in the synchronous area by releasing system-wide activated frequency containment reserves, is performed by large conventional power plants, connected to the high-voltage transmission system. It is mainly the responsibility of the TSO. In the new scenario, a high penetration of RES will force the secondary frequency regulation to compensate for fast ramps. The imbalance between generation and demand in both directions (upwards and downwards) is faced by using frequency response services over very short time frames (seconds and minutes) The services could be provided by PV and wind power plants, coupled with storage devices and demand side providers.

**Table 8-7 Observability needs and requirements with respect to RES.**

Observability needs	Challenges	Observable	Requirement
1. Increased need for data collection	If in the future smaller units tend to participate in this control, it is necessary that the participation of these units in the secondary control can be verified.	Power and frequency	Sampling frequency, reference location to the network's topology and time stamp
2. Availability of secondary RES reserves	Information will be provided by the market to the TSO. It is important that these services are reliable to the TSO. The time aspect plays an important role, since the impact of these units will be more challenging to estimate.	Availability : power output within a certain timeframe	reference location to the network's topology and time stamp.

**Table 8-8 Observability needs with respect to DSOs.**

Observability needs	Challenges	Observable	Requirement
1. Real-time availability of distributed secondary reserves	The DSO's will become more responsible in maintaining the balance in the distribution grid. Therefore this requires a detailed knowledge of the power output,	Status, power output of the resource and availability within the timeframe	Increased power measurements in the distribution grid, increased sampling frequency, 'ready-to-

Observability needs	Challenges	Observable	Requirement
	availability of resources that will or will not be participating to the secondary control		start' signal ?
2. Data collection as input to the forecasting algorithms	Integration of weather and geographical data to have more reliable forecastings of availability	Forecasting	
3. Real - time power flow measurements in the MV- grid and to injections at the LV-grid	These measurements are needed to regulate the balance locally. This requires more integration of measurement devices with the sampling frequency high enough and the latency in the data transfer acceptable	power flows in the MV-grid and power injections to the LV-grid	Integration of measurement devices and the role out of the communication infrastructure.

#### 8.4.4 Secondary voltage control

The secondary voltage control, acting to restore the voltage profiles to the required values within a region, by minimizing the circulation of reactive power flows and maximizing reactive reserves, is the role of the TSO and the DSO. At transmission level, it is achieved by controlling the voltage at certain pilot nodes. The role of the DSO is to keep the voltage at the regulated values and determine the adequate reactive power reserve to support this service, and to assist the TSO. In the future, due to the presence of more distributed generation at the MV-level, the reactive power control in the distribution grid will become an important aspect for amongst others the voltage control of the transmission grid.

**Table 8-9 Observability needs and requirements with respect to DSO.**

Observability needs	Challenges	Observable	Requirement
Availability of RES who can participate in MV-voltage control	In the future, more distributed RES will participate in the secondary voltage control, but their presence and availability must be tracked, and the injected reactive power in the grid. The DSO needs to check whether or not the RES-unit can manage to keep it's voltage setpoint.	Availability, injection of reactive power	Measurement of reactive power and voltage at the RES-unit
2	In order to optimize the fixed assets that contribute to the secondary voltage control, such as capacitor banks and synchronous compensators, with respect to other units that participate in the secondary control, the DSO must track the position of these devices and there operating points to estimate the margin left for these devices.	Tap changer positions, number of steps of C-banks that participate, operating points of FACTS devices.	Signals from the devices indicating their states.

### 8.4.5 Tertiary frequency control

In the process described in [6] tertiary control as seen from the TSOs perspective will remain almost unchanged. The main difference is further diversification of the resources involved into the tertiary regulation. The following providers are expected to be involved into the process:

- Central storage providers
- Renewable Energy Sources on different voltage levels
- Consumers on different voltage levels
- Combination of the above mentioned, acting as a single controllable entity i.e. microgrids

The introduction of more renewables and the contribution from DSOs will require more advanced forecasting and scheduling algorithms. With traditionally large scale central units the tertiary reserve is more or less guaranteed after contractual agreements have been made, assuming that no unforeseen problems occur. The amount of tertiary reserves that RES and DSOs can provide is merely an estimate; due to this the following new needs are identified:

**Table 8-10 Observability needs and requirements with respect to RES.**

Observability needs	Challenges	Observable	Requirement
1. Increased need for data collection as input for the forecasting algorithms.	The forecasting algorithms will have to couple weather and loading data. This increases the need for correctly time stamped data.	Power consumed and power produced	Sampling frequency, reference location to the network's topology and time stamp
2. Availability of RES tertiary reserves.	According to the requirements specified in R3.1 this information is provided to the TSOs by the market operator; meaning that change when it comes to observability as far as the TSOs are concerned is merely the increased importance of availability data. The observability needs related to the estimation of the availability data is explained in the relevant sections at a later stage.	Availability of RES tertiary reserves	Reference location to the network's topology, sampling frequency and latency
3. Geographical distribution of RES and DSO tertiary reserves.	According to the requirements specified in R3.1 this information is provided to the TSOs by the market operator; meaning that change when it comes to observability as far as the TSOs are concerned is merely the increased importance of availability data. The observability needs related to the estimation of the availability data is explained in the relevant sections at a later stage.	Power injections from RES and DSOs into transmission networks	Reference location to the network's topology, sampling frequency and latency

Observability needs	Challenges	Observable	Requirement
4. Increased accuracy	If tertiary reserves are to be remotely activated by the TSO there will in general be higher requirements for the observed data.	This need reflects a general need for higher accuracy	accuracy
5. Increased time resolution	If tertiary reserves are to be remotely activated by the TSO there will in general be higher requirements for the observed data.	This need reflects a general need for higher time resolution or event-based increase of the resolution	time resolution

In the requirements specified in R3.1 it is stated that the TSO also needs information on availability and geographical distribution of DER, which it shall receive from the DSOs. From the TSOs' perspective it would be better to view the DSOs as aggregated elastic loads that bid into the market rather than having to deal with their inner workings such as the geographical distribution of the DSOs' DER.

Several European countries are already using the big-scale consumption side as a reserve for the tertiary or even secondary frequency balancing (see [6]). The increasing demand for the regulation reserves and cost considerations will gradually reduce the size of the involved customers. Depending on the size of the involved RES and consumers' units, they can be involved directly or via Aggregators. In the writing moment it is difficult to assign this role to any particular actor (-s). The future involvement of DSO, for example, is under discussion in [3] and [23].

The nature of the consumption side makes it difficult to have firm contractual terms for provision of the DR. Preliminary result from demonstration project applying DR and RES for balancing purposes (as for example EcoGrid EU, see Section 12.1) show that prediction of the response volume or availability of the DR related resources seem to be one of the main challenges. It is complicated to model and forecast the response without close to real time information about state of the Distribution Network.

Even though Smart Metering can register consumption with resolution five minutes or even more often, the latency of the used communication solution does not allow using it for this purpose very efficiently in the writing moment. However, if the study assumes that the present technical limitations can be neglected, Smart Metering can be applied for observability purposes.

**Table 8-11 Observability needs and requirements with respect to DSOs**

Observability needs	Challenges	Observable	Requirement
1. Availability of tertiary reserves	To operate the distribution network aggregators will need to know the availability of reserves provided both by DER and aggregators	Availability of tertiary reserves	Physical location, sampling frequency and latency

Observability needs	Challenges	Observable	Requirement
2. Geographical distribution of the tertiary reserves	If the loads and DER are to participate as reserves the geographical distribution of the loads are needed. In particular with respect to potential network congestions	Power injections of distributed tertiary reserves	Physical location, sampling frequency and latency
3. Voltages in the distribution grid	Increased bi-directional line flows in the distribution grid due to demand response and DER might lead to voltage issues	Voltages in the distribution grid	Physical location, sampling frequency, latency and stamp
4. Line flows	Increased bi-directional line flows in the distribution grid due to demand response and DER might lead to voltage issues	Line flows	Physical location, sampling frequency and latency
5. Data collection as input for the forecasting algorithms.	The forecasting algorithms will have to couple weather and loading data. This increases the need for correctly time stamped data.	Meteorological data used as input to operators and forecasts(not an observable by our definition)	Physical location, sampling frequency

The relevant discussion for aggregators is mostly the same as for the DSOs. In fact the DSOs might even act as aggregators. The observability needs are, however, different as the aggregator needs rather detailed knowledge for each particular customer.

**Table 8-12 Observability needs and requirements with respect to Aggregators.**

Observability needs	Challenges	Observable	Requirement
1. Prosumers' real time load and flexibility	To participate in the market the aggregators will have to know the flexibility of the loads, as well as how much load there is at any given moment	Prosumers' load and prosumers' flexibility	Physical location, sampling frequency, and latency, time stamp
2. Geographical distribution of the reserves	The aggregators may not be operating the networks, but they will have to provide the geographical distribution of the reserves to the operator.	Same observable as above	
3. Data collection as input for the forecasting algorithms.	The forecasting algorithms will have to couple weather and loading data. This increases the need for correctly time stamped data.	Meteorological data used as input to operators and forecasts(not an observable by our definition)	Physical location, sampling frequency, time stamp

### 8.4.6 Tertiary voltage control

Basically, Tertiary Voltage Control (TVC) is defined as the determination of set points for the secondary voltage controllers located at pilot nodes. It is assumed that tertiary voltage control operation will be carried out by both TSO and DSO in the future operation. Although TVC has similar observability for TSO and DSO, it is explained below respectively.

TSO is the first main actor executing Optimal Power Flow (OPF) and determining initial voltage and reactive power set-points for the secondary controllers and DSOs in its region. TSO interacts with conventional power plants, big customers and aggregators controlling flexible devices connected to its own transmission network for the tertiary voltage reserves.

**Table 8-13 Observability needs tertiary voltage control with respect to TSOs.**

Observability needs	Challenges	Observable	Requirement
1. Availability of tertiary voltage reserves	To plan the TVC reserve operation, TSOs needs to receive reactive power reserve information including location and capacity from aggregators, conventional generators and big customers.	Availability	Physical location, sampling frequency, time latency
2. Verify and control TVC service provider	TSOs needs to verify the status of the providers and monitor assigned providers whether or not they provides requested reactive power. Verification process can be a real time/near time or a subsequent verification after the measurement while monitoring process may be carried out either instantly or after the event.	Injection of reactive power	Physical location, sampling frequency
3. Input data for OPF calculation	<p>a. Network topology and system data (lines, protection devices, transformers, etc.) from SCADA. A state estimator may be used to get reliable results in case of missing data.</p> <p>b. Load and generation data of the network for the next day. It is assumed that generation and consumption data is known by the market mechanism (day-ahead market). On the other hand, forecasting activities may require in some cases to obtain better results especially for consumption data.</p> <p>c. Voltage control reserves and location information of the tertiary voltage reserve participants.</p>	State estimation	Physical location, sampling frequency, time latency, time stamp
4. Checking the voltage ranges in pilot nodes	The TSO monitors voltage values at the pilot nodes and reactive power flows at the connection points of DSOs in order to be sure that all voltage and reactive power limits are satisfied. This measuring may occur in every 15 (or 30) minutes.	Pilot node voltages, reactive power flows	Physical location, sampling frequency, time latency

Observability needs	Challenges	Observable	Requirement
5. Intraday periodic system data (same data as in 3)	If any voltage value at the pilot nodes extends beyond of the tolerance band, TSO executes OPF for determining new set-point values using additional tertiary voltage reserve market and new system data.	Pilot node voltages	Physical location, sampling frequency, time latency

The first two observability needs: availability of tertiary voltage reserves and verify and control TVC service provider, concern the “certification of tertiary voltage control service provider”. In other words they are related to market system of voltage reserves. Therefore, observables regarding in market structure (confirmation data, price based bids, etc.) may also be a part of tertiary voltage control observables.

While modelling the network for OPF calculation, TSO also needs active power information from each DSO connected to its network. In this manner, TSO is able to calculate the optimum reactive power flow for each pilot nodes and DSO.

DSO is the second main actor executing OPF and determining initial voltage set-points for the secondary controllers in its region. TVC operation in DSO is quite similar with the operation in TSO, but all points will be explained in this part anyway. In TVC operation, DSO interacts with renewable generation parks, battery banks and voltage regulators, DG units, DR flexibility providers, and aggregators controlling flexible devices connected to its own transmission network for the tertiary voltage reserves.

**Table 8-14 Observability needs tertiary voltage control with respect to DSOs.**

Observability needs	Challenges	Observable	Requirement
6. Availability of tertiary voltage reserves	To plan the TVC reserve operation, DSO needs to receive reactive power reserve information including location and capacity from generation parks, battery banks and voltage regulators, DG units, DR flexibility providers, and aggregators.	Availability	Physical location, sampling frequency, time latency
7. Verify and control TVC service provider	DSO needs to verify the status of the providers and monitor assigned providers whether or not they provides requested reactive power. Verification process can be a real time/near time or a subsequent verification after the measurement while monitoring process may be carried out either instantly or after the event.	Injection of reactive power	Physical location, sampling frequency
8. Input data for OPF calculation	a. Network topology and system data (lines, protection devices, transformers, etc.) from SCADA. A state estimator may be used to get reliable results in case of missing data.	State estimation	Physical location, sampling frequency, time latency, time stamp



Observability needs	Challenges	Observable	Requirement
	<p>b. Load and generation data of the network for the next day. It is assumed that generation and consumption data is known by the market mechanism (day-ahead market). On the other hand, forecasting activities may require in some cases to obtain better results especially for consumption data.</p> <p>c. Voltage control reserve and location information of the tertiary voltage reserve participants.</p> <p>d. The amount of reactive power flow between DSO and TSO at the MV/HV points, which is determined by the TSO tertiary voltage control center.</p>		
9. Checking the voltage ranges in pilot nodes	The DSO monitors the voltage values at the pilot nodes in order to be sure that all voltage and reactive power limits are satisfied. This measuring may occur in every 15 minutes (or 30 minutes?)	Pilot node voltages, reactive power flows	Physical location, sampling frequency, time latency
10. Intraday periodic system data (same data as in 3)	If any voltage value at the pilot nodes extends beyond of the tolerance band, DSO executes OPF for determining new $V_{set}$ values using additional tertiary voltage reserve market and new system data.	Pilot node voltages	Physical location, sampling frequency, time latency

The first two observability needs: availability of tertiary voltage reserves and verify and control TVC service provider, concern the “certification of tertiary voltage control service provider”. In other words they are related to market system of voltage reserves. Therefore, observables regarding in market structure (confirmation data, price based bids, etc.) may also be a part of tertiary voltage control observables.

Aggregator primarily groups and manages flexibility of a cluster of devices with the purpose to offer services to different power system participants.

**Table 8-15 Observability needs tertiary voltage control with respect to aggregators.**

Observability needs	Challenges	Observable	Requirements
11. Prosumers' real time load, generation and flexibility	To participate in the market the aggregators will have to know the flexibility of the loads and generation, as well as how much load and generation there is at any given moment	Active and reactive power injections	Sampling frequency, time latency, physical location

Observability needs	Challenges	Observable	Requirements
12. Geographical distribution and capacity of the reactive reserves	The aggregators may not be operating the networks, but they will have to provide the geographical distribution and capacity of the reactive reserves to the operator.	Same as above	Same as above

### 8.5 Conclusions drawn from mapping of observability needs and requirements

The mapping of observability needs and requirements has revealed that the most relevant needs are state estimation and the availability of reserves. This should come as no surprise given the ELECTRA scenario, which predicts a higher penetration of RES. As figure ref shows most of the needs point at observables that are already in use, however, the two observables that out have to be further investigated. The reason for this is that the observables available reserves and state estimation are dependent on the components of which the system consists.

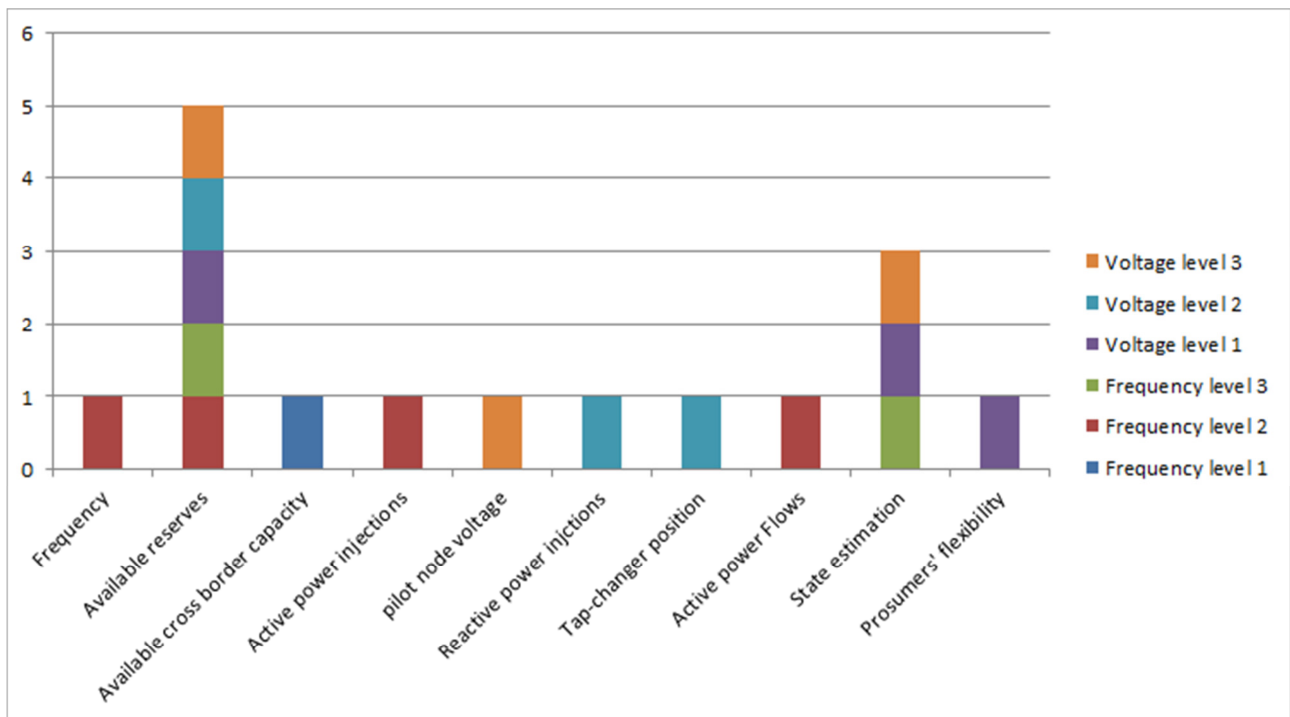

Figure 8-1 Observables for different control types.

## 9 Conclusions

### 9.1 The main concepts for the succeeding activities in WP5

The starting sections of the report define the main definitions and formal framework for the whole WP5 "Increased Observability" and conclude that the work should be based on two proposed concepts: Control Triples and Single Reference Power System.

### 9.2 Similar observables in two different functional architectures

The present study is based on two alternative approaches for the future control systems: centralised and decentralised architecture, which have been described in WP3 of the present project. While the first proposes a gradual evolution of the traditional centralised controls, the second architecture is based on a novel concept, which was coined web-of-cells by ELECTRA. In order to explore differences between these two alternative architectures, especially with regard to observability, a comparative evaluation of information exchanges in different control schemes has been conducted.

Despite significant differences in these two architectures, the identified observables appear to be very similar. The reason for this is most likely the fact that they are both dependent on the same future scenario. This means that they are two answers to the same challenges. Consequently, one cannot expect to derive fundamentally different observables from the high level descriptions.

### 9.3 Present observability practices are not adequate for the expected transformation of the power sector

In order to get a broader reference picture of what observability is in use today the task made an overview of the existing practices. The overview is based on a simple questionnaire collected from eight European countries. The main lessons learned from the questionnaire are:

- Practices for Observing of the Transmission Networks are quite similar (most likely due to compliance with ENTSO-E's requirements). Very little variation among countries.
- Observing of the Distribution Network varies from country to country and in general is limited i.e. "observability decreases as the voltage level decreases"
- DSOs seem to be most concerned what happens at HV/MV connection points, connection of big customers.
- Most participating countries had intentions for improving observability of the distribution grid
- The present practices for observing both Transmission and especially Distribution networks are not adequate for the expected transformation of the power sector in order to meet the European 20/20/20 goals

## 9.4 Growth of RES and use of DR schemes create new observability needs

The mapping of observability needs and requirements has identified a comprehensive list of the emerging observability needs. It is however necessary to mention specifically that the most relevant needs are state estimation and the availability of reserves.

## 9.5 Summary of observables identified in the different studies

Throughout the work leading to this report various studies have been performed to identify relevant observables for the future power systems. These observables are summarized in the next figure. The decentralized structure proposes some new observables such as:

- Cell inertia
- ROCOF
- Cell system state

However, new observables can be found in the centralised structure as well. In particular in the observability needs study, potential areas where observables should be developed, have been identified. The most obvious observable being prosumer flexibility. This observable also touches upon the aspects making the observability needs study relevant for both the centralised and decentralised futures. Although, the observability needs study where based upon a description of the centralised future, its focus was on the observability needs arising due to higher penetration of RES and introduction of new devices. These aspects are common for both architectures, as they are intrinsic to the ELECTRA scenario. Consequently, the biggest changes with respect to the observability needs are expected to be due to the introduction of more RES, new actors and devices.

The most interesting observables to further investigate are obviously the observables:

- directly related to the cell concept
- the observables related to inertia control
- prosumers flexibility
- available reserves
- state estimation

The two last items on the list are directly related to the introduction of more RES , prosumers and new devices. The important questions being:

- How can the operator observe the amount of available reserves provided by RES and prosumers?
- How do new devices affect the state of the system?

It outside the scope of this task to develop these observables. However, these are the areas where subsequent tasks should put their focus to ensure that the ELECTRA visions are accomplished.

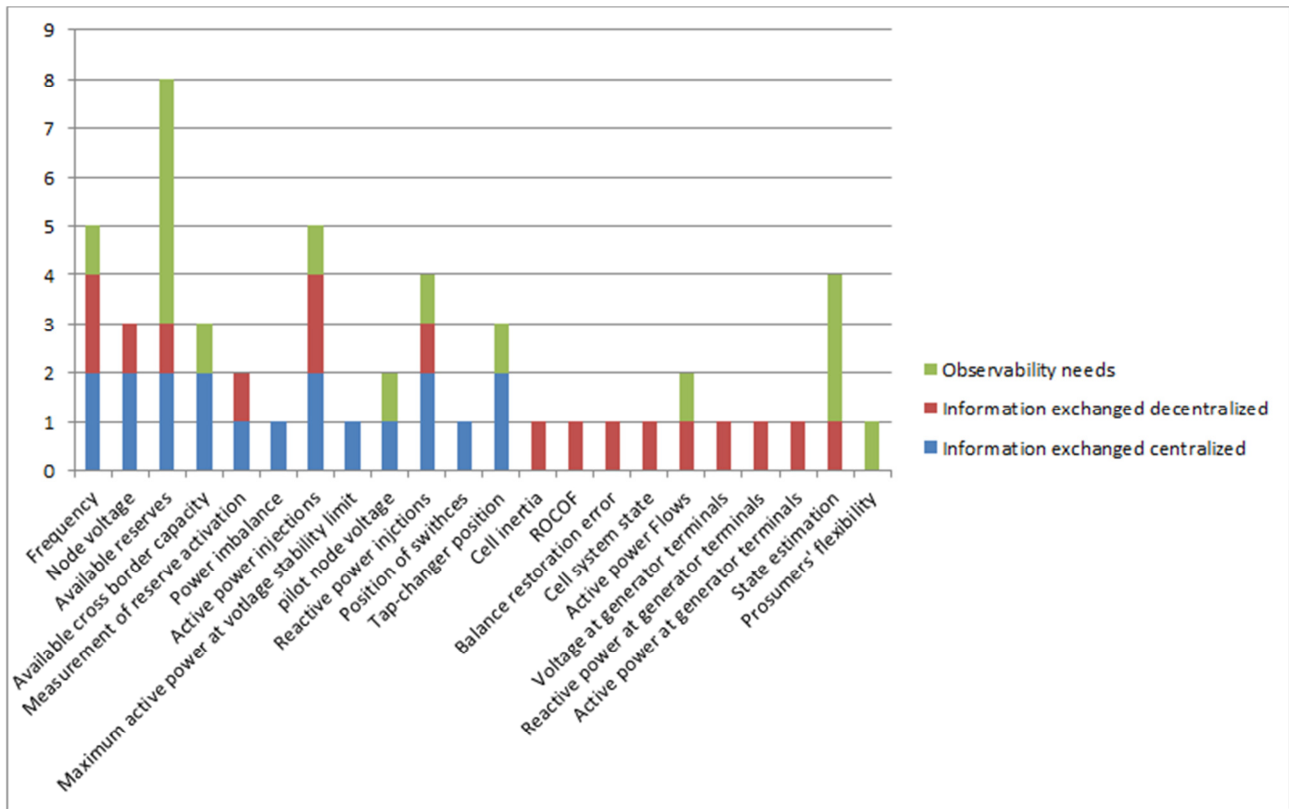

Figure 9-1 Overview of observables from the different studies.

## 10 References

- [1] <http://www.electrairp.eu> (ELECTRA IRP web site)
- [2] Kundur P., "Power System Stability and Control" McGraw-Hill Education, 1994
- [3] Flexibility: The role of DSOs in tomorrow's electricity market. EDSO for Smart Grids. June 2014.
- [4] ENTSO-E Network Code on Electricity Balancing (NC-EB) 2013-12-23
- [5] <http://www.e-highway2050.eu/>
- [6] Rodríguez Seco, J. M. et al. ELECTRA Internal Report R3.1 "*Problem Description: specification of the requirements for the overall Smart Grid Voltage and Frequency Control*". July 2014
- [7] ENTSO-E Network Code on Load-Frequency Control and Reserves (NC-LFCR) 2013-06-28
- [8] Tornelli C. et al. ELECTRA Internal Report R4.1 "*Description of the methodology for the detailed functional specification of the ELECTRA solutions*" September 2014
- [9] IEC/PAS 62559 ed1.0. Available from:  
[http://webstore.iec.ch/Webstore/webstore.nsf/ArtNum\\_PK/38920?OpenDocument](http://webstore.iec.ch/Webstore/webstore.nsf/ArtNum_PK/38920?OpenDocument)
- [10] IEEE Standards Dictionary: Glossary of Terms & Definitions
- [11] Caerts C. et al. ELECTRA Report D3.1 "*Specification of Smart Grids high level functional architecture for frequency and voltage control*" December 2014
- [12] CIGRE, "Benchmark Systems for Network Integration of Renewable and Distributed Energy Resources", July 2009.
- [13] Handbook on Data Quality Assessment Methods and Tools, European Commission / EUROSTAT, 2007
- [14] The EU 2020 climate and energy package
- [15] EU Energy Roadmap 2050  
[http://ec.europa.eu/energy/energy2020/roadmap/doc/com\\_2011\\_8852\\_en.pdf](http://ec.europa.eu/energy/energy2020/roadmap/doc/com_2011_8852_en.pdf)
- [16] Andersson G. "Dynamics and Control of Electric Power Systems", EEH - Power Systems Laboratory, ETH Zurich, February 2012
- [17] Hair J.F et al. "*Multivariate Data Analysis with Readings*" 4th Edition. Prentice-Hall International Inc. New Jersey 1995
- [18] Load-Frequency Control and Performance Policy  
[https://www.entsoe.eu/fileadmin/user\\_upload/library/publications/entsoe/Operation\\_Handbook/Policy\\_1\\_final.pdf](https://www.entsoe.eu/fileadmin/user_upload/library/publications/entsoe/Operation_Handbook/Policy_1_final.pdf)
- [19] Definition of Technology Readiness Levels (NASA)  
[http://esto.nasa.gov/files/trl\\_definitions.pdf](http://esto.nasa.gov/files/trl_definitions.pdf)
- [20] Visscher K. et al., PDF print of Google spreadsheet:

“20150117-Observables inventory survey”:

<https://drive.google.com/file/d/0B1uuSjXAFJovcnBPZHE4dEx4M0k/view?usp=sharing>.

- [21] Visscher K. et al., online Google spreadsheet: “20141103-Observables inventory survey”:  
<https://docs.google.com/spreadsheets/d/1W2dKNbEG4rGC4fa9snHaODWQDiynS5UOM7JtJ5LKlyk/edit?usp=sharing> .
- [22] The Wikibook of: “Control Systems and Control Engineering”  
[http://en.wikibooks.org/wiki/Control\\_Systems](http://en.wikibooks.org/wiki/Control_Systems)
- [23] ACER's Public Consultation on European Energy Regulation: A Bridge to 2025. April-June 2014.  
[http://www.acer.europa.eu/Official\\_documents/Public\\_consultations/Pages/PC\\_2014\\_O\\_01.aspx](http://www.acer.europa.eu/Official_documents/Public_consultations/Pages/PC_2014_O_01.aspx)
- [24] IEEE PES Examples of Distribution Test Feeders  
<http://ewh.ieee.org/soc/pes/dsacom/testfeeders/>
- [25] Radial Distribution Test Feeders  
<http://ewh.ieee.org/soc/pes/dsacom/testfeeders/testfeeders.pdf>
- [26] Webinar “Observables Inventory Survey” (video)  
<https://docs.google.com/file/d/0B5F9i09SSxQ5VkZtcW5Nc0E5Ykk/edit?pli=1>

## 11 Annex I Observability Fundamentals

### 11.1 Print of Observables spreadsheet

A print in PDF format of the Observables spreadsheet is provided in the document [20141103-Observables inventory survey](#). [20]



## 11.2 Observables Inventory spreadsheet

Anybody can view the [Observables inventory survey](#) [21] Google spreadsheet.

Everybody can place comments,

## 11.3 Webinar-Observables Inventory Survey

On the 4<sup>th</sup> July 2014 a Webinar was held to explain and demonstrate the Observables Inventory spreadsheet [26].

Link to the presentation video:

[20140703-ELECTRA-T5.1-Webinar-Observables Inventory Survey-View.mp4](#)

<https://docs.google.com/file/d/0B5F9i09SSxQ5VkZtcW5Nc0E5Ykk/edit?pli=1>

It lasts 25 minutes, and should directly run in your web browser (including Internet Explorer).

No download needed.

## 12 Annex II Overview over relevant projects

### 12.1 EcoGrid EU

#### 12.1.1 Full project name

EcoGrid EU: Large scale Smart Grid demonstration of real-time market-based integration of DER and DR

#### 12.1.2 Description

The EcoGrid EU project develops and demonstrates a near real-time market concept that is designed to incorporate small-scale distributed energy resources as well as flexible demand into the existing power system markets, balancing tools and operation procedures. The concept provides a market-based platform and information and communication technology (ICT) infrastructure that extends the current electricity market to a shorter time horizon and to smaller assets, including household customers. This core market concept is based on publication of near-real time prices with high (5 minutes resolution). The prices are published and streamed to the consumers via TCP/IP.

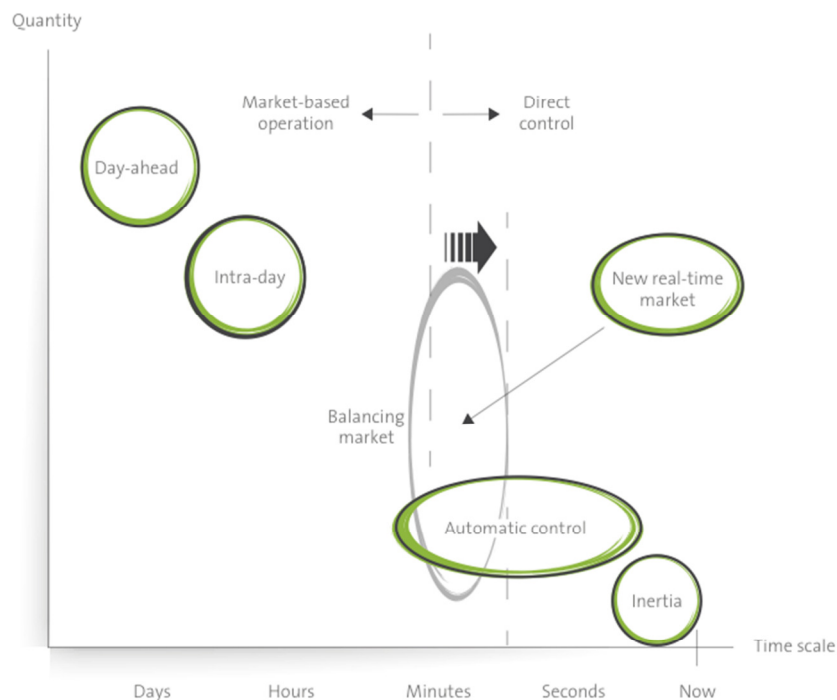

**Figure 12-1 EcoGrid EU New real-time market concept within the existing timeline. Source: EcoGrid EU.**

The idea is that the customers respond to the 5 minutes pricing increasing the demand-side market participation and thereby reduce the need for costly flexibility on the productions side or/and compensates for traditional balancing power and services from conventional generation displaced by RES.

The EcoGrid EU market concept is tested on Bornholm, where approximately 2 000 households participate in the demonstration.

### **12.1.3 Work specifically relevant for WP5**

Since the market is bidless, it is not necessary to verify whether customers' demand response has been activated or not. All participating customers are metered with 5 minutes resolution and invoiced based on combination of 5 minutes prices and corresponding consumption.

For EcoGrid EU market operator it is however necessary to make prognoses, showing dependency (elasticity) between generated real-time price and actual demand response from the participants. The challenge is that participating customers are not concentrated in a specific network area, but distributed around the island, making it difficult to measure aggregated changes in the consumption. Since this is a demo project and the customers' group is limited, it cannot substantially influence the system's frequency. The demand response feedback is estimated based on 5 minutes resolution metering (Landis+Gyr) of individual customers. The metered consumption data is transferred to the project's data warehouse 20 minutes after the operation time.

### **12.1.4 References and Relevant Documents**

- EcoGrid EU: From Design to implementation. A large scale demonstration of a real-time marketplace for Distributed Energy Resources. Project Report 2014.
- <http://www.eu-ecogrid.net/rss-feed/55-new-ecogrid-eu-report-from-design-to-implementation>

## **12.2 SYNC Project**

### **12.2.1 Full project name**

Frequency support and stabilisation by Virtual Synchronous Generators (VSG's)

### **12.2.2 Description**

#### ***12.2.2.1 Virtual Synchronous Generator operating principle***

The Virtual Synchronous Generator (VSG) operating principle is portrayed in the next picture (figure 1.2.2-A). The VSG is part of the power electronic converter, connecting a distributed generator to the main grid. It consists of a:

- bi-directional converter,
- small energy store,
- VSG algorithm.

The VSG algorithm controls the power flow between the grid and the energy store in such a way that it matches the electro-mechanical power flow between a synchronous rotating mass (like in a synchronous generator), and the grid.

When grid frequency rises, the virtual rotating mass has to speed up by the same amount, so power is drawn from the grid for a short time and stored. The opposite occurs when grid frequency falls. The virtual rotating mass has to spin down the same amount, resulting in a short lasting power flow from the energy store to the grid.

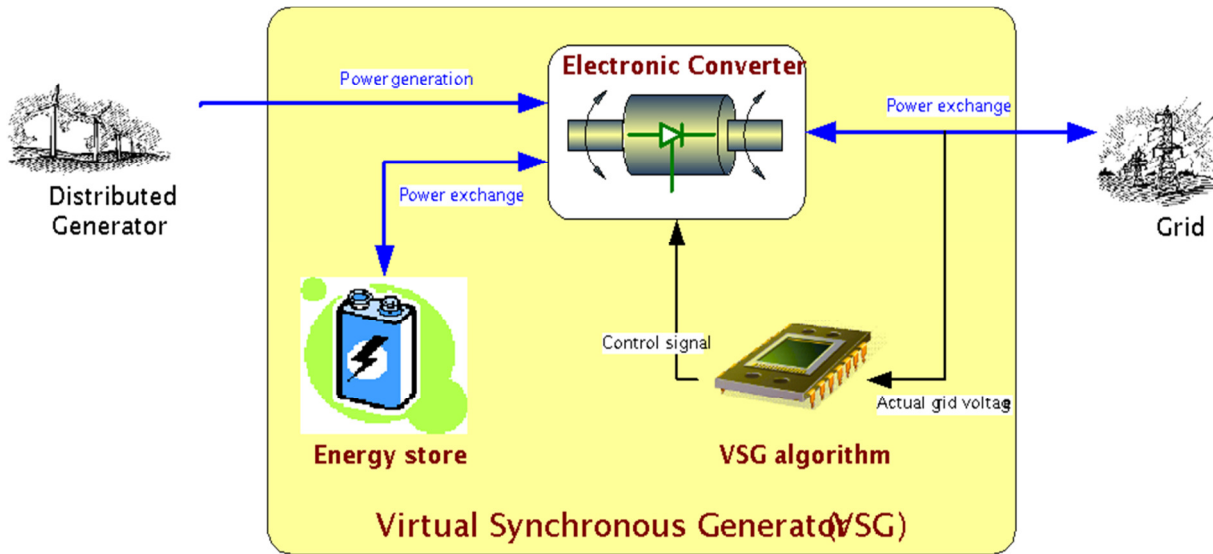

**Figure 12-2 VSG operating principle.**

An example histogram of calculated power flows for a 10KVA VSG is given in the Figure 12-3. As can be seen there, the averaged power is zero in normal operation, reflecting the continuous positive and negative power bursts between grid and energy store at constant averaged frequency. These power bursts counteract fast changes in grid frequency, thus making the power system more stable.

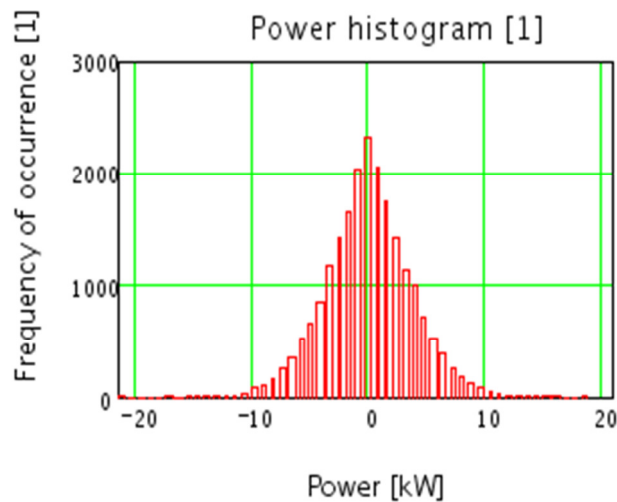

**Figure 12-3 Power histogram of a 10 kW ideally frequency-following VSG, calculated for 10 April 2008 (24 hrs, sample time 4s).**

**12.2.2.2 Essence of VSG Operation**

Distributed energy resources in general do not possess rotating inertial mass at all. In a future grid where a large part central generation is being replaced by distributed generation therefore has much less synchronous rotating mass compared to the grid as it is now.

The result is that the electro-mechanical time constant of the power system becomes shorter. In essence this means that frequency deviations during normal operation become larger and switching of major loads or generators or faults leads to large frequency and voltage swings. Thus

this future grid will be much more unstable and will suffer from frequent blackouts.

Virtual Synchronous Generators emulate rotating inertia for limited time intervals,

- with the aid of complementary control algorithms to sustain operation in case of faults or contingencies.
- thereby giving balancing algorithms, control and protection devices ample time to restore normal operation in the system.

By fitting every decentralised generator with a VSG, the electro-mechanical time constant of the power system is preserved when decentralised generation is added, resulting in smaller frequency deviations in normal operation and much smaller frequency and voltage swings as a response to faults and switching actions. In this way the stability of the power system is preserved.

Therefore in a power system with proper installations of VSG's, the penetration level of decentralised generation can become significantly higher than at present without compromising system stability.

#### ***12.2.2.3 Field test results***

VSG algorithms have been developed in labs at several partners in the European VSYNC project . Extensive testing was carried out at two test sites in the Bronsbergen, Netherlands and Cheia, Romania. Additionally, a field-like lab test was set up at Gastec, Netherlands. The partners involved have carried out successfully all demonstration activities as mentioned the grant agreement of the VSYNC project.

#### ***12.2.2.4 VSG action during load switching***

As a first example, the next picture show the frequency dampening effect of a VSG in the set-up at Gastec, The Netherlands. A load connected to an islanded generator is switched in intervals, causing severe frequency jumps and oscillations. When the inertial effect (virtual rotating mass) of a VSG is added, the oscillations are damped strongly, and the overshoot diminishes significantly. The resulting frequency deviation is caused by the absence of a droop control algorithms, that was intentionally switched off to in order to measure the effects of the virtual inertia. With the droop control switched on the result is even better than shown in the picture.

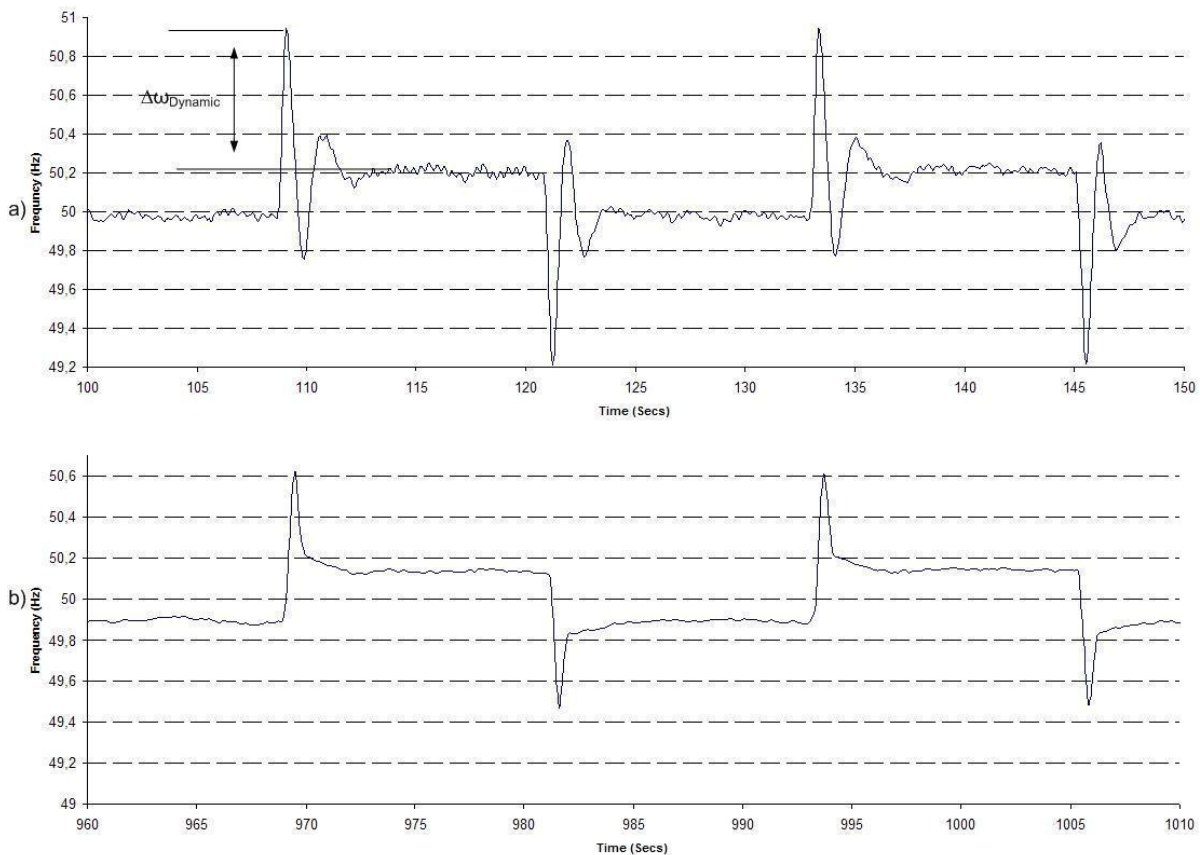

**Figure 12-4 Frequency oscillations 35kW generator, a) without VSG, b) With VSG only inertia emulation operational.**

**12.2.2.5 VSG action during normal operation**

The second example is from Cheia, Romania, where the local grid was run in islanded mode for some time. As can be seen in the next picture, switching on the VSG algorithm with inertia emulation and droop control significantly reduces the frequency changes in normal operation.

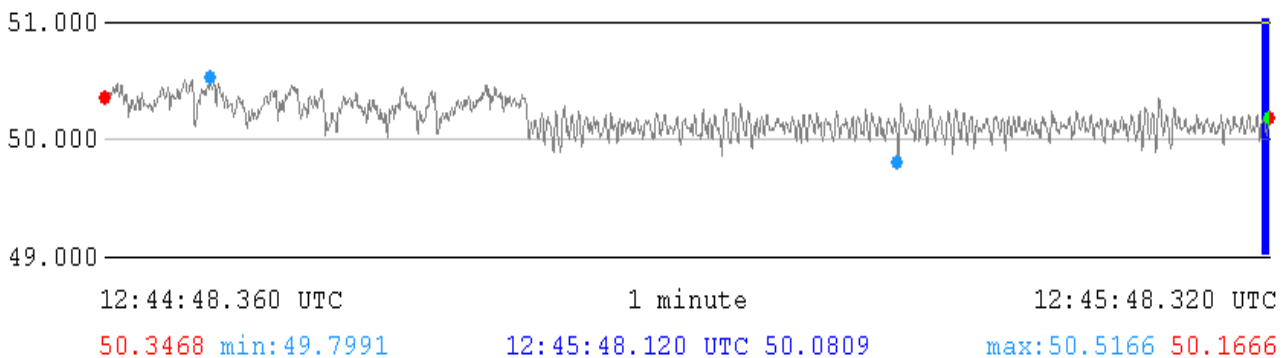

**Figure 12-5 Set-up and preliminary results – island operating mode, running the VSG algorithm, frequency reference: 50 Hz.**

**12.2.2.6 Résumé**

For both cases, load switching and normal operation, the measured effect is less when the VSG is connected to the main grid. This is mainly because the base power of the grid is much higher than

the nominal power of the VSG's installed.

Still, in Cheia an improvement in power quality is observed in grid connected mode, whereas in Bronsbergen this is much less noticeable due to the low impedance of the main grid.

In case a large VSG, or a great many of small VSG's, with a nominal power in the order of 10% or more of the grid base power would be installed, the effect will be much higher and clearly visible. However, VSG equipment of that size was out of scope and budget for the VSYNC Project.

### 12.2.2.7 Conclusions

Virtual Synchronous Generators perform very well in practical LV networks:

- During normal operations, the VSG units keep frequency closer to set-point values;
- During switching actions, the VSG units significantly reduce frequency and voltage oscillations.

The VSG is a promising technology for stabilization of the future power system with huge amounts of renewable energies.

### 12.2.3 Work specifically relevant for WP5

Concurrent use of the detailed shape of the local voltage sine wave for:

- Frequency stabilisation by inertial response power. This supports the system wide generation and load balance at very short dead times (milliseconds) and suppresses frequency variations.
- Local voltage stabilisation by reactive response power. This supports the detailed sine shape and amplitude of the local voltage at very short dead times (milliseconds).

### 12.2.4 References and Relevant Documents

<b>Article Title</b>	<a href="http://ieeexplore.ieee.org/xpl/articleDetails.jsp?arnumber=5282048&amp;contentType=Conference+Publications">Grid tied converter with virtual kinetic storage</a> http://ieeexplore.ieee.org/xpl/articleDetails.jsp?arnumber=5282048&contentType=Conference+Publications
<b>Publication Title</b>	PowerTech, 2009 IEEE Bucharest
<b>ISBN</b>	978-1-4244-2234-0
<b>Authors</b>	van Wesenbeeck, M.P.N.; de Haan, S.W.H.; Varela, P.; Visscher, K.

<b>Article Title</b>	<a href="http://ieeexplore.ieee.org/xpl/articleDetails.jsp?arnumber=5638946&amp;contentType=Conference+Publications">Virtual synchronous generator: An element of future grids</a> http://ieeexplore.ieee.org/xpl/articleDetails.jsp?arnumber=5638946&contentType=Conference+Publications
<b>Publication Title</b>	Innovative Smart Grid Technologies Conference Europe (ISGT Europe), 2010 IEEE PES
<b>ISBN</b>	978-1-4244-8508-6

<b>Authors</b>	Van, T.V.; Visscher, K.; Diaz, J.; Karapanos, V.; Woyte, A.; Albu, M.; Bozelie, J.; Loix, T.; Federenciuc, D.
----------------	---

<b>Article Title</b>	<a href="http://ieeexplore.ieee.org/xpl/articleDetails.jsp?arnumber=4596800&amp;contentType=Conference+Publications">Virtual synchronous generators</a> http://ieeexplore.ieee.org/xpl/articleDetails.jsp?arnumber=4596800&contentType=Conference+Publications
<b>Publication Title</b>	Power and Energy Society General Meeting - Conversion and Delivery of Electrical Energy in the 21st Century, 2008 IEEE
<b>ISBN</b>	978-1-4244-1905-0
<b>Authors</b>	Driesen, J.; Visscher, K.

<b>Article Title</b>	<a href="http://ieeexplore.ieee.org/xpl/articleDetails.jsp?arnumber=5281790&amp;contentType=Conference+Publications">Virtual synchronous generator: Laboratory scale results and field demonstration</a> http://ieeexplore.ieee.org/xpl/articleDetails.jsp?arnumber=5281790&contentType=Conference+Publications
<b>Publication Title</b>	PowerTech, 2009 IEEE Bucharest
<b>ISBN</b>	978-1-4244-2234-0
<b>Authors</b>	Van Thong, Vu; Woyte, A.; Albu, M.; Van Hest, M.; Bozelie, J.; Diaz, J.; Loix, T.; Stanculescu, D.; Visscher, K.

<b>Article Title</b>	<a href="http://ieeexplore.ieee.org/xpl/articleDetails.jsp?arnumber=5281969&amp;contentType=Conference+Publications">Storage selection for DG applications containing virtual synchronous generators</a> http://ieeexplore.ieee.org/xpl/articleDetails.jsp?arnumber=5281969&contentType=Conference+Publications
<b>Publication Title</b>	PowerTech, 2009 IEEE Bucharest
<b>ISBN</b>	978-1-4244-2234-0
<b>Authors</b>	Albu, M.; Visscher, K.; Creanga, D.; Nechifor, A.; Golovanov, N.

<b>Article Title</b>	<a href="http://ieeexplore.ieee.org/xpl/articleDetails.jsp?arnumber=5282160&amp;contentType=Conference+Publications">Layout and performance of the power electronic converter platform for the VSYNC project</a> http://ieeexplore.ieee.org/xpl/articleDetails.jsp?arnumber=5282160&contentType=Conference+Publications
----------------------	--



	tType=Conference+Publications
<b>Publication Title</b>	PowerTech, 2009 IEEE Bucharest
<b>ISBN</b>	978-1-4244-2234-0
<b>Authors</b>	Loix, T.; De Breucker, S.; Vanassche, P.; Van den Keybus, J.; Driesen, J.; Visscher, K.

<b>Article Title</b>	<a href="http://ieeexplore.ieee.org/xpl/articleDetails.jsp?arnumber=6119919&amp;contentType=Conference+Publications">Real time simulation of a power system with VSG hardware in the loop</a> http://ieeexplore.ieee.org/xpl/articleDetails.jsp?arnumber=6119919&contentType=Conference+Publications
<b>Publication Title</b>	IECON 2011 - 37th Annual Conference on IEEE Industrial Electronics Society
<b>ISBN</b>	978-1-61284-969-0
<b>Posted Date</b> <b>Online</b>	Mon Jan 02 00:00:00 EST 2012
<b>Authors</b>	Karapanos, V.; de Haan, S.; Zwetsloot, K.

<b>Article Title</b>	<a href="http://ieeexplore.ieee.org/xpl/articleDetails.jsp?arnumber=6629425&amp;contentType=Conference+Publications">A battery energy storage based virtual synchronous generator</a> http://ieeexplore.ieee.org/xpl/articleDetails.jsp?arnumber=6629425&contentType=Conference+Publications
<b>Publication Title</b>	Bulk Power System Dynamics and Control - IX Optimization, Security and Control of the Emerging Power Grid (IREP), 2013 IREP Symposium
<b>Authors</b>	Vassilakis, A.; Kotsampopoulos, P.; Hatziargyriou, N.; Karapanos, V.

## 12.3 Demand as frequency controlled reserve

### 12.3.1 Full project name

Demand as Frequency-controlled reserve

### 12.3.2 Description

The project demonstrated ability of frequency controlled demand to provide primary control i.e. to improve frequency quality in the system with high share of RES (normal frequency reserve) and disturbance frequency reserve to support system security. The study includes a pilot with more 100

devices, which were frequency-controlled. These devices can be used for both Normal Reserve Operation and Disturbance reserve operation.

When the frequency is below a set point e.g. 49.9 Hz the switch turns off the connected appliance. It is possible to differentiate the set points across the portfolio of units and achieve a classical proportional control for the reserves. The set-up of frequency-controlled thermostats for space heating allows activation within the normal frequency intervals.

### **12.3.3 Work specifically relevant for WP5**

The project describes in general terms the set-up of the demonstration, which data were collected, how often and how. This is specifically interesting because of use of consumption (including small appliances) as a primary reserve.

The study concludes that it is possible to postpone electricity demands as a function of frequency and thereby maintain the system balance.

### **12.3.4 References and Relevant Documents**

- Jacob Østergaard et al. "Demand as Frequency-controlled Reserve" Rapport 1. DTU-CEE Kgs. Lyngby, Danmark. May 2013

## **12.4 CCPP**

### **12.4.1 Full project name**

The Cell Controller Pilot Project (CCPP)

### **12.4.2 Description**

The CCPP project spanned a seven-year period from 2005 through 2011 and included a full cycle from development, to implementation and pilot testing of a control system – CCPP. The system was intended to control and actively use local DER in a specific geographic area and if necessary secure islanded operation for this area. Description of the project includes the following functionalities:

- On-line monitoring the total load and production within the cell.
- Active power control of synchronous generators.
- Active power control of wind farms and large wind turbines.
- Reactive power control by utilizing capacitor banks of wind turbines and grid.
- Reactive power or voltage control by activating automatic voltage regulators (AVRs) on synchronous generators.
- Frequency control by activating speed governing systems (SGSs) on synchronous generators.
- Capability of remote operation of 60 kV breaker on 150/60 kV transformer.
- Capability of remote operation of breakers of wind turbines and load feeders.
- Automatic fast islanding of entire 60 kV Cell in case of severe grid fault.
- Automatic fast generator or load shedding in case of power imbalance.
- Voltage, frequency and power control of islanded Cell.
- Synchronizing Cell back to parallel operation with the transmission grid.
- Black-starting support to transmission grid in case of black-out.

The pilot was deployed in Hølsted, DK (see the topology of the cell below)

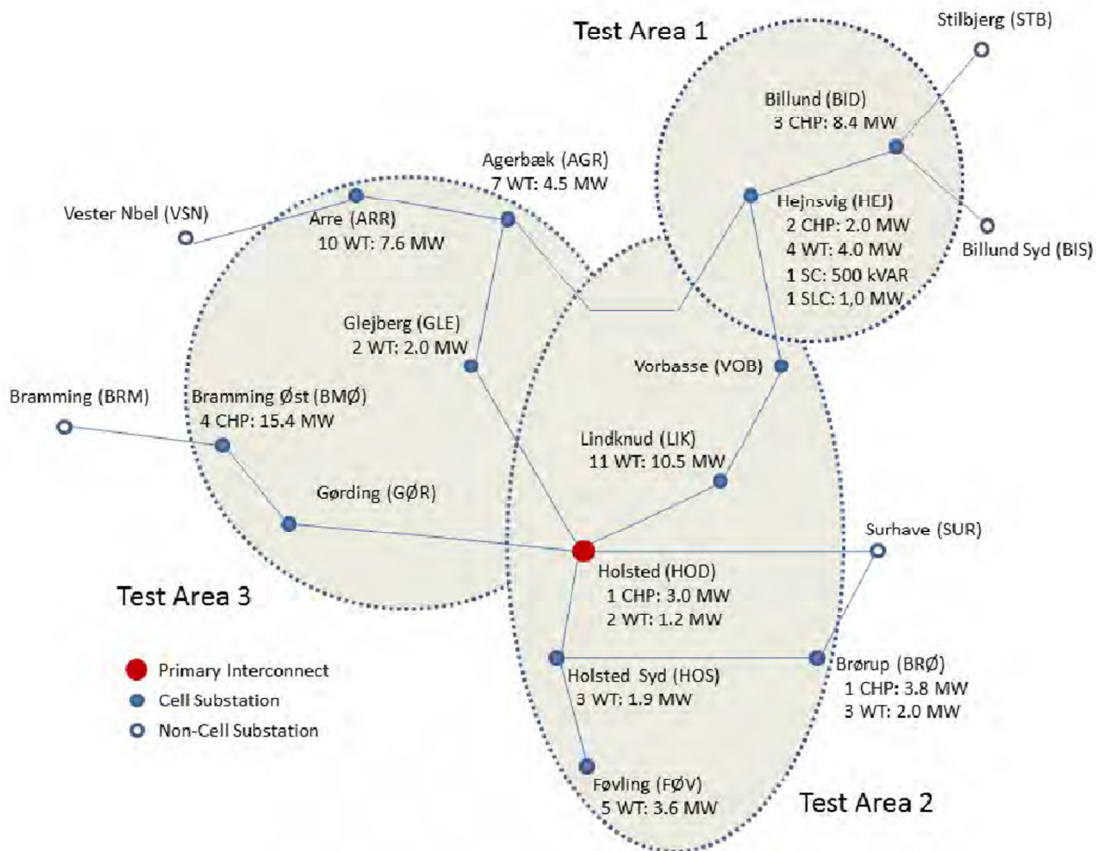

**Figure 12-6 Topology of the Cell.**

The Cell Controller went through several simulation and field tests in 2008-2011 (see the reference for a complete description of the test program). The field test included islanded operation and reconnection with several different configurations of components available in the given geographic area. It was concluded that the CCPP was able to achieve successful island operation by leveraging the existing field assets and communication infrastructure.

### 12.4.3 Work specifically relevant for WP5

The project is extremely relevant for the project, because it combines operation of power system with a local share of RES, including observing and controlling the system.

Since this was an industrial project, only a limited amount of information is publically available.

### 12.4.4 References and Relevant Documents

- Cell Controller Pilot Project. Public Report. Energinet.dk 2011.

## 12.5 STRONGGrid

### 12.5.1 Full project name

STRONGGrid – Smart Transmission Grids Operation and Control

### 12.5.2 Description

The main objective of STRONGrid is the development of wide-area monitoring and control applications and their implementation in a common platform. The applications will include:

- Monitoring applications for improved situational awareness including novel state estimators paradigms and stability risk indicators (on-line power oscillation damping, voltage instability prediction, etc.), and appropriate visualization methods. The monitoring applications relate to transmission system operation as well as to distribution grids. A specific challenge to be addressed is the need for improved monitoring applications for DSOs to operate the future Smartgrids
- Control applications in transmission grid operation (stabilizers, system protections, coordinated voltage controls) and in smart distribution grids (focusing on the exchange of power balancing controls and other system services between TSOs and DSOs).
- Data management for off-line analysis, and research on data compression and data mining applications.

Work packages:

#### WP1

- Wide area development platform
- ICT architectures

#### WP2

- Wide area monitoring applications
- Wide area stabilising control

#### WP3

- PMU-applications in distribution
- Smartgrid control challenges
- Laboratory implementations

#### WP4

- Education and dissemination
- Laboratory implementations
- WAMS applications

### 12.5.3 Work specifically relevant for WP5

All the work related to Wide area monitoring could be of interest for WP5

### 12.5.4 References and Relevant Documents

- <http://www.kth.se/en/ees/omskolan/organisation/avdelningar/eps/research/smarttslab/projekt-smartslab/strongrid-1.461968>
- <http://www.nordicenergy.org/project/smart-transmission-grid-operation-and-control/>

## 12.6 Nikola

### 12.6.1 Full project name

Nikola - Intelligent Electrical Vehicle Integration

### 12.6.2 Description

Nikola is a Danish research and demonstration project with a focus on the synergies between the electric vehicle (EV) and the power system. With sufficient control and communication it is possible to influence the timing, rate and direction of the power and energy exchanged between the EV battery and the grid. This ability can be used in a set of "services" that bring value to the power system, the EV owner and society in general. Nikola seeks to thoroughly investigate such services, to explore the technologies that can enable them and finally to demonstrate them through both simulations and in-field testing.

Using the energy and power behaviours described above, the EV can support a number of services. In Nikola, the formal definition of "Service" is the act of influencing the timing, rate and direction of the power and energy exchanged between the EV battery and the grid to yield benefits for user, system, and society. In Nikola these services are divided into categories according to the level of the power system to which they add value.

Therefore the services are described as either *System-wide services (WP1)* or *Distribution system services (WP2)*

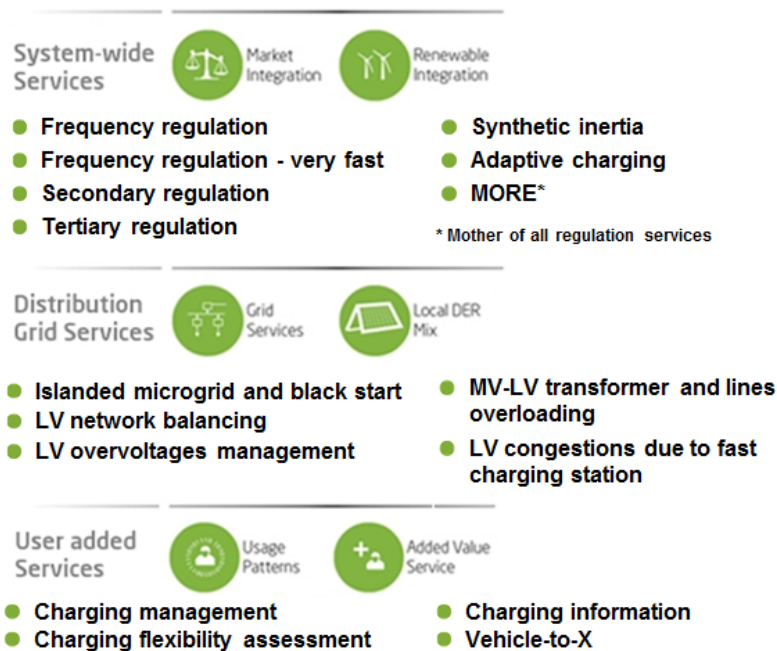

Figure 12-7 Categories of services in the Nikola project.

#### WP1 – System wide services

This category of services can aid in maintaining a cost-efficient, secure power system with a high degree of renewable production. Such operational and strategic targets are in Denmark managed by the transmission system operator on a system-wide ( $\geq 132$  kV) level via the ancillary service (A/S) market. Nikola will both investigate services that can be provided through present A/S products as well as services not yet enveloped by a market product.

## WP2 – Distribution grid services

In this service group, Nikola investigates the integration of the electric vehicle (EV) in the distribution grids (< 132 kV) as part of the operational and strategic targets of a distribution system operator. Parameters addressed include voltage, thermal, and reactive power limits. This area also cover islanded and microgrid scenarios where EV services are used to maintain a stable and secure operation. Finally Nikola investigates "mixed-DER" scenarios where EV battery (dis)charging is coordinated with the behavior of other types of distributed energy resources such as photovoltaic micro-combined heat and power units, heat pumps, and home appliances

### 12.6.3 Work specifically relevant for WP5

The services that EV could provide to the network can in principle (and are already today especially for WP1 services) be provided by other types of distributed resource be this EV or PV or controllable load.

In order to activate this kind of services, proper network status observations are needed (frequency, RMS voltages and RMS currents)

### 12.6.4 References and Relevant Documents

Nikola - Intelligent Electrical Vehicle Integration

- <http://nikola.droppages.com/>
- P. B. Andersen, M. Marinelli, O. J. Olesen, G. Poilasne, B. Christensen, C. Amstrup, and O. Alm, "The Nikola Project: Intelligent Electric Vehicle Integration", Innovative Smart Grid Technologies (ISGT Europe), 2014 5th IEEE PES International Conference and Exhibition on, pp.1-5, Istanbul, 12-15 Oct. 2014
- K. Knezović, M. Marinelli, R. Juul Møller, P. B. Andersen, C. Træholt, and F. Sossan, "Analysis of Voltage Support by Electric Vehicles and Photovoltaic in a Real Danish Low Voltage Network," Universities Power Engineering Conference (UPEC), 2014 Proceedings of the 49th International, pp.1-6, Cluj Napoca, 2-5 Sep. 2014.
- S. Martinenas, M. Marinelli, P. B. Andersen, and C. Træholt, "Implementation and Demonstration of Grid Frequency Support by V2G Enabled Electric Vehicle," Universities Power Engineering Conference (UPEC), 2014 Proceedings of the 49th International, pp.1-6, Cluj Napoca, 2-5 Sep. 2014.
- Zarogiannis, M. Marinelli, C. Træholt, K. Knezović, and P. B. Andersen, "A Dynamic Behavior Analysis on the Frequency Control Capability of Electric Vehicles," Universities Power Engineering Conference (UPEC), 2014 Proceedings of the 49th International, pp.1-6, Cluj Napoca, 2-5 Sep. 2014.

## 12.7 ESVM

### 12.7.1 Full project name<http://www.eu-ecogrid.net/rss-feed/55-new-ecogrid-eu-report-from-design-to-implementation>

ESVM – Energy Saving by Voltage Management<http://www.eu-ecogrid.net/rss-feed/55-new-ecogrid-eu-report-from-design-to-implementation>

### 12.7.2 Description<http://h>

The main objective of this project is to develop and demonstrate two new energy optimization units:

- DVC (Digital Voltage Control) which is a small-scale digital transformer, designed to reduce power consumption in private households by optimizing voltage. The DVC can offer three functions that are voltage reduction, voltage stabilization and voltage optimization.
- 10/04 VOU (Voltage Optimization Unit) which is for use in the distribution networks and will be designed as an addition to the 10/04 distribution transformer. The 10/04 VOU optimizes the voltage of the supply grid following the same principles as the DVC. It makes it possible to raise or lower the voltage on the load as needed, it stabilizes the voltage, and it balances the difference between the three phases at  $\pm 1.5\%$  /  $\pm 2.5\%$ .

Several scenarios have been defined in order to evaluate the (potential) benefits of having a MV-LV transformer with single phase tapping capability and having a separate tapping from the trafo (i.e. a tapping device or an autotransformer in the feeder instead of having it installed in the substation).

As a reference LV network, the LV feeder (property of DONG Energy) used in the iPower project has been used, reported in Figure 12-8.

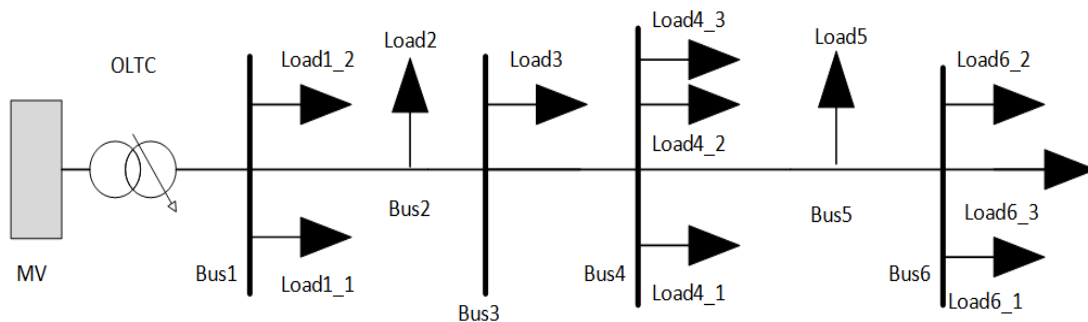

**Figure 12-8 Reference network of the iPower project.**

The network data includes topology of the distribution network, single phase measurements of active power, current and voltage. The network has been implemented in the simulation software Powerfactory. The model describes a single phase detailed network with the possibility to inject/consume different level of active and reactive powers on each phase. Several days of measurements are available with 10 minutes resolution. Dynamic simulations are performed in order to evaluate the single phase current flows and voltage levels under the different scenarios.

Since the network data provided allows the modelling of a single feeder, in order to study the effects on LV network with two feeders (with different loading/generation profiles), the model will include 2 times the same LV feeder with different loading conditions.

### 12.7.3 Work specifically relevant for WP5<http://h>

Observability of LV network single phase RMS voltages in order to properly tap the transformer

### 12.7.4 References and Relevant Documents<http://h><http://h>

- M. Coppo, M. Marinelli, X. Han, and R. Turri, “Voltage Management in Unbalanced Low Voltage Networks Using a Decoupled Phase-Tap-Changer Transformer,” Universities Power

Engineering Conference (UPEC), 2014 Proceedings of the 49th International, pp.1-6, Cluj Napoca, 2-5 Sep. 2014.

<http://www.eu-ecogrid.net/rss-feed/55-new-ecogrid-eu-report-from-design-to-implementation>

## 12.8 OPTIMATE

### 12.8.1 Full project name

An Open Platform to Test Integration in new MARkeT designs of massive intermittent Energy sources dispersed in several regional power markets

### 12.8.2 Description<sup>3</sup>

The project aims at developing a numerical test platform to analyse and to validate new market designs which may allow integrating massive flexible generation dispersed in several regional power markets. OPTIMATE will therefore contribute to the construction of a pan-European electricity market.

The two following intertwined OPTIMATE goals are based on a joint numerical modelling of the various market stakeholder interactions (including TSOs) in a multiple area system (where inter area interactions are ruled by flow based market coupling):

- To develop an open simulation platform able to mimic existing and future day-ahead, intra-day and balancing markets involving conventional and intermittent generation units
- To demonstrate that the above platform can help TSOs compare new market rules and tools capable of integrating massive intermittent generation into electricity markets, while keeping the European power system secure

### 12.8.3 Work specifically relevant for WP5

The most relevant work for WP5 is the second and third work packages of OPTIMATE:

- Real time adjustment of generation and load balance
- Day ahead and intraday markets

### 12.8.4 References and Relevant Documents

- Carlos Rodríguez, Mayte García Casado, “Assumptions on accuracy of photovoltaic power to be considered at short term horizons”, Project report, 30 September 2010
- PE Morthorst, JM Coulondre, ST Schröder, P Meibom, “Wind Power accuracy and forecast”, Project report, 23rd July 2010

---

<sup>3</sup> The description uses relevant formulations from <http://www.optimize-platform.eu>.



## 13 Annex III ENTSO-E frequency control requirements

Below is given requirements on the frequency control according to the ENTSO-E document [18]

**A-S2.1. Accuracy of Frequency Measurements.** For PRIMARY CONTROL, the accuracy of local frequency measurements used in the PRIMARY CONTROLLERS must be better than or equal to 10 mHz.

**A-S2.2. Adjustment of Power and Insensitivity of Controllers.** Power under PRIMARY CONTROL must be proportionally adjusted to follow changes of SYSTEM FREQUENCY. The insensitivity range of PRIMARY CONTROLLERS should not exceed  $\pm 10$  mHz. Where dead bands exist in specific controllers, these must be offset within the CONTROL AREA / BLOCK concerned.

**A-S2.3. Physical Deployment Times.** The time for starting the action of PRIMARY CONTROL is a few seconds after the incident, the deployment time for 50 % or less of the total PRIMARY CONTROL RESERVE is at most 15 seconds and from 50 % to 100 % the maximum deployment time rises linearly to 30 seconds. Each TSO must check the deployment times within his CONTROL AREA / BLOCK on a regular basis. By this, the total PRIMARY CONTROL within the entire SYNCHRONOUS AREA (as well as within each CONTROL AREA / BLOCK) follows the same deployment times.

**A-S5.3. Measurement Cycle for Frequency Observation.** The cycle for measurements of the SYSTEM FREQUENCY for CONTROL AREA observation must be in the range of 1 second (strongly recommended) to at most 10 seconds.

**B-S2.1. Control Target for SECONDARY CONTROL.** In general, the target is to control random deviations of the SYSTEM FREQUENCY and the POWER EXCHANGES during normal operation with normal noise and after a large incident. The AREA CONTROL ERROR (ACE) as a linear combination of FREQUENCY DEVIATION and POWER DEVIATION must be controlled to return the SYSTEM FREQUENCY and the POWER EXCHANGES to their set point values after any deviation and at any time. After 30 seconds at the latest, the SECONDARY CONTROLLER must start the control action by change in the set-point values for SECONDARY CONTROL to initiate corrective control actions. As a result of SECONDARY CONTROL, the return of the ACE must continue with a steady process of correction of the initial ACE as quickly as possible, without overshoot, being completed within 15 minutes at the latest.

**B-S3.2. Controller Cycle Time.** The cycle time for the automatic SECONDARY CONTROLLER has to be between 1 second and 5 seconds, to minimise the total time delay between occurrence, reaction and response in the scope of the overall control performance of the CONTROL AREA.

**B-S3.5. Power Exchange Set-Point.** The algebraic sum of the programmed power exchanges of the CONTROL AREA / BLOCK (including compensation program) constitutes the input for the POWER EXCHANGE set point of the SECONDARY CONTROLLER. When changes of CONTROL PROGRAMS occur, it is necessary that each change is converted to a ramp with a ramp period of 10 minutes, starting 5 minutes before the agreed time of change (the change of the hour or of the quarter, see 8P2 for definition of exchange schedules) and ending 5 minutes after. The power exchange set-point value may only be composed of values from the schedules including ramp changes.

**B-S3.6. Controller System Clock Setting.** To avoid possible errors due to asynchronous operation of different secondary controllers, the time setting of each SECONDARY CONTROLLER needs to be synchronized to a reference time.

**B-S3.8. Accuracy of Frequency Measurement.** For SECONDARY CONTROL, the accuracy of frequency measurement must be between 1.0 mHz and 1.5 mHz.

**B-S5.5. Accuracy of Measurements.** The accuracy of the active power measurements on each TIE-LINE must be better than 1.5 % of its highest rated value (the complete measurement range, including discretisation). The local measurement renewal / refresh rate should not exceed 5 seconds and the time stamps of the measurement values at the SECONDARY CONTROLLER should not differ more than 5 seconds to ensure consistent calculations of AREA CONTROL ERROR

**B-S5.6. Total Active Power Flow Measurement.** The total active power flow of a CONTROL AREA / BLOCK towards the remaining UCTE SYNCHRONOUS AREA must be calculated by the sum of all power flow measurements of all TIELINES of this area (PHYSICAL TIE-LINES and VIRTUAL TIE-LINES). The total active power flow may be composed of measurements only.

**B-S6.1. Availability and Reliability of the Control Function.** The automatic SECONDARY CONTROLLER is operated on-line and closed-loop and must have a very high availability and reliability. A backup system must be available to overtake the control function in case of an outage or fault of the system for SECONDARY CONTROL. Functions and reserves from all providers used for control must be monitored.

**B-S6.2. Transmission of Measurements.** Measurements must be transmitted in a reliable manner (e.g. parallel data links) to the SECONDARY CONTROLLER.

**B-S6.3. Metering and Measurement Transmission to opposite side.** Usage and provision of alternative measurement from neighbouring CONTROL AREAS for comparison or eventual backup are required. Substitute measurements and reserve equipment should be available in parallel to the primary measurement. Substitute measurements are obligatory for all TIE-LINES with significant impact to SECONDARY CONTROL. Accuracy and cycle times for the substitute TIE-LINE measurements must fulfil the same characteristics (see 8P1-B-S5).

**B-S6.4. Data Recordings.** Each TSO must perform continuous recordings of all values needed for monitoring of the input and response of SECONDARY CONTROLLERS and for analysis of normal operation and incidents in the INTERCONNECTED SYSTEM. These values include the frequency measurement, the total active power flow measurement and the power exchange set-point value.

**B-G3.3. Sample Interval.** The values used for monitoring and observation are based on a sample interval of 10 seconds.

## 14 Disclaimer

The ELECTRA project is co-funded by the European Commission under the 7<sup>th</sup> Framework Programme 2013.

The sole responsibility for the content of this publication lies with the authors. It does not necessarily reflect the opinion of the European Commission.

The European Commission is not responsible for any use that may be made of the information contained therein.