

Technical University of Denmark



Technical Feasibility of Ancillary Services provided by ReGen Plants

Altin, Müfit; Han, Xue; Hansen, Anca Daniela; Løvenstein Olsen, Rasmus ; Cutululis, Nicolaos Antonio; Iov, Florin

Publication date:
2015

Document Version
Publisher's PDF, also known as Version of record

[Link back to DTU Orbit](#)

Citation (APA):
Altin, M., Han, X., Hansen, A. D., Løvenstein Olsen, R., Cutululis, N. A., & Iov, F. (2015). Technical Feasibility of Ancillary Services provided by ReGen Plants. DTU Wind Energy. (DTU Wind Energy E; No. 0099).

DTU Library

Technical Information Center of Denmark

General rights

Copyright and moral rights for the publications made accessible in the public portal are retained by the authors and/or other copyright owners and it is a condition of accessing publications that users recognise and abide by the legal requirements associated with these rights.

- Users may download and print one copy of any publication from the public portal for the purpose of private study or research.
- You may not further distribute the material or use it for any profit-making activity or commercial gain
- You may freely distribute the URL identifying the publication in the public portal

If you believe that this document breaches copyright please contact us providing details, and we will remove access to the work immediately and investigate your claim.

Technical Feasibility of Ancillary Services provided by ReGen Plants

Agreement no.: PSO ForskEl 12347
Project Name: Ancillary Services from Renewable Power Plants
Acronym: RePlan
Duration: 2015 - 2018
Co-ordinator: DTU Wind Energy
Report no: DTU Wind Energy E-0099
ISBN: 978-87-93278-55-4

Document information

Document name:	Technical Feasibility of Ancillary Services provided by ReGen plants
Document number:	DTU Wind Energy E-0099
Contributors:	Müfit Altin, Xue Han, Anca D. Hansen, Rasmus Løvenstein Olsen, Nicolaos A. Cutululis, Florin Iov
Document type:	Report- Deliverable D1.2
Dissemination level:	PU
Date:	30.09.2015
WP:	1
Task:	1.2

Content

Preface.....	5
1 Scope of document.....	1
2 RePlan objectives.....	1
3 Background.....	1
3.1 Danish Power System	2
3.2 Ancillary services	4
3.2.1 Frequency services	5
3.2.2 Voltage services.....	6
3.3 Technical Capabilities of ReGen	7
3.3.1 Overview.....	7
3.3.2 Congestion management and peak shaving.....	8
3.3.3 Voltage control and VAR support	9
3.3.4 Mapping of ReGen capabilities.....	10
3.4 Information and Communication Technology (ICT)	12
3.4.1 Challenges in reliable and timely communication	12
3.4.2 Overview of communication technologies.....	13
3.4.3 Multiple networks (Internet).....	15
3.4.4 Application layer protocols.....	17
3.4.5 Useful standards.....	18
4 RePlan framework	19
4.1 Ancillary services	19
4.2 Power system	20
4.2.1 Transmission System	21
4.2.2 Distribution System	22
4.3 Control architecture	24
4.3.1 Centralized Control Architecture.....	24
4.3.2 Decentralized Control Architecture.....	24
5 Guidelines for assessment of results.....	25
5.1 Control Validation using AAU facilities.....	25
5.2 Control Validation using SYSLAB facilities	26
6 Summary.....	27
7 References	27



RePlan

Ancillary services from Renewable Power Plants

Preface

This report is the first deliverable in WP1 in the project “Ancillary services from renewable power plants” (RePlan). RePlan is funded as POS project 2015 no. 12347 by the Danish PSO-programme ForskEL, which is administered by Energinet.DK. RePlan is carried out in collaboration between DTU Wind Energy, DTU Elektro, Aalborg University Energy Technology, Aalborg University Wireless Communication Networks and Vestas Wind System A/S. DTU Wind Energy is manager of the project

1 Scope of document

The scope of this document is to present the state-of-the art of the ancillary services provided by renewable power plants (ReGen) – existing and/or proposed ones – with focus on the ones that will be specifically investigated in the RePlan project. Moreover, it presents an overview of the power system models to be used in the case studies, together with the main communication technology and protocols available today. Finally, the report is including an initial guideline for assessment of the simulation results in laboratory environment.

2 RePlan objectives

The overall objective of this project is to contribute to the integration of large share of renewable energy in the Danish grid and thus to enable a resilient future power system by developing technical solutions for the provision of ancillary services by renewable power plants. RePlan focuses on wind power (WP) and solar photovoltaic (PV) plants since they are expected to jointly produce the lion's share of renewable energy generation capacity needed to reach the Danish government 2050 targets.

With respect to renewable generation (ReGen) plants like WP and PV, investigation of ancillary services, coordinated control, fast communication and forecast of available power are crucial step stones on the route toward a future resilient power system. The ability to provide ancillary services from ReGen plants depends on the communication and the forecast of availability power. In this respect, RePlan develops controllers for the delivery of ancillary services, incorporating communication properties in the control loops of the ReGen plant model and using state-of-the-art methods for simulation of renewable generation patterns and wind power forecast methods. Based on both simulation models and verification in laboratory facilities, this project intends to address this challenge:

What is the impact of communication and power availability forecast error in providing coordination and ancillary services from ReGen plants?

The novelty of RePlan consists in the investigation and verification of:

- 1) ancillary services provision from WP and PV plants and,
- 2) suitability to coordinate their services' provision to system operator.

In this respect, RePlan strives to identify and analyze the strengths and limitations of WP and PV plants, anticipating new challenges and exploring some of the more complex issues and uncertainties related to the coordination of their ancillary services. The services with great concerns in the future include: ***voltage, frequency and rotor angular stability support.***

3 Background

This chapter starts with an introduction to the Danish grid, presenting an overview of the existing system today, as well as possible scenarios for 2035 as coming from Danish and EU documents. The second part of the chapter provides the state-of-the-art in ancillary services for ReGen plants, including both existing and possible future services for transmission and distribution systems.

3.1 Danish Power System

The Danish power system is strongly connected to the neighboring countries of Nordic and Continental European (CE) powers systems, as illustrated in Figure 1. It is electrically divided into two parts, Eastern and Western Danish power systems. The Eastern Danish power system is synchronously connected to the hydro power dominated Nordic synchronous power system, while the Western Danish power system is connected to the fossil fuel dominated CE synchronous power system. The Eastern and Western Danish power systems are connected through the Great Belt Link (GBL) which is a High Voltage Direct Current (HVDC) link. The HVDC links also connect Eastern Danish power system to CE power system and Western Danish power system to Nordic power system. In both parts of the Danish system the electrical power is mainly generated by Combined Heat and Power (CHP) plants, De-centralized Combined Heat and Power (DCHP) plants and onshore/offshore wind power plants (WPPs).



Figure 1: Danish power system interconnections with Nordic and CE power systems; Red lines indicate the AC connection and the Blue lines indicate the HVDC connection.

According to ENTSO-E approximately 5000 MW of wind power is currently installed in the Nordic system. Wind power generation in the Nordic countries is expected to increase in the coming decade due to the European wide climate policy and renewable support systems. The total amount of wind power capacity in the synchronous Nordic power system can be estimated to increase up to about 15-20 GW in 2020.

The foreseen evolution of the network all over Europe leads to an acute need for detailed studies investigating the system needs with large amount of renewable generation both at Distribution System Operator (DSO) and Transmission System Operator (TSO) levels. TSOs and DSOs have to rely more and more on such studies, when estimating and planning the expansion of the network up to 2050. In this respect, there is the European project e-Highway2050 [1] which is aimed at developing a methodology to

support the planning of the Pan-European Transmission Network, including possible electricity highways and options for new complete pan-European grid architecture, based on various future power system scenarios.

The flexibility in the TSO/DSO interaction will also be more and more important, as well as the growing role of DSOs in the ongoing process to accommodate concentrated large scale renewable energy generation in their grids and the transition to future power systems [2].

In Denmark, the national TSO Energinet.dk has launched various initiatives, like expanding the electricity infrastructure, increasing the flexibility of the power system and ensuring efficient integration of wind power. The electrical power generation is a combination of conventional and renewable generation sources. The conventional power generation is typically based on centralized thermal power plants and DCHPs, while renewable generation is mainly from WPPs and slightly from PV. Most of the centralized thermal power plants are also used for the production of heat along with electricity generation and therefore they are typically classified as centralized CHPs. CHPs are located in large cities, while DCHPs are located at smaller centers. Sixteen CHPs and approximately 415 DCHPs supply public heating in Denmark [3]. Most of the CHP in Denmark are coal fired, while DCHPs typically use natural gas, waste, biomass or bio gas as a fuel [4].

During last decades, the Danish power system has evolved from fossil fuel to more environmental friendly mix of renewable energy, generating 33.2% of the annual electricity consumption from the wind power in 2013 and aiming to increase it to 50% by 2020. In view of future ambitious goal, Table 1 provides the future intended power generation from conventional power plants by the Danish TSO in the Eastern and Western grid [5]and [6].

Table 1: Future intended Conventional power generation in Danish power system [5] and [6].

	DCHP		CHP	
	Fuel	Generation capacity (MW)	Fuel	Generation capacity (MW)
Eastern Danish power system	Bio Mass	124	Coal	1166
	Coal	35	Gas	560
	Gas	624	Oil	692
	Waste	96	Internal Combustion	20
	Oil	34	-	-
Western Danish power system	Bio Mass	193	Bio Mass	350
	Waste	154	Coal	1130
	Gas	1261	Gas	436

As highlighted in Table 1, DCHP plants mainly use gas for energy production, while CHP plants use coal as a fuel.

The increased penetration of renewable energy to attain the goal of the Danish government to convert the present energy system into an entire renewable energy integrated system by the end of 2050 [7], will be

accomplished by large scale of WP and PV plants. For example, the WP generation capacity in Denmark of 4792 MW, supplying 33.2% of total electricity consumption in 2013 [8], will be increased to 6700 MW already in 2020 [9]. According to [10], the PV generation capacity in Denmark of 610 MW in 2014 [11], will be increased at 1000 MW in 2020.

The WP and PV trend indicates that the increased share of installed renewable energy in Denmark in the coming years will mainly be accomplished by siting and integrating large concentrations of offshore WP plants in the transmission system, as well as large scale concentrated PV plants and new generation onshore WP plants in the distribution system. For example, the offshore wind capacity in Denmark will be increased by 1500 MW in the coming years, while 500 MW of additional onshore capacity will be achieved by scraping 1300 MW of outdated onshore wind turbines and building of 1800 MW of modern wind turbines with increased controllability [12].

3.2 Ancillary services

The foreseen high penetration of WP and PV into the electricity supply all over the world imposes the requirement that the bulk addition of large scale renewable generations to the grid to not be detrimental to the overall stability of the power system. One way of ensuring this, is to require WP and PV plants to play a role not only into the energy production, as it is today, but also into the delivery of system services which are needed to ensure the system stability comprising both transmission and distribution level, namely ancillary services. This fact leads to fundamental changes in the way TSOs and DSOs will have to use grid support services from ReGen plants to manage the voltage and frequency stability in the future power system, which will continuously evolve through new interconnections and use large scale renewable technologies. According to [2], the amount of power system needs for ancillary services in the future will increase with high share of ReGen. Another aspect for services and requirements for future systems is the need to minimise curtailment and to avoid costly and burdensome retrofitting of generators to enhance their capabilities.

Definitions for ancillary services can differ significantly based on who is using the terms [13]. While some definitions emphasize the importance of ancillary services for system security and reliability, others mention the use of ancillary services to support electricity transfers from generation to load and to maintain power quality. Furthermore, some definitions limit the contribution of ancillary services to the transmission network; others include distribution purposes as well.

A possible definition for ancillary and system services as defined in [2] is as:

- **Ancillary services** are all grid support services required by the transmission or distribution system operator to maintain the integrity and stability of the transmission or distribution system as well as the power quality. These needs can be fulfilled by connected generators, controllable loads and/or network devices. Ancillary services are provided by users to system operators
- **System services** contain all services provided by a system (or a network) operator to users connected to the system. **System services** are provided by operators to all users.

The system operator (SO) manages the ancillary services by obtaining contributions (“elementary” ancillary services) from service producers (some of which follow from regulatory or contract obligations); carrying out

the technical management of the system, while making sure there is a suitable level of security; adding its own share (implementation of controls, load dispatching function) and thus elaborates the final system services.

Ancillary services are related to capabilities of generators and loads to deliver specific performances (responses etc.) in the point of connection to the network. Under the different groups of ancillary services (like frequency, voltage, etc.) there are different ancillary service products that generators can deliver to network operators to assist network operation and management.

Looking at the different definitions for which services can be included in under ancillary services from [14], [15] and [16], three main groups of services appear in all lists:

Frequency control – services related to the short-term balance of energy and frequency of the power system; it includes automatic (primary/secondary) and manual (tertiary) frequency regulation and operational reserves. This is the main service provided by generators (online for automatic services and online or offline for longer term activated services). It can also be provided from flexible loads, and storage units.

Voltage control – services required for maintaining the power system voltage within the prescribed bounds during normal operation and during disturbances by keeping the balance of generation and consumption of reactive power. Voltage control includes reactive power supply (injection or absorption) and it can be provided by the dynamic sources (generators, synchronous compensators) and static sources (capacitor banks, static voltage controllers and FACTS devices), including, Unified Power Flow Controller as well as network equipment like tap-changing transformers in the substations and loads. In the event of a disturbance to the system, dynamic reactive power response is required to maintain system stability. Network reinforcements and reconfiguration will impact on the voltage control needed.

System restoration – services required to return electrical power system to normal operation after a blackout; from the generator point of view it includes mainly black start, and can in future also include islanding operation.

In Denmark, Energinet.dk has published an ancillary services strategy for 2011–2015 [17]. This strategy classifies the ancillary services into:

- a. Frequency-controlled reserves,
- b. Secondary reserves,
- c. Manual reserves and regulating power and
- d. Properties required maintaining power system stability. Those properties include short-circuit power, continuous voltage control, voltage support during faults, and inertia.

3.2.1 Frequency services

Frequency control maintains the frequency within the given margins by (continuous) modulation of active power. It has several time scales of operation that differ in their response times in different systems. In RePlan, the ENTSO-E classification [18] is adopted:

Frequency Containment Reserve (FCR) or Primary Response: The automatic response to frequency changes released increasingly with time over a period of some seconds. As a generation resource it is a fast-action, automatic and decentralized function e.g. of the turbine governor, that adjusts the power output as a

consequence of the system frequency deviation. With an instant response and a full activation time of up to typically 30 s, it is activated automatically and locally. In UK and Ireland the full activation time is faster than for Central European system, 5-10 s. The response has to be maintained for up to 15 minutes before it is released. The need is assessed collectively at synchronous area level and the procurement duty is split among TSOs.

Frequency Restoration Reserve (FRR) or Secondary Response: Activation of Frequency Restoration Reserve (FRR) modifies the active power set points /adjustments of reserve providing units in the time-frame of seconds up to typically 15 minutes after an incident. Activated centrally and has automatically activated and manually activated parts. It is managed by each TSO and coordinated through the control of transits between TSO's area of responsibility.

Replacement Reserve (RR) by Tertiary response: Manually activated, activation time from 15 minutes to hours. Replacement reserves are activated manually and centrally at the TSO control center in case of observed or expected sustained activation of FRR and in the absence of a market response.

This division of services (reserves) also applies in cases of disturbances such as contingencies i.e. tripping off of a large generator or transmission line. After a disturbance in the balance between generation and demand the following steps are performed:

- **Automatic procedures:** Frequency Containment (0 – 30 sec) and automatic Frequency Restoration (30 sec – 15 min).
- **Manual Procedures:** manual Frequency Restoration and Replacement of Frequency Restoration. Also balancing energy from market parties can be used for longer term.

The time frame of frequency support is usually within the delivery hour. The energy markets, day-ahead and intra-day can be used for balancing the supply and demand in the time scales of hours and day ahead.

The automatic reserve will be delivered from spinning reserve and the manual reserve can be either from spinning or from standing reserves. Spinning reserve means an increase or decrease of generation or reduction in consumption that can be provided at short notice, carried out by partially loaded generating units and interruptible consumers (loads). Standing reserve involves increase in generation or a reduction in consumption by those generating units that are not synchronously on-line, or by interruptible consumers (loads).

A mapping between the process and the equivalent product, for different countries in Europe, has been published by ENTSO-E [19] and is reproduced in Annex 1.

3.2.2 Voltage services

Control of voltage is tightly connected to reactive power control. Voltage can be controlled through voltage control, reactive power control, power factor control or by a combination of two of these, so they are often referred to as voltage/reactive power control.

The need for reactive power varies as demand varies and as the sources of generation vary. As reactive power is not viable to be transmitted over long distances in transmission network, its production is distributed across the system, usually closer to the locations where it is needed. In some power system

locations there may not be a strong link between the need for active power and reactive power from the same sources (locations).

As regards TSOs real time operations and operational planning, voltage control has two targets:

1. **Voltage profile management and reactive power dispatch** (steady state): The aim is to keep the voltage profile close to the desired profile and within the tolerance band margins with time frame of hours. This entails minimization of the system active power losses while keeping steady-state system security in the face of possible contingencies.
2. **Maintaining voltage stability** (dynamic): This service controls the network voltages in a dynamic time frame (seconds to minutes). The aim is to prevent a slow voltage collapse event or limit its depth and extension in case of an incident (loss of main, loss of generation unit).

To achieve the above control strategies, the following voltage control services are needed to ensure that adequate voltage support is maintained in normal operation:

Steady-state Reactive Power/Voltage Control: Controlling voltage node profile to a target value or within a target range. This control is commonly achieved by injecting or absorbing reactive power at a voltage controlled node by means of synchronous sources, static compensation, tap changing transformers in the substations, transmission lines' switching, virtual power plants including demand facilities and if necessary load shedding. The system operator dispatches the reactive power using the active and passive reactive power sources that belong to different levels: generation, transmission and distribution, using Optimal Power Flow methods. This type of services has a similarity with the active power economic dispatch related to the implementation of the hourly pool-based energy market.

Fast reactive current injection: Oriented toward system dynamic security and voltage quality, it can be provided by spinning generators and synchronous compensators, reactors and capacitors, Static VAR Compensators (SVCs), HVDC (implemented with technology VSC) substations and other FACTS devices, or other equipment capable of fast regulation. This type of service can be considered analogous to active power reserve and frequency-control services (primary and secondary AGC frequency regulation).

3.3 Technical Capabilities of ReGen

3.3.1 Overview

Wind turbines and PV systems connected in the medium and low voltage distribution grids are providing many opportunities for assisting grid operation with both active power and reactive power control capability. In addition to the existing ancillary services as stipulated in the Grid Connection Requirements [41], there are a few more that can be of interest. Instead of reinforcing the grid by oversizing the grid components, the DSOs are given an alternative solution, using the ancillary services provided by the actively controlled units in the network, e.g. wind turbines and PVs. Here follows some typical ancillary services in distribution grid that ReGen plants can provide.

Congestion management – service related to the capacity of the grid components, such as cables and transformers, in order to postpone or avoid reinforcement and upgrade. The difference between the base load and peak load gives the space for the DSO to ask for reshaping the load profiles.

Voltage control – service required to maintain the quality of the power delivered to the customers, of which the most concern is the voltage magnitude deviation from the nominal value. Unlike in the high and medium voltage systems, both active power and reactive power can have significant influence on the voltage magnitudes in low voltage distribution grids, due to the high R/X ratio.

Loss minimization and reactive power compensation – service related to the efficient power delivery and grid operation. By compensating the reactive power from the ReGen units with reactive power control capabilities, the reactive power flow in the distribution grids can be optimized to correct the power factor, and to reduce the transmission losses.

Contingency situation services – services that are used to ride through and recover from the contingency situations, such as blackout restoration programs, and a part of the distribution grid operates in islanded mode as a cell.

So far, there are not standardized service products for low voltage grids available in Denmark. However, the values of ReGen on providing distribution grid services are being recognized through:

- Government and industrial efforts: in Denmark, a document named Smart Grid in Denmark 2.0 prepared by the Danish Energy Association and the Danish TSO Energinet.dk [20] shows the initiative on utilizing the available active resources in distribution network for supporting system operation. It is recommended that both flexible electricity consumption and production from small customers provide services to support the grid either by being mobilized by price signals, or via a pre-arranged flexibility product. In the United States, both the government and the utility companies are aware of the additional values of ReGen in terms of providing grid support [21] and [22]. In Germany and Italy, new grid codes regarding small scale distributed resources are updated, so that the inverters are capable to support the grid operation, in terms of frequency, voltage, and communication possibility for energy management (VDE-AR-N 4105 [23] or BDEW [24], CEI 0-16 [25]).
- Research and demonstration projects: many ongoing and finalized projects are focusing on the distributed resources in power system, such as REserviceS [26], iPower [27] and IDE4L [28]. A series of publications concerning PV integration issues are published by NREL [29], which show both the challenges and potentials on supporting grid operation and accommodating more ReGen in the system.

Two typical distribution grid service categories are in focused in the following.

3.3.2 Congestion management and peak shaving

The interconnection of ReGen plants in the distribution grids decreases the total energy demand to be transmitted from the distance, whereas the peak production from ReGen is not always consistent with the peak load in the grid. It is the DSO's duty to reinforce the grid and replace the aged components. Overloading the grid assets may reduce the life time of the grid components (e.g. distribution cables, transformers), and even damage them. The enlarged difference between the peak and base load in the distribution network offers the DSOs an alternative solution than the reinforcement: aggregating the ReGen with energy storage to transact energy and eliminate the peak load in the grid [30],[31],[32]. The integration of ReGen with all other distributed energy resources (DER) in the grid is essential to enable such service.

In iPower [33], there are 4 products related to the congestion management in normal operation.

- **PowerCut – Planned:** A certain amount of power is curtailed during a certain period as planned in advance. The triggering time, the maximal duration of service per activation, and the size of service in power are specified in the agreement. The details of the product are specified in the quality in supply as part of the agreement.
- **PowerCut – Urgent:** similar to PowerCut – Planned, except that the triggering time is not specified, but notified by the DSO.
- **PowerCap:** the amount of power flowing through a single point in the distribution grid should not overpass a threshold value agreed between the DSO and the service provider. The service provider should be able to limit their total consumption by receiving the real-time explicit numbers from the DSO.
- **PowerMax:** the amount of power that a service provider is obliged to consume in total should not be above a certain value. By doing so, the communication between the DSO and service providers is simplified.

The service provision has to follow the procedure defined by the market scheme, named FLExibility Clearing House [34]. Four stages described in the procedure guarantee the service activation and clearance: Offline Planning, Online Scheduling, Real-time Operation, and Offline Settlement.

3.3.3 Voltage control and VAR support

In steady state, the voltage magnitudes of the buses in the network must be kept in a range around the nominal value [EN50610, IEC 60038]. Similar to voltage support in transmission grid, reactive power capability of ReGen can provide voltage support by regulating the reactive power output. In high penetration scenario, active power curtailment could also contribute to voltage control in distribution grid, as the resistance of cables is unneglectable. Reactive power regulation can also be used to reduce the power loss, and to correct power factor in the distribution grid.

It is described in [35] how the voltage control strategies can be implemented in distribution grid operation in given case studies. Various control strategies are available for controlling individual DERs. Two types of approaches are investigated:

Local regulation – the reactive power output is a function of the local measured voltage at DER delivery point. The controller derives and actuates the setpoint locally.

Central regulation – the reactive power outputs of individual DERs are calculated based on the current operating condition of the whole network. The setpoints are dispatched to individuals and implemented by the local controller.

Two relevant products are described as voltage regulating products in the iPower project. The setpoints communicated between the DSO and the service providers in these two products are voltage range and reactive power respectively. A hierarchical voltage control strategy is designed to perform the voltage control by activating the flexibilities from various DERs [36]. Its large scale implementation in a market context is further presented in [37].

The active ReGen units in the distribution grid have the potential to provide various kinds of ancillary services to support both transmission and distribution networks. However, there exist some scenarios that the provision of two services from a single unit may conflict each other. The ReGen units may create some local problems while providing the service to solve large problems. Therefore, the interaction between the transmission and distribution, and the coordination between the global and local problems are interesting topics to be investigated.

3.3.4 Mapping of ReGen capabilities

Recent studies have concentrated on analyzing the capabilities of ReGen plants– WP and PV – to provide ancillary services. The REservices study has published the findings of an in-depth analysis – validated by industry enquiry – with an overview of the capabilities [2].

An overview of the capabilities of WP and PV plants is given in Table 2. For each technology (wind, solar PV), level of aggregation (wind farm, cluster, single PV plant and portfolio) and plant size (small and medium scale - less than 500 kW - and large scale) a color scale represents the current and future possibilities for providing a specific Grid Support Services (GSS), divided in two different aspects: technical capabilities and procedures.

When single power plants or aggregation of plants are analysed, technical capabilities are rated against standards and grid connection requirements. When service provision is analysed from the point of view of the System Operators' procedures or requirements, the ability of providing a service is compared against national grid code connection requirements, transmission codes, operational procedures, service's prequalification documents and various ENTSO-E Network Codes, constituting the procedural aspects and labeled as "Procedures".

The rating of technical aspects (represented with circles) makes a distinction between:

- capabilities for providing a specific service are already implemented (green);
- capabilities partially implemented - missing functionalities can be implemented at a reasonable cost (yellow);
- specific capabilities are not implemented and the implementation costs are an obstacle to availability in the near or medium-term future (red).

Table 2. Capabilities of WP and PV [2]

		Wind System Size				Solar PV System Size					
		WF		Aggregation ¹⁶		Small scale		Large scale		Aggregation ¹⁷	
		Tech.	Procedures	Tech.	Procedures	Tech.	Procedures	Tech.	Procedures	Tech.	Procedures
Frequency	FCR	●	▲ 3	●	▲ 8	● 10	▲ 12	● 14	▲ 12	●	▲ 8
	FRR	●	▲ 3	●	▲ 8	● 10	▲ 12	● 14	▲ 12	●	▲ 8
	RR	●	▲ 3	●	▲ 8	● 10	▲ 12	● 14	▲ 12	●	▲ 8
	FFR	● 1	▲ 4	● 7	▲ 9	● 10	▲ 4	●	▲ 4	● 15	▲ 9
	RM	●	▲ 5	●	▲ 9	● 10	▲ 12	●	▲ 12	●	▲ 9
Voltage	SSVC	●	▲	●	▲ 9	●	▲	●	▲	●	▲ 9
	FRCI	● 2	▲ 6	●	▲ 9	● 11	▲ 13	●	▲ 6	●	▲ 9

LEGEND

Tech. = Technical Aspects		Procedures = Grid Code Requirements, prequalification procedures and Network Code Requirements, amongst other	
●	Implemented	▲	Well defined requirements/ specifications in most procedures at European level.
●	Partially implemented/ implementable/ low cost or investment to enable the required capabilities.	▲	Poorly defined requirements/ specifications or not addressed in most of the procedures.
●	Not implemented/ high cost to implement	▲	Not defined/ not possible due to requirements in all or most Procedures-
■	Existing Grid Support Services	■	New Grid Support Services

Regarding procedures (grid codes etc.) and technical requirements in general (triangle symbols) the rating distinguishes between:

- The provision of a specific grid support service and their requirements are well defined in general in grid/ network codes for a specific technology, (green);
- Poorly defined capabilities/ requirements, meaning that grid/ network codes could be improved to facilitate renewable energy sources to provide a specific service.(yellow);
- The provision of the referred grid support service is not defined or even not possible due to the grid/ network code requirements (red).

The requirements, in terms of capabilities, for grid connection of generators are defined in the grid codes.

In grid codes it is specified how a generating plant should behave under both continuous and dynamic condition of the grid while maintaining a safe and reliable operation. Moreover, requirements for voltage, power and frequency operation range are given in a detailed manner.

In addition, typical system disturbances are specified, so the generating plant should withstand them without disconnecting from the grid. In extreme cases, disconnection is also possible when it is allowed by the TSO. When grid code applies specifically to wind parks, the wind turbine manufacturer has to ensure a safe operation of the wind farm by fulfilling all the technical requirements for interconnection of the

generating plant. The requirements that cannot be tested experimentally are verified through software-aided simulation platforms.

3.4 Information and Communication Technology (ICT)

Although the transmission system is linked physically with the distribution grids for power transfer between the two grid types, the actual data exchange between DSO's and TSO's are currently scarce when it comes to real time data. Further, distribution grid states are not monitored very effectively and with the bidirectional flow of power in connection with added ancillary services data exchange for effective operations of the grid is required, [38] and [39]. When it comes to data exchange, the network is often assumed to simply work, but in fact this component in the grid system is critical for operations to be executed as planned. If the network does not perform as expected, this may endanger the reliability of the system operation.

In regards to the communication between any entities, there are a set of critical aspect that needs to be considered:

- Timing requirements: how strict and how tight are deadlines for data to be exchanged?
- Reliability requirements: how critical is it that data reaches destinations?

These two types of requirements more or less open or close different options to the type of communication that can be utilized. Often, 5-15 min. of intervals between data to be exchanged is seen as the base for data exchange. Nearly all communication technology today can easily support such update interval if reliability is not considered. Generally for any machine to machine (M2M) communication the level of correct service is in the order of 99,99...% magnitudes, where the severity of consequences is a matter of adding more or less 9's to the set of digits. The cost of adding more 9's however, increases heavily fast, so trade-off's and other fall back solutions must be considered as well. This in particular is an issue if the communicating entities are sharing any physical medium of communication since cross traffic from other independent sources always has an impact on the necessary traffic.

In the following, challenges and state-of-the-art in this regards are briefly overviewed.

3.4.1 Challenges in reliable and timely communication

The standard Interconnection Reference (OSI) model divides the communication into different layers each addressing different issues in relation to communication between entities.

At the physical layer, the issues are focused on sharing of the communication medium (e.g. frequency spectrum, copper wire or fiber wire), i.e. how should the devices avoid interfering with each other. Different techniques are here applied, e.g. time and frequency division. Since time and frequency are constrained resources, any technology has only limited capacity in terms of numbers of nodes and bandwidth at this level. Depending on the technology, the bandwidth and capacity may be interchangeable, i.e. with a low number of nodes, a high bandwidth can be achieved and vice versa. Physical range of communication is also a critical element, both for wired and wireless technology and even for optical lines there are limits of how far a line can be.

Therefore, data traffic more than often is required to pass by additional network equipment such as switches, routers and so forth to cross interlinked networks. The Internet is probably the most extreme

case of this, but allows any entity to be connected to virtually all other nodes in the world (if the technology had been implemented as intended). At these nodes where traffic crosses network boundaries, data packets may be stored and forwarded, an efficient approach when the target is to support a highly scalable network of networks with thousands and thousands of nodes. However, since these nodes need temporarily to store data packets, they also need memory as a buffer, and although memory is reasonable cheap compared to packet sizes, this store and forward mechanism becomes a trade-off between end-to-end latency and packet drops (if buffers runs out incoming packets are dropped).

If networks are private, it is relatively simple to mitigate this effect since entities can be scheduled for data transmission, and the overall data packet rates are limited to a known number of devices each producing a well-defined traffic pattern. If the network, on the other hand is public, then these are shared, and there is in principle no control of what goes on. Certain network operators provide Quality of Service as a way to provide certain classes of traffic a priority when travelling through the network, and it is expected that such priority services becomes more relevant as business cases as machine to machine communication as smart grids, becomes a reality.

Finally, at the application layer, data itself can be modelled in many ways. Since there are many vendors of entities, data needs to be described in a common way for interoperability of entities. Protocols needs to be designed such interfaces among the sender and receiver are matching. Therefore, it is critical also to consider the application layer protocols when doing communication.

3.4.2 Overview of communication technologies

In [40] a thorough overview of relevant communication technologies for smart grids were performed, and in the following two tables a summary of some of the properties of these technologies are listed

	xDSL	EuroDOCSIS	PLC	GPON	ISDN	Dial-up
Standard	ADSL: ITU-G.991.1 ADSL2+: ITU-G.992.5 VDSL2: ITU-G.993.2	DOCSIS 1: ITU-T Rec. J.112 DOCSIS 2: ITU-T Rec. J.122 DOCSIS 3: ITU-T Rec. J.222	IEEE 1901	ITU-T G.984	ITU-T G.961 ITU-T I.430 T Q.920/921/930/931	ITU-T V-Series
Data rate (up to)	ADSL: 12Mbps (DL), 1,8Mbps (UL) ADSL2+: 24Mbps (DL), 3,3 Mbps (UL) VDSL2: 100 Mbps (DL & UL)	50 Mbps per channel (DL) 27 Mbps per channel (UL) Number of channels dependent on version of standard Typical: 100/5 Mbps Up to: 400/108 Mbps	500 Mbps	1 Gbps (DL & UL)	64k bps per channel, up to 30channels	56 kbps
Coverage	<4km	over 100km (including HFC)	up to 1,5km	over 100km	<8km	<8km
Physical Medium	twisted pair wire	coaxial cable	electrical lines	optical fiber	twisted pair wire	twisted pair copper

In the following, an overview of relevant wireless technologies are listed

	GSM	UMTS	TETRA	CDMA450	WiMAX	
Frequency	900 MHz 1,8 GHz	1,9 GHz, 2,1 GHz	BOS: 380-395 MHz Private:400MHz	450 MHz	2,6 GHz, 3,5 GHz	
Data rate	9,6 kbit/s (GPRS: 171,2 kbit/s, EDGE: 384 kbit/s)	2 Mbit/s (HSPA: 14 Mbit/s, HSPA+: 168 Mbit/s)	28,8 kbit/s	144 kbit/s (EV-DO & EV-DV): DL: 3,1 Mbit/s UL: 1,8 Mbit/s)	70 Mbit/s (up to 1Gbit/s for low mobility users)	
Coverage	up to 35 km	up to 20 km	up to 22 km	up to 45 km	up to 5 km	

These can be summarized also visually to give an impression of the ranges and data rates achievable for the different technologies, [40] as shown in Figure 2.

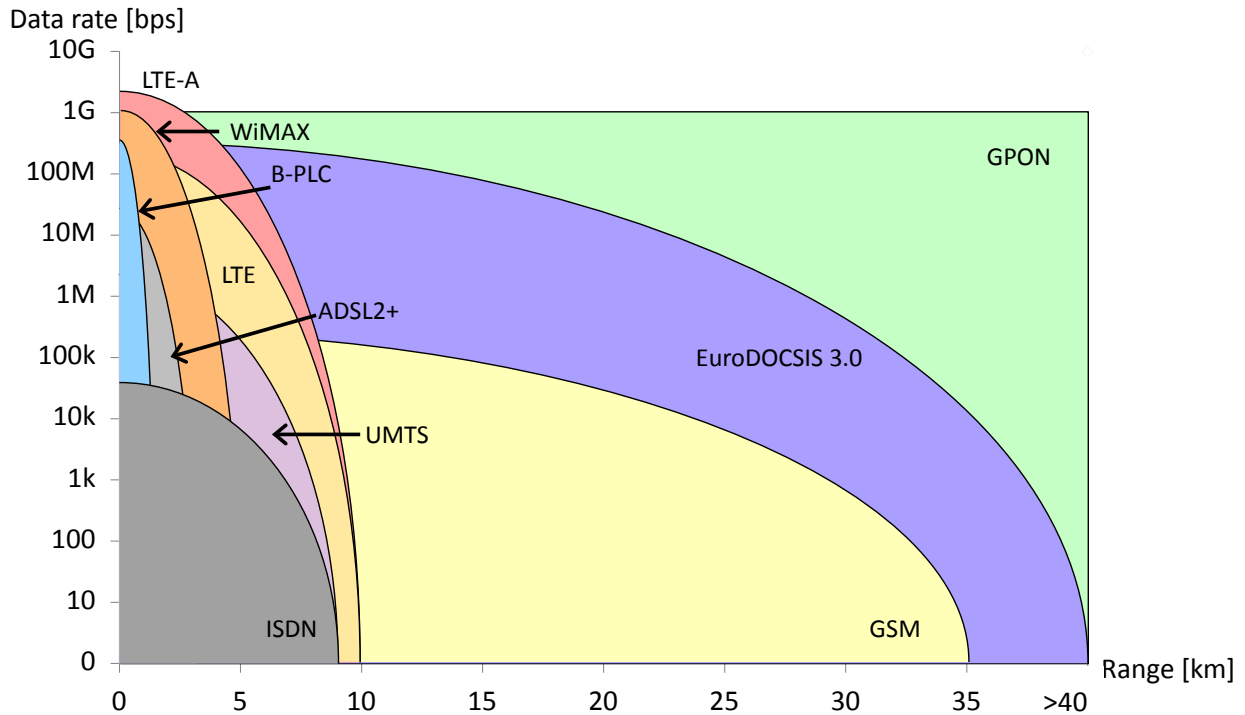

Figure 2. Overview of different physical technologies, their ranges and available raw data rates, [40]

Overall, it can be seen from these tables and figure that each technology comes with some benefits and some downsides. In particular, cost of deployment and maintenance is critical, and it should therefore be investigated in RePlan project, several solutions need to be considered.

3.4.3 Multiple networks (Internet)

A particular critical point comes when data has to be transported beyond a single network boundary, which is the case if data is to be exchanged over rather large ranges. Figure 3 shows an example of what data undergoes when being transported from source to destination, and what happens with the data packets along the way. The data is being handled by software across the communication stacks on each physical device it meets across its journey, and will be buffered at times when the device that bridges to the next link in the chain is not able to transmit. Depending on how the network is managed and whether it is a public or privately owned network, there are difficulties and levels of stochastic elements that need to be addressed to ensure timely and reliable communication.

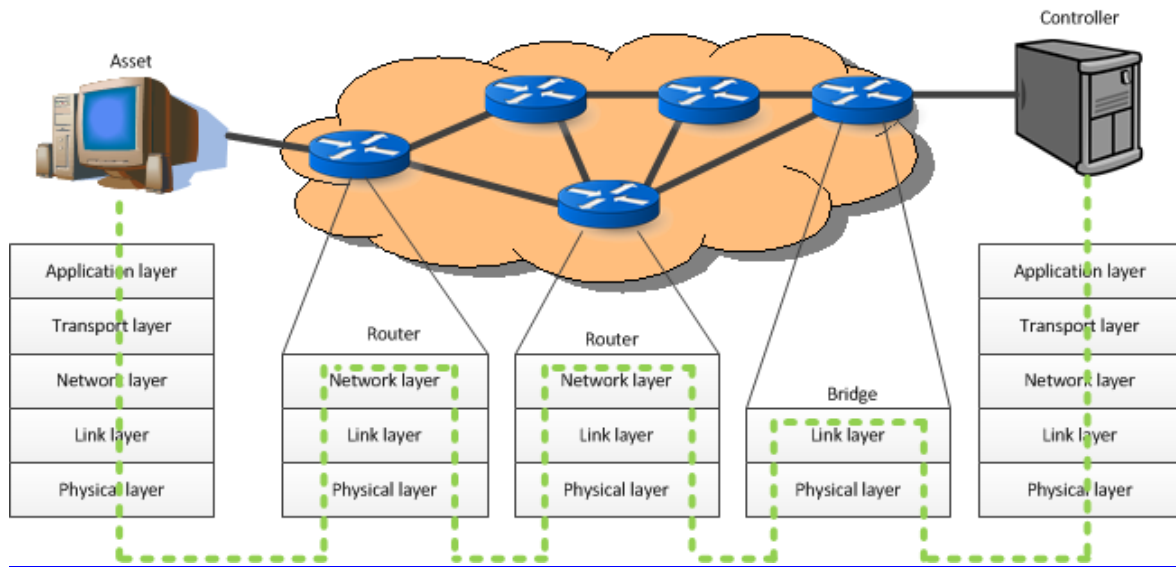

Figure 3. Illustration of data transport across multiple networks. Data may in public lines not travel the same route always, and be exposed to buffering due to cross traffic in the routers between source and destination.

Private networks:

For private networks, things are simple since cross traffic can be easily managed. In fact, if the only entities allowed on the network are those with time critical data, then in most cases (i.e. cables are not physical cut, the wireless frequency is not directly jammed by external sources etc.) data will be reliably transported fast and efficient with most modern communication technology. However, this is an extremely expensive solution and can be compared to implement a highway for having three cars to drive on it, so largely very inefficient. Additional traffic can obvious be put on the network, but the routers in between, that takes care of the traffic ending at the right address, must be able to differentiate between packets, i.e. provide Quality of Service (QoS), which requires configuration and management. Owning the network enables full control of QoS settings but is costly and requires proper manning and expertise to operate and maintain the network. Finally, private networks are for security reasons more likely to be stand alone, disabling communication and data exchange beyond certain boundaries which for some applications a degradation, e.g. remote monitoring or control of systems are often not possible outside control rooms due to physical separations of external networks.

Public networks (or third party):

Public networks refers to those networks that are operated by e.g. tele-operators or any other third party company or service provider which has the expertise and manning to operate the network, routers etc. In such network one does not need to worry about the internals of the network, and can enjoy data being transported from source to destination in most cases at best effort. Only limited possibility to control QoS settings are given if additional money is paid. Teleoperators works with the concept of Machine to Machine communication which allows certain timely and reliability requirements to be satisfied since traffic is internally prioritized effectively for transportation. It should be mentioned that is only the case as long the data traffic stays within boundaries of the given teleoperator. If data goes outside the domain of the teleoperator, then QoS is most likely to be lost, and time and packet losses cannot be guaranteed. However, these types of networks are cheap and flexible, but suffers to the extend it has to be shared

among millions of other customers, hence exposes data exchange to stochastic non-controllable delays and packet drops.

On top of the raw data transportation between entities handled by the IP protocol, two popular transport protocols, UDP and TCP are implemented and offers different level of data transportation service quality to the application. UDP is simpler and faster due to the lack of functionality, and basically offers the raw IP layer with some additional information, hence transportation using UDP (or UDP like protocols) are best effort, and the application must accept that packets (or data) may very well be lost in the network, e.g. dropped by a router or arrive in different order than it was send from the source.

For TCP this is different, since TCP includes mechanisms to acknowledge and retransmit data, such that data is reliably transmitted and received in causal order. However, due to retransmissions of lost data packet which are detected by timers running out, TCP generally suffers in delays when packets are dropped. This is in particular bad when networks are congested or many clients are on the same network.

Although the implications of network conditions are fairly known for TCP and UDP on the delay, its implications on the applications, and in particular on networked control is not known and requires additional research. For example the trade-off between using TCP and UDP, is in fact a trade-off between loosing data in the network or accept much higher delays.

3.4.4 Application layer protocols

On top of the TCP and UDP protocol (or at the same level) there are a high variety of application level protocols that needs to be studied further. These protocols are designed to service the application and therefore come with much different functionality which is built on the assumption of a working network. The functionality they offer are disrupted by delays and packet losses, depending on the use of TCP and UDP as mentioned earlier, which again is affected by the network topology and its performance, and that again is affected by the weakest link and physical layer in the communication chain.

An exhaustive analysis of such protocols can be found in [40].

Some info regarding different much used application layer protocols (relevant)

- GOOSE (Generic Object Oriented Substation Events): is a part of the IEC 61850 standard and is used for fast and reliable transmission of data over a substation network. It embeds several of the OSI layers, but is based on VLAN and Ethernet technology.
- MMS (not to be compared with the multimedia MMS designed for the mobile telecom world) (Manufacturing Message Specification) is an international standard (ISO 9506) dealing with transport of real time data and supervisory control information and is a part of the IEC 61850 standard. The original implementation of the MMS was done based on the OSI model but with its own layers, however, the modern versions of this protocol used the standard TCP over IP protocol set.
- SOAP (Simple Object Access Protocol): is a protocol that is used in combination with web services, and allows flexible exchange of data objects between web servers and clients. It defines message structure for expressing instances and how to process these and works on top of TCP/IP in any

network types. Up to 2009 this protocol specification was maintained by the WWW consortium, but is continuously being used.

- HTTP (Hypertext Transfer Protocol) is the classical web interaction protocol for web servers and clients, and works by a request/response pattern. Using underlying protocols between HTTP and TCP, security can be obtained via e.g. the TLS protocol that encrypts the HTTP session when being exchanged via TCP. HTTP is developed and maintained by the IETF and W3C.

There are many more protocols, and further work is required to focus on what needs to be communicated between which entities and functionality, before a final selection of relevant protocols can be found and further evaluated for optimization.

3.4.5 Useful standards

In the following a brief overview of relevant standards is provided:

IEC 61850 standard

IEC 61850 series consists of ten parts (all parts may have not been published yet) and is a part of the working group TC57 reference architecture. In particular the parts 7 and 8 are of interest to the communication, but also the -90-1 and 2 are of interest. The abstracted models of communication can be mapped into a number of already existing protocols, e.g. MMS, GOOSE, and soon also web services. The protocols may be run over TCP/IP over public as well as private networks to ensure response times for certain services. The standard includes data modelling, reporting schemes, fast transfer of events, sampled data transfer, commands, storage and other relevant issues for the project.

- *IEC 61850-7: Basic communication structure for substation and feeder equipment*
- *IEC 61850-8: Specific communication service mapping (SCSM)*
- *IEC 61850-90-1 — Use of IEC 61850 for the communication between substations [Published]*
- *IEC 61850-90-2 — Use of IEC 61850 for the communication between control centres and substations [Approved New Work]*

IEC 61400 standard:

The IEC 61400 standard defines all relevant parts for installing and using wind turbines. For the communication aspect the 61400-25 is the most interesting part since this focuses on monitoring and control of wind power plants. In this part, overall description of principles and models are described, information models and exchange mechanisms are described as well as a mapping to communication profiles are described. This includes details on the use of existing protocols as:

- SOAP/web based services
- MMS
- OPC XML
- IEC 60870-5-104 (specifications for transmission protocols and network access)
- DNP3

IEC 60870 standard:

In electrical engineering and power system automation, the International Electrotechnical Commission 60870 standards define systems used for telecontrol (supervisory control and data acquisition). Such systems are used for controlling electric power grids and other geographically widespread control systems. By use of standardized protocols, equipment from many different suppliers can be made to interoperate. IEC standard 60870 has six parts, defining general information related to the standard, operating conditions, electrical interfaces, performance requirements, and data transmission protocols. Part 6, defines the Inter Control Center Protocol (ICCP) and uses a client/server approach with the control centers as being either client or servers (they can be both). TCP over IP seems to be a common approach of implementation, and it does not provide even basic authentication.

4 RePlan framework

4.1 Ancillary services

The main ancillary services to be investigated in the RePlan project are:

Table 3: Ancillary services considered in RePlan

Frequency support	Voltage support	Rotor angle stability
Fast frequency control FFR (<2 sec)	Voltage control: power factor, reactive power or voltage (HV)	Power oscillation damping
Frequency containment reserve FCR (<2, 10 or 30 sec)		Synchronizing power
Frequency restoration reserves FRR (<15 min)		
Over-frequency response		

The technical specifications related to ancillary services are to a large extent based on the requirements for capabilities, described in Grid Codes, or Network Codes as they are called at ENTSO-E. Currently, there is a high divergence amongst Grid Codes in Europe. Consequently, requirements and their applicability are different in almost every country. There is an on-going formal process (Third Package) of creation of Network Codes that is intended to streamline the requirements in Europe. In the light of the progressed stage of the first network code issued by ENTSO-E, RePlan project takes the ENTSO-E Network Code (NC) for Requirements for Grid Connection Applicable to all Generators [18] as a reference document, rather than taking requirements from all present Grid Codes in Europe. The ENTSO-E NC intends to bring more consistency primarily for the requirements relevant for cross-border system management. For RePlan project, this is most useful for the frequency response capabilities, where the NC RfG contains quite detailed specifications. However, the NC RfG leaves many of the requirements open for detailed specification at national level. In these cases, the detailed requirements will be taken from the Danish regulations for grid connections [41], with detailed specifications for wind and PV and the Nordel Grid code [42]. For the fast frequency response, requirements are given in [43].

RePlan project will also address challenges related to the accommodation of large penetration of ReGen plants in terms of small signal and midterm stability, with specific aim to investigate the power system impact of ReGen plants capabilities to provide enhanced services like power oscillation damping (POD) and synchronizing power (SP). RePlan will analyse the suitability to coordinate POD and SP functionalities

between ReGen plants aiming at improved power system stability. Different case studies investigating the technical boundaries of WP and PV for angular stability service provision will be performed.

The basic principle for POD feature is to modulate the output power of the acting ReGen device in an appropriate phase, so the positive damping torque is induced on the oscillating generator units. Any signal reflecting the power system oscillations, being representative of a measured or estimated network state (line current, power flow, voltage amplitude or other) can be used as input to POD the controller. However, in respect to the output of the POD controller, WP can provide POD by modulating either active and/or reactive power output, while PV plant can provide POD by only modulating its reactive power.

The basic principle for SP to improve the steady state stability of a power system by surging additional active power into the system from an acting device, in cases when the rotor angle rises above a safe limit, due to an increase in the share of converter connected generators in the system. As SP provision requires prior curtailment of a ReGen plant, ReGen plant's participation in SP is mainly addressing WP plants.

Currently grid codes do not demand such control functionalities from ReGen. However, due to the ever changing and expanding nature of power systems and the planning of large displacement of conventional power plants by ReGen plants in the future, it is highly expected that ReGen plants will provide power system operators additional means, like POD and SP, to enhance power system stability. In this light, a number of TSOs have already started discussing the possibility to include new control functionalities from ReGen plants in future requirements. However, so far, there are not written specifications or requirements for those services. Possible specifications are available in the literature, i.e. in [44] a list of requirements specification for wind power based low frequency POD controller is given, while in [45] some specification requirements for SP are given.

In distribution systems, voltage drop and rise have to be taken care of, according to the existing standards concerning power quality, such as EN50610, IEC 60038. Distributed ReGen units have the capability to adjust their active power and reactive power output. A large number of units in the distribution grid increase the complexity of a control strategy that can be used for coordinating the ReGen to provide grid services. A robust and scalable control algorithm for optimally dispatching the active and reactive power for the ReGen units is important. Therefore, in RePlan, we will investigate coordination schemes that can provide scalable features to handle the aforementioned challenges.

There are a large amount of ReGen units connected with distribution grid. They are anticipated to provide ancillary services not just for the local distribution grid, but also for the bulk transmission grid. How the resources in such ReGen units are being allocated for different types of ancillary services, and how different services demanding the resources are of interest in RePlan to be investigated. However, some conflicts of demands from various ancillary services may exist (e.g., the provision of frequency restoration service may create local congestion and voltage rise problems that demands contradictory actions from the ReGen units).

4.2 Power system

In order to capture and power system phenomena addressed by the ancillary services described in section 4.1, RePlan project is considering a large power system comprises of Nordic system, Danish Western grid (DK-1) including the UCTE power system as shown in Figure 4. Moreover since RePlan project has also focus

on renewable plants located in the distribution grids a representative MV distribution network is considered in a selected node from DK-1 system.

4.2.1 Transmission System

West Denmark (DK-1) power system model is provided by Energinet.dk. The model consists of 411 buses, 124 transmission lines, 325 transformers (316 of them 2-winding and 9 of them 3-winding), 140 synchronous machines, 56 asynchronous machines, 40 shunts, and 70 loads. The total active power generation is 3488 MW with 671 MVAR reactive power. Accordingly the installed generation capacity is 6967 MVA. In the transmission system the losses are 74 MW and -798 MVAR (due to line charging). The interconnections to the neighboring countries are also included in the DK-1 model. The interconnection to Sweden, Konti-Skan, consists of two 285 kV DC connections with a total transmission capacity of 740 MW. The export capacity from Jutland is 740 MW, and the import capacity is 680 MW. The two connections were established in 1965 and 1988. In 2006, substation equipment relating to the oldest interconnection was replaced, which increased the total transmission capacity to 740 MW from the earlier 630 MW.



Figure 4. Overview of power system model used in RePlan.

The interconnection to Norway, Skagerrak, consists of three DC connections with a total transmission capacity of 1,000 MW. The first two interconnections of 250 kV and 250 MW each were established in 1976-1977, and the latest interconnection of 350 kV and 500 MW was established in 1992.

The interconnection to Germany (UCTE system) consists of four AC connections. Two 400 kV connections which start from Kassø were established in 1978. Two 220 kV connections which start from Kassø and Ensted Power Station respectively were established in 1965 and 1961. In addition to the four AC connections, there is a further 150 kV connection starting from Ensted Power Station to the city of Flensburg. The total transmission capacity is determined by congestions in the surrounding grids and is normally 1,780 MW in southbound direction (export) and 1,500 MW in northbound direction (import). The

last interconnection is between Jutland-Funen and Zealand (the Great Belt Power Link), a 400 kV DC connection with a transmission capacity of 600 MW.

The Nordic system is based on a variant of the so-called Nordic32 test system (Figure 5) and detailed in [46]. The model is intended for long-term voltage stability, being able to reproduce the system evolution over several minutes after a disturbance [47]. It includes 400, 200 and 130 kV levels, 74 buses, 20 generators and 102 branches.

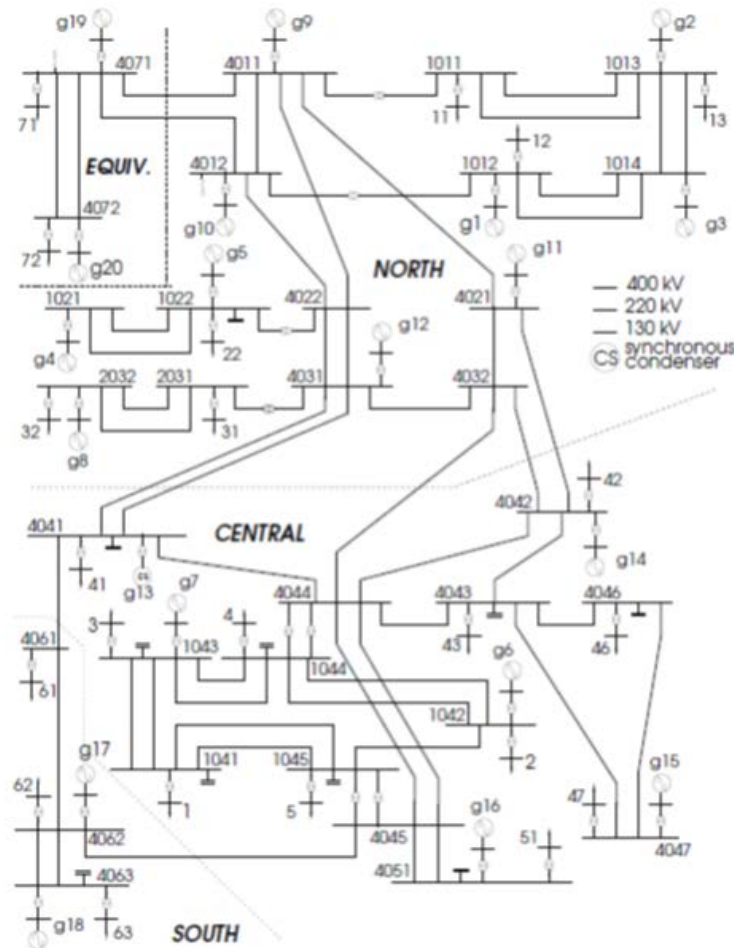

Figure 5: Modified Nordic32 system [47].

4.2.2 Distribution System

The distribution system considered in RePlan project is based on a grid operated by Himmerland Elforsyning (HEF) near Aalborg in North Jutland as shown in Figure 6.

This MV feeder comprises of 15 secondary substations distributed along the feeder and some kW wind turbines connected at the end of it. The rated power of the secondary substations is 100 to 1000 kVA. These substations has different types of loads e.g. households with or without electric heating, commercial, small and medium industry, farms/agriculture. This MV feeder was modified to support the research activities in the EU-FP7 project SmartC2net [48] as shown in Figure 7. The consumer types include Industry, Agriculture, Commercial and Residential. The DG units consist of a solar PV plant and Wind farm. As the

4.3 Control architecture

This section is defining two main architectures for controls that are to be addressed in the RePlan project namely hierarchical centralized control and decentralized control respectively.

4.3.1 Centralized Control Architecture

This control architecture is based on the current setup used by system operators. It involves basically 3 layers starting i.e. TSO, DSO and Plant control. Specific functionalities are included in each level where typically the ancillary GSS are placed in the ReGen Plant control. Dispatching functionalities accounting for availability of assets to provide a given GSS are also included here. Typically communication between these levels is done via SCADA system. Inside ReGen plant e.g. WPP or Solar PV other communication technologies including protocols may be used.

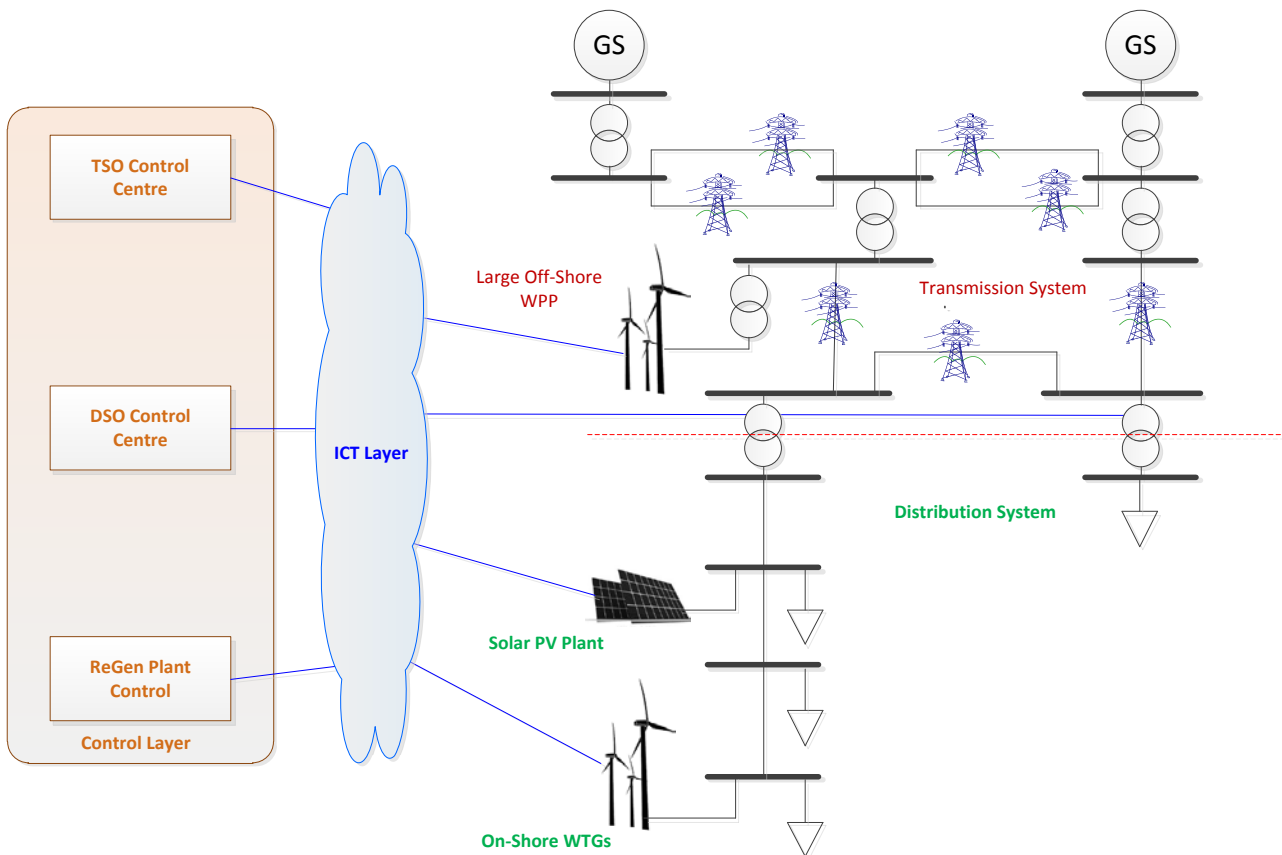

Figure 8 Centralized control architecture.

4.3.2 Decentralized Control Architecture

Decentralized control assumes that there is no communication between assets and the upper hierarchical control i.e. DSO and TSO. It can be completely independent when assets are not exchange information about the actual GSS or it may involve data exchange regarding the GSS functionalities.

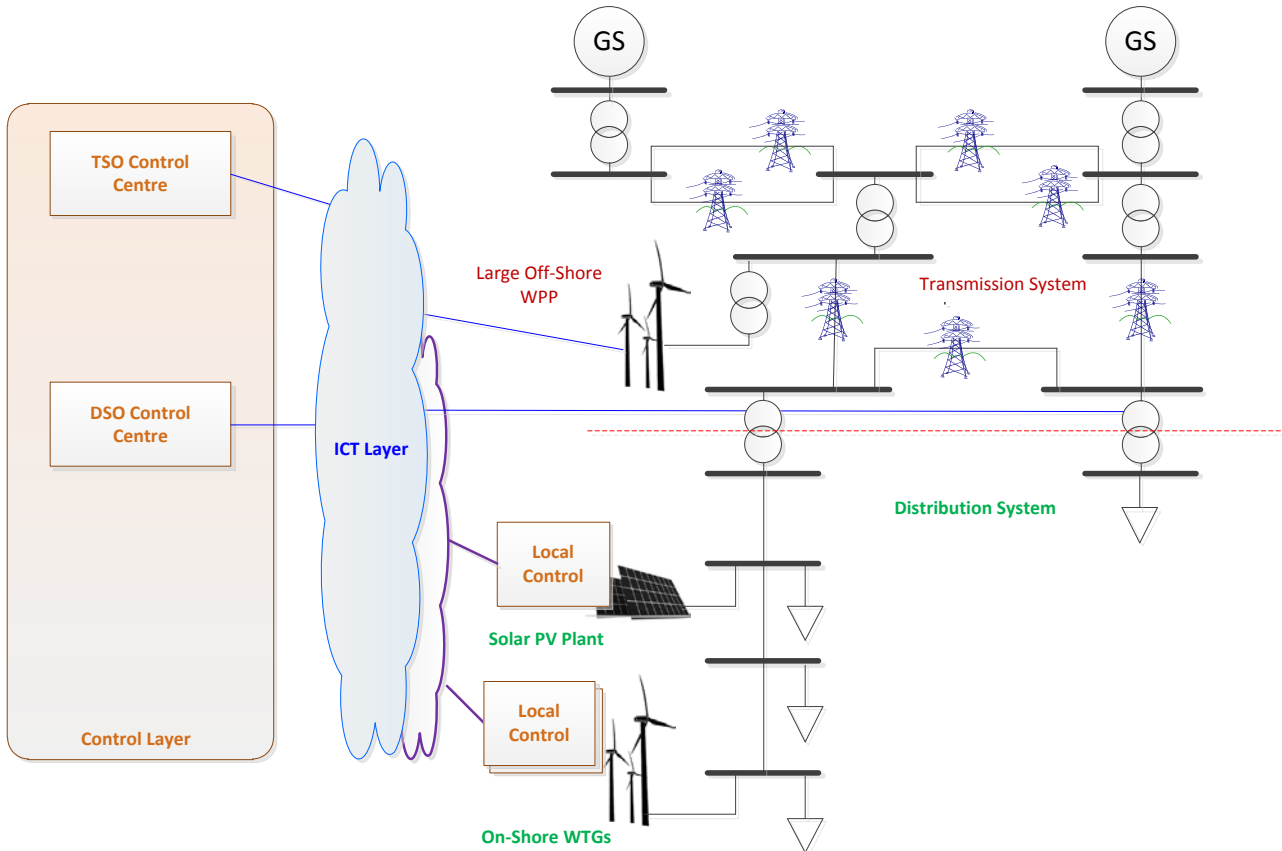

Figure 9 Decentralized control architecture.

5 Guidelines for assessment of results

The following workflow is expected for developing, testing, verification and validation of the GSS functionalities in Replan:

- Control development including tuning procedures is to be done using simplified and reduced models for the power system
- Verification of developed control is using a complete power system grid incorporating properties of interest. The verification stage is assuming extensive simulations under different scenarios and test cases.
- Validation of controls is done on laboratory facilities using a complete Real-Time model of the power grid. A reduced set of scenarios and test cases stemming from the verification stage is to be used.

5.1 Control Validation using AAU facilities

The Smart Energy Systems Laboratory in the Department of Energy Technology, Aalborg University is an open access Real-Time Power Hardware-In-the-Loop Platform for research and testing of new intelligent energy systems' solutions.

- ICT Layer - is the backbone for the setup and aims to emulate different technologies and topologies for the communication networks. A dedicated server is used to mimic the characteristics of

different communication networks such as 3G, LTE, xDSL etc, for which all traffic between controllers and assets are routed through. A dedicated server is used for generating stochastic or trace-based background traffic patterns to emulate realistic cross traffic. This traffic is based on traffic models and traces of real network traffic. The network configuration includes mapping GIS data to communication network as well as Offline and Online network reconfiguration is done from a Visualization server. It is the purpose of the Laboratory to develop an ICT platform that manipulates with the data access strategies in between entities (controllers and assets) to overcome potential issues in the network affecting the end to end Quality-of-Service.

- Control Layer (Hardware-In-the-Loop) – consists of different computers and industrial hardware platforms that are hosting functionalities of different actors e.g. DSO, TSO, Aggregator, Renewable plant owner, etc. Implementation of controls in all platforms is done using MATLAB/Simulink. New actors and/or functionalities can be easily added to the platform.
- Real-Time Digital Simulator – is capturing the electrical system from the transmission level (TSO) down to low voltage distribution grids (DSO). The system is able to simulate up to 200 three-phase bus-bars in EMT domain and very large electrical networks in RMS domain (up to 10.000 buses). All the modelling work in this real-time platform is done in Matlab/Simulink including Toolboxes.

The power system as described in section 4.2 is implemented in Real-Time Digital Simulator. Ancillary services in scope as defined in section 4.1 will be implemented in the dedicated hardware platforms according to roles and responsibilities of actors i.e. TSO level, DSO level, Plant Control including dispatch functionalities for WTGs and PV. Each communication link between actors is characterized by network type, data traffic, etc using the components of the ICT layer.

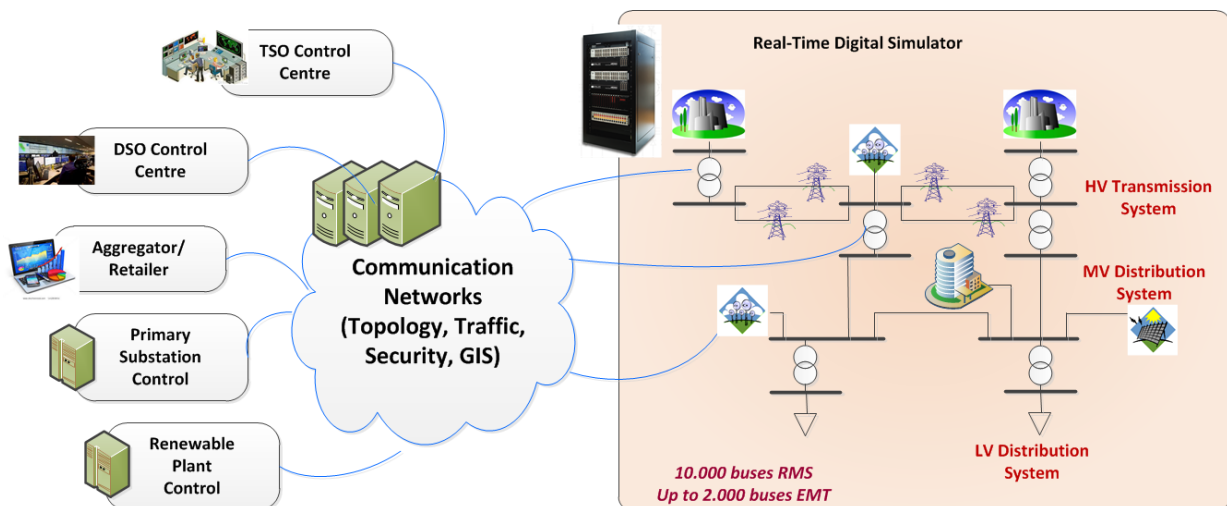

Figure 10 AAU facilities for control validation.

5.2 Control Validation using SYSLAB facilities

SYSLAB is a laboratory for intelligent distributed power systems located in DTU Risø Campus, as a part of PowerLabDK platform belonging to Center for Electric Power and Energy in DTU. SYSLAB facility enables research platform for testing control concepts and strategies for power systems with distributed control, integrating a number of distributed production and consumption components in a physical system context.

Figure 11 illustrates the physical layout of the electrical connections and available DERs. The grid topology is designed to be highly configurable for different experimental set-ups, which is composed out of offered power system components. Each DER or cross-busbar in SYSLAB is equipped with a dedicated computer, which is responsible for collecting the locally measured data and for running low level control of the attached electrical component. The computers can communicate with each other that compose a software and communication platform as a basis for research in control and communication infrastructure.

SYSLAB can be used to implement some distributed control algorithms that enable ancillary services scoped in section 4.1. Several practical considerations can be taken into consideration during the implementation process of the control algorithms. Some advantages can be identified from the perspective of implementation. In addition, SYSLAB can be used as a real LV feeder as part of the bulk power system in the feeder-in-the-loop platform to identify the local constraints from the distribution grids for DERs providing ancillary services to a larger system.

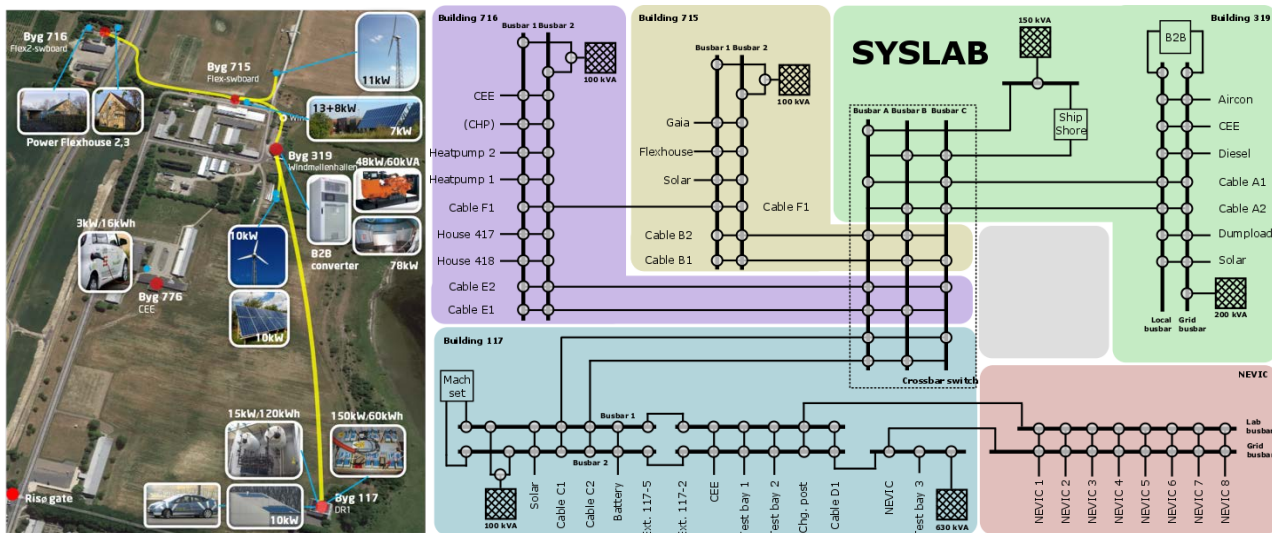

Figure 11 Geographical and electrical layout of the SYSLAB infrastructure

6 Summary

This document is presenting the state-of-the art regarding ancillary services provided by renewable power plants (ReGen) - existing and/or proposed ones – with focus on the services that will be specifically investigated in the RePlan project. It also gives an overview of the main communication technology and protocols available. The document is defining the structure of power system to be used in the project, together with two control architectures of interests. Finally, the report is including an initial guideline for assessment of the simulation results in laboratory environment.

7 References

- [1]. EU FP7 E-HighWay 2050 project, <http://www.e-highway2050.eu>
- [2]. F.v Hulle et al., Grid support services by wind and solar PV: a review of system needs, technology options, economic benefits and suitable market mechanisms. Synthesis report of the

- REserviceS project, REserviceS project, 2014. http://www.reservices-project.eu/wp-content/uploads/140724_REserviceS_D7.1_Synthesis-report1.pdf
- [3]. Odgaard O., “Large and small scale district heating plants,” Danish Energy Agency, [Online]. Available: <http://www.ens.dk/en/supply/heat-supply-denmark/large-small-scale-district-heating-plants>
- [4]. “Denmark/Powerplants,” [Online]. Available: <http://enipedia.tudelft.nl/wiki/Denmark/Powerplants>
- [5]. Dong Energy, “Central Power Stations,” Dong Energy, [Online]. Available: http://www.dongenergy.com/en/business%20activities/generation/activities/central_power_stations/pages/default.aspx
- [6]. Andersen, A.N.; Ritter, P.; Lange, B.; Toke, D.; Fragaki, A.; Madina, C.; Wojdyga, K.; Terno, O., “CHP-plants with big thermal stores balancing fluctuating productions from Wind turbines,” DESIRE ProjectWP 4, Aalborg, 2007
- [7]. The Danish Government’s “Our future Energy”, November 2011.
- [8]. Danish Energy Authority, Energy Statistics 2013, <http://www.ens.dk/sites/ens.dk/files/info/talkort/statistik-noegletal/aarlig-energistatistik/energystatistics2013.pdf>
- [9]. Store Project, “Energy needs in Denmark. Executive summary: “Overview of the Danish Power system and RES integration”, www.store-project.eu
- [10]. PVTECh, “Denmark to reach 2020 installation goal by Q4 2012”, http://www.pv-tech.org/news/denmark_to_reach_2020_installation_goal_by_q4_2012
- [11]. Energinet.dk, “Solar Power”, <http://www.energinet.dk/EN/KLIMA-OG-MILJOE/Miljoerapportering/VE-produktion/Sider/Sol.aspx>
- [12]. Danish Energy Authority, “New Offshore Wind Tenders in Denmark”, http://www.ens.dk/sites/ens.dk/files/dokumenter/publikationer/downloads/new_offshore_wind_tenders_in_denmark_final.pdf
- [13]. P. Sørensen, A.D. Hansen, N.A. Cutululis, Ancillary services from wind power plants, 10th Conference on Sustainable Development of Energy, Water and Environment Systems, 27 September – 2 October 2015, Dubrovnik, Croatia
- [14]. EURELECTRIC, Ancillary Services. Unbundling Electricity Products – an Emerging Market. EURELECTRIC Thermal Working Group, Ref: 2003-150-0007, Feb. 2004
- [15]. CIGRE, Ancillary Services: an overview of International Practices, CIGRE Working Group C5.06, Oct. 2010.
- [16]. ILEX Energy Consulting, Ancillary Service Provision from Distributed Generation, DTI Distributed Generation Programme, 2004.
- [17]. Energinet.dk Ancillary Services Strategy, <https://www.energinet.dk/SiteCollectionDocuments/Engelske%20dokumenter/EI/77566-11%20v1%20Energinet%20dk's%20ancillary%20services%20strategy.pdf>
- [18]. ENTSO-E, NC RfG: Network Code Requirements for Grid Connection (adopted by Member States in Comitology in Junw 2015) https://www.entsoe.eu/Documents/Network%20codes%20documents/NC%20RfG/draft_ec_networkCodesJune.pdf
- [19]. ENTSO-E, Survey on Ancillary Services Procurement and Electricity Balancing Market Design, https://www.entsoe.eu/Documents/Publications/Market%20Committee%20publications/150127_WGAS_Survey_2014.pdf

- [20]. <http://www.danishenergyassociation.com/Theme/SmartGrid2.aspx>
- [21]. <https://www.smartgrid.gov/>
- [22]. <http://integratedgrid.epri.com/>
- [23]. German Association for Electrical, Electronic & Information Technologies (VDE), "Guideline for the connection and parallel operation of generation units at low voltage level", VDE-AR-N 4105, 2011
- [24]. Technical Guideline for Generating Plants Connected to the Medium-Voltage network. Bundesverband der Energie- und Wasserwirtschaft e.V. (BDEW) 2008, 'Technische Richtlinie für Anschluss und Parallelbetrieb von Erzeugungsanlagen am Mittelspannungsnetz', Berlin, Germany
- [25]. Norma CEI 0-16 aggiornamento dicembre 2013
<http://www.ceiweb.it/it/comunicati/news/432-norma-cei-0-16-aggiornamento-dicembre-2014.html>
- [26]. <http://www.reservices-project.eu/>
- [27]. <http://www.ipower-net.dk>
- [28]. <http://ide4l.eu/>
- [29]. E. Liu and J. Bebic, "Distribution System Voltage Performance Analysis for High-Penetration Photovoltaics," NREL, Tech. Rep. February, 2008
- [30]. E.Malashenko et.al., "Energy Storage Framework Staff Proposal," California Public Utilities Commission (CPUC), April 2012.
- [31]. Reliability Pricing Model Demand response and Energy Efficiency, PJM.
<http://www.pjm.com/~media/markets-ops/rpm/20090406-dr-ee-in-rpm-collateral.ashx>
- [32]. Costanzo, Giuseppe Tommaso, et al. "A coordination scheme for distributed model predictive control: Integration of flexible DERs." Innovative Smart Grid Technologies Europe (ISGT EUROPE), 2013 4th IEEE/PES. IEEE, 2013.
- [33]. Development of a DSO-market of flexibility services. iPower Consortium, 2013.
- [34]. Heussen, Kai, et al. "A clearinghouse concept for distribution-level flexibility services." Innovative Smart Grid Technologies Europe (ISGT EUROPE), 2013 4th IEEE/PES. IEEE, 2013.
- [35]. D. Craciun et al., Report on the evaluation and conclusion of the DSO case, REserviceS project, 2014, <http://www.reservices-project.eu/wp-content/uploads/REserviceS-D6.2-Final.pdf>
- [36]. Han, Xue, et al. "Activate distributed energy resources' services: Hierarchical voltage controller as an application." T&D Conference and Exposition, 2014 IEEE PES. IEEE, 2014.
- [37]. Han, Xue, et al. "Hybrid control scheme for distributed energy resource management in a market context." 2015 IEEE PES General Meeting.
- [38]. Grid Innovation Online, "State of the art in TSOs-DSOs cooperation",
<http://www.gridinnovation-on-line.eu/Articles/Library/State-Of-The-Art-In-TSOs-DSOs-Cooperation.kl>
- [39]. ISGAN Discussion Paper, TSO - DSO interaction: An Overview of current interaction between transmission and distribution system operators and an assessment of their cooperation in Smart Grids, 2014, <http://www.cleanenergyministerial.org/Portals/2/pdfs/ISGAN-TSO-DSO-interaction.pdf>

- [40]. Christian Hägerling et al, "Preliminary SmartC2Net Communication Architecture and Interfaces", SmartC2net project, Deliverable D3.2, http://smarc2net.eu/public-deliverables/preliminary-smarc2net-communication-architecture-and-interfaces/@@download/document/SmartC2Net_20130930_D3.1-final.pdf
- [41]. Energinet.dk, Regulations for grid connections, <http://www.energinet.dk/EN/EI/Forskrifter/Technical-regulations/Sider/Regulations-for-grid-connection.aspx>
- [42]. Nordic Grid Code, 2007, https://www.entsoe.eu/fileadmin/user_upload/library/publications/nordic/planning/070115_entsoe_nordic_NordicGridCode.pdf
- [43]. Fast Frequency Response product, EirGrid, http://www.eirgrid.com/media/SS_May_2013_TSO_Recommendations_Paper.pdf
- [44]. Andrzej Adamczyk, "Damping of Low Frequency Power System Oscillations with Wind Power Plants", PhD thesis, Aalborg University, 2012
- [45]. Müfit Altin, Dynamic Frequency Response of Wind Power Plants, PhD Thesis, Aalborg University, 2012, http://vbn.aau.dk/files/76661450/Mufit_Altin.pdf
- [46]. T. Van Cutsem and L. Papangelis, Description, Modeling and Simulation Results of a Test System for Voltage Stability Analysis, Report of University of Liege, Nov. 2013
- [47]. T. Van Cutsem, THE NORDIC TEST SYSTEM FOR VOLTAGE STABILITY ASSESSMENT, 14PESGM0110, IEEE PES General Meeting, Washington D.C., 2014, <http://orbi.ulg.ac.be/bitstream/2268/171162/1/14PESGM0110.pdf>
- [48]. Nuno Silva et al, "Control framework and models", SmartC2net project, Deliverable D4.1, http://smarc2net.eu/public-deliverables/control-framework-and-models/@@download/document/SmartC2Net_D4.1.pdf

Annex 1

Sync. Area	Process	Product	Activation	Local/Central	Dynamic/Static	Full Activation Time
BALTIC	Frequency Containment	Primary Reserve	Auto	Local	D	30 s
Cyprus	Frequency Containment	Primary Reserve	Auto	Local	D	20 s
Iceland	Frequency Containment	Primary Control Reserve	Auto	Local	D	variable
Ireland	Frequency Containment	Primary operating reserve	Auto	Local	D/S	5 s
Ireland	Frequency Containment	Secondary operating reserve	Auto	Local	D/S	15 s
NORDIC	Frequency Containment	FNR (FCR N)	Auto	Local	D	120 s -180 s
NORDIC	Frequency Containment	FDR (FCR D)	Auto	Local	D	30 s
RG CE	Frequency Containment	Primary Control Reserve	Auto	Local	D	30 s
UK	Frequency Containment	Frequency response dynamic	Auto	Local	D	Primary 10 s / Secondary 30 s
UK	Frequency Containment	Frequency response static	Auto	Local	S	variable
BALTIC	Frequency Restoration	Secondary emergency reserve	Manual	Central	S	15 Min
Cyprus	Frequency Restoration	Secondary Control Reserve	Auto/Manual	Local/Central	D/S	5 Min
Iceland	Frequency Restoration	Regulating power	Manual	Central	S	10 Min
Ireland	Frequency Restoration	Tertiary operational reserve 1	Auto/Manual	Local/Central	D/S	90 s
Ireland	Frequency Restoration	Tertiary operational reserve 2	Manual	Central	S	5 Min
Ireland	Frequency Restoration	Replacement reserves	Manual	Central	S	20 Min
NORDIC	Frequency Restoration	Regulating power	Manual	Central	S	15 Min
RG CE	Frequency Restoration	Secondary Control Reserve	Auto	Central	D	≤ 15 Min
RG CE	Frequency Restoration	Direct activated Tertiary Control Reserve	Manual	Central	S	≤ 15 Min
UK	Frequency Restoration	Various Products	Manual	D/S	N/A	variable
BALTIC	Replacement	Tertiary (cold) reserve	Manual	Central	S	12 h
Cyprus	Replacement	Replacement reserves	Manual	Central	S	20 min
Iceland	Replacement	Regulating power	Manual	Central	S	10 Min
Ireland	Replacement	Replacement reserves	Manual	Central	S	20 Min
NORDIC	Replacement	Regulating power	Manual	Central	S	15 Min
RG CE	Replacement	Schedule activated Tertiary Control Reserve	Manual	Central	S	individual
RG CE	Replacement	Direct activated Tertiary Control Reserve	Manual	Central	S	individual
UK	Replacement	Various Products but the main one is Short Term Operating Reserve (STOR)	Manual	D/S	N/A	from 20 min to 4 h