



## Integrated smart infrastructures

**Østergaard, Jacob; Nørgård, Per Bromand; Wen, Fushuan; Rode, Carsten**

*Published in:*  
DTU International Energy Report 2015

*Publication date:*  
2015

*Document Version*  
Publisher's PDF, also known as Version of record

[Link back to DTU Orbit](#)

*Citation (APA):*  
Østergaard, J., Nørgård, P. B., Wen, F., & Rode, C. (2015). Integrated smart infrastructures. In H. Hvidtfeldt Larsen, & L. Sønderberg Petersen (Eds.), DTU International Energy Report 2015: Energy systems integration for the transition to non-fossil energy systems (pp. 15-22). Technical University of Denmark (DTU).

## DTU Library

Technical Information Center of Denmark

---

### General rights

Copyright and moral rights for the publications made accessible in the public portal are retained by the authors and/or other copyright owners and it is a condition of accessing publications that users recognise and abide by the legal requirements associated with these rights.

- Users may download and print one copy of any publication from the public portal for the purpose of private study or research.
- You may not further distribute the material or use it for any profit-making activity or commercial gain
- You may freely distribute the URL identifying the publication in the public portal

If you believe that this document breaches copyright please contact us providing details, and we will remove access to the work immediately and investigate your claim.

## Energy systems integration for the transition to non-fossil energy systems

Edited by **Hans Hvidtfeldt Larsen** and **Leif Sønderberg Petersen**, DTU National Laboratory for Sustainable Energy

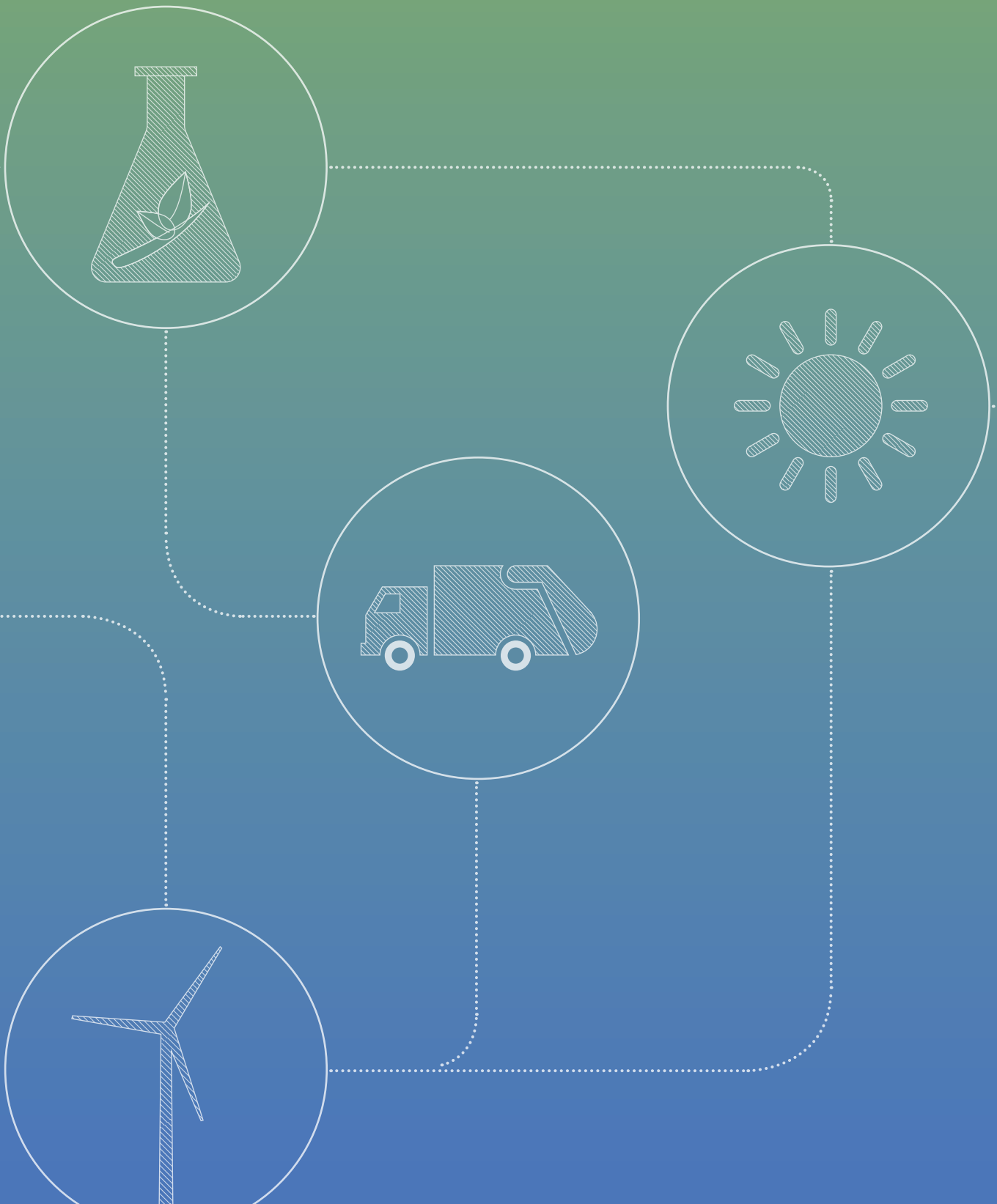

**DTU International Energy Report 2015**  
**Energy systems integration for the transition**  
**to non-fossil energy systems**

November 2015

**Edited by**

Hans Hvidtfeldt Larsen and Leif Sønderberg Petersen  
DTU National Laboratory for Sustainable Energy

**Reviewed by**

Marc O'Malley  
Professor  
University College Dublin  
Ireland

Lina Bertling Tjernberg  
Professor  
KTH Royal Institute of Technology  
Sweden

**Design**

e-Types Daily

**Print**

GraphicCo

**ISBN 978-87-550-3970-4**

# DTU International Energy Report 2015

## **Energy systems integration for the transition to non-fossil energy systems**

Edited by **Hans Hvidtfeldt Larsen** and **Leif Sønderberg Petersen**,  
DTU National Laboratory for Sustainable Energy





Through extensive integration of energy infrastructures it is possible to enhance the sustainability, flexibility, stability, and efficiency of the overall energy system. This in turn will reduce energy costs, improve security of supply, and help meet environmental needs - including the mitigation of climate change.

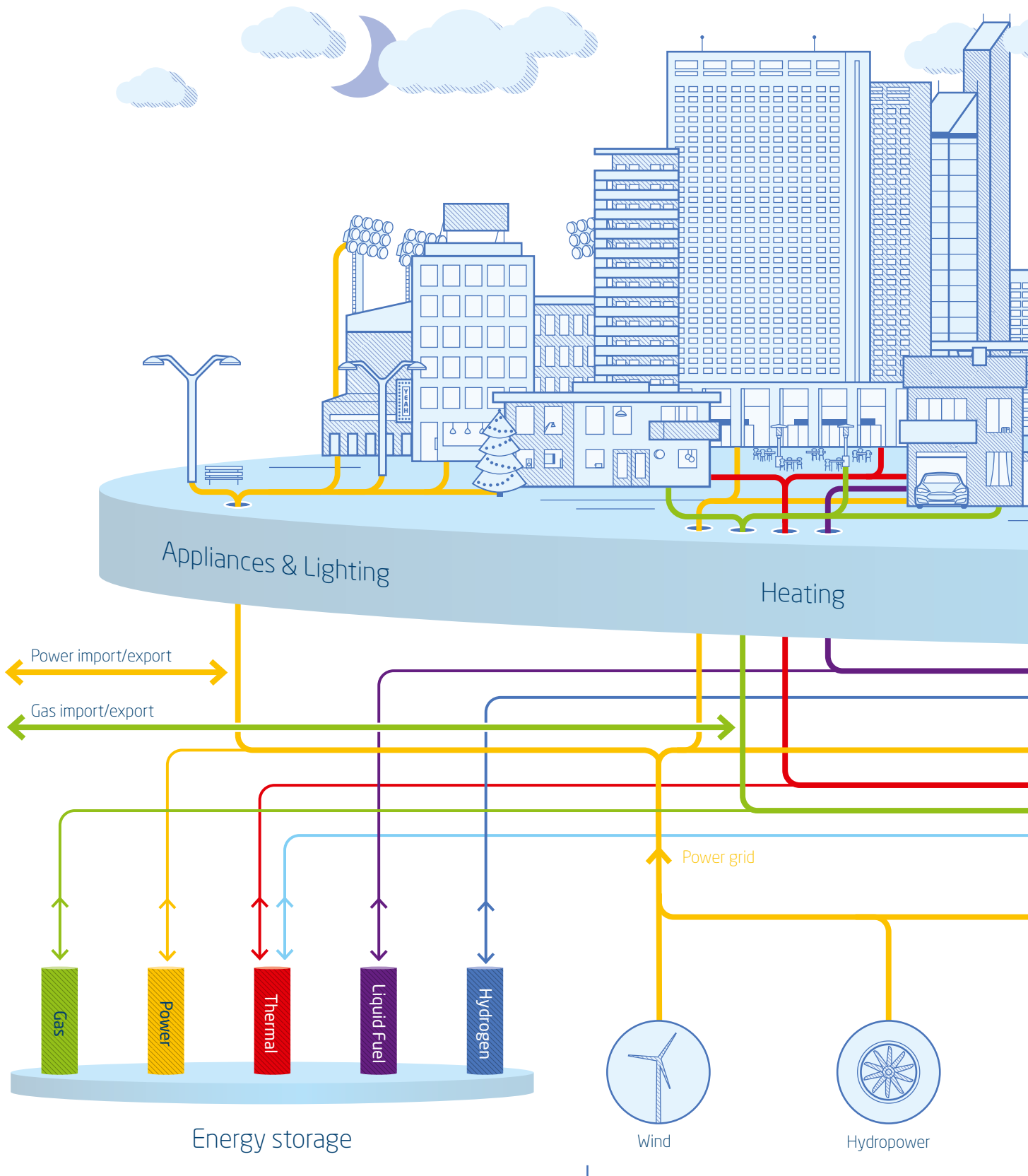

Today, flexibility in the energy system is mainly obtained by import/export of power and gas. Energy storage becomes important in order to increase the overall flexibility of the energy system.

Information and communication technology

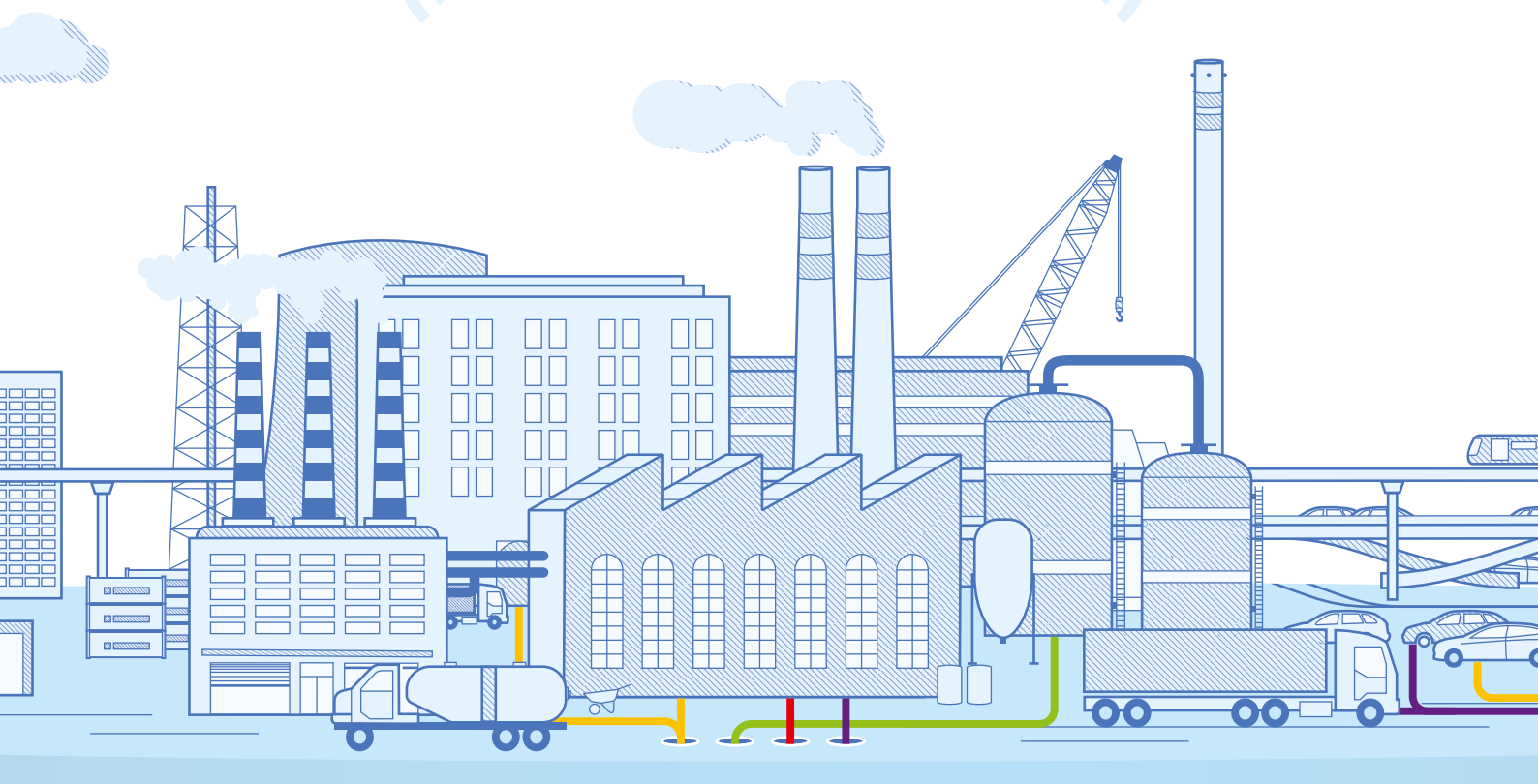

Industry

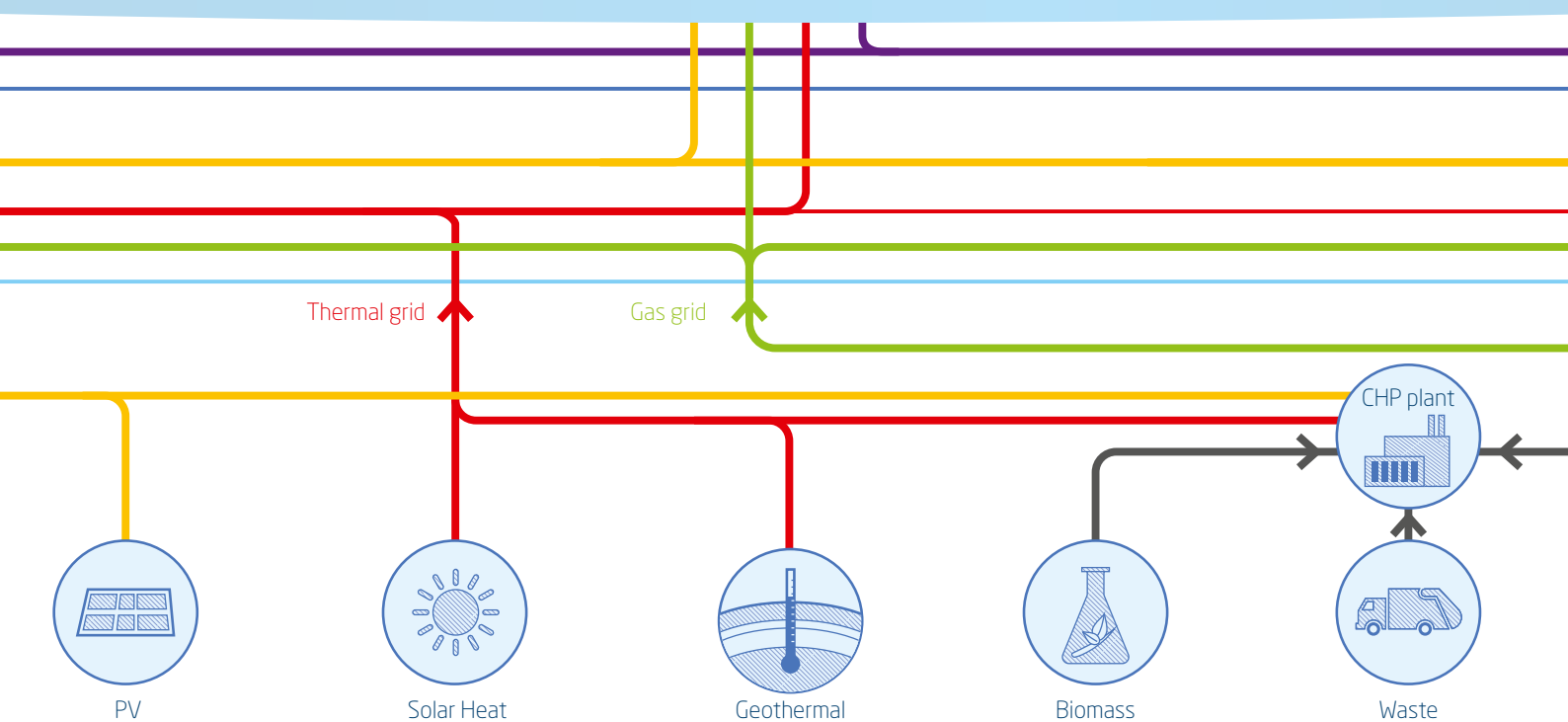

Fluctuating sustainable energy sources

- Power production will depend on the weather, making it more difficult to maintain stable and secure power services to end-users.
- Infrastructures like gas and heating have different characteristics and fluctuate on different time-scales. They can support the power grid.
- Technologies concerned with sustainable energy supply, conversion and storage must also be assessed with a view to grid integration.

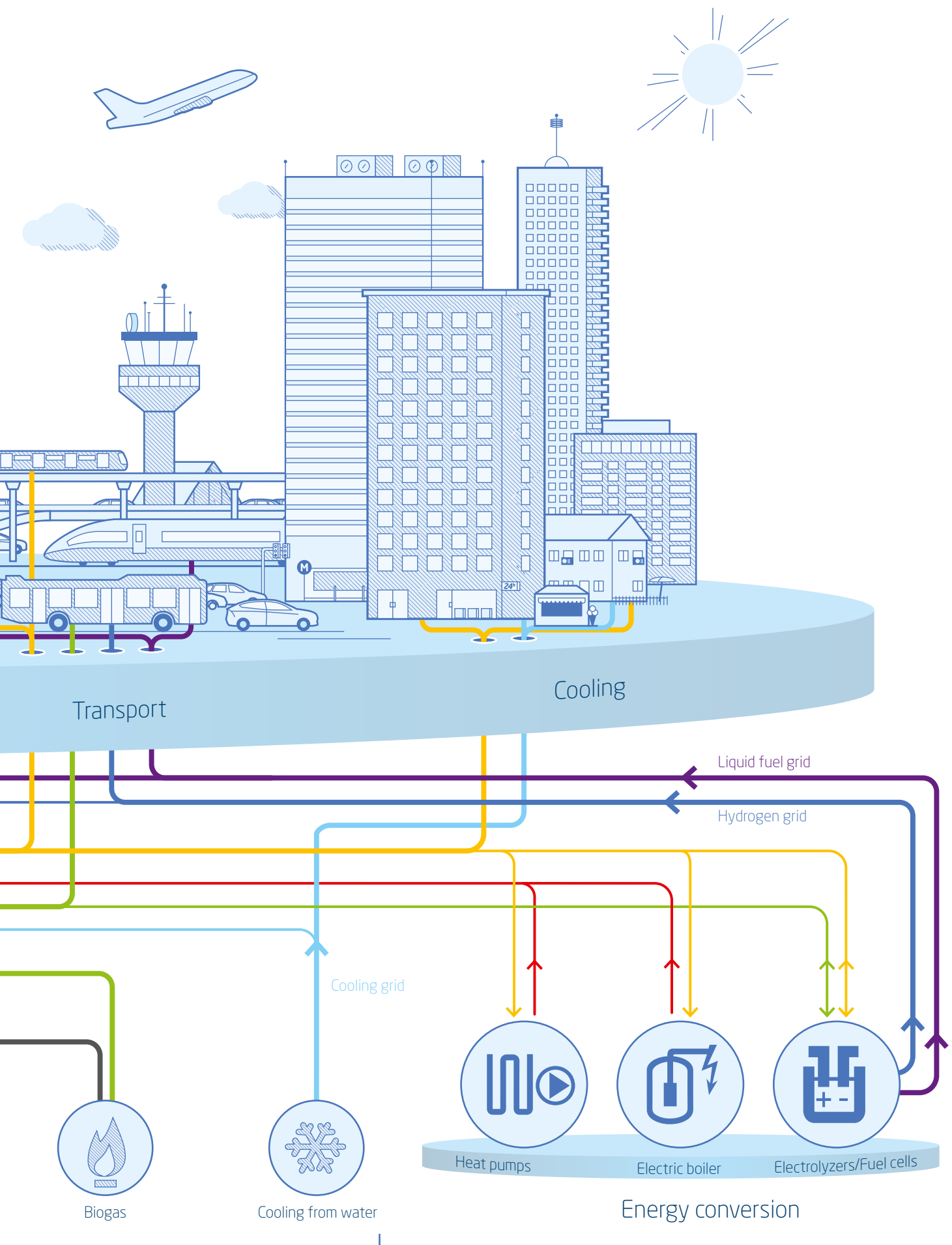

Transformation of the energy system requires new technologies for energy conversion and demand-side management, with more emphasis on making end-users active players.





# Contents

---

Chapter 1	<b>Preface</b>	6
Chapter 2	<b>Conclusions and recommendations</b>	7
Chapter 3	<b>Synthesis</b>	8
Chapter 4	<b>Integrated smart infrastructures</b>	13
Chapter 5	<b>Integrated energy systems modelling</b>	21
Chapter 6	<b>Integrated energy systems; aggregation, forecasting, and control</b>	32
Chapter 7	<b>Demand-side management</b>	39
Chapter 8	<b>Resilient integrated energy infrastructures</b>	48
Chapter 9	<b>Trends in energy supply integration</b>	54
Chapter 10	<b>Danish, nordic and european perspectives for energy system development</b>	75
Chapter 11	<b>Energy systems integration for a decarbonising world</b>	82
Chapter 12	<b>Index</b>	91
Chapter 13	<b>References</b>	92

## Chapter 1

# Preface

---

One of the challenges in the transition to a non-fossil energy system with a high share of fluctuating renewable energy sources is to secure a well-functioning and stable electricity infrastructure. Today, conventional generation is responsible for providing many of the power system services needed for stable and reliable electricity infrastructure operation. When fluctuating renewable energy sources are taking over, the heating, cooling, gas, and transport infrastructures may be able to provide some of the flexibility needed.

Closer integration of the various energy infrastructures is thus a means to solve some of the challenges introduced by the broader integration of renewable sources.

Closer integration and coordination of energy infrastructures might also lead to a more cost-effective energy system with a lower impact on the environment and climate.

The DTU International Energy Report 2015 discusses these issues and analyses the possibilities for – and challenges to – the wider introduction of integrated energy systems.

## DTU International Energy Report series

---

DTU International Energy Reports deal with global, regional, and national perspectives on current and future energy issues. Individual chapters of the reports are written by DTU researchers in cooperation with leading Danish and international experts.

Each Energy Report is based on internationally recognized scientific material and is fully referenced. It is then refereed by independent, international experts before being edited, produced, and published in accordance with the highest international standards.

The target readership is DTU colleagues, collaborating partners and customers, funding organizations, institutional investors, ministries and authorities, and international organizations such as the EU, IEA, WEC, and UN.

## Chapter 2

# Conclusions and recommendations

---

Future energy systems with high shares of fluctuating energy from sustainable sources pose particular challenges for the power grid. Power production will depend largely on the weather, the variability of which will make it more difficult to maintain stable and secure power services to end-users.

Other energy infrastructures like gas, heating/cooling, and liquid fuels have different characteristics and fluctuate on different timescales. They have some energy storage capabilities of their own, as well as a range of interconnections to the power grid.

This Energy Report demonstrates that through extensive integration of energy infrastructures it is possible to enhance the sustainability, flexibility, stability, and efficiency of the overall energy system. This in turn will reduce energy costs, improve

security of supply, and help meet environmental needs – including the mitigation of climate change.

The Report also makes it evident that such a transformation of the energy system requires the introduction of new technologies for energy conversion, storage, and demand-side management, with more emphasis on making end-users active players in the energy system. A number of economic, commercial, and regulatory barriers also need to be removed.

Finally, the Report points out that at local, regional, and global level, inadequately performing energy infrastructures may impose severe economic losses on society, reduce economic growth and even impair sustainable development. This field of energy research is still relatively young and is charged with challenges.

## Recommendations

---

To stimulate the development of integrated energy systems, a series of initiatives is recommended for the years ahead. Efficient transformation to a smart, energy system with multiple integrated infrastructures requires focused development efforts. The following key initiatives should be prioritized:

- 1 **Research and development on integrated energy systems should be intensified, including full-scale demonstration sites.**
- 2 **Regulation of the energy system, including taxes, should evolve to remove barriers and facilitate deployment of integrated energy solutions across sectors.**
- 3 **Better and more integrated forecast services for intermittent sustainable energy resources should be developed.**
- 4 **Development perspectives for technologies concerned with sustainable energy supply, conversion and storage must be assessed, not only in relation to their economic and environmental performance, but also with a view to grid integration.**
- 5 **Systems modelling and analysis techniques for resilient infrastructures are under development, but more focused research is needed.**
- 6 **In Denmark, interactions between the three major networks - power, natural gas, and district heating - should be further exploited to create flexible solutions.**

## Chapter 3

# Synthesis

## Development toward more integrated energy infrastructures

→ High penetrations of renewable energy, like wind and solar, challenge the conventional planning, design and operation of the electricity infrastructure, due to the intermittent nature of the resources. Furthermore, renewable energy sources displace conventional generation, which today is responsible for providing many ancillary services to the power system. These ancillary services – including generation reserves, voltage control, frequency control, short-circuit power, stability services and black start restoration – are essential to ensure stable and reliable operation of the electricity infrastructure.

Energy trading through electricity and gas interconnects to neighbouring

countries is widely used to balance the energy system and ensure stable and reliable operation. However, the ability of neighbouring energy systems to interact is only valuable if they have different characteristics, as is the case for Norway and Sweden, for example.

The heating, cooling, gas, and transport infrastructures each have a certain intrinsic storage capability and can therefore provide some of the flexibility needed in the electricity infrastructure. The demand side of the electricity system also has some inherent flexibility if proper mechanisms (markets, communication, etc.) are introduced.

Closer integration of energy infrastructures will solve some of the challenges of integrating renewable resources. Closer integration and coordination of the different energy infrastructures lead to a cost-effective energy system with a high share of intermittent renewable energy sources. Furthermore, closer integration

should not be limited to infrastructure technology. A higher degree of integration and coordination should also be pursued in terms of regulation and organization across sectors.

An integrated energy system with a high share of renewable energy will utilize, and be highly reliant on, digital technology. Examples are sensors and actuators embedded in the system, various internet technologies, service-based designs, and novel business models that go beyond just selling energy at fixed prices. The integration of energy infrastructures through the use of novel IT solutions is addressed under the broad heading of Smart Energy.

The Smart Energy system also has close relations with the broader Smart City and Smart Community concepts. Smart Cities and Smart Communities focus on how IT can be utilized to enhance the performance of complete neighbourhoods and improve the quality of life for the people who live and work in them. They cover not just energy, but also other critical infrastructures such as water and traffic.

### Electricity infrastructure

The combination of increasing distributed generation, intermittent generation from wind and solar, load fluctuations, and limited storage capacities challenges the electricity system and infrastructures in many ways.

As large numbers of small-scale generation systems replace some centralized



power plants, power will increasingly flow through the distribution system in all directions and at rapidly changing rates. Individual areas – and even individual customers – may become self-sufficient in power when averaged over a year. New flexible power generation units, increased consumption flexibility (through demand response and fuel shifting), and new energy conversion units will be introduced. Fuel shifting allows the required energy services to be provided from more energy sources. Heat, for instance, may be provided from dynamic combinations of energy sources such as district heating, electricity and gas, depending on their availabilities and prices. The conversion technologies used will include conversion from electricity to heat (e.g. by heat pumps), from electricity to gas (power-to-fuel), and from gas to electricity and heat (micro-CHP).

### Heating and cooling infrastructure

Thermal energy infrastructures, especially district heating, will be challenged by the reduced heat demand of new low-energy buildings. These new buildings will mainly need part-time space cooling and tap water heating. New concepts and business models must therefore be developed to meet these new needs. These include low-temperature and ultra-low-temperature district heating systems, for easier and more cost-effective re-use of waste heat from buildings and industry. (Ultra-low-temperature



systems work at temperatures below 60°C, so they require temperature boosting for domestic hot water.) Also expected to play increasingly important roles are district cooling, local thermal systems, the transport of excess generated heat to areas with heating needs, and all types of heat exchangers.

### Gas infrastructure

With their flexibility in terms of operating pressure and large storage volumes in the form of pipelines and caverns, natural gas infrastructures already provide energy storage on a large scale. Power can be converted into gas (either hydrogen or methane), some of which can be injected into the gas system – though not without changing the quality of the existing gas. High-temperature electrolyzers such as solid oxide electrolyzes cells (SOECs) provide the potential for high-efficiency conversion of power to gas. In the opposite direction, gas can easily be converted into electricity and heat by combined heat and power (CHP) systems. Various types of fuel cells provide the potential for high-efficiency conversion at scales as small as household units (micro-CHP).

### Mobility infrastructure

The transition of the transport sector towards renewable energy is a major challenge. In addition to what optimal urban planning can do, the dominant trends are solutions based on electricity, gas, biofuels, and hydrogen. These different energy carriers may be combined in ‘serial hybrid’ solutions, in which electric motors provide traction while a fuel is converted to electricity on board the vehicle and stored in a battery. These trends apply to all means of transport – vehicles, trains, ships and even aircraft. The electrical solutions will increase demand for electricity, and if properly designed and controlled they may add flexibility to the power system (the ‘vehicle-to-grid’ concept).

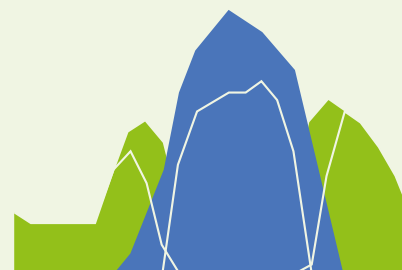

## Demand-side flexibility, customers, and price signals

→ Buildings, industry and the demand side in general can provide energy services to support the operation and integration of energy infrastructures. Building management systems, for instance, are being developed to intelligently manage the exchange of energy between a building and the energy system. This allows the building to provide local energy services and at the same time to participate actively in the energy markets through demand management. Information and communication technologies, and data processing, are key to this interchange. Local storage technologies can also play an important role here.

The existing energy markets, and their schemes for billing and regulation, are largely designed for yesterday’s energy systems. They are characterized by separate markets for electricity, heat, and gas; large-scale centralized supply; one-way flows from generators to consumers; inflexible patterns of consumption; and small numbers of well-defined market players. Tomorrow’s energy operations, markets, and business models must be reconsidered and redesigned. To support smart operation, dynamic energy pricing must become available at consumer level.

## Grey-box modelling of integrated energy systems

→ Integrated energy systems require a greater degree of optimization than those that operate independently. This optimization requires models that describe the dynamics of all the parts of the system, extending all the way down to individual units.

Take the example of an electrically driven heat pump in a house, which clearly has the potential to provide flexibility by load shifting. To take advantage of this by using the heat capacity of the building as energy storage, we need a model of the thermal dynamics of the building.

A typical practical model of such a system is known as a 'grey-box' model, allows a wide variety of systems to be coupled to the main energy infrastructures and controlled in such a way as to optimize their operation as flexible consumers and providers of energy services.

## Aggregation, forecasting, and control

→ Future electricity systems with increasing shares of fluctuating renewable power generation must be designed such that it is possible to activate flexibility on many different scales or at aggregation levels. This implies, for instance, that we must be able to describe the links between individual household appliances, distributed energy resources (DERs), and the electricity or other energy markets.

Aggregation is a very important concept for energy systems integration. The idea of representing a large number of DERs as an aggregated whole is not entirely

new, since market participants representing aggregations of both producers and consumers already exist. Examples are the BRPs that manage consumption, and generation BRPs for wind energy. Experience shows that a high level of aggregation improves the accuracy with which production or consumption can be forecast.

In markets characterized by efficient integration of energy systems, balancing services ensure that, for instance, excess wind power can be used for district heating, or biogas-fired power plants started up when wind power production is low. Both the district heating and the gas networks are therefore important for the implementation of some energy balancing services.

### Meteorology for integrated energy systems

Integrated energy systems (ESIs) will in practice be based on a large share of fluctuating, weather-dependent energy sources, as well as weather-dependent flexible DERs and energy management systems. It is therefore important to have meteorological models and methods that are customized to the needs of energy management and storage. Gas networks can provide seasonal storage, while district heating networks can store energy for, say, two or three days ahead. This means that meteorological forecasts with different lead times are needed, introducing the challenge of how to optimize existing meteorological models for this purpose.

In general, decisions on the weather forecasts needed for IESs must take account of their resolution in time and space, update frequency and forecast horizon, as well as the actual variables being forecast, such as temperature, wind speed, or solar intensity. The resolution in time and space is often directly implied by the requirements specified by the user of the forecasts.

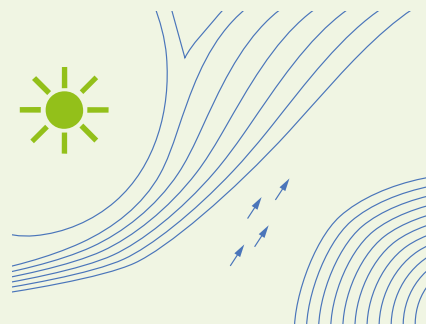

## Resilient integrated energy infrastructures

→ Energy infrastructures that perform inadequately – whether they are global or local in scale, in developing or developed societies – may cause severe economic losses to society, hamper economic growth, and even impair sustainable development. The challenges are tremendous. Despite our generally improved knowledge, technology, and organizational capacity with respect to the design and operation of energy infrastructures, supplies are repeatedly interrupted by natural hazards, technical failures, and malevolent acts. The consequences can be devastating in terms of deaths and injuries, health problems, economic losses, and damage to the environment.

Continued economic growth, and the eventual move towards sustainable societies, pose significant challenges for the next generation of energy infrastructures. Climate change, increasing population, and growing demands, in combination with the global societal need for more efficient, diverse and distributed energy production, add new challenges for the design and operation of energy infrastructures. At present, the answer to these challenges is considered to lie in resilient integrated infrastructures.

Many factors affecting the performances of energy infrastructures in general are



associated with uncertainties, some of which are very substantial. As a result, it is clear that the performance of energy infrastructures is also subject to significant uncertainty. Modelling and analysing them realistically and consistently thus necessitates the use of probability theory.

The performance of energy systems in the face of disturbances can be assessed in terms of robustness and resilience. Robustness is the ability of a system to limit consequences to direct losses, avoiding indirect consequences related to the functionality of the system. Resilience is the ability of a system to recover to its initial state after a disturbance.

Despite substantial efforts to understand, model, and analyse energy infrastructure systems over recent decades, this field of research is still relatively young and charged with challenges.

## The need for platforms for development and demonstration

→ Transformation to a smart energy system requires the development of new solutions on multiple scales and dimensions. New energy technologies will have to be applied, and existing technologies adapted to new contexts. New business models, new architectures, and new solutions for system operation have to be developed and implemented. Development also has to take place on multiple scales: component level, infrastructure level and system level.

Examples of districts offering platforms for the development and demonstration of new energy solutions are the Jeju Island Smart Grid Testbed (Korea), Masdar City (United Arab Emirates), Vienna

and Smart Cities Demo Aspern (Austria), Stockholm Royal Seaport (Sweden), and Sino-Singapore Eco-City in Tianjin (China).

In Denmark, the two largest demonstration sites are Bornholm and EnergyLab Nordhavn. Bornholm is an island with an annual average penetration of renewables of more than 50%; the project is part of the PowerLabDK experimental platform. EnergyLab Nordhavn is a new city development area focusing on sustainability and smart, integrated energy infrastructures.

## Technology integration aspects

→ Development perspectives for the different sustainable energy supply technologies such as solar PV, solar thermal, wind energy, and biomass must be assessed with a special view to grid integration. The same goes for enabling technologies for sustainable energy, which include fuel cells, electrolyzers, heat pumps and energy storage. Integration of the transport sector through e.g. electrification of public transportation, EVs, et cetera is likewise important. All these technologies are traditionally evaluated with regard to their economic and environmental performance. In the future, it will be equally important to study their performance within the integrated energy system.

## European perspectives

→ As energy systems with high shares of renewable energies develop, so new challenges arise. The European Community is facing three major challenges within the energy field:

- **Sustainability.** Current energy and transport policies imply that EU CO<sub>2</sub>

emissions will increase by approximately 5% by 2030.

- **Security of supply.** Europe is becoming increasingly dependent on imported fuels. If existing trends continue, the present import share of 50% will increase to approximately 65% by 2030.
- **Competitiveness.** Rising energy prices could jeopardize additional job creation in the EU. Investing in energy efficiency and renewable energy could encourage innovation and industrial development, with benefits for EU employment and the economy.

The establishment of a single European electricity market has been and still is a priority for the European Commission. The results of this drive are already becoming apparent: as of February 2014, the Nordic electricity market is closely connected with those of central, western, and southern Europe through price coupling.

The EU strategy of relying on an increasingly high share of sustainable energy sources will radically change European energy systems within the next decade. Energy technologies based on intermittent sources, especially wind and solar PV, are expected to play a large role in the future energy supply.





## Denmark in a European context

In a European context, the Danish energy system has two main characteristics:

- Denmark has a diverse and distributed energy system based on three major national grids: power, district heating, and natural gas. The way in which these grids work together shows that Denmark has a highly efficient supply system.
- Renewable energy technologies – especially wind power – play a large and increasingly important role in the Danish energy system. By 2014, 39% of Danish power needs were supplied by wind power. Denmark is one of the global front-runners in the development of offshore wind farms.

For more than 25 years Denmark has succeeded in keeping gross energy consumption constant – and even reducing it slightly since 2008 – despite an increase of more than 80% in GNP over the same period. For a number of years, Denmark was the only country in the EU to be a net exporter of energy.

Geographically, Denmark is located on the border between the European continent and the Nordic countries. Consequently, Denmark acts as a kind of transit area between the Nordic and the European electricity systems, especially Germany. The Danish natural gas grid also connects Sweden with Germany. Denmark has strong connections to Norway and Sweden, the oldest of these having been established back in the 1950s. The exchange of Danish wind power and Norwegian hydropower is especially important for the Danish power system. A new connection to Norway, the 700 MW Skagerrak4, was inaugurated in spring 2015. Denmark

also has strong interconnectors to Germany, though the full utilization of these is sometimes hampered by grid bottlenecks in central Germany.

## Global perspectives

→ Global energy demand is set to increase in the coming decades, particularly in countries that are expected to witness significant economic growth. However, there is a large disparity among regions, countries, and socio-economic groups in terms of how energy will be used, and how much. Industrialized countries and high-income groups use a larger proportion of their energy for transport. In developing nations and among low-income groups, most energy is used for



residential and commercial needs – in other words for lighting, heating, cooling, and cooking. As developing countries mature, their energy needs will grow. The IEA's World Energy Outlook 2014 estimates that the world primary energy demand will increase by 37% by 2040, if current and planned policies are taken into account. The main regions driving this growth trend are the industrialising countries of South-East Asia and Africa.

## Spatial integration in developing countries

Renewable energy resources are especially important for future electricity generation. A significant proportion of the 1,317 million people who now lack access to electricity live in remote areas, where grid connections are often technically difficult and prohibitively expensive. In such cases, mini-grid and off-grid systems are the best solution. RETs, in particular mini-hydro and solar PV, are more often than not the most viable technologies for electricity generation.

To date, most energy systems integration (ESI) in developing countries (excluding China), to the extent that it exists, has addressed spatial integration, i.e. the distribution of energy from large centres of generation to major demand centres. Often, this is done by transmitting electricity across national borders through grid interconnectors. A typical example is a large hydro plant sending power to neighbouring countries that lack significant or low-cost domestic primary energy resources.

## Grid integration in China

In China, the National Energy Administration has set national renewable and nuclear energy targets. One of these is to have 15% non-fossil-fuel energy in the total primary energy mix by 2020. Since the enactment of the Renewable Energy Law in 2005, renewable capacity (excluding hydro) has increased exponentially, and by 2010 China's installed wind power capacity had become the world's largest. Long-distance power transmission and grid integration are needed for the future large-scale deployment of wind power, however. China's wind resources are concentrated far from the demand centres, and the grid infrastructure and transmission capacity have not kept up with increasing generation capacity.

## Chapter 4

# Integrated smart infrastructures

By **Jacob Østergaard** and **Per Nørgård**, DTU Electrical Engineering;  
**Fushuan Wen**, Zhejiang University, China  
**Carsten Rode**, DTU Civil Engineering

### Development toward more integrated energy infrastructures

High penetrations of renewable energy like wind and solar challenge the conventional planning/design and operation of the electricity infrastructure due to the intermittent nature of the resources. To avoid system breakdown in the electricity infrastructure, generation and demand have to be in balance on second-scale.

Furthermore, the renewable energy sources displace conventional generation which today is responsible for providing many of the power system services such as reserves, voltage control, frequency control, stability services, and black start restoration that are needed for stable and reliable operation of the electricity infrastructure.

Trading of energy through electricity and gas interconnects to neighbouring countries is widely used to balance the system and ensure stable and reliable operation. But the ability of neighbouring energy systems to interact may be limited if the neighbouring systems have similar characteristics like renewable energy penetration, and new interconnectors are often very difficult and take long time to establish.

The heating, cooling, gas, and transport infrastructures have certain intrinsic storage capability (e.g. due to the temperature of the hot water in the pipes, state-of-charge of the electric vehicle battery, or pressure of the gas in the system) and can therefore provide some of the energy flexibility needed in the electricity infrastructure. Also, the demand side in the electricity system in itself has some ability if

proper mechanisms (markets, communication etc.) are introduced. Utilizing this potential of integration of the infrastructures requires either direct coupling of the systems through energy conversion technologies or through couplings at the generation side and/or demand side. (*Figure 1*)

A closer integration of the energy infrastructures will not only solve some of the challenges of integration of renewable sources at the technical level. Closer integration and coordination of different energy infrastructures are a prerequisite for a cost-effective energy system with a high share of variable and somewhat difficult to predict renewable energy sources.

An example of the importance of integrating different energy infrastructures is reflected in the strategy of the Danish electricity and gas transmission system operator, Energinet.dk. The main theme of the strategy is ‘integration’ (in Danish: ‘Sammentækning’) [4.2]. Another example is the establishment of a national Danish Partnership for Smart Energy Networks, which in 2015 provide a vision for smart, integrated energy systems in Denmark [4.3].

The integration should be strengthened not only at infrastructure technology level. Also, a higher degree of integration and coordination of regulatory and organizational aspects across sectors should be pursued. In many countries, regulations of different energy infrastructures are separated in different sets of rules and laws based on different principles. This creates barriers for efficient integration and possibilities or incentives for optimal solutions at the technical level.

1. Renewable energy capacity includes wind, solar PV, solar CSP, biomass, geothermal, pumped hydro, small & large hydro.

**Figure 1** - Integration of multiple energy infrastructures with different energy carriers provides flexibility for cost-effective integration of renewable energy sources (only main interactions indicated). Intrinsic storage capability is indicated with a battery symbol [4.1].

**Ressource**



**System**

**Denmark**

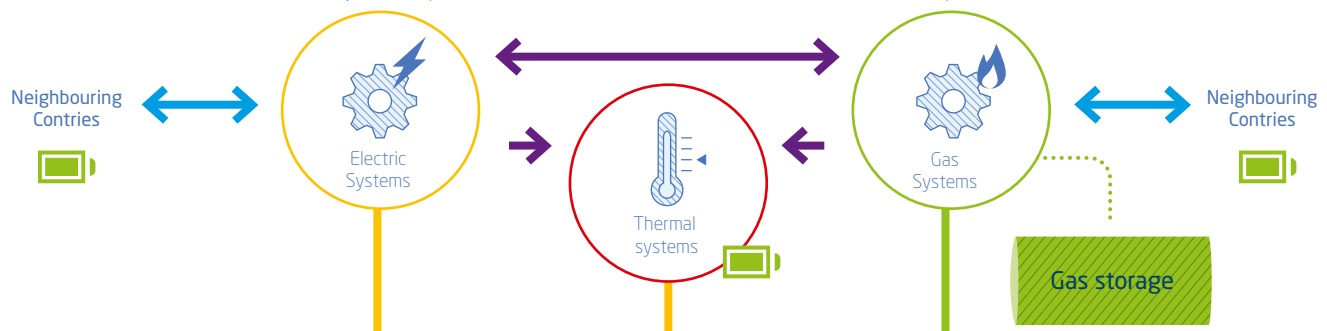

**Services**

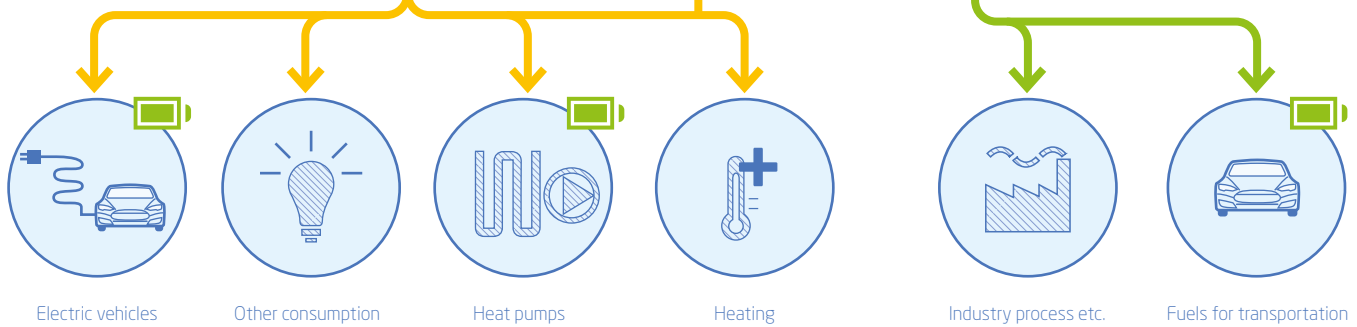

- █ Transmission connections
  - █ Energy conversion technologies (Gas motors, electric heating, electrolysis)
- █ Active demand
  - █ Biomass, -gas and -fuels
  - █ Energy storage (Vehicle-to-grid, VPP, Biofuels, heat, gas...)

### Smart energy in the digital society

An integrated energy system with a high share of renewable energy will take advantage of and be relying extensively on digital solutions, including sensors and actuators embedded in the system, various internet technologies, service-based designs, and novel business models beyond just selling energy at fixed prices. The use of digital solutions is required to efficiently manage the complex control and optimization task of a more integrated energy system. This development of integration of energy infrastructures by use of novel IT-solutions is broadly addressed as Smart Energy.

No globally applied definition of Smart Energy exists. A definition, aligned with the understanding adopted in this chapter, is:

A smart energy system is a cost-effective, sustainable, and secure system in which renewable energy production, infrastructures and consumption are integrated and coordinated through novel services, active users and enabling technologies [4.2].

Development of a smart, integrated energy system is well-aligned with the mega trend of a society based on digital solutions, the so-called ‘third industrial revolution’. This is covered extensively by authors like Jeremy Rifkin and others [4.4]. The third industrial revolution is expected to fundamentally rearrange human relationships, from hierarchical to lateral structures that will impact the way we conduct business, govern society, educate our children, and engage in civic life. Rifkin considers five pillars of the third industrial revolution, namely (1) shifting to renewable energy; (2) transforming the building stock into green micro-power plants to collect renewable energies on-site; (3) deploying storage technologies in every building and throughout the infrastructure to store intermittent energies; (4) using Internet technology to transform the power grid into an energy internet that acts just like the Internet where millions of users can interact and make transactions; and (5) transitioning the transport fleet to electric plug-in and fuel cell vehicles that can buy and sell green electricity on a smart, interactive power grid. Even though the feasibility of some of these suggestions rely on assumptions as declining cost of storage the overall vision is clear.

Some of the leading IT companies in the world are deeply engaged in the development of modern IT-infrastructures based on Internet of Things, Big Data etc. IBM’s ‘Smarter Planet’ [4.5], Siemen’s ‘Sustainable Cities’ [4.6], GE’s ‘Industrial Internet’ [4.7], and Cisco’s ‘Internet of Everything’ [4.8] are among the major initiatives currently underway. These initiatives will develop solutions that enable or interact with the smart energy system as well as push the general development directions of a more integrated energy system. The aim of these initiatives is to bring online an intelligent infrastructure that can connect neighbourhoods, cities, regions, continents and the global economy, in a global network. The network is designed to be open, distributive, and collaborative, allowing anyone, anywhere, and at any time, the opportunity to access it and use data to create new applications for managing their daily lives.

Development of the smart energy system will be an integrated element of this megatrend. During the past years, many of the involved concepts and technologies have been under development for electricity systems. The most recent major players like electric vehicle manufacturer Tesla Motors has started selling home battery systems for photovoltaic solutions [4.8b]. These technologies are known as Smart Grid technologies. Smart Grid has been defined by, among others, the European Technology Platform for Smart Grids as ‘an electricity network that can intelligently integrate the actions of all users connected to it – generators, consumers and those that do both – in order to efficiently deliver sustainable, economic and secure electricity supplies’. Many of the ideas within Smart Grid can be transformed or extended to cover Smart Energy, so not only the electricity infrastructure is optimized, but all the energy infrastructures are coordinated. This includes new market designs, distributed control, IT-architectures, customer engagement, etc.

The smart energy system is also closely related to the broader Smart City and Smart Community concept. Smart Cities and Smart Communities focus on how IT can be used to enhance the performance of a complete neighbourhood to improve the living of people, and deal not only with energy, but also other critical infrastructures like water, traffic etc.

**Table 1** – Different infrastructures have different levels of intrinsic storage capacity and different needs for flexibility.

Energy infrastructure	Properties	Intrinsic flexibility	Flexibility need
Electricity	Long-distance transport Low losses Easy to generate from renewable energy sources Easy conversion to other energy carriers	Very low (seconds)	High
Heating	Local/district Medium losses Difficult to convert to other energy carriers	Medium (days)	Medium
Gas	Long-distance transport Low transmission losses Intrinsic losses during conversion at the point of use Easy to convert to heat, but more difficult to convert to other energy sources	High (months)	Low

## Smart energy networks

In the following, the major energy infrastructures are treated with special focus on their system integration. (*Table 1*)

### Electricity infrastructure

The combination of the increasing distributed generation, intermittent generation from wind and solar, load fluctuations and limited storage capacities challenges the electricity system and infrastructures in many ways. Large numbers of small-scale generations replace some centralized power plants. More fluctuating power will flow in all directions in the distribution system, and areas – or even a single customer – may in average over the year become self-sufficient. New, smart means are required to balance the power and energy taking into account spatial and temporal constraints and to maintain a proper operation of the system – including system stability, reliability and power quality. New business models are required with the new roles of the infrastructures from supply to distribution and storage.

The new means will include new technologies, solutions and control schemes, all and in combination meeting the needs for increased energy flexibilities in a cost-effective way. New flexible power generation units, increased consumption flexibility (demand response and fuel shift), and new energy conversion units will be introduced. The fuel shift solutions offer the ability to provide the required

energy service from more energy sources – e.g. heat may be provided based on dynamic combinations of energy sources like district heat, electricity and gas, depending on their availabilities and prices. The conversion technologies will include conversion from electricity to heat (e.g. by heat pumps), from electricity to gas (power-to-fuel), and from gas to electricity and heat (micro CHP – combined heat and power generation).

### Heating and cooling infrastructure

The business of thermal energy infrastructures, especially district heating will be challenged by the new low-energy buildings' reduced heat demand. The new buildings will mainly need part-time space cooling and tap water heating. New concepts and business models, designed for the new needs, must be developed.

The concepts will include low temperature and ultra-low temperatures (<60°C, requiring heat booting for the hot tap water) district heating systems, which allows for easier and more cost-effective reuse of waste heat from buildings and industry (feedback into the district heating system). This will increase the integration among energy systems at the end-user level. Furthermore, district cooling systems, local thermal systems, transporting excess heat generation to areas with heat needs, and all types of heat exchangers – including heat pumps, heat exchangers and heat re-generation are expected to play an increasingly important role.

If properly designed, the thermal capacities in the infrastructures, in the building constructions and in the hot water tanks can be used for short-term energy storages.

### Gas infrastructure

With their pressure flexibility and large volumes in pipelines and caverns, the gas infrastructures are already designed with large-scale storage capabilities.

Power can be converted into gas (in terms of either hydrogen or methane) and to a certain degree injected into the gas system – however with a change of the gas quality. The high-temperature electrolyzers, like Solid Oxide Electrolysis Cells (SOEC), provide the potential for highly efficient energy conversion.

Gas can easily be converted into electricity and heat by combined heat and power (CHP). Various types of fuel cells provide the potentials for small-scale, highly efficient energy conversion (micro CHP), even in scales down to household units.

### Mobility infrastructure

The transition of the transport sector towards renewable energy is a grand challenge. In addition to what optimal urban planning can do, the dominating trends are solutions based on electricity, gas, biofuels or hydrogen and their combinations, in terms of serial hybrid solutions, where the traction is pure electrical and a fuel is converted on-board to electricity and stored in a battery. These trends apply for all means of transportation – vehicles, trains, ships and even airplanes.

The electrical solutions will provide additional use of electricity, and if properly designed and controlled, they may in addition provide flexibility for the power system concerned. Electric vehicles may be charged when appropriate for the power system, and they may even become able to send power back to the power system when needed (the vehicle-to-grid concept) [4.9].

All in all, the energy infrastructures will be highly integrated at all scales, such as micro-scales at the customers e.g. by hybrid heat solutions, heat pumps and micro CHP, and large scales, e.g. by large-scale combined heat and power generation (CHP), or

large-scale heat pumps in the thermal infrastructures, or large-scale power-to-gas conversions.

## Demand-side flexibility in energy infrastructures

Buildings, industry, and the demand side in general can provide energy services that support the operation and integration of the energy infrastructures. Building management systems are being developed for intelligently managing the building's energy exchange with the energy system. The local energy services can be provided and at the same time the demand can participate actively in the energy markets. Information and communication technologies play an important role in this process, as do data processing. Local storage technologies can play an important role here.

In the EU-supported project EcoGrid EU, focusing on the flexibility in the electrical system, 2000 customers – 10% of the population at the island of Bornholm – participate in an experiment where flexibility from mainly local heating systems in buildings is provided to the electricity system [4.10]. The results show that customers with installed automatic solutions, which control their electric heating systems (and other types of electricity consumption), and which receive 5-minute real-time pricing, can provide flexibility services to the electricity system.

Preliminary results show that flexibility or shiftable demand from the electricity consumers represents about 12% of the average demand. Nearly 50% of the analysed population does not have access to the external market signals or equipment to enable them to automatically respond to the external signals. Therefore, it is expected that the vast majority of the flexibility comes from only a part of the demand, and the demand response implemented widely is expected to be 20–25% of the average demand.

During the experiment, up to 285 kWh has been shifted for the 1,900 customers. If 10% of Denmark's houses with heat pumps were to receive EcoGrid automation and real-time pricing, the amount of energy shifted would be sufficient to manage much of today's wind power imbalance in the balancing market in Denmark during the winter months. (Figure 2) (Table 2)



Figure 2 - An example of obtained response in the EcoGrid EU demonstration

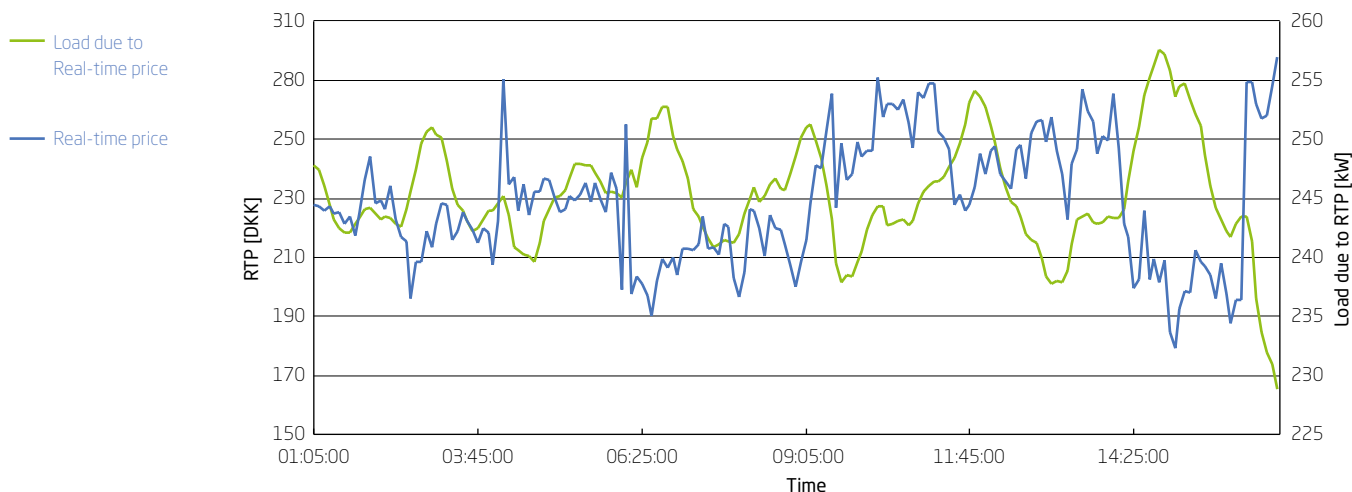

The real-time price is relative to the day-ahead price. This means that any deviation from the day-ahead price activates balancing power.

The demand response from the main heating system in buildings responds to the real-time price which is relative to the day-ahead price. Any deviation from the day-ahead price activates balancing power. From: [4.11].

Table 2 - The maximum change in DR that can be activated in any 5-minute period in the EcoGrid EU experiment in the winter 2014/15.

Time	Demand response (kW)
23:00-07:00	±109 kW
07:00-15:00	±61 kW
15:00-23:00	±101 kW

DR is noticeably higher in the evening and at night-time, compared to daytime, due in part to lower night-time temperatures, and in part because the smart controllers are more effective at night where the load is more accurately predictable [4.11].

## Customers, business models, and markets

When designing a smart energy system, it is crucial to focus on the energy services requested by the customers – like indoor comfort, mobility, and industrial processes – as these services may be provided in different ways, requiring less energy, and where part of the energy required is provided locally. The physical energy infrastructures, the energy markets, and the business models must be designed for these new conditions.

An energy service provider is an actor that offers a given energy service at a given price. The service provider will then find the most cost-effective solution and operate on all the energy markets.

The energy markets and the regulations (including taxes) must be designed, coordinated, and even integrated for optimal operation of the entire energy system. Local, dynamic prices must reflect the actual conditions and costs, and must support smart and optimized operation of the entire energy system. The billing schemes must reflect the actual cost structures. And the energy taxes should provide appropriate incentives and support the political goals – like CO<sub>2</sub> and fossil fuels.

The existing energy markets and billing and regulation schemes are to a large extent designed for yesterday's energy systems with separated energy systems (electricity, heat, gas), large-scale centralized energy generation, one-way energy flows from the generation units to the consumers, inflexible

consumptions, and few, well-defined market players. The future energy system is much more complex. The operation, markets, and business models have to be reconsidered and redesigned. The dynamic energy prices must become available at customer level in order to support the smart operation. In other words new markets, products, supporting technology, and regulatory framework have to be developed to increase the customer engagement.

### Need for community-scale and city-scale demonstrations enabling research-based innovation

Transformation to a smart energy system requires development of solutions on multiple scales (customer, local community, regional, national and international) and multiple dimensions (e.g. technology, business, and regulation). The transformation will require applications of new energy technologies and existing technologies in the new context. New business models, new architectures, and new solutions for system operation have to be developed and implemented. Development also has to take place on multiple scales: component level, infrastructure level, and system level. Future analysis and research will be required in this area.

Challenges especially have to be addressed at system level, as these solutions will enable new opportunities and innovation at the component and infrastructure levels. Many of the cost/benefits of an integrated smart energy system will be enabled by new system-level solutions. The development is therefore highly dependent on large-scale demonstrations with integrated research and development on all levels. There is a need for development of large-scale living labs, where smart energy solutions in interaction on all levels and dimensions can be developed and tested. In several places around the world, such large-scale areas are emerging. Many of these are focusing on the broad scope of smart cities, but there are several different focuses at play. Examples of districts offering a platform for development and demonstration of new energy solutions are the Jeju Island Smart Grid Testbed (Korea), Masdar City (United Emirates), Vienna and Smart Cities Demo Aspern (Austria), Stockholm Royal Seaport (Sweden), Sino-Singapore Eco-City in Tianjin (China).

It is important that these initiatives are set up with realistic objectives and as open platforms.

In Denmark, the two largest demonstration sites are on Bornholm, an island with more than 50% renewables (annual average penetration) and which is part of the PowerLabDK experimental platform [4.12], and in EnergyLab Nordhavn, a new city development area focusing on sustainability and smart, integrated energy infrastructures [4.13].

In several aspects, these areas complement each other and are role models for investigating and developing global smart energy solutions.

The Bornholm Island has a population of 40,000 people. Its energy system includes an electricity system which is interconnected with the Nordic grid. The island has a high share of wind power (>30 MW) and solar PV (>5 MW) penetration in the electricity system (peak demand 55 MW) [4.14]. The heating infrastructure includes five local district heating networks. The island is the host of several smart grid and smart energy projects, including the EcoGrid EU project [7.10], where new real-time market solutions are developed and tested. These solutions enable flexibility services from individual heating systems (mainly heat pumps and direct electric heating) and other small-scale energy resources to the electricity system. (*Figure 3*)

Copenhagen Nordhavn is one of the largest city development areas in Europe. Over the next 50 years, the area will host 40,000 new residents and 40,000 new jobs. Under the name EnergyLab Nordhavn, the area will be developed into a full-scale laboratory for a smart energy solution (electricity, district heating and cooling, electric transport). The aim of EnergyLab Nordhavn is to develop new innovative business models, new energy technologies, and intelligent operating solutions, such as integrated and flexible energy markets, coordinated operation of electricity and heating systems, energy storages, energy-efficient buildings – subject to local optimization and intelligent interactions with the infrastructure and energy markets – and demand technologies offering flexible switching among energy carriers.



## Future initiatives and recommendations

An efficient transformation to a smart energy system with multiple integrated infrastructures requires focused development efforts, and the following key initiatives should be given priority:

- Intensified research and development efforts regarding system architectures and frameworks, which enable development of a smart energy system. This includes new integrated operational frameworks, multi energy carrier market designs, business model frameworks and IT support systems for services, data processing etc. These types of architectures and frameworks will foster the development of new components, tools, and specific solutions.
- European and/or global technology standards at component and system levels with respect to interoperability should be developed to optimize and accelerate development and deployment, while reducing costs.
- Focused full-scale demonstration sites that can act as comprehensive platforms for research, innovation of new solutions, and verification on a large scale of how multiple different sub-solutions and sub-systems interact and create added value, should be developed. These demonstrations should closely interact with the research and development efforts outlined above.
- System-wide and cross-sector barriers that enable novel business cases and practical sharing of smart energy costs and benefits should be identified and addressed.
- The energy system regulation, including tax systems, should be evolved to remove barriers and facilitate seamless deployment of smart energy solutions across sectors – especially addressing barriers due to incompatibility of different regulations. Solutions in this area should be based on solid scientific findings and ideally be verified in demonstrations before deployed.

Figure 3 – Bornholm Energy system: a real-life laboratory for smart energy solutions in a smart renewable-based community.



## Chapter 5

# Integrated energy systems modelling

By **Kenneth Karlsson, Klaus Skytte** and **Poul Erik Morthorst**, DTU Management Engineering; **Peder Bacher**, DTU Electrical Engineering; **Henrik Madsen**, DTU Compute

Large-scale introduction of fluctuating renewable energy implies that the key to successful integration is not to focus solely on the power system, but on the entire energy system and on energy systems integration. Successful integration of large fractions of fluctuating renewables calls for complex interactions between energy production, storage, distribution, and consumption. At the same time a successful integration calls for a paradigm shift that is envisaged from distinct, radial, and mostly centralized systems

for power, gas, biomass, and district heating, to a single integrated interconnected, distributed, and partly autonomous energy system.

Energy systems integration will enable virtual energy storage (also called indirect energy storage solutions, which, e.g., in Denmark is considered to be an important element in order to obtain a fossil-free power and energy system by 2035; see [5.1] for further information. (Figure 4)

Figure 4 - Overview of a future Danish integrated energy system.

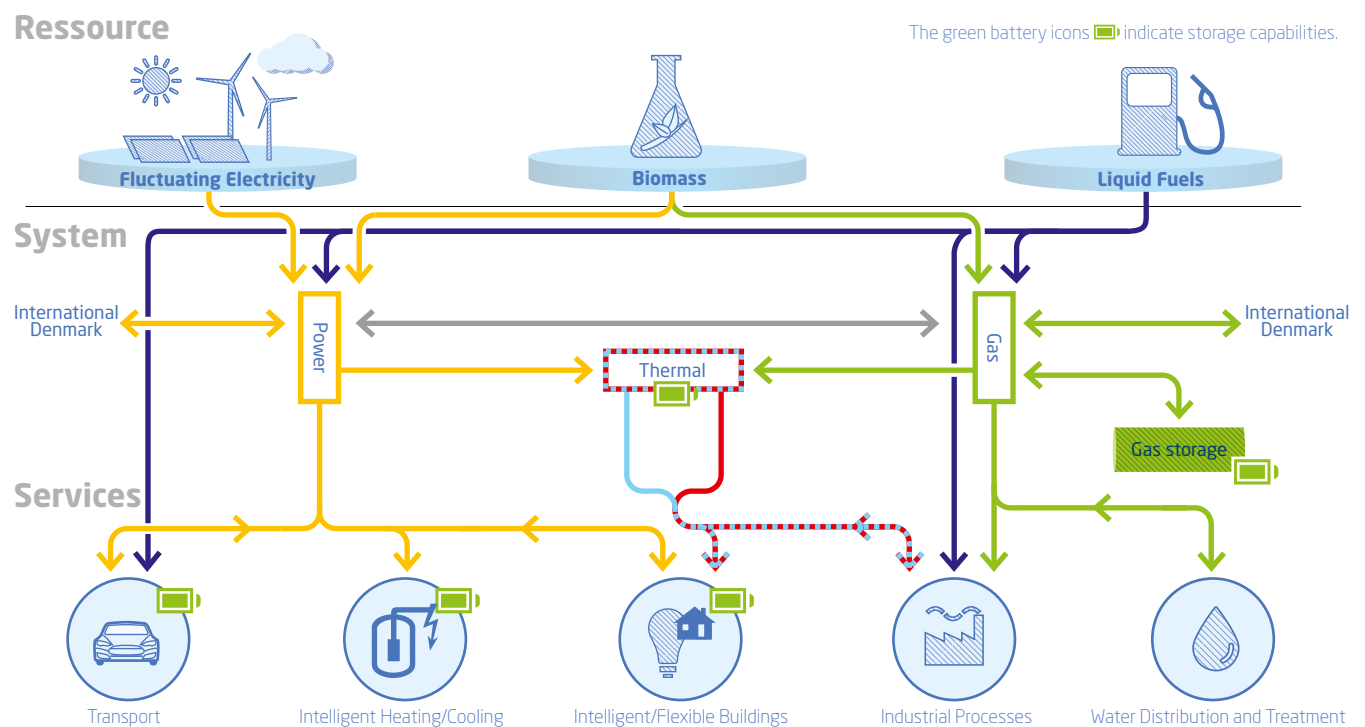

These complex future energy systems call for models that are tuned towards energy system integration, illustrated by the grey dashed line in *Figure 4*. The energy system models have to link to market functionalities and detailed sub-system modelling to secure a correct, although simplified, representation of technologies and market interactions. In this chapter, we will discuss how to include different markets in the analysis and present examples of integration options, energy system modelling, and detailed sub-system modelling.

## Coupling and regulation of different markets

Modelling of the future energy markets must take into account the changes in market designs, regulatory framework condition, and coupling of markets necessary for keeping down the integrations cost of variable renewable energy (VRE).

A stronger integration of the energy markets will be essential for ensuring flexibility in the future energy systems with high VRE shares. Most VRE will be seen in the electricity markets, which will also be the central arena for achieving increased system flexibility. They can be linked to the heat, gas, and transport sectors through co-generation, power-to-heat, power-to-gas, power to transport fuels, and e-mobility measures. These linkages can all add to increased flexibility provided by electricity generation, power transmission, storage, and demand-side-management.

When the amount of VRE surpasses a certain level, it will influence the operation of the electricity supply system. Therefore, the planning and redesigning of the regulatory framework have to take this into account in order to minimize the integration cost of VRE and to increase the flexibility in the system [5.2], [5.3], [5.4].

One way of increasing the flexibility in the system and thus lower the cost of VRE integration is by improving the regulatory frameworks for integration of the different energy sectors (electricity, heat, gas, and transport). This will increase the use of electricity in other sectors than the traditional electricity sector and thereby increase the supply of flexibility. The

integration must occur along with the growth of VRE in the electricity supply in order to develop coherent energy markets. This will require well-thought-out market designs and framework conditions implemented in a timely fashion, as well as systems analysis model-studies of the integrated markets. Otherwise, integrating across energy markets with very different framework conditions (e.g. heat vs electricity) may prevent the transition towards integrated energy systems and increased flexibility.

Today, the North European electricity market is very effective both within the Nordic region, but also in terms of its connection to the electricity markets in the surrounding countries. The other energy markets are either local or national markets and very differently organized and regulated; these framework conditions can be a barrier for a more integrated energy system, e.g. the framework conditions for district heating and individual heating differ not only between the countries, but also between local regions and consumer groups within the countries. This gives the actors in the different heating markets different incentives/possibilities to act flexibly.

Not all markets need to be international, however. As long as we have a well-functioning common power market, the flexibility in a local or national energy market (e.g. heat market) in one country can be used to solve a local need for flexibility in another country if the markets are well-coupled to the common power market.

While modelling this, we have to analyse these opportunities for flexibility-enhancing market coupling through a holistic system approach whereby the regulatory framework conditions are considered the common breeding ground for both the electricity, heat, gas, and transport sectors that can create synergies and eliminate barriers between the different sectors.

Employing a technical approach, we can systematically identify flexibility potentials in each energy sector and collect data in the countries, e.g. from use of electric boilers in a local district heating system. How large is the technical potential in each market segment with respect to flexibility at the electricity markets? At what cost? Are additional investments needed? The identified technical potentials of flexibility from each

sector can be used in the modelling, e.g. to analyse the economic value/cost and system effects of flexibility within different scenarios without taking technological or regulatory barriers into account.

Using a regulatory approach, we can identify regulatory and technological barriers to intensified market interaction and supply of flexibility. What is promoting and what is hindering utilization of the flexibility potentials? Why are some flexibility options used in some sectors in some countries and not in others? By identifying best practices for regulatory and technical frameworks and market design, we can assess which regulatory barriers exist, i.e. identify regulatory and technological barriers to intensified market interaction and flexibility.

By coupling the technical potential determined in the technical analysis for flexibility supply in each sector and country with the institutional, regulatory, or techno-economic barriers identified in the regulatory analysis, we are able to produce the available realizable potential (*Figure 5*). This means that we couple the technical potentials with barriers that hinder the realization of some part of the potentials.

The degree of barriers and how they can be lifted can be a part of the scenario parameters in the modelling of the systems. (*Figure 5*)

### Important technologies in the power and heating system for integration of renewables

In the following some important options for integration is described and such options has to be adequately represented in the energy system models used for analysing the future energy system.

District heating systems can be important in balancing future energy systems with large shares of VRE. Extraction CHP plants can produce power and heat with variable shares, and adding a heat storage with capacity from 1–2 days to a week of local heat demand increases the flexibility even more. In periods with high wind and low power prices the CHP plant can shut down power production and supply heat from storage, in low wind and high price situation the plant can produce maximum power

Figure 5 - From technical to realizable flexibility potentials.

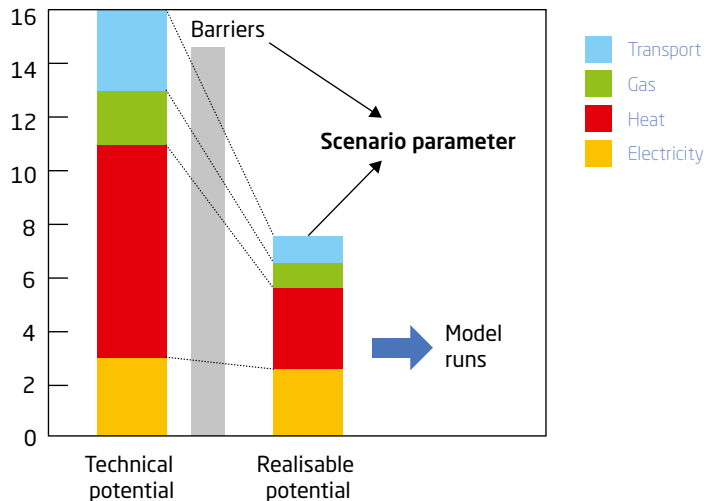

and heat to storage. When adding even more VRE to the system, situations will arise where the CHP plant cannot run for longer periods because of too low power prices. In this case, large heat pumps can add the needed flexibility, efficiently converting the 'cheap' VRE to heat.

Bio-refineries can turn out to be a very important player in the future energy system with huge shares of VRE. When producing the different kind of bio-fuels the electricity, heat and biomass are inputs to the processes and depending on the type of process, the output will be different kinds of bio-fuels for transport, surplus heat and waste products. The surplus heat can be utilized for district heating, and some waste products can be burned in a boiler producing steam for a turbine producing electricity and heat for district heating. The utilization of waste heat for district heating is dependent on having district heating nearby the production facility. If bio-fuel is imported, there is no linking to the heating system. In a future fossil-free energy system, bio-fuels will play an important role in the transport sector for long-distance transport, ships, and air transport. The amount needed will be substantial and the waste heat from these plants would be able to cover 20–40% of the total district heating consumption in a country like Denmark. Therefore, it is vital if Denmark chooses to import bio-fuels or produce them locally.

Electric vehicles (EVs) can be charged at different times during the day, so that demand can be moved around over a day. It makes a difference if there are quick-charging options (80–100% charged in less than an hour) or ‘slow’ charging. The latter can move consumption from day to night while the quick charging can provide capacity that can be regulated up and down within a given hour. Energy-wise the electric vehicles will not have a big influence on the power system, so what is most important is to avoid charging of EVs in system peak situations.

Apart from the above-mentioned technologies, flexible power demand can also arise from industrial processes, cooling and heating of buildings, and groups of consumers bidding in flexibility commonly to the power market. Some industrial processes such as cooling and freezing can postpone electricity demand several hours especially if they are cooling down to a lower temperature when power is cheap and let it increase to a slightly higher temperature before starting the cooling machinery again. The same is relevant for buildings where the building’s heat capacity can be used to store energy if small variations in indoor temperature can be accepted. Consumers can also pool their electricity demand from electric appliances and accept that part of their consumption are being cut of when needed by the system and then they can get some kind of compensation for this system service.

#### **Virtual storage solution for integrated energy systems**

In the following, we will illustrate the concepts by describing a couple of examples for virtual energy storage solutions. Other possibilities for enabling virtual storage solutions are described in [5.5] and [5.6].

#### **Virtual storage through intelligent water management**

In the future, energy and water management systems are closely interconnected as indicated in *Figure 4*. A joint analysis and operation can be performed at two scales. At a local scale, all water supply and waste water collection and treatment systems involve pumping and storage of large quantities of water, and in parallel, at regional to continental scales, the joint energy-water management can integrate regions with high photo-voltaic or wind potential and regions with good conditions for large-scale pumped-storage or hydro-power systems.

Focusing on the local scale, an intelligent operation of water systems will provide an efficient technology to store energy and shift energy consumption in time (load shifting). The flexibility of water supply and waste water systems may be exploited to even out (balancing) the fluctuations of renewable power generation. Next-generation water treatment tools also includes new approaches for using groundwater facilities for water supply and seawater desalination for the purpose of providing the needed water supply.

In Denmark, about 3% of the total electric power is used for water distribution and treatment, and in countries with desalination requirements, this number is expected to be somewhat larger. Since the water supply and treatment system contains large buffers and integrated storage facilities (intended for being able to handle rain falls), much of this consumption might be shifted to, e.g., periods with low power consumption. In this way, it is estimated that, for instance, more than 10% of the total power production during night-time can be balanced by an intelligent operation of water systems. For countries with a large wind power penetration, like Denmark with about 40% wind power, such new schemes for water treatment can help solving existing problems with excess wind power during, e.g. the night when the load is lowest and the prices typically are low.

#### **Virtual storage through integration with district heating and cooling**

In some countries District Heating (DH) are widespread, and it can easily be shown that DH systems provides efficient possibilities for load shifting and for shifting between various energy supply systems (power, gas, biomass, etc.), and consequently for providing virtual energy storage solutions. A DH system network provides efficient methods for time shifting, and in addition, most DH systems have a water based storage tank. For instance, in Denmark 60% of the heat supply is covered by DH systems. District heating energy, i.e. hot water, is relatively cheap to store. Furthermore, DH systems can benefit or utilize energy losses in connection with, e.g., conversion processes and solid waste incineration. DH systems can facilitate the flexibility to generate heat from different plants connected to the grid, e.g., a Combined Heat and Power (CHP) plant for power generation at high power prices, and for use



of surplus heat from industrial processes, biofuel production, power to gas (electrolysis), or similar. A well-developed district heating system is therefore very useful to ensure high energy efficiency and to enable flexibility and energy storage solutions.

In many cases, CHP systems are based on gas, and by shifting between gas and power-based production of heat, such systems offer a potential for even seasonal storage of energy for countries with a well-developed gas grid (like Ireland, Denmark and many other countries).

Remote cooling, where cold water is distributed in a closed pipe system in the same way as district heating, also holds possibilities for storage in storage tanks, either when the power price is low or in case of surplus heat in connection with electricity generation. The energy consumption for remote cooling is approximately half of traditional cooling. It has been estimated that limited sized storage systems linked with HVAC systems can reduce the price for cooling by about 40%. This large saving originates from the lower price during night-time, and a more efficient production of ice at the lower temperatures at night.

### **Grey-box modelling - combined physical and statistical modelling**

In the future, data and complex modelling will be the key to energy systems integration. Methods for complex modelling, like the grey-box principles for modelling, will be needed to understand the dynamics at the detailed system level.

Operation of integrated energy systems requires a great deal of optimization, which at the overall level will be handled via markets. The markets will provide an incentive to utilize storage and flexibility capabilities in the systems; however, these will only work if the properties and dynamics of the individual units can be understood – in real time operation. Therefore, models that describe the dynamics of all parts of the system are needed to form the basis for the optimization – all the way down to the individual units. Take the example of controlling an electrical heat pump in a residential house, which clearly has a potential of providing flexibility by load shifting. A model of the heat dynamics of the building is needed in order to operate the system and utilize the heat capacity of the building as energy storage. The model must

predict the indoor temperature as a function of the heat input, such that the optimal operation plan can be calculated, while not compromising the comfort (by keeping the indoor temperature in a given band). Physical models for the heat dynamics of buildings are very well known from general level (hourly with a few states) down to a very fine-scale, however, here there are challenges: how is a good model for the particular building formulated and how can its parameters be tuned? Further, the model must adapt automatically to the users and even model their (stochastic) behaviour.

At this point, the link to real-time observations of the systems become apparent and the need for modelling techniques, which bridge the gap between physics and statistics, become vital. The concept to strive for is called grey-box modelling, which simply is a framework of models combining white-box (purely first-principles physical) and black-box (purely statistical) models. The advantage over white-box models is that the model parameters can be estimated from data using proper statistical methods, [5.7], as well as statistical tests are available for determining the suitable model complexity for a set of observations from a particular system. The advantage over black-box models is that the knowledge from physics about the appropriate model structure can be applied directly, thus the formulation of the model is much more straightforward and understandable for an expert in the field of application. Further, the grey-box modelling framework enables modelling of non-linear and stochastic phenomena which is not feasible in other settings.

A wide variety of systems which are coupled to the energy system provide possibilities for enabling a flexible load and call for grey-box models as a basis for optimization. Apart from buildings, current work involves modelling of: hot water tanks, solar thermal, supermarket refrigeration, and urban drainage, sewer and waste water systems. At DTU, software for grey-box modelling has been developed over the last decade resulting in a freely available R package named CTSM-R (<http://ctsm.info>), which based on the extended Kalman-filter implements maximum likelihood estimation of grey-box models, and provides a flexible and user friendly interface.

A fresh example of an application is the development of a grey-box model for the nitrogen removal

processes in a waste water treatment plant (WWTP) [5.8]. This model will then form the basis for a controller enabling the energy flexibility of the process. The process can be modelled using a rather complicated white-box model, which can be reduced, however still requiring a large number of parameters to be set and requiring a large number of measurements of load and flow being available. The advantage of the grey-box model is that it has fewer parameters and they are estimated using measurements from fewer sensors. Hence, the grey-box model is adapted to the system automatically and the cost of the controller is reduced. Currently, a test case study is being conducted at a Danish WWTP with a 120,000 PE capacity for which the models are developed to form a framework to be used as basis for control of WWTPs for energy flexibility.

## Energy system optimization modelling

As an example of simplified representation of a larger part of the energy system to handle and analyse energy system integration across technologies and sectors, we present two energy system analysis tools. Both being partial equilibrium models focusing on two timescales; how to run the system within a year and at the same time creating long-term investments pathways.

The dynamical balancing of the energy system in a future with high shares of VRE has to be treated on several timescales and markets. In the planning of these future systems we need to have models that can analyse the short-term balancing using the methodologies mentioned above, we need modelling of power markets and linked markets as heating markets, CO<sub>2</sub> and certificate markets and we need long-term energy system investment optimization models. With the energy system optimization (ESO) models we try to find the best way to configure our energy system from the state it has today to a system that fulfils the long-term policy targets. Typically, this will include analysing parts of or the entire energy system and its development until 2050.

The art of building models means to include enough details to give a realistic description of the energy system while keeping the model as simple as possible so users can understand and interpret the results, and to keep computation time and data needs down.

The ESO models have less detail on the shorter timescale. Typically they use from 12 to around 300 time slices in a year. This means that the intra hour balancing of the energy system cannot be handled by these models directly, and different ‘tricks’ are therefore introduced to simulate system limits occurring at the timescale level below the models time resolution.

Two examples of ESO model are presented in the following: a Balmorel model ([www.balmorel.com](http://www.balmorel.com)) covering the North European power and district heating system, and a TIMES model ([www.etsap.org](http://www.etsap.org)) covering all sectors in the Danish energy system.

The TIMES-DTU model is developed in a cooperation between DTU and the Danish Energy Agency. Documentation of TIMES-DTU is being prepared and can be followed at <http://www.ens.dk/en/info/facts-figures/scenarios-analyses-models/models/interact>. It is a technology-rich partial equilibrium optimization model that includes all sectors and all energy conversion in Denmark. This means that policy measures and their impact can be studied across all sectors at the same time, e.g. the model can illustrate in which sectors the cheapest greenhouse gas (GHG) reductions can be obtained. The model horizon is until 2050 and the number of time-slices per year is 32, which challenges the models ability to secure that VRE, electricity demand, and the whole system, can balance hour by hour. In TIMES-DTU this problem is solved by making sure that some of the 32 time-slices represents the most critical situations in the power system (e.g. situations with high wind production and low demand and the opposite situation as well).

The model has a detailed description of all economic sectors and their energy consumption. The household sector has 12 different existing building types and two types of new houses. There is a building-model keeping track on demolishing, introduced heat savings and new buildings. Seven different electrical household appliances are modelled in a vintage model. Industry is divided into nine different sectors aggregating sub-sectors that look alike energy wise and then there is a public service sector. All these have six different energy services that are supplied by different technologies. The Transport sector is divided in passenger transport and freight. Passenger transport work is

divided into five different modes and car trips are furthermore divided into three different intervals of driven distances per trip. There are four different modes of freight transport and then internal transport on construction sites etc. that are modelled under each industry (haulage).

Power and district heating sectors represent all existing power and heating plants in the Danish energy system today and planned investments until 2017. For future investments, the model can choose from a technology database mainly based on the Danish Technology Catalogues published by the Danish Energy Agency (<http://www.ens.dk/en/info/facts-figures/scenarios-analyses-models/technology-data>). The model has four district heating districts, a central district heating area and a de-central district heating area in Denmark East and Denmark West. Power and heating plants are described by efficiencies, investment costs, running

costs, fuel type, and lifetime. The model can invest in new plants also before end-of-lifetime for some plants if it is economically feasible to the overall system. To cover power trade between the Nordic countries, the power and district heating supply systems in these countries are modelled as well.

Traditional refineries and bio refineries are included. The model is tracking inputs, outputs and costs and it is possible to trade the products on a global market. Especially the bio-refineries can take part in balancing the power system as they can produce bio-fuels for storage while there is a lot of wind and stop when there is not.

Figure 6 illustrates the structure of TIMES-DTU and how integrated the different energy streams are. Large heat pumps will produce district heat and thereby connect the power system and wind power production to the district heating system and thereby

Figure 6 - Illustrates in a simplified way the structure of TIMES-DTU.

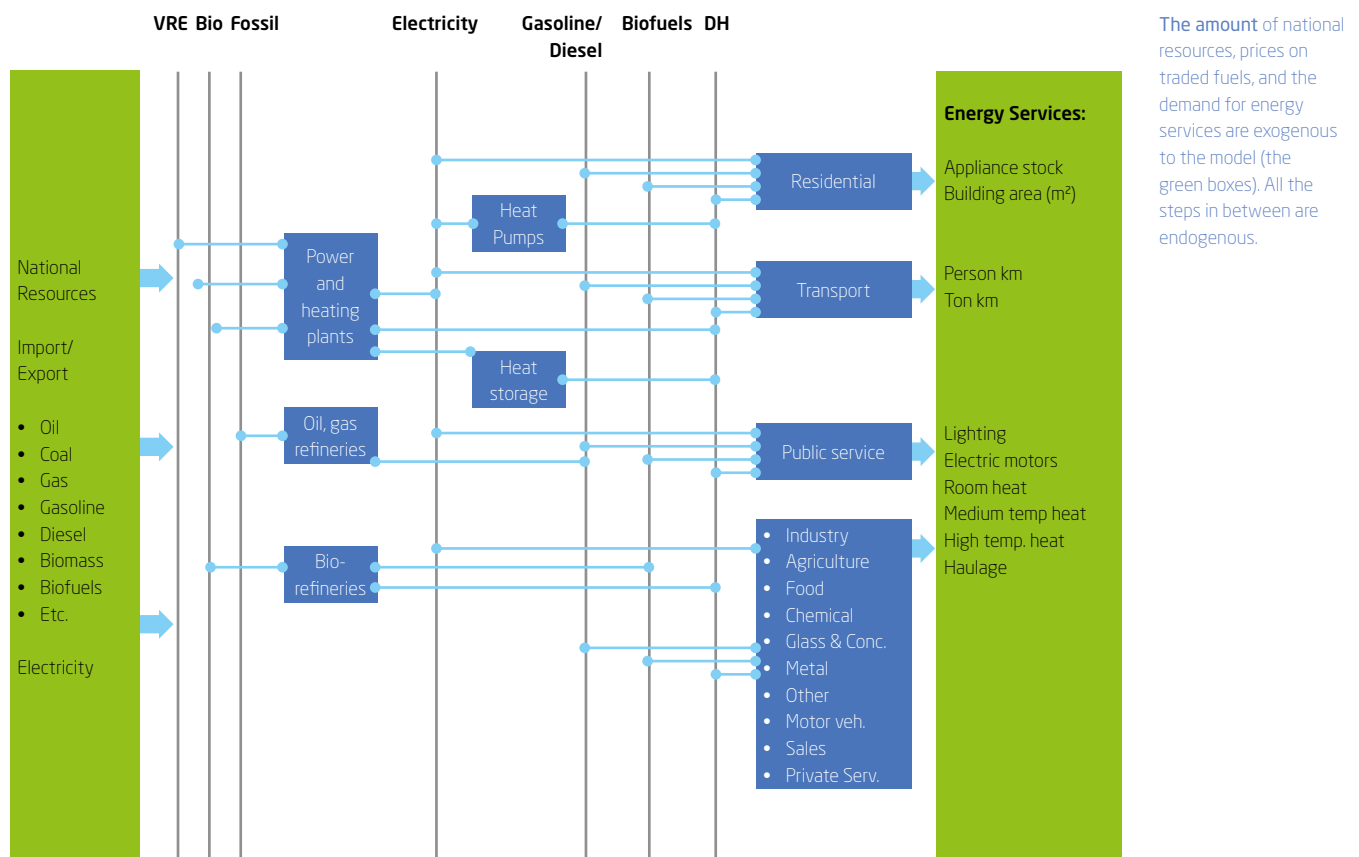
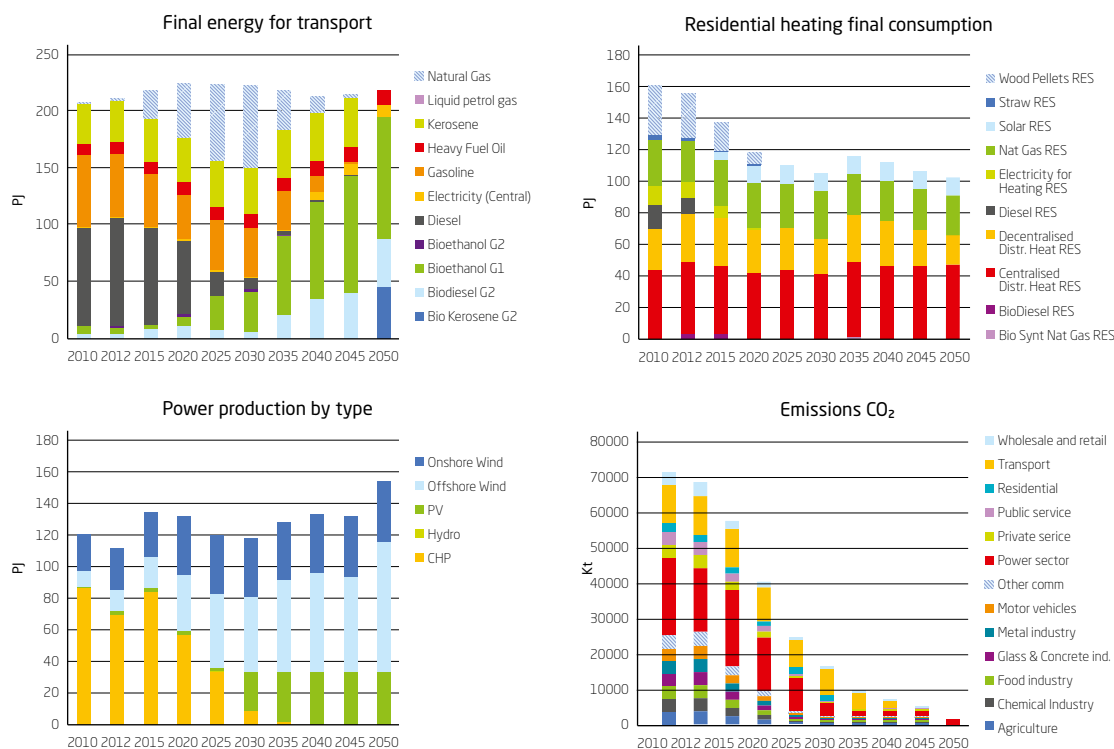



Figure 7 - Fossil-free scenario for Denmark.

Upper left: Final energy consumption in the transport sector;  
 Upper right: Final energy for heating in residential sector;  
 Lower left: Power production divided on fuel type (import and export are not shown in the graph);  
 Lower right: Total Danish energy-related CO<sub>2</sub> emissions.



help with the balancing. Bio-refineries will produce bio-fuels and from the process, surplus heat can be utilized as district heat.

When running a scenario in TIMES-DTU, it goes through all sectors and all possible technologies to find the optimal investment strategy and energy mix over the full scenario period (e.g. until 2050). The model has full foresight, meaning that it knows what is going to happen to all the exogenous parameters in the whole model horizon.

In Figure 7, we are showing some results from TIMES-DTU. The scenario is following the Danish government's targets on GHG and energy mix, which include:

- At least 50% of power production should be based on wind in 2020
- No fossil fuels allowed for electricity and heat production in 2035
- No fossil fuels in any sectors by 2050

The benefits of having a model covering all sectors become clear when looking at the results. Fossil fuels are phased out for electricity and heat production in 2035. Power production is then alone based on wind and solar energy. This is possible because of strong interconnectors to the countries around Denmark. When oil is phased out for residential heating then the oil boilers are replaced by heat pumps, which fits well together with wind and solar power. The transport sector is mainly shifting to different types of bio-fuels. EVs do not come in so strong, as the assumption on range of EVs was quite pessimistic in this model run. CO<sub>2</sub> emission from all the sectors in the model drops fast until 2035 and then a little slower until 2050 where only the power and district heating sector emits CO<sub>2</sub> from waste incineration.

This emphasizes the importance of coupling energy vectors across time and space in the models to capture energy system integration options realistically.



**Figure 9** – Illustration of system operation of the German power system through two weeks during winter in 2030 from a scenario in [5.11].

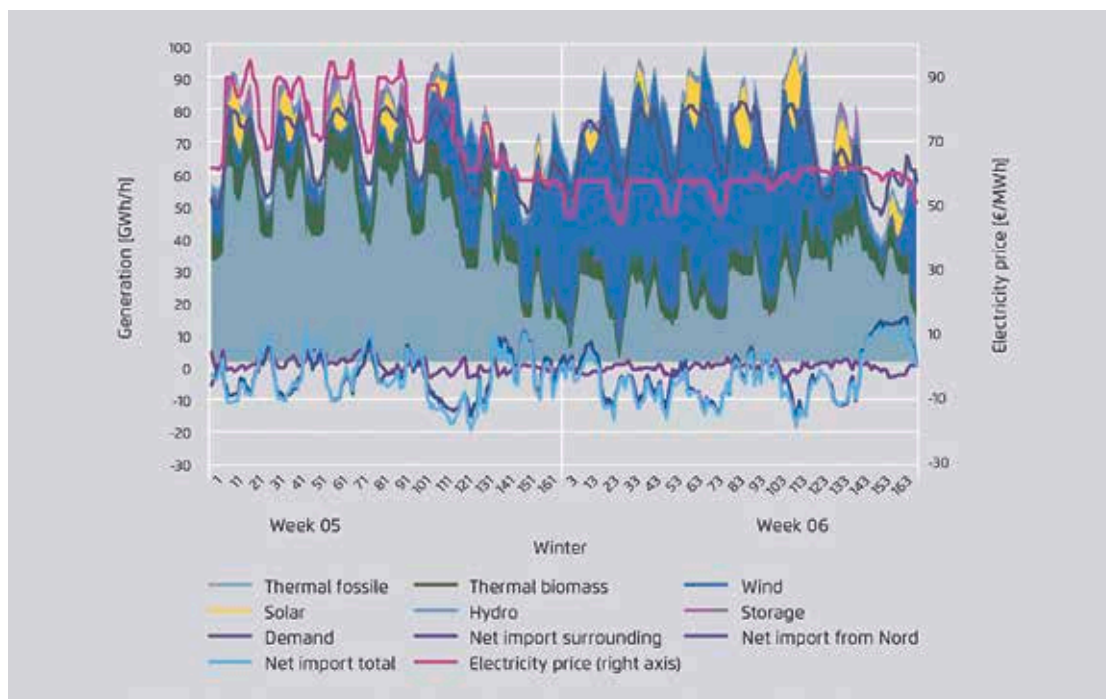

Balmorel can run with variable time resolution and are typically using 268 to 8,760 time steps per year. The high time resolution and more detailed split of the power system in price regions makes Balmorel more feasible to study power market issues, supporting schemes, and other implementing policies for RE. (Figure 8)

Balmorel can also be expanded to include other sectors than power and district heating production. Several versions of Balmorel exist at different institutions and with different focuses. Some versions feature a detailed representation of electric vehicles [5.9], some include the natural gas system, the role of hydrogen [5.10], and most recently a study with focus on transmission lines [5.11].

Balmorel is strong in modelling integration of VRE as it combines long-term investment projections with hourly simulations of the power and district heating system.

How Balmorel can balance the power system hourly is illustrated by two winter weeks from Germany in

Figure 9. The first week has almost no wind, but in the second week, there is a lot. Electricity price drops when the wind increases and the thermal plants are regulated down.

### Linking short-term and long-term modelling

Building a model covering all timescales, all sectors, and all relevant technologies is very challenging. Besides, in solving such a major mathematical problem, only a few persons would be able to understand the results coming out of the model. The way forward is rather to link models with different focus areas, depending on the scope of the analysis provided. This way we ensure that expertise from different timescales and sectors is maintained, and that the experts representing the different models employed are forced to collaborate and agree on results and conclusions.

The grey-box simulation models can offer a realistic description of how heating, power, and sewage systems can function on a short timescale providing

**Figure 10** - Illustration of the timescale and linkages between the different models described in this chapter.

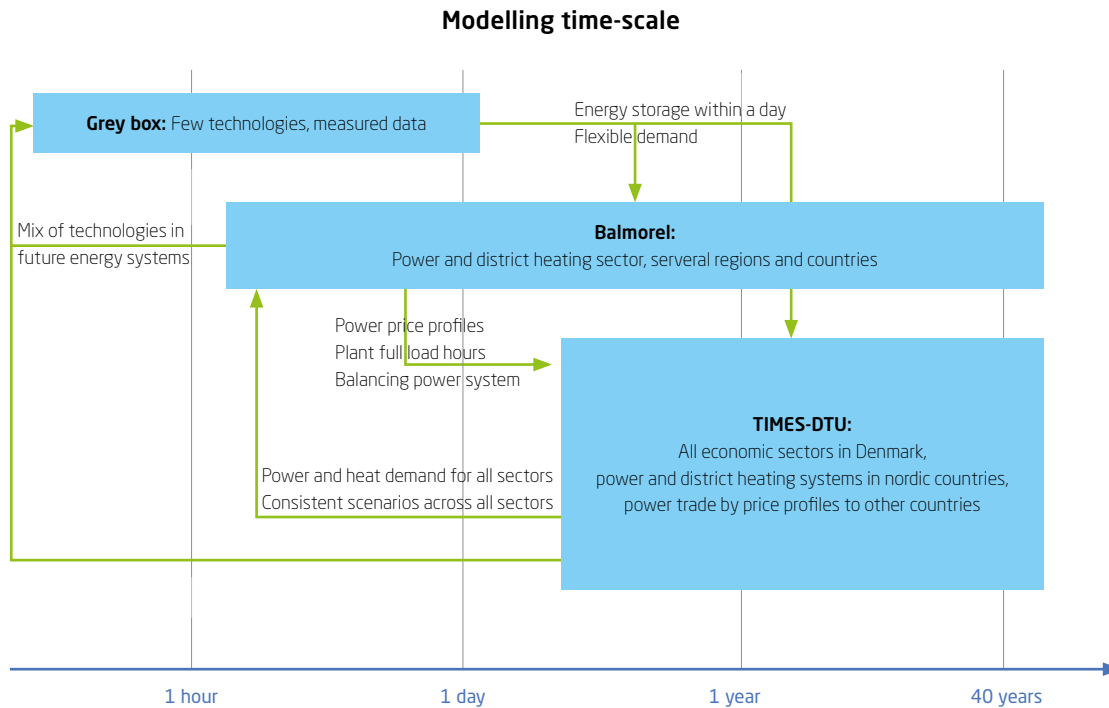

balancing and storage services. Power system modelling from hour level to a 30-40 year horizon are important to study required power plant and transmission line capacities and the future energy mix in the power sector. Integrated energy system models including all sectors can teach us about the trade-off between sectors. None of the models offers the full picture and therefore it is important to understand where the different models can learn from each other improving the quality of advice based on modelling. (Figure 10)

### Recommendations

We need collaboration between the different types of models, covering different timescale and different

parts of the energy system. It will strengthen the validity of results from each of the models if they are tested against other models and/or aligned with these where they are overlapping.

There is a global trend in soft-linking energy system models with models covering macro-economics, power system simulation, industrial processes, hydrology, end-use, transport, etc. and the way forward is to strengthen this work. The soft-linking of models gives more realistic insight into the processes influencing our energy system and it forces different research disciplines to work together in reaching a higher level of consistency in the advice to decision-makers.

## Chapter 6

# Integrated energy systems; aggregation, forecasting, and control

By **Henrik Madsen** and **Jacopo Parvizi**, DTU Compute;  
**Anna Maria Sempreviva**, DTU Wind;  
**Henrik Bindner**, DTU Elektro;  
**Chris Dent**, Durham University;  
**Reinhard Mackensen**, Fraunhofer IWES

## Introduction

During the past decade a large number of research projects have focused on individual aspects of the energy system, such as zero-energy buildings or intelligent power systems (smart grids). Such research projects have provided valuable insight, but overlook the potentials, the efficiency, cost, and prospective emission savings with an integrated approach that facilitates flexibility throughout the energy systems. Therefore, large-scale introduction of fluctuating renewable and non-dispatchable energy sources implies that the key to a successful integration is to consider the entire energy system and focus on methods for Energy Systems Integration (ESI). The integration calls for a paradigm shift that is envisaged from distinct, radial, and mostly centralized systems for power, gas, biomass, and district heating/cooling, to a single integrated interconnected, distributed and partly autonomous system. Hence, a successful integration of large fractions of fluctuation renewables calls for intelligent interactions between energy production, storage, distribution and consumption. The complexity of the integrated system implies that Big Data, Grey-box modelling, Internet-of-Things (IoT) and Internet-of-Services (IoS), and related technologies such as data analysis, aggregation, forecasting, and control, will play an important role.

Also, in the CITIES project (*see smart-cities-centre.org*), it is concluded that a focus on data, aggregation,

modelling, forecasting, control, and optimization is important to establish solutions for energy systems integration. Methods for handling and generating information from rather different data sources, such as local weather stations, meteorological forecasts, smart meters, energy flow meters, and a plethora of other sensors must be established. Hence, new ICT solutions, based on new methods, models and standards, are needed for achieving the more ambitious renewable energy targets.

Future electric energy systems with an increasing, fluctuating and non-dispatchable renewable power generation must be designed such that it is possible to activate flexibility on many different scales or at aggregation levels. This implies, for instance, that we must be able to describe the link between individual household appliances, Distributed Energy Resources (DER), and the electricity or energy markets. This chapter aims at describing how to outline the future electric energy system as hierarchies of nested control and optimization problems that are formulated based on dynamical models of energy loads, flexibility, and renewable power generation.

Reliable and optimized forecasts of renewable power generation and loads are important for solving the control and optimization problems, and due to the stochastic and complex nature of mainly wind and solar power generation, a section is devoted to probabilistic forecasting and meteorology. The forecasts

are used as input at various levels of the hierarchies of aggregators.

Methodologies for forecasting, optimization, and control across all levels in the hierarchies of nested energy systems are needed, and this chapter aims at giving a short overview of such requirements.

## A set-up of future electric energy systems

The backbone of the future energy system will still be electricity, and the power systems will glue together various elements of the future energy system. Consequently, the focus will here be on the power system, but the set-up with a focus on price-based control and optimization facilitates an integration between power, gas, heat, biomass, etc.

The introduction of flexible DERs in the system, which can shift the consumption and production, gives rise to two major changes. Firstly, an important actor is introduced: the Aggregator or Virtual Power Plant [6.2], which is responsible for representing the flexible part of the load towards the system operators, either through a Balance Responsible Party (BRP) or as a BRP itself. The other major change, associated with demand-side management, is the addition of balancing markets operated by the DSOs in each distribution network. The idea of implementing such a system originates from the fact that each DER does not have sufficient flexibility to offer to bid into the electricity market. The Aggregator is thus a new intermediary functionality, or even actor, between the flexible DERs/electricity consumers, on one hand, and the grid operators (TSO and DSOs) and, potentially BRPs, on the other.

*Figure 11* is a schematic representation of a future system with flexible DERs.

## Aggregation

Aggregation is a crucial concept for Energy Systems Integration. Various principles for aggregation exist: 1) Area specific aggregation (typically TSO or DSO related), 2) Domain or physical aggregation (typically BRP- or DSO-related), 3) Commercially related

aggregators (typically to level out fluctuations). For IC, the related delta-price should be related to these principles.

The idea of representing a large number of DERs with an aggregated whole is not entirely new, since market participants representing an aggregation of either producers or consumers in the market already exist (e.g. the consumption BRPs and generation BRPs of wind energy, etc.). Experiences from these aggregated market participants have shown that a more accurate forecasting of the behaviour is obtained by a higher level of aggregation [6.9].

The Aggregator typically comprises a number of sub Aggregators. Each sub Aggregator may represent a distinct pool of DERs in the grid to facilitate e.g. area specific aggregation. Another possibility with this set-up is that each sub Aggregator specializes in, e.g., supermarket cooling, waste water treatment, EVs, heating, etc. Through these sub Aggregators, the main Aggregator is able to provide services at the DSO level by separately estimating the flexibility of each portfolio and, e.g., in the case of IC the sub Aggregator, correspondingly broadcasts a reference signal for the specific portfolio. The responsibility of estimating flexibility and determining the signal is nevertheless in the hands of the actual Aggregator. For instance, in the case of a waste water treatment plan specialized aggregator is needed to estimate the available flexibility given the constraints with respect to the quality of the waste water treatment. In this way, the Aggregator can maximize the benefits of the flexibility it represents by offering DSO services like voltage and frequency control where they are needed, and mobilize the rest for energy balancing services.

In systems with an efficient integration of the energy systems, the energy balancing services are used for instance to use excess wind power in district heating networks, or, in the other extreme, to start up e.g. bio-gas fired power units in periods with a low production of wind power. Consequently, both district heating and gas networks are important for being able to implement some of the energy balancing services. Since indirect control (IC) is based on prices this concept is ideal for implementations of technologies for Energy Systems Integration since price-based solutions provide a metric which is comparable between energy vectors.

**Figure 11** – Schematic representation of a future power system with hierarchies of Aggregators and flexible Distributed Energy Resources (DERs).

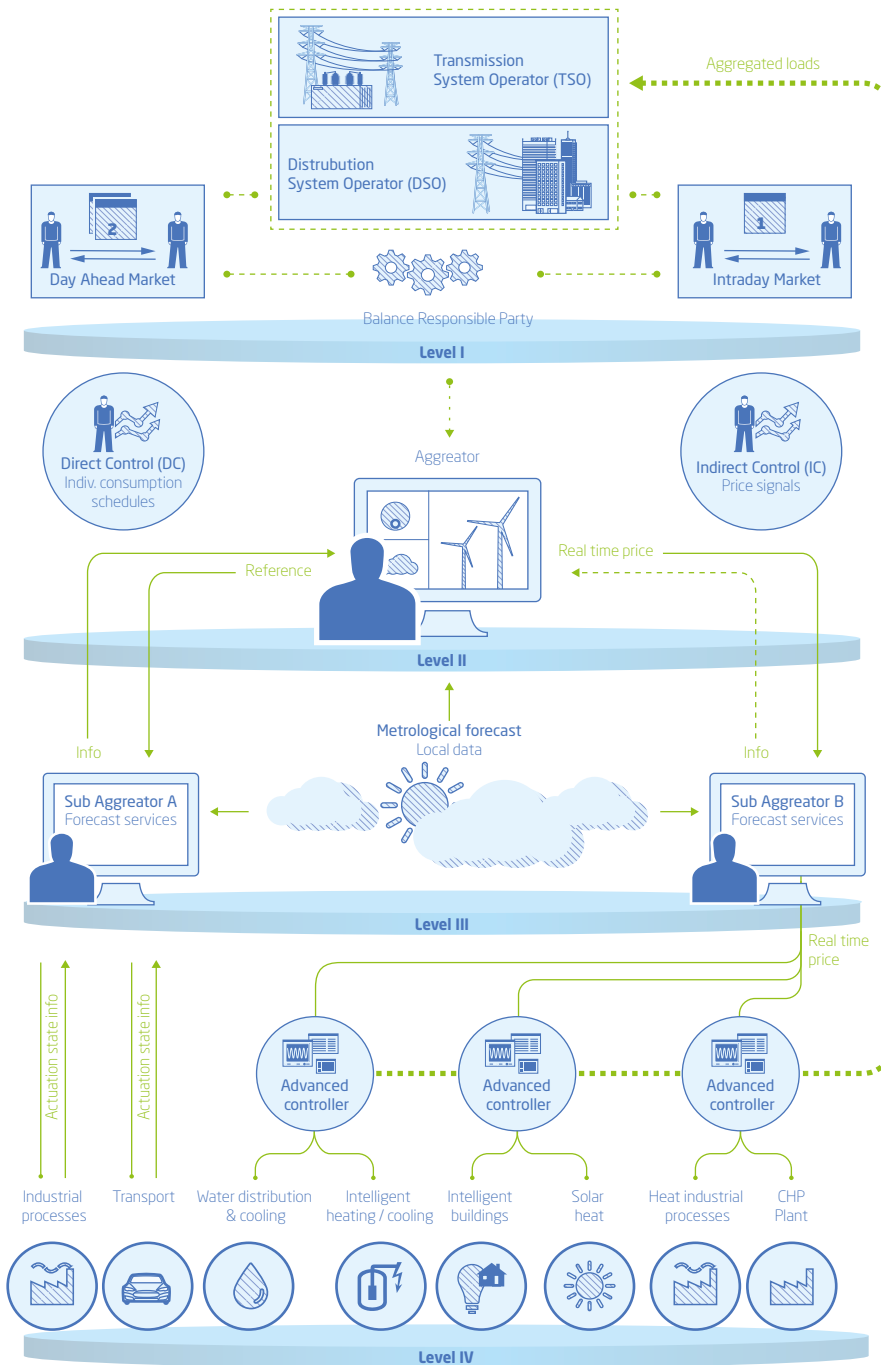

**Level I**

This level contains a market clearing where the producers are selected based on bids. The connections between the actors in the market are represented with dashed lines because different markets have a different layout. The description is inspired by the Nordic layout with a day-ahead spot market, Elspot, and an intraday market or balancing market. Lines with circles indicate that these parts of the system are connected. Lines with arrows indicate information flow.

**Level II**

The Aggregator estimates its available flexibility and submits bids to the regulating power market directly or through the Balance Responsible Party (BRP). After clearing of the spot market, the Direct Control Aggregator (DC) will dispatch individual consumption schedules, while the indirect Control Aggregator (IC) will broadcast price signals.

**Level III**

For the DC part, an important role of the Sub-Aggregator is to estimate the states of the DERs and compare the states with contractual values. In the case of IC the role of the Sub-Aggregator is to determine and communicate a signal in real-time to which the DERs respond by adjusting their operation according to the Aggregators needs. Another role of the Sub-Aggregators is to provide reliable probabilistic forecasts for loads, prices, and weather conditions depending on the control strategy implemented.

**Level IV**

In the DC part the Sub-Aggregator A communicates the actuation signal based on the state information received from the DERs, and hence a two-way communication is needed. In the IC part, advanced controllers regulate the DERs (industrial processes, transport, water distribution & treatment, intelligent heating/cooling, etc.) based on real-time price signal transmitted from the Sub-Aggregator B, and this control scheme only requires a one-way signal. The price signal from the Sub-Aggregator is a delta-price, which is added to the market price in order to obtain the needed control objective.

Different hierarchies are displayed vertically with roman numbers (from I to IV), moving from the markets to the consumers. Direct control (DC) on the left where the power is altered directly by the aggregator, and indirect control (IC) on the right where the aggregator sends out a price signal to incentivize changes in power consumption [6.1].



For indirect control of flexible DERs, the reliability of the forecast response increases with the size of the portfolio. Thus, services at the transmission level can be provided with greater certainty than in the distribution grid. This of course prompts the questions of how much reliability can be obtained in the response for the intended services and how much certainty is required in the response so that the provision of services is practically feasible. The answer to these questions depends on various external factors such as market design and the share of flexible DERs in the system. It is, however, unlikely that service requiring unique responses at different branches of the distribution network, e.g. voltage control, could be provided with acceptable reliability using IC, and consequently these services most likely have to be provided by DC. The total set-up suggested here is further described in [6.1].

## Meteorology for integrated energy systems

Future integrated energy systems (IES) will be based on a major share of fluctuating, weather dependent energy sources as well as weather dependent flexible DERs and energy management. First of all an important aspect is to customize the MET models and methods to the needs of energy management and storage solutions. Since gas systems can provide seasonal storage and district heating networks can provide energy storage up to, say, 2–3 days ahead, meteorological forecasts are needed with different lead times, and it is very important to understand how to optimize the MET models to this important usage. Weather dependent flexibility, like for instance those which can be provided by waste water handling or supermarket cooling, might also call for tailored MET models.

The second part affects the field of converting meteorological predictions into energy relevant energy forecasts, e.g. demand, wind or solar power forecasts. Here a combination of forecasting models like statistical or physical approaches and furthermore, aggregations of forecasts or measurements have proven to be very important. This section considers briefly meteorological aspects, but focuses on the conversion into energy forecasts.

## Forecast services

The purpose of this section is briefly to describe forecasting methodologies with a focus on both probabilistic and multivariate aspects. Both aspects are important for the energy systems integration. The purpose is also to ensure that forecasts are generated in a homogeneous way so that they can be used for integrated energy systems applications as well as for different use cases. Forecasts are used as input for design of controllers and for decision making based on optimization.

Forecast services are crucial for optimal decision making, production planning, trading of power and for control, as indicated in *Figure 11*. In this section, we briefly describe the list of forecast services needed, discuss the statistical forecast characteristics, and illustrate how the forecasts can be used in optimal control and decision-making.

It is clear that forecasts are needed both on a day-to-day basis, e.g. in order to provide input for the market clearing, and for the optimal production planning, as well as on a shorter horizon, e.g. in order to use the flexibility of the DERs to control the electricity load.

The actors at level I and II in *Figure 11* need forecasts to provide bids for market participation and for production planning. This includes methods for wind power forecasting (see e.g. [6.3], [6.4], and [6.5]). Methods for using forecasts in integrating renewable electricity sources like wind and solar power in electricity markets are described in [6.6].

Basically, all models and methods for energy forecasting take meteorological forecasts as input, and some forecasts also take advantage of online measurements of local weather conditions.

### Forecast services

The predictive controllers considered are based on forecasts of load, prices, etc. This section will focus on forecast services for the lower part of *Figure 11*, and in particular the forecast services related to DERs or a portfolio of DERs.

Depending on the control principle (DC or IC) the following forecast services are needed:



- Load (demand or flexibility) forecasts (for both DC and IC)
- Price forecasts (for both DC and IC)
- State forecasts (e.g. room temperature) (only for DC)

The forecast of the power load is further divided into three main categories. The first one is the forecasting of the system flexibility or the demand, which is used by the Aggregator to control the flexible part of the load. Secondly, a set of forecasts for all the different factors affecting the electricity system, either directly or indirectly, is needed. Finally, forecasts for the behaviour of the individual appliances present within a single household are in most cases needed at the consumer level in the case of direct control.

In the case of IC, the overall control of the consumer's portfolio of DERs is in the hands of an advanced controller, which for a domestic consumer could either be a home automation system or an integrated controller of the DER. This advanced controller gathers the price signal from the Aggregator, the current status from the DERs, and typically two different sets of forecasts provided by the Sub-Aggregator, namely the load and price forecasts. Based on this information the advanced controller determines an optimal control for the DERs [6.7].

Hence, the set of forecasts, which the advanced controller operates according to, is for external factors such as weather conditions and energy system forecasts (e.g. system power load and renewable power production, etc.). These forecasts are not necessarily made in-house, but could be bought as a service from the Sub-Aggregator, the manufacturer of the appliances, or even a specialized third party.

In addition to the dependence on external forecasts and data, the future flexibility of some appliances when considering direct control depends on the current state and actions. Thus, for DC a set of forecasts for the equipment's own flexibility, and hence its states, is necessary for optimally dispatching it. The necessary models for providing these forecasts have to be installed somewhere and most likely at the Sub-Aggregator level. Notice that in *Figure 11* state information is sent from the DERs

to the Sub-Aggregators, but in most cases the state information is only partial and approaches like state estimation techniques [6.8] are used to provide an estimate of all the states.

### Resolution of forecasts in time and space

In general, a characterization of needed forecasts includes decisions on resolution in time and space, update frequency, and horizon together with the actual statistical characteristics forecasted. Requirements on the resolution in time and space are often directly implied by the requirements specified by the user of the forecasts.

Regarding the horizon, forecasts are typically needed with a horizon ranging from few minutes to days. Typically, the longer forecast horizons are needed for production planning and for trading, whereas the shorter horizons are needed for operational and control purposes.

Control and scheduling of power systems require online electricity forecasts with lead times from a few minutes to day-ahead. Predictions with lead times up to 30 minutes are called very short-term forecasts, while short-term forecasts are from 30 minutes to day-ahead [6.5]. Forecasts with greater lead times are called medium- and long-term forecasts.

The spatial resolution needed is typically related to the TSO or DSO grid, and we will refer to [6.1] for further discussions.

### Control and optimization

The characteristics of the optimization or control problem depend on the considered aggregation level in *Figure 11*, and this relates to long- and short-term aspects:

- Long-term: (Day-ahead in the Nordic market): Every day, the Aggregator actively designs its load profile for the upcoming day(s), typically using Stochastic programming. The target is to establish an optimal hourly production schedule for the entire portfolio for the coming day(s). This is typically a mixed integer optimization problem which can be dealt with using e.g. stochastic programming.
- Short-term: Within the day or within a given hour, the Aggregator participates in the ancillary

**Table 3** – Difference between direct (DC) and indirect (IC) control.

Level	Direct Control (DC)	Indirect Control (IC)
III	$\min_{x,u} \sum_{k=0}^N \sum_{j=1}^J \phi_j(x_{j,k}, u_{j,k})$	$\min_{\hat{z}, p} \sum_{k=0}^N \phi(\hat{z}_k, p_k)$
IV	$\downarrow_{u_1} \dots \downarrow_{u_J} \quad \uparrow_{x_1} \dots \uparrow_{x_J}$ $\text{s.t. } x_{j,k+1} = f_j(x_{j,k}, u_{j,k}) \quad \forall j \in J$	$\text{s.t. } \hat{z}_{k+1} = f(p_k)$ $\min_u \sum_{k=0}^N \phi_j(p_k, u_k) \quad \forall j \in J$ $\text{s.t. } x_{k+1} = f_j(x_k, u_k)$

For DC, the optimization is solved globally at level III whereas for IC, the problem is split up in two problems; the problem in level III finds the optimal prices that are sent to the  $J$ -units at level IV. At level IV, the DERs optimize their own energy consumption taking into account ( $p$ ), i.e. the price of energy. The main dynamics are described by the states ( $x$ ) of the DERs which are controlled by the power consumption ( $u$ ). The aggregated total power load ( $z$ ) is not directly measured, but estimated using appropriate models [6.1].

markets, e.g. the regulating power market, balancing its load using, e.g., predictive controllers. The goal is to utilize the flexibility provided by the portfolio in a way which supports the needs of the TSO and DSO, and the integration of large shares of fluctuating renewables.

Table 3 shows a comparison between direct and indirect control in terms of optimization problems. For DC, the entire optimization problem is solved at Level III, and information about changes in power consumption are then sent directly to the individual units. Consequently, this approach typically leads to large optimization problems, but due to the structure of the problem so-called decomposition methods like Dantzig-Wolfe decomposition can be used to simplify the problem.

Typically, DC must respect some constraints at the end-user. For instance, for control of the power consumption in supermarkets the temperature may not exceed 5 degrees Celsius in the refrigerator display units. In order to ensure that such constraints are respected, this type of control implies a need for sensors at the end-user. In some situations, these sensors can be replaced by software sensors obtained by state estimation techniques, as described previously.

For IC, the optimization problem is split into two smaller problems; one for each aggregation level, and

the information flow is from level III to level IV. At level III, the prices ( $p$ ) are found as a result of an optimization or control problem which aims at keeping e.g. the voltage level or the total power load equal to some target values. Small deviations from the target values are typically not a problem, whereas large values typically have large impacts. This implies that an optimization problem which defines the optimal control strategy could be a quadratic cost function implemented, e.g. by Linear-Quadratic-Gaussian (LQG) or Minimum Variance (MV) controllers. These controllers are found based on estimated dynamical models between prices and consumption as illustrated in Figure 12.

The price is then broadcasted to Level IV. At level IV, these prices are used by the DER or home automation system to optimally schedule the actual consumption. The optimization problem defining the optimal control at Level IV is typically a problem which minimizes the cost for energy (or electricity) and a popular type of controllers are the so-called Economic Model Predictive Controllers (E-MPC). This type of controllers could easily be built in a home automation systems.

Price-responsive devices must evaluate how high or low the actual electricity price is by filtering out slow variations in prices due to trends and seasonal variations. This can be obtained by ([6.9] considering a local standardized price which is obtained by

**Figure 12** - Control of aggregated consumption based on a dynamic model (Price-response estimator) for the price-responsive consumption.

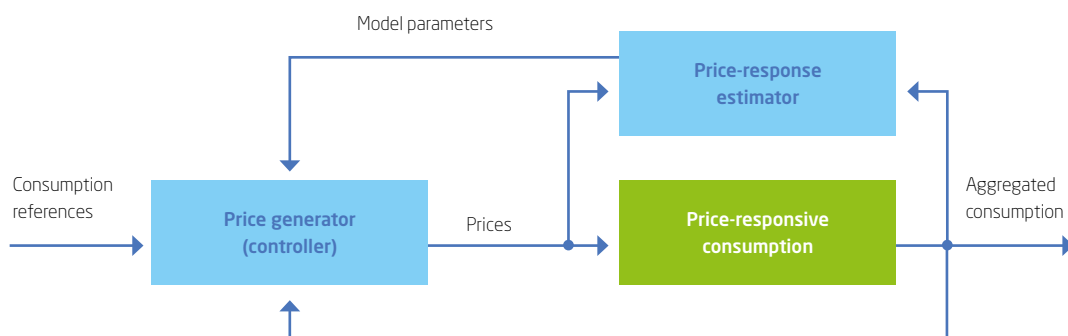

normalizing the actual price with an exponentially discounted moving average of the observed prices.

Another difference between DC and IC is, that DC is perhaps most adequate for power or voltage control, whereas IC is most suitable for energy control. This also implies both type of controllers are most likely needed in future integrated electric energy systems.

## Conclusions and recommendations

This chapter has provided a conceptual description of a suggested layout for future integrated electrical energy systems with a large penetration of fluctuating power generation, typically wind and solar power. It is argued that ICT technologies that contain implementations of methods for aggregation, optimization, control and forecasting, are crucial for a successful transition to systems based on such fluctuating and non-dispatchable generation.

The concept of the aggregators at various levels in the hierarchy of model based control and optimization problems becomes important for operations of future electric energy systems. The aggregators optimize or

control their portfolio mainly by computing signals that are set points for its subsystems. At lower levels in the hierarchy of optimization and control problems, subsystems of flexible consumption units become important, and this flexibility can most efficiently be activated through the introduced concepts of indirect (typically price-based) control.

At higher level in the hierarchy, the concept of scenario based stochastic programming needs some future attention in order fully to take the uncertainty into account.

At the lower levels, the flexible consumption units (DERs) optimize their objectives. The set-up must be flexible enough to avoid mismatch between the Aggregators' requirements and the actions taken at the DER level. A study of new design methods for data and economical based control technologies is needed. The set-up calls for new services and technologies for handling data in a secure manner, while respecting privacy issues, and those technologies need some further development. Also, new services, e.g. cloud based services, for forecasting and control are needed in order to obtain a robust and reliable implementation.

## Chapter 7

# Demand-side management

## - electricity savings in Danish households reduce load variation, capacity requirements, and associated emissions

By **Henrik Klinge Jacobsen** and **Nina Juul**, DTU Management Engineering

### Introduction

Demand-side management (DSM) can reduce not only electricity demand, but also the load variation and capacity requirements. If consumption categories with high peak hour and winter share can be targeted the effect on the aggregate load profile can be substantial. Reducing the variation of load will reduce the absolute required flexibility in the power system and contribute to integrating more fluctuating generation such as wind and PV. This is a secondary contribution to flexibility that reduces the need for other kinds of flexible demand, flexible generation capacity, interconnection capacity, and storage. New demand from privately owned EVs and residential heat pumps can potentially provide flexibility, but it is very unlikely that these small demands from many individuals/households provide flexible demand in the short run of 5 to 10 years and therefore private consumers can mainly contribute by changes in the load profile.

Private household consumption is one of the consumption categories that have the highest share of consumption in wintertime and during the late afternoon/evening peak hours, especially in Denmark. If electricity savings can be targeted not only to households, but also to the appliance categories of households with the highest winter and peak hour consumption, then savings of this kind should be incentivized the most through public schemes or standards. Targeted savings with this profile also contribute to reducing emissions and costs in the power sector as well as for the consumers and this will contribute to the same objective as increasing the fluctuating renewable wind and PV capacity in the power mix.

Demand-side options to increase flexible demand and reduce required power system flexibility thus include measures such as programmes targeting behavioural changes, investment in control equipment and investment in efficiency for electric end use technologies. These solutions add to the primary flexibility measures on the supply side such as direct and indirect electricity storage, heat storage, and electricity-based heat production in district heating networks. Here, the focus is effects from household investment in appliances and not consumption behaviour.

Energy and electricity savings are seen as contributing substantially to reducing fossil fuel dependence in Denmark and improving energy efficiency. Electricity savings in households are contributing to this through the marginal fossil fuel content of generating the electricity. As the fossil fuel content of generation varies across hours, so does the fossil fuel reduction based on the hourly profile of the electricity saved. Furthermore, the hourly profile of savings may have very different effects on capacity requirements in the power sector, depending on which category of household demand is reduced. The value of the savings hereby depends on the profile of the reduced electricity demand and it is vital to know the consumption profile of the particular end-use demand that is reduced.

Flexibility requirements depend on the profile of demand. Thus, demand-side management which reduces the variation in demand across hours and seasons will also contribute to reducing the required flexibility. For example, annual peak demand hours will be characterized by different situations with regard to non-controllable generation from wind and

PV. A few of these peak hours will have little or no wind generation and thereby the need for controllable generation including imports will be defined by these hours. Reducing the electricity demand in these hours from households is especially important if it is possible to target parts of household demand that is having a large fraction of demand in hours with high fossil fuel content and in peak load hours. Overall, household electricity demand in Denmark contributes substantially to peak load as the seasonal pattern is particularly winter-heavy and its daily peak coincides with system peak where households in peak hours constitute 35–40% of total load relative to their average annual share of 20% (2013).

It is possible to contribute substantially to reducing the flexibility requirement if residential loads can be affected such that their average profile shifts outside the day and evening peak hours.

## Demand-side management and demand-side response in Denmark

The flexibility seems very limited when examining household electricity demand, contrary to the flexibility in large-scale heat pumps, boilers and some parts of industrial demand. Large heat pumps and boilers in district heat production in Denmark can be expected to contribute much more to flexibility in the future, but these are part of the energy supply system and not the demand side. The demand side has potential to contribute to flexibility, but the evidence and economic incentive for households to switch to active short-term adjustment of demand following price changes is very limited [7.5]. In other countries with lower residential electricity prices and similar income levels, the electricity consumption is higher and partly because of this, heating is based to a higher degree on electric heating (or air-conditioning) or heat pumps. Here, the value of active adjustment of consumption and incentive is higher since the amount of switchable consumption is higher than in most DK households.

Therefore, traditional DSM measures might produce an impact on the power system that still contribute to reduce emissions and even may contribute to peak savings at hours where wind is not available. Households are expected to react very little to the price changes for electricity in the short run and may

often not even be exposed to the short run hourly price changes. Specifically for Denmark the energy duty and tax part together with network charges is a very high share of the household tariff (approx. 80%). Therefore, the price impact and signal from fluctuation in wholesale electricity markets are weakened substantially at the household retail level.

Price impacts are more likely observed for the long-term adjustments of household consumption patterns and also when choosing the technology variants of the appliances in a household. Electricity demand in households may be affected in the long term through the prices of efficient appliance variants relative to the less efficient versions. Our objective here is to quantify if the effect on emissions in the power sector and the contribution to reduce peak demand is different depending on which part of household demand is being affected. Such difference exists if the hourly profile of the consumption from different appliances varies across the day and across seasons. If the profile varies so does the effect of savings for each appliance category. The relevance of this lies in the policy implication from such difference:

Potentially, the choice in favour of efficient appliances should be based on different levels of support due to differences in the value in terms of both emission reduction (fossil fuels) and reduction of peak electricity requirements.

This chapter aims to clarify if some end-uses provide better social return on the investment in the efficient appliance model/version than others, and whether policy should be designed accordingly.

## Methods

The link between the aggregated hourly household load profile in Denmark and a number of household appliance categories has been established. The objective is to evaluate the effects of increasing the average efficiency of different types of appliances. Electricity demand is reduced for all appliance categories, but the effect on the load profile varies substantially between the appliance categories, resulting in different impacts on capacity requirements and emissions. The analysis focuses on the part of household demand that is related to appliance

categories in households today and does not consider additional important consumption categories that may be important if considering savings options in future scenarios, where electricity for heating (heat pumps) and electric vehicles may constitute a higher share of household consumption. The analysis uses a combination of three datasets:

1. Danish hourly load profile for the aggregated household demand in 2008 [7.1]
2. Danish composition of stocks of appliance categories and their annual electricity consumption [7.6]
3. REMODECE project data for appliance category load profiles [7.3], [7.4] and EURECO data for comparison

By combining the three types of data it was possible to scale the REMODECE load profile for each type of appliance with the Danish annual consumption for a similarly defined category. Following this, the total Danish load profile was calibrated for households.

## Construction of the aggregated Danish households load profile

First of all, the actual aggregated Danish load profile for one household during an average day of 2008 is calculated. The chosen year is 2008 in order for it

to be comparable with REMODECE project which is dated to 2008. Data were taken from [7.1]. The available data set contains the aggregated load of an average Danish household as percentage of the total yearly load, for each of the 8760 hours of the year. Therefore, in order to obtain the average weekday and weekend of the year, the 365 days of one year were sorted in weekdays and weekends first. Afterwards, the average of each of the 24 daily hours for weekdays and weekends were calculated separately, resulting in the load profile of the actual Danish average weekday and weekend. This procedure was repeated for each of the five different types of buildings considered in the data set. The results are presented in *Figure 13*.

Each of the three graphs show the load distribution for an average day. In the figure, the load profile for 24 hours are given as a fraction of the total consumption for that category over 24 hours. The data represent the weighted hourly average over one year, such that the sum adds to 100% of the total consumption for each category. Thus, the average consumption for each of the 24 hours is found by multiplying with annual demand in the category. This is the profile that the consumption from all appliance categories within each household category should add up to. The comparison was done separately for average week and weekday profiles. The main observation from the load profiles are that load variation within household consumption over 24 hours is very substantial and it is also larger than

Figure 13 - Load profiles in DK for three categories of households, comparison of weekdays and weekends.

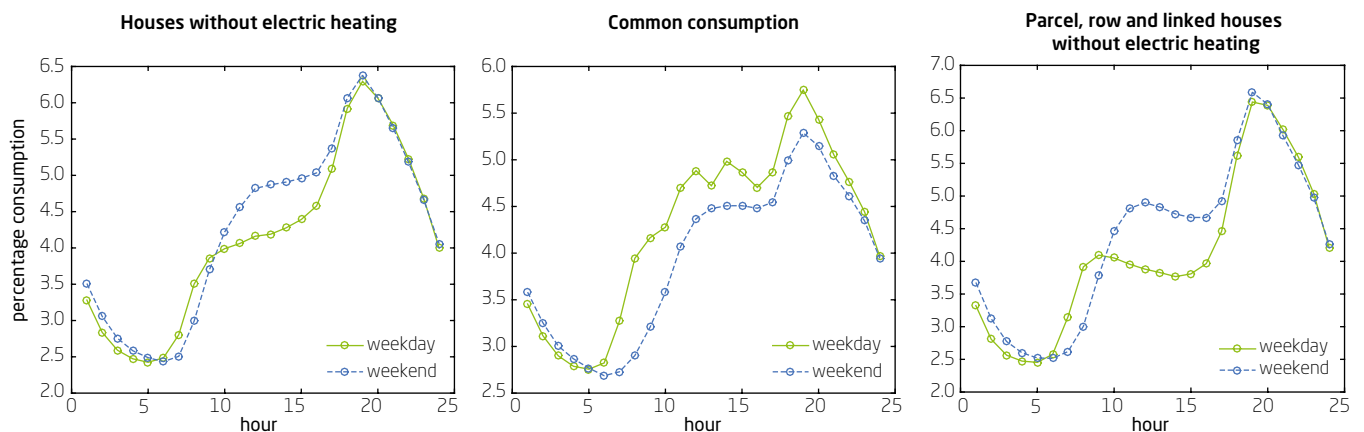
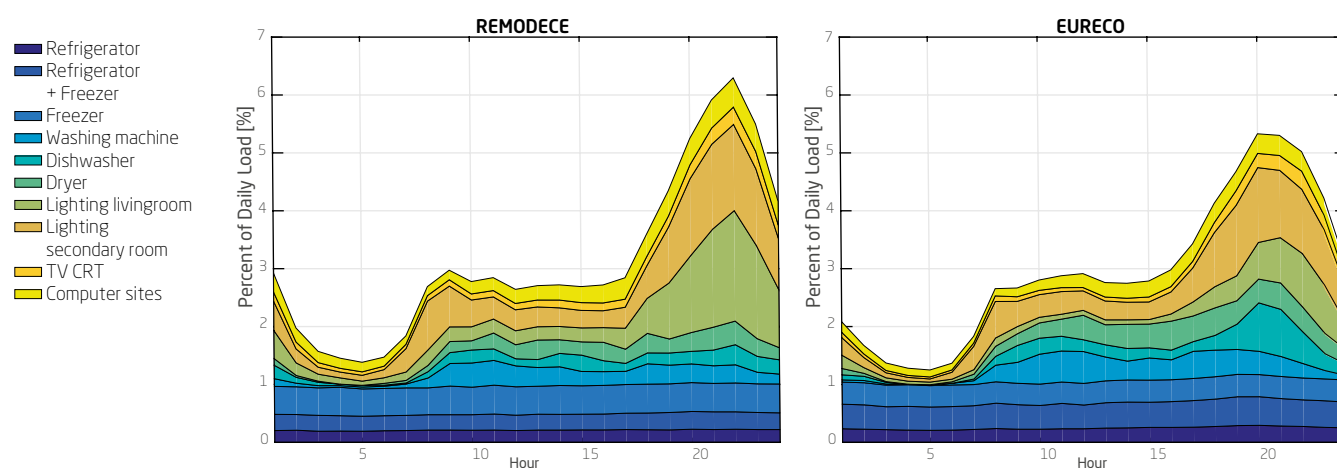



Figure 14 - Composition of load profiles for household electricity demand in Denmark, comparing two datasets



for the other consumption categories. Reducing load variation for this consumer segment is where the impact on overall load variation will be the largest.

### Electricity savings for lighting and cold appliances could reduce load variation and flexibility requirements

A possible difference between two categories with an expected load profile that diverges, i.e. lighting and cold appliances, has been examined.

The analysed savings scenarios compare the effects of savings of equal amount of annual electricity consumption from the two appliance categories. In both cases, we reduce the consumption of the appliance category by 260 GWh per year where the total household consumption is approximately 8,650 GWh. The savings corresponds to around 100 kWh per household per year and about 3% of the household electricity consumption. The average annual household consumption in Denmark is 3,435 kWh.

The savings for each of the two categories correspond to around 20% efficiency increase for each. This is only achievable in time as the more efficient choice for replacement has to diffuse through the stock of appliances. The example thus implicitly assumes a time horizon of 5–10 years if the more efficient version is 25–50% better than the average version of the appliance bought.

Demand is assumed to react indirectly through investment choice to a price change of the electricity on average or a measure that reduce the cost of the efficient appliance (support). Furthermore, it is assumed that there is no reaction to the price change or the higher efficiency on the profile of electricity consumption for each appliance category. Hence, any savings from efficiency will just reduce the electricity consumption proportionally for any hour of the year. This assumption is quite unproblematic as the assumption is that the demand for the service from the appliance is unaffected by the electric efficiency increase. It could be discussed whether a rebound in the use of the appliance should be included, but here we disregard that possible effect as unlikely or at least rather small and not affecting the profile of the savings.

Examining two different datasets based on panel data of household-measured consumption for actual appliances, we compare the composition on appliance categories. The left panel illustrates the composition from the most recent study [7.3] with the largest number of appliance categories included. This dataset is based on a cross section of European countries and as such may deviate a bit from the Danish profile. Therefore, a comparison with the EURECO dataset (right panel) is made where specific Danish households in the Odense area are included, but this dataset is old (around 2000) and the number of households and appliance categories are less. There is a quite good correspondence



Figure 15 - Fuel shares in DK electricity generation (Balmorel simulation)

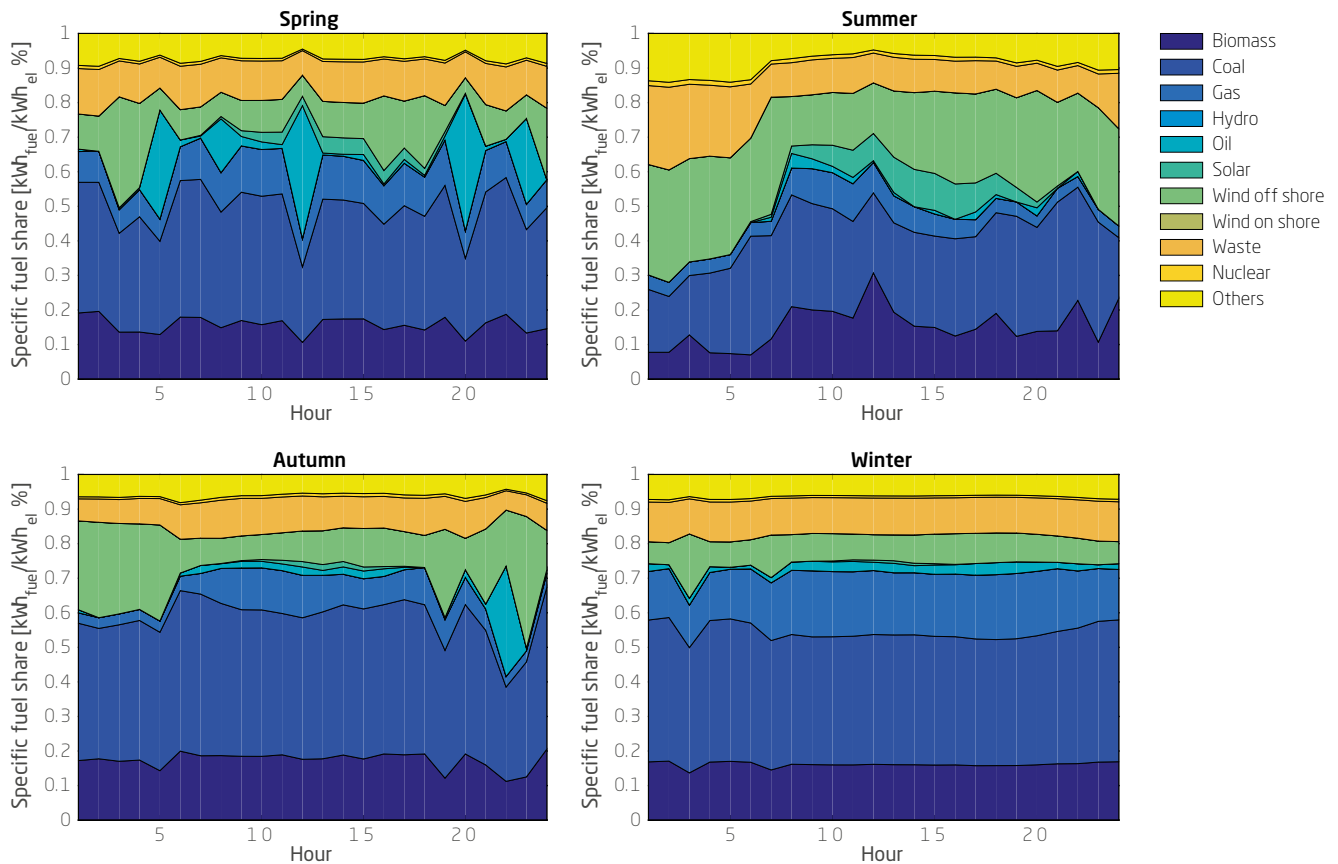

between the datasets for the distribution on appliance categories and the overall profile, but the peak is located later in the REMODECE data. Therefore, an adjustment is made for the location of the peak using the REMODECE left panel data and shifting the hours around the peak corresponding to the annual average total profile and according to the profile in *Figure 14*.

#### Comparing the effects on the power system for emissions and peak load

To quantify the emission effects of saving electricity consumption a measure of the fuel use and the associated emissions have to be combined with the consumption profiles and the corresponding savings profiles. We use the output from a Balmorel model of Denmark and surrounding areas to exemplify the emission content in electricity for a year that corresponds to around 2015. When calculating the effects of specific emissions, it is possible to use

the marginal fuel used for the hour or the average fuel use for every given hour. As the demand scenario is not aligned with the Balmorel solution, we do not compare a base-run emission result with one including the savings options. Therefore, it is not possible to verify if the savings change the actual marginal plant and marginal fuel use. Due to this uncertainty, we illustrate the emission savings based on the average fuel content for the hours of each seasons. Average fuel shares include some of the variation of the marginal fuel shares across the days as for example fluctuations in wind generation will influence the marginal fuel used in the same hour for different days. A relevant alternative would be to compare two solutions of Balmorel with and without the reduced electricity demand from the appliance categories. The four seasons are based on simulation for one particular week of each season. (*Figure 15*)

Figure 16 - Specific CO<sub>2</sub> emissions in DK generation per hour for the different seasons  
(Based on previous fig)

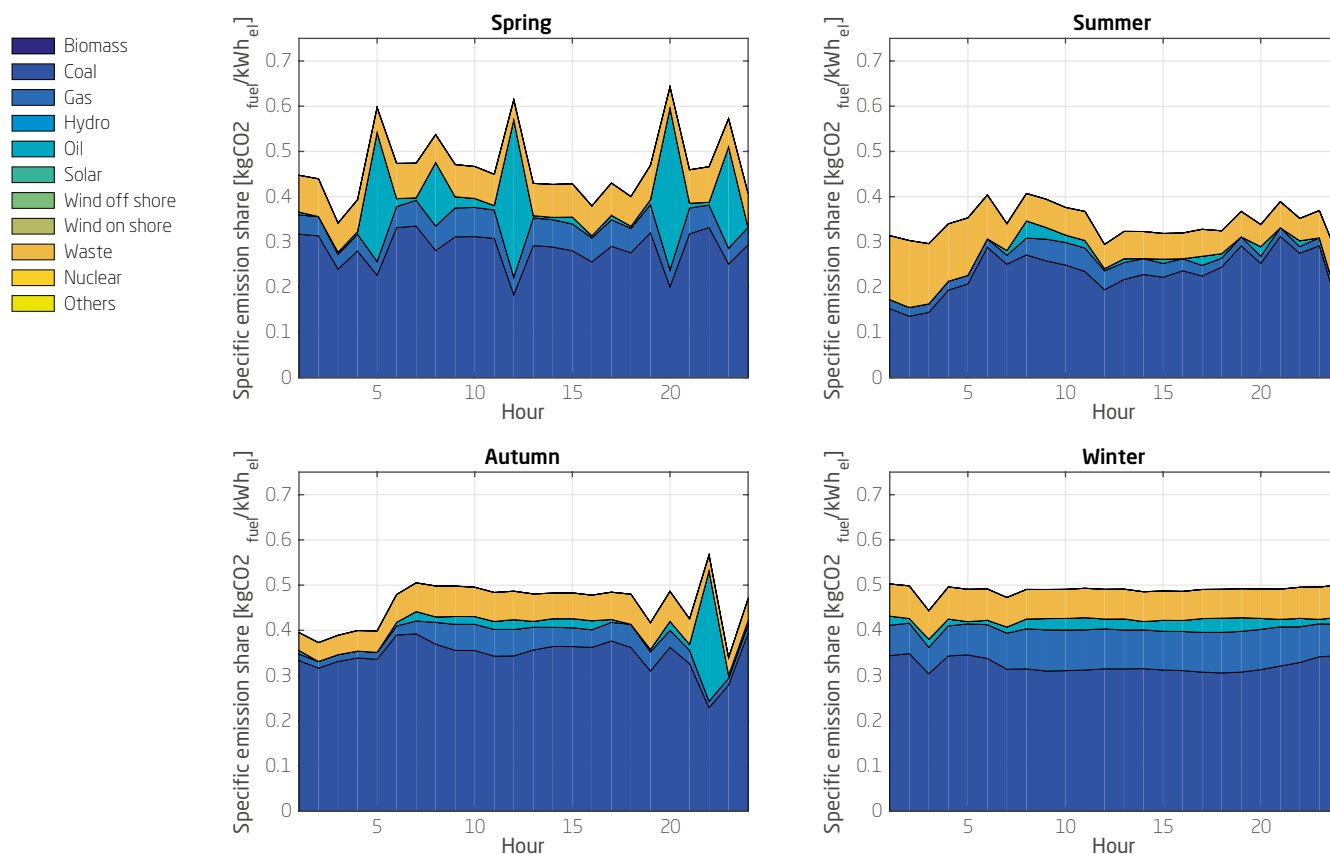

The four seasons examined show quite different properties with regard to variation in emissions throughout the day. (Figure 16) The spring season has the most variation, whereas the winter season is the most stable even though it is the season with the highest average emission per kWh. The summer season has the lowest average emission, hence, electricity savings matter the least during summer hours. Surprisingly, the winter season shows very stable emission levels and composition throughout the day. This season with its peak demand would have been expected to contain the largest variation in emissions. The winter season is also characterized by high wind generation and large variation in this from week to week. Thereby some weeks will show large hourly variation in fuel composition and emissions where other weeks with high wind generation will have much less variation in fuel use throughout the day. The spring and summer seasons seem to have the expected peak in emission content per kWh in

the peak load hours. Autumn season have as the only one a clear profile with higher emissions during day time and lower at night time. Spring and autumn only have slightly lower emissions during a few night hours. The main reasons being that 1) coal as the main contributor to emissions runs throughout the night and 2) the extent of natural gas and oil-based generation during day-time which increases fossil fuel shares in generation is very limited.

The emission distribution across the hours of the days mainly illustrate the large variation in household electricity demand throughout the day. The variation in specific emissions does not have a big impact. For winter season, Figure 17 shows that the largest absolute savings are during day time and especially at peak hours. The left panel shows absolute emissions related to total electricity consumption for one household for each hour of the day. The right panel illustrates the accumulated emissions for the

Figure 17 - Emission effect of savings in lighting and cold appliances in Denmark, winter season.

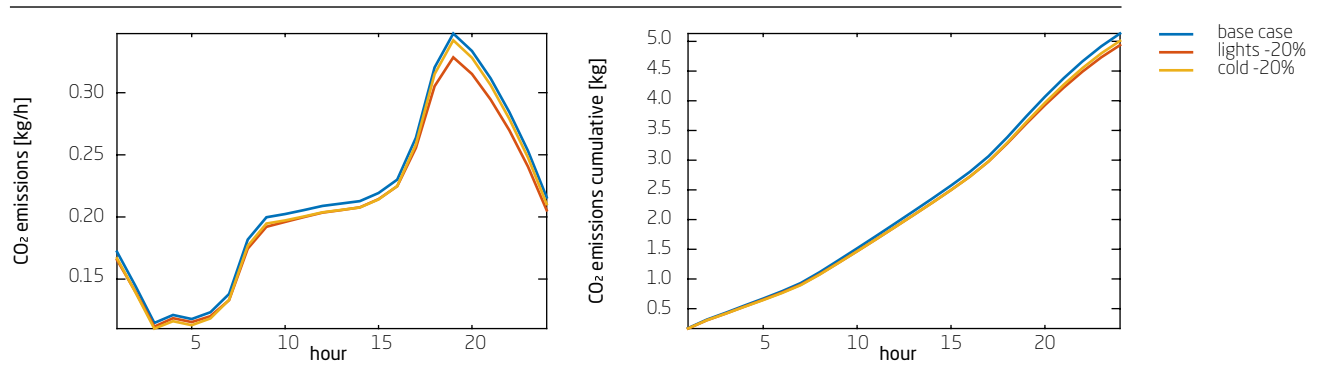

Figure 18 - Emission effect of savings in lighting and cold appliances in Denmark, summer season.

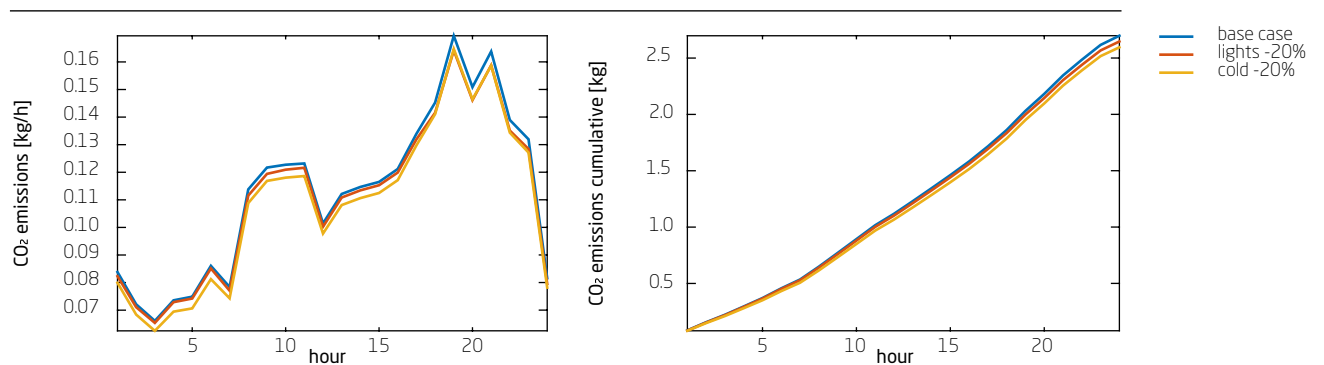

Figure 19 - Emission effect of savings in lighting and cold appliances in Denmark, spring.

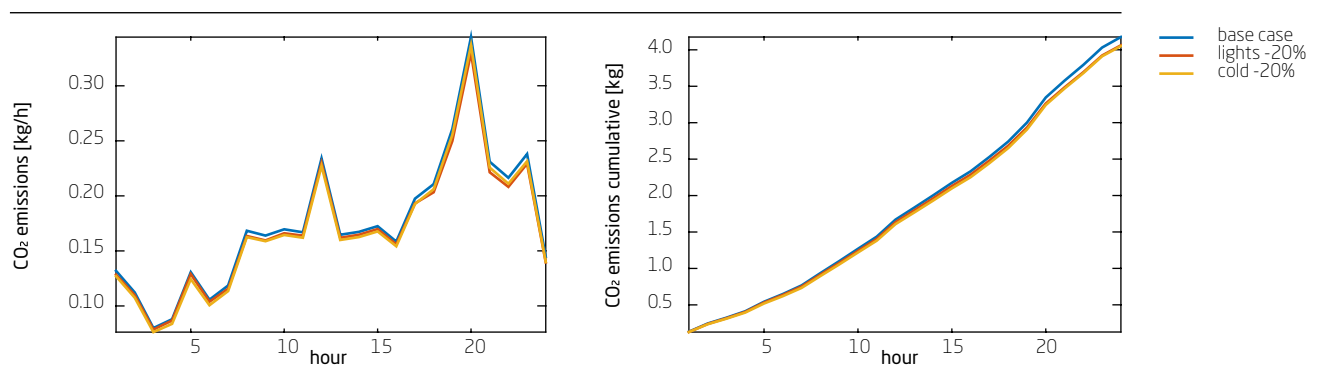
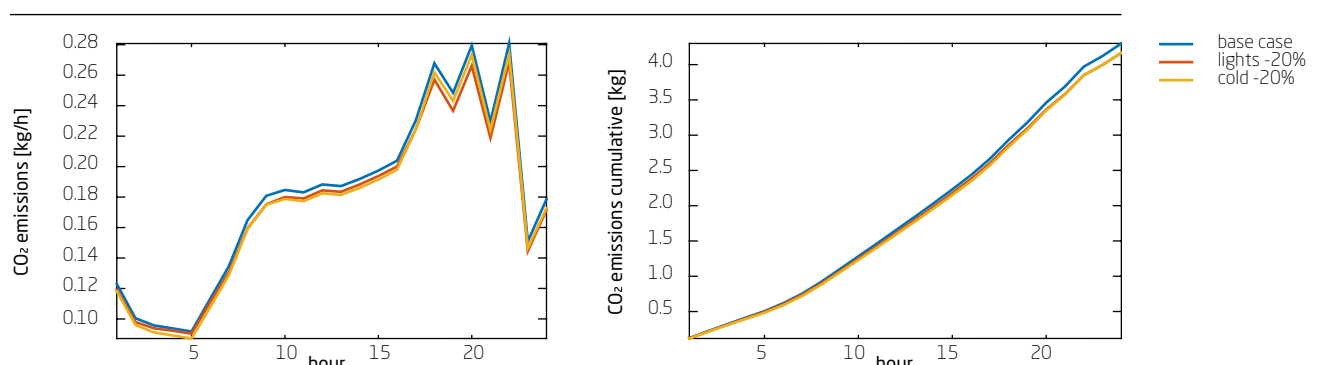

Figure 20 - Emission effect of savings in lighting and cold appliances in Denmark, autumn.



**Table 4** - Summary of the seasonal electricity savings, emissions and possible effect on peak demand. (Own calculations).

Category and season	Total electricity savings in DK	Total electricity savings per household per year (assumption)	Emission savings per household kg CO <sub>2</sub>	Emission savings relative to household emissions %	Peak reduction per season (average weekly)
Lighting full year	260 GWh	100 kWh	45.2	3.04	
Cold appliances full year	260 GWh	100 kWh	44.2	2.97	
Lighting winter			17.8	3.97	approx. 300 MW
Cold appliances winter			11.3	2.47	approx. 100 MW
Lighting summer			4.7	1.93	
Cold appliances summer			9.4	3.97	

household over one day. The two savings options are illustrated by the yellow (cold appliances) and red (lighting) curves. These two curves illustrate total household electricity consumption reduced by the savings in just one of the appliance categories at a time. It can be observed that the lighting consumption contributes much more to reducing emissions during peak hours simply because there is a higher electricity consumption for lighting in these hours with limited daylight.

In the summer season, the opposite pattern for the two appliance categories compared to winter season show up. During night and also the morning, absolute savings in the cold appliances category are at their peak. Even for the evening peak, the savings in the lighting category are only at the same level as savings for cold appliances. (Figure 18)

The spring and autumn seasons have the same variation in demand during the day and night. However, the situation is more in between with regard to the lighting category. This is also seen from the right panel where accumulated emission over one day is reduced approximately the same (the two curves cannot be distinguished) for the two categories. (Figure 19)(Figure 20)

Table 4 reports the main results with regard to emission savings for the two appliance categories and for summer and winter season. Overall, the two saving options compared result in almost identical savings of emissions with lighting only marginally better than cold appliances. The differences are only observed for the seasons where lighting reduces

emissions almost 4% during winter (where emissions are highest) and cold appliances only 2.5%. In the summer season, this is reversed with cold appliances contributing 4% here. Lighting is, however, much more interesting than cold appliances when considering the likely impact on peak demand. Using a rough estimate, the contribution to reducing peak load in Denmark is almost 300 MW for lighting compared to only 100 MW for cold appliances. This is a very large difference in impact and should not be neglected even though the actual benefit is depending on many assumptions about how the rest of the power system and loads evolve. The actual figure is uncertain since this is based entirely on data for one particular week. Second, the actual peak for a full winter season will be influenced by endogenously determined power prices as dependent on the reduced demand from the household appliance category and this is not considered in the analysis here. Other electricity savings in households and changes in composition of demand from various consumer segments may change this effect on the peak. Changes in the supply side both from the stochastic elements from wind and solar and particularly the interconnection capacity does also influence the value of reducing the peak load. With more than sufficient interconnection capacity and access to outside capacity in the peak hours, this value is not that high, but if regulatory restrictions (obligations) enforce capacity requirements, then the effect on peak load is associated with a high value.

Summer savings contribute much less to the total emissions savings than winter savings. Summer contribution for lighting is only 10.4% compared to a

savings contribution in the winter season of 39.4% of the annual savings for lighting.

## Conclusions

Demand-side management in households does not provide much short-term flexibility, but an efficiency increase of electric appliances can still help ensure extensive fossil fuel savings in Denmark and even peak capacity savings. However, the categories of appliances contribute very differently to these elements, and it is therefore important to construct the load profiles for the different categories of household consumption in Denmark. This work made an important contribution to this end by matching several panel data studies with appliances to the profile of overall household consumption for all of the hourly profiles for all weeks of the year.

It is evident from *Figure 14* that the load profile of households in Denmark is influenced very differently by the respective appliance categories. Some of the categories have a stable profile whereas e.g. lighting, dishwasher, TV has a large fraction of the consumption in peak hours (household peak).

The value of demand reduction is highest for the peak hours and the value of improving appliance efficiency is the highest for those categories that have the largest fraction of consumption in these hours.

When combining with fuel use and emission based on a Balmorel simulation, the effect on emissions is compared for lighting and cold appliances. A similar electricity saving of 260 GWh in both categories produce almost the same annual savings in emissions (around 3% of emissions attributable to household electricity demand). This is, however, on a very different seasonal background. Savings are highest for lighting in winter (4% compared to 2.5%) where the largest fraction of emissions are and particularly it is both the hour of the day and the season where the annual peak load in the system is. Lighting contributes approximately 300 MW to peak load reduction whereas the contribution from cold appliances is only 100 MW. Therefore based on these findings it is suggested that lighting, dishwasher; TV appliances

etc. are categories where annual efficiency increases should be supported (incentivised) more than for other categories with more stable load pattern (for example, freezers).

There does not seem to be a big difference between the electricity savings impact on fossil fuel from the two categories of savings. This is partly due to the power system composition and associated fuel use (present system) on which the Balmorel analysis was based. We are calculating the effects based on average emission per hour, including generation from non-fossil resources. Marginal emissions per hour can be expected to have a higher emission content as it will rarely be wind and PV that will be the marginal generation. In a future system with less coal CHP capacity in Denmark, this may change in a way where emissions content are much higher in peak hours and during winter time, due to more gas based generation in peak hours and little fossil fuel use outside peak hours. In our results, the peak load hours have only slightly higher fossil fuel content and it is mainly observed in autumn and summer seasons. In a future scenario, there will probably be a larger difference between the two categories, with winter and daytime savings having a much higher impact on emissions (lighting) than savings distributed more evenly across hours and seasons (cold appliances).

An energy policy with a fossil fuel reduction objective should thus focus more on reducing consumption from these appliance categories than from others given that the (support) costs per annual reduction unit is similar. Combining the fossil fuel reduction objective and the value from power capacity reduction the policy conclusion is thus:

*Public support for electricity savings (e.g. saving obligations) should be considered differentiated across different load categories (e.g., household appliances)*

Further work could integrate the reduced total load profile with a power systems model to determine the hour by hour fossil fuel reduction from savings (efficiency increase) for specific appliance categories in future policy scenarios involving more savings options at the same time.

## Chapter 8

# Resilient integrated energy infrastructures

By **Michael Havbro Faber**, Global Decision Support Initiative (GDSI)  
at DTU Management Engineering

### Introduction

Whether addressed at global or local scale and whether focus is directed on developing or developed societies, inadequately performing energy infrastructures may impose severe economic losses to society, lessen economic growth, and even impair sustainable developments, see e.g. [8.1]. The challenges are tremendous; despite generally improved knowledge, technology, and organizational capacity with respect to the design and operation of energy infrastructure systems, events of natural hazards, technical failures, and malevolence repeatedly lead to devastating consequences in terms of economic losses, human safety and health problems as well as damage to the quality of the environment. In developing countries, it is often seen that poor performance of energy infrastructures may be attributed to inappropriately high vulnerabilities of the systems and their constituents in combination with frequent and violent events of natural hazards. In more developed countries where infrastructure systems generally are increasing in complexity, both technically and organizationally, failures of energy infrastructure systems and associated losses are more often related to insufficient robustness, cascading event scenarios, and indirect consequences.

Continued economic growth and ultimately sustainable societal developments pose significant challenges for next-generation energy infrastructures. Climate change, increasing population, and growing demands in combination with the global societal need for more efficient, diverse, and distributed energy production add new challenges for the design and operation of energy infrastructures – the answer to which is presently considered to be resilient integrated infrastructures.

The following initially gives a brief outline of experiences and insights on the past performance of energy infrastructure systems and based on this, the necessity of an integrated resilience-oriented perspective to governance is highlighted. As this in turn will require the availability of consistent representations of the performance of energy infrastructures, an overview account is provided on the state of knowledge in this regard. Finally, observations are made with respect to known and unknown challenges, and suggestions for future efforts are provided in the conclusions.

### Experience - need for integrated resilient energy infrastructures

Considering the experiences from past events, the consequences associated with energy infrastructure failures are realized to have the potential to severely affect all dimensions of what is understood to be of importance for sustainable developments, namely the economic dimension, the social dimension, and the environmental dimension – over extended periods of time.

From past events, some of the major challenges associated with the performance of energy infrastructure systems may be identified. This is surely very useful, but of course it should be remembered that the challenges of the future in many ways are yet to be understood, [8.3]. Historical events reveal that severe energy infrastructure system failures may originate from relatively small, isolated, and distant events as well as from large impact, broad scale and close events.

Examples of the first type of events are the Italian blackout event [8.4] and the USA Northeast



blackout event, both occurring in 2003, ([8.5] U.S.-Canada Power System Outage Task Force Draft Report, (2006)) and both each affecting around 55 million people.

The cause of the Italian blackout was subsequently identified as the event of a transmission line in Switzerland which due to high loading began to sag and got in contact with trees, [8.6] leading to a transmission line trip, cascading further into an all, but total loss of electrical power supply in Italy for around 12 hours. The USA Northeast blackout was reportedly caused by the same phenomenon in combination with software bug, allowing for a local transmission line overload event to cascade into a global scale system failure event, severely affecting power supply in Ontario and eight states for up to two days [8.5].

Examples of the second type of events include the energy infrastructure failures caused by hurricane Sandy in 2012 and the Fukushima earthquake-related tsunamis in 2011. In both cases, very intense and large-scale natural hazard events severely damaged energy infrastructures over a large area, leading to a wide spread loss of power supply over extended periods of time and devastating consequences to society. Estimates of the economic consequences associated with power outages caused by the Sandy event range between \$30 and \$50 billion, [8.7]. The consequences of the Fukushima event are estimated to \$340 billion, see e.g. [8.8].

From these experiences, some insights may be collected. First of all the significant spatial distribution of energy infrastructure systems which is one of their typical characteristics significantly adds to both the likelihood that damage or failure may occur localized and at large scale and also to the evolution of consequences over space in the event of damage and failures. Hence, the spatial distribution of energy infrastructure systems and the dependencies between events of damage, failure and consequences are of crucial importance for the performance of energy infrastructure systems. In addition, the interconnectiveness of energy infrastructure systems with other systems, such as monitoring and control systems significantly add to the likelihood of localized failure events propagating from one system to the other in a highly dependent manner and further leading to total system functionality loss [8.9]. Moreover, from

the past events it is also clear that the consequences associated with major failures of energy infrastructure systems are tremendous. Not only do such failures pose major economic losses, but they also result in loss of lives, compromise wellbeing and health, damage livelihoods, and cause widespread damage to the environment. Energy infrastructure failures clearly have the potential to severely affect all dimensions of what is understood to be of importance for sustainable developments, namely the economic dimension, the social dimension, and environmental dimension – over significant geographical areas and periods of time.

In recent years, attention has been brought to the potential benefits of a far more integrated and holistic approach to energy infrastructure in terms of sustainability, meeting the challenges of climate change and also in the general pursuit of improving societal resilience, see e.g. ([8.10] and [8.11]), and as such integration of energy infrastructures is highlighted as a part of the strategy for the Europe to meet the challenges of the future, see e.g. [8.12]. Integration in governance, planning, maintenance and renewal, however, comprises a tremendous challenge – not least with respect to the understanding and the representation of the performance of the energy infrastructure systems. In the following, an overview account of these aspects is therefore provided.

### On the characterization and modelling of energy infrastructure systems

Energy infrastructures may be characterized as systems providing and transporting energy from source to demand. Energy provisions, such as fossil, nuclear, and renewable energies are very diverse with respect to their individual characteristics and this concerns not least the manner in which they, like the energy demands, exhibit variability over time. As underlined in the foregoing, energy infrastructure systems are typically widely geographically distributed and typically comprised by large numbers of hierarchically organized and interconnected subsystems and constituents, see *Figure 21*.

The systems are often managed by utilization of combinations of passive, automated, and active control systems maintained and operated by several different



organizations. Through this characterization and supported by experiences from past failures, it is clear that the performances of energy infrastructure systems are critically dependent, in a rather complex and dynamic manner, on the joint effect of all possible external and internal events – exposures – which have the potential to lead to damage and failures of their constituents, over time and space. With reference to *Figure 22*, external events include damage and failures caused by, e.g., natural hazards, technical failures, malevolence, and human and organizational errors. Internal events include overloading, deterioration, and operational and organizational errors. Depending on the vulnerability of the subsystems and constituents, exposure events lead to damages and failures that in turn produce direct consequences and, moreover, have the potential to generate cascading failure scenarios of the subsystems and constituents of the system, thereby causing loss of functionality and associated indirect consequences, see e.g. [8.17].

In *Figure 22*, it is also illustrated which principal types of decisions might be taken to manage the potential losses associated with the performance of energy infrastructure systems.

The many factors which are affecting the performances of energy infrastructures are in general associated with uncertainties, some of which are very substantial. The performances of energy infrastructure systems are also uncertain. Their realistic and

**Figure 21** - Illustration of how a system can be seen to comprise a hierarchical interdependence between sub-system each comprised by constituents – which themselves may be represented as (sub-) systems.

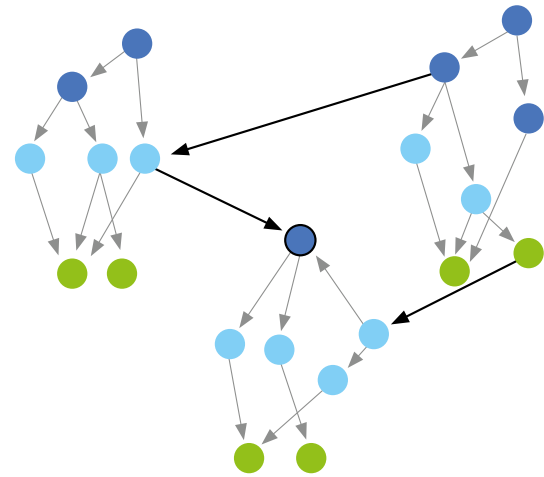

consistent modelling and analyses thus necessitate the use of probabilistic concepts. This fact coupled with the substantial challenges associated even with the deterministic modelling and analysis of complex energy infrastructure performance renders modelling of the performance of energy infrastructure very demanding both in conceptual and technical terms.

In addition to the complexity associated with the characterization of the performance of the energy

**Figure 22** - Illustration of how the performance of energy infrastructure systems and the different decision options with respect to their management may be related to characteristics of the systems in terms of robustness and resilience.

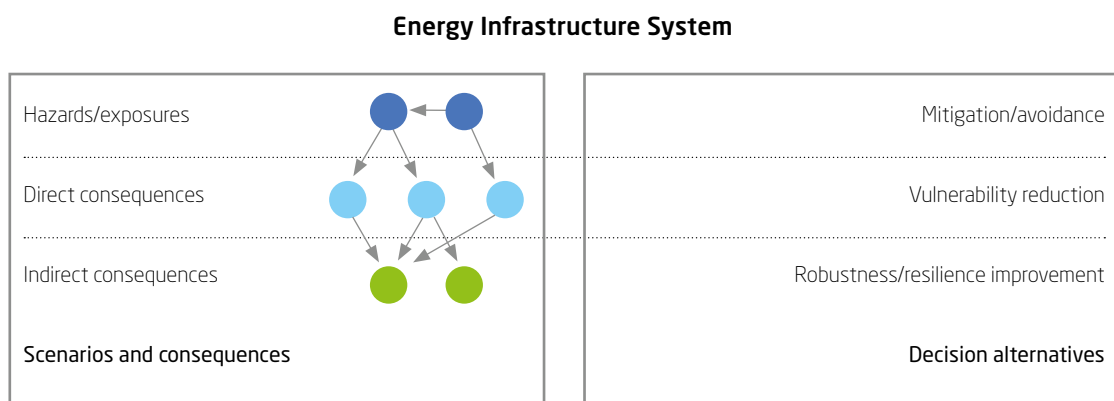

infrastructure systems themselves comes their interactions with other societal systems and the consequences they generate as a result of these interactions in case of inadequate performance; the indirect consequences, see also [8.13]. In fact, the indirect consequences which may arise from failures of energy infrastructure systems are generally substantially in excess of the direct consequences, i.e. the consequences associated with the physical damage and failures of the infrastructures in isolation. Typical indirect consequences count disruptions and failures of transport systems, communication systems, security systems, water distribution and waste treatment systems, hospital functionality, etc. These failures in turn, individually and in combination, may cause severe economic losses, loss of lives and damage to the qualities of the environment.

As the performances of energy infrastructure systems are best described in probabilistic terms, the consequences associated with inadequate performance and failures are best described in terms of risk, i.e. the expected value of consequences where the expectation is taken with respect to all relevant uncertainties.

Finally, the total risk associated with inadequate performance or failure of energy infrastructure systems depends not only on the set of external and internal events that may cause damage and failures, or the vulnerability of the system constituents with respect to these events, but moreover and to a very large

degree on the preparedness and capacity of society and the environment to respond, limit indirect consequences, recover and reinstall functionalities, see also *Figure 23*.

These factors in conjunction are decisive for the development of consequences over time, and their joint effect on risk is associated with the terms robustness and resilience. Robustness is the ability of a system to limit consequences to direct losses and thereby avoid functionality-related indirect consequences (JCSS (2008)). Resilience is the ability of a system to recover to its initial state after a disturbance ([8.14], [8.15] and [8.16], see also *Figure 24*.

In *Figure 24*, it is illustrated how an exposure event acting on an energy infrastructure system may cause losses from the point in time of its occurrence and onwards with a distinct profile which varies over time. The drop in system benefit after the disturbance is fundamentally caused by the cost equivalents of two components, namely 1) the immediate damage implied by the disturbance and 2) the loss of service provided by the system.

As indicated in *Figure 24*, the phase following the disturbance and the immediate losses can be understood as a system reorganization phase in which the necessary resources for the rehabilitation of the systems are mobilized. The duration of this phase, and thereby also the associated indirect consequences depend on the ‘capacity’ of the system, in terms of

**Figure 23** - Illustration of the how the loss potential for energy infrastructure systems may be managed by means of barriers.

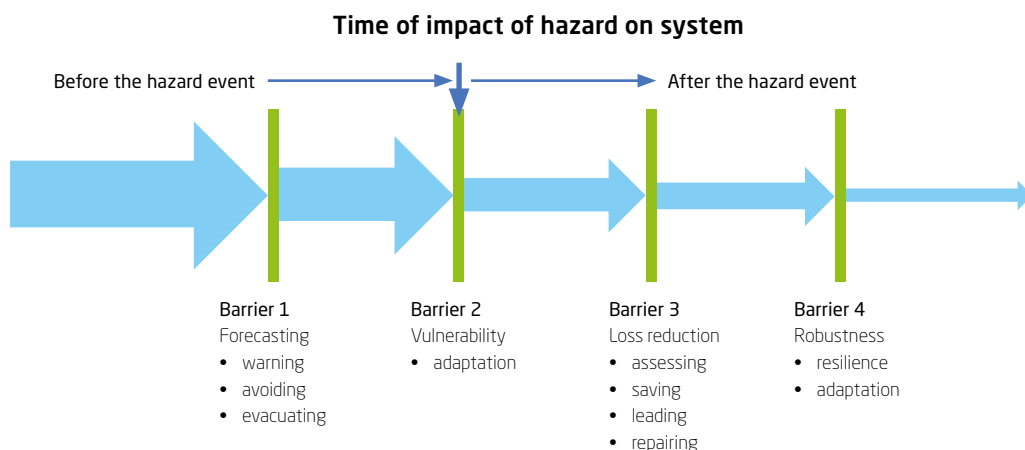

financial, organizational, and operational resources. The capacity of the system is furthermore decisive for the degree to which and how fast the performance of the system can be rehabilitated. Here, it should be highlighted that ‘capacity’ for reorganization and rehabilitation depends on the boundaries of the considered system.

If the system is rehabilitated to original state (performance) within a specified time horizon – i.e. original level of performance – the system may be considered resilient, see *Figure 24*. If on the other hand the original system performance is not reached at the specified time the system is non-resilient. Most importantly, it should be realized that the re-organization phase holds potential for introduction of new technology and new procedures instead of those that are lost in the disturbance. Clearly, such an approach to rehabilitation may be associated with higher immediate rehabilitation costs, but it can also lead to increased performance and overall reduced service life risks. In such cases, the system is super-resilient, see *Figure 24*. One potential of this insight for the life-cycle management of energy infrastructure systems is to assess whether strategically planned renewals may lead to a continuously optimized management of systems performance and also be utilized as a leverage to benefit from the performance gains which are observed in the events of unplanned and random renewals.

Despite the very substantial efforts that have been put into the understanding, modelling, and analysis of energy infrastructure systems over the last decades, this field of research is still relatively young and charged with challenges. In addition to the general challenge of keeping track of the interconnectivity within, between, and beyond energy infrastructure systems, the consistent modelling of knowledge – and uncertainty associated with their performance for the purpose of risk- and sustainability-informed decision-making with respect to their life-cycle management – comprises a challenging task, but at the same time also holds significant potential for contributing to sustainable societal developments.

### Emerging known and unknown challenges for energy infrastructure systems

Looking ahead for improved management of the performance of energy infrastructure systems, general experience of risk management clearly highlights two potentials: 1) based on past experience and understanding – our present knowledge basis – to identify the main loss contributors and find or improve means for their efficient management, and 2) with a view to ongoing relevant societal trends to assess which parts of our knowledge basis, in terms of assumptions, may be changed in the future

Figure 24 - Illustration of the variability of losses associated with systems performing non-resilient, resilient and anti-fragile/super-resilient, (Faber (2015)).

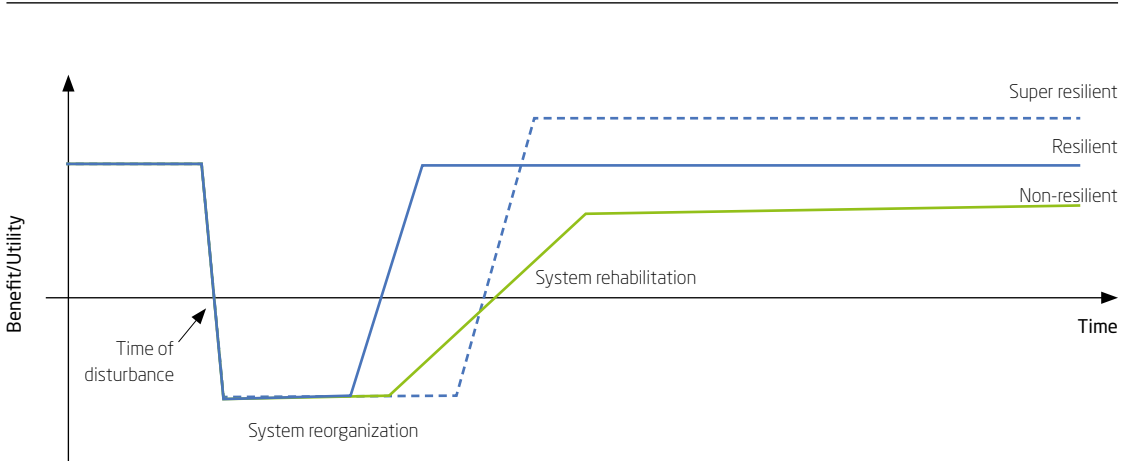

to such a degree that present strategies need to be reassessed. With respect to 1), as highlighted in the forgoing, major potentials for improvements in the management of energy infrastructure systems are associated with advances in ability and capacity for system inventory management, modelling, and analysis; keeping track of existing and new developments of energy infrastructure systems, the threats to which these are exposed, and the many-fold interdependencies affecting their performances and associated consequences. Utilizing improved knowledge in this regard will provide ample basis for reducing vulnerability, increasing robustness and improving resilience. With respect to 2), there are a number of known unknowns and surely also some unknown unknowns that significantly will affect the performance of energy infrastructures in the future. Considering first the known unknowns, major issues to be envisaged include increased interconnectivity within and between systems both inside and beyond national borders, increased exposures to natural hazards caused by land use pressures in the face of growing populations, introduction of new energy sources and the effects of their integration with traditional fossil based energies, continued and possible increased exposure to malevolence and political instability, technological developments in general and a broader utilization of advanced IT based solutions to monitoring and control of systems in particular and of course a range of possibly adverse consequences of climate change. All these items – and more – must in principle be accounted for in the life-cycle management of energy infrastructure system. Since the associated effects of the various different issues are yet unknown and some of them are associated with a very high degree of uncertainty, it is important that decisions made at present on the one side are as robust as possible with respect to assumptions and uncertain future developments and that future options for adaptation are included such as to facilitate a running adjustment and optimization of life-cycle management strategies in dependence of societal developments. With respect to the more challenging unknown unknowns – in the nature of the problem – little can be assumed with respect to

what could cause damage and failure. However, what can be done is to assume various degrees of damage and failures and develop strategies on how to deal with these should they occur.

## Conclusions

Energy infrastructures play a vital role for society. They are essentially everywhere and we depend critically on their reliable performance. At present, energy infrastructures are interconnected in rather complex manners and also connected to other critical infrastructure systems. The trend is that the complexity of energy infrastructures and their interrelations with other critical societal infrastructures will only increase in the years to come. At the same time, with growing populations and evolving climate changes, the exposure of energy infrastructures to hazards is increasing and the need to ensure adequate management of energy infrastructure performance-related risks has become a crucial factor for sustainable societal developments.

Systems modelling and analysis techniques accounting for relevant uncertainties and consequences are under development, which does provide decision support with respect to risk management for energy infrastructure systems. However, there is still a long way to go before they can forecast the performances of these systems consistently. This situation – coupled with the fact that even to keep an updated inventory of all relevant energy infrastructure and their interconnections with other societally critical infrastructure systems comprises a very substantial organizational task – underlines the dimension of the challenges associated with energy infrastructure risk management. To achieve and maintain energy infrastructure systems with adequate performances necessitates much more and strongly focused research on systems modelling and analysis, but also – and maybe even more so a strong capacity for governance and coordination within and between nation states.

## Chapter 9

# Trends in energy supply integration

## Solar PV

*Hanne Lauritzen, DTU Energy*

Solar PV integrated in the energy system ranges in size from small, roof-top- or building-integrated systems with a capacity of 1-10 kWp for residential buildings and several tens of kWp for commercial buildings (*Figure 25*) to utility-scaled installations with capacities slightly above 500 MWp. Off-grid systems account for only for about 10% of the installations. A grid-connected solar PV system comprises the solar panels and balance-of-system components, i.e. what is needed for installation and connecting to the grid (inverter, cables, connectors, etc.) and possibly also a battery bank. PV is an intermittent source of energy that cannot be dispatched to meet the electricity grid's demand. This presents challenges for its integration.

The power output of a given solar PV installation is proportional to the intensity of the sunlight striking the panel. This causes variability with respect to the time of day, the time of year, and the local weather, but the larger the number of systems and the area

considered, the smaller the variability if the power is generated by PV systems in the area. The large area covered by utility-scale plants cause some smoothing of the short-term variation [9.1], whereas smoothing occurs on longer timescales between separate installations [9.2]. Interconnections are thus beneficial, because they allow, to some extent, for smoothing of the variability over large areas. When integrating large amounts of PV power, however, this has to be accommodated by reserves that can change their output to match the changes in the solar resource; the regular daily – and seasonal variation, the partially predictable changes in cloud cover and the uncertainty regarding atmospheric haziness. The possibility of long periods with few solar resources – more frequent in winter – calls for adequate firm capacity. Reliable weather forecasting gives reasonably predictable generation that is increasing with the geographical scale of the forecasting area [9.3]. Unexpected episodes of fog can cause significant forecasting errors.

Due to its variability, solar PV is most adequately deployed as part of a balanced portfolio of renewables. In temperate countries, the match with wind power is ideal as wind tends to be stronger during winter

Figure 25 – Commercial roof-top installation from 2014.

The 2.1 MWp Danish installation covers 30,000 square meters, generates more than 2.1 mill. kWh/year and does not involve any subsidies or feed-in tariffs [9.5].

Photo: City 2



and hence compensate for low solar irradiance. In hot and wet countries, hydropower offers considerable resource in complement to solar PV, while in hot and arid countries a mix with solar thermal electricity with built-in thermal storage capacity is beneficial for alleviating the daily variation [9.4].

The variability can be alleviated by adjusting the tilt and orientation of the PV panels. This can maximize output at certain times of day or year instead of maximising the annual output, and depends on adequate price signals. Systems with fixed-tilted panels with different orientations are an option for more regular output throughout the day and also for increased deployment in buildings. Such installations with ‘non-optimal’ orientation of the individual panels have become more feasible with the reduced panel costs seen over the last years.

Load management, including electricity efficiency improvements and load shifting, offers affordable options for integrating the variable PV output. This strategy has a great potential, but it is not infinite light will always be needed at night.

The predictable mid-day peak generated by distributed PV generation could, via load management and schemes stimulating self-consumption, be used to flatten the net load curve, i.e. the load curve minus the solar PV generation (*Figure 26*). PV integrated in buildings other than residential (office buildings, supermarkets, etc.) have a great

potential as their load curve shows a good match with the solar resources. The prospects for such self-consumption are generally higher in sunnier countries, where consumption is partly driven by air-cooling loads. Charging stations for electrical vehicles at work sites would be effective to increase midday charging and thereby help flattening the net load curve [9.5]. Experiments in South-East France have shown that a PV system installed over the parking space for one car could produce enough electricity to run a four-passenger car over 10,000 km per year [9.4].

Storage would be needed to shift more PV electricity to other consumption times. Unlike most other renewable technologies, the decentralized PV generation opens also for decentralized storage that can be used for alleviating the daily cycle. Decentralized battery storage is currently more expensive than relevant centralized storage, but may have a grid-stabilizing effect and a local economic value for the plant owner dependent on the schemes favouring self-consumption and battery cost. Load management and small storage could both increase self-consumptions by 10 percentage points [9.4]. It also makes inflow to the grid more predictable.

Solar PV is in its nature non-dispatchable as it will continue to deliver power as long as the solar irradiance is sufficient. For this reason, the solar inverters contain an automatic protection mechanism ensuring that the system cuts the connection to the grid

Figure 26 - The net load curve of a household with a rooftop PV system with and without self-consumption, [9.4]

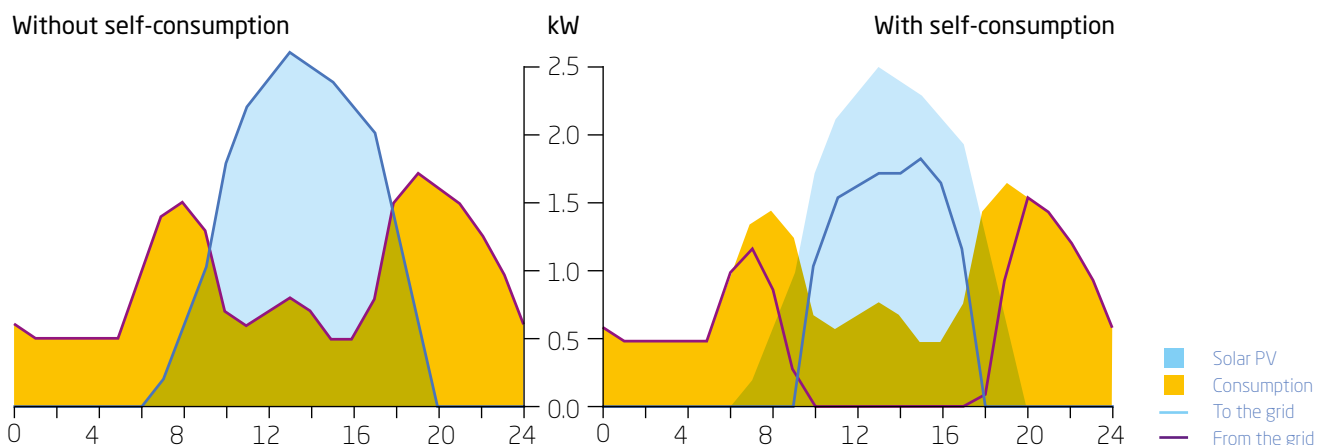



in case of power outage. This is done by setting the PV panel's output current to zero. Such islanding is an issue of operator safety, especially at utility scale, as the PV system is still powered. Alternatively, the power can be switched to a local circuit (intentional islanding) possibly equipped with decentralized battery storage. Incorporation of ICT in solar inverters will enable decentralized PV systems to support the grid to a larger extent than we see today.

The bottleneck for large-scale deployment of PV in urban areas will be the availability of roofs and façades exposed to the sun. The electricity generated will most likely be self-consumed or consumed in the immediate vicinity. In areas with low power demand and less dense population, the bottleneck for decentralized deployment will most likely be the distribution grid. An appropriate framework for self-consumption and curtailment should be considered before a grid strengthening that would only serve when peak production occurs and the demand is at its minimum.

### Conclusions and recommendations

High penetration of PV in the electricity supply while maintaining stable operation and high security of supply requires a holistic view of on the entire energy system and implementation of tools that helps flattening the net load curve on daily and season basis: interconnects, storage, demand-side management, flexible generation. High penetration requires moreover weather forecasting tools that turn the solar power into a variable, but reasonable predictable source. High penetration requires moreover reserves that can change their output to match the daily and seasonal variations in the solar resource, and the partial predictable changes in the local weather. Due to its variability solar PV is most adequately deployed as part of a balanced portfolio of renewables. In Europe, PV shows a strong seasonal match and an average weekly match with wind.

The short-term, local variability at consumer- and neighbourhood level is a factor of high concern for the network operation. This is presently addressed by schemes favouring self-consumption. The incentives for self-consumption should be maintained at a high level, and decentralized battery storage might play a role, in line with the foreseen drop in the cost of batteries. The evening demand peak is

presently not a concern in Europe [9.3], but will be as the penetration increases. This peak should be smoothed by economic incitements shifting the demand from evening to midday and production from midday to afternoon. Shifting production calls for time-of-delivery payments and/or limitation to instantaneous injection except at peak times.

The gap in competitiveness between PV-generated and conventionally generated electricity is closing quickly [9.3], and PV-generated electricity might perfectly well become the cheapest power available, but only for a few hours around noon. Research and development should therefore be directed towards optimum use of this power for the benefit of the society, the energy system, and the consumer.

## Solar thermal

*Simon Furbo, DTU Civil Engineering*

Solar thermal systems used to cover a small or large part of society's heat demands can be centralized or decentralized systems. Most solar radiation is available in periods with low heat demands, and periods with high heat demands are typically not sunny. Therefore, solar thermal systems are often equipped with a heat storage which can store heat from sunny periods to less sunny periods. For centralized solar heating systems, the heat storage can be large while the heat storage volume for decentralized solar heating systems often is relatively small.

The heat storages cannot only be used by the solar heating systems, but also by other energy systems. In this way a solar heating system combined with another energy system can fully cover our heat demand and at the same time secure a good interplay between the solar heating system and the other renewable energy system/the energy system.

### Centralized solar heating systems

Centralized solar heating systems can be solar heating plants connected to district heating systems. These systems can consist of a solar collector field situated on the ground and a heat storage. *Figure 27* shows a schematic sketch of a solar heating plant without heat storage connected to a district heating system.



Solar heating plants can cover a small or a large part of the yearly heat demand of a town, depending on the size of the solar collector field and of the size of the heat storage.

The solar collectors can either be flat plate collectors, evacuated tubular solar collectors or concentrating tracking solar collectors.

The heat storage can be hot water tank(s), a water pit with water as heat storage material, or a borehole heat storage with earth as the heat storage material. In periods where the solar collectors produce more heat than required in the district heating system the excess heat can charge the heat storage. Solar energy can fully cover the heat demand of the district heating system as long as the solar heat content of the heat storage is high enough. In periods where solar energy cannot completely cover the heat demand heat can be supplied by other renewables. For instance, biomass boilers or heat pumps can be used. The heat storage can be used by other energy systems than the solar heating plant. The heat pump can, for instance, cool down the heat storage and supply heat to the district heating system at the same time with a relatively high COP. Due to the decreased temperature level in the heat storage, the thermal performance of the solar collectors is increased in the recharge periods.

Denmark is the frontrunner on solar heating plants, first of all due to the excellent integration of the plants into the Danish energy system, [9.7]. Figure 28 shows the largest solar heating plant in the World.

Besides the abovementioned advantages related to the heat storage, the main reasons related to the successful integration of solar heating plants in Denmark are:

- An ambitious Danish energy plan. By 2030 no fossil fuels must be used for heat, by 2035 no fossil fuels must be used for heat and electricity, and by 2050 no fossil fuels must be used.
- High share of wind energy for electricity production. In the first 6 months of 2015, 43% of the Danish energy consumption was produced by wind turbines. By 2020, 50% of the Danish electricity consumption must be produced by wind turbines. In windy periods, it will not be economically attractive for many combined heat and power plants to be in operation due to low electricity prices. Heat is, however, required and solar heating plants can produce the heat and in this way be integrated in the energy system in a good way.
- A lot of district heating. Today 64% of all Danish buildings are heated by district heating.
- Low temperature levels in district heating systems. A typical forward temperature to towns is about 80°C and a typical return temperature from towns is about 40°C.
- Decentralized energy supply system.

Figure 27 - Schematic sketch of a solar heating plant.

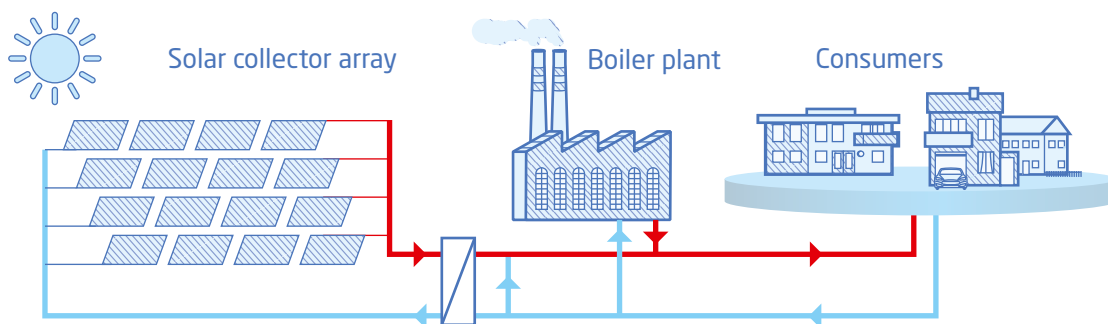

There are great opportunities for development of improved solar heating plants, both with regard to collector field designs and improved long-term heat storages. Also, there are great opportunities for making use of the technology around the World. (Figure 28)

### Decentralized solar heating systems

Decentralized solar heating systems can be used outside the district heating areas. In these systems, the solar collectors are placed on roofs and the heat storage of the solar heating system can also in future systems be used by a heat pump or by an electric heating element. A heat unit consisting of solar collectors, a heat storage and a heat pump and/or an electric heating element can supply a house with all the required heat. If possible, electricity is only used in periods where the solar collectors are not able to fully cover the heat demand and in periods with low electricity costs. Consequently, the controller will be based on detailed weather forecasts and electricity price prognoses. In this way, a good interplay between the solar heating systems and the energy system can be obtained. These solar heating systems can be attractive for homeowners and at the same time be integrated in an excellent way into our future energy system consisting of different renewables, [9.9].

There is a need to develop smart heat storages for these systems. The top of the smart heat storages will be heated by the electric heating element/heat pump, and the top which is heated in this way will be fitted to the expected future heat demand, [9.10]. It is recommended to start development of solar/electric heating systems for low energy houses and solar/heat pump systems for houses with high heat demands in order to secure that the potential of decentralized solar heating systems will be utilized in the future.

### Summary

Solar heating systems are equipped with heat stores. Since the heat stores can be used both by solar collectors and by other energy systems, solar heating systems can be integrated with future energy systems in an excellent way.

### Wind power

*Poul Sørensen and Asger Bech Abrahamsen,  
DTU Wind Energy*

The rapidly growing development of wind energy makes it a key technology in the transition to non-fossil energy systems. The share of wind energy

Figure 28 - Vojens solar heating plant with a solar collector area of 70,000 m<sup>2</sup>, the World's largest solar heating system with start of operation in June 2015 [9.8].



Photo: Vojens District Heating.

was 3% of the global electricity production in 2013, and according to Global Wind Energy Council scenarios, this share is expected to grow to 6-9% by 2020 [9.11]. At a national level, Denmark is a leading example with wind power providing 39% of the gross electricity consumption in Denmark in 2014 [9.12]. However, this high national penetration level is strongly supported by strong interconnections to a well-functioning Nordic power market with high shares of flexible hydropower. In this sense, the 19% wind power penetration in Ireland [9.13] which is weakly interconnected is equally remarkable.

This development of wind power has been followed by corresponding increasing requirements to grid connection of wind power plants. Those requirements ensure that the modern wind farms have become advanced wind power plants, which are not only capable of producing electricity, but also contribute to the control and stabilization of the power system by provision of ancillary services instead of or in competition with conventional resources [9.14]. Those grid connection requirements are primarily affecting the electrical design and control of the wind turbines and wind power plants, but some of the requirements also influence the mechanical structure [9.15].

Another factor in the development of wind power which is significantly affecting the integration is the offshore wind power development. According to outlooks for wind power development in Europe [9.16], the offshore deployment is at a very early stage, and is expected to increase rapidly towards and beyond 2030. The actual numbers in this early EWEA outlook are, of course, sensitive to policies, cost development, CO<sub>2</sub> prices, and many other uncertain parameters, but the recent actual development has confirmed the high growth rates. Although the present cost of offshore wind power is quite high compared to onshore wind power, the costs are expected to decrease significantly along with the increasing scale and consequential development of industrial experience, just like it has happened to onshore wind power and now also PV. Thus, significant cost reductions are already reported in Danish offshore projects [9.17].

Figure 29 shows a map with detailed scenario for offshore wind power development by 2030, which is aligned with the EWEA outlook. The map shows an

exceptional concentration of massive scales of wind power in relatively small areas, which will affect the wind power production patterns in terms of higher ramp rates [9.18] and forecast errors at large power system level, compared with the present onshore wind power. This is important for the integration of wind power, because the increased ramp rates and forecast errors increase the need for other power plants that can balance the wind power fluctuations.

There is also a significant trend towards larger wind turbines and wind power plants [9.20]. The increased wind turbine size calls for higher voltage levels in the power collection systems connecting the wind turbines in the wind power plant, especially for offshore wind power plants, because transformer stations offshore require costly offshore platforms [9.21].

Another trend in the wind power industry is towards a decreasing ratio between the rated power and the rotor area of large offshore wind turbines as shown in Figure 30. In other words, the trend for new large wind turbines is towards larger rotors for a given rated power corresponding to a given grid capacity. This trend was originally introduced for wind turbines in low wind areas, because the design of the wind turbine to the full power was not justified by the low probability for high wind speeds in such areas. Today, however, the low power-to-area ratio is widely used on high-wind offshore sites, where this

Figure 29 - Offshore wind farms scenarios

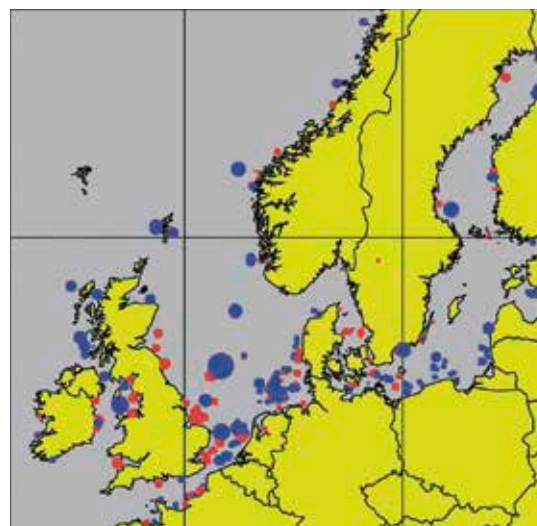

41 GW in 2020 (red)  
and 107 GW in 2030  
(blue) as used in the  
TWENTIES studies  
[9.19].

type of wind turbines uses the costly infrastructure better. From a power system integration point of view, the low power-to-area ratios lead to higher capacity factors, i.e. better utilization of the grid infrastructure, but another effect is that the wind turbine power curve becomes steeper for lower wind speeds, which means that the power ramp rates and uncertainties increase.

Finally, the trend towards building offshore wind power plants further away from the shore has an influence on the need for transmission technology. Today, the first HVDC connected offshore wind power plants are already built in Germany, and more are expected. The use of HVDC technology has an effect on the grid integration, which is reflected in the different grid connection requirements compared to AC connected wind power plants.

### Conclusions and recommendations

In conclusion, the successful development of wind power has been followed by corresponding increasing requirements to grid connection of wind power plants, which are not only capable of producing energy to the electricity consumers, but also contribute to the control and stabilization of the power system. The trend in the wind power development towards larger units and higher share of offshore deployment with increasing distances to shore is also affecting the

wind power integration, both in terms of transmission network (HVDC and higher voltage levels) and in terms of increased variability. As for other variable renewable energy sources, the increasing variability calls for more flexible power systems which will be analysed in other parts of this report.

### Thermal and biological conversion of biomass and waste

*Ulrik Birk Henriksen, Jesper Ahrenfeldt, Hanne Østergård, Rasmus Gadsbøll, Maria Puig Arnavat, Anne Juul Damø, DTU Chemical Engineering*

### Biomass pelletization and combustion

Biomass as an energy source presents some disadvantages like scattered distribution, irregular in shape, low bulk and energy density, high moisture content and thus potential for degradation during storage and transport. This contributes to a complex supply chain and high transportation, storage and handling costs. Biomass pelletization is a densification process that produces a solid energy carrier with homogenous quality and geometry, low moisture content, high energy content, and improved storage and transport properties. These properties, together with the increasing pressure on power plant owners to change

Figure 30 - The rated power per rotor area of the top 10 largest turbines in 2014 as function of the rotor diameter D [9.20].

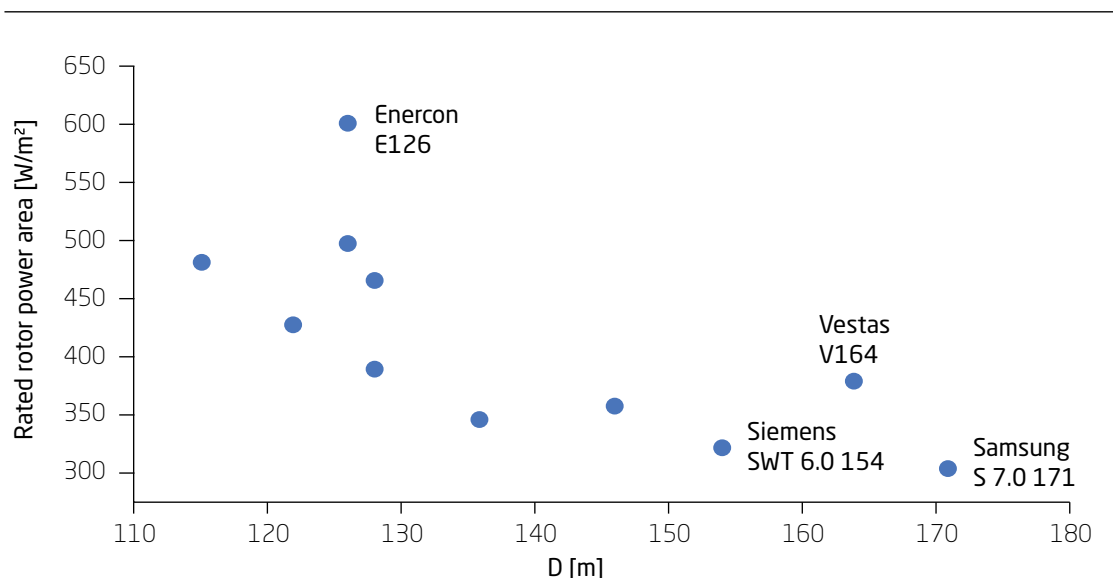



from coal to biomass fuels have led to an increase in demand and a rapid expansion of the wood pellet industry that will continue in the following years.

Most of the raw materials processed by pellet production plants in Europe are sawdust and shavings coming from sawmill and wood processing industries [9.23]. Considering the increasing demand and to avoid dependency on imported pellets, investigation on alternative raw materials and techniques for pelletization are required and will be an important research field in the area.

### Heat, power, and fuel synthesis production via gasification

Biomass gasification has proved to be highly efficient for heat, power, cooling and/or fuel synthesis production. Gasification plants have thus been able to reach high electric and total efficiencies, ranging from 25–35% and 80–90% even at small scale <10 MWth respectively [9.24]. Developments with fuel cell technology have shown plant electric efficiencies up to 58%, when coupled with gasification [9.25].

As a multi-purpose energy carrier, gasification plants have the ability to operate in co-, tri- or poly- generation production; producing heat, power, fuels and/or chemical simultaneously (e.g. [9.26], [9.27], [9.28], [9.29]). While gasification can produce a broad variety of fuels (e.g. DME, methanol, ethanol, Fischer-Tropsch), the production of methane or bio-SNG from biomass is currently the best business case. Bio-SNG can be produced by upgrading product gas from biomass gasification at high efficiencies >65% [9.30] and it is moving very quickly towards commercialization. Biomass can thus renewably substitute natural gas directly in the infrastructure without any changes in quality. Many big projects are ongoing and commercialized internationally, e.g. Gaya Project in France [9.31] and E.ON Bio2G Project [9.32] and GoBiGas in Sweden [9.30].

### Biogas produced from anaerobic digestion

Through Anaerobic Digestion (AD) it is possible to convert the broadest spectrum of societal waste into a methane rich biogas [9.33]. Most of the organic fraction of incoming waste streams from traditional agriculture and industry can be used for biogas production, making this an attractive practice to integrate into the different energy production systems.

Treatment of waste water is among the many possibilities. While converting the organic content of the waste through AD, there is also the possibility of retaining many valuable compounds in the nutrient-rich digestate, which could further be applied as fertilizer to the soil [9.34].

Both structural and scientific accomplishments are needed in order to make biogas more economically attractive and implementing its potentials in relation to combining with other energy technologies such as gasification and biorefining. The recent achievements of integrating biogas production with other technologies are evident in the fields of process and reactor design. Modern biogas reactors are able to manage a wider range of substrates, thereby improving the versatility of anaerobic digesters and making the processes more economically interesting [9.35]. The production scale may vary depending on the purpose with the possibility of centralized as well as decentralized biogas plants.

Biogas production offers also an advantage in its use. Biogas may be distributed directly into a grid and used for different purposes such as cooking and heating. Biogas may also be upgraded for utilization as a transport fuel or in cogeneration (CHP), where electricity and heat are produced.

### Biomass gasification in a smart-grid context

The technical feasibility and potential of biomass-based poly-generation plants that incorporate storage of electricity from fluctuating sources is currently under research. Several configurations are suggested and the most significant one integrates a gasifier with solid oxide fuel cell (SOFC) technology. These cells have the ability to either convert gaseous fuels to electricity or convert electricity to oxygen and hydrogen by electrolysis (SOEC). During high wind and/or solar penetration, the excess of electricity can be used in the SOEC, that coupled with the gasifier can produce biofuels (e.g. bio-SNG) and thus store the electricity as chemical energy. During low wind and/or solar production, the gasifier can produce gas that can be utilized in the SOFC for high-efficient electricity production. This solution provides a highly efficient path to store excess electricity, while also being able to increase its feasibility by producing electricity on demand. The concept is shown schematically on *Figure 31*.

### Biochar and ash utilization

The solid products from pyrolysis and gasification contain a fraction of solid carbon and ashes (combined called biochar). Utilization of ashes is an essential part of sustainable power generation, as nutrients must be recycled in order to maintain a sustainable production. Several investigations of biochar/bioashes show a great potential to increase crop growth and nutrient uptake [9.36], and hence substitute fossil fertilizers. Biochar contains several minerals for fertilization, but not perhaps the most significant one: nitrogen. Nitrogen fertilizer can, however, be synthesized from biomass gasification product gas, by using a catalyst downstream of the gasifier. This will require a high fraction of hydrogen in the gas that can either be originated from steam gasification or from electrolysis using wind power. Production of biochar also enables thermal systems to capture carbon stably in the soil and hence become carbon negative.

### Waste utilization

Incineration with recovery of the energy (incineration-based Waste-to-Energy, WtE), is an important part of the treatment of municipal solid waste (MSW). What is left, after suitable source separation, collection, and reuse of the MSW, is often incinerated.

By burning the non-recyclable portion of the total amount of waste, we can produce very large amounts of energy in the form of electricity and

heat, that are both climate- and environmentally friendly, and furthermore competitive with the production of all other forms of energy. In addition, disposal and utilization of this residual waste at the same time will reduce the environmental impact and the potential risk of contamination and many forms of harmful emissions, as the treatment significantly reduces the mass, volume and chemical reactivity of the rest waste. Furthermore, not only can energy be recovered, but also valuable materials in the incineration residues, such as scrap metals in the bottom ash.

In the past century, Denmark has been one of the frontrunners in developing incineration-based WtE technology, and has a leading role in exporting WtE knowledge and technology. All current Danish WtE plants are state-of-the-art Combined Heat and Power (CHP) production plants.

### Future challenges for waste incineration CHPs

A drawback of the current incineration-based WtE is that the systems are not very flexible with respect to integration into energy systems with a large share of fluctuating energy sources, such as wind power.

When aiming at integrating WtE production in future energy systems with a large share of fluctuating energy sources, such as wind power, the question arises: Which type of energy recovery is optimal? As current CHP waste incineration is constant and

Figure 31 - Biomass gasification polygeneration concept, producing Bio-SNG at low power demand and electricity at high demand.

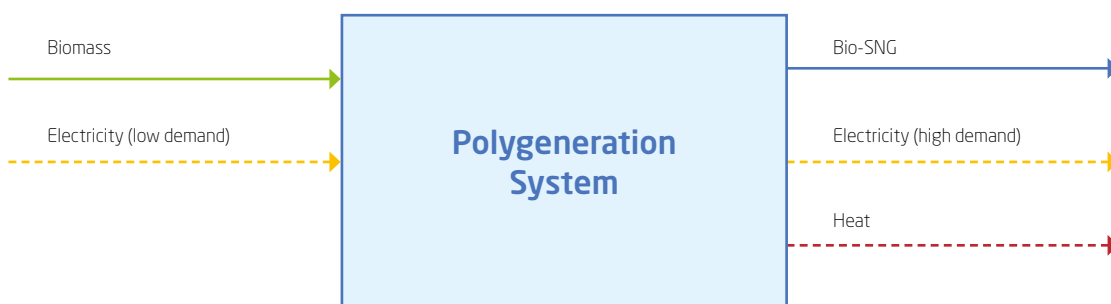

produces a high percentage of heat, it may be interesting to look at more flexible alternatives. A range of new WtE technologies are promising in terms of offering electricity, heat and transport fuels [9.37], [9.38]. Such technologies have the potential for increasing electric efficiency, substituting transport fuels and storing waste fractions and fuel, thus contributing to an increased flexibility in the energy system, as compared to the current practice of waste incineration.

### Main conclusions and recommendations

Bioenergy is a highly flexible and abundant source of energy with a lot of applications as *Figure 32* indicates. The use of biomass and waste in the energy system will provide cost-effective solutions for CHP and enable renewable fuel production for transport. Bioenergy and waste is seen as a vital contributor towards an environmental and economic sustainable future energy system.

## Geothermal Energy

*Ida Fabricius, DTU Civil Engineering;  
Søren Berg Lorenzen, Allan Mahler, Birte Røgen,  
Danish Geothermal District Heating*

Denmark is situated in an area with a geothermal gradient of 25–28°C/km [9.39], and in Denmark geothermal energy is utilized in two ways: via primarily

individual heat pumps associated with heat extractors in the ground (in common Danish usage: “jordvarme”) and by using geothermal energy for district heating (in common Danish usage: geotermi).

Local electrical heat pumps associated with heat collectors in the ground can be used in most of Denmark and is typically installed as a long horizontal winding tube buried 0.9–1.2 meters below the surface – below the potential frost depth. In Sweden, a similar form of geothermal energy is extremely popular and is typically extracted by drilling a vertical hole down to maybe 100 meters where a Borehole Heat Exchanger (BHE) is installed [9.40]. Such individual ground source heat pumps (GSHP) are less prevalent in Denmark than in the other Scandinavian countries. A main reason for this is the cheaper electricity in Norway and Sweden as compared to the highly taxed electrical power in Denmark. In Denmark the choice between shallow geothermal energy and energy from the wide net of natural gas or from district heating depends on local conditions such as the construction of a given building and access to gas and district heating.

### Geothermal energy in relation to its integration in infrastructure

In relation to **electricity grids**, geothermal energy can be directly integrated where the geothermal energy is used for electricity generation. Generation of electricity from geothermal energy can be done

Figure 32 - Thermal and biological conversion paths for biomass.

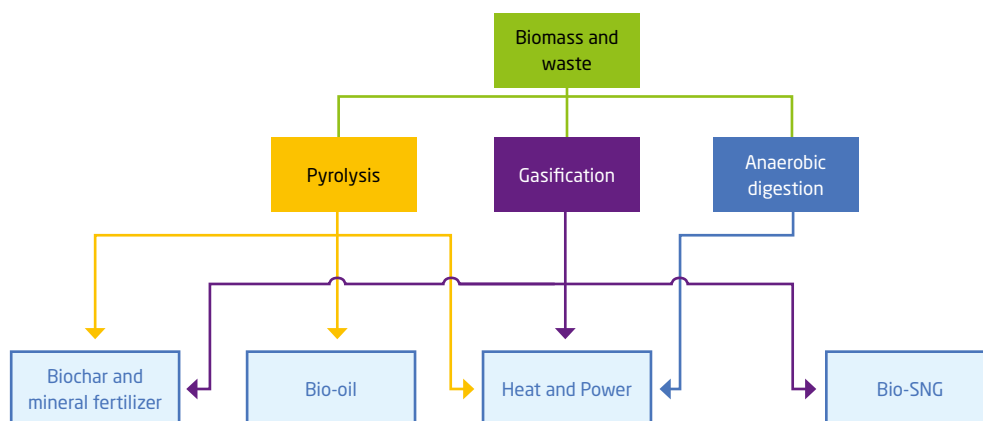



directly from hot steam via steam turbines provided the temperature is above about 150°C. For temperatures below 150°C, electricity can be generated by using e.g. Organic Rankine Cycles (ORC).

Electrical power generation from geothermal energy is at present not economically viable in Denmark. A reason for this is that at low temperatures, high amounts of water are required to provide a given amount of energy, and that efficiency even decreases with amount of water. This means that a significant electrical energy is required for circulating the geothermal water and that the net gain may be low or even negative.

Potentially, deep geothermal energy in combination with heat pumps can augment efficiency of renewable power sources as e.g. wind. The mechanism is as follows (*Figure 33*): 1) The geothermal water is continuously pumped from the ground at a rate depending on power costs and the heat demand, most of the time at full capacity; 2) The geothermal water exchanges heat to water in a stock tank; 3) An electrical heat pump transfers heat from the stock tank to the district heating system when power is cheap or demand requires it. This leaves a possibility for flexible use of power and integration of geothermal energy with electricity grids.

In relation to **gas grids**, areas with district heating and areas provisioned with natural gas grids are no longer separated by legislation. For this reason, geothermal energy can compete with natural gas and potentially replace it, so that natural gas can be reserved for other purposes, e.g. transport.

**Liquid fluids** are used only for district heating to a minor extent. In general, geothermal energy can reduce the utilization of oil for heat generation. Shallow geothermal installations, in particular, can replace local oil boilers.

In relation to **district heating grids**, geothermal energy can be directly integrated. For this purpose, geothermal energy from deep, warm aquifers are preferred. The heat is transferred by heat exchange and/or by the use of heat pumps.

**District heating and district cooling grids** can be integrated so that heat pumps on geothermal plants are used both for transfer of heat from geothermal water to district heating grids and district cooling.

**The geothermal energy potential in Denmark varies geographically.** The possibility of using deep geothermal aquifers depends on the presence of aquifers deep enough to be sufficiently warm, and shallow enough to have a high enough permeability

Figure 33 - Principal sketch of flexible use of power for heat pumps and pumps on a geothermal plant.

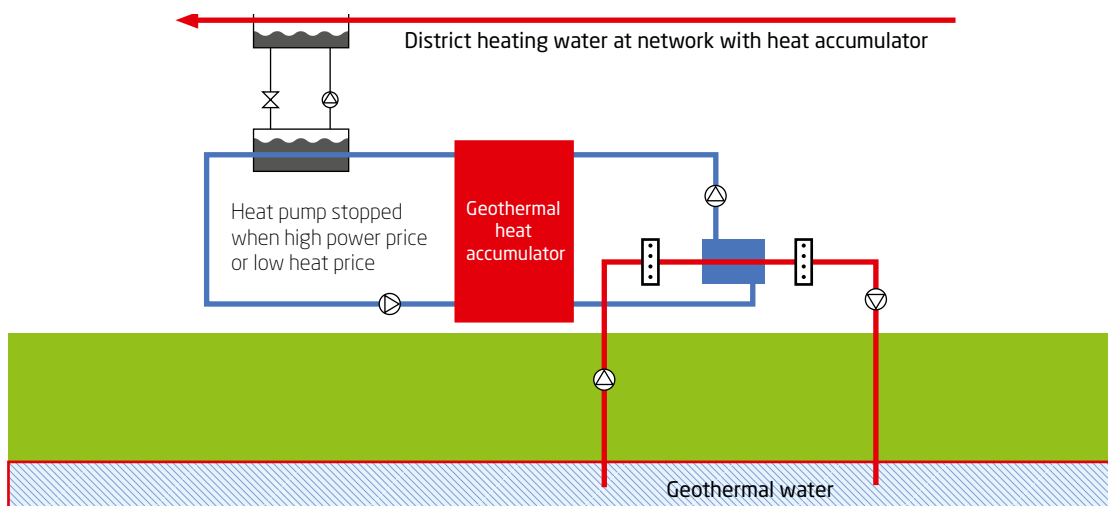

to permit a reasonable production rate. Deep geothermal energy is probably not viable everywhere.

With respect to shallow geothermal energy, its feasibility depends on the thermal properties of the local soil. In general dry soils have a low potential whereas water-rich soils have a high potential.

**Predictability of shallow geothermal energy** is high because a given soil is easily accessible and can be evaluated directly.

By contrast, the **predictability of deep geothermal energy** has a characteristic pattern of low predictability until the first well has been drilled, followed by high predictability after the presence of a viable aquifer has been proven by drilling.

With respect to cost, geothermal energy is more predictable than other sources of energy. It is only to a small extent dependent on the variable prices on oil/power/biomass for running plant and heat pumps.

With respect to **Capacity factor**, the geothermal resource is available **with no practical limits** and can be utilized as requested. Technical problems can prevent full utilization at a given time.

With respect to **dispatchability**, it is a general rule that stopping geothermal plants should be avoided in order not to harm the geothermal reservoir. On the other hand, the production can be flexibly regulated within certain limits, e.g. 20%–100% of the overall capacity.

The variability of the potential for deep geothermal energy cannot be **mitigated by siting**. On the other hand established geothermal plants in the same area can **improve the predictability** in the early phase before drilling the first well for a new plant.

**Active power frequency control and voltage reactive power control** are indirectly relevant in context of geothermal energy in the sense that high power consumption on electrical heat pumps on geothermal plants can influence the net frequency and voltage.

### Economy aspects

With the present legislation and taxation rules in Denmark, the competitiveness of geothermal energy

depends on the suitability of the geological layers for geothermal production and the potential for sale.

Four determining factors for competitiveness:

- Resource (geological conditions)
- Heat demand
- Production costs (power costs and/or access to and cost of absorption heat pump driving heat)
- Local alternative heat supply options

### Conclusions and recommendations

Heat exchangers in the ground are a potentially significant source of heat in Denmark provided the price on electricity for this purpose could be reduced.

Deep geothermal energy integrated with district heating holds high potential in Denmark. A main obstacle is providing capital for the first high-risk borehole in a given geographical setting. This requires a very capital-strong risk taker, as for example the Danish government.

## Fuel cells and electrolyzers

*Mogens B. Mogensen, DTU Energy,  
Ifan E. L. Stephens, DTU Physics*

Fuel cells and in particular electrolyzers may help implement non-fossil energy systems through energy conversion and storage in a fossil free future energy system. A main feature is in this context the need for storage of the irregular supply of renewable electricity from wind and solar and – on a seasonal timescale – hydropower. There is a need for conversion of both power-to-gas-to-power in order to balance the electric grid, and of power-to-fuel in order to supply renewable, CO<sub>2</sub> neutral hydrocarbon fuels for the heavy duty transport sector such as airplanes, trucks and ships.

In brief, four main types of fuel cells are under development worldwide today and available for sale from private companies [9.41], [9.42], [9.43]. They are named after their electrolytes: alkaline electrolyte cells (ACs), polymer electrolyte membrane cells (PEMCs), molten carbonate cells (MCC) and solid oxide cells (SOCs).

In principle, all four cell types are reversible, i.e. it is possible to operate them in both fuel cell and electrolyzer mode, but with today's practical cell, only the SOFC is reversible in the sense that the very same cell can be operated in both modes without any drawbacks. In fact, alternating operation may be beneficial by decreasing the degradation over time significantly [9.44]. The other cells have significant differences in design and materials selection between fuel cells and electrolyzer cells even though they use the same electrolytes.

Of the available cell types, AEC and PEMEC can only produce  $H_2$  by water splitting whereas SOEC can split both water (steam) into  $H_2 + O_2$  and  $CO_2$  into  $CO + O_2$ . Only little research has been done on using MCC for electrolysis, so this will not be treated further here.

The principle of a reversible electrolyzer/fuel cell is shown in Figure 34 using SOFC as example. If a mixture of  $H_2O$  and  $CO_2$  is electrolyzed using SOEC then it is termed co-electrolysis. The product is a mixture of  $H_2$  and  $CO$  at the negative electrode and  $O_2$  at the hydrogen electrode. The mixture of  $H_2$  and  $CO$  is called syngas and can be converted to many kinds of synthetic fuels by catalytic conversion using well-known commercial catalysts. If the  $CO_2$  is captured from the air, has biological or geological (volcanic) origin and only renewable electricity is used for the electrolysis then the gas or fuel will be  $CO_2$  neutral and sustainable in the strictest sense.

The short technical-economic status is that none of these main types of fuel cells/electrolyzer cells are commercial in the sense that they have a viable market inside the energy sector. Yet, all types can be bought from private companies, but they all will need either big subsidy or a much higher price than that of the market, e.g. in demonstration projects or very special applications that will allow a much higher cost per installed kW than the kW market price for conventional electricity production equipment. Therefore, the main R&D efforts in Denmark and worldwide are aimed at increasing the electrochemical performance further and at the same time increase the lifetime and reliability of the cells.

Significant R&D efforts are focused on the development of low-temperature electrolyzers similar to AEC and PEMEC with the capacity to directly producing syngas, hydrocarbons or alcohols. The catalyst at the electrode, i.e. the electrocatalyst, plays a critical role in determining both the overall electricity conversion efficiency and the product distribution. The electrocatalysts often contain precious metals, which are both expensive and scarce; the scale up of these technologies will require that the loading of precious metals be minimized or eliminated altogether. Long-term research in this area is taking place through international cooperation involving several DTU departments, other Danish universities and Danish industry [9.46], [9.47].

Figure 34 - Working principle of a reversible Solid Oxide Cell (SOC).

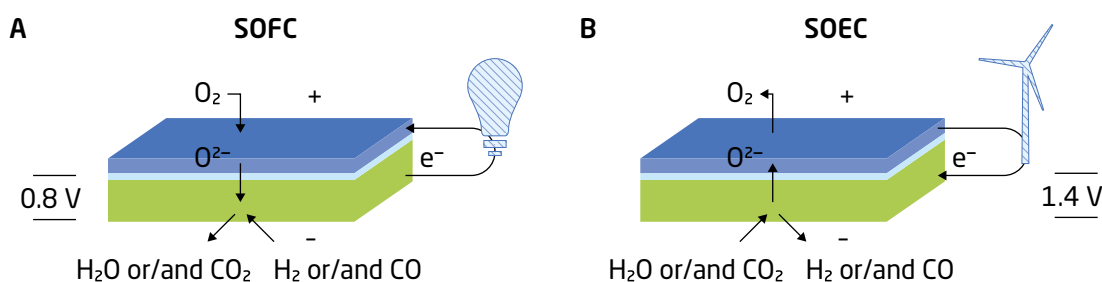

The cell can be operated as a fuel cell, SOFC (A), and as an electrolysis cell, SOEC (B). After [9.45].

### Conclusions and recommendations

Fuel cells and electrolyzers have a great potential to facilitate the utilization of renewable energy sources such as wind, solar and hydropower. They are technically ready for commercialization, but the production costs are still too high for a broad application in the energy market. In order to initiate mass production, economic incentives from governments are necessary, either by direct subsidy or by taxation of fossil fuels while keeping the technology of conversion of renewables free of tax. Naturally, the electrolyzer and fuel cell technologies can and should also be further improved by continuing the intense R&D efforts that have taken place in large parts of the industrial world during the latest three decades.

### Heat pumps and refrigeration plants for enabling integration of renewable sources in the energy system

*Brian Elmegaard, Wiebke Brix Markussen,  
Torben Ommen, Jonas Kjær Jensen;  
DTU Mechanical Engineering*

#### Electric Boilers

The conversion of electricity to heat by electric boilers is a common technology both in many household appliances and for industrial applications as illustrated in *Figure 35*. During the recent years, similar technology has been installed in the Danish district

heating system [9.48]. This makes it possible to consume electric power almost instantaneously whenever needed. It also illustrates the requirements that a technology for consumption of power as a service for the electric grid should meet. The time-integrated power, i.e., the energy, [kWh] supplied to the boiler as well as the instantaneous energy transfer [kW] must be transferred to the heat consumer in the form of heat. In a district heating system, it should thus be respected that heat demand varies considerably over the year. On the other hand, a heated medium may often be stored for a period of time, and thus heating provides an option for utilization of excess electricity at very short start-up times. Boilers with capacity up to 100 MW at temperatures of about 100°C are installed.

#### Vapour compression cycles

One significant drawback of the electric boiler is the low utilization of the potential of the input energy in terms of power, in thermodynamic terminology, the exergy [9.49], which may easily be determined by an estimate of the energy efficiency evaluated as heat supplied divided by energy content of the electric power is close to 100%, but this is actually far from what is possible theoretically according to the laws of thermodynamics. A much higher utilization of the potential of power as energy supply may be obtained by utilizing the power to drive a vapour compression cycle to generate a temperature difference for either a heat pump or a refrigeration plant. The system may even utilize both the cold and the hot sides of

Figure 35 - Principle Diagram of Electric Boiler.

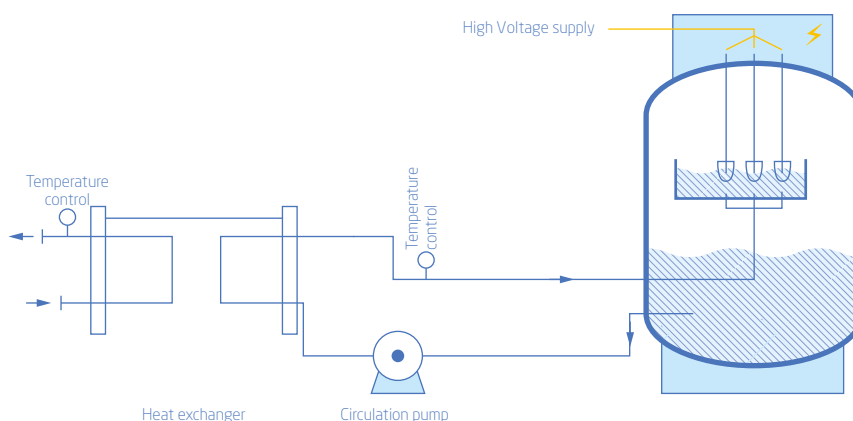
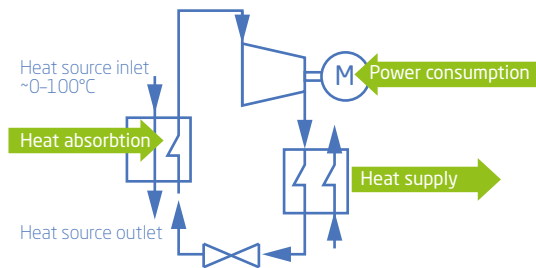

Figure 36 – Principle diagram of Vapour Compression Cycle.



the plant, such that heat is absorbed from a source with a cooling demand and heat is supplied to a sink with heating demand potentially by utilizing a storage tank. Examples of such installations are present in industry [9.50] and district energy systems [9.50b]. If a heat pump for space heating at 20°C used an average Danish ambient temperature of 5°C in the heating season, the maximum possible energy efficiency would be reached by utilizing the exergy of the electric power fully, resulting in an energy efficiency of almost 20 units heat to 1 unit electricity, or 2,000%. (Figure 36)

The theoretical limit is not reached in practice. The vapour compression cycle illustrated in Figure 36 consumes power and transfers heat from a low temperature heat source to a high-temperature heat source. These utilize the power much better than a simple conversion from power to heat. Usually, 2–6 units energy may be transferred from the heat source per unit electric power consumed, and thus 3–7 unit heat are delivered to the heat sink. This defines the Coefficient of Performance for a refrigeration plant,  $COP_c = \text{Heat from source} / \text{Power}$  and for a heat pump  $COP_h = \text{Heat to sink} / \text{Power}$ , respectively. In a district heating system where the low-temperature heat source might be at ambient conditions, e.g., water or air, and would thus be available freely, a  $COP_h$  of e.g. 3 may be expected which should be compared to the electric boiler which has an apparent  $COP_h$  of 1. A vapour compression plant is thus more efficient than direct power to heat conversion in a boiler, but it also introduces additional constraints and demands of the system.

Figure 37 – Heat sources available for integrating heat pumps in district heating.

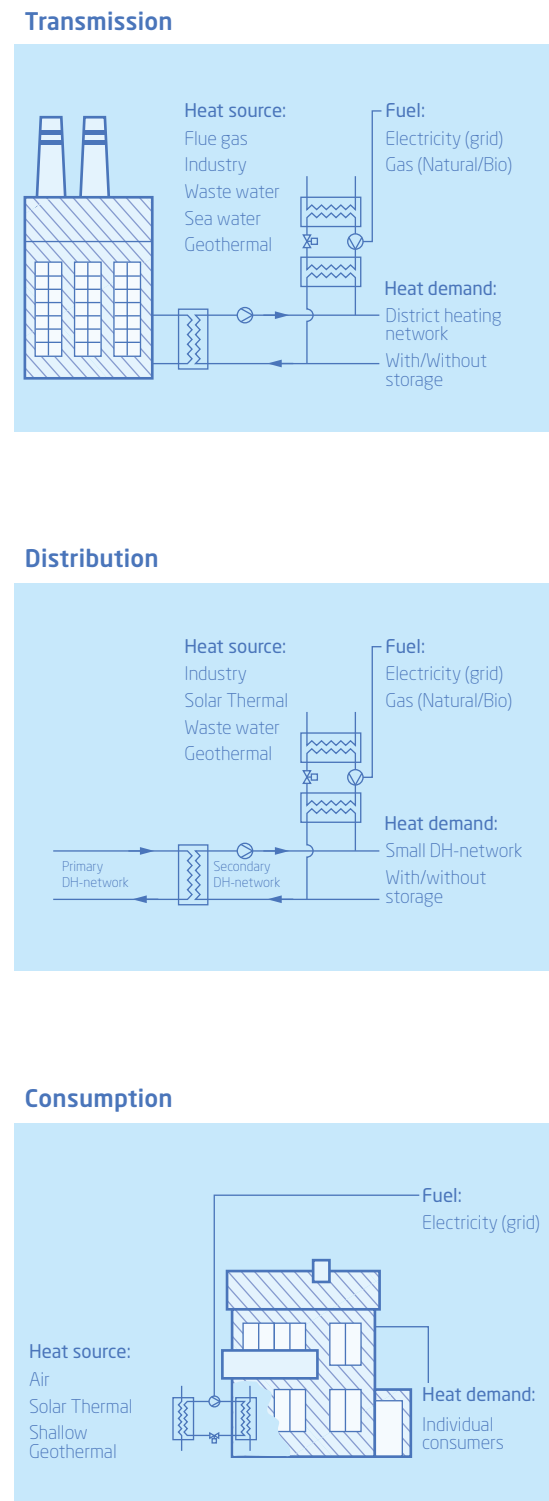

**Table 5** - Summary of the seasonal electricity savings, emissions and possible effect on peak demand.  $\infty$  means that the source is in practice unlimited. [9.53]

	Temperature Min/Max [°C]	Potential [MW]	Carnot COP Winter/Summer
Sewage water	10 / 20	87	4.5 / 6.9
Sea water (near)	0 / 20	$\infty$	4.0 / 6.9
Sea water (far)	5 / 10	$\infty$	4.3 / 5.7
Ground water	8 / 18	—	4.4 / 6.6
Drinking water	7 / 15	15	4.4 / 6.2
Air	-10 / 25	$\infty$	3.6 / 7.6
Ground	7 / 9	$\infty$	4.4 / 5.6

### Heat pumps

The example above also illustrates the additional challenges when using a heat pump as a consumer of electricity instead of a boiler. The heat pump requires the electric power, the heat sink, and the heat source to be available simultaneously in terms of both energy [kWh] and energy rates [kW] to generate heat at the high utilization rate. In addition, the heat pump cycle involves a compressor, a throttling valve and two heat exchangers by circulating a refrigerant between the components. This means that a heat pump needs longer time for start-up before the expected capacity and performance is reached. The compressor will consume power as soon as it is on, but the highly efficient operation of the unit will be reached after a start-up period of 5 to 15 minutes.

Numerous heat sources may be available for larger heat pumps in an integrated system which involves district heating as will be the case for a large number of Danish consumers [9.51]. Heat sources may be available for installing heat pumps in the high-temperature transmission systems, in the lower-temperature distribution system, as well as by the individual consumers also outside district heating networks. Heat pumps will inherently have better COP if smaller temperature lifts between source and sink are required, which favours the location of heat pumps by the consumer, but is in contrast with the economy of scale and the options for central control which favours larger, centralized units. A number of possible heat sources are identified by [9.52] as illustrated in *Figure 37*. Presently, a significant effort is given to the large-scale units, even if

these will have lower COP and involve heat losses from the heating network. (*Figure 37*)

For the Copenhagen area, a number of potential heat sources for large units have been identified and their capacity has been estimated [9.53]. In addition to these, a high potential for use of geothermal sources is available.

The capacity and technological readiness of the heat sources varies, and no straightforward solution has been demonstrated at commercial level yet. Some applications are in operation, based on different heat pump technology depending on capacity and temperature demands, e.g., Drammen, Norway, Frederikshavn, Denmark [9.55], and Helsingfors, Finland [9.56]. For domestic heat pumps, the heat source is air or ground. Sweden and Norway have the largest penetration of such installations in Europe [9.57]. (*Table 5*)

The utilization of each possible source and location causes different demands for the heat pump technology in terms of e.g., construction of compressors and heat exchangers, selection and development of working fluids, investment cost, and operational flexibility. As an example, large-scale heat pump technology is not commercially available for high-temperature applications due to restrictions in e.g., selection of refrigerant, pressure and temperature limits of components and demands for economic feasibility. *Figure 38* [9.58] illustrates the restrictions of working domains for different heat pump technology in conditions which resemble



Figure 38 - Working domains of single-stage heat pumps.

Left: Domains for different types of heat pumps;

Right: Best available technology with respect to economic feasibility [9.58].

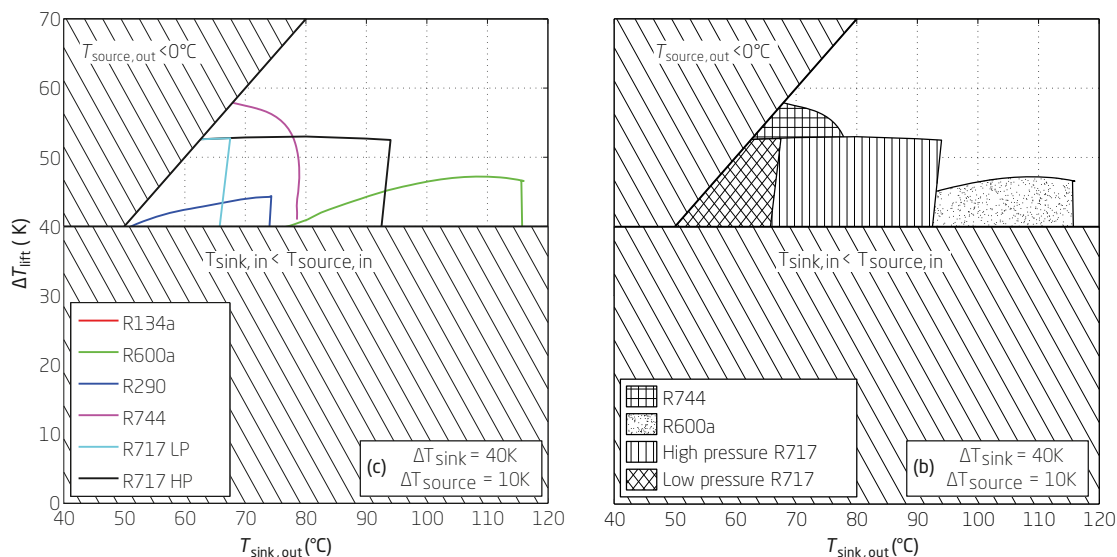

typical district heating conditions based on the definition of temperature lift as the difference between heat source inlet and heat sink outlet temperatures. (Figure 38)

It is evident that for high-temperature applications, the options are limited. This may to some extent be remedied by multi-stage cycles or serial connections at the cost of additional investment. Future development of technology with focus on application areas with higher temperature demands seem to be under consideration and will be beneficial for implementation of significant shares of heat pumps in district heating.

Heat pumps using different compressor technology are available for different cycle capacity. Positive displacement types are e.g., piston, scroll, and screw. Turbomachinery is typically used for larger capacity as centrifugal or axial flow configurations. These machines all involve demands for cooling, lubrication, operation temperatures and start-up times for constructional reasons. Similarly, the working fluid as well as the other components in the system, heat exchangers and valves, introduce requirements and limits the working domain and economic potential. Working fluids are of particular concern due to their cost and environmental impact due to leakage. For this reason, the focus is on natural refrigerants, e.g.,

ammonia, propane or carbon dioxide, but also new synthetic gases with low global warming potential, GWP, are marketed. It is of primary concern that the refrigerant is applicable from mechanical, thermodynamic, chemical as well as legal viewpoints, however.

For small, domestic units, the main obstacle for larger market penetrations seems to be the economic feasibility compared to other heating technologies. This is mainly caused by high investment costs and relatively low seasonal performance [9.59]. In addition, the units are not developed for high flexibility and centralized control of a system of distributed units [9.60].

### Refrigeration

As an alternative to deliver heat with the vapour compression cycle, the low-temperature side may be utilized for generating low temperature. In principle, the technology is the same, but the actually available components have other working domains than for heat pumping. This may provide other options for the technology, but also suggests that it is important to consider any limitations of power or energy capacity of heat source or sink. For instance, using freezing goods as a flexible demand for consumption of power is sometimes considered, but this is only possible if the good itself has the capacity to reject the required energy and to conduct the required heat rate at the time of the power supply.



### Thermo-electric energy storage

Finally, the electricity storage technology termed Thermo-Electric Energy Storage, [9.62] is recognized. It is in principle a vapour compression cycle which may be reversed and thus may operate in power generation mode as well. In this way, a dedicated electricity storage system is proposed, utilizing components that are relatively close to commercial level. The technology has the benefits of a vapour compression cycle, but may store electricity at an efficiency of about 50%. The working fluid is suggested to be carbon dioxide, R744, which operates in a transcritical cycle both in heat pump mode and power production mode. (Figure 39)

### Conclusions and recommendations

The use of electricity to generate heating by electric boilers is an established technology, which is commercial at varying capacity and has proven to be feasible as well. The method utilizes the potential of the input power very efficiently. This may be improved by using the power to run a compressor in a vapour compression cycle either for generating heating, cooling, or even both. This technology is commercially available, but has significantly more limitations regarding capacity and technology limitations. There is a significant potential for further research, development and commercialization of technology solutions before it will be technically and economically feasible to introduce high-efficient heat pump to large extent. Ideas for integrating vapour compression cycles in

combination with power cycles may make it feasible to use this technology for actual electricity storage.

## Energy storage

*Raquel Garde Aranguren, RES Integration CENER, Spain; Allan Schröder Pedersen, DTU Energy*

In principle, all needs for flexibility (the ability to match demand and supply) in the future energy system can be fulfilled by application of energy storage but naturally the role of 'competing' technologies will be finally determined by market forces based on economy and performance characteristics of the technologies. Here, it seems important to realize that economy is not the only significant parameter. Other characteristics – e.g. comfort and convenience – are equally important.

### Electricity services

Grid stability – e.g. frequency and voltage stability – is crucial in electricity systems, but the fluctuations of renewable generation impose large challenges. As an example, solar power has been vastly installed over recent years in households all over Europe. Because of attractive feed-in tariffs and agreements between governments and owners of solar power installations large amounts of solar power often imply bottlenecks in local distribution grids associated with voltage rise. Such bottleneck problems can be solved by the use

Figure 39 - Principle of Thermo-Electric Energy Storage.

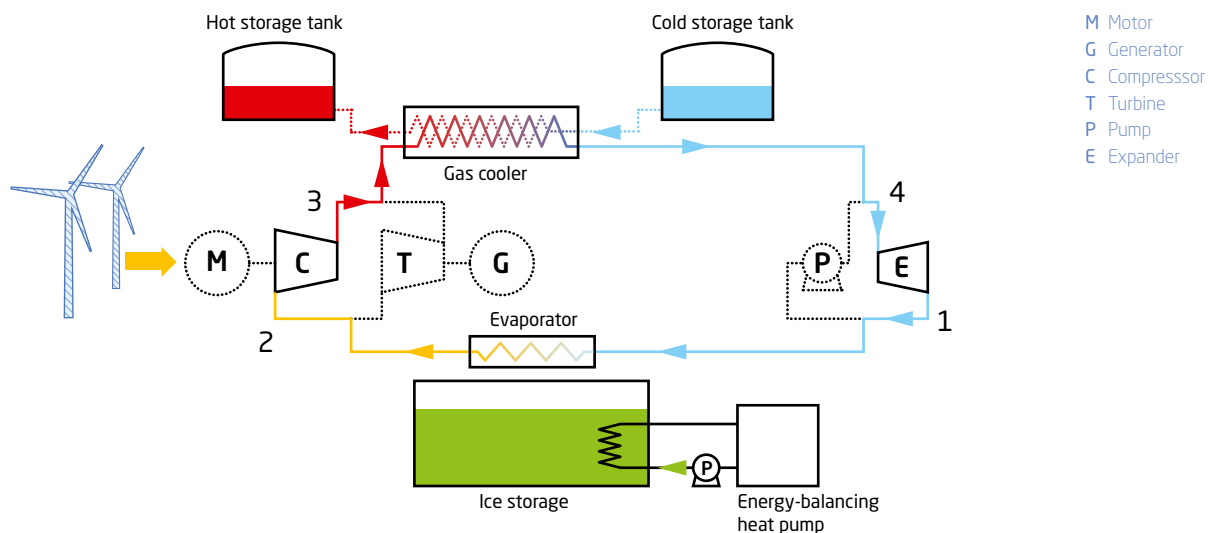

of local electricity storage either in the households or in the local feeder or transformer station. For these kinds of solutions, batteries seem a proper solution.

On a larger power scale, wind turbine installations can profit from installation of storage capacity as a stabilizing measure able to secure the voltage and frequency output within acceptable limits.

### Heating and cooling services

Given the strong daily and seasonal variation in demand for heating and cooling in households and the independently varying renewable energy production, energy storage has an important role to play in matching the demand with supply. Large and small thermal energy storage devices are suitable for providing these services. Heat and cold can be stored in huge amounts in underground formations (e.g. aquifers) and small thermal storage units can be used for levelling day/night variations in need.

### Fuel for transport

As mentioned above, transport and mobility accounts for approx. 30% of total final energy demand in Europe. Transport is currently fuelled almost exclusively by fossil resources, and the transport sector is often considered as the most difficult part of the energy system to transform to renewable fuels. Electricity for transport is slowly gaining market shares. Trains driven by overhead lines have been used for many years, and battery electrical vehicles are now frequently observed in streets and on highways in many countries. However, batteries based on today's technology are insufficient for provision of power for long distance passenger driving, heavy truck transport, marine transport and aviation. For these types of transport, only chemical fuels seem able to fulfil the requirement concerning energy density on volumetric as well as gravimetric basis.

### Energy storage technologies

Traditionally, energy storage technologies are classified in the following main categories (major sub-categories shown as well):

- **Chemical**
  - Variety of specific chemical compounds (e.g. CH<sub>4</sub>, CH<sub>3</sub>OH)
  - Mechanical
  - Pumped hydro

- Compressed gas
- Flywheels

- **Electrochemical**

- Variety of specific battery chemistries
- Supercapacitors (categorization disputed and supercaps are basically power storage technology)

- **Electrical**

- Classical capacitors
- Superconducting magnetic energy storage

- **Thermal – heat and cold**

- Sensible heat storage
- Phase change
- Thermochemical

### Status and perspectives for promising storage technologies

#### *Pumped Hydro Storage*

In today's worldwide energy storage scene pumped hydro storage (PHS) accounts for about 99% of total capacity and has been utilized commercially for more than a century. Classical PHS requires certain topographic conditions usually found in mountain areas suitable for establishing two reservoirs separated vertically to allow utilization of the difference in potential energy of mass. In a recent assessment [9.63] the JRC concluded that a realisable potential for PHS in Europe exceeds 80 TWh. However, environmental concerns must be taken into consideration and therefore such numbers for potential should always be used with caution.

PHS is a mature technology, but new operation modes (head ranges, varying loads etc.) still require R&D efforts to be realised.

#### *Chemical energy storage*

Storage of electricity in chemical form usually involves electrolysis of water. By splitting water the simple chemical fuel hydrogen is formed and can be utilized directly for re-electrification (e.g. in a turbine of a fuel cell) or as a fuel in the transport sector. Furthermore, hydrogen can be stored in huge amounts in underground caverns, e.g. formed by solution mining in salt deposits, which can be found in many places of Europe. The technology has already been utilized for a century for storage

of natural gas and experience is available also for hydrogen, *see e.g. footnote 1.*

Although hydrogen has many attractive properties as a fuel, the difficulties (in terms of economy and conversion losses) about making hydrogen available in a form with high-energy density (in particular on a volumetric basis) has led to increasing interest in storing electrical energy in the form of carbon-containing gaseous or liquid fuels. If a suitable source of CO<sub>2</sub> is available (e.g. from cement and steel industry) hydrogen can be reacted with this gas and form a variety of carbon-containing fuels like methane, methanol or dimethylether. Furthermore, some electrolyzer technologies are able to split not only water, but also CO<sub>2</sub> into CO and oxygen. This is attractive because electrolysing a mixture of water and CO<sub>2</sub> can form mixtures of H<sub>2</sub> and CO, called synthesis gas, from which the same kind of carbon-containing fuels, mentioned above, can be obtained. A particular application of the technologies is the upgrading of CO<sub>2</sub> in biogas to form pure grid-quality methane, which can be injected directly into the existing natural gas grid.

Recently, several power-to-fuel projects have been kicked off in Europe. Here, only reference to two should be given as they represent two interesting technical approaches, i.e. upgrading of biogas and direct injection of hydrogen into the natural gas grid:

- The first one is the BioCat Project focusing on fully biological conversion of waste extracted from waste water into methane using electrolysis in the city of Copenhagen in Denmark [9.64].
- The other is the power-to-gas pilot unit in Falkenhagen [9.65] in Eastern Germany operated by the German energy supplier E.ON. During the first year of operation the installation has injected more than two million kilowatt-hours of hydrogen from electrolysis into the gas transmission system.

Synthetic chemical fuels hold sufficiently large storage capacity to meet the needs for seasonal energy storage (several months). In addition, chemical fuels can provide energy for transport forms (see above), where batteries are insufficient. For these reasons, car manufacturers in the EU, the US, Japan, and Korea are focusing on hydrogen and fuel cells for traction in parallel to purely battery electrical vehicles.

### Batteries

In principle, batteries store energy in chemical form, but probably for reasons of tradition and operation principle they are often considered a special category of energy storage devices. Batteries are user-friendly and have a relatively high electricity to an electricity efficiency of about 85% for a new Li Ion battery, but dependence about use pattern and state of the battery (degradation) are recognized widely.

Batteries are well-known from numerous mobile appliances like PCs or cell phones and they are well-known for rapidly increased use in cars as well. However, the energy density of batteries is low – about an order of magnitude lower than for chemical fuels – and this puts limitations to their mobile use as discussed above.

Whereas the use of batteries in grid applications were formerly limited to small and/or weak grids (like remote locations or minor islands) batteries have now started to find applications also in strong and well-connected electricity grids implied by the still deeper penetration of intermittent energy generation. An illustrative example is the installation of two large batteries in conjunction to a wind farm in Northern Germany. The battery system has been delivered by Bosch [9.66] and includes [9.67] a Sony Li ion battery of size 2 MWh/2 MW and a vanadium redox flow-battery (Vanadis Power) of size 1 MWh/325 kW, making it one of the largest battery installations in Europe in terms of power and capacity. The system is designed to supply electricity to 200 households based on an average demand of 7 kWh per household per day. The batteries have allowed new local installation of wind generation capacity in spite of relatively weak grid environment.

New types of batteries are being developed mostly based on cheap metals such as Zn, Al, Mg, Fe, etc. and the flow battery concept (Zn-Br and Zn-air flow batteries).

### Thermal energy storage

Although much focus is usually on electricity when talking about the energy system, it is worth noting that in Europe electricity currently accounts for about 20% of total final energy demand, whereas heat accounts for 50%. Thus, heat is a very large and important component of the energy system.

1. C. W. Forsberg, "Assessment of Nuclear-Hydrogen Synergies with Renewable Energy Systems and Coal Liquefaction Processes", Oak Ridge National Laboratory 2006, ORNL/TM-2006/114

The future supply of heat for industry and households is anticipated to come from the combined resources of wind and solar (electricity) and biomass. As discussed briefly above the seasonal and daily variance of those resources suggest that storage can play an integrating role to match supply and demand. This is indeed the case and is to some extent already realized in the form of small boilers for domestic hot water supply. Here energy (heat) is stored over a period and a peak use load is manageable, e.g. in the morning where many customers have a shower.

However, heat and cold can also be stored in much larger amounts in underground formations like aquifers (although not all aquifers are suitable for the purpose) by using ATES technology (Aquifer Thermal Energy Storage). As an example, Copenhagen Airports have recently installed [9.68] a 110 m deep ATES system able to provide heating in the winter period as well as cooling in the summer period (*Figure 40*). The system relies on the use of heat pumps (forming a viable connection with the electricity system) and can deliver cooling capacity up to 5 MW and 10,000 MWh per year (an impressive COP of 60 is quoted). The system will secure Copenhagen Airport annual savings of up to EUR 1 million for an investment of approx. EUR 8 million.

In general, thermal energy storage holds potential to be profitably integrated in many environments of the future sustainable energy system. Several new types of thermal storage technologies, however, need further development to become commercially viable. This is true for phase change materials and in particular for thermo-chemical systems, which are attractive because of high energy density and economic potential in use of very cheap materials and open systems based on abundant components of the atmosphere.

### Conclusions

Without doubt, energy storage – predominantly in the form of storing electrical energy – will be a significant component of the future sustainable energy system and some promising storage technologies have been briefly discussed above.

Electricity storage almost exclusively involves some kind of energy conversion process and is usually associated with release or uptake of heat. Therefore, an optimal integration of energy storage with the heating system is important to obtain the most profitable overall energy system, including energy storage.

**Figure 40** - Copenhagen Airport ATES system provide cooling in the summer (top) and heating in the winter (bottom).



Illustration: Copenhagen Airport

## Chapter 10

# Danish, nordic and european perspectives for energy system development

By **Poul Erik Morthorst** and **Lena Kitzing**, DTU Management Engineering

## European development and perspectives

Energy systems around the world are currently undergoing an important transformation, from being CO<sub>2</sub>-intensive and centralized towards becoming sustainable and more integrated between sectors and regions. In this, policy makers play an important role as they provide the investment incentives for making the transition become reality. As energy systems with high shares of renewable energies develop, also new challenges arise. The European Community is facing three major challenges within the energy field:

- **Sustainability.** Current energy and transport policies imply that EU CO<sub>2</sub> emissions are to rise by approx. 5% by 2030. Global emissions are expected to increase by 55% in the same period if no actions are taken.
- **Security of supply.** Europe is increasingly becoming more dependent on imported fuels. A continuation of existing trends will imply that the present import share of 50% will increase to approx. 65% in 2030. This implies a high vulnerability of the energy system, e.g. in relation to terrorism.
- **Competitiveness.** Rising energy prices could jeopardize additional job creation in the EU. Investing in energy efficiency and renewable energy could induce innovation and industrial development benefiting employment and the economy in the EU.

To tackle these challenges, the EU member states have adopted different policies and long-term targets over the last decades, at first in White Papers [10.1], [10.2], and non-binding targets (e.g. [10.3]). In 2009, the Climate and Energy package became law after intense inter-governmental negotiations, containing first binding targets. The package and the new renewable directive implied, e.g., the establishing of national support schemes for renewable energy in all EU member states, a big step in the transition of the European energy systems.

Overall, long-term targets for 2020 include: 1) a binding reduction of greenhouse gases of 20% compared to 1990, 2) a mandatory target of 20% renewables in final energy demand, and 3) a (at first voluntary) agreement to reduce 20% of EU energy consumption compared to a reference projection. Also, 10% of the fuels used in transport shall come from renewable sources in 2020. In 2014, these targets were accompanied by targets for 2030: 1) the binding target to reduce EU domestic greenhouse gas emissions by at least 40% below the 1990 level, 2) the (at EU level) binding target to increase the share of renewables to at least 27% of the EU energy consumption, 3) an indicative target of 27% in energy savings (to be reviewed in 2020).

With the Lisbon Treaty, energy has become a 'shared competence' between the EU and its Member States [10.4]. Although EU member states still have their 'energy sovereignty' [10.5], i.e. the decision on the energy mix, usage of resources, and on taxation and



support policies within their territories, cooperation in a European renewable energy policy should be seen as the only strategic option for rapidly reducing energy import dependency (and thus relieving security of supply concerns) as well as for reducing greenhouse gas emissions [10.6].

The latest state aid guidelines [10.7] are rather detailed on concrete options for renewable support instruments employable by Member States. Although suggestions for harmonising renewable support across Europe has never found the necessary unanimity amongst Member States [10.8], there is still a strong development towards Europeanization of energy policy governance (see also [10.6]), aiming at facilitating the advancement towards policy coherence.

Following these lines, the new European Commission has established the ‘Energy Union’ commissioner. An important part of the newly defined Energy Union strategy is “redesigning the electricity market, to be more interconnected, more renewable, and more responsive” [10.9].

The establishing of a single European electricity market has been and still is a priority for the European Commission. And results are apparent: As of February 2014, the Nordic electricity market is tightly connected with Central Western and Southern Europe through price coupling and implicit allocation of cross-border transmission capacity, thus forming

a common spot market covering approx. 75% of the European power market [10.10].

The strategy of the European Union to rely increasingly on renewable sources is going to change the European energy systems radically within the next decade. Energy technologies based on variable sources, especially wind power and photovoltaics, are expected to have a large role to play in the future energy supply. For example, in Denmark wind power is by 2020 expected to supply almost 50% of Danish electricity consumption implying that from time to time wind power will produce more power than needed in the Danish system. Accordingly, the integration of renewable energies is one of the short-term priorities in the Energy Union: “ensuring that locally produced energy – including from renewables – can be absorbed easily and efficiently into the grid” (EC 2015). Certainly, this is a challenge that will not only require significant changes in the overall energy system, but with electricity as the point of departure also close interactions with other large energy system infrastructures such as the gas and district heating networks.

### Denmark in a European perspective

In a European context, the Danish energy system has two main characteristics:

1. Denmark has a highly diversified and distributed energy system, based upon three major national

Figure 41 - Development of Danish gross energy consumption and emissions of CO<sub>2</sub>. Adjusted for export/import of electricity and temperature. Source: Danish Energy Authority.

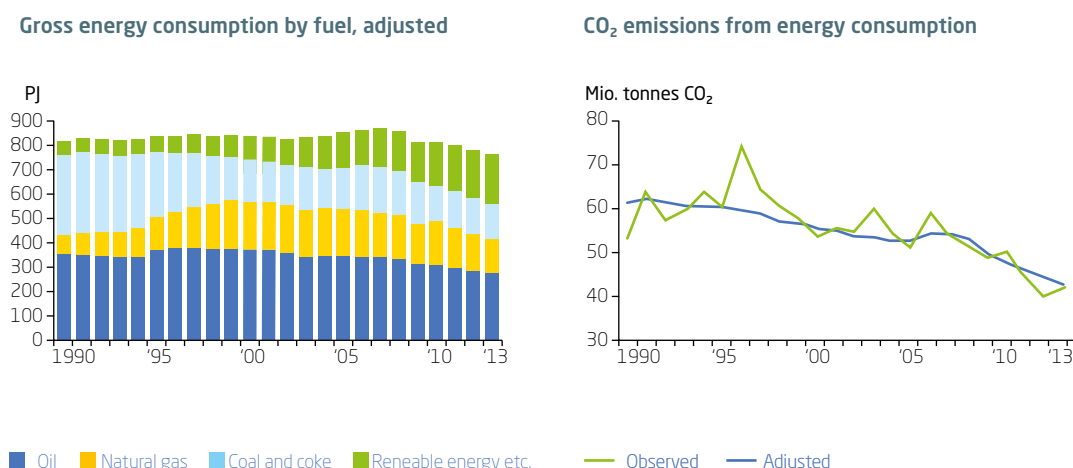

grids; the power grid, the district-heating grid and, finally, the natural gas grid. The combined utilization of these grids has implied that Denmark has a highly efficient supply system with a high share of combined heat and power.

2. Renewable energy technologies – especially wind power – play a large and increasingly important role in the Danish energy system. By 2014, 39% of the Danish power needs are supplied by wind power and Denmark is one of the global front runners in the development of offshore wind farms.

For a period of more than 20 years, Denmark has succeeded in keeping gross energy consumption at a constant level – in recent years with a small reduction (Figure 41) – although gross national product in the same time period has increased by more than 80%. For a number of years, Denmark was the only country in the EU being a net exporter of energy. However, by 2013 the production from the Danish oil and natural gas fields in the North Sea fell below the Danish gross energy consumption for the first time in many years (Figure 42). Denmark still is self-sufficient in oil, although the degree of self-sufficiency also here is decreasing quite fast (Figure 42). However, in general combining the above-mentioned issues implies that Denmark has an energy situation better off than most countries in the EU.

Nevertheless, Denmark is also facing a number of challenges, some of them in line with the EU in general, some specific for the Danish system:

- Oil and gas production peaked in 2005 and will gradually decrease to a level below domestic consumption, thus increasing the vulnerability of the Danish energy supply (Figure 42). The transport sector is almost entirely depending on oil and is a major user of energy. A major challenge in the future will be to replace fossil fuels in the transport sector by renewable sources.
- Combined heat and power production utilized in combination with an extensive district heating system is the corner stone in the highly efficient energy system in Denmark. However, the large and increasing amounts of wind produced power implies that conventional power plants, including CHP-plants, are gradually being pushed out of the power market, because of low running hours and thus reduced profitability.
- Denmark has the highest share of wind power in the world, 39% of total power supplied by wind turbines by 2014 (33% by 2013, cf. Figure 42). The variability of these large amounts of wind-generated power requires strong interconnectors to neighbouring countries and back-up from other generating power units. Aiming at a higher share of wind power the integration into the power system will require innovative and advanced

Figure 42 - Development of wind power and degree of self-sufficiency in oil and natural gas. Source: Danish Energy Authority.

Wind power capacity and wind power's share of domestic electricity supply

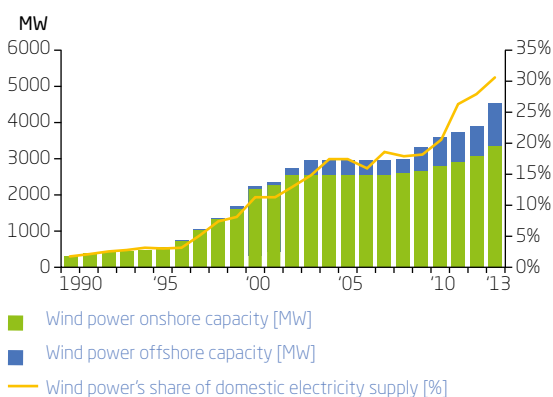

Degree of self-sufficiency

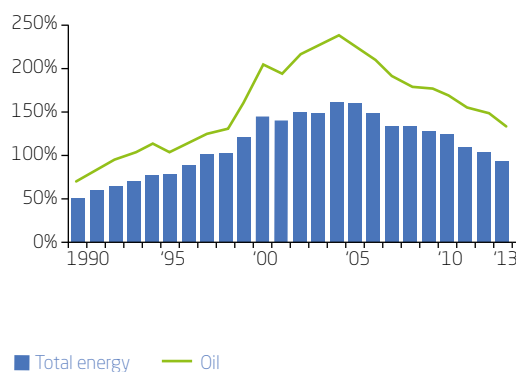



Figure 43 – Distribution of fuels by 2008 and 2050 (scenario) in Denmark. Source: [10.11].

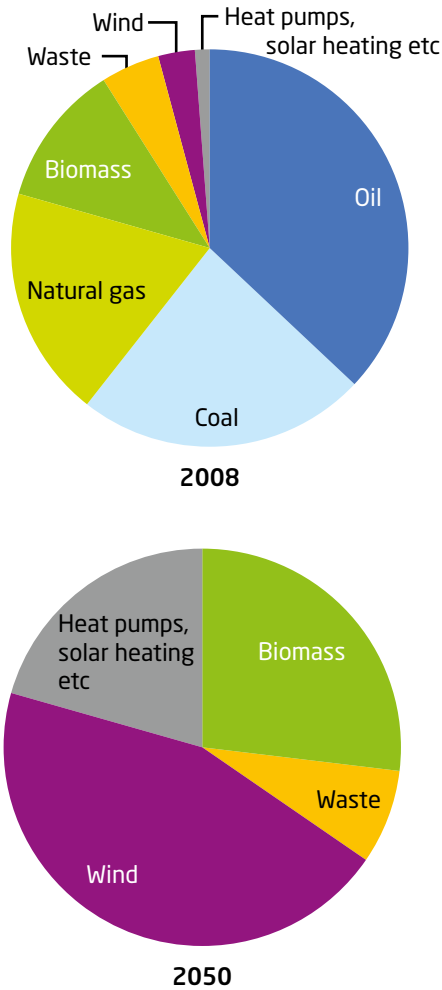
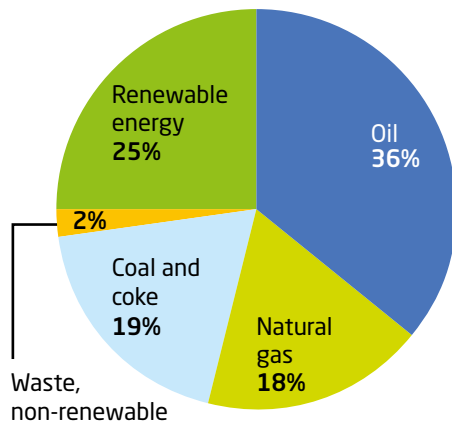

Figure 44 – Distribution of fuels by 2013 in Denmark for comparison with the above 2008 distribution. [10.12].



solutions, including flexibility in power demand, an efficient utilization of interacting networks and eventually storage facilities.

Thus, the present energy situation calls for new policies and new system developments.

### Danish energy policy and targets

For more than a quarter of a century, Denmark has developed an environmentally strong profile with regard to development of the energy sector, and since the beginning of 1990s, the problem of climate change has been the most important driving factor behind the Danish energy policy. Thus, as a member of the EU, Denmark has a commitment to reduce its emissions of greenhouse gases by 21 percent by 2020 as compared to 1990 for the energy sectors not covered by the EU CO<sub>2</sub> quota. However, Denmark is one of those countries that want to go even further.

In 2008, the Danish prime minister announced a vision of a Denmark being independent of fossil fuels in the long-term time perspective, thereby not only improving our security of energy supply but also significantly reducing our GHG-emissions. This vision led to the establishment of the Danish Commission on Climate Change policy, launching its report in 2010, stating that by 2050 a Danish energy system independent of fossil fuels is achievable without excessive costs to society ([10.11]). This requires a significant change in the Danish energy system, converting a mainly fossil fuel based system today to a system based entirely on renewable energy sources by 2050 (see Figure 43). Moreover, a significant contribution is expected from energy efficiency measures, both in the short and the long-term time perspective.

In 2011, the Danish Government launched its follow-up report; the official plan entitled Energy Strategy 2050. The Energy Strategy suggests a number of policy initiatives for phasing out fossil fuels in the long term [10.13]. Naturally, such a long-term development requires significant changes in the structure of the energy system, as well as a continued use of strong policy measures. The main points of the strategy include:

- **2020:** Almost 50% of Danish Power consumption is supplied by wind power
- **2030:** No use of coal in Danish Power plants
- **2035:** All heat and power consumption is supplied by renewable energy technologies
- **2050:** The entire Danish energy consumption is supplied by renewable energy technologies

This vision of the future energy system is shared by a large majority of the Danish Parliament.

On basis of the long-term vision an action plan until 2020 has been approved by the Danish Parliament. This action plan includes a strong development especially of offshore wind power, but also strong measures for energy conservation and shifting some of the existing coal-fired power plants to biomass. Wind power is expected to be the most important power supply technology by 2020, covering almost half of the Danish power consumption this year. Strong energy efficiency contributions are to be implemented through an agreement with the Danish energy distribution companies, implying that a 7% decrease in final energy consumption is to be achieved before 2020. According to the action plan, total gross energy consumption is to be reduced by 12% by 2020 compared to 2006 and approx. 35% will be covered by renewable energy sources.

## Denmark as part of the Nordic and European energy system

Geographically, Denmark is located on the border between the European continent and the Nordic countries, and consequently acts as a kind of transit area between the Nordic and the European energy systems, especially Germany. Also, the Danish natural gas grid connects Sweden with Germany.

Denmark is member of the Nordic power exchange, NordPool. The NordPool power exchange is geographically bound to Norway, Sweden, Finland and Denmark. As the first international market for electricity, NordPool was established in 1991 and until the end of 1995 the electricity exchange covered Norway, only. From 1996 Sweden joined the exchange and

the name was changed to NordPool. In 1998 Finland was included and Denmark in 1999–2000. Approx. 75–80% of the power supplied within the Nordic area is traded at the NordPool power exchange.

Within recent years the NordPool market model has spread over Europe and by now a large number of EU member states have organized their power exchanges along similar principles. By 2010 the Central Western European Market coupling (CWE) was launched, consisting of Belgium, France, Germany, Luxembourg and the Netherlands. By 2014 CWE was coupled with the Nordic system and the price coupling in North Western Europe (NWE) was a reality. This market cooperation is further being developed in 2015 and new countries are being included.

The Nordic market is dominated by Norwegian and Swedish hydropower, though power trade with CWE markets are increasing and thus reducing the hydropower dominance. Because Denmark is situated on the border between the large conventional fossil fuel-based power systems of central Europe (especially Germany) and the hydro-dominated Nordic system, Denmark has the role as a kind of buffer between these systems. Thus, Denmark has extensive power trade with Germany but also a considerable transit of power between the continent and the other Nordic countries. This implies that the price of power in the Danish area partly is related to the Nordic market, partly to the continental one (especially Germany), depending on the situation in these markets.

The strong reliance on wind power in the Danish energy system requires strong interconnectors to the neighbouring countries:

- Denmark has strong connections to Norway and Sweden, the oldest of these being established back in the 1950s. Especially the exchange of Danish wind power and Norwegian hydropower is of high importance for the Danish power system. A new connection to Norway, Skagerrak4, with a capacity of 700 MW was inaugurated in spring 2015.
- Denmark also has strong interconnectors to Germany. However, full utilization of these is from time to time being hampered by grid bottlenecks in central Germany.

- A 700 MW transmission to the Netherlands is at the time being in the planning process and new interconnectors are being considered, e.g. to UK.

Interconnectors to neighbouring countries of course have a large role to play in the integration of wind power and might be seen as competitors to the development of other kinds of flexible solutions.

**A flexible and integrated energy system**

One of the major opportunities to increase the flexibility in the Danish energy system is to utilize interactions between the three major networks: the power grid, the natural gas grid and the district heating network. Managing interactions in an optimal way might improve the system efficiency significantly while at the same time paving the way for the integration of larger amounts of variable energy sources as wind power and photovoltaics.

When more grids are interacting, the complexity of the system will be strongly increased. As shown on *Figure 45* a number of technological possibilities exist in the interacting field of power and gas, with the natural gas system as the major storage facility:

- In times of excess production of wind generated power, electrolysis (e.g. based on SOEC fuel cells) can convert electricity to gas subsequently being stored and at a later stage utilized for peak shaving (e.g. in gas turbines or fuel cells), eventually converted by Biofuel catalysis to transport fuel.
- Biomass could be thermally gasified and stored, eventually converted into transport fuel using Biofuel catalysis.
- Another possibility could be to digester biomass, upgrading methane to get natural gas quality and

**Figure 45 -** Possibilities in interactions between the grids. The internationally connected grids for power and natural gas are highlighted while the local district heating networks are shown as being partly supplied by waste heat from gas and power processes.

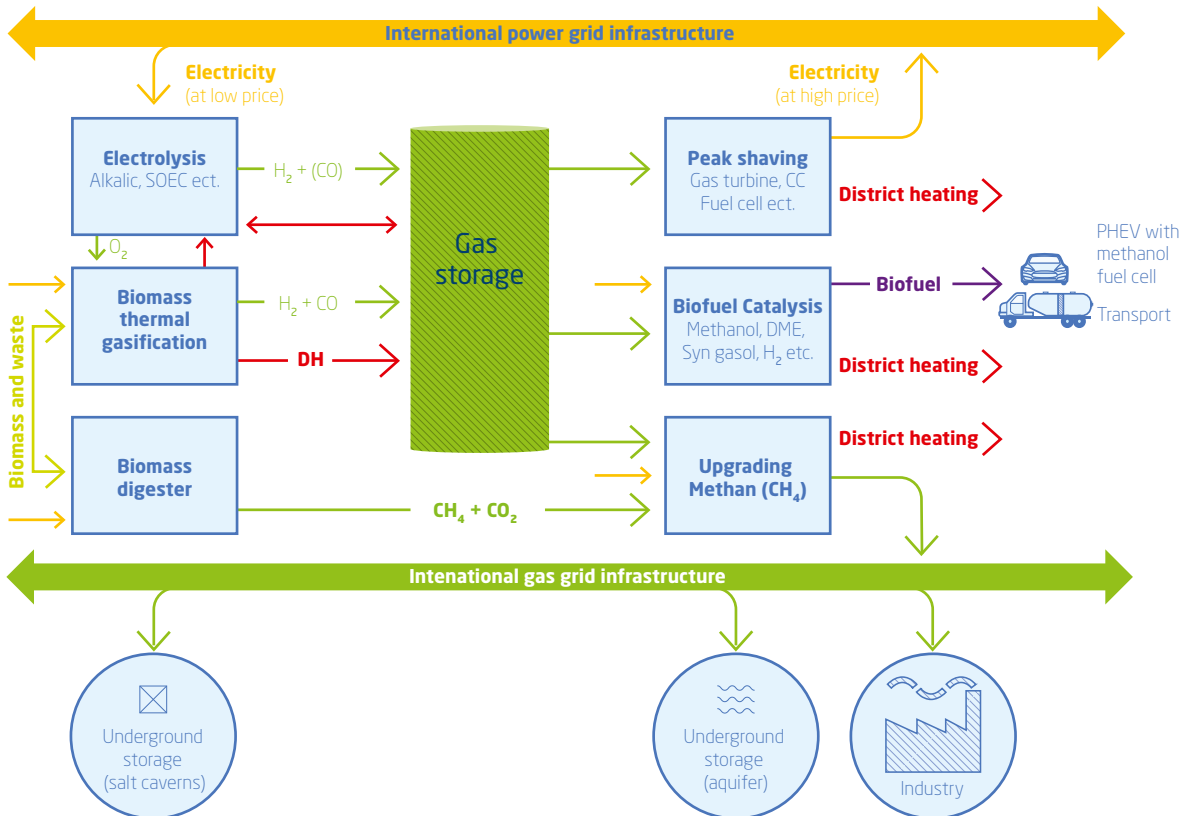

subsequently insert it into the natural gas grid. An interesting opportunity is to inject hydrogen based on electrolysis into the biogas process and in this way get biogas upgraded to methane.

Moreover, interplay between the different processes will increase the flexibility even further; however some of these solutions might prove quite costly. Finally, to increase the value of gas it is important that the transport sector is part of this cycle, as transport fuel is the most difficult to replace and has a fairly high cost.

The role of the district heating network will not only be to utilize waste heat from the above-mentioned processes, although this might be an important issue to get high system efficiency. The district heating network will by itself act as a storage facility for absorbing excess wind power:

- Large heat pumps may be installed in the district heating network utilizing excess power production from wind turbines when there is plenty of wind. The district heating system may then act as storage facility using the existing hot water storage tanks but also utilizing the large amounts of water in the grid as a buffer.
- The existing CHP-production on large-scale coal-fired power plants may gradually be converted to biomass or decommissioned implying that a smaller part of the district heating supply would be covered by CHP. Thus, new supplies of district heating based on renewable sources would have to be introduced into the energy system. However, also an increased utilization of waste heat from industrial processes could be utilized through the district heating system.

The attempt to increase energy efficiency will imply that the future energy system also will increase significantly in complexity, implementing new possibilities of interacting grids. A major outcome will be that more products will be produced by the energy system and especially a strong link will be established from the power and gas sectors to the transport sector, implying increased security of supply for society at large.

Thus, although the Danish energy system is facing a number of challenges, new solutions increasing

the flexibility and the efficiency of the system are on the way.

### Summary and recommendations

- The high and fast-increasing amounts of wind power in the Danish energy system (39% of total power supplied by wind turbines by 2014) will require innovative and advanced solutions for the future, including interactions of energy system components.
- Interactions between the three major networks – the power grid, the natural gas grid and the district heating network – opens up for a number of flexible solutions:
  - Excess wind power can be utilized for producing hydrogen (electrolysis) subsequently upgraded to natural gas quality or used as transport fuel
  - A future opportunity is to inject hydrogen based on electrolysis into the biogas process and in this way get biogas upgraded to methane.
  - Large heat pumps may be installed in the district heating network utilizing excess power production from wind turbines when there is plenty of wind
  - The district heating system may act as storage facility using the existing hot water storage tanks, but also utilizing the large amounts of water in the grid as a buffer.
- It is important that the numerous opportunities opened up by system interactions are analysed in an energy system context to provide a solid basis for decision-making
- When several grids are interacting the complexity of the system will be strongly increased, and might require the development of advanced control and communication systems
- The strong network of international interconnectors may be further expanded, however, this has to be done with a balanced view to other flexible solutions.

## Chapter 11

# Energy systems integration for a decarbonising world

By **James Haselip, Rasa Narkeviciute, Gordon Mackenzie,**

UNEP DTU Partnership, DTU Management Engineering;

**Bothwell Batidzirai,** Energy Research Centre,

University of Cape Town, South Africa

### Global perspective to understanding the needs, trends, and barriers to scaling up grid-connected renewable energy

There is an ever-stronger scientific consensus that anthropogenic climate change, due to the accumulation of greenhouse gases in the atmosphere, is a reality [11.4]. There is strong evidence that a major contributor to global warming is the atmospheric accumulation of carbon dioxide (CO<sub>2</sub>) from the combustion of fossil fuels that provide energy for transport, industrial production, households, commerce and not least electricity generation. Addressing the issue of climate change at the national as well as the global level will inevitably involve a massive increase in the utilization of low CO<sub>2</sub>-emitting forms of energy, and particularly grid-connected RETs such as wind, solar, geothermal, hydropower and biomass. In general, an increased utilization of RETs inevitably requires in turn more integrated energy systems, mostly in order to address the temporal imbalances between the supply and demand for electricity from the grid. The need for more ESI is manifested essentially in three ways [11.1]:

1. The fluctuating or intermittent nature of many renewable energy sources (primarily solar and wind), coupled with a shortage of natural and cheap storage possibilities for electricity, implies a temporal dimension. There is a need to manage intermittent power generation, often from different sources, both at the short timescale (frequency) and the long timescale (generating capacity), as well as considerations of moving

electricity demand from periods of maximum load (load levelling).

2. Renewable energy sources are often highly localized and distant from the main centres of energy load, necessitating the transport of (mostly) electricity over significant distances, even across national boundaries. Hence, spatial integration of energy systems is an important issue.
3. There are opportunities to maximise the rational use of renewable energy by planning and operating energy systems in a more holistic way, i.e. sectoral integration that takes into account the storage possibilities of the transport, space heating and water supply systems. In addition, the integrated planning and operation of energy systems across sectors, such as health, agriculture, education and water supply, is an essential component of meeting the future sustainable needs of developing societies, where integrated matching of supply and demand is often lacking.

Given the overriding need to increase levels of access to modern energy in most lower-income countries, while pursuing a low-carbon development path, this chapter focuses on temporal and spatial ESI as the key means to scale up investment in grid-connected RETs. As such, the focus here is primarily on electricity generation, as opposed to ESI for natural gas or district heating which generally require higher-cost infrastructure investments that in any case may not be relevant for lower-income countries with warmer climates.

## Global energy trends to 2040

### Energy demand evolution

Global energy demand is set to increase in the coming decades, and particularly in countries that are expected to witness significant economic growth [11.2], [11.3]. However, there is a large disparity among regions, countries, and socio-economic groups in terms of how and how much energy will be used. Industrialized countries and high-income groups use a larger proportion of their energy for transport, while in developing nations and among low income groups, the majority of energy is used for residential/commercial needs – in other words: lighting, temperature control, and cooking. As these countries develop and industrialize, they will experience additional energy needs.

The IEA’s World Energy Outlook 2014 estimates that the world primary energy demand will increase by 37% by 2040, if current and planned policies (e.g. national plans for reducing GHG emissions) are taken into account. The main regions driving this growth trend are industrialising countries in the South and East Asia, as well as Africa. In *Figure 47*, the yellow and red bars in the regional charts indicate the 2012 and 2040 demand levels in Mtoe respectively, and the largest increases are apparent in non-OECD Asia and Africa. Asian and African countries are projected to

contribute 62% and 12% of the increase in primary energy demand. Increasing access to modern energy services, population growth, improved quality of life and demand for energy services in these regions will both necessitate and enable greater spatial and temporal ESI, to allow for the scaled-up use of RETs.

### Future energy and emissions challenges in developing countries

Higher-income countries and the larger ‘emerging economies’ (including China) face significant different challenges in planning their future energy systems in comparison with developing countries, e.g. Sub-Saharan Africa. While energy security and the impact on the environment are important factors across the globe, developing countries face additional challenges of ensuring access to electricity (as the main modern energy carrier), and clean fuels, mainly for cooking. As populations grow, so do the challenges. In particular, energy access is an essential development priority, which has major implications for demand growth and the need for greater ESI, if we assume RETs are to meet the majority of future electricity demand. There are nearly 1.3 billion people in the world currently without access to electricity, about half of them in Sub-Saharan Africa. As populations grow, nearly 1 billion people in Sub-Saharan Africa are expected to gain access

**Figure 46** - World final energy (GJ) per capita vs cumulative population for 11 regions sorted by declining per capita energy use (colour bars) and total per capita final energy use for 137 countries in 2005 (black, solid line) [11.2].

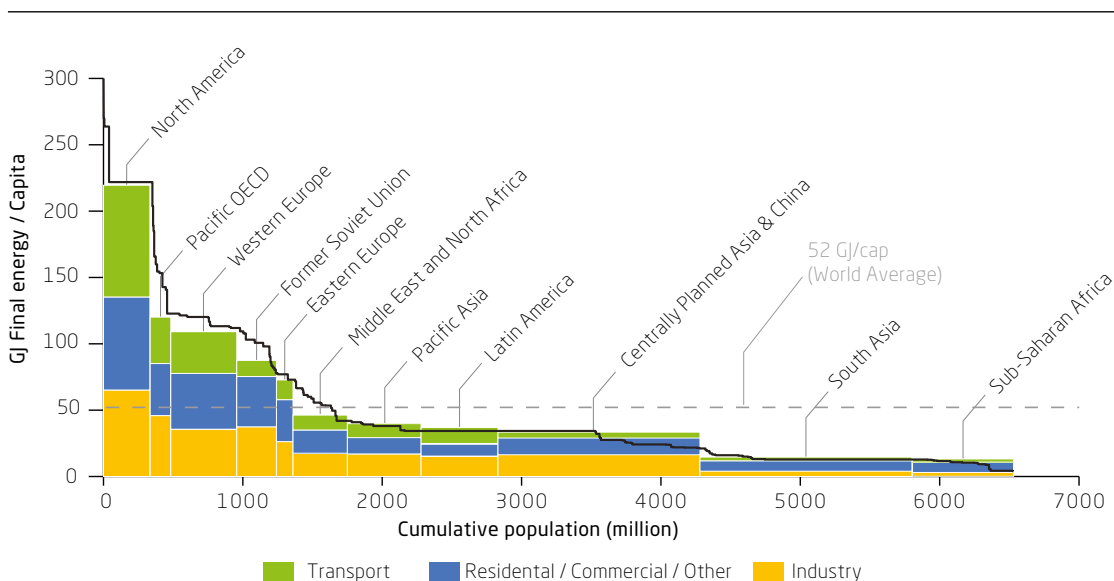
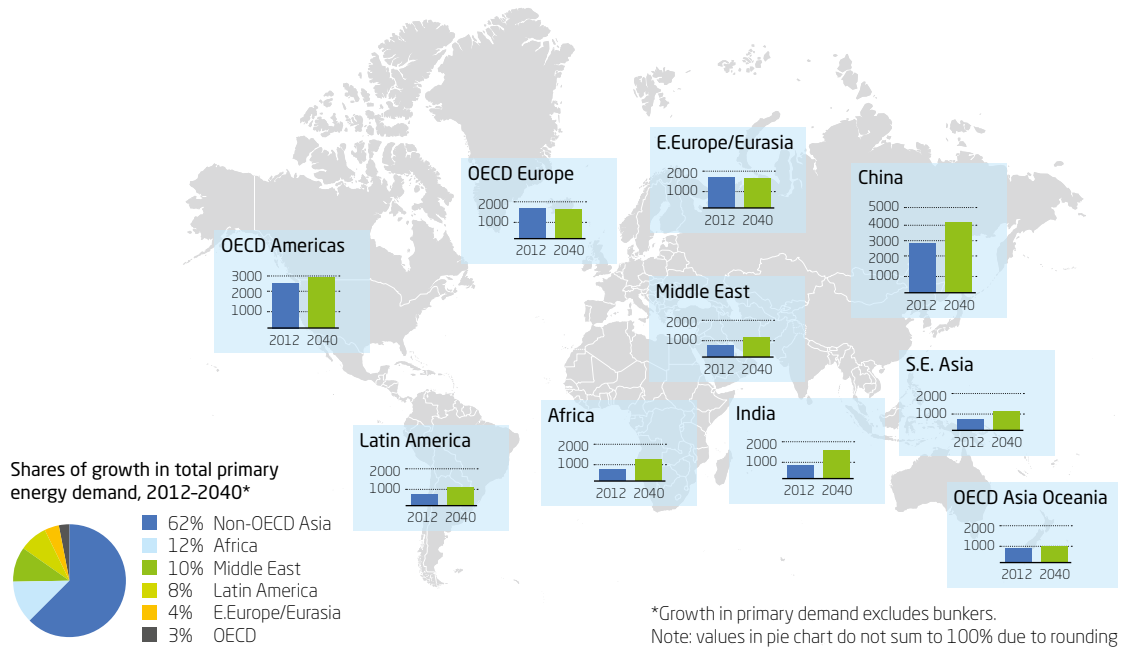



Figure 47 - Primary energy demand by region in the New Policies Scenario (Mtoe) [11.3].



to electricity before 2040 [11.3], though this would still leave 500 million without access, for which traditional and non-grid RETs are likely to be the only viable solution. As such, it is important to clarify that ESI is unlikely to affect – or be of benefit to – the 500 million people that are expected to occupy the bottom of the energy pyramid in 2040.

Limiting global temperature increase to below 2 degrees (above pre-industrial levels) requires a

significant commitment to reduce GHG emissions, across all economies. Specifically, to keep the global mean temperature rise below this 2-degree level with 50% probability requires stabilizing the concentration of GHG in the atmosphere below 450ppm CO<sub>2</sub> eq. [11.4]. With current and planned policies, it is projected that the remaining carbon budget to keep the long-term concentrations below this level, will run out in 2040 [11.3]. Taking into account the need to increase energy access in developing countries through the lens of climate change, it is clear that the scaled-up use of grid-connected RETs (as well as greater energy efficiency), will play a driving role, thus indicating the need for greater temporal and spatial integration of energy systems.

Figure 48 - Share of global renewables consumption by sector in the New Policies Scenario (IEA WEO).

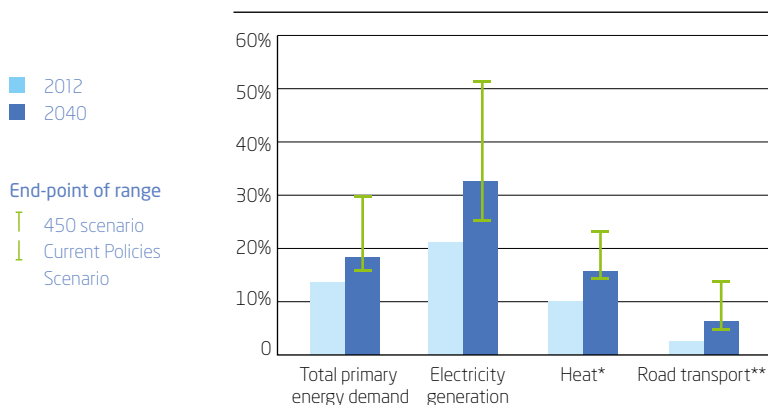

### Role of renewables in solving energy challenges

As IEA [11.3] states: “If carefully developed, renewable energies can provide many benefits, including job creation, increased energy security, improved human health, environmental protection, and mitigation of climate change.” Renewable energy has the potential to address many of these challenges, and it has a key role to play in developing countries, many of whom have significant wind, solar, geothermal and hydro



resources. As technologies improve and economies of scale are harnessed, the cost of generating power from proven RETs (per megawatt-hour) is dropping and is expected to decline further. Cost reductions as well as policies to support or incentivise investment are driving the uptake of RETs around the world. The share of renewables is projected to increase significantly by 2040/2050 in all sectors: from 13% to 19% in the new policies scenario [11.3].

Renewable energy resources are especially significant for future electricity generation. Depending on the scenario and methodology used, the share of renewable generation is projected to increase to between 25% and 52% (as compared to 21% in 2012).

Under the IEA’s New Policies scenario, renewable generation triples between 2012 and 2040, avoiding a total of 6.6 Gt of CO<sub>2</sub> emissions in the year 2040 (that would arise if non-renewable generation was used instead). Nearly three quarters of these savings come from new power plants, indicating a significant increase in the future commissioning of renewable power plants. *Figure 49* shows the CO<sub>2</sub> emissions avoided in 2040 from the use of different types of renewables. The majority is attributed to hydro, followed by wind energy.

A significant proportion of the 1,317 million people without access to electricity [11.5] live in remote areas, and connecting those areas to the grid is often technically difficult and prohibitively expensive [11.6]. In such cases mini-grid and off-grid systems are the best solution, where RETs, in particular mini-hydro and solar PV, are more often than not the most viable for electricity generation.

At the same time, larger RET projects will be required to ensure large-scale connections to grid, supplying urban, peri-urban and accessible rural demand loads. Different regions or areas have different resource potential, and by focusing on the most abundant resources and creating regional pools, costs can be lowered and power supply reliability improved [11.3]. Harnessing these grid-connected renewable energy sources implies both spatial and temporal ESI, which, in turn, requires the creation of solid framework conditions for investment (either public or private), overcoming a range of regional and national non-financial risks.

**Figure 49** – Global CO<sub>2</sub> emissions avoided in 2040 from increased use of renewables in the New Policies Scenario [11.3].

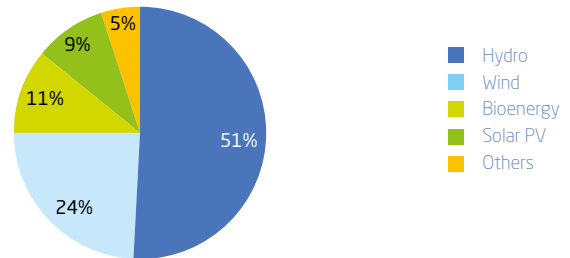

\*Solar CSP, geothermal and marine

**Figure 50** – Technology mix for mini-grids and off-grids in sub-Saharan Africa, 2040 [11.3].

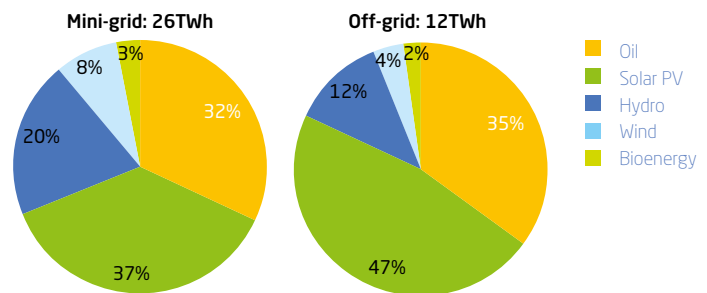

### Regional and national non-financial risks and framework conditions

In order to assess the trends and barriers to greater spatial and temporal ESI it is necessary to consider the main non-financial risks that stand to constrain or limit investment in ESI, especially in the non-OECD regions that will dominate future energy demand growth. These constraints include conflicts between national priorities for energy security and regional integration, macro-economic (in) stability, geopolitical risk, terrorism, and climate change. All of these risks affect investor confidence and influence government decision making.

It is relevant to highlight the issue of market and regulatory conditions in non-OECD energy markets, i.e. the extent of liberalisation, private investment and competition by major donors (principally the World Bank Group), how this is likely to affect interest and uptake of ESI technology and policy. In doing so these issues can be highlighted as a pressing reality in non-OECD regions and countries, as compared

Table 6 – Projected share of renewables in power generation (sources as in table).

Share of renewables	Year	Source	Notes
25%-51%	2040	IEA	25% corresponds to the 'current policies scenario' while 51% is the optimistic '450 scenario'
33%	2040	IEA	New Policies scenario
31%-48%	2050	WEC	
30%-70%	2050	GEA	In some regions, the share of renewables is 90%

to where ESI has, thus far, mostly been pursued (North America, EU, China). This points to the need for a 'reality check' when discussing complicated technologies and policies that depend upon an array of stable factors that cannot be assumed to exist in Africa and LatAm, for example.

### Non-financial risks facing energy markets in developing countries

To date most ESI in developing countries (excluding China), to the extent that it exists, has addressed spatial integration, i.e. the distribution of energy from large centres of generation to major demand centres. More often than not, this is the transmission of electrical energy across national borders through grid interconnectors, supplying for example power from large-scale hydro plant to neighbouring countries that do not have significant or low-cost domestic primary energy resources.

Indeed, there are significant technical opportunities to further harvest renewable energy from high-resource areas, though this requires high levels of coordination and control across large geographic areas that in turn are faced by significant non-financial barriers and constraints. Unlike the EU or US where a strong legal, regulatory and macro-economic framework offers security and certainty for investors (whether public or private) in ESI projects, the political and economic landscape in most regions of the developing world present significant risks to investors. These risks include:

- Diverging political agendas and/or lack of political consensus on development pathways

- Influence of major foreign States and development partners including the World Bank and China (see previous point)

- Lack of monetary unions (however these do exist, such as in West Africa) that create financial risks including currency fluctuations and inflation

- Armed conflicts, terrorism, civil or region wars

- Climate change, specifically its impact of the stability of renewable energy resource distribution, including changing precipitation (for hydropower projects), wind and solar and well as the impact of extreme weather events on such infrastructure

Nonetheless, there is increasing regional integration, at least on a political level, occurring in many parts of the developing world. Political and economic integration is occurring in South America through various groups and levels, including MERCOSUR in the 'Southern Cone' and Brazil and the continent-wide UNASUR. The UNASUR was signed in 2008 and oversees the Initiative for Infrastructure Integration of South America (IIRSA) that has also received financial support from multi-lateral agencies including the Inter-American Development Bank and the Development Bank of Latin America.

Plans for an 'Energy Ring' to interconnect Argentina, Brazil, Chile, Paraguay, and Uruguay with natural gas from various sources, including Peru's Camisea Gas fields and the Tarija production in southern Bolivia are being slowly realised. There is a strong need to connect centres of natural gas production

Figure 51 - Primary energy resource distribution in Africa [11.3], [11.2], [11.4].

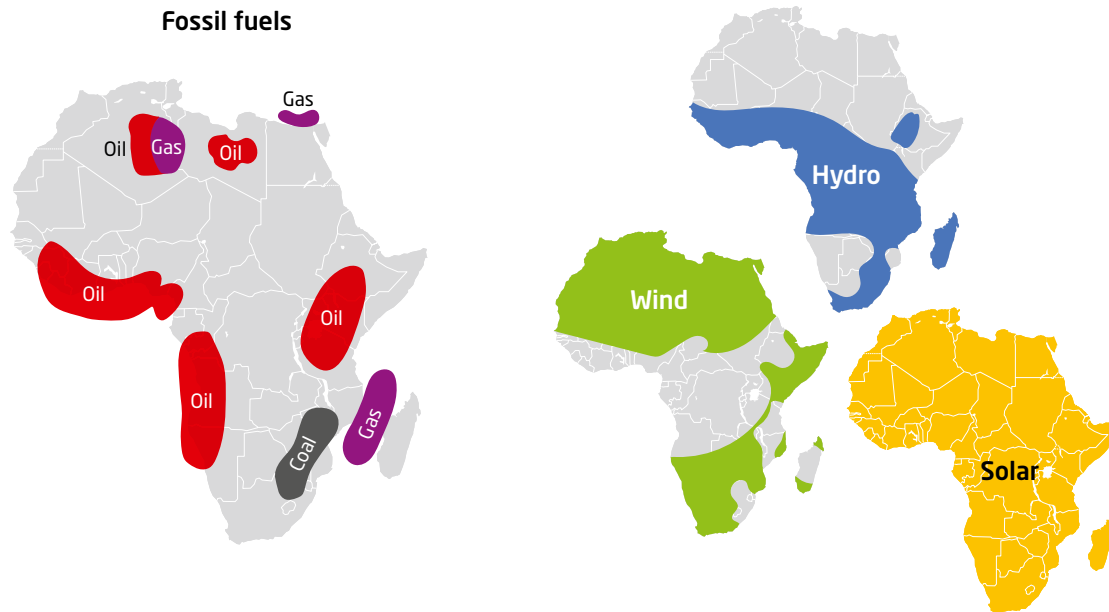

to centres of demand within the region, for example from land-locked Bolivia that has minimal industrial demand to neighbouring Chile whose economy, and mining sector in particular, is suffering from energy constraints, including the high cost of imported fossil fuels. However, despite strong high-level political commitments to achieve greater natural gas integration, the reality of signing mutually beneficial agreements and attracting investors has proved difficult and Chile has opted to diversify its primary energy imports by constructing shipping terminals to import LNG, thus avoiding cross-border complications.

In Africa, the most infamous example of a spatial ESI project is the 'Grand Inga' hydropower plant in the Democratic Republic of Congo, which would be an extension of the existing Inga hydro plant on the Congo River and which could generate 44 GW of power cost approximately US\$ 50 billion to construct (IRENA, 2012). Grand Inga is listed as a priority development by the Southern African Development Community (SADC), and by the New Partnership for African Development (NEPAD). However, plans to develop Grand Inga have been under discussion since the 1960s, when construction began on the 350MW Inga I dam. Feasibility studies were first conducted in the 1990s by a consortium led by EDF

which concluded that Grand Inga was technically, economically and environmentally viable in 2007, the African Development Bank commissioned another US\$14 million feasibility study. More recent plans involve a partnership between China and the World Bank to finance and construct the first phase of expansion.

Operating at full capacity, Grand Inga would increase total power supply across Africa by a third, and generate twice as much electricity as the Three Gorges Dam in China – as much as 320 terawatt hours per year. Located 250 km west of Kinshasa, Grand Inga provides a geographically central location from which to transmit electricity to supply other African countries as far away as Egypt, Nigeria and South Africa.

The lack of low-cost and reliable electricity is one of the key economic barriers to African development, though poor governance and instability also undermine industry investment, thus many least-developed countries are stuck in an apparent vicious cycle of poverty, corruption and poor infrastructure and public services. The World Bank estimates that power outages cost African economies as much as two percent of GDP, and for the continent's big businesses, unreliable electricity supplies reduce revenues by as much as six percent. Despite

the high construction cost and huge transmission distances, the WEC estimates that Grand Inga could even supply electricity to southern Europe at lower than current retail prices. According to the IEA, DR Congo has one of the lowest electrification rates in the world, at 8 percent. If Grand Inga's full capacity were utilised, it would help provide access to electricity for the estimated 500 million Africans who currently live without it. However, DR Congo remains one of Africa's least investor-friendly countries, with ongoing conflicts in the eastern Kivu region making the country politically unstable, in addition to an array of infrastructure and capacity shortcomings typical of low-income African countries.

Another major spatial ESI project in Africa is the Desertec Industrial Initiative that was set up in 2009 to pursue the huge technical opportunities of transporting grid-connected solar power generation of the Sahara to the EU grid via undersea DC cables. On a purely technical and economic level, many

African solar energy projects have been deemed profitable, with modest FIT support from European markets. An example is the 'TuNur' project in Tunisia to supply the Italian grid with 2.25 GW of power generated by Concentrated Solar Power (CSP) technology. However, recent political instability in North Africa, triggered by the so-called 'Arab spring' of 2011 combined with weak political support from EU governments in the face of concerns over energy security and terrorism has scared away investors, thus illustrating the kind of non-financial risks that can delay or cancel plans for what are otherwise technically and economically viable intercontinental ESI projects.

### Case study 1: Integrating large-scale wind power in China

China's National Energy Administration has set national renewable and nuclear energy targets, one of

Figure 52 - Potential grid infrastructure to distribute renewable power generation from North Africa and the Middle East to (mainly) Europe.

Source: DESERTEC Foundation, [desertec.org](http://desertec.org).

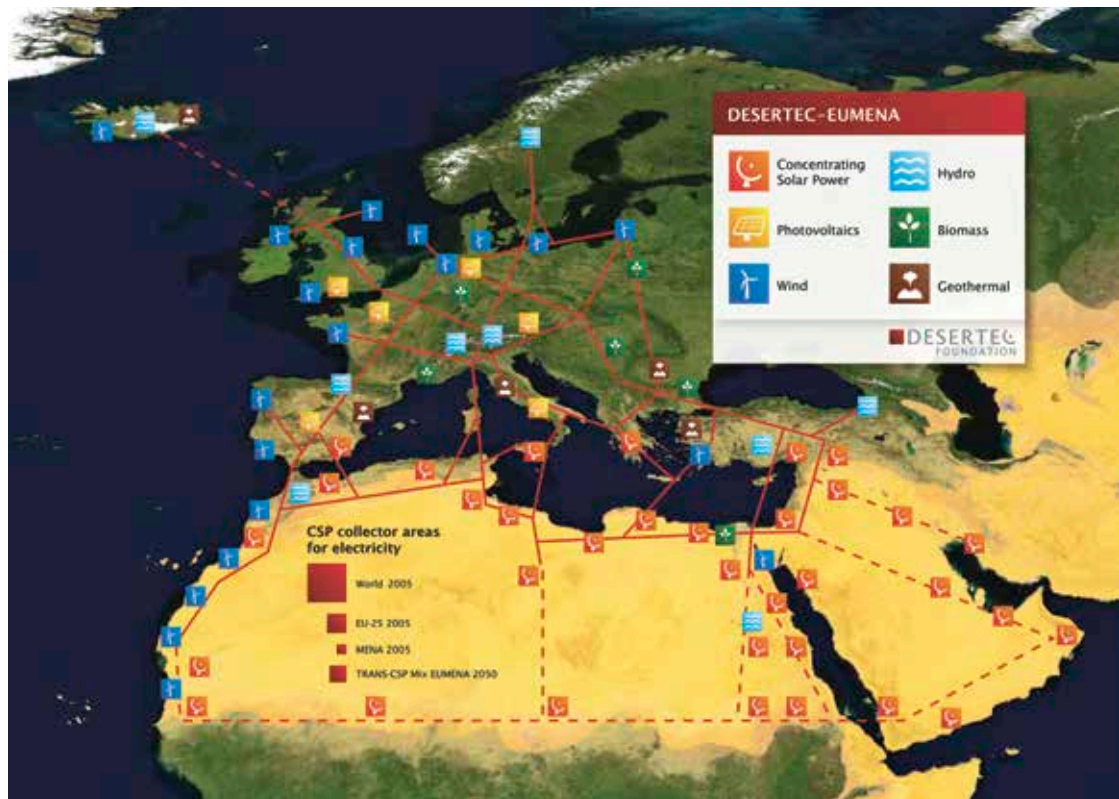

which is to have 15% non-fossil fuel energy in the total primary energy mix by 2020. Since the enactment of Renewable Energy Law in 2005, renewable capacity (excluding hydro) has increased exponentially and by 2010 China's installed wind power capacity had become the world's largest [11.10]. Although the share of renewables remains small due to even higher increases in coal capacity, the country faces the challenges posed by the intermittency and location of its major wind resources. However, to support China's clean energy goals (increased proportion of non-fossil fuels in the energy mix, reduced energy and CO<sub>2</sub> emissions intensity of GDP), wind capacity is expected to grow further, and detailed resource assessments have been conducted both for onshore and offshore potential generation.

Long-distance power transmission and grid integration is an important factor for future deployment of wind power. China's wind resources are concentrated far from the demand centres, and the grid infrastructure and transmission capacity have not kept up with the increasing generation capacity. At the same time, local power demand is low and there are insufficient resources to balance the market. Finally, the power market for trade among regions is not well-developed in China, unlike in the EU or US. These issues lead to significant curtailments of wind generation [11.5], and a higher proportion was curtailed in regions with a higher share of wind generation [11.11].

Partly in an attempt to address the curtailment problem, a pilot system of 'efficient' dispatch was set up in 2007 in 5 provinces and expanded to another 5 in 2010. In this system, wind and other renewables are dispatched first, followed by fossil power, in order of efficiency. However, it has not been expanded to the national level, as the system lacks a generation pricing system which creates distorted revenues.

The challenge of long distance transmission to achieve greater spatial and temporal integration therefore key to scaling-up China's use of RETs, and one of the national priorities is to build a high voltage transmission infrastructure to connect the different (currently largely disconnected) regional grids, leading to a national grid. However, even with better interconnection, the exchange will be challenged by

the rigid power market rules where prices are remain largely State-regulated, which limits the integration of a higher share of renewables, unlike in the liberalized Nordic power market. Similarly, demand-side measures that can increase flexibility in consumption/peak load times, and thereby facilitate renewable integration, cannot be used in the same way in China, as they are in some European countries (e.g. Finland), due to the complex electricity pricing and absence of real-time market trading. Nevertheless, smart meter pilot projects have started in China, which will enable the measurement of real-time consumption, as an important step towards greater demand-side management and the integration of more RETs into the grid.

Finally, China is looking at electricity storage options as a means to integrate a higher share of renewables, of which the preferred options are pumped hydro and electric vehicles, as these are potentially large-scale opportunities. Electric vehicles are being introduced in Chinese cities, and the standardization of charging facilities is underway. However, in order for this to be a viable option for generation balancing, major investments in infrastructure will be required, in addition to policies and incentives to shape consumer behaviour.

## Case study 2: Electricity market integration under the Southern African power pool

Access to electricity in Southern Africa ranges from 75% in South Africa to 8% for the Democratic Republic of Congo (DRC) [11.12]. Regional electricity forecasts for 2010–2040 anticipate an average annual growth in electricity consumption of 4.4% and an increase in average electricity access across the region to 64% by 2040. This will require an additional 129 GW of installed capacity within the region [11.13]. Current installed capacity in the region is 57 GW, of which nearly 53.7 GW is interconnected, only 51.3 GW is available and 70% is coal-based. South Africa accounts for about 80% of total capacity. Generally, available capacity falls short of requirements and planned load shedding has become a permanent feature in most SADC countries, forcing consumers to invest in standby capacity, usually petrol or diesel generators using expensive imported fuel (*ibid*).



Several options are open to countries to address the huge energy gap in the region. These include, among other options, the enhancement of intra-regional energy cooperation. This is required because the electricity markets in many countries in the region are very small and may not be able to finance the huge investment costs needed to develop alternative energy sources [11.2]. Africa has made great strides in enhancing energy related regional cooperation through regional power pools and electricity regulators. Although challenges still exist, there are opportunities for countries to share the risks and costs of investment and extend supplies from countries with excess generation capacity to countries with chronic deficits [11.14]. This also provides opportunities to share green energy from countries endowed with renewable energy resources to countries that are largely fossil based such as South Africa. A key barrier to GHG emission reduction in South Africa is the lack of immediate low carbon fuel switching options in the country.

Created in 1995, the Southern African Power Pool (SAPP) is a specialized institution of SADC mandated to improve energy supply within the region by integrating national power system operations into a unified electricity market. It was established on the basis of historical interconnections between 9 of the 12 member countries [11.13] and allows for the free trading of electricity between SADC member countries, providing its member states with access to the clean hydropower potential in the countries to the north, notably the significant potential in the Congo River (see discussion of the Grand Inga project above). The bulk of trading arrangements in SAPP are concluded under bilateral contracts. However, the development of the regional trade is constrained by transmission congestion within the transit countries and at interconnection level. This constraint is also affecting the development of available power generation capacity in countries like Mozambique, Zambia and Zimbabwe. Therefore, the implementation of SAPP generation and transmission priority projects will contribute to scaling up the regional energy market by providing a better energy mix (hydro represents 80% of new priority generation projects), better security of supply and grid stability (almost all SAPP countries are contributing with new generation capacity). According to IRENA [11.13], there is no policy or legal barrier to cross-border trading in any of

the countries in electricity and in renewable energy project development.

## Conclusions

When it comes to understanding the opportunities, barriers, and risks to investing in greater spatial and temporal energy integration in developing countries, it makes sense to look at the broad economic, legal, and regulatory regimes in place in each country. It is useful to consider what has happened, and what works, in more developed regions, principally the EU and US. EU countries, partly due to EU-wide policy reform, and most US States have embraced a model of energy market liberalization characterized by high levels of privatisation, competition and regulation that is mostly limited to standard-setting and quality control. However, while such liberal framework conditions have been effective in attracting investment, achieving price stability, improved service quality, and technical efficiency, ESI strategies and technologies that address spatial and temporal mismatches also depend upon strong government-driven planning efforts and incentives. Indeed, it appears that market forces alone are insufficient to drive forward ESI and that clear direction and coherent planning from governments and energy market regulators are necessary, not least to help overcome the range of non-financial risks discussed in this article.

Future research on the topic of ESI as a means to accelerate the global decarbonization agenda should focus on the regions and sectors that are projected to make up the majority of future energy demand growth, in addition to analyses of how large-scale fossil fuel energy infrastructure can be phased out across the world. There is also a case for pursuing research into the relationship between ESI and energy access. For example, Southern Africa has significant hydro, biomass, wind and solar energy resources, combined with low levels of access (except in South Africa). However, these resources remain largely unexploited partly due to poor or lacking grid infrastructure and limited regional power market integration. Applied research could explore the political, economic, and technical viability of accelerating greater ESI that would enable, but also depend upon, the bottom-up trends in industry innovation and investment in MW-scale power generation.



## Chapter 12

# Index

---

### A

ACs 67  
AD 63

### B

black-box 27  
BRPs 12, 35

### C

CHP 11, 19  
COP 70  
CWE 81

### D

DC 36  
DERs 36  
DH 26

### E

EDF 89  
ESI 14  
ESO 28

### H

HVDC 62

### I

ICT 34, 40, 58  
IEA 14, 85, 86

### M

MCC 67  
MSW 64

### N

NEPAD 89  
NordPool 81  
NWE 81

### O

ORC 66

### P

PEMCs 67  
PHS 74

### R

RETs 84, 85, 86, 87, 91

### S

SADC 89  
SOCs 67  
SOEC 68  
SOFC 63

### W

WEC 90  
white-box 27  
WtE 64  
WWTP 28

## Chapter 13

# References

### Chapter 4

- 4.1 Østergaard, J., Heussen, K.: Grid storage and flexibility, In: DTU Energy Report 2013, 2013.
- 4.2 **Energinet.dk**: Sammentænkning, Strategiplan 2014 (in Danish), 2014.
- 4.3 **The Partnership Smart Energy Networks**: Vision for Smart Energy Networks in Denmark, Research, Development and Demonstration, 2015.
- 4.4 Rifkin, J., **The Third Industrial Revolution**: How Lateral Power Is Transforming Energy, the Economy, and the World, 2013.
- 4.5 **IBM, Smart Planet** (<http://www.ibm.com/smarterplanet>)
- 4.6 **Siemens**: Sustainable Cities (<http://www.siemens.com/cities>)
- 4.7 **GE**: Industrial Internet (<http://www.ge.com/stories/industrial-internet>)
- 4.8 **Cisco**: Internet of Everything (<http://ioeassessment.cisco.com/>)
- 4.8b **Tesla Motors**: PowerWall (<http://www.teslamotors.com/powerwall>)
- 4.9 **Wu, Q.**: Grid Integration of Electric Vehicles in Open Electricity Markets, Wiley-VCH, 2013.
- 4.10 **Ding, Y., Nyeng, P., Østergaard, J., Maj Dang Trong, Pineda, S., Koen Kok, Huitema, G.B., Grande, O.S.**: Ecogrid EU – a large-scale smart grids demonstration of real time market-based integration of numerous small DER and DR, 3rd IEEE PES International Conference and Exhibition on Innovative Smart Grid Technologies (ISGT Europe), 2012, Berlin, Germany, 2012.
- 4.11 **Larsen, E. M.**: xxx
- 4.12 **PowerLabDK - experimental platform for electric power and energy** (<http://www.powerlab.dk>)
- 4.13 **EnergyLab Nordhavn** (<http://energylabnordhavn.dk>)

- 4.14 **Østergaard, J., Nielsen, J.E.**: The Bornholm Power System, An Overview (available from: [www.powerlab.dk](http://www.powerlab.dk)), 2011.

### Chapter 5

- 5.1 **P. Meibom, K. Hilger, H. Madsen, D. Vinther**: Energy comes together in Denmark: The key to a future fossil-free Danish power system, IEEE Power and Energy Magazin, Vol. 11, pp. 46–55, 2013.
- 5.2 **Skytte & Ropenus**: 2006, Assessment and recommendations. Overcoming in short-term grid system regulatory and other barriers to distributed generation. DG-GRID project, report D2, 2006. 108 p.
- 5.3 **Skytte & Ropenus**: 2007, Economic, policy and regulatory barriers and solutions for integrating more DER in electricity supply. SOLID-DER project.
- 5.4 **Ropenus, S & Skytte, K**: 2007, 'Regulatory review and barriers for the electricity supply system for distributed generation in the EU-15' Int. J. Distr. Energy Resources, vol 3, pp. 243-257.
- 5.5 **O. Corradi, H. Ochsenfeld, H. Madsen, P. Pinson**: Controlling electricity consumption by forecasting its response to varying prices, IEEE Transactions on Power Systems, Vol. 28, pp. 421-429, 2013.
- 5.6 **H. Madsen, J. Parvizi, R. Halvgaard, L.E. Sokoler, J.B. Jørgensen, L.H. Hansen, K.B. Hilger**: Control of Electricity Loads in Future Electric Energy Systems, in Handbook of Clean Energy Systems, Wiley, 2015.
- 5.7 **Kristensen, N. R.; Madsen, H. & Jørgensen, S. B.**: Parameter estimation in stochastic grey-box models Automatica, 2004, 40, 225–237.
- 5.8 **Halvgaard, R. F.; Munk-Nielsen, T.; Tychsen, P.; Grum, M. & Madsen, H.**: Stochastic Greybox Modelling of an Alternating Activated Sludge Process, IWA Specialist Conference, Watermatex, 2015

- 5.9 **Hedegaard, K., H. Ravn, N. Juul, P. Meibom, 2012**. Effects of electric vehicles on power systems in Northern Europe, 48:1, 356–368. Conference article presented at: 6th Dubrovnik Conference on Sustainable Development of Energy, Water and Environment Systems, Dubrovnik.
- 5.10 **Karlsson, K., P. Meibom, 2008**: Optimal investment path for future renewable based energy systems using the optimization model Balmorel. Int. J. Hydrogen Energy 33: 1777–1787.
- 5.11 **Hethey, J., Kofeod-Wiuff, A., Bornak, L. P., Lindboe, H. H., Sawatzki, S., Vestarchi, M., Skytte, K., Katz, J., Egerer, J., Zerrahn, A. & von Hirschhausen, C.**: 2015 Berlin Increased Integration of the Nordic and German Electricity Systems – Full Version: Modelling and Assessment of Economic and Climate Effects of Enhanced Electrical Interconnection and the Additional Deployment of Renewable Energies. Agora Energiewende. 170 p.

### Chapter 6

- 6.1 **Madsen, H., Parvizi, J., Halvgaard, R., Sokoler, L.E., Jørgensen, J.B., Hansen, L.H., and Baggesen Hilger, K.**: (2015), 'Control of electricity load in future electric energy systems', Wiley Clean Energy Handbook.
- 6.2 **Gkatzikis, L., Koutsopoulos, I., and Salonidis, T.**: (2013), 'The role of aggregators in smart grid response markets', IEEE Journal on selected areas in communication, 31, 1247–1257.
- 6.3 **Giebel, G., Brownsord, R., Kariniotakis, G., and Draxl, C.** (2011): 'The state-of-the-art in short-term prediction of wind power; a literature review', Technical Report, DTU.
- 6.4 **Bacher, P., Madsen, H., and Nielsen, H.A.** (2009): 'Online short-term solar power forecasting', Solar Energy, 83, pp. 1772–1783.
- 6.5 **Taylor, J.**: 'An evaluation of methods for very short-term load forecasting using minute-by-minute British data', Journal of Forecasting, 24, 139–152.

- 6.6 **Morales, J., Conejo, A., Madsen, H., Pinson, P., and Zugno, M. (2014):** 'Integrating renewables in electricity markets', Vol. 205 of Operations Research and Management, Springer.
- 6.7 **Halvgaard, R., Poulsen, N.K., Madsen, H., and Jørgensen, J.B. (2013):** 'Thermal storage power balancing with model predictive control', in 'Proceedings of 2013 European Control Conference, July, Zurich, pp. 2567-2572.
- 6.8 **Madsen, H. (2008):** Time Series Analysis, Chapman & Hall.
- 6.9 **Corradi, O., Ochsenfeld, H., Madsen, H., and Pinson, P. (2013):** 'Controlling electricity consumption by forecasting its responses to prices', IEEE Transactions on Power Systems, pp. 421-429.

## Chapter 7

- 7.1 <http://www.elforbrugspanel.dk/Pages/Rapportering.aspx>, Danish Energy Agency, date visited: 03/26/2015.
- 7.2 Demand-side management – end-use metering campaign in 400 households of the European community – assessment of the potential electricity savings, Commission of the European Communities, 2002. SAVE PROGRAMME CONTRACT N° 4.1031/Z/98-267.
- 7.3 Residential monitoring to decrease energy use and carbon emissions in Europe, ISR – University of Coimbra, Coimbra, Portugal, 2008. IEEA programme.
- 7.4 **B. Grinden:** Analysis of monitoring campaign in Europe, ISR – University of Coimbra, Coimbra, Portugal, 2008. REMODECE project, IEEA programme.
- 7.5 **Andersen FM, Larsen HV, Kitzing L, Morthorst PE. (2014):** Who gains from hourly time-of-use retail prices on electricity? An analysis of consumption profiles for categories of Danish electricity customers, Wiley's Energy and Environment, 3, issue 6, p. 582-593. doi: 10.1002/wene.120
- 7.6 Elmodelbølg Statistics, Energy Agency, <http://statistic.electric-demand.dk/>

## Chapter 8

- 8.1 **Hulten, C. R. (1996):** Infrastructure Capital and Economic Growth: How well you use it may be more important than how much you have. NBER Working Paper Series, Working Paper 5847, National Bureau of Economic Research, 1050 Massachusetts Avenue, Cambridge, MA 02138, 1996.

- 8.2 **Faber, M. H. (2011):** On the governance of global and catastrophic risks, International Journal of Risk Assessment and Management 01/2011; 15(5/6):400-416. DOI: 10.1504/IJRAM.2011.043698.
- 8.3 **Kunreuther, H. and Useem, M. (2009):** Learning from Catastrophes: Strategies for Reaction and Response, Pearson Prentice Hall, Nov 16, 2009 - Business & Economics - 352 pages.
- 8.5 **U.S.-Canada Power System Outage Task Force Draft Report, (2006):** [http://energy.gov/sites/prod/files/oeprod/DocumentsandMedia/Outage\\_Task\\_Force\\_-\\_DRAFT\\_Report\\_on\\_Implementation.pdf](http://energy.gov/sites/prod/files/oeprod/DocumentsandMedia/Outage_Task_Force_-_DRAFT_Report_on_Implementation.pdf).
- 8.7 **Hampson, A., Bourgeois, T., Dillingham, G. and Panzarella, I. (2013):** Combined Heat and Power: Enabling Resilient Energy Infrastructure for Critical Facilities, by ICF International for Oak Ridge National Laboratory, Tennessee, 2013.
- 8.8 **Srinivasan, T. N. and Rethinaraj T. S. G. (2013):** Fukushima and thereafter: Reassessment of risks of nuclear power, Energy Policy 52 (2013) 726-736.
- 8.9 **Buldyrev, S. V., Parshani, R., Paul, G., Stanley, H. E. and Havlin, S. (2010):** Catastrophic cascade of failures in interdependent networks, Nature 464, 1025-1028 (15 April 2010).
- 8.10 **McCalley, J. D. and Krishnan, V. K.:** "Planning for Long Haul- Investment Strategies for National Energy and Transportation Infrastructures," IEEE Power and Energy "IEEE Power and Energy Magazine (2013).
- 8.11 **Meibom, P., Hilger, K. B., Madsen H. and Vinther, D., Energy Comes Together in Denmark:** The Key to a Future Fossil-Free Danish Power System, IEEE Power and Energy Magazine, vol. 11, no. 5, pp. 46-55, 2013
- 8.12 **European Commission's communication, (2010):** Energy infrastructure priorities for 2020 and beyond – A Blueprint for an integrated European energy network. ISBN 978-92-79-18877-0, doi:10.2833/78572.
- 8.14 **Ouyang, M., Dueñas-Osorio, L. and Min, X., (2012):** A three-stage resilience analysis framework for urban infrastructure systems, Structural Safety, Elsevier, 2012, Vol. 36, pp. 23-31.
- 8.15 **Francis R. and Bekera B. (2014):** A metric and frameworks for resilience analysis of engineered and infrastructure systems, Reliability Engineering & System Safety 121, pp. 90-103, 2014.

- 8.16 **Faber, M. H. (2015):** Codified Risk Informed Decision Making for Structures, In proc. to Symposium on Reliability of Engineering System, SRES'2015, Hangzhou, China, Oct. 15-17, 2015.
- 8.17 **Dueñas-Osorio, L. and Vemuru S. M. (2009):** Cascading failures in complex infrastructure systems, Structural Safety, Volume 31, Issue 2, 2009, Pages 157-167.

## Chapter 9

- 9.1 **Shedd, S, Hodge B.-M., Florita, A. (2012):** "A Statistical Characterization of Solar Power Variability at Small Timescales", Conference paper, NREL/CP-5500-56165. August 2012
- 9.2 **Fraunhofer ISE (2015):** "Recent Facts about Photovoltaics in Germany", compiled by Harry Wirth [www.ise.fraunhofer.de/en/publications/veroeffentlichungen-pdf-dateien-en/studien-und-konzeptpapiere/recent-facts-about-photovoltaics-in-germany.pdf](http://www.ise.fraunhofer.de/en/publications/veroeffentlichungen-pdf-dateien-en/studien-und-konzeptpapiere/recent-facts-about-photovoltaics-in-germany.pdf)
- 9.3 **EPIA (2012):** "Connecting the sun, Solar Photovoltaics on the road to large-scale grid integration", Full report, September 2012, page 29, [www.epia.org/fileadmin/user\\_upload/Publications/Connecting\\_the\\_Sun\\_Full\\_Report\\_converted.pdf](http://www.epia.org/fileadmin/user_upload/Publications/Connecting_the_Sun_Full_Report_converted.pdf)
- 9.4 **IEA (2014):** "Technology Roadmap, Solar Photovoltaic Energy, 2014 edition", [www.iea.org/publications/freepublications/publication/TechnologyRoadmapSolarPhotovoltaicEnergy\\_2014edition.pdf](http://www.iea.org/publications/freepublications/publication/TechnologyRoadmapSolarPhotovoltaicEnergy_2014edition.pdf)
- 9.5 **Denholm, P., Kuss M. and Margolis R.M. (2013):** "Cobenefits of large-scale plug-in hybrid electric vehicle and solar PV deployment", Journal of Power Sources, vol. 2, no. 36: 350-356
- 9.6 **pv magazine (2014):** [www.pv-magazine.com/news/details/beitrag/danica-pension--greengo-energy-complete-largest-rooftop-solar-plant-in-nordic-region\\_100017527/#axzz3buFKsq6F](http://www.pv-magazine.com/news/details/beitrag/danica-pension--greengo-energy-complete-largest-rooftop-solar-plant-in-nordic-region_100017527/#axzz3buFKsq6F)
- 9.7 **Jens Windeleff, Jan Erik Nielsen:** Solar district heating in Denmark. Danish Energy Agency and PlanEnergi, 2014.
- 9.8 <http://ramboll.com/projects/re/south-jutland-stores-the-suns-heat-in-the-worlds-largest-pit-heat-storage>

- 9.9 Simon Furbo, Mark Dannemand, Bengt Perers, Elsa Andersen, Jianhua Fan, Peder Bacher, Henrik Madsen, Rasmus Halvgaard, Henrik Aalborg Nielsen, Kristian Pagh Nielsen, Sisse Camilla Lundholm, Bent Hansen Sass, Thomas Engberg Pedersen, Jakob Nymann Rud, Kristian Harley Hansen: Solar/electric heating systems for the future energy system. Report R-288, Department of Civil Engineering, Technical University of Denmark, 2013.
- 9.10 DTU International Energy report 2013: Energy storage options for future sustainable energy systems.
- 9.11 Fried, L., Qiao, L., Sawyer, S., & Shukla, S. (2014): Global Wind Energy Outlook 2014. Global Wind Energy Council, Brussels.
- 9.12 Energinet.dk. (2014): Annual report 2014 - Ready energy - now and into the future. Fredericia: Energinet.dk.
- 9.13 Matthews, K. (2015): Taking control of our own energy destiny. Hentede 2015 fra Irish Examiner: <http://www.irishexaminer.com/ireland/a-debate-on-the-use-of-wind-power-in-ireland-310136.html>
- 9.14 Miller, N., & Clark, K. (2010): Advanced controls enable wind plants to provide ancillary services. IEEE Power and Energy Society General Meeting, Minneapolis: IEEE.
- 9.15 Barahona Garzón, B., You, R., Hansen, A., Cutululis, N., & Sørensen, P. (2013): Assessment of the impact of frequency support on DFIG wind turbine loads. 12th International Workshop on Large-Scale Integration of Wind Power into Power Systems as well as on Transmission Networks for Offshore Wind Power Plants (s. 6). London: Energynautics GmbH.
- 9.16 EWEA. (2011): Pure power. Wind energy targets for 2020 and 2030. Brussels: EWEA.
- 9.17 Caruso, J.: Denmark gets cheaper power from offshore wind turbines. Danish Ministry of Energy, Utilities and Climate. Available at <http://www.kebmin.dk/node/1379>. from 27 February 2015.
- 9.18 Sørensen, P., Pinson, P., Cutululis, N., Madsen, H., Jensen, L., Hjerrild, J., et al. (2009): Power fluctuations from large wind farms - Final report. Roskilde: Risø National Laboratory.
- 9.19 Cutululis, N., Altiparmakis, A., Litong-Palima, M., Detlefsen, N., & Sørensen, P. (2013): Market and system security impact of the storm demonstration in task-forces TF2. TWENTIES Deliverable D16.6.
- 9.20 Rasmussen, F., Grivel, J.-C., Faber, N., Mijatovic, N., & Abrahamsen, A. (2014): Emerging wind energy technologies. I.H. Larsen, & L. Petersen, DTU International Energy Report 2014.
- 9.21 Saez, D., Iglesias, J., Giménez, E., Romero, I., & Rez, M. (2012): Evaluation of 72 kV collection grid on Offshore Wind Farms. EWEA. Copenhagen: EWEA.
- 9.23 Mediavilla, I., Esteban, L. S., Fernández, M. J. (2012): Optimisation of pelletization conditions for poplar energy crop. Fuel Processing Technology, 104: 7-15.
- 9.24 Ahrenfeldt, J., Thomsen, T. P., Henriksen, U., & Clausen, L. R. (2013): Biomass gasification cogeneration - A review of state of the art technology and near future perspectives. Applied Thermal Engineering, 50: 1407-1417.
- 9.25 Bang-Møller, C. (2010): Design and optimization of an integrated biomass gasification and solid oxide fuel cell system. PhD Thesis. Department of Mechanical Engineering, Technical University of Denmark.
- 9.26 Maniatis, K. (2001): Progress in biomass gasification: an overview. In: Bridgwater, A.V. (Ed.) Progress in thermochemical biomass conversion. Blackwell Science Ltd, Oxford, UK, pp. 1-31.
- 9.27 Knoef, H.A.M. (Ed.) (2005): Handbook biomass gasification. BTG biomass technology group B.V, Meppel, The Netherlands.
- 9.28 Raj, N.T., Iniyar, S., Goic, R. (2011): A review of renewable energy based cogeneration technologies. Renew Sustain Energy Rev, 15: 3640-3648
- 9.29 Puig-Arnavat, M., Bruno, J. C., & Coronas, A. (2013): Modelling of trigeneration configurations based on biomass gasification and comparison of performance. Applied Energy, 114:845-856
- 9.30 GoBiGas (2014): Homepage of the GoBiGas project, accessed 23/03/2015. <http://gobigas.goteborgenergi.se/>
- 9.31 Gaya Project (2014): Homepage of the Gaya Project, accessed 23/03/2015 <http://www.gayaproject.com/projet-gaya-en.shtml>
- 9.32 Bio2G (2014): Homepage of the Bio2G Project, accessed 23/03/2015 <https://www.eon.se/bio2g>
- 9.33 Khalida A, Arshadb M, Anjuma M, Mahmooda T, Dawson L (2011): The anaerobic digestion of solid organic waste. Waste Management, 31, 1737-1744
- 9.34 Oleskowicz-Popiel P, Kádár Z, Heiske S, Klein-Marcuschamer D, Simmons BA, Blanch HA, Schmidt JE, (2012): Co-production of ethanol, biogas, protein fodder and natural fertilizer in organic farming - Evaluation of a concept for a farm-scale biorefinery. Bioresource Technology, 104, 440-446
- 9.35 Tauseef, S. M., Abbasi, T., & Abbasi, S. a. (2013): Energy recovery from waste waters with high-rate anaerobic digesters. Renewable and Sustainable Energy Reviews, 19, 704-741.
- 9.36 Schiemenz, K., Eichler-Löbermann, B. (2010): Biomass ashes and their phosphorus fertilizing effect on different crops. Nutr Cycl Agroecosyst, 87:471-482
- 9.37 Münster, M., Lund, H. (2009): Use of waste for heat, electricity and transport - Challenges when performing energy system analysis. Energy, 34: 636-644
- 9.38 Münster, M., Lund, H. (2010): Comparing Waste-to-Energy technologies by applying energy system analysis. Waste Management, 30: 1251-1263
- 9.39 Mathiesen, A, Kristensen, L., Bidstrup, T. and Nielsen, L.H. (2009): Vurdering af det geotermiske potentiale i Danmark, Danmarks og Grønlands Geologiske Undersøgelse Rapport 2009/59.
- 9.40 Gehlin, S., Andersson, O., Bjelm, L., Alm, P.-G., and Rosberg, J.-E. (2015): Country Update for Sweden. Proceedings World Geothermal Congress 2015, Melbourne, Australia, 19-25 April 2015, 6 pp.
- 9.41 Wang Y., Chen K.S., Mishler J., Sung Chan Cho S.C., Adroher X.C., (2011): A review of polymer electrolyte membrane fuel cells - Technology applications and needs on fundamental research. Applied Energy 88: 981-1007.
- 9.42 Badwal S.P.S., Giddey S., Munnings C., Kulkarni A., (2014): Review of Progress in High Temperature Solid Oxide Fuel Cells. J. Austr. Ceram. Soc. 50: 23-37.
- 9.43 Mogensen M., Allebrod F., Bowen J.R., Chatzichristodoulou C., Chen M., Ebbesen S.D., Graves C., Hallinder J., Hauch A., Hendriksen P.V., Holtappels P., Høgh J.V.T., Jensen S.H., Lapina A., Møllerup P.L., Sun X.: Electrolysis and Routes towards Sustainable Fuels, (2011). 10th Int. WS on Large-Scale Integration of Wind Power into Power Systems, Aarhus, Denmark, [http://orbit.dtu.dk/fedora/objects/orbit:72449/datastreams/file\\_6351539/content](http://orbit.dtu.dk/fedora/objects/orbit:72449/datastreams/file_6351539/content)

- 9.44 Graves C., Ebbesen S. D., Jensen S. H., Simonsen S. B., Mogensen M. B.: Eliminating degradation in solid oxide electrochemical cells by reversible operation, (2015) *Nature Materials*. 14: 239-244.
- 9.45 Jensen, S.H., Larsen. P.H., Mogensen, M., (2007): Hydrogen and synthetic fuel production from renewable energy sources. *Int. J. Hydrogen Energy*, 32: 3253 – 3257.
- 9.46 Stephens, I. E. L., Bondarenko, A. S., Grønbjerg, U., Rossmeisl, J., Chorkendorff, I., (2012): Understanding the oxygen reduction reaction on platinum and its alloys. *Energy Environ. Sci.* 5: 6744-6762.
- 9.47 Vesborg, P. C. K., Seger, B. & Chorkendorff, I., (2015): Recent Development in Hydrogen Evolution Reaction Catalysts and Their Practical Implementation. *J. Phys. Chem. Lett.* 6: 951-957.
- 9.48 Sanne Wittrup: Dong: Vores kraftværker bruger allerede billig vindmøllestrøm i elpatroner, Ingeniøren, 15. jan 2015, <http://ing.dk/artikel/dong-vores-kraftvaerker-bruger-allerede-billig-vindmoellestroem-i-elpatroner-173488>
- 9.49 I Dincer, MA Rosen: Exergy: energy, environment and sustainable development, 2012, ISBN 9780080970899
- 9.50 Malene Rustad Berntsen: Optimalisering av CO<sub>2</sub>-varmepumpe for kjøling av isvann / oppvarming av tappevann til 85°C, Norwegian University of Science and Technology, Faculty of Information Technology, Mathematics and Electrical Engineering, Department of Electrical Power Engineering, 2013 Master thesis
- 9.50b Kim S. Clausen et al: Inspirationskatalog for store varmepumpeprojekter i fjernvarmesystemet, November 2014, Danish Energy Authority
- 9.51 Danish Energy Agency: Energy Statistics 2013, March 2015 ISBN 978-87-93071-92-6 [www](http://www.danishenergyagency.com)
- 9.52 Torben Ommen: Heat pumps in CHP systems – High-efficiency Energy System Utilising Combined Heat and Power and Heat Pumps, Ph.D. Thesis, 2015, Technical University of Denmark
- 9.53 Bjarne Bach, Jesper Werling, Torben Ommen, Marie Münster, Juan M. Morales, Brian Elmegaard: Integration of Large-scale Heat Pumps in the District Heating Systems of Greater Copenhagen, 2015, submitted to *Energy – the International Journal*
- 9.54 Star Refrigeration, Neat Pump, Case Study Number 64, July 2010, <http://www.star-ref.co.uk/star/images/stories/pdf/Case%20Study%20No%2064%20-%20Neatpump.pdf>
- 9.55 Kent Krøyer: Nu kører Danmarks første kæmpe-varmepumpe på billig møllestrøm, Ingeniøren, 3. sep 2009, <http://ing.dk/artikel/nu-korer-danmarks-forste-kaempe-varmepumpe-pa-billig-mollestrom-102000>
- 9.56 Friothers, 5 Unitop® 50FY heat pump / chiller units simultaneously generate 90 MW heat energy and 60 MW chilled water, [http://www.friothers.com/webautor-data/41/katri\\_vala\\_e012\\_uk.pdf](http://www.friothers.com/webautor-data/41/katri_vala_e012_uk.pdf)
- 9.57 Thomas Nowak: Future Perspectives for Heat Pumps in Europe, presented at DTU Energy Conference 2013
- 9.58 Ommen, T. S., Jensen, J. K., Markussen, W. B., Reinholdt, L., & Elmegaard, B. (2015): Technical and economic working domains of industrial heat pumps: Part 1 - single stage vapour compression heat pumps. *International Journal of Refrigeration*. doi:10.1016/j.jirefrig.2015.02.012
- 9.59 Carmo C., Elmegaard B., Nielsen M. P., Detlefsen N.: Empirical Platform Data Analysis to Investigate How Heat Pumps Operate in Real-life Conditions in Proceeding of ICR 2015, International Congress of Refrigeration, Yokohama, Japan, 2015
- 9.60 Zampollo M., Madani H., Lundqvist P.: The Role of Heat Pumps in Smart Grids in Proceeding of ICR 2015, International Congress of Refrigeration, Yokohama, Japan, 2015
- 9.61 Kim, Young Min. "Novel concepts of compressed air energy storage and thermo-electric energy storage." (2012).
- 9.62 Morandin, Matteo, Samuel Henchoz, and Mehmet Mercangöz: "Thermoelectrical energy storage: a new type of large-scale energy storage based on thermodynamic cycles." *World Engineers Convention*, Geneva, Switzerland (September 4-9 2011). 2011.
- 9.63 Assessment of the European potential for pumped hydropower energy storage, JRC Scientific and policy report. M. Gimeno-Gutiérrez and R. Lacal-Arántegui, European Commission Joint Research Centre, The Netherlands 2013. ISBN 978-92-79-29512-6
- 9.64 <http://biocat-project.com/>
- 9.65 <http://www.eon.com/en/media/news/press-releases/2014/9/1/eon-power-to-gas-pilot-unit-falkenhagen.html>
- 9.66 [http://www.bosch.com/en/com/boschglobal/braderup/wind\\_farm/the-wind-farm.html](http://www.bosch.com/en/com/boschglobal/braderup/wind_farm/the-wind-farm.html)
- 9.67 [http://www.bosch.dk/da/dk/newsroom\\_8/nyheder/news-detail-page\\_51584.php](http://www.bosch.dk/da/dk/newsroom_8/nyheder/news-detail-page_51584.php)
- 9.68 <http://www.cph.dk/om-cph/csr/miljo-og-energi/klima-og-energi/ates---grundvandskoling/>

## Chapter 10

- 10.1 EC, 1995. Communication COM(95)682, An Energy Policy for the European Union, White Paper. Commission of the European Communities.
- 10.2 EC, 1997. Communication COM(97)599, Energy for the future: Renewable sources of energy, White Paper for a Community Strategy and Action Plan. European Commission.
- 10.3 EC, 2001. Directive 2001/77/EC on the promotion of electricity produced from renewable energy sources in the internal electricity market. European Parliament and the Council.
- 10.4 TFEU: Consolidated Version of the Treaty on the Functioning of the European Union art. [], 2008 O.J. C 115/47.
- 10.5 TFEU: Consolidated Version of the Treaty on the Functioning of the European Union art. [], 2008 O.J. C 115/47.
- 10.6 Morata and Sandoval (Eds.), 2012: "European Energy Policy - An Environmental Approach. Edward Elgar, Cheltenham (UK), Northampton (USA).
- 10.7 EC, 2014. Communication C(2014) 2322, Guidelines on State aid for environmental protection and energy 2014-2020. European Commission.
- 10.8 Fouquet, D., Nysten, J. V., Johnston, A., 2012. Potential areas of conflict of a harmonised RES support scheme with European Union Law. D3.1 Project Report for beyond 2020: Design and impact of a harmonised policy for renewable electricity in Europe. European IEE-project. Intelligent Energy Europe, ALTENER.
- 10.9 EC 2015: "Energy Union: secure, sustainable, competitive, affordable energy for every European", Press Release, 25 February 2015, [http://europa.eu/rapid/press-release\\_IP-15-4497\\_en.htm](http://europa.eu/rapid/press-release_IP-15-4497_en.htm)

- 10.6 **Morata and Sandoval (Eds.), 2012:** "European Energy Policy - An Environmental Approach. Edward Elgar, Cheltenham (UK), Northampton (USA).
- 10.10 **NordPool Spot 2014:** "Successful operation of PCR solution: Power Exchanges focus on Pan-European power market", Press release No. 10/2014.
- 10.11 **Danish Commission on Climate Change Policy,** 2010
- 10.12 **Danish Energy Agency**
- 10.13 **Danish Government,** 2011

## Chapter 11

- 11.1 **NREL (2012):** Energy Systems Integration - A Convergence of Ideas. <http://www.nrel.gov/es/pdf/55649.pdf>
- 11.2 **Global Energy Assessment, Toward a Sustainable Future,** 2012
- 11.3 **International Energy Agency (IEA) (2014):** World Energy Outlook 2014. <http://www.worldenergyoutlook.org/publications/weo-2014/>
- 11.4 **IPCC, 2014:** Climate Change 2014: Synthesis Report. Contribution of Working Groups I, II and III to the Fifth Assessment Report of the Intergovernmental Panel on Climate Change Core Writing Team, R.K. Pachauri and L.A. Meyer (eds.). IPCC, Geneva, Switzerland, 151 pp.
- 11.5 **IEA (2011):** China Wind Energy Development Roadmap 2050. International Energy Agency.
- 11.6 **Alazraki, R. and Haselip, J. (2007):** Assessing the Up-take of Small-Scale Photovoltaic Electricity Production in Argentina: the PERMER project. *Journal of Cleaner Production*, Vol.15 (2) pp.131-142
- 11.10 **Cheung, K. (2011):** Integration of Renewables: status and challenges in China. International Energy Agency working paper. Paris, France.
- 11.11 **Kahrl, F., and Wang, X. (2014):** Integrating Renewables Into Power Systems in China: A Technical Primer – Power System Operations. Beijing, China: Regulatory Assistance Project.
- 11.12 **ICA. 2011:** Regional Power Status in African Power Pools Report Infrastructure Consortium for Africa (ICA). African Development Bank November 2011, Tunis Belvédère.
- 11.13 **IRENA. 2015:** Africa Clean Energy Corridor: Analysis of Infrastructure for Renewable Power in Camco and TIPS. 2010. *Climate Change: Risks and Opportunities for the South African Economy – An Assessment of Mitigation Response Measures.*
- 11.14 **Zhou, P.P. Simbini, T., Wright, N., and Sonny, T. (2013):** Towards Inclusive Green Growth in the Energy Sector in Africa. Fifth Sustainable Development Report on Africa. UNECA, Addis Ababa.



## Recent volumes of DTU International Energy Report



**Wind energy - drivers and barriers for higher shares in the global power generation mix**

November 2014.  
ISBN 978-87-550-3969-8

In areas with good wind resources and favourable financing conditions, wind energy is now competitive with fossil fuel-based energy technologies. DTU International Energy Report 2014 addresses a selection of scientific and technical issues relevant to further increase the share of wind power in the global electricity mix. It covers the assessment and forecasting of wind resources, the development of wind energy technologies, the integration of large amounts of fluctuating wind power in future energy systems, and the economic aspects of wind power.



**Energy storage options for future sustainable energy systems**

November 2013.  
ISBN 978-87-550-3968-1

Energy storage technologies can be defined as technologies that are used to store energy in the form of thermal, electrical, chemical, kinetic or potential energy and discharge this energy whenever required. Energy storage technologies and systems are diverse and provide storage services at timescales from seconds to years. One of the great challenges in the transition to a non-fossil energy system with a high share of fluctuating renewable energy sources, such as solar and wind, is to align consumption and production in an economically satisfactory manner. This Report provides convincing evidence that energy storage can provide the necessary balancing power to make this possible.



**Energy efficiency improvements - a key element in the global transition to non-fossil energy**

November 2012.  
ISBN 978-87-550-3965-0

Increasing energy efficiency, much of which can be achieved through low-cost measures, offers huge potential for reducing CO<sub>2</sub> emissions during the period up to 2050. On this background, the report addresses the global, regional, and national challenges in pursuing energy efficiency improvements, together with the main topics in research and development for energy efficiency. The report also analyses a selection of barriers hindering the broader implementation of energy efficiency improvements. Finally, it gives examples of how more stringent performance standards and codes, as well as economic incentives, can unlock energy efficiency potential and scale up the financing of energy efficiency improvements



**Energy for smart cities in an urbanised world**

November 2011.  
ISBN 978-87-550-3905-6

Volume 10 takes as its point of reference the rapid urbanisation of the world. The report addresses energy-related issues for smart cities, including energy infrastructure, onsite energy production, transport, economy, sustainability, housing, living, and governance, including incentives and barriers influencing smart energy for smart cities.



**Non-fossil energy technologies in 2050 and beyond**

November 2010.  
ISBN 978-87-550-3812-7

The report analyses the long-term outlook for energy technologies in 2050 in a perspective where the dominating role of fossil fuels has been taken over by non-fossil fuels, and CO<sub>2</sub> emissions have been reduced to a minimum. Against this background, the report addresses issues such as: How much will today's non-fossil energy technologies have evolved up to 2050? Which non-fossil energy technologies can we bring into play in 2050, including emerging technologies? What are the implications for the energy system? Further, the report analyses other central issues for the future energy supply: The role of non-fossil energy technologies in relation to security of supply and sustainability; System aspects in 2050; Examples of global and Danish energy scenarios in 2050



**The intelligent energy system infrastructure for the future**

September 2009.  
ISBN 978-87-550-3755-7

The report takes its point of reference in the need for the development of a highly flexible and intelligent energy system infrastructure which facilitates substantially higher amounts of renewable energy than today's energy systems. The report presents a generic approach for future infrastructure issues on local, regional, and global scale with focus on the energy system.



An overview of the complete report series is available at:  
[natlab.dtu.dk/english/Energy\\_Reports/Report\\_series](http://natlab.dtu.dk/english/Energy_Reports/Report_series)

