



Planning and development of wind farms: Environmental impact and grid connection

Clausen, Niels-Erik

Publication date:
2013

Document Version
Publisher's PDF, also known as Version of record

[Link back to DTU Orbit](#)

Citation (APA):
Clausen, N-E. (2013). Planning and development of wind farms: Environmental impact and grid connection. DTU Wind Energy. (DTU Wind Energy I; No. 46).

DTU Library

Technical Information Center of Denmark

General rights

Copyright and moral rights for the publications made accessible in the public portal are retained by the authors and/or other copyright owners and it is a condition of accessing publications that users recognise and abide by the legal requirements associated with these rights.

- Users may download and print one copy of any publication from the public portal for the purpose of private study or research.
- You may not further distribute the material or use it for any profit-making activity or commercial gain
- You may freely distribute the URL identifying the publication in the public portal

If you believe that this document breaches copyright please contact us providing details, and we will remove access to the work immediately and investigate your claim.

Planning and Development of Wind Farms: Environmental impact and grid connection

Department of
Wind Energy
I-Report

Niels-Erik Clausen, Tom Cronin and William Jowitt
DTU Wind Energy Report-I-46
December 2013

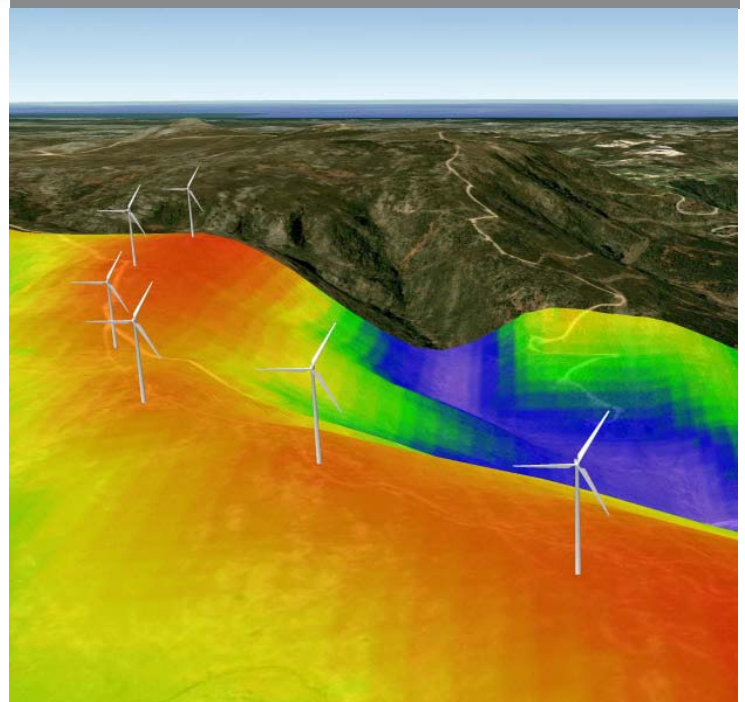

Author: Niels-Erik Clausen, Tom Cronin and William Jowitt
Title: Planning and Development of Wind Farms:
Environmental impact and grid connection
Department: Wind Energy

Summary (max. 2000 characters):

These course notes are intended for the three-week course 46200 *Planning and Development of Wind Farms* given by DTU Wind Energy, Technical University of Denmark. The purpose of the course notes is to give an introduction to planning procedures, environmental impact assessments, and grid connection.

DTU Wind Energy Report-I-46
December 2013
(Second edition)

Contract no.:
n/a

Project no.:
44504 E-3

Sponsor:
n/a

Cover:
Wind farm in Northern Portugal.

Pages: 71
Tables: 4
Figures: 39
References: 94

In no event will the Technical University of Denmark (DTU) or any person acting on behalf of DTU be liable for any damage, including any lost profits, lost savings, or other incidental or consequential damages arising out of the use or inability to use the information presented in this report, even if DTU has been advised of the possibility of such damage, or for any claim by any other party.

Technical University of Denmark
Department of Wind Energy
Risø Campus, Building 118
Frederiksborgvej 399
4000 Roskilde
Denmark

Telephone 46 77 50 79
necl@dtu.dk
www.vindenergi.dtu.dk

Preface

The present notes are intended for use with the 3-week course 46200 Planning and development of wind farms. The general course objectives and the learning objectives for the course are listed below for reference. The full course description is given in the current DTU Course Catalogue.

General course objectives

The student is provided with an overview of the steps in planning and managing the development of a new wind farm. The student is introduced to wind resource assessment and siting, wind farm economics and support mechanisms for wind energy. An overview of the various environmental impacts from wind farms is offered.

Learning objectives

A student who has met the objectives of the course will be able to:

- Describe the methodologies of wind resource assessment and their advantages and limitations.
- Explain the steps in the selection of a site for measurement of the wind resource and good practice for measurement of the wind resource.
- Calculate the annual energy production using the WAsP software for simple wind farm cases in terrain within the operational envelope of the WAsP model.
- Identify and describe factors adding to the uncertainty of the wind resource and wind farm production estimates.
- Estimate the most important key financial numbers of a wind project and explain their relevance.
- Identify the main environmental impact from a wind farm and suggest mitigation measures.
- List the three most common policy tools for support of wind energy projects.
- Explain the steps in the development of a wind farm layout considering annual energy production, wind turbine loads and environmental impact.
- Explain the main steps in developing the grid connection of a wind farm

The issues related to wind resource assessment are described in the course notes DTU Wind Energy Report no. I-45.

The present notes are related to the environmental impact assessment and grid connection of wind farms.

Contents

Preface	3
1 Introduction	7
2 Environmental impact assessment	7
2.1 The EIA process and report	7
2.1.1 Why do an EIA?	7
2.1.2 Who is the EIA for?	8
2.1.3 When is an EIA required?	8
2.1.4 The EIA procedure in Denmark	8
2.1.5 What should be in a typical EIA report?	9
2.2 Land based wind farms	10
2.2.1 Visual impact	10
2.2.2 Noise	13
2.2.3 Birds and bats	19
2.2.4 Flora and fauna	28
2.2.5 Electromagnetic interference	29
2.2.6 Shadow flicker	32
2.3 Offshore wind farms	34
2.3.1 Coastal morphology	34
2.3.2 Marine substrate and vegetation	34
2.3.3 Bottom fauna	35
2.3.4 Benthos	35
2.3.5 Fish	36
2.3.6 Birds	37
2.3.7 Marine mammals	40
2.3.8 Raw materials extraction and mineral resources	43
2.3.9 Marine archaeology	44
2.3.10 Recreational issues	45
2.3.11 Protected areas	45
2.3.12 Naval traffic	45
2.3.13 Aviation	46
2.3.14 Commercial fishery	46
2.3.15 Unexploded ordnance	47

2.4 Public acceptance	49
3 Grid connection	53
3.1 The wind farm connection	53
3.1.1 The importance of the grid connection	53
3.1.2 Major elements of a typical wind farm connection	54
3.1.3 Cost of the connection	55
3.2 Some electrical engineering principles	56
3.2.1 Active and reactive power	56
3.2.2 Equivalent circuits	56
3.2.3 Generator types for wind turbines	57
3.3 The grid power system and connecting to it	59
3.3.1 Grid architecture	59
3.3.2 Finding the “right” connection point	60
3.3.3 Grid strength	60
3.3.4 The impact of grid strength	61
3.3.5 How to use grid strength	61
3.3.6 Other indicators of grid strength	61
3.3.7 Grid codes	62
3.4 Offshore connections	62
3.4.1 Why is offshore different to onshore?	62
3.4.2 Offshore connection options: AC vs DC	62
3.5 Summary of tasks for planning a grid connection	64
3.6 References	64
4 References	65
5 Acknowledgements	71

1 Introduction

The present course notes provide an overview over the activities that are carried out in the planning and development phase of a wind farm project on land or offshore. The activities are mainly carried out by (or on behalf of) the project developer and by the planning authorities and time wise they occur from selection of the location of the wind farm and start of measuring the wind resource to the end of the construction phase where the project is handed over to the owner (taking-over-certificate TOC).

In the following the activities are grouped according to the nature of the activity:

- Wind resource
- Environmental impact
- Public acceptance
- Grid connection
- Project economy

These are called the five cornerstones of wind farm planning and development.

While wind resource assessment is covered in separate notes I-45 the present notes will deal with environmental impact assessment, public acceptance and grid connection.

2 Environmental impact assessment

Gaining environmental permission is crucial for every wind farm project but there are both local and global rules to consider, many stakeholders and experts involved and everything has to be done within limited time and budget. In this chapter we will look at the process of gaining the permissions needed and what, typically, needs to be considered in the main document: the Environmental Impact Assessment report.

Note: Many of the examples used are from Denmark but the general procedure and principles are similar in most countries. What may be very different are the actual laws that govern the environment.

DTU students should appreciate that the content of this section goes beyond the knowledge required for the course itself. As such, this section should be viewed as a support that may further round the students' knowledge of the subject matter by presenting case studies and current research. It is the hope of the authors that it may, at some stage in the future, be able to be used as a reference guide.

2.1 The EIA process and report

2.1.1 Why do an EIA?

The simple answer is to fulfil the various regulations concerning the environment and to get the environmental permission for our project. These regulations can be at many different levels: local, regional, EU or even UN.

The main reason behind the many conventions, directives and laws is the preservation of the flora and fauna, its diversity and the habitat it lives in. So, the first step in an environmental impact assessment is to assess what the environment is now, before the project starts. It is then the desire of the developer who is developing the project to show that the impact of the project is as small as possible. However, the impact will never be zero and – in the longer run – all our interests will be served by an accurate, truthful and

honest appraisal. What should never be forgotten, though, is that especially in the case of a wind farm project, the future impact of not doing the project may, indeed, have a higher environmental impact (e.g. from continuing to burn fossil fuels) than not implementing it.

As well as this somewhat “technical” assessment of the impact of a proposed wind farm, the process of the EIA also has a more “soft” purpose. This is that it allows all affected parties (stakeholders) to learn about the project and how much it might impact them. It also enables them to have a chance to influence the project and thus create a better acceptance of the project. In essence, it is a possibility for information exchange between the developer and local authorities, the general public, various organisations, neighbours etc. This second reason is sometimes underestimated but is equally important as the technical assessment.

2.1.2 Who is the EIA for?

The EIA report is to be submitted to the authority who will grant (or deny) the environmental permission. In some countries there may well be more than one authority who needs to give permission about the various aspects of possible environmental impact. In Denmark, however, there is only one relevant authority to deal with for the developer and that is the local municipality for land based wind farms up to a maximum of 150 m. Since 2007, this is the only point of contact required for wind farm developers: the local authority, who will do all the co-ordination and checking with the various other bodies to find out if the project complies with the legal requirements. Many municipalities receive assistance from the Danish Wind Turbine Secretariat under the Ministry of Environment. It is, however, the responsibility of the developer to ensure that the municipality receives all the correct information in the EIA report.

The developer will rarely do the whole EIA report themselves. It is usual for the various aspects to be contracted out to specialists in the area, firstly because very specialist expertise is required that the developer will not have, and secondly because it gives a valuable degree of independence and adds credibility to the report: it should not be unfairly biased by the strong interest of the developer.

2.1.3 When is an EIA required?

Usually, projects above a certain size will require a full EIA. For instance, in Denmark an EIA is required if either:

- The turbine(s) are higher than 80m (to blade tip), or
- The wind farm comprises of three or more turbines

Projects below these requirements will be subject to a simplified “screening” procedure whereby the regional planning authority will consider the impact of a reduced number of factors. In reality, only small household turbines will fit into this category.

2.1.4 The EIA procedure in Denmark

The responsible authorities for planning in relation to wind turbines in Denmark are:

- Offshore projects: Ministry of Climate & Energy - The Energy Authority
- Land based projects < 150 m: The Municipalities
- Land based projects > 150 m: Ministry of Environment – Danish Nature Agency

The height is the total height to the tip of the blade.

The procedure for environmental approval can take a considerable time, depending on the co-ordination of the various approvals required. In Denmark, where the procedure is relatively well-defined, the process may take a year or more. During this time the EIA report and planning documents at all levels must be prepared as they are to be subjected to publication in two separate phases during the procedure.

As mentioned above, as well as the technical assessment of the impact on the environment, the procedure also ensures that all affected parties have an opportunity to influence the project by contributing ideas or objecting to specific details.

A flow chart of the EIA procedure in Denmark is shown below in Figure 1 .

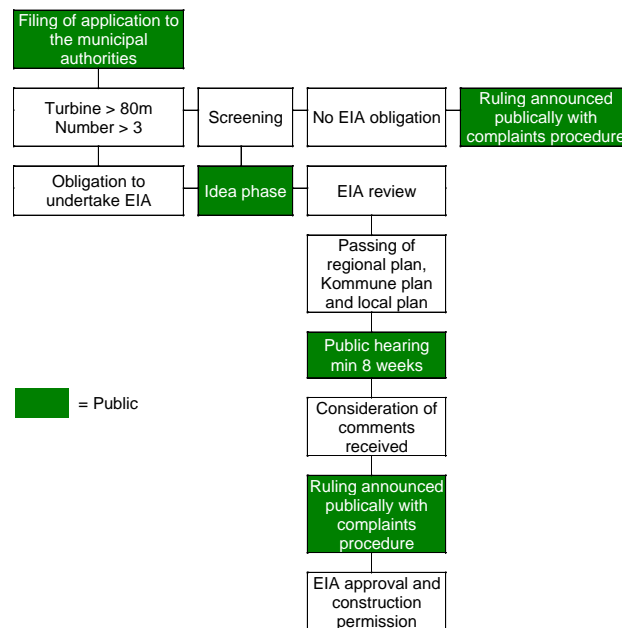

Figure 1 EIA procedure in Denmark

2.1.5 What should be in a typical EIA report?

The EIA report should cover every conceivable aspect of a wind farm project that might affect the surroundings and the people who live there: the environment in its broadest possible sense.

More specifically, the report needs to demonstrate that the relevant legislation is complied with. This includes minimum distances between turbines and dwellings, not exceeding defined noise levels, and various other demands that relate to the protection of citizens, the open countryside, the landscape, flora & fauna, agricultural interests and historic items of cultural value.

A step-by-step manual for preparing an EIA report for onshore wind farms in Denmark is available. (It is in Danish as the principle is that developers should have an understanding of the locality of the area they are working in.)

It is important to note that whilst the EIA report focuses on the wind farm project in question, consideration should be taken of other wind farms in the area (existing and planned).

2.2 Land based wind farms

The following section contains the components of the environmental impact assessment that are more relevant to the development of an onshore wind farm. Some of these issues may also be relevant for an offshore wind farm and thus information from both sections must be taken as necessary for each individual project.

2.2.1 Visual impact

Of all of the issues involved in the siting of a wind power development, no issue seems to be more greatly argued than that of landscape; considered from both naturalistic and socioeconomic views to be one of the most important natural resources (Bishop et al.; 2007). This trend has been noted worldwide and the strongest opinions voiced within this argument are usually those of the protection of the scenic qualities of the landscape from visual impact (Bishop et al.; 2007, Lothian, 2008).

This issue has gained momentum in recent years mainly as a consequence of the increase in the number of wind power developments (to help meet government targets on renewable energies) and the increasing size of wind turbines. It is also more hotly contested than in the construction of a classical power plant due to the lower energy density of the wind resource requiring a larger area over which development is required.

To date there has been only a limited amount of research done on the aesthetic impact of wind turbines on landscapes and since the 1960s assessment of such issues has been conducted using photographs and/or verbal descriptions (Bishop et al.; 2007).

With the increase in the prevalence of the issue, however, has come the need to understand the visual preferences of the public and mitigate the effects of the developments (Torres Sibille et al.; 2009) and this has started to be achieved using computer simulations to model the effects of development (Bishop et al.; 2007). Visual impacts are present at all stages of wind farm development including construction and decommissioning (with large overhead cranes) and that all aspects of the wind farm add to the visual impact (including overhead power lines and transformer stations).

As this is a multi-disciplinary issue that draws on aspects of sociology, psychology, and geography as well as engineering and the sciences, it is beneficial to initially view the issue from the standpoint of either a sociologist or psychologist as opposed to that of an engineer to determine the root cause of visual impact. A person's attitude towards any issue can be broken into three components: cognition (active beliefs), feeling (associated emotions) and action tendency (readiness to act) which, in turn, are influenced by material, aesthetic, ethical and metaphysical values. In the case of the visual impact of a wind power development it is clear that aesthetic values will play a dominant role in shaping attitudes and the emotional component of the attitude is closely linked to the experiences associated with the landscape (e.g. closeness to nature) (Waldo, 2012).

A method of qualitatively assessing the visual impact of a wind power development is clearly desirable as even though it is extremely unlikely that a numerical impact threshold will ever be established (Moller, 2006) it would provide not only an objective measure of the impact (such as those available for noise or flicker) but also allow comparison of options during the planning phase (Torres Sibille et al.; 2009). This, however, is an immensely difficult thing to accomplish due to the mixed objective and subjective nature of visual impact which must take into account a host of factors, some

of which can be seen in Fig. 2. Here the term ‘objective’ has been used to denote any parameter that it is possible to assign a definite value to, free of subjective influence.

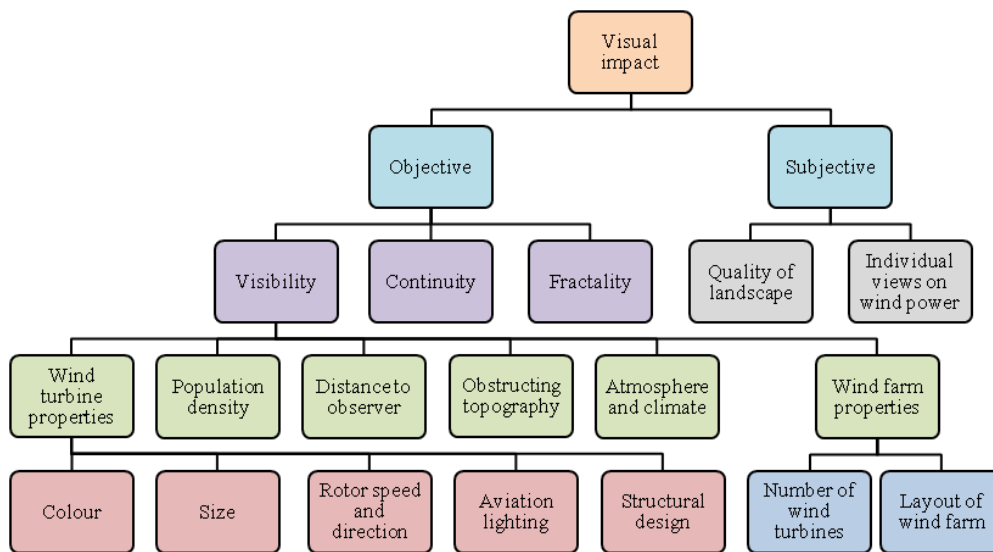

Fig. 2. Some of the factors that must be considered when assessing the visual impact of a wind power development.

A baseline for the quantitative assessment of visual impact has been developed using geographical information systems (GIS). These determine the line of sight visibility of the turbines by combining a landscape of the region in which the development will be sited with population data and using a simple geometric approach (Bishop et al.; 2007, Moller, 2006). This is useful as it has been found that a wind farm is more likely to meet with approval if it is out of sight (Jones et al.; 2010). This will result in a binary output as to whether it is possible to see the turbine from a certain location taking into account local topography. Most modern GIS software has this capability inbuilt and the results provide a clear benchmark for comparison of sites rather than absolute exposures, as the exact movement of people cannot be predicted.

The visual impact of a wind farm has been shown to be highly dependent upon its perceived size with distance to the farm playing an important part in this (Bishop et al.; 2007, Jones et al.; 2010, Molnarova et al.; 2012) as well as the size and number of turbines within it. As well as this, the contrast between the colour of the turbine and its environment has been studied and it has been shown that low levels of colour contrast result in lower perceived visual impact (Bishop et al.; 2007, Moller, 2006) with blue, white and grey turbines preferred in most areas (Lothian, 2008).

The visual impact of a wind farm is usually heavily mitigated at night. This however, may not be the case if aviation warning lights are required on the turbines. If lights are required then simple measures can be taken to reduce their visual impact. These include synchronisation of their intermittent light and possibly shielding around the lights so that they can only be seen from heights greater than the turbines (i.e. from aircraft).

As more research has been conducted into the issue of visual impact more attempts have been made to create an index that will accurately predict the visual preferences of the general public. One such attempt (Torres Sibille et al.; 2009) has been made that combines visibility, colour contrast, fractality and continuity in a weighted sum which also incorporates the mean atmospheric climate at a site to determine visual impact.

When tested, this method appeared to be able to correctly predict average public opinion on the preference between wind farms. Thus a fully comprehensive, comparative index of all objective variables should be possible to produce but this would require rigorous validation (Torres Sibille et al.; 2009). The importance of both fractality and continuity has been seen with operational wind farms where it has been found that wind farms with either regular geometric patterns or that follow natural feature lines have proved more popular than those with a more random arrangement.

Although the aforementioned index is a step in the right direction it still does not account for many factors that are unlikely to be able to be quantified. In several studies it has also been found that the visual impact of a wind power development is highly related to the landscape in which it is sited (Lothian, 2008, Molnarova et al.; 2012). Wind farms placed in areas which are perceived to have a high aesthetic quality are thought to detract from this quality while those placed in low quality landscapes are generally thought to improve the aesthetics (Lothian, 2008).

One further feature of the wind turbine that influences its perceived visual impact is the motion of its rotor. Although studies have shown that in general a turbine with its blades in motion will appear 10-20% larger than a stationary one (Molnarova et al.; 2012) they are of a lesser visual impact and that this difference in visual impact increases with the relative size of the turbine (Bishop et al.; 2007). There have been two arguments put forward to explain this effect. The first is that when the turbines are in motion they are seen to be producing energy and thus serve a purpose. The second is related to environmental aesthetics and suggests that the turbines in motion give expression to the landscape through their ability to give visual presence to the wind in the same way as trees (Bishop et al.; 2007). It has also proved aesthetically important to ensure that the blades of each turbine are rotating in the same direction at the same speed.

Of course as a partially subjective impact, an individual's attitude towards wind energy will affect their perception of its visual impact. Those holding a negative attitude towards wind power usually have dominant aesthetic values and will view the development of wind power as a threat to local landscape qualities (Waldo, 2012). This expression from an aesthetical standpoint does, however, come from strong feelings that a greater value inherent to an area will be lost and is not simply rooted in egotism (Waldo, 2012). It is also useful to note that even those with a positive view of wind power believe that there is a point at which further development in a certain area should be limited (Waldo, 2012).

One popular belief was that visual impact could be highly mitigated by placing wind farms offshore. This, however, has not proved to be the case and a good case study is the Lillgrund wind farm in Øresund, 7 km off the south coast of Sweden, where local opinion of the visual impact is far from positive (Waldo, 2012). Large scale wind farms just off the coast are visible from a greater distance due to the lack of visually obstructing topographical features and therefore affect many local areas (Bishop et al.; 2007, Ladenburg, 2009). Those with a strong emotional connection to the coast or the sea will also be more likely to object to development in these areas.

To conclude, the visual impact of a wind power development is by far the most difficult aspect of the planning and development of a project to mitigate due not only to the subjective nature of the issue and the difficulty in establishing thresholds but also to the comparative lack of research on the issue. In many locations the value of aesthetics is still not given enough weight when compared to hard engineering or financial aspects

(Waldo, 2012). Communities are much more likely to support a development if their views are taken into consideration during the planning process. Using interactive visualisation tools, turbines could be moved by members of the community to create a more sympathetic wind farm design while compromises in power output are monitored by the developer (Bishop et al.; 2007). Although significant progress has been made towards numeric tools that will allow the comparison of visual impacts at different sites it is unlikely, due to subjectivity, that local communities will ever entirely accept a quantitative visual assessment of a landscape (Bishop et al.; 2007).

2.2.2 Noise

Noise is defined as any unwanted sound (Rogers et al.; 2002) and, as with a visual impact, the impact due to noise has a partially subjective nature as it affects people and their perceived quality of life. The environmental impact due to noise depends upon many parameters and physical effects and as such is difficult, but not impossible, to model. The difference between visual and audible impact is that a definite threshold can be established for noise impact and has been in many countries.

Sound is created by sinusoidal pressure variations within a medium. The magnitude (or 'loudness') of this sound can be described by three values (Eshbach; 2009):

- Sound power level: The total amount of sound energy that is produced by a source per unit time
- Sound intensity level: The time averaged flux of sound energy that is detectable at a given radius from a spherically emitting source.
- Sound pressure level: The deviation of pressure from ambient values created by the sound waves emitted by a source.

Each of these is expressed compared to a minimum threshold value in a logarithm unit known as the decibel. If the cumulative sound level of more than one source requires calculating then all addition must be done before the units are changed to decibels (note that pressures must be summed in square form). The intensity of the sound decreases with the square of the distance, whereas the pressure decreases linearly with distance. It must be noted that if the source emits constantly and there are no attenuators then the sound power will be constant at all times and distances.

The human ear is more sensitive to certain frequencies than others and so to ensure that the measured volume corresponds well to the perceived volume a weighting filter is applied to measurements. This is important for wind turbine applications as the noise that they emit is of a predominantly low frequency nature which penetrates walls easily (Bolin et al; 2011). For relatively quiet sounds; those less than 100 dB (i.e. a helicopter or a chainsaw) the A-weighting curve is applied to measurements. This can be seen in results by the use of dB(A) at the units of sound.

There are two potential sources of noise associated with a wind turbine: mechanical and aerodynamic.

Mechanical noise is created by the machinery inside the nacelle of the wind turbine and although this includes components such as yaw drives, cooling fans and hydraulics (Rogers et al.; 2002), the dominant sources of noise are the gearbox and the generator (Pedersen et al; 2003). These noises are usually of constant frequencies as their generation is associated with rotational equipment, and they are transmitted along the

structure of the turbine (the tower and nacelle) before being emitted from its surface (Rogers et al.; 2002).

In the last 20 years, mechanical noise in large turbines has been reduced considerably, to a level below that of aerodynamic noise and thus is no longer the dominant source of wind turbine noise (Pedersen et al; 2003, Rogers et al.; 2002). This has primarily been accomplished through improved acoustic insulation of the structure (Leloudas et al; 2007) and component mountings but also by innovations such as low speed cooling fans and changing the finishing of gear teeth (Rogers et al.; 2002). Another reason that the mechanical noise of wind turbines is now comparably lesser than that of aerodynamic noise is a consequence of the increased size of wind turbines. As turbine size increases, the aerodynamic noise increases at a much greater rate than the mechanical noise (Pedersen et al; 2003). One possible way to reduce mechanical noise further could be to use direct drive generators, thus removing one of the noisiest components (the gearbox) entirely.

There are three components that contribute to aerodynamic noise and these are created by a large number of complex flow phenomena (Pedersen et al; 2003, Rogers et al.; 2002, Leloudas et al; 2007);

- Airfoil self noise – generated by the air flow along the airfoil.
 - Turbulent boundary layer trailing edge noise
 - Separation-stall noise
 - Laminar boundary layer vortex shedding noise
 - Tip vortex formation noise
 - Trailing edge bluntness vortex shedding noise
- Low frequency noise – due to flow deficiencies caused by e.g. the tower, wakes, and wind speed changes.
- Inflow turbulence noise – generated by the interaction with atmospheric turbulence.

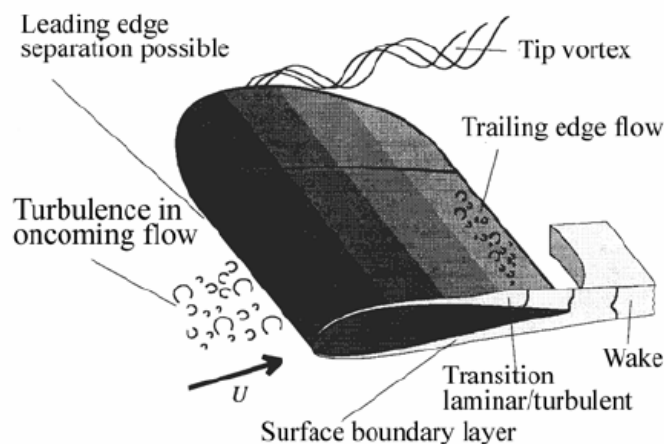

Fig. 3. Some of the effects that contribute to the generation of aerodynamic noise (Rogers et al.; 2002).

Unlike mechanical noise, aerodynamic noise is inevitable as it is directly associated with the production of power although steps are taken to limit it by slowing the tip speed to 60 m/s onshore and 80 m/s offshore (Leloudas et al; 2007). Even though aerodynamic noise increases proportional to the wind speed it has been shown that there exists a threshold

wind speed, over which the noise created by the interaction of the wind with vegetation (which when A-weighted is proportional to \log_{10} of the wind speed) will dominate the noise created by the wind turbine (Rogers et al.; 2002). An example of this can be seen in Fig. 4 where at 8 m/s the background noise exceeds that of the wind turbine. This threshold will be reached earlier if the wind turbine is sited in an area with a greater background noise such as close to a highway or on an industrial site.

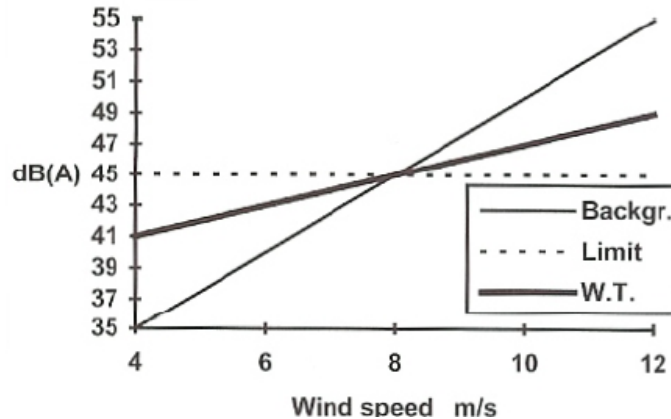

Fig. 4. An example of the increase in background noise that occurs with wind speed (Unknown source).

Although it is unlikely that the component of noise created by turbulence can be reduced, significant steps have been taken to reduce both the low frequency and airfoil self noises. These include the design of low noise blades, the dominance of upwind turbine designs, specially modified blade trailing edges and the employment of variable speed operation (Rogers et al.; 2002). Allowing the turbines to operate at a lower speed in lower wind speeds will allow the noise threshold to be reached much earlier, reducing the audible impact of the turbine.

Much research has been aimed at modelling the effects responsible for the creation of aerodynamic noise in order to try and determine ways in which to reduce it further. This has been done with varying degrees of success due to the extremely large number of effects and variables that require consideration (Zhu et al.; 2005). In one paper (Leloudas et al; 2007) it is shown, at certain wind speeds, that by pitching the blades, significant reductions (-2dB) in noise could be made with negligible cost to the power generation (-1%). At the wind speed at which the greatest noise is created, however, the power losses increased greatly when the blades are pitched to reduce noise.

Once the noise generated by the wind turbine (or wind farm) has been quantified it is important to be able to model its propagation correctly as it is this that will ultimately determine its impact upon local communities. It is well known that doubling the distance from a sound source results in a decrease in sound pressure level of 6 dB. This fails, however, to account for a large range of physically relevant effects such as (Eshbach; 2009, Rogers et al.; 2002);

- Source characteristics (sound levels, hub height, geometric arrangement of wind farm)
- Distance to observer
- Ground effects (reflection, refraction, absorption)

- Atmospheric effects (absorption, temperature, turbulence, wind speed and direction)
- Solid obstacles

Several models have been developed that do account for these physical effects and the general trend of noise propagation from one such simulation can be seen in Fig. 5.

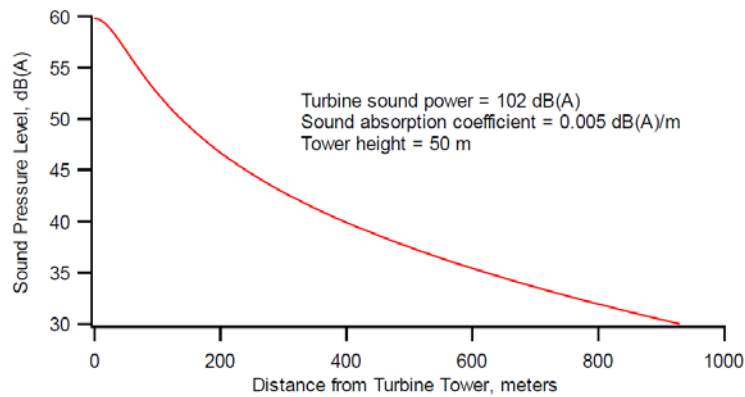

Fig. 5. The decrease in wind turbine noise with distance from the turbine (Rogers et al.; 2002)

With these models a whole host of changes of conditions can be modelled. Two of these scenarios that are of importance to wind farm planning can be seen in Fig. 6. Here a ray theory model has been used which shows that in reality when distance doubles, sound pressure levels are reduced by 7 dB at the low frequency end of the spectrum and by 20 dB at the high frequency end of the spectrum (Prospathopoulos et al.; 2005). This is mainly due to the frequency dependent nature of atmospheric absorption. It can also be seen that as the wind direction changes from the optimal direction for this farm (10 degrees) that the noise level increases. As the direction of the wind changes from optimal, the wake interaction between the turbines increases. This leads to an increase in the inflow turbulent noise and hence the total aerodynamic noise (Prospathopoulos et al.; 2005).

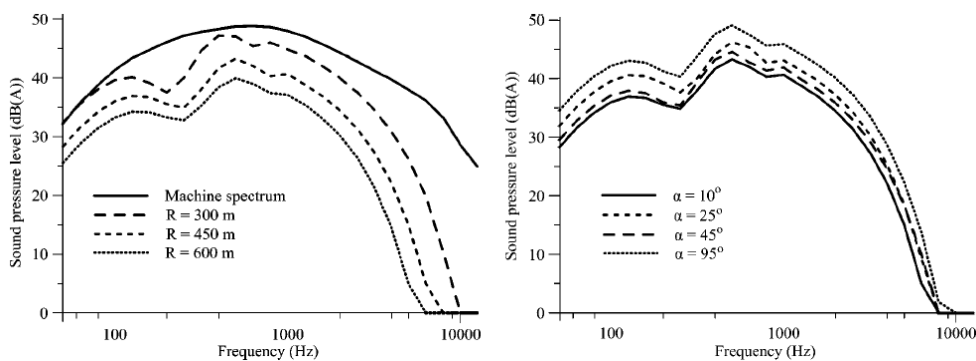

Fig 6. Sound pressure levels for various distances from the centre of the wind farm (left) and for various wind directions (right) (Prospathopoulos et al.; 2005).

Using these models, the changes in the propagation of noise that occur due to a change in conditions can be studied and mitigated during the planning phase. These changes

include the lessening of propagation effects with increased turbulence and noise near the ground being audible over larger distances (Eshbach; 2009).

There is, to this date, no scientific evidence that the noise caused by wind turbines could cause any health problems beyond those of annoyance (stress) and sleep disturbance (Bakker et al; 2012, Bolin et al; 2011, Pedersen et al; 2003, Shepherd). Human health is defined by the WHO as a state of complete physical, mental and social wellbeing (Pederson) and in several European studies strong correlation has been found between noise annoyance from wind turbines and sleep disturbance and psychological distress (Bakker et al; 2012, Pedersen et al; 2003). As this is the case then a prolonged exposure to wind turbine noise could lead to a stress induced decrease in quality of life as shown in Fig. 7.

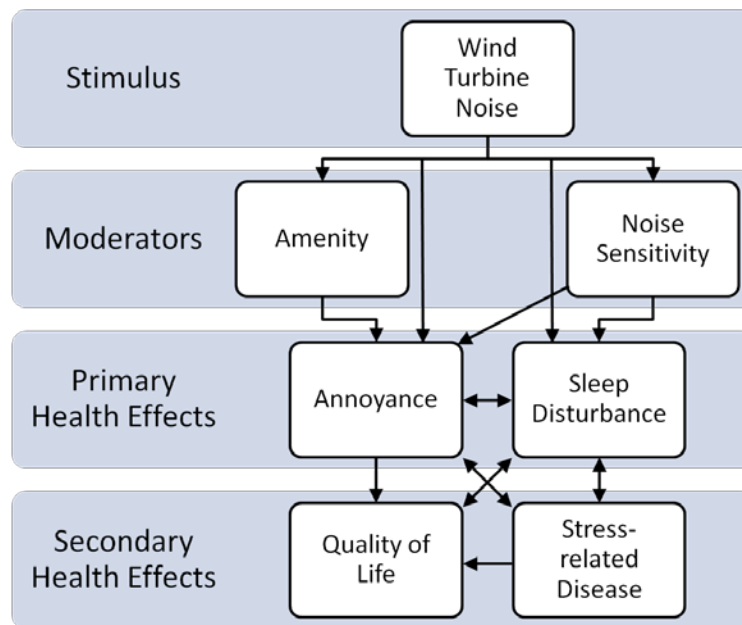

Fig. 7. The impact of wind turbine noise on people (Shepherd et al.; 2011).

A case study conducted in Sweden (Pedersen et al; 2004) found that the proportion of people annoyed by wind turbine noise is higher than for other community noise sources at the same volume (Fig. 8) and that this proportion increased at a much higher rate. The main complaints came from swishing, whistling, throbbing and pulsating noises created by aerodynamics (Pedersen et al; 2004). One other important finding of the study was that a person's perception of the turbines visual impact on the landscape also affected their audible perception highlighting the subjective aspects of the impact.

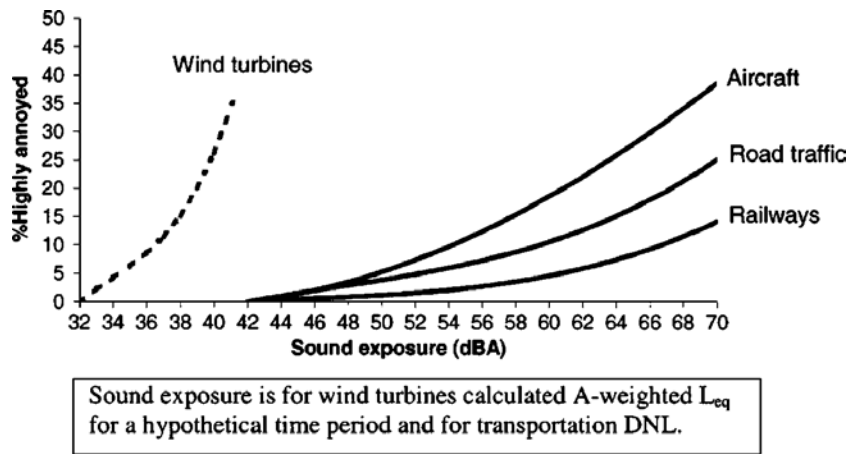

Fig. 8. The increase in annoyance of wind turbine noise compared to transport noise (Pedersen et al; 2004).

A separate study (Bolin et al; 2011) found that up until 40 dB, the proportion of people annoyed by wind turbine noise was approximately equivalent to the proportion annoyed by traffic noise. After 40 dB, however, the proportion annoyed by wind turbine noise increased at a much higher rate. Although the two studies present different thresholds it should be noted that both show the same trend.

There have been several theories put forward to explain this trend. The first is that the rural areas where wind turbines are usually sited have an ambient noise of approximately 10-15 dB lower than the cities where road traffic studies are often conducted (Bolin et al; 2011) allowing perception of lower volumes (it is also likely that the turbine will be the only real noise source in these areas). Another theory is that transport noise studies are assumed to be conducted inside, whereas wind turbine noise studies are conducted outside and so the wind turbine values should be adjusted to account for hypothetical attenuation by walls (Pedersen et al; 2004).

There has been little research done on the effects of wind turbine noise in wilderness areas but similar studies (Pedersen et al; 2003) carried out in the USA on the noise annoyance from airplanes over wilderness areas indicate that there is little evidence of spoilt enjoyment. As a wind turbine is stationary it may be fairer to compare its noise with that of a ski lift instead of an airplane (Pedersen et al; 2003) even if the ski lift only has seasonal operation.

A study conducted in The Netherlands (Bakker et al; 2012) found that those respondents that benefitted economically from the wind power development were significantly less annoyed by the noise than those who did not benefit from it, even though they lived closer to the turbines. This could provide a very simple mitigating measure by offering those living in the vicinity of the turbine shares in its operation. Another important finding from this study was that those who perceived the noise but weren't annoyed by it suffered no detrimental health effects related to it at all (Bakker et al; 2012).

There are a great number of guidelines concerning wind energy noise and every country has a different form of legislation and different noise limits. Denmark has a special legislation for wind turbines whereas Sweden uses legislation that was developed for other noise sources and the USA has no federal legislation on the issue whatsoever

(Pederson, Rogers et al.; 2002). Some of the different national wind energy noise limits can be seen in Table 1.

<u>Country</u>	<u>Commercial</u>	<u>Mixed</u>	<u>Residential</u>	<u>Rural</u>
Denmark			40	45
Germany				
(day)	65	60	55	50
(night)	50	45	40	35
Netherlands				
(day)		50	45	40
(night)		40	35	30

Table 1. Wind turbine noise limits for Denmark, Germany and The Netherlands (Rogers et al.; 2002).

The WHO recommends that for uninterrupted sleep no more than 40 dB(A) must be incident on the facade outside a bedroom (Bolin et al; 2011). The limits set by national legislations can be seen to agree with this.

To conclude, great steps have been taken in the last 20 years to reduce wind turbine noise. It does, however, remain a pressing concern to those who live in the general vicinity of wind turbines. There has been no hard scientific evidence presented to suggest negative health impacts caused by wind turbine noise greater than stress and sleep loss although over time these effects may trigger more serious conditions. Several measures can be taken to mitigate the impacts of wind turbine noise from correct simulation of sound power levels of the turbine and the propagation of the sound in the planning phase to variable speed operation and offering economic benefits to those affected in the operational phase. The differing nature of legislation between countries has briefly been discussed and the limits set by planning authorities must be adhered to.

2.2.3 Birds and bats

All man-made structures affect birds in a number of different ways. These include direct habitat loss and fragmentation, displacement (due to disturbance), death, injury and disruption of movements (both local and migratory) (Drewitt et al.; 2008). Wind turbines are often located in areas inhabited by rare or endangered birds and an assessment of impacts to avian populations should include the effects of all infrastructure: access roads, substations and power lines as well as the wind turbines themselves (Drewitt et al.; 2008). Direct avian mortality and injury at wind farms is caused both by birds colliding with wind turbines, power lines and meteorological masts as well as being forced to the ground by strong turbulence in the wake of the rotor.

Although all of the studies conducted on the impact of wind power on birds suggest a significant negative impact on avian abundance, there is considerable variation in the impact of individual wind farm sites on individual bird species. It is also unclear if the negative impact is a decline in population abundance (due to habitat loss or collision) or a decline in use owing to avoidance (which can also be viewed as a form of habitat loss). At the moment there is a poor evidence base in this field with many studies being methodically weak and more long term impact assessments required. Studies have only

been conducted at a small proportion of wind farms and tend to focus on passerines, raptors and species of conservation concern. Another problem with many of the studies in this field is that they do not incorporate a control or pre-development comparator and thus are technically unable to make comparisons to conditions before the wind farm was established (Stewart et al.; 2007) .

It is thought that habitat loss associated with wind farm development (in Europe) is a greater threat to bird populations than collisions and much evidence has been presented that shows birds being disturbed by turbines (Kuvlesky et al.; 2007). Displacement can occur during both the construction and operational phases of the wind farm and may be caused by either the wind farm itself, heavy machinery or maintenance crews. This is a very site specific effect and must be treated as such. It is usually assumed that a significant displacement of a population will result in its decline and displacement distances of up to 600 m have been recorded in some areas (Drewitt et al.; 2006). The scale of direct habitat loss resulting from the construction of a wind farm typically amounts to approximately 2-5% of the development area (Drewitt et al.; 2008)

Although those fatalities caused by collisions with wind turbines pale in comparison to those caused by all other man-made structures: buildings, communications towers and transmissions lines (800,000 km of transmission lines in the USA is estimated to cause approximately 174 million avian fatalities annually!), they receive far more media attention (Drewitt et al.; 2008). The causes of avian mortality in the USA have been obtained from two different sources and can be seen in Fig. 9 and Table 2. Although there is a discrepancy in the actual numbers killed, a general trend can be seen where many other factors kill far more birds than wind turbines and it is quite clear that the scale of the deaths caused by wind turbines is blown out of all proportion by the media.

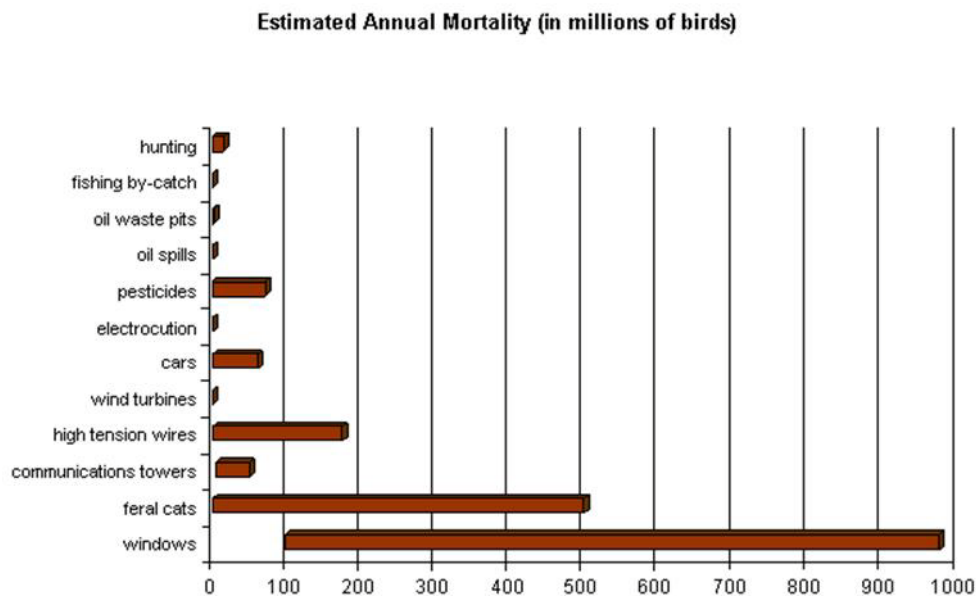

Fig. 9. Causes of avian mortality in the USA (Sibley; 2010)

Human related causes	Number of birds killed per year (million)
Cats	1000
Buildings	100
Hunters	100
Vehicles	60-80
Communication towers	10-40

Pesticides	67
Power lines	0.01-174
Wind turbines	0.15

Table 2. Causes of avian mortality in the USA (Saidur et al.; 2001)

A high proportion of the studies into avian collision fatalities show low collision rates which can be misleading due to the units used. For example in the Altamont Pass, California, USA the rate of Golden Eagle deaths is 0.02/year/turbine, which in reality corresponds to 67/year. In an attempt to correct for this, most papers now use units of either birds/year/turbine or birds/year/MW depending on relevant factors to different species (Drewitt et al.; 2008). As well as misleading units, many of the rates presented in the literature do not account for statistical errors created by searcher bias and scavenger removal rates which, even when accounted for, are not always correct. More research needs to be done here to correct for these factors and values in older literature may require adjusting before being used (Shaw Smallwood; 2007). It is for all of these reasons that even in the best case scenario these studies can only really be used to represent the magnitude of the fatalities and not their actual number. Collision rates with turbines depend, primarily, on four groups of variables: turbine and wind farm characteristics, avian species present and weather factors.

As with all man-made structures, the size and dimensions of the turbine should influence the risk of a bird strike. Strangely, though, it has been shown in many studies that avian fatality rates are, on the whole, almost completely independent of increases in either rotor height or diameter (Fig. 11) (Barclay et al.; 2007, Krijgsveld et al.; 2009). It is possible that this may be either a species dependent trait or that a threshold of structure (wind turbine) size may exist after which the rate of fatalities becomes constant. It was thought that lattice towers provided a greater collision risk than tubular towers as they offered more attractive perching opportunities, but this has been proven to be untrue.

The layout, orientation and spacing of wind turbines within a wind farm, as well as overhead transmission lines, will directly affect the collision risk (Drewitt et al.; 2008). If a wind turbine is placed on or near an area regularly used by large numbers of birds (either for feeding, breeding, roosting or flight paths) then its impact on birds will, logically, increase. Topographical features, such as valleys, may concentrate the numbers of birds flying through an area and wind turbines placed at these bottlenecks, or at topographical features followed by migratory birds, will also pose a greater risk (Drewitt et al.; 2008). It has also been found that lower collision rates are associated with wind turbines sited in grassland and moorland while the highest are found on mountain ridges and in wetland habitats.

The level of impact caused by the wind facility will also, to a great extent, be determined by the species of birds present; their physical characteristics (eyesight, reaction time in flight etc) and flight behaviour (hunting, flocking etc). For example, those birds with high body mass and relatively small wings have been shown to be at much greater risk of power line collision (Drewitt et al.; 2008). Species that flock not only create a greater density of birds in the air but the birds following the lead bird tend to have relaxed levels of attention which reduces their ability to react to danger (Krijgsveld et al.; 2009). The overriding species factor, however, to the level of impact upon an avian community is that species' response to a decline in population. The most vulnerable species to wind farms are large birds of prey as, collision risk notwithstanding; they are relatively long

lived with a long reproduction cycle meaning that they cannot compensate for higher mortality rates.

For most migratory birds, wind turbines are only a potential hazard on both take off and landing as birds tend to fly at very high altitudes during migration. Mortality rates are also likely to differ throughout the year depending on when breeding and migration events occur. If authors are not careful, their data can become heavily skewed by migration events at a wind farm that also has an individual, local population. It is likely that migrant birds will be unfamiliar with local obstacles and so may have a greater collision risk with the wind turbines than those birds that live there all year round. As they are only there ones or twice, however, migrant bird fatalities are likely to be much lower than those of local birds that may pass with wind turbines on a regular basis (Krijgsveld et al.; 2009). As with misleading units all of these factors must be taken into consideration when assessing the level of impact of a wind farm.

Mortality rates are also likely to increase during periods of adverse weather conditions as not only will visibility be reduced, meaning that birds have less time to respond to approaching hazards, but the bird is likely to have to fly at a lower height increasing the probability of it encountering the rotor plane.

One of the best examples of poor siting with respect to avian issues is the wind farm at Smøla, Norway (Follestad et al.; 2007, Lie Dahl et al.; 2012). The Smøla Archipelago, based off the west coast of Norway was, in 2003, home to a minimum of 19 breeding pairs of white-tailed sea eagles (a very high breeding density). In 2005 the wind farm became operational and by 2007, 5 breeding pairs had left and 10 fatal collisions had been recorded, although it is likely that the fatality count may have been greater (Follestad et al.; 2007). The sea eagles found were all injured either on their body or the inside part of the wing, some had been cut into two or more pieces. By 2009 another 18 fatalities had been reported and the majority of mortality was occurring during the breeding season (autopsies showed that some of the birds had either eggs or chicks in the nest). Before the establishment of the wind farm breeding attempts within the wind farm were approximately 50% successful, whereas since the building of the wind farm this has fallen to 10% (Lie Dahl et al.; 2012). This case study highlights the importance of considering the avian species present at the site.



Fig. 10. White-tailed sea eagle at Smøla wind farm (Follestad et al.; 2007).

It is usually recommended that a survey of birds be taken at the site of any proposed wind power development. This survey should be conducted for a minimum of 12 months before construction begins and detail the number, species and intensity of birds as well as their flight characteristics (Drewitt et al.; 2006). With the information gained from this survey not only will wind farm operators have a control scenario by which to measure the impact of the wind farm on the birds but they can also, to an extent, predict collision risks.

A number of models have been formed that predict the likelihood of avian collision with wind turbines. These are useful to establish a standard scale which can be used for comparisons (Drewitt et al.; 2006) but although the approach behind them is theoretically robust (accounting for number of blades, maximum chord width, angle of attack, rotor speed and diameter, bird size and flight characteristics amongst other variables) they all assume that a bird will take no avoiding action upon interaction with a wind farm (Chamberlain et al.; 2006). This is clearly an important effect which is both species and state (activity of the bird under a range of conditions) specific and will affect the collision risk. Further research is required in this area in order to establish more robust predictions of collision risks (Chamberlain et al.; 2006). Although it would seem logical that the rotor diameter be included as a variable in the collision risk, it has been shown by many studies to be fairly independent of this factor and so once reliable collision risks have been developed for one turbine they can be reused for repowering situations (Krijgsveld et al.; 2009).

The siting of the wind turbines is agreed to be the single most important factor in mitigating the impact to birds of a wind farm and the avoidance of impacts should always take precedence over their reduction (Drewitt et al.; 2008). There follows a list of best practices for the planning and operation of a wind farm with respect to the impact on birds (Drewitt et al.; 2006, Drewitt et al.; 2008, Krijgsveld et al.; 2009, Kuvlesky et al.; 2007):

1. Ensure that key areas of conservation importance and sensitivity are avoided.
2. Implement appropriate working practices to protect sensitive habitats.
3. Provide adequate briefing for site personnel and employ an on-site ecologist during construction.
4. Implement an agreed post development monitoring program through planning or license conditions.
5. Site turbines together to minimise the development footprint (allowing for the minimum inter-turbine spacing to minimise wake effects).
6. Group turbines in clusters (to encourage birds to fly around them) and leave corridors between turbines that are parallel to flight paths. If turbines must be placed in rows then ensure that they do lie perpendicular to flight paths.
7. Increase visibility of rotor blades. This can be done with either high contrast patterns (black and white stripes) or UV paint to enhance visibility to birds. It is, however, likely that this would lead to conflict with human visibility impacts!
8. Install transmission cables underground where possible.
9. Mark overhead cables using deflectors and avoid use over areas of high bird concentrations. Locate power lines close to higher features that birds must avoid anyway e.g. bridges. Use as few horizontal levels of wires as possible.
10. Time the construction of the wind farm to avoid biologically sensitive periods.
11. Implement habitat enhancement for species using the site.
12. Use the minimum level of lighting, consistent with obligatory requirements for navigation and aviation.

13. Offshore: carefully time and route maintenance trips to reduce disturbance from boats, helicopters and personnel.

Other more site-specific mitigation techniques could include a temporary shutdown of the wind facility during peak bird activities (controversial as it would result in a loss of generating capability) or radar activated sound deterrents (controversial due to possible noise impact) and emergency shutdown procedures (controversial for technical reasons). Repowering of sites in the near future offers the opportunity to micro-site turbines away from locations in which they were installed before the full impact of their operation was known (Drewitt et al.; 2008) without any increase in impact from larger turbines.

To conclude, the impact of wind farms on bird populations is highly dependent upon the species present at the site. If the source of mortality from the wind farm is less than that required to prevent population recovery then the impacts may be considered justified, although larger birds with slower reproductive cycles will find it much harder to compensate for population decline. One of the greatest concerns is that the wind farm will act as an ecological sink: one species suffering high mortality rates will leave the area free to be re-inhabited by another population which will then suffer the same impacts. The impact of the wind farm is highly localised and in fact there is no evidence of population effects on a regional or national level due to wind power development (Kuvlesky et al.; 2007). It has even been suggested by some that collision mortality for migratory birds is totally negligible compared to the number of them that die during the migration due to a range of factors (including adverse weather).

The impact of wind power developments upon avian populations is inevitable and although every step should be taken to reduce the magnitude of that impact (while still maintaining a high level of power production) it must also be viewed in the context of the possible impact of climate change on avian populations in the absence of wind farms (Stewart et al.; 2007).

Bat fatalities received very little attention up until approximately 20 years ago when small numbers were recorded in California during an avian fatality search (Arnett et al.; 2008). Since then, bat fatalities have been recorded at wind power installations over the world (Australia, North America and Europe) but until recently have not received as much attention as avian fatalities. It is now thought that bat fatalities are of greater concern than bird fatalities due to the number of bats that are being killed (Arnett et al.; 2008), their relatively low reproduction rate (1 or 2 offspring every few years) making it more difficult for the species to recover (Baerwald et al.; 2009) and the fact that many species are known or suspected to be in decline. Since the discovery of high bat fatalities post construction monitoring has intensified and most planning authorities now require some form of bat fatality mitigation to be produced (Arnett et al.; 2008)

The searches for carcasses are conducted on a similar basis to those that look for avian fatalities either by humans or dogs and have the following biases in the sampling that must be accounted for (Arnett et al.; 2008);

- Time frame of study (may miss periodic nature of phenomenon)
- Carcass removal rates by scavengers (modelled as for small)
- Searcher efficiency
- Fatalities that end up outside the search plot

Although with the increase in interest in bat fatalities many more searches and studies are being conducted there is a lack of consistency between these studies. Many are conducted over different time periods with different search criteria and so it is difficult to draw common trends (Arnett et al.; 2008). It is generally agreed that longer and more comprehensive studies are required.

As part of several studies, autopsies were carried out on bat fatalities to try to determine the cause of death. During a search at a wind farm in Wisconsin 39 bat carcasses were retrieved and after radiography it was found that 74% has at least one broken bone with wing fractures being the most common of these. The majority of broken bones were found to be comminuted (shattered or crushed), characteristic of a blunt trauma force (Grotsky et al.; 2011) which was proved unlikely to be due to the fall to the ground. Autopsies were then conducted on suitable carcasses and the most common internal injuries (all of which are consistent with barotrauma) found can be seen in Table 3.

Injury	Number	%
Pneumothorax (collapsed lung)	14 / 33	42
Hemothorax (blood in cavity between lung and chest wall)	13 / 33	39
Pulmonary haemorrhage (bleeding from lungs)	11 / 24	46
Inner or middle ear haemorrhage	12 / 23	52

Table 3. Most common injuries found in bats during fatality search and subsequent autopsies.

Certain cavities of the body (e.g. ears, lungs, intestines) contain air pockets that will change volume in response to a change in pressure. Barotrauma includes any of several injuries that arise from pressure changes within the body. These include the rupturing of tissues as air expands in response to low pressures (Encyclopaedia Britannica; 2012).

It should be noted here that pneumothorax and hemothorax often occurred together but hemothorax can also result from a blunt force trauma. It was concluded that the exact cause of death could not be determined for any of the bats but that it was likely to be an indiscernible combination of barotrauma and blunt force trauma (Grotsky et al.; 2011).

A second study was conducted in Alberta, Canada where 188 bats were autopsied to find that 92% had haemorrhaging consistent with barotrauma and only about half of the bats had suffered a blunt force trauma (Baerwald et al.; 2008).

There are two theories as to the cause of the blunt force trauma. The most widely accepted is direct impact of the bats with some part of the wind turbine. The second theory is that the large proportion of wing fractures suggests that the bats could be caught in the vortices behind the wind turbine and their wings be broken by the relatively large forces present (Grotsky et al.; 2011).

Bats are far more susceptible to barotrauma than birds due to differences in their respiratory anatomy. Bats have large, pliable lungs which, when exposed to a sudden pressure drop, will expand, whereas birds have compact, rigid lungs which will not (to the same extent) (Baerwald et al.; 2008). Although the extent to which a change in pressure will affect the anatomy of a bat is unknown, evidence can be found elsewhere to suggest that it would be detrimental. The pressure at points along a moving blade can be between 5 - 10 kPa which is more than enough to kill the Norway rat (common brown rat) which is of a similar size and anatomy to the average bat (Baerwald et al.; 2008). So

even if the bat avoids the turbine itself it can still be killed by the invisible pressure changes.

If the bat is not killed by the turbine, massive damage can still be done to its hearing (primary hunting mechanism) by pressures behind the rotor which are equivalent to sound levels 10,000 times higher in energy density than the human threshold of pain (Grodsky et al.; 2011).

Out of the numerous surveys that have now been conducted in North America on bat fatalities, several trends have started to become apparent. Out of the 19 species of bat that reside on the North American continent almost exclusively 6 species are susceptible to wind turbine induced deaths (Kuvlesky et al.; 2007). These 6 species are all migratory, tree roosting species and the majority (90%) of fatalities occur between July and September, peaking in August (Arnett et al.; 2008, Kuvlesky et al.; 2007).

Strong correlations between different facilities in the same areas have been determined but no clear trends present themselves for fatality distribution within an individual wind farm (Arnett et al.; 2008). There have also yet to be any solid trends drawn between number of fatalities at a site and its location relative to a particular habitat in North America. A minor increase close to wetland habitats has, however, been seen in some studies (Arnett et al.; 2008).

Unlike with birds, it has been found that the number of bat fatalities increases with the height of the turbine but not its generating power (proportional to the rotors swept area). These trends can be seen in Fig. 11 (Barclay et al.; 2007).

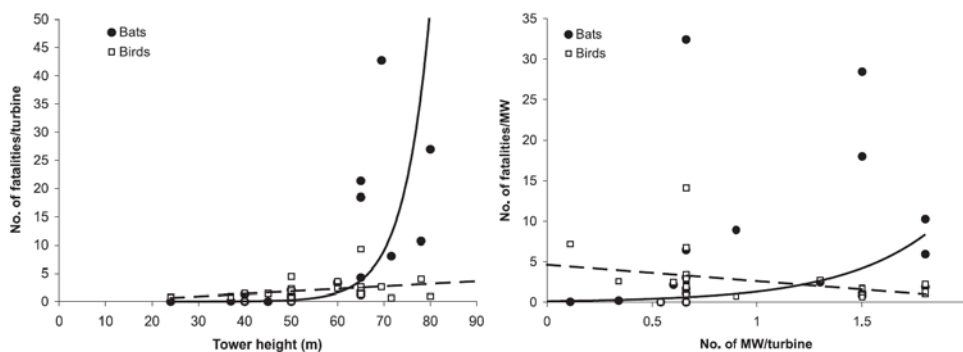

Fig. 11. Fatalities as functions of tower height (left) and turbine capacity (right) (Barclay et al.; 2007)

Other trends that have been seen include bats only striking blades in motion and not stationary meteorological masts or turbine towers (Arnett et al.; 2008) and that those periods of highest fatalities were found to correlate strongly to nights with low wind speeds (< 6 m/s), low moon illumination, high cloud cover and low pressure indicating the passage of a weather front (Cryan et al.; 2007).

A similar review has been conducted in Europe using surveys from Germany, Austria, Switzerland, England and France. Although this review agrees with the findings from North America that the majority of fatalities occurred on nights with low wind speeds between July and October and increase with rotor height and area it suggests a different trend in both species and siting significance. In Europe it was found that the species killed were almost exclusively those adapted for open air hunting, 98% were high risk

species and that the number of bats killed per turbine differed with the terrain in which they were situated (lower fatalities in flat, open farmland and highest in coastal regions, forested hills and ridges) (Rydell et al.; 2010). Given this conflict in findings it is possible that different mitigations measures may have to be taken for bats on different continents.

There have been many theories put forward to suggest why so many bats seem to be killed by wind turbines. It is clear that the bats are attracted to the turbines as thermal imaging does not show the bats being struck by the blade accidentally while passing straight through the farm to another destination (Horn et al.; 2008). Theories include the availability of prey at hill top sites and that audible noise made by the turbines may attract bats over great distances (although this latter theory has been widely discredited due not only to the low frequency nature of wind turbine noise but also that high frequencies attenuate very quickly in air) (Arnett et al.; 2008). It has also been suggested that aviation lights attract more insects (and thus bats) but after a comparison of turbines with and without lights this was found not to be the case (Arnett et al.; 2008).

The most popular theory at the moment is that the wind turbines, being tall prominent features in most landscapes, are investigated by migratory tree bats as possible roosts (Arnett et al.; 2008, Cryan; 2008, Cryan et al.; 2007, Kuvlesky et al.; 2007, Horn et al.; 2008). The periodicity of the fatalities and large numbers of them may also indicate that the bats flock to these prominent features during their autumn migration to mate.

There is substantial evidence to support this theory. Thermal imaging has shown bats actively investigating and attempting to land on both moving and stationary blades (Horn et al.; 2008). This may result in barotrauma, being caught in the vortices from the blades or being struck by the blade as shown in Fig. 12.

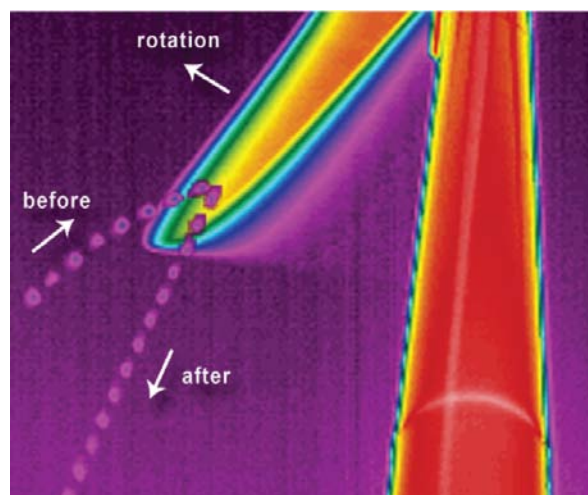

Fig. 12. A time lapse thermal image of a bat approaching a turbine blade in motion before being struck (Horn et al.; 2008).

Although the random distribution of fatalities within a facility precludes micro-siting and the attraction of bats to turbines precludes macro-siting, a range of mitigation measures can still be taken (Arnett et al.; 2008). These mitigation measures centre around the limitation of operation during those periods where highest bat activity is known to occur (i.e. August, 2 hours after sunset, low wind speeds, dark moon, low pressure, low rain).

This has been tested at a wind facility in Alberta, Canada where, during August 2007, the cut in wind speed for 21 wind turbines was increased from 4 m/s to 5.5 m/s (Baerwald et al.; 2009). Due to the technology at the time, this scheme had to be implemented 24 hours a day, not just in those hours of peak bat activity. This meant that the turbines were out of operation for 42.3% of the time that they would have been in operation otherwise. It was found that this reduced bat fatalities by up to 60% at a revenue loss of \$3,000 - \$4,000 (Canadian) (approximately €2,000 - €2,700 at the time) (Baerwald et al.; 2009). If, however, the cut in speed of the turbine could be increased automatically at times of peak bat activity then this profit loss would decrease significantly.

To conclude, recent estimates suggest that if mitigation measures are not taken, then at the current rate of wind energy installation, the bat fatality rate could be between 33,000 and 110,000 per year in the Eastern United States of America alone (Arnett et al.; 2008). If current theories about the flocking of migrating bats to wind turbine to mate are correct then this has grave implications as not only will wind facilities create a population sink but they will kill those bats primed for reproduction (Cryan; 2008).

It has been shown that taller turbines present an increased risk to bats and this will add to the fatality rates as re-power schemes are enacted (Rydell; 2010). Although European evidence, in contrast to that from North America, points towards few migratory bat fatalities it should be noted that European migratory bats are known to move over offshore waters and future wind facilities in these areas will doubtless attract them (Cryan et al.; 2007).

2.2.4 Flora and fauna

The impact of wind energy on flora and fauna results from the destruction of habitat due to the construction of the wind farm (including the entire infrastructure such as buildings, electrical transmission lines and access roads as well as the wind turbines themselves) as well as disturbance from human activity (solely for fauna) (Gipe; 1995, Kuvlesky et al.; 2007).

Although the site in which a wind facility is developed can no longer be considered pristine, the average footprint per turbine is roughly equal to just 2% of the entire area of the wind farm (Kuvlesky et al.; 2007). The cumulative loss in wildlife and habitat that results from the construction of the wind farm is considered insignificant and certainly much less than a residential development of similar size (Gipe; 1995). It has also been found that very few small animals are killed during maintenance at the wind farm and those that are are primarily killed by vehicle collisions (Gipe; 1995). Although the operation of a wind farm may prevent animals from denning in the area it has not been found to stop them foraging and no changes in predator levels have been seen (Gipe; 1995).

In the USA it is required that a wind farm be fenced off to prevent unauthorised access. This was thought to inhibit migration of certain animals but since investigation has been found to actually be of ecological benefit to some species as it has restricted all off-road traffic within the wind farm (Gipe; 1995). As a result it is now suggested that all areas of critical environmental concern are fenced off in a similar manner for protection (Gipe; 1995).

Roads can act as barriers to the movement of animals and have been found to have potentially disastrous effects on certain populations due to genetic isolation (Gipe; 1995).

As, however, it is difficult to justify a 6 lane highway for wind farm maintenance access where a single lane track will suffice, this is unlikely to be a concern. The frequency of traffic on this single lane road is also likely to be far too low to inhibit animals crossing it.

The mitigating strategies for the impacts on flora and fauna can be described as a mixture of common sense and carefulness. Best practice measures are;

- Conduct a thorough environmental survey of the area to identify any highly localised or endangered species making sure that local enthusiasts are consulted.
- Either micro-site to avoid these species or make efforts to relocate them, if present.
- Cut migratory animal sized holes in fencing to allow migration through the wind farm.
- Drive carefully during maintenance and try not to run any animals over.

2.2.5 Electromagnetic interference

Electromagnetic interference (EMI) is any electromagnetic disturbance that interrupts, obstructs or otherwise degrades or limits the effective performance of electrical equipment. Electromagnetic waves are characterised by their amplitude, frequency and phase (and also by polarisation). This can be seen in Fig. 13 where two electromagnetic waves have been plotted to show their basic properties. From this it can be seen that phase is a relative property and not an absolute.

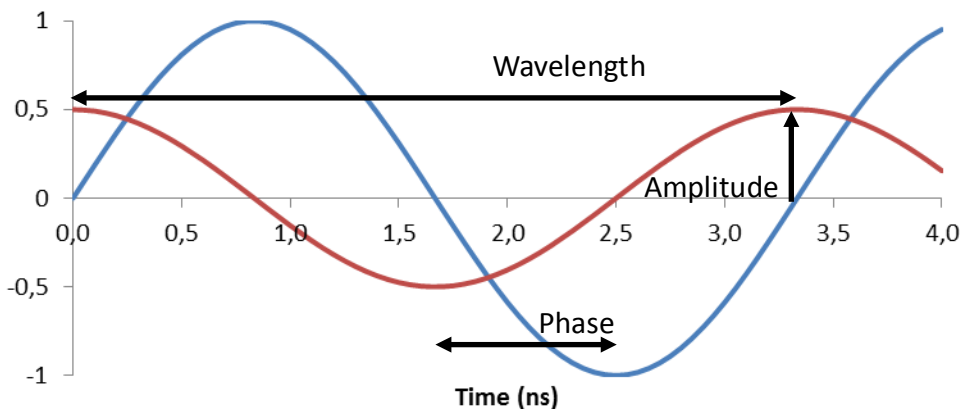

Fig. 13 Two electromagnetic waves with wavelength 1 m (frequency 300 MHz). The red wave has half the amplitude of the blue wave and they are 90° out of phase (sine and cosine waves).

When two electromagnetic waves are received simultaneously they interfere to create a superposition of their respective properties. With respect to the EMI from wind turbines, secondary waves can be created by passive effects such as reflection, refraction and diffraction, or by active effects such as near field emission. In the case of wind turbines, EMI is usually discussed in reference to telecommunications which include (but are not limited to);

- Television (~50 MHz - 1 GHz)
- Radio (~1.5 MHz (AM), ~100 MHz (FM))
- Mobile phones (~ 1 - 2 GHz)

- Radar (although only Germany and the UK consider this an issue (Jago et al.; 2002))

It is clear that the level of impact that EMI from wind turbines will have on telecommunications will vary depending on the purpose of the primary signal. A disruption in an entertainment signal will cause annoyance whereas a disruption in navigation signals could be potentially hazardous.

Wind turbines are known to cause EMI via three principle mechanisms; reflection (from this point to more generally termed scattering), diffraction and near field effects (Krug et al.; 2009), each of which will now briefly be discussed.

Scattering occurs when the rotating blades of a wind turbine receive a primary transmitted signal and then retransmit this signal (Sengupta et al.; 1979). This secondary signal can be either front or back scattered from the wind turbine (Sengupta et al.; 1979) and it is usually scattered by the blades. Interference is created, in this scenario, by the difference in phases between the two received signals (ignoring minor Doppler shifted frequency contributions) due to the fact that the scattered signal will have travelled a greater path length to reach the receiver than the primary signal. This different in path length can be seen in Fig. 14. It has been found that apart from the phase difference, that there is also a periodic amplitude modulation of the secondary signal due to the oscillatory blades that it scatters from (Dabis et al.; 1997, Sengupta et al.; 1979). The impact of interference from scattering decreases with both decreasing signal frequency and increasing distance from the wind turbine.

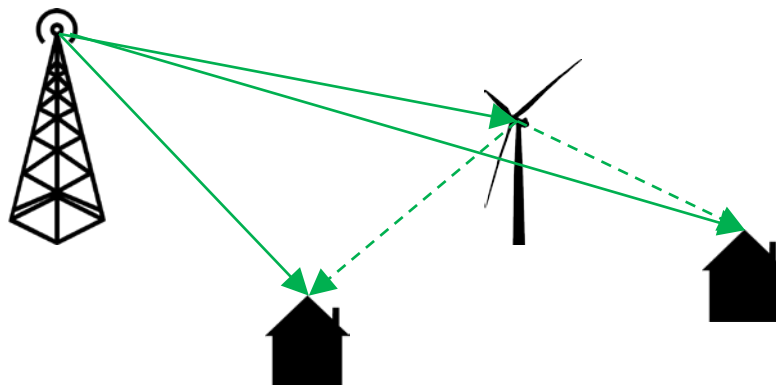

Fig 14. The production of a scattered signal (dashed line) by the retransmission of a primary signal (unbroken line) by a wind turbine.

Diffraction occurs when an object modifies an advancing wavefront by obstructing the wave's path of travel (Krug et al.; 2009). This can reduce the amplitude (energy) of a signal before it reaches a receiver and this is the EMI in this scenario. If the turbine blades cause diffraction, the radio wave perturbations may cause a periodic disturbance of signal at the receiver. The diffraction caused by the turbine may also create a very thin blocking region directly behind the turbine where no signal can be received at all. This effect can only occur in an arc behind the turbine.

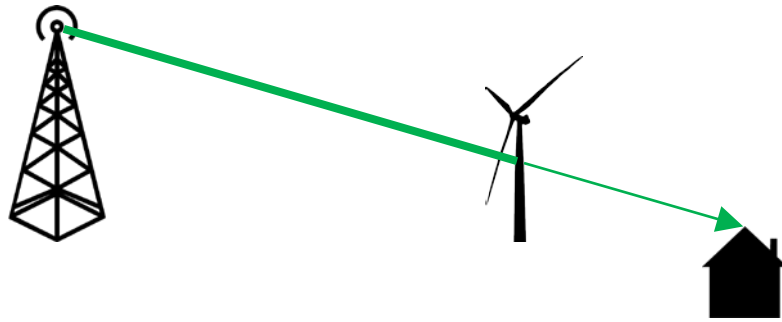

Fig 15. Diffraction of a signal received by an antenna behind a wind turbine.

The generator and switching components in the turbine nacelle or hub emit electromagnetic fields by nature of their operation (Krug et al.; 2009). Near field effects refer to these electromagnetic fields being received along with a primary signal and this creates interference by the fact that the secondary signal is totally different to the primary.

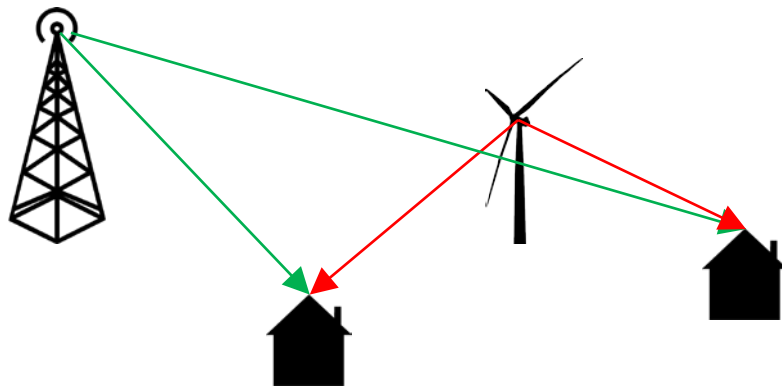

Fig 16. The interference of the primary signal (green) and electromagnetic fields produced by the wind turbine (red).

Several models have been developed that allow developers to model the EMI impact of a wind farm on surrounding electromagnetic signals although most still come with a substantial level of error (Angulo et al.; 2011, Casanova et al.; 2009). In the UK, the BBC has developed a model, based on simple geometry that will give an indication of the number of properties whose television and radio reception may be affected by the construction of a wind farm in a given location. This tool can be accessed at

http://www.bbc.co.uk/reception/info/windfarm_tool.shtml

It is still recommended that developers conduct their own assessments of EMI, firstly as this model will not account for impacts to radar and secondly as there may be local effects or features that the model of the BBC does not account for.

Standard mitigation techniques involve;

- Re-orientation of existing aerials to an alternative transmitter
- Supply of directional aerials to mildly affected properties
- Switch to supply of cable or satellite television (subject to parallel broadcast of terrestrial channels)
- Installation of a new repeater station in a location where interference can be avoided (this is more complex for digital but also less likely to be required.)

More recently, research has begun on the possibilities of reducing the EMI impact by adapting practices usually employed by the military to create 'stealth' turbines. Significant reductions in scattered signal have been achieved by reducing the radar cross section of the rotor hub and tower (Matthews et al.; 2007, Pinto et al.; 2009) while blades coated with radar absorbent materials are currently going through testing phases but show promising results (Appleton et al.; 2006, Matthews et al.; 2007, Pinto et al.; 2009).

2.2.6 Shadow flicker

Wind turbines, like all other tall structures, will cast a shadow on the neighbouring area during hours of bright sunshine. Shadow flicker describes the pulsing change in light intensity that is observed when the blades of a wind turbine pass periodically through sunlight in front of an observer.

Flicker illness, or the Bucha effect, is caused by low frequency (2.5 - 40Hz), periodic variations in light intensity that can result in mild discomfort and headaches or, in a very small proportion of the population, profound spatial orientation and seizures (Cushman et al.; 2006, Parsons Brincherhoff; 2011). Photosensitive epilepsy has been noticed to be induced by sunlight shining through rotating helicopter blades (Cushman et al.; 2006) which will induce flashing at 24-27 Hz.

Several studies have been done into the effects of wind turbine induced photosensitive epilepsy and in worst case scenarios it has been found that the risk is negligible further than 1.2 times the total turbine height on land and 2.8 times the height when offshore (Smedley et al.; 2009). It has also been found that the flicker frequency should be kept below 3 Hz (Harding et al.; 2008).

Approximately 0.5% of the population is epileptic (in the UK), of which around 5% are photosensitive and of these, 5% are sensitive to lowest frequencies of 2.5-3Hz (Parsons Brincherhoff; 2011). Larger, modern turbines have rotational speeds that mitigate this concern. The nominal rotational frequency of the Vestas V90-3MW wind turbine is 16.1 rpm which equates to a flicker frequency of 0.92 Hz. Mitigation may, however, still be required due to both the possible annoyance caused by flicker and to account for smaller, faster turbines.

Levels of shadow flickering are generally not regulated explicitly but guidelines do exist in most countries of either acceptable maximum levels of flickering, or the distance within which any flickering effects must be mitigated. Some of the shadow flickering guidelines for different countries can be seen in Table 4 where it can be seen that although there is a wide range of guidelines, it is generally considered that further from 1 km from the turbine that shadow flickering is not an issue as the turbine is perceived to be just another static obstacle in front of the sun.

Country	Distance of flickering	Worst case	Realistic	Max effect	Notes on limits
Australia	500 m	-	-	-	
Belgium	-	30 hours/year	-	30 min/day	
Denmark	500-1000 m	-	10 hours/year	-	
Germany	-	30 hours/year	8 hours/year	30 min/day	2 m from ground
Ireland	10 rotor diameters	30 hours/year	-	30 min/day	Within 500 m of turbine
The Netherlands	-	5.67 hours/year	-	20 min/day	
UK	10 rotor diameters	-	-	-	
France	No guidelines but an analysis is required as part of the EIA				
Spain	No guidelines as most wind facilities are in remote areas and there have been no complaints				
Canada	No guidelines but those of Denmark, Germany and UK are discussed				
USA	No guidelines as shadow flicker is not considered to be an issue				

Table 4. Shadow flicker guidelines for several countries (Parsons Brincherhoff; 2011).

Three main software packages (WindFarm, GH WindFarmer and WindPRO) are used by developers to predict and quantify the impact of shadow flicker on a certain location. All of the models give similar results using a geometric approach as shown in Fig. 17 and require a standard set of inputs;

- Observer location
- Wind turbine location, hub height and rotor diameter
- Latitude and longitude (determines the relative motion of the sun and thus variations in daylight hours over the year)

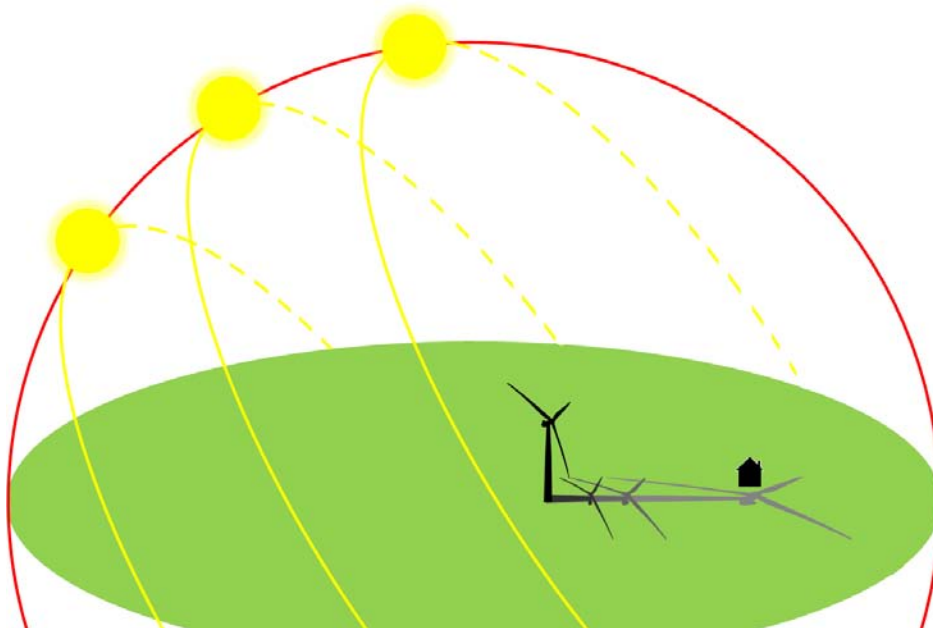

Fig. 17. The geometric approach used to evaluate the worst case scenario for shadow flickering. The lowest sun represents its zenith at the winter solstice while the highest sun represents its zenith at summer solstice.

A worst case scenario is predicted where the rotor yaws so as to track the movement of the sun exactly (giving maximum shadow), the turbine is always in operation and the sun is always unobstructed (during the day). This estimate can be made more realistic by accounting for the following factors;

- Wind turbine operation
 - The frequency of actual rotor direction can be determined using the wind rose from the site.

- The frequency of operation can be calculated from the Weibull distribution of wind speeds at the site and the cut out speeds of the turbine.
- Hours of sunlight
 - Accounts for the frequency of relevant atmospheric effects (e.g. cloud cover, fog etc).
 - Assumes that the sun must be more than 3° above the horizon (to clear light blocking obstacles).

In Denmark, the realistic model gives a flickering time that is 18% that of the worst case scenario and so it is usually useful to calculate both values even if national guidelines do not require it. For those who are impacted by shadow flickering, the usual mitigating strategy is to shut down the turbines during flickering periods. Other strategies such as landscaping, vegetation screening or installing blinds have been suggested.

To conclude, shadow flickering from large, modern turbines should not pose any serious health risks to those with photosensitive epilepsy as its flickering frequency is too low. It is still important, however, to plan for mitigation should properties be affected by shadow flickering as it is still a source of annoyance.

2.3 Offshore wind farms

As with the previous section, this section contains those impacts which are more likely to occur at an offshore wind farm. The previous section should, however, be used in parallel with this one.

2.3.1 Coastal morphology

The construction of any structure at sea will influence the passage of water through that area as it will now have to pass around an obstacle and this may lead to changes in wave and current properties which can influence coastal erosion. The magnitude of this impact will not only depend on the structural properties of the obstacle (i.e. shape, size, and rigidity) but also by the properties of the flow passing it (i.e. wave height, current speed).

For an offshore (not coastal) wind farm this impact is mitigated by the structure of the wind farm and its distance from the shore (approximately 10 km). As the monopiles of offshore wind turbines are usually fairly thin (approximately 5m diameter) they will not impede the passage of water or change the direction of its global flow but will only influence it in the locality of the monopile.

The laminar solution of flow around a circular cylinder gives a maximum speed up of +100% at the surface of the cylinder which drops to +4% by 10m and just +1% at 20m. In real life, even though it is a symmetric problem, there will still be a degree of vortex shedding but the effect of this on the coastline is again likely to be mitigated with distance. It is, however, still recommended to follow a monitoring scheme and especially for coastal wind farms, the impact on coastal morphology of which will not be mitigated by the distance to shore.

2.3.2 Marine substrate and vegetation

The substrate of an area is the physical material that rests on the seabed. This can be described by the size of the bodies that lie on the seabed: mud, sand, pebbles, boulders etc, as well as their distribution. The substrate of an area will determine the composition

of the flora and fauna living in it and the introduction of a foreign body with a different substrate to the surrounding substrate (such as a monopile into sand) can alter this composition (see the section on benthos for more details on this effect). Scour protection around the base of wind turbine foundations can also create highly localised artificial reefs, again changing the composition of the ecosystem. The impact of the wind farm upon vegetation is confined to sediment dispersal (which can reduce photosynthetic production) and minor direct habitat loss during construction.

2.3.3 Bottom fauna

Bottom fauna (infauna) are those that live within the seabed. These are likely to be disturbed only by direct habitat loss due to foundation construction and the impact of this has been found to be statistically negligible upon a population.

2.3.4 Benthos

Benthic organisms (epifauna) are those that live at the bottom of the water column, either on or very close to the seabed. These are a diverse group of organisms including, amongst others, crustaceans, corals, sponges and echinoderms. Benthic organisms are highly affected by changes in abiotic factors such as salinity, temperature, sediment conditions and depth of water.

The negative impacts on the benthic community are likely to be felt most strongly during the construction stage of the wind farm (Koller et al.; 2006). During this stage not only will there be a direct habitat loss of approximately the area of the foundations but shifting sediments during this process will impact upon the suspension-feeding species of the group. Certain species of benthos are known to be attracted to hard substrata and although this gain in habitat area more than makes up for that lost due to foundations it could cause a change in the benthic species composition of an area, especially if it had a predominantly soft sandy seabed to begin with. There have also been questions raised about the effects of electromagnetic fields and increased temperatures around the cables in the wind farm but knowledge of their effects on benthos is either lacking or non-existent (Koller et al.; 2006).

Heavy trawling is particularly destructive to benthic communities as not only does it destroy the entire seabed but also releases large quantities of sediment into the water which affects benthos over a much wider area (Koller et al.; 2006). As trawling is usually forbidden within offshore wind farms the bottom dwelling benthic communities within such a site will be protected from its destructive effects.

In studies done at both Horns Rev 1 (Leonhard et al.; 2006) and FINO 1 (Koller et al.; 2006) it has been found that the introduction of monopiles as hard substrata increases the biodiversity of an area by attracting a wide range of benthos. The process of colonisations can begin to occur within as little as two weeks after the completion of construction and this in turn attracts large predators to the area (increasing the biodiversity further). This is, however, associated with a change in the species composition of the area.

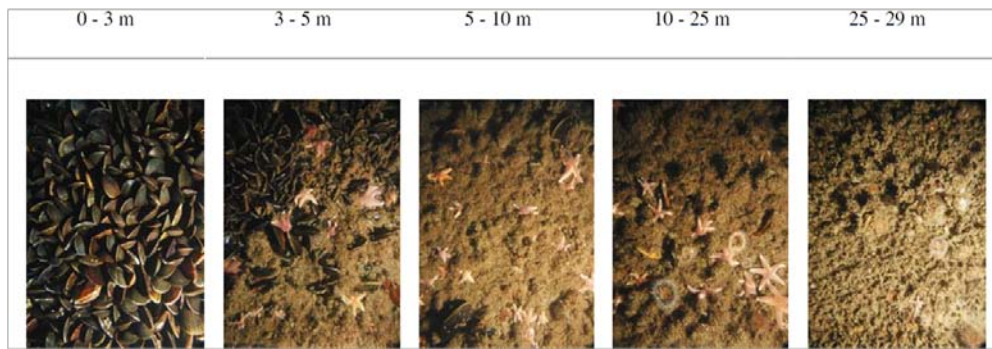

Fig. 18. Depth gradient of epifauna on FINO 1 in Nov. 2004 (Koller et al.; 2006)

It is unlikely that permission to develop in an area will hinge upon its benthic population.

2.3.5 Fish

The impacts of an offshore wind farm on fish will be fairly similar to those for other marine creatures; potential loss of habitat and disturbance from noise. During the construction of the wind farm habitat will be lost and the seabed disturbed. If the seabed is soft this can lead to mobilised sediment which can smother neighbouring habitats (Gill; 2005). There have been no indications that construction of wind farms has any effect on sediment composition (Jensen et al.; 2004) and any loss of habitat is mitigated by the artificial reef effect.

During construction there will be an impact from the noise created by pile driving the monopile foundations into the ground (Thomsen et al.; 2006). Fish have a large range of hearing responses from species to species and little research has been done into their response to sound. Out of the work that has been done there is little to suggest that they are effected by construction noise (Brown trout have not shown any response to pile-driving 400m away (Thomsen et al.; 2006)). Some preliminary data does suggest that salmon may hear the turbine in operation within 1 km whereas cod and herring may hear it within 5km. This, however, is the range of audibility and not response which will be much less. Mitigation for noise is discussed in the section on marine mammals.

Some species of fish are magnetosensitive and it has been suggested that the magnetic fields induced by the currents running through the transmission cables could disrupt their behaviour (Ohman et al.; 2007). Some species of magnetosensitive fish use the magnetic field of the Earth to navigate and magnetic fields could also influence the reproduction and survival of some fish (Ohman et al.; 2007). A study of European silver eels transversing a submerged cable in the South Baltic showed a slight deviation from their course and delays of around 30mins (Ohman et al.; 2007). To interact with a magnetic field of a similar magnitude to that of the Earth a fish would have to swim within approximately 6 m of the cable and so would only be in the field of influence for a brief period of time (Gill; 2005).

Offshore wind farms have been seen to attract fish for several reasons. Firstly, due to the artificial reef effect, there is an increase in food availability at these sites and juveniles are shelters from predators in the area (Gill; 2005, Wilson et al.; 2009). The fish are found to retreat back to the vicinity of the wind turbine foundation when disturbed (Wilhelmsson et al.; 2006, Wilson et al.; 2009) and protection from fishing is also afforded to fish within the wind farm (Gill; 2005).

There is the danger that creation of the artificial reef will change the composition of the ecosystem and at Horns Rev eels have been found to move into the wind farm (populations increased by 300% in 2 years (Jensen et al.; 2004)). Mitigation measures include picking sites with sparse communities (Gill; 2005) and the same noise mitigation discussed for marine mammals later.

2.3.6 Birds

The construction of an offshore wind farm can affect both resting and foraging waterbirds as well as birds that cross the sea during migration (Exo et al.; 2003). The possible collision risks associated with avian species at wind farms has been covered in depth in a previous chapter and very little is different at offshore sites. The potential impacts on food sources such as fish/bottom species have also been discussed and as such this chapter will not reproduce this material but, instead, focus on long-term habitat loss as well as disturbance and barrier effects.

As with all other research into the environmental impacts of offshore wind energy, the research conducted on the impact on avian species offshore is skewed towards the species of northern Europe. Combine the fact that every year several million birds migrate across the North and Baltic seas with the planned construction of multiple offshore wind farms consisting of hundreds of turbines and it becomes apparent that there exists the potential of a considerable impact to be mitigated (Hueppop et al.; 2006).

The behaviour of birds with offshore wind farms has been studied using a range of techniques including (Desholm et al.; 2006, Hueppop et al.; 2006);

1. Visual observation.
 - This allows species composition to be easily determined by trained birdwatchers. Aside from being especially time consuming it is limited by human anatomy and a thorough assessment is almost impossible to achieve due to eyesight (maximum range of 2 km with an optical aid), visibility, concentration span etc.
2. Radar.
 - High powered radar can detect birds up to 100-240 km away and can be fixed to tripods, observation towers or vehicles. Some issues can be encountered with scatter from rain or the surface of the sea but it is a tried and tested method in multiple countries (Denmark, Netherlands, and USA). It is, however, relatively expensive and requires two radars for a full resolution image in 3 dimensions. An example of the results achievable can be seen in Fig. 19.
3. Infrared camera systems.
 - These allow body shape, wing beat frequency, flock formation and flight pattern to be determined to help with species identification. They can also be used to count collision events and the number of birds passing through the rotor plane.
4. Acoustic monitoring
 - Using directional microphones helps with both identification of species (from birdcalls) and measuring collision rates through impact noise. This is a fairly cheap option but the information gained from it is limited in its scope.

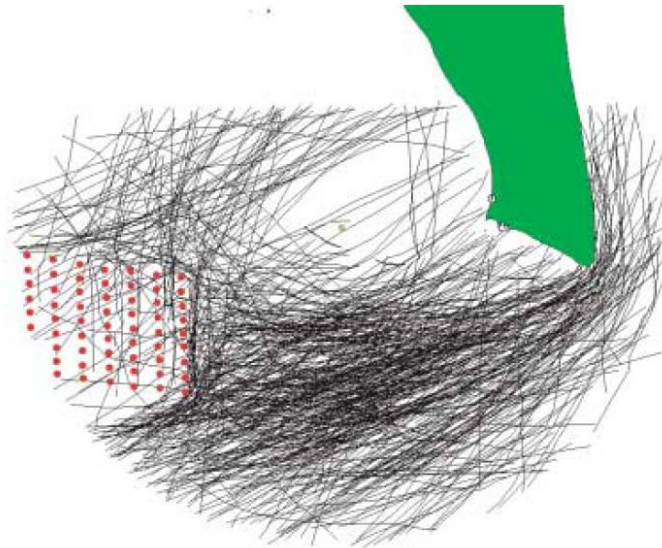

Fig. 19. Radar observed flight paths of migratory eider past the Nysted wind farm (Desholm et al.; 2006).

The disturbance caused by the construction of the wind farm is likely to be considerable but brief. Although direct habitat loss due to the construction of the wind farm is not a major concern for birds (especially at sea), they can be excluded from suitable breeding, roosting and feeding habitats by the disturbance caused by operating wind turbines (Exo et al.; 2003). Some species are more prone to disturbance than others with divers and scooters being amongst the most sensitive. In the long term, birds are likely to be disrupted by almost daily maintenance trips to the larger wind farms (Exo et al.; 2003).

Wind farms may act as barriers between roosting and feeding sites although in general it is thought that migrants are more affected than local residents (Exo et al.; 2003). Many species of bird, including geese, waders and terns, have been seen to react to the presence of turbines at a few hundred metres and change direction to fly around, instead of through, the wind farm (Exo et al.; 2003, Hueppop et al.; 2006). This effect is independent of the motion of the rotors and so it is thought that birds avoid the structures themselves as opposed to the moving blades (Larsen et al.; 2007). This total avoidance of the wind farm may lead to a reduced use of a habitat suitable for feeding. It has, however, been hypothesised that migratory birds that land at a greater distance from the wind farm may swim into it to feed (Larsen et al.; 2007). It has also been found that terrestrial birds that migrate over water are especially attracted to illuminated obstacles in periods of poor visibility (Hueppop et al.; 2006) and so are much more prone to collision.

The best practices for planning an offshore wind farm with respect to the impact on birds are fairly similar to those for onshore turbines (Exo et al.; 2003, Hueppop et al.; 2006, Larsen et al.; 2007);

- Avoid locating parks in areas with large concentrations of marine birds.
- Align turbine rows parallel to main migratory direction
- Establish a free migration corridor of several km between rows.
- Avoid constructing wind farms between foraging and roosting grounds
- Turn off turbines on nights predicted to have adverse weather conditions and high migration intensity.
- Refrain from large scale illumination

- Make turbines more visible to birds

A study (Masden et al.; 2009) has been conducted, using radar observations, to determine the impact of the Nysted wind farm (West Baltic) on the autumn migration of eiders (a species of sea duck). Flight paths of the eiders in the vicinity of the wind farm were recorded and compared to pre-construction records. It was found that a great majority of the eiders responded to the wind farm at a median distance of 224 m and took evasive action to fly around it. The additional distance incurred due to this was approximately 500 m, the energy usage associated with which, when compared to their total migratory distance of 1,400 km, was negligible compared to factors such as unfavourable weather and strong winds. It was also calculated that to achieve an extra 1% reduction in body mass due to extra distance travelled, the eiders would have to encounter 100 wind farms the size of that at Nysted.

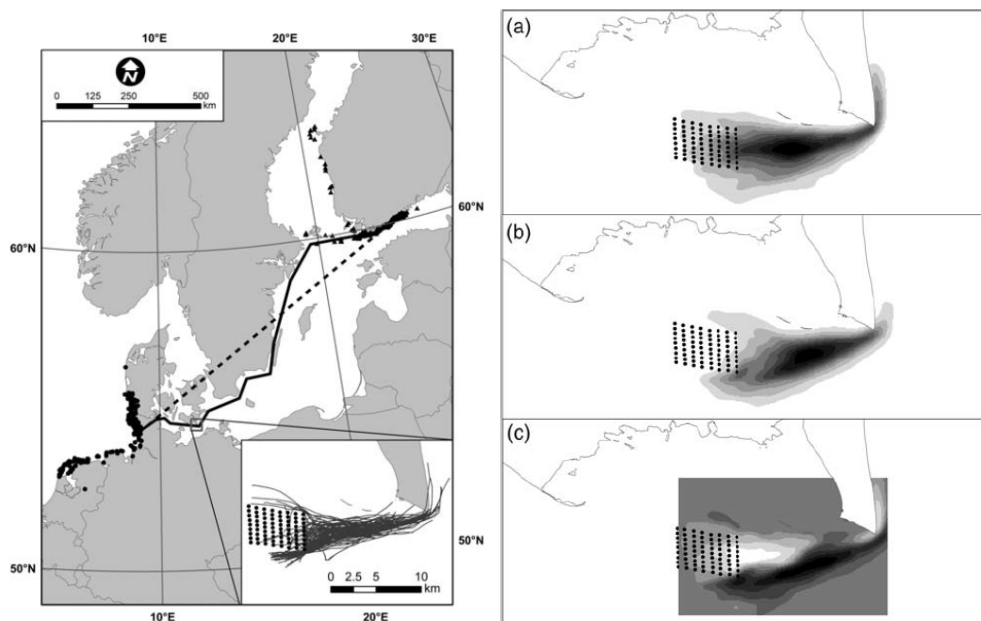

Fig. 20. The migratory route of the eiders (left) with an insert of the radar studies of their course at the wind farm and the kernels of space used by the eiders in the case study area (right) before (a) and after (b) the construction of the wind farm and difference (c) with high densities represented by the darker shades (Masden et al.; 2009).

This was, however, a species dependent study and although many other species have been seen to successfully avoid wind farms, the level of impact will depend upon the species of bird and their type of movement (i.e. migration or feeding). The results are also likely to be different at other wind farms as the size and layout of the wind farm are also relevant variables. The cumulative effects of many wind farms in a migration route should be assessed given the increasing capacity of offshore wind energy in northern Europe (Desholm et al.; 2006, Masden et al.; 2009).

To conclude, it has been found that there is no direct habitat loss for marine birds from offshore wind farms although avoidance of an area in which wind turbines operate may indirectly lead to the loss of feeding grounds. Most migratory birds will take action to avoid flying through a wind farm, usually choosing to fly around it instead with negligible impact to their migration. Mitigation strategies similar to those suggested on land should be implemented and care should be taken to avoid areas of high sea bird density and to not build too many wind farms on a migration route.

2.3.7 Marine mammals

The potential impacts of offshore wind power on marine mammals have been studied extensively since the expansion of offshore wind power in northern Europe. The term “marine mammal” includes cetaceans (whales, dolphins and porpoises), pinnipeds (seals, sea lions and walruses), polar bears, sea otters, manatees and dugong. Data on the distribution of marine mammals throughout the world’s oceans is limited but it is thought that many species are threatened by anthropomorphic activities with 6 of the 41 species of Europe having been assigned a conservation status of vulnerable or higher (Temple et al., 2007).

Marine mammals have well developed underwater hearing systems that allow them to hunt or communicate over great distances and so the greatest potential impact of offshore wind power is related to the underwater noise at the wind farm (effects on prey are dealt with in other sections). This is generated by the forcing of monopiles into the seabed as foundations (either by pile-driving or vibration), by the wind turbines themselves while in operation and by the shipping required to both construct and maintain the wind farm. As with all perceived sound, its impact will depend upon the ambient sound levels on the environment in which it is produced. These ambient levels will differ depending on the weather and the nature of sea in question.

The relatively localised distribution of offshore wind facilities has led to the production of a body of research that is skewed towards those marine mammals that are native to the waters of Denmark, Germany, Netherlands and the UK and indeed heavily biased towards two species in particular; the harbour porpoise (vulnerable) and the harbour seal, primarily due to their activity in shallow waters. Both species have a U-shaped frequency response curves with communication conducted at low frequencies (Thomsen et al.; 2006). The harbour porpoise is most sensitive to frequencies in the 100 kHz range and employs high frequency echolocation for hunting while the harbour seal’s more sensitive hearing lies at around 10 kHz (Thomsen et al.; 2006) and it is more sensitive to lower frequencies than the porpoise.

The greatest threat to these species comes from the noise generated by pile-driving of the monopiles during construction. The source-levels of this noise are similar to those of tactical sonar, which has been speculated to be the cause of several mass stranding events recently, although other characteristics such as its frequency and directionality are different. Several studies into the behaviour of harbour porpoises have been conducted at Danish offshore wind farms (Brandt et al.; 2011, Cartensen et al.; 2006, Maden et al.; 2006) by measuring levels of echolocation activity. The general consensus of these studies is that pile-driving provokes a short-term response from the harbour porpoise with it returning to the region of the construction site sometime within 4 hours to 1 day of the cessation of pile-driving. Although the noise can be detected up to some 50-80 km from the site it is thought that it does not affect the behaviour of the mammals at these ranges (Bailey et al.; 2010, Tomsen et al.; 2006) and it is broadly agreed that the zone of responsiveness (the area in which a response is provoked by a stimulus) for both the porpoises and seals extends to between 15-20 km from the pile driving site (Brandt et al.; 2011, Cartensen et al.; 2006, Thomsen et al.; 2006) although greater distances have been discussed (Tougaard et al.; 2009). Hearing loss is thought to be a concern within 1.8 km for porpoises and within 400 m for seals (Tomsen et al.; 2006). The sound emitted by piling depends on many factors such as monopile design, impact profile and sea state. There are several mitigating measures for this impact which include (Thomsen et al.; 2006);

1. Using different foundations
 - Although it is extremely unlikely that the choice of foundations will hinge on its construction impact on fauna if the wind turbines happen to use foundations other than monopiles (i.e. gravity based) then there will be no pile-driving and mitigation is not required.
2. Seal scarers / porpoise pingers
 - These are designed to emit a noise of a certain frequency that will drive marine mammals from an area. They should be deployed for a certain period of time before pile-driving begins to ensure that there are no animals left in the area of possible hearing loss.
3. Soft start / ramp-up procedure
 - Slowly increasing the force of pile-driving will gradually increase the energy of the emitted sound giving the mammals within range time to vacate the area.
4. Air-bubble curtain around the pile
 - This will help to attenuate the volume of the sound by around 10-20 dB, depending on the frequency.
5. Extending the duration of the impact during piling
 - This is extremely effective (decrease of 10-15 dB at frequencies over 2 kHz) but shorter impacts are more effective at piling and a longer signal may mask mammal communications to a greater extent.
6. Mantling of the ramming pile with acoustically isolated material
 - This works better at higher frequencies and can achieve decreases of 5-25 dB.
7. Limitation of pile-driving periods
 - Try to avoid biologically sensitive periods such as calving. This may not be possible due to weather limitations on offshore construction.

The sound generated by a 1.5 MW wind turbine while in operation at 12 m/s has been found to audible to both species at around 100 m from the turbine (Madsen et al.; 2006, Thomsen et al.; 2006) but whereas this sound becomes inaudible to the porpoise by 1 km it is likely that the seal can hear it at distances greater than this due to its low frequency nature (Thomsen et al.; 2006). Although in calmer conditions this distance is likely to increase, the noise generated by the turbine will decrease accordingly and so the levels of audibility are unlikely to change much with weather conditions. It must also be noted that the majority of these studies are conducted in the relatively quiet Baltic sea; ambient noise in, for example, the North Sea is higher. It should also be noted that as the size of offshore turbines increases, so will the levels of noise that they are likely to produce.

With regards to the noise created by shipping to and from the wind farm, it has been seen that harbour porpoises respond up to 1 km away but during the construction phase of the wind farm the impact of this is likely to be marginal, if any, compared to the piling of the foundations (Thomsen et al.; 2006). It is estimated that each wind turbine requires 1-2 days of maintenance per year (Thomsen et al.; 2006) and so attempts should be made to minimise the number of trips to the wind farm to limit the impacts of disturbance.

Although normal activities such as hunting will not be possible within the area of the wind farm during pile-driving, after the wind farm has been constructed it is likely that the food source of marine mammals will increase due to the artificial reef effect and the restriction of commercial fishing within the wind farm area.

As has already been mentioned, the bulk of the research in this field has, thus far, concentrated on two species of marine mammal. This limited scope has been highlighted by several authors who, rightly, argue that as offshore wind power goes deeper (as is the current trend) it will affect a greater number of species of marine mammal. The current body of research can, however, be applied to several other species once their sensitivities to a range of frequencies are known. This can be seen in Fig. 21 where the similarities of frequency response curves of 5 different cetaceans can be seen.

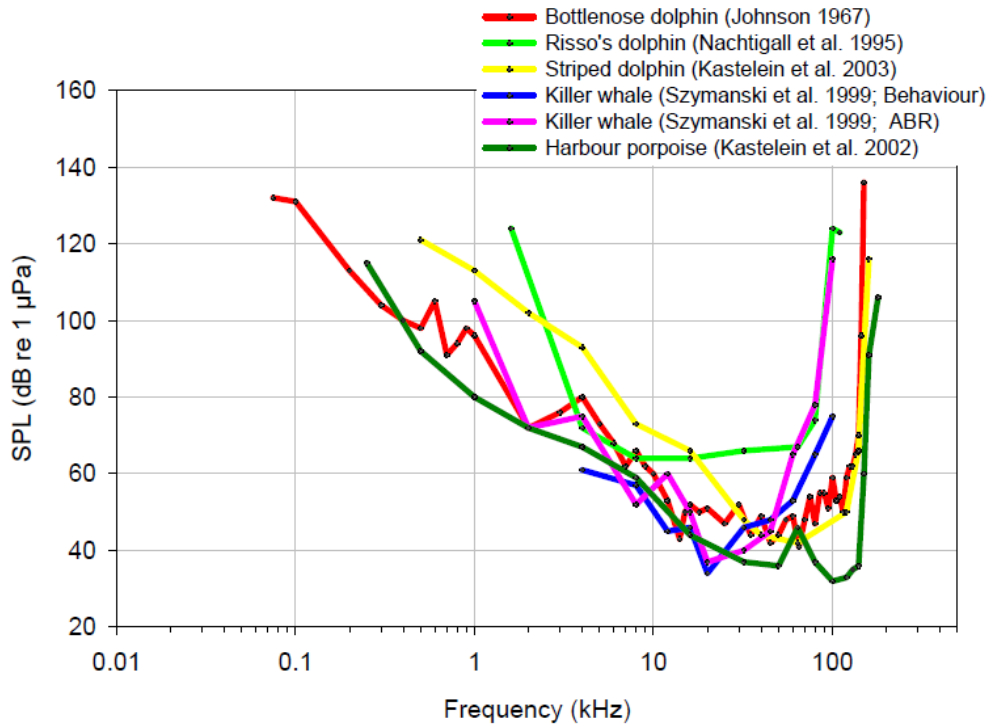

Fig. 21. The frequency response curves of 5 cetacean species (Thomsen et al.; 2006)

During the construction of Horns Rev II, porpoise activity at a range of distances from the wind farm was recorded (Brandt et al.; 2011). The results can be seen in Fig. 22 where the effect of distance can clearly be seen. The porpoises returned to the construction site 1-3 days after pile-driving had ceased and at a distance of 22 km there was no negative effect from the construction.

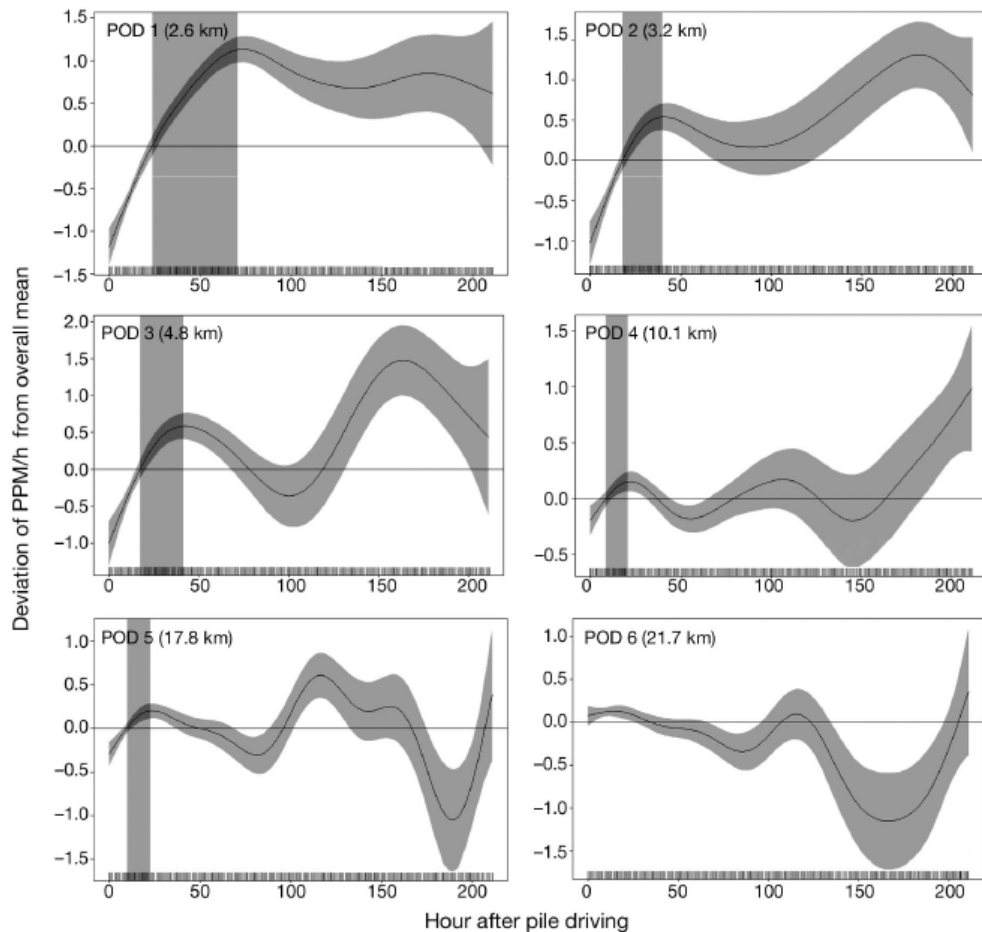

Fig. 22. Relationship between porpoise positive minutes per hour (PPM/h) and hour after pile driving. Grey shaded areas represent 95% confidence intervals. Grey shaded vertical boxes indicate the area that is reported as the range of the possible duration of the effect. (Brandt et al.; 2011)

In conclusion, the greatest impact of offshore wind energy to marine mammals is the generation of noise of which shipping and operational noise pale in comparison to that created by pile-driving during construction. This creates a short-term effect for which a large range of mitigating measures can be employed and the response region of both harbour porpoises and harbour seals to this sound is limited at approximately 20 km from the construction site. Although the research is limited to the behaviour of 2 species it is likely that the conclusions of these studies can be applied to other similar species.

2.3.8 Raw materials extraction and mineral resources

Sand, gravel, natural gas and oil have been extracted from the sea bed for decades, but the ores and mineral deposits on the sea floor have attracted little interest until recently. Yet with the decreasing availability of these important resources on land leading to increasing prices, the appeal of mining them in the ocean has increased. It is important that areas of seabed containing such deposits be avoided, if at all possible, so that they can be extracted if required. While surveying the sea bed of a potential site to determine its suitability for foundations the likely impact of the development of an offshore wind farm on that site to mineral extraction can also be assessed.

2.3.9 Marine archaeology

Historic sites are a finite resource which, once damaged or destroyed, cannot be replaced (English Heritage; 2005). The historic environment is defined as including “archaeological remains, historic structures and buildings, designed landscapes, the historic character and associations of wider landscape” and the impacts of a wind power development on each aspect of these should be assessed (English Heritage; 2005). Heritage acts will differ from country to country and the exact outlines of it can usually be obtained from the heritage agency of that nation. Most of these include restrictions on the moving, removal, excavation or damage of archaeological artefacts and sites. International treaties prevent developments of any descriptions from occurring at World Heritage Sites (English Heritage; 2005).

For onshore archaeological sites, the impacts of a wind development are fairly limited. This is due to the both the low levels of ground required to erect turbines as well as the flexibility in siting them. Wind turbines of approximately 1-2 MW generating capacity will usually require 16m diameter, 3.5m deep foundations (English Heritage; 2005). These will account for 2% of the total wind farm area, which averagely covers 108 hectares. The average size of a historical site is 2.5 hectares in size and so micro-siting allows this to be avoided (English Heritage; 2005). A geophysical survey of the wind turbine micro-sites can easily be done to ascertain whether any historic site would be disturbed by the development. The main impact to historical sites again reduces to the issue of visual impact which has already been discussed.

Those archaeological sites that are situated offshore can include shipwrecks, submerged settlements and other objects of cultural importance. The latter of these includes wrecks from either of the World Wars, airplanes and vessels unique at the time of sinking or that are associated with large loss of life (Bengtsson; 2008).

An archaeological assessment of the actual wind farm area should be conducted in the area including all cables and substructures. Any potential damage from maintenance, decommissioning, large scale vessels and scouring effects should be included as well as mitigation (Bengtsson; 2008).

The best practice concerning archaeological assessment for the EIA can be simplified to 3 steps;

1. Desk based assessment
 - Consult existing archives to determine the probability of encountering archaeological remains. This saves time and money as someone has already done the work.
2. Archaeological survey
 - This can be done with either geophysical methods (sonar, bathymetry, test pits) or by visual inspection (divers, remote operated vehicles). It is suggested that an archaeologist is consulted to ensure that it is done correctly.
3. Avoid the site
 - If a site is found then it cannot be built upon. Micro-siting is relatively easy, fast and cheap whereas a full excavation is hard, slow and expensive (especially underwater).

A good example of both a robust archaeological assessment and the possible time that must be invested in it can be seen with the Lillgrund wind farm (Bengtsson; 2008).

- 1997: A desk based assessment of the archaeological potential was conducted of the entire Lillgrund area which showed high potential of shipwrecks and submerged settlements.
- 1999: Permission to develop was given under the condition that a full archaeological survey was done.
- 2001: Another desk based assessment was conducted now that the working area of the wind farm was known, to refine the survey area.
- 2002: The visual survey took 5 days in autumn and found 1 shipwreck in the area. A diving archaeologist inspected the wreck and it was designated a monument. As a result a cable had to be run around the site instead of through it.
- 2006: A new survey was carried out with geophysical methods before construction began. Diving archaeologist checks the wreck site to ensure that it is not disturbed by the rerouted cable.
- 2008: Generation of electricity begins.

To conclude, an archaeological survey of the proposed wind farm area must normally be conducted, either onshore or offshore, before permission to develop is granted. This is normally much more difficult to achieve offshore and the quality of the survey must be balanced by the cost and time taken to conduct it. If a site is discovered then it can be easily avoided due to the flexible nature of micro-siting.

2.3.10 Recreational issues

The construction of an offshore wind farm can influence recreational activities both by restricting access to the area of the wind farm during construction (affecting some watersports such as sailing, kite surfing and kayaking) and affecting recreation activities from the shore through visual impact. A few studies have been done in the USA (Landry et al.; 2012) and the UK on the visual impact to recreational users of the area which conclude that the construction of a wind farm makes no difference to beach users. Mitigation can also be achieved from the visual impact section from earlier. Usually once the wind farm has been constructed recreational vessels are permitted inside it.

2.3.11 Protected areas

There have been multiple directives issued by the EU as well as nationally recognised bodies that denote certain areas as protected. These directives act to conserve an area which is thought to be of either ecological or historical significance. It is obvious that all infrastructure associated with the wind farm must avoid such an area and depending on the legislation surrounding such an area, a minimum distance to start of said area may have to be observed.

2.3.12 Naval traffic

Due to the risk of collision, wind farms must be constructed a reasonable distance from recognised shipping lanes and not lie in sheltered areas or those used for anchoring. Offshore wind farms must also be correctly marked both during the day and night, details of which can be found in the “IALA Recommendation O-117 on The Marking of Offshore Wind Farms” and sound signals may also be required. The construction of an offshore wind farm that obstructs a smaller shipping route may have to be mitigated by compensating the shipping operator affected by the detour around the wind farm (e.g. the Anholt wind farm).

2.3.13 Aviation

Although there are no international rules for the marking of wind turbines for aviation safety, the regulatory bodies in most countries treat them as they would any other large structure. The general consensus on night time marking involves some combination of red lighting on top of the nacelle. Wind turbines in Germany are also required to be marked for visual detection during the day and this involves marking the tip of each blade of the turbine with a single red stripe (unless the turbine lies within 5 km of an airfield in which case 2 red stripes are used). Most countries will also specify a minimum height at which marking becomes necessary (in Denmark this is 100 m) but as the size of wind turbines increase this becomes less relevant to large developments.

2.3.14 Commercial fishery

Offshore wind energy has two potential impacts on commercial fisheries. The first is related to the impact that it has on fish and the second relates to the restriction of fishing within the wind farm. Commercial fishing is usually discouraged within offshore wind farms for fear of collisions with wind turbines and entanglement of fishing equipment with underwater infrastructure with trawling forbidden outright. This effectively reduces the size of a fishing ground to trawler fishing (in itself seen as disastrous to an ecosystem) and as such there is a conflict between offshore wind developers and commercial fishers. This conflict is exacerbated by two factors. The first is inadequate consultation between developers and fishers and the second is the negative characterisation of each of the fishers, developers and regulators by each of the other two (Gray et al.; 2005).

The standard view of the developer is that “while some fishers had a right to be involved in the consultation process, and that some claims for compensation were genuine, others were chancers and jumped on the compensation bandwagon hoping to exploit the situation.” (Gray et al.; 2005). Although it is unlikely that objections from the fishing industry would prevent the development of a wind farm (due to a host of factors including the fragmented nature of the fishing industry, the strength of the offshore wind industry and overwhelming support in favour of offshore wind energy (government, public and NGOs such as Greenpeace and Friends of the Earth)), given both the cultural and economic importance of the commercial fishing industry and the environmental and economic importance of the offshore wind industry it is beneficial to find a solution acceptable to both parties (Fayram et al.; 2007).

Mitigation of this impact must begin with a reduction of exacerbating factors. This can be achieved by the implementation of a better consultation process between involved parties and a better method of handling the compensatory claims of the fishers (although this would require some level of hard proof of impact which is currently very difficult to produce). Involving all affected parties at all stages of the planning process builds both trust and good will (Rodmell et al.; 2003). Once this is achieved then mitigation of the main issue: limitation of fishing grounds can be addressed in a more rational manner (Gray et al.; 2005, Rodmell et al.; 2003).

Offshore wind turbines have long been seen to enable the establishment of artificial reef colonies (Rodmell et al.; 2003) which increases fish biodiversity, size and density as well as protecting juveniles. This has a positive effects on fisheries, especially when a population is severely overfished (Fayram et al.; 2007, Rodmell et al.; 2003). Offshore wind turbines, especially floating designs, also have the potential of acting as fish

aggregating devices which attract fish to them (Fayram et al.; 2007). This will also increase the catch rate of a number of fish species, but it does run the risk of recruitment overfishing as the catch rate of juveniles may increase faster than that of the adults (Fayram et al.; 2007). Both of these effects can, however, be argued to be of a benefit to commercial fisheries.

The easiest mitigating strategy for the developer of a wind farm to employ is simply to establish a marine protected area (prohibiting all access other than for maintenance) within the wind farm and then dealing with compensation for fishers on a case by case basis. This strategy ensures that infrastructure cannot be damaged by fishing boats but is likely to be seen as a one sided solution even if fisheries do potentially benefit from the effects of the wind farm structures on fish.

A more even handed strategy of mitigation could be to allow access to the offshore wind farm to certain types of fishing on a regulated basis. Although this would negate claims for compensation it would be difficult to regulate and enforce and there would be a risk of damage to infrastructure. The feasibility of this would depend on the layout of the wind farm and the type of fishing allowed. Trawling is unlikely to be permitted even if all cables were either buried or had sufficient scour protection to avoid entanglement.

An innovative attempt at mitigation was made recently in the German North Sea by combining the space requirements of aquaculture (in this case mussels) with those of an offshore wind farm (Buck et al.; 2008). This was seen as beneficial due to the solid foundations of the wind turbines serving as attachment points and a restricted access inside the wind farm. Aquaculture includes the growing of all marine organisms and so it would be possible to farm fish in the space between the turbines, thus mitigating the losses to the fishing industry even though it would do nothing to mitigate the impact to trawler fishing specifically. The effectiveness of this scheme depends upon local sea conditions but it does offer a versatile solution where anything from fish to shellfish to seaweed could be grown.

2.3.15 Unexploded ordnance

Encountering unexploded ordnance (UXO) while constructing an offshore wind farm has the potential to result in not only the destruction of equipment and machinery (that represents a large investment) but also in human injury or fatalities. It is therefore of the utmost importance that a survey of UXO at a site be conducted before development begins.

During the 1st and 2nd World Wars, significant quantities of high explosive ordnance were either dropped from the air or placed in the waters around Europe. Some of this was designed not to explode until triggered (i.e. sea and beach mines) and from the remainder (torpedoes, depth charges, air delivered bombs and ordnance) it is estimated that approximately 10% failed to detonate as designed (Carnell; 2011). In addition to the ordnance deployed in war there is a legacy of military activities in European waters including the dumping of munitions at sea, live firing exercises and various wrecks with ordnance payloads (Carnell; 2011).

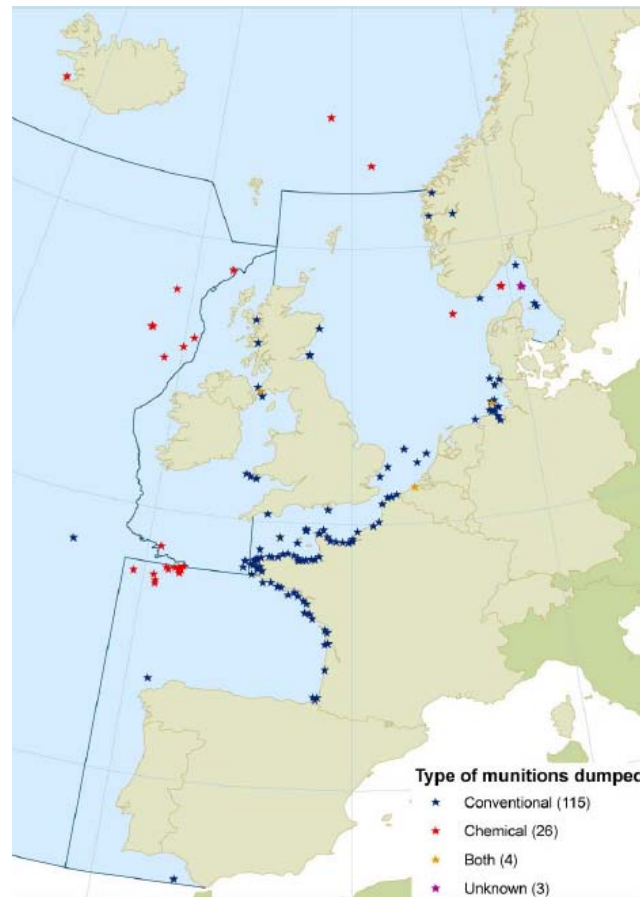

Fig. 23. Locations of munitions dumps in western European waters (Ospar; 2010)

As with archaeological impact, it is suggested that determining the risk from UXO is started with a desktop survey. Most military activity during, and after, the World Wars was well documented and war records provide a fairly good indication of the danger at a particular site. It is, however, still recommended that a secondary survey at the site be done by professionals as not only are war records sometimes patchy, incomplete or absent but they do not account for the movement of underwater bodies by 70 to 100 years of tides and currents.

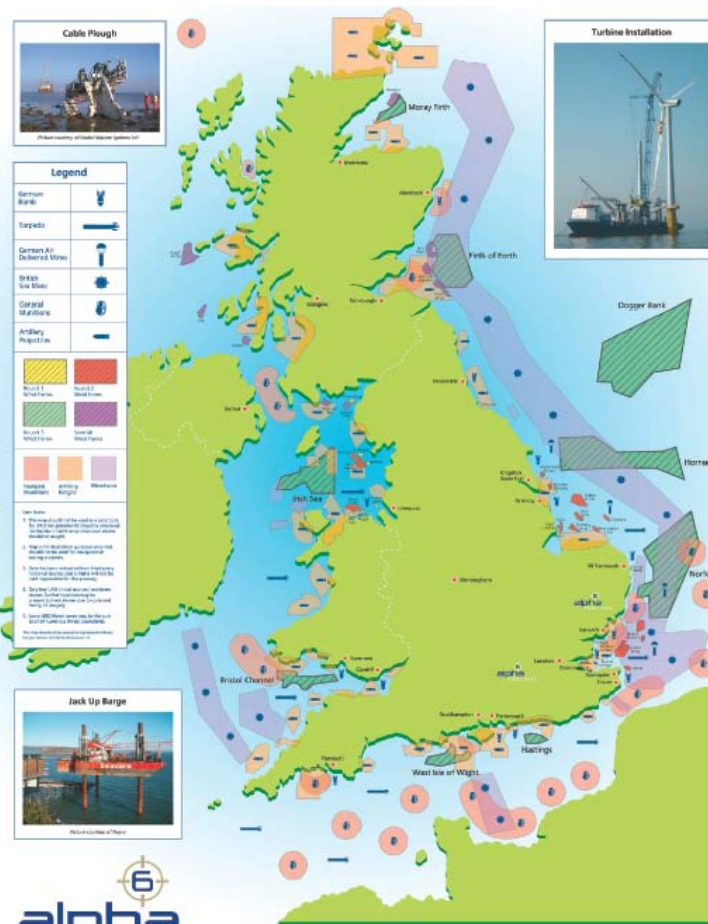

Fig. 24. Probable locations of munitions (solid pastel colours) and wind farm regions (hashed regions) in UK waters (Carnell; 2011).

There are several companies that currently specialise in the location of marine munitions using techniques similar to those used for archaeological surveying (including magnetometry). These secondary surveys can take some time but are worth the cost as UXO has been found at several offshore wind farm sites including a 250 lb (114 kg) WWII bomb at the Sheringham Shoal site after a 3 month UXO survey. There are still problems associated with the secondary survey such as difficulties in locating ammunition buried in bottom sediment (Kjellsson; 2003) and non ferrous devices not being detected by magnetometry (Carnell; 2011). It should be remembered that due to the dynamic nature of the sea that the results of any survey of UXO are temporal and this is highlighted recently at an offshore wind farm in the UK where, when coming to lay the cables, a 1,000 lb (450 kg) WWII bomb was found to have drifted against one of the monopiles (Carnell; 2011).

2.4 Public acceptance

Public acceptance of renewable energy technologies can be broken down into 3 components which can be seen in Fig. 25. The study of social acceptance was largely ignored in the 1980s and the little that was done was mainly focussed on the socio-political component of public acceptance (Wustenhagen et al.; 2007). In such studies it has been found that support for wind power appears to be consistently high across countries with 80% of British, Canadian, Danish and Dutch citizens expressing the belief that their respective countries should utilise a greater capacity of wind power (Krohn et al.; 1999). Findings such as these have lead developers to the conclusion that due to the

high level of support for the technology on the whole, that there would be little resistance to developments in local areas (Wustenhagen et al.; 2007). This has generally proved to be untrue and localised resistance to wind power developments has been picked up by the media throughout the world. The component of public acceptance that this section will deal with is that of community acceptance which can be broken down into procedural justice (how fair is the planning process in giving all stakeholders a voice), distributional justice (how are the costs and benefits of the project distributed amongst actors) and trust (does the community trust the intentions of an outside developer).

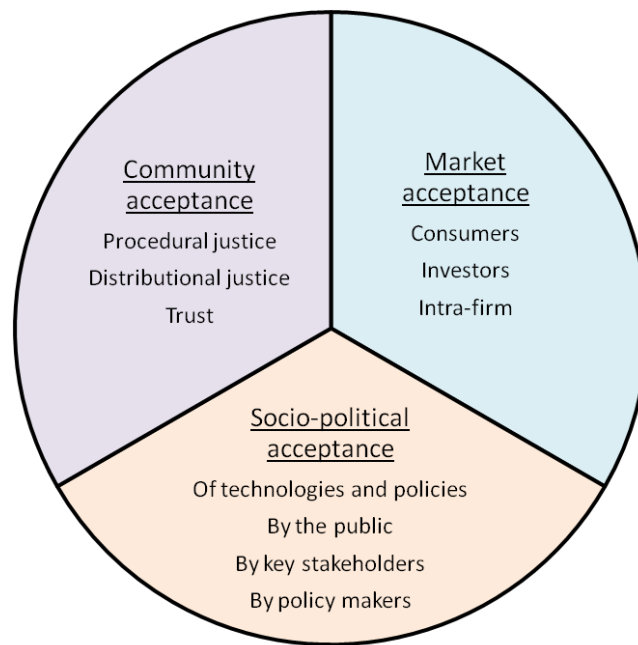

Fig. 25. The components of public acceptance of renewable energy innovation (Wustenhagen et al.; 2007)

Of the studies that have been conducted in the last 10 years concerning the issue of community acceptance, multiple key themes have come to light that fit within the framework shown in Fig. 25. The majority of these will be discussed shortly in the form of case studies but before that two prevalent findings that have been seen in every study will briefly be mentioned. Firstly, the classical theory of community resistance: NIMBY (not in my back yard) has been shown, by many authors, to not be a significant contributing factor to local opposition and as such should no longer be considered as highly as other factors (Krohn et al.; 1999, Wolsink; 2000). It has also been found that, regardless of overall levels of support for a wind power development, that community acceptance for wind power follows a U shape during a development as seen in Fig. 26. The extent of this decrease in acceptance is found to be less in areas where the population already has experience of wind turbines (Krohn et al.; 1999).

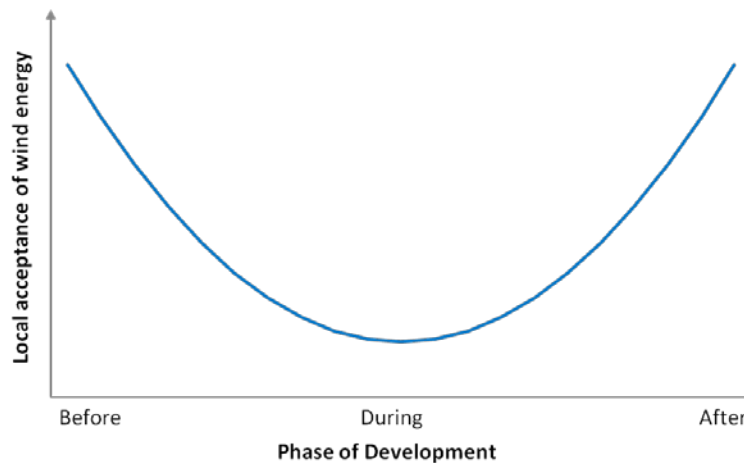

Fig. 26. Community acceptance of wind power during the development of a local wind farm

With respect to procedural justice it has been found that the main wish of the public is to be kept informed of a transparent planning process in which the wishes of all local actors are considered. A study of 11 wind farms in the UK and 7 in Denmark found that “Projects with high level of participatory planning are more likely to be publicly accepted and successful. In addition, stable supporting networks are more likely to form. Although the presence of a stable network of supporters is not related to project acceptance and success, the absence of a stable network of opponents is necessary for project acceptance and success in receiving planning permission.” (McLaren Loring; 2007). It should be noted that the stability of an opposition to the project does not seem to be able to be influenced by participatory planning which would seem to indicate that nothing can be done to negotiate with those in the opposition camp who have already made their minds up.

As was mentioned in the visual impact subsection of the onshore EIA considerations GIS tools are becoming more widespread in the planning process as an attempt to involve the local community in siting decisions. This has been tested in Switzerland during a workshop specifically set up to mitigate concerns of local stakeholders using a graphic interface. All of the participants felt as though they benefitted from attending with all saying that their concerns had been addressed and that they were now better able to judge the proposed development (Lange et al.; 2005).

A hypothetical wind power development in the North West of England found that although local residents were receptive to the idea of being involved with the project, the attractiveness of such a proposal fell as their level of involvement and thus responsibility increased (Rogers et al.; 2008). This seems to indicate that community members would prefer more of a passive role in the development with their opinions noted.

It is now, more than ever, even more important to involve the public in the planning process as the wind power industry has started to outgrow community involvement in the form of individual farmers and small local co-operatives owning wind turbines (Warren et al.; 2012). Historically the high level of planning permission given to Danish wind power installations came from the fact that Denmark had a bottom up approach to these developments with a very local approach (McLaren Loring; 2007). The multi-megawatt projects planned these days can only be realised by large, multinational companies and

these have become the main players in the market leading to community opposition in Denmark that has not been seen before (Moller; 2006).

Distributional justice can be found in two forms, that between developers/operators and communities and that which exists between different communities. The first form of distributional justice involves the benefits of the wind farm being shared out between all parties involved. Local communities are more likely to lend their support to a project if they own the land upon which it is sited. The importance of ownership is highlighted by the contrast between Gigha and Kintyre (Scotland) where the community owned wind farm on Gigha is much more positively viewed than those owned by commercial companies on Kintyre (Warren et al.; 2012). One mitigating measure that has proven very successful both in Denmark and Germany is to offer shares in the project to community members. The gesture of this has actually been found to be more important than the shares themselves (Jobert et al.; 2007). The second form can sometimes be seen in a single community that has experienced a large installation of wind power capacity believing that it is now another community's turn to host some development as they have "done their bit" (Warren et al.; 2012).

When it comes to distributional justice it has been found that local communities are usually willing to compromise on issues such as wind power developments. In the case of a hypothetical offshore wind farm off the Delaware coast the community was more than happy to pay a premium for their electricity for several years once the positive benefits to air quality and the stability of electricity rates were made clear (Firestone et al.; 2009). There was also a great increase in support for the project when it was hypothesised to lead to the large scale implementation of offshore wind power in the USA. This highlights both the importance of local pride in setting trends and of the idea that they will not be isolated in their experience (Warren et al.; 2012).

Trust is a factor of community acceptance whose importance increases as the size of the community decreases. Developers can often be seen as outsiders whose sole interest is to make profit at the expense of the local community (Jobert et al.; 2007). If the developers are not trusted then it is of little use to implement a participatory planning program. It is suggested that a developer integrate as much of their project locally as is possible in terms of proximity, local contacts and the network of actors around the project (Jobert et al.; 2007).

Of course even if each aspect of community acceptance is accounted for it must still be remembered that anomalies occur and that each community must be treated as individual; not everything can be planned for and adjustments to planning will always have to be made during the process. This is highlighted by lobbying against a proposed east coast American offshore wind farm by a firm with interests in fossil fuels actually increasing public support for the development (Firestone et al.; 2009). Some local communities also manage to integrate their wind farm into the tourism concept with one wind farm in France combing tours of the wind farm from local inhabitants with wine tours and bird watching (Jobert et al.; 2007). A solution agreeable to all actors should always be strived for.

Although community acceptance is an important aspect of public acceptance it must be remembered that both socio-political acceptance and market acceptance must also be dealt with and it has been found in the Netherlands that in some areas institutional constraints are more of an impedance to a wind energy development than public opinion (Wolsink; 2000).

3 Grid connection

The grid connection is what enables the wind farm project to receive revenue: it is here that the meter is placed that records the energy delivered to the grid and thus the income that should be delivered to the wind farm owner. It is, therefore, very important!

This chapter is an overview of the key aspects of a grid connection that a wind farm developer should know when considering a project. It does not tell you how to design it - how large the cables should be, for instance - but rather gives an overview of those features that go together to get the power from the wind turbine into the grid.

There are five sections that make up this chapter. Firstly, the connection itself from the wind farm is covered including what sort of equipment is typically needed. Then there is a section on some of the electrical engineering principles behind power transfer and the different electrical concepts of the various generators used in wind turbines. Thirdly, we look at the grid system and how to find the right point to connect into. Following that, offshore matters are discussed and, in particular, how it differs from onshore. Finally, a summary is given of the steps necessary in planning a typical onshore grid connection.

3.1 The wind farm connection

First of all: “What is the grid connection?” The grid connection consists of all the equipment needed to deliver the power generated by the wind farm to the grid where it is sold. Figure 2 below shows the principle whereby the connection from the wind farm ends up at the Point of Common Coupling (PCC): this is where the project interfaces with the public network and usually where the meter is placed.

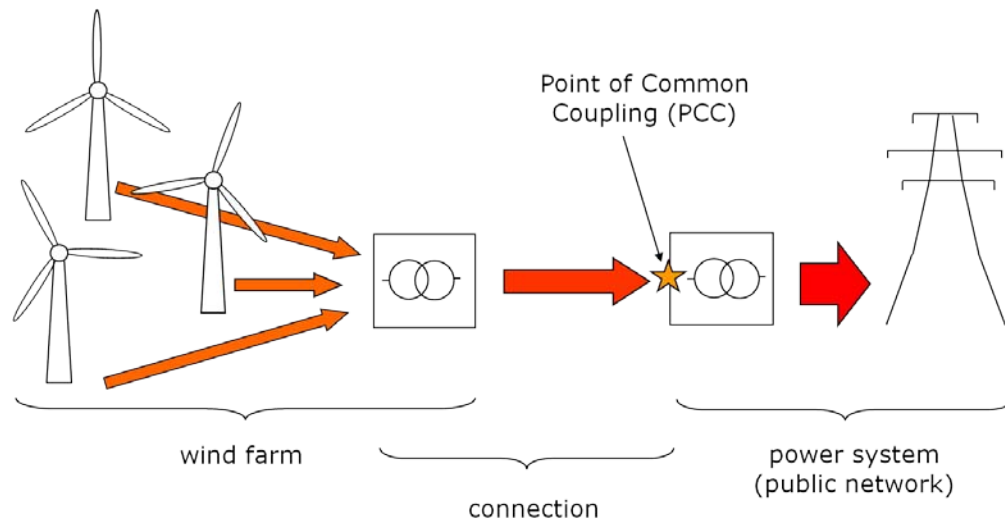

Figure 2 The wind farm grid connection and Point of Common Coupling (PCC)

It should be noted that quite often the grid connection is limited to the connection between the wind farm sub-station and the PCC, however, in this chapter we will also consider transferring the power from the wind turbine generator to the wind farm sub-station. This is frequently called the “internal grid” of the wind farm.

3.1.1 The importance of the grid connection

The grid connection is one of the five cornerstones of wind farm planning and development, not least for the following reasons:

- *Without it the project cannot earn money.* It may seem obvious that it is needed but the consequences of it not being there are catastrophic. So, it needs to be designed to

operate efficiently with an appropriate consideration of redundancy, a matter that becomes much more important when considering offshore.

- *It is not insignificant proportion of the cost of a wind farm project.* Whilst it is not the major cost of a project, it is substantial.
- *Permissions, construction and testing can delay the project.* It is, perhaps, this aspect that is the most troublesome to the project. The grid connection involves more parties than just the developer. Land owners, authorities, electrical utilities, regulators, etc. will all have an input and any lack of cooperation can have a major impact on the project.
- *Important project interface with a (usually traditional) authority.* The authority that has responsibility for the grid that the wind farm connects into is, in most countries, a very conservative and traditional organisation. Often this is because they are state owned, or recently privatised, companies and their view of project planning and delivering on time is very different from a commercial developer with banks and shareholders to please. On the other hand, this organisation may well have the very important task of keeping the grid stable and secure.
- *The responsibility for different elements varies from country to country.* In most countries it is the responsibility of the developer to construct and operate (and pay for!) the grid connection so that it (and the wind farm) meets the requirements of that country's particular grid codes. In others, for instance Denmark, it is the electrical utility's responsibility to do this. In some others, there is a mixture of the two. It is thus very important for a developer to know where its responsibilities are with regard to the grid connection.

3.1.2 Major elements of a typical wind farm connection

In this part we look at what equipment typically goes into a land-based wind farm. The differences for offshore wind farms will be covered in Section 3.4. By far the majority of wind farms operate throughout with alternating current (AC) and this is the assumption in the description that follows. The advantages and opportunities of using direct current (DC) will be described as they arise.

Figure 3 shows the structure of a typical grid connection. It is important to note that, in general, the voltage of the power increases from the wind turbine generator (below 700V), up to medium voltage (maybe 20kV) in the internal grid, and further up to high voltage (60kV and upwards) as the power is transferred into the grid.

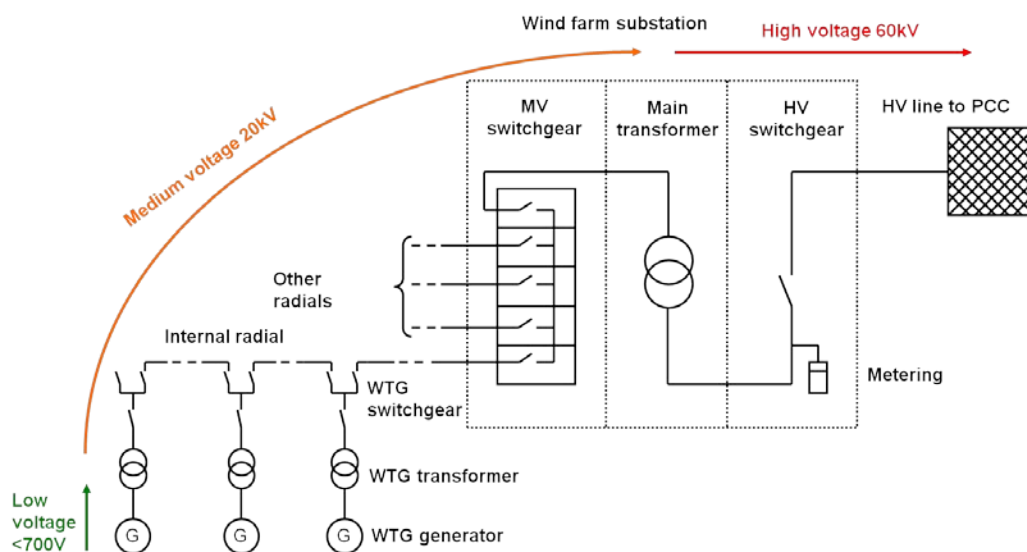

Figure 3 The main structure of a wind farm internal grid and grid connection

The various elements will be taken in turn below:

- *Wind turbine generator, transformer and switchgear.* The turbine generator will usually generate at a voltage below 700V for legal and safety reasons and the power will be transferred down the tower at this voltage to a transformer in the base of the tower where it will be stepped up to the voltage of the internal grid. Some turbines have this transformer up in the nacelle where it can be used as a counter-weight to the rotor. There will always be switchgear at the base of the tower for isolation and protection purposes. (It should be noted that a few turbines transfer the power down the tower using DC (e.g. the Enercon concept) in which case there will need to be power electronic inverters to turn this into AC before transforming it up to the medium voltage level.)
- *Turbine cables to sub-station (wind farm “internal grid”).* The power is taken from the turbines using cables to the wind farm sub-station. There is usually more than one turbine on each ‘radial’ cable but the optimisation of the cables and circuits is a delicate balance of efficiency and cost.
- *Medium voltage switchgear in sub-station.* In the sub-station the various cables coming from the transformer are “gathered” into switchgear panels and onto busbars. These allow the isolation of equipment for safe maintenance and repair working conditions and also contain the protective devices to remove power from equipment in the event of a fault.
- *Wind farm transformer.* This transformer is the electrical focal point of the whole wind farm, transforming the whole of the wind farm’s power from medium voltage up to the high(er) voltage necessary to transmit it to the PCC. These transformers are usually very robust and somewhat over-engineered because if they fail then all revenue from the wind farm stops. Moreover, as they are usually designed and manufactured specifically for each wind farm then the time required to obtain and install a replacement can be very long, maybe six months or more. This will have disastrous consequences for the project but fortunately, main transformer failures are rare.
- *High voltage switchgear.* This switchgear provides the means for Protection and isolation between the transformer and the outgoing high voltage power transfer.
- *Overhead line / underground cables to the Point of Common Coupling (PCC).* These transfer the power at high voltage to the public network. The choice of either overhead line or cables can be complex. Overhead lines are efficient, relatively cheap and do not require power factor compensation. But they are unsightly and exposed to weather elements. Buried cables are conversely not visible and are protected from the weather. But they are more expensive, more difficult to install, require power factor compensation for long distances and it tends to be harder to locate faults in them.

3.1.3 Cost of the connection

The cost of the connection can vary widely depending on many factors, not least the distance to be covered, wind farm capacity, equipment necessary to comply with grid codes, etc. However, the breakdown of indicative costs for a wind farm as described in the previous section is shown in Figure 4. For this wind farm, there was no particular requirement for additional equipment to satisfy grid codes and the length of the overhead line was around 30km.

It should not be forgotten that an important factor in the analysis of costs of a wind farm is the elasticity of price with supply and demand constraints. There is a relatively constrained supply of wind turbines in the world market and, for example, back in the mid-2000s it was not uncommon for difficult or remote wind farm projects not to receive

any tender bids because manufacturers considered there to be sufficient easier projects with greater profit margins elsewhere.

Wind farm of 50 wind turbines @ 2MW each = 100MW			
Wind turbines	95 M€	} 103 M€	} ~119 M€
Civil works	10 M€		
Electrical	8 M€	} ~16 M€	
Overhead lines	5 M€		
Utility work for connection	0.8 M€		

Figure 4 Indicative costs for a typical onshore (land-based) wind farm

3.2 Some electrical engineering principles

The topics covered here are some of those that commonly arise when talking about wind farms, their generating capacity and their compliance with grid codes. Please note, however, that this is not a electrical engineering text book. For this, please refer to examples given in the reference section 3.6.

3.2.1 Active and reactive power

The concept of reactive power is one that is commonly brushed aside by those who are not electrical engineers, but it is fundamental to the understanding of electrical power and thus deserves an explanation in this section. The following are some topics that, when covered during the lecture, will hopefully lead to a greater understanding.

- Direct and alternating currents/voltages (“DC” and “AC”):
- Real power and resistive circuits/components
- What happens when reactive components are introduced?
- Concept of apparent power
- Reactive power and its implications / applications
- Common reactive components (motors, transformers, fluorescent lighting, cables, etc.)

3.2.2 Equivalent circuits

The Thévenin equivalent circuit: principles and uses.

Léon Charles Thévenin was a French telegraph engineer who, in 1883, came up with a means of reducing complex electrical circuits with discrete components down to a simple circuit of a voltage source and an impedance. This can be used to great effect for initial investigations into what a wind farm connection will “see” when “looking” into the power system at the PCC. For more detailed studies of the effects of the wind farm on the system (and the other way round) computer simulation models are used by grid

authorities (Transmission System Operators – TSOs), utility companies and, to a lesser extent, wind farm developers.

3.2.3 Generator types for wind turbines

The various concepts behind today’s wind turbines can be found in many text books and articles (e.g. “Powering Europe: wind energy and the electricity grid” by EWEA) and so only a brief overview is given here.

Direct connection induction generator: “The Danish Concept”

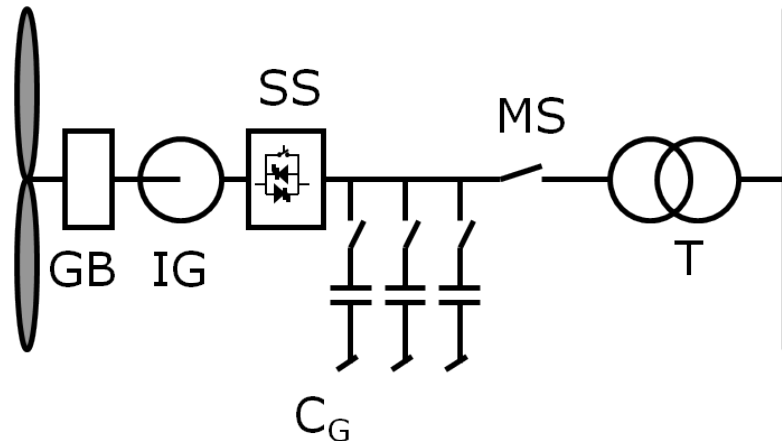

Figure 5 Directly-connected induction generator wind turbine

This is the “original” concept for a wind turbine, the so-called “Danish Concept”. It uses an induction generator that is connected directly to the main grid. There is, of course, a gearbox so that the generator can rotate much faster than the rotor but the rotor speed is, nonetheless, fixed (within the narrow slip range of the induction generator). It is very simple and robust but the high electrical “stiffness” of this concept means that variations in wind power translate into large variations in electrical power that go straight into the grid. The induction machine also needs power factor correction capacitors and a soft start device to limit in-rush currents. It is thus no longer a very common concept for new turbines.

Doubly fed induction generator

Part of the problem with the induction generator is that with fixed rotor characteristics, the rotational speed is fixed because the frequency of the output power must be the same as the main grid frequency. Being able to vary the rotational speed of the rotor would mean a better energy capture over a range of wind speeds combined with a smoother feed in of wind power gusts into the power system.

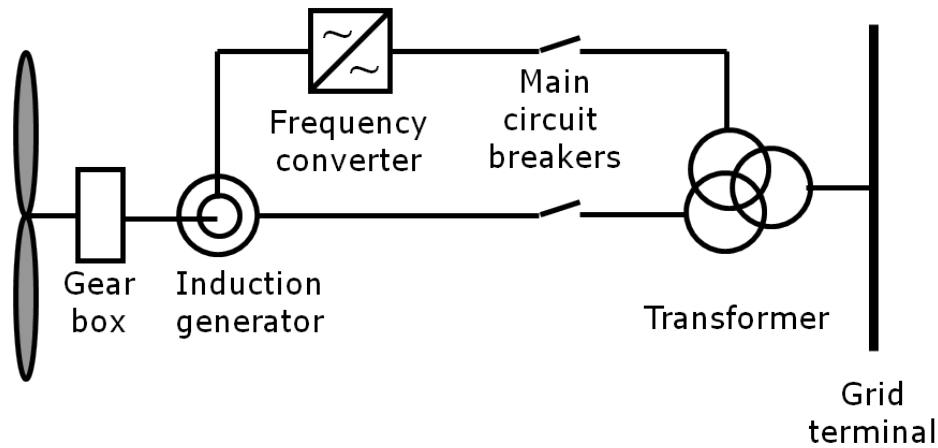

Figure 6 Doubly fed induction generator

The first move towards variable speed was to have a device on-board the generator rotor that could change the properties of the rotor and thus the speed at which it rotate (e.g. the “OptiSlip” from Vestas). This provided a limited variable speed but a more extensive variable speed was later obtained by connecting the rotor itself (through slip rings or other power transfer method) to the grid via a power electronics device / frequency converter: hence being “doubly fed” (Figure 6). The larger the converter the larger the variable speed range.

A gearbox is still required but the reactive power from the stator can be controlled thus minimising the need for additional power factor correction equipment.

This is the concept with the highest market share at present.

Direct drive machines

The ability to do away with the gearbox is one of the main advantages of the direct drive generator. The higher efficiency and controllability of the synchronous generator is also attractive. However, in order to achieve this the generator rotor diameter must be relatively large (due to the large number of pole-pairs needed for the turbine rotor to rotate at a sensible speed) and there must be a full-capacity power converter (to allow the rotor to rotate at full variable speed). See Figure 7. The German wind turbine manufacturer, Enercon, has however been able to make this their central concept despite the additional cost involved.

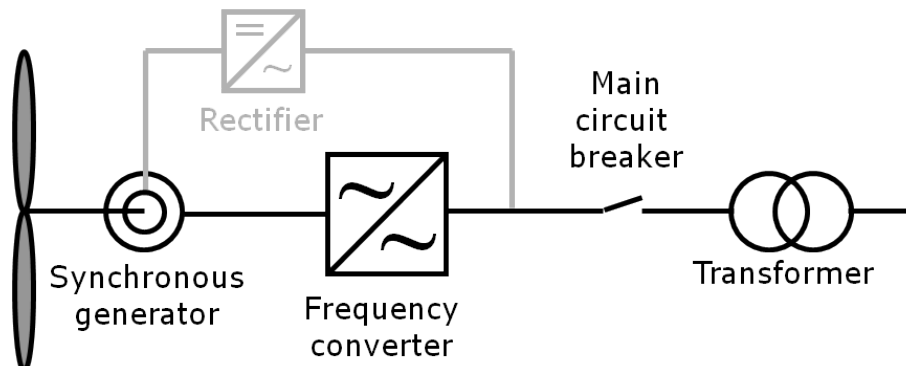

Figure 7 Direct drive generator

In the last few years the use of a permanent magnet generator has seen increased interest from many manufacturers as this allows both the omission of the gearbox from the DFIG concept and the reduction in generator size compared to the direct drive in Figure 7. The

increased capacity of the latest machines (e.g. Siemens Wind Power SWT-6 and Alstom Haliade 150 6MW) can somewhat offset the increased cost of the more exotic materials for the permanent magnets.

Other concept variations

There are a few other concepts on the market that are variations of the ones already described that are worth mentioning.

- The Multibrid concept (produced by Areva in the M5000 turbine and WinWind in the WWD-1 and 3 turbines) combines a permanent magnet generator, full power converter and a gearbox to reduce the overall size of the drive train.
- The concept promoted by the manufacturer Clipper Windpower in America is similarly one with a gearbox but this time it drives four permanent magnet generators and power electronics.

3.3 The grid power system and connecting to it

3.3.1 Grid architecture

Three “challenges” with wind power (and power generation from many renewable energy sources) are that, a) it is a varying power input into a system that has been built up using generators that, generally, have a more constant output, b) it is connected at a voltage level that is lower than conventional generation, and c) it is often generated in places that are far away from where the main consumption is. To understand the interaction of wind power with grid systems a little bit of history is required.

Today’s power systems have their origin in the late 1800s when electricity was produced for local consumption by small generators producing DC power. Without any means to step up the voltage produced, these systems could not be connected to each other because the distances between them were too large and the losses would be intolerable. When it was realised that AC power could be stepped up (and down) then interconnection of systems became a reality as the transmission efficiency improved. The efficiency of larger generating units lead to the development of the systems we have today: a relatively few large generating power stations linked together by a backbone of high (or extra-high) voltage transmission. The electrical power then flowed from the transmission system down the voltage levels into the distribution system and to the end users (Figure 8).

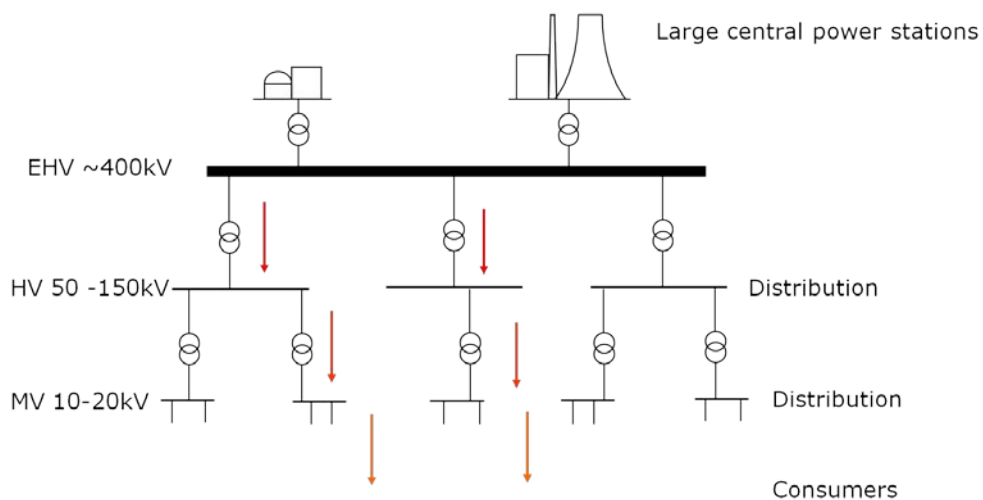

Figure 8 Simplified diagram of a traditional power system

Until recently, most wind farms have been connected into the power system at a voltage level that is considerably lower than conventional generation. Depending on the loads in the system this can result in power flowing up the system – an event that the system has not been designed for. Utility companies, in general, would like wind farms to be connected at a high voltage level in their system. By contrast, wind farm developers want to connect at the lowest possible because the lower the voltage level the lower the equipment costs.

3.3.2 Finding the “right” connection point

There are many considerations involved when trying to find the ‘right’ PCC and they mostly revolve around balancing cost and efficiency. Just considering voltage levels will not necessarily give the right connection point. What is needed is the *grid strength* at the PCC being considered. The grid strength gives an indication as to how well the grid can cope with the injection of power from the wind farm at that particular point. The higher the grid strength the less of an adverse impact the wind farm will have and the more comfortable the utility will be with the developer connecting the wind farm there.

3.3.3 Grid strength

The strength of the grid at a particular point can usually only be obtained from the authority that has responsibility for the grid by making a formal application to that authority. However, it is important to understand what the grid strength means in order to use it properly.

Using the Thévenin equivalent theorem mentioned in Section 3.2.2, the grid system that the wind farm will “see” electrically can be represented by a circuit with just one impedance (Z_k) and one voltage source (U_n), as in Figure 9.

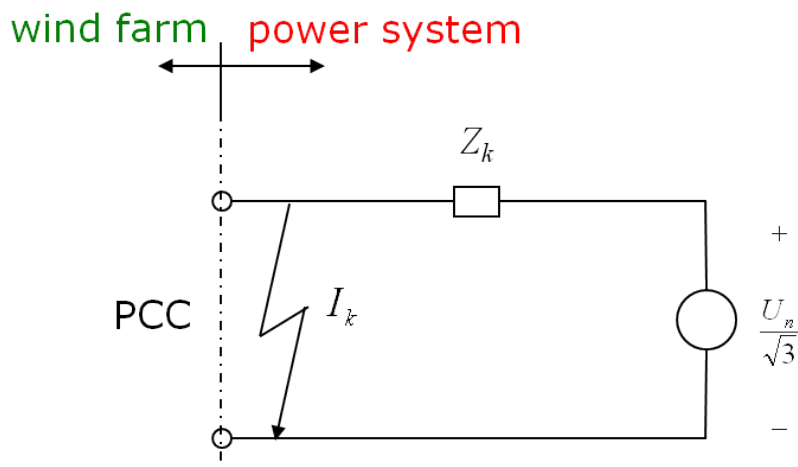

Figure 9 Equivalent circuit as seen by the wind farm at the PCC

If, and this should not be done physically (!), a short circuit were to be made at the PCC then a short circuit current would flow (I_k) resulting in an apparent power being dissipated in Z_k . Logically, this power is called the short circuit power, S_k :

$$S_k = 3 \cdot |Z_k| \cdot I_k^2 = \frac{U_n^2}{|Z_k|}$$

This short circuit power is, in turn, known as the strength of the grid and is quoted in apparent power units (MVA, kVA, etc.).

It can be seen from the equation above that a PCC with a high connection voltage (U_n) will have a high short circuit power and thus be “strong” and grids with a low impedance (Z_k) will also be strong.

3.3.4 The impact of grid strength

The important impacts of grid strength can be summarised as follows:

- Weak grids imply small conductors – these quickly reach the thermal limit of the cables.
- The injection of active and reactive power affects the voltage at the PCC depending on the strength. (See Figure 10 which is explained more in the lecture.)
- The stronger the grid the smaller the voltage change
- The stronger the grid the lower the effect of flicker and harmonic emissions.

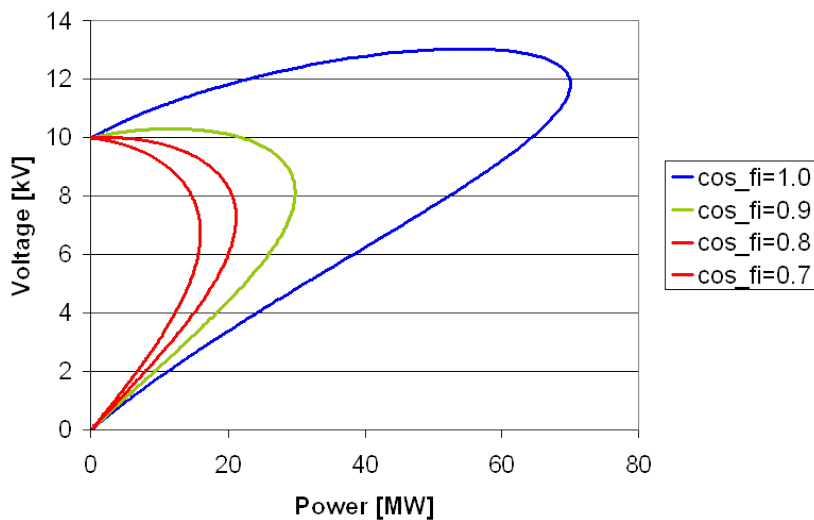

Figure 10 Influence of active:reactive power ratio injection into a PCC on the voltage

3.3.5 How to use grid strength

A rough rule of thumb to get a grid strength will be given in the lectures (as it is unlikely that you will be able to find the relevant grid strength for your study project elsewhere). This grid strength figure can then be used to make an approximation of how large a wind farm that connection could sensibly support, by application of the relationship below:

$$\text{OK} \rightarrow 2\% \leq \frac{\text{Wind farm capacity}}{\text{Short circuit power}} \leq 20\% \leftarrow \text{Problematic}$$

What this says is that if the wind farm capacity divided by the short circuit power is greater than 2% then it is likely that the grid can support a wind farm of that size. The closer this ration gets to 20% the more problematic it becomes.

3.3.6 Other indicators of grid strength

Having stated in section 3.3.2 that voltage level is not necessarily an indication of the right connection point, it can be argued that the higher the voltage level then the stronger the grid providing there are other indications. These indications could include a power station in the vicinity, a large consumer nearby (e.g. heavy industry), a town or city not too far away, higher-voltage power lines close to the PCC, a large sub-station, etc. These are items that can be seen from a map or from a first site visit and can give a good

indication of the likelihood of finding a good PCC or, if not, the magnitude of the cost of providing one.

3.3.7 Grid codes

“Grid Codes” are a set of rules, normally written and enforced by the Transmission System Operator (TSO), that dictate how a generator is to behave in order for it to be connected to the grid. It is very important to comply with them – without this the wind farm cannot be connected. It is the responsibility of the developer to demonstrate compliance in order to obtain a connection licence.

The codes applicable vary from country to country and although there are attempts to harmonise them, the process is slow as the TSOs are inherently conservative. After all, they have the heavy responsibility to keep the power system stable. As wind power, in particular, becomes more common then the grid codes tend to become more restrictive and are now requiring the large wind farms to act more like conventional generators.

Typical issues that the grid codes address are:

- Active power and power control
- Reactive power control
- Voltage and frequency tolerance
- Behaviour during grid faults
- Voltage quality

3.4 Offshore connections

3.4.1 Why is offshore different to onshore?

Offshore wind farms provide a number of further challenges for the grid connection when compared to a conventional onshore wind farm.

- The conditions under which the equipment has to operate are more severe and therefore there is a greater emphasis on reliability: access to the turbines both for inspection and repair/replacement of parts is very much more difficult offshore.
- Offshore wind farms are, generally, larger than onshore and thus provide a challenge of scale but there is generally still only one sub-station.
- Distances between turbines are larger due to wake effects. This affects the internal grid layout of the wind farm and complicates the balance between cost, reliability and efficiency.
- Distance to the PCC can be longer (a suitable PCC may not be on the shoreline) thus providing problems using AC cable connections without the possibility of power factor correction.
- Construction conditions and options are more limited, especially for the cable connection.
- Environmental considerations are very different and may limit the design and methods for construction e.g. cable laying

3.4.2 Offshore connection options: AC vs DC

Providing the distance to the PCC is not too great and the wind farm capacity is not too large, then essentially the same system for grid connection can be used offshore as for onshore. However, as the power goes up and the distance to the PCC becomes longer, using AC becomes problematic due to the power factor correction needed to compensate for the capacitance of the cables. This is difficult to do at sea. This is why DC connections are becoming more attractive as they require fewer cables and no correction. They are also more efficient than AC cables.

The three connection options are:

- 1) Medium Voltage AC: Connect at the wind farm internal voltage – losses increase with distance
- 2) High Voltage AC: Step up voltage to higher voltage level – equipment more expensive and there needs to be a transformer and possible power factor compensation at sea
- 3) High Voltage DC: Use a DC link – even more expensive equipment but losses are lower for longer distances and higher power

At present, by far the most common connection method is Option 2 with just one DC connection currently in use for a wind farm. See Figure 11.

Offshore wind farm		Capacity (MW)	Internal voltage (kV)	Connection voltage (kV)	Voltage type	Connection distance (km)
Middelgrunden	DK	40	30	30	MVAC	3
Horns Rev	DK	160	36	150	HVAC	15
Nysted	DK	165.6	33	132	HVAC	10
Lillgrund	SE	110.4	36	145	HVAC	9
Walney 1	UK	183.6	34	132	HVAC	45
Borkum 2 / BARD	D	400	36	150	HVDC	203

Figure 11 A selection of offshore wind farms with different connection options

A relationship between wind farm capacity, distance and connection type can be seen from Figure 12 which is taken from “Wind Power in Power Systems”, published by Wiley.

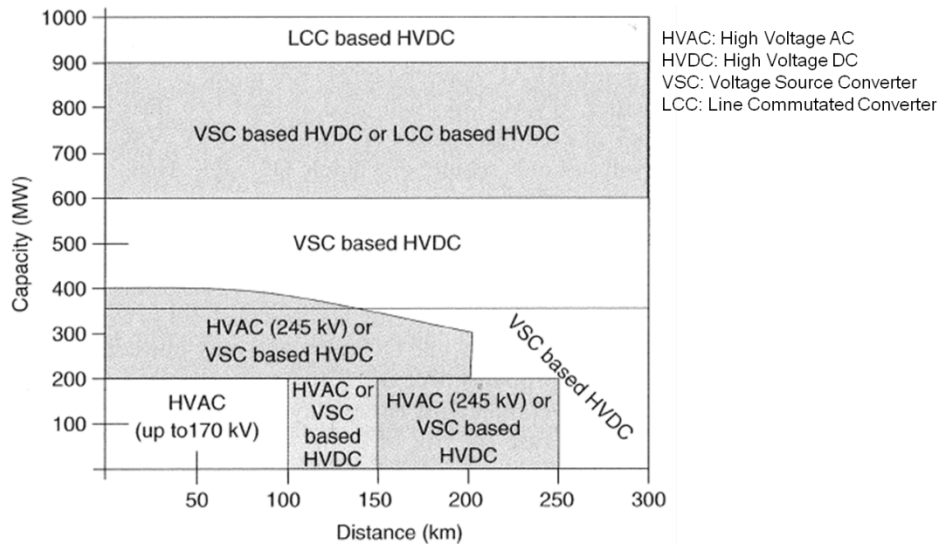

Figure 12 An approximate guide to the choice of AC or DC connection for offshore wind farm projects

3.5 Summary of tasks for planning a grid connection

Different wind farm developers approach their projects in different ways but the figure below gives the most important steps and can be used as a manner of check list for your study projects.

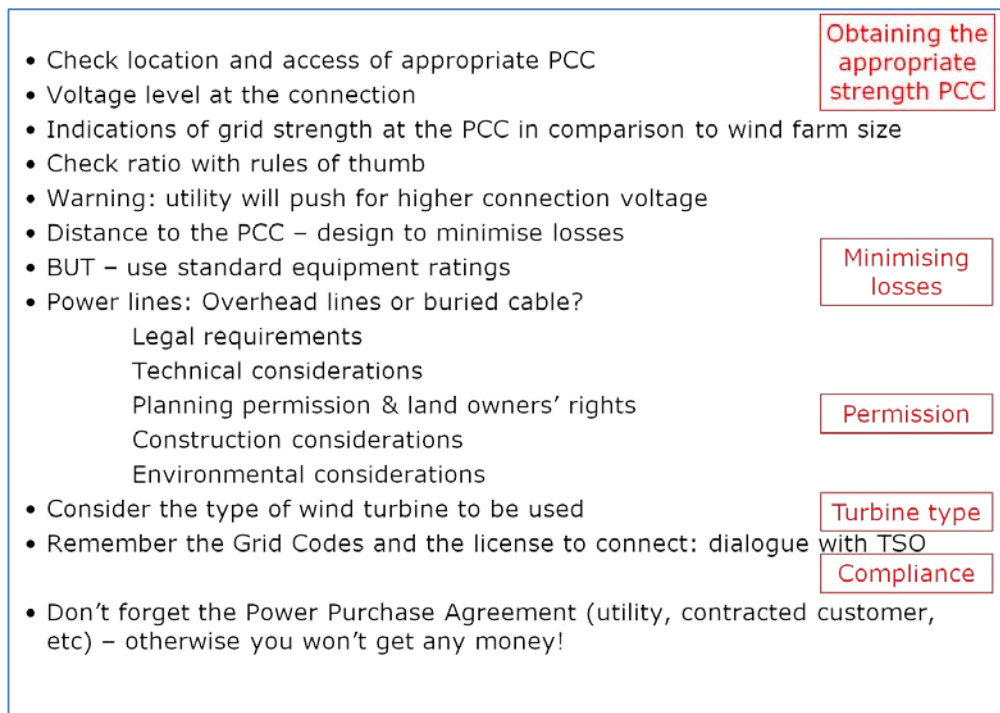

Figure 13 Essential steps in planning a wind farm grid connection

3.6 References (Grid)

Some useful references for this topic are given below:

“Wind Power in the Power System”, published by Wiley (2006)

Danish TSO, Energinet.dk: www.energinet.dk

European Wind Energy Association: www.ewea.org

Danish Energy Authority www.ens.dk

Middelgrunden offshore wind farm, <http://www.middelgrunden.dk>

For active/reactive power visualisation: www.circuit-magic.com/acpower.htm

Practical electrical power engineering textbooks:

“Electric Power Systems”, B.M. Weedy & B.J. Cory, published by Wiley.

“Renewable and Efficient Electric Power Systems”, Gilbert M. Masters, published by Wiley.

“Understanding Electric Power Systems : An Overview of the Technology and the Marketplace”, J. Cassaza & F. Delea, published by Wiley-IEE press

4 References (EIA)

ANGULO, I., DE LA VEGA, D., FERNÁNDEZ, C., GUERRA, D., WU, Y., ANGUEIRA, P. and ORDIALES, J.L., 2011. An Empirical Comparative Study of Prediction Methods for Estimating Multipath Due to Signal Scattering From Wind Turbines on Digital TV Services. *Broadcasting, IEEE Transactions on*, (99), pp. 1-1.

APPLETON, S. and BRANSON, J., 2006. Stealthy Wind Turbines—Addressing the Radar Issue. *BWEA28*, .

ARNETT, E.B., BROWN, W.K., ERICKSON, W.P., FIEDLER, J.K., HAMILTON, B.L., HENRY, T.H., JAIN, A., JOHNSON, G.D., KERNS, J., KOFORD, R.R., NICHOLSON, C.P., O'CONNELL, T.J., PIORKOWSKI, M.D. and TANKERSLEY, R.D.,JR., 2008. Patterns of bat fatalities at wind energy facilities in North America. *Journal of Wildlife Management*, 72(1), pp. 61-78.

BAERWALD, E.F., D'AMOURS, G.H., KLUG, B.J. and BARCLAY, R.M.R., 2008. Barotrauma is a significant cause of bat fatalities at wind turbines. *Current Biology*, 18(16), pp. R695-R696.

BAERWALD, E.F., EDWORTHY, J., HOLDER, M. and BARCLAY, R.M.R., 2009. A Large-Scale Mitigation Experiment to Reduce Bat Fatalities at Wind Energy Facilities. *Journal of Wildlife Management*, 73(7), pp. 1077-1081.

BAILEY, H., SENIOR, B., SIMMONS, D., RUSIN, J., PICKEN, G. and THOMPSON, P.M., 2010. Assessing underwater noise levels during pile-driving at an offshore windfarm and its potential effects on marine mammals. *Marine pollution bulletin*, 60(6), pp. 888-897.

BAKKER, R.H., PEDERSEN, E., VAN DEN BERG, G.P., STEWART, R.E., LOK, W. and BOUMA, J., 2012. Impact of wind turbine sound on annoyance, self-reported sleep disturbance and psychological distress. *Science of the Total Environment*, 425, pp. 42-51.

BARCLAY, R.M.R., BAERWALD, E.F. and GRUVER, J.C., 2007. Variation in bat and bird fatalities at wind energy facilities: assessing the effects of rotor size and tower height. *Canadian Journal of Zoology-Revue Canadienne De Zoologie*, 85(3), pp. 381-387.

Barotrauma. 2012. *Encyclopædia Britannica Online*. Retrieved 09 July, 2012, from <http://www.britannica.com/EBchecked/topic/53888/barotrauma>

BENGTSSON, B., 2008. *Archaeological Handbook for Establishing Offshore Wind Farms in Sweden: Lillgrund Pilot Project*. 21858-1. Sweden: The Swedish Energy Agency.

BISHOP, I.D. and MILLER, D.R., 2007. Visual assessment of off-shore wind turbines: The influence of distance, contrast, movement and social variables. *Renewable Energy*, 32(5), pp. 814-831.

BOLIN, K., BLUHM, G., ERIKSSON, G. and NILSSON, M.E., 2011. Infrasound and low frequency noise from wind turbines: exposure and health effects. *Environmental Research Letters*, 6(3), pp. 035103.

BRANDT, M.J., DIEDERICHS, A., BETKE, K. and NEHLS, G., 2011. Responses of harbour porpoises to pile driving at the Horns Rev II offshore wind farm in the Danish North Sea. *Marine Ecology-Progress Series*, 421, pp. 205-216.

BUCK, B.H., KRAUSE, G., MICHLER-CIELUCH, T., BRENNER, M., BUCHHOLZ, C., BUSCH, J., FISCH, R., GEISEN, M. and ZIELINSKI, O., 2008. Meeting the quest for spatial efficiency: progress and prospects of extensive aquaculture within offshore wind farms. *Helgoland Marine Research*, 62(3), pp. 269-281.

CARNELL, J., 2011. Unexploded Ordnance Risk: Considering Unexploded Ordnance Risk on and around the British Isles. UK: Project Management Support Services Ltd.

CARSTENSEN, J., HENRIKSEN, O.D. and TEILMANN, J., 2006. Impacts of offshore wind farm construction on harbour porpoises: acoustic monitoring of echolocation activity using porpoise detectors (T-PODs). *Marine Ecology-Progress Series*, 321, pp. 295-308.

CASANOVA, A.C., RAMÓN, M.C., DE HARO Y ARIEL, L. and BIANCO-GONZALEZ, P., 2009. Software development for the prediction of interferences in wind farms, *Systems, Signals and Devices*, 2009. SSD'09. 6th International Multi-Conference on 2009, IEEE, pp. 1-4.

CHAMBERLAIN, D.E., REHFISCH, M.R., FOX, A.D., DESHOLM, M. and ANTHONY, S.J., 2006. The effect of avoidance rates on bird mortality predictions made by wind turbine collision risk models. *Ibis*, 148, pp. 198-202.

Concerns relating to dumped munitions. 2010. OSPAR Commission.

CRYAN, P.M. and BROWN, A.C., 2007. Migration of bats past a remote island offers clues toward the problem of bat fatalities at wind turbines. *Biological Conservation*, 139(1-2), pp. 1-11.

CRYAN, P.M., 2008. Mating behavior as a possible cause of bat fatalities at wind turbines. *Journal of Wildlife Management*, 72(3), pp. 845-849.

CUSHMAN, J.T. and FLOCCARE, D.J., 2007. Flicker illness: An underrecognized but preventable complication of helicopter transport. *Prehospital Emergency Care*, 11(1), pp. 85-88.

DABIS, H. and CHIGNELL, R., 1997. The establishment of guidelines for the installation of wind turbines near radio systems. EDMUNDS; P O BOX 24 NORTHGATE AVE BURY ST, EDMUNDS, SUFFOLK, ENGLAND IP32 6BW: MECHANICAL ENGINEERING PUBL.

DAHL, E.L., BEVANGER, K., NYGARD, T., ROSKRAFT, E. and STOKKE, B.G., 2012. Reduced breeding success in white-tailed eagles at Smola windfarm, western Norway, is caused by mortality and displacement. *Biological Conservation*, 145(1), pp. 79-85.

- DESHOLM, M., FOX, A.D., BEASLEY, P.D.L. and KAHLERT, J., 2006. Remote techniques for counting and estimating the number of bird-wind turbine collisions at sea: a review. *Ibis*, 148, pp. 76-89.
- DREWITT, A.L. and LANGSTON, R.H.W., 2006. Assessing the impacts of wind farms on birds. *Ibis*, 148, pp. 29-42.
- DREWITT, A.L. and LANGSTON, R.H.W., 2008. Collision effects of wind-power generators and other obstacles on birds. *Year in Ecology and Conservation Biology* 2008, 1134, pp. 233-266.
- ENGLISH HERITAGE., 2005. *Wind Energy and the Historic Environment*. England: English Heritage.
- ESHBACH, O.W., 2009. Chapter 19: Acoustics. In: M. KUTZ, ed, *Eshbach's handbook of engineering fundamentals*. 5th edn. Hoboken, N.J.: Wiley, pp. 1151-1199.
- EXO, K.M., HUPPOP, O. and GARTHE, S., 2003. Birds and offshore wind farms: a hot topic in marine ecology. *BULLETIN-WADER STUDY GROUP*, 100, pp. 50-53.
- FAYRAM, A.H. and DE RISI, A., 2007. The potential compatibility of offshore wind power and fisheries: an example using bluefin tuna in the Adriatic Sea. *Ocean & Coastal Management*, 50(8), pp. 597-605.
- FIRESTONE, J., KEMPTON, W. and KRUEGER, A., 2009. Public Acceptance of Offshore Wind Power Projects in the USA. *Wind Energy*, 12(2), pp. 183-202.
- FOLLESTAD, A., FLAGSTAD, Ø., NYGÅRD, T., REITAN, O. and SCHULZE, J., 2007. *Vindkraft og fugl på Smøla 2003–2006*. NINA Rapport 248: 78 pp., 248.
- GILL, A.B., 2005. Offshore renewable energy: ecological implications of generating electricity in the coastal zone. *Journal of Applied Ecology*, 42(4), pp. 605-615.
- GIPE, P., 1995. Impact on Flora and Fauna. *Wind energy comes of age*. John Wiley & Sons Inc, pp. 342-343.
- GRAY, T., HAGGETT, C. and BELL, D., 2005. Offshore wind farms and commercial fisheries in the UK: A study in Stakeholder Consultation. *Ethics Place and Environment*, 8(2), pp. 127-140.
- GRODSKY, S.M., BEHR, M.J., GENDLER, A., DRAKE, D., DIETERLE, B.D., RUDD, R.J. and WALRATH, N.L., 2011. Investigating the causes of death for wind turbine-associated bat fatalities. *Journal of mammalogy*, 92(5), pp. 917-925.
- HARDING, G., HARDING, P. and WILKINS, A., 2008. Wind turbines, flicker, and photosensitive epilepsy: Characterizing the flashing that may precipitate seizures and optimizing guidelines to prevent them. *Epilepsia*, 49(6), pp. 1095-1098.
- HORN, J.W., ARNETT, E.B. and KUNZ, T.H., 2008. Behavioral responses of bats to operating wind turbines. *Journal of Wildlife Management*, 72(1), pp. 123-132.

- HUEPPOP, O., DIERSCHKE, J., EXO, K., FREDRICH, E. and HILL, R., 2006. Bird migration studies and potential collision risk with offshore wind turbines. *Ibis*, 148, pp. 90-109.
- HUNT, G. and HUNT, T., 2006. The trend of golden eagle territory occupancy in the vicinity of the Altamont Pass Wind Resource Area: 2005 survey. Unpublished report of the California energy Commission, PIeR energy-Related environmental Research, CeC-500-2006-056, .
- JAGO, P. and TAYLOR, N., 2002, European Turbine and Aviation Interests – European Experience and Practice, ETSU W/14/00624/REP DTI PUB URN No. 03/515, STASYS Ltd
- JENSEN, H., KRISTENSEN, P.S. and HOFFMANN, E., 2004. Sandeels in the wind farm area at Horns Reef. Danish Institute for Fisheries Research Charlottenlund.
- JOBERT, A., LABORGNE, P. and MIMLER, S., 2007. Local acceptance of wind energy: Factors of success identified in French and German case studies. *Energy Policy*, 35(5), pp. 2751-2760.
- JONES, C.R. and EISER, J.R., 2010. Understanding 'local' opposition to wind development in the UK: How big is a backyard? *Energy Policy*, 38(6), pp. 3106-3117.
- KJELLSSON, J., 2003. «Investigation, Mapping and Location of Dumped Ammunition, a Project of the Swedish Armed Forces», 3 rd International Disposal Conference, Karlskoga, Sweden, Karlskoga 2003, pp. 55-58.
- KRIJGSVELD, K.L., AKERSHOEK, K., SCHENK, F., DIJK, F. and DIRKSEN, S., 2009. Collision risk of birds with modern large wind turbines. *Ardea*, 97(3), pp. 357-366.
- KROHN, S. and DAMBORG, S., 1999. On public attitudes towards wind power. *Renewable Energy*, 16(1), pp. 954-960.
- KRUG, F. and LEWKE, B., 2009. Electromagnetic interference on large wind turbines. *Energies*, 2(4), pp. 1118-1129.
- KUVLESKY, W.P.,JR., BRENNAN, L.A., MORRISON, M.L., BOYDSTON, K.K., BALLARD, B.M. and BRYANT, F.C., 2007. Wind energy development and wildlife conservation: Challenges and opportunities. *Journal of Wildlife Management*, 71(8), pp. 2487-2498.
- KÖLLER, J., KÖPPEL, J. and PETERS, W., 2006. Research on Benthic Associations. In: KOLLER, J KOPPEL, J PETERS,W., ed, *Offshore Wind Energy: Research on Environmental Impacts*. HEIDELBERGER PLATZ 3, D-14197 BERLIN, GERMANY: SPRINGER-VERLAG BERLIN, pp. 182-200.
- LADENBURG, J., 2009. Visual impact assessment of offshore wind farms and prior experience. *Applied Energy*, 86(3), pp. 380-387.
- LANDRY, C.E., ALLEN, T., CHERRY, T. and WHITEHEAD, J.C., 2012. Wind turbines and coastal recreation demand. *Resource and Energy Economics*, 34(1), pp. 93-111.

- LANGE, E. and HEHL-LANGE, S., 2005. Combining a participatory planning approach with a virtual landscape model for the siting of wind turbines. *Journal of Environmental Planning and Management*, **48**(6), pp. 833-852.
- LARSEN, J.K. and GUILLEMETTE, M., 2007. Effects of wind turbines on flight behaviour of wintering common eiders: implications for habitat use and collision risk. *Journal of Applied Ecology*, 44(3), pp. 516-522.
- LELOUDAS, G., ZHU, W.J., SØRENSEN, J.N., SHEN, W.Z. and HJORT, S., 2007. Prediction and reduction of noise from a 2.3 MW wind turbine, *Journal of Physics: Conference Series* 2007, IOP Publishing, pp. 012083.
- LEONHARD, S.B. and PEDERSEN, J., 2006. Benthic communities at Horns Rev before, during and after construction of Horns Rev Offshore Wind Farm. Final report to Vattenfall A/S.Bio/Consult, Aarhus, Denmark, .
- LOTHIAN, A., 2008. Scenic perceptions of the visual effects of wind farms on South Australian landscapes. *Geographical Research*, 46(2), pp. 196-207.
- MADDERS, M. and WHITFIELD, D.P., 2006. Upland raptors and the assessment of wind farm impacts. *Ibis*, 148, pp. 43-56.
- MADSEN, P.T., WAHLBERG, M., TOUGAARD, J., LUCKE, K. and TYACK, P., 2006. Wind turbine underwater noise and marine mammals: implications of current knowledge and data needs. *Marine Ecology-Progress Series*, 309, pp. 279-295.
- MASDEN, E.A., HAYDON, D.T., FOX, A.D., FURNESS, R.W., BULLMAN, R. and DESHOLM, M., 2009. Barriers to movement: impacts of wind farms on migrating birds. *ICES Journal of Marine Science*, 66(4), pp. 746-753.
- MATTHEWS, J., PINTO, J. and SARNO, C., 2007. Stealth Solutions to solve the radar-wind farm interaction problem, *Antennas and Propagation Conference, 2007. LAPC 2007. Loughborough 2007, IEEE*, pp. 101-104.
- MCLAREN LORING, J., 2007. Wind energy planning in England, Wales and Denmark: Factors influencing project success. *Energy Policy*, **35**(4), pp. 2648-2660.
- MOLLER, B., 2006. Changing wind-power landscapes: regional assessment of visual impact on land use and population in Northern Jutland, Denmark. *Applied Energy*, 83(5), pp. 477-494.
- MOLNAROVA, K., SKLENICKA, P., STIBOREK, J., SVOBODOVA, K., SALEK, M. and BRABEC, E., 2012. Visual preferences for wind turbines: Location, numbers and respondent characteristics. *Applied Energy*, 92, pp. 269-278.
- OHMAN, M.C., SIGRAY, P. and WESTERBERG, H., 2007. Offshore windmills and the effects electromagnetic fields an fish. *Ambio*, 36(8), pp. 630-633.
- PARSONS BRINCKERHOFF, 2011. Update of UK Shadow Flicker Evidence Base. United Kingdom: The Department of Energy and Climate Change.
- PEDERSEN, E. and NATURVÅRDSVERKET, 2003. Noise annoyance from wind turbines: a review. *Naturvårdsverket*.

- PEDERSEN, E. and WAYE, K., 2004. Perception and annoyance due to wind turbine noise - a dose-response relationship. *Journal of the Acoustical Society of America*, 116(6), pp. 3460-3470.
- PINTO, J., MATTHEWS, J. and SARNO, G., 2010. Stealth technology for wind turbines. *Radar, Sonar & Navigation, IET*, 4(1), pp. 126-133.
- PROSPATHOPOULOS, J. and VOUTSINAS, S., 2005. Noise propagation issues in wind energy applications. *Journal of Solar Energy Engineering-Transactions of the Asme*, 127(2), pp. 234-241.
- RODMELL, D.P. and JOHNSON, M.L., 2003. The development of marine based wind energy generation and inshore fisheries in UK waters: are they compatible? .
- ROGERS, A.L. and MANWELL, J.F., 2002. Wind turbine noise issues. *Renewable Energy Research Laboratory, Amherst*, , pp. 1-19.
- ROGERS, J.C., SIMMONS, E.A., CONVERY, I. and WEATHERALL, A., 2008. Public perceptions of opportunities for community-based renewable energy projects. *Energy Policy*, 36(11), pp. 4217-4226.
- RYDELL, J., BACH, L., DUBOURG-SAVAGE, M., GREEN, M., RODRIGUES, L. and HEDENSTROM, A., 2010. Bat mortality at wind turbines in northwestern Europe. *Acta Chiropterologica*, 12(2), pp. 261-274.
- SAIDUR, R., RAHIM, N.A., ISLAM, M.R. and SOLANGI, K.H., 2011. Environmental impact of wind energy. *Renewable & Sustainable Energy Reviews*, 15(5), pp. 2423-2430.
- SENGUPTA, D.L. and SENIOR, T.B.A., 1979. Electromagnetic interference to television reception caused by horizontal axis windmills. *Proceedings of the IEEE*, 67(8), pp. 1133-1142.
- SHEPHERD, D., MCBRIDE, D., WELCH, D., DIRKS, K.N. and HILL, E.M., 2011. Evaluating the impact of wind turbine noise on health-related quality of life. *Noise & Health*, 13(54), pp. 333-339.
- SIBLEY, D., 18/11/2010, 2010-last update, Causes of Bird Mortality. Available: <http://www.sibleyguides.com/conservation/causes-of-bird-mortality/> [17/07, 2012].
- SMALLWOOD, K.S., 2007. Estimating wind turbine-caused bird mortality. *Journal of Wildlife Management*, 71(8), pp. 2781-2791.
- SMEDLEY, A.R.D., WEBB, A.R. and WILKINS, A.J., 2010. Potential of wind turbines to elicit seizures under various meteorological conditions. *Epilepsia*, 51(7), pp. 1146-1151.
- STEWART, G.B., PULLIN, A.S. and COLES, C.F., 2007. Poor evidence-base for assessment of windfarm impacts on birds. *Environmental Conservation*, 34(1), pp. 1-11.
- TEMPLE, H.J. and TERRY, A., 2007. The status and distribution of European mammals. *The status and distribution of European mammals*, .

THOMSEN, F., LÜDEMANN, K., KAFEMANN, R. and PIPER, W., 2006. Effects of offshore wind farm noise on marine mammals and fish. Biola, Hamburg, Germany on behalf of COWRIE Ltd, .

TORRES SIBILLE, A.D.C., CLOQUELL-BALLESTER, V., CLOQUELL-BALLESTER, V. and DARTON, R., 2009. Development and validation of a multicriteria indicator for the assessment of objective aesthetic impact of wind farms. *Renewable & Sustainable Energy Reviews*, 13(1), pp. 40-55.

TOUGAARD, J., CARSTENSEN, J., TEILMANN, J., SKOV, H. and RASMUSSEN, P., 2009. Pile driving zone of responsiveness extends beyond 20 km for harbor porpoises (*Phocoena phocoena* (L.)). *Journal of the Acoustical Society of America*, 126(1), pp. 11-14.

WALDO, A., 2012. Offshore wind power in Sweden-A qualitative analysis of attitudes with particular focus on opponents. *Energy Policy*, 41, pp. 692-702.

WARREN, C.R. and MCFADYEN, M., 2010. Does community ownership affect public attitudes to wind energy? A case study from south-west Scotland. *Land Use Policy*, 27(2), pp. 204-213.

WILHELMSSON, D., MALM, T. and OHMAN, M.C., 2006. The influence of offshore windpower on demersal fish. *ICES Journal of Marine Science*, 63(5), pp. 775-784.

WILSON, J.C. and ELLIOTT, M., 2009. The Habitat-creation Potential of Offshore Wind Farms. *Wind Energy*, 12(2), pp. 203-212.

WOLSINK, M., 2000. Wind power and the NIMBY-myth: institutional capacity and the limited significance of public support. *Renewable Energy*, 21(1), pp. 49-64.

WÜSTENHAGEN, R., WOLSINK, M. and BÜRER, M.J., 2007. Social acceptance of renewable energy innovation: An introduction to the concept. *Energy Policy*, 35(5), pp. 2683-2691.

WWII bomb found on Sheringham Shoal site30/04/2010, 2010-last update. Available: http://www.scira.co.uk/news/news30_04_10.php [07/13, 2012].

ZHU, W.J., HEILSKOV, N., SHEN, W.Z. and SORENSEN, J.N., 2005. Modeling of aerodynamically generated noise from wind turbines. *Journal of Solar Energy Engineering-Transactions of the Asme*, 127(4), pp. 517-528.

5 Acknowledgements

The authors acknowledge the assistance from several of our colleagues at DTU Wind Energy and especially the excellent collaboration with Niels G. Mortensen.

DTU Wind Energy is a department of the Technical University of Denmark with a unique integration of research, education, innovation and public/private sector consulting in the field of wind energy. Our activities develop new opportunities and technology for the global and Danish exploitation of wind energy. Research focuses on key technical-scientific fields, which are central for the development, innovation and use of wind energy and provides the basis for advanced education at the university.

We have more than 230 staff members of which approximately 60 are PhD students. Research is conducted within 9 research programmes organized into three main topics: Wind energy systems, Wind turbine technology and Basics for wind energy.

Technical University of Denmark
Department of Wind Energy
Risø Campus, Building 118
Frederiksborgvej 399
4000 Roskilde
Denmark
Telephone 46 77 50 85
info@vindenergi.dtu.dk
www.vindenergi.dtu.dk