

The new European wind atlas

Lundtang Petersen, Erik; Troen, Ib; Ejsing Jørgensen, Hans; Mann, Jakob

Published in:
Energy Bulletin

Publication date:
2014

Document Version
Publisher's PDF, also known as Version of record

[Link back to DTU Orbit](#)

Citation (APA):
Lundtang Petersen, E., Troen, I., Ejsing Jørgensen, H., & Mann, J. (2014). The new European wind atlas. Energy Bulletin, (17), 34-39.

DTU Library

Technical Information Center of Denmark

General rights

Copyright and moral rights for the publications made accessible in the public portal are retained by the authors and/or other copyright owners and it is a condition of accessing publications that users recognise and abide by the legal requirements associated with these rights.

- Users may download and print one copy of any publication from the public portal for the purpose of private study or research.
- You may not further distribute the material or use it for any profit-making activity or commercial gain
- You may freely distribute the URL identifying the publication in the public portal

If you believe that this document breaches copyright please contact us providing details, and we will remove access to the work immediately and investigate your claim.

ENERGY BULLETIN



Sustainable
Energy
Development



International centre
under the auspices of UNESCO

United Nations
Educational, Scientific and
Cultural Organization

Energy Bulletin
№17, 2014



WIND ENERGY: OPPORTUNITIES AND CHALLENGES OF GLOBAL WIND ENERGY DEVELOPMENT

SMALL WIND WORLD MARKET CONTINUES GROWING

World Wind Energy Association,
p. 10

DEVELOPMENT OF ON-GRID WIND POWER PLANTS IN RUSSIA

«Wind Energy Systems» company, Russia,
p. 18

THE NEW EUROPEAN WIND ATLAS

Technical University of Denmark,
p. 34

Энергетический вестник №17, 2014

Energy bulletin №17, 2014

Le bulletin énergétique №17, 2014

Boletín energético №17, 2014



United Nations
Educational, Scientific and
Cultural Organization

Sustainable
Energy
Development



International centre
under the auspices of UNESCO

ENERGY BULLETIN

Published in two languages – Russian and English

Founder

International Sustainable Energy Development Centre under the auspices of UNESCO (ISEDC)

Address of the Centre

Kedrova St., 8/1 bld. 2, Moscow, Russia, 117292

Tel. +7 (495) 641-0426

E-mail: info@isedc-u.com

Published by ISEDC in cooperation with "IntellInform Vision", LLC

"Energy Bulletin" is registered at the Federal Service for Supervision of Communications, Information Technology, and Mass Media of the Russian Federation

PI № ФС77-35391 of February 18, 2009

Distribution

UNESCO member-states (permanent delegations to UNESCO), international organisations and information agencies, ministries and agencies of the Russian Federation, sectoral Russian and foreign companies, Russian and international libraries.

ISSN 2075-2318

© UNESCO 2014

© ISEDC 2014



This publication is printed on paper, partially consisting of recycled paper fibers. Trimming of the circulation was used for the production of notebooks and pens.

Editorial Board

Executive Secretary of the Board

Yury POSYSAEV

*Executive Director of International Sustainable Energy Development Centre (ISED),
Russia*

Osman BENCHIKH

*Programme Specialist Responsible for Renewable Energy at UNESCO,
France*

Ali SAYIGH

*Professor, Director-General of the World Renewable Energy Congress/Network,
Great Britain*

Hans-Josef FELL

*President of Energy Watch Group,
Germany*

Ugo FARINELLI

*Professor, Secretary-General of the Italian Association of Energy Economists,
Italy*

Vladimir FORTOV

*President of the Russian Academy of Sciences (RAS),
Russia*

Oleg FAVORSKY

*Full member of the Russian Academy of Sciences (RAS),
President of the Centre of Energy Policy,
Russia*

Aleksander MIKHALEVICH

*Academic supervisor of the Institute of Power Engineering of the National Academy of Sciences of Belarus,
Belarus*

Spyros KYRITSIS

*Professor of Agricultural University of Athens,
Vice-President of the Hellenic Agricultural Academy,
Greece*

Noam LIOR

*Chair, Scientific Committee of the International Centre for Sustainable Development of Energy, Water and Environment Systems,
Professor of Mechanical Engineering and Applied Mechanics at University of Pennsylvania,
USA*

Editorial Office

Director: Irina KEVBRINA

Editor: Alexey GRAMMATCHIKOV

Science consultant of issue: Vladimir KUZMINOV

Address of the Editorial Office

Kedrova st., 8/1 bld. 2, Moscow, Russia, 117292

Tel. +7 (495) 641-0426

E-mail: kevbrina@isedc-u.com;

a_gramm@isedc-u.com; info@isedc-u.com

Authors are solely responsible for selection and presentation of facts in the signed articles which express their opinion and may not correspond with the official position of UNESCO and ISED.

Materials of the issue or parts of them in any language may not be reproduced in any form including web media without prior written permission of the Editorial Office.

CONTENTS

EDITORIAL.....	4
----------------	---

WIND ENERGY

SMALL WIND WORLD MARKET CONTINUES GROWING	10
<i>Stefan Gsänger, Secretary General of the World Wind Energy Association, Germany with participation of Jean Pitteloud, Public Relations & Marketing Manager, World Wind Energy Association, Venezuela</i>	

DEVELOPMENT OF ON-GRID WIND POWER PLANTS IN RUSSIA – CASE OF MIRNY WIND POWER PLANT PILOT PROJECT IN YEYSK DISTRICT OF KRASNODAR REGION	18
<i>Georgy Ermolenko, Director-General Ilya Gordeyev, Chairman of the Board of Directors Mikhail Ryzhenkov, Deputy Director-General Alexandra Nikomarova, Project manager Nina Bogoroditskaya, Project manager «Wind Energy Systems» company, Russia</i>	

UNESCO NEWS	29
-------------------	----

WIND ENERGY

THE NEW EUROPEAN WIND ATLAS.....	34
<i>Erik Lundtang Petersen, Ib Troen, Hans E. Jørgensen, Jakob Mann Wind Energy Department, Technical University of Denmark, Denmark</i>	

SUSTAINABLE ENERGY FOR ALL: MYTH OR REALITY?	40
<i>Yuri Bychkov, Professor, Doctor of Technical Sciences (D.Sc.Tech.), Russia</i>	

HYBRID WIND SYSTEMS FOR THE SUPPLY OF SERVICES IN RURAL SETTLEMENTS OF SOUTH MEDITERRANEAN COUNTRIES – CASE STUDY OF THE HYBRID SYSTEM IN EGYPT	46
<i>Essam Sh.Mohamed, G. Papadakis, G. Kyriakarakos, Agricultural University of Athens</i>	
<i>Abdel-Wahab S. Kassem, Faculty of Agriculture, Alexandria University, Greece</i>	
EVENTS	55
ENERGY AND ECOLOGY	
MULTICRITERIAL ASSESSMENT OF MARINE WATER POLLUTION IN AREAS OF OFFSHORE OIL AND GAS FIELD DEVELOPMENT	68
<i>Olga Esina, Galina Monakhova, Sergey Monakhov, Alexey Kurapov, Caspian Marine Scientific Research Centre, Russia</i>	
LETTERS TO THE EDITOR	
HIGH-ALTITUDE WIND ENERGY: FICTION OR REALITY?.....	73
<i>Efim Dwoskin, inventor, Russia</i>	
ISED NEWS.....	76

EDITORIAL

Waves of political, economic and moral-ethical interests developed by the mankind to renewable energy reach the levels, which have been unprecedented till now, and if they sustain for at least one decade, it can be stated certainly that our society will have a new power industry capable of satisfying not only the increasing energy requirements of most economies and the world's population, but also eradicating energy poverty observed now in many places on our planet in various manifestations. Of course, the replacement of conventional energy sources by renewable ones will not result in energy well-being, which will depend on many factors, and, most of all, on economical attitude of every person, of all elements of the economy to energy, on clear understanding that there will not be "renewable energy" and "renewable energy industry" in the direct sense of the adjective "renewable". There will be an energy industry based on efficient and economic use of renewable energy sources (RES), which will produce the same types of energy: electrical, thermal, chemical, or even mechanical; they must be used rationally by way of steadily increasing the energy efficiency of all economy's branches, of our everyday life, which leads to substantial energy savings. If it is accomplished, the energy saved by this way will completely cover constantly increasing energy requirements of the world.

The present issue of "Energy Bulletin" ones again addresses some problems of the renewable energy development as one of the most important components of sustainable energy. As the magazine has emphasized many times, the renewable energy is a multicomponent industry, each part of which is based on the use of one type of RES, whose scientific knowledge and technologies of use differ greatly from those of other RES. They have only one thing in common: the generated power, which is supplied to the customer through existing energy grids or used at the places of its generation. First of all, this applies to electricity generating systems, where energy produced does not depend on the type of renewable energy sources. And if we speak about electrical energy being generated using

RES, we should dwell on wind energy, which is ahead of all other energy branches, including all renewable energy sub-branches. We think that wind energy will not only help solve the above problems of sustainable energy development, but also turn renewable energy into an industry that will occupy a dominant place in the world's energy balance. These conclusions come not only from the impressive dynamics of the wind energy development, but also from the historical analysis of using wind energy by the mankind.

Generally, the learning of the past in the development of knowledge and technologies based on this knowledge is a quite informative and often exciting process. And this is especially applicable to the wind energy. Wind, as an energy source, became to be used later than such RES as sun or biomass, and when the experience of life and knowledge allowed the humanity to create devices for its use. There is an evidence of using wind energy by people more than five thousand years ago to drive sea and river vessels. The drawing of a sailboat used five thousand years ago on the Nile River testifies about this. Thor Heyerdahl, a famous Norwegian traveller, devoted his life to prove the use of sailboats by our ancestors to cross enormous sea and ocean spaces. And he managed to demonstrate how wind energy was used skillfully and effectively at the dawn of human civilization. And later, the man began to use practically the same sails to drive rotating devices for various purposes: to lift water, to grind grain, and to saw trees. There is also an evidence that the first wind mills were used in Persia about two hundred years before Christ. These were devices with vertical axles, upon which reed sails were installed to move millstones to grind grain. Later, wind mills with horizontal axles appeared in the Mediterranean and Central Asia, where they were actively used for a long time, and during the Crusades they were brought to Europe, where they were used more widely. For example, in Holland, they were considerably improved and successfully used to lift water in drain systems for land drainage. Many mechanisms of various types, which used wind as a driving force, were widely used

in Europe in the 16th century, and somewhat later, in North America, South Africa, Australia, and Russia. The main areas of application were flour milling and oil pressing, wood sawing, water lifting and transportation for farmland irrigation.

However, technical progress, which was associated with steam as a new energy carrier that drove machines and mechanisms, superseded wind energy on a large scale by the end of the 19th century replacing it with coal and oil products. From that time, single copies of wind mills have remained, which are now used for demonstration purposes. Wind energy was forgotten, but not for long. At the beginning of the 20th century, small wind mills were broadly used in rural areas to drive water pumps for irrigation purposes.

The appearance and spread of electricity, the generation of which is associated with the rotation of electric conductors in magnetic field, prompted the use of wind energy for electricity generation. This way of wind energy was also motivated by massive electrification of rural areas and agriculture in most European countries and North America, and the creation and use of small-power wind generators was best suited for these purposes. Many agricultural farms were equipped with wind energy installations which were used for a long time to generate electricity and for other purposes. Even now they can be seen in some small households.

Special interest in wind energy appeared in the 1930s and 1940s of the past century, when the possibility of building large wind electric plants with an installed capacity of 100 KW and higher and their inclusion in existing energy grids was seriously considered. The first wind electric unit with an installed capacity of 100 KW was put into operation in the Crimea, within the USSR territory, in 1931, which was followed by the construction of a 5 MW wind facility in the Crimea, which, unfortunately, was not completed. Sometime later a 1.25 MW wind electric plant was constructed and tested in the USA in the first half of the 1940s. After the end of the World War II some European countries also began to use wind energy, and Great Britain, Denmark, Germany and France achieved considerable successes, having put into operation several 100 to 800 KW wind electric plants in the 1950s and 1960s. It should be noted that all

these plants were integrated in energy transmission networks and were real network power stations.

At the same time, international organizations of the UN system also turned their attention to the prospects of using renewable energy sources in some developing countries, and in the beginning of the 1950s UNESCO began to implement a large-scale international programme dedicated to the development of countries situated in arid zones of the Earth (Arid zone programme). This programme made a significant contribution to solving scientific and technical problems of wind energy utilization, and became a starting point of international cooperation in the use of various RES.

However, the destiny of wind energy after its apparent success was unenviable, and the work for its further development was suspended until the mid-1970s, when the world economy entered a severe energy crisis, and when the society recalled the enormous unused potentials of RES, including wind. A new stage of the wind energy development began at that time, which, however, was not smooth and rapid, as it was expected at that time. Sometime, this process was like hanging about, because wind energy (just like any other renewable energy sources) could not make an immediate tangible contribution to the energy production in the countries that were making efforts to the extended use of RES. It can be explained by a number of reasons, and first of all, by a high cost of energy produced at the plants based on RES utilization, which prevented the new energy branch (including wind energy) from competing with the traditional power industry. At the same time, it was clear that the increase in the economic efficiency of renewable energy depended on successful scientific developments and their practical application, which should lead to reduced cost of energy equipment, its maintenance, and a considerable increase in its energy efficiency. However, the leading world economies and large international associations (both economic and political) did not hasten to invest in the renewable energy, which experienced the lack of material and moral support, and this finally led to the mentioned above "hanging about". All of this was also experienced by wind energy, but to a lesser degree, because it could absorb a rich historical experience of the practical use

of wind energy (as compared to other sections of renewable energy), as well as successful application of the scientific knowledge obtained in the end of the 19th and beginning of the 20th centuries, within the frame of a new science named “aerodynamics” and developed owing to several scientific schools of Russia, Germany and Great Britain founded by N.E. Zhukovsky, L. Prandtl and F. Lanchester. Their work, which laid the scientific foundation of aviation, rendered an invaluable service to the wind energy by creating the theory of rotor aerodynamics and methods of calculating wind plants, which are exceptionally important until now and successfully used in the wind energy R&D and are the basis for designing wind power plants and searching ways to increase their efficiency and reliability. However, it would be wrong to mention only aerodynamics when speaking about the scientific basis of the wind energy, in the creation of which the knowledge obtained within the theory of machines and mechanisms, theoretical and applied mechanics, electrical engineering, electrochemistry, material science, control systems, meteorology and others was also used. Thus, the modern wind energy united many branches of knowledge, which in most cases were not directly connected, and their joint use made this segment of renewable energy truly interdisciplinary.

In what ways have the wind energy and other methods of using energy of wind developed lately? It should be noted that crisis situations in the human society stimulate a more creative approach to understanding these situations and finding a way out of them. This fact showed itself especially in the second half of the twentieth century, when the economic development of the mankind was of sinusoidal character, since it had ups and downs, which encompassed the economy as a whole and its individual branches. As was noted above, the 1970s were struck by a very strong energy crisis, which was observed until the early 1980s and impelled the international community to develop the concepts of energy saving based on increasing the energy efficiency of the economy and the everyday life of all members of the society, the sustainable development of the mankind, and others, which helped create fairly strong economic and moral-ethical boundary conditions for the development of the international community as a whole and

individual nations. Considerable efforts were made to actively use alternative energy sources and power generation technologies, which were decided to “be brought to the service of Man”. At that very time, the problem of the large-scale utilization of wind energy arose. In this context, a number of quite interesting projects appeared, some of which were soon forgotten. Those projects included the scientific and technical developments concerning the possible use of sails as an additional propulsion device for heavy-tonnage sea vessels, which could give enormous fuel saving and significant environmental benefits. However, those projects did not go beyond discussions, and the scientific thought followed the way of further development and improvement of the already known methods and patterns of using wind energy. Wind power plants with horizontal and vertical rotors have been developed until now, and the former are considerably ahead of the latter in their development and utilization.

One of the characteristic features of wind as a source of energy is its inconstancy caused by the great variability of its speed. This leads to considerable changes in the kinetic energy of wind flows even within relatively short periods of time: from zero density of energy flows during no-wind conditions to a density that considerably exceeds the design density during windstorms and hurricanes. This results in inconstant power developed by wind power plants. That is why automatic control systems are an important element of these energy generating facilities, as they allow maintaining a certain power of the plant at preset wind speeds and preventing it from inevitable overloads. During no-wind conditions, it is necessary to have certain devices that make it possible to compensate the lack of power and, of course, the generation of energy, which must come to the customer without fail. The low density of air is the reason of a relatively low concentration of energy in wind flows per unit area of its cross-section. Therefore, in order to obtain perceptible power, it is necessary to use plants with wind wheels of a sufficiently large diameter.

Wind changes not only its speed, but also its direction. Therefore, in order to achieve the maximum efficiency of a wind plant, it should be equipped with an automatic orientation system.

The above is the evidence of the incomplete scope of scientific and engineering problems to be solved in designing wind energy generating facilities, which are currently large electric power stations composed, as a rule, of many wind “mills”, which occupy vast areas of land.

Here we come to a group of ecological issues, which were used and are still used today by critics of the wind energy development. One of the critical moments is the removal from the use of other than energy-specific, large plots of land for the construction and operation of wind power stations. Up until now, the coastal zones of large bodies of water (lakes, seas and oceans) characterized by more stable winds in terms of direction and speeds have been con-

One of the characteristic features of wind as a source of energy is its inconstancy caused by the great variability of its speed. This leads to considerable changes in the kinetic energy of wind flows even within relatively short periods of time: from zero density of energy flows during no-wind conditions to a density that considerably exceeds the design density during windstorms and hurricanes.

sidered the most favorable locations for wind power plants. However, as a rule, these zones have the greatest density of population, much greater attractiveness and better conditions for economic activities, recreation and tourism, and therefore, they have great economic and environmental value. There are other, insignificant environmental limitations, which used to be overcome and are now overcome successfully by the modern wind energy industry. At the same time, in spite of the fact that wind is practically a clean source of energy (if we do not mention that wind carries over all contaminations present in the atmosphere), today it is still early to say that the energy industry based on the use of wind is really “green”, because during the environmental impact assessment one should analyze the presence of contaminations and undesirable emissions which appear over the entire life cycle of the power plant, beginning with the production of its individual components, operation, disposal of its assembly units and parts, as well as the entire plant upon completion of its service life. Today, special attention is given to the fundamental reduction of greenhouse

gas emissions, and although the wind energy is free of these emissions, they accompany the process of producing the components of wind plants, where considerable amounts of energy are used, which generally is not “clean”. However, we think that in the near future this ecological “shortcoming” of wind energy, as well as renewable energy as a whole, will be overcome, because there will be enough energy generated by this energy sector for the industrial production of machines, mechanisms and various materials for the construction and operation of power plants that use RES.

And what should be done with the necessary involvement of large plots of land in the development of the wind energy industry? Here, we have many solutions to this problem, which do not come into conflict with the interests of the local population and the socio-economic development of local areas. One of these solutions is using plots of land located in places, the use of which for habitation and some activities in the foreseeable future will be difficult, as well as using water areas of coastal zones. This option is quite attractive, because, as was mentioned above, wind in those places, that is, above the water surface, is more constant in terms of its power and direction. This circumstance laid the foundation for the so-called offshore wind energy industry, which has developed successfully in countries with long coastal sea or ocean areas, the use of which, however, have certain limitations and is difficult due to the above reasons.

In some countries, the wind energy industry has developed in recent years at an unprecedented pace, which can only be compared to the growth pace in the nuclear power industry in the 1970s. Thus, the average annual growth of the installed capacity of the wind energy in the world in 2012 was 44.7 GW, and the total power of this industry in the same year amounted to 282 GW. In terms of the annual electricity generation it is still considerably behind the nuclear power industry, which produced in 2012 about 2500 TWh, while wind power plants generated about 600 TWh. However, considering its ever-

increasing growth rate, it will draw up with the nuclear power industry or even will surpass it by the end of the current decade. It is anticipated that by 2050 the installed capacity of the wind energy will increase tenfold and reach 2500 GW, out of which 500 GW will be in Europe.

By now, the obvious leaders in the use of wind energy have established themselves in the world. These are China with 75 GW of installed capacity, the USA with 60 GW, Germany with 31 GW, and Spain with 25 GW. However, in terms of the proportion of the wind energy to the entire electric power industry, Denmark holds the leading position with 27% followed by Portugal with 17%, Spain with 16% and Germany with 11%.

No in-depth analysis is needed to see the change in the status of this energy segment from single power plants to the industrial power branch. Strong world markets of machines and mechanisms, as well as electrical and other associated equipment and materials for this industry have appeared lately. The labor market has also appeared, and the security of this

In some countries, the wind energy industry has developed in recent years at an unprecedented pace, which can only be compared to the growth pace in the nuclear power industry in the 1970s. It is anticipated that by 2050 the installed capacity of the wind energy will increase tenfold and reach 2500 GW, out of which 500 GW will be in Europe.

market causes some concern in the European Union (EU) countries, where a rapid growth of the wind energy sector is observed. According to the existing estimates, about 270,000 people are directly or indirectly employed in this energy sector in these countries, and this number is expected to increase to 328,000 by 2020 and by more 50,000 by 2030. Taking account of the natural renewal of the existing and replenished labor force, the EU will need an annual inflow of about 20,000 new, well-trained personnel of various qualifications for the wind energy industry and associated sectors. This is not an easy task, which is why the problem is now examined of creating a brand-new system of training engineers, technicians and highly-skilled workers for the wind energy industry, as well as retraining labor reserves, which will become available in some sectors of the traditional power industry

due to their reduction. This problem also becomes important for countries that are at the very beginning of developing this industry, and international cooperation in this area would be very fruitful, which is testified by the historic experience of the development of many branches of science, technology and economic activities.

Speaking about international cooperation as a distinctive feature of the evolution of the present human society, it should be noted that it is also an important factor in the wind energy development. The efforts of specialists of many countries in solving scientific and engineering problems, which exist now and will appear in this sector, are consolidated in many cases by using practically all types of international intellectual activities: from personal contacts of specialists and bilateral agreements to large-scale regional and international multilateral projects and programs implemented under the auspices of non-governmental and governmental organizations. Meetings of specialists held regularly within the framework of these programs and outside of

them play an important role in this cooperation. Such meetings are still a reliable instrument for the exchange of scientific and practical information and the experience available in solving certain problems of developing

one or another branch of science and technology, as well as of industrial production. As a rule, they precede the organization and implementation of the aforementioned projects and programs, as well as the establishment of cooperation agreements. The exceptional importance and timeliness of the International Forum "Renewable energy: Towards raising energy and economic efficiencies" initiated by the Russian Academy of Sciences and the Scientific - Technical Council of the United Unified Energy System of Russia should be noted in this context. The first session of this Forum – REENFOR 2013 – took place in last October "Energy Bulletin", which was an information partner of this important event, dedicated a considerable part of its 16th issue to the latter, paying special attention to the issues of energy education and training specialists for the renewable energy, which were discussed at

the plenary session meeting of the Forum. The wind energy and issues of its development were the subjects of discussions at a special session, which gathered leading specialists from Russia, Denmark, Germany, Canada. The key issues discussed at the session were as follows:

- the state and trends of the wind energy development in the world and Europe,
- solutions for increasing the capacity of wind power stations,
- the state and problems of the wind energy development in Russia,
- problems of and solutions for integrating wind power stations into electricity grids,
- autonomous electric power plants: wind-diesel and wind-diesel-solar, and using energy storage systems.

This session was probably one of the most productive, not only in discussing the raised issues, but also in working out proposals for concrete steps to be made in Russia to adequately develop this energy branch which is still treated as a minor energy sub-sector, as well as to create favorable conditions for establishing cooperation agreements between Russian and foreign research centers.

The Editorial Board of “Energy Bulletin” would like to note with great satisfaction that some recommendations of the session and cooperation agreements have already begun to be implemented, which is reported in this issue of our magazine.

Certain issues of the wind energy will find their place in the programs of scientific events of the Forums that are planned for 2014, the announcement of which can be seen in this issue of our magazine.

It is not accidental that this editorial article is dedicated to the wind energy. In this issue of

“Energy Bulletin” the reader will find materials prepared by Russian and foreign experts and dedicated to the use of wind energy, to which the magazine has not given adequate consideration till now.

The Editorial Board would also like to express its appreciation to the authors of these materials, the publication of which will certainly promote the wind energy development and international cooperation in this field, as well as its hope that the next issues of the magazine will have enough space for articles and information materials dedicated to topical issues of this energy sector, upon the success of which the creation of conditions of the sustainable energy development and of the sustainable development of the mankind as a whole will depend to a great degree.

Finishing this brief introduction to the 17th issue of “Energy Bulletin”, we want to note that wind is probably the most successful, along with sun, element of the nature used by poets to strengthen the expression of their feelings. They have used epithets of every kind for wind in their poems! Wind has been fragrant and fresh, fitful and dull, persistent and harsh, swan-like and velvety, winged and resilient etc. The poetical images of wind express especially well the attitude of people to that wonderful natural phenomenon, which now returns to serve people after certain oblivion. But it was the great Russian poet A.S. Pushkin who gave the most successful description to wind and its power by the mouth of a character of his poetical tale:

*“Wind, wind! You are mighty,
You drive flocks of clouds,
You excite the blue sea,
Everywhere you blow at large,
You aren't afraid of anybody,
Except only God.”*

SMALL WIND WORLD MARKET CONTINUES GROWING



Stefan Gsänger,

Secretary General, World Wind Energy Association, Germany

with participation of Jean Pitteloud,

Public Relations & Marketing Manager, World Wind Energy Association, Venezuela

World Wind Energy Association (WWEA) is an international non-profit association embracing the wind sector worldwide, with members in 95 countries. WWEA works for the promotion and worldwide deployment of wind energy technology. WWEA provides a platform for the communication of all wind energy actors worldwide, advises and influences national governments and international organizations, enhances international technology transfer. Head office of WWEA is situated in Bonn, Germany.

World market for small wind has continued to grow: As of the end of 2012, a cumulative total of at least 806'000 small wind turbines were installed all over the world. This is an increase of 10% compared with the previous year, when 730'000 units were registered.

Most of the growth happens in only three countries: China, USA and UK. This situation is a clear indication that the world market for small wind turbines is still in its infancy stage. In most countries you can at least find a handful of small wind turbines, but the vast majority of these countries is far from market size which would enable companies to reach mass production. More and better policies are imperative for making small wind a success all over the world.

The numbers presented here are based on available figures and even exclude major mar-

kets such as India and Italy so that WWEA estimates an actual total number of close to one million units to be installed worldwide.

China is still by far the largest market in terms of units ever installed, and the number the cumulative of installed units grew by 70'000 to a total of 570'000 by end of the year of 2012. This represents 70% of the world market in terms of total as well as new installed units. According to estimations, around half of the turbines continue to produce electricity in China given that this market started already in the early 1980s.

The second largest market can be found in the USA with a total of 155'000 units installed, clearly behind China, but well ahead of a number of medium-sized small wind markets. The UK, Canada, Germany, Japan and Argentina are all medium-sized markets with total number of small wind turbines between 7'000 and 23'500 units.

In terms of new installations China is again leading by far with 70'000 units, followed by two countries: the US and the British market had both similar size, with 3'700 respectively 3'646 units installed in 2012. However, both markets have only 5% of the size of the Chinese market.

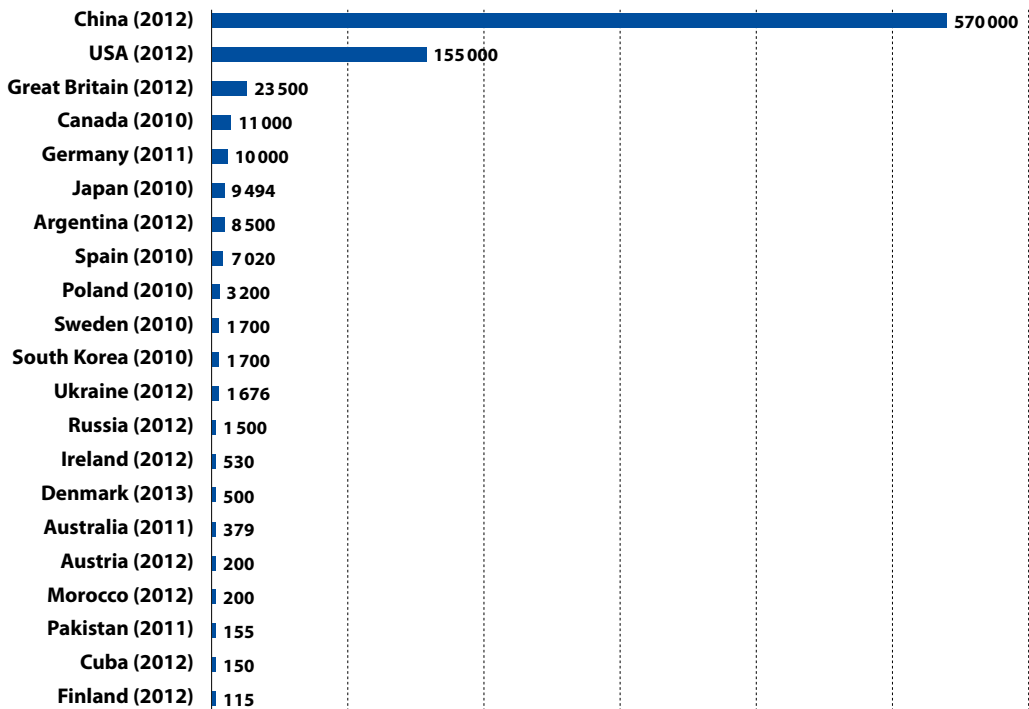

Total Cumulative Installed Units

Increase in Global Small Wind Capacity

The recorded small wind capacity installed worldwide has reached more than 678 MW as of the end of 2012. This is a growth of 18% compared with 2011, when 576 MW were registered. In 2011, the growth rate was still at 21%.

China accounts for 39% of the global capacity, USA for 31% and UK for 9,4%. These three leading markets, China, USA and UK installed together around 89 MW of new capacity in the year 2012 (80% of the world market), a capacity increase of 16%, slightly below the global growth rate.

The USA small wind market grew by 18,4 MW in 2012, representing around 3'700 installations and \$101 million in investment. On a unit basis, small wind turbines comprised 35% of all 2012 USA wind installations.

In the UK, the small wind market witnessed further growth in 2012 mainly driven by the Feed-in tariff scheme. 37 MW were installed during 2012 with the biggest growth rate observed in the 15 kW – 100 kW size range.

Globally, an increase in the average size of small wind turbines can be observed: In 2010y, the average installed size was 0,66 kW, in 2011 0,77 kW, and in 2012, it has already reached 0,84 kW.

Small Wind Turbine Manufacturing

Five countries (Canada, China, Germany, UK, and USA) account for over 50% of the small wind manufacturers. By the end of 2011, there are over 330 small wind manufacturers that have been identified in the world offering complete one-piece commercialised generation systems, and an estimate of over 300 additional firms supplying parts, technology, consulting and sales services.

Based on the world distribution of turbine manufacturers, production of small wind remains concentrated in few world regions: in China, in North America, and in several European countries. Developing countries continue to play a minor role in small wind manufacturing. It is obvious that tremendous wind resourc-

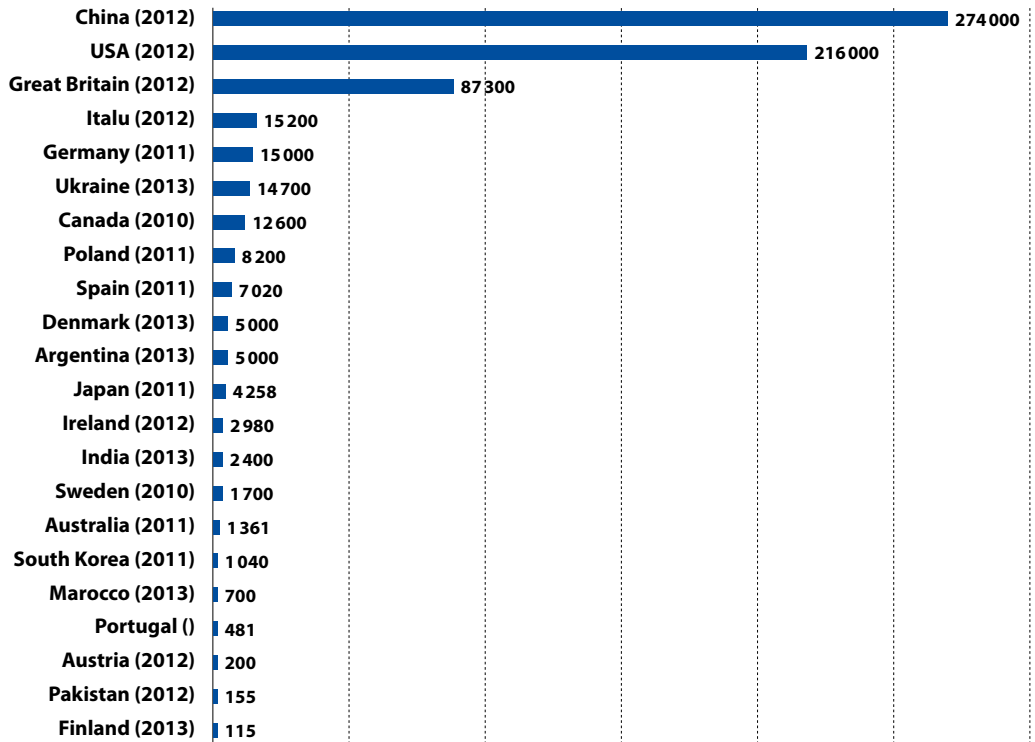

Total Cumulative Installed Capacity [kW]

es of Africa, Southeast Asia, and Latin America, where many regions are ideally suited for small wind application, have not yet lead to the establishment of domestic small wind industries and it would be worthwhile joint efforts of these countries and the international community to set up international programmes to change this.

However, in general small wind industry has already demonstrated remarkable growth in the past decade, as consumer interest was increasing and many new companies have entered the sector. Figure above illustrates the raise of the small wind industry in the past decade: More than 120 new small wind manufacturers were established between 2000 and 2010 worldwide. China alone has an exceptional manufacturing capacity of more than 180'000 units per annum (as of 2011).

This impressive size illustrates how large the small wind sector could become also in other world regions and on the global scale. Compared with its global potential, the small wind industry outside China is still very small.

Driving Factors

The future of the small wind industry depends on the cost of technology, the enactment of supportive policies and economic incentives, fossil-fuel prices, investor interest, consumer awareness, certification and quality assurance, permitting processes and regulations, and wind evaluation tools. Financial, wind, and energy experts anticipate high growth rates for the production of SWTs if consumer demand increases.

Costs

Cost remains to be the one of the main factors and challenges in the dissemination of small wind.

In the USA the installed cost estimates of top ten small wind turbine models in 2011 ranged between \$2'300/kW and \$10'000/kW, and the average installed cost of all SWTs was \$6'040 kW, an 11 percent increase from 2010. Chinese small wind industry yielded, in comparison, a significantly lower average turnover of 12'000 Yuan/kW (1'900 USD – 1'500 EUR).

The small wind industry is still under development and without doubt economies of scale will help reduce manufacturing cost in future. However, in order to achieve such cost reductions, it is important that small wind markets will see further growth, which requires appropriate legal frameworks and support schemes. Hence political incentives continue to play a key role for the wider deployment of small wind.

Policies

Like most other renewable energy technologies and in particular the market for “big wind”, the success of the small wind market depends on stable and appropriate support schemes. Today feed-in tariffs, net metering, tax credits, and capital subsidies are the major energy policies geared specifically towards small wind. The small wind sector has especially benefited from the growing global trend of feed-in tariffs (FITs). Unfortunately, only few countries have yet implemented specific FIT schemes for small wind which can be seen as the best tool for grid-connected small wind. Whenever the wholesale electricity prices are sufficiently high, net-metering has also been an effective incentive, e.g. in Denmark. Additional policies that encourage the use of renewable sources of energy also play an important role in the growth of the small wind industry.

However, tax credits and capital subsidies may not be as effective as production-based incentives because they promote directly the sales of the hardware, but not the energy generation itself, and hence may not encourage sufficiently investment in efficiency.

Standards & Certification

Development of standards and certification, already in progress, will serve to promote the sales of better-performing SWTs, and the growth of a healthy and well-established market. As safety and noise have grown important due to the proximity of the technology to users, the internationally accepted IEC 61400-2 (3rd edition, 2013) standard from the International Electrotechnical Commission stipulates specific safety design requirements. In 2009, American, Canadian, and British Wind Energy Associations (now Renewable UK) coordinated efforts to develop the Small

Table. Small Wind Feed-in Tariff Pricing Worldwide

Country/ Region	Size limit	EUR/kWh
Chinese Taipei	1-10 kW	0,185
Canada		
Ontario	< 10 kW	0,074
Nova Scotia	< 50 kW	0,332
Cyprus	< 30 kW	0,220
	Off-grid	0,190
Grece	< 50 kW	0,250
	> 50 kW	0,090
	Off-grid	0,100
Italy	1-20 kW	0,285
	20-200 kW	0,262
	0,2-1,0 MW	0,146
Israel	< 15 кВт	0,250
Japan	< 20 kW	0,418
	≥ 20 kW	0,167
Lithuania	< 10 kW	0,095
	10-350 kW	0,092
Portugal	< 3,68 kW	0,432
Slovenia	< 50 kW	0,095
Switzerland	< 10 kW	0,247
UK	< 100 kW	0,207
USA		
Indiana	5-100 kW	0,130
Hawaii	< 20 kW	0,123
	20-100 kW	0,105
Vermont	< 15 kW	0,181

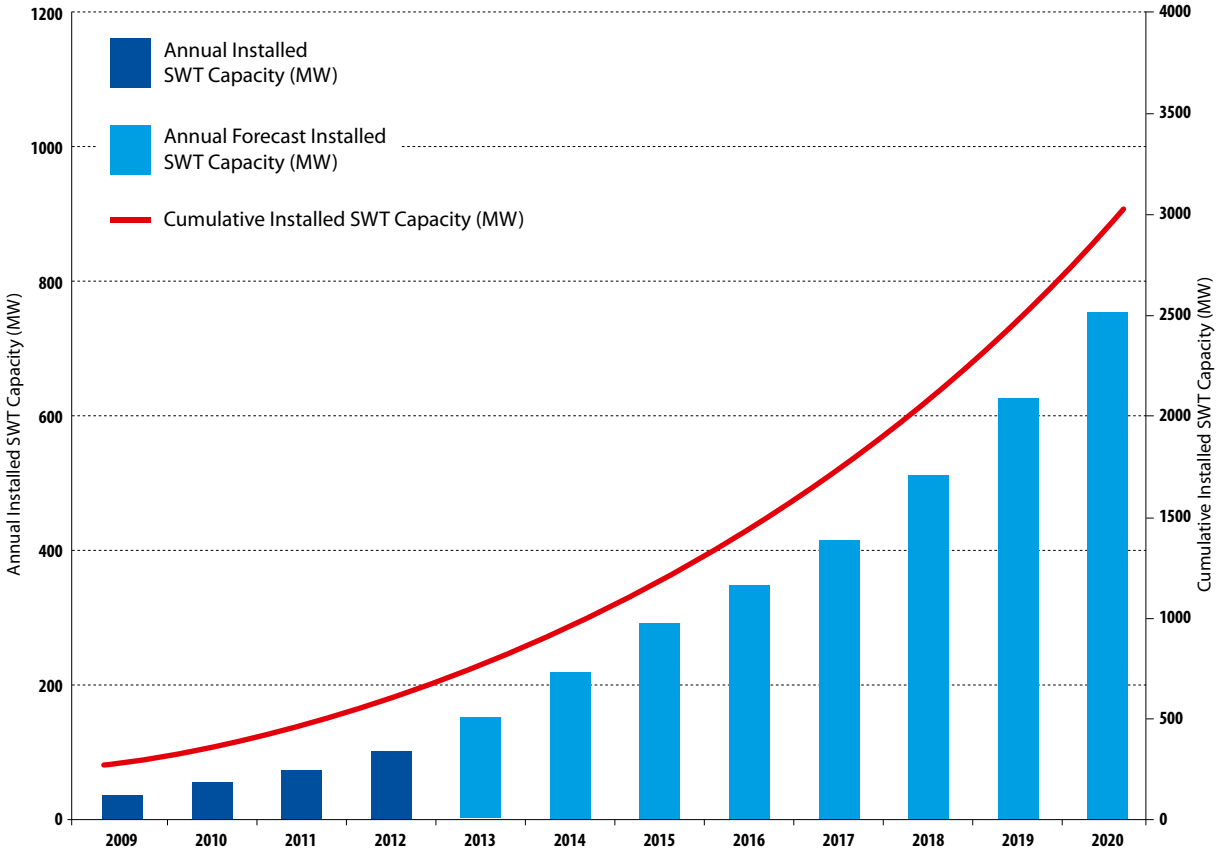

SWT Installed Capacity World Market Forecast 2009–2020

Wind Turbine Performance & Safety Standard, a subset based on IEC61400-2 (SWTs design), IEC61400-12-1 (performance) and IEC61400-11 (acoustics). The derived standards were later adopted by the AWEA and RenewableUK for their certification programs Small Wind Certification Council (SWCC) and Microgeneration Certification Scheme (MCS), respectively.

The International Energy Agency’s IEA Wind Task 27 has been preparing a consumer label for small wind turbines which aims at enabling customers of small wind turbines to easily the basic information about safety and performance of the turbine while reducing the efforts for the certification process compared with large wind turbines. The first consumer labels are about to be issued.

Wind Resource Assessment

The basic condition in order to harvest wind power successfully is, of course, the availability of wind: Hence the accurate prediction of the wind speed is essential to calculate the electricity output of a small wind generator, representing the basis for its economic performance.

As wind assessment tools are costly in relation to the cost of a small wind turbine, this evaluation currently presents a real challenge for the small wind industry, however, it is important to underline the importance of such data at the site where the wind generator is supposed to be installed.

Special challenges can be found in urban environments: The shading and turbulence effects of surrounding obstacles may produce complex wind patterns that are difficult to pre-

Definition of Small Wind

There is still no globally unified definition of small wind. Originally, small wind was defined by its characteristics to produce small amount of electricity for house appliances or to cover various household-based electricity demands. However, this definition does not make sense on a universal level as energy consumption patterns are very different in different parts of the world: While an American family would need a 10 kW turbine to cover its full consumption, a European household demands a 4 kW turbine while an average Chinese household requires as small as a 1 kW turbine.

Technically, there are several definitions of small wind turbines: the most important international standardisation body, the IEC, defines SWTs in standard IEC 61400-2 as having a rotor swept area of less than 200 m², equating to a rated power of approximately 50 kW generating at a voltage below 1'000 V AC or 1'500 V DC. In addition to this standard, several countries have set up their own definition of small wind. The discrepancy of the upper capacity limit of small wind ranges between 15 kW to 100 kW for

the five largest small wind countries. The major pattern of today's upper limit capacity leans towards 100 kW. This is largely caused by the leading role of the North American and European market. Over the past decades, a growing average size of the small wind capacity has been observed. This pattern is largely caused by increasing interest in larger grid-connected systems and a comparatively diminishing market of standalone systems. Nevertheless, in order to create a standardised and healthy small wind market share, an agreeable definition of small wind should be agreed upon. This article intends to bring forward the discussion on the definition of small wind and aims to create eventually a unanimous international classification system of small wind accepted by all parties of the industry. For the purpose of generating comparable graphs, figures and charts in this research, 100 kW is chosen as the temporary reference point. The definition, however, requires further discussion until a globally harmonised agreement is reached. In practice, the major pattern of today's upper limit capacity leans towards 100 kW, although the IEC defines a limit of equivalent to 50 kW.



dict. Traditional wind resource maps prove inadequate as wind conditions are evaluated at a greater altitude of 50 m while most SWTs do not reach above 30 m. As a result, the vast demand for inexpensive and efficient methods of predicting and collecting local wind data is another key driving factor that requires further innovation and cost reduction in the technology.

World Market Forecast 2020

The increasing demand for clean and affordable energy all over the world will without doubt lead to an increasing demand for small wind. In particular in the developing countries, small wind can easily and fast contribute to electrify millions of people in rural areas. Governments

and international organisations such as IRENA have started to understand this potential and are now more and more including small wind in their renewable energy programmes. Also several industrialized countries have ambitious small wind targets and corresponding policies in place. In general, political support can be expected to increase the installed capacity of small wind in the upcoming years further.

Increasing fossil fuel prices, global warming and the ever-growing electricity demand will continue to be the three long-term drivers of the small wind industry. In order for the small wind technology to mature, however, the industry must be driven by supportive policies and standards.



Recent trend of the small wind industry has shown an annual 19–35 % increase in the new installed capacity for the past years. The rate of growth is anticipated to continue until 2015, reaching an annual installation of 190 MW of SWTs. Within this time frame, individual countries and the international small wind community will be able to establish more rigorous and structured standards and policies to regulate the market and support investments. Based on a conservative assumption, the market could subsequently see a steady compound growth rate of 20% from 2015 to 2020.

The forecast is based on opinions of industry experts, growth pattern of the large wind industry, and the historical growth trend of the solar PV renewable industry for the past decade that shares many characteristics in common with the small wind industry. Accordingly, the small wind industry can be expected to follow similar growth patterns of the large wind and solar industry until 2020.

Recent trend of the small wind industry has shown an annual 19–35% increase in the new installed capacity for the past years. The rate of growth is anticipated to continue until 2015,

reaching an annual installation of 190 MW of SWTs. Within this time frame, individual countries and the international small wind community will be able to establish more rigorous and structured standards and policies to regulate market and support investments. Based on a conservative assumption, the market could subsequently see a steady compound growth rate of 20% from 2015 to 2020. The industry is forecasted to reach approximately 480 MW of newly installed capacity added annually in 2020 and achieves a cumulative installed capacity of close to 3 GW by 2020.

DEVELOPMENT OF ON-GRID WIND POWER PLANTS IN RUSSIA – CASE OF MIRNY WIND POWER PLANT PILOT PROJECT IN YEYSK DISTRICT OF KRASNODAR REGION



*Georgy Ermolenko,
Director-General*

*Ilya Gordeyev,
Chairman of the Board of Directors*

*Mikhail Ryzhenkov,
Deputy Director-General*

*Alexandra Nikomarova,
Project manager*

*Nina Bogoroditskaya,
Project manager*

“Wind Energy Systems” company, Russia

The Wind Energy Systems company specializes in the development and implementation of projects of on-grid wind power plants in the Russian Federation and has key competencies for wind monitoring, wind farm design, organizing the processes of financing, construction and operation of wind energy facilities. The company has wind farm construction projects of an installed capacity of 1099 MW in four regions of the Russian Federation. The project of construction of the 60 MW Mirny Wind power plant in Yeysk District of Krasnodar Krai is included in the Location Plan of Electric Power Generating Facilities Based on RES (Renewable Energy Sources) in Russia as well as in the General Plan of Electric Power Facilities in Krasnodar Krai and in Russia Electric Power Industry Modernization Program up to 2020.

The wind energy formation in modern Russia is not a new and imported branch of domestic electric power industry. It has an almost century-long history marked by great names and events, periods of bloom and decline.

The problem of using wind energy for electricity generation in Russia was posed in 1918 by Professor V. Zalevsky who created the windmill theory and formulated a number of principles for building a wind generator. In 1920, Professor N. Zhukovsky developed the theory of wind turbine, and somewhat later, a wind turbines

department was organized in the Central Aero-hydrodynamics Institute (TsAGI). The first 8 kW wind power unit was installed in 1930 in Kursk. The wind energy sector began to develop rapidly, and in the 1930s 3–4 kW wind energy generators were produced serially. The USSR was then the world leader in the use of wind energy for electricity generation. The world's largest on-grid wind energy facility (at the time) with a rotor diameter of 30 m and a 100 kW asynchronous generator was connected to the Crimean power grid in 1931 near Balaklava and remained in operation until its destruction during the 1942 bombings. Then dozens similar wind generators were installed in the south of the country. In 1938, the construction of a 5 MW wind power plant was commenced in Crimea. In the late 1940s, the TsAGI and other organizations began active developments of wind energy plants of various capacities, purposes and structure. From 1950 to 1955 the country produced up to 9 thousand wind generators annually, with a unit capacity of up to 30 kW. During the years of the Virgin Lands Campaign in Kazakhstan, the first multi-unit wind-diesel power plant with a total capacity of 400 kW was constructed, a prototype of today's wind parks and wind-diesel generating complexes. But when in 1960-1980s the energy industry of our country was oriented towards the creation and operation of large thermal power stations, hydroelectric stations and nuclear power plants, the plants generating electricity using wind energy lost the competition with the electric power giants united into a single national grid, and their large-scale production was closed down in late 1960s.

But as time passed the situation began to change again, and in 1986 the Decree of the Central Committee of the CPSU and the Council of Ministers of the USSR ordered the Gosplan (State Planning Committee) and other ministries and agencies to develop "Measure to Increase the Use of Alternative Sources of Energy in the National Economy for the Period of 1987-1990", and the State Scientific and Engineering Program "Ecologically Clean Energy" was adopted in 1987. In 1988 the Council of Ministers of the USSR adopted the Decree "On Accelerated Development of Wind Energy Technologies for the Period of 1988-1995". In accordance with the adopted Decree it was suggested that 57 thou-

sand wind units be put into operation by 1995. At that, state capital investments were foreseen for the production base development. The USSR Ministry of Energy planned to construct experimental wind energy plants (WEP) with a total installed capacity of 58.5 MW, including the Leningrad WEP on the Gulf of Finland shore (25 MW), the Dzungar WEP in Kazakhstan (15 MW), the Crimean WEP on the eastern Crimean coast (125 MW). Somewhat later, an idea appeared to construct the Kalmyk WEP (22 MW) 20 km away from Elista – the capital city of Kalmykia). At the same time, R&D aimed at creating WEPs with capacities of 16, 30, 60, 100 и 250 kW was under way. Raduga Design Bureau (Dubna), Yuzhnoye Design Bureau (Dnepropetrovsk, Ukraine), Tushino Engineering Plant (Moscow), Vetroen Research and Production Association (Istra), Lenpodyomtransmash (Leningrad), Energobal-ance Association (Moscow) were employed to carry out the work. However, the established goals were not reached and adopted plans were never implemented. The political and economic crisis of the 1990s terminated the large-scale works aimed at developing the national power industry, including wind energy.

The slow revival of the Russian wind energy started at the boundary between the 20th and 21st centuries. During this period, the world wind energy was in the process of rapid development (see Fig. 1, Fig. 2), and in 2012 the total installed capacity of wind energy plants and units in the world amounted to 282 GW surpassing the total installed capacity of all power generation plants in Russia, which was 223 GW.

In 2012 wind energy allowed a global reduction in greenhouse gas emissions of around 400 million tons. China became the undisputed leader in terms of the total WEPs installed capacity with 75 GW. It is followed by the USA, and the EU countries had 40% share of the world wind energy balance.

The Global Wind Energy Council (GWEC) published statistical data of the world wind energy market, which showed that over the past five years the total global installed capacity of wind energy generation grew by almost 200,000 MW and totaled 318,137 MW by the end of 2013. In 2013 the market increased by 12.5% or 35,467 MW, which characterizes 2013 as a difficult year for this energy branch. This was due

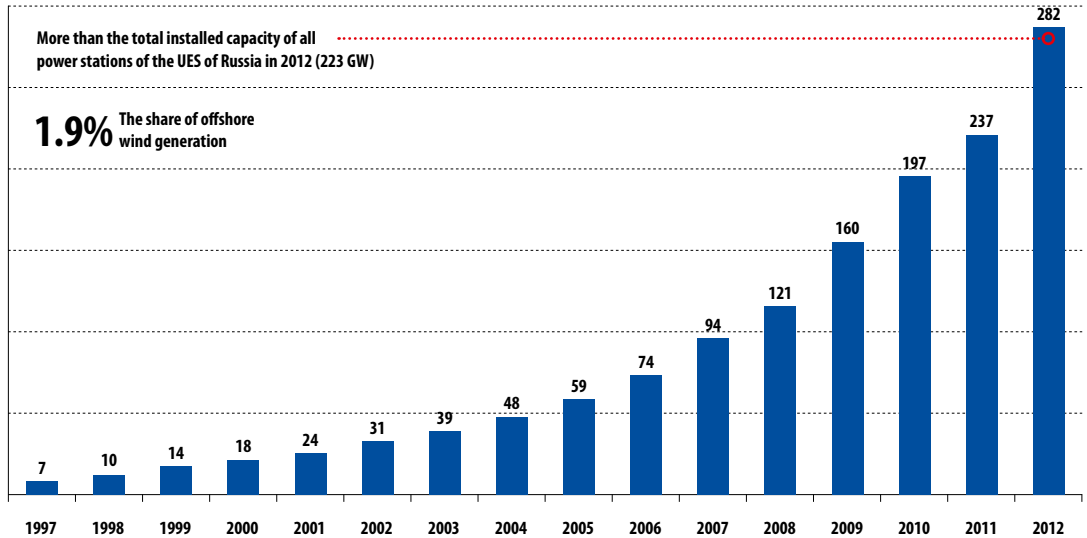

Fig.1. Growth in the installed capacity of WEPs (GW) (Source: WWEA (World Wind Energy Association))

mainly to a sharp drop in new generation facilities put into service in the USA, where over the last five years wind energy accounted for 36.5% of all new generating facilities put into operation, and reached 42% in 2012. The decline in growth rates of the wind energy market was caused by political obstacles created by the US Congress for renewable energy sources in 2012.

Outside Europe and the USA, a moderate growth of the global market was observed last year led by China and owing to the exceptionally high figures in Canada. Despite the fact that the US policy struck a heavy blow in the 2013 global figures, the volume of construction of WEPs in the USA amounted to record-breaking 12,000 MW by the end of the year. The average European capacities put into operation were limited to a modest 8% growth, with substantially higher figures in Germany and Great Britain as compared with the other EU countries.

The position of the Chinese government regarding wind energy development changed toward a higher installed capacity target: up to 200 GW in 2020.

The high figures for the capacities put into operation in China characterize a new phase in the wind energy market growth in this country associated with the completion of the formation phase of the Chinese wind energy industry,

which began after 2010, the peak year, when China came out on top in terms of the total installed capacity of its wind energy facilities.

India approved its new national “Wind Energy Development Strategy”. In Brazil, new WEPs construction projects of a total capacity of 4.7 GW were declared in 2013. The reformation of the Mexican electric power sector is aimed at starting its own wind energy market. Africa led by South Africa, Egypt, Morocco, Ethiopia, Kenya and Tanzania scheduled to put 90 MW into operation in 2013 and now plans a large-scale growth of its wind energy market.

Wind energy markets in countries that are not members of the Organization for Economic Cooperation and Development (OECD) show positive trends: a sustainable growth of new markets has been observed in Asian and Latin American countries.

As for the prospects for 2014 and further on, they look much more optimistic. According to the GWEC estimates, the return to the 2012 level of new facilities being put into operation is expected in the world in 2014, and moreover, that level can be exceeded.

The high rates achieved in the wind energy development and ambitious plans for the further growth are based on the mature, increasingly improved and now global industry of develop-

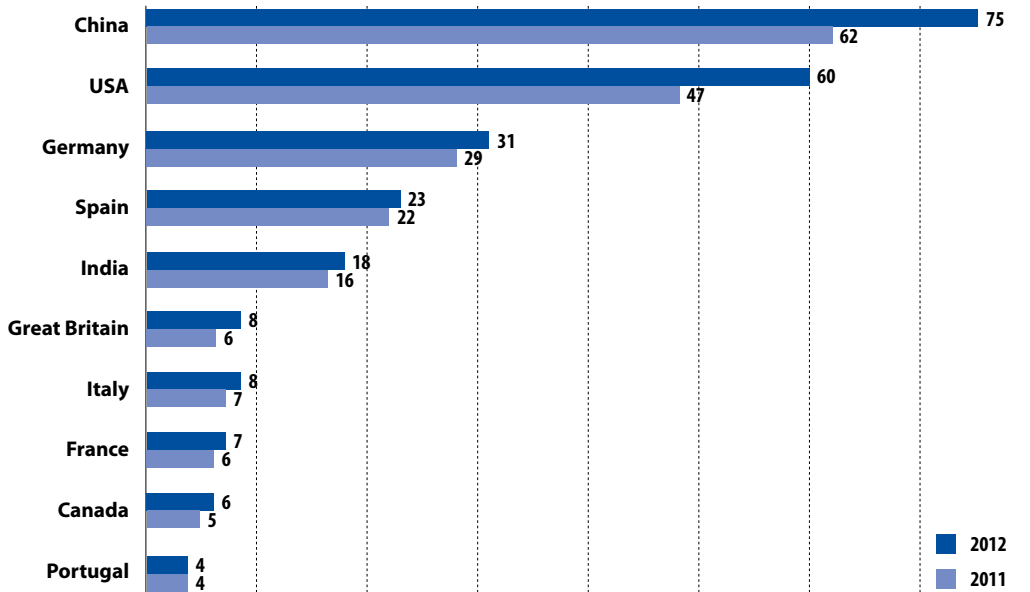

Fig.2. The leading countries in terms of the total WEPs installed capacity (GW) (Source: WWEA)

ment and production of wind energy generation equipment (Fig. 3)

The undisputed leaders of this industry are such European companies as Vestas (Denmark), Siemens (Germany), Enercon (Germany), Gamesa (Spain), with 38% of the global market and the presence in more than 70 countries, and GE Wind (USA) with 17% of the global market and the presence in some 30 countries. In recent years, as a result of intensive international cooperation and active governmental support, the international market entered Chinese manufacturers now holding 16% of the market share, and Indian Suzlon Group accounting for 7% of the market. The installed unit capacity of wind turbines has grown over the past 20 years from hundreds of kilowatts to 3-4 MW for onshore wind turbines and 6-7 MW for offshore wind turbines. The average installed capacity of WEPs being in operation in the world is 100 to 150 MW.

In Russia, the WEP in Kaliningrad Oblast put in operation in 2002 (the first turbine in 1999) is currently considered to be the most powerful. It consists of 21 Vestas wind turbines presented as a gift by the Danish government. Its total capacity is 5.1 MW. Along with the Kaliningrad WEP,

the Vorkuta WEP of 1.5 MW (wind turbines produced by Yuzhnoye Design Bureau), the Kamchatka WEP (Bering Island, Nikolskoye) of 500 kW (Micon turbines, Denmark), the Tyupkildy WEP (Oktyabrsky, Bashkiria) of 2.2 MW (HAG turbines, Germany), the Rostov WEP of 300 kW (HSW turbines, Germany), the Murmansk WEP of 200 kW (Micon turbine, Denmark), the Chukotka WEP, composed of 10 units with 250 kW each (Vetroen turbines) are now in operation in Russia with various degrees of efficiency (capacity factor = 0-11.5%). As of today, all existing WEPs in Russia generate only 0.1% of all electricity produced in the country, and their total installed capacity is about 13 MW.

According to current estimates, Russia has the largest wind potential in the world. The maximum amount of Russia's wind energy resources measured as a gross potential is part of the average long-term total wind energy available for use in the Russian territory during one year. It is determined at 2,571,843 billion kWh/year.

The favorable areas for wind energy development include the North-Western part of the country (Murmansk and Leningrad Oblasts), the northern territories of the Urals, Kurgan Oblast, Kalmykia, Krasnodar Krai, the Far East. The

technical potential of wind energy in a region is a part of the gross potential that can be used at the up-to-date level of wind energy equipment in compliance with applicable environmental standards. On the whole, the technical potential of Russia's wind energy is estimated at more than 50,000 billion kWh/year. The amount of annual economic wind energy potential of a region is measured by the amount of electricity than can be supplied to consumers from wind power plants, whose construction is economically sound at the existing level of costs for generation, transportation and consumption of energy

and fuel in that region and with the standard environmental quality being ensured. The economic potential of Russia's wind energy is 260 billion kWh/year, i.e. about 30% of the electricity generation by all electric power stations of the country, whereas the share of WEPs currently existing in Russia is only 0.1% in the total electricity generation, which leads to the conclusion that Russia's wind energy potential practically is not used.

A considerable impetus to today's development of the domestic wind energy was given by legislative and subordinate acts related to

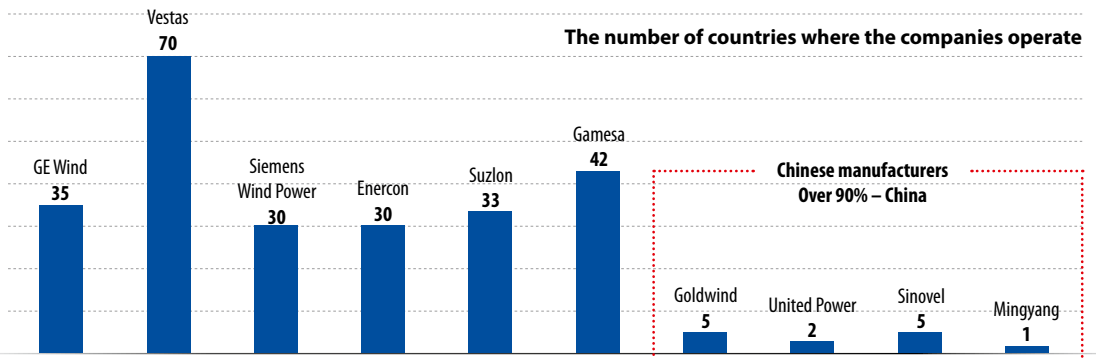
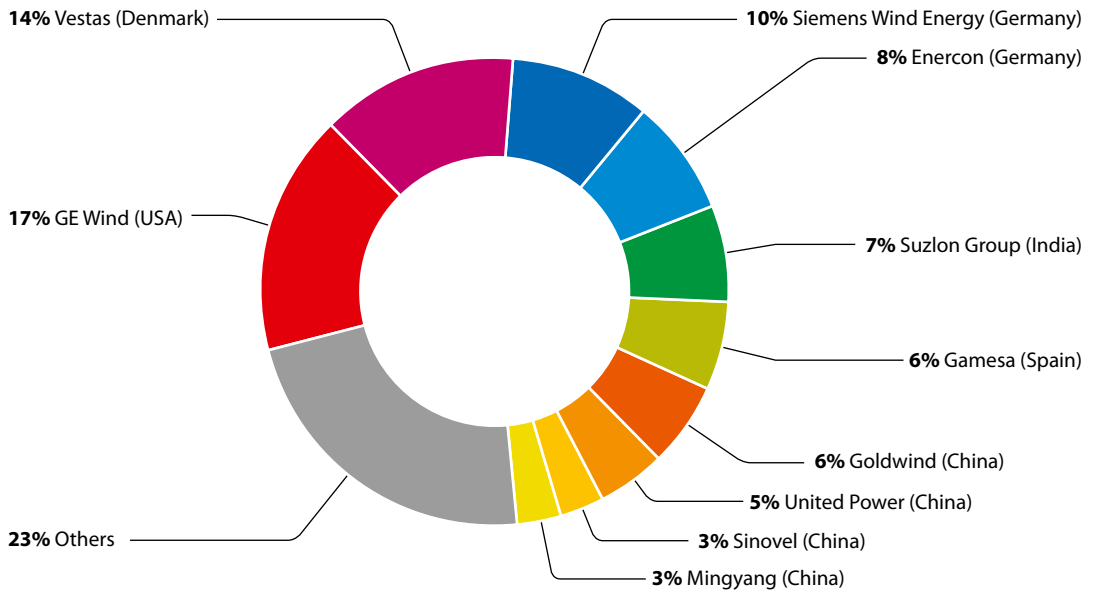

Fig. 3. The largest world's manufacturers of wind generators (Sources: WWEA, GWEC (Global Wind Energy Council), EWEA (European Wind Energy Association))



Fig. 4. Distribution of average annual wind speeds over the territory of Russia at a height of 50 m. (Source: Joint Institute for High Temperatures of the Russian Academy of Sciences)

wind energy development. Federal Law No. 35-FZ “On Electric Power Industry “ of November 4, 2007 for the first time provided the classification of RES, defined the basic measures to support the development of the electric power industry based on RES utilization, determined the powers of governmental authorities with regard to the implementation of mechanisms of the governmental support for the power industry based on RES. Presidential Decree No. 899 “On Certain Measures to Increase the Energy and Ecological Efficiency of the Russian Economy “was released on July 4, 2008. There the problem of increasing the economic and ecological efficiency was formulated, the liability for non-conformity with environmental impact standards was increased, a thesis was spelled out concerning the budget support measures for using RES and environmentally clean technologies. In January, 2009, Governmental Decree No. 1-r was adopted about increasing the share of RES-based electricity generation in the Russian power industry to 20% by 2020 (15.5% should be generated by large hydroelectric stations, and 4.5% by other types of RES, including wind). This Decree provides quantitative indicators for RES utilization, which determine the share of energy by 2020 produced by the renewable energy branch at about 1%, which is 17.5 billion

kWh with a total installed capacity of WEPs of 7 GW. Governmental Order No. 1839-r of October 4, 2012, became a legal base for the large-scale development of renewable energy in Russia. It established that 3.6 GW of wind energy capacities should be put into operation by 2020 with a mandatory localization condition, that is, the organization of the domestic production of wind energy equipment.

Governmental Order No. 861-r and Governmental Decree No. 449 were issued on May 28, 2013. They established the following:

- power supply agreement as a mechanism for returning funds when power stations operate based on RES on the wholesale market;
- targets for the number of power stations based on RES to be put into operation in the years from 2014 to 2020;
- targets for the degree of localization in the Russian Federation of main and/or auxiliary wind generation equipment until 2020;
- limit values of capital costs for the construction of 1 kW of installed capacity of a RES-based generating facility.

In comparison with previous documents, these documents will ensure:

- guaranteed repayment of invested funds for the entire payback period;

Table 1

Year of putting into operation	2014	2015	2016	2017	2018	2019	2020	TOTAL
Target, MW	100	250	250	500	750	750	1 000	3 600
Target for localization degree, %	35	55	65	65	65	65	65	
Limit values of capital costs for the construction of 1 kW of installed capacity	65 762	65 696	65 630	65 565	65 499	65 434	65 368	

- increased economic efficiency of projects (the payback period is considerably shorter than when selling electricity to cover losses, as was provided for by FZ No. 35-FZ);
- development of the domestic production base of wind energy by means of meeting the localization conditions for the equipment being put in service by the developers of wind parks in Russia to take part in the power supply agreement program.

The repayment of investments in the construction of WEPs by way of selling electricity and power on the wholesale market using the power supply agreement mechanism is carried out as follows:

1. according to Governmental Decree No. 449 of May 28, 2013 and Governmental Order No. 861-r of May 28, 2013, the commercial operator of the wholesale market (trade network administrator) invites bids every June until 2019 inclusive for the right to conclude a power supply agreement between the trade network administrator and an investing company (investor);
2. the winning investors conclude the power supply agreement with the trade network administrator, according to which:
 - 2.2.1. an investor shall undertake to construct and commission a WEP of a certain capacity at a certain site and within a certain period (these parameters are declared by the investing company when submitting its bid);
 - 2.2.2. an investor shall undertake to achieve at the constructed WEP a localization degree of equipment and operations as indicated in Governmental Decree No. 449 of May 28, 2013;

2.2.3. a trade network administrator shall undertake to repay the investor's investment outlays within the agreement period (15 years) out of the funds collected by the trade network administrator from all wholesale electricity buyers in the Russian Federation, i.e., the wholesale market participants, and:

- 2.2.3.1. investor's investment outlays to be compensated by the trade network administrator may not exceed the limit values specified in Governmental Decree No. 449 of May 28, 2013.

The appearance of some elements of the legal base in the renewable energy sphere attracted attention of a number of companies to initiate projects of WEP construction in some regions favorable for the wind energy development.

Fig. 5 shows the geography of these projects indicating the installed capacity of WEPs under development and the names of the companies-developers. Today, WEP projects are being implemented in these regions at different stages with a total installed capacity of about 2 GW.

The Mirny WEP in Yeysk District of Krasnodar Krai with a total installed capacity of 60 MW holds the leading position among these projects. The relations between the company that implements the project and Krasnodar Krai were consolidated in 2007 by signing cooperation agreements with the Ministry of Industry and Energy of Krasnodar Krai, the Kubanenergo System Administrator and the Yeysk District Administration within the framework of the Sochi-2007 International Investment Forum. In 2010 the project was included in the RF Electric Power Industry Modernization Program up to 2020 as a pilot project,

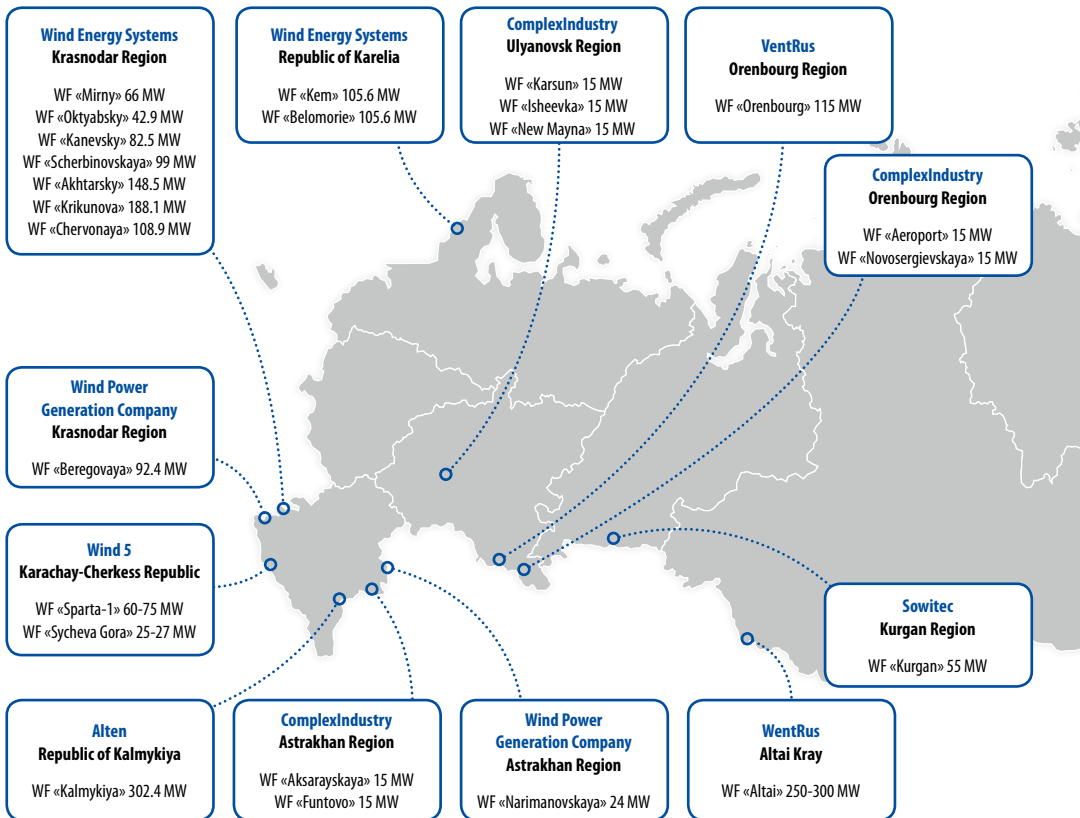

Fig.5. Wind generation projects being implemented in the Russian Federation

as well as in the energy-saving program and in the general plan of power generating facilities location in Krasnodar Krai.

The problem of electricity deficit in Krasnodar Krai

Electricity consumption within the framework of the Kuban energy system grows every year. Even during the 2009-2010 World Financial Crisis, when the electricity consumption decreased in the Russian energy system as a whole, the electricity consumption in the Kuban energy system continued to grow. Thus, over the period from 2006 to 2010 the amount of consumed electricity grew by 2718 million kWh or 15.3%. In 2010 the total electricity consumed by the Kuban energy system reached 20,601 million kWh and exceeded the maximum consumption recorded during the Soviet period of the development of Krasnodar Krai economy in

1991 by 3711 kWh or 18%. Over the five-year period (2006-2010) the average annual growth in electricity consumption by the Kuban energy system totaled 3.7%. The consumption of electricity by the Kuban energy system customers is only partially covered by the electric power stations present in Krasnodar Krai. The generating equipment of power stations is mainly represented by thermal facilities: steam power units, gas turbines and modern equipment that uses the supercharged boiler cycle. Hydropower generation and generation by independent retail market suppliers (isolated generating plants) are also present in the Kuban energy system. Recently, the number of thermal power stations in the Kuban energy system has increased owing to the commissioning of a combined cycle gas turbine (PGU-410) at the Krasnodar thermal power plant and the construction of the Adler thermal power plant composed of combined cycle gas

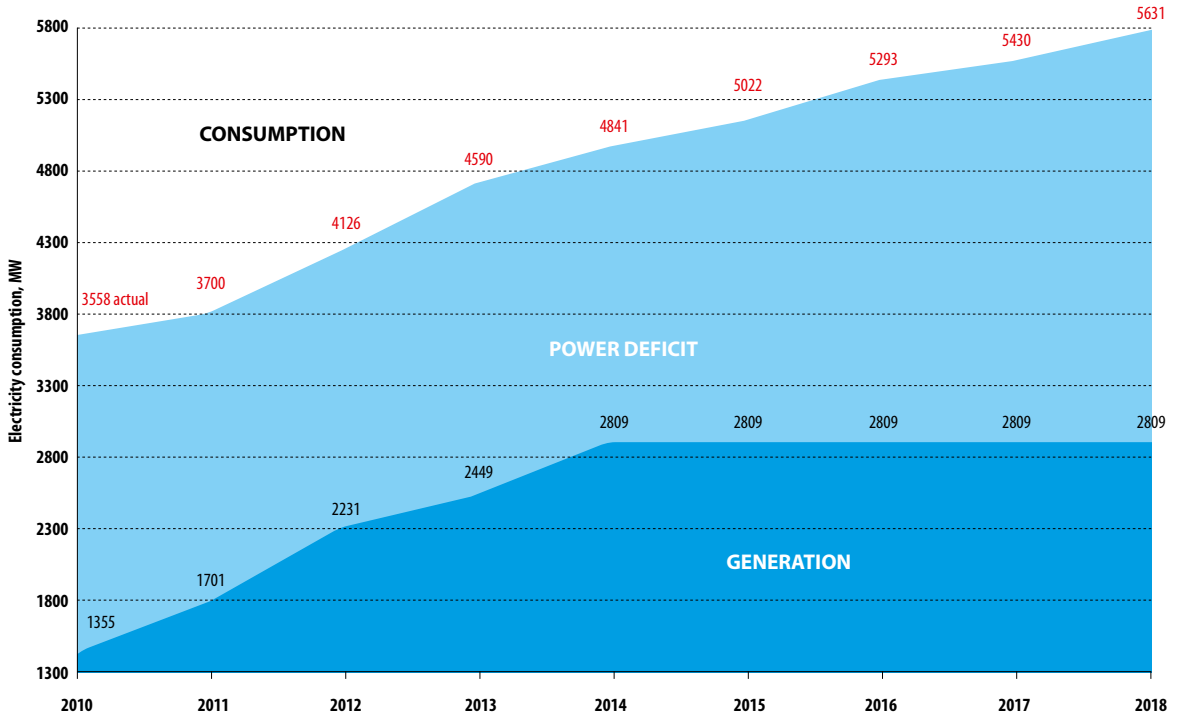

Fig. 6. Forecast of the annual maximums of power consumption, the maximum generation and the deficit of the Kuban energy system until 2018.

turbines (PGU-180). The generation of electricity by power stations has not changed substantially over the five-year period. In 2010 the amount of electricity generated by the Kuban energy system's own stations totaled 6590 million kWh, which is 32% of the region's consumption.

So, the Kuban energy system is highly deficient. This deficit is covered via a 220-500 kV network from the Rostov and Stavropol energy systems. When passing the maximum load of 3558 MW at 22:00 on August 11, 2010, the Kuban energy system was carrying the maximum available load. And the covering by the Kuban system's own power stations was only 25.3% of the system's consumption. In this February, another historical maximum of the Kuban system load was registered: 3977 MW.

The assessment of the electricity consumption and the maximum loads during the implementation of the socio-economic development plans in Krasnodar Krai and in the Republic of Adygea has shown that by 2018 the electricity consumption of the Kuban energy system will reach 31863 million kWh, which is 54.6% higher

than in 2010. The Kuban energy system will remain deficient throughout the forecast period until 2018. And this deficit will grow by the end of the forecast period. (Fig. 6).

The Kuban energy system can be divided into several conditional zones (energy districts), where the main loads of the electricity consumption and power are concentrated.

The maximum percentage of growth in the electricity consumption and power is observed in the South-Western, Central and Southern energy districts of the Kuban energy system.

The growth in the maximum load in various energy districts of the Kuban energy system differs significantly. Thus, the average annual growth in the maximum load in the South-Western energy districts exceeds the respective figure for the entire energy system more than 2.5 times. Due to the deficiency of the Kuban energy system, as well as the increased share of thermal power stations in power generation, the commissioning of environmentally-friendly WEPs that utilize renewable natural resources seems to be very urgent.



As of today, all existing WEPs in Russia generate only 0.1% of all electricity produced in the country, and their total installed capacity is about 13 MW. According to current estimates, Russia has the largest wind potential in the world. The maximum amount of Russia's wind energy resources measured as a gross potential is the part of the average long-term total wind energy that is available for use in the Russian territory during one year and determined at 2,571,843 billion kWh/year.

Wind energy development as one of the methods for solving the energy deficit problem.

The calculated deficits can be partially covered by power transmission from the neighboring United Energy Systems (UES). However, the intensive development of the economy will result in a substantial reduction in the power surplus in the neighboring UES. Therefore, the energy deficit in the South, in particular in the Krasnodar Krai energy system, can be covered mainly by way of the intensified development of alternative non-conventional energy using renewable energy sources.

The involvement of renewable energy in the energy balance is one of the strategic directions in the development of Krasnodar Krai.

The development of Krasnodar Krai's energy industry based on the use of wind energy is expedient due to a number of reasons:

- The growing deficit of the own traditional fuel and energy resources.
- A considerable wind potential.
- The high environmental safety of wind energy technologies.

- The dynamics of growth in the electric power and heat costs significantly increases the investment attractiveness of WEP wind farm construction projects.
- The stable economic development of Krasnodar Krai.
- The vast coastal areas of the Sea of Azov and the Black Sea, as well as the extended area of the Armavir wind corridor (a zone of intensive winds that are constant in strength and direction) are of practical interest for the large-scale development of wind energy.

Yeysk District is one of the most dynamically developing districts of Krasnodar Krai. The maximum electrical load of the Yeysk power center in 2011 exceeded 100 MW. The Yeysk power center is "dead-locked" and fed by the only source: a 110 kV bus line of the 220/110 Starominskaya substation, which in turn is fed by the 220 kV Starominskaya-A30 overhead line from the Rostov energy system, by the 220 kV Starominskaya-Kanevskaya overhead line from the Kuban energy system, as well as

by the 110 kV Starominskaya-Shkurinskaya and 110 kV Starominskaya-Romashki overhead lines.

Based on the above, and due to the great length and relatively high accident risk of the 110 kV overhead line, the power supply arrangement for the consumers of the Yeysk power center can be considered extremely unreliable.

The single generation source for the power center is currently the 18 MW Yeysk gas-reciprocating thermal station connected to 6 kV bus lines of the Yeysk-1 substation.

According to the results of the winter check measurement in 2010, the consumption of the Yeysk power center over 18:00 hours was 80.7 MW (ignoring the load of 6-35 kV connected directly to the 220/110 Starominskaya substation). The main share of load falls on the Yeysk-1 and Yeysk-2 substations.

According to the results of the summer check measurement in 2010, consumption of the Yeysk power center over 4:00 hours was 50.3 MW (ignoring the load of 6-35 kV connected directly to the 220/110 Starominskaya substation). The District is currently 80% energy deficient. At the same time, the wind characteristics determine Yeysk as one of the most high-priority areas for the construction of a wind farm in the Southern Federal District.

The factors listed above have been the basis for the implementation in this area of a wind farm construction project with an installed capacity of 60 MW, which will make it possible to reduce the deficiency of the Yeysk power center and decrease the electricity transport losses (including those from the neighboring Rostov energy system).

The article will be continued in the next issue of the «Energy Bulletin».

UNESCO'S EXECUTIVE BOARD PREPARES FOR LANDMARK YEAR IN 2015

Global development goals after 2015 were high on agenda of the 194th session of UNESCO's Executive Board. UNESCO is fully engaged in the elaboration of the post-2015 development agenda, which will build on the Millennium Declaration of 2000 and the lessons learned from the Millennium Development Goals, 2000-2015. The Board highlighted the importance of education, sciences, culture, communication and information for a comprehensive development agenda built on sustainability, equality and human rights. It urged the Director-General to continue efforts to ensure that these domains are reflected in the ongoing discussions to define the development blueprint for post-2015.

The state of the World Heritage site of Jerusalem was also discussed by the Board. In line with earlier decisions by both the Board and the World Heritage Committee, it decided to dispatch an expert mission to the Old City of Jerusalem and its Walls to assess 18 projects included in a UNESCO Action Plan for the safeguarding of the site, and – in a second phase – the major monumental complexes designated in the Plan (Haram-es-Sharif, the Citadel, the Western Wall, the Holy Sepulchre and the City walls).

In addition, the UNESCO Executive Board expressed “deep concern over the safeguarding of Crimea’s cultural heritage” and invited the Director-general to “follow-up on the situation in Crimea in the fields of UNESCO’s competence and report back” to the Board at its 195th session later this year.

Other decisions made by the Board during this session included authorization for the establishment of a South Asia Centre for Teacher Development as a Category 2 UNESCO Centre in Sri Lanka. It also approved the renewal of the designation of the Regional Centre for the Safeguarding of the Intangible Cultural Heritage of Latin America (CRESPIAL) in Peru as a Category 2 Centre. Such centres are not administratively part of UNESCO, but are formally associated with it. They contribute to UNESCO’s programme through capacity building, information exchange in a particular discipline, theoretical and experimental research and advanced training, and technical cooperation among developing countries.

The Board also approved a cooperation agreement between UNESCO and the Vienna-based King Abdullah Bin Abdulaziz International Centre for Interreligious and Intercultural Dialogue (KAICIID).

Finally, the Board requested the Director-General to prepare a plan of action for the Organization’s 70th anniversary, which will be celebrated next year. It also entrusted its Chairperson, Mohamed Sameh Amr (Egypt), to convene a series of events and debates in 2014 and 2015 as part of the “UNESCO: Future Perspectives” programme.

These events will include participation of eminent personalities and high officials of national and international bodies and agencies, and will serve to enrich UNESCO’s contribution to the post-2015 United Nations Development agenda and other landmark events next year, including COP 21 – the 21st session of the Conference of Parties to the United Nations Framework Convention on Climate Change (UNFCCC).

UNITED NATIONS REPORT WARNS RISING ENERGY DEMAND WILL STRESS FRESH WATER RESOURCES

The world's fresh water resources will suffer from efforts to meet the growing global demand for energy, concludes the 2014 United Nations World Water Development Report (WWDR). Launched in Tokyo on the occasion of World Water Day, the report critically reviews the lack of coordination and planning between the two domains and urges improved management and planning at all levels to avoid shortages in energy and water supplies, and further deterioration of natural resources.

"The 2014 World Water Development Report sheds light on the interdependence between management of water and energy," said Irina Bokova, Director-General of UNESCO "This interdependence calls for vastly improved cooperation between these sectors because there will be no sustainable development without better access to water and energy for all," she added.

"Water and energy are among the world's pre-eminent development challenges and must feature prominently in the post-2015 agenda," said Michel Jarraud, Chair of UN-Water. "This fifth World Water Development Report marks a milestone as the first annual edition. The new format responds to the need of the global community for an annual, factual and evidence-based publication with a thematic focus that links to World Water Day. I would like to express my profound appreciation to the UN Educational, Scientific and Cultural Organization (UNESCO) for hosting and leading the World Water Assessment Programme (WWAP), which has been coordinating the production and publication of the report. I am pleased that the United Nations, through UN-Water, is able to now annually deliver up-to date information on an issue that will only become more important to create a sustainable future."

Water and energy: two interdependent sectors

Seven-hundred-sixty-eight million people in the world have no access to an improved source of water, 2.5 billion people do not have access to improved sanitation, while 1.3 billion people are not connected to an electric power grid and close to 2.6 billion use solid fuel—mainly biomass—to cook. The report shows that places where people do not have adequate access to water largely coincide with those where people have no electric power, and how closely the two sectors are interconnected

Collection, transportation and treatment of water require energy, while water is used in energy production and for the extraction of fossil fuels. Electric power plants which produce 80% of electricity worldwide use large quantities of water for the cooling process.

Strategic choices made in one domain have repercussions on the other: droughts make energy shortages worse, while lack of electricity reduces farmers' ability to irrigate their fields. Pricing policies also highlight the interdependence between water and energy. Water is often considered as a "gift of Nature", and prices rarely reflect the real cost of its provision. Energy producers—and users—are therefore not encouraged to save water.

Thus, in the Indian part of the Western Indus Basin decades of cheap energy, associated with the digging of millions of private wells and inefficient irrigation techniques have led to an overexploitation of the water table. Similar situations have been observed in Latin America and some Arab States, notably Oman and Yemen.

Rising demand

In total, energy production accounts for close to 15% of water withdrawal. But that figure is rising, and by 2035 population growth, urbanization, and changing consumption patterns are expected to push water use for energy up by 20%. Demand for electricity is expected to rise by 70% by 2035, with more than half of this growth due to developments in China and India.

Declining water resources are already affecting many parts of the world and 20% of all aquifers are believed to be overexploited. In 2050, 2.3 billion people will be living in regions subjected to severe water stress, notably in North Africa, Central and South Asia.

The challenge of meeting the demand for energy may well come at the expense of water resources. As concern about the environment and social impacts of thermal and nuclear power plants increases, countries are trying to diversify their energy sources, seeking to reduce dependence on foreign supplies and mitigate the effects of fluctuating prices. But all of the present options have their limits.

Biofuel cultivation, which requires a great deal of water, has increased on a large scale since 2000. Shale gas extraction has also spread in recent years, particularly in the United States. But this fossil energy can only be extracted through hydraulic fracturing which requires large quantities of water and poses the risk of contaminating water tables.

Renewable energy sources appear less damaging for water supplies. Hydroelectricity currently meets 16% of energy demand worldwide and its potential is still underexploited. Nevertheless, the construction of dams can have a negative impact on biodiversity and human communities.

Other alternative energies are gaining ground. Between 2000 and 2010 wind power and solar energy around the world grew by 27% and 42% respectively. But although these technologies require very little water, they supply power intermittently and need to be combined with other sources that do require water. So, despite progress in renewable energies, fossil fuel is likely to retain its lead in the years ahead. The International Energy Agency expects fossil fuels to dominate at least until 2035, followed by renewable energies.

Meeting the power challenge

The Report highlights the need to coordinate water and energy management policies to meet the challenges ahead. This includes revising pricing practices to ensure that water and energy are sold at rates that reflect their real cost and environmental impact more accurately.

Considering the scope of investments required to develop durable alternative infrastructures, the private sector has a major role to play in supplementing public expenditure. In 2008, it was estimated that developing countries would need to spend \$103 billion annually on improved water, sanitation and wastewater treatment to achieve the internationally agreed Millennium Development Goals by 2015. Another \$49 billion per year will be needed to achieve universal energy access by 2030.

Systems which allow for the combined production of water and electricity probably hold the key to the future. This solution is particularly adapted to the arid regions. Thus, the power plants of Fujairah in the United Arab Emirates and Shoaiba in Saudi Arabia serve both for sea water desalination and energy production.

Water is increasingly being recycled to generate energy. The organic matter it contains serves for the production of methane-rich biogas. In Chile, the Farafana plant treats 50% of the wastewater of Santiago producing close to 24 million cubic metres of biogas. One hundred thousand residents use this energy in lieu of natural gas. In Stockholm (Sweden), buses and taxis run on biogas produced from wastewater. The interest in this technology is also growing in developing countries. In Maresu (Lesotho) 300 families use biogas as cooking fuel.

The United Nations World Water Development Report (WWDR) is a collaborative effort of 31 UN entities and 36 international Partners that make up UN-Water. It is coordinated and produced by the World Water Assessment Programme (WWAP) which is hosted by UNESCO. Until 2012, the report was issued every three years, taking comprehensive stock of the world's water resources. As of this year, the report will focus on one topic and be presented annually on World Water Day whose theme will be the same as that of the report. This year's events for the Day will be coordinated by United Nations University (UNU) and the United Nations Industrial Development Organization (UNIDO) on behalf of UN-Water.

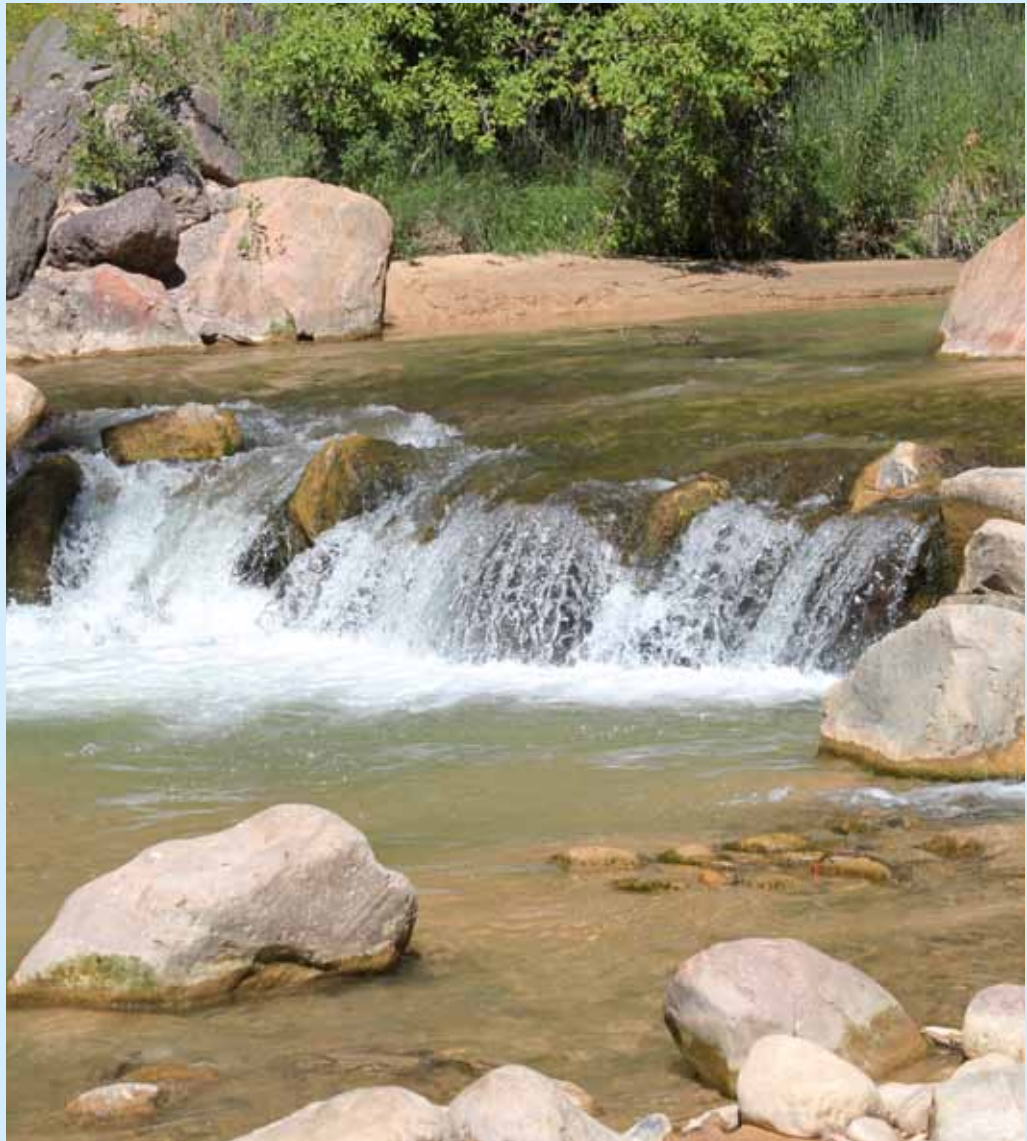

UNESCO WELCOMES GROWING COMMITMENT BY OIL, GAS AND MINING CORPORATIONS TO KEEP OUT OF WORLD HERITAGE SITES

UNESCO has welcomed confirmation from French-based oil and gas corporation Total that it will refrain from prospecting or exploiting oil and gas in natural sites inscribed on the World Heritage List, saying this was an encouraging sign for World Heritage conservation.

In a letter sent earlier this month to UNESCO, Total's Vice-President for NGO and public relations, Alain Castinel, reaffirmed a pledge made by Total in June 2013 concerning the 217 natural sites inscribed on the World Heritage List at that time.

Total's letter follows appeals in 2012 and 2013 by the World Heritage Committee to oil companies with concessions infringing on the Virunga National Park (Democratic Republic of Congo) to steer clear of World Heritage properties. Shell and the International Council on Mining and Metals, which groups the world's 22 leading mining companies, have already made commitments to this effect.

"This landmark decision by one of the major oil companies is an encouraging indication of growing awareness in the corporate world of the outstanding universal value of World Heritage properties and the need to preserve them," said Mechtild Rossler, Deputy Director of UNESCO's World Heritage Centre.

"I trust that the sensitivity demonstrated by Total, Shell and the International Council on Mining and Metals will gain ground among other economic players who have a responsibility to respect the World Heritage Convention not just today but for future generations as well," she added. "I sincerely hope that Total's commitment will be further extended to include World Heritage sites to be designated in the future."

The World Heritage List presently includes 981 sites in 160 countries; 222 of these sites are recognized for their natural values (193 natural sites and 29 mixed properties with both natural and cultural features of outstanding universal value).

UNESCO is committed to continue the dialogue with the major players in the oil, gas and mining industry to ensure conservation of natural World Heritage sites.

THE NEW EUROPEAN* WIND ATLAS



Erik Lundtang Petersen,

Ib Troen,

Hans E. Jørgensen,

Jakob Mann

Wind Energy Department, Technical University of Denmark, Denmark

Today a number of well-established models and methodologies exist for estimating resources and design parameters, and in many cases they work well. This is true if good local data are available for calibrating the models or for verification. But the wind energy community is still hampered by many projects having large negative discrepancies between calculated and actual experienced resources and design conditions. However, when such significant discrepancies are found, no well established methods exist to correct the situation. Discrepancies can be introduced at any point in the modeling chain, from insufficient input data to deficient physics and resolution in any of the models, model linking issues, insufficient resolution or errors in surface topographical data such as terrain heights, land cover data etc.

Therefore it has been decided on a European Union level to launch a project "The New European Wind Atlas" aiming at reducing overall uncertainties in determining wind conditions; standing on three legs: A data bank from a series of intensive measuring campaigns; a thorough examination and redesign of the model chain from global, mesoscale to microscale models and creation of the wind atlas database. Although the project participants will come from the 27 member states it is envisioned that the project will be opened for global participation through test benches for model development and sharing of data – climatologically as well as experimental. Experiences from national wind atlases will be utilized, such as the Indian, the South African, the Finnish, the German, the Canadian atlases and others.

Introduction

An important objective of the European Union's Strategic Energy Technology Plan for wind energy is to accelerate the reduction of costs of wind energy. For this purpose the wind energy technology roadmap highlights the need for more accurate mapping of wind conditions for estimating wind resources and loads for wind turbine design. It is recognized that this objective can only be accomplished by highly coordinated research and development focusing on creation of a new EU wind atlas, including a climate database, and on the improvement of models for wind energy physics [1]. Based on these considerations the European Commission decided to issue a call on the Wind Atlas project in their research programme FP7, July 2012. It is issued as an ERANet Plus call, which means that the Commission shares the budget for the project with participating member states. Duration of the work will be five years beginning 2015.

The wind atlas will have to be validated by onshore and offshore measurement campaigns,

* **Editorial note:** Here and further the authors speak about the European Union (EU) and its territory

targeting also complex and hostile environments. Experimental campaigns will provide extended reference data, will improve spatial planning tools and will reduce the uncertainty in wind resource and load estimation and thereby in the economic assessments.

The project will therefore be structured around three areas of work, to be implemented in parallel, as shown in the figure:

- Creation and publication of a European wind atlas in electronic form, which will include the underlying data and a new EU wind climate database which will as a minimum include: Wind resources and their associated uncertainty; extreme wind and uncertainty; turbulence characteristics; adverse weather conditions such as heavy icing, electrical storms and so on together with the probability of occurrence; the level of predictability for short-term forecasting and assessment of uncertainties; guidelines and best practices for the use of data, such as extremes and turbulence (especially relevant for micro-siting).
- Development of dynamical downscaling methodologies and open-source models (including coupling to wake models), validated through measurement campaigns, to enable the provision of accurate wind resource and external wind load climatology and short-term prediction at high spatial resolution and covering Europe. The developed downscaling methodologies and models will be fully documented and made public available and will be used to produce overview maps of wind resources and other relevant data at several heights and at high horizontal resolution.
- Measurement campaigns to build and validate the EU wind atlas together with selected European wind climatologies. At least five coordinated measurement campaigns will be undertaken and will cover at least complex terrains (mountains and forests), offshore, large changes in surface characteristics (roughness change) and cold climates.

The Wind Atlas work will benefit from the accomplishments of the ongoing work with the IRENA (the International Renewable Energy Agency) project: The Global Solar and Wind Atlas, especially with regard to building the database, which most likely will use the architecture form the Global Atlas.

The new European wind atlas database

The work with the existing European Wind Atlas [2] was performed 1982–1989 and published by Risø National Laboratory for the European Commission in 1989, covering 12 of the 27 current member states. A number of national wind atlases exist today, but they do not provide a consistent and comprehensive coverage of the entire territory of the EU, which results in a lack of verified and publicly available data on European wind conditions. Further to this, the 1989 atlas does not cover new EU Member States and was developed using standard climatological data being less suited for wind energy purposes. The new EU wind atlas will take advantages of newly created long-term datasets well suited for the purpose of the atlas and thereby contribute to the creation of an EU standard for site assessment.

The new EU wind energy atlas will provide a unified, high resolution and public-domain dataset of wind energy resources and design condition for the entire European Union.

The work with the new atlas will provide new information relevant for all life-cycle and stakeholders of wind energy. It will be a new kind of wind atlas, incorporating comprehensive information about wind conditions for all stages of wind projects' life-cycle (prospecting, design, development and operation). The atlas of wind conditions will be based on newly available atmospheric and topographic data and pay particular attention to the challenges of offshore winds, coastal winds and winds induced by terrain as well as other relevant geophysical data as waves for offshore. The atlas database will give much more than resource information. It will give measures of wind variability, diurnal and seasonal variations and predictability. The work with the new atlas is required to maintain a strong position of the wind energy community in terms of wind energy knowledge, technology and deployment.

The database will be structured on several levels reaching from the need of planners for regional overview-maps to very detailed time series for technical/scientific applications. Selected important issues to be covered by the database are:

- Wind resource: Wind resource calculation requires frequency distributions of wind speed and direction as a function of height. For the

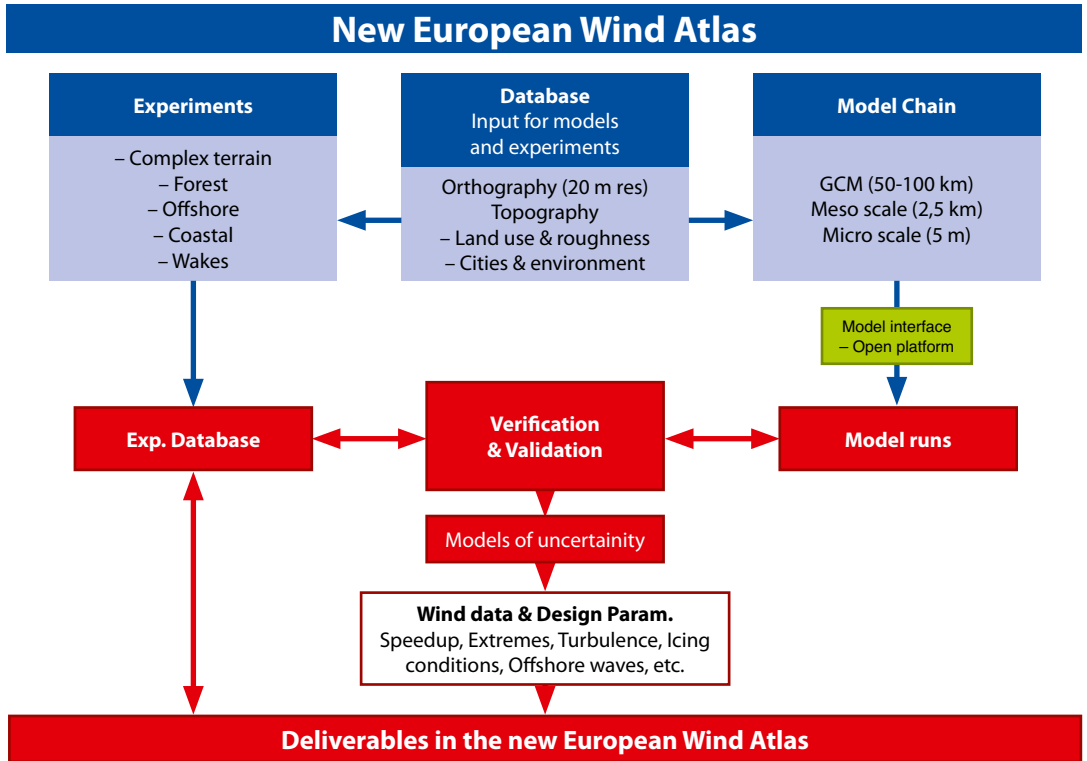

Flow Chart showing the structure of the New European Wind Atlas.

wind turbines of the future this information will be required up to 300 meters or more for accurate prediction of the wind energy production. Dependent of whether the need is regional or local, this information can be acquired from the database maps or database utility programs.

- Wind variability: Characterization of the variability of the wind conditions on time-scales from hours to months (seasonal and daily included). This is important for determining modes of operation for the wind farm and how the wind resource may be integrated into existing and/or alternative power supply, including other renewable energy sources.
- Inter-annual variability: Tools and wind conditions data that allow the placement of short-term measurement data into long term climatological perspectives is of great value for wind farm developers. This can be achieved by quantifying variation of wind conditions, relative to climate, over any arbitrary limited period of site measurements.

- Wind power predictability: When a farm is in operation, the ability to predict the wind power over the next hours and days is of value for operators and power grid managers. The degree of predictability will depend on the kinds of meteorological phenomena impacting a wind farm site and the ability of models to resolve and model these phenomena.
- Uncertainty: Throughout the wind atlas work, verification and estimation of uncertainty will be of utmost importance. The uncertainty estimations will be based on a network of in situ measurements over Europe and modeling sensitivity studies. The uncertainty estimate map makes an important statement about the confidence of the wind atlas and the intensity to which in situ measurement must be employed before development of a wind farm.

The model chain

In order to achieve the objective of very high accuracy of the wind potential assessment and

the real conditions being faced by wind turbine generators both at the design and deployment phase, a new generation of models has to be developed: Covering all scales from synoptic to microscale; based not only on local measurements but also in global atmospheric databases (i.e. reanalysis) and new measurement techniques with much more detailed turbulence models able to give useful information for the design of wind turbines; considering extremes specifically (extreme winds, extreme shears, high wind variability, etc); models being able to simulate onshore and offshore conditions, with stability effects and large offshore wind farms with cumulative wake effects and modified atmospheric boundary layer. As a result of the project models will be developed, validated and published as open source to ensure the impact of the project, guarantee the transparency, and facilitate scientific and technical progress and cooperation.

In a recent publication [3] the modelling issues are described as follows: “The assumption of large scale homogeneity of the overall wind resource, and the modelling of the indicated important local influences, was the basis of the development of the European Wind Atlas and the WAsP analysis and siting programme. The methodology has since been used in a number of similar studies in other parts of the world. In this application the “correction” of local wind statistics is done by modelling the local influences (using simplified diagnostic models) to construct a “generalised” or “regional” wind climate pertaining to idealised conditions (e.g. the wind frequency distributions for 100 m above a flat and open large stretch of land). Ideally (meaning if the original data are of good quality, the simplified models and the site specifications used for corrections are sufficiently accurate and that data locations are close enough to resolve the climatological variations), one can obtain maps of the variation of the (regional) resources, and by using these in reverse, introducing the necessary local corrections pertaining to any candidate wind turbine/farm site, one can estimate the actual resource and production potential for the particular site .

In areas, where resources are more determined by or dominated by smaller (than synoptic scale) flow phenomena (mesoscale flows) the methodology is still applicable, but the dis-

tance to which one can use the generalised or cleaned statistics may be much reduced. For Europe parts of the Mediterranean area poses such challenges to the wind atlas methodology. In such circumstances improved resource assessment can be obtained using mesoscale modelling.

Using global reanalyses as boundary conditions decades long time series and/or wind climatologies can be modelled at nominal resolution (grid cell length in mesoscale model) down to a few kilometres and covering areas with side lengths of some thousands of kilometres is becoming possible.

The application of mesoscale models for resource calculation is by no means a simple matter. The large scale reanalyses are performed in only a few global weather prediction centres using models that have been developed over many years, and which are still being developed and validated and are being used in operational services. Mesoscale models are more diverse, but nowadays quite a number have a proven track record in applications such as for regional weather prediction and also for wind resource assessment. There are still some issues, and use of model results without proper validation may lead to gross errors. It is important to realise that large scale and mesoscale models are extremely complex and that published validation studies in general focus on details other than low-level boundary layer winds. For resource assessment it is therefore highly advisable to include direct validation with in situ observed wind data over sufficient long periods. In doing so, however, the mesoscale model output must be downscaled using some microscale physical or empirical/statistical model. The linking from the global scale datasets to the mesoscale model is most often done by “nesting” the mesoscale model, that is selecting its domain over the region of interest and using the large scale data as initial data and as lateral (time varying) boundary conditions for the model. Since, however, mesoscale models are fully dynamical (unlike microscale models, which in general can be used as “diagnostic” downscaling tools) they need some integration time after initialisation to “spin-up” the mesoscale features not resolved in the initial large scale field. Depending on domain size this necessary spin-up time

can be days. At the same time the mesoscale model may start deviating from the large scale fields (the large scale “truth” from the reanalysis) over the domain over similar time spans and therefore need to be reinitialised regularly or some “nudging” or relaxation technique needs to be applied to keep the system on track. The difference in resolution and model details tend to give rise to model artefacts near the lateral boundaries, therefore they need to be sufficient far from the area of interest to have negligible influence on the results. All these “technical” details and choices (not to mention the model formulation itself, the numerical schemes used and the physical parameterizations) can have significant impact on the results. A particular issue often misunderstood is the actual model resolution. This is most often quoted as the grid cell size in the model grid, but the actual physical resolution, the size of features that are well represented and modelled, is always larger. This “real” resolution depends on model details, not only the grid size and numerical methods used, but also on the physical formulation [4;5]”

In conclusion, the necessary “model-chain” for the downscaling from the available climatological data to local wind resource estimates (the “top-down” approach) consists of the large scale re-analysis model giving dynamical consistent large scale time resolved data at some spatial and temporal resolution, a mesoscale dynamical model to provide data at higher spatial resolution, and a microscale model. Data from the experimental campaigns and available wind observations of good quality at the specific sites of interest will be used for validation and accuracy/error estimation.

The developed downscaling methodologies and models will be fully documented and made publicly available and will be used to produce overview maps of wind resources and other relevant data at several heights and at high horizontal resolution. However, it should be borne in mind that use of mesoscale models for resource assessment is quite computer-intensive if one wants to resolve all (or almost all) relevant scales and produce climatology covering several years.

The experimental program

The experiments will be designed to target the main outstanding problem in the Wind

Atlas work: To develop or re-develop the essential models so they are specifically tailored to the Wind Atlas use and can provide results with accuracy unseen today. A model issue which is crucial is the development of a robust protocol for linking the local micro scale wind conditions via mesoscale phenomena to larger scale climatologies.

The outcome of the experimental program is a comprehensive dataset of flow conditions in a range of topographic and climatological settings. Each dataset will document a specific setting, but the working assumption is that the data shall be detailed enough and cover a sufficient range of spatial scales from micro- to mesoscale and with sufficient temporal resolution and length to give a reference climatology.

The initial activities will comprise an examination of a number of possible experimental sites and a suggested selection of at least five sites, which are found to best cover the climatological and topographic conditions in the European Union: From Arctic to Subtropics and from sea to mountains (called “The Experimental Matrix”). The selection will be based on the quality of the site with respect to the target outcome and will be guided by detailed flow modeling and will also consider logistics and costs.

For each of the sites a plan will be developed for setting up of instrumentation and other logistics for a long term (3 years or more) backbone climatology program. The intention is to ensure a maximum of commonality of this program between sites (the selected and future sites). This will include a partial standardization of instrumentation, time and spatial resolution. A set of guidelines will be developed to ensure standardization while taking into account site specific considerations in the interest of maximization of the value of the data.

A plan for a series of shorter term intensive measurement campaigns (a few weeks to several months duration) to investigate specific flow phenomena in high temporal and spatial resolution (turbulence and gusts, wind shear, flow separation, local circulation systems...). Also for these measurement campaigns a maximum standardization will be sought in the interest of consistency and quality of the final database.

The new the European Research Infrastructure “3D wind scanner” facility will be engaged

to supplement and strengthening the experimental activities.

The measuring campaigns will not solely ensure proper modeling validation and uncertainty estimation, but will also provide extensive and highly valuable data to be used by a broader community of private and public partners to develop models and engineering tools or data sets to be used as design input, standardization of design codes or certification schemes. As an example that aerodynamics and aeroelastics codes as well as remote sensing techniques will definitely benefit from this data.

Conclusions

According to the European Wind Energy Technology Platform [1], the Atlas will have an added value and benefits as viewed from the manufactures, developers, utilities etc. which can be expressed as follows: The development of a new generation of flow models as part of the EU Wind Atlas will significantly contribute to the reduction of technical and financial uncertainties. The increased security for investors and thus easier financing will in turn result in more investments in wind energy. This accelerated penetration of wind energy in the EU will be of benefit for the local industry having a geographically near-by prosperous and healthy market. The new models can thus contribute to increased employment in the EU wind energy

sector and significantly reduced cost of energy while at the same time help to achieve the CO₂ targets. The reduced costs of energy will – also on a global level – increase competitiveness of the European wind industry.

Finally, the development of a new EU wind energy atlas represents a clear priority not only of the European Wind Initiative (EWI) and of European Wind Energy Technology Platform (TPWind), but also of the European Energy Research Alliance (EERA). It is therefore a key goal of the entire EU wind energy sector, which confirms its importance for the future of wind power in Europe.

References

1. New EU Wind Energy Atlas (2011): Proposal for an ERANET+ project. Produced by the Wind Energy Technology Platform Secretariat; Brussels.
2. Troen I. and E.L.Petersen (1989). "European Wind Atlas". Risø National Laboratory, 656 pp.
3. Thomas Tomkins Warner. Numerical Weather and Climate Prediction. Cambridge University Press. 2011. 526 pp
4. Petersen, E.L. and I.Troen (2012). Wind conditions and resource assessment. WIREs Energy Environ 2012. Doi:10.1002/wene.4
5. W.C. Skamarock (2004): Evaluating meso-scale NWP models using kinetic energy spectra. Mon. WEA. Rev., 132,

SUSTAINABLE ENERGY FOR ALL: MYTH OR REALITY?



Yuri Bychkov,

Professor, Doctor of Technical Sciences (D.Sc.Tech.), Russia

Professor, Doctor of Technical Sciences Yuri Bychkov is the author of over 300 scientific works and inventions. Currently Yuri Bychkov is a managing director and a full owner of the company BYCHKOV GmbH in Germany.

The world's fuel energy production poses a real threat to the sustainable development of the human civilization due to the following main reasons:

1. the unavoidable depletion of raw material base for the fuel energy industry in the near future;
2. the irreversible processes of destruction of natural ecosystems of our planet by resource-extractive, processing and consuming sectors of economy;
3. frightening pace at which nuclear energy capacities are growing without reliable guarantees of comprehensive safety of nuclear power plants under the conditions of potential natural or technogenic disasters.

Depressing figures were pronounced at the Vienna Energy Forum held on the UN initiative in June of 2011: three quarters of the world's poor population use only 10% of energy being produced in the world, electricity is still economically inaccessible for 1.5 billion people, about 3 out of 7 billion people do not have access to modern energy services and use traditional biomass re-

sources and coal as their main sources of energy, "energy hunger" takes up to 2 million human lives every year.

The SEFA (Sustainable Energy for All) program adopted by the UN on the initiative of its Secretary-General Ban Ki-moon is a very timely program aimed at attaining three strategically interconnected objectives:

- to provide universal access to modern and inexpensive energy services;
- to double the energy efficiency level of the economy;
- to double the share of renewable energy sources in the world energy balance.

Based on the importance of energy for eliminating poverty and for sustainable development of the mankind as a whole, the UN General Assembly adopted a resolution which proclaimed the years of 2014-2024 as the Decade of Sustainable Energy for All. Initially in accordance with Declaration No. 65/151, the UN proclaimed the year 2012 as the International Year of Sustainable Energy for All and recommended that the United Nations member states and all other interested parties use this particular year to raise awareness about the importance of solving quite a number of problems related to sustainable en-

ergy and thereby create favorable conditions for applying the technologies of using new and renewable energy sources, including measures to expand access to such technologies.

Thus, the technologies of using new and renewable energy sources are given the key role in the successful implementation of the SEFA program.

Available today high energy technologies (HighEnergyTech) are based on new energy sources, which are systems of complementary energy carriers that ensure the mono- or poly-generation of energy in various combinations and which should be used in the first place according to the sustainable energy development concept. As a rule, such technologies are based on patented inventions, which meet the requirements of novelty, the inventive level and industrial applicability, and are the intellectual property of private and/or legal entities protected by law. Therefore, it is very important to create a mechanism to involve such intellectual property rules for the implementation of the SEFA program.

Exceptional opportunities are provided in this respect by the Patent Cooperation Treaty (PCT) numbering 192 member countries, being the UN members at the same time. According to the PCT system, each patent holder receives a protection document in the form of a Patent application registered by the WIPO (World Intellectual Property Organization). This gives them the right to promote new technologies (of the HighEnergyTech type) in the national economy of any PCT member country using the national or regional patenting systems. This provides one of the most effective measures to ensure equal access to these technologies for each PCT member country, as well as universal access to modern inexpensive energy services owing to the high-yield capitalization of intellectual property. And this, as was noted above, is one of the strategic objectives that should be attained by 2030 according to the SEFA Program.

Among new feasible technologies of the HighEnergyTech type, over-unity energy technologies deserve the closest attention, as they meet the selection criteria for the world sustainable energy most of all. These technologies are characterized by the energy conversion efficiency ($KПЭ$ in the formula below) of more than unity. In general, the expression for determining

the energy conversion efficiency is written in the form of a ratio of the produced useful energy E_1 : of electric, thermal (warmth, cold) or mechanical energy, each one of them separately or in their combination, to the useful energy E_2 of one of the above-listed energies or also in their combination, that comes to the energy process from the outside:

$$KПЭ = \frac{\sum_{i=1}^n E_1}{\sum_{j=1}^m E_2}$$

where $l = 1, \dots, n$ and $j = 1, \dots, m$ are the numbers of energies participating in the energy process, at the input and output, respectively.

Numerous facts are known of manifestations of over-unity energy processes, both in the surrounding nature and in man-made processes and devices for various purposes.

Thus, the program of construction of the International Thermonuclear Experimental Reactor (ITER) has become widely known throughout the world; Russia, the USA, Canada, China, India, South Korea, Japan and the EU countries participate in this project. The estimated time of construction completion is 2020, the budget is more than 15 billion euros. The temperature of the thermonuclear reaction is expected to be over 100 million degrees, which will exceed the temperature of the Sun many times. In the event of successful implementation of the ITER project, the industrial application of the thermonuclear technology is planned to be commenced after 2050, which exceeds the time of the SEFA Program completion already by 20 years. The theoretical energy conversion efficiency in the thermonuclear process is 1:5. However, it has been asserted that this figure can be increased to 1:10 on the experimental thermonuclear reactor, that is, the reactor's electricity consumption capacity will be 40 megawatts of electricity while its production capacity will reach 400 megawatts.

Thus, fundamental science has provided theoretical grounds for an over-unity energy process for the first time and it believes that its practical implementation is possible.

We should not draw the conclusion based on this example that all energy processes of using fossil fuels are over-unity ones. During the

combustion of any fossil fuel useless losses of thermal energy are unavoidable, which can be minimized using energy-saving technologies, but cannot be completely eliminated. In the case of a thermonuclear process, ordinary sub-unity electric energy is introduced from the outside, which initiates an over-unity process of nuclear energy release from nuclear fuel with an abnormally high energy content.

Under the scientific supervision and with the direct participation of the author, the previously unknown phenomenon of the release and accumulation of over-unity energies in multiphase gas-liquid flows accelerated up to supersonic velocities was discovered.

The following generalized definition could be given to this phenomenon:

“In the cyclic processes of uncompensated changes in the phase state of substance, the release and accumulation of excessive energy occur as a result of the growing energy content of substance”.

Similar phenomena observed in other processes make it possible to come closer to the formulation of the unified law of energy conservation and conversion in the following simple form: $1,0 \leq \text{energy conversion efficiency} \geq 1,0$. (2)

The above attempt to formulate the unified law of energy conservation and conversion crucially changes the level of knowledge of the material world and presents a new paradigm of the world energy development.

It is this circumstance that has substantiated the process of patenting a series of energy technologies, out of which we would like to single out the wind energy technology, which is characterized by the world novelty and protected with a priority of April 27, 2011 by an international patent application (WIPO/PCT: WO 2012/146233 PCT/DE 2012/000411) and by patent DE No. 102011018840 “A method for harvesting wind energy and converting same into different forms of energy, and a wind turbine for carrying out the said method”, the patent holder is BYCHKOV GmbH, Germany, the author is Prof., Dr. Sci. Bychkov Yu.M.

1 Title: Method for harvesting wind energy and converting same into different forms of energy, and wind turbine for carrying out said method.

Bezeichnung: Verfahren zur gewinnung von windenergie und umwandlung derselben in andere energieformen und windkraftanlage zur durchführung dieses verfahrens.

This wind energy technology has the following principal advantages in comparison with the known sub-unity wind energy technologies for the direct conversion of kinetic wind energy into electrical or mechanical energy:

1. Devices for the implementation of wind energy technology may have various designs depending on the type and method of external power supply, as well as the energy conversion level.

The presented figure shows the overall appearance of the prototype of one of the versions of the wind energy device for generating thermal and mechanical energy of compressed air and water which has the maximum specific heat capacity among all known energy carriers, which in this case is a necessary condition for the over-unity process of heat generation.

The main components of the prototype of the wind energy device are as follows: electric motor; centrifugal pump; suction pipeline and delivery pipeline; wind accelerator; reactor; separation tank; intermediate tank; standby tank; filling device.

Centrifugal pump feeds a stream of water under a pressure of up to 7 atmospheres with a weight flow of up to 16-17 t/h to reactor, to which reactor an air flow is supplied at the same time via wind accelerator with a wind acceleration factor of 1:10, with an initial speed of 0.5 m/s and accelerated to 5.0 m/s at the reactor inlet. In the same reactor supersonic conditions are created in the water-air fluid stream by an actuating element of special design with the release and accumulation of excessive energy owing to the growing pressure and temperature. Downstream of the reactor, the water-air stream is returned to the subsonic conditions and routed to separation tank, where compressed air is separated from the circulating water flow. Compressed air having an excessive temperature and pressure can be used in different combinations for air heating, for operation of pneumatic mechanisms and/or for electricity generation. And the circulating water flow, or liquid energy carrier, which also has an excessive temperature and pressure, can be used for water heating, conditioning, for performing mechanical work and for electricity generation. For electricity generation the wind plant should be additionally equipped with a hydraulic turbine generator.

Table 1

P, atm.	Δp , atm	T, °C	Pe, kW	G, t/h	Pm, kW	Pc, kW	ΔT , °C
6,0876	3,0528	24,796/64,929	4,658	16,0704	2,7709	26,163	1,3997



Fig. 1. General appearance of the prototype. Key elements: electric motor, centrifugal pump, suction pipeline, delivery pipeline, wind accelerator, reactor, separation tank, intermediate tank, standby tank, filling device.

The wide functional capabilities of this wind energy technology for generating thermal, electrical and mechanical energy, each one of them separately or in different combinations, are of unconditional interest for sustainable energy.

2. There is a convincing evidence base of the high energy efficiency of wind power plants with over-unity figures of the energy conversion efficiency.

Table 1 shows the results of the prototype acceleration for 2 hours and 16 minutes from a tem-

perature of 24.796 °C to reaching the operating conditions at 64.929 °C.

At an installed motor power of 7.5 kW the pump consumes electric power P_e which is equal to 4.658 kW, of which the useful hydromechanical power P_m amounts to 2.771 kW, i.e., the efficiency of electric energy conversion into hydromechanical energy by power is $2.7709/4.658 = 0.595$. At the same time, the efficiency of hydromechanical energy conversion into thermal energy by power is $P_c/P_m = 26.163/2.7709 = 9.442$. However, the ratio between the power of the produced thermal

Table 2

Natural gas heating plant	Power consumption kWh/m ² per year	Power cost euro/m ² per year	Natural gas price euro per kWh
Heating	100	7,00	0,07
Hot Water	30	2,10	
Total	130	9,10	
Wind power plant			Electricity price euro per kWh
Energy conversion efficiency	1:5		
Heating	20	3,80	0,19
Hot water	6	1,14	
Total	26	4,94	

*Average annual data for 2011 were taken at www.heizspiegel.de

energy and the power of the consumed electricity is of the greatest interest to the economy, which is equal to $P_c/P_e = 26.163/4.658 = 5.617$. It is this figure that should be used to determine the energy efficiency of the prototype.

In this prototype, the energy conversion efficiency = $(P_c + P_m)/P_e = (26.163 + 2.771)/4.658$ and amounts to 6.21

Currently, no sub-unity energy technology has such a high energy efficiency.

3. The produced over-unity energy is highly profitable economically.

The comparative engineering and economic analysis of electric energy costs for producing 1 Gcal of heat by our wind plant prototype and by the EVP-02 flow-through electric water-heating boiler has shown that the prototype generates 5.617 kWh of the accounted useful thermal energy per kWh of the utilized electricity without taking account of the additionally generated mechanical energy and 16 ÷ 18% of heat losses into the environment. In addition, heat transportation is also implemented in this prototype. So, 1163 kWh: 5.617 = 207.05 kWh is required for the generation and transportation of 1 Gcal of useful heat.

The EVP-02 boiler is a heating boiler equipped with an electric water heater that directly converts electricity into heat. Simultaneously with the heating of the heat-transfer fluid, this boiler ensures its forced circulation under a gage pressure of up to 2 atm. without installing additional pumps. The boiler efficiency is 95%. So, for the generation and transportation of 1 Gcal of useful heat the

EVP-02 boiler spends 1163 kWh/0.95 = 1224.2 kWh, that is, 5.91 times greater than the above prototype.

The energy efficiency of generating thermal energy on the wind power plant has been determined for the Russian conditions (Moscow). The cost of 1 Gcal of heat supplied to the population by the largest power companies, MOEK (Moscow United Energy Company) and Mosenergo, can be reduced 2.11 and 1.69 times in the daytime, and 8.39 and 6.70 times due to the reduced rates in the nighttime, respectively. So, the economic efficiency can be increased many times when using inexpensive night electricity.

For the German conditions, Table 2 shows the annual costs of heating and hot water per a single living room and demonstrates the opportunity to reduce expenses 1.84 times due to the use of the wind power plant in comparison with natural gas heating.

4. This wind energy technology has a huge potential for improvement and positive impact on the efficiency of the existing sub-unity energy technology, and is a breakthrough technology. As it requires external sources of energy, the joint utilization of below- and over-unity energy technologies can ensure their highly efficient operation. Thus, for example, if a wind power plant with energy conversion efficiency of ≥ 6 is combined with any other sub-unity energy technology with energy conversion efficiency = 0.3...0.9, their joint energy conversion efficiency will be $\geq 1.8...5.4$, that is, within the over-unity interval.

The concept of combination of below- and over-unity energy technologies can play a special role in the economical sustainable utilization of renewable energy sources, as well as fossil fuels, including nuclear fuel, replacing them in an evolutionary manner where this is technologically possible and economically feasible.

5. Energy resources for this wind energy technology form a new class of non-exhaustible sources of energy, which include such accessible interacting fluids as air and water. With rare exceptions, they are widely spread everywhere. In addition, for cyclic processes, they are conservative working fluids, which are removed from the natural circulation in very limited amounts that do not disturb the natural ecological balance. As a result, total energy independence of each national energy industry can be achieved from the import of energy carriers and external energy sources.

6. The scalability of wind power plants, both in the sub-kilowatt and kilowatt range and in the megawatt and over-megawatt range, is extremely important for sustainable energy. This makes it possible to create universal series of energy facilities and devices economically accessible to a wide range of consumers of different levels of energy consumption and social status.

7. The facilities of this wind energy technology are safe and reliable in operation with a guarantee of accident-free operation of at least 10 years. The achievement of such parameters is explained, first of all, by the absent of a rotor wind motor, instead of which the low-grade wind energy is captured and amplified many times by a fixed wind accelerator of special design.

It is known that the efficiency of rotor-type wind energy plants depends considerably on the wind speed. As a rule, they work in the speed range from 3...5 m/s (starting speed) to 20...25 m/s (braking speed because of the risk of wind turbine destruction), and the optimum operating conditions is in the range of 8...12 m/s.

Wind speeds from 0.3...0.5 m/s to 3...5 m/s are sufficient for wind energy plants with the above technology. Moreover, the operating efficiency remains high even in the total absence of wind. All this definitely points to the fact that the

operation of the wind power plant depends to a small degree on the wind speed characteristics of and can be efficiently used even in those regions of the globe, where the rotor-based wind energy is not practicable because of low wind speeds.

8. Non-use of the rotor-type wind motor creates additional advantages of the wind power plant, namely:

- given the non-waste production concept, the ecological nature of operation is greatly enhanced, because negative vibro-acoustic impact on people and the environment is practically completely excluded, which in turn allows placing of wind plants as close as possible to the consumer and, therefore, decentralizing power supply systems with the minimum length of or no power transmission lines;
- the reliability of power supply systems is increased, the construction and operation costs are reduced;
- due to their small weight and dimensional characteristics, wind plants require small areas for installation, in the order of 0.05...1.0 m² per 1 kW of installed capacity .
- areas that are not currently used because of the absence of energy (deserts and sparsely populated areas, remote special-purpose facilities) can be developed for economic activities.

The whole of the above advantages of this wind energy technology creates objective opportunities to produce inexpensive energy with a short payback period of not more than one year, because the costs of its industrial development are many times lower than the costs of other traditional energy technologies.

Thus, the answer to the question posed at the beginning of this article is obvious: if the process of creating Sustainable Energy for All involves new over-unity energy technologies of equal and general accessibility, high energy efficiency, economic feasibility, ecological cleanness, operating safety and reliability, then such Program indicators as the energy efficiency level and the share of renewable and inexhaustible energy sources in the world's energy balance will be really doubled in accordance with the SEFA Program, and can be even surpassed. And in this way, a strong foundation for Sustainable Energy for All will be created.

HYBRID WIND SYSTEMS FOR THE SUPPLY OF SERVICES IN RURAL SETTLEMENTS OF SOUTH MEDITERRANEAN COUNTRIES – CASE STUDY OF THE HYBRID SYSTEM IN EGYPT



*Essam Sh. Mohamed,
G. Papadakis,
G. Kyriakarakos,
Agricultural University of Athens*

*Abdel-Wahab S. Kassem
Alexandria University, Faculty of Agriculture, Greece*

Agricultural University of Athens, Faculty of agriculture of Alexandria University are large scientific and educational institutions of Greece engaged in research in the field of agriculture. In recent years, they also develop research in the direction of alternative energy sources.

Hybrid renewable energy systems is one of the most promising applications of renewable energy technologies in remote areas, where the cost of grid extension is prohibitive and the price of fossil fuels increase drastically with the remoteness of the location. Applications of hybrid systems range from small power supplies for remote households providing electricity for lighting or water pumping and water supply to village electrification for remote communities. Also the problem of energy storage could be addressed by the use of a hydrogen subsystem, which is an alternative to diesel generators as a backup and can help to reduce dramatically the

size of the battery banks as well. The strategic objective of the HYRESS project is to remove the knowledge barriers against the installation of Renewable Energy Systems and creation of micro and mini-grids. An efficient tool to apply and fulfill the strategic objective is the development, installation, testing and evaluation (technically and socially) of the performance of low-cost pilot hybrid renewable energy systems and mini-grids in selected remote sites far away from the grid, of Mediterranean Partner Countries. This paper describes the three hybrid systems in general and analyzes the hybrid system installed in Egypt as a case study.

Introduction

The strategic objective of the HYRESS project is to remove the knowledge barriers against the installation of Renewable Energy Systems

and the creation of mini-grids based on renewable (RES). Research challenges can be found in the field of system management but also best combination of available technologies according to the local prevailing conditions, that is build up hybrid systems to match a varying supply with very different consumption profiles. For reducing expenses it is also very important to minimize the system storage requirements. Next to this excellent system management, the technology design has to carefully adapt to the extreme framework conditions:

- The technologies have to be very robust and designed for the local climatic and social conditions
- The requirements for service and maintenance must be very low
- The technologies should be cost effective and preferably locally manufactured
- Appliances must have low levels of energy consumption, and be able to cope with the power supplied from stand-alone systems (e.g. fluctuating power, Direct Current or Alternating Current supply etc.)
- Several system typologies is examined i.e. Direct Current based versus Alternating Current mini grid systems for optimum and continuous power and energy supply.
- The storage systems have to perform well under the high temperature conditions of the MPC. Under these conditions the research that has already taken place for the operation of hydrogen subsystems is minimal and so this project will provide valuable new data. This paper describes the three hybrid mini grids that have been designed and being installed within the HYRESS project. The hybrid minigrid that has been already installed in Egypt is presented as a case study of the design, installation and data monitoring of a hybrid renewable energy system.

Description Of The Hybrid System To Be Installed In Tunisia

Ksar Guilène can be described as a “renewable village”. There are several solar home systems, stand-alone photovoltaic system, solar thermal equipment and a wind turbine. There are 50 families, about 300 people, and most of them work in the tourist area. About 47 houses, each of which has 100 W, solar home system

connected in the DC bus. This PV system supports the house electrification and other little consumers. While, the mosque, the primary school and the health centre are covered by a stand alone wind energy system.

Nowadays it is well known that more flexible systems, with consequently modular structure systems, are achieved via coupling all consumers and generators on the AC side. The structure of such supply systems requires, in addition to the power conditioning equipment, a control and supervision unit which is responsible for implementing a specific operation control strategy and for securing the grid and system components. In small and medium power systems (3–30 kW) this control unit is often integrated into the key component (bi-directional battery inverter) which simplifies system operation and decreases the investment costs. This distribution also helps to reduce the cost of the entire system, especially the costs for the cabling on the DC side and the subsequent distribution on the AC side, see Fig. 1.

The hybrid minigrid in Tunisia consists of one small wind turbine of 1 kW nominal power, 6.5 kWp PV modules, 3000 Ah/48 V solar batteries, two Sunny Boy 3000 grid inverters, one Sunny Island 5048 bidirectional battery inverter and one Windy Boy 1100 inverter for the wind generator. This minigrid aims at covering the energy needs of the houses of the village while the other buildings needs will still be covered by the already exists wind turbine. The meteorological data are collected by the SMA SensorBox that collects data such as wind speed, solar irradiation and ambient temperature. The data monitoring is performed by using the SMA WebBox that collects all data from the inverters and send it to a remote PC via GSM modem. The data monitoring plan is shown in Fig. 2

Description Of The Hybrid System To Be Installed In Morocco

Energy storage plays an important role in the development and operation of a RE system. The integrated wind and solar energy system, based on long-term seasonal storage as hydrogen, is considered a promising alternative to overcome the intermittence of the RE sources. In comparison to commonly used battery storage, hydrogen is well suited for long-term (weeks) storage

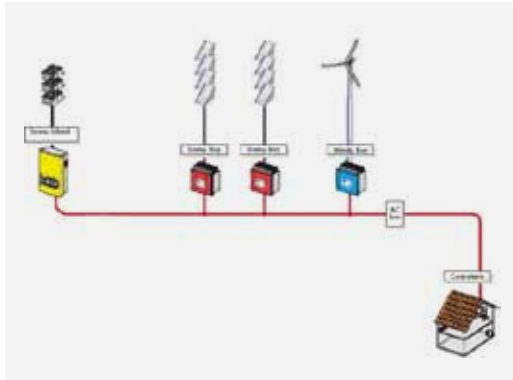

Figure 1: the Hybrid mini grid in Tunisia [4]

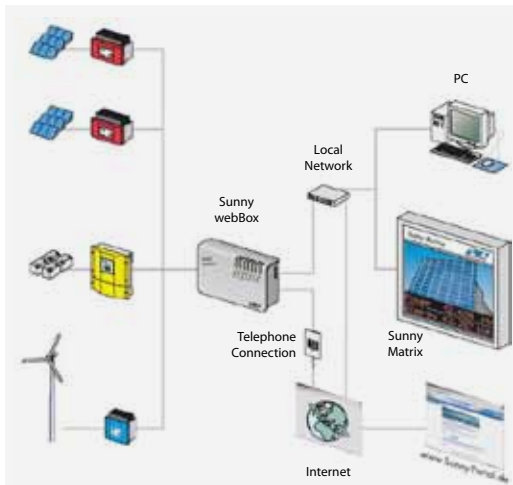

Figure 2: Data monitoring concept [4]

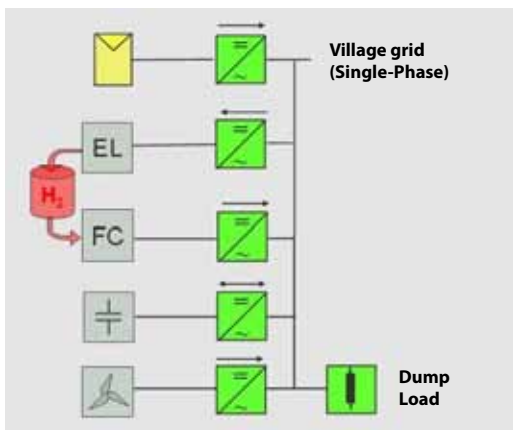

Figure 3: Concept of hydrogen based hybrid system

applications, because of its high mass energy density.

A typical autonomous RE-hydrogen system must include both short-term and long-term energy storage. A battery bank is used for short-term energy storage due to its high charging-discharging efficiency, and to take care of the effects caused by instantaneous load and electrolyser transients and wind energy peaks. Batteries alone are not appropriate for long-term storage because of their low energy density and self-discharge.

The combination of a battery bank with long-term energy storage in the form of hydrogen can significantly improve the performance of a stand-alone RE systems. In such a RE system, the electrolyser generates hydrogen during times when excess solar and wind energy is available and then the fuel cell utilizes this hydrogen to produce electricity when there is insufficient solar and wind energy. The intent of this part of project is to demonstrate that hydrogen is reliable energy storage medium for RE and that it is safe. Fig. 3, system shows the concept of hydrogen based hybrid system to be installed in Morocco.

Case Study Of The Hybrid System Installed In Egypt

Description of the site

The site is located in east of El-Gaar Village. It is about 125 Km south of Alexandria and belong to Behera Governorate. The site is a new reclaimed desert land. Currently, the main activities of the people who live in the area are farming. There are seven houses and a mosque. The main agriculture production is olives, tomatoes, onion, potatoes, and sun flowers. Most of the people live in the area are farm workers with low income.

The electricity production from the hybrid system will serve only the houses that are near to the site (7 houses) and the mosque. About 20 farmers live at these houses. More than 200 people who live some kilometers far from the site, are expected to come also to the site to get desalinated fresh water. The number of people benefiting from the drinking water is expected to increase in the near future. Due to the success of the Hyress concept as a show case, the mosque has been built just after the installation

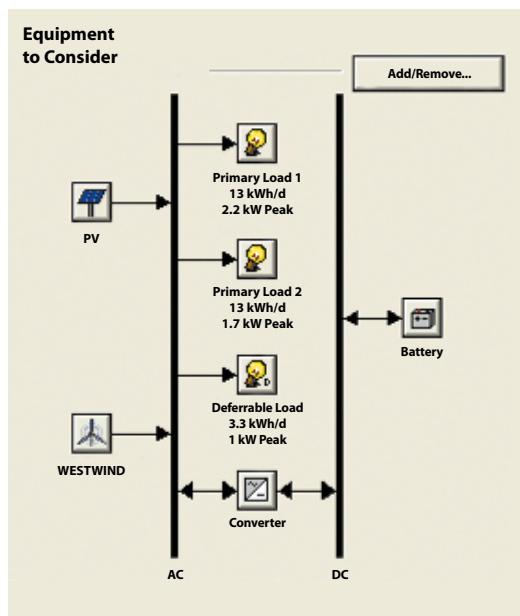

Figure 4: Layout of the system in HOMER

of the hybrid system has been completed, which is a good signal of the development of the village.

Available renewable energy potential

Egypt is a country of abundant solar radiation. At the selected site, the average solar radiation reaches the value of 7.5 kWh/m²/d in June. As far as the wind energy concerned, at the site and according to the nearest weather station the annual average wind speed was recorded to be 6 m/s. which leads to the conclusion that exploiting wind energy in this site is visible.

Preliminary design of the hybrid system

The aim of the preliminary design of the hybrid system was to roughly determine the size of the PV array, the wind turbine and the battery bank required to cover the energy needs of the electrification, water pumping and the desalination unit. HOMER software was used [1] for the preliminary design, simulation of the hybrid system. The model inputs, which describe technology options, component costs, and resource availability, were provided. HOMER uses these inputs to simulate different system configurations, or combinations of components, and generates results that could be viewed as a list of feasible configurations

sorted by net present cost. HOMER also displays simulation results in a wide variety of tables and graphs that help the user to compare configurations and evaluate them on their economic and technical merits. Also HOMER performs sensitivity analyses that explore the effect that changes in factors such as resource availability and economic conditions might have on the cost-effectiveness of different system configurations

The input data used in HOMER is as follows: The PV system sizes realized was between 5–10 kWp, 5 kW wind turbine, a battery bank size of 0–24 items 3000 Ah/2 V and a bidirectional inverter power of 0–20 kW. A layout of the system is shown in Fig. 4.

The electrical load is divided into three types; the first of which is the electrification load which is about 1 kW. The electrification load presents some lamps for street lightening, electrification of the houses which contains some basic electrical equipment such as color TV, radio, refrigerator and in house lightening. The water pumping system which has a power of 1 kW is represented in HOMER as a deferrable load which is an electric demand that must be served within some time period, but the exact timing is not important. The desalination system which has a power of 2.2 kW, is represented in HOMER as a primary load operating as many hours so as to cover the water needs of the populations. The average total daily energy needs were calculated to be 24 kWh/d. The preliminary design and simulation results of HOMER are summarized in Table 1.

Detailed design of the hybrid system

The main goal of the detailed system design is to specify the technical characteristics of the subsystems, such as the RO unit, the water pumping system, and the electrification and the microgrid subsystem.

In order to size and simulate the RO unit operation, the ROSA (Reverse Osmosis System Analysis) software was used. This software is provided by Dow Chemicals [2], the Filmtc membrane manufacturing company, it provides detailed information about the organization of membranes in the pressure vessels, the effect of variable parameters such as feed water salinity and temperature, in the quality and quantity of the product water. Some of the input data for ROSA are shown in Table 2.

Table 1: HOMER simulation results

Component	Value
PV system	7 (kWp)
Wind Turbine	5 (kW)
Battery Bank 2V /3000 Ah	2 (Items)
Power Inverter	1 (kW)
Annual Energy Production	19186 kWh/y

Table 2: Input data for ROSA software

Description	Value
Feed water salinity	2500 ppm
Potable water needs	30 m ³ /d
Feed water intake	Brackish water 120 m depth
Design feed water temperature	25 °C
PH	7,6
Type of membranec	BW30-4040
Fouling factor	85%

Table 3: Specification of the desalination unit

Description	Value
Feed Flow	2,50 m ³ /h
Feed salinity	2500 ppm
Number of elements	6
Number of pressure vessels	1
Water recovery	50%
Permeate flow	1,25 m ³ /h
Permeate salinity	50 ppm
Energy consumption	0.9 kWh/m ³

After several runs of the software, a brackish water desalination unit of the following specifications was designed as shown in Table 3.

The aim of realizing a water pumping system is to provide feed water for the desalination system and if possible, the excess water will be directed to irrigation.

The WinCAPS software [3] was used to design the pumping system which contains of the submersible multistage centrifugal pump, electric motor, cables, pipes and water tank,. For a 100 m pumping depth and a flow of 24 m³/d. The selected pump was found to be the Grundfos SQ-1-110, see Fig. 5

The renewable energy production system consists of one wind turbine with the associated inverter, PV modules in string configuration and string inverters, solar battery bank and battery inverter. The PV system and the string inverters were designed using the Sunny Design software v1.41 from SMA [4]. The inputs and outputs of this design tool is as follows:

- The PV data base of the software was edited by Thin film PV modules, the site was selected, and inclination angle was set to 20° north facing and first estimation of the peak power to be installed to 6 kWp.
- The second step was to select the suitable type and size of inverter after several runs of the software till no warning messages of the software appear. By this, two inverters SB3300 were needed as well as 72 PV modules in two strings each contain 36 modules.
- Finally, the final results are reported. The results for the PV systems and string inverters are summarized in Table 4.

No specific software was used to size the battery bank. The size of the battery was calculated based on the following basic battery capacity calculation equation:

$$C_{nom} = \frac{E}{\alpha \cdot \beta \cdot V} = \frac{30000}{0.85 \times 0.8 \times 48} = 1470.58 Ah$$

When C_{nom} is the battery capacity in Ah, E is the energy storage needs in Wh, α is the battery efficiency, β is the battery depth of discharge and V is the battery bank voltage. These calculations resulted in a battery capacity of approximately 1500 Ah. The selected battery bank and its char-

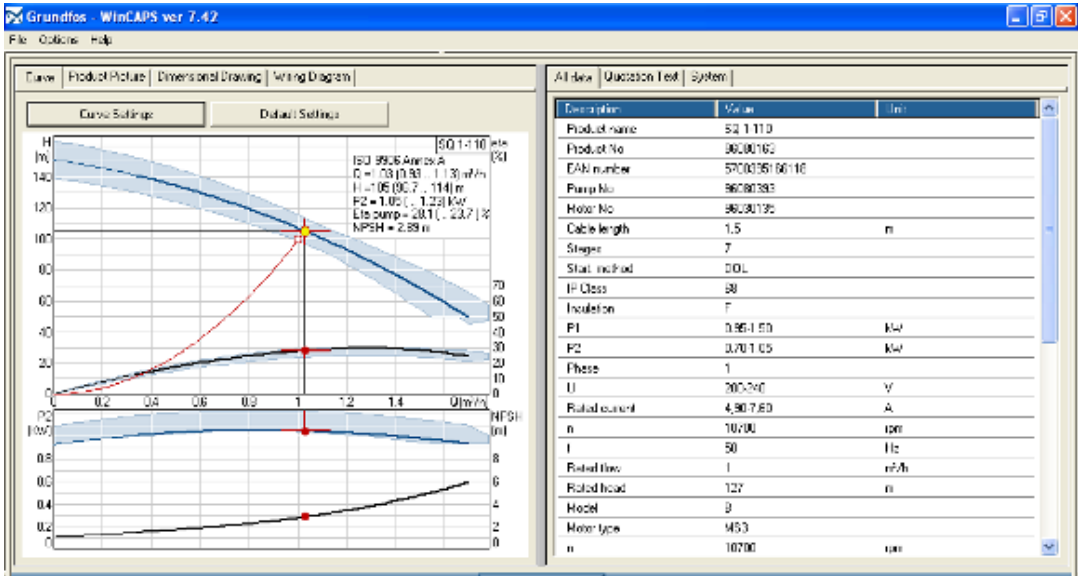

Figure 5: Results from WinCAPS software [3]

acteristics are shown below in table 5.

The size of the wind turbine was predetermined to be 5 kW. This installed power will allow about 50 to 60% of wind energy penetration in the hybrid system as this has been calculated from HOMER. A bio diesel generator 5 kVA is also included in the hybrid system as a back-up system in order to increase system reliability and sustainability. Finally the electricity was delivered to the houses nearby the installation covering basic energy needs such as lightening, refrigeration and TV.

Total system simulation

In order to simulate and design such complex system, see Fig. 6., the TRNSYS software was used [5]. TRNSYS is a transient systems simulation program with a modular structure. It recognizes a system description language in which the user specifies the components that constitute the system and the manner in which they are connected. The TRNSYS library includes many of the components commonly found in thermal and electrical energy systems, as well as component routines to handle input of weather data or other time-dependent forcing functions and output of simulation results. The modular nature of TRNSYS gives the program tremendous flexibility, and facilitates the addition to the program

of mathematical models not included in the standard TRNSYS library. TRNSYS is well suited to detailed analyses of any system whose behavior is dependent on the passage of time.

Monitoring and master control system

The data monitoring system (see Figure 7) was designed to support all subsystem components. Hence, it has also modular configuration and is divided into subsystems as follows.

- Energy system data monitoring: The energy system consists of the wind turbine, PV system, solar batteries, inverters and bio diesel generator. All corresponding parameters of the energy system are managed by the Sunny Boy control Plus that provides system monitoring, remote diagnostics, data storage and visualization. It continuously gathers all data from the inverters and thereby allows for constant information of the power system status.
- Meteorological station data monitoring: besides the Sunny Boy Control Plus, the Sunny SensorBox is also used for connecting the wind speed, ambient temperature and the wind direction sensors. The solar irradiance sensor is already included in the Sunny SensorBox.
- The desalination and the water pumping system have their own sensors such as flow, pressure energy and temperature sensors that

Table 4: Summary of the PV system design

Parameter	Value
PV peak power	7.62 kWp
Total number of modules	72
Number of inverters	2
Annual energy production	11.115 kWh/y
Type of inverters	SB3300
Type of PV modules	Sharp NA-901(WQ)
Number of strings	2

Table 5: The battery bank characteristics

Parameter	Value
Type of battery bank	Vented stationary lead acid batteries, from Hoppecke, 12 OPzS 1500
Nominal capacity at 10 hr rate @ 20 °C	1500 Ah
Nominal voltage	2 V
Internal resistance	0.21 mΩ

are collected and storage in the Sunny Data Control by using the analogue and digital kit of SMA.

- Electrification monitoring is done by using electronic energy meter for all the electrification line houses.

Control of the system

The controller is realized through a Siemens Logo! PLC using also 3 relays from the installed SMA Sunny Island 5048 inverters. The control cycle is set at 15 minutes. This period was chosen since this is the minimum time for optimal desalination unit operation and since the rest of the devices could be turned ON and OFF in smaller time periods. Three control schemes run in parallel:

1 Double hysteresis control scheme

This is one of the most used schemes in PV/ Wind – Hybrid systems control [6,7]. The hysteresis is used to prevent the devices to be turned ON or OFF continuously. In the system hysteresis is used for the diesel generator and the 2 consumptions (pumping and desalination unit). When the SOC of the battery is as low as 40% then there is an ON command to the diesel generator. When the battery is charged and the SOC reaches 70% then there is an OFF command to the diesel generator. This is actualized directly by the first relay contact present on the Sunny Island 5048. When the SOC of the battery is higher than 90% then both of the consumptions can be turned ON (that is decided in cooperation with the following two control schemes). When the SOC of the battery is between 80% and 90% only one of the consumptions can be turned ON (which one is decided in cooperation with the following two control schemes). When the battery is discharged and the SOC falls below 80% then both consumptions are turned off. The SMA Sunny Island 5048 features two relay contacts which can be programmed to turn ON and OFF in relation with the SOC. Since there are 2 inverters a total of 4 relay contacts exist. As it was mentioned above the first is controlling directly the diesel generator. Two more are programmed to give an ON/OFF command according to the SOC limits mentioned above.

2 Safety scheme

The control algorithm always checks if there is enough water in the brackish water tank and enough space in the potable water tank before turning ON or retaining the ON status of the desalination unit. This means even if the SOC is higher than 90% not always both or even one of the devices are turned ON. If the SOC is between 80% and 90% then the safety scheme in cooperation with the third scheme decide if the devices are going to be turned ON/OFF. If both tanks are full both devices are turned or remain OFF.

3 Hierarchy of the consumptions

Desalinated Water is considered to be more important than pumped brackish water. This is the reason why the controller gives priority to the desalination unit in comparison to the pump. This means that if the SOC

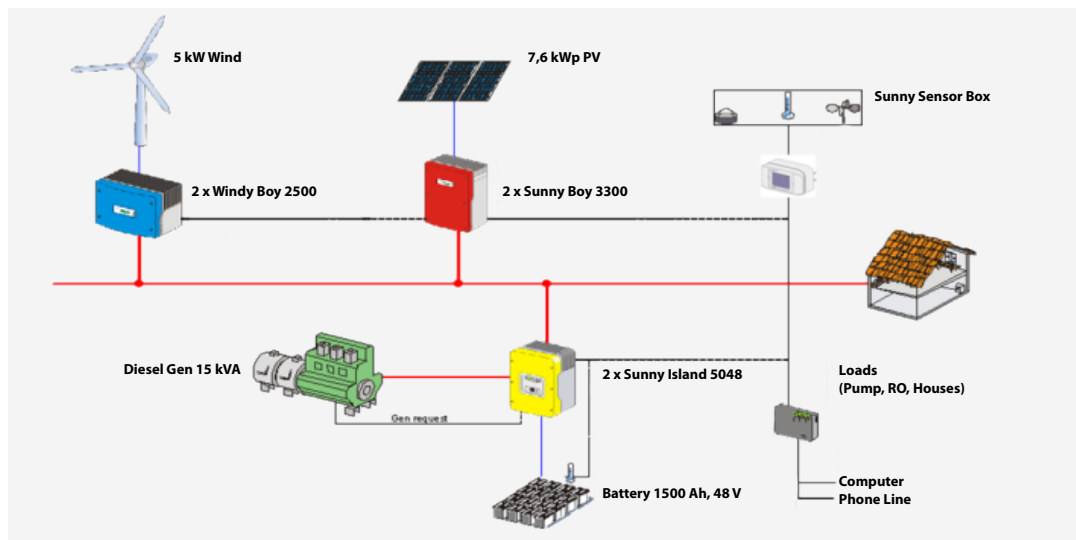

Figure 6: Layout of the hybrid system in Egypt

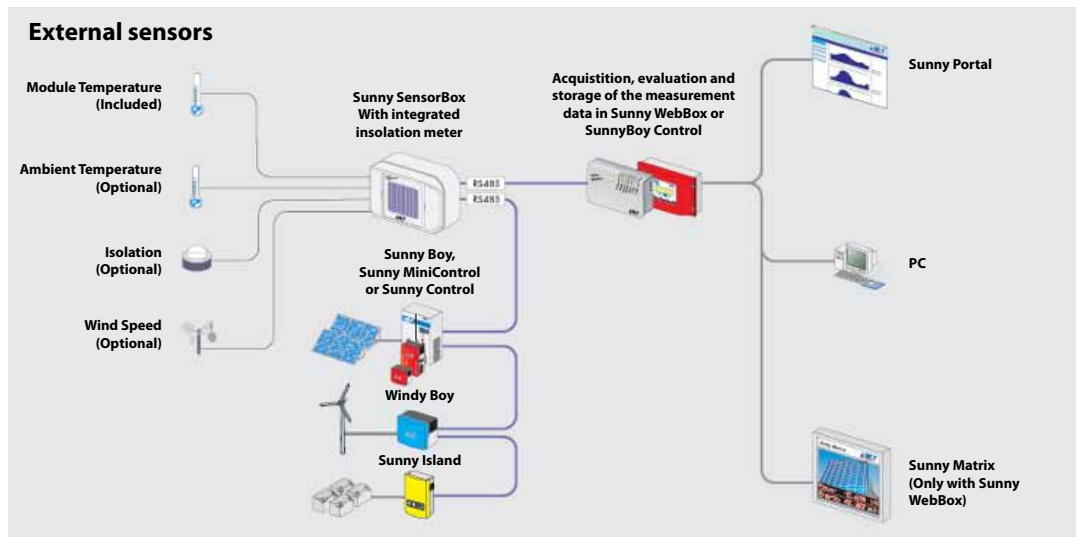

Figure 7: The monitoring system of the hybrid system in Egypt [4]

is between 80% and 90% and the second schemes gives a green light to both consumptions then the desalination unit is going to be turned or remain ON. If the second scheme gives a red light to the desalination unit then the pump is going to be turned or remain ON depending on the status in the previous control cycle.

This simple yet effective control algorithm was realized with robust and relatively low-

cost hardware and makes possible the automatic and optimized operation of the system

5 Some real data from the operation of the system

The hybrid system has been installed successfully in February 2009. Since the installation continues fine tuning is performed to the several parts of the system. Also new sensors have been added, to the desalination system and

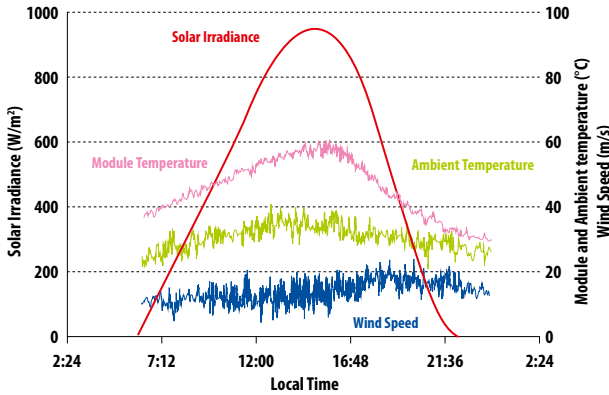

Figure 8: Available meteorological data at the site

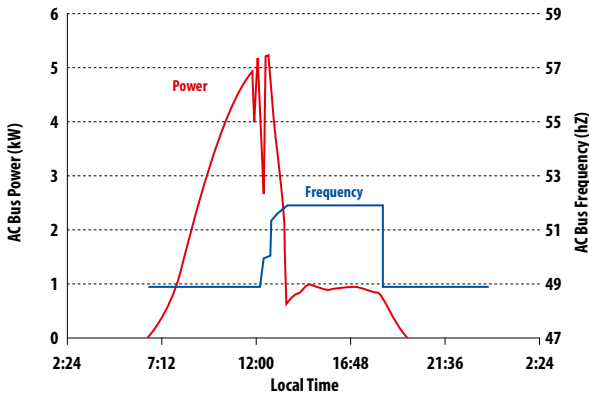

Figure 9: AC power production

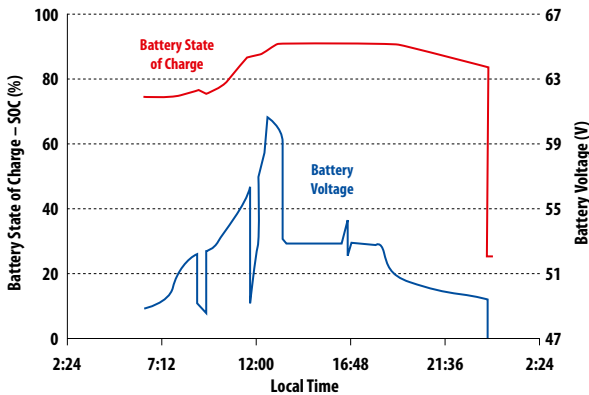

Figure 10: Charging and discharging of the battery bank

the Sunny Boy Control Plus data logger. Fig.8 shows the available meteorological data in the site in 23/7/2009. The data represent the solar irradiance, the ambient temperature, the module temperature and the wind speed.

Fig. 9. presents the AC bus power produced from the PV array and the bus frequency. The produced power was recorded to be 5.2 kW. This power is used mainly to cover the loads and to charge the batteries. The frequency control strategy of the Sunny Island is also presented in Fig.9, which shows that when the stat of charge of the battery reach 90% (Fig. 10) and there are no electrical consumption, the Sunny Island inverter increases the frequency of the AC bus (Fig. 9) to reach the value of 52 Hz. This frequency prevents the Sunny Boy inverters (PV inverters) from producing more power to the AC bus.

The state of charge and the battery voltage are shown in Fig.10 which presents the charging and discharging procedure of the battery.

References

1. The Micro Power Optimization, HOMER. Also available at: www.nrel.gov/homer.
2. DOW (2007). ROSA, Version 6.1. Dow Liquid Separations. Also available at: <http://www.dow.com/liquidseps/design/rosa.htm>.
3. GRUNDFOS, WinCAPS Version 7. Also available at www.Grundfos.com/wincapssupport.
4. SMA Solar Technology, Sunny Design Software. Also available at: <http://www.sma.de/en/products/software/sunny-design.html>.
5. Transient Systems Simulation Program, TRNSYS version 16 (2008). The University of WISCONSIN MADISON. Also available at: <http://sel.me.wisc.edu/trnsys/>.
6. Zhou K, et al. Optimal energy management strategy and system sizing method for stand-alone photovoltaic-hydrogen systems. Int J Hydrogen Energy (2007), doi:10.1016/j.ijhydene.2007.09.027
7. Oystein Ulleberg, The importance of control strategies in PV–hydrogen systems, Solar Energy 76 (200)

Research results described in this article, were initially presented at the 24th European Photovoltaic Solar Energy Conference, held in Hamburg, Germany on 21–25 September 2009 and published in its proceedings.

COOPERATION IN THE FIELD OF “GREEN” ENERGY: THE DIALOGUE BETWEEN RUSSIA AND DENMARK.



*Valery Okulov,
Institute of Thermophysics, Siberian Branch of Russian Academy
of Sciences.*

Currently, there is no doubt that we need to develop “green” energy. Climatic deterioration makes this task a priority development issue of the entire international community, regardless of any political nuances. As long as it is clear that only by joint efforts the society can cope with this man-made challenge of disrupted heat balance on the planet, of the foremost importance is an ongoing dialogue between scientists from different countries which would let them share knowledge, views and data in order to obtain an objective assessment of the current situation and prepare recommendations for further industrial development of society and renewable energy sources (RES) utilization.

In pursuit of this goal, establishing a direct dialogue between Danish and Russian scientists, a series of roundtables under the general name "Energy Cooperation (Interdependence) – Dialogue between Russia and Denmark" has been organized. It was initiated by the Russian Centre of Science and Culture in Copenhagen (<http://ruscenter.dk/index.php?id=424>). The events were supported by the Russian Federation Embassy in the Kingdom of Denmark, while Russian scientists now working in the Danish energy research and education centers actively participated in these events and contributed substantially to their scientific supervision. Three meetings in the Russian center in Copenhagen have been held and it would be desirable to hold them annually on a regular basis. Indeed, it is undeniable that such a contact pattern is direct interpersonal interaction and might contribute more to the development of bilateral and multilateral scientific and cultural cooperation than some formal treaties and agreements, which are often left unrealized.

Our first round table was held on June 18, 2012 in Copenhagen and presented brief updates of a comprehensive topic, i.e. “Energy efficiency and renewable (green) energy”. Despite the wide range of the topics, we were able to gather leading experts and discuss with them issues of common interest at this meeting. First of all, European and Danish green energy developments were presented there. The roundtable was open by Michael Ertmann, Vice President at DONG Energy, who said that his company’s cooperation with "Gazprom", introduction of "Nord Stream" and gasification of its energy facilities in Europe resulted in a significant reduction of atmospheric emission of pollutants, and in a step towards the “green” energy standards. Then, Anja Pedersen, Consultant of Danish Wind Industry Association, talked about the wind energy development in Denmark as the most important country's energy sector. Professor Eigil Kaas, University of Copenhagen, presented his "Energy, Environment and Health" communication in which he generally dispelled the unreasonable concerns of Russian skeptics regarding renewable energy due to alleged environmental damage. Another important issue was brought up by

S.V. Alexeenko, Corr. Member of RAS and Chairman of the Energy Saving Coordination Council. He emphasized an exclusive importance of energy saving, since the energy saving equally contributes the environmental protection. Besides, some matters of Russian wind energy resources were raised (refuting another thesis of Russian skeptics regarding RES utilization that "there is no wind in Russia") and important issues of education in the field of RES R&D. Hence, our first round table turned out to be very helpful, but oversaturated a bit with too many important "green" energy development tendencies at once.

Taking into account this experience, we decided to devote further our meetings to individual specific issues of renewable energy development. The following round table, held on September 23, 2013 in the Russian center, was dedicated to the issues of education in the RES area. We addressed issues of potential integration of the Russian educational system into the already existing European educational system. Professor Jørgen Kjems, Developer of the European RES Roadmap on Education, proposed to integrate several specific Russian universities into the European educational system, and Professor Jens Sorensen, Danish Technical University (DTU), proposed potential training of specialists, including advanced training of RES academic teaching staff, based on the DTU experience. Indeed, DTU is currently the best European university in the RES R&D; enough to mention that DTU together with Siemens and Vestas participates in creating a unique Scientific and Experimental Wind Farm, consisting of the most advanced and powerful wind turbines (including the most powerful turbine of 5 megawatts with its wheel size up to 160 m in diameter and tower height up to 180 m). It is interesting to note that this discussion started in Copenhagen was continued at the first session of the International Forum "Renewable Energy: Towards raising energy and economic efficiencies" – REENFOR-2013, held in October 2013 in Moscow.

It so happened that during the Forum I and my colleagues Jens Sørensen and Jørgen Kjems discussed the pilot project on creation of Energy and Educational Cluster at Russky and Popov islands based on the facilities of Far Eastern Federal University (FEFU). We highly evaluated the significance of this project and discussed the ways it can be supported by the Danish side, specifically through participation in various joint projects of the Ministry of Education and Science or other funds. We may soon identify the first concrete participant for implementing Jørgen Kjems' proposal on potential integration of several leading Russian universities for RES in this Roadmap and it can be FEFU. This step will allow access to specialists' training plans and work programs for RES utilization at all leading European universities. Another Forum recommendation was about the need to continue organizing our RES-themed round tables.

The third round table was held on March 17, 2014 at the Russian Centre in Copenhagen. We touched upon a very important topic, i. e. creating of new Russian Wind Atlas and advanced features of experimental data verification. Danish side took initiative, since Danish scientists were co-authors of the first Russian Wind Atlas, published in 2000, and they very well understand the importance of such wind power potential assessment.

Now the situation is as follows (regardless of today's skepticism about the Russian Wind Industry development): the wind is a powerful energy source and the country's energy potential component; it should be properly studied and evaluated. Indeed, there is no doubt that we need to prepare and update hydrocarbon deposit maps, even for future use, i.e. not always for their immediate and speedy recovery. Similarly to hydrocarbons, the wind carries a huge energy potential, which can be effectively used as already been proved in many countries. Notably, this potential just needs to be known in order to properly assess the country's energy potential. European countries understand its value, as follows from the report presented by Professor Erik Lundtang Petersen and dedicated to the development of a new European Wind Atlas. There has been designed a detailed Roadmap, which spells out not only implementation stages, but also funding sources. Unlike the European Wind Atlas, the situation with the new Russian Wind Atlas

is much worse. As evidenced from the presentation made by V. Nikolaev, Dr. Sc. Eng., there is only one initiative group for the development of Russian Wind Atlas, under his headship, at “Artemograf” Scientific Information Center. This team of enthusiasts, surely, needs to start with the development of Roadmap for creating Russian Wind Atlas. It would be appropriate to see involvement of relevant Russian government agencies in these useful initiatives.

Both authors pointed out the reasons for creating new European and Russian Wind Atlases. This is primarily due to an increase of wind turbine sizes as compared to their height, which specified creating of old Atlases (European in 1986 and Russian in 2000). As far as wind speed increases at high altitudes, so large kinetic energy can be recovered. Second question — how to verify the mapping accuracy? Certainly, they contain quite adequate hydrodynamic models for the calculation of atmospheric boundary layer, but they must be verified and checked. To create these models, we obviously use modeling and measurement data of turbulent boundary layers at wind tunnels, but for these purposes we need the largest and costly wind tunnels. Such super-large tunnel, not only for these purposes, is being created in DTU, while we in Russia can use TsAGI tunnels in Russia. However, these model tests are certainly not sufficient. We need full-scale experiments usually carried out at new-built costly 200-300 meter measuring towers, but these cannot be built throughout the country, especially as big as Russia. One real opportunity is to use aircraft laboratories, as suggested by E.V. Son, Corr. Member of RAS, RAS JIHT Deputy Director. Another opportunity is to use different laser Doppler velocimeters. Kurt S. Hansen spoke about currently used LIDARs, whose accuracy, however, is not enough to prepare reliable wind maps. Concluding this meeting I.V. Naumov, Dr. Sc. Eng., pointed out the possibilities of developing more accurate and efficient velocimeters.

"DEVELOPMENT OF THEORIES OF OPTIMAL ROTORS" BOOK PUBLISHED

"Energy Bulletin" would like to inform its readers of a remarkable book, dedicated to the 100th anniversary of Vortex Theory of the Screw Propeller developed by Professor N. Zhukovsky. The book is entitled "Development of theories of optimal rotors" and was published in Russia in 2013.



The book was prepared for publishing by an international team of authors: Professor V. Okulov, Institute of Thermophysics, Siberian Branch of the Russian Academy of Sciences, Professor J.N. Sørensen, Danish Technical University, and Professor G.A.M. van Kuik, Dutch University of Delft. It is directly relevant to fundamental and applied aspects of wind energy, which comes from its name, "Development of theories of optimal rotors", without the knowledge and everyday use of which the success of wind energy seems very problematic. But it's not only for these facts the this book is extremely interesting. It gives a retrospective of the development of scientific aerodynamic thought which led to the creation of the wind energy fundamental principals. Paying tribute to all known European scientific schools that made their valuable contributions to this process with the results utilized by the modern wind industry, the authors have dedicated their work to the 100th years' anniversary of Vortex Theory of the Screw Propeller developed by Professor Nikolay Zhukovsky, known by international scientific and engineering communities as one of the founders of the science called "aerodynamics". Fundamentals of this theory were stated in first Joukowsky's papers, published in Russia in the early XX century, and further developed in series of scientific articles, and the last work was published in 1920, where the great scientist came to a conclusion about the maximum possible coefficient of using wind energy in wind generator.

In the same year an article was published by Albert Betz, a student of Ludwig Prandtl, a remarkable German scientist. The article was devoted to the maximum limit of wind energy usage. It was recognized by scientific "aerodynamic" community, which appreciated the results of Betz studies and called this maximum limit the "Betz limit".

It may seem a miracle that two schools or two scientists, as a result of their research works — which were separated not only by a considerable distance, but carried out in politically isolated countries (first war, and then revolution), and not being bound by existed at that time means of communication — came to similar scientific conclusions and created the fundamentals of the effective wind energy technologies! To some this may seem like a real miracle, but in science it happens quite often, and it is an awesome phenomenon of science and the process of knowledge "generation", which can hardly be found in other areas of human intellectual activities. And so it happened that two almost identical results obtained in Germany and Russia, received the name of only one of the authors, namely A. Betz, in view of the fact that the results were published in certain periodicals in Germany and other European countries, while as N. Zhukovsky's articles saw publication only in Russia and the references to them were made in other countries with a delay of almost two decades.

So why is there the need for international recognition of the role of Professor Zhukovsky in the development of wind energy theoretical foundations, the scientist who not only received national and international recognition as one of the founders of a new scientific field in fluid mechanics, named as aerodynamics, and as "the Father of Russian Aviation", but whose name is also given to a science city (possibly the first Science, Technology and Innovation Centre in the world) also in respect of his role in modern science?

Here, we see another extremely important phenomenon of science — not to forget anyone who made contribution to the development of its branches, which for some reason were not immediately demanded, and the need for them for several reasons appears somewhat later. During the development process of wind energy, whose success depends on the wind turbine rotor performances, the international scientific community recalled the works of Joukowsky in this area and concluded that the limit of energy extraction by wind energy generators should be called "Betz-N. Zhukovsky limit". This statement was made at the International Conference "The Science of making torque from wind", held in October 2012 in Oldenburg, Germany.

This book, giving a fascinating retrospective of aerodynamics development, represents an analysis of the key theories of optimal rotor and provides new analytical solutions for ideal rotor with finite number of blades.

It should be interesting for a wide range of researchers who deal with solving theoretical and applied aerodynamics problems, primarily related to wind energy. It was published by NIC Publishing House "Regular and chaotic dynamics" in Russia in 2013. The book purchase conditions can be found on the website <http://www.ozon.ru/context/detail/id/23074844>.

The book is published in Russian and "Energy Bulletin" hopes that it will be translated and published in other languages. "Energy Bulletin" presents to its readers the "Preface" and "Appendix" to the book, which best represent history of the concept evolution from its beginning to the present days.

V.L. Okulov, J.N. Sørensen and G.A.M. van Kuik
"DEVELOPMENT OF THEORIES OF OPTIMAL ROTORS.
100 years of Vortex Theory of the Screw Propeller by prof. N. Zhukovsky"
(Parts from the book)

Foreword

This work of leading experts on the rotor aerodynamics, professors Okulov, Sørensen and van Kuik is devoted to glorious date – 100th Anniversary of the publication of Professor N. Zhukovsky on a new vortex rotor concept theory in the first article of "Vortex Theory of the screw propeller" series. Joukowski's article was dated 1912, but according to Mr. Vetchinkin it was published in early 1913; while the first presentation was to the Moscow Mathematical Society on October 14, (1 by Julian calendar), 1912.

Rotor Vortex Theory is recognized as one of the major achievements of fluid mechanics in the twentieth century. It is very remarkable that its creation is associated with the name of our great compatriot, Professor Nikolai Zhukovsky, who was well in advance of the relevant researches abroad. Said series of his articles still, a century later, remains the basis for the calculation of air and water propellers, wind turbines, compressors and turbines, as one of the most complex and wonderful chapters of modern aerodynamics.

In respect of the Zhukovsky theory anniversary, the first introductory section of work presented here describes the history of the rotor aerodynamics, where in the early twentieth century the dominant role was that of the Russian scientific school headed by Professor N. Zhukovsky. Explaining to readers the significance and topicality of Joukowski rich scientific heritage, the authors describe the current state of the main theories of optimal rotor amidst their historical perspective. As a result of meticulous work with originals they are able to restore joint priority of N. Zhukovsky and A. Betz in getting a very important result for the wind energy thriving today in Europe: about the maximum energy value that can be extracted from the wind kinetic energy. A century later, this result was returned to the Russian science, as the authors stated, not only in this paper, but also on the pages of popular international magazine for wind energy (Okulov & van Kuik, Wind Energy 2012) and in a special lecture at International Forum "The Science of Making Torque from Wind", Oldenburg, 2012.

It is important that beside the historical aspect the authors presented in this paper their original research, greatly enriching the rotor vortex theory created by Zhukovsky. First, they have successfully completed a rigorous mathematical analysis in the annex to the wind turbines with small rapidity values, in order to understand the paradoxical unlimited growth of CWEU (Coefficient of Wind Energy Usage) as defined by Zhukovsky's generalized impulse theory.

The most significant result of the work consisted in obtaining an analytical solution for the finite number of rotor blades and the finite size of the nucleus tip vortices. Exactly this concept of vortex rotor was proposed by N. Zhukovsky a century ago, but due to the analysis complexity its solution at that time was not found and only the limiting case of an infinite number of blades was studied. Moreover, the approach proposed by these authors for this solution allowed analyzing and comparing the other well-known concepts of optimal rotors (Betz, Goldstein, Theodorsen) and finding out that the Zhukovsky's optimal rotor is more effective for its operation modes as a wind turbine.

THE INTERNATIONAL SCIENTIFIC COMMUNITY CELEBRATED 100 YEARS OF THE ROTOR VORTEX THEORY OF PROF. ZHUKOVSKY

October last year marked the 100th anniversary of the rotor vortex theory (screw propeller, propeller, wind turbine, etc), one of the most significant works of the great Russian aerodynamics scientist Nikolay Zhukovsky. The theory was published in the first article of "Vortex theory of the screw propeller" series, released at the end of 1912. The screw theory is the most difficult and important chapter in aerodynamics. And that publication first generalized the results concerning flowing around individual bodies and wings, for rotating objects, i. e. blades. The Vortex theory make it possible to explain their working principle: the creation of the propeller thrust and turbine torque. Vortex calculating method proposed by Joukowsky a century ago is still widely used in designing rotor blades for different purposes.

A special session at the 4th International Conference, titled a bit unusually, "The Science of Making Torque from Wind", (Oldenburg, Germany) was dedicated to the 100-year anniversary of this theory. The conference was devoted to the aerodynamics of wind turbines, it was attended by more than 300 scientists from leading European universities (Germany, England, France, Spain, Denmark, Netherlands, Norway, Sweden, Greece, etc.), integrated into the European Academy of Wind Energy (EAWE) and specialists from the world's largest energy companies (Siemens WP, Hitachi Ltd, Nordex Energy GmbH, DONG energy, Vestas, etc.).



Conference Venue: University of Oldenburg (Germany)

According to one of the participants, Prof. Valery Okulov, Dr. Phys.-Math. Sci., after the rapid formation phase of aviation theory in the twentieth century the rotor aerodynamics is entering a new period of fast growth due to the development of wind energy in Europe. It is very important that the legacy of the great Russian scientist was once again in demand, and the vortex theory created by him 100 years ago was again a subject of heated debate and discussion at the international forum. The initiators of this discussion were the world's leading experts: prof. J. Peinke, EAWE President, prof. G.A.M. van Kuik, EAWE Vice President, prof. J.N. Sørensen, Danish Technical University and others.



Chairman of the Organizing Committee, President of the European Academy of Wind Energy, Professor J. Peinke, announces a special session on Wednesday, 10th of October 2012, dedicated to the 100th anniversary of rotor vortex theory of prof. N. Zhukovsky.



Prof. J.N. Sørensen speaks about the results preceding the creation of rotor vortex theory.

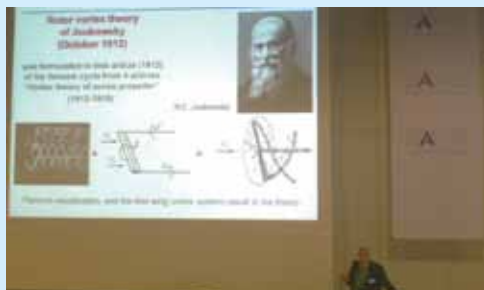

Prof. VL Okulov explores the essence of rotor vortex theory created by N. Zhukovsky.



Key lecturers at the anniversary session (left to right: Professors Sorensen, Okulov and van Kuik).

WORLD RENEWABLE ENERGY CONGRESS – WREC XIII

3–8 August 2014
London, UK

The World Renewable Energy Congress (WREC) and Network (WREN) is a non-profit company set up in 1990 to help foster transfer of renewable energy technology from developed countries to developing countries. More than 40 countries have hosted the Congress, among them: UK, Germany, Italy, USA, UAE, and Sweden. The Congress participants have been from more than 80 countries.

Topics of the World Renewable Energy Congress include:

1. Photovoltaic Technology
2. Solar Thermal Applications
3. Sustainable & Low Energy Architecture (Making buildings work with renewables)
4. Biomass & Waste-to-energy
5. Policy, Finance, Education & Sustainability
6. Energy Meteorology
7. Wind & Hybrid Energy
8. Water & Hydropower
9. Ocean Energy
10. Geothermal Energy
11. Hydrogen & Fuel Cells
12. Renewable System Integration

More information: www.wrenuk.co.uk



20TH LATIN OIL WEEK/ UPSTREAM 2014

1–3 September, 2014
Rio de Janeiro, Brazil

The Conference focuses on Latin America's oil, gas and energy landscapes and corporate/state upstream strategies, evaluating in-depth a range of near to long-term exploration, development, investment and strategy perspectives now in play, their potential upstream impacts, and how private and state oil/gas companies and Governments as well as Licensing Agencies will reshape Latin America in the world upstream game.

With some of the world's fastest-growing oil and gas reserves found in Latin America – plus huge unconventional resources in oil and gas – the Continent will see major capital investment projects across the region, despite resource nationalism initiatives in Argentina and Venezuela, to accommodate acreage openings, new oil/gas and LNG projects, plus huge gas developments in gas-prone onshore and offshore basins, as well as rising corporate deal-flow, so ensuring that this high-level and annual meeting – celebrating twenty years of upstream focus - will once again highlight significant opportunities for companies, state oil players, Governments and investors, financiers and traders across the Latin American value chain.

More information: www.petro21.com/events/?id=844



THE 9TH CONFERENCE ON SUSTAINABLE DEVELOPMENT OF ENERGY, WATER AND ENVIRONMENT SYSTEMS

20–27 September, 2014
Venice, Italy

The 9th Conference on Sustainable Development of Energy, Water and Environment Systems – SDEWES Conference is dedicated to the improvement and dissemination of knowledge on methods, policies and technologies for increasing the sustainability of development by decoupling growth from natural resources and replacing them with knowledge based economy, taking into account its economic, environmental and social pillars, as well as methods for assessing and measuring sustainability of development, regarding energy, transport, water, environment and food production systems and their many combinations. Sustainability being also a perfect field for interdisciplinary and multi-cultural evaluation of complex systems, the SDEWES Conference has at the beginning of the 21st century become a significant venue for researchers in those areas to meet, and initiate, discuss, share, and disseminate new ideas. The special topic of the conference, including a special session, a plenary, a panel and technical visits will be dedicated to the ships energy, water, environment, food and transport systems.

More information: www.mediterranean2014.sdewes.org



INTERNATIONAL CONFERENCE & EXHIBITION ON CLEAN ENERGY

20–22 October, 2014
Quebec, Canada

This conference is organized to share and discuss recent developments in clean energy sector. This highly interactive conference and exposition is designed to promote information exchange among scientists, technologists, engineers, entrepreneurs and exhibitors involved in Clean Energy sector.

The aim of ICCE 2014 is to gather researchers, scientists, engineers, practitioners, policy makers, from all over the world to present advances in the clean energy technologies. ICCE 2014 will provide a forum to exchange information, present new technologies and developments, and discuss the future direction, strategies and priorities in the field of clean energy.

More information: www.iaemm.com/ICCE2014/



REENFOR-2014: CONFERENCES, MEETINGS, SEMINARS, YOUTH SCIENCE SCHOOL

International forum “Renewable energy: Towards raising energy and economic efficiencies” (REENFOR) is a platform for discussing the role of renewable energy in sustainable energy development, determining levels of development of various renewable energy technologies, and analyzing best practices of using them, finding solutions for practical application of advanced technologies in renewable energy in Russia, improving their energy and economic indicators in various climatic and socio-economic conditions.

The Forum is organized by the Russian Academy of Sciences (RAS), Scientific and Technical Council of the Unified Energy System (NP NTS UES) and the Agency of scientific and business communications (NP ANDK).

REENFOR-2013 showed great interest in the development of renewable energy in Russia and in the world demonstrated by representatives of the scientific community, educational institution, business, federal and regional governmental bodies, and international organizations.

Within the **REENFOR-2014** a series of conferences, meetings, seminars, and youth science schools on topical issues of development of renewable energy has been planned to be held in 2014 with support of the Ministry of education and science of the Russian Federation, RusHydro, Russian Foundation for Basic Research as well as of other REENFOR partners.

Two successful REENFOR-2014 events were held during the first half of the current year and namely: Conference “Renewable Energy – a ground for high-tech economic growth”, within Sochi Spring Forum on Energy Efficiency and Innovations, on 30 May in Sochi, Russia, and International conference “Renewable energy: Applied aspects of development and practical use” on 30 June-2 July in Chernogolovka, Moscow Region, Russia, in conjunction with the 10th International Conference “Physic-chemical issues of renewable energy”.

REENFOR-2014 actions of 2014 will be concluded at its general session to be held in Moscow on 10-11 November. Its young participants will be invited to the IX scientific youth school “Renewable energy sources” to take place at the Moscow State University named after M. Lomonosov.

For more information: www.reenfor.org



MULTICRITERIAL ASSESSMENT OF MARINE WATER POLLUTION IN THE AREAS OF OFFSHORE OIL AND GAS FIELDS DEVELOPMENT



Olga Esina,

Galina Monakhova,

Sergey Monakhov,

Alexey Kurapov,

Caspian Marine Scientific Research Centre, Russia

The Caspian Marine Scientific Research Centre (KaspMNIZ), was founded in 1995; it is an organization under Federal Service for Hydrometeorology and Environmental Monitoring (Roshydromet) and is located in the city of Astrakhan.

The Centre aims to study the meteorological, hydrological, and hydrochemical regimes and pollution of the Caspian Sea. The research is based on the long-term observation data provided by Roshydromet observation stations and vessels.

KaspMNIZ is the coordinator and research supervisor for programs of state and industrial environmental monitoring of the Caspian Sea; organizes and carries out hydro-meteorological and ecological investigations in the river estuaries, the shelf zone and the open part of the sea; develops and implements programs of marine environmental monitoring in the location of marine hydraulic installations; assesses actual impact of hydraulic installations on marine environment using a complex of methods for diagnosis and assessment of marine environment pollution. Unified technology of assessment of water area pollution, developed by KaspMNIZ is currently used by Russian oil and gas companies in the Russian sector of the Caspian Sea.

KaspMNIZ is the coordinating center of CASPCOM – the Coordinating Committee on Hydrometeorology and Pollution Monitoring of the Caspian Sea created in 1994 by the national hydrometeorological organizations of the all Caspian littoral states with the support of the World Meteorological Organization.

Environmental assessment is extremely important in the context of society and nature interaction [1-3]. Environmental assessment helps balance our goals and current circumstances and set specific plans and objectives. It mainly refers to the assessment of natural sites pollution, which is a component of environmental assessment [4].

In our opinion, pollution assessment should take into account the chemical background, the level of chemical load and transformation of pollutant substances in the environment to fully perform its mission in regulating technogenic flows of pollutants. Alongside with this, the assessment should be both comprehensive and concise, combining differential and integrated approaches. These qualities are essential for the assessment of pollution of natural sites, which are under economic development, including marine water areas where gas and oil are produced.

The differential approach to environmental assessment consists in applying different parameters and criteria [5]. Russian practices of

environmental pollution assessment comprise multi-parametric approach, but as a rule only one criterion is used, i.e. maximum permissible concentration (MPC) of a pollutant [6], so pollution assessment is reduced to the assessment of environmental quality. To assess marine pollution, the official technique uses MPC adopted for fishery water bodies [7]. In accordance with this technique only four parameters are used to assess marine environmental quality, including the concentration of dissolved oxygen [8,9].

To assess the pollution of gas and oil bearing areas of the sea we have offered a multi-criterial and multi – parametric approach. The integrated assessment of the water area pollution implemented in compliance with this approach presents an “ensemble” of three estimates: 1) quality estimate, where MPC serves as a criterion (C_i); 2) accumulation estimate with background concentration is a criterion (C_f); and load estimate, where maximum permissible load is a criterion ($\Delta_f = C_i - C_f$). Earlier we focused mainly on integration of these estimates. This paper pays more attention to the differentiation of the estimates.

Before giving a description of this method we should note that the term background concentration in Russia can be used in two meanings: 1) standard background, which is determined in water bodies under least favorable conditions (from the point of pollutants inflow and dissemination) and is applied in calculating maximum permissible discharges of pollutants into water bodies; 2) geochemical background concentration, which is determined through statistical analysis of substance distribution parameters and is a relatively aligned value. The value of geochemical background which lies close to data distribution centre can strongly differ from the normative value lying far from the data distribution centre (in the area of the least favourable period).

In this paper we use the geochemical concept of background concentration, which can also be called natural background concentration or ambient background concentration.

The methods used to determine background concentration are a subject of scientific disputes [10, 11], which consist in the search of a parameter which adequately represents the natural distribution of admixtures in the water environment. In our opinion, background concentration of sub-

stances is best described by the median, which is the most robust statistical parameter (i.e. stable to the influence of outliers and other deviations).

The technique of multi-criterial pollution assessment of marine water areas developed in the Caspian Marine Scientific Research Center jointly with Dagestan State University comprises several stages and results in a diagnostic matrix, which columns are quality estimation criteria and rows are pollution parameters.

The first stage includes the calculation of numerical estimation values for every criterion (j), pollutant (i) and data array cells (q) obtained through measurements of pollutant concentration at the same time in different observation points or at different periods in one observation point.

The numerical value of quality estimate (E_j), which criterion is maximum permissible concentration (C_i) is calculated by formula (1):

$$E_{liq} = C_i / C_1 \quad (1)$$

The numerical value of accumulation estimate (E_f), which criterion is background concentration (C_f) is calculated by formula (2):

$$E_{fiq} = C_i / C_f \quad (2)$$

The numerical value of load estimate (E_f), which criterion is maximum permissible load ($\Delta_f = C_i - C_f$) is calculated by formula (3):

$$E_{piq} = (C_i - C_f) / (C_1 - C_f) \quad (3)$$

At the following stage, pollution estimates are averaged for the whole data array for every pollutant substance separately. Pollution estimate E_{li} is calculated as an arithmetic mean of E_{liq} series, accumulation estimate E_{fi} – as an arithmetic mean of E_{fiq} series, load estimate E_{pi} – as an arithmetic mean of E_{piq} series.

To make the estimates (E_{ji}) obtained through different criteria comparable with each other they are converted into scores with help of the unified scale presented in Table 1.

The following operation is to calculate the multi-criteria average estimate of water area pollution with every pollutant in particular (E_{ki}). Different estimates (of quality, accumulation and load) expressed in scores are summed up and divided by the number of the criteria used. At the

final stage single – parametric and multi-criteria estimates E_{ki} are averaged into the multi-parametric and multi-criteria estimate E_{kn} . The calculation results are used to classify and describe marine pollution in accordance with table 2.

The advantage of this method is as follows: it helps perform not only synthetic, but also

analytical assessment of marine pollution. The synthetic estimation is calculated in accordance with E_{kn} value, while analytical estimation is based on the matrix, where the number of rows corresponds to the number of pollutants, and the number of columns is the number of estimates included in the ensemble and completed

Table 1. The unified scale for the conversion of mean numerical values of single-criterion assessments into scores

Score estimate	Quality estimation, E_{ii}	Accumulation estimation, E_{fi}	Load estimation, E_{pi}	
			If $C_i > C_f$	If $C_i < C_f$
0	$E_{ii} \leq 1.0$	$E_{fi} \leq 2.0$	$E_{pi} \leq 0$	$E_{pi} \geq 0$
1	$1.0 < E_{ii} \leq 2.0$	$2.0 < E_{fi} \leq 3.0$	$0 < E_{pi} \leq 1.0$	$0 \leq E_{pi} < 1.0$
2	$2.0 < E_{ii} \leq 3.0$	$3.0 < E_{fi} \leq 4.0$	$1.0 < E_{pi} \leq 2.0$	$-1.0 \leq E_{pi} < 0$
3	$3.0 < E_{ii} \leq 5.0$	$4.0 < E_{fi} \leq 5.0$	$2.0 < E_{pi} \leq 3.0$	$-2.0 \leq E_{pi} < -1.0$
4	$E_{ii} > 5.0$	$E_{fi} > 5.0$	$E_{pi} > 3.0$	$E_{pi} < -2.0$

Table 2. Classification of pollution in accordance with the ensemble assessment

Class of pollution	Verbal assesment	Numerical assesment
First	Clean	Less or equal 0,50
Second	Moderately polluted	Ranging from 0,51 to 1,50
Third	Polluted	Ranging from 1,51 to 2,50
Fourth	Dirty	Ranging from 2,51 to 3,50
Fifth	Very dirty	More or equal 3,51

Table 3. The results of ensemble assessment (estimation) of marine water pollution in the shallow estuarine – coastal area of the Volga in the autumn of 2012

Pollution index	Pollution estimates			
	Quality estimation, E_i	Estimation of accumulation, E_f	Load estimation, E_{pi}	Ensemble estimation, E_k
BOD	1	0	1	0,67
Ammonium N	0	0	1	0,33
Oil products	1	0	1	0,67
Iron	3	0	1	1,33
Zinc	0	0	1	0,33
Nickel	3	0	1	1,33
Cooper	1	0	1	0,67
Lead	0	1	2	1,0
Cadmium	0	0	0	0,00
E_1	1,0	0,1	1,0	0,70
E_2	1,8	1,0	1,1	0,79
E_3	3,0	1,0	2,0	1,33

with Eki ensemble estimation. Such an example is Table 3, which represents the results of the ensemble assessment of marine pollution in the shallow area of the Volga coastal estuary in the autumn of 2012.

To make a more complete analysis and assessment of marine water pollution we recommend representing every estimate as follows:

- 1) $E_1 = E/n$;
- 2) $E_2 = E/N$;
- 3) $E_3 = E_{\max}$;

where n is the total number of pollution indices (pollutants); N is the number of indices which $E > 0$; E_{\max} – is the maximum E value.

We suggest referring to E_1 (E_{kn}) as to generalized estimate, E_2 priority estimate, and E_3 – extreme estimate.

The results of assessment of marine water pollution (E_k), presented in Table 3, can be interpreted as follows: in accordance with the generalized ensemble estimation (by a complex of indices which consists of 9 pollutants), sea water in the coastal area of the Volga in the autumn of 2012 was assessed as moderately polluted ($E_{k1} = 0.70$). The content of 8 pollutants didn't correspond to the criteria set for pollution assessment. According to ensemble priority estimation the water was also assessed as moderately polluted ($E_{k2} = 0.79$). Nickel and iron showed the highest pollution level ($E_{k3} = 1.33$), but in accordance with the extreme ensemble estimation the water was assessed as moderately polluted.

It is important to note that matrix representation of assessment of marine water pollution makes it possible to differentiate it not only by separate parameters and their groupings, but also by different estimation types with help of the unified scale. For example, pollution assessment by permissible load is presented as follows: in accordance with generalized load estimate (by a complex of indices which consists of 9 pollutants), sea water in the coastal area of the Volga in the autumn of 2012 was assessed as "moderately polluted" ($E_{p1} = 1.0$). The content of 8 pollutants didn't correspond to the criteria set for load estimation. According to ensemble load estimation the water was also assessed as moderately polluted ($E_{p2} = 1.1$). Lead has shown the maximum load level ($E_{p3} = 2.0$). In accordance

with the extreme load assessment water was described as "polluted".

Matrix representation of the ensemble assessment of marine water pollution facilitates the comparison of different estimates, which total number equals to product of column number by matrix row number. In some cases the results of comparative analysis are important to determine the reason of water pollution and to develop measures on protection of the marine environment from pollution. An example can be set by the comparison of quality estimate with accumulation estimate. If $E_i > E_p$, external sources are mainly responsible for the water area pollution (in this case it refers to BOD, oil products, iron, nickel and copper, see Table 3). If $E_i < E_p$, local sources are mainly responsible for pollution (lead, see Table 3). It is interesting to note that lead load on the considered water area strongly exceeds the permissible level.

The peculiarity of this method of multi-criterial assessment of marine water pollution is the use of chemical parameters only, in particular those, which MPCs are set in standards. It is connected with the fact that the ensemble includes the assessment of water quality, where MPC serves as a criterion. At the moment there are no standards for the concentration of pollutants in bottom sediments in Russia. However if we use foreign MPC values, the ensemble method can be applied to the assessment of soil pollution. The combination of estimations of water pollution and bottom sediments pollution can be considered as the assessment of marine water area pollution in general.

In conclusion we want to stress that the suggested method was developed on the basis of the data of state and industrial environmental monitoring in different areas of the Russian sector of the Caspian Sea is included into the programmes of the Caspian Sea environmental monitoring. It makes possible to perform a detailed analysis of the state of pollution of marine water areas, to assess the contribution of different components on the basis of different criteria and to draw a well-grounded conclusion on marine water quality. The suggested technique of ensemble assessment of marine environmental pollution can be applied to any marine water areas subject to economic development.

References

1. Monakhov S.K., Esina O.I., Monakhova G.A. Environmental standard-setting, assessment and monitoring // Environmental protection in oil and gas complex. – 2011.- No.10.- P. 5 – 9
2. Monakhov S.K., Kurapov A.A. Past, present and future of the system of standard-setting and environmental pollution assessment // Materials of the 4th International Scientific Conference “Issues of Caspian ecosystem conservation under the conditions of oil and gasfields development” (11-13 October 2011). – Astrakhan: KaspNIRKh Publishers, 2011.- P. 173-178.
3. Esina O.I., Monakhov S.K. Current state and development prospects of the system of standard-setting and environmental pollution assessment // Energy Bulletin.- 2012.- No.1 (13).- P. 45-52.
4. Monakhov S.K., Monakhova G.A., Kolmykov E.V. Environmental assessment and protection // Environmental protection in oil and gas complex.- 2013.- No. 5. – P. 9-14
5. Dmitriyev V.V. Determination of the integral index of the state of the natural object as a complicated system // Society. Environment. Development (Terra Humana). – 2009. – No. 4.- P. 146-165
6. Opekunov A.Y. Environmental standard-setting and environmental impact assessment. St. Petersburg. – SPB University Publishers, 2006.- 261 p.
7. Order of the Federal Agency for Fishery from 18th January, 2010 No. 20 “On adoption of water quality standards in the water bodies of economic significance, including standards of maximum permissible concentrations of harmful substances in the water bodies of economic significance”
8. Temporary guidelines on integrated quality assessment of surface and sea water by hydrochemical parameters. – M. Goskomhydromet of the USSR, 1986. – 6 p.
9. Guidelines on formalized integrated quality assessment of surface and sea water by hydrochemical parameters. – M. Goskomhydromet of the USSR, 1988. – 8 p.
10. Estimation of Background Reference Concentrations for Metals in UK Freshwaters // Environment Agency and the Scotland and Northern Ireland Forum for Environmental Research (SNIFFER). – Edinburg, Scotland. – 2012.
11. Milos Gregor. Surface and Groundwater Quality Changes in Periods of Water Scarcity. – Springer Themes. – Springer Berlin Heidelberg. 2013. 230 pp.

HIGH-ALTITUDE WIND ENERGY: FICTION OR REALITY?



*Efim Dwoskin,
inventor, Russia*

Today, the citizens of our Planet begin to understand and feel more and more how harmful the traditional methods of electricity production are for ecology and health of our globe. The present methods of mining and wastes deposits are equally harmful. The nuclear energy might serve as an example: nuclear power plant explosions cause, besides destructions and instant death of people, soil and water poisoning and polluted crops being produced for many years. A hydropower plant (HPP) for its operation uses river's energy, dams it up and due to captured huge water amounts accumulates the river's energy and gets the amount of demanded energy, but huge water reservoirs occupy vast areas of forests and arable lands. Dams prevent fish spawning. Coal-fired stations and gas stations smoke the sky and contribute to the planet heating. Europe imposed quotas. But electricity is in very high demand all over the world, and so the mankind recalled the wind energy.

Indeed, the wind energy is environmentally clean, but depending where wind turbines are installed and what they are. They are all set in the atmospheric boundary layer. They frighten birds, and being installed near residential areas, spoil the residents' quiet life with the noise. The wind velocity decreases due to friction of air

masses on the earth's surface. Such winds do not possess energy density enough for the industrial scale of electricity production and they have unstable velocities. Wind turbines are installed in places where the wind velocity is greater due to the space openness, but the friction of air masses on the earth's surface remains.

But there is a technical solution. And it is in high-altitude wind farms or "high-altitude wind energy". The latter, if created, has to solve a range of current issues. First of all, as it happens in all energy branches, technical methods and devices for converting natural energy into electricity should be developed. According to the observation data of upper-air stations, at the altitude of 1–1.5 km the wind speed exceeds 10 m/s and is more stable. You can achieve these heights by aerostat and then hang there, or better to say, hold a vertical structure of several kilometers at that height. These structures have horizontal platforms arranged at regular distances. Wind turbines should be installed on these platforms. But winds' velocities are unstable even at such altitude. They will not be able to uniformly rotate typical industrial electric generators in order to produce three-phase alternating current of standard frequency.

So at the beginning, we must save the energy potential that can be given by the wind energy

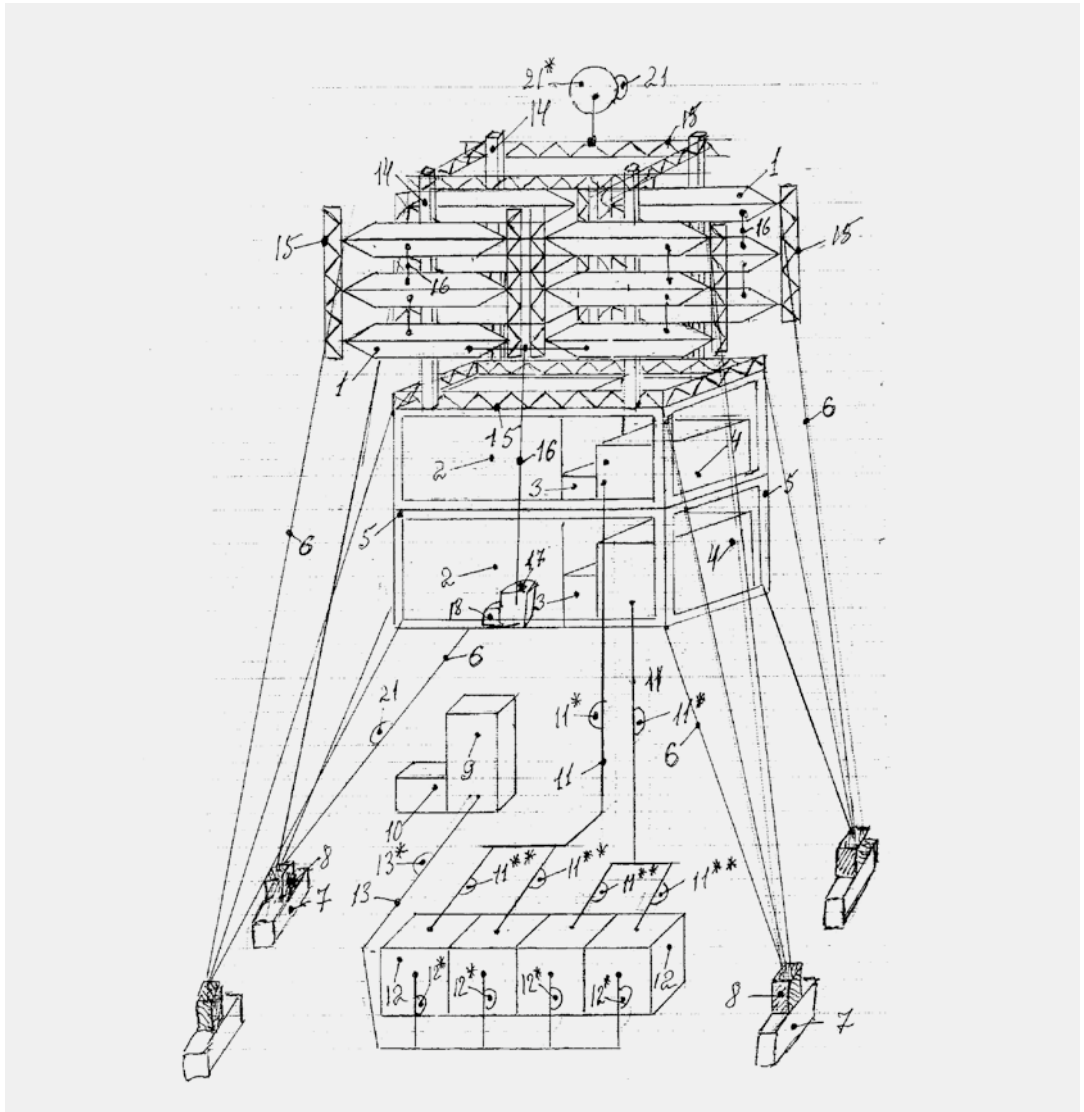

An element of «high-altitude wind farm» – high altitude platform.

rotating the wind turbine. And compressed air is the best accumulator of any energy capable through mechanical devices to rotate the compressor. Its advantage over the water is its compressibility and capability to store large energy amounts in small space volumes. Therefore, each platform has a wind turbine coupled with a screw compressor. Piping goes down from the compressor to receivers installed on lower levels platforms and fills them with compressed air.

There (on these platforms) are hydro-pontoon engines, proposed by myself, that operate full power at a pressure of one atmosphere and rotate standard three-phase generators.

Now the question is, what the aerostat should be like? The aerostat should not be gaseous. Hydrogen is explosive, and helium is expensive and leaky. Branded airships should be lowered every 30 days for refueling, and if a single wind energy plant has several aero-

stats, energy extracted from wind by this plant will not be enough to cover expenses involved in the constant refilling of aerostats with huge volumes of helium. So, there remains only one solution to resolve this problem and namely to replace a traditional aerostat by a vacuum one. This idea has long been a lure to inventors, but until recently there were no light and durable enough materials to build such an aerostat. And now we have carbon fiber-reinforced plastic. Its density is 1.3-1.5 g/cc, strength is 2000 MPa. Its form should look like two dinner plates stacked together, or two truncated cones stacked to each other by the bases. The advantage of this form over the traditional one is that aerostat side walls form a fin and the wind flow will be split whichever side it goes. This form will be more resistant to winds. Dimensions are approximately the following: large diameter – 70 m, small diameter – 40 m, height – 40 m. Its volume is 97,389 cubic meters. The lifting buoyant force is 118,815 kg at the air density of 1.24 kg/cubic meters. This is not a aerostat traditional form, but it should not fly in the wind direction; vertical structure that will be raised up by few such vacuum aerostats should be anchored to concrete blocks on the ground. The aerostat shell is composed of two layers of carbon fiber, and vertically mounted strips are installed between the carbon fiber layers forming a cell. This shell structure withstands the atmospheric pressure. Additional interior resistant pipes are installed

between the surfaces 40 m in diameter around the small diameter.

The stationary hydro-pontoon engine comprises a 10 m tall reservoir with liquid (water), the water is filled up to 9.5 m. At the reservoir bottom and top there are installed tooth gears on the same vertical axis, which are connected with roller chain. It looks like a bicycle chain transmission. But it has identical tooth gears. pontoons are attached throughout the chain. They are of a spinescent form and bottomless. Each pontoon is equipped with normally closed valve. One roller is installed at the rod end. All valves are connected with individual hose and common intake channels for compressed air at a pressure of one atmosphere. A thrust plate is mounted at the lowest reservoir point. When a pontoon passes the thrust plate, the valve roller opens it and rolls on along the plate keeping the valve open. Compressed air pushes the water through the nonexistent bottom. The water itself serves as the bottom, since 10 meter water reservoir pressure is slightly less than one atmosphere. The appearing buoyant force pulls the pontoon up. At the reservoir top, the pontoon changes its position to a horizontal one, and the air exits through the open pontoon bottom. All engine pontoons are connected to the chain. When a pontoon takes up an inclined position, water by gravity fills the pontoon. Buoyant force, which would have been a negative force on the other side of the vertical engine axis, disappears.

ISEDG GATHERED EXPERTS TO DISCUSS DEVELOPMENT POTENTIAL OF RUSSIAN INDUSTRY IN THE CONTEXT OF COUNTRY'S MEMBERSHIP IN WTO AND CUSTOMS UNION

On 24 April 2014 the round table on “Russia’s state policy for support and protection of the industrial sector in regard to the country’s membership in WTO and Eurasian Economic Union (EaEU)” took place at the International Sustainable Energy Development Center (ISEDG) under the auspices of UNESCO.

Representatives of ISEDG, Ministry of Industry and Trade of the Russian Federation, Analytical Center for the Government of the Russian Federation, Eurasian Economic Commission, Public Council under the Ministry of Energy of the Russian Federation, Russian academics and experts took part in the meeting.

Communications on the formation of comprehensive measures set for the protection and support of Russian industry under the conditions of WTO membership, directions of industrial exports with regard to regulations and rules of WTO and OECD, balancing of the viable conditions during product purchases by subjects of natural monopolies and oil-gas companies were brought to attention of participants.

Along with that experts considered and discussed issues of the WTO joining impact on the national pipe and metal industry, situation in industry, as well as reasons of low motivation matter of the energy efficiency increase in Russia.

Taking into account importance of discussed issues participants in the Round table decided to continue and extend the discussions of matters related to national economy integration process into WTO system with a view to form integrated formalized approach to the above issues.



ISED DC TOOK PART IN THE 7TH MOSCOW INTERNATIONAL ENERGY FORUM AND EXHIBITION “RUSSIAN FUEL AND ENERGY COMPLEX IN THE XXI CENTURY”

From 21 to 23 of April 2014 the 7th Moscow International Energy Forum and Exhibition “Russian fuel and energy complex in the XXI century” took place in Moscow in Gostiny Dvor where leading experts discussed new vectors of the world energy development.

Holding of the Forum’s business program events and exhibition at one site facilitated the participation in the events of the chief executives of Russian F&EC and also representatives of federal and regional legislative and executive bodies, top managers of the leading energy companies, experts from public associations and scientific organizations, foreign guests and officers of legations from 14 countries, official delegations from 45 subjects of the Russian Federation and also more than 200 journalists of Russian and foreign mass media.

Vladimir Berdin, Deputy Executive Director of International Sustainable Energy Development Center under the auspices of UNESCO (ISED DC), and ISED DC experts participated in the business program of the International Forum.

The range of issues discussed at the Forum was extremely wide. It covered all spectrum of problems and issues of fuel & energy complex and topics of sustainable development of the Russian energy sector, as well as transfer to a resource-innovating model of F&EC development. Special attention was paid to the discussions of the updated and revised version of “Energy Strategy of Russia for the period till 2035”.

The “Russian fuel and energy complex in the XXI century” Forum demonstrated the commitment of the Russian business community to more active participation in discussions of national energy issues. Representatives of business community were not restrained only by presentation of their strategies, plans, new ideas and projects, but also actively participated in discussions, gave their own interpretation of current events, occurred in the world and Russian energy branch, and voiced constructive proposals to update the above version of “Energy Strategy of Russia”.

The pressing problems of the world and Russian energy development were discussed within the business program of the Forum “Russian fuel and energy complex in the XXI century” and more than 70 companies presented their innovations, processes and projects for efficiency improvement of so important economy branch.



ISEDc TOOK PART IN THE INTERNATIONAL CONFERENCE “TRANSFER OF PROCESSES AND EXCHANGE OF EXPERIENCE IN THE FIELD OF PROCESS PLATFORM DEVELOPMENT IN INDUSTRY AND ENERGY BRANCH”

On 27 March 2014 the International Conference “Transfer of processes and exchange of experience in the field of process platform development in industry and energy branch” took place in Moscow under the auspices of Government of Moscow and Ministry of Energy of the Russian Federation and within the Second International Exhibition-Forum of Equipment for and Innovations in Oil-Gas and Production Industry “Exploration, production, processing 2014”.

Representatives of Ministry of Energy, Ministry of Industry and Trade, Ministry of Education and Science of the Russian Federation, Delegation of the European Union to Russia, Embassy of France in Russia, OJSC “NK “Rosneft”, OJSC “Gasprom Neft”, SC “RUSNANO”, OJSC “RITEC”, Shtokman Development AG Group, OJSC “VNIPIneft”, NPU Higher School of Economics, NPU “MPEI”, OJSC “Federal Hydrogeneration Company”, Fund “Energy without borders”, “Siemens” Ltd, CJSC “Science and innovations” (ROSATOM), RAN CPI, RTTN, technological platforms related to industrial and energy sectors of Russian economy, leading scientific, educational, industrial and energy institutions and associations, including Deputy Executive Director of International Sustainable Energy Development Center under the auspices of UNESCO (ISEDc) Vladimir Berdin, participated in the Conference.

The Conference was held to promote efficiency improvement of state development institutions activities aimed at the technological renovation of the Russian economy and generation of proposals on the concentration of their resources for developing innovation processes.

The discussions and exchange of views, held in the course of the conference, were devoted to the experience of implementation and sources of financing technological platforms (TP) in EU states, the role of state regulations and mechanisms of promoting private investments within TP, as well as to the role of TP in the formation of high-technology economy branches in Russia and other countries.



ISEDC DISCUSSED COSTS, BENEFITS AND STRATEGY OF DEVELOPMENT OF LOW-CARBON ECONOMY IN RUSSIA

On 21 March 2014 the press-conference “Costs and benefits of low-carbon economy in Russia. Prospects till 2050” took place in Moscow, in the RIA Novosti press center. Issues of the comprehensive measures implementation for state regulation of greenhouse gas emissions in terms of Decree of President of Russian Federation dd. 30.09.2013 No 752 “On reduction of greenhouse gas emissions” were discussed.

Representatives of the governmental, managers and specialists, who are members of the scientific-technical councils of leading research organizations, including Deputy Executive Director of ISEDC Vladimir Berdin, took part in this event.

The communication, presented by Igor Bashmakov, Executive Director of Center for effective energy use, clearly demonstrated that transfer of Russia to low-carbon model of economic development in accordance with assumed obligations to reduce before 2020 greenhouse gas emissions by 25% to 1990 level will not result in slowdown of economic growth, but on the contrary it will stimulate further industrial modernization. The experts considered and discussed the matrix of agreed scenarios, where scenarios with moderate rates of economic growth and effective or new emission control measures were widely presented. Mr. Bashmakov noted that Russia should also consider transfer to more efficient economy. And it is necessary to introduce incentive schemes or payment for emissions in the form of the fuel carbon tax or price formula in greenhouse gas emission trade in order to keep the greenhouse gas emissions at low level and improve economic attractiveness of low-carbon technologies.

INVITATION TO COOPERATION ON ENERGY BULLETIN PAGES

Ladies and Gentlemen,

The Editorial Board invites experts, governmental and non-governmental, both public and private, organisations to cooperate on the pages of our periodical.

The objective of the Energy Bulletin is to facilitate development of international scientific discussions on sustainable energy development, utilisation and exchange of clean energy technologies, climate change mitigation as well as to attract attention of energy experts, politicians and representatives of various economy sectors to the most important energy problems facing our society.

It is extremely important today to hold a continuous international dialogue at the experts, politicians and public levels on the issues of strengthening interdependency in the fields of energy, ensuring of energy security, energy efficiency and energy conservation, environmental responsibility during development and use of energy resources, reduction of energy poverty.

We would be pleased to publish materials on the actual energy and related problems in the coming issues of the Bulletin.

For additional information you may contact Alexey Grammatchikov, Editor.

Tel.: +7-495-6410426

Mob.: +7-916-1508172

E-mail: a_gramm@isedc-u.com

Technical requirements to the presented materials

The materials should be in the form of articles, reviews, analysis, assessments (MS Word, Excel). It is also possible to put schedules, diagrams, tables (MS Word, Excel), illustrations, photographic materials (Jpg format, 300 dots resolution) to the Bulletin. The volume of materials should range from 15,000 to 25,000 printed characters in a language chosen by author. It is also necessary to provide the photo of author (Jpg format, 300 dots resolution).



United Nations
Educational, Scientific and
Cultural Organization

**Sustainable
Energy
Development**



**International centre
under the auspices of UNESCO**



www.isedc-u.com