

**SYSTEM RESPONSE TIMES IN A SIMULATED DRIVING TASK:
EFFECTS ON PERFORMANCE, VISUAL ATTENTION, SUBJECTIVE
STATE AND TIME ESTIMATION**

by

TANJA BAUER

submitted in fulfilment of the requirements for
the degree of

MASTER OF ARTS

in the subject

PSYCHOLOGY

at the

UNIVERSITY OF SOUTH AFRICA

SUPERVISOR: DR HC JANEKE

FEBRUARY 2009

&

ABSTRACT

The utilisation of navigation systems in cars has given rise to road safety concerns, and the design and functionality of such systems must therefore be adjusted to the users' needs, since they have to divide their attention between driving and the operation of the navigation system. The study was aimed at finding the optimum system response time (SRT) which would enable a driver to focus as much as possible on the road while attaining an efficient task completion time using an electronic navigational system. The research project consists of two separate experiments and was completed by 10 subjects. Experiment 1 included a temporal reproduction task and a secondary memory task. The subjects had to memorise two symbols and then reproduce six time spans ranging from 1 to 30 s to provide a baseline measurement of their time estimation abilities. Experiment 2 consisted of a simulated automobile driving task. While driving in the simulator the subjects completed a memorising task displayed on a touch screen. The task was presented with seven different system response times (SRTs) ranging from 0 to 30 s. The effects of different SRTs on the eye movement from road to monitor, regarding the duration of fixation and the frequency of change were evaluated. The distribution of gazes to the secondary task was analysed to provide information about the time estimation performance in the driving simulator. Other dependent variables tested were the accuracy of selected items, memory game performance, drive performance and the subjective state of the test person. The results of this study can be employed to find the optimum duration of inter-task delays for in-vehicle technical devices.

Key Terms

System Response Time (SRT); inter-task delays; duration estimation; simulated driving task.

Declaration

Student no: 3433-607-9

I declare that "System response times in a simulated driving task: effects on performance, visual attention, subjective state and time estimation" is my own work and that all sources that I have used or quoted have been indicated and acknowledged by means of complete references.

SIGNATURE

(MISSST BAUER)

DATE

Acknowledgements

Firstly, I would like to thank my supervisor, Dr Chris Janeke, for his outstanding help and guidance. He has aided me greatly in the structuring and completion of my work.

Secondly, I would like to acknowledge the assistance provided to me by my research collaborator and advisor, Jan Churan at the Generation Research Program (GRP) in Bad Toelz. He conceptualised the thesis for me and his help with the experimental setup was invaluable to me. I further would like to thank my technician, Albert Sper, who assisted me greatly with the operation of the driving simulator and design of measurement devices.

The completion of this dissertation was only possible with the encouragement of my family and I thank them for their valuable and continued support.

LIST OF ABBREVIATIONS

ACC	Autonomous Cruise Control
SRT	System Response Time
SET	Scalar Timing Model
SOA	Stimulus Onset Asynchronies
ADHD	Attention Deficit / Hyperactivity Disorder
BPD	Borderline Personality Disorder
IQ	Intelligence Quotient
CA	Catecholamine
DA	Dopamine
DRL	Differential Reinforcement of Low rates
FI	Fixed Interval
FR	Fixed Ratio
TSC	Theory of Stochastic Counters
JND	Just Noticeable Difference
PRP	Psychological Refractory Period
TSE	Time's Subjective Expansion
STM	Short Term Memory
LTM	Long Term Memory
SBs	Significant Brakes
SDPA	Standard Deviation of Positive Acceleration
SDNA	Standard Deviation of Negative Acceleration
SMs	Steering Movements
COL	Crossing of Outside Line per mile on total duration
SDLP	Standard Deviation of Lane Position
NLE	Number of Lane Exceeds
SD	Standard Deviation

TABLE OF CONTENTS

CHAPTER 1.....	1
GENERAL OVERVIEW.....	1
1.1. INTRODUCTION.....	1
1.2. PROBLEM STATEMENT AND RESEARCH AIMS.....	3
1.3. MOTIVATION FOR CONDUCTING THE STUDY.....	5
1.4. OUTLINE OF CHAPTERS.....	5
CHAPTER 2.....	7
THEORETICAL FRAMEWORK AND LITERATURE REVIEW.....	7
2.1. THE NATURE OF TIME.....	8
2.2. THE NEURAL REPRESENTATION OF TIME.....	10
2.2.1. The window of simultaneity.....	12
2.2.2. Temporal integration.....	14
2.3. FACTORS INFLUENCING TEMPORAL PERCEPTION.....	16
2.3.1. Influence of mental and neurological disorders.....	18
2.3.2. Influence of affective factors.....	20
2.3.3. Influence of age.....	22
2.3.4. Influence of stress and drugs on.....	23
2.4. LAWS AND MODELS OF TEMPORAL PROCESSING.....	27
2.4.1. Basic laws in chronometric research.....	28
2.4.1.1. <i>Weber's law applied to temporal perception</i>	28
2.4.1.2. <i>Duration estimation and Vierordt's law</i>	33
2.4.2. Basic models of temporal processing.....	34
2.4.2.1. <i>Clock- and memory-based models of temporal processing</i>	34
2.4.2.2. <i>The scalar timing model (SET)</i>	35
2.5. INFLUENCE OF MULTIPLE-TASKS ON ATTENTION, TIME ESTIMATION AND MEMORY.....	37
2.5.1. Basic concepts of attention.....	37
2.5.2. Theories of attention and resource allocation.....	39
2.5.2.1. <i>Task-switching costs</i>	42
2.5.2.2. <i>Theories on dual-task inference</i>	44
2.5.3. Temporal perception in a multiple-task environment.....	47
2.5.4. Basic concepts of memory.....	51
2.5.4.1. <i>Factors influencing memory performance</i>	52
2.5.4.2. <i>Impact of concurrent tasks on resources allocation and memory</i>	53
2.6. OVERVIEW OF THE THEORETICAL VIEWPOINT ADOPTED BY THE STUDY.....	54
2.7. RESEARCH QUESTIONS.....	55

CHAPTER 3.....	61
METHODOLOGY.....	61
3.1. RESEARCH DESIGN.....	61
3.2. SAMPLE SELECTION.....	61
3.3. RESEARCH INSTRUMENTS.....	62
3.3.1. Experiment 1: temporal reproduction.....	62
3.3.2. Experiment 2: driving simulator.....	63
3.3.3. Subjective-state questionnaire.....	66
3.4. VALIDITY AND RELIABILITY.....	67
3.5. ETHICAL CONSIDERATIONS.....	70
 CHAPTER 4.....	 72
RESULTS.....	72
4.1. EFFECTS OF SRTS ON DRIVING PERFORMANCE, VISUAL ATTENTION, SUBJECTIVE STATE AND TIME ESTIMATION.....	72
4.1.1. Temporal reproduction in dual-task setting.....	73
4.1.2. Effects of SRT duration on breaking, acceleration and deceleration.....	75
4.1.2.1. <i>Number of significant brakes</i>	75
4.1.2.2. <i>Standard deviation of average positive acceleration</i>	76
4.1.2.3. <i>Standard deviation of average negative acceleration</i>	77
4.1.3. Effects of SRT duration on steering and line crossings.....	78
4.1.3.1. <i>Number of steering movements</i>	78
4.1.3.2. <i>Incidences of crossing outside line on total driving duration</i> ...	79
4.1.4. Effects of SRT duration on gaze behaviour and gaze adaptation...	80
4.1.4.1. <i>Gaze frequency under each SRT</i>	80
4.1.4.2. <i>Average focus time on game monitor under each SRT</i>	81
4.1.5. Distribution of gazes within the various SRTs.....	82
4.1.6. Effects of SRT duration on game performance.....	85
4.1.7. Effects of SRT duration on subjective experience.....	86
 CHAPTER 5.....	 88
DISCUSSION OF RESULTS AND CONCLUSION.....	88
5.1. SUMMARY OF THE STUDY.....	88
5.2. DISCUSSION OF THE RESULTS.....	89
5.2.1. Temporal reproduction task.....	89
5.2.2. Effects of SRT duration on breaking, acceleration and deceleration.....	90
5.2.3. Effects of SRT duration on steering and line crossings.....	91
5.2.4. Effects of SRT duration on gaze behaviour and gaze adaptation..	91
5.2.5. Distribution of gazes within the various SRTs.....	93
5.2.6. Effects of SRT duration on game performance.....	93
5.2.7. Effects of SRT duration on subjective experience.....	94

5.2.8. Practical implications of research findings.....	94
5.2.9. Implications for further research.....	95
5.3. CONCLUSION.....	98
REFERENCE LIST.....	98
APPENDIX A – List of symbols.....	120
APPENDIX B – Questionnaire.....	121
APPENDIX C – Information and Consent Form.....	122

LIST OF TABLES

Table 4.1:	Average number of over- and underestimation in reproduction task.....	74
Table 4.2:	Average number of significant brakes per driven kilometre.....	75
Table 4.3:	Standard deviation from the average positive acceleration.....	76
Table 4.4:	Standard deviation from the average negative acceleration....	77
Table 4.5:	Average number of steering movements per driven kilometre.	78
Table 4.6:	Average number of incidences of crossing the outside line per kilometre on total driving duration.....	79
Table 4.7:	Average number of gazes per minute under each SRT.....	80
Table 4.8:	Average focus time on game monitor under each SRT.....	81
Table 4.9:	Average error rate under each SRT.....	85
Table 4.10:	Rating for stress and boredom.....	86
Table 4.11:	Rating for driving performance and task completion.....	87

LIST OF FIGURES

Figure 4.1:	Over- and underestimation of measured time span in the temporal reproduction task.....	73
Figure 4.2:	Number of significant brakes per drive kilometre.....	75
Figure 4.3:	Standard deviation from the average positive acceleration....	76
Figure 4.4:	Standard deviation from the average negative acceleration....	77
Figure 4.5:	Number of steering movements per driven kilometre.....	78
Figure 4.6:	Incidences of crossing the outside line per kilometre on total duration.....	79
Figure 4.7:	Gazes per minute under each SRT.....	80
Figure 4.8:	Average focus time on game monitor under each SRT.....	81
Figure 4.9:	Distribution of gazes within the 3-s delay.....	82
Figure 4.10:	Distribution of gazes within the 6-s delay.....	83
Figure 4.11:	Distribution of gazes within the 12-s delay.....	83
Figure 4.12:	Distribution of gazes within the 20-s delay.....	84
Figure 4.13:	Distribution of gazes within the 30-s delay.....	84
Figure 4.14:	Error rate under each SRT.....	85
Figure 4.15:	Rating for stress and boredom.....	86
Figure 4.16:	Rating for driving performance and task completion.....	87

LIST OF DIAGRAMS

Diagram 3.1:	Side view of driving simulator setup.....	63
Diagram 3.2:	Top view of driving simulator setup.....	64

CHAPTER 1

GENERAL OVERVIEW

1.1 INTRODUCTION

Electronic innovations are changing the demands placed on drivers of motor vehicles, and support, or may even partly release the driver from, the driving task. Examples of such systems are collision warning systems, autonomous cruise control (ACC) and electronic handling control systems. Furthermore, drivers have recourse to new navigation and traffic information systems (Bullinger & Dangelmaier, 2003). Subscribers to premium telematics services can even take advantage of sophisticated features such as verbal e-mail messages, digital music, tailored traffic and weather updates as well as on-demand news, sports and stock market reports (Ashley, 2001).

Even though these systems are aimed at providing assistance to the driver, they also have a negative aspect. Technical systems that need input from the driver while driving are a source of distraction. Thus, some navigation systems require on-the-move destination entry whereby the driver needs to perform a series of data entry steps. Prohibiting the use of these systems is not feasible because that hinders the development of new design solutions based on a dual-task paradigm, in which electronic devices are developed to assist in the driving task (Burnett, Summerskill & Porter, 2004). Kamp and his colleagues Martin-Lamettet, Frozy and Causeur (2001) conducted a study to assess various control interfaces of an in-vehicle Internet browser offering services such as district map, route planning, electronic messaging, leisure programs and a phone directory. The subjects used keyboards, touch pads and voice commands as control devices. The assessment criteria of this

experiment were speed, distance to target vehicle, lane position, and visual activity. The functioning of the system, operating time and error rate were recorded, and a post-trial questionnaire was used to obtain input from the subjects. The results of the study indicated that browsing while driving is complicated and dangerous, even when using a simplified browser. The results also showed that different control devices were not equally efficient, and that their efficiency varied in terms of the task that had to be executed (Kamp, Martin-Lamettet, Frozy & Causeur, 2001).

Tsimhoni and Green (2001) conducted a study focusing on the attentional demands experienced by subjects who were required to perform a driving task while completing a display-intensive in-vehicle task. They compared the driving performance of their subjects during straight and curved road conditions of various degrees while performing a map-reading task of short, medium and long duration. While they were driving, the subjects engaged in a constant switching process between the road and the task. The results showed that the mean glance duration decreased and the gaze frequency rose as the curve radius increased, demanding more visual attention. The researchers concluded that test subjects did not maintain risk homeostasis since test subjects' driving performance decreased as visual demand increased. It was found that the drivers drifted more in the lane or even left it as driving conditions became more difficult. An insignificant increase in task completion time under increased visual demand indicated that subjects gave up driving safety for the sake of fast task completion.

The result of this study clearly showed that drivers are distracted when operating technical devices while driving. In future the number of technical gadgets available to drivers will increase and therefore research evaluating the impact of these devices on driving performance is of great importance. Hence, the process of resource allocation must be taken into consideration when investigating optimal system response times (SRTs) for software

programs used in environments that place high cognitive demands on the operator.

1.2 PROBLEM STATEMENT AND RESEARCH AIMS

The study was divided into two parts, involving two separate experiments. The purpose of the first experiment was to determine whether the test subjects had normal time estimation abilities. Numerous factors such as mental and neurological disorders and stress can influence a person's temporal perception. In addition, affective factors and age influence the subjective experience of time (Eisler, 1993 & Friedman, 1990). The first experiment provided insight into the subjects' performance under dual-task conditions with a simple secondary task and served as a baseline measurement of the subjects' time estimation abilities.

The second experiment consisted of a simulated driving task in a static driving simulator. While driving the subjects were asked to play a memory game that was displayed on a touch screen mounted to the right of the steering wheel to imitate the operation of an on-board navigation system. The subjects were forced to divide their attention between the road and the game monitor. The glances from the road to the monitor gave an indication of how accurate the currently tested SRT was estimated by the test subject. An SRT can be defined as the time that elapses from entering a command until the computer is ready to process a new command. If the SRT was underestimated numerous glances from the road to the game monitor were performed before the SRT had elapsed. Therefore the resulting gaze frequency for the various SRTs was evaluated by means of this experiment. The distribution of the control gazes during each SRT was also analysed. The average focus time on the game monitor was also examined since the time

periods that are spent not focusing on the road have a negative impact on driving safety.

Driving performance was another important focus point of the study since the findings provided information regarding the effects of SRT on traffic safety. Another aspect considered was the subjective state of the subjects, since the well-being of the user can have a significant influence on motivation and efficient task completion, which in turn can influence overall driving performance (Angrilli, Cherubini, Pavese & Manfredini, 1997).

Further questions that were addressed by this study concerned the influence of SRT on the memory performance and subjective state of the test subjects. The accuracy of the selected items in the memory game provided an indication of how severely these performance parameters were influenced by the magnitude of the cognitive load. The subjects needed to remember four items at the same time in the memory game and had to recall them in the pre-established order. Therefore, the results also provided insight into the effects of a multiple-task environment on memory performance. After carrying out a session in the driving simulator with a certain SRT the subjects were asked what influence each delay time had on the process of task completion and on their driving performance. The subjects were also questioned about the amount of stress and boredom they experienced during the experiment with regard to the different SRTs. This information about subjective factors was collected in order to establish which SRT was the most agreeable to the test subjects.

1.3 MOTIVATION FOR CONDUCTING THE STUDY

During the design of computer interfaces for automobiles, the focus changes from road to monitor need to be considered since unnecessary checking of the screen while waiting for the system to respond can cause the driver to spend less time focusing on the road. The study was aimed at finding the optimum SRT that permits users to focus as much as possible on the road while also achieving an efficient task completion time. An optimum SRT between independent (sub) tasks enables the user to achieve the ideal readiness for the subsequent task execution. However, one difficulty in determining the optimal SRT is that there are two types of SRT. In intra-task SRTs there are dependencies between the user's responses to the different stimuli, and the user may need to keep a provisional result in his or her memory which is then used as input to the next subtask. In inter-task delay SRTs there are no such dependencies between the responses to the stimuli. In this study intra-task SRTs ranging from 0 to 30 s were used to include short, medium and long durations.

1.4 OUTLINE OF CHAPTERS

The study is subdivided into five chapters. Chapter 1 gives an introduction to the topic and presents the research aims and problems. Chapter 2 first describes the nature of time itself and then looks at the neural presentation of time within the human brain. Overviews of the factors known to influence temporal perception along with various laws and models that try to explain the phenomenon of temporal perception are presented in this chapter. The influence that performing multiple concurrent tasks can have on attention, time estimation and memory is also highlighted. At the end of this chapter,

the hypotheses of the study are set out, accompanied by the corresponding research findings.

Chapter 3 gives an outline of the research methodology and the research design. In addition, the sample, the measuring instruments, the method of data collection and the statistical methods that were employed are included in this chapter. Chapter 4 presents the results of the statistical analysis performed on the data yielded by the two experiments. Chapter 5 provides a discussion of the research findings and a summary of the conducted research. The practical implications of the research findings and their influence on further research are also included in this chapter.

CHAPTER 2

THEORETICAL FRAMEWORK AND LITERATURE REVIEW

The sense of time differs significantly from all people's other senses and can only be observed in an indirect way. A general discussion of the neural representation of time is provided, extending to the functional parts in the brain that are involved in the processing or storage of temporal information. The 'window of simultaneity' is also discussed, which explains how the brain integrates information from different sensory modalities into one coherent moment (Pöppel, 1988). Factors influencing the process of temporal perception are then described. These include mental and neurological disorders, age, stress and drugs as well as affective factors, as well as the effect of stress and other subjective factors such as boredom.

The laws and models of temporal processing are also discussed to highlight the difficulties in finding a common law or model that could explain the variations in the production and reproduction of temporal intervals. Particular attention is devoted to Weber's law, which has been widely applied to temporal perception and Vierordt's law which addresses the process of duration estimation. In addition, an overview of the basic models of temporal processing is given, including clock- and memory-based models as well as the scalar timing model (SET), which combines clock- and memory-based models (Gibbon, 1977).

To provide an understanding of the cognitive process involved in the completion of the conducted experiments in this study an overview of the basic concepts of attention, perception and memory is given. This is necessary to provide an understanding of the attentional limits that exist when performing a task that includes numerous sub tasks. The human

information processing-capacity is limited by people's working memory capacity and can be negatively influenced by concurrently processed information. Various models try to give an explanation of the phenomenon of dual-task interference, and some of the relevant theories and models are discussed, such as Broadbent's (1958) filter theory, the sensory store and channel theory by Atkinson and Shiffrin (1968), the attenuation theory of Treisman (1963) and the limited capacity models of attention by Kahneman (1973). Models depicting the internal processing of perceived data such as the bottleneck model (Pashler, 1984) and the capacity-sharing model and the crosstalk theory (Sternberg, 2003) are also mentioned. The chapter concludes with an overview of the theoretical standpoint that was adopted in the study and describes the various research questions that were investigated.

2.1 THE NATURE OF TIME

The understanding of how to define time has undergone significant changes since the introduction of the theory of relativity by Einstein. Prior to this, according to Newtonian physics, physical time was seen as an independent quantity. It was believed that absolute time existed within absolute space and therefore that time stayed constant throughout cosmic space. The theory of relativity linked time with space in four-dimensional space-time. Physical time is regarded as a stream of irreversible change running through physical space. Space-time itself is a-temporal physical space where change runs and the duration of change can be measured with clocks. The theory of relativity cannot be imagined without gravitational ether which is non-homogeneous and has no autonomous existence but depends on the field generating matter (Sorli & Sorli, 2004a). Through the introduction of

gravitational ether into physical space, physical space is no longer of constant density. It now corresponds to the density of matter. The density of physical space is measured in GR (General Relativity) based on the curvature of space. The gravitational force of an 'area' depends on its density of physical space. Gravitational forces attract one another directly via physical space, unlike the three other basic forces (electromagnetic force and weak and strong nuclear forces), which rely on particles or waves to travel through physical space. The gravitational forces between dense matters are created instantly and they are therefore a-temporal (Sorli & Sorli, 2004b).

The gravitational forces humans are exposed to have an effect on their brain functions. In weightlessness the spinal ganglia neurons of the hypothalamic nuclei reduce their production of arginine, vasopressin and certain growth hormone-releasing factors. The somatosensory cortex and spinal ganglia undergo structural changes due to a decreased afferent flow to the somatosensory cortex. These structural changes are necessary to cope with the neuron hypoactivity experienced under microgravity (Krasnov, 1994). According to Penrose (1994) and Hameroff (1994), the gravitational force of physical space is a basis for human consciousness, acting on the mass of neurons and their microtubule networks.

Penrose even suggests that these microtubules may be responsible for the emergence of consciousness, and that the process is fundamentally related to the influence of quantum gravity within the tubules. Physical space and gravitational force are a temporal and therefore, the consciousness emerging in them can also be a-temporal, explaining why feelings of 'timelessness' and 'spaciousness' are so commonly experienced (Penrose, 1994, pp. 369-377).

2.2 THE NEURAL REPRESENTATION OF TIME

One of the most elusive concepts still remaining for the field of neurobiology is the representation of temporal information because there are no dedicated sensors for time as there are for the five human senses, including vision and audition. The phenomenon of time perception with regard to its underlying neurobiological functions is best conceptualised in terms of the three concepts of duration, succession and temporal perspective (Block, 1990). The memory for duration refers to the memory for the persistence of an event or the interval between time periods or certain events. The sequential occurrence and the memory with regard to the relative regency or temporal order of events are handled by the memory for succession.

The memory for time perspective can be mediated by the use of retrospective and prospective strategies and it is based on the memory derived from the past, present and future. As time markers for the memory representation of these three different temporal features, space, response, affect, sensory perception and language are employed. The hippocampus and interconnected neural circuits are assumed to mediate the temporal aspects of memory (Meck, Church & Olton, 1984). It is further posited by some neuroscientists that the dorsolateral prefrontal cortex and interconnected neural circuits mediate the temporal attribute within the data-based memory system. In addition to these vital functional parts within the human brain, anatomical connections exist between the hippocampus and prefrontal cortex, which aid in the representation and processing of temporal information (Ferino, Thierry & Glowinski, 1987).

Numerous studies have addressed the role of the cerebellum as an internal clock. The cerebellum has been hypothesised to operate as an internal clock that serves to precisely time the temporal relationships between events in

both the motor and perceptual domains (Ivry & Keele, 1989). Anatomical connections have been identified between the dentate nucleus of the cerebellum and the prefrontal cortex. Patients with neocerebellar lesions were found to have impaired performance in tests requiring planning and mental fluency. In addition to this, an increased variability during a repetitive tapping task has been reported in patients with neocerebellar lesions (Ivry, 1996; Mangels, Ivry & Shimizu, 1998; Nichelli, Always & Grafmanet, 1996).

In a series of three experiments, Mangels and his co-workers (1998) tried to separate the role of the cerebellum and the prefrontal cortex by comparing patients with unilateral cerebellar or prefrontal lesions with the help of a time discrimination task consisting of 400-ms and 4-s intervals. The results showed that neocerebellar damage impaired timing in the millisecond and the second ranges. Prefrontal lesions resulted in deficits in the estimation of longer duration and impairment in the working memory. The findings indicate that the frontal lobe is necessary for memory and attention and is therefore required in all timing tasks. The prefrontal cortex further provides supportive functions regarding the acquisition, maintenance, supervision as well as the organisation of temporal intervals in working memory.

The brain also has to register self-continuity in time and must enable the individual to perceive his or her own ongoing existence. Given that the sensory systems work in this temporal manner, the sense of a continued existence must be supplied by some part of the brain. The sense of self-continuity can be regarded as a very primitive requirement and extends well beyond human beings, since almost all organisms have to have a continuing awareness of self in both space and time (Hume, 1739). The continuity function is believed to be located in a part of the primitive brain, the limbic system and has been observed to be temperature dependent (Hancock, 1993; Matell & Meck, 2000; Treisman, 1999).

The system that permits temporal continuity also possesses a counter-part located in the frontal lobes. This system allows the individual to go 'faster than time' and enables the individual to construct numerous 'what-if' scenarios and therefore makes it possible to process time in a proactive mode (Hancock, Szalma & Oron-Gilad, 2005). This observation essentially implies that the primary function of memory is not recording the past but, the storing of information. The stored memory can be regarded as the tool that the brain uses to construct useful 'what-if' scenarios for the future (Staddon, 2005). According to Dennett (1991), Hawkins and Blakeslee (2004) the human brain can be regarded as an anticipation machine.

2.2.1 The window of simultaneity

The general experience of seeing lightning before hearing the associated thunder reveals the discrepancy in human perception of a synchronous, though distant, multisensory event. The underlying reason for this phenomenon lies in the physical differences in the relative time of arrival of stimuli at the eye and ear. Light travels at about 300 000 000 metres per second, and this is a significantly higher speed than that of sound, which only progresses at about 340 metres per second at sea level, but differences in arrival time with respect visual and auditory information for events in one's vicinity are generally unnoticed (Pöppel, 1988). This can be explained by looking at the way the incoming sensory information is processed since the mechanical transduction of sound waves at the ear is faster than the chemical transduction of light at the retina (King & Palmer, 1985). These physical and biophysical differences in the arrival time of light and sound cancel each other out at a distance of approximately 10 metres where the receiver is placed in a so-called 'horizon of simultaneity' (Pöppel, 1988).

The continued perception of multisensory synchrony is achieved by two alternative means, according to recent research. Psychophysical data reported by Sugita and Suzuki (2003) suggest that the window for multisensory temporal integration actually also moves farther away as audiovisual stimuli become more distant from people. In this way it allows for the fact that sound will increasingly lag behind vision with increasing distance. An alternative account comes from Morein-Zamir, Soto-Faraco and Kingstone (2003). They contend that the multisensory perception of simultaneity is occasionally upheld by our ability to ventriloquise visual stimuli across time into temporal alignment with later presented auditory stimuli. Additionally, the phenomenon of temporal ventriloquism is involved in the synchronisation of the rate at which sensory events are perceived to occur.

Pöppel (1988; 1997) hypothesises about the existence of a temporal integration mechanism in the brain that integrates the sequences of events into one 'gestalt'. The mechanism makes decisions concerning which event is graded as now and which events count as non simultaneous or as successive. To study the phenomenon of temporal integration, Pöppel exposed his test subjects to tones lasting for 1 ms. If the left and right ears were stimulated simultaneously the two tones were fused together into one stimulus by the test subject. Up to a fusion threshold of 2 ms the two tones were regarded as simultaneous. Past this threshold subjects perceived two separate tones. One interesting finding of this experiment was that only at intervals of around 20 ms were the subjects able to tell which click came first. The window of simultaneity also varies individually, ranging from 2 ms to 5 ms. Experimental evidence further proved that older people fuse more events together than younger people. The minimum threshold duration for the simultaneous integrating of sensory information is relatively fixed and cannot be modified by practice. Values of 20 ms for vision and 10 ms for

tactile sense have been found, but these values can vary slightly from person to person (Euler, 1997; Pöppel, 1988).

The underlying causes of the large individual differences in the perception of multisensory synchrony were further examined by Stone, Hunkin, Porrill, Wood, Keeler, Beanland, Port and Porter (2001). They found dramatic individual differences, which were robust across testing sessions. The stimulus onset asynchrony (SOA) at which people were most likely to judge sound and vision as being synchronous ranged from sounds preceding vision by 20 ms to vision leading by as much as 150 ms (Spence, Shore & Klein, 2001). These differences in multisensory perception were first noted by astronomers more than 200 years ago and were formalised by the notion of the 'personal equation'. This led to the very foundation of experimental psychology (Mollon & Perkins, 1996).

2.2.2 Temporal integration

Experimental evidence has confirmed that the neuro-cognitive machinery runs on two separate temporal processing systems. The first is a high-frequency processing system operating at a 30-ms threshold. By studying temporal order thresholds it has been established that data picked up within a time window of 30 ms are treated as co-temporal and therefore distinct events need a minimum temporal distance of 30 ms to be regarded as successive. Neural oscillations with a period of 30 ms are initiated after the transduction of a stimulus (Madler & Pöppel 1987; Schwender, Klasing, Peter & Pöppel, 1994).

A variety of studies using qualitatively different paradigms provide evidence for the existence of distinct processing stages. Under stationary experimental

conditions, response distributions of reaction times (Harter & White, 1968) and of pursuit (Pöppel & Logothetis, 1986) indicate multi-modal characteristics with a 30-ms separation of distinct response modes. These multi-modalities present an explanatory basis for the existence of neuronal oscillations. After the transduction of a stimulus, a relaxation oscillation with the duration of 30 ms is initiated. The relaxation oscillator is then triggered instantaneously by the stimulus. The oscillator is phase locked to that one stimulus and allows the integration of information from different sensory modalities to define a basic system state that functions as a building block of conscious activity (Pöppel, 1997). The temporal order analysis of the speech signal can be regarded as the basis for the identification of this phenomenon, and a disturbance of temporal acuity has been strongly linked to language disorders such as aphasia and other language impairments (Tallal, Miller & Fitch 1993).

The neural oscillation system provides the basis for the temporal integration window. The phenomenon of temporal integration was studied by Wundt in 1911 with the help of subjective accentuation of metronome beats where the subject had to impose a subjective structure onto identical physical events. The auditory stimuli consisted of click sounds in this experiment. If the sounds follow each other with an interval of one second the subjects are able to impose a subjective structure by giving a subjective interpretation to every second of the stimuli. When presented with long temporal gaps, temporal binding of the temporally adjacent stimuli is no longer possible and the two separate sequential stimuli are not incorporated into one percept (Wundt, 1911). The result indicated a maximum value of approximately 2.5 s for the successive integration windows.

Subsequently the duration of the subjective present has been assessed by numerous experiments in the domains of temporal perception, proper movement control, speech, vision, audition as well as memory. Some visual

stimuli, such as the three-dimensional Necker cube, can be given two different perceptual interpretations. In the case of the Necker cube, an automatic shift in perceptual content takes place every 3 s (Gomez, Argandona, Solier, Angulo & Vazquez, 1995; Schleidt & Kien 1997). The same phenomenon is found with auditory stimuli. When subjects are instructed to synchronise a regular sequence of finger taps the accuracy of the stimulus anticipation is only provided up to an inter-stimulus interval of 3 s and thereafter the tap movements become irregular. This suggests that the segmentation is based on an automatic and pre semantic integration process that provides a temporal platform for conscious activity and that every 2 to 3 s an endogenously generated 'question' arises for new information from the external or internal environment.

Studies of brain-injured patients indicate the involvement of the frontal brain regions in the temporal integration process. Lesions in the right frontal lobe led to a longer temporal integration while lesions in the left frontal lobe had the opposite effect and shortened the integration interval. These findings led to the suggestion that an inter-hemispheric push-pull mechanism operates between the two homologous frontal regions. This mechanism controls any tendency towards temporal dilation by contra-lateral temporal processing and leads to a long-term stabilisation of the temporal integration interval (Pöppel, 1997).

2.3 FACTORS INFLUENCING TEMPORAL PERCEPTION

Nature itself shows the existence of temporal regularities including short and long time cycles. The type of time as it exists in nature is referred to as 'natural time' by Nelson (1996). From natural time it is possible to construct a more abstract idea about time. Time is not a phenomenon that can be

experienced directly since humans do not possess a sensory organ that is specialised for the measurement of time. The five senses, which include seeing, hearing, taste, smell and touch, receive their information through receptors adjusted to the stimulus they are meant to process. Since there are no receptors that would enable humans to sense time, time can only be observed in an indirect way.

The notion that subjective time is related to the information-processing rate of the individual has been introduced a century ago by psychologists and has in recent years received support from some cosmologists. It involves two assumptions: first, that subjective time is based upon the overall information processing rate and, second, that the subjective experience of life's duration is related to, if not based on, the total information processed, also called the 'cumulative uncertainty' (Davies 1994). Thus, the faster one processes information and the more information one accrues, the more one has experienced in life and the greater will be the subjective experience of time for those events.

Conversely, if a person processes small amounts of information there will be little subjective experience of time having passed. In the current astrophysical environment, proper time is presumably accepted as the appropriate measure of time because the information-processing rate of humans is directly proportional to proper time (Tipler & Barrow, 1986). In other words, one second of subjective time corresponds fairly well with one second of 'external' time. In mathematics and physics, the number of bits processed per second is a system's information-processing rate. In psychology, however, most evidence indicates that chunks (meaningful units) instead of bits (mathematical units) are critical in human information processing and memory and that the amount of processed information is used as an indicator for the passage of time (Gruber, Wagner, Block & Matthews, 2000).

The personal idea of time or 'personal experiential time' by Nelson (1996) includes, amongst others, the concepts of sequence and duration. Under 'sequence' is understood the relation between two or more events, and 'duration' refers to the time during which an event takes place or the elapsed time between two events. Since time can be regarded as a personal construction, this view leads to the development of a variety of ways to measure a person's ability to perceive time. Some of these include time estimation, whereby a person observes stimulus duration and then estimates the duration of that stimulus. In the case of time production subjects are instructed to produce a certain time duration and in time reproduction the subjects are instructed to reproduce a prior given stimulus of the same duration that has been experienced previously (Nelson, 1996). It has been established in psychological research that the judgement of specific duration often varies from person to person. Factors influencing these variations are personality, amount of light, age, gender, cognitive ability, learning, culture and drug intake as well as mental or neurological disorders (Eisler, 1993; Friedman, 1990).

2.3.1 Influence of mental and neurological disorders

Davids and Falkoff (1975) suggest that the sense of time evolved as an ego function. The sense of time enables the integration of temporal perspectives and attention to the present moment and provides the individual with the power to delay gratification. Furthermore, the accurate assessment of the passage of time makes it possible to tolerate the delay of reward. It can therefore be concluded that a systematic relationship between time perception and delayed gratification provides an individual with the ability to assess the passage of time accurately. To estimate the right duration one

must wait in order to attain gratification, and therefore the ability to control impulsive actions is a basic function of people's time sense.

Barrett and Patton (1983) maintain that there is a relationship between impulsivity and time estimation, based on the assumption that impulsive individuals have difficulty with delayed gratification. They argue that such individuals usually exhibit a tendency to respond quickly to a given stimulus without evaluating the consequences of their actions. The researchers also postulate that a faster cognitive tempo is related to impulsivity and that the internal clock of an impulsive individual is therefore faster than that of a non impulsive individual. However, Lennings and Burns (1998) tested the hypotheses regarding the influence of impulsivity on time estimation but were unable to establish a significant correlation between the variables 'impulsivity' and 'inaccuracies in time estimation'.

Cappella, Gentile and Juliano (1977) tested the assumption that children with attention deficit/hyperactivity disorder (ADHD) seem to have an internal clock that runs faster than that of healthy children. In their experimental set-up, the experimenter dropped a ball to start a time interval, and the children were then instructed to drop another ball when they thought that a given time interval had passed. They found that the hyperactive children sensed a larger difference between the estimated time and the actual elapsed time than the control group and always underestimated the pre-established time period. The difference in time estimation between children with ADHD and normal subjects increased with the length of the estimated duration, suggesting that children with ADHD had more difficulty in delaying their need for gratification over a longer time period.

A study conducted by Berlin and Rolls (2004) focused on people with borderline personality disorder (BPD) with regard to time perception, impulsivity and personality types. The test subjects had to complete a time

perception task, a matching familiar figures test and a spatial working memory task. They found that BPD patients produced shorter time spans across all time intervals (10, 30, 60 and 90 s) than normal controls. The underestimation of durations became more apparent as time intervals increased. The results indicate that BPD patients possibly have a faster cognitive pace and therefore feel that the set time interval has passed earlier than normal subjects. The findings can also be attributed to increased frustration levels when waiting for the time interval to end. The results of the study suggests that there may be a slight tendency for BPD patients to overestimate shorter times more than the normal control group, but that BPD patients do not experience any significant difficulties with the completion of tasks involving spatial working memory.

2.3.2 Influence of affective factors

Angrilli, Cherubini, Pavese and Manfredini (1997) tested the influence of stimulus-induced emotional arousal and affective valence on time estimation with the help of standardised photographic slides. Two groups of subjects had to estimate durations of 2, 4 and 6 s. The first group used an analogue scale and the second group reproduced the interval by pushing a button. The estimated time, skin conductance response and heart rate were recorded. The results showed that negative slides with low-arousal stimuli were judged shorter than positive low-arousal slides, and the duration of high-arousal negative slides was judged longer than that of high-arousal positive slides. These results suggest the existence of a one-time estimation system that gets activated under low-arousal conditions and another time estimation system that gets activated in high-arousal situations. The findings are in accordance with the theory proposed by LeDoux (1995), which is based on the concept that one subcortical and one cortical neural pathway are

responsible for the processing of emotional stimuli. Highly activating and potentially dangerous stimuli are processed by the subcortical pathway but it only receives incomplete information. The cortical pathway receives more precise information but is therefore slower and is able to inhibit faulty responses elicited by the subcortical pathway.

Another factor that can influence duration estimation is the so-called 'watched pot' phenomenon where the duration experience is lengthened when one is attentively or impatiently waiting for some event to occur. Factors responsible for this phenomenon are inter alia the fact that waiting is a basic, affective condition that simulates the feeling of time (Fraisse, 1963). Ornstein (1969) further proposes that waiting increases vigilance, resulting in a higher awareness of input. Finally, Block (1979) posits that attention to time and duration depends on cognitive factors and showed that it is subjectively experienced as longer in a 'prospective paradigm' than in a 'retrospective paradigm'. In a prospective paradigm subjects are instructed before an experiment is conducted that they will have to report specific details about an event, whereas they are only given vague instructions and then questioned afterwards about an event in the retrospective paradigm.

To test his hypothesis Block (1979) conducted three experiments in which the test subjects had to observe a liquid-containing beaker on an electrical burner for 270 s. Observers in the prospective paradigm were told that the experiment concerned time perception. In the retrospective paradigm they were informed that it is about visual perception. Two types of trial were conducted; in the one the liquid started boiling and in the other the liquid never reached the boiling point. The trials were conducted once with interruptive questioning and then without questioning. The study indicated that the prospective paradigm led to a greater duration overestimation in the temporal reproduction task, which was even higher when the liquid did not boil. When the observers were interrupted by task-unrelated questioning it

led to a shortened reproduction if the liquid did not boil. In the retrospective paradigm a boiling liquid or questioning alone led to a duration overestimation. The overestimation did not increase significantly when both boiling and questioning were present (Block, George & Reed, 1980).

2.3.3 Influence of age

A further factor that has to be addressed in connection with temporal perception is age, and there have been indications that a slowing of clock speed occurs with ageing. A slowing down of the internal clock would influence overall time perception and influence the ability to estimate durations correctly. Using a reproduction time-estimation method in which a person had to delimit a subsequent duration to be subjectively equal to a previously experienced one, Vanneste and Pouthas (1995) found that at around the age of 65 the mean duration judgement ratio was approximately 60-70% compared to the age of 20. They concluded that the adult age-related change in retrospective duration judgements resembles that noted for the overall information-processing rates. After age 20, both information-processing rates and retrospective duration judgements decrease. It is therefore questionable whether the differences in time estimation between the young and the elderly should be attributed to a slowing of an internal clock or whether they are due to a decline in information-processing rates and memory performance.

Wearden, Wearden and Rabbitt (1997) investigated possible age-related changes in timing behaviour with subjects aged from 60 to 80 years. They employed a temporal generalisation as well as other timing tasks. The subjects were split into two age groups (60-69 and 70-79) with average IQ equated or three IQ groups (lowest, middle and highest third) with age

equated to safeguard against the age-related decline in IQ (Wearden, 1997). The results indicated that the temporal generalisation gradients were influenced by age because the older group produced slightly flatter gradients, suggesting more errors in identifying the comparison durations. The three IQ groups showed significant differences and the temporal generalisation gradients varied among the groups, with the lowest-IQ third being much flatter than the one of the highest-IQ third. The steepness of the generalisation gradients indicates the precision of timing whereby a steeper gradient represents a more precise timing performance. The results of the study therefore suggest that there is a slight decrease in timing precision with increasing age and significant decrease in precision with decreasing IQ.

2.3.4 Influence of stress and drugs

Another aspect that has to be considered is the influence of affective factors on time perception. Not only do attention and amount of information processed influence time estimation but arousal and affective valence also have an effect. People who undergo extreme short-term psychological stress often claim that time slowed down for them during this experience. Traumatic events such as car accidents or lengthy falls often appear to take place in slow motion, and scientists suspect that slowed time perception is an evolved defence mechanism that is part of people's fight-or-flight response (Hancock & Warm, 1989; Stokes & Kite, 1994). The slowing down of time provides us with more subjective time in which to deal with a crisis situation, and extreme stress helps them to think faster. According to the contextual theory stress drains attentional resources and reduces the allocation of the needed resources. This leads to an assignment of the remaining resources to task-relevant activities, and the attention to time-based cues is highly

reduced. This results in a distortion of temporal perception for time-in-passing and for time recollection in memory (Hancock & Weaver, 2005).

The time distortions experienced during a high-threat situation have been researched by Fair (1984). He interviewed 28 subjects who had ejected from a jet aircraft and were put in a high-stress situation since they had to decide on the right time to leave the aircraft and cope with the dangers in the ejection procedure itself. An apparent slowing of time was reported by 64% of the subjects; 18% reported a speeding up of time. In both cases the flow rate of the external environment was reported to have changed significantly. The results indicate that time distortions under stress lead to two different forms of experience. In the first form events seem to be stuck into a temporal 'blur' and time seems to have speeded up. In the second form time appears to slow down and events can be recalled with great clarity.

The phenomenon of these opposite directions in time distortion can be explained with the help of the accumulation model according to which the individual creates his or her own time perception by filling moments in time with a sequence of experiences (Roedelein, 2000). The perceived slowing of time is an adaptive response to the stress situation and provides the individual with more time to deal with a threatening situation and also provides an increased event registration for accurate recall of the event. Time slows in proportion to the increase in event registration and the clarity of recall and number of events cannot be reconciled with normal time translation and therefore time seems to slow down.

The apparent speeding up of time can be explained by the re-direction of attention towards 'internal' events and the flight response so that only a few external events are registered within a perceptual moment. The decrease in event registration leads to a perceived speeding up of time. It is further assumed that response stereotypes are enhanced during stressful situations.

This leads to a higher number of 'flight' responses among introverts while extroverts more frequently choose 'fight' responses. Under normal and medium levels of stress the time distortion seems to be only unidirectional leading to a perceived speeding up of time (Hancock & Weaver, 2005). The way in which stress reduces attentional capabilities can be compared to the effect that is found during attentional 'narrowing'. With regard to visio-spatial cues, the effect of 'tunnel vision' has been reported by pilots when exposed to high-G loading. It can be concluded that stress affects both vision and time in a similar systematic way since the strategy of narrowing the perceptual field is an effective way to deal with the lack of attentional resources (Dirkin & Hancock, 1984).

Drugs can also influence the subjective experience of time. With the use of animal subjects, Meck (1996) investigated the effect of drugs that stimulated the dopamine system of the brain with regard to their impact on the pacemaker of the internal clock. His findings indicated that elevated dopamine levels speed up the internal clock and that reduced dopamine levels slow the clock down. The rats in his experiment remembered the time at which food was delivered as being shorter or longer than it really was, and it can therefore be concluded that cholinergic drugs influenced temporal memory processes systematically to a greater degree than clock processes. Evidence that the internal clock exists as a real physical mechanism is provided by experiments involving pharmacological manipulations or physical manipulations such as the change in body temperature. The pharmacological separation of clock and memory processes further suggested that they are not just different parts of a psychological model but that they are also based on separate cognitive mechanisms.

A significant amount of research has analysed the impact of stressors on the functioning of cortical catecholamine (CA) neurotransmission and has generally indicated that the synthesis and utilisation of adrenergic and

dopaminergic systems were altered (Anisman & Zacharko, 1990). The degree of CA alteration was found to be dependent on the nature of the stressors employed. After the application of tail-pinch as mild stressors in rats, an alteration of the releases of dopamine (DA) and noradrenalin indicated a different distribution across the striatum, the nucleus accumbens and the medial prefrontal cortex, which are part of the mesotelencephalic DA systems. The peripheral administration of d-amphetamine also results in the activation of parts of the mesotelencephalic DA systems by altering the extracellular concentrations of DA in the striatum and the nucleus accumbens significantly.

Chang, Liao, Lan and Shen (2000) tested the effects of stress on the timing behaviour of rats with the aid of lever-press experiments. The method of tail-pinching with a sponge-padded paper clip was used as stressor and was applied for 10 minutes, 1 hour before the commencement of each test session. In the study three different set-ups were used. The first design included a differential reinforcement of low rates of 10 s (DRL10). To obtain a reward, the rats had to estimate correctly when 10 s had elapsed since the previous press. Each lever press prior to the 10-s period resulted in a reset of the delay timer. In the second set-up a fixed-interval of 60 s (FI60) was employed and the first lever press given 60 s after the preceding reinforcer was rewarded. Any lever presses made during each 60 s interval did not reset the timer. In the fixed-ratio of 20 accumulated 20 lever presses.

The loss of behavioural inhibition due to the exposure to the stressors had little effect on the performance of the subjects under FI60 and FR20. The artificially induced stress significantly altered the DRL10 behaviour. Following a tail-pinch the number of early lever presses increased, indicating that the stressed rat was unable to estimate the time interval. One explanation for this alteration would be that DRL behaviour requires a more precise cognitive representation of the time interval. Early lever presses result in the resetting

of the timer and give no reward. The reward acts as a periodic reinforcement, which is always present under F160. DRL10 lacks this constant reinforcement, making it even more difficult to reproduce the correct duration. When the subject had been given a d-amphetamine treatment (0.2 and 2.0 mg/kg) after application of the stressors, its performance under DRL10 equalled non-pinch trials.

This indicates that CA systems are involved in the modulation of DRL10 behaviour following a stressor in the form of a tail-pinch. Another effect of the applied stressors was that the normal bimodal distribution of inter-response times (IRT) frequencies was significantly shifted to the left under DRL10. The median IRTs of 5.1-7.5 s increased significantly and long IRTs of 10 s or greater decreased. The study has shown that tail-pinch manipulation and amphetamine administration produced quantitatively the same effects on response and reinforcement frequency during a differential reinforcement of low rates (DRL) test (Chang *et. al.*, 2000).

2.4 LAWS AND MODELS OF TEMPORAL PROCESSING

The underlying mechanisms allowing people to possess a sense of time are not yet fully understood. Precise timing is only relevant for shorter intervals that are needed in order to perform activities such as music, dance, sport, vehicle driving and communication. It is not yet clear whether a single timing mechanism handles time perception for both short and long durations, since long durations do not have to be estimated with the same accuracy as short duration activities, and could be processed by a different mechanism (Madison & Merker, 2000). The fact that more than one mechanism could be responsible for human time perception can explain why it has been so difficult to find a single model that can explain how altered perceptions of

time occurs, and that can estimate the length of temporal activities and durations correctly.

2.4.1 Basic laws in chronometric research

2.4.1.1 Weber's law applied to temporal perception

The two basic laws in chronometric research are Weber's law, which has been widely applied to temporal perception, and Vierordt's law, which is relevant to the process of duration estimation. Weber's law was put forth by Weber (1846), who is famous for his research into aural and cutaneous sensations and whose work can be regarded as the foundation for a branch of scientific investigation that has come to be known as psychophysics. With the application of psychophysics, definite measurements regarding the relation of physical stimuli to the resulting psychical or mental facts were developed. These measures provided the basis for the field of experimental psychology. Weber's law is now frequently used in studies of time perception and has been the foundation for several theories of timing. It introduced the idea that the increase of stimulus necessary to produce an increase of sensation in any sensory modality is not a fixed quantity. The necessary alteration required for a given stimulus will be proportional to the change in the immediately preceding stimulus.

Weber's law basically states that the difference between the intensities of two stimuli can be so low that the distinction is barely noticeable. This sensation, also called 'just noticeable difference' (JND), is according to Weber proportional to the physical intensity of the stimuli. The Weber fraction is useful for measuring and comparing discriminability across different modalities and stimulus ranges (Boring, Langfeld & Weld, 1935; Eisler, 1993). The relative accuracy may be measured as the amount of change in a

stimulus necessary for it to be detected some proportion of the time, divided by the magnitude of the stimulus on which that is superimposed, $\Delta S/S$, where ΔS is the amount of stimulus change necessary to exceed threshold, t and S is the magnitude of the stimulus on which it is superimposed. Weber's law asserts that this ratio is constant over variation in S (Allan & Kristofferson, 1974; Gibbon, 1977; Killeen & Weiss, 1987). The coefficient of variation (cv), provides an alternate measure of relative variability and is proportional to the Weber fraction. For the time domain the formula

$$cv = \frac{\sigma}{t} \quad (1)$$

is used where σ is the standard deviation of the temporal estimates or productions and t is the mean of those times. The application of Weber's law has been shown to be valid for interval estimation of durations from 0.2 to 2 s (Grondin, 2001). Research findings invalidating the applicability of Weber's indicated that the standard deviations of time estimates for well-trained subjects became invariant over substantial ranges. Furthermore, the law does not generally hold for durations less than 0.25 s (Allan & Kristofferson, 1974; Fetterman & Killeen, 1992). Weber's law has been generalised by Getty (1975). He divided the variability of temporal discrimination into one dependent and one independent component relating to the magnitude of the stimulus. The sum of these two components is the total variance.

$$\sigma_T^2 = \sigma_t^2 + \sigma_r^2 \quad (2)$$

Here the total variance is σ_T^2 and the variance that covaries with the

magnitude of the stimulus is σ_t^2 and the constant residual variance is σ_r^2 .

$$\sigma_t^2 = w^2 t^2$$

then

$$\sigma_T^2 = w^2 t^2 + \sigma_r^2$$

and

$$\sigma_T = \sqrt{w^2 t^2 + \sigma_r^2} \quad (3)$$

In eq (1) σ is the standard deviation of the temporal estimates and is divided by t .

To provide a Weber fraction the derived formula is also divided by time.

$$\frac{\sigma_T}{t} = \sqrt{\frac{\sigma_r^2}{w^2 + t^2}}, \quad t > 0 \quad (4)$$

In a case where σ_r is smaller than wt the third equation is reduced to a more or less linear relation between the values of σ_T and t , where w stands for the slope and σ_r for the intercept. In eq (4) the Weber fraction becomes an asymptote of w as t increases. This version of Weber's law was able to account for the performance on duration discriminations less than 2 s but was not valid for longer time periods. A subsequent generalisation by Killeen and Weiss (1987) assumed that timing errors arise from either the pacemaker or the counter and that accuracy is improved by dividing a long interval into subcomponents that are produced by the pacemaker. The counter counts the intervals and their sum is $t = nd$. The duration estimated is t , the average number of components is n and the average component duration is d . The random sum of random variables constitutes the total timing variance σ_T^2 that is the weighted sum of the pacemaker variance, σ_D^2 and a counter variance of σ_N^2 .

$$\sigma_T^2 = n \sigma_D^2 + d^2 \sigma_N^2 \quad (5)$$

In a further development of the formula, the variances in pacemaker and counter are quadratic functions of their means.

$$\sigma_D^2 = a_2 d^2 + a_1 d + a_0 \quad (6)$$

$$\sigma_N^2 = \beta_2 n^2 + \beta_1 n + \beta_0 \quad (7)$$

Killeen and Weiss (1987) further minimised the overall timing variance σ by selecting the best values of n and d . This was achieved by estimating intervals close to 0.

$$\sigma_T^2 = (AT)^2 + Bt + C \quad (8)$$

The parameters A , B and C are concatenations of the parameters of eqs (6) and (7). Because $A = \beta_2$, asymptotically the Weber fraction equals the Weber fraction for the counter alone. Expressed in terms of standard deviations, (8) becomes:

$$\sigma_T = \sqrt{(AT)^2 + Bt + C} \quad (9)$$

In order to provide a Weber fraction the formula can be divided by time

$$\frac{\sigma_T}{t} = \frac{\sqrt{(AT)^2 + Bt + C}}{t} \quad (10)$$

Killeen and Weiss's model was tested and evaluated by Ivry and Hazeltine (1995). They came to the conclusion that eq (8) provided the best description of temporal variance, and that the function was easily portrayed by outlining the target interval in units squared, which resulted in a fairly accurate straight line. It remains questionable where and how the Weber variance can be introduced in the commonly used models. For the majority of clock counter models, all β coefficients and a_1 in eqs (6) and (7) are

implicitly 0. This problem aspect led to the reintroduction of the Weber error in subsequent theories and models, including the scalar timing model (SET).

The most often cited theory of timing is Gibbon's (1977) SET, which is based entirely on Weber's law. The validity of the SET has been undermined by the demonstrations of a systematic departure from Weber's law that have been reported for temporal perception (Crystal, 2001) and also for other types of stimuli. These have been termed "the near miss to Weber's law" and "the severe departure from Weber's law" (Gallego & Micheyl, 1998; Oxenham & Moore, 1995). A study conducted by Bizo (2006) and his colleagues aimed at providing evidence for the Weber's law by using a temporal production and a categorisation experiments. They employed a production task which required pigeons to switch between keys within a specified temporal window. The categorisation task required them to classify stimulus duration as either short or long. The results showed a severe departure from the values predicted under Weber's law. The resulting fractions did not descend to a horizontal asymptote, but resulted in a U-shaped curve that decreased as a function of the target duration and increased again at intermediate and long durations.

A subsequent generalisation of Killeen and Weiss's interpretation of Weber's law was conducted by Killeen and Taylor (2000). They employed the theory of stochastic counters (TSC), which provides the architecture for counters that conform to Weber's law in the large but deviate from it locally so that it allows an increase in the timing error that can be caused by failures of the count register because it was kept at a random setting between zero and its last count. The TSC permits deviations from Weber's law in which the Weber fraction can increase by as much as the $3/2$ power of the interval timed. Further possible explanations are random responding and a slowing of the pacemaker itself.

2.4.1.2 Duration estimation and Vierordt's law

In the same time period Karl Vierordt studied temporal integration with the help of stimulus reproduction and further conducted time estimation experiments, which led to the development of Vierordt's law. Vierordt's law predicts that human test subjects will overestimate short durations and underestimate long durations with some difference point between the two values (Wearden, 2003). The existence of an indifference point at which the estimated time is closest to being equal to the pre-established duration was of great interest to classical time psychologists and they attributed profound psychological significance to this phenomenon (Fraisse, 1963).

During a temporal reproduction task the subject is first exposed to a stimulus for the sample duration, 's'. The subject then has to reproduce the pre-given duration and indicate the end of the duration 'r', with the help of a motor response. The method can also be described as 'reproduction by waiting' and involves just a single motor response. Data from reproduction experiments have shown that r and s often differ and that $r > s$ when s is small and closer to it when s is longer. One essential point to consider is that the measured reproduction, r, is generated by two consecutive processes. First, subjects wait until the elapsed time is 'close enough' to s before initiating a response. Second, making the response itself requires the time, d. The total reproduction, r, is made up of the time of response initiation (t) plus d (Wing & Kristofferson, 1973).

2.4.2 Basic models of temporal processing

2.4.2.1 Clock- and memory-based models of temporal processing

Numerous models concerning the workings of an internal timer have been proposed, which also try to provide an explanation for the effects of rising cognitive demands on the estimation of time. One such model consisting of an internal clock that emits pulses by several independent stochastic sources that are accumulated in an internal counter was proposed by Creelman (1962). Treisman (1963) had a different vision regarding the inner workings of the clock model. She assumed that a single pacemaker emits a regular series of pulses that increases with the subject's arousal level. Other researchers reject and favour the storage hypothesis.

Ornstein (1969) was the first theorist to move away from a chronometric mechanism and introduced the idea of a storage model. His theory maintains that remembered durations depend on the amount of information taken up by encoded and retrievable stimuli. The experience of a lengthened duration is according to Ornstein caused by a high number of stimuli or by complex encoded stimuli. Attentional models provide a neuronal explanation for the phenomenon of dual-task interference. Thomas, Brown and Weaver (1974; 1975) were interested in the question how allocating attention influences the perception of duration. In their model the judged duration of an interval is monotonically related to the weighted average of the amount encoded by two parallel processors. They came to the conclusion that when more attention is allocated to the non temporal information processor the timer becomes less reliable (Thomas & Brown, 1974; Thomas & Weaver, 1975).

It has further been proposed by Macar that time bases rely on specific neuronal interactions. One type of neurons responsible for feature detection fires in response to specific configurations of parameters in various

modalities. Another type the 'periodic neurons' is time conditioned to one of the several periodic activities of the organism and provides it with an internal timing mechanism independent of external stimulation. The third type of neuron focus on modality and evaluate the physical characteristics of the stimulus. These neurons are responsible for the effects of temporal information on subjective time. The different firing patterns of the three types of neuron result in the construction of the subjective time experience (Macar, 1985).

2.4.2.2 The scalar timing model (SET)

The SET by Allan and Gibbon (1991) merges timing models based on clock and memory processes. Despite the lack of evidence for a brain mechanism working with a pacemaker-accumulator clock they nevertheless propose an internal clock model consisting of a pacemaker, switch, accumulator, working memory, reference memory and comparator. The pacemaker produces pulses or 'ticks' that are collected in the accumulator. For the timing of a stimulus, the switch closes and the pulses flow from the pacemaker into the accumulator, and when the stimulus ends the switch opens again and cuts the connection between them. The number of accumulated pulses is stored in the working memory. Important times, such as the standard time needed for a particular task, are stored in reference memory, and the number of pulses in working and reference memory is then compared inside the comparator to make temporal judgements. It is further assumed that the rate of the pacemaker is variable and proportional to the rate of reinforcement. Most theoretical analyses using the SET have regarded the reference memory as the source of scalar variance that arises during the transformation of time representations from working memory to reference memory (Meck, 1996).

According to Wearden's (1992) model of temporal generalisation, during each trial the just-presented stimulus duration, t , timed without variance, is compared with a sample, s^* , drawn from the standard, s , which has been stored in reference memory. The reference memory of s is assumed to be a Gaussian distribution with mean s and coefficient of variation, c , which is constant as s varies in absolute value between conditions. The model judges that t is 'close enough' to s when $|(s^* - t)|/t < b^*$. The threshold, b^* , can be variable from trial to trial or assumed to be fixed without substantial loss of predictive accuracy. In subsequent studies, Wearden changed his initial assumption that reference is the source of errors in time estimation and started to investigate the possible influence of the other parts of the SET.

Inaccuracies in time estimation are therefore assumed to be produced by the internal clock itself. Other possible sources of temporal variance are errors within the pacemaker, the counting of pulses or the switch mechanism. One hypothesis concerning the switch that controls the start and end of timing is that it does not operate instantaneously with the physical onset and offset of the timed stimulus. This discrepancy between external stimulus and internal timer is assumed to occur with zero variance from trial to trial, and the switching processes must be taken into consideration as a potentially important source of variance in cross-modal timing (Wearden & Culpin, 1998).

Wearden and Bray (2001) further investigated the clock as the source of timing inaccuracies by conducting three experiments, testing whether the scalar property of timing could occur when humans timed short durations under a condition that made it highly improbable that the subjects could have developed reference memories of temporal standard intervals. In their first experiment they used an episodic version of a temporal generalisation task and judgements on the potential equality of two durations presented on each trial had to be made. The durations of 200, 400, 600 or 800 ms and

variable duration were presented to the subjects. The temporal generalisation gradients indicated the scalar property of superimposition at standard values greater than 200 ms. In the second experiment a variation of the 'roving bisection' method invented by Rodriguez-Girones and Kacelnik (1998) was used. It had been adapted in such a way that the scalar property of timing could be observed empirically.

The experimental data revealed almost perfect scalar-type superimposition bisection with short/long standard pairs of 100/400, 200/800 and 300/1200 ms. In the third experiment an episodic temporal generalisation was employed again, but in this experimental set-up the durations were not repeated and came from three distinct time ranges. The resulting data indicated a superimposition of all ranges except for the shortest visual stimuli timed. The results of the three experiments led to the conclusion that scalar timing can also be possible under conditions where the formation of reference memories with regard to the creation of temporal standards must be regarded as very unlikely.

2.5 INFLUENCE OF MULTIPLE-TASKS ON ATTENTION, TIME ESTIMATION AND MEMORY

2.5.1 Basic concepts of attention

Perception is the process through which a person is exposed to information. The input from the external environment is received through the person's senses and he or she attends to the information by allocating processing capacity. Through the process of interpretation the information obtains meaning and is comprehended. In order to receive information from the

external environment cognitive capacity has to be allocated to an object or task. A distinction can be drawn between three types of attention. The first is voluntary attention whereby a person actively searches out information that has personal relevance. The second is selective attention whereby a person selectively focuses attention on relevant information. The last is involuntary attention whereby a person is exposed to something surprising, novel, threatening or unexpected.

The received information is comprehended through the use of interpretation processes, and people draw upon their experience, memory and expectations to attach meaning to a stimulus. Expectations include prior beliefs about what should be happening in a given situation, and they can influence the interpretation of information. The level of involvement is influenced by the process through which a person is influenced by the perceived personal importance and/or interest evoked by a stimulus. Personal importance increases as perceived risk increases. As involvement increases, a person has greater motivation to comprehend and elaborate on information, and higher levels of involvement are expected to result in a greater depth of information processing, increased arousal and more extended decision making (Styles, 1997).

Certain tasks take time to complete and require sustained attention. One of the first people to study sustained attention was Mackworth (1950) who discovered that if a person was asked to concentrate on a tedious task his or her performance deteriorated over time. This deterioration is termed performance decrement and researchers were interested in examining ways in which tasks could be designed to minimise this effect. In an experiment using visual stimulation it has been found that light signals that were brighter or longer led to a reduction in performance decrement. It was further established that stimulants such as amphetamines can counter performance decrement. The provision of feedback has been shown to be

useful and introverts have proven to be less susceptible than extroverts. External factors such as a moderate disturbance and the presence of other people can help reduce performance decrement.

Selective attention is the ability to attend to one stimulus rather than another and implies that people can consciously focus on one stimulus but do so usually at the expense of another. One of the first key studies in the investigation of selective attention was that carried out by Colin Cherry (1953). He investigated the cocktail party problem to see how people can carry on a conversation and focus their attention on one person, amongst all the noise and distractions found at a party. To study the phenomenon of 'focused auditory attention' Cherry employed the dichotic listening task. During this kind of experiment subjects had to wear special headphones in which two different messages were presented to each ear and they had to concentrate on just one of the messages. Later they were asked to repeat the content of both messages. It was found that the listeners obtained very little information from the unattended ear (Wood & Cowan, 1995). However, physical changes in the unattended message were noticed, for example whether speech was replaced by a pure tone, whether the sex of the speaker changed or if the loudness changed.

2.5.2 Theories of attention and resource allocation

Based on the fact that humans only have enough resources to effectively attend to one channel at a time, they need some mechanism to limit the information that they take in. The British psychologist Donald Broadbent (1958) put forward the first detailed theory of attention. His filter theory was based on findings from shadowing and dichotic listening tasks. Broadbent's key assumptions included the theory that two stimuli or messages presented

at the same time gain access in parallel to a sensory buffer that holds information for a short period before it either attends to or deletes the information from the processing system. If an input is allowed to pass through a filter on the basis of its physical characteristics, it is stored with other input in the buffer for later processing. The filter can be directed by top-down or bottom-up influences. Top-down influences include a person's own intentions and expectations. Bottom-up influences, in contrast, are directed by stimuli in the world that 'catch' people's attention (Broadbent, 1958).

The cocktail party effect is a combination of top-down and bottom-up influences on attention. Taking the environment of a cocktail party as example where numerous conversations are going on at once, one sees that it is possible to tune out other voices and pay attention only to the ones that are of interest and they are then assigned to the primary input channel (Desimone & Duncan, 1995; Duncan, 1996). If another conversation includes a certain cue word of personal importance the attention is diverted and the primary focus is given to this conversation. This effect is bottom-up in that it is driven by a stimulus in the environment. However, it also depends on top-down influences in that it hinges on what is important or familiar to a certain person. Stimuli are more likely to draw attention if they have been previously primed by recent or frequent thought. The function of the filter is to prevent overloading of the limited-capacity mechanism beyond the filter where the filtered information input is processed thoroughly and given meaning by higher centres in the brain.

The sensory store in the channel theory explains people's ability to follow numerous inputs from similar sources. It is common to pay attention to more than one channel at a time and this is not problematic if the stimuli are different enough since this leads to less interference. However, in cases where the stimuli are similar or people have to listen to more than one

conversation at the same time by, for example, rapidly switching between the two channels in the sensory store where visual or audio information is stored. In this model, STM information is stored for a period of a few seconds regardless of whether it was attended to or not. After switching back to one channel, information is retrieved from the sensory store; but due to the switching process, some information from each channel may be lost.

To deal with this anomaly Triesman (1964) developed the attenuation theory, which posits that in a first filter the information is reduced in strength or attenuated rather than filtered out according to some physical characteristics. A second-stage filter processes the information semantically to extract meaning, and if found to be significant the information is strengthened and made conscious. Triesman proposed that information would have different thresholds of response for each individual, depending on the personal significance and meaning of the information. She also regarded other characteristics such as the noise level as important. Other researchers such as Deutsch and Deutsch (1963) and later Norman (1976) regarded the two-stage model of Triesman's attenuation theory as unnecessarily complex. They proposed a 'late selection model' according to which all information is filtered semantically regardless of physical characteristics, to determine whether the information should be attended to or ignored. According to this model, the selection of stimuli for final processing is delayed until the information has been analysed for meaning.

Kahneman (1973) proposed a theory based on the assumption that the attentional system has a limited capacity and can only process a certain amount of input at any one time and is not limited because it has to pass through filters. Norman and Bobrow (1975) have suggested that the reason for such limitations in attention is because the available information is simply inadequate for the task at hand. In other situations the data may not be inadequate, but the ability to process that data is impaired. According to

these models, there is therefore an upper limit to the amount of information that can be attended to satisfactorily. The limited capacity models of attention have been criticised by Spelke, Hirst and Neisser (1976). Their studies have shown that attentional ability can be extended with practice. In their experiments they asked students to read stories and at the same time to listen to and write down a list of words. After six weeks of practice the subjects had no difficulty in performing these tasks simultaneously. Subsequent studies on divided attention studies conducted by Allport, Antonis and Reynolds (1972) indicated that instead of just a single general purpose attentional mechanism, there may be several different mechanisms that are used depending on the information to be processed.

Shiffrin and Schneider (1977) suggest that people are able to perform multiple tasks because one of them has been practised to the extent that it has become automatic and therefore largely unconscious. One example of this is driving, which at first requires a great deal of concentration to master all the skills involved, but then with practice becomes automatic and unconscious. This allows the driver to do other things while driving, such as holding a conversation or tuning the radio. Gopher (1993) also found that practice can improve people's ability to divide their attention. He found that trainee pilots who practised dividing their attention by using a computer game called Space Fortress were twice as likely as other trainees to become qualified pilots.

2.5.2.1 Task-switching costs

Multitasking takes place when two or more tasks are performed simultaneously requiring a person to switch from one task to another, or to perform the tasks in rapid succession. The process is generally efficient in terms of time and resources, but could lead to inaccuracy, and if complex tasks are involved it could even have a negative influence on productivity.

Moreover, multitasking can become problematic when the cost of switching between tasks conflicts with environmental demands for productivity and safety. This type of negative effect can occur even when switching costs are relatively small, involving no more than a few tenths of a second per switch. The problem is that these small amounts can add up, and shifting between tasks may lead to the creation of brief mental blocks so that as much as 40% of a person's productive work time can become compromised (Rubinstein, Meyer & Evans, 2001). Research on multitasking seem to suggest that despite its parallel processing capabilities, the brain has not been designed to always perform multiple tasks simultaneously in an optimal manner.

The extent to which the switching between two tasks is controlled consciously has been evaluated by Meiran, Hommel, Bibi and Lev (2002). Subjects had to indicate their readiness for a task switch, and the time needed to achieve readiness for the task switch and the target reaction times were of interest in this experiment. It was assumed that a long task preparation time would lead to a faster target reaction time, but the opposite effect occurred. The results of the study indicated that a long task preparation time led to a significant lengthening of the target reaction time. The results further showed that the subjects lacked conscious awareness concerning their preparedness to switch between the two tasks. The results reported by Meiran *et al.* therefore contradict the broad consensus that higher-level control operations such as task set selection, ordering and chaining lower-level task execution processes are consciously controlled (Meiran *et al.*, 2002).

A similar study Rogers and Monsell (1995) reinforced this interpretation, indicating that the switching costs between tasks can be split up into two parts. The first component relates to the time and resources needed to adjust the mental control settings. If sufficient time is provided subjects can

prepare for this adjustment so that it appears to be amenable to conscious control. The second part of the switching costs is immune to preparation and pertains to the competition over resources and a 'carry-over' effect of the control settings from a previous experimental trial.

Rubinstein, Meyer and Evans (2001) provide evidence for a noteworthy increase in task-switching costs among more complex tasks. Time costs were also greater when the subjects switched to an unfamiliar task and less significant when they switched to a more familiar task. These differences are probably due to the 'executive control' of the human brain, because task switching entails two processing stages. The first stage is involved in the process of goal shifting. In the second stage the rules for the new task are activated and the rules of the previous process are deactivated, which will require more time for new or complex rule sets. Meuter and Allport (1999) reported an interesting finding relating to the switching costs from a more habitual task to a less frequently done task. In their experiment the subjects had to name digits in their first or second language, depending on the colour of the background. In switching trials the results showed that the number reading was slower in their first language than in their second language.

2.5.2.2 Theories on dual-task inference

Various models try to explain the phenomenon of dual-task inference, including the processing bottleneck model, the capacity-sharing model and the crosstalk theory. The first model includes a strict processing bottleneck and is also known as the single-channel model and refers to the idea that certain critical mental operations are carried out sequentially. Operations that have to be processed according to this single-channel model lead to a bottleneck whenever two tasks require an important mental operation at the same time. One explanation for the existence of bottlenecks would be that

the brain contains only one mechanism capable of carrying out the required operation. Another interpretation would be that two operations that are carried out by separate mechanisms inhibit each other, leaving only one mechanism operable at a time.

The theory of a central processing bottleneck can be evaluated with the help of classical psychological refractory period (PRP) experiments. Here two isolated stimuli are presented with variable stimulus onset asynchronies (SOA), and the reaction times are recorded. In the basic PRP paradigm, two stimuli are presented to subjects in rapid succession and each stimulus requires a quick response. Typically, responses to the first stimuli are unimpaired, but responses to the second stimuli are slowed by 300 ms or more. There is evidence that the second response is delayed due to a postponement of the response selection stage. This places the processing bottleneck within the central resources that perform response selection for diverse tasks (Ruthruff, Johnston & Selst, 2001).

Pashler and Johnston (1989) conducted a PRP experiment with the help of a microcomputer. Subjects were required to perform tone recognition and letter recognition tasks. For task 1, the subjects had to distinguish between a 300-Hz tone and a 900-Hz tone. For task 2, the subjects had to recognise one of the following letters 'A', 'B', or 'C'. Three SOA of 50, 100 or 400 ms were tested in the experiment. In a control experiment only task 1 needed to be completed and no response to the presented task 2 stimuli was required. The mean reaction time (RT) for all SOA was about 600 ms. At the 400-ms SOA the RT2 was a little over 600 ms, but at the 50-ms SOA the RT2 was found to be 850 ms. The delay of several hundred ms in responding to the second stimulus can be attributed to a 'buffer and switch' effect. The shorter SOA had no effect on the error rate with regard to choosing the correct item in task 2. The data further showed that RT1 in the dual-task condition was

not significantly influenced by the different SOA but was overall slower than in the control experiment, which did not include a secondary stimulus.

The second concept suggests a capacity-sharing model whereby mental operations are processed in parallel, but the number of processes running is limited by the amount of resources available at this point in time. The parallel-running operations have to share the available processing resources and therefore the rate or efficiency of the processing depends on the capacity available to each task. The third concept attributes interference to crosstalk or other impairment in performance that depends on the specific nature of the processed information. It is assumed that two similar tasks interfere with each other to a greater degree than two different tasks (James, 1890). The amount of interference depends on the similarity or confusability of the mental representations involved in each task and the need to keep each task's processing streams separate is therefore a possible cause of dual-task interference (Navon & Miller, 1987).

The crosstalk theory is not entirely incompatible with the bottleneck concept; even so, one could argue that certain mental operations have to run sequentially in order to avoid crosstalk (Kinsbourne, 1981). So far no evidence confirming crosstalk interference with regard to the processing of multiple items has been found since the inference can be caused by tasks involving similar or different sorts of judgements (Duncan, 1993). Inputs involving a single sensory modality such as audition or vision have been shown to lead to a stronger interference than inputs presented in different modalities (Treisman & Davies, 1973). A possible explanation for this phenomenon is that the identification of a stimulus needs specific processing resources for each sensory modality. Particular perceptual discriminations need different amounts of processing capacity which can be allocated as long as total capacity demands are not exceeded, since that would reduce

efficiency. The three concepts mentioned above open the possibility for the construction of various hybrids.

2.5.3 Temporal perception in a multiple-task environment

The hypothesis that attention plays a significant role in the perception of duration has been confirmed by an extensive amount of literature. Important work in this field has been done by researchers such as Creelman, (1962), Treisman, (1963), Cantor and Thomas, (1977), Thomas and Brown, (1974), Thomas and Cantor, (1978), Thomas and Weaver, (1975), Hicks, Miller, Gaes and Biederman, (1977) Hicks, Miller and Kinsbourne, (1976). They proposed attentional allocation or distraction models predicting that attention to a matter can lead to an increase or decrease in the subjective experience of objective time units. The model is built on the principle that the processing of non temporal information interferes with the processing of temporal information to such a degree that the judged duration decreases and the process of time estimation becomes more unreliable. Distortions in time perception can be attributed to the fact that attention is directed toward a secondary task and there are therefore not sufficient attentional resources free to record cues for the passage of time. The lack of proper time cues could therefore lead to an underestimation of the experienced duration (Fraisse, 1963).

Another possible explanation of the phenomenon of SET is that the number of units of temporal information processed is boosted above the normal baseline whenever an observer orients his or her attention to an improbable event. It is assumed that the attention given to an external stimulus animates the counter to count more units and this results in a boost of the information processing of that stimulus which results in an expansion of the

perceived time. The missed temporal cues theory and the attentional boost theory must not be seen as oppositional or mutually exclusive since they both expect the cause of the distortions in perceived duration to be found in a counter or some or other mechanism that measures the amount of information processed for the calculation of the duration of perceived events (Thomas & Weaver, 1975; Treisman, 1963).

The majority of research in the time literature supports a model according to which the amount of allocated attention to a task has an effect on the duration of an event. What needs to be established is whether the expansion in perceived duration can be attributed to the attention allocated or to the amount of information processed. If it is true that attention increases the amount of stimulus information processing then one has difficulty to separate these two influencing factors. The allocation of attentional resources must be regarded as a major factor due to the following four facts:

- The first fact to consider in this regard is that at least 120–150 ms are necessary before attention can be allocated to a new stimulus due to the findings that there is an expansion of perceived durations for objective durations above 120 ms but none for objective durations below this time span (Hikosaka, Miyauchi, & Shimojo, 1993; Nakayama & Mackeben, 1989).
- The second important fact is that attention is believed to be composed of two components: one transient or exogenous and one sustained or endogenous (Nakayama & Mackeben, 1989). The attentional components have two different temporal dynamics and this should be visible from time's subjective expansion (TSE) data.
- The third factor to be reflected on is that attention is a central process and that the visual and auditory modalities are exerted by this process in a similar way.

- The last important fact is that, attention cannot be applied to the perceived image itself but only to information that has been pre-attentively processed by processes such as grouping, shaping formation or similar processes (Baylis & Driver, 1995; He & Nakayama, 1992; Rensink & Enns, 1995). Therefore TSE cannot be regarded as function of image novelty but as a function of the novelty of pre-attentively processed information.

The influence of two concurrent tasks on the estimation of durations was studied by Hemmes, Brown and Kladopoulos (2004). Subjects were exposed to durations ranging from 2 to 23 s, once with and once without a concurrent number-reading task. The results of the study are in accordance with the attentional resource allocation model since the perceived duration decreased under concurrent task conditions. These findings can also be interpreted according to the perceptual hypothesis which argues that different sources of sensory input under task and non-task conditions control temporal perception. Under non-task conditions the subjects based their time estimation on chronometric counting since it is easier to subdivide long durations into short time periods. With the additional number reading task it was not possible for the subjects to count (Hemmes, Brown & Kladopoulos, 2004). Due to these results the subjects of the temporal reproduction task were advised not to count to aid them with the estimation of longer durations since this would influence the outcome of the experiment.

Wilsoncroft and Stone (1976) tested the validity of the storage-size model proposed by Ornstein (1969). They included a secondary task at different difficulty levels and investigated whether an increase in difficulty would lead to an increased duration underestimation. The factorial design included a 1-digit x 1-digit and a 2-digit x 1-digit task, with the difficulty levels easy for small multipliers and hard for high multipliers. The 2-digit x 1-digit easy task resulted in the highest underestimation of work duration and therefore only

provided partial support for the hypothesis that rising cognitive demands shorten a perceived time span. The hypothesis regarding STM control of time estimation proposes that temporal information is accumulated in short-term memory, and that the concurrent non temporal processing that takes place in STM disrupts the accumulation process. To prove this theory Fortin and Rousseau (1998) conducted a study in which they evaluated the effects of STM processing during the encoding period of the interval and the reproduction phase of the interval. The results show that time estimation may be interrupted during both periods.

The storage-size model suggests that more stimuli use up a greater quantity of memory storage space and therefore lengthen the perceived time based on the classic filled-duration illusion. The change and segmentation model takes a different approach and introduces the idea that more stimulus events do not always correspond to more perceived changes and consequently lead to longer time judgements. Poynter and Homa, (1983) proposed that greater numbers of stimulus events will not necessarily lengthen the perceived time, and that expansion of the perceived duration only occurs if the events form very discrete and distinctive chunks. According to him undifferentiated additional stimuli will have no effect on the perception of time. The same principle can be applied to moving objects; a greater number of moving stimuli would only lead to a lengthening of perceived time if they are highly distinctive, perhaps travelling at different speeds on identifiably different routes. One example of the gestalt principle of common fate is a flock of birds in flight. The flock of birds is perceived to be a single entity rather than comprised of separate individuals (Wertheimer, 1958).

2.5.4 Basic concepts of memory

Memory processes can be divided into short-term memory (STM) and long-term memory (LTM) processes. There are two types of LTM storage mechanism. One is called episodic memory and the other semantic memory. Episodic memory stands for the memory of events and experiences in a serial form. The knowledge of the order in which events took place makes it possible to reconstruct the actual events that took place at a given point in time. Semantic memory consists of skills, general knowledge as well as conceptual structure (Tulving, 1972). LTM processes can further be subdivided into the three main activities of storage, deletion and retrieval. Information from STM is stored in LTM by the rehearsal of a piece of information or the process of repeated exposure to a stimulus. Additional learning has been proven to be most effective if it is distributed over time. Deletion is mainly caused by decay and interference.

The reason why previously stored information becomes unavailable has not been clarified yet since it is questionable whether information is forgotten and permanently lost or whether it only becomes increasingly difficult to retrieve certain items from memory. Information that cannot be recalled can in some instances be recognised or recalled with prompting. There are two types of information retrieval: recall and recognition. In recall, the information is reproduced from memory while the process of recognition supplies the knowledge that the information has been seen previously (Lockhart, 2000). Recognition is a less complex process since the information is provided as a cue and this aids the retrieval process (Standing, Conezio & Haber, 1970).

The span of absolute judgement and the span of immediate memory impose severe limitations on the amount of information that can be received,

processed, and remembered. If the new information is not meaningfully encoded or rehearsed within working memory, the information stored in STM decays rapidly, because STM only has a limited holding capacity. The visual image store, called 'iconic memory', decays quickly in less than one second and the auditory image store, called 'echoic memory', can last up to four seconds (Beatty, 1995).

By organising the stimulus input simultaneously into several dimensions and successively into a sequence or chunks it is possible to break the informational bottleneck. The successful formation of a chunk is known as closure, and without rehearsal the average person can hold about four chunks in STM. The chunking of information is the most effective way to increase the STM capacity; the most effective way to remember numbers is to place them into chunks of four digits. Therefore it is easier to remember a long number by partitioning it than attempting to keep a single long number in mind. The amount of numbers that an individual can store in STM is around seven items, plus minus two (Miller, 1956).

2.5.4.1 Factors influencing memory performance

Interference can lead to a disturbance in STM retention, and this accounts for the need to complete the tasks held in STM as fast as possible to avoid information loss. According to the interference theory of forgetting, new information interferes with and ultimately displaces the old information stored in STM. Peterson and Peterson (1959) conducted a study investigating the ability to recall information after different time delays ranging from 3 to 18 s. The subjects had to remember three letters and their correct number of recalls dropped significantly with the length of the delay time. After 3 s the letters were recalled correctly only half of the time and after 12 s the three-consonant groups were only seldom recalled.

There are two different kinds of interference in psychological theory. The first is retroactive interference and is caused by an activity that has occurred after something has been learned. The second is proactive interference and is caused by inference occurring before the encoding of new information. Research findings suggest that both types of interference are responsible for the loss of information; even so, it seems as if proactive interference plays a greater role (Keppel & Underwood, 1962).

Another factor besides interference that can lead to information loss is stress. It has been shown that stress has a complex effect on memory. Memory for non emotional experience is preserved or even strengthened under the influence of stress, but memory for the neutral elements of the emotional experience is reduced. These contradictory findings can be explained by the fact that stress hormones potentiate the functioning of the amygdala which inhibits the working of the hippocampus. Stress-related memory impairment is found in studies of the hippocampus since this part of the brain is known to be vital for any kind of normal episodic memory function (de Quervain, Henke, Aerni, Treyer, McGaugh, Berthold, Nitsch, Buck, Roozendaal & Hock, 2003). At high levels the stress hormone cortisol disrupts the hippocampal function and impairs episodic memory since the hippocampus is densely packed with receptors for this substance and sustained exposure to high cortisol levels can even damage the part of the brain that sub serves learning and memory (Kim & Diamond, 2002).

2.5.4.2 Impact of concurrent tasks on resources allocation and memory

The storage and retrieval process of information itself is limited by people's working memory capacity and could be negatively influenced by concurrently processed information. The connection between 'attention' and short-term retention is of significance here since people have selective control over what information they hold onto for immediate report. Classic partial-report

experiments involving audition (Darwin, Turvey & Crowder, 1972) and vision (Sperling, 1960) investigate the transfer of items into short-term memory with the help of cued elements such as the position or colour of a letter. Another way that attentional limitations has been studied, entails examining the transfer of information into STM while the test subject performs a secondary unrelated task. This approach makes it possible to evaluate whether the transfer of information into STM is subjected to the same central bottleneck when two stimuli are closely positioned, which causes a delay in processing called the "psychological refractory period" (PRP) effect (Pashler, 1984).

To answer this question Murdock (1965) conducted a dual-task experiment whereby subjects listened to a spoken list of words while sorting cards. After completion of the task they were asked to repeat the items back in any order. Having to retrieve information without any given cue is known as 'free recall'. The memory for the last-presented items the 'recency effect', was reasonably intact indicating that the secondary sorting task had no significant negative impact on the storage of the words in the STM of the test subjects. The findings provide evidence that the encoding of auditory information does not involve the same cognitive mechanisms that are implicated in the process of sorting cards.

2.6 OVERWIEV OF THE THEORETICAL VIEWPOINT ADOPTED BY THE STUDY

Long SRTs caused by slow or badly designed software can cause irritation and a negative work attitude. They are also undesirable from an economic standpoint because they limit the number of operations per time cycle. The common design guideline, 'the faster the better', is not always appropriate because users need a certain amount of time to achieve readiness for task

execution. The optimum SRT must be determined empirically for a particular kind of task, since the more information that have to be connected in STM, the longer the SRT that is required (Kohlisch & Kuhmann, 1997).

The results of a study conducted by Martin and Corl (1986) indicate that the cognitive demands of a task need to be considered in regard to the optimum SRT. They tested the idea that reducing computer SRTs from a few seconds to sub second levels highly increases user productivity. Subjects had to complete data-entry and problem-solving tasks with eight different SRTs between 0.1 and 5 s. The results pointed out that some increase in productivity did occur as SRTs decreased. However, this effect only occurred in data entry tasks and disappeared in problem-solving tasks and also declined in strength as data entry tasks became more complex. The relationship between time and productivity was linear, indicating that a shorter SRT did not accelerate the completion of more demanding tasks.

In this study the relationship between SRT and proper task performance is explored in the context of a simulated driving task. The specific research questions that will be investigated in this simulated driving setting, are described below.

2.7. RESEARCH QUESTIONS

Hypothesis 1

In the temporal reproduction task short durations will be overestimated and long durations will be underestimated, verifying the principles of Vierordt's law.

This hypothesis is aimed at replicating the findings obtained from a study conducted by Wearden (2003). He investigated the validity of Vierordt's law and found that Vierordt-type effects are present regardless of the threshold value. The results of Wearden's study indicate that reproduced mean times overshoot target times to a higher degree when the target times were short than when they were long. Short target times have been found to be 'overestimated' while long target times were 'underestimated' with threshold values ranging between 30% and 40%. The existence of an 'indifference' point where the mean reproduction is supposed to be perfectly accurate was of further interest in this study. For the 30% and 40% thresholds the indifference point was found between 600 ms and 800 ms. It is anticipated that an 'indifference' point will be visible in the results of the temporal reproduction experiment included in this study.

Hypothesis 2

It is assumed that there will be a statistically significant relationship between acceleration and braking behaviour and the length of the SRT. The number of significant brakes (SBs) will increase under short SRTs. Acceleration and deceleration will also become more volatile, resulting in a higher standard deviation, which is a measure of the dispersion of the numbers from their expected mean value. The standard deviation of the positive acceleration (SDPA) as well as the standard deviation of the negative acceleration (SDNA) will therefore increase in magnitude under short SRTs.

Research findings validating the impact on braking behaviour were previously provided by Hancock, Simmons, Hasemi, Howarth and Ranney (1999). They investigated the effects of in-vehicle distractions on driver response during a crucial driving manoeuvre. During a simulated driving task, the drivers responded to the in-vehicle task using a touch screen. Having to perform a secondary task that shifted the eye focus away from the road led to a decrease in braking reaction time at changing traffic lights and the drivers

compensated for the late detection by braking more intensely. In order to make appropriate braking decisions the driver has to detect relevant information from the environment and therefore his or her decision to braking is dependent on visual input (Lee, 1976). It is reasonable to assume that these previously established results will be repeated in the current study, since there is some overlap between the studies given that the driver's visual attention has to be divided between two tasks in both cases.

Hypothesis 3

Driving parameters regarding the position of the car are also expected to be negatively affected under the shorter SRTs. The number of steering movements (SM) and the number of incidences of crossing the outside line (COL) are expected to increase significantly during short SRT.

Braking behaviour is not the only driving parameter found to be affected by a secondary in-vehicle task. Noy, Lemoine, Klachan and Burns (2004) looked at the connection between three different secondary tasks and the driving performance measures such as standard deviation of lane position (SDLP) and number of lane exceeds (NLE) or line crossings. The baseline driving scenario had significantly smaller values for SDLP than all of the dual-task driving scenarios. No noteworthy variations were found among the scrolling visual search task, a static visual search task, and a radio-tuning task. The NLE was significantly different across the four driving tasks. There were significantly fewer line crossings during the baseline driving scenario. During the less cognitively demanding scrolling and visual search task the subjects also performed better than during the more demanding radio-tuning task. These findings support the hypothesis that the increased difficulty of driving under short SRTs will have a statistically significant impact on the number of outside line crossings.

Hypothesis 4

The high demand on attentional resources during the short SRTs will force the drivers to switch their focus more often between the road and the game monitor, resulting in a high gaze frequency. The gaze frequency measured in gazes per minute will increase significantly during short SRTs, and the average focus time on the game monitor should therefore decrease to a significant degree during the short SRTs.

Hypothesis 5

The distribution of gazes within the various SRTs will not be influenced by their duration. The subjects will switch at a constant frequency between two tasks.

The high frequency of gaze shifts can be interpreted as an automatic process that splits the attention between the two tasks independently of the temporal-estimation abilities of the subjects. Previous research findings indicate that humans are equipped with a range of memory buffers that enable them to employ a 'buffer and switch' processing strategy in order to process numerous tasks concurrently (Baddeley, 1986).

Hypothesis 6

The performance with regard to correctly remembered items in the memory game will not be influenced by the SRTs.

Evidence showing that central capacity demands do not have a significant impact on the functioning of visual STM was provided by Anderson and Craik (1974). They presented a list of spoken words concurrently to a visual/manual choice reaction-time task. In a similar test subjects had to make a fast-choice response to a tone. After the response they were abruptly presented with a pattern of black and white squares. The information about the patterns was stored in visual STM without interference

from the secondary task. This indicates that the subjects were able to maintain good performance and were not negatively influenced by the temporal overlap of the two tasks (Pashler, 1993). The assumption made in this research is, therefore, that memory performance will not deteriorate under the elevated central capacity demands.

Hypothesis 7

The subjective state of the test subjects, indicating how they personally experienced performing the simulated driving task, will be influenced significantly by the duration of the SRT.

The subjective state will be measured with four variables. Regarding the subjects' mood, the levels of stress and boredom will be assessed and rated as low, medium or high. Their ability to cope with the multiple concurrent tasks given to them will also be measured. For this they will rate the time provided for task completion as either too short, a convenient length or too long. Additionally, the effect of the SRT on their driving performance will be investigated in the same way. It is expected that the ranking of stress will be significantly higher for short SRTs. The opposite will be found for the ranking of boredom, which is expected to be significantly lower for short SRTs. The time granted for task completion and good driving performance is anticipated to be rated significantly more often as too short for the short SRTs.

The importance of finding the best SRT to improve task performance was the focus point of research undertaken by Kuhmann, Boucsein, Schaefer and Alexander (1987). Apart from physiological measurements, they also investigated the impact of the duration of various SRTs on the subjective state of the subjects. While aiming at finding the optimum duration for a simple detection and correction task, Kuhmann and his colleagues tested short, medium and long SRTs ranging from 1 to 9 s. They measured heart rate, electrodermal activity, and blood pressure, and employed subjective

measures of mood and psychological well-being. They found that short SRTs induced frequent incidences of headache and eye pain and resulted in poor performance and increased cardiovascular activity. Short SRTs did not enable the users to achieve readiness for task execution and generated stress. The long SRTs achieved the lowest mean error rate and the lowest systolic blood pressure and did not lead to differences in working speed. An indication of irritation during long inter-task delay is provided by the higher number of skin conductance reactions.

Medium SRTs gave the best results in terms of task completion time, reaction time and error rate. They further led to a moderate heart rate and reduced the incidences of negative self-assessment (Kohlisch & Kuhmann, 1997; Kuhmann *et al.*, 1987; Kuhmann, 1989). It therefore appears from this research that the medium-duration SRTs will receive the best marks in the subjective-state questionnaire. It is anticipated that medium SRTs will provide the best results, indicating medium amounts of stress and boredom. Medium-length SRTs will further offer a convenient waiting period, allowing optimum task completion and driving performance.

CHAPTER 3 METHODOLOGY

3.1 RESEARCH DESIGN

The study is based on an experimental paradigm and attempts to provide answers to specific research questions about the effects of system response times on visual attention, driving performance and subjective state during a simulated driving task. In order to answer the proposed research questions, a quantitative study was used because numerical data serve best to establish the relationship between the tested parameters.

3.2 SAMPLE SELECTION

In this study a convenient sample of 10 licensed drivers was used. The sample consisted mainly of employees of the Generation Research Program (GRP) in Bad Toelz in Germany, where the experiments were carried out. The driving simulator can induce nausea, and it takes over an hour to complete all the test rounds in this experiment. For these reasons, some employees of the institute were used because they had been desensitised against motion sickness by taking part in numerous experiments at the institute.

The sample consisted of 3 females and 7 males between the ages of 22 and 64, and the mean age was 38.5 years. The wide age range can influence the results of the experiment, but the older subjects had more drive experience to compensate for any disadvantage in regard to their cognitive abilities.

Subjects who were not familiar with the driving simulator were given a training session of 15 minutes. All subjects were familiar with the use of touch screens. All subjects were paid 40 euro for their participation. The number of subjects was kept small since there were practical difficulties in recruiting suitable test subjects, and all the gathered data had to be analysed manually in a very time-consuming manner.

Due to the small sample size, it is not possible to verify that the data are normally distributed and parametric techniques can therefore not be applied. For this reason, two non-parametric techniques, Spearman's rho and Kendall's tau, were used to analyse the data.

3.3 RESEARCH INSTRUMENTS

3.3.1 Experiment 1: temporal reproduction

The subjects were placed in front of a standard PC using a keyboard as input device. The computer program used was created with MatLab 5 (Pratap, 1999). In a training round the subjects were made familiar with the task. First the subjects had to memorise two symbols. Then a white square was presented to them on the computer screen for a duration of 1, 3, 6, 12, 20 or 30 s in a different randomised order for each subject. After that the white square was replaced by a yellow square. When the subject decided that the yellow square had been visible for the same duration as the white square he or she pressed a key. After this task the subjects were presented with one symbol and asked to indicate whether it had been shown to them prior to the temporal reproduction task. The subjects were instructed not to count during the temporal reproduction task.

3.3.2 Experiment 2: driving simulator

Diagram 3.1: Side view of driving simulator setup

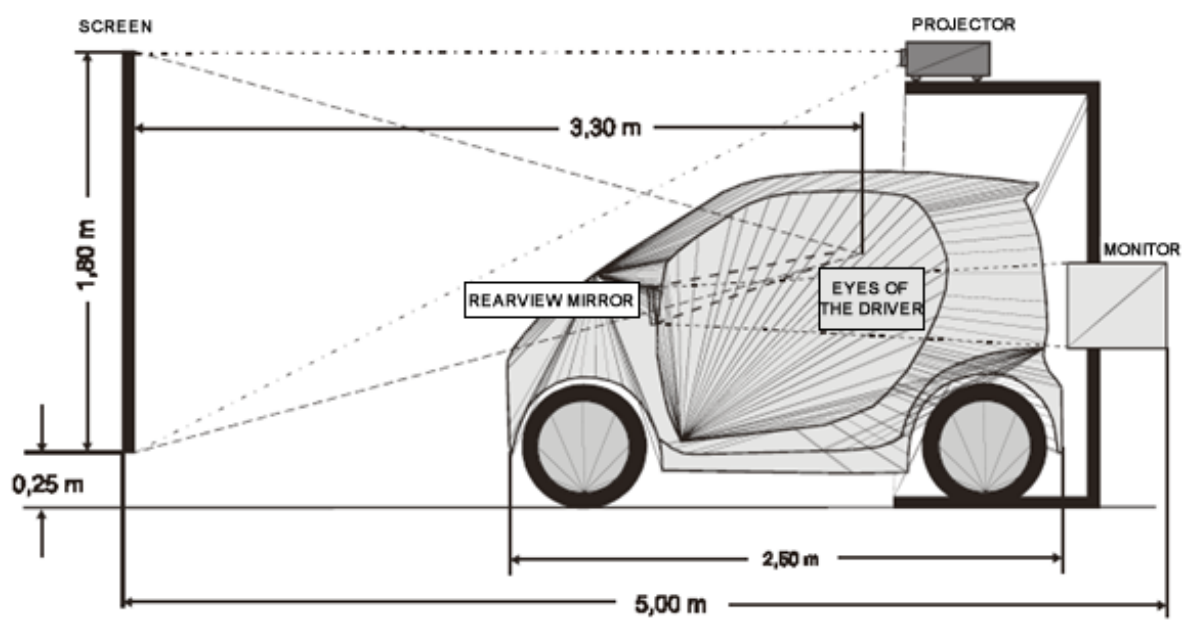
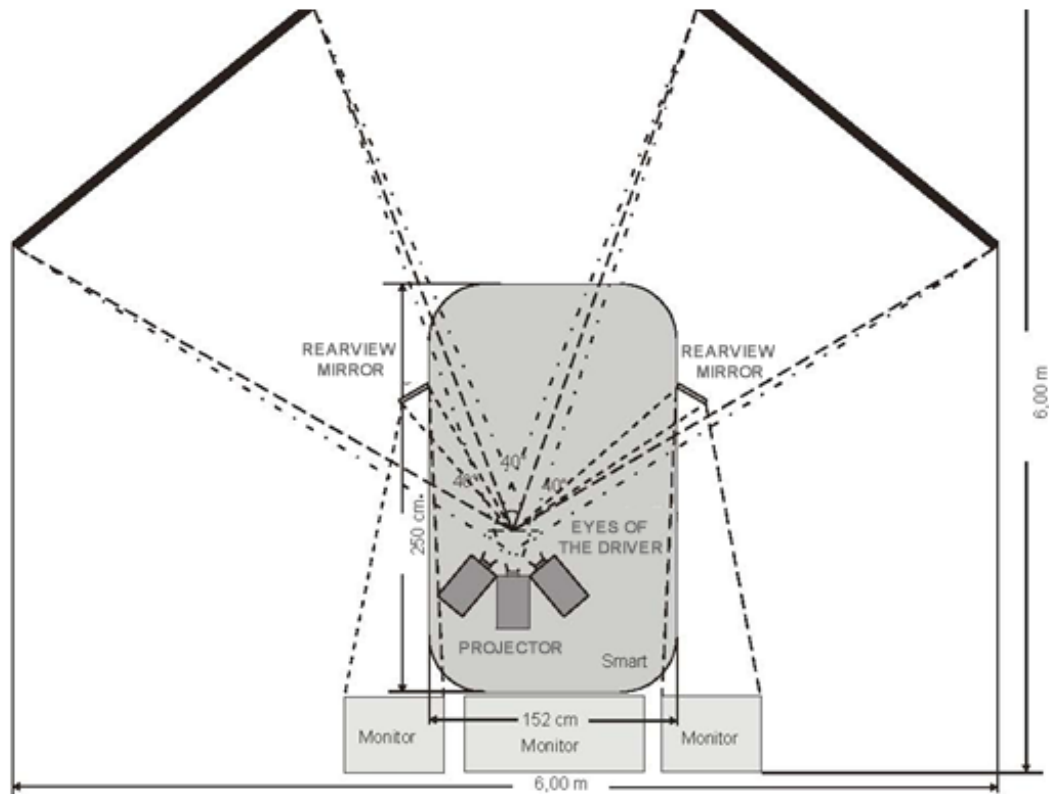

Diagram 3.2: Top view of setup



The experiment was carried out on a static driving simulator. The set up of the driving simulator is represented in Diagram 3.1 and Diagram 3.2. The visual simulation provided a front view of 120 degrees and a rear-view through all three rear mirrors. Car and road sounds were simulated. A touch screen displaying the game was mounted on the middle console next to the steering wheel. The simulation consisted of a round course on a normal one-lane road with no oncoming traffic and under good weather conditions. The subjects were instructed to follow a car travelling at a speed of 70 km/h at a safe driving distance. The eye movements of the test subjects were recorded

with a video camera. Another video camera recorded the touch screen of the game and a third video camera recorded the front screen of the driving simulator. With the help of a quad processor, a four-split screen was produced. In the fourth partition of the screen a digital stop watch was displayed. A video recorder with a jog shuttle was used so that the exact time of the eye movements could be established. With this set-up it was possible to manually record the beginning and end of each eye movement.

The operation of a technical system was imitated with the use of a memory game. From a pool of 16 items the subjects were shown four items for the duration of 15 s. The subjects were required to remember the items in the presented sequence. After the items had been presented, a selection field with 16 items was presented and the subjects had to identify the items presented to them in this field. Following each selection, the subject had to wait until the next selection field appeared, and after they had selected all four items, they were given four new items to learn. The subjects completed eight rounds for each of the seven SRTs of 0, 1, 3, 6, 12, 20 or 30 s and one round consisted of four separate games. Under the 0 s SRT the system responded without additionally added delay time within approximately 300 ms. The SRTs were presented to each subject in a different randomised order. An inter-task delay of 6 s was introduced between each game. The subjects were given an encoding time of 15 s to memorise the items while driving and were instructed to complete the game as fast as possible; they were also informed about the duration of the tested SRT.

Prior to the tests in the driving simulator the subjects took part in a training session consisting of eight rounds with a delay of 3 s and 8 rounds with a delay of 0 s to familiarise them with the memory game. Before the first training round the subjects were presented with examples of all 16 items so they could give names to them. This procedure was repeated after the

training rounds. This was done to safeguard against a change in memory strategies from visual to verbal encoding methods.

The independent variable in this experiment was the duration of the SRT. The dependent variable was the eye movement from road to monitor. The duration of fixation and frequency of change were of interest here. Another dependent variable was the number of wrongly selected items in the memory game. Dependent variables concerning the drive performance of the subjects were also recorded. These variables included the amount of significant brakes (SBs), the standard deviation of the positive acceleration (SDPA), the standard deviation of the negative acceleration (SDNA), the number of steering movements (SM) and the number of incidences of crossing the outside line (COL). In addition, the incidences of crossing the middle lane and line crossings per mile for the total duration, as well as incidences of leaving the lane were also documented.

3.3.3 Subjective state questionnaire

After the completion of eight rounds with a certain SRT the subjects were asked about the influence the different delay times had on their performance and their subjective experience in regard to the amount of stress and boredom they experienced during the simulated driving task. The effects on task completion and driving performance were evaluated on a three-point scale (1 = to short, 2 = convenient and 3 = to long). The subjective state of the subjects in terms of stress and boredom was also evaluated on a three point scale (1 = low, 2 = medium and 3 = high). The questionnaire was self-constructed and may therefore lack reliability and validity but the findings can give an indication of the subjective state of the subjects.

3.4 VALIDITY AND RELIABILITY

The validity of the memory game itself with regard to the simulation of a navigation system raises some issues. The task is simpler than a real navigation system because the use of a navigation system requires that the user enters letters and numbers to specify a certain destination address, and the menus of navigation system and on-board computers are often complicated and include a vast amount of functions. Noel, Nonnecke and Trick (2005) investigated the ability to learn and memories the functioning of in-car navigation devices and looked at the problems first time users of a specific navigation system encountered.

The destination input tasks itself was problematic since some subjects exited the address input menus several times by clicking on a button that brought them elsewhere in the system and many subjects had to input the same addresses multiple times. The subjects initially encountered difficulties in recognising the functions of some controls, such as the pull-down menus for the destination entry. However, this problem cleared up after the second session, and did not occur again after that. During the study it became apparent that the subjects generally had less problems the second time they operated the navigation system. The subjects were able to remember choices concerning the selection of one item over another, but they could not remember more complicated mechanisms (Noel, Nonnecke & Trick, 2005).

Because many different types of navigation system with different menu set-ups and functions are available, in this study a memory game was used to simulate the memory and recognition processes involved in operating a navigation system. The rules of the memory game were easier to be learnt by the test subjects than the operation of most navigation systems and therefore the use of the memory game was efficient in terms of time. The

memory game was intended to simulate the memory and recognition processes involved in operating a navigation system. In such systems, the user has to remember the functions of certain menu items and recognise and select them. When using menu functions that need numerous selection steps the user has also to bear in mind at which point in the menu he or she currently is and which further steps are required to access the desired function. The memory game simulates parts of this process because it requires that the user remembers four items in the correct order. The memory game is based on simple abstract symbols that have to be encoded, which simulates the functioning of a menu system in a real navigation systems. With regard to these aspects the memory game can be seen as a valid instrument to simulate the operation of a navigation system.

With regard to the validity of the obtained data it has to be considered that the symptoms of simulator sickness could have affected the performance of the subjects. These symptoms could have led to loss of motivation and interfere with the normal attention allocation process. The subjects were further distracted by the fact that they were placed in a virtual driving environment which evoked the feeling that something was not quite right (Mollenhauer, Romano, & Brumm, 2004). Many different driving simulator designs are currently employed and therefore validity issues have to be taken into consideration. A lack of standardisation in the areas of simulator graphics, audio and movement as well as scenario design and validation needs to be addressed.

There are several factors that can compromise the validity of the experiment:

- When subjects are asked to reproduce a certain time period, they can count internally during the presented time period, and then use this as an aid when reproducing the time span. To prevent this from

occurring, the subjects were instructed not to count during the temporal reproduction task, but there is of course no guarantee that they did not use counting as a memory aid.

- Age may have an effect on retrospective duration judgements. Given that this study used subjects of various ages ranging 20 to 64, this needs to be taken into consideration.
- Fatigue, low attention span and motion sickness could have affected performance.
- The driving experience of the test person. Even though only subjects with a driving license were used the individual differences in drive experience possibly influenced their ability to handle the secondary tasks while driving.
- The possibility of peripheral vision of display change, but this was prevented with a special designed interface of the game that used blue and green colours with similar brightness levels.

Other issues that need clarification are the subjects' adaptation to the virtual environment and their comfort levels. The selection of performance measures and the technical standards for reporting the experimental set-up and results also need to be standardised (Rizzo, 2004). Nevertheless, for the study the use of simulation was more cost effective, less dangerous, faster or otherwise more practical than experimenting with a real system. The recorded video material was analysed manually; this provided a possibility for an inaccurate reading of the eye movements. The manual set-up proved to be more reliable than using eye-tracing software, which often needed to be recalibrated and prolonged the driving sessions of the subjects.

3.5. ETHICAL CONSIDERATIONS

The process and purpose of the test in the time laboratory were explained to the subjects. The purpose of the test in the driving simulator, to record the shift of visual attention from the road to the screen, was only revealed to the subjects after completion of the test since this could have influenced their performance. The subjects were informed that they could stop the experiment in the driving simulator any time if they felt uncomfortable or tired. All gathered data was kept confidential and each subject signed the consent form.

One concern when conducting experiments in a driving simulator was the appearance of Vertigo. This is a type of dizziness that is characterised by the sensation of spinning. It is sometimes referred to as a hallucination of motion. It can be induced by virtual environments where the mind is exposed to the illusion of movement while the body stays stationary (Regan, 1993). A theoretical explanation of this phenomenon is provided by the sensory conflict theory and the postural instability theory. The sensory conflict theory posits that there is a conflict between motion information obtained from various sensory systems (visual, vestibular, and proprioceptive systems) and learned representations of what those inputs should be in a given environment. The mismatch generated by the conflicting sensory patterns is theorised to result in both motion sickness and, with time, adaptation (Reason & Brand, 1975).

The postural instability theory hypothesises that motion sickness is caused by a breakdown in postural stability. According to the postural instability theory, motion sickness occurs when the organism encounters an environment for which it has not learned the requisite strategy for maintaining postural stability (Riccio & Stoffregen, 1991). Postural stability is

defined as the coordinated stabilisation of all body segments. Common symptoms are light-headedness, feeling faint, unsteadiness, a false sensation of movement, either of the self or the external environment, confusion and nausea. Additional symptoms that can appear are unusual eye movements, such as flitting of the eyes (nystagmus), headache, vomiting, ringing sound in the ears (tinnitus), speech difficulties, such as slurring, deafness, muscular weakness, staggering gait and loss of coordination (ataxia) and loss of consciousness (Kenny, Hettinger & Lillenthal, 1988). About one third of the population is highly susceptible to motion sickness, a third experiences it in fairly rough conditions and another third only becomes sick in extreme conditions. The subjects of the study were informed about the symptoms and advised to look for early warning signs such as sweating and nausea and were instructed to stop the experiment in case they experienced any of these symptoms.

CHAPTER 4

RESULTS

The experiment was completed by all 10 human subjects. The mean amount of years concerning drive experience was 19.8 years, ranging from 4 to 46 years of drive experience. All the subjects were right handed.

4.1 EFFECTS OF SRTS ON DRIVE PERFORMANCE, VISUAL ATTENTION, SUBJECTIVE STATE AND TIME ESTIMATION

As previously pointed out, nonparametric statistics were utilised for the statistical analysis of all gathered data. These techniques make it possible to process data of 'low quality' from small samples, and to analyse variables about which nothing is known with regard to their distribution. Nonparametric methods do not rely on the estimation of parameters such as the mean or the standard deviation (SD), which describes the distribution of the variable of interest in the population. Therefore, these methods are also sometimes known as parameter-free methods or distribution-free methods.

The first nonparametric method used is known as the Spearman R, which is similar to the regular Pearson product-moment correlation coefficient with regard to the proportion of variability accounted for. The only difference is that the Spearman R is computed from ranks. A prerequisite for using the Spearman R is that the variables under consideration should be measured on at least an ordinal scale. The second method, the Kendall tau rank correlation coefficient also known as the Kendall tau coefficient or Kendall's τ or tau test, is a non-parametric statistic used to measure the strength of

association of the cross-tabulations. It measures the degree of correspondence between two rankings and assesses the significance of this correspondence. The tau b tests is applied when both variables are measured at the ordinal level since it makes adjustments for ties and is most suitable for square tables. Values range from -1 for negative association, or perfect inversion to +1 for positive association, or perfect agreement. The absence of any association is shown by a value of zero.

4.1.1 Temporal reproduction in dual-task setting

Figure 4.1: Over- and underestimation of measured time span in the temporal reproduction task

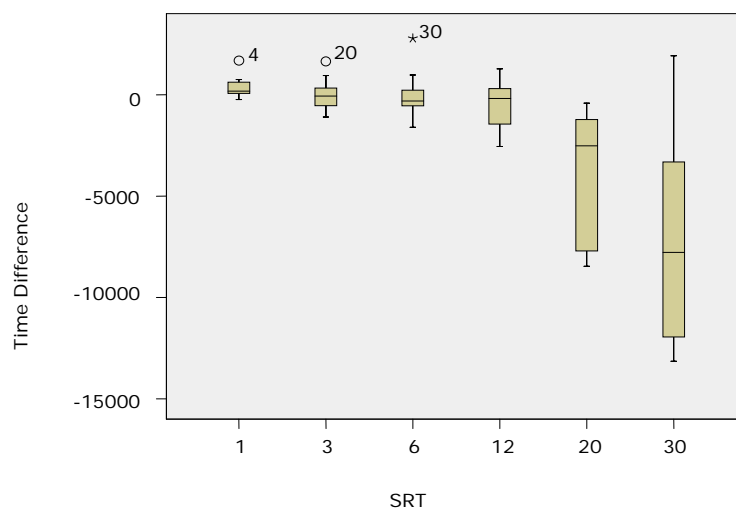

Table 4.1: Average number of over- and underestimation in reproduction task

SRT	1	3	6	12	20	30
In ms	359.90	67.00	-13.30	-414.20	-3796.80	-6970.80

The box plot diagram in Figure 4.1 illustrates to what extent a subject failed to reproduce the pre-established time period accurately. From Table 4.1 it is clearly visible that the short SRT durations of 1s and 3s have been overestimated. The medium and long time intervals of 6s, 12s, 20s and 30s have been underestimated in the temporal reproduction task. Based on the results of the study, the principles of Vierordt's law and the stated hypothesis were therefore confirmed. The existence of an 'indifference' point where the mean reproduction is supposed to be perfect was located close to a 6s delay in this experiment. At this duration the average underestimation only amounted to 13.3 ms.

4.1.2 Effects of SRT duration on breaking, acceleration and deceleration

4.1.2.1 Number of significant brakes

Figure 4.2: Number of SBs per driven kilometre under each SRT

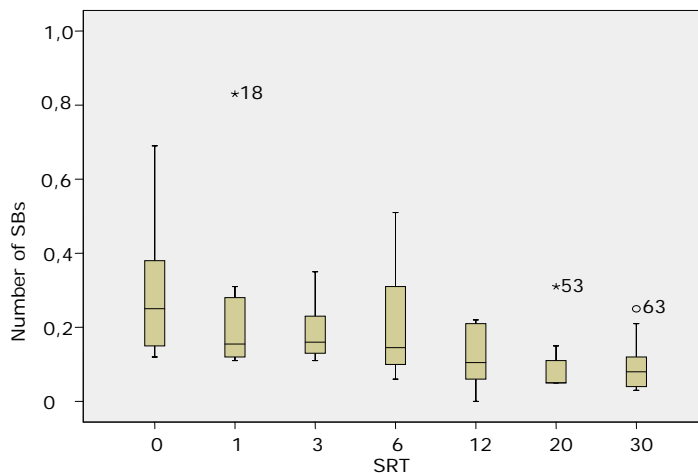

Table 4.2: Average number of SBs per driven kilometre

SRT	0	1	3	6	12	20	30
SBs	0.2900	0.2410	0.1878	0.1240	0.1220	0.0980	0.1020

The number of SBs per driven kilometre under each of the seven tested SRTs is represented in Figure 4.2. In Table 4.2 the mean numbers of SBs per driven kilometre are visible, showing a steady decline of brakes with the lengthening of the SRT. Under the 0s delay, which gives the user only about 300 ms until the system is ready again, the highest numbers of brakes has been indicated. In order to prove that the high mental load placed on the driver during the short will have a statistically relevant impact on his or her breaking behaviour, a two-way nonparametric correlation analysis employing the method of Spearman R was conducted. As cut-off level for significance and as control for the occurrence of type 1 error, a Bonferroni adjusted alpha

level of $p < .05$ was used. The negative correlation between the delay time and number of SBs per driven kilometre was significant with a correlation coefficient of $-.531$ ($n = 68$, $p = .000$).

4.1.2.2 Standard deviation of average positive acceleration

Figure 4.3: SDPA under each SRT

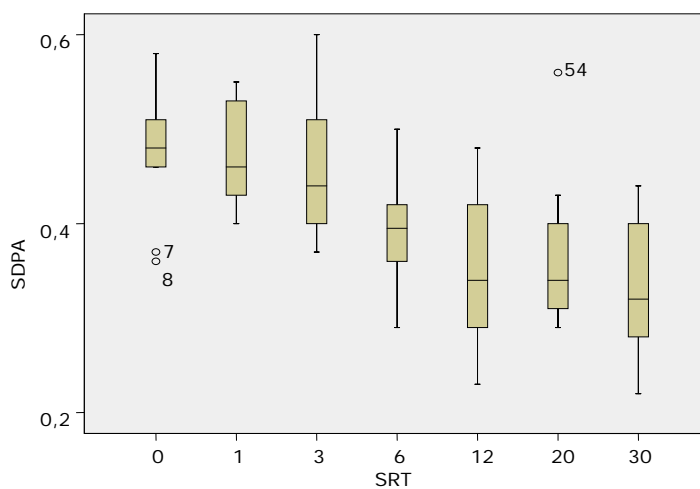

Table 4.3: SDPA

Delay	0	1	3	6	12	20	30
In m/s^2	0.4700	0.4710	0.4556	0.3940	0.3560	0.3680	0.3260

In Figure 4.3 the SDPA ranging from 0s to 30s is represented. In Table 4.3 the SD indicates how strongly the acceleration varies. The SDPA was used to show the increased inconsistency in acceleration and deceleration. The SD is a measure of dispersion, measuring how widely spread the values are in a set of data. A SD is found when many data points are close to the mean. If many data points are far from the mean, the SD is large. The SD is zero if all data values are equal. The method of Spearman R nonparametric correlation analysis was utilised again. A cut-off level for significance of $p < .05$ was

used for this two-tailed analysis. The negative correlation between the delay time and the SDPA was significant with a correlation coefficient of $-.604$ ($n = 68$, $p = .000$).

4.1.2.3 Standard deviation of negative acceleration

Figure 4.4: SDNA under each SRT

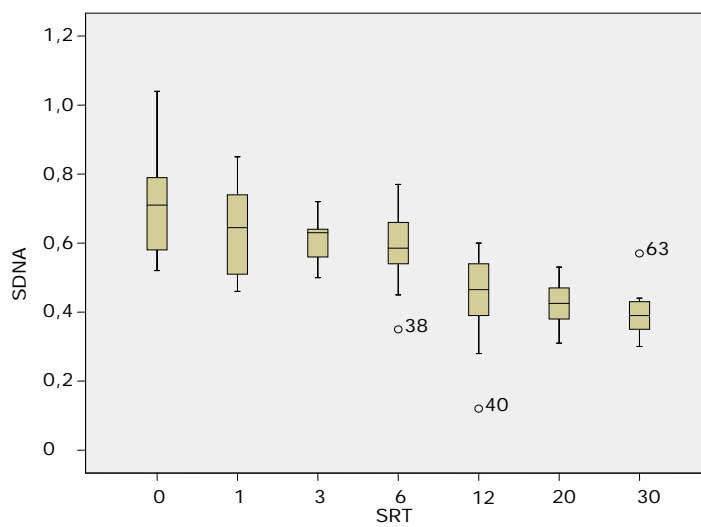

Table 4.4: SDNA

SRT	0	1	3	6	12	20	30
In m/s ²	0.7167	0.6350	0.6133	0.5790	0.4340	0.4240	0.4020

In Figure 4.4 the SDNA ranging from 0s to 30s is represented. In Table 4.4 the standard deviation indicates how strongly the acceleration varies. The Spearman R nonparametric correlation analysis was employed once more, with a cut-off level for significance of $p < .05$ for this two-tailed analysis. The

negative correlation between the delay time and the SDNA was significant with a correlation coefficient of $-.727$ ($n = 68$, $p = .000$).

4.1.3. Effects of SRT duration on steering and line crossings

4.1.3.1 Number of steering movements

Figure 4.5: Number of SMs per driven kilometre under each SRT

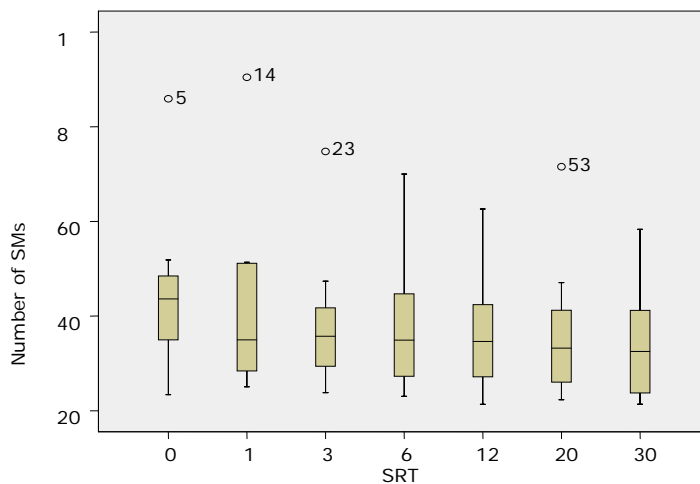

Table 4.5: Average number of SMs per driven kilometre

SRT	0	1	3	6	12	20	30
SMs	44.92	42.45	38.26	37.57	36.32	35.10	34.90

The number of SMs per driven kilometre under each SRT is visible in Figure 4.5, ranging from 0 s to 30 s. In Table 4.5 the mean number of SMs per driven kilometre indicates that less steering is taking place under the long SRTs. To find out whether this decline is statistically significant, a two-way nonparametric correlation analysis employing the method of Spearman R was used. The cut-off level for significance was set at $p < .05$. The negative

correlation between the delay time and number of SMs per driven kilometre was not significant with a correlation coefficient of $-.218$ ($n = 68$, $p = .074$).

4.1.3.2 Incidences of crossing outside line on total driving duration

Figure 4.6: COL per kilometre on total driving duration under each SRT

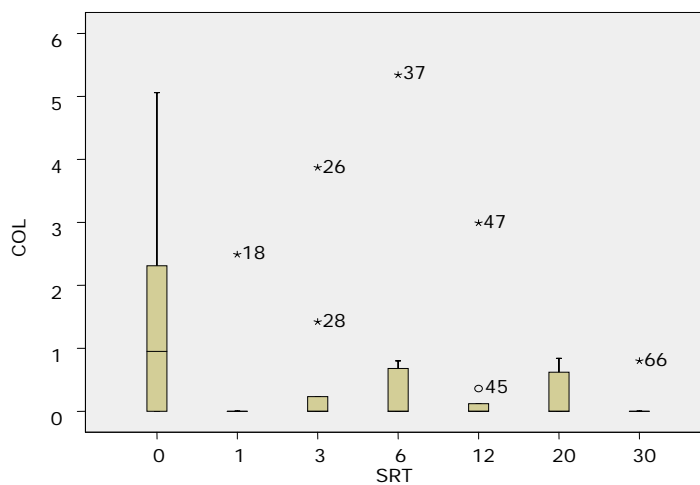

Table 4.6: Average number of COL per kilometre on total duration under each SRT

SRT	0	1	3	6	12	20	30
COL	1.6767	0.2490	0.6133	0.6820	0.3470	0.2260	0.0800

Figure 4.6 and Table 4.6 show how often the drivers crossed the outside line in each kilometre they drove for all seven tested SRTs. The data shows that the number of crossings declines under longer waiting times. A two-way correlation analysis utilising the method of Spearman R was performed. The cut-off level for significance was set at $p < .05$. The negative correlation between the delay time and number of incidences of COL per kilometre on total driving duration was not significant with a correlation coefficient of $-.148$ ($n = 68$, $p = .229$).

4.1.4 Effects of SRT duration on gaze behaviour and gaze adaptation

4.1.4.1 Gaze frequency under each SRT

Figure 4.7: Gazes per minute under each SRT

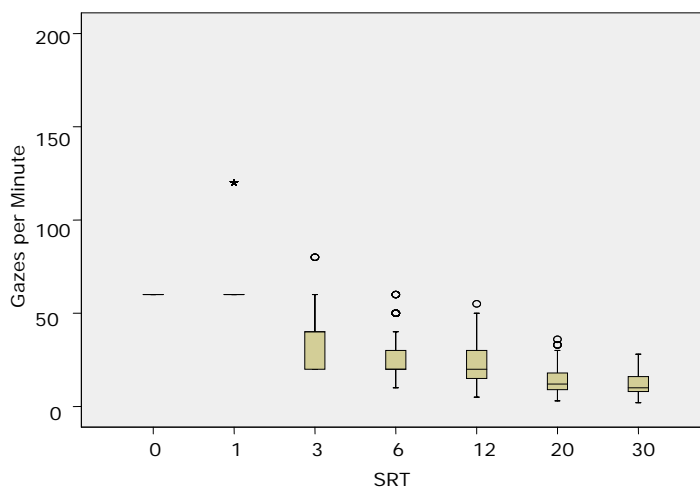

Table 4.7: Number of gazes per minute under each SRT

SRT	0	1	3	6	12	20	30
Gazes	60.2	73.0	38.3	26.0	21.7	14.6	11.8
Average shift interval in s	0.99	0.82	1.56	2.30	2.75	4.10	5.05

The number of gazes to the game monitor made by the subjects within one minute is visible in Figure 4.7 and Table 4.7. A high reduction in the number of gazes is apparent with the increase in SRT duration. The method of Spearman R was used to analyse the correlation between the number of steering movements and the SRT. The cut-off level for significance was set at $p < .05$ and the analysis was two-tailed. The negative correlation between

the delay time and mean number of gazes per minute was significant and very strong with a correlation coefficient of $-.964$ ($n = 7$, $p = .000$).

4.1.4.2 Average focus time on game monitor under each SRT

Figure 4.8: Average focus time on game monitor under each SRT

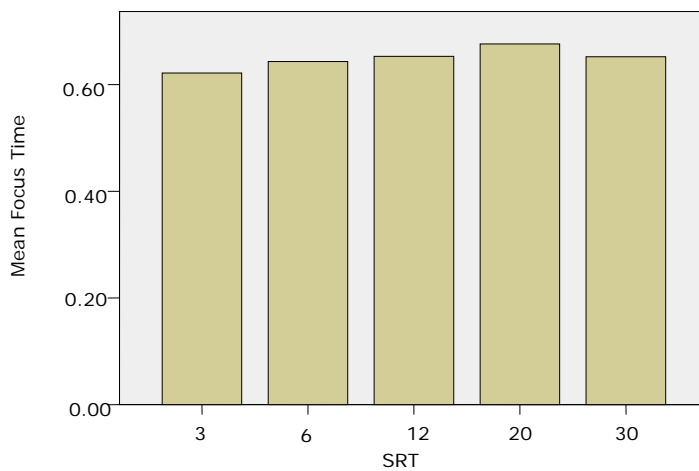

Table 4.8: Average focus time on game monitor under each SRT

SRT	1	3	6	12	20	30
In s	0.6218	0.6432	0.6529	0.6761	0.6522	0.6575

The Spearman R nonparametric correlation analysis was utilised once more, with a cut-off level for significance of $p < .05$ for this two-tailed analysis. No correlation between the length of the delay time and the mean focus time on the monitor was noticed with a correlation coefficient of $-.011$ ($n = 4784$, $p = .432$).

4.1.5 Distribution of gazes within the various SRTs

In order to present the number of gazes to the monitor at any given point in time during the various SRTs a division into blocks of 0.5 s was carried out. In the histograms Figure 4.8 to Figure 4.12 the number of gazes is displayed on the x-axis. The y-axis shows time in a 0.5-s interval. A two-way nonparametric correlation analysis employing the method of Spearman R was used to analyse the distribution of gazes within the various SRTs. The cut-off level of was set at $p < .05$.

Figure 4.9: Distribution of gazes within the 3-s delay

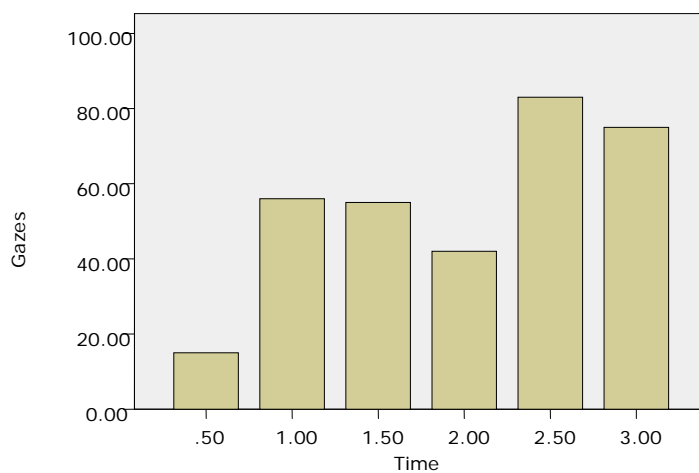

The histogram in Figure 4.9 shows an increase in the number of gazes towards the end of the waiting period. The correlation between time and number of gazes failed to be significant for the 3-s delay with a correlation coefficient of .714 ($n = 6$, $p = .111$).

Figure 4.10: Distribution of gazes within the 6-s delay

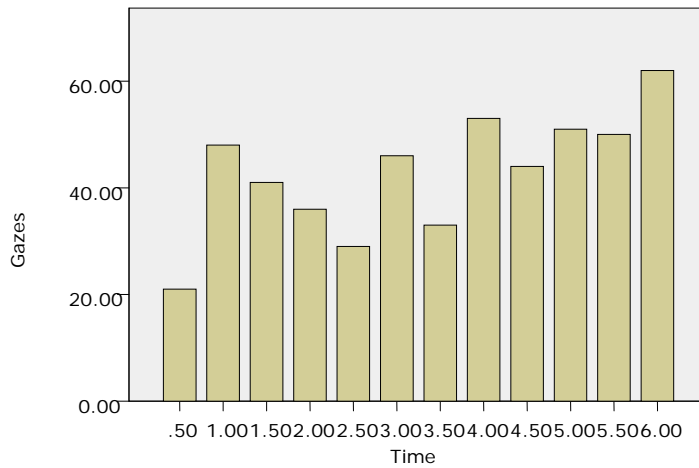

For the 6-s delay, the correlation between time and number of gazes was significant and positive with a correlation coefficient of .692 ($n = 12$, $p = .013$).

Figure 4.11: Distribution of gazes within the 12-s delay

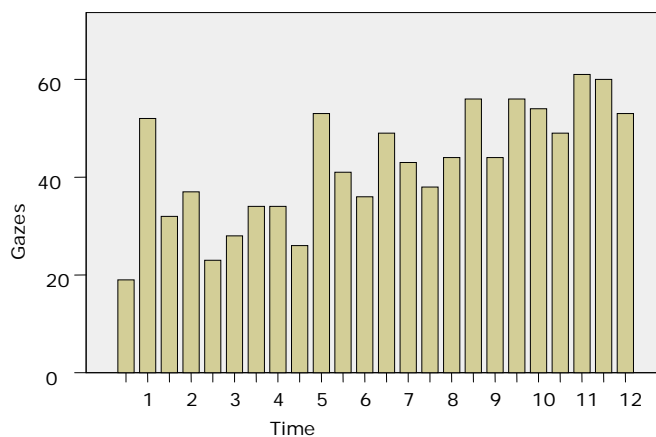

For the 12-s delay, the correlation between time and number of gazes was also significant and positive with a correlation coefficient of .762 ($n = 24$, $p = .000$).

Figure 4.12: Distribution of gazes within the 20-s delay

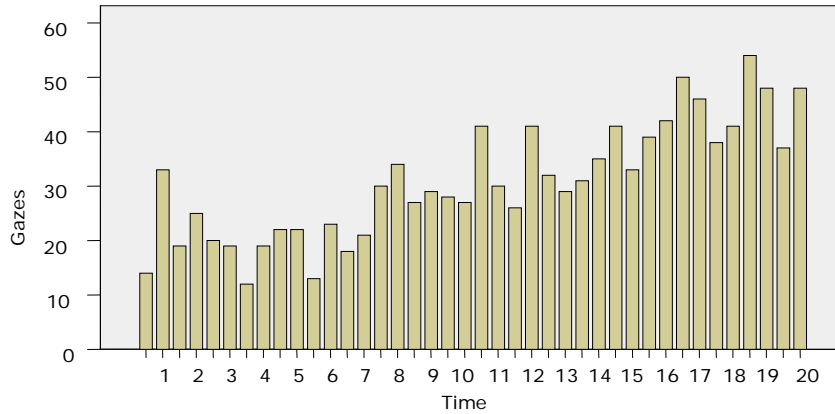

The positive correlation between time and number of gazes for the 20-s delay, was significant and very strong with a correlation coefficient of .845 ($n = 40$, $p = .000$).

Figure 13: Distribution of gazes within the 30-s delay

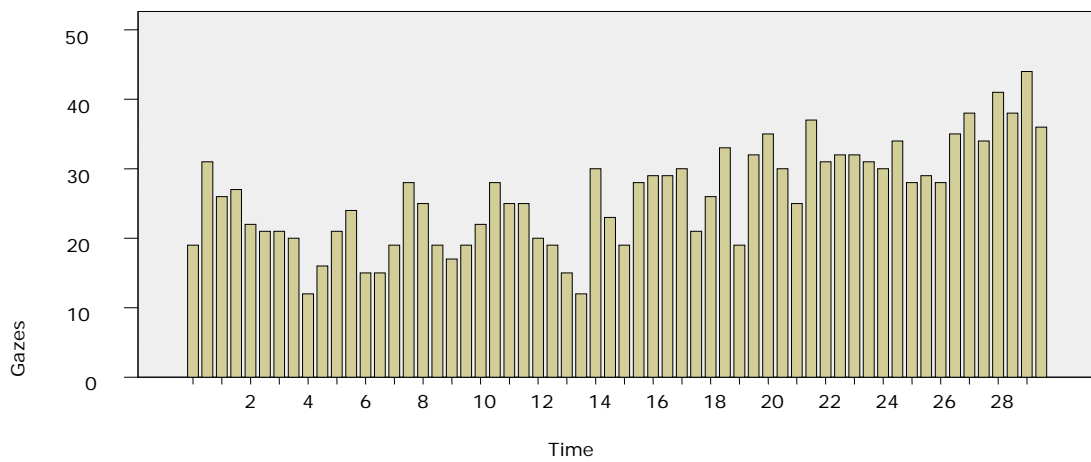

The positive correlation between time and number of gazes for the 30-s delay was significant and strong with a correlation coefficient of .709 ($n = 60$, $p = .000$).

4.1.6 Effects of SRT duration on game performance

Figure 4.14: Error rate under each SRT

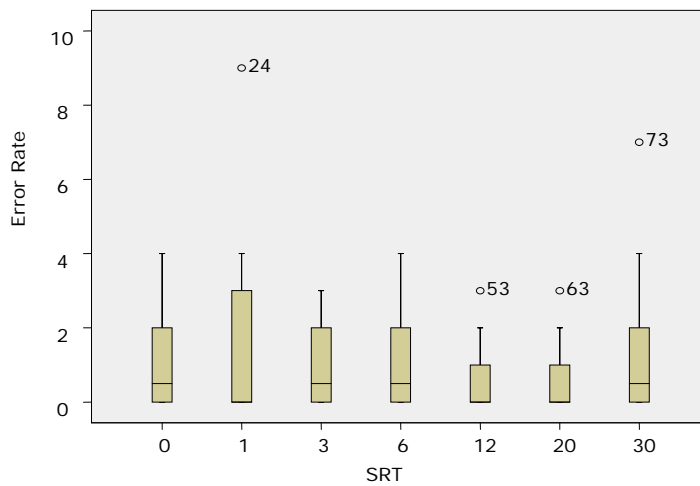

Table 4.9: Average error rate under each SRT

Delay	0	1	3	6	12	20	30
Errors	1	1.8	0.9	1.8	1	0.7	1.5

The Spearman R nonparametric correlation analysis was also used to analyse the mean error rate for each tested SRT. The cut-off level for significance of $p < .05$ was chosen for this two-tailed analysis. No significant correlation between error rate and the delay time was detected with a correlation coefficient of $-.035$ ($n = 70$, $p = .773$).

4.1.7 Effects of SRT duration on subjective experience

Figure 4.15: Rating for stress and boredom

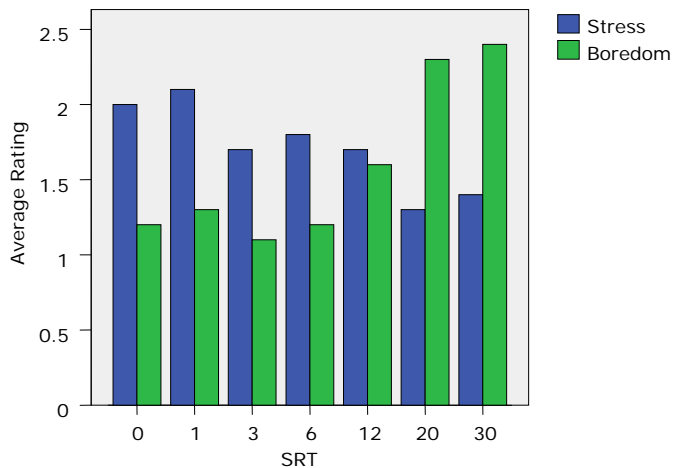

Table 4.10: Rating for stress and boredom

SRT	0	1	3	6	12	20	30
Stress	2.00	2.10	1.70	1.80	1.30	1.40	1.71
Boredom	1.20	1.30	1.10	1.20	1.60	2.30	2.40

Low (1)

Medium (2)

High (3)

The nonparametric Kendall-tau-b correlation coefficient analysis was also used to examine the impact the length of SRT had on the ratings of stress, boredom, driving performance and task completion. The cut-off level for significance of $p < .05$ was chosen for this two-tailed analysis. A significant correlation between the rising delay time and the rating for the experienced stress was discovered. The correlation coefficient was negative with a value of $-.683$ ($n = 7$, $p = .033$). The correlation between the rising delay time and

the rating for the experienced boredom is positive and significant with a correlation coefficient of .683 ($n = 7$, $p = .033$).

Figure 4.16: Rating for drive performance and task completion

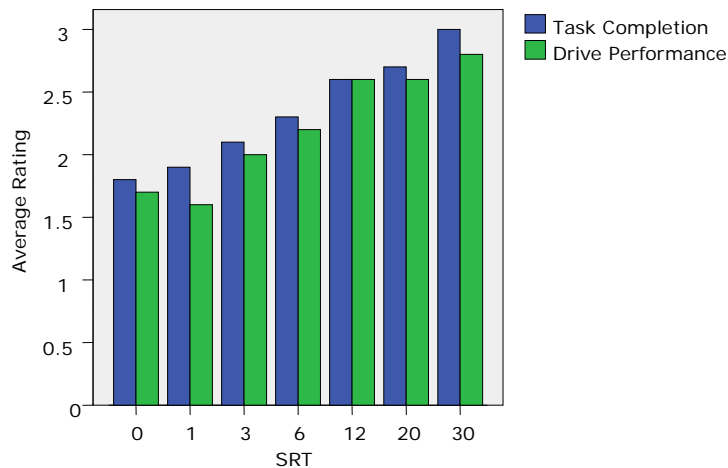

Table 4.11: Rating for driving performance and task completion

SRT	0	1	3	6	12	20	30
Task Completion	1.80	1.90	2.10	2.30	2.60	2.70	3.00
Drive Performance	1.70	1.60	2.00	2.20	2.60	2.60	2.80

To short (1)

Convenient length (2)

Too long (3)

The significant correlation between the rising delay time and the rating for the experienced drive performance is positive and very strong with a correlation coefficient of .878 ($n = 7$, $p = .006$). The correlation between the rising delay time and the rating for the experienced task completion was significant with a correlation coefficient of .810 ($n = 7$, $p = .011$).

CHAPTER 5

DISCUSSION OF RESULTS AND CONCLUSION

5.1. SUMMARY OF THE STUDY

The study was aimed at finding the optimum SRT that will enable users to focus as much as possible on the road while attaining an efficient task completion time. The utilisation of navigation systems in cars has raised road safety concerns since users need to divide their attention between driving and the operation of the navigation system. The research project investigated the use of such systems, and focused in particular on optimal SRTs. The study involved two separate experiments. The first experiment included a temporal reproduction task that was conducted in the time laboratory. The second experiment took place in a driving simulator. The study employed an experimental correlational design. A total of 10 test subjects took part in the experiments, and they were mostly students or employees at the research institute where the study was conducted.

Seven hypotheses were tested. The first hypothesis concerning the temporal reproduction stated that short durations would be overestimated and long durations would be underestimated. The second and third hypotheses predicted a statistically significant relationship between driving performance and the length of the SRT. It was hypothesised that the number of SBs would increase under short SRTs. Acceleration and deceleration would become more volatile, resulting in a higher SD under short SRTs. Driving parameters regarding the position of the car were also expected to be negatively affected under the shorter SRTs. The number of SMs and the

number of incidences of COL were expected to increase significantly during short SRTs.

The fourth hypothesis investigated the impact of the high demand on attentional resources during the short SRTs. It was hypothesised that short SRTs would force the drivers to switch their focus more often between the road and the game monitor. The gaze frequency would therefore increase significantly during short SRTs. The average focus time on the game monitor should decrease considerably during the short SRTs. The fifth hypothesis stated that the distribution of gazes stays constant during the entire waiting period.

In the sixth hypothesis it was assumed that the performance with regard to correctly remembered items in the memory game would not be influenced by the SRT. Hypothesis 7 stated that the subjective state of the test subjects, indicating how they personally experienced performing the simulated driving task, would be significantly influenced by the duration of the SRT. Hypotheses 2 to 6 were analysed using the nonparametric method known as Spearman R. Hypothesis 7 was analysed with the Kendall-tau-b rank correlation coefficient. All data were processed with the Statistical Package for Social Sciences (SPSS) version 14.0.

5.2. DISCUSSION OF THE RESULTS

5.2.1 Temporal reproduction task

The principles of Vierordt's law were confirmed in the dual-task environment of the temporal reproduction task. The hypothesis concerning

the temporal reproduction task was verified by the data yielded by the experiment. Short durations were overestimated and long durations were underestimated as expected according to the principles of Vierordt's law. The secondary task of memorising two symbols before encoding and reproducing the various time periods did not drain the subject's attentional resources to such a degree that changes in the time estimation performance could be observed. From the findings of the temporal reproduction task it can be concluded that a concurrently processed simple memory task did not interfere with the process of temporal reproduction to a significant degree. The results further indicate that all the test subjects performed within the expected parameters indicating that their ability to estimate durations was not in any way impaired or altered and made them suitable subjects for the experiment in the driving simulator.

5.2.2 Effects of SRT duration on braking, acceleration and deceleration

The second hypothesis predicted a statistically significant relationship between the number of SBs and the SDPA as well as the SDNA and the duration of the SRT. The anticipated effect that driving performance will be negatively influenced during short SRTs was confirmed with regard to the number of SBs per driven kilometre. This indicated that the high mental load placed onto the driver during the short SRT resulted in a less stable and fluent drive performance and had a severe impact on braking behaviour.

The negative effect of the short SRTs became apparent when looking at the SDPA and SDNA. The correlational analysis also confirmed that the acceleration and deceleration became more volatile, resulting in a higher SD under short SRTs. The results of the driving simulator gave strong evidence that the short SRTs made it difficult to keep up a constant speed and the

acceleration and deceleration became more volatile and abrupt. Such driving behaviour could have a negative impact on the flow of traffic and sudden unexpected braking can endanger cars driving behind the stopping vehicle.

5.2.3 Effects of SRT duration on steering and line crossings

The high mental load placed on the driver during the short SRTs seemed to have affected variables relating to travelling speed to a greater extent than the position of the car on the road. The number of SBs per driven kilometre did not vary significantly during the different SRTs. The decrease of COL with the increase of the SRT was also not significant. Therefore it can be concluded that the short SRTs impacted less severely on the ability to steer correctly and to stay in the driving lane. A complicating factor is that the COL increase under short SRTs may have been due to the fact that the display monitor was mounted to the right of the steering wheel. The head movements to this side could have provoked the driver to move the steering wheel to the right. The possible effect of this aspect on driving behaviour should therefore be investigated in future research.

5.2.4. Effects of SRT duration on gaze behaviour

The hypotheses with regard to the frequency of gazes and average focus time on the game monitor were partly confirmed. The average focus time on the game monitor did not show a decrease to a significant degree during the short SRTs, but the gaze frequency was significantly lower during the longer SRTs. This may suggest that an automatic switching strategy was performed, that was adjusted to each of the SRTs. The average gaze frequency recorded

during the 6-s, 12-s, 20-s and 30-s delays lay close to or above the values of 2 s to 3 s proposed for the duration of temporal integration by Pöppel (1997). Temporal integration or perceptual accentuation is proposed to be a general principle of the neurocognitive machinery, incorporating all perceptual processes into a time window in the range of 2 s to 3 s.

The temporal segmentation mechanism provides a platform for conscious activity and makes it possible to search for new information from the external or internal environment once the data gathered during the previous temporal integration moment have been processed or stored (Schleidt, Eibl-Eibesfeldt & Pöppel 1987). The gathered data showed that during the short SRTs the gaze shift frequency was pushed above the usual operational value, which could explain why driving performance with regard to many tested parameters declined significantly under these conditions.

The high frequency of gaze shifts can be interpreted as an automatic process that splits the attention between the two tasks independently of the temporal-estimation abilities of the subjects. It seems that humans operate like computers with regard to handling multiple operations at the same time. Time-sharing entails that the computer must be able to hold information in STM and it requires facilities to store or buffer a considerable number of information for concurrent task processing. Computers generally are equipped with buffers both for inputs that have not yet been fully processed and for outputs that have been planned but not yet carried out, as well as various internal buffers. There are suggestions in the literature that humans likewise are equipped with a range of memory buffers that enable them to employ a 'buffer and switch' processing strategy in order to process numerous tasks concurrently (Baddeley, 1986).

The expectation that all SRTs would be underestimated, as predicted by the attentional resource allocation model (Hemmes, Brown & Kladopoulos,

2004), was partly confirmed since all subjects started to shift their attention to the game monitor very soon after the start of the SRT, and they significantly underestimated the duration. An interesting observation emanating from the data recorded was that many irrelevant gaze shifts occurred between the driving scene and the secondary task.

5.2.5 Distribution of gazes within the various SRTs

The hypothesis stating that the distribution of the gazes would stay constant during the entire waiting period had to be refuted. With the help of a nonparametric analysis the correlation between the elapsed time and the number of gazes to the monitor was analysed. The results indicated that the number of gazes continuously increased with the increase in duration and was therefore not constant during all the tested SRTs. Except for the 3 s SRT the number of gazes increased significantly with time. A stronger rightward shift of the gaze distribution was seen during the shorter SRTs.

5.2.6 Effects of SRT duration on game performance

The hypothesis that the number of inaccurately chosen items in the memory game would stay the same with all SRTs was confirmed. The data indicate that the performance with regard to the secondary task was not significantly affected by the duration of the SRT. The stress experienced by the test subjects during the short SRTs did not seem to have affected their performance on item memorisation task. This suggests that a correct completion of the secondary task was prioritised by the test subjects, confirming the findings of Tsimhoni and Green (2001), who found that there

was a trade-off between driving safety and task performance for the benefit of task performance.

5.2.7 Effects of SRT duration on subjective experience

The hypothesis that the subjective state of the test subjects would be significantly influenced by the duration of the SRT was confirmed. The analysis of the stress and boredom levels showed a significant correlation with the duration of the SRT. Short SRTs resulted in a higher rating for stress and lower rating for boredom. The ratings of the SRT duration with regard to task completion and drive performance were significant. The medium SRTs were evaluated as being the most suitable for the test subjects with regard to the resulting task completion and driving performance. This indicated that the drivers did not find that the medium-length SRTs were a hindrance to the completion of the secondary task and that they felt more comfortable driving without the time pressure generated by a fast-responding system.

5.2.8 Practical implications of research findings

The high frequency of gaze shifts found in all the subjects during each tested SRT in the driving simulator highlights the importance of the spatial set-up of the navigation system monitor. The navigation system should be placed as close as possible to the front screen, which would entail that the focus change from the road to the monitor is relatively fast and does not involve significant head movements. New technologies employed in the next generation of navigation systems are already designed to project the screen content of navigation systems onto the windscreen.

With the help of an on-board computer the video recording of the current driving environment and the stored street information are merged to provide instructions on the driving direction in the form of three-dimensional arrows. On the navigation display the driver is also provided with a recording of the external environment and a so-called 'augmented reality' that offers the same view of the world as when the driver is looking directly at the road. Three-dimensional navigation systems employ interactive 3-D computer graphics with graphics processors constructed for game consoles and enable the production of a virtual space and deliver entire animations of road features, buildings and road works. An additional safety feature used in the latest navigation systems is a head-up display that ensures that drivers do not have to turn their head sideways and can look straight at their route (Thiel, 2007).

5.2.9 Implications for further research

The results of the tests performed in the driving simulator stress the importance of a thorough understanding of the hidden costs of multitasking. They highlight the need for the development of strategies that boost task completion efficiency. Previous research on the effects of multitasking has shown that in certain situations the loss of just half a second to task switching can make a life-or-death difference. In the case of driving at a speed of 60 kilometres while using a cell phone, the distraction caused by multitasking can have disastrous consequences. During the short time period the driver is not totally focused on driving the car he or she can travel far enough to collide with an obstacle that might otherwise have been avoided.

Research exploring the effects of multitasking on productivity such as the work done by Meyer and Kieras is aimed at providing an understanding of

switching costs. A thorough understanding of the cognitive tasks involved in multitasking and set switching with regard to the allocation of executive control processes can help to improve the design and engineering of human-computer interfaces. Such sophisticated technologies, especially when employed in the area of vehicle and aircraft operation or even air traffic control where safety issues have to be considered, need to be adjusted to the brain's capability to cope with multiple tasks at the same time (Meyer & Kieras, 1997). Further research is, however, needed to clarify which types of stimulus significantly affect the experience of time. Research also still needs to elucidate what exactly the effects of simultaneously encoding from different sensory channels are, what additional stress they place on attentional resources, and how this may lead to a greater distortion of the sense of time.

5.3 CONCLUSION

The main goal of this study was to examine the effect of SRTs on driving performance. The study also investigated how the subjects divided their visual attention between the road and the monitor, and explored the impact of the SRT on memory performance. A further goal of this study was to find out how the test subjects personally experienced the simulated driving task under the various tested SRT durations.

The study makes a significant contribution to our understanding of the impact of navigation systems on driving performance and road safety. It shows that fast SRTs are not desirable in on-board devices. The 30-s delay, being the longest tested SRT, had the least negative impact on driving performance. Short SRT durations were found to correlate significantly with an increase in braking and a higher volatility in acceleration and

deceleration. Both the number of SMs and the COL show some increase under short SRTs.

The study also examined how visual attention was divided. The results indicate that the gaze frequency is significantly higher during the short SRTs while the average focus time on the game monitor stays constant. Another interesting result was that the number of gazes increased towards the end of the SRT.

With regard to the task of item memorisation, the results suggest that the stress experienced by test subjects during short SRTs did not have a negative impact. A delay of 3 s was rated as the most convenient length by the test drivers. Short SRTs resulted in high levels of stress and low levels of boredom.

REFERENCE LIST

- Allan, L. G., & Kristofferson, A. B. (1974). Judgements about the duration of brief stimuli. *Perception & Psychophysics, 15*, 434-440.
- Allan, G. A., & Gibbon, J. (1991). Human bisection at the geometric mean. *Learning & Motivation, 22*, 39-58.
- Allport, D. A., Antonis, B., & Reynolds, P. (1972). On the division of attention: A disproof of the single channel hypothesis. *Quarterly Journal of Experimental Psychology, 24*, 225-35.
- Anderson, C. M. B., & Craik, F. I. M. (1974). The effect of a concurrent task on recall from primary memory. *Journal of Verbal Learning and Verbal Behavior, 13*, 107-113.
- Anisman, H., & Zacharko, R. M. (1990). Multiple neurochemical and behavioral consequences of stressor: Implication for depression. *Pharmacol. Ther., 46*, 119-136.
- Angrilli, A., Cherubini, P., Pavese, A., & Manfredini, S. (1997). The influence of affective factors on time perception. *Perception & Psychophysics, 59* (6), 972-982.
- Ashley, S. (2001). Driving on the info highway. *Scientific American, October*, 45-50.

- Atkinson, R. C., & Shiffrin, R. M. (1968). Human memory: A proposed system and its control processes. In K. W. Spence & J. T. Spence (Eds.), *The psychology of learning and motivation* (Vol. 8). London: Academic Press.
- Baddeley, A. D. (1986). *Working memory*. Oxford: Oxford University Press.
- Barrett, E. S., & Patton, J. H. (1983). Impulsivity: cognitive, behavioural, and psycho physiological correlates. In: M. Zuckerman (Ed.), *Biological bases of sensation seeking, impulsivity, and anxiety* (pp. 77-116). Hillside ,NJ: Lawrence Erlbaum.
- Baylis, G., & Driver, J. (1995). One-sided edge assignment in vision: 1. Figure- ground segmentation and attention to objects. *Current Directions in Psychological Science*, 4, 140-146.
- Beatty, J. (1995). *Principles of behavioural neurosciences*. Madison, WI: Brown & Benchmark.
- Berlin, H. A., & Rolls E. T. (2004). Time perception, impulsivity, emotionality, and personality in self-harming borderline personality disorder patients. *Journal of Personality Disorders*, 18 (4), 358-378.
- Bizo, L. A., Chu, J. Y. M., Sanabria, F., & Killeen, P. R. (2006). The failure of Weber's law in time perception and production. *Behavioural Processes*, 71, 201-210.
- Block, R. A. (1979). Time and consciousness. In G. Underwood & R. Stevens (Eds.), *Aspects of consciousness* (Vol. 1). London: Academic Press.

- Block, R. A., George, E. G., & Reed, M. A. (1980). A watched pot sometimes boils: a study of duration experience. *Acta Psychologica*, *47*, 81-94.
- Block, R. A. (1990). Models of psychological time. In R. A. Block (Ed.), *Cognitive models of psychological time* (pp. 1-36). Hillsdale, NJ: Erlbaum.
- Boring, E. G., Langfeld, H. S., & Weld, H. P. (1935). *Psychology a Factual Textbook*. New York: Wiley.
- Broadbent, D. E. (1958). *Perception and communication*. London: Pergamon Press.
- Bullinger, H. J., & Dangelmaier, M. (2003). Virtual prototyping of in-vehicle interfaces. *Ergonomics*, *46* (1-3), 41-51.
- Burnett, G. E., Summerskill, S. J., & Porter, J. M. (2004). On-the-move destination entry for vehicle navigation systems: Unsafe by any means? *Behaviour & Information Technology*, *23* (4), 265-272.
- Cappella, B., Gentile, J., & Juliano, D. (1977). Time estimation by hyperactive and normal children. *Perceptual & Motor Skills*, *44*, 787-790.
- Cantor, N. E., & Thomas, E. A. (1977). Control of attention in the processing of temporal and spatial information in complex visual patterns. *Journal of Experimental Psychology: Human Perception & Performance*, *3*, 243-250.

- Cenci, M. A., Kalen, P., Mandel, R. J., & Bjorklund, A. (1992). Regional differences in the regulation of dopamine and noradrenaline release in the medial frontal cortex, nucleus accumbens and caudateputamen: a microdialysis study in the rat. *Brain Research*, *581*, 217-228.
- Chang, Y. H., Liao, R. M., Lan, C. H., & Shen, Y. L. (2000). Operant Performance Following Tail-Pinch in the Rat: Effects of d-Amphetamine. *Chinese Journal of Physiology*, *43* (3), 105-111.
- Cherry, E. C. (1953). Some experiments on the recognition of speech with one or two ears. *Journal of the Acoustical Society of America*, *25*, 975-979.
- Creelman, C. D. (1962). Human discrimination of auditory stimuli. *Journal of the Acoustical Society of America*, *34*, 582-593.
- Crystal, J. D. (2001). Circadian time perception. *Journal of Experimental Psychology: Animal Behaviour Processes*, *27*, 68-78.
- Darwin, C. J., Turvey, M. T., & Crowder, R.G. (1972). An auditory analogue of the Sperling partial report procedure: Evidence for brief auditory storage. *Cognitive Psychology*, *3*, 255-267.
- Davids, A., & Falloff, B. D. (1975). Juvenile delinquents then and now: Comparison of findings from 1959 and 1974. *Journal of Abnormal Psychology*, *84*, 161-164.
- Davies, P. (1994). *The last three minutes*. New York: Basic Books.
- Dennett, D. C. (1991). *Consciousness explained*. Boston: Little, Brown & Co.

- Desimone, R., & Duncan, J. (1995). Neural mechanism of selective visual attention. *Annual Review of Neuroscience, 18*, 193-222.
- Deutch, J. A., & Deutsch, D. (1963). Attention: some theoretical considerations. *Psychological Review, 70*, 80-90.
- de Quervain, D. J., Henke, K., Aerni, A., Treyer, V., McGaugh, J. L., Berthold, T., Nitsch, R. M., Buck, A., Roozendaal, B., & Hock, C. (2003). Glucocorticoid-induced impairment of declarative memory retrieval is associated with reduced blood flow in the medial temporal lobe. *European Journal of Neuroscience, 17* (6), 1296-302.
- Dirkin, L. W., & Hancock, P. A. (1984). Attentional narrowing to the visual periphery under temporal and acoustic stress. *Aviation, Space and Environmental Medicine, 55*, 457.
- Duncan, J. (1993). Similarity between concurrent visual discriminations: Dimensions and objects. *Perception & Psychophysics, 54*, 425-430.
- Duncan, J. (1996). Cooperating brain systems in selective perception and action. In T. Inui & J. L. McClelland (Eds.), *Attention and performance XVI* (pp. 549-578). Cambridge, MA: MIT Press.
- Eisler, A. (1993). *Time perception: theoretical considerations and empirical studies on the influence of gender, age, and culture on subjective duration*. Doctoral dissertation. Stockholm University: Akademitryck AB.
- Euler, M., (1997). Sensations of Temporality in Acoustic Perception. In H. Atmanspacher & E. Ruhnau (Eds.), *Time, Temporality, Now*. NY: Springer.

- Fair, D. G. (1984). *Temporal distortion*. Unpublished manuscript, Department of Safety Science, University of Southern California. Los Angeles, CA.
- Ferino, F., Thierry, A. M., & Glowinski, J. (1987). Anatomical and evidence for a direct projection from Ammon's horn to the medial prefrontal cortex in the rat. *Experimental Brain Research*, *65*, 421-426.
- Fetterman, J. G., & Killeen, P. R. (1992). Time discrimination in *Columba livia* and *Homo sapiens*. *Journal of Experimental Psychology: Animal Behaviour Processes*, *18*, 80-94.
- Fortin, C., & Rousseau, R. (1998). Interference from short-term memory processing on encoding and reproducing brief durations. *Psychology Research*, *61*, 269-276.
- Fraisse, P. (1963). *The psychology of time*. London: Eyre & Spottiswoode.
- Fraisse, P. (1984). Perception and estimation of time. *Annual Review of Psychology*, *35*, 1-36.
- Friedman, W. J. (1990). *About time: Inventing the fourth dimension*. Cambridge: MIT Press. A Bradford Book.
- Gallego, S., & Micheyl, C. (1998). Intensity discrimination and auditory brainstem responses in cochlear implant and normal-hearing listeners. *Behaviour & Neuroscience*, *112*, 793-799.
- Getty, D. J. (1975). Discrimination of short temporal intervals: a comparison of two models. *Perception & Psychophysics*, *18*, 1-8.

- Gibbon, J. (1977). Scalar expectancy theory and Weber's law in animal timing. *Psychology Review*, *84*, 279-325.
- Gomez, C. E. D., Argandona, R. G., Solier, J., Angulo, C., & Vazquez, M. (1995). Timing and competition in networks representing ambiguous figures. *Brain & Cognition*, *29*, 103–114.
- Gopher, D. (1993). The skill of attentional control: Acquisition and execution of attentional strategies. In S. Kornblum & D. E. Meyer (Eds), *Attention and Performance* (Vol. 14). Cambridge, MA: MIT Press.
- Gottsdanker, R. (1980). The ubiquitous role of preparation. In G. E. Stelmach, & J. Requin (Eds.), *Tutorials in motor behaviour* (pp. 355-371). Amsterdam: North-Holland Press.
- Grondin, S. (2001). From physical time to the first and second moments of psychological time. *Psychology Bulletin*, *127*, 22-44.
- Gruber, R. P., Wagner, L. F., Block, R., & Matthews, S. (2000). Subjective time vs. proper (clock) time. *Studies on the structure of time* (pp. 49-63). New York: Kluwer Academic.
- Hameroff, S. (1994). Quantum coherence in microtubules: A neural basis foremergent consciousness? *Journal of Consciousness Studies*, *1* (1), 91-118.
- Hancock, P. A., & Warm, J. S., (1989). A dynamic model of stress and sustained attention. *Human Factors*, *31*, 519–537.
- Hancock, P. A. (1993). Body temperature influences on duration estimation. *Journal of General Psychology*, *120*, 197-216.

- Hancock, P. A., Simmons, L., Hasemi, L., Howarth, H., & Ranney, T. (1999). The effects of in-vehicle distractions on driver response during a crucial driving manoeuvre. *Transportation Human Factors*, 1 (4), 295-395.
- Hancock, P. A., & Weaver, J. L. (2005). On time distortion under stress. *Theoretical issues in Ergonomics Science*, 6 (2), 193-211.
- Hancock, P. A., Szalma, J. L., & Oron-Gilad, T. (2005). Time, emotion, and the limits to human information processing. In: D. McBride & D. Schmorrow (Eds.), *Quantifying Human Information Processing* (pp. 157-175). Lanham, MD: Lexington Books.
- Harter, M. R., & White, C. T. (1968). Periodicity within reaction time distributions and electromyograms. *Quarterly Journal of Experimental Psychology*, 20, 157-166.
- Hawkins, J., & Blakeslee, S. (2004). *On intelligence*. New York: Times Books.
- He, Z. J., & Nakayama, K. (1992). Surfaces versus features in visual search. *Nature*, 359, 231-233.
- Hemmes, N. S., Brown, B. L., & Kladopoulos, C. N. (2004). Time perception with and without a concurrent non-temporal task. *Perception & Psychophysics*, 66 (2), 328-341.
- Hicks, R. E., Miller, G. W., & Kinsbourne, M. (1976). Prospective and retrospective judgements of time as a function of number of information processed. *American Journal of Psychology*, 89, 719-730.

- Hicks, R. E., Miller, G. W., Gaes, G., & Bierman, K. (1977). Concurrent processing demands and the experience of time-in-passing. *American Journal of Psychology, 90*, 431-446.
- Hikosaka, O., Miyauchi, S., & Shimojo, S. (1993). Focal visual attention produces illusory temporal order and motion sensation. *Vision Research, 33*, 1219-1240.
- Hume, D. (1739). *A treatise of human nature*. Cheapside: Noon.
- Ivry, R. B., & Keele, S. W. (1989). Timing functions of the cerebellum. *Journal of Cognitive Neuroscience, 1*, 136-152.
- Ivry, R. B., & Hazeltine, R. E. (1995). Perception and production of temporal intervals across a range of durations: evidence for a common timing mechanism. *Journal of Experimental Psychology: Human Perception & Performance, 21*, 3-18.
- Ivry, R. B. (1996). The representation of temporal information in perception and motor control. *Current Opinion in Neurobiology, 6*, 851-857.
- James, W. (1890/1950). *The principles psychology*. (Vol.1). New York: Dover.
- Johnston, J. C., & Delgado, D. (1993, November). *Bypassing the single-channel bottleneck in dual-task performance*. Paper presented at the 34th annual meeting of the Psychonomic Society.
- Kahneman, D. (1973). *Attention and effort*. Englewood Cliffs, NJ: Prentice-Hall.

- Kamp, J. F., Martin-Lamettet, C., Frozy, J. F., & Causeur, D. (2001). HMI aspects of the usability of internet services with an in-car terminal on a driving simulator. *IATSS Research*, 25 (2), 29-39.
- Keppel, G., & Underwood, B. J. (1962). Proactive inhibition in short-term retention of single items. *Journal of Verbal Learning and Verbal Behaviour*, 1, 153-161.
- Kenney, R., Hettinger, L., & Lilienthal, M. (1988) Simulator Sickness. In Boca Raton (Ed.), *Motion and space sickness*, (pp. 317-341), Florida: CRC Press.
- Killeen, P. R., & Weiss, N. A. (1987). Optimal timing and the Weber function. *Psychology Review*, 94, 455-468.
- Killeen, P. R., & Taylor, T. J. (2000). How the propagation of error through stochastic counters affects time discrimination and other psychophysical judgments. *Psychology Review*, 107, 430- 459.
- Kim, J. J., & Diamond, D. M. (2002). The stressed hippocampus, synaptic plasticity and lost memories. *Nature Reviews Neuroscience*, 3, 453-462.
- King, A. J., & Palmer, A. R. (1985). Integration of visual and auditory information in bimodal neurones in the guinea-pig superior colliculus. *Experimental Brain Research*, 60, 492-500.
- Kinsbourne, M. (1981). Single channel theory. In D. Holding (Ed.), *Human Skills* (pp. 65-89). Chichester, UK: Wiley.

- Krasnov, I. B. (1994). Gravitational neuromorphology. *Advances in Space Biology and Medicine*, 4, 85-110.
- Kuhmann, W., Boucsein, M., Schaefer F., & Alexander J. (1987). Experimental investigation of psychological stress-reactions induced by different system response times in human computer interaction. *Ergonomics*, 30 (6), 933-943.
- Kuhmann, W. (1989). Experimental investigation of stress-inducing properties of system response times. *Ergonomics*, 32 (3), 271-280
- Kohlisch, O., & Kuhmann, W. (1997). System response time and readiness for task execution - the optimum duration of inter-task delays. *Ergonomics*, 40 (3), 265-280.
- Landsdown, T. C., Brook-Carter, N., & Kersloot, T. (2004). Distraction from multiple in-vehicle secondary tasks: Vehicle performance and mental workload implications. *Ergonomics*, 47 (1), 91-104.
- Lee, D. N. (1976). A theory of visual control of braking based on information about time of collision. *Perception*, 5, 437-45.
- LeDoux, J. E. (1995). Emotion: Clues from the brain. *Annual Review of Psychology*, 46, 209-235.
- Lennings, C. J., & Burns, A. M. (1998). Time perspective: Temporal extension, Time estimation and impulsivity. *The Journal of Psychology*, 132 (4), 367-380.

- Lockhart, R. S. (2000). Methods of memory research. In E. Tulving & F. I. M. Craik (Eds.), *The Oxford handbook of memory* (pp. 45-58). New York: Oxford University Press.
- Macar, F. (1985). Time psychophysics and related models. In J. A. Michon & J. L. Jackson (Eds.), *Time, mind, brain and behavior* (pp. 112-130). Berlin: Springer-Verlag.
- Mackworth, N. H. (1950). *Researches on the measurement of human performance*. Medical Research Council Special Report 268, London: HMSO.
- Madison, G., & Merker, B. (2000). *On the limits of asynchrony in pulse attribution*. Manuscript submitted for publication.
- Madler, C., & Pöppel, E. (1987). Auditory evoked potentials indicate the loss of neuronal oscillations during general anaesthesia. *Naturwissenschaften*, *74*, 42-43.
- Mangels, A. J., Ivry, R. B., & Shimizu, N., (1998). Dissociable contributions of The prefrontal and neocerebellar cortex to time perception. *Cognitive Brain Research*, *7*, 15-39.
- Martin, G. L., & Corl, K. G. (1986). System response time effects on user productivity. *Behavior & Information Technology*, *5* (1), 3-13.
- Matell, M. S., & Meck, W. H. (2000). Neuropsychological mechanisms of interval timing behaviour. *Bioessays*, *22*, 94-103.
- Meck, W. H., Church, R. C., & Olton, D. S. (1984). Hippocampus, time and memory. *Behavioural Neuroscience*, *98*, 3-22.

- Meck, W. H. (1996). Neuropharmacology of timing and time perception. *Cognitive Brain Research, 3*, 227-242.
- Meiran, N., Hommel, B., Bibi, U., & Lev, I. (2002). Consciousness and control in task switching. *Consciousness & Cognition, 11*, 10-33.
- Meuter, R. F. I., & Allport, A. (1999). Bilingual language switching in naming: Asymmetrical costs of language selection. *Journal of Memory and Language, 40* (1), 25-40.
- Meyer, D. E., & Kieras, D. E. (1997). A computational theory of executive cognitive processes and multiple-task performance: Part 2. Accounts of psychological refractory-period phenomena. *Psychological Review, 104*, 749-791.
- Miller, G. A. (1956). The magical number seven, plus or minus two: Some limits on our capacity for processing information. *Psychological Review, 63*, 81-97.
- Mollenhauer, M. A., Romano, R. A., & Brumm, B. (2004). *The Evaluation of a motion base driving simulator in a CAVE at TACOM*, 24th Army Science Conference, Orlando, Florida.
- Mollon, J. D., & Perkins, A. J. (1996). Errors of judgement at Greenwich in 1796. *Nature, 380*, 101-102.
- Morein-Zamir, S., Soto-Faraco, S., & Kingstone, A. (2003). Auditory capture of vision: Examining temporal ventriloquism. *Cognitive Brain Research, 17* (1), 154-163.

- Murdock, B. B. (1965). Effects of a subsidiary task on short-term memory. *British Journal of Psychology*, *56*, 413-419.
- Nakayama, K., & Mackeben, M. (1989). Sustained and transient components of focal visual attention. *Vision Research*, *29*, 1631-1647.
- Navon, D., & Miller, J. (1987). Role of outcome conflict in dual-task interference. *Journal of Experimental Psychology: Human Perception and Performance*, *13*, 435-448.
- Nelson, K. (1996). *Language in cognitive development: The emergence of the mediated mind*. United States of America: Cambridge University Press.
- Nichelli, P., Always, D., & Grafman, J., (1996). Perceptual timing in cerebellar degeneration. *Neuropsychologia* *34*, 863–871.
- Noel, E., Nonnecke, B., & Trick, L. (2005). *Evaluating first-time and infrequent use of in-car navigation devices*. Retrieved September 14, 2006, from http://ppc.uiowa.edu/drivingassessment/2005/final_papers/55_noelformat.pdf.
- Norman, D. A., & Bobrow, D. G. (1975). On data-limited and resource limited processes, *Cognitive Psychology*, *7*, 44-64.
- Norman, D. A. (1976). *Memory and attention*, 2nd Ed, Chichester: John Wiley.
- Noy, Y. I. Y., Lemoine, T. L., Klachan, C., & Burns, P., C. (2004). The occlusion technique. *Applied Ergonomics*, *35* (3), 207-213.

- Ornstein, R. E. (1969). *On the experience of time*. Middlesex, England: Penguin.
- Oxenham, A. J., & Moore, B. C. J. (1995). Overshoot and the "severe departure" from Weber's law. *Journal of Acoustics & Sociology* 97, 2442-2453.
- Pashler, H. (1984). Processing stages in overlapping tasks: Evidence for a central bottleneck. *Journal of Experimental Psychology. Human Perception & Performance*, 10, 358-377.
- Pashler, H. (1993). Doing two tasks at the same time. *American Scientist*, 81, 46-55.
- Penrose, R. (1994). *Shadows of the mind* (pp. 377-391). Oxford.
- Peterson, L. R., & Peterson, M. J. (1959). Short-term retention of individual verbal items. *Journal of Experimental Psychology*, 58, 193-198.
- Pöppel, E. (1971). Oscillations as possible basis for time perception. *Studies General (Berl)*, 24, 85-107.
- Pöppel, E., & Logothetis, N. (1986). Neural oscillations in the brain. Discontinuous initiations of pursuit eye movements indicate a 30-Hz temporal framework for visual information processing. *Naturwissenschaften*, 73, 267-268.
- Pöppel, E. (1988). *Mindworks: Time and conscious experience*. San Diego: Harcourt Brace Jovanovich.

- Pöppel, E. (1997). A hierarchical model of temporal perception. *Trends in Cognitive Science*, 1 (2), 56-61.
- Poynter, W. D., & Homa, D. (1983). Duration judgement and the experience of change. *Perception & Psychophysics*, 33, 548-560.
- Pratap, R. (1999). *Getting started with MATLAB 5: A quick introduction for scientists and engineers*. Oxford: Oxford University Press.
- Reason, J. T., & Brand, J. J. (1975). *Motion sickness*. London: Academic Press.
- Regan, E. C. (1993). *Side-effects of immersion virtual reality*. Paper presented at the International Applied Military Psychology Symposium, July 26-29.
- Rensink, R. A., & Enns, J. T. (1995). Pre-emption effects in visual search: Evidence for low-level grouping. *Psychological Review*, 102, 101-130.
- Riccio, G. E., & Stoffregen, T. A. (1991). An ecological theory of motion sickness and postural instability. *Ecological Psychology*, 3 (3), 195-237.
- Rizzo, M. (2004). *Establishing a worldwide driving simulator scenario library*. Retrieved July 14, 2006, from [http://www.uiowa.edu/~neuroerg/Simulator %20Users%20 Group/Rizzo.HFES04.sim.lib.ppt](http://www.uiowa.edu/~neuroerg/Simulator%20Users%20Group/Rizzo.HFES04.sim.lib.ppt).
- Rubinstein, J. S., Meyer, D. E., & Evans, J. E. (2001). Executive control of cognitive processes in task switching. *Journal of Experimental Psychology: Human Perception and Performance*, 27, 763-797.

- Ruthruff, E., Johnston, J. C., & Selst, M. V. (2001). Why Practice Reduces Dual-Task Interference. *Journal of Experimental Psychology: Human Perception and Performance*, 27 (1), 3-21.
- Rodriguez-Girones, M. A., & Kacelnik, A. (1995). Interval bisection with and without reference memory. In M. Richelle, V. DeKeyser, G. d'Ydewalle & A. Vandierendonck (Eds.), *Time and the dynamic control of behaviour* (pp. 47–72). Liège: Université de Liège P.A.I.
- Roeckelein, J. E. (2000). *The concept of time in psychology: A resource book and annotated bibliography*. Westport, CT: Greenwood Press.
- Rogers, R., & Monsell, S. (1995). The costs of a predictable switch between simple cognitive tasks. *Journal of Experimental Psychology: General*, 124, 207-231.
- Schleidt, M., Eibl-Eibesfeldt, I., Pöppel, E. (1987). A universal constant in temporal segmentation of human short-term behaviour. *Naturwissenschaften*, 74, 289-290.
- Schleidt, M., & J. Kien. (1997). Segmentation in behavior and what it can tell us about brain function. *Human Nature*, 8, 77–111.
- Schwender, D., Madler, C., Klasing, S., Peter, K., & Pöppel, E. (1994). Anesthetic control of 40-Hz brain activity and implicit memory. *Conscious Cognition*, 3, 29-147.
- Shiffrin, R. M., & Schneider, W. (1977). Controlled and automatic human information processing: II Perceptual learning, automatic attending and a general theory. *Psychological Review*, 84, 127-90.

- Sorli, A., & Sorli, I. (2004a). A-temporal gravitation. *Electronic Journal of Theoretical Physics*, 2, 1-3.
- Sorli, A., & Sorli, I. (2004b). Mathematical time and the physical time in the theory of relativity. *Electronic Journal of Theoretical Physics*, 4, 25-27.
- Spelke, E., Hirst, W., & Neisser, U. (1976). Skills of divided attention. *Cognition*, 4, 215-230.
- Spence, C., Shore, D. I., & Klein, R. M. (2001). Multisensory prior entry. *Journal of Experimental Psychology: General*, 130, 799-832.
- Sperling, G. (1960). The information available in brief visual presentations. *Psychological Monographs: General and Applied*, 498, 1-29.
- Staddon, J. E. R. (2005). Interval timing: memory, not a clock. *Trends in Cognitive Sciences*, 9 (7), 312-314.
- Standing, L., Conezio, J., & Haber, R. N. (1970). Perception and memory for pictures: Single trail learning of 2500 visual stimuli. *Psychonomic Science*, 19, 73-74.
- Sternberg, R. J. (2003). *Cognitive psychology*, 3rd (pp. 180-206). Wadsworth: Thomson.
- Stone, J. V., Hunkin, N. M., Porrill, J., Wood, R., Keeler, V., Beanland, M., Port, M., & Porter, N. R. (2001). When is now? *Perception of simultaneity. Proc. R. Soc. London. B. Biological Science*, 268, 31-38.
- Strokes, A. F., & Kite, K. (1994). *Flight stress: Stress, fatigue and performance in aviation*. Brookfield, Vermont: Ashgate.

- Styles, E. A. (1997). *The psychology of attention*. Hove, UK: Psychology Press.
- Sugita, Y., & Suzuki, Y. (2003). Audiovisual perception: Implicit estimation of sound-arrival time. *Nature*, *421*, 911.
- Tallal, P., S. Miller, & Fitch, R. (1993). Neurobiological basis of speech: A case for the preeminence of temporal processing. In P. Tallal, A. Galaburda, R. Llinas & C. von Euler (Eds.), *Temporal Information Processing in the Nervous System. Special Reference to Dyslexia and Dysphasia* (pp. 27-47). New York: The New York Academy of Sciences.
- Thiel, T. (2007) "You have reached your destination!" Position, positioning and superpositioning of space through car navigation systems. *Social Geography*, *2*, 63-75.
- Thomas, E. A. C., & Brown, I. Jr. (1974). Time perception and the filled duration illusion. *Perception & Psychophysics*, *16*, 363-367.
- Thomas, E. A. C., & Weaver, W. B. (1975). Cognitive processing and time perception. *Perception & Psychophysics*, *17*, 363-367.
- Thomas, E. A. C., & Cantor, N. E. (1978). Interdependence between the processing of temporal and non-temporal information. In J. Requin (Ed.), *Attention and performance* (Vol.7, pp. 43-62). Hillsdale, NJ: Erlbaum.
- Tipler, F. J., & Barrow, J. D. (1986). *The anthropic cosmological principle*. Oxford, England: Clarendon Press.

- Treisman, M. (1963). Temporal discrimination and the indifference interval: Implications for a model of the "internal clock." *Psychological Monographs*, 77, 1-31.
- Triesman, A. (1964). Verbal cues, language and meaning in attention. *American Journal of Psychology*, 77, 206-14.
- Treisman, A., & Davies, A. (1973). Dividing attention to ear and eye. In S. Kornblum (Ed.), *Attention and performance*. (Vol.4, pp.101-117). New York: Academic Press.
- Treisman, M. (1999). The perception of time. In: J. Butterfield (Ed.), *The arguments of time* (pp. 217-246). Oxford: Oxford University Press.
- Tsimhoni, O., & Green, P. (2001). *Visual demand of driving and the execution of display-intensive in vehicle tasks*. Paper presented at the 45th annual meeting of the human factors and ergonomics society, Michigan.
- Tulving, E. (1972). Episodic and semantic memory. In E. Tulving & W. Donaldson (Eds.), *Organization of memory*. New York: Academic Press.
- Vanneste, S., & Pouthas, V. (1995). Estimation temporelle prospective et retrospective chez la personne agee: Comparaison avec le jeune adulte [Prospective and retrospective time estimation in elderly people: Comparison with young adults]. *Bulletin de Psychologie*, 48, 539-543.
- Wearden, J. H. (1992). Temporal generalisation in humans. *Journal of Experimental Psychology: Animal Behavior Processes*, 18, 134-144.

- Wearden, J. H., Wearden, A. J., & Rabbitt, P. (1997). Age and IQ effects on stimulus and response timing. *Journal of Experimental Psychology: Human Perception & Performance*, *23*, 962-979.
- Wearden, J. H., & Culpin, V. (1998). Exploring scalar timing theory with human subjects. In V. DeKeyser, G. d'Ydewalle, & A. Vandierendonck (Eds.), *Time and the dynamic control of behaviour* (pp. 33-49). Gottingen: Hogrefe & Huber.
- Wearden, J. H., & Bray, S. (2001). Scalar timing without reference memory? Episodic temporal generalisation and bisection in humans. *The Quarterly Journal of Experimental Psychology*, *54B* (4), 289-309.
- Wearden, J. H. (2003). Applying the scalar timing model to human time psychology: progress and challenges. In: Helfrich, H. (Ed.), *Time and Mind II: Information-processing perspectives* (pp. 21-39). Cambridge, MA: Hogrefe & Huber.
- Wertheimer, M. (1958). Principles of perceptual organization (Abridged trans. by M. Wertheimer). In D. S. Beardslee & M. Wertheimer (Eds.), *Readings in perception* (pp. 115-137). New York: Van Nostrand. (Reprinted from *Psychologische Forschung*, 1923, *4*, 301- 350.)
- Wilsoncroft, W. E., & Stone, J. D. (1976). Temporal estimates as a function of difficulty of mental arithmetic. *Perceptual & Motor Skills*, *46*, 1311-1317.
- Wing, A. M., & Kristofferson, A. B. (1973). Response delays and the timing of discrete motor responses. *Perception & Psychophysics*, *14*, 3-12.

Woodrow, H. (1951). Time perception. In S. S. Stevens (Ed.), *Handbook of experimental psychology* (pp. 1224-1236). New York: Wiley.

Woodworth, R. S., & Schlosberg, H. (1954). *Experimental psychology*. New York: Holt.

Wundt, W. (1911). *Introduction into psychology*. Leipzig: Voigtländer.

APPENDIX A - List of symbols



--	--	--	--

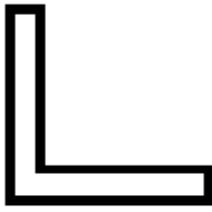

--	--	--	--



--	--	--	--

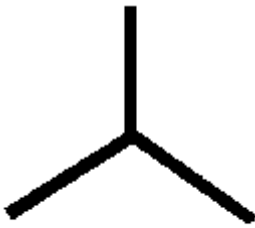

--	--	--	--

1.1. APPENDIX B - Questionnaire

Waiting period for	Too short (1)	Convenient length (2)	Too long (3)
Task completion			
Drive performance			

Subjective state	Low (1)	Medium (2)	High (3)
Stress			
Boredom			

APPENDIX C – Information and Consent Form

Thank you for being prepared to participate.

My name is Tanja Bauer and I am a postgraduate student undertaking research for degree purposes. I would like you to take part in two experiments. The resulting data will be treated confidentially and full anonymity is insured. It will only be used for research purposes.

The study as will be explained by me before you begin, involves two separate experiments. In the first experiment you will be ask to reproduce a previously given time span. The second experiment will take place in the driving simulator. It is possible that the driving simulator will induce vertigo, a feeling of dizziness. Should this be the case please inform me, so we can stop the test. If you are willing to participate please sign below that you voluntarily give your consent to participate in these experiments. If you are not willing to participate please feel free to leave and stop the experiment at any time.

In return for participating in the study I will offer you personalised results from the study that could help you better understand the way in-vehicle devices influence your driving. If you do wish to receive results please fill in your e-mail address on the space provided below. If you have any questions feel free to ask me now or contact me later at:

tanja_x_x@yahoo.com

INFORMED CONSENT

If you are participating in the research sign in the space provided below:

I am voluntarily participating in this research and fully understand that the results will be kept anonymous and confidential, will be used for research purpose only, and will not be made available to any third party.

Do you wish to receive personal feedback (Please make a bold tick)

Yes	<input type="checkbox"/>
No	<input type="checkbox"/>

Email address:
