

THE BIOSYNTHESIS OF BILE ACIDS

BY

Iain Walter Percy-Robb, M.B., Ch.B

A thesis submitted for the degree of Doctor of Philosophy

University of Edinburgh, 1967

SUMMARY



Cholesterol, along with a number of its derivatives and very small quantities of its precursors, is the only sterol which can be identified in extracts of mammalian tissue. Cholesterol is eliminated from the body in the form of bile acids, the degradation products of the steroid hormones and by way of excretion of neutral sterols in the faeces. The formation of the bile acids is the major quantitative pathway.

In the rat, the major bile acids which have been identified in bile are the dihydroxy acid, chenodeoxycholic acid and the trihydroxy acid, cholic acid. Small quantities of the muricholic acids (trihydroxy acids) have also been identified. There is no interconversion of chenodeoxycholic acid and cholic acid in the rat. The bile acids are excreted in bile as conjugates, mainly with taurine and are reabsorbed from the small intestine and returned to the liver in the portal blood. The re-excretion of the bile acid conjugates in bile thus establishes an enterohepatic circulation. The total biliary content of bile acid conjugates represents both those conjugates which have been reabsorbed from the small intestine and a small quantity which have been newly synthesised. Thus direct measurement of the concentration of bile acid conjugates does not provide an estimate of the bile acid synthesis rates.

Methods for measurement of bile acid synthesis rates have involved the use of radioactive preparations of bile acids; depending either on measurement of the rate of excretion of faecal

radioactivity or on the rate of decay of the specific activity of the intestinal bile acid pool. These methods are therefore indirect, and a more direct method of study was required.

All mammalian tissues containing nucleated cells have the capacity for cholesterol synthesis and there is equilibrium between plasma cholesterol and tissue cholesterol at rates which vary from tissue to tissue. Therefore, the study of plasma/liver cholesterol equilibria in vivo is extremely complex.

The liver perfusion technique was thought to be a possible approach to the study of bile acid synthesis rates in a situation which was isolated from the intestinal bile acid pool. Liver perfusion was also thought to provide an approach to the study of plasma/liver cholesterol equilibria.

Studies on the liver perfusion technique indicated that, where a 4 hr. perfusion period was desirable, the perfusate of choice was pooled, heparinised rat blood. Livers perfused thus showed a number of well maintained biochemical functions and demonstrated normal histology both by light and electron microscopy. The isolated perfused liver was shown to synthesise bile acids throughout a 4 hr. perfusion period and these acids were identified to be chenodeoxycholic and cholic acids. They were excreted in a ratio which was similar to that seen in bile fistula rats.

The formation of a bile fistula in the rat has been shown to be a potent stimulus to bile acid synthesis and this large increase in the synthesis rate of both chenodeoxycholic and cholic acids was confirmed in the isolated liver preparation. [¹⁴C]-cholesterol in the form of cholesterol bearing plasma lipoprotein was found to act as precursor for bile acids at an increased rate in livers

from bile fistula rats. The addition of [2. ¹⁴C]-DL-mevalonic acid to the perfusate was shown to produce labelling of the liver cholesterol and in this case the labelled cholesterol also acted as substrate for bile acid synthesis at an increased rate.

The effects of hypothyroidism and mild hyperthyroidism on bile acid synthesis were studied in the perfused liver. A possible increase in the rate was seen in the livers from hyperthyroid rats but the numbers of perfusions were small. The specific activities of the excreted bile acids suggested that one effect of thyroid hormone was to alter the rates of equilibrium between the various cholesterol pools in the liver and plasma. Livers were perfused from cholesterol fed rats and increased bile acid excretion rates were found.

The effects of thyroid status, cholesterol feeding and starvation on the pattern of bile acid excretion in fistula rats were studied. Hypothyroidism inhibited the response to a marked degree while starvation produced some reduction in the maximum rate of synthesis. Cholesterol feeding produced an accelerated response.

Using direct measurements of bile acid synthesis it has been confirmed that the major rate controlling factor is the feedback mechanism which exists from the enterohepatic circulation of bile acids and while other factors may play a role it would appear that it is a minor one. It is possible that bile acids act in the hepatic parenchymal cell as inhibitors of synthesis

of the rate limiting enzyme in the bile acid biosynthetic pathway. Cholesterol feeding appears to stimulate bile acid synthesis and it is suggested that this may be associated with the formation of some form of mixed micelle within the liver cell which renders the bile acid molecules unavailable for inhibition of the rate limiting step. The marked inhibition of the increased rate of bile acid synthesis following biliary drainage in the hypothyroid rat is in keeping with inhibition of the synthesis of the enzyme concerned with bile acid biosynthesis.

INDEX

	Page
INTRODUCTION	1
Reasons for commencing studies reported	14
METHODS	
1. Method for extraction, purification and estimation of biliary bile acids.	
1.1 Description of method.	16
1.2 Precision and recovery data.	18
2. Thin-layer chromatography of bile acids.	18
3. Estimation of radioactivity in bile acids and cholesterol	19
4. Estimation of perfusate plasma total cholesterol concentration	21
5. Estimation of perfusate plasma glucose concentration	21
6. Estimation of perfusate plasma urea concentration	22
7. Estimation of plasma sodium, potassium, chloride and bicarbonate concentrations.	22
8. Estimation of plasma pH and haemoglobin oxygen saturation.	23
9. Estimation of bromsulphthalein concentration.	23
10. Measurement of liver microsomal CO-binding pigment.	23
THE PRINCIPLES OF THE METHOD FOR ISOLATED PERFUSION OF RAT LIVER	
1. Introduction	25
2. The perfusion method	
2.1 Selection of perfusion conditions	26
2.2 Selection of perfusate	33
2.3 Modification of perfusion apparatus and techniques	36
2.4 Portal vein perfusion pressure	38
2.5 Blood flow arrest during portal vein cannulation	39
3. Description of the metabolic environment maintained in liver perfusions.	
3.1 Measurement of haemolysis rate in the perfusate	40
3.2 Measurement of perfusate haematocrit	40
3.3 Perfusate sodium and potassium concentrations	41
3.4 Measurement of the perfusate pH	41
3.5 Perfusate total CO ₂ levels	41
3.6 Perfusate haemoglobin oxygen saturation	42
3.7 Measurement of perfusate flow rates	42
3.8 Measurement of perfusate volume	43

	Page
4. The metabolic status of the isolated perfused rat liver.	
4.1 Bile flow rates	43
4.2 Perfusate glucose concentration	44
4.3 Excretion of sulphobromophthalein	44
4.4 Perfusate urea concentration	45
 STUDIES ON CHOLESTEROL AND BILE ACID METABOLISM IN THE ISOLATED PERFUSED RAT LIVER	
1. Introduction	46
2. Studies using rat blood and Rheomacrodex as liver perfusate.	
2.1 Perfusion of livers from normal rats. (addition of [¹⁴ C]-cholesterol)	46
2.2 Perfusion of livers from rats subjected to 44 hr. biliary drainage. (addition of [¹⁴ C]-cholesterol)	50
2.3 Perfusion of livers from rats subjected to 44 hr. biliary drainage. (addition of [2- ¹⁴ C]-DL-mevalonic acid)	52
3. Studies using heparinised, whole rat blood as liver perfusate.	
3.1 Perfusion of livers from normal rats and from rats subjected to 44 hr. biliary drainage. (addition of [2- ¹⁴ C]-DL-mevalonic acid).	55
3.2 Perfusion of livers from normal rats and from rats subjected to 44 hr. biliary drainage. (addition of [¹⁴ C]-cholesterol).	58
3.3 Perfusion of livers from thyroidectomised and from sham thyroidectomised rats. (addition of [2- ¹⁴ C]-DL- mevalonic acid)	60
3.4 Perfusion of livers from normal rats and from rats injected with triiodothyronine. (addition of [2- ¹⁴ C]- DL-mevalonic acid).	62
3.5 Perfusion of livers from normal rats and from rats fed 0.5% dietary cholesterol supplement. (addition of [2- ¹⁴ C]-DL-mevalonic acid).	64
 STUDIES ON THE BILIARY BILE ACID EXCRETION IN RATS WITH CHRONIC BILE DUCT FISTULAE	
1. Introduction	66
2. Operative techniques	66
3. General metabolic studies on bile fistula rats	68

	Page
4. Studies on the total bile acid excretion rate in the bile fistula rat.	
4.1 Introduction	70
4.2 Surgical thyroidectomised animals, and sham thyroidectomised animals	72
4.3 Animals rendered hypothyroid by feeding 0.5% propylthiouracil in the diet, and control animals	74
4.4 Animals fed 0.5% cholesterol in the diet, and control animals	76
4.5 Animals rendered hyperthyroid by the intraperitoneal injection of 50 μ g. of triiodothyronine daily and control animals	77
4.6 Animals starved for 20 hr. prior to the insertion of the bile duct cannula and throughout the period of biliary drainage and control animals	78
5. The ratio of the excretion rate of cholic acid to chenodeoxycholic acid in the bile fistula studies described above.	
6. Microsomal CO-binding pigment in liver microsomes of bile fistula rats.	

DISCUSSION

The liver perfusion technique	81
Studies on cholesterol and bile acid metabolism in the isolated perfused rat liver	98
Studies on bile acid excretion in bile fistula rats	114

APPENDIX

1. Experiments to study steps in the bile acid extraction and analysis procedure.	
1.1 Hydrolysate extraction period	123
1.2 Liquid:liquid partition system	124
1.3 The modified Pettenkofer reaction	126
1.4 Confirmation of partition column system separation of bile acids	127
1.5 Bile acid extinction values	129

	Page
2. Purification and preparation of laboratory reagents	130
2.1 Celite	
2.2 Benzene	
2.3 Petroleum ether	
2.4 Sulphuric acid	
2.5 Furfural	
2.6 Ethanol	
2.7 Toluene	
2.8 Acetic acid	
2.9 Chloroform	
2.10 Silica gel	
2.11 Scintillation phosphors	
3. Bile acid reference compounds	131
4. Animals	131
5. Diet	131
6. Estimation of bile flow rates	132
7. Estimation of rat heart rates	132
8. Blood haematocrit estimation	133
9. [2- ¹⁴ C]-DL-mevalonic acid lactone	133
10. Perfusion of a liver from a thyroidectomised rat	133
11. Statistical analysis of data	134
12. Method of estimation of CO-binding pigment	134
ACKNOWLEDGEMENTS	135
BIBLIOGRAPHY	136
PUBLICATIONS BASED ON WORK DESCRIBED HERE	

INTRODUCTION

The major pathways for the elimination of cholesterol from the body are degradation to form the bile acids and excretion of neutral sterols in faeces. The conversion of cholesterol to form the steroid hormones is of little quantitative importance (Siperstein and Chaikoff 1952).

Cholesterol belongs to a group of secondary alcohols of plant and animal origin which have a common characteristic in that they are crystalline solids. For this reason they are termed the sterols or solid alcohols. Cholesterol, along with a number of its derivatives and very small quantities of its biological precursors, is the only sterol which can be identified when extracts of mammalian tissue are made with lipid solvents. The structure of cholesterol is shown in Fig.1. Rings A, B, C and D comprise a hydrogenated cyclopentenophenanthrene system to which are joined two angular methyl groups at C₁₀ and C₁₃. An eight carbon side chain is attached at C₁₇. There is a double bond between C₅ and C₆ and the secondary hydroxyl group is at C₃. It is conventional to consider the angular methyl substituent as projecting to the front of the molecule and to term this type of orientation as β orientation. Both angular methyl groups and the side chain are β oriented and this is represented by full-line bonds. The C₃ hydroxyl group and the C₈ hydrogen are also β oriented while the hydrogens at C₉ and C₁₄ are both α oriented (behind the plane of the molecule). Thus the fusion of rings B and C, C and D is trans in each case. Compounds with this conformation in the ring structure belong to the so-called 5 α -cholestane series when the fusion of rings A and B is trans, while modification to cis linkage produces the 5 β -cholestane

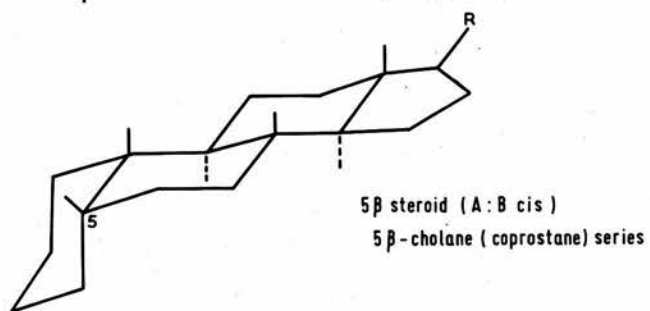
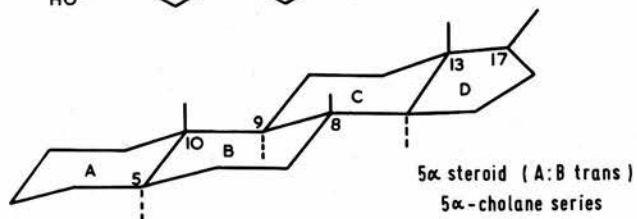
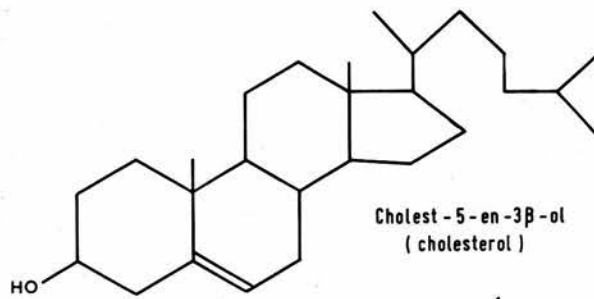

The structure of cholesterol and the conformation of the 5 α - and the 5 β -steroid ring system

Fig. 1

(coprostane) series in which group the majority of the naturally occurring bile acids are found.

Rings A, B and C each consist of a cyclohexane ring which can have two possible conformations - "chair" and "boat". The chair conformation is the more stable of the two, since non-bonded H:H interactions contribute to an extent which increases exponentially with increasing proximity, and in the "chair" conformation this interaction is reduced to a minimum. In cholesterol, rings B and C are locked in the "chair" form through their trans fusions to rings A and D. Ring A also assumes the "chair" form since the "boat" form would produce strong interaction between the hydroxyl group at C₃ and the methyl group at C₁₀ which is minimised when the chair form is assumed.

A possible relationship between cholesterol and bile acids was first suspected by Windaus (1908); and demonstrated when cholanic acid (5 β -cholan-24-oic acid) was produced after oxidation of coprostane which could in turn be prepared from cholesterol (Windaus 1919). Subsequent studies have confirmed the relationship between the structure of cholesterol and the various bile acids found in the bile of different mammalian species (Haslewood 1966).

The direct in vivo conversion of cholesterol to bile acids was first conclusively demonstrated in the dog. Bloch et al (1943) injected deuterium labelled cholesterol into a dog with a cholecystnephrostomy and subsequently recovered deuterium labelled bile acids in the urine with similar specific activity

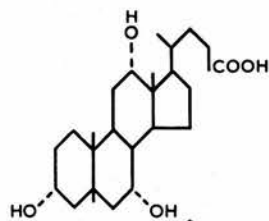

3 α ,7 α ,12 α -trihydroxy-5 β -cholan-24-oic acid
(cholic acid)

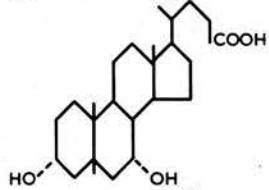

3 α ,7 α -dihydroxy-5 β -cholan-24-oic acid
(chenodeoxycholic acid)

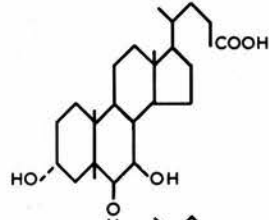

3 α ,6 β ,7 β -trihydroxy-5 β -cholan-24-oic acid
(β -muricholic acid)

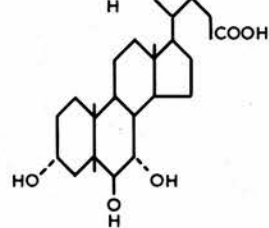

3 α ,6 β ,7 α -trihydroxy-5 β -cholan-24-oic acid
(α -muricholic acid)

Bile acids identified in rat bile

to the blood or biliary cholesterol. This was followed by the demonstration of the conversion of tritium labelled cholesterol to cholic acid in the rat (Byers and Biggs 1952). When [26. ^{14}C]-cholesterol was injected into rats the isotope was excreted rapidly in the form of carbon dioxide, while [4. ^{14}C]-cholesterol injection was followed by excretion of labelled biliary bile acids only (Siperstein and Chaikoff 1952). Thus the conversion of cholesterol to bile acids involved the removal of the terminal carbon atoms of the cholesterol side chain and at least part of the ring structure in cholesterol remained intact.

A number of bile acids have been identified in rat bile (Fig.2). Cholic acid and chenodeoxycholic acid are the major bile acids, being conjugated mainly with taurine. They are present in normal bile approximately in the proportion 4:1. (Bergström and Sjövall 1954). The conversion of [4. ^{14}C]-cholesterol to radioactive cholic acid and chenodeoxycholic acid has been demonstrated by Bergström and Norman (1953). Bergström and Sjövall (1954) studied the metabolism of chenodeoxycholic acid and concluded that it was not converted into cholic acid. Thus the biosynthesis of cholic acid appeared to require some obligatory order and did not involve the random, progressive hydroxylation of the cholesterol molecule. The lack of interconversion between chenodeoxycholic acid and cholic acid was confirmed by Mahowald et al (1957) who observed the conversion of chenodeoxycholate to two acids similar to cholic

acid but not to cholic acid itself. Approximately 55% of the chenodeoxycholic acid was excreted unmodified while 15% was incorporated into β -muricholic acid (3α , 6β , 7β -trihydroxy- 5β -cholan-24-oic acid) and 20% into α -muricholic acid (3α , 6β , 7α -trihydroxy- 5β -cholan-24-oic acid) (Hsia et al 1960). A small quantity of the radioactivity was also recovered in the bile as ursodeoxycholic acid (Mahowald et al 1958). Cholic acid was shown to be unaltered (Bergström and Sjövall 1954) except that it was rapidly converted into taurocholic acid which is the major conjugate of all biliary bile acids in the rat (Norman 1954). Lithocholic acid (3α -hydroxy- 5β -cholan-24-oic acid) was identified as a minor product following the injection of [4 . 14 C]- cholesterol in the rat (Siperstein et al 1954), and when this bile acid was injected into bile fistula rats it was extensively transformed into several compounds none of which was identical with cholic acid (Bergström et al 1953). This suggested that lithocholic acid was unlikely to be an intermediate in cholic acid synthesis. While deoxycholic acid (3α , 12α -dihydroxy- 5β -cholan-24-oic acid) is found in human bile it is actively hydroxylated at position 7 and does not represent a major bile acid in the rat (Bergström et al 1953).

The conversion of cholesterol into bile acids may be divided into two major groups of reactions - those involved in cleavage of the cholesterol side chain and those involved in the transformation of the ring structure. The metabolism of cholesterol in vitro in preparations of mouse liver

mitochondria has been shown to produce 26-hydroxy cholesterol (Frederikson and Ono 1956, Danielsson 1960) and when $3\alpha, 7\alpha, 12\alpha$ -trihydroxy- 5β -cholestane was similarly incubated with liver mitochondria a number of acidic products was formed, the major one of which was identified as $3\alpha, 7\alpha, 12\alpha$ -trihydroxy- 5β -cholestane-26-oic acid (Danielsson 1960). This compound has been shown to be converted into cholic acid in vivo (Bridgewater and Lindstedt 1957). It seems likely that the cleavage of the cholesterol side chain involves hydroxylation, followed by oxidation, of the terminal methyl group and that the resulting carboxylic acid is then oxidised, thus forming propionic acid and the bile acid (Suld et al 1961, Mitropoulos and Myant 1965). These events have been demonstrated in the liver mitochondrial fraction.

The changes in the ring structure of the cholesterol molecule precede the oxidation of the side chain since both $3\alpha, 7\alpha, 12\alpha$ -trihydroxy- 5β -cholestane and $3\alpha, 7\alpha$ -dihydroxy- 5β -cholestane are converted into cholic acid (Bergström and Lindstedt 1956) while 3β -hydroxy, Δ^5 cholane-24-oic acid is not (Bergström 1955). It has also been shown that of a number of saturated and unsaturated mono-oxygenated sterols with either a hydroxyl or a keto group at C_3 , cholesterol was the only compound which gave rise to cholic acid (Harold et al 1955 and 1957). Therefore the inversion of the 3β -hydroxyl group and saturation of the $C_5 - C_6$ double bond must occur after hydroxylation at C_7 and/or C_{12} . Since both 7α -hydroxy cholesterol and $3\alpha,$

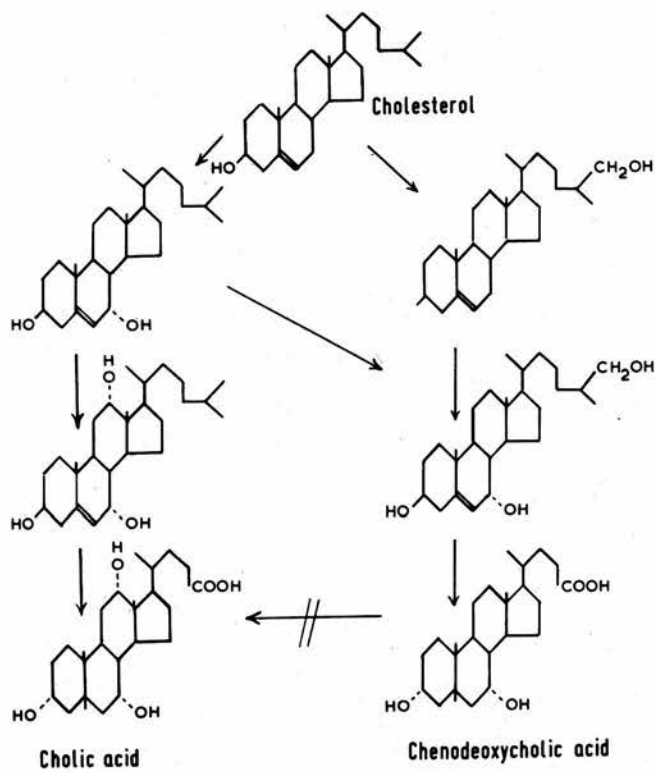

Proposed scheme for conversion of cholesterol to cholic acid and chenodeoxycholic acid in the rat

Fig. 3

7 α -dihydroxy-5 β -cholestane were converted into both chenodeoxycholic and cholic acids (Bergstrom and Lindstedt 1956, Lindstedt 1957), hydroxylation at C₁₂ can occur after saturation of the C₅ - C₆ double bond and inversion of the 3 β -hydroxyl group. On the other hand 3 α , 7 α -dihydroxy-5 β -cholestan-26-oic acid was converted into chenodeoxycholic acid and not into cholic acid, and when 26-hydroxy cholesterol was injected into the bile fistula rat chenodeoxycholic acid and its 6 β -hydroxy metabolites were the main products (Bersesus and Danielsson 1963). These findings indicate that 12-hydroxylation precedes 26-hydroxylation in the formation of cholic acid.

Danielsson (1962) showed that 7 α -hydroxy cholesterol was converted into cholic acid in the fistula rat while 12 α -hydroxy cholesterol was a relatively inefficient precursor which suggested that hydroxylation at C₇ was followed by hydroxylation at C₁₂. A proposed scheme for the conversion of cholesterol to cholic acid and chenodeoxycholic acid is shown in Fig.3. (After Danielsson 1961).

The in vitro conversion of cholesterol to cholic acid using rat liver slices or homogenates has not as yet been reported. Frederikson and Ono (1956) incubated [4. ¹⁴C]-cholesterol with a mouse liver mitochondrial preparation and isolated three compounds in the acidic fraction. Two of these had polarities similar to those of cholic acid and chenodeoxycholic acid, but repeated recrystallisation and chromatography established that they were not identical to the primary bile acids. Kritchevsky (1961) studied the "cholesterol oxidase" system in rat liver mitochondrial preparations using either [4. ¹⁴C] - or [26. ¹⁴C] - cholesterol as

substrate and he showed that a number of acidic products was formed of which none was identical with cholic acid. On the other hand the conversion of cholesterol to both lithocholic acid and chenodeoxycholic acid has been reported (Mitropoulos and Myant 1966, 1967) in incubations of rat liver mitochondria plus soluble supernatant fraction.

The rate of turnover of bile acids and the amount of cholesterol converted to bile acids has been measured by means of isotope techniques which provide indirect evidence through the study of the appearance of radioactive bile acids and their metabolites in the faeces (Lindstedt and Norman 1956). In this way, the biological half-life time for cholic acid and chenodeoxycholic acid was found to be 2 - 3 days (Lindstedt and Norman 1956, Portman and Murphy 1958, Strand 1963). Since the cholic acid pool in rats fed the same type of diet was shown to be 14 mg. (Eriksson 1960), the daily synthesis of cholic acid would be 4 mg. and of chenodeoxycholic acid 1 mg. The effect of diet (Portman and Murphy 1958), thyroid status (Strand 1963), cholesterol feeding (Wilson 1962) on bile acid synthesis and turnover have been studied in each case using indirect methods with isotopically labelled bile acids. No direct assessment of bile acid synthesis has yet been possible. It is known that insertion of a bile fistula for collection of bile for direct examination interferes with the enterohepatic circulation of bile acids and that the rate of bile acid excretion in the bile represents both bile acid reabsorbed from the small intestine and bile acid newly synthesised (Eriksson 1957, Myant and Eder 1961, Strand 1961). The interruption of the enterohepatic circulation of bile salts

also affects the negative feedback mechanism which is known to control the rate of bile acid synthesis (Eriksson 1957, Bergström and Danielsson 1958).

Cholesterol synthesis is a function of a large number of tissues (Eckles et al 1955). The equilibrium between liver cholesterol and serum free cholesterol is reached in 2 - 4 hr. (Eckles et al 1955, Gould et al 1955) while equilibrium between serum esterified and free cholesterol takes up to 4 days (Gould et al 1955, Hellman et al 1954). On the other hand the equilibrium between plasma cholesterol and extrahepatic tissue cholesterol is slower. Avigan et al (1962) found that complete equilibrium was not reached after as long as 7 weeks. Dietary cholesterol becomes indistinguishably mixed with serum cholesterol after a few days (Hellman et al 1954).

A direct method for the study of plasma/liver cholesterol equilibria, and the metabolism and excretion of bile acids, might be the use of the isolated perfused liver preparation since the effects of both the bile acid enterohepatic circulation and extrahepatic cholesterol synthesis and metabolism are thereby excluded from the experimental system.

A number of studies has been described using this technique. The perfusion technique of Brauer et al (1951) was used by Robbins et al (1953) to study the cholesterol and cholate concentration of the perfusate and bile when the perfused livers were taken from normal donor rats. Perfusions were run until bile flow failed (3 hr. 40 min. - 11 hr. 10 min.). Biliary cholesterol and cholic acid were secreted at concentrations of 13% and 60% respectively of the concentrations found in bile collected from

bile fistula rats. The perfusate cholesterol concentration was only 13.8 mg.% (mean conc. in normal rats 48 mg.%), since the perfusate consisted of diluted blood, and the concentration failed to rise during the perfusion experiments. No change was found in the perfusate cholic acid concentrations. Using a perfusion system consisting of two isolated livers in parallel, perfused with 50% hypercholesterolaemic blood, 50% electrolyte solution Friedman et al (1956) studied the removal of excess cholesterol and cholic acid from the perfusate. The hypercholesterolaemic blood was obtained from rats subjected to bile duct ligation 72 hr. before and given 200 mg. of cholic acid daily by stomach tube. This procedure raised the plasma cholic acid levels three fold. It was found that the hepatic cholesterol content did not change when these livers were perfused with normo-cholesterolaemic perfusate but that the cholesterol content of the perfusate rose from 22 - 34 mg./100 ml. However the hepatic cholesterol content rose by 21% when livers were perfused with the hypercholesterolaemic, hypercholataemic perfusate and there was no change in the perfusate cholesterol concentration. The livers perfused with the perfusate containing high cholic acid concentrations excreted almost 10 times as much biliary cholate as the livers perfused with the normal cholic acid concentration. These studies therefore provided evidence for the biliary excretion of bile salts and demonstrated that some cholesterol exchange was occurring between the perfusate and the liver. No evidence was obtained regarding the de novo synthesis of bile

acids since the hepatic bile acid pool sizes were not estimated and therefore the excreted bile acids could not be divided into the newly synthesised and the previously synthesised quantities. The perfusion studies of Vanlerenberghe et al (1960) confirmed the presence of biliary taurocholate and also demonstrated material with similar properties to glycocholate.

The metabolism of [4. ^{14}C] - cholesterol and of [26. ^{14}C] - cholesterol was studied in the isolated perfused liver preparation by Harold et al (1955). The perfusion technique of Miller et al (1951) was used. The perfusate consisted of undiluted heparinised rat blood. The radioactive cholesterol substrates were added to the perfusate in the form of Tween 20 suspensions in 0.9% saline. Both radioactive forms of substrate disappeared rapidly from the perfusate during the first hour and then the radioactivity present in the perfusate remained constant. When [26. ^{14}C] - cholesterol was substrate about twice as much [^{14}C] was eliminated as $^{14}\text{CO}_2$ as was excreted in bile. Of the biliary [^{14}C] 20 - 50% was in the neutral fraction, the remainder being found in unidentified acidic compounds. When [4. ^{14}C] - cholesterol was substrate the [^{14}C] was excreted exclusively via the bile. Approximately 10 - 20% of this [^{14}C] was recovered in neutral sterols the remainder being in the acidic fraction which was separated on paper chromatograms and identified as taurochenodeoxycholic acid, taurocholic acid and a relatively slowly migrating band which was not identified. Taurochenodeoxycholic acid and the unidentified compound became labelled with

[¹⁴C] before taurocholic acid. In contrast with the in vivo situation taurocholic acid never became the major [¹⁴C] labelled bile acid during perfusions, some of which lasted as long as 12 hr. Further studies using the isolated perfused liver preparation were performed by Danielsson et al (1961) using [4. ¹⁴C] - cholesterol as substrate. Three groups of experiments were performed in which the substrate was added to the perfusate in different forms. In the first group the [4. ¹⁴C] - cholesterol was injected directly into the perfusate in a Tween 20 emulsion in saline. In the second group the [4. ¹⁴C] - cholesterol emulsion was injected intravenously into a rat and 1 hr. later the rat was used as liver donor animal: while in the third group a rat was injected with the [4. ¹⁴C] - cholesterol intravenously and 24 hr. later its blood was used as part of the perfusate. The perfusate consisted of rat blood diluted with Ringer's solution (5:1). In each of these groups of perfusions exchange took place between the liver and the perfusate cholesterol pools. In the first group, 74 - 76% of the added radioactivity was recovered in the liver while 0.3 - 0.8% had been excreted in the bile. In group 2, 64 - 82% of the radioactivity remained in the liver and 0.8 - 1.1% had been excreted in bile while in group 3, 8 - 16% was in the liver and 0.9 - 2.3% in the bile. The biliary bile acids were present exclusively as the taurine conjugates; the only radioactive bile acids identified being cholic acid and chenodeoxycholic acid in the ratio of 8:2 respectively. These studies further confirmed the ability of the isolated perfused liver preparation to excrete bile acids and to form the

taurine conjugates of these bile acids. However the pattern of excretion of these compounds was not established. The labelled cholesterol substrate was added to the perfusate in a Tween 20 emulsion which cannot be considered a physiological form, and where the labelled cholesterol was added to the perfusate as lipoprotein the pattern of disappearance of the radioactivity from the perfusate was different from the emulsified form. In the second group of perfusions performed by Danielsson (1961) the [^{14}C] - cholesterol was injected into the donor rat 1 hr. prior to removal of the liver and therefore the appearance of [^{14}C]-bile acid during the perfusion cannot be interpreted as being due solely to metabolism of the isolated liver preparation.

The biliary excretion of bile acids following the insertion of a bile fistula shows a characteristic pattern (Thompson and Vars 1953, Eriksson 1957, Myant and Eder 1961 and Strand 1962). An initial fall in total bile acid excretion rate is followed after about 18 hr. by a rise, until the rate is approximately equal to that in the first few hours of bile drainage. This has been interpreted (Eriksson 1957) as indicating that the rate of bile acid synthesis rises in response to the interruption of the feedback of bile salt from the small intestine to the liver. The infusion of taurochenodeoxycholate into the duodenum of bile fistula rats has been shown to inhibit the secondary rise in excretion of cholic acid (Bergström and Danielsson 1958), and since chenodeoxycholic acid and cholic acid are not interconvertible (Bergström and Sjövall 1954) this was taken as evidence in favour

of a control mechanism on the liver by feedback from the intestine. Increased rates of synthesis of taurocholic acid in livers from fistula rats have been confirmed (Kay and Enterman 1961). These authors perfused livers from normal rats and from bile fistula rats with a perfusate consisting of undiluted rat blood. Perfusate cholesterol concentrations rose slightly when livers from fistula rats were perfused and did not change in the perfusions of livers from normal rats.

The studies reported here were commenced for the following reasons -

(a) The methods used to estimate the rate of bile acid synthesis in the rat have required techniques which provided evidence of an indirect nature and which depended on a number of assumptions. The use of isotope techniques of the type introduced by Lindstedt and Norman (1956) assumed that -

1. The radioactive bile acids administered to the rats were rapidly and completely mixed with the bile acid pool in the animal.
2. The radioactive bile acids were metabolised in a fashion identical with the endogenous bile acids.
3. Since only a single radioactive bile acid was administered the assumption was made that other bile acids would be similarly metabolised.
4. No further metabolism of the bile acid administered occurred to non bile acid compounds.

While these assumptions probably were fulfilled a more direct method of study was required and the isolated perfused liver seemed a suitable approach.

(b) To study the quantities and types of bile acids excreted by the isolated perfused rat liver, and in particular to examine the synthesis of radioactive bile acids following the addition of either radioactive cholesterol or radioactive cholesterol precursors to the perfusion system.

(c) To study the transfer of cholesterol between the plasma and liver (in both directions) in isolation from extrahepatic tissues.

(d) To study biliary bile acid excretion rates in bile fistula rats and to examine factors which may affect the response to the interruption of the enterohepatic circulation of bile salts.

METHODS

1. Method for extraction, purification and estimation of biliary bile acids

1.1 General description

The method used for the estimation of the bile acid content of bile was a modification of the method of Reid and Boyd (1959) (See also Boyd, Eastwood and McLean 1966). A flow diagram of the procedure is shown in Fig.4.

Bile samples were diluted with approximately 10 times their volume of ethanol and kept in a domestic refrigerator at 4° prior to estimation of the bile acid content.

Extraction of the bile samples was performed 3 times from boiling ethanol. The precipitated protein was centrifuged at 2,000 r.p.m. in a bench centrifuge for 10 min. The precipitate was resuspended in ethanol and the procedure repeated twice. The ethanolic extracts were pooled and taken to dryness in vacuo in a warm water bath.

Hydrolysis of the bile acid conjugates was carried out in approximately 2.5 N aqueous sodium hydroxide solution in nickel crucibles. The dried bile acid conjugates were transferred to the crucibles in a 1% sodium carbonate, 1% sodium bicarbonate solution to which was added an equal volume of 5 N aqueous sodium hydroxide solution. The hydrolysis procedure was performed at a pressure of 15 lb./sq.in. for a period of 5 hr.

The conditions of hydrolysis described above are identical to those described by Reid (Ph.D. thesis 1961). Hydrolysis of bile acid conjugates in vessels made of glass was accompanied

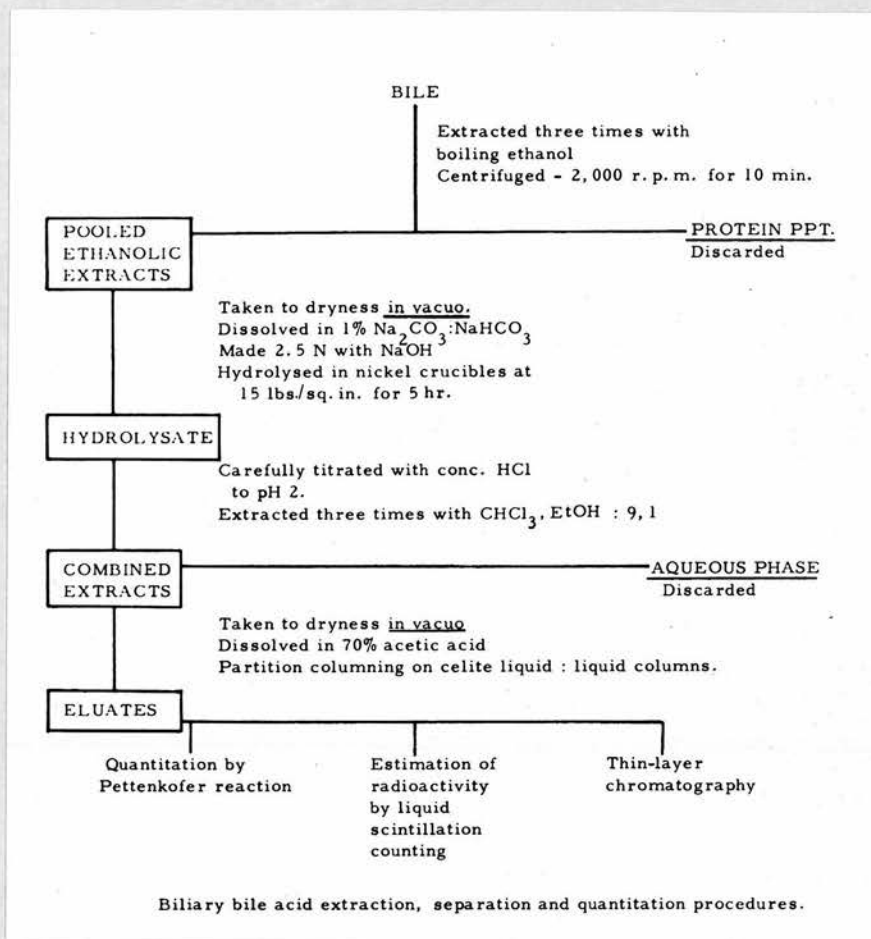

Fig. 4

by recoveries of cholic acid which were both low and inconsistent. This appeared to be due to adsorption of the free bile acid on to silicate dissolved from the glass vessel during the hydrolysis procedure. Similar, poor recoveries were found when stainless steel, nylon or polyethylene crucibles were used and only nickel crucibles were found to give satisfactory recoveries.

Reid (1961) showed that hydrolysis proceeded to 100% when the normality of the sodium hydroxide was greater than 1.5 N and the hydrolysis time greater than 2½ hr.

Following hydrolysis, the hydrolysate was transferred quantitatively to a glass separating funnel and acidified by the dropwise addition of hydrochloric acid, to approximately pH 2. Universal indicator paper (British Drug Houses) was used to estimate the pH of the solution after thorough mixing. The resultant solution was extracted 3 times with a mixture of chloroform, methanol:9,1 (each extraction being with 5 vol. of chloroform, methanol solution to one vol. of aqueous phase). The chloroform, methanol solutions were pooled and taken to dryness in vacuo.

The dried bile acid residue was taken up in 70% aqueous acetic acid and this was applied to a column system which consisted of a stationary liquid phase of 70% aqueous acetic acid (Mosbach 1954, Matschiner 1957, Reid and Boyd, 1959) applied to a support of Celite. The mobile phase used to elute the added bile acid from the column consisted of petroleum ether (bp. 60° - 80°) with stepwise addition of benzene.

Day	1	2	3	4
Dihydroxy bile acid (ug)	63.7	67.9	59.3	60.2
	53.6	62.5	64.4	68.1
	62.9	63.1	64.2	66.1
	61.0	60.1	56.8	64.0
	67.5	66.7	62.9	64.7
Trihydroxy bile acid (ug)	181.1	195.8	203.1	196.6
	220.1	208.4	195.2	195.9
	209.0	194.7	195.2	201.1
	189.7	196.8	189.9	187.6
	199.3	189.1	199.1	192.4

Fig. 5 Recovery values for bile acid analyses carried out on different days.

This system will be referred to as the liquid:liquid column system.

The bile acid content of each eluate was estimated by a modified Pettenkofer reaction (Reid and Boyd 1959), while radioactivity was estimated by liquid scintillation spectrometry. Further identification of the material in the eluates was carried out by the use of thin-layer chromatography.

1.2. Precision and recovery studies

A sample of bile was divided into suitable aliquots which were then kept at 4° as described above. Four aliquots were analysed on each of five days, the dihydroxy and trihydroxy bile acids being estimated separately. Fig.5 shows the daily estimates of the dihydroxy and the trihydroxy bile acids. The mean figure for the dihydroxy bile acids was 62.9 µg. and the standard deviation was 3.70 µg. while the mean figure for the trihydroxy acids was 197.0 µg. and the standard deviation was 8.52 µg.

Recovery studies were performed by the addition of [¹⁴C] labelled bile acid to a sample of rat bile which was then divided into aliquots which were extracted and bile acid estimations performed in the usual way. Aliquots of the column eluates were taken and the radioactivity estimated. The recoveries of radioactivity were found to be between 80 and 85% of the radioactivity added.

2. Thin-layer chromatography of bile acids

Thin-layer chromatography of bile acids was performed on layers of Silica Gel G approximately 0.25 mm. thick and either

20 cm. x 20 cm. or 20 cm. x 5 cm. in area. The plates were spread with a slurry of Silica Gel G in distilled water using a simple spreader and activated in a hot air oven at 105° for 30 min.

Three solvent systems were used. The system of Hamilton (Kritchevsky et al 1963) consisting of isooctane: isopropyl ether:glacial acetic acid, 2:1:1 by volume was found to be satisfactory for the separation of the different hydroxylated bile acid classes and could also produce separation of chenodeoxycholic acid from deoxycholic acid. Two systems (Eneroth 1963) were used for more specific separations of compounds in the dihydroxy and the trihydroxy bile acid classes. The first (for dihydroxy acids) consisted of trimethylpentane:ethyl acetate:acetic acid, 10:10:2 while the second consisted of cyclohexane:ethyl acetate:acetic acid, 7:23:3.

Demonstration of the separated bile acids was usually carried out by spraying the plate (after drying in the hot air oven) with a 10% solution of phosphomolybdic acid in ethanol (Kritchevsky and Kirk 1952) and heating the sprayed plate in the hot air oven at 105° for 10 min. This developed the spots on the chromatogram as dark grey/blue areas with a pale green background.

3. Estimation of radioactivity in bile acids and cholesterol

Estimation of the [¹⁴C] content of biliary bile acids or perfusate plasma cholesterol was performed in a Packard liquid scintillation system 314 EX. Prior to scintillation

counting the bile containing the labelled bile salts was subjected to the extraction, hydrolysis and column chromatography procedure and finally aliquots of the column eluates were measured directly into Packard glass counting vials (this type of vial was used throughout these studies). The solvents were evaporated off in a hot air oven at 105° for approximately 30 min. Scintillation fluid (5 ml.) was measured into the cooled vials and the samples subjected to scintillation counting.

The scintillator used throughout these studies consisted of a solution of 2,5 diphenyloxazole (PPO), 5 g./l. and 1,4-bis-[2-(4 methyl-5-phenyloxazolyl)] - benzene (POPOP), 0.3 g./l. in toluene.

Suitable settings of the high voltage tap and window size were determined by plotting the counting efficiency of a standard [¹⁴C] source in a glass counting vial containing the same type of scintillation fluid as used in the experiments to be described. These settings were repeatedly checked throughout the performance of the work. The counting efficiency of the [¹⁴C] standard was found to vary between 78% and 83% of the theoretical disintegration rate.

Estimation of the incorporation of the [¹⁴C] into cholesterol was carried out by taking aliquots of the petroleum ether extraction; following hydrolysis and extraction of the cholesterol from the biological material with methanolic KOH. (See methods for cholesterol estimation (Abell, Brodie, Levy and Kendall, 1952). The aliquots were measured directly into the counting ampoules (and taken to dryness) in the same way as the bile acid aliquots.

Samples of the scintillation fluid alone were routinely counted with the [^{14}C] containing samples in order to obtain an estimate of the background counting rate which was then subtracted from the total sample counting rate to provide the net counting rate for that sample.

4. Estimation of total cholesterol concentration in plasma

The total plasma cholesterol was hydrolysed and extracted by the method of Abell, Brodie, Levy and Kendall (1952); and the cholesterol content estimated by the Liebermann-Burchardt reaction. The petroleum ether phase from the extraction procedure, or a suitable aliquot of that phase, was taken to dryness under a stream of nitrogen and chloroform was used as solvent for the cholesterol in the dried extract. Redistilled acetic anhydride containing 5% v/v of concentrated sulphuric acid was prepared in a flask immersed in an ice bath and then allowed to warm to room temperature at which point it was added to the chloroform phase. The colour was developed at 25 $^{\circ}$ for 30 min. and the optical density of the solution estimated at 625 m μ . in glass cells with a light path of 1 cm. in a Unicam SP 600 spectrophotometer. Suitable blank solutions and solutions of known cholesterol content were run with each group of estimations (Boyd 1962).

5. Estimation of perfusate plasma glucose concentration

Plasma glucose concentration was estimated by the glucose oxidase method for estimation of "true glucose". Standard Biochemical Test Combination kits (Boehringer Corporation) were used. These contain both glucose oxidase and peroxidase and

utilise the oxidation of o-dianisidine hydrochloride as coloured end point. The reactions are buffered in 0.10 M phosphate buffer, pH 7.0. Blanks and standard glucose solutions were run in parallel with the plasma samples. Measurements of the optical density of the final solutions were made in a Unicam SP 600 at 450 m μ . following 35 min. incubation at room temperature.

Precipitation of plasma proteins was carried out by addition of 0.1 ml. plasma to 1.0 ml. of 3.8% aqueous perchloric acid which was mixed and centrifuged. The colourless supernatant solution was sampled for glucose analysis.

6. Estimation of perfusate plasma urea concentrations

Perfusate plasma urea concentration was measured by a modification (Campbell and Annan 1966) of the diacetyl monoxime method of Marsh, Fingerhut and Miller (1965) using an AutoAnalyzer technique. In the plasma urea ranges found in these experiments the coefficient of variation of this method lies between 4% at 30 mg.% urea concentration and 2% at 130 mg.% urea concentration.

7. Perfusate plasma sodium, potassium, chloride and bicarbonate concentrations

These analyses were performed by standard Technicon AutoAnalyzer methods (Campbell and Annan 1966). Drift, inherent in AutoAnalyzer methods, was corrected on the basis of a standard sample analysed every tenth sample. The bicarbonate method gives an estimation of the plasma total acid-releasable CO₂.

The standard deviation for the methods are as follows:-

Plasma sodium - 1.5 meq./l.

Plasma potassium - 0.1 meq./l.

Plasma chloride - 1.5 meq/l.

Plasma bicarbonate - 1.5 meq/l.

These estimates were carried out both by repeated analyses of pooled human sera and by duplicate analyses of human sera (Campbell and Annan 1966).

8. Estimation of plasma pH and haemoglobin oxygen saturation

Perfusate plasma pH values were estimated by means of a micro electrode pH meter using a capillary glass electrode requiring approximately 0.1 ml. of whole blood for a single measurement. Perfusate samples were taken anaerobically from the reservoir at the lower end of the "lung" and the pH value estimated within 30 min. (Andersen and Engel 1960).

Haemoglobin oxygen saturation was measured by direct reflectometry using samples equilibrated with pure oxygen as 100% saturation reference values.

9. Estimation of biliary bromsulphthalein concentration

Biliary bromsulphthalein concentrations were measured by reading the optical density (520 m μ .) of a sample of bile suitably diluted with 0.1N sodium hydroxide using a similar sample of bile diluted with 0.1N hydrochloric acid as reference blank (Varley 1962). Beer's Law was obeyed for samples of pure bromsulphthalein at concentrations in the range found in bile.

10. Measurement of liver microsomal CO-binding pigment

Liver microsomes were prepared by ultracentrifugation of a mitochondrial supernatant at 105,000 g. for 60 min. (Hogeboom 1957). The microsomal pellet was then resuspended in 0.1M phosphate buffer pH 7.3, a small amount of dithionite added,

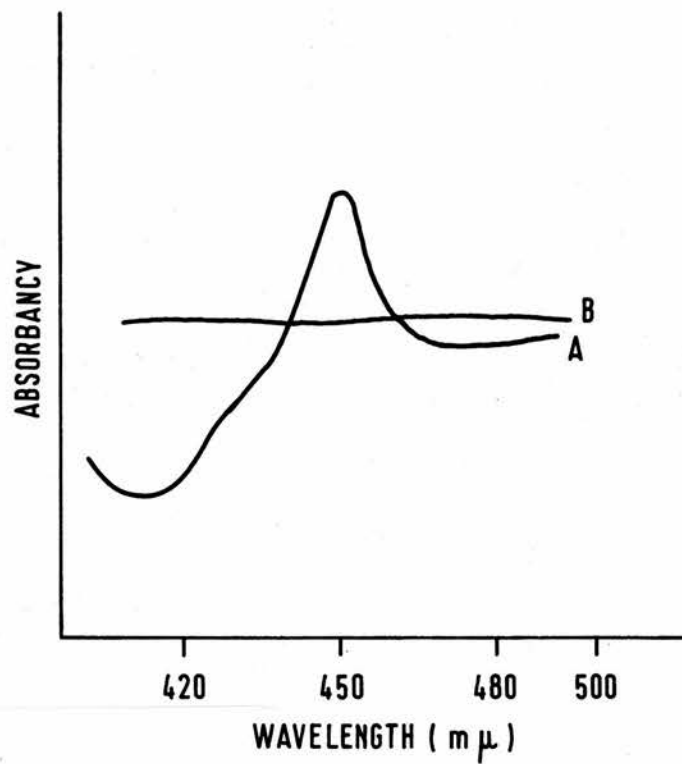

CO difference spectra of reduced rat liver microsomes.
Curve A, dithionite reduced microsomes ;
curve B, aerobic microsomes.

Fig. 6

and the solution divided between two glass cells one of which was carefully saturated with carbon monoxide by bubbling the gas through the solution for 1 min., and then sealing the cuvettes.

Fig. 6 shows the carbon monoxide difference spectrum produced and demonstrates the well defined peak at 450 $m\mu$ which is characteristic of this preparation (Omura and Sato 1964).

Measurement of the CO-binding pigment was carried out by referring the difference between the optical density readings at 450 $m\mu$ and 490 $m\mu$ to the protein content of the microsomal suspension (Layne 1957) using bovine serum albumin as standard.

THE PRINCIPLES OF THE METHOD FOR ISGLATED PERFUSION OF RAT LIVER

1. Introduction

At the start of the development of the method for isolated perfusion of the rat liver certain principles were established. The most important of these was to set up a system which would maintain the isolated organ in conditions as nearly as possible exactly equivalent to those physiological conditions normally existing in vivo. This immediately raised the problem of the route by which the organ should be perfused since the liver in vivo is in the unique position of receiving both venous blood by way of the portal vein and arterial blood by way of the hepatic artery. The majority of isolated rat liver perfusion systems which have been described have perfused the organ by way of the portal vein alone (Miller et al 1953, Brauer et al 1951, Burton et al 1960, Ostashever et al 1960), although there are reports of perfusion in a reverse direction with the perfusate entering the organ by way of the hepatic vein. (Trowell 1942, Heimberg et al 1958). It was decided that this study should be performed by perfusing the livers by way of the portal vein, thus ensuring that the perfusate would traverse the liver in the normal direction, and it was considered that the use of well oxygenated blood should provide adequate oxygen supply to the tissue (Markowitz et al 1949).

Many of the published studies describing isolated liver perfusion have used volumes of perfusate between 100 ml. and 200 ml. (Miller et al 1953, Brauer et al 1951, Ostashever et al 1960). The blood volume of the rats (body weights 200 - 250 g.)

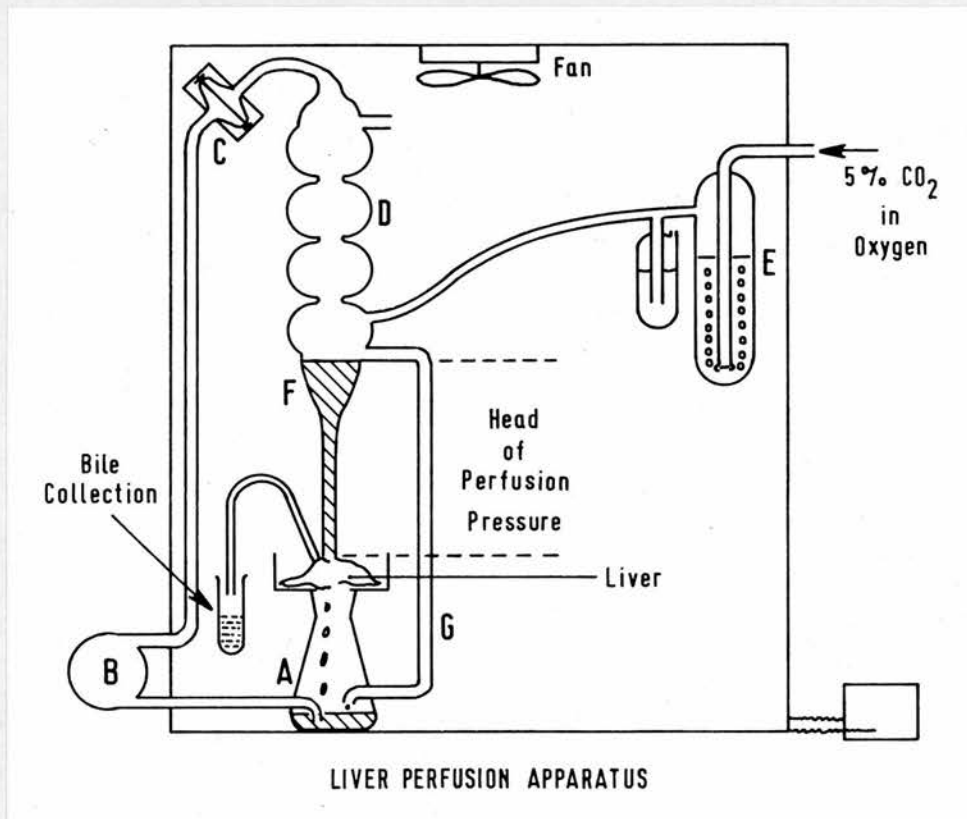

Fig. 7

used in the studies to be described here was estimated to be 15 - 20 ml., and it was considered desirable to construct a liver perfusion system in which the perfusate volume was approximately equal to the blood **volume** of the donor animals. This was particularly important since cholesterol is the immediate precursor for hepatic bile acid synthesis (Bloch et al 1942) and the use of large perfusate volumes would alter the dynamic equilibria which exist in vivo between the liver and plasma cholesterol pools and hence might affect the biosynthesis of bile acids by the perfused liver.

It was considered essential to demonstrate that the isolated perfused liver preparation as performed here, was indeed capable of performing a number of biochemical functions normally attributable to the liver, including secretion of bile (Danielsson et al 1961), as well as possessing normal morphological appearances (following perfusion) both with the light microscope and the electron microscope.

2. The perfusion method

2.1 Selection of perfusion conditions

The perfusion method which was used was a modification of that described by Miller et al (1951). Since it was considered desirable to perfuse with a total perfusate volume of approximately 20 ml. the apparatus was scaled down in size from that of Miller et al which was designed for a perfusate volume of 135 - 240 ml. (Miller et al 1951).

The course of circulation of the perfusate in the apparatus was as follows (see Fig.7). The perfusate was placed in the

reservoir, A, from which it was pumped by the roller pump, B, through the steel mesh filter, C, to the top of the 'lung', D, down which the perfusate flowed in a very thin film in order to attain equilibrium with the 95% oxygen; 5% carbon dioxide gas mixture in the 'lung'. This gas mixture was humidified by bubbling through a water column, E, some 10 cm. high. The perfusate collected in the second reservoir, F, at the lower end of the 'lung' from which it could flow, either directly through the portal vein cannula to the hilum of the liver and hence through the liver substance to exit by way of the hepatic vein and return directly to the main reservoir, or over the overflow channel, G, also to the main reservoir. A bubble trap was placed in the tubing between the reservoir, F, and the portal vein cannula. The insertion of the overflow tube in the small reservoir, F, allowed a constant perfusate level to be automatically maintained in the reservoir and thus permitted simple regulation of the perfusion pressure by alteration of the height of the hilum of the liver below the perfusate level in the reservoir.

The liver which was being perfused was supported in a glass petri dish of suitable size which was fused to a Quickfit joint in such a way as to allow free passage of perfusate, exiting from the hepatic vein of the perfused liver, to the reservoir below. This type of liver support left the liver freely exposed to the warmed atmosphere of the thermostatically controlled perfusion chamber and the resultant tendency to drying of the liver surface was minimised by placing gauze, previously damped with 0.9% saline solution, in contact with the liver.

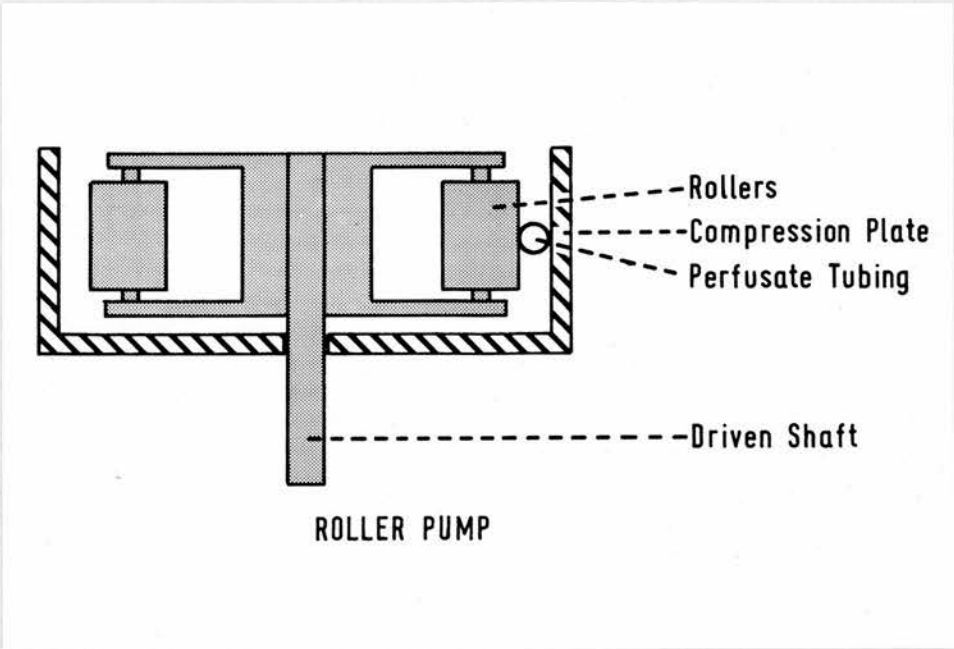

Fig. 8

The filter chamber was machined from perspex and was similar to that described by Miller et al (1951). It consisted of 2 halves, each of which was a hemispherical chamber, with a groove for a rubber 'O' ring. Thus, when the halves were placed together a sealed joint was formed by the 'O' rings which also served to hold the filter membrane in position. The halves were held together by 4 screws. In this way damage to the erythrocytes in the perfusate was kept to a minimum, since the perfusate passed through a relatively large area of filter membrane at low velocity. The membrane used in these studies was a fine stainless steel mesh (pore size 0.15 mm.) of the type used to filter the blood in the cardiac bypass apparatus in The Royal Infirmary of Edinburgh.

The roller pump was of the design shown in Fig. 8 and was made in the Biochemistry Department workshop. It consisted of a brass driven shaft on which were mounted 4 freely rotating rollers, each in the same plane as its neighbours, rotating in a vertical axis and mounted at the circumference of the driven shaft. This was driven by a commercial electric motor (1/8 h.p.) the speed of which could be continuously varied by means of a rheostat. The pumping action was produced by alternating compression of the perfusate filled tube between the 4 small rollers described above and a circular aluminium compression plate which could be easily removed for insertion of the tubing. The size of the pump rollers

was carefully adjusted in order to produce apposition, but not crushing, of the walls of the tubing and hence to minimise trauma to the erythrocytes suspended in the perfusate.

The glass walled 'lung' was made to the same design as that described by Miller et al (1951) with 6 bulbs joined by narrow necks constituting the main body. The humidified 95% oxygen; 5% carbon dioxide entered the 'lung' just above the level of the perfusate in the small reservoir and left the 'lung' directly into the atmosphere of the perfusion chamber. No provision was considered necessary for the trapping of carbon dioxide from the perfusion system and hence no gas flow was needed through the main reservoir or through the perfusate overflow tubing as was provided by Miller et al (1951).

The whole of the perfusion apparatus was placed in a chamber with glass fibre walls and a tight fitting plate glass door. The temperature in the perfusion chamber was maintained by a series of heavy duty resistance wires wound around the inside of the chamber and connected through a rheostat in order to provide variable heat output. The atmosphere in the chamber was constantly circulated by a fan mounted in its roof and driven by a small electric motor.

All of the glassware, apart from the 'lung', was siliconised by baking twice in a hot air oven for 2 hr. at 110^o following immersion in a polymethylhydrogensiloxane fluid (MS 1107, Hopkin and Williams).

This process was repeated at regular intervals throughout the period of the study. The tubing through which the perfusate

flowed around the apparatus, was of the type manufactured by Esco Rubber Products (Siliconised rubber, internal diam. 0.25 cm., external diam. 0.4 cm.).

Provision for the collection of bile from the isolated perfused liver was made by suspending small glass tubes with lips (length 2 in., diameter $\frac{1}{4}$ in.) in a fraction collector, made from perspex, which was capable of holding 10 such tubes and was rotated manually.

In order to confirm that a constant temperature of approximately 37° was being maintained in the perfusion chamber 2 thermometers were mounted, one at 5 cm. and the second 20 cm., above the floor of the chamber. The glass front of the chamber was sealed, the heating coils energised and the fan started. After approximately 30 min. the temperature fluctuated in the range 32° - 38° with different ambient conditions in the laboratory. Further, when the door of the chamber was opened, even for very brief periods, the temperature in the chamber dropped by 10° and only returned to 37° very slowly. It was found that the fan was maintaining an adequate circulation of the atmosphere in the chamber since, with the chamber door closed, the temperature gradient between the 2 thermometers was never more than 0.5° . The loss of heat through the walls of the perfusion chamber was reduced to very low levels by covering the outside of the chamber with a 1 in. thick layer of fibreglass wool of the type commonly used for domestic lagging. In this way the time required to reach 37° in the chamber was reduced and also the temperature

fluctuations due to changes in the ambient temperature disappeared. Two large capacity resistors were placed in the roof of the chamber close to the fan and these were activated automatically when the recorded temperature in the chamber fell below 37° . Thus, when the door of the chamber was opened these resistors cut in and reduced both the tendency for the temperature in the chamber to drop and the length of time required to regain 37° . In this way 37° could be regained within 25 - 30 sec. following a period of 30 sec. during which the door of the chamber was open. Using this type of temperature control system the chamber could be maintained at $37^{\circ} \pm 1^{\circ}$ except for the short period following the door being opened.

The operative technique for the removal of the liver from the liver donors was performed in a fashion similar to that described by Brauer et al (1951). The animal was placed under light ether anaesthesia and restrained in the prone position by bands placed around each limb. A long midline incision was made through the anterior abdominal wall and the flaps retracted. The bile duct was identified and 2 linen sutures placed loosely around it. One of these sutures was tied close to the duodenum and the bile duct carefully retracted and dissected free from adherent fat with the aid of a fine pair of forceps using a dissecting microscope providing a magnification of 20 times. A small incision was made into the bile duct and the bile duct cannula (Portex Poly 45-polythene cannula, external diam. 0.030 in.- internal diam. 0.024 in.) secured into place by the second suture.

Bile was then flowing freely in the cannula. Two sutures were placed around the abdominal oesophagus which were tied and the oesophagus divided between them.

The portal vein was dissected free from adherent tissue in the lesser omentum and two sutures loosely placed around it. The proximal suture was tied, an incision made in the vein, and the portal vein cannula which was filled with bubble free perfusate inserted and secured by the second suture. (Portal vein cannula - polythene tubing, internal diam. 1.5 mm., wall 0.5 mm.). At this point the liver was rapidly removed from the donor animal which process was much simplified by applying traction to the stomach by means of the suture tied to the abdominal oesophagus (Brauer 1951). During the removal of the liver, the hepatic vein was simply divided between the liver and the diaphragm and was not subjected to cannulation as has been described by several authors (Miller et al 1951, Brauer et al 1951, Ostashever et al 1960). The liver was then placed in the liver support resting on its diaphragmatic surface and the liver lobes carefully arranged in their correct relative positions one to another. The reservoir was connected to the portal vein cannula and the perfusate flow started. At no time during the operative technique was heparin administered to the liver donor animals.

The studies of Kunkel and Eisemenger (1949) showed that the normal portal venous pressure in the rat ranges from 100 - 160 mm. of water and therefore in order to perfuse the preparation in a way strictly in keeping with the criteria laid down with regard

to physiological conditions these preliminary perfusions were performed at a perfusion pressure of 15 cm. of the perfusate used.

Using the apparatus and the operative technique described above a number of perfusions were performed in order to select the best conditions for perfusion and to allow modifications to be made to the apparatus and operative techniques used.

2.2 Selection of perfusate

A number of different perfusion media have been used in published accounts of isolated rat liver perfusion methods. Broadly these perfusates fell into 2 classes, either perfusates consisting of pooled undiluted whole rat blood using heparin as the anticoagulant (Burton et al 1960, Brauer et al 1953, Kay and Entelman 1961) or perfusates consisting of synthetic salt solutions with or without the addition of blood and/or albumin (Miller et al 1951, Trowell 1942 and Morris and French 1958). The final haematocrit values of the synthetic perfusates ranged from 11% to 40%.

In the experiments described here 3 different perfusion media were used and the development of hepatic oedema, the maintenance of the bile flow rate and the light microscopic appearances (usually after a 4 hr. perfusion period) were used as criteria to judge their relative merits. The perfusion media used were as follows:-

- (a) 0.98% sodium chloride solution in distilled water
(normal saline).
- (b) Heparinised, pooled rat blood taken by cardiac puncture from donor rats of the same species as the liver donors and diluted with an equal volume of

Perfusate	Oedema	Bile flow rate	Histology
0.98% sodium chloride solution.	+++	+ -	Very poor
Blood:Rheomacrodex, 1:1	+	+	Poor
Whole blood	-	++	Good

Table 1 Summary of findings in isolated livers perfused with different perfusates.

Rheomacrodex, 10% in normal saline. (The donor rats were anaesthetised with ether prior to cardiac puncture). Rheomacrodex is a dextran with average molecular weight of about 40,000, and the 10% solution in normal saline has approximately the same colloid osmotic pressure as normal plasma.

(c) Heparinised, pooled rat blood taken as described above.

The experience with each of these perfusates is summarised in Table 1. The use of normal saline as perfusate was very limited because livers perfused in this way rapidly developed extensive oedema and the bile flow rates, which were very low at the start of these perfusions, rapidly fell away to zero usually within one hour or at most 90 min. after the start of the perfusion. The light microscopic studies of these livers perfused with saline showed large areas of the liver parenchyma to be necrotic and the cells separated by spaces consistent with the appearances of oedema. It seemed likely that one reason for the failure of these perfusions was the development of hepatic oedema due to the different osmotic properties of the perfusate from normal plasma. The appearances of necrotic parenchymal cells may have been due both to the effects of the organ oedema and to relative lack of oxygen since saline acts as a poor oxygen transport medium. For these reasons experiments were started using heparinised rat blood diluted with an equal volume of Rheomacrodex in normal saline. In these perfusions slight oedema could be seen to develop in a few cases but the naked eye appearances of the perfused organ were much more normal. The bile flow rates at the start of the perfusions were higher than in the group perfused with saline and

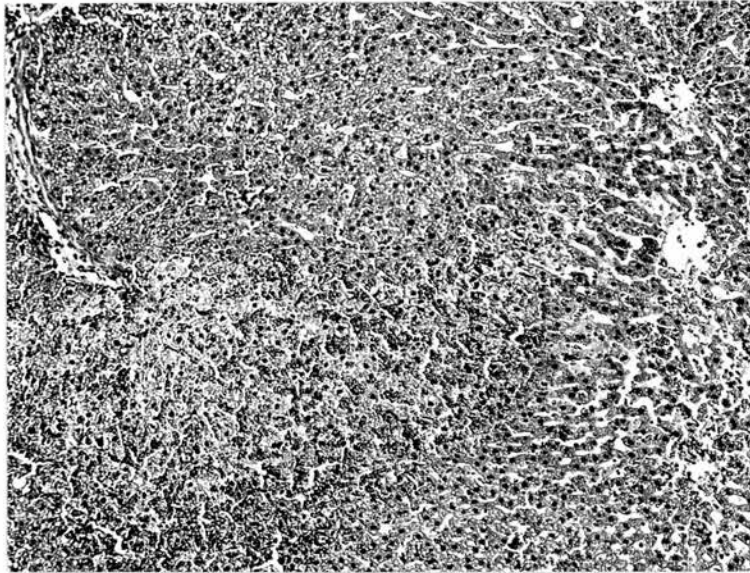

Section of liver taken after 4 hr. perfusion with blood:Rheomacrodex 1:1 (magnification x 100). A large necrotic area is seen in the lower left hand portion of the section while fatty change and oedema is present throughout the tissue.

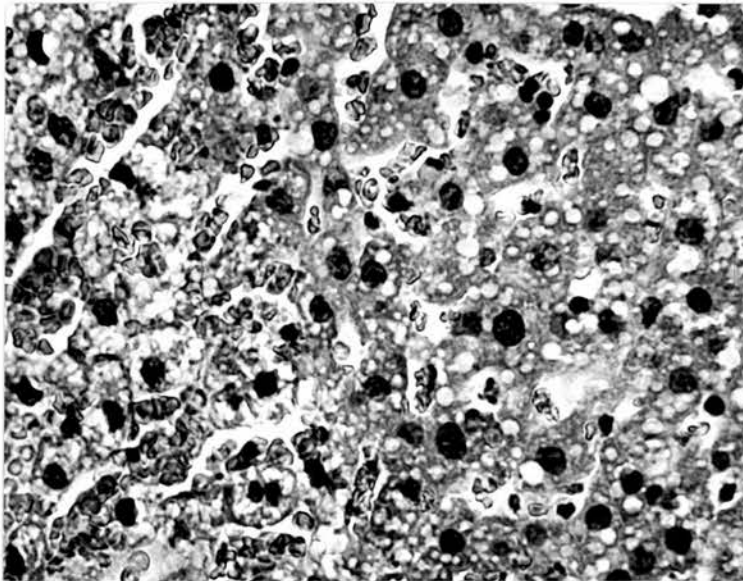

Section of liver taken after 4 hr. perfusion with blood:Rheomacrodex, 1:1 (magnification x 525). A large area of haemorrhage is present on the left of the section while extensive fatty change is seen throughout the section. Many cells show loss of definition of the nuclei suggesting early necrotic change.

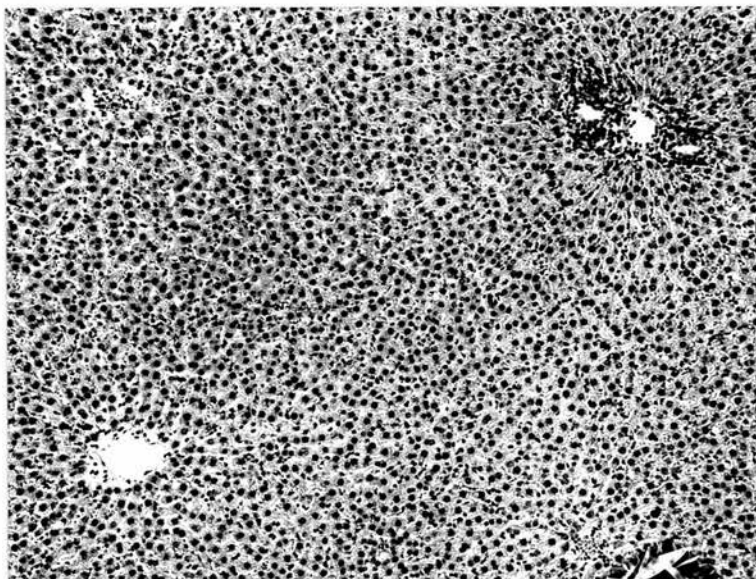

Section of liver taken from normal rat (magnification x 100). A portal tract (top right hand corner) and a central vein (lower left hand corner) are clearly seen. Parenchymal and Kupffer cells are clearly defined.

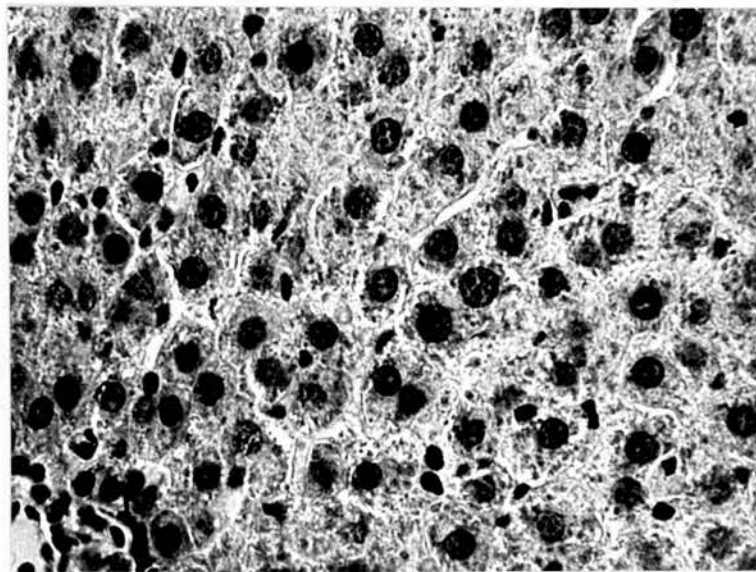

Section of liver taken from normal rat (magnification x 525). A portion of a bile ductule is seen in the lower left hand corner. Both parenchymal and Kupffer cells are seen and show no signs of fatty change.

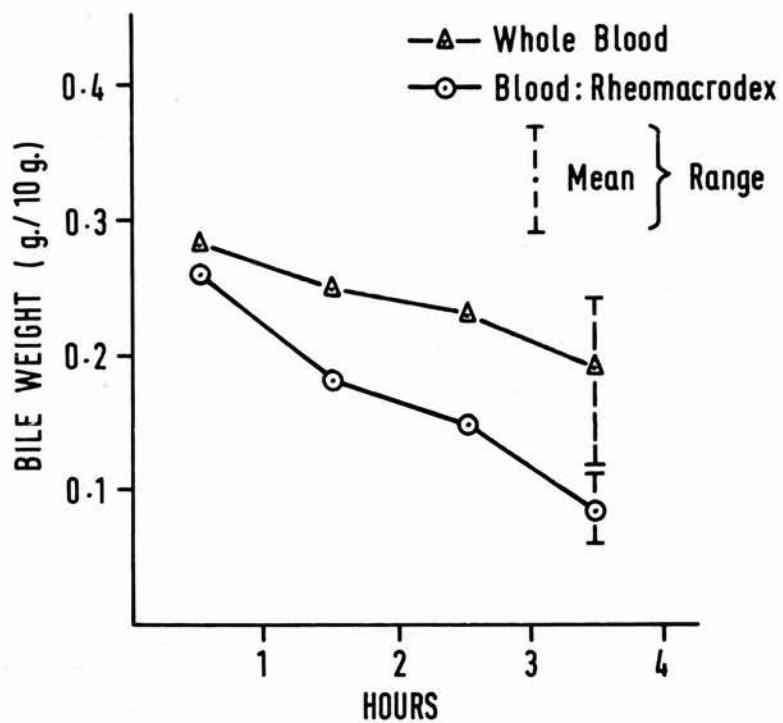

Bile flow rates (g./ 10g.liver weight)
 in perfusions (5 each group) of rat livers.

Fig. 11

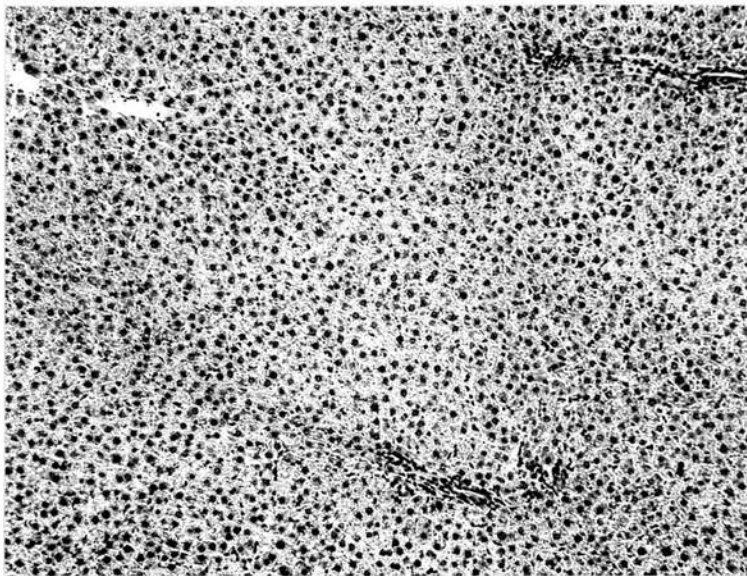

Section of liver following 4 hr. perfusion with whole blood perfusate (magnification x 100). A portal tract is seen in the top right hand corner of the section and at the lower right hand corner. A central vein appears in the upper left hand corner. Slight oedema is present around the central vein but otherwise the tissue appears normal.

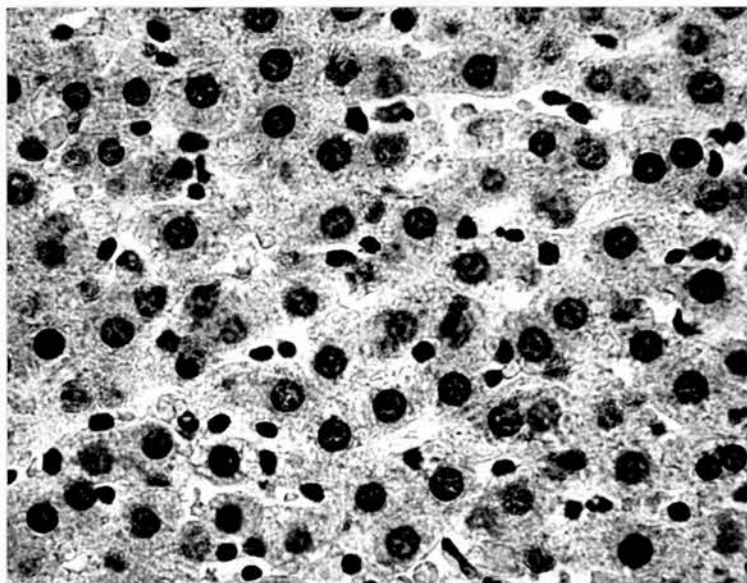

Section of liver following 4 hr. perfusion with whole blood perfusate (magnification x 525). Both parenchymal and Kupffer cells appear well defined throughout the section. No fatty change or haemorrhagic areas are present.

and perfusions were now possible for a period of 4 hr.

The light microscopic appearances of livers following a 4 hr. perfusion with blood:Rheomacrodex, 1:1 are illustrated in Fig.9 while the appearances in samples of normal livers are shown in Fig. 10. It is seen that there are fairly large areas in these perfused livers in which extensive 'fatty change' has taken place and that there are also numerous small areas of cellular necrosis present.

Since oedema still developed in some of the livers perfused with blood:Rheomacrodex, 1:1 and the bile flow rates were low and poorly maintained; as well as extensive changes being present in the morphology of the hepatic parenchymal cells in these perfusions, experiments were started using pooled, undiluted, heparinised rat blood as the perfusate. 2,000 I.U. of heparin was added to each 50 ml. of blood. In these perfusions the naked eye appearances of the perfused organ were entirely normal apart from the occasional development of tiny, superficial haemorrhagic areas on the liver surface. Fig.11 shows the mean bile flow rates found in 5 perfusions using whole blood perfusate in comparison with the mean bile flow rates found in 5 perfusions in the blood:Rheomacrodex group. It is seen that the bile flow rates in the livers perfused with whole, heparinised blood were higher and better maintained than in those experiments using blood:Rheomacrodex as perfusate.

Histological appearances of livers perfused with heparinised, undiluted blood are illustrated in Fig.12. Livers which had

Parts of the cytoplasm of 3 parenchymal cells and one Kupffer cell are visible, along with the nucleus of one parenchymal cell and one Kupffer cell. The structure of the cytoplasmic organelles is well maintained. The biliary canaliculi appear normal.

In the upper left corner of the figure part of an erythrocyte is visible within the cytoplasm of a Kupffer cell. The space of Disse is clearly seen. The structure of mitochondria and endoplasmic reticulum appear normal.

Fig. 13 Electron micrographs of rat liver following 4 hr. perfusion with whole heparinised rat blood. Fixed by perfusion with 0.25% glutaraldehyde in Kreb's Ringer solution followed by post fixation in osmium tetroxide.

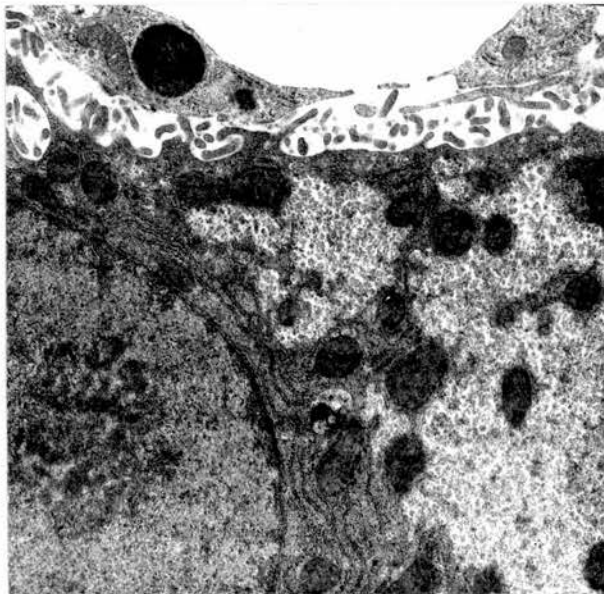
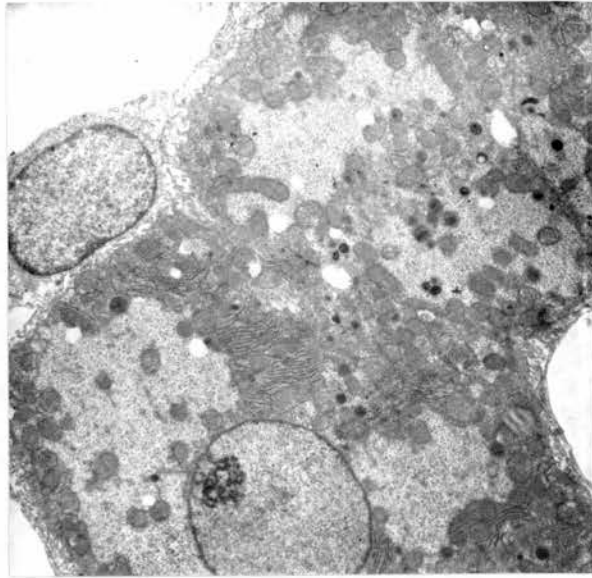
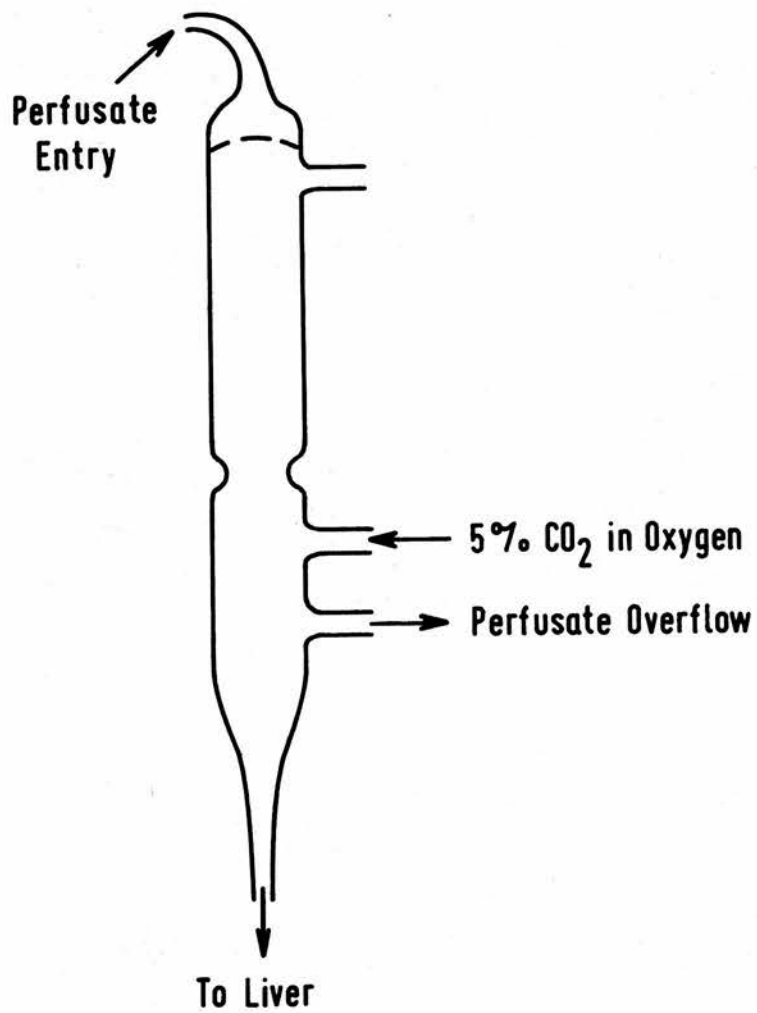

Fig. 13



Redesigned 'Lung' for perfusion apparatus.

Fig. 14

been perfused with the whole blood perfusate for 4 hr. were also fixed by perfusion with a 0.25% solution of glutaraldehyde in Krebs-Ringer bicarbonate solution, pH 7.2. This method produced extremely rapid tissue fixation and was followed by further fixation in osmium tetroxide prior to the preparation of sections for electron microscopy. Examples of electron micrographs from these perfused livers are shown in Fig.13.

Since the bile flow rates were improved and better maintained, the light microscopic and electron microscopic appearances consistent with normal, and the appearance of oedema in the perfused organ eliminated by the use of the pooled whole blood perfusate, it was decided to continue the use of this perfusate for future studies.

2.3 Modification of perfusion apparatus and techniques

While these preliminary studies were being performed a number of modifications to the perfusion apparatus and technique were made, as follows:-

(a) It was found that the multilobe design of the 'lung' did not produce a good filming of the perfusate and that there was a tendency for frothing and bubbling of the perfusate (particularly the whole blood perfusate) in the narrow necks between the bulbs. Experiments were performed using a simpler 'lung' design (Fig.14) in which the bulbs were replaced by a plain parallel-walled tube which had a glass membrane at its upper end which was perforated close to the walls of the 'lung', thus delivering the perfusate directly to the walls of the vessel.

This new design immediately removed the problem of bubbling of

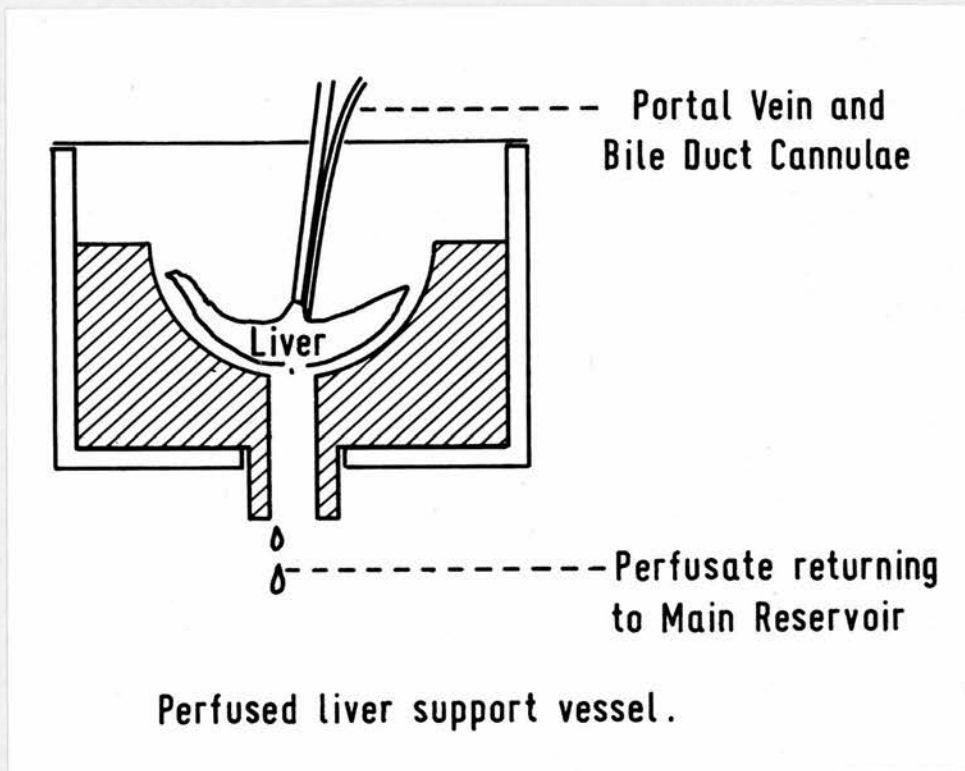

Fig. 15

the perfusate and a satisfactory film of perfusate could be maintained, provided that the 'lung' was thoroughly cleaned after each perfusion by soaking for 12 hr. in a solution of potassium dichromate in concentrated sulphuric acid.

(b) It was found that the flat surface of the petri dish in which the liver was supported during the perfusion did not support the lobes of the liver in a satisfactory position relative to one another; since in some perfusions there was a well maintained perfusate flow through the major lobes while some of the smaller lobes were poorly perfused. A new support vessel was machined from perspex (Fig. 15), in which the size of the support cup was approximately equal to the size of the "cup" formed by the diaphragm of a 200 g. rat. By this means the liver lobes received better support, and perfusate flow through the lobes was well maintained throughout the period of the perfusions.

(c) In the first experimental perfusions performed the portal vein cannula consisted of a piece of polythene tubing the end of which had been bevelled. It was found that this tubing was not easy to insert into the portal vein because it was pliable and it was replaced by a glass cannula the tip of which was ground at a bevel. This could be inserted into the portal vein very rapidly thus cutting down the period during which the liver blood flow was arrested.

(d) As described above the liver was protected from the drying influence of the atmosphere in the perfusion chamber by covering it with a piece of saline soaked swab. This was found to be of

limited value only and was replaced by a cover formed with Parafilm which was stretched across the top of the liver support approximately 1 cm. above the liver. This was found to act as a very efficient means of preventing the drying of the liver surface.

(e) A suitable means of supporting the bile duct cannula was required since the bile duct itself was found not to act as a sufficiently firm support for the weight of the cannula. It was found that tying the bile duct to the portal vein cannula provided good support and also helped to maintain the bile duct cannula in the correct plane parallel to the portal vein.

2.4 Portal vein perfusion pressure

Kunkel and Eisenmenger (1949) have demonstrated that the pressure within the branches of the mesenteric veins in rats maintained under light ether anaesthesia ranges from 100 - 160 mm. of water. Deep anaesthesia was found to cause considerable increase in the mesenteric venous pressure found in these experiments but the animals used to describe the normal portal venous pressure were kept under very light anaesthesia and thus probably represent a range only slightly in excess of the normal.

Perfusions were carried out using heparinised whole blood as the perfusate either at a pressure of 14 cm. or 24 cm. These perfusions were continued for a period of 4 hr. each; at the end of which time the livers were examined for the presence of oedema and superficial haemorrhage by eye. Tissue was taken from at least 2 lobes in each case for microscopic study. Those livers which were perfused at 14 cm. perfusion pressure were seen to be macroscopically normal apart from occasional small areas of

superficial haemorrhage, while the livers perfused at 24 cm. showed large regions of superficial haemorrhage and were swollen. The histological studies showed that there were large congested areas in the livers perfused at the higher pressure and that there were areas in which the central veins were dilated. The livers perfused at the lower pressure appeared normal.

2.5 Blood flow arrest during portal vein cannulation

Published accounts of methods for the isolated perfusion of the rat liver describe the period during which the blood perfusate flow was arrested as varying from less than 4 min. (Harold et al 1955) to as long as 10 min. (Robins et al 1953). It seemed desirable to modify the technique of the cannulation used in our experiments in such a way as to shorten the period of stoppage of blood perfusate flow as much as possible, thus keeping potential tissue anoxia to a minimum. To this end, the tubing carrying the perfusate from the small reservoir at the lower end of the 'lung' to the portal vein was lengthened to a total of approximately 50 cm. In this way the perfusate flow could be restarted immediately following the portal vein cannulation and the perfusate flowing through the liver at this time was allowed to flow through the liver substance and escape into the chest of the rat by way of an incision in the inferior vena cava. During the remainder of the operative procedure the flow of perfusate was maintained, and in this way the arrest of the flow of perfusate was generally less than 30 sec. and never longer than 90 sec. This method of maintaining liver perfusate flow meant that

Perfusion	Time (Hours)				
	Zero	1	2	3	4
1	1.1	3.2	4.9	7.9	9.5
2	1.9	4.1	7.0	8.3	9.7
3	0.9	3.7	6.4	7.8	8.9
Mean	1.3	3.7	6.1	8.0	9.4

Table 2 Perfusate haemolysis values (% of perfusate haemoglobin concentration)

Perfusion	Zero	Time (hr).			
		1	2	3	4
1	37	38	38	40	40
2	37	37	37	38	38
3	41	41	41	42	42
Mean	38	39	39	40	40

Table 3 Perfusate haematocrit values (% of perfusate volume).

usually about 15 ml. of perfusate was lost from the perfusion system into the chest of the donor animal. The priming volume of perfusate was suitably enlarged to compensate for this loss.

3. Description of the metabolic environment maintained

3.1 Measurement of the haemolysis rate in the perfusate

When samples of the perfusate were taken and the plasma separated by centrifugation it was clear that haemolysis was taking place progressively throughout the perfusion period. In order to study the rate of this haemolysis during the 4 hr. perfusion period samples of the perfusate were taken before the start of the perfusions and at hourly intervals thereafter from each of three perfusions. The extent of the haemolysis was measured as described in the methods section. Table 2 shows the mean haemolysis rates, taking the perfusate total haemoglobin content as 100%. There was a mean haemolysis rate of 1.3% at the start of the perfusions which represents haemolysis during the period when the perfusate was being equilibrated with the 95% oxygen, 5% carbon dioxide in the 'lung'. There was then a mean rate of haemolysis of approximately 2% per hr. throughout the perfusion period.

3.2 Measurement of the perfusate haematocrit

Samples of the perfusate were taken at the start of each of 3 perfusions and at hourly intervals during the 4 hr. perfusion period in order to study the haematocrit value; as an index of the possible concentration of the perfusate as a consequence of the passage of the gaseous phase (which had been humidified) over the perfusate film in the 'lung'. Table 3 shows the results of these

Perfusion	Zero	Time (hr).			
		1	2	3	4
1	150	153	155	156	158
2	144	145	147	150	150
3	148	150	150	155	155
Mean	147	149	150	154	154

Table 4 Perfusate sodium concentration (meq/l).

Perfusion	Zero	Time (hr).			
		1	2	3	4
1	6.6	8.4	10.4	11.1	12.4
2	5.8	6.3	9.1	10.0	11.8
3	6.0	7.1	8.5	10.8	12.8
Mean	6.1	7.3	9.3	10.6	12.3

Table 5 Perfusate potassium concentration (meq/l).

Animal number	Sodium (meq/l)	Potassium (meq/l)
1	146	4.9
2	145	4.3
3	144	5.0
4	145	4.8
5	147	4.7
6	144	4.1
Mean	145	4.6

Table 6 Plasma sodium and potassium concentrations in normal rats.

Perfusion	Zero	1	2	3	4
		Time (hr).			
1	7.34	7.28	7.28	7.27	7.26
2	7.41	7.36	7.32	7.33	7.32
3	7.35	7.29	7.29	7.31	7.28
Mean	7.37	7.31	7.29	7.30	7.29

Table 7 Perfusate pH values.

experiments. The mean haematocrit value was 38% at the start of the perfusions and there was a small rise in this value to a mean of 40% after both 3 and 4 hr. of perfusion. When these results were interpreted in conjunction with the perfusate haemolysis data which indicated a mean haemolysis figure of 9.4% after 4 hr. perfusion it seemed likely that there was a real increase in the haematocrit value which was higher than that found in these experiments.

3.3 Measurement of the perfusate sodium and potassium concentrations

Samples of the perfusate were taken at hourly intervals from each of three perfusions and estimations of the plasma sodium and potassium concentrations were performed as described in the methods section. The results of these studies are shown in Tables 4 and 5. In order to establish normal values for the plasma sodium and potassium concentration, blood was taken from 6 rats by clean cardiac puncture following ether anaesthesia. The blood was placed in heparinised tubes and the estimations were carried out on plasma. The results are shown in Table 6.

3.4 Measurement of the perfusate pH values.

Samples of the perfusate were taken at zero time and then at hourly intervals from each of three 4 hr. perfusions and the perfusate pH value measured. Table 7 shows the results of these experiments and demonstrates that the perfusate pH was maintained between 7.37 and 7.29.

3.5 Perfusate total CO₂ levels

Samples of the perfusate were taken at zero time and at hourly intervals from each of three 4 hr. perfusions for the

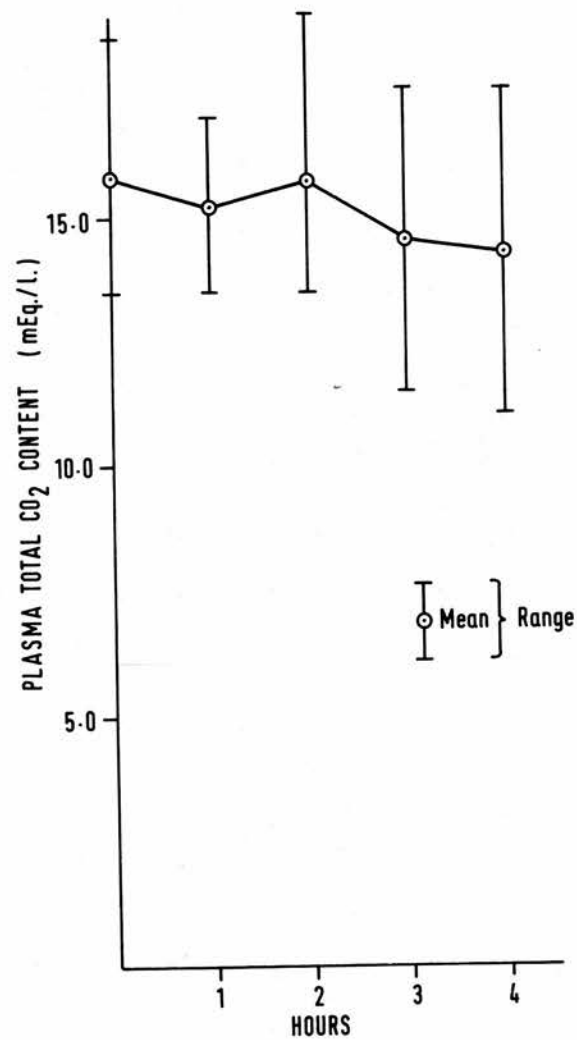

Perfusate plasma total CO₂ content
(three perfusions).

Fig. 16

Perfusion	Zero	1	2	3	4
		Time (hr).			
1	96	94	94	96	89
2	98	96	87	92	94
3	98	94	94	90	90
Mean	97	95	92	93	91

Table 8 Perfusate haemoglobin oxygen saturation (%).

measurement of the plasma total CO₂ content. The results of these experiments are shown in Fig.16.

3.6 Perfusate haemoglobin oxygen saturation

Samples of the perfusate were taken at zero time and then at hourly intervals from each of three 4 hr. perfusions for the estimation of the perfusate haemoglobin oxygen saturation.

Table 8 shows the results of these experiments and confirms that the mean haemoglobin oxygen saturation was maintained between 97% and 91% in these perfusions.

3.7 Measurement of perfusate flow rates

A measurement of perfusate flow rate was obtained by placing a measuring cylinder under the outflow from the liver chamber for a fixed length of time, and estimating the volume of perfusate which flowed through the liver. This method was unsatisfactory since it involved opening the perfusion chamber and hence the temperature control of the system was disturbed. For this reason perfusate flow rates were only measured accurately at 15 min. after the start of a number of perfusions and thereafter estimates of flow rate were obtained by counting the number of drops of perfusate falling from the liver chamber. The mean flow rate found in 7 perfusions of livers from normal animals using whole heparinised blood as perfusate was 1.8 ml./min./g. liver weight (range 1.1 - 2.4 ml./min./g.). Estimation of flow rates by drop counting showed that during the 4 hr. perfusion periods studied there was a fall of approximately 10 - 15% of the initial flow rates found.

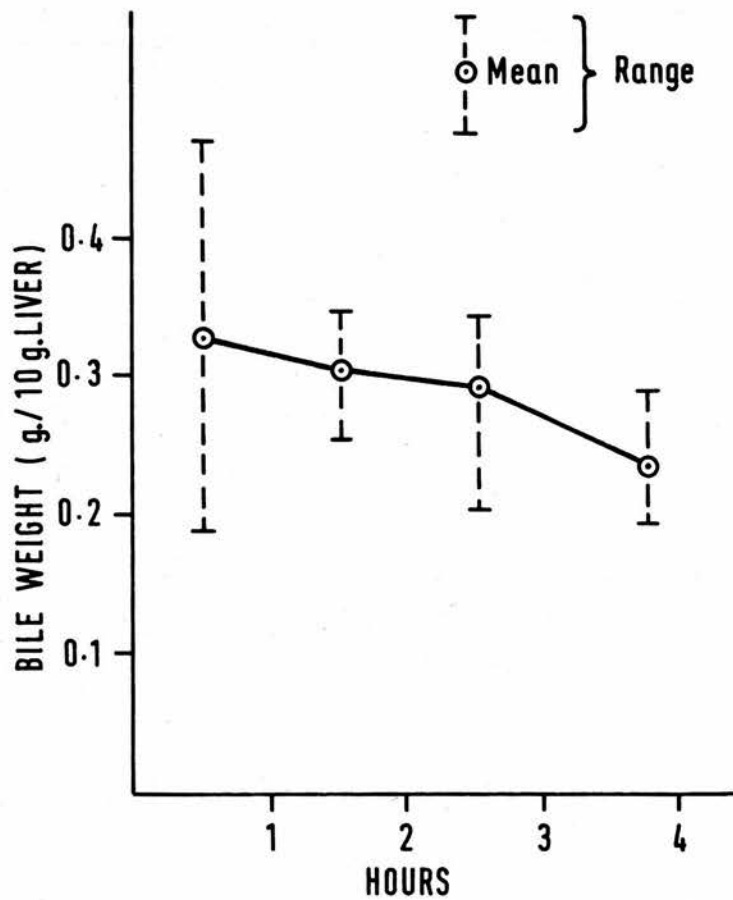

Bile flow rates (g./10g.liver weight) in perfusions (15) with whole rat blood.

Fig. 17

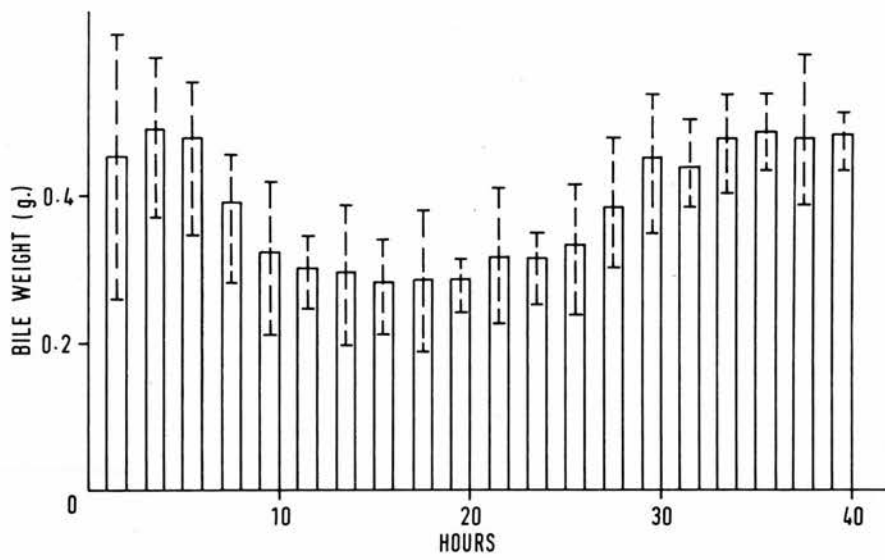

Bile flow rates in six rats subjected to biliary drainage.

Fig. 18 Bile weights shown as mean and range

3.8 Measurement of perfusate volume

Total perfusate volume was measured in 18 perfusions at the end of the 4 hr. perfusion period, using heparinised whole blood as perfusate. The mean perfusate volume was 22.7 ml. (range 19.9 ml. - 25.4 ml.).

4. The metabolic status of the isolated perfused rat liver

Using the apparatus described above and modified as shown above, with a perfusate pressure of 15 cm. of perfusate (whole heparinised rat blood), a number of studies was performed in order to establish the metabolic status in these isolated livers.

4.1 Bile flow rates

Fig. 17 shows the bile flow rates found in the first 15 perfusions of livers taken from normal rats. The flow rate was well maintained during the first 3 hr. of the perfusion period and in the fourth hr. there was a fall in the flow rate equal to 18% of the rate found in the first hr.

In order to compare the flow rates from the isolated perfused preparation with the bile flow rates found in rats subjected to biliary drainage, rats of the same body weights as the donor animals for the perfusion experiments were subjected to biliary drainage (average liver weight 9.1 g.). The highest bile flow rate (Fig. 18) was found in the fourth hr. following bile duct cannulation (mean 0.489 g./hr.) and approximately the same rate was found some 36 hr. following the start of the period of bile drainage. The early high flow rate was followed by a period when the rate fell rapidly till a minimum of 0.284 g./hr. was found at the sixteenth hr.

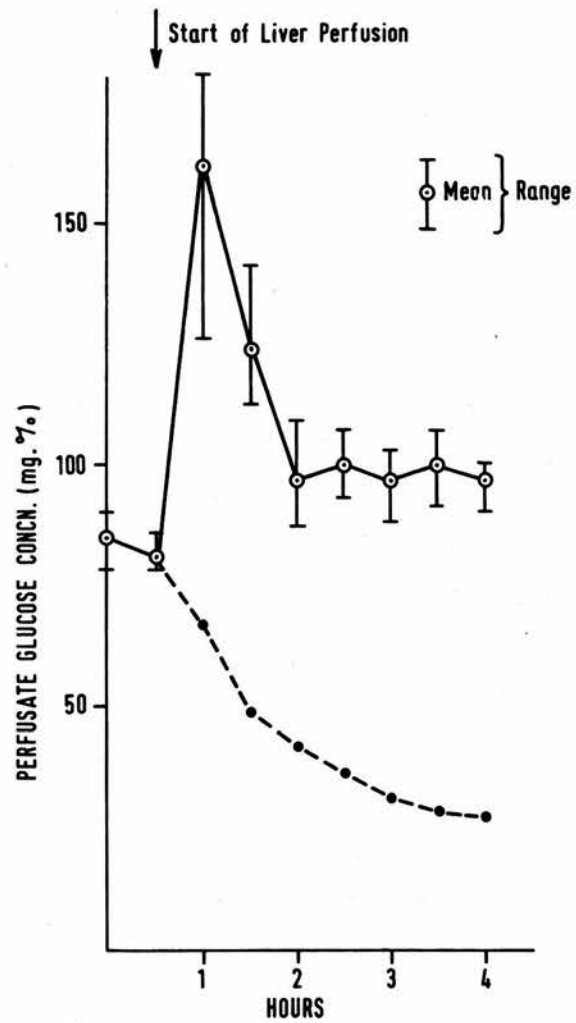

Perfusate glucose concentrations (four perfusions).
 ● - - ● Perfusate only circulated.
 ○ — Livers perfused.

Fig. 19

Perfusion	40 min.	2 hr. 40 min.	4 hr. 40 min.
1	2.17	2.11	—
2	2.04	1.97	1.98
3	2.05	1.98	2.09
Mean	2.09	2.02	2.04

Table 9 Biliary bromsulphthalein recoveries (mg)
from isolated perfused livers.

4.2 Perfusate glucose concentration during the 4 hr. perfusion period

Samples of the perfusate were taken directly into 0.38% aqueous perchloric acid solution at intervals of $\frac{1}{2}$ hr. for the estimation of the perfusate glucose concentration in each of 4 perfusions of normal livers. Samples were also taken from a perfusion system in which perfusate was circulated in the usual way but in which there was no liver included in the system. There was (Fig.19) an initial rise in the perfusate glucose concentration immediately following the insertion of the liver into the system and this rise was followed by a fall to levels which were, on average 12 mg.% higher than the levels found before the liver was inserted into the system.

When no liver was perfused there was a steady fall in the glucose concentration in the perfusate to a value of 27 mg.% at the end of the 4 hr. circulation period.

4.3 Excretion of bromsulphthalein by isolated perfused livers and by rats in vivo with bile duct cannulae

Bromsulphthalein was added to the perfusate after 40 min., 2 hr. 40 min. and 4 hr. 40 min. perfusion in 3 perfusions of normal livers. Bile was collected in 5 min. aliquots following the addition of the bromsulphthalein (except for the first aliquot which was of 10 min. duration in each case) and estimation of the biliary bromsulphthalein was carried out. Table 9 shows the recoveries of bromsulphthalein in the bile following the addition of 2.5 mg. of bromsulphthalein in each case. The time intervals

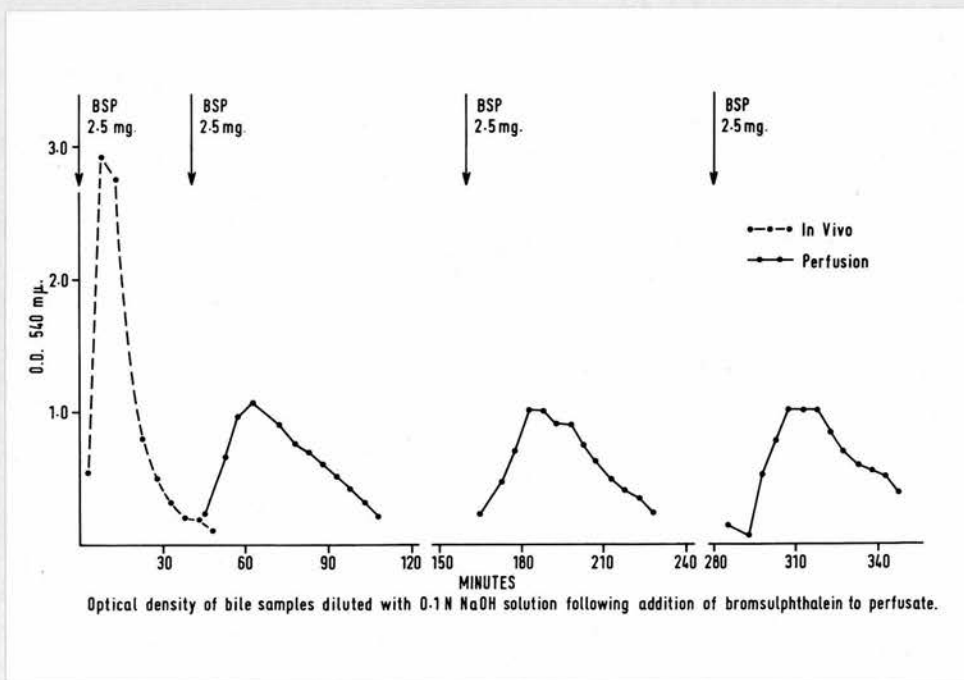

Fig. 20

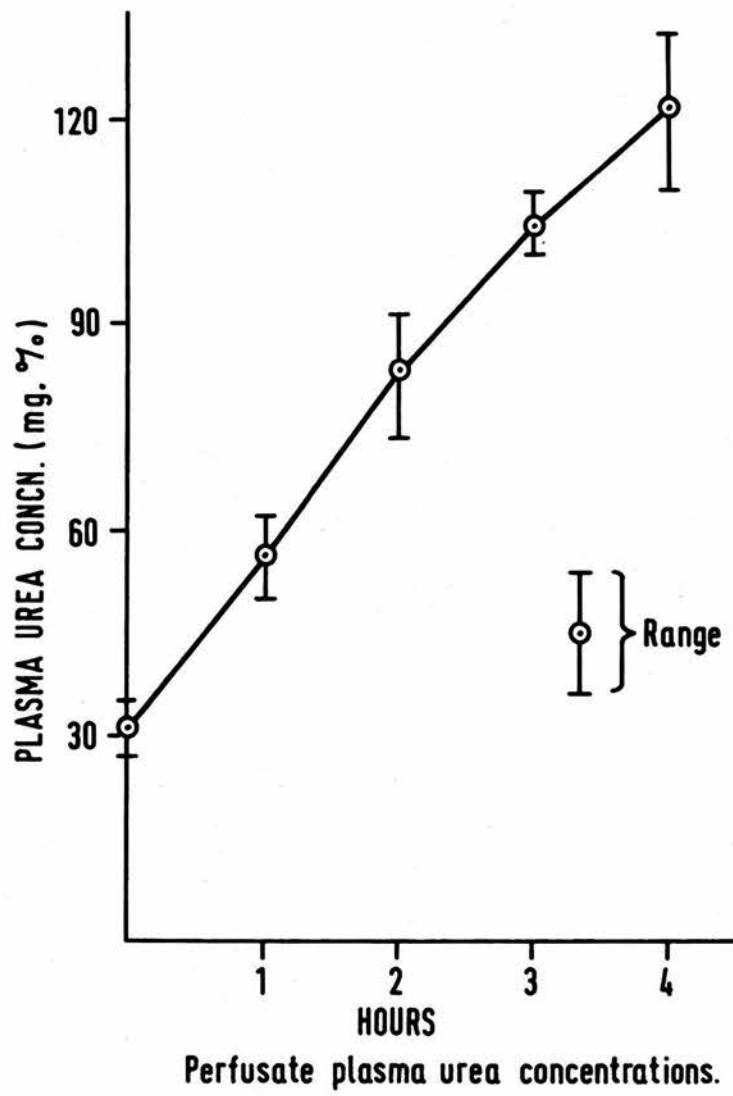

Fig. 21

chosen in these experiments were designed to test the capacity of the liver in bromsulphthalein excretion beyond the time which perfusions would normally be run. Fig. 20 shows the pattern of the excretion of the bromsulphthalein in a typical experiment.

In order to compare the excretion of bromsulphthalein found in the perfused liver with the situation found in vivo, 2 rats of approximately the same body weight as the donors for the perfusions described above were anaesthetised and subjected to bile duct cannulation. Once a free bile flow had been established, 2.5 mg. of bromsulphthalein was injected into the femoral vein of each animal and bile collected for bromsulphthalein estimation in 5 min. aliquots. The recoveries of bromsulphthalein found in these experiments were 2.43 mg. and 2.47 mg. respectively while the excretion pattern in one experiment is shown in Fig. 20.

4.4 Perfusate urea concentration during the 4 hr. perfusion period

Samples of the perfusate were taken at hourly intervals during 3 perfusions, each of 4 hr. duration, and the plasma was separated for the estimation of the urea concentration. The results of these experiments are shown in Fig. 21. There was a steady rise in the mean perfusate urea concentration, the hourly increments being 25 mg.%, 26 mg.%, 20 mg.% and 18 mg.% respectively.

**STUDIES ON CHOLESTEROL AND BILE ACID METABOLISM IN THE
ISOLATED PERFUSED RAT LIVER**

1. Introduction

Studies on the synthesis and excretion of bile acids by the isolated perfused rat liver preparation were performed in parallel with the preliminary work on the perfusion method. Thus, a number of preparations perfused with Rheomacrodex: blood, 1:1 were used to ascertain whether de novo bile acid synthesis was progressing. These early studies will be described in order to demonstrate the relatively poor perfusion preparation which was obtained by this method.

2. Studies using blood and Rheomacrodex as liver perfusate

2.1. Perfusion of livers from normal rats

Six perfusions were performed using livers taken from normal female rats weighing approximately 250 g. Bile collections were made hourly and each perfusion was continued for a period of 4 hr. [^{14}C]-cholesterol was added to the perfusate in each of these preparations in order to study the de novo synthesis of [^{14}C] bile acids. The use of radioactive labelled substrate was required to differentiate the newly synthesised bile acid (which would be radioactive) from the biliary bile acids which would represent either the excretion of the hepatic bile acid pool present at the start of the perfusions or the excretion of bile acids newly synthesised from non-radioactive hepatic or plasma cholesterol.

The [^{14}C] cholesterol was obtained by injecting [2. ^{14}C]-DL-mevalonic acid intraperitoneally into 6 rats which were anaesthetised 8 hr. later and killed by exsanguination by cardiac

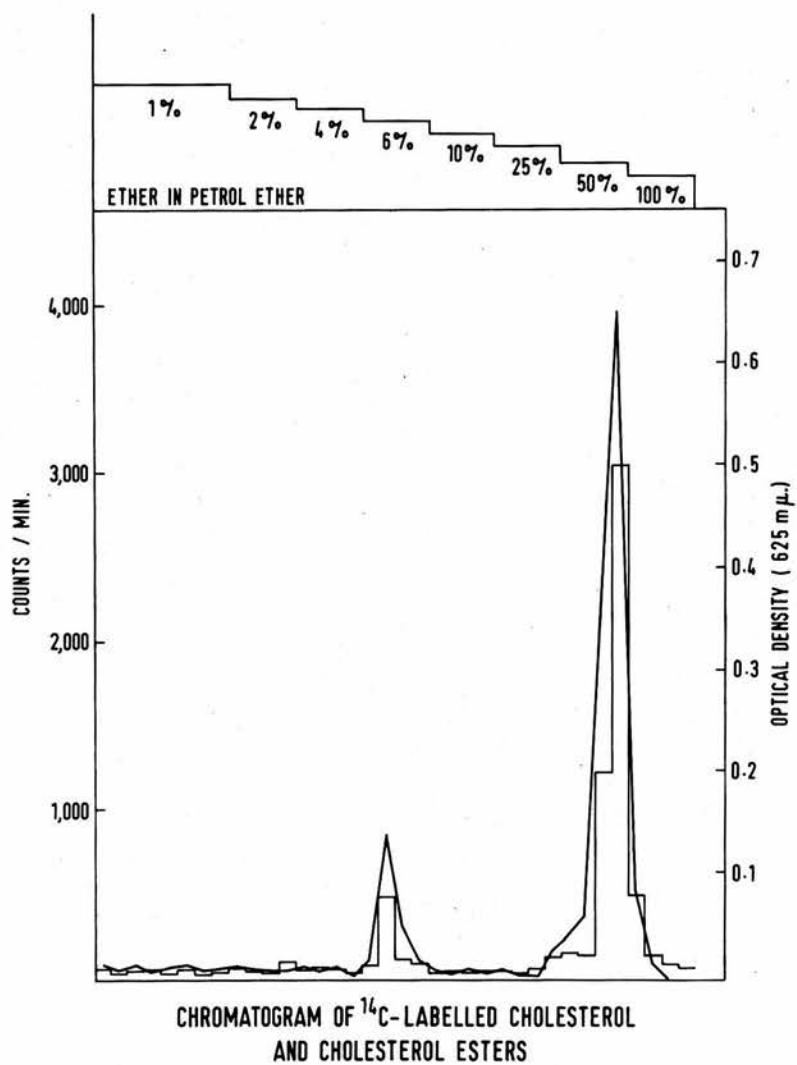
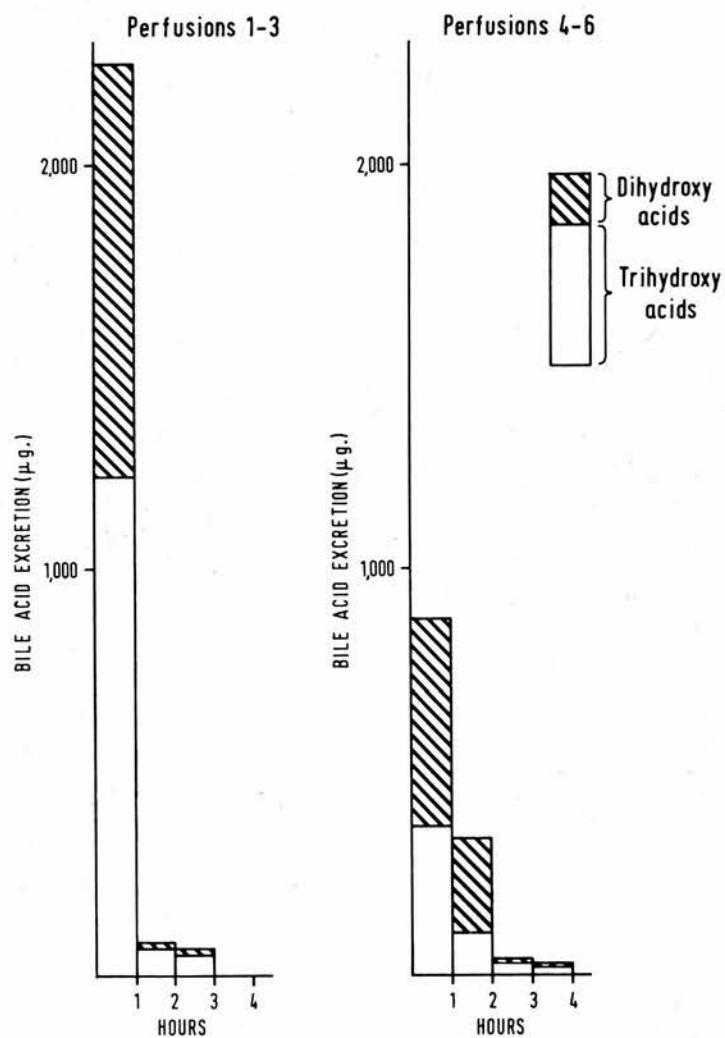

Fig. 22

puncture. These plasma samples were then pooled and an aliquot added to the perfusate, once each perfusion had been satisfactorily established. The studies of Elwood and Van Bruggen (1961) have demonstrated that between 2% and 3% of the total radioactivity from an injection of [2-¹⁴C]-DL-mevalonic acid appears in the blood and that this fraction remains constant for at least 4 hr. after injection. To confirm that the identity of the molecular species carrying the radioactive labelled carbon was cholesterol, a sample of the plasma obtained from these rats was extracted with ethanol under reflux for 1 hr., the ethanolic phase taken to dryness and chromatographed on a silicic acid column (see methods section). Aliquots of the eluates from the columns were taken for liquid scintillation counting and for estimation of the cholesterol content. Fig. 23 shows the results of this experiment. Two well defined peaks of radioactivity and Liebermann-Burchardt positive material were found, confirming that the Liebermann-Burchardt positive material appeared in the same eluates as the radioactivity. It seemed likely that the smaller peak was cholesterol ester while the larger peak was unesterified cholesterol. Thin-layer chromatography of material from these eluates confirmed that the latter contained material with the same mobility as a standard sample of unesterified cholesterol and that the former peak contained material with a faster mobility consistent with cholesterol ester. In each case the radioactivity was localised to the cholesterol or the cholesterol ester region. There was no evidence for the presence of significant quantities of bile acid in these plasma samples

22



Bile acid excretion by isolated perfused livers taken from normal rats.

Fig. 23

since eluting the column with a 10% aqueous sodium hydroxide solution, after the 100% ether elution, did not remove any further radioactive material.

Bile samples from these perfusions were combined. The hourly aliquots from the first 3 perfusions and from the last 3 perfusions were combined separately into hourly pools. Fig. 23 shows the quantities of bile acids found. The pool for the fourth hr. in the first group was lost through breakage of a tube. It is clear from these results that while bile acid excretion does continue in both groups throughout the perfusion period the original high rate of excretion falls off rapidly to figures less than a total of 100 $\mu\text{g.}/\text{hr.}$ in both cases. In the first group approximately equal quantities of dihydroxy and trihydroxy acids were excreted in the first hr. and thereafter the ratio of trihydroxy acid to dihydroxy acid was 4:1. In the second group rather more dihydroxy than trihydroxy acids were excreted in the first 2 hr. and thereafter the ratio of trihydroxy to dihydroxy acid was 4:1.

The eluates containing the Pettenkofer positive material from the dihydroxy acid peak were pooled as were the eluates containing the Pettenkofer positive material from the trihydroxy peak. The combined eluates were taken to dryness in vacuo and the dried residue taken up in ethanol for analysis by thin-layer chromatography. The chromatograms were developed using trimethylpentane-ethyl acetate-acetic acid in the proportions 10:10:2 for the material from the dihydroxy peak, and cyclohexane-ethyl acetate-acetic acid in the proportions 7:23:3 for the

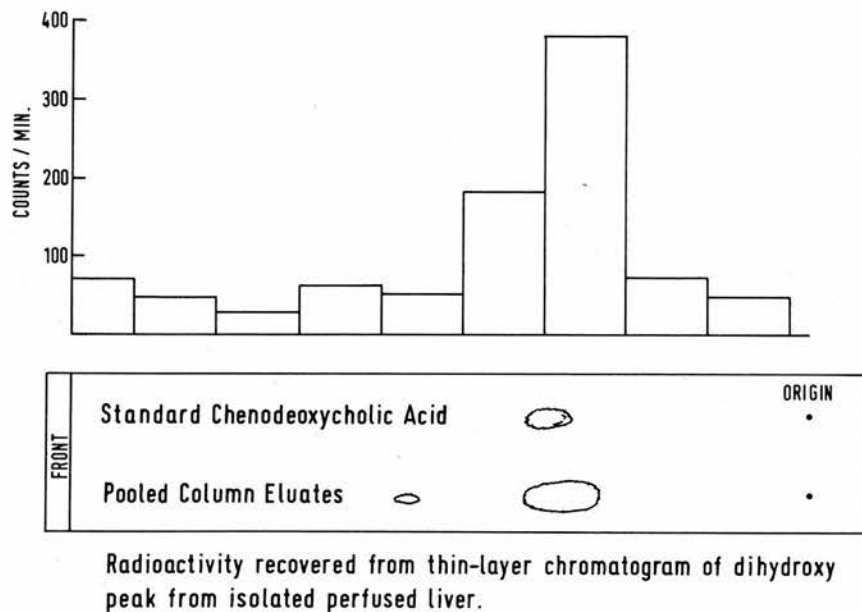
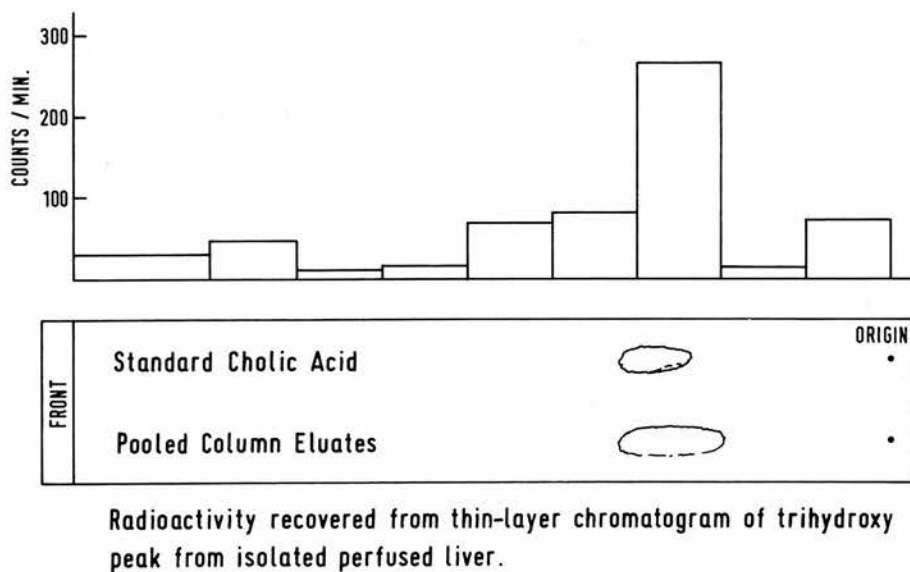

Fig. 24



material taken from the trihydroxy peak (Eneroth 1963), (see appendix). In each case pure cholic acid and chenodeoxycholic acid were run as standards. The material in the dihydroxy acid peak ran as two spots (Fig.24). The majority of the material had a mobility identical with standard chenodeoxycholic acid while the minor spot ran with approximately twice that mobility. The plate was segmented into 2 cm. strips and the silica gel scraped off and extracted with ethanol which was taken to dryness in an air oven. The dried extracts were taken up into scintillation fluid for estimation of the radioactivity. Fig.24 shows that the majority of the radioactivity on the plate was found at a position corresponding with the mobility of the standard chenodeoxycholic acid. 82% of the total radioactivity was recovered in the two segments corresponding to the mobility of the standard bile acid. Fig. 25 shows the results for the material from the trihydroxy peak. The majority (81%) of the radioactivity here was recovered from a position corresponding to the mobility of the standard cholic acid. The pooled column eluates ran as a single spot in this case with mobility identical with the standard cholic acid.

From these experiments, it seemed likely that the livers perfused with blood:Rheomacrodex, 1:1 were capable of the synthesis of both chenodeoxycholic acid and cholic acid utilising, as substrate, biosynthetically labelled plasma cholesterol in the form of lipoprotein. However the rapid falling off in the rate of biliary bile acid excretion in these preparations prompted

the question, whether the livers were failing as a consequence of the perfusion process. On the other hand it seemed possible that the hepatic bile acid pool was being excreted in the first hr. of perfusions and the low total excretion rates thereafter were then equal to the de novo bile acid synthesis rates.

The studies of Eriksson (1957), Myant and Eder (1961) and Strand (1962) demonstrated that following institution of chronic biliary drainage in rats the total bile acid excretion rate falls during the first 24 hr. and that there is then a rise in the excretion rate to a maximum in the second or third day. These findings have been interpreted as indicating a rise in the de novo total hepatic bile acid synthesis rate in response to the interruption of the enterohepatic circulation of bile salts. If this was a correct interpretation of these findings and the perfused liver preparation used here was not failing due to the perfusion technique then it appeared likely that it should be possible to show a constant total bile acid excretion rate throughout the 4 hr. perfusion period since in this preparation the total excretion of bile acids would represent de novo synthesis and not excretion of bile acids reabsorbed from the gut.

2.2. Perfusion of livers from rats subjected to 44 hr. biliary drainage

Six female rats weighing 220 - 240 g. were each subjected to biliary drainage for 44 hours. Liver perfusions were performed on the livers from these animals using Rheomacrodex: blood, 1:1

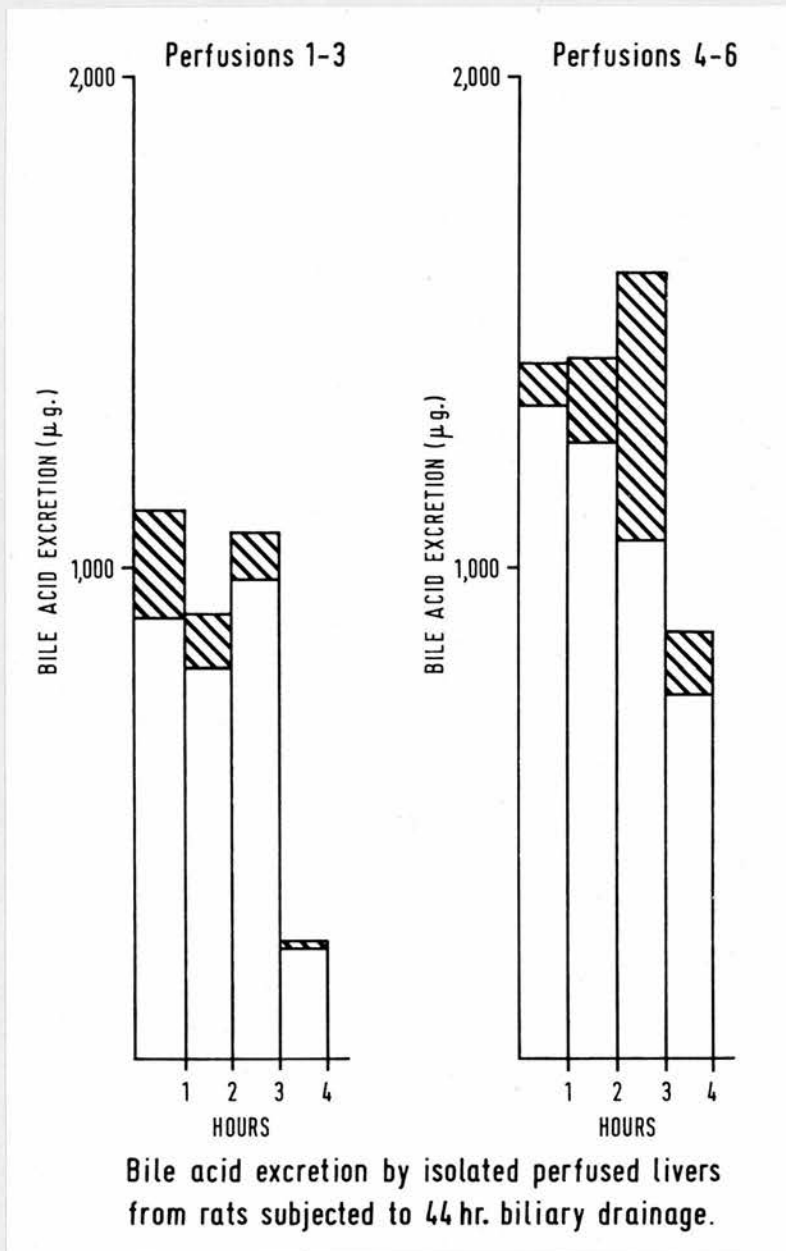

Fig. 26

as perfusate, and [^{14}C]- cholesterol was delivered into the perfusate of each system in the same manner as described above. These perfusions were continued for a total of 4 hr. each with hourly bile collections and the bile samples were combined and analysed as described above. Fig. 26 shows the results of the bile acid analyses from these experiments. The pattern of total bile acid excretion in these perfusions differs fundamentally from that seen in the perfusion of normal livers. In both groups of experiments the initial rate of bile acid excretion was well maintained for the first 3 hr. of the perfusion period while in the fourth hr. there was a considerable drop in the rate in both groups. The ratio of trihydroxy to dihydroxy bile acids was variable, particularly in the fourth hr. of the first group in which the ratio was 21:1 and in the third hr. of the second group, 5.6:1. The mean ratio of trihydroxy to dihydroxy acids in the groups was 6.5:1 in group one and 4.7:1 in group two.

The dihydroxy acid and the trihydroxy acid eluates from the liquid:liquid columns were combined separately and run on thin-layer chromatograms as described above. The dihydroxy peak in this case contained material which ran as a single peak with the same mobility as standard chenodeoxycholic acid and the trihydroxy peak contained material with the same mobility as standard cholic acid. When the silica gel from these chromatograms was segmented and eluted the radioactivity corresponded to the standard spots in both cases.



This group of perfusion experiments provided confirmation that these isolated liver preparations were able to synthesise bile acids de novo and that cholesterol in the form of lipoprotein was utilised as substrate for the synthesis. Comparison of the perfusions using normal livers (experiment 1.1) and the perfusions using livers from animals subjected to biliary drainage suggested that the falling off in the rate of total bile acid excretion in the former was not due to the livers failing on account of the perfusion technique. It seemed likely that the hepatic bile acid pool present at the start of each perfusion was excreted in the first hr. and that the subsequent low bile acid excretion rate represented the normal de novo bile acid synthesis rate. On the other hand, the livers from animals subjected to biliary drainage showed no such reduction in total bile acid excretion rate during the first 3 hr. of perfusion; suggesting a high de novo synthesis rate. It seemed probable, however, that some reduction in liver function was present during the fourth hr. of perfusion when the total bile acid excretion rate (and hence probably also the total synthesis rate) in the livers from fistula rats fell significantly.

2.3. Perfusion of livers from rats subjected to 44 hr. biliary drainage

The studies of Elwood and Van Bruggen (1961) showed that a maximum of approximately 3% of the radioactivity injected intraperitoneally into rats as [2. ¹⁴C] DL-mevalonic acid appears in the blood as non-saponifiable material. As a procedure for the

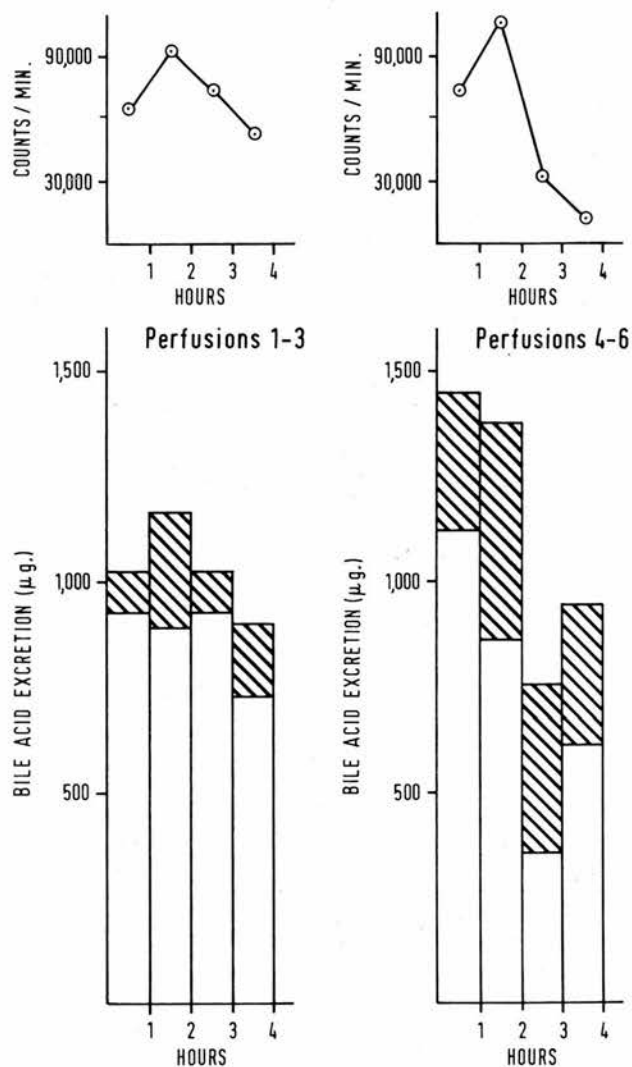

Bile acid radioactivity and excretion rates by isolated perfused livers from rats subjected to 44 hr biliary drainage.

Fig. 27

biosynthesis of lipoprotein containing [^{14}C]-cholesterol it seemed rather wasteful of radioactive material and it was decided to study the possibility of adding [2. ^{14}C]-DL-mevalonic acid directly to the perfusate. This procedure might possibly permit high specific activity labelling of the cholesterol in the perfusion system. Six perfusions were performed using livers taken from female rats (body weights 206 - 225 g.) which had been subjected to 44 hr. biliary drainage. In each case 4 μC . [2. ^{14}C]-DL-mevalonic acid (in 0.1 ml. acetone) was added over a period of 2 min. to the perfusate once the perfusion was running satisfactorily. This solution was injected directly into the perfusate flow leading to the portal vein of the perfused liver. Careful study of the rate of perfusate flow from the liver during the injection of the acetone solution did not demonstrate that any adverse effects were produced by the procedure. Thereafter, bile collections were made hourly for 4 hr. and the samples combined in the same way as described above.

The results of the bile acid analyses on these combined bile samples are shown in Fig.27. In group one the total bile acid excretion rate in the first hr. was well maintained throughout the whole of the 4 hr. perfusion period while in group 2 there was a drop in the excretion rate during hr. 3 and 4 indicating a reduced rate of de novo bile acid synthesis and therefore, some reduction of liver function during the last 2 hours. Aliquots were taken from each eluate from the liquid:liquid partition column system for liquid scintillation

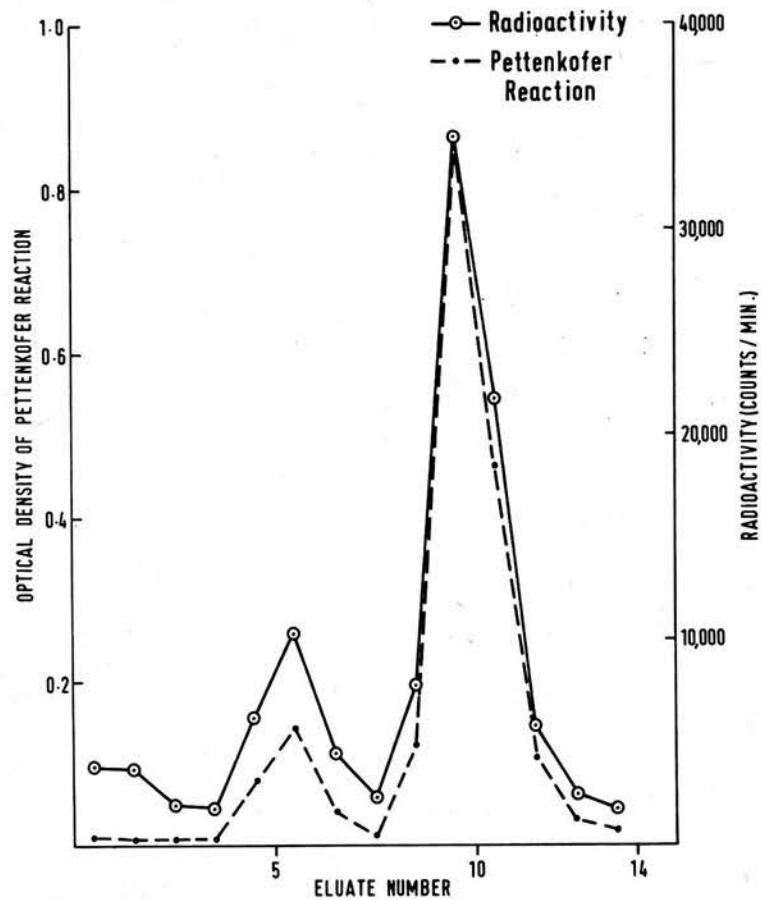

Pettenkofer reaction and radioactivity in bile acids from perfused livers.

Fig. 28

counting. The resulting association between the Pettenkofer optical density and radioactive counting rate is shown in Fig.28. Two well defined peaks of Pettenkofer chromogenicity and of radioactivity were found which corresponded exactly one with the other. This provided further evidence that the molecular species carrying the label in the bile collected from these perfused livers were chenodeoxycholic and cholic acids. The specific activity of the bile acids recovered from these experiments was much greater than from the perfusions in which the substrate was [^{14}C]-cholesterol in the form of plasma lipoprotein. It seemed possible, therefore, that direct addition of [$2. \text{}^{14}\text{C}$] DL-mevalonic acid to the perfusate would provide a suitable method for radioactive labelling of the cholesterol in these preparations.

The remaining material in the dihydroxy eluates from both columns was combined and authentic non-radioactive chenodeoxycholic acid was added. The material from the trihydroxy peaks was also combined with the addition of authentic non-radioactive cholic acid. Both groups of material were taken to dryness in a hot air oven and the residue dissolved in each case in a small volume of ethyl acetate. Following 24 hr. in the deep freeze a satisfactory harvest of crystalline material was obtained in each case. These crystals were dried over calcium chloride in vacuo and a sample taken for the Pettenkofer reaction and radioactive scintillation counting. This process was repeated 3 times in each case. Tables 10 and 11 show the results of these

Recrystallisation	Pettenkofer optical density	Bile acid weight	Radioactivity (counts/min)	Specific activity (counts/min/ μ g)
1	0.270	42.9	171	4.00
	0.261	41.4	168	
2	0.307	48.7	189	3.76
	0.299	47.5	173	
3	0.422	67.0	262	4.00
	0.437	69.4	284	

Table 10 Recrystallisation of bile acid from eluate 5 of liquid:liquid column system.

Recrystallisation	Pettenkofer optical density	Bile acid weight (μ g)	Radioactivity (counts/min)	Specific activity (counts/min/ μ g)
1	0.442	33.0	108	3.08
	0.460	34.2	110	
2	0.536	39.8	112	2.85
	0.611	45.6	131	
3	0.406	30.3	90	3.03
	0.422	31.5	97	

Table 11 Recrystallisation of bile acid from eluate 10 of liquid:liquid column system.

recrystallisation experiments. In both cases the material recrystallised to constant specific activity, confirming the identity of the material in the bile from these perfused livers. Since there was no measurable initial fall in the specific activities of the samples it was probable that the radioactivity present was exclusively in the same molecular species as the primary bile acid added as 'carrier'.

The finding of a reduced bile acid synthesis rate during the fourth hr. of these perfusions, and other indications of poor maintenance of liver function (see liver perfusion method section) in livers perfused with Rheomacrodex: blood, 1:1, led to efforts to perfuse livers with whole blood. This method appeared to produce better liver function throughout the 4 hr. perfusion period (see liver perfusion method section) and thereafter all perfusions were performed using whole rat blood as perfusate.

3. Studies using heparinised whole rat blood as perfusate

3.1. Perfusion of livers from normal rats and from rats subjected to 44 hr. biliary drainage - addition of [2-¹⁴C] DL-mevalonic acid

Perfusions using whole, heparinised rat blood were carried out on 3 livers taken from normal female rats (body weights 190 g., 200 g. and 220 g.) and 3 livers taken from rats each previously subjected to biliary drainage for a period of 44 hr. (body weights 200 g., 220 g. and 230 g.). The rats subjected to biliary drainage were allowed free access to their normal diet and to drinking fluid containing electrolyte as described in the section "General metabolic studies on bile fistula rats". Once each perfusion was established, 3 μ C. of [2-¹⁴C]-DL-mevalonic acid in

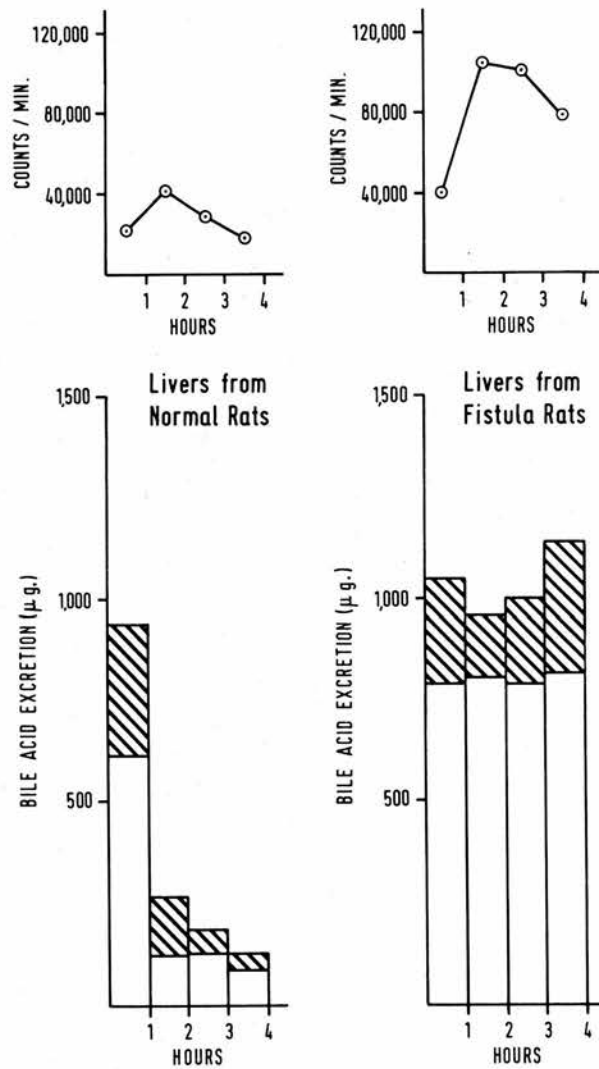

Bile acid radioactivity and excretion rates in livers perfused with whole rat blood.

Fig. 29

0.2 ml. acetone was added to the perfusate. Bile samples were collected hourly from each perfusion for a total of 4 hr. and the samples combined as described above. Samples of perfusate (1.0 ml. in each case) were taken at the start of each perfusion (before the addition of [2. ¹⁴C]-DL-mevalonic acid) and then at hourly intervals for 4 hours. These samples were centrifuged and the supernatant plasma sampled directly into methanolic potassium hydroxide in preparation for total cholesterol estimation (Abell, et al 1952).

Fig. 29 shows the results of the bile acid analyses performed on the pooled bile samples from these perfusion experiments. The rate of total bile acid excretion in the livers from normal animals was 940 μ g. in the first hr. and this rate fell to 120 μ g. in the fourth hr. of perfusion. The ratio of cholic acid to chenodeoxycholic acid was 1.8:1 in these perfusions. The rate of total bile acid excretion in the livers from animals subjected to biliary drainage was 1050 μ g. in the first hr. and this rate was well maintained throughout the whole of the 4 hr. perfusion period. In this group of perfusions the ratio of cholic acid to chenodeoxycholic acid was 3.4:1. In both of these groups of perfusions the total radioactivity recovered in bile acids reached a maximum value in the second hr. of perfusion and in each case there was some reduction in this figure during hr. 3 and 4. The total radioactivity recovered as biliary bile acid was greater in the livers taken from bile fistula animals than in the normal group by a factor of 2 in the first hr., rising to a factor of 4

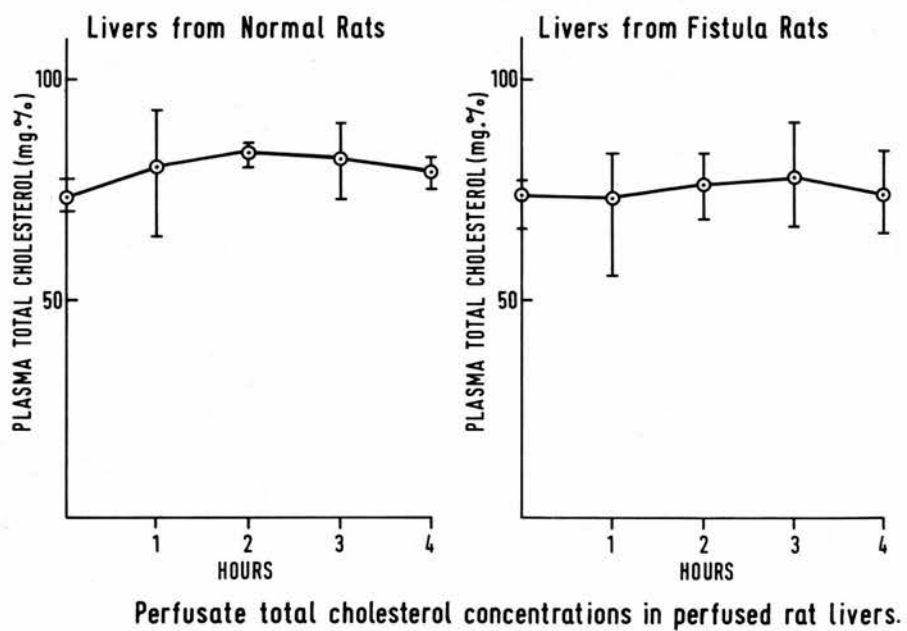

Fig. 30

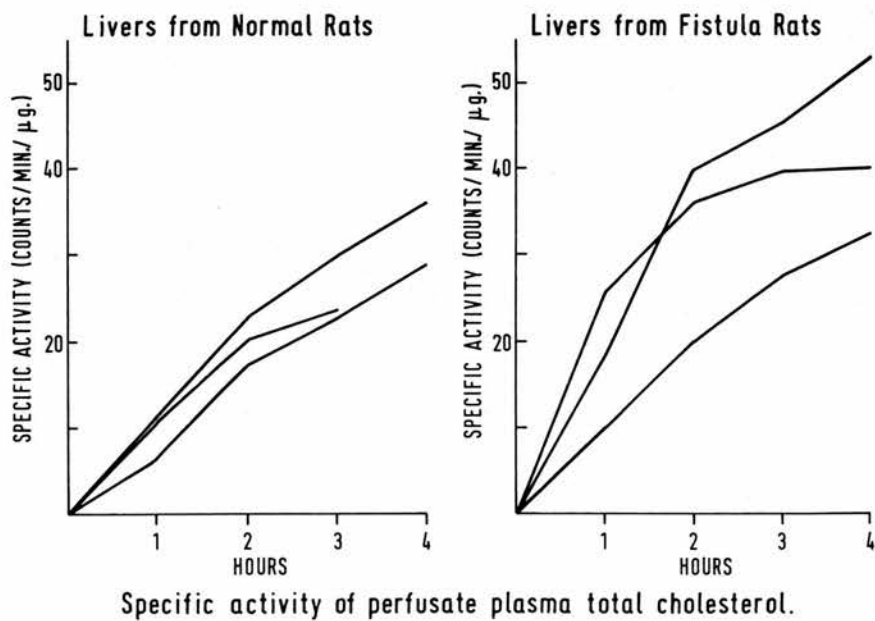

Fig. 31

in the fourth hr. of perfusion.

The plasma total cholesterol concentrations during these perfusions are shown in Fig. 30. In the perfusions of livers from normal rats there was a small rise in the total cholesterol concentration from a mean of 72.3 mg.% at the start of the perfusions to a mean of 83.1 mg.% after 2 hr. perfusion and a fall to 78.6 mg.% after 4 hr. perfusion. No significant change in total cholesterol concentrations occurred in the perfusions of livers from bile fistula rats. The specific activity of the perfusate plasma total cholesterol in the perfusions of livers from normal rats (Fig. 31) showed a steady rise throughout the perfusion period while a similar pattern was seen in the perfusions of liver from fistula rats. The mean specific activity of the perfusate total cholesterol was 9.6 counts/min./ μ g. after one hr. perfusion in the livers from normal rats and 18.0 counts/min./ μ g. in the livers from fistula rats. Since the same amount of radioactive mevalonic acid was added to all perfusions this suggested that the liver cholesterol of the fistula rats was more rapidly in equilibrium with the perfusate plasma cholesterol than the liver cholesterol of the normal rats.

At the end of 4 of these perfusion experiments the whole perfusate and the perfused liver were extracted separately with ethanol and then with ethyl acetate under reflux. The pooled ethanol and ethyl acetate extracts were made up to a known volume and a measured aliquot taken for total cholesterol and radioactivity estimation. The conversion of radioactive mevalonic acid

to radioactive cholesterol in these 4 perfusions was found to be 44.8%, 46.9%, 52.4% and 52.9% of the added radioactive mevalonic acid which is consistent with the complete conversion of the biologically active isotope of mevalonic acid to cholesterol.

In these perfusions the added [2. ^{14}C]-DL-mevalonic acid is converted in the liver into [^{14}C]-cholesterol. This experimental design therefore permits the study of the conversion of this newly synthesised cholesterol into [^{14}C]-biliary bile acids as well as the manner in which this [^{14}C]-cholesterol equilibrates with the cholesterol circulating as lipoprotein in the perfusate. In this way, confirmation has been obtained that the rat liver responds to interruption of the bile salt enterohepatic circulation by increased bile acid synthesis. However, further study seemed desirable to investigate the conversion of added [^{14}C]-cholesterol in the form of lipoprotein since it seemed possible that this plasma cholesterol pool might not be utilised in the same rapid fashion as the newly synthesised cholesterol studied above.

3.2. Perfusion of liver from normal rats and from rats subjected to 44 hr. biliary drainage - addition of [^{14}C]-cholesterol as lipoprotein

Perfusions were performed on livers taken from 3 normal rats (body weights 210 g., 200 g. and 230 g.) and from 3 rats (body weights 230 g., 195 g. and 210 g.) each previously subjected to 44 hr. biliary drainage. The radioactive cholesterol substrate was obtained by removing the plasma from a number of rats 10 hr. following intraperitoneal injection of 10 μC . [2. ^{14}C]-DL-mevalonic acid into each animal. In each case the cholesterol substrate in the form of plasma lipoprotein was added to the perfusate once

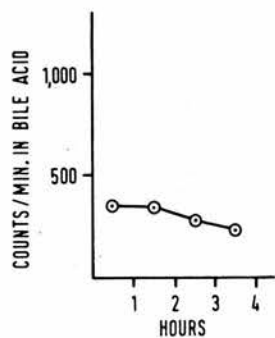

Perfusions of
Livers from
Normal Rats

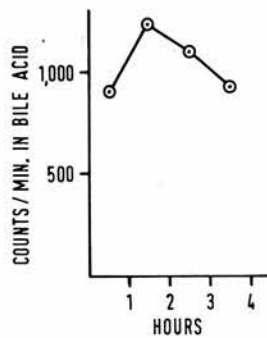

Perfusions of
Livers from
Fistula Rats

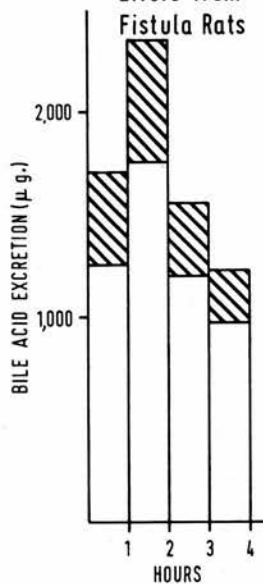
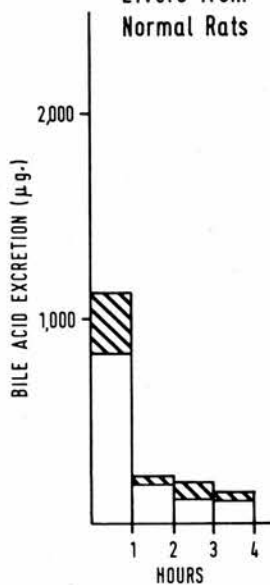

Bile acid radioactivity and excretion rates in
livers perfused with whole rat blood.

Fig. 32

the perfusion system was satisfactorily established. Bile samples were collected hourly for 4 hr., combined as described above and bile acid analyses performed. Fig. 32 shows the results of these analyses. There was a marked difference between the total bile acid excretion pattern in the 2 groups of perfusions. The rate of total bile acid excretion in the perfusions of livers from normal animals was 1130 μg . in the first hr. and this fell to a figure of 200 μg . and 150 μg . in the third and fourth hr. of perfusion. The ratio of cholic acid to chenodeoxycholic acid was 2.7:1 in this group. In the liver from fistula animals total bile acid excretion rate during the first hr. was 1740 μg . and this rate rose to 2360 μg . in the second hour. This was followed by a fall in the rate of excretion to 1650 μg . in hr. three and 1270 μg . in the fourth hour. The ratio of cholic acid to chenodeoxycholic acid was 3.1:1. The recovery of radioactivity in the excreted bile acids in these groups was much lower than in the perfusions to which [2. ^{14}C]-DL-mevalonic acid was used as precursor (Fig.29). The radioactivity recovered in bile acids from the fistula animals' livers was 3 - 4 times higher than from the normal livers.

Plasma samples (1.0 ml.) were taken at the start of the perfusions (30 sec. following addition of radioactive plasma to the perfusate) and at hourly intervals throughout the 4 hr. perfusion period. In the perfusions of livers from normal rats the mean plasma total cholesterol concentration rose from 68 mg.%

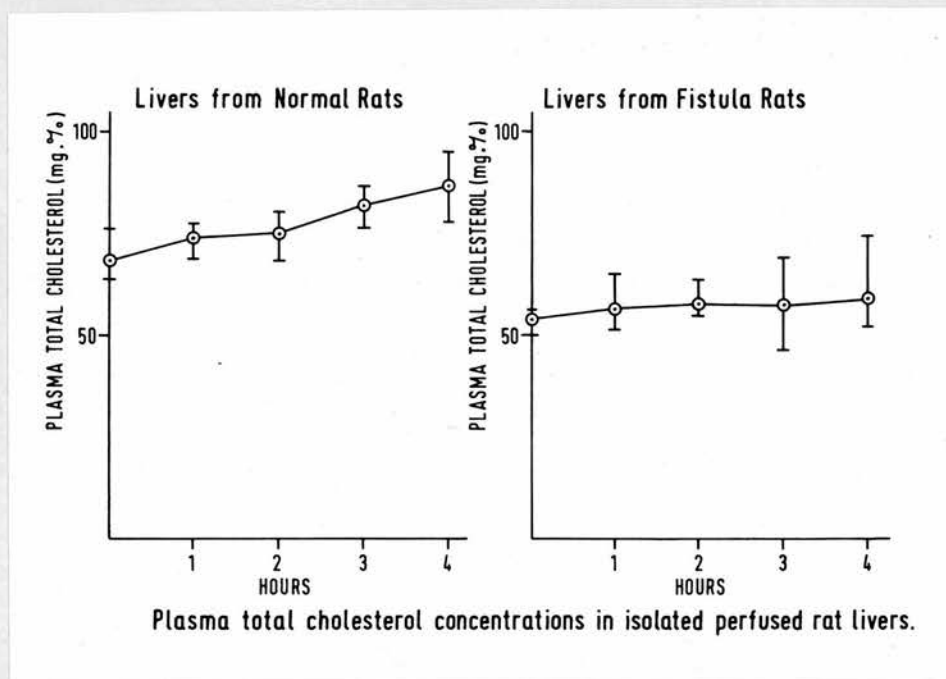

Fig. 33 Total cholesterol conc. shown as mean and range

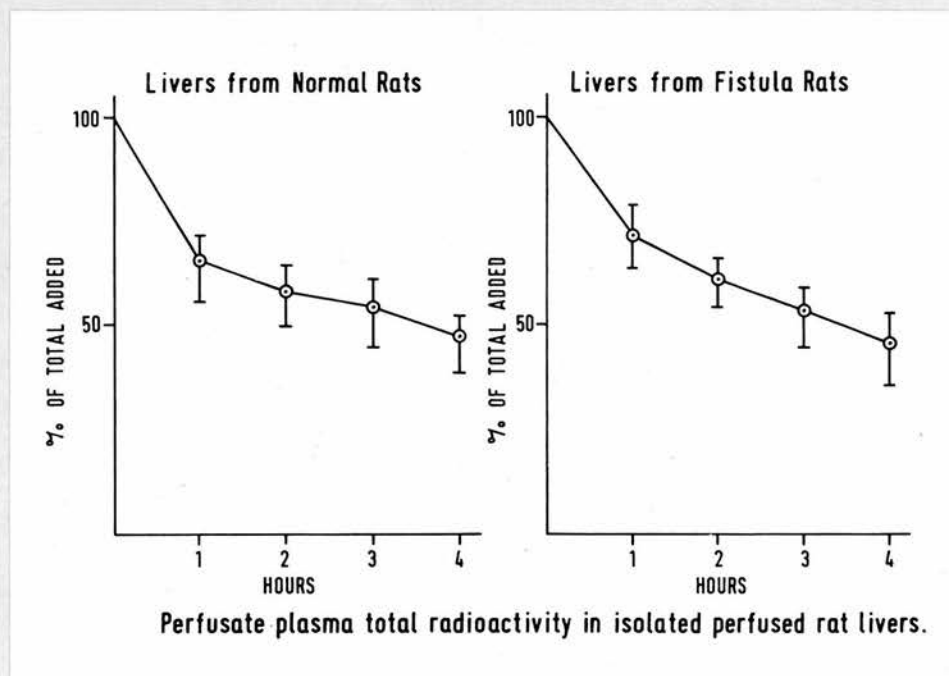

Fig. 34 Radioactivity added shown as mean and range

to 86 mg.% after 4 hr. (Fig. 33) while in the perfusions of livers from fistula animals the mean starting concentration was 53.5 mg.% and this rose slightly to 59 mg.% after 4 hour. Since the amount of radioactivity added to these perfusions was not identical in each case the total radioactivity added to the perfusate at the start of each perfusion has been expressed as 100% and the calculated quantity of radioactivity remaining in the perfusate during the perfusion has been expressed as a percentage of the quantity added (Fig. 34). In both groups of perfusions there was a steady fall in the perfusate total radioactivity to 47% in the perfusions of livers from normal animals and 45.5% in the perfusions of livers from fistula animals. This reduction in perfusate plasma total cholesterol radioactivity indicates equilibration between plasma and liver cholesterol pools.

The total bile acid excretion rates found in these experiments are similar to those found where the radioactivity is added to the perfusion system in the form of [2. ^{14}C]-DL-mevalonic acid. The rate of [^{14}C] labelling of the excreted bile acids is lower where the substrate used is [^{14}C]-cholesterol than where it is [2. ^{14}C]-DL-mevalonic acid. For this reason it was decided to add radioactive label to future perfusions by means of the addition of [2. ^{14}C]-DL-mevalonic acid.

3.3 Perfusion of livers from thyroidectomised rats and from control rats - addition of [2. ^{14}C] DL-mevalonic acid

A group of 12 female rats (body weights 160 - 185 g.) were maintained together on the stock diet (see appendix) for a period

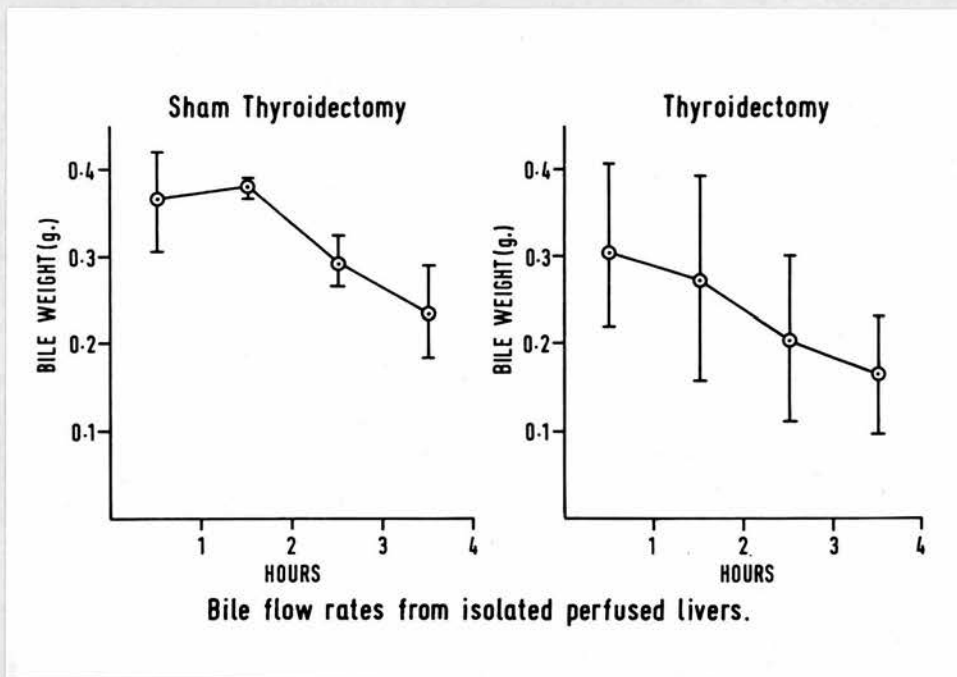
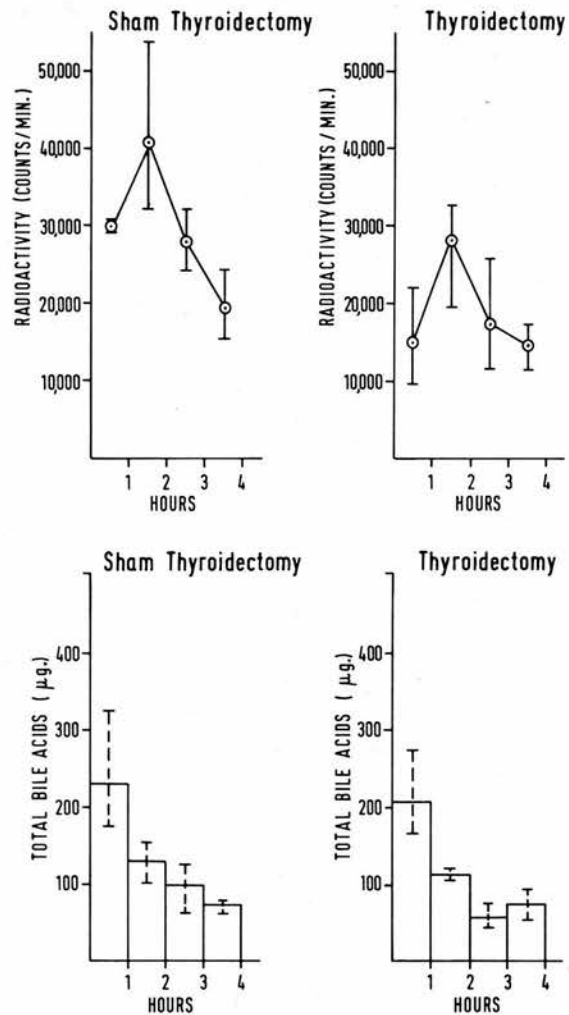

Fig. 35 Bile weights shown as mean and range



Total bile acid and radioactivity excretion rates by perfused livers from sham thyroidectomised and thyroidectomised rats.

Fig. 36 Total bile acids and radioactivity shown as mean and range

of 2 months. Six of these rats were then subjected to surgical thyroidectomy and 6 to sham thyroidectomy. The animals were maintained for a further 6 weeks while body weights and heart rate studies were carried out. These studies showed a distinct separation of the groups similar to that described in "Studies on the total bile acid excretion rate in the bile fistula rat". Livers from 3 animals of each group were perfused with the addition of [2. ¹⁴C]-DL-mevalonic acid (in 0.2 ml. acetone) to the perfusate. Each perfusion was continued for 4 hr. the bile samples were weighed and bile acid analyses performed on each sample separately. The bile acid analyses on the samples from the first perfusion in the thyroidectomised group demonstrated total excretion rates far outside the range of the other perfusions. An additional perfusion was included in this group and the anomalous perfusion is reported as a separate report in the appendix.

The bile flow rates in these perfusions are shown in Fig.35. The mean flow rate in the thyroidectomised group was lower than in the corresponding sham thyroidectomised group.

The results of the biliary bile acid analyses from these perfusions are shown in Fig. 36. In both groups of perfusions there was a fall in the mean total bile acid excretion rate the values being 230 μ g. and 210 μ g. in the first hr. in the sham operated and the thyroidectomised groups respectively. In the third and fourth hr. the excretion rates in the sham operated group were 100 μ g. and 70 μ g. and in the thyroidectomised group

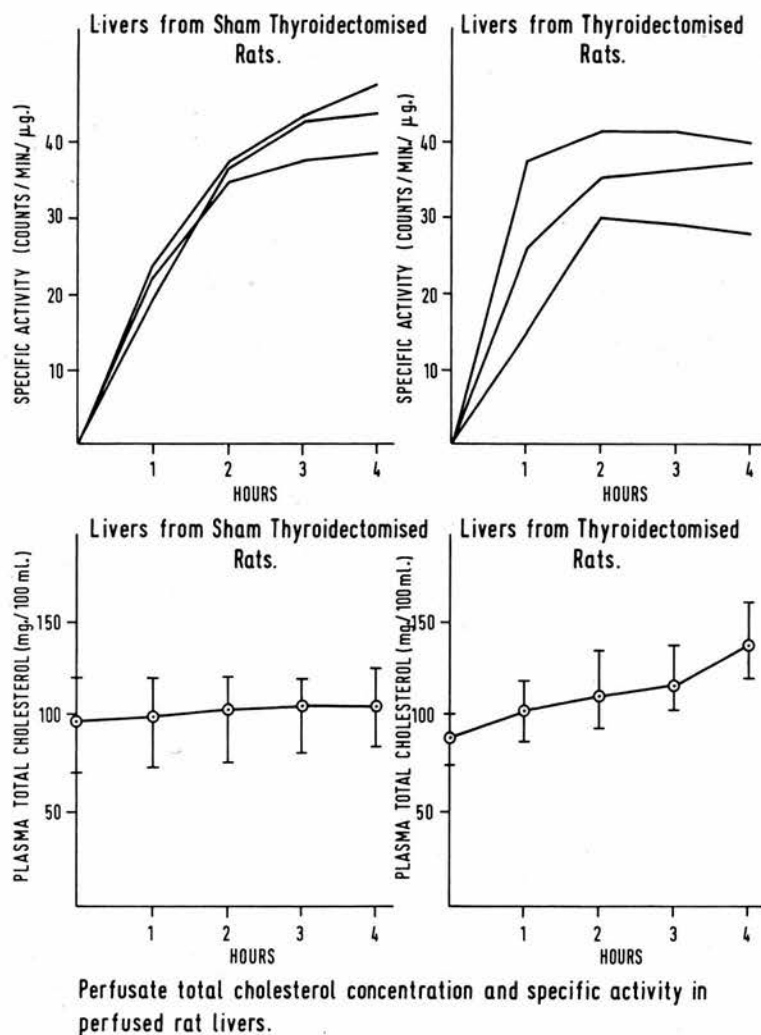

Fig. 37 Perfusate total cholesterol and specific activity shown as mean and range

60 $\mu\text{g.}$ and 70 $\mu\text{g.}$ The range of values in each hr. was very similar in both groups of experiments. There was no difference found in the ratios of trihydroxy acids to dihydroxy acids in the 2 groups. When the total recovery of radioactivity in biliary bile acid was determined (Fig. 36) the amount of radioactivity rose in both groups of perfusions to a maximum after 2 hr. and then fell throughout the remainder of the perfusion period. The mean total radioactivity recovered was greater in the group of livers from sham thyroidectomised rats than from the thyroidectomised group. There was no difference in the ratio of the radioactivity recovered in trihydroxy acids and dihydroxy acids in the 2 groups of perfusions.

The rate of appearance of radioactivity in the perfusate plasma total cholesterol was studied in hourly aliquots of perfusate (Fig. 37). In both groups of perfusions the plasma total cholesterol became rapidly labelled during the first hr. of the perfusions. The perfusate plasma total cholesterol concentrations (Fig. 37) showed little change in the perfusions of livers from sham thyroidectomised rats while in the group from thyroidectomised rats there was a marked increase in the total cholesterol concentration from a mean of 87.8 mg.% at the start of the perfusions to a mean of 139.9 mg.% after 4 hr. perfusion. This rise in total cholesterol concentration was found in all of the perfusions in this group.

3.4 Perfusion of livers from normal rats and from rats injected with triiodothyronine (3-5-3^I-triiodo-L-thyronine) addition of [2. ¹⁴C]-DL-mevalonic acid

A group of 12 female rats, all of the same age and with body weights of approximately 180 g. were maintained on the stock diet

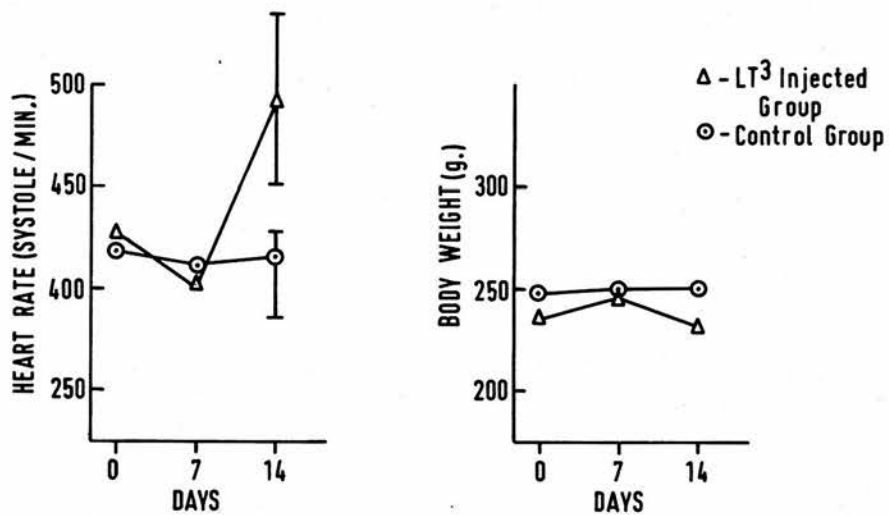

Heart rates and body weights of rats injected with triiodothyronine (50 μ g.daily) and of control rats.

Fig. 38 Heart rates shown as mean and range

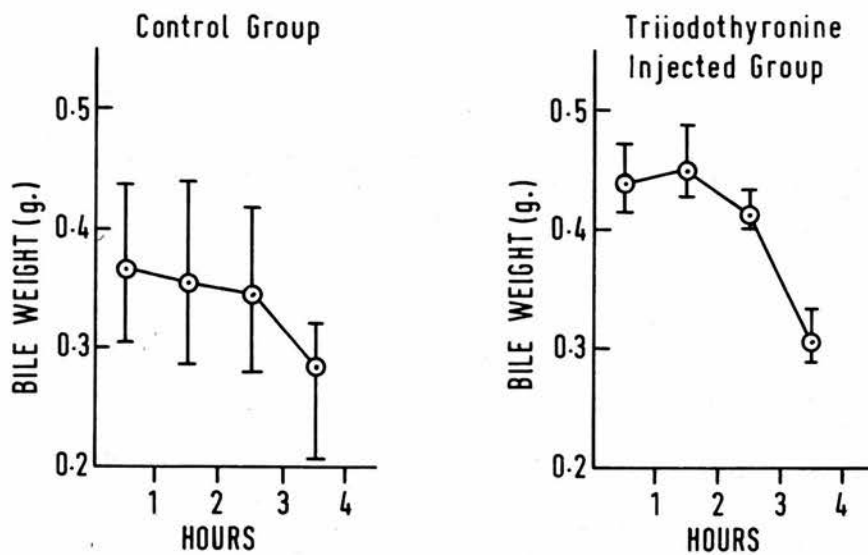

Bile flow rates in perfused livers from triiodothyronine injected and control rats.

Fig. 39 Bile weights shown as mean and range

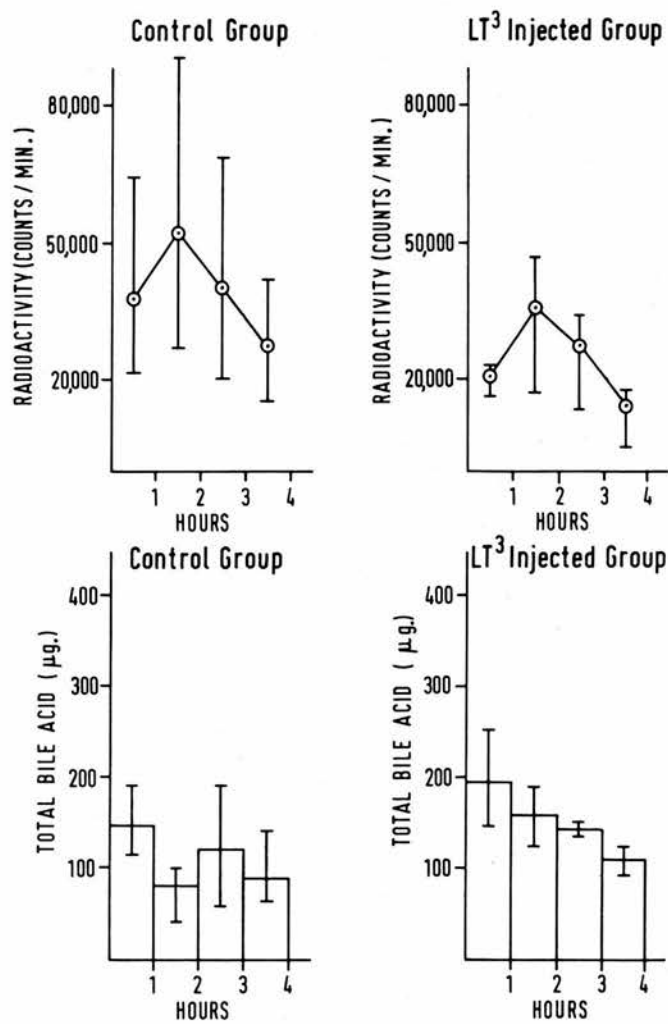

Total bile acid and radioactivity excretion in perfused livers from control rats and rats injected with triiodothyronine.

Fig. 40 Total bile acid and radioactivity shown as mean and range

for a period of 6 weeks. Heart rates and body weights were estimated twice, at weekly intervals, and the animals were then separated into 2 groups one of which received 50 μ g. triiodothyronine daily, by intraperitoneal injection, while the second group received saline injections. The triiodothyronine was dissolved in saline with a small quantity of a 1% sodium hydroxide solution added. The heart rate and body weight findings are shown in Fig. 38. There was a rise in the mean heart rate from 405/min. prior to injection with triiodothyronine to a mean figure of 493/min. after daily injections for 7 days which was accompanied by a small loss in body weight.

Perfusions were performed on livers from 3 saline injected and 3 triiodothyronine injected rats and [2. 14 C]-DL-mevalonic acid (in 0.2 ml. acetone) was added to each perfusion when the procedure was established. Bile flow rates were estimated and are shown in Fig. 39. The mean flow rate was higher throughout the perfusion period in the livers from animals treated with triiodothyronine than from the control animals. The mean total bile acid output (Fig. 40) was higher in the triiodothyronine injected than in the control group throughout the whole perfusion period. The ratio of trihydroxy acids to dihydroxy acids was 4.0:1 in the control group and 2.3:1 in the injected group. In the control group the radioactivity recovered as bile acids was higher than in the triiodothyronine injected group by a factor of almost 2 throughout the perfusions. The ratio of radioactivity

recovered as trihydroxy bile acids to dihydroxy bile acids was 2.1:1 in the control group and 1.6:1 in the injected group. In one of the perfusions in the triiodothyronine injected group a third peak of radioactivity was found in the eluates from the liquid: liquid partition columns. There was no Pettenkofer positive material present in these eluates. The radioactivity in this peak was equal to 25%, 50% and 70% of the radioactivity present in the trihydroxy acid peak in the first, second and third hr. of the perfusion and in the fourth hr. no radioactivity was found in this position. In each case the radioactive material was found in eluate number eight (60% benzene, 40% petroleum ether) and was a single sharp peak. No further characterisation of this material was possible since both the Pettenkofer reaction and liquid scintillation counting procedure are destructive techniques.

3.5 Perfusion of livers from normal rats and from cholesterol fed rats - addition of [2-¹⁴C] DL-mevalonic acid

A group of 12 female rats (mean body weight 184 g.) were maintained on the stock diet for a period of 2 months. The group was then divided into 2 subgroups both of which received stock diet plus a supplement of 10% olive oil; while one subgroup also received a 0.5% cholesterol supplement. The animals continued on these diets for a period of 3 weeks during which time their weights rose by a similar amount. Perfusions were performed on the livers of 3 animals from each of the groups. In each case [2-¹⁴C]-DL-mevalonic acid (in 0.2 ml. acetone) was added to the perfusate once the perfusion was established and bile was collected

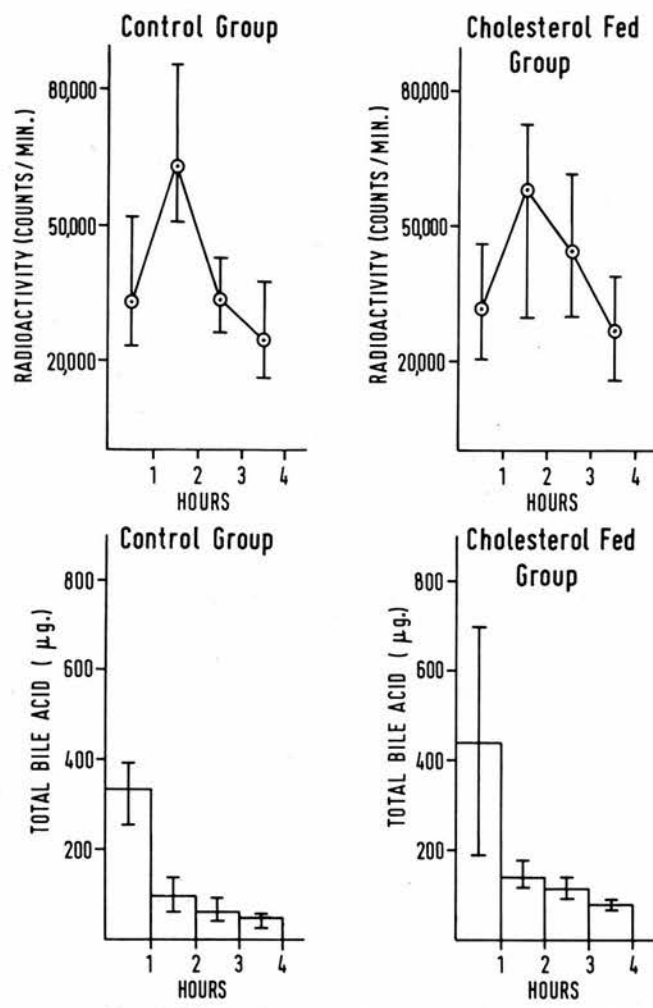

Total bile acid excretion and radioactivity in perfused livers from control rats and cholesterol fed rats.

Fig. 41 Total bile acid and radioactivity shown as mean and range

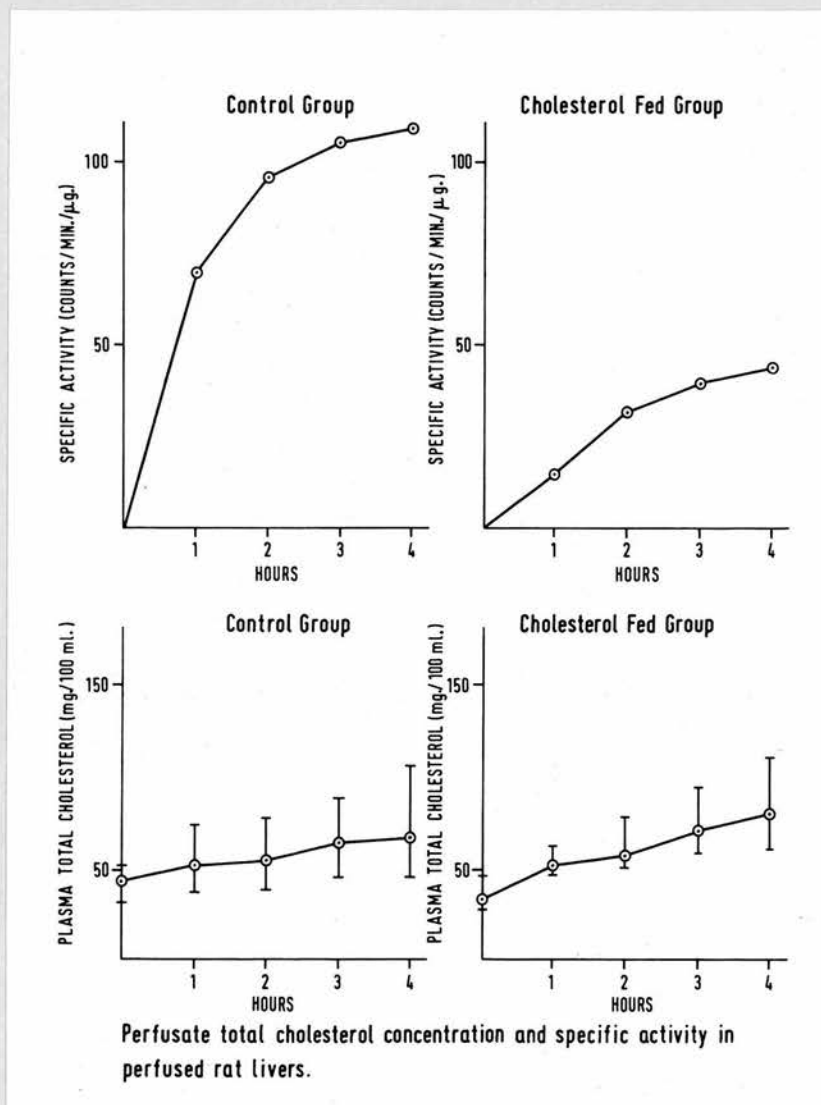

Fig. 42 Plasma total cholesterol conc. and specific activity shown as mean and range

for 4 hr. in hourly aliquots.

Fig. 41 shows the hourly total bile acid output in these perfusion experiments. The mean excretion rate was higher in the cholesterol fed group than in the control group throughout the perfusion period. The ratio of trihydroxy bile acids to dihydroxy bile acids was 1.3:1 in the control group and 1.1:1 in the cholesterol fed group. The radioactivity recovered in the total bile acids was very similar in both groups of perfusions and showed the same pattern as described above with a rise in the second hr. followed by a fall in hr. 3 and hr. four.

The mean perfusate plasma total cholesterol concentration rose in both groups of perfusions (Fig. 42). In the control group the value at zero time was 40.3 mg.% and this rose to 64.2 mg.%, while in the cholesterol fed group the value at zero time was 32.6 mg.% which rose to 79.6 mg.%. The mean plasma total cholesterol specific activity rose to 119 counts/min./ μ g. in the control group and to 44 counts/min./ μ g. in the cholesterol fed group.

**STUDIES ON THE BILIARY BILE ACID EXCRETION IN RATS WITH
CHRONIC BILE DUCT FISTULAE**

1. Introduction

The chronic drainage of bile from laboratory animals is a technique which is well established for the investigation of the physiology of the alimentary tract and the liver. The technique has also been used in the field of cholesterol and bile acid metabolism in particular for the study of the metabolism of a variety of theoretical intermediates in the degradation of cholesterol to form bile acids (Bergstrom 1955, Harold et al 1955, Lindstedt 1957).

The studies of Thompson and Vars (1953), Eriksson (1957), Bergstrom and Danielsson (1958) and Myant and Eder (1961) have indicated that a major factor involved in the control of the rate of bile acid synthesis is the enterohepatic circulation of bile acid conjugates from the small intestine which acts as a feedback mechanism on the liver thus inhibiting bile acid synthesis. The partial interruption of the normal enterohepatic circulation of the bile acid conjugates is always a potential situation in the normal system, since factors such as diet and intestinal bacterial flora may influence the reabsorption of these compounds (Portman and Murphy 1958). It therefore seemed valuable to study possible effects which situations such as thyroid status and dietary cholesterol supplements might have on the response to the insertion of a chronic bile duct fistula.

2. Operative techniques

The studies to be described here were performed as follows. The rat was lightly anaesthetised with ether and placed on its back with its feet secured by bands. Anaesthesia was maintained throughout the operative procedure by means of an ether soaked

nose pad. A midline incision was made through the skin of the anterior abdominal wall and then a similar incision was made through the whole thickness of the underlying muscles. Both of these incisions started midway between the pelvic ramus and the xiphisternum and were carried as far as the xiphisternum. The bile duct was isolated in the free edge of the lesser omentum. Two sutures were then placed around the bile duct, the more distal of these was tied and used to place traction on the duct. A small incision was made in the duct wall above the tied suture by inserting the point of a fine needle into the duct under direct vision through a dissecting microscope (magnification x 20). A piece of suitable cannula was inserted through the hole in the wall of the duct and the tip of the cannula was advanced to a position approximately 1 mm. from the point at which the main branches of the bile duct fuse. At this point, satisfactory bile flow was confirmed by inspection of the column of bile within the cannula and the second suture was tied firmly around the duct and the inserted cannula.

The anterior abdominal wall was then carefully reconstituted and the animal transferred to the restraining cage in which it was free to move apart from being firmly held by the tail which was placed through a hole in the wall of the restraining cage and fixed in place by a ring of surgical tape. In order to prevent the rat from pulling on the bile duct cannula a wooden tunnel was placed over its body and the cannula was led through a slit in the floor of the restraining cage. Bile aliquots were

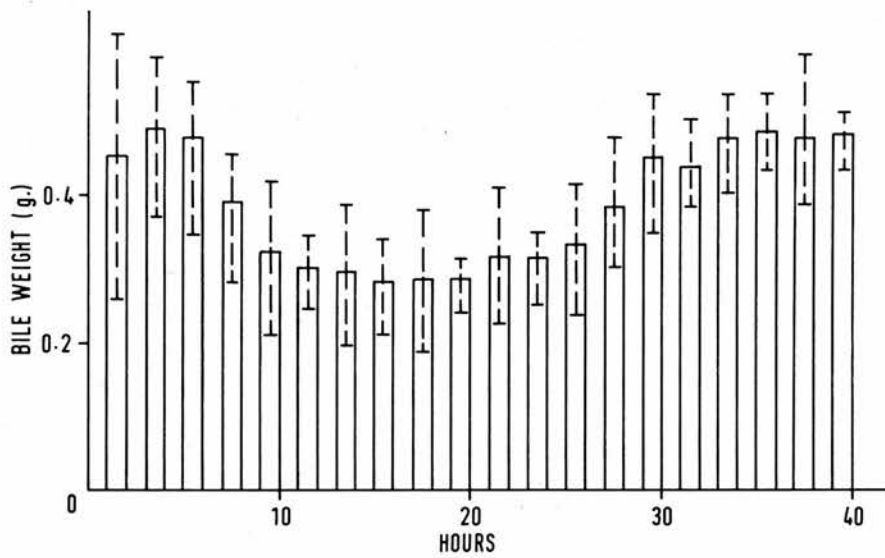

Bile flow rates in six rats subjected to biliary drainage.

Fig. 43 Bile flow rate shown as mean and range

collected in small glass tubes (2 in. long and 1/4 in. diameter) which were held in a fraction collector which automatically rotated once per hour.

The rats in the restraining cages were kept in a large chamber which was maintained at 70°F and in which the lighting was arranged to provide 12 hr. darkness and 12 hr. light in the same manner as in the animal house. Air circulation was maintained in the chamber by means of an extraction fan which drew air out of the chamber expelling it from the building.

The rats were provided with free access to drinking fluid which consisted of a 1% sodium chloride solution with added potassium chloride to a final potassium concentration of 5 meq./l. In most experiments the rats were also allowed free access to their normal diet.

3. General metabolic data

It was considered desirable that the rats studied by the chronic biliary drainage technique should be maintained in as satisfactory a general state as possible and particularly that, taking into account the considerable loss of water and electrolyte in the bile, they should not develop abnormal water and electrolyte balance.

Fig. 43 shows the mean weight of the hourly bile aliquots during a period of 40 hr. biliary drainage in 3 experiments on normal rats. During the first 4 hr. there was a rise in the mean bile volume from 0.39 g./hr. in the 2nd hr. to 0.48 g./hr. in the 4th hr. and this was followed by a fall in the mean flow rate to a minimum of 0.21 g./hr. in the 12th hr. This low

	Sham operated	Bile drainage
Na ⁺	145 (144-146) meq/l.	152 (150-153) meq/l.
K ⁺	4.7 (4.3-5.0) meq/l.	4.0 (3.5-4.5) meq/l.
HCO ₃ [']	26.3 (25.5-27.0) meq/l.	24.5 (24.0-25.0) meq/l.
Urea	34 (31-37) mg./100ml.	38 (37-40) mg./100ml.

Table 12 Serum electrolyte and urea concentrations in normal rats and rats subjected to biliary drainage.

mean bile flow rate was followed by a rise to levels of 0.43 g./hr. in the 38th hr. which demonstrated that the bile flow rate was capable of responding to the choleric effect (Sperber 1965) of the increased rate of bile acid excretion which occurs during chronic biliary drainage. Bile samples collected from 3 fistula rats were used for the estimation of the biliary sodium, potassium, chloride and bicarbonate concentrations by the methods described for serum. During the 48 hr. drainage period studied, the sodium, potassium and chloride and bicarbonate concentrations changed little. The mean sodium concentration was 159.0 meq./l., the mean potassium concentration 5.0 meq./l., the mean chloride concentration 119.3 meq./l. and the mean bicarbonate concentration 26.0 meq./l.

Estimation of the blood haematocrit values was performed on blood taken by cardiac puncture from 4 rats which had been subjected to a period of 48 hr. biliary drainage in the usual way and from 4 rats which were sham operated and then kept in the restraining cages, also for 48 hours. The mean haematocrit value for the sham operated group was 36% (range 34% - 38%) while the mean value in the drained group was 39% (range 34% - 45%). Serum sodium, potassium, bicarbonate and urea levels were estimated on these same blood samples and the results are presented in Table 12.

During the bile drainage period the animals normally had free access to their usual diets. It was found that following a 48 hr. bile drainage they lost on average 7.6% of their original body weights. This is similar to the 5% weight loss found by Myant and Eder (1961).

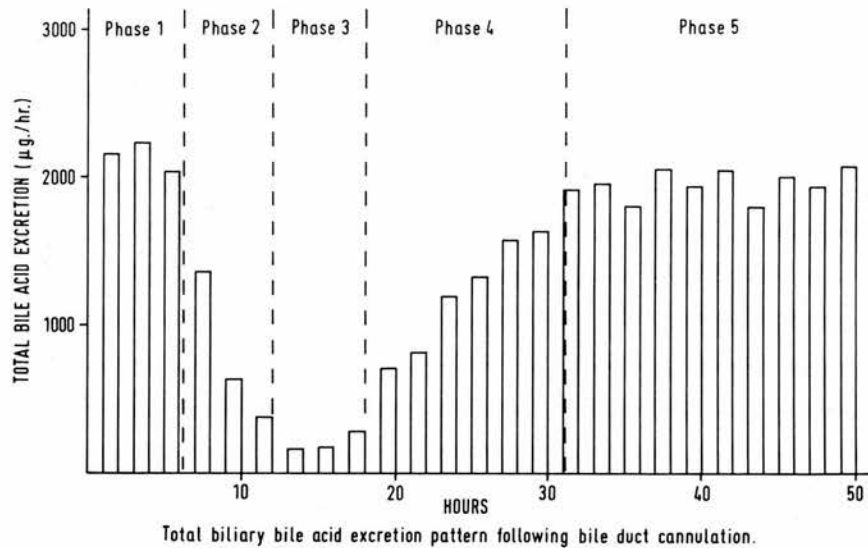

Total biliary bile acid excretion pattern following bile duct cannulation.

Fig. 44

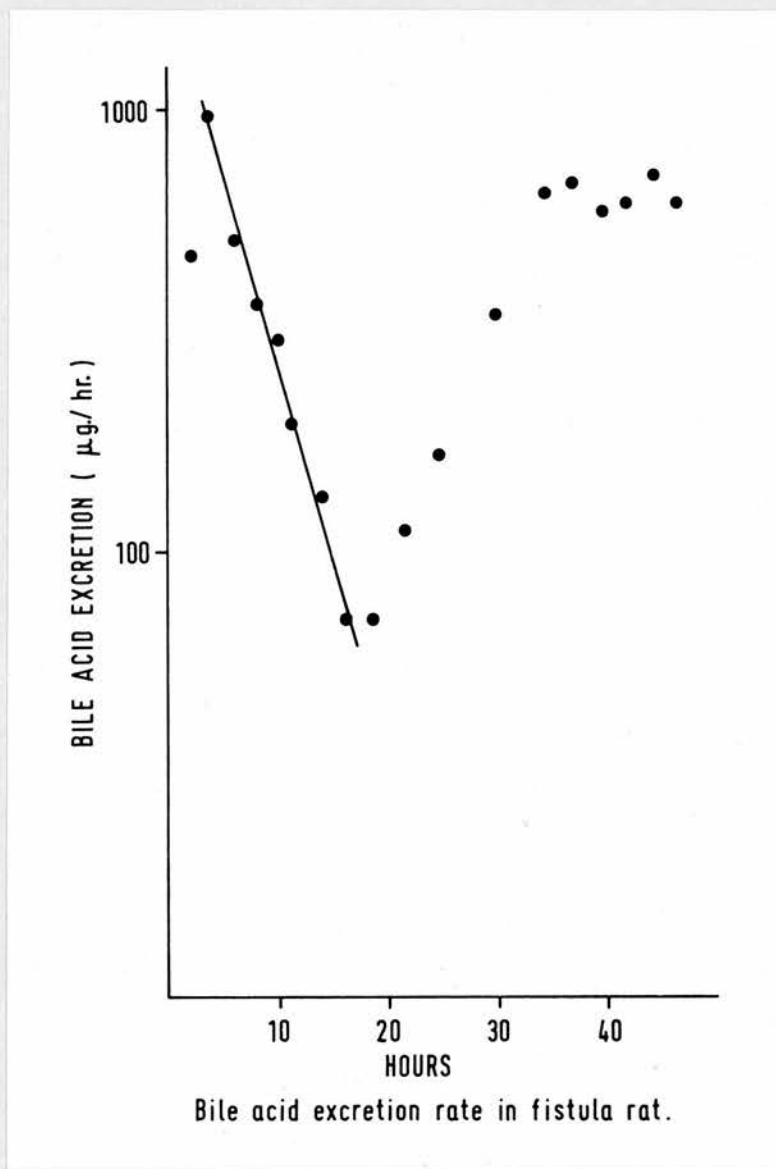

Fig. 45

4. Studies on bile acid excretion rate in the bile fistula rat

4.1 Introduction

An example of the pattern of total bile acid excretion is shown in Fig.44. It may be divided into the following phases:-

Phase 1 during which a high level of bile acid excretion is found. The level of excretion during this phase represents the sum of the rate at which the small intestinal pool of bile salts is being reabsorbed and returned to the liver via the portal circulation for subsequent excretion in the bile, plus the rate of de novo bile acid synthesis in the liver (Eriksson 1957, Myant and Eder 1961).

Phase 2 during which the rate of total bile acid excretion is rapidly falling due to the latent exhaustion of the small intestinal bile salt pool.

Phase 3 when the bile acid excretion approximates the normal rate of de novo synthesis of bile acids in the liver.

Phase 4 during which there is a rise in the rate of excretion of biliary bile acids which indicates the response of the liver to the interruption of the normal bile acid enterohepatic feedback mechanism.

Phase 5 which indicates the maximum rate at which the liver can synthesise bile acids in response to the drainage stimulus.

A graph of the type shown in Fig. 44 has been drawn for each animal subjected to chronic biliary drainage. A semi-logarithmic plot of the same data has also been prepared in each case with the total bile acid excretion rate on the logarithmic scale (Fig. 45). From these plots the following values have been calculated in order to describe the bile acid excretion data concisely.

- (a) The maximum excretion rate in phase 1. This value has been called 'C max' since it represents the maximum measured bile acid excretory rate of the perenchymal cells into the biliary canaliculi in the animal studied.
- (b) The excretion rate in phase 3. This is called the de novo excretory rate.
- (c) It will be seen from the semilogarithmic plot of the bile acid excretion data (Fig. 45) that there is a good straight line relationship between the logarithm of the total bile acid excretion rate per hr. and time during phase 2. This relationship has been demonstrated repeatedly during the studies reported here. The total fraction of the small intestinal pool which is reabsorbable can be calculated by computing the sum of the hourly excretions from a semilogarithmic plot and subtracting from this figure an amount equal to the total estimated de novo synthesis during this period. This is equal to the hourly de novo synthesis rate multiplied by the time required for complete drainage of the intestinal absorbable pool (i.e. the time required to reach the end of phase 2).
- This total absorbable pool has been calculated for each animal subjected to biliary drainage and is called "the computed pool size".
- (d) The observed maximum secretory rate of the liver during phase 5. This rate is usually found to plateau some 36 hr. after the start of biliary drainage and is considered to represent the maximum synthetic rate for the liver when subjected to this stimulus to bile acid synthesis (Eriksson 1957). This term is called 'S max'.

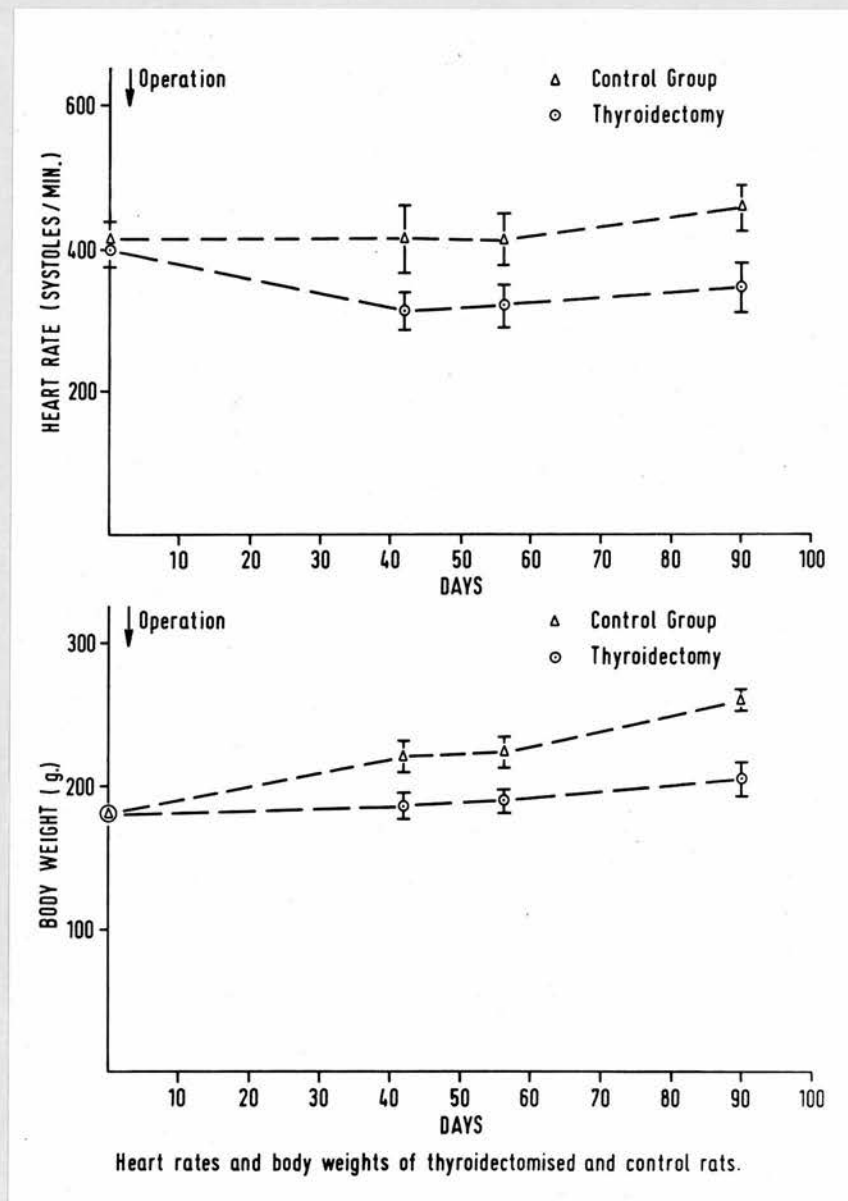

Fig. 46 Heart rate and body weight shown as mean and range

4.2 Studies on thyroidectomised and control (sham thyroidectomised) rats

A group of female rats was selected from litters born on the same day. These animals were fed throughout on the rat cake diet and were kept together until they reached a body weight of approximately 180 g. and 12 animals were then subjected to surgical thyroidectomy while 12 animals were sham operated. The thyroid glands were carefully dissected free from the anterior surface of the trachea following demonstration of both recurrent laryngeal nerves, and the neck was reconstituted using continuous sutures for muscle layers and Michele clips for skin. In the sham operated group the animals' necks were opened and reconstituted without disturbing the thyroid gland.

In order to confirm that the thyroidectomies were adequately performed, both groups of animals were weighed and electrocardiographs were performed at intervals throughout the following 90 days (see Fig. 46). It is seen that the mean heart rates in the thyroidectomised group fell from a rate of 400/min. to 312/min. after 42 days, and that there was a subsequent small rise in the rate to a mean of 345/min. 90 days after operation; while the heart rates in the sham thyroidectomised group rose from a mean level of 406/min. to 414/min. after 42 days and 456/min. after 90 days.

The mean body weight in both groups was 180 g. before operation. The mean value for the sham thyroidectomised group rose to 258 g. after 90 days while the mean value for the thyroidectomised group was 204 g.

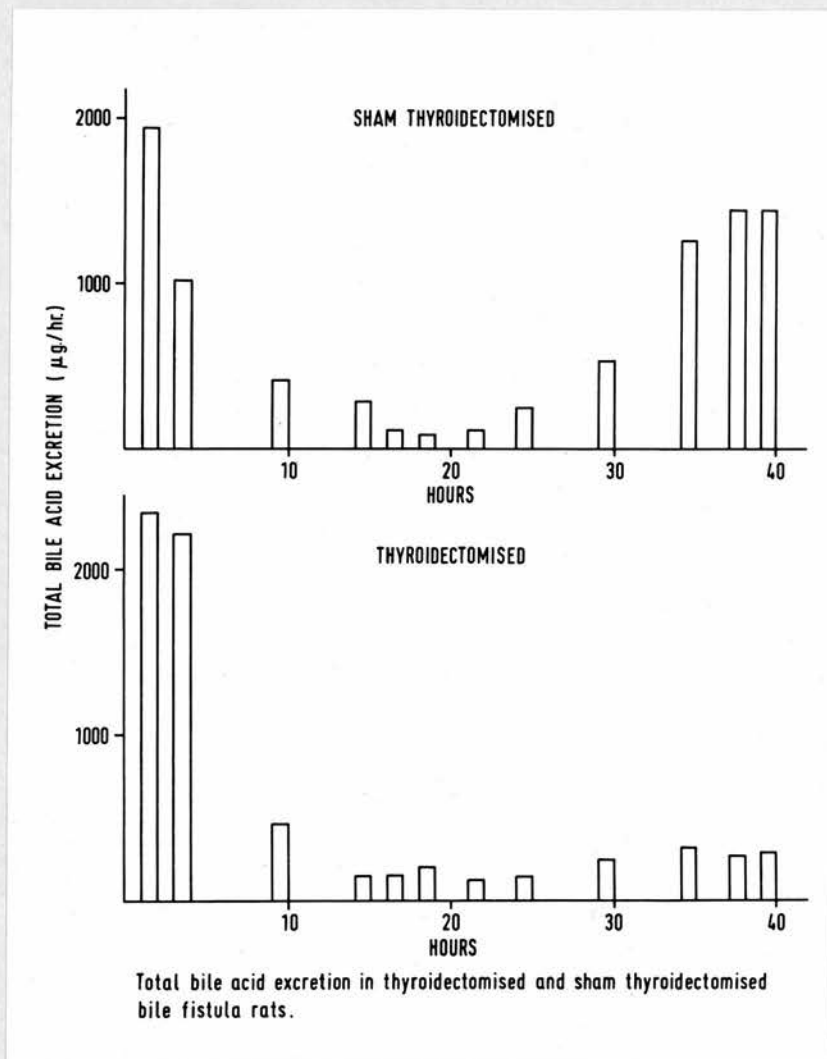

Fig. 47

Sham operated group					
Experiment	Body weight (g)	'C max' (µg/hr./100g. body weight)	'S max'	De novo	Computed pool (µg/100g)
1	269	727	542	31	4,154
2	254	504	323	14	2,181
3	261	360	173	25	1,132
Mean	261	530	346	23	2,489
Thyroidectomised group					
1	212	1,109	151	71	6,672
2	194	1,258	129	30	8,142
3	193	1,115	61	22	6,273
Mean	200	1,161	114	41	7,029

Table 13 Bile acid excretion findings (expressed /100g. body weight) in normal and in thyroidectomised rats.

Three rats from each of these groups were subjected to a period of biliary drainage in the usual way. Bile samples were collected at hourly intervals and each was weighed and delivered into ethanol. Bile acid estimations were then performed on the samples collected during hr. 2, 4, 10, 15, 17, 19, 22, 25, 30, 35, 38 and 40 following cannulation. Fig. 47 shows an example of the biliary bile acid output in a typical sham thyroidectomised animal and in a typical thyroidectomised animal respectively.

The results calculated for the five indices described above in each of the thyroidectomised and control animals are shown in Table 13. The mean 'C max' in the thyroidectomised animals was found to be twice as high as the mean rate in the sham thyroidectomised group while the de novo bile acid synthesis rate was similar in both groups. A marked difference was demonstrated when the mean 'S max' value was calculated since the mean rate in the control group was 346 $\mu\text{g.}/\text{hr.}/100 \text{ g.}$ body weight and in the thyroidectomised group 114 $\mu\text{g.}/\text{hr.}/100 \text{ g.}$ body weight; there being no overlap between the ranges found.

The mean computed total bile acid absorbable pool size was found to be 7,029 $\mu\text{g.}/100 \text{ g.}$ body weight in the thyroidectomised group and 2,489 $\mu\text{g.}/100 \text{ g.}$ body weight in the control group; there being fairly wide ranges in each case which were not overlapping.

From these studies it appeared that the major difference between the thyroidectomised and control groups was in the response

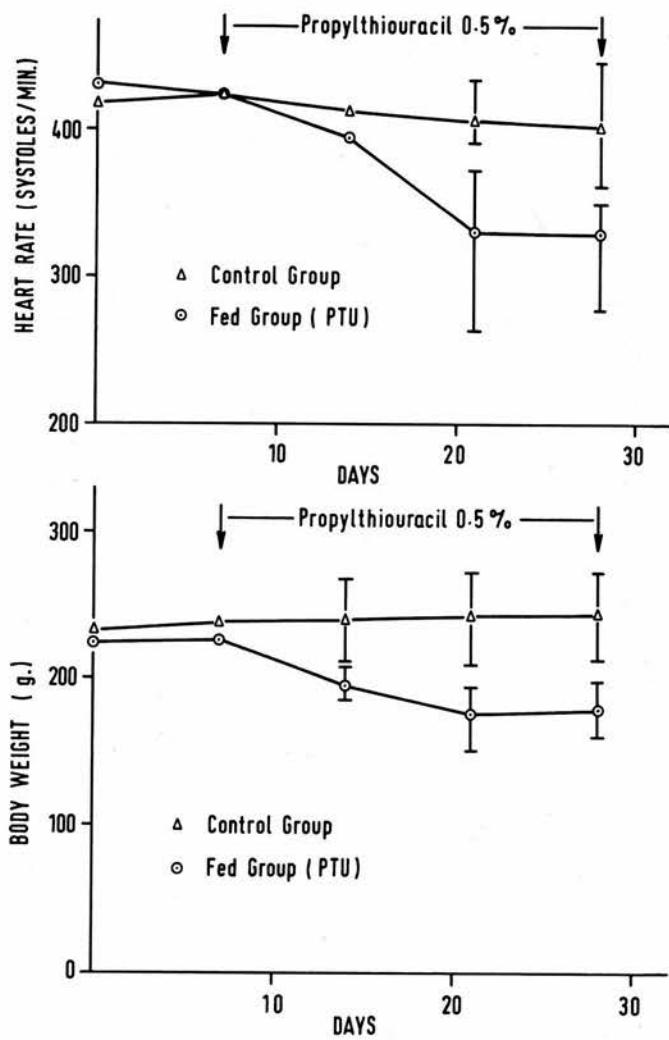

Heart rates and body weights in propylthiouracil and control groups of rats.

Fig. 48 Heart rate and body weight shown as mean and range

to the stimulus to bile acid synthesis which is produced by biliary drainage. Qualitatively these findings are similar to those of Eriksson (1957) who found a difference of rather less than twofold when comparing propylthiouracil fed animals and controls. It therefore seemed of interest to study animals rendered hypothyroid by feeding propylthiouracil.

4.3 Studies on hypothyroid (propylthiouracil fed) and control animals

A group of 12 female rats born in litters on the same day were maintained on the stock diet until they reached a body weight of approximately 225 g. At this point the animals were weighed and their heart rates estimated. The animals were then divided at random into 2 groups and 0.5% propylthiouracil was added to the diet of one group. The animals were maintained on the respective diets for a period of 4 weeks and they were weighed and their heart rates estimated at weekly intervals. Fig. 48 shows the results of these observations and shows that the mean heart rate at the end of the 4 week period in the group fed 0.5% propylthiouracil was 330/min. while in the control group the mean rate was 405/min. The mean body weight in the former group was 178 g. and in the latter group 244 g. These results confirmed the expected metabolic effects of propylthiouracil feeding.

Three animals from each of these groups were then subjected to a period of 40 hr. biliary drainage in the usual way, and hourly bile samples were collected. Bile acid estimations were performed on the bile samples collected during hours 2, 4, 6, 8, 10, 12, 15, 17, 19, 22, 25, 35, 38 and 40 following the start

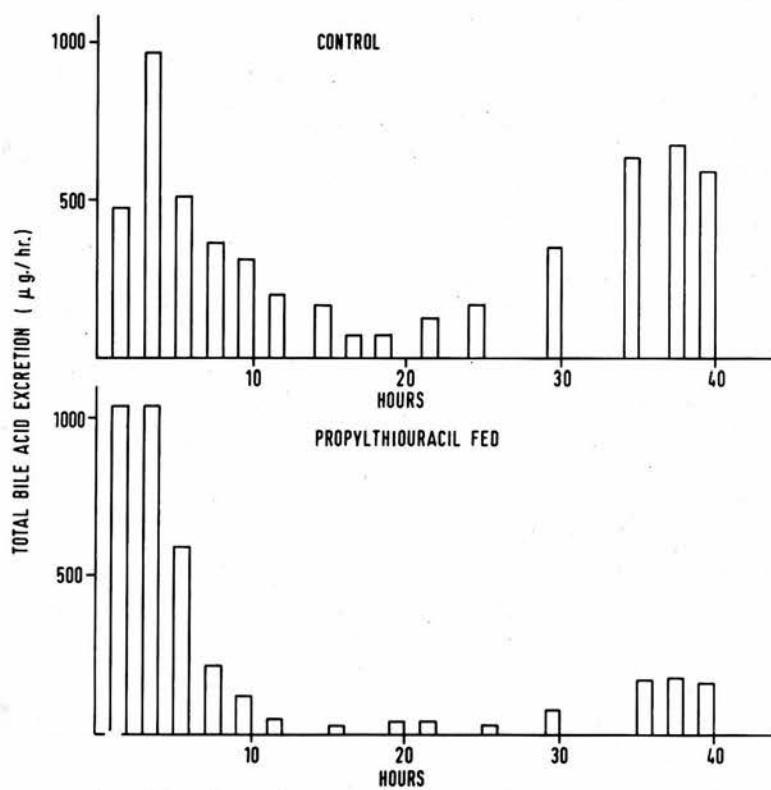

Total bile acid excretion rates in propylthiouracil fed and control bile fistula rats.

Fig. 49

Experiment	Body weight (g)	Control group			Computed pool ($\mu\text{g}/100\text{g}$)
		'C max' ($\mu\text{g}/\text{hr}/100\text{g}$.body weight)	'S max'	De novo	
1	241	402	280	29	2,262
2	233	449	230	54	1,969
3	239	312	360	17	2,642
Mean	238	388	290	33	2,291
Propylthiouracil fed group					
1	190	547	92	18	1,631
2	204	380	93	16	2,179
3	173	373	26	15	3,328
Mean	189	433	70	16	2,379

Table 14 Bile acid excretion findings (expressed /100g.body weight) in normal and in propylthiouracil fed rats.

of the period of biliary drainage.

Fig. 49 shows an example of the bile acid excretion data in animals from each of these groups and the calculated data for the whole of each group is shown in Table 14. In these animals the mean value for the 'C max' in the control group was 388 $\mu\text{g./hr./}$ 100 g. body weight while in the propylthiouracil fed group the mean value was 433 $\mu\text{g./hr./}$ 100 g. body weight. Once again a large difference was seen when the mean values for the 'S max' were compared since the mean result for the control group was 290 $\mu\text{g./}$ hr./100 g. body weight and in the propylthiouracil fed group 70 $\mu\text{g./}$ hr./100 g. body weight. The mean de novo bile acid synthesis rate was found to be 33 $\mu\text{g./hr./}$ 100 g. body weight in the control group and 16 $\mu\text{g./hr./}$ 100 g. body weight in the propylthiouracil fed group.

Thus the large difference in the response of the control and propylthiouracil fed groups following 40 hr. biliary drainage was in agreement with the results found in the previous group of experiments and similar to the data of Eriksson (1957) and Strand (1962).

At the end of the period of biliary drainage the animals used in these experiments were anaesthetised with ether and the thyroid glands were excised, weighed and the whole glands embedded in paraffin. Sections were cut and stained with haematoxylin and eosin. The mean thyroid weight in the control group was 19.1 mg. and in the propylthiouracil group 47.0 mg.; confirming the presence of hyperplasia in response to the propylthiouracil treatment. Sections taken from the thyroid of one rat in each group are

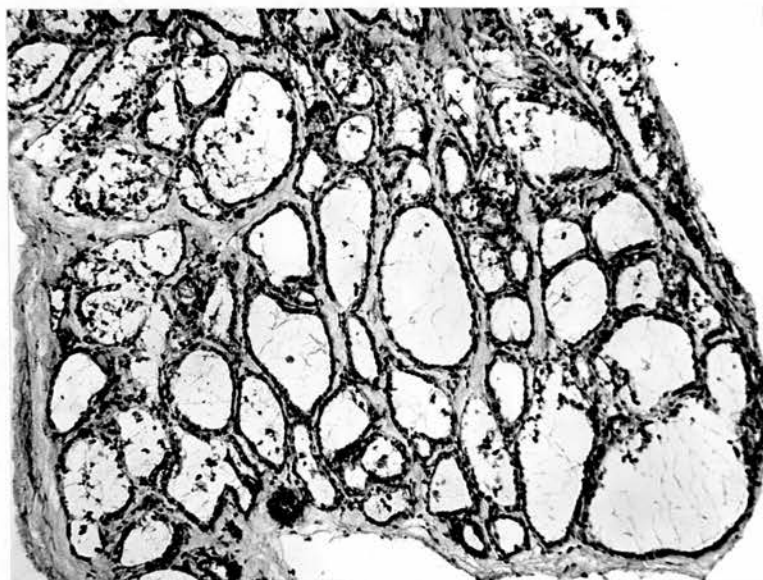

Section of thyroid gland taken from control propylthiouracil fed rat (magnification x 120).

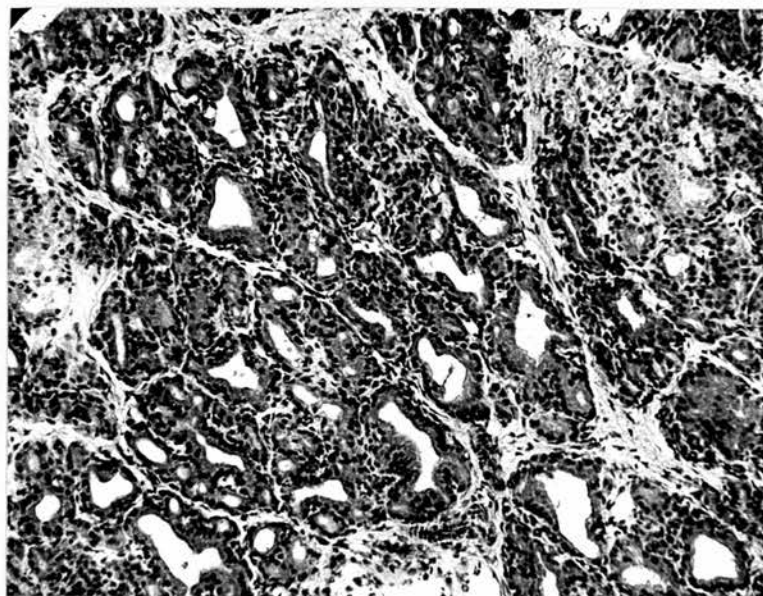

Section of thyroid gland taken from propylthiouracil fed rat (magnification x 120). The tissue is seen to be intensely hyperplastic.

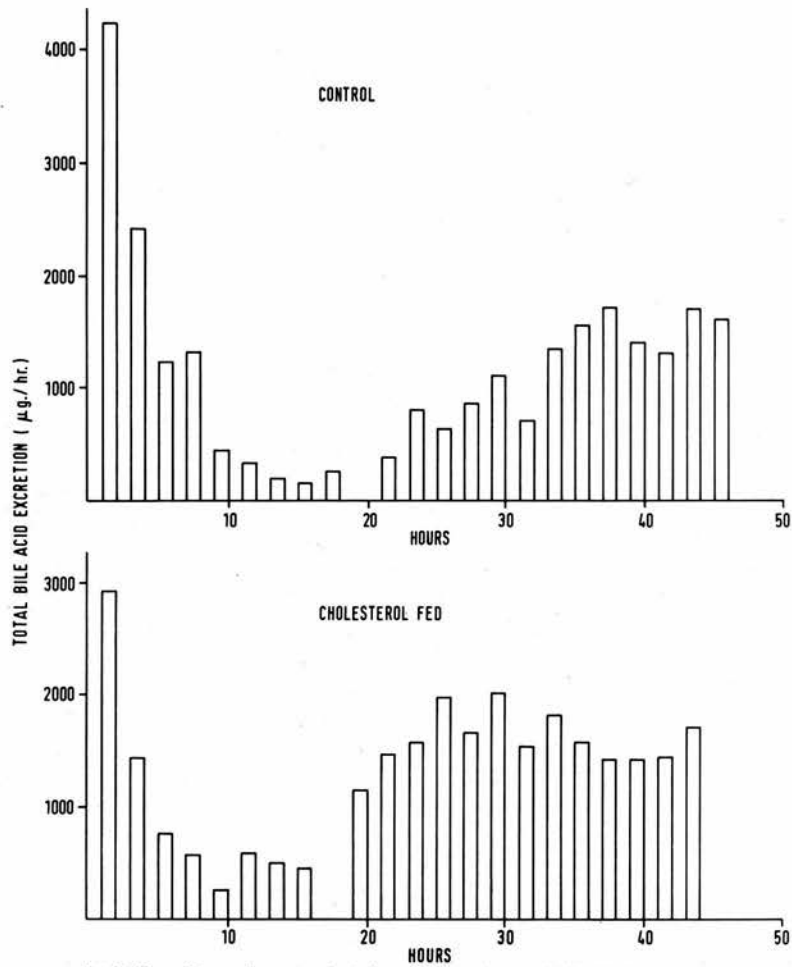

Total bile acid excretion rates in cholesterol fed and control bile fistula rats.

Fig. 51

Experiment	Body weight (g)	Control group			Computed pool ($\mu\text{g.}/100\text{g}$)
		'C max' ($\mu\text{g.}/\text{hr.}/100\text{g. body weight}$)	'S max'	De novo	
1	264	1,000	625	57	5,144
2	240	2,260	725	38	9,435
3	314	1,350	545	51	5,915
Mean	273	1,570	632	49	6,831
		Cholesterol fed group			
1	239	1,222	837	108	10,113
2	238	2,845	966	195	11,234
3	300	1,658	880	213	8,243
Mean	259	1,925	894	172	9,863

Table 15 Bile acid excretion findings (expressed /100g.body weight)in normal and in cholesterol fed rats.

shown in Fig. 50 and demonstrate the hyperplastic thyroid tissue in the thyroid taken from the propylthiouracil fed group.

4.4 Studies on animals fed 0.5% cholesterol in the diet, and control animals

Twenty-four female rats were fed the stock diet for a period of 2 months and at the end of this period 10% olive oil was added to the diet of one group of 12 animals (the control group) while 10% olive oil plus 0.5% cholesterol was fed to the 12 remaining animals. The mean body weights of the groups were 239 g. and 233 g. respectively after a period of 3 weeks on these diets.

At the end of the 3 week period on the diet, 3 animals from each of the groups were subjected to biliary drainage for a period of 48 hr. in each case. Bile acid analysis was performed on every second hourly bile aliquot. Fig. 51 shows examples of the pattern of total bile acid excretion in one animal from each group. Table 15 shows the data for the whole of each group. It will be seen that the general pattern of total bile acid excretion in these groups of animals was similar to the pattern found in the groups previously discussed. The secondary rise in total bile acid synthesis rate reached a maximum value after approximately 36 hr. in the control group of animals but in the cholesterol fed group the maximum value was reached between 22 and 26 hours.

The mean 'C max' in the control group was 1570 $\mu\text{g.}/\text{hr.}/100$ g. body weight and in the cholesterol fed group 1925 $\mu\text{g.}/\text{hr.}/100$ g. body weight. The mean de novo synthetic rate in the control group was 49 $\mu\text{g.}/\text{hr.}/100$ g. body weight while in the cholesterol

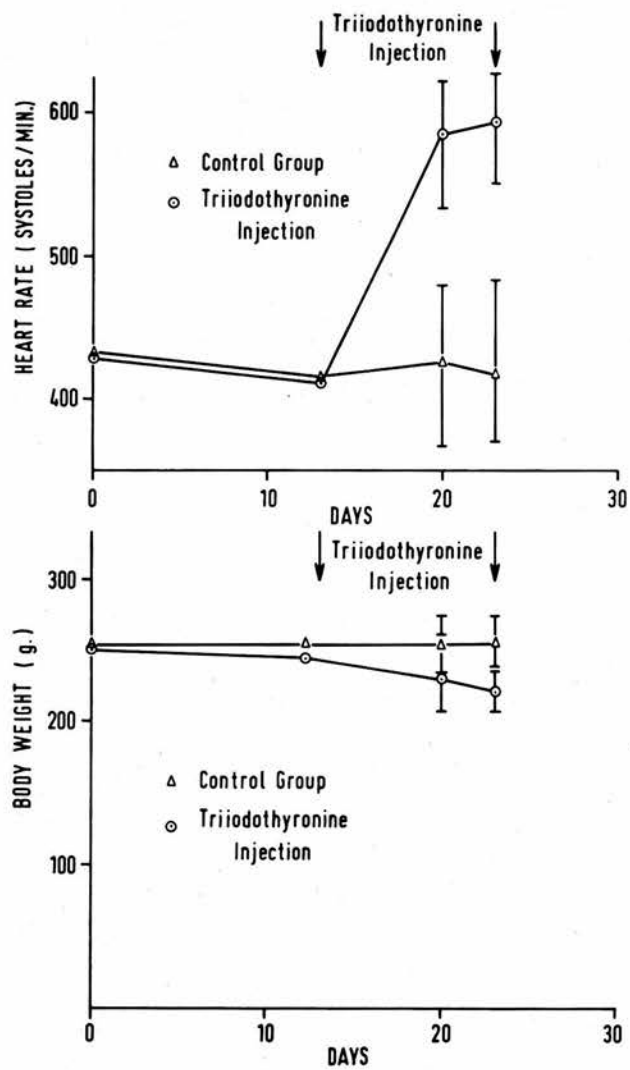

Heart rates and body weights in triiodothyronine injected and control groups of rats.

Fig. 52

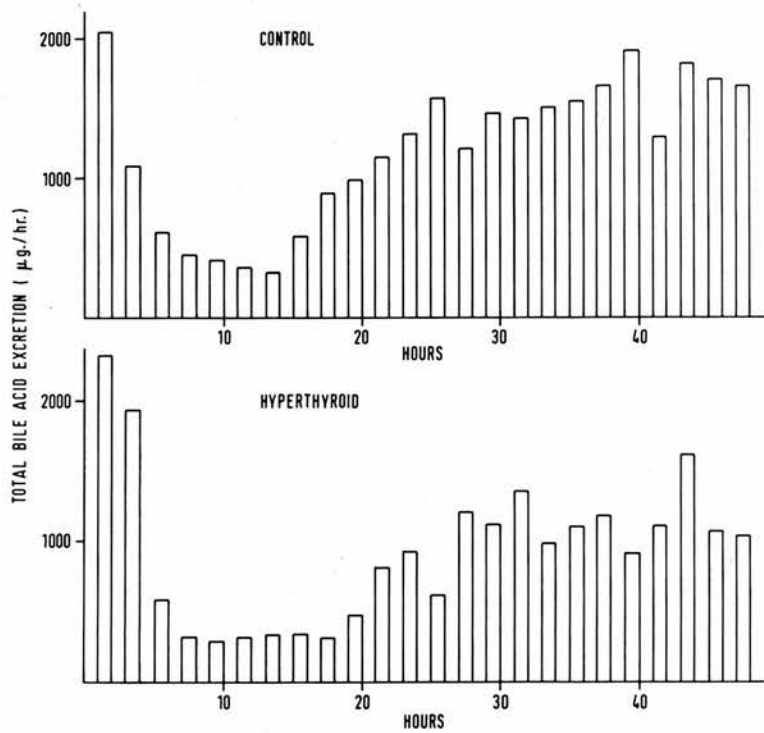

Total bile acid excretion rates in triiodothyronine injected and control bile fistula rats.

Fig. 53

Experiment	Body weight (g)	Control group			Computed pool ($\mu\text{g}/100\text{g}$)
		'C max' ($\mu\text{g}/\text{hr}/100\text{g}\cdot\text{body weight}$)	'S max'	De novo	
1	226	762	562	115	3,536
2	232	874	678	135	3,778
3	241	802	603	120	3,326
Mean	233	813	614	123	3,547
Triiodothyronine injected group					
1	214	934	638	140	3,432
2	236	981	490	138	3,864
3	209	1,087	703	166	4,254
Mean	219	1,001	610	151	3,850

Table 16 Bile acid excretion data (expressed /100g.body weight) in normal and in triiodothyronine injected rats.

fed group it was 172 $\mu\text{g.}/\text{hr.}/100 \text{ g.}$ body weight and the mean 'S max' in the control group was 632 $\mu\text{g.}/\text{hr.}/100 \text{ g.}$ body weight and in the cholesterol fed group it was 894 $\mu\text{g.}/\text{hr.}/100 \text{ g.}$ body weight. There was a large range in the values for the computed pool size which showed no real differences between the groups.

4.5 Studies on animals rendered hyperthyroid and control animals

Twelve female rats were fed the stock diet for a period of approximately 6 weeks and the group was then divided into 2 equal subgroups. One of the subgroups was injected with 50 $\mu\text{g.}$ of triiodothyronine intraperitoneally daily, for 10 days while the second subgroup (control animals) received saline injections. Fig. 52 shows the body weights and heart rates found in these animals. The large increase in the heart rates found in the triiodothyronine injected group which was accompanied by a decrease in body weight confirmed that the expected metabolic effects of the triiodothyronine injections had taken place.

Three animals from each group were then subjected to chronic biliary drainage for a period of 48 hours. Bile acid analysis was performed on every second bile sample. Fig. 53 shows examples of the pattern of total bile acid excretion in each of the groups. In both cases there was a fall in total bile acid excretion rates after some 4 hr. drainage followed by a rapid rise to levels which plateaued after approximately 30 hr. drainage. The 'C max' was slightly higher in the triiodothyronine injected group than in the corresponding control group (Table 16) as was the de novo synthesis rate. Both the 'S max' figures and the computed pool sizes were very similar in both groups.

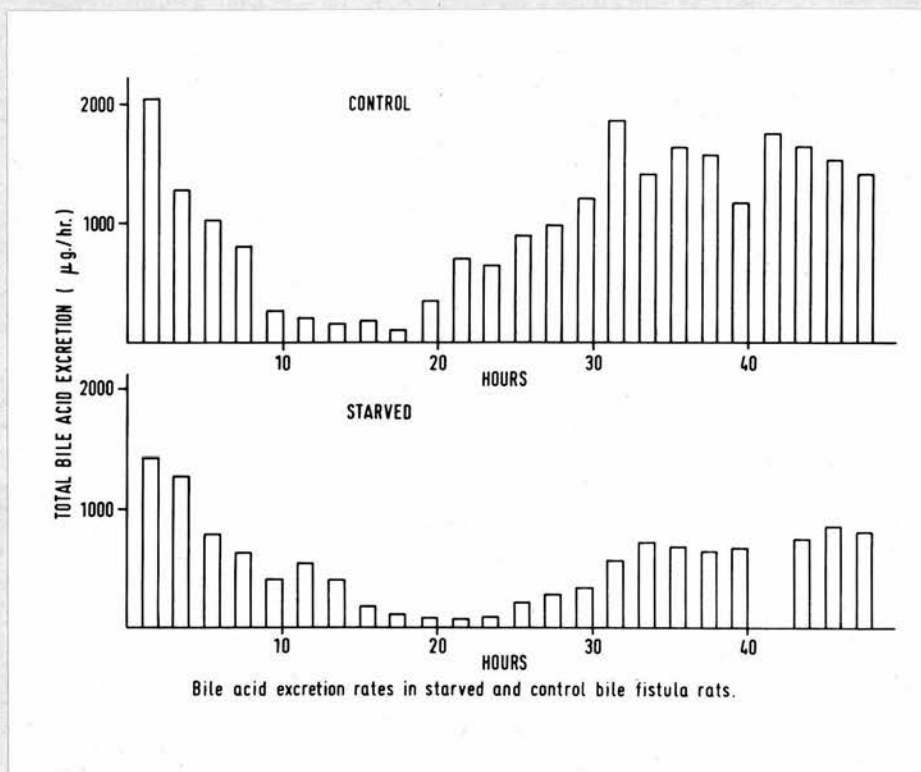

Fig. 54

Experiment	Body weight (g)	Control group			Computed pool ($\mu\text{g}/100\text{g}$)
		'C max' ($\mu\text{g}/\text{hr.}/100\text{g. body weight}$)	'S max'	De novo	
1	223	920	693	72	5,906
2	229	1,015	622	86	6,384
3	-	-	-	-	-
Mean	226	968	658	79	6,145
Starved group					
1	219	1,166	293	80	5,978
2	231	714	366	81	4,333
3	227	628	295	38	5,427
Mean	226	835	318	66	5,246

Table 17 Bile acid excretion data(expressed/100g.body weight) in normal and in starved rats.

4.6 Studies on animals starved (but allowed free access to water) for 20 hr. prior to bile duct cannulation followed by starvation during the bile drainage period, and control animals.

A group of 12 female rats was maintained on the stock diet for a period of approximately 6 weeks. Pairs of animals were then taken and placed in separate cages. One animal was allowed access to food and water while the other animal was allowed water only for a period of approximately 20 hours. The animals were subjected to chronic biliary drainage, the starved animal having access to the normal drinking fluid only, while the control animals continued to eat the stock diet. Bile samples were collected in hourly aliquots as described above.

Three pairs of animals were studied but the bile duct cannula in the last control animal became obstructed and since bile sampling was incomplete the samples were discarded. Fig. 54 shows examples of the total bile acid excretion pattern found in these groups of animals. The time course of the changes in bile acid excretion rate was similar in both groups. Table 17 shows the calculated values for these animals. The mean 'C max' value was rather lower in the starved animals than in the controls while the de novo synthesis rates in the groups were very similar. The most significant finding was that the 'S max' figure in the starved group was only 50% of that found in the control group. One of the starved animals pulled the bile duct cannula out after only 40 hr. drainage but since the total bile acid excretion value had already risen to a constant rate it was considered valid to use the smaller number of figures in this animal to calculate the 'S max' value.

5. Cholic acid; chenodeoxycholic acid excretion ratios in chronic bile fistula rats

The ratio of the biliary excretion of cholic acid to chenodeoxycholic acid in normal rats has been shown to be about 4:1 (Bergstrom and Sjoval1 1954, Eriksson 1957, Strand 1962). In the studies described here this ratio has been calculated in each animal during phase 1 of the excretion pattern and during phase 5, in order to determine whether any significant change occurs in the ratio during the drainage period. The mean ratio in the control animals for phase 1 was 3.63:1 and for phase 5, 5.15:1. This change in the ratio is statistically significant ($p < .001$).

In order to compare the ratios in the control animals and the experimental animals, the mean ratio has been calculated for phase 1 in the control animals and the experimental animals in each group. The mean ratio in the propylthiouracil group was 4.9:1 while in the control group the figure was 4.3:1. In the thyroidectomised group the mean ratio was 7.9:1 and in the control group 4.6:1. Eriksson (1957) and Strand (1962) showed that the relative quantity of cholic acid in propylthiouracil fed animals was increased to such extent that chenodeoxycholic acid constituted less than 10% of the total. While a similar rise has been found here, in the thyroidectomised group, no such increase in the relative quantity of cholic acid excreted in the propylthiouracil fed group has been shown. The value for the

ratio in the hyperthyroid group of animals was 0.8:1 and in the control group of animals 3.2:1. This finding is in keeping with the results of Eriksson (1957) and Strand (1962).

In the control group for the starved animals the mean ratio found was 3.2:1 while in the starved group the mean ratio was 2.5:1. The ratio gave highly variable results in the group of animals fed cholesterol. The mean value found in phase 1 was 1.4:1 while in phase 5 this ratio was 14.2:1. The ratio in the control group for the cholesterol fed animals was 4.2:1.

6. Microsomal CO-binding pigment in liver microsomes of bile fistula rats

Livers were excised from rats following 48 hr. biliary drainage and from control rats kept in restraining cages for 48 hr. Microsomal CO-binding pigment was estimated in fractions prepared from these livers. The 450m μ - 490m μ optical density difference was 0.061/mg. microsomal protein (range 0.046 - 0.072) in the control group and 0.058/mg. protein (range 0.040 - 0.070) in the fistula group. Each group consisted of 6 rats.

DISCUSSION

The liver perfusion technique

Isolated organ perfusion techniques provide a link between in vivo methods of studying the metabolism of individual tissues and in vitro preparations requiring a departure from the normal anatomical organisation of tissue (e.g. tissue slices, isolated viable cells, homogenates, and subcellular fractions). While possible failings of the latter group of techniques appear obvious, the in vivo methods may often give rise to difficulties of interpretation since chemical and hormonal interaction between tissues can occur and may not be able to be monitored.

The isolated liver perfusion technique was used by Luchsinger (1875) to study the hepatic synthesis of glycogen using defibrinated blood as perfusate. A review of this technique, using defibrinated whole blood as perfusate was published by Brodie (1903) who emphasised the importance of restoring perfusate flow as soon as possible after isolation of the liver. Brodie also discussed the difficulties of using whole blood as perfusate since organ flow rates tended to fall rapidly but he considered that the use of diluted blood was no advantage since hepatic oedema tended to develop rapidly with these diluted perfusates. Both the tendency to a fall in perfusate flow rates and the formation of extensive oedema were also emphasised by Bauer (1932). The introduction of the relatively simple tissue-slice method by Warburg (1923) and the difficulties of isolated liver perfusion led to a period when

perfusion was almost superseded by tissue-slice studies. However renewed interest in the metabolism of whole tissues led to a return to the use of the technique of isolated organ perfusion which was greatly stimulated by the work of both Miller and his colleagues and Brauer and his colleagues. Efforts to improve perfusate flow rates included the use of various "physiological" electrolyte solutions such as Locke's solution (Brauer and Pessotti 1949) and Krebs-Henseleit Bicarbonate solution (Trowell 1942 and Heimberg et al 1958). While Trowell (1942) made specific mention of the relative lack of oedema in his studies (he found that the liver volume rose 20% on average) neither Brauer and Pessotti (1949) nor Heimberg (1958) made reference to liver viability and while perfusate flow rates were apparently improved it is not clear whether liver viability was affected. Blood diluted with saline (final haematocrit 25 - 40%) (Miller et al 1951), with an albumin containing mixture of saline and phosphate buffer (Brauer et al 1951) and with Gey's balanced salt solution plus a mixture of amino acids (Ostashever 1960) has been used as perfusate with a view to providing satisfactory flow rates and oxygen transport capacity. The use of these diluted perfusates has allowed much work to be performed with the liver perfusion method but many of the recent studies using the liver perfusion technique have returned to the use of heparinised whole blood as perfusate (Brauer et al 1954, Brauer et al 1956, Burton et al 1960). Since the use of autologous blood is impracticable in mammals of the size of rats

these perfusates have all consisted of pooled homologous blood.

The necessity of testing the viability of the perfused liver has been recognised by many of the workers who have used this technique. The early workers (Brodie 1903, Brauer 1932 and Trowell 1942) were limited to macroscopic examination of the organ having no other means at their disposal; but more recent descriptions have introduced sophisticated perfusion techniques and methods for assessing the viability of the perfused organs. Miller et al (1951) were unable to distinguish between sections from perfused livers and from normal livers which were examined under the light microscope and they showed that the perfused organ could maintain amino acid clearance, bile secretion, plasma protein synthesis, CO₂ output and the ability to respond to a second dose of amino acid substrate. Brauer et al (1951) showed that the light microscopic appearances of the perfused liver were indistinguishable from normal during the first few hours of perfusion but that oedema and cell necrosis appeared when perfusion was continued for extended periods (beyond 5 - 6 hr.). Bile flow rates showed a rise of 30 min. after the perfusion had been established and the flow rate then fell to "30 - 50% of the rate found in vivo". This lower bile flow rate was maintained for at least 5 hr. when livers had been taken from rats whose body weights were between 200 g. and 233 g. Brauer et al (1951) also studied the removal of bromsulphthalein from the perfusate and showed that the time to remove 50% of the injected dose was

17 min. in comparison with 5.6 min. in vivo. The clearance of India ink from the perfusate in these preparations indicated that the function of the reticulo-endothelial elements of the liver was normal. Reticuloendothelial function in the isolated perfused rat liver was examined by the addition of [^{32}P] - CrPO_4 colloid (Brauer et al 1956) and the removal of this colloid was found to follow simple first order kinetics. The efficiency of removal of the colloid was shown to be as high in the isolated perfused preparation as in vivo. Further study of the metabolic characteristics of the isolated perfused liver was reported by Ostashever et al (1960) who showed that during a 4 hr. perfusion the oxygen utilisation fell slightly while the R.Q. of the system rose. Perfusate urea nitrogen rose throughout the perfusion period. Bile flow rates fell fairly rapidly from 0.81 ml./hr. to 0.35 ml./hr.

As described in the section "Perfusion Method" it was considered desirable to develop a perfusion system whose perfusate volume was 15 - 20 ml. One report of such a system using whole heparinised blood as perfusate has been published (Burton et al 1960). These perfusions were each carried out for 3 hours. The plasma glucose levels were found to rise in the first 15 - 30 min. of perfusion and then to fall gradually to levels rather higher than the initial concentration. The hepatic glycogen concentrations remained relatively unchanged at the end of the perfusions. Plasma sodium concentrations were found to fall on average 15 meq./l. and plasma potassium concentrations rose an average 15.4 meq./l. Bile flow rates were found to be continuous throughout the perfusion period at an average rate

In general, the experience in the experiments reported here with the isolated liver perfusion preparation using either saline or blood diluted with Rheomacrodex was similar to that of other workers. While high perfusate flow rates were seen with the saline perfusate, oedema developed rapidly and the poor initial bile flow rates failed within one hour. Considerable improvement was found with the diluted blood perfusate although morphological changes were common and easily seen with the light microscope. In this case bile flow rates were better maintained and could be measured throughout the 4 hr. perfusion period. The studies on bile acid excretion in these perfusions indicated that the perfused livers were being maintained in a satisfactory state of approximately 3 hr. but that there was a fall in the rates of bile acid synthesis during the fourth hr. of perfusion which was particularly well illustrated where livers from bile fistula rats were perfused. No other indices of liver function were measured using either of these perfusates and it may be that preparations of this kind could prove adequate where short term perfusions are required. Ostashever et al (1960) have suggested that bile production may not be a critical index of the viability of the perfused liver since they were unable to show any correlation between the metabolic activity of perfused liver from hyperthyroid rats and their bile flow rates. On the other hand, in the perfusions of livers from triiodothyronine injected rats (Fig. 39) the bile flow rates were higher in the livers from the treated rats than from the control group. Further, Danielsson et al (1961)

considered that the production of bile by the isolated perfused liver was a major criterion of viability and these authors terminated their perfusion experiments when bile flow rates fell below 0.2 ml./min. (rat body weights 250 - 300 g.). The mean bile flow rates (Fig.11) in the early part of the study fell from 0.28 g./hr. to 0.21 g./hr. (rat body weights 200 g.) where the perfusate consisted of whole blood while the bile flow rates of a larger number of livers perfused with whole blood (Fig.17) showed a mean of 0.32 g./hr. which fell to 0.24 g./hr. in the fourth hour. In these livers there is evidence that the viability of the organ was well maintained as shown by the synthesis of urea, the excretion of bromsulphthalein, the maintenance of the plasma glucose concentration and the microscopic appearances. The low bile flow rates and the failure to maintain these rates in the perfusions using saline or diluted blood as perfusate may be an index of the mechanical effects of oedema development and not directly of loss of viability of the cells themselves but morphological changes were present with the use of both of these perfusates which indicated that cellular viability was diminished.

Where the bile flow rates were estimated in bile fistula rats a mean rate of 0.49 g./hr. was found in the fourth hr. after bile duct cannulation and this rate fell to 0.28 g./hr. in the 16th. hr. (Fig. 18). Bile salts are well known to have a powerful choleric effect in the rat (Sperber 1965). In the normal rat, bile salts are constantly being reabsorbed from the intestine and the liver is therefore subjected to a continuous

stimulus to bile secretion. This stimulus was present for the first few hours following the start of bile drainage while the intestinal bile salt pool was being depleted and the low bile flow rates found 16 hr. after bile duct cannulation indicate the bile flow rates where the bile salt choleric effect had disappeared. The mean bile flow rate in the perfusions of normal livers using whole blood as perfusate fell to 0.24 g./hr. after four hours. This figure compares well with the mean of 0.284 g./hr. in vivo after 16 hr. drainage. This comparison would appear perfectly valid since in both cases the livers were not subject to the choleric effects of bile salt in the portal blood stream. Therefore these perfused livers were capable of the secretion of bile in quantities closely comparable with non stimulated in vivo flow rates.

The necessity of perfusing livers with a perfusate volume approximately equal to the total blood volume of the liver donor animals (see "The Perfusion Method" - Introduction) introduced difficulties both in the size of the perfusion apparatus and more particularly in the possible effects of the appearance in the perfusate of conditions deleterious to the liver which might be diluted out were the perfusate volume larger. Thus, changes in perfusate pH and electrolyte concentrations might be more marked with the small perfusate volume. For this reason the experiments were designed to establish the environment maintained in the perfusate.

The use of the roller type of pump produces trauma to the perfusate erythrocytes with subsequent release of haemoglobin, potassium and other cell contents. Ostashever et al (1960) found that the haemolysis rate was 1.6% after a 4 hr. perfusion using diluted rat blood while Burton et al (1960) found that haemolysis ranged from 6% to 10% after 3 hr. using 25 ml. whole rat blood as perfusate. The results reported here (Table 2) show that the mean haemolysis rate was 9.4% after 4 hr. perfusion. This haemolysis was accompanied by a rise in the perfusate plasma potassium concentration (Table 5) from a mean of 6.1 meq./l. at the start of the perfusions to a mean of 12.3 meq./l. after 4 hours. This rise in plasma potassium concentration is less than the rise found by Burton et al (1960) who found a mean increase of 15.2 meq./l. during a 3 hr. perfusion period. The same authors showed that the majority of this rise in potassium concentration was due to damage to the perfusate erythrocytes since circulation of perfusate alone caused a rise in plasma potassium concentration of 10 meq./l. Mortimore (1961) has shown that there was a loss of potassium from the liver into the perfusate during perfusion experiments which lasted for one hr. and this finding may explain the difference between the perfusate plasma potassium levels found during circulation of perfusate only and experiments in which livers were perfused. The plasma sodium concentration in the perfusions reported here rose slightly to a mean of 154 meq./l. (Table 4) while the perfusate haematocrit values also showed a small rise (Table 3) equal to 5% of the initial haematocrit value. The rise in

perfusate sodium concentration may simply indicate that a small amount of haemoconcentration was occurring in the perfusate either as a consequence of loss of water from the perfusate in the 'lung' or loss of water to the perfused liver or the perfusate red cells. Burton et al (1960) found that the perfusate plasma sodium concentrations fell when perfusate was circulated with or without a liver being included in the circuit. This change was interpreted as being due to migration of sodium into the erythrocytes as a consequence of altered cell surface permeability due to the action of the roller pump. The changes in plasma sodium concentration are, however, quite small in the experiments reported here and probably of little consequence to the status of the perfused organ. It seems likely that the small rise in the perfusate haematocrit was due to loss of water in the 'lung' and possibly also into the perfused liver since bile was being constantly secreted to a total volume of approximately 1.0 ml. during the 4 hr. perfusion period and this would represent approximately 8% of the total perfusate plasma volume.

Perfusate pH and total CO₂ concentrations were measured in the experiments reported here. Perfusate pH fell from a mean value of 7.37 at the start of the perfusions to a mean of 7.29 after 4 hr. perfusion and there was a small fall in the total CO₂ concentration. The pH of the perfusate used in liver perfusion systems has ranged from pH 7.4 (Trowell 1942, Brauer and Pessotti 1949, Heimberg et al 1958, Ostashever et al 1960) to pH 7.45 (Young et al 1955) and Ostashever reported that the

perfusate pH remained essentially constant throughout the 4 hr. perfusion period. No perfusion study report has included measurements of perfusate pH throughout the perfusion period. There is no evidence that the fall in pH is due to poor CO₂ exchange in the 'lung'. The perfusate haemoglobin oxygen saturations were found to fall slightly to a mean of 91% (Table 8) suggesting that the oxygen transfer in the 'lung' was not sufficiently rapid to keep pace with oxygen utilisation by the perfused liver.

The manner in which whole blood perfusate flow rates fall during liver perfusion has provided one of the major problems of liver perfusion techniques. Trowell (1935) reported that the oxygen consumption of rat liver slices was 1.0 - 2.0 ml./g./hr. and showed that his saline perfusate flow rates could only provide approximately 30% of the hepatic oxygen requirements, assuming 100% deoxygenation of the perfusate as it flowed through the liver. Both the difficulties of adequate oxygenation and the appearance of oedema in the perfused organ were the more important reasons for stimulating efforts to use blood or blood containing solutions as perfusate. Brauer et al (1954) showed a direct relationship between perfusion pressure and perfusate flow rate, with values as high as 12.0 ml./min./g. liver at a perfusion pressure of 18 cm. of blood and 7.0 ml./min./g. liver at a pressure of 14 cm. of blood. Burton et al (1960) found whole blood perfusate flow rates of 10 - 15 ml./min. in livers

taken from 240 g. animals. In the perfusion experiments reported here the perfusate flow rates were 1.1 - 2.4 ml./min./g. liver (equivalent to 11 - 24 ml./min. in a 10 g. liver). Brauer et al (1954) showed that bile flow rates fell steeply when the whole blood perfusate flow rates were less than 20 ml./min. (15 - 16 g. liver) and suggested that areas of the hepatic vascular bed were not being adequately perfused at the low flow rates. Macroscopic and microscopic examination of the livers perfused in the experiments described here have shown that perfusion of the whole hepatic sinusoidal system was adequate. The whole blood perfusate flow rates found were in the range in which bile flow rates would not be expected to fall off, again suggesting adequate perfusion in these experiments.

The use of histological studies as an index of viability of tissues is open to a number of criticisms since tissues may appear normal, particularly under the light microscope, for at least one hr. following removal from the animal without special preservation measures being taken (Miller et al 1951). On the other hand histological studies do provide evidence regarding the maintenance of normal anatomical relationships and the appearances of the cells may give information of a positive kind from which conclusions can be drawn regarding the metabolic status of the tissue studied. Further, in combination with biochemical studies, histological studies provide strong evidence of the viability of tissue. Brodie (1903) described

the appearances of liver after 2 or 3 hr. perfusion as being commonly normal, while oedema was present in other perfusions. Trowell (1942) found widely dilated central veins and sinusoids, rounding of the Kupffer cells and swollen parenchymal cells with abnormal appearances of their cell walls. Brauer et al (1951) showed that sections taken from livers perfused with blood diluted with an albumin containing electrolyte solution were not distinguishable from normal in the first few hours of perfusion and that slight oedema and occasional necrotic cells were found after a 24 hr. perfusion period. Miller et al (1951) could detect no differences microscopically between sections from liver perfused for 6 - 9 hr. and control livers when the well perfused parts of the liver were examined, while congestion, haemorrhage and some cloudy swelling was seen in cells when portions of perfused livers which had been poorly perfused were examined. Young et al (1955) perfused rabbit liver with diluted blood and after 12 hr. perfusion a considerable degree of congestion of the tissue was seen but the cells themselves appeared relatively normal.

The histological studies reported here showed that changes could be detected after the 4 hr. perfusion experiments using blood:Rheomacrodex, 1:1 as perfusate. Large areas of necrotic cells with pale staining nuclei were present as well as extensive "fatty change" and haemorrhage. These sections did not show evidence to suggest that the perfused organ was congested. When whole blood perfusates were used occasional necrotic cells were seen but otherwise the appearances could not be distinguished

from normal. The appearances of sections examined with the electron microscope following fixation by perfusion with glutaraldehyde showed that the architecture of the cells was well preserved and that the intracellular structure also appeared normal. The majority of the cytoplasm of a Kupffer cell can be seen in the section in Fig. 13 and a part of an erythrocyte can be clearly seen within the cytoplasm of this cell. This would most likely represent part of an erythrocyte damaged by the action of the perfusion pump and would suggest that the Kupffer cells had maintained their ability to phagocytose particulate material from the perfusate. This function has been studied by Brauer et al (1951) who showed that India ink was rapidly taken up by the reticuloendothelial elements of the perfused liver.

During cannulation of the portal vein the hepatic blood flow was arrested in these studies (apart from some possible flow through the hepatic artery) and modifications were made to the apparatus in order to reduce the flow arrest time to a minimum. Brodie (1903) found that oedema formation appeared to be related directly to the length of arrest of hepatic blood flow and showed that oedema was commonly absent when flow arrest was as short as possible. In published accounts of perfusion methods the length of time of flow arrest has been 5 - 10 min. (Robbins et al 1953), 6 - 8 min. (Miller et al 1951), 4 - 6 min. (Danielsson 1961), 5 min. (Ostashever et al 1960), 3 - 5 min. (Brauer et al 1951), 3½ min. (Burton et al 1960) and less than

4 min. (Harold et al 1955). The original operative technique used in the studies described here consisted of tying the portal vein cannula (previously filled with perfusate) firmly into place followed by removal of the liver from the donor animal and only then restarting perfusate flow, having placed the liver in the perfusion apparatus. This technique left the liver without perfusate for about 4 min. This was considered to be too long a time since it was found that in a number of cases it was not possible to restart hepatic perfusate flow once the liver was connected to the perfusion apparatus in spite of there being no apparent difficulty in the portal vein cannulation procedure. It appeared likely that the reason for these perfusion failures was clotting of the blood in the liver since no anticoagulant was administered to the donor animals. The modifications described allowed the insertion of the portal vein cannula previously filled with perfusate and still connected directly to the perfusion system. Therefore perfusate flow could be restarted immediately the cannula had been firmly tied in place with a consequent reduction in flow arrest time. In this way failure to reestablish perfusate flow was reduced to a minimum.

The synthesis of urea was demonstrated in liver slices by Krebs and Henseleit (1932) and in the isolated perfused liver by Trowell (1942). While urea synthesis is not normally considered a useful test of "liver function" in vivo the concentration of urea in the perfusate provides a valuable indication in the isolated

perfused preparation where no mechanism, apart from a biliary route, is available for the excretion of urea from the perfusion system as a whole. Burton et al (1960) found that perfusate urea concentration rose an average of 18 mg.% during the perfusions of 3 hr. duration (equivalent to the synthesis of 4.2 mg. urea in 3 hr.) while Ostashever et al (1960) found that the urea production during the 4 hr. perfusion period was 60 mg. The perfusate used by Ostashever et al consisted of diluted rat blood with the addition of amino acids and when the amino acid supplements were omitted the urea synthesis rate fell by 50%. In the studies reported here the perfusate plasma urea concentration rose steadily throughout the perfusion period from a mean of 30 mg.% at the start of the perfusions to a mean of 121 mg.% after 4 hr. This is equivalent to a synthesis of 20 mg. urea and corresponds to approximately 60 mg.urea/100 g. body weight/day. Finlayson and Baumann have shown that the urea synthesis rate in vivo is 38 mg. urea/100 g. body weight/day. Therefore these perfused livers are capable of sustained urea synthesis at rates higher than equivalent in vivo rates during the 4 hr. perfusion period.

The perfusate glucose concentrations (Fig.19) were found to rise to a mean of 161 mg.% 30 min. after the livers had been placed in the perfusion system. This rapid rise in glucose concentration was followed by a fall to mean levels of 95 - 100 mg.% which was well maintained throughout the rest of the perfusion period. These findings are similar to those of Burton et al (1960)

and Kay and Entermann (1961), while Miller et al (1959) found a smaller rise in perfusate glucose concentration. Comparison of sections taken from livers after 4 hr. perfusion with livers from fed rats indicated that the glycogen content of the parenchymal cells was normal and Burton et al (1960) found that total hepatic glycogen fell by 2.4% after 3 hr. perfusion. The maintenance of perfusate glucose concentration was therefore not at the expense of hepatic glycogen and since urea was continuously synthesised during these perfusions it seems likely that at least part of the perfusate glucose originated from the degradation of amino acids.

The removal of bromsulphthalein from the perfusate, and its biliary excretion (Fig. 20), showed that the pattern of appearance of this compound in bile after 4 hr. 40 min. was similar to that found after 2 hr. 40 min. and 40 min. perfusion. This finding further demonstrates the satisfactory status of these isolated livers. The peak excretion of bromsulphthalein in vitro occurred 22 - 25 min. after the addition of the dye to the perfusate while in vivo the peak occurred 8 min. after injection of the dye into the femoral vein. While there is clearly some impairment in the handling of the dye by the perfused organ when compared with the in vivo situation, several factors may be involved in this process since the overall rate of appearance of dye in bile will depend both on the rate of its removal from the perfusate - a function of the multi-plate extractor mechanism

of the liver - and on the rate of its excretion from the parenchymal cell into the bile. Brauer et al (1951) have shown that the time to remove 50% of a single injection from the circulation is 5.6 ± 0.5 min. in vivo and 17.0 ± 2.5 min. in the perfused preparation. These figures are very similar to the elapsed time findings in the experiments described here and the difference between the in vivo and in vitro results is probably mainly in the removal of the dye from the blood, the transport and conjugation processes (Brauer et al 1950) in the parenchymal cells being relatively unimpaired.

Studies on cholesterol and bile acid metabolism in the isolated perfused rat liver.

Livers perfused with blood:Rheomacrodex

The bile acid excretion studies in livers perfused with blood:Rheomacrodex served to demonstrate that bile acid excretion continued throughout the 4 hr. period in perfusions of livers from normal and bile fistula rats (Figs. 23 and 26). Where [¹⁴C]-cholesterol was substrate the bile acids consisted of compounds which were clearly separated on the liquid:liquid Celite columns and which were Pettenkofer positive. Thin-layer chromatography indicated that the material in the 40% benzene, 60% petroleum ether eluate ran as a single spot where the livers were from fistula rats and as a single spot with a small quantity of more mobile material in the livers from normal rats. The mobility of the majority of the material was identical with standard chenodeoxycholic acid and more than 80% of the total radioactivity on the plates was in a position corresponding exactly with the standard compound (Fig. 24). The material in the 80% benzene, 20% petroleum ether eluates was shown to have a mobility identical with standard cholic acid; here also, more than 80% of the radioactivity corresponded with the standard compound (Fig. 25).

The pattern of bile acid excretion in these series of perfusions was fundamentally different. Where livers from normal rats were perfused, both the dihydroxy and trihydroxy bile acid excretion rates fell to low levels during the first hour. Excluding the first hr. the total excretion rate was 50 - 100 µg./hr. in the first group of perfusions and less than 50 µg./hr. in the

second group. These findings are similar to the results of Kay and Entenman (1961) who studied the biliary excretion of taurocholate only and found that after 30 min. perfusion the taurocholate excretion rate had fallen to trace levels compared with a mean of 950 μg . in the first 30 min. Confirmation that these bile acid excretion rates represented de novo synthesis was obtained since the added [^{14}C]-cholesterol lipoprotein was converted into [^{14}C]-compounds with chromatographic properties similar to standard bile acids. The fall in total bile acid excretion rate could be interpreted as being due, either to a failure of liver function as a consequence of the perfusion technique itself, or as the excretion of the hepatic and biliary bile acid pool in the first hr.; with the subsequent excretion of the low normal synthesis rate thereafter. It is important to note that no [^{14}C]-bile acids could be eluted from the silicic acid columns after separation of the [^{14}C]-cholesterol and [^{14}C]-cholesterol ester from the plasma extract added to the perfusate. Therefore the presence of small quantities of [^{14}C]-bile acid in the bile could not represent excretion of performed [^{14}C]-bile acid. Where livers from fistula rats were perfused, both dihydroxy and trihydroxy bile acids were excreted throughout the 4 hr. period (Fig. 26). The secretion rate was well maintained for the first 3 hr. of the perfusions only. These findings suggested that the falling excretion rates found in the livers from normal rats was not due simply to the perfusion technique but was rather a property of the perfused livers themselves. However, the low total excretion rate found in the fourth hr. in the perfusions of livers from fistula rats did suggest first--

function towards the end of the perfusion period. The well maintained high excretion rate of cholic acid is similar to the findings of Kay and Entenman (1961) who studied taurocholate excretion by livers following 48 hr. biliary drainage.

The ratio of cholic acid to chenodeoxycholic acid in rat fistula bile is normally approximately 4:1 (Bergström and Sjövall 1954) although dietary factors (Portman and Mann 1955) and endocrine factors (Eriksson 1957, Strand 1962) can produce marked alteration in the relative quantities. Approximately equal quantities were excreted during the first hr. of the perfusions of livers from normal rats. Thereafter the ratio was approximately 4:1. The livers from fistula rats showed less variable relative excretion rates, the mean ratio being 6.5:1 in the first group and 4.7:1 in the second group. These ratios are very similar to those found in fistula bile after 44 hr. biliary drainage (Eriksson 1957), Strand 1962 and present study).

Since no change in the ratio was found when livers from fistula rats were studied the perfusion technique did not itself affect the relative rates of synthesis of bile acids. Therefore the changing ratio found when livers from normal rats were studied was produced by some factor inherent in the livers themselves. This changing ratio indicates that during the first hr. the total bile acid excreted was a combination of newly synthesised bile acid and bile acid which had been reabsorbed from the intestine prior to removal of the liver and was present in the liver and bile at the start of the perfusion. During the

first hr. the majority of the bile acid excreted would be from the latter source and hence the relative ratio of the bile acids would be an indication of the amounts reabsorbed from the intestine; the newly synthesised acids being overwhelmed. Thereafter the ratio was a true indication of the quantities newly synthesised. A significant change in ratio was also seen in the fistula rats. In these animals the same argument holds since the overall ratio in the first few hr. of drainage represents both newly synthesised and reabsorbed bile acids while after 20 hr. drainage the ratio relates exclusively to newly synthesised compounds.

These perfusion experiments allowed the study of bile acid excretion on a time basis and confirmed that bile acid synthesis was proceeding during the perfusion period. However it was found that the relatively low specific activity of the [^{14}C]-cholesterol lipoprotein added to the perfusate (and the subsequent dilution with perfusate cholesterol) did not produce sufficiently high specific activity bile acid for hourly study in the livers from normal rats. The place of DL-mevalonic acid in the biosynthesis of cholesterol was reported by Tavormina et al (1958). It was shown by Tavormina and Gibbs (1958) that there was a high degree of incorporation of [^{14}C] into cholesterol when [2. ^{14}C]-DL-mevalonic acid was used as substrate in incubations with cell-free homogenates of rat liver. While several workers have shown that the rate of cholesterol synthesis is affected by dietary factors such as cholesterol feeding (Tomkins et al 1953, Siperstein and Guest 1960) and starvation (Bucher et al 1960) and hormonal factors such as thyroid status (Kritchevsky 1960)

these factors mainly affect the conversion of acetate to cholesterol. Where mevalonic acid has been used as substrate little affect has been demonstrated (Fletcher and Myant 1958). It was for these reasons that [2. ¹⁴C]-DL-mevalonic acid was preferred as precursor since in the studies with livers from pretreated rats the incorporation of this substrate into cholesterol should not be affected.

When [2. ¹⁴C]-DL-mevalonic acid was added to the perfusate the pattern of bile acid excretion was very similar to that described above (Fig. 27). In the first group of perfusions the total excretion rate was well maintained throughout the 4 hr. period; the ratio of trihydroxy to dihydroxy acids was 5:1 throughout. In the second group the total excretion rate was poorly maintained in the last 2 hr. In this group the ratio was 2:1. Thus the addition of mevalonic acid to the perfusate did not appear to influence the pattern of bile acid excretion. The total recovery of radioactivity as bile acids showed that maximum incorporation was occurring in the second hour. In both groups the total bile acid radioactivity fell after the second hr. and this fall was more marked in the second group. The reason for this pattern of excretion of radioactivity was not clear. The specific activities of the bile acids excreted in the first group of perfusions were 62.9, 78.0, 70.2 and 57.4 counts/ μ g./min. in each of the hourly collections. Since the early stages of bile acid biosynthesis are carried out in the

endoplasmic reticulum (Danielsson and Einarsson 1964, Mitton and Boyd 1965) these specific activities must equal the specific activity of the cholesterol which is the immediate precursor of the bile acids and therefore, since the cholesterol present in endoplasmic reticulum is in equilibrium with the plasma cholesterol (Harold et al 1955, Danielsson et al 1961), a study of the appearance of radioactivity in the perfusate plasma was required.

Confirmation of the identity of the isolated biliary bile acids was available from these perfusions. Estimation of the total radioactivity present in aliquots taken from the eluates from the liquid:liquid columns allowed comparison of the radioactivity with the Pettenkofer chromogenicity (Fig. 28). These parameters were shown to correspond exactly in all of the bile samples analysed. This suggested that the same compounds were radioactive and Pettenkofer positive. Recrystallisation of material taken from the radioactive peaks from the liquid:liquid columns, following the addition of the appropriate standard bile acid, allowed constant specific activity to be attained (Tables 10 and 11) without a fall in the original specific activity. This confirmed that chenodeoxycholic acid and cholic acid were being excreted throughout the perfusions. No other radioactive bile acids were detected.

Comparison of radioactivity and Pettenkofer chromogenicity in the eluates from the liquid:liquid columns demonstrated an extremely close relationship between these parameters. Since both dihydroxy and trihydroxy bile acids were recovered throughout these perfusions the time course of incorporation of radioactivity into cholic acid and chenodeoxycholic acid was similar.

addition, no significant quantity of radioactivity was incorporated into other acidic compounds. Harold et al (1955) found that radioactivity from [4. ^{14}C]-cholesterol was rapidly incorporated into taurochenodeoxycholic acid in the perfused liver and that little or no incorporation into taurocholic acid took place, while a third compound became labelled. On the other hand, Danielsson et al (1961) found that cholic acid and chenodeoxycholic acid were present in bile from perfused livers in the ratio of 4:1. Radioactivity was incorporated in the same proportions. The relative proportions of bile acids and radioactive incorporation found here are similar to the bile fistula rat (Bergström and Norman 1953).

Livers perfused with pooled rat blood

Two series of experiments were performed with the whole blood perfusate in order to study liver/plasma cholesterol equilibria and bile acid synthesis rates in normal livers and livers from fistula rats. In the first series [2. ^{14}C]-DL-mevalonic acid was used as cholesterol precursor while in the second the substrate was [^{14}C]-cholesterol in the form of plasma lipoprotein. In both of these perfusion series the bile acid excretory pattern was similar to that found in the perfusions using blood:Rheomacrodex as perfusate. The excretory rates were higher in the last 3 hr. of the perfusions of livers from normal rats and where livers from fistula rats were perfused the excretion rates were well maintained throughout the 4 hr. period (Fig. 29). The incorporation of

radioactivity into bile acids showed maximum incorporation in the second hr., but the subsequent fall in the rate of radioactive labelling was not so marked. The ratio of trihydroxy to dihydroxy bile acids in the first perfusion series was 1.8:1 in the normal livers and 3.4:1 in the livers from fistula rats and in the second series 2.7:1 and 3.1:1 respectively.

If the pool of bile acids present in the liver and bile at the start of the perfusion experiments with livers from normal rats is excreted within the first hr., then the subsequent total excretion rates should represent the normal de novo bile acid synthesis rates. The mean total bile acid excretion rate in these two series of perfusions of livers from normal rats was 190 $\mu\text{g./hr.}$ in the last 3 hr. of both series. That is equivalent to an excretion rate of 63 $\mu\text{g./hr.}$ for each liver. The rate of total bile acid synthesis in normal rats on laboratory diet has been estimated as 110 - 170 $\mu\text{g./hr.}$ (Lindstedt and Norman 1956) and 200 $\mu\text{g./hr.}$ (Gustafsson et al 1960) using isotope dilution techniques in vivo, while the influence of various dietary regimens has been shown to affect both the intestinal bile salt pool size as well as the rate of bile acid turnover. Thus the daily excretion of cholic acid varied between 300 $\mu\text{g./hr.}$ on a Purina laboratory chow diet, and 64 $\mu\text{g./hr.}$ on a sucrose synthetic diet (Portman and Murphy 1958). Direct assessment of bile acid synthesis rate is only possible where the affects of the enterohepatic circulation of bile salts are excluded. The liver

perfusion technique affords such direct assessment and the estimate of a total excretion rate of 63 $\mu\text{g./hr.}$ suggests that previous estimates were too high.

In the first of the 2 groups of livers from fistula rats the total bile acid excretion rate was 1040 $\mu\text{g./hr.}$ while in the second group the rate was 1750 $\mu\text{g./hr.}$ The total bile acid excretion after 44 hr. biliary drainage represents the maximum capacity of the liver to synthesis bile acids when the bile salt feedback mechanism is removed (Eriksson 1957). Thompson and Vars (1953) found a cholic acid excretion rate of 27 mg./24 hr. (rats 220 - 260 g.) after 48 hr. drainage, while Eriksson (1957) found that the total excretion rate was 50 mg./24 hr. (200 - 300g. rats). In the studies on bile fistula rats reported here the total excretion rate ranged between 700 - 1940 $\mu\text{g./hr.}$ The rates found in these perfused livers from fistula rats were therefore in good agreement with the in vivo studies on fistula rats and demonstrate that the increased rate of total bile acid excretion which occurs after 44 hr. bile drainage may all be accounted for by increased hepatic synthesis and excretion.

The plasma cholesterol consists of a heterogeneous pool of sterol associated with the various plasma lipoproteins. This plasma cholesterol is in dynamic equilibrium with the cholesterol of many tissues including the liver (Avigan et al 1962) in which case the equilibrium is very rapid in vivo (Popjak and Beeckmans 1950, and Hotta and Chaikoff 1955).

In these liver perfusion experiments the plasma total cholesterol

concentration did not change when livers from fistula rats were studied. There was a small rise in plasma total cholesterol concentration in one of the groups of perfusions of normal livers and no change in the other group. Interpretation of the real meaning of this small rise in total cholesterol concentration is complicated by the evidence which suggested a degree of haemoconcentration, and this rising concentration may not represent a true net shift of cholesterol into the perfusate. Kay and Enterman (1951) showed no change in perfusate plasma cholesterol (free or ester) concentration where livers from normal rats were studied and a slight rise where livers from fistula rats were perfused. Similarly, no change in perfusate plasma cholesterol concentration was shown by Roheim et al (1963) where livers from rats on normal diets were studied. It is important to note that these authors did not specify the perfusate volumes used, but the methods quoted in both cases were originally designed for use with large volumes which would make plasma concentration changes rather insensitive. On the other hand, the small volumes used in the studies reported here permitted a more sensitive detection of any changes if these were occurring. Fig. 31 shows the plasma total cholesterol specific activity following the addition of [2-¹⁴C]-DL-mevalonic acid. In both perfusion groups the specific activity rose throughout the 4 hr. period thus demonstrating the transfer of [¹⁴C]-cholesterol from the hepatic synthetic site; the endoplasmic reticulum, into the plasma. The transfer of [¹⁴C]-cholesterol lipoprotein added to the perfusate is shown in Fig. 34. In both groups the added [¹⁴C]-cholesterol was removed from the plasma (plasma cholesterol)

relatively constant) at a comparable rate. Since [^{14}C]-bile acids appeared in the bile in these perfusions it is clear that the plasma cholesterol is in equilibrium with the endoplasmic reticulum cholesterol pool.

These studies allow further interpretation of the data showing the incorporation of radioactivity into the biliary bile acids. Where the radioactive precursor used was [$2\text{-}^{14}\text{C}$]-DL-mevalonic acid, rapid incorporation into [^{14}C]-cholesterol in hepatic endoplasmic reticulum would be expected during the first hr. of the perfusion period (Elwood and Van Bruggen 1961). Hence, the specific activity of the substrate cholesterol for bile acid synthesis will rise rapidly in the first part of the perfusion period. Thereafter equilibrium with the plasma cholesterol will produce a fall in the cholesterol specific activity in the endoplasmic reticulum. It seems likely that equilibrium between the endoplasmic reticulum cholesterol and the other cholesterol containing membranes in the cell would also contribute to the falling specific activity of the substrate cholesterol for bile acid synthesis. The pattern of recovery of radioactivity therefore follows the deduced pattern of specific activity of the substrate cholesterol pool. Where the radioactive substrate used was [^{14}C]-cholesterol lipoprotein, the plasma compartment was labelled immediately and thereafter the specific activity fell throughout the period of study. In the perfusions of livers from normal rats the bile acid radioactivity was constant for the first 2 hr. and thereafter fell by approximately 15% per hour. This fall was similar in size to the fall in bile acid excretion rate and

may represent only a reduction in bile acid synthetic rate. The specific activity of the bile acids in the last 3 hr. of these perfusions was relatively constant and thus the precursor cholesterol pool specific activity was also constant. In the perfusions of livers from fistula rats the bile acid radioactivity rose rapidly in the first 2 hr., and then fell. In this case also the specific activity of the bile acids excreted during the last 3 hr. was constant. The rate of cholesterol synthesis has been shown to rise following interruption of the bile salt enterohepatic circulation (Myant and Eder 1961). Thus the rate of cholesterol synthesis is an additional factor involved in the interpretation of these data since the rate of synthesis of cholesterol will affect the rate of dilution of the radioactive cholesterol in the endoplasmic reticulum.

The total cholesterol content in the perfusate in these experiments was between 15 mg. and 16 mg. and the total hepatic cholesterol content was approximately 17 mg. (total hepatic cholesterol content in rats on same dietary regime, 1.8 - 2.0 mg./100 g. wet weight). Since the perfusate cholesterol total radioactivity (Fig. 34) was found to be still falling when more than 50% of the added [^{14}C]-cholesterol had disappeared from the perfusate compartment this continuing fall must represent either, preferential uptake of the added cholesterol by the liver, or the removal of significant quantities of [^{14}C]-cholesterol from the system as a whole. The de novo bile acid synthesis rates in these livers represented a significant fraction of the total cholesterol content of the system, particularly where livers from fistula rats were studied, and the removal of this cholesterol

from the system may explain the continuing fall in the plasma cholesterol specific activities.

Comparison of the recoveries of radioactivity in bile acids in livers from normal and fistula rats demonstrated a higher incorporation in the livers from fistula rats when the radioactive substrate was either [^{14}C]-cholesterol lipoprotein, or [$2\text{-}^{14}\text{C}$]-DL-mevalonic acid. Thus, newly synthesised cholesterol in the endoplasmic reticulum or circulating plasma cholesterol are both substrates for bile acid synthesis in the normal and fistula rat. Where the rate of bile acid synthesis is increased as in the fistula rat both of these forms of cholesterol are drawn on at increased rates.

Perfusions were performed on livers taken from rats rendered mildly hyperthyroid by injection of triiodothyronine, or hypothyroid by surgical thyroidectomy. In each case confirmation of thyroid status was obtained by body weight and heart rate measurements. The relationship between oxygen consumption rate and heart rate has been demonstrated (Oliver and Boyd 1960). The bile acid excretion rates were found to be changed by these procedures by only small amounts. The livers from thyroidectomised rats excreted bile acids at very similar rates to the livers from control rats while the livers from triiodothyronine injected rats appeared to excrete slightly increased quantities (Figs. 36 and 40). These findings are similar to those of Strand (1963) who used the indirect isotope dilution method. Strand showed that in thyroid hormone treated rats the total bile acid synthesis rates were raised by up to 60% while in hypothyroid (propylthiouracil treated)

Weiss and Marx (1955) found an increased faecal excretion of both neutral and acidic products following [4-¹⁴C]-cholesterol injection in hyperthyroid mice while Abell et al (1956) could detect no change in faecal excretion of sterols and bile acids in hypothyroid dogs. It was clear from these perfusion experiments that, if differences in total bile acid synthesis rate do exist, they are small and these aspects of the rate of bile acid synthesis were not studied further.

In both of these groups of perfusion experiments, [2-¹⁴C]-DL-mevalonic acid was added as cholesterol and bile acid precursor. The recoveries of radioactivity in bile acids were lower in the livers from thyroidectomised rats than control livers. It has been shown that hypothyroidism does not significantly affect the rate of incorporation of mevalonic acid into hepatic cholesterol (Fletcher and Myant 1958). Therefore, since the specific activity of the cholesterol pool used for bile acid synthesis must have been lower in the livers from the thyroidectomised rats than the controls, thyroidectomy appears either to affect the rate of equilibration of cholesterol in the endoplasmic reticulum with cholesterol in other parts of the cell or the newly synthesised [¹⁴C]-cholesterol has been diluted out by a larger pool of non-radioactive cholesterol. The total hepatic cholesterol concentration is not altered by thyroidectomy (Fletcher and Myant 1958) and while it remains possible that the overall distribution of the hepatic cholesterol is altered, the differences in

cholesterol specific activity found here may indicate an effect on the rate of equilibrium between different subcellular cholesterol pools. A similar effect was seen when livers from triiodothyronine injected rats were perfused. The total bile acid excretion rate appeared to be higher than in the control perfusions while the recovery of radioactivity in bile acids was lower than in the controls. Kritchevsky et al (1961) and Duncan and Best (1962) have shown a small fall in total hepatic cholesterol concentration following administration of thyroid hormone and it seems possible that the lower bile acid specific activities in the treated group were due to an altered equilibrium between hepatic subcellular cholesterol pools.

Balance studies in vivo have shown that supplementation of the diet with cholesterol induces increased synthesis of bile acids in the rat (Wilson 1962). Livers from rats given a 0.5% cholesterol supplement in their diet were perfused. These studies showed that the total bile acid excretion rates were increased in the livers from the cholesterol fed group compared with the controls. The recovery of bile acid radioactivity incorporated from the added [2-¹⁴C]-DL-mevalonic acid was approximately equal in the 2 groups. Cholesterol feeding causes a rise in the total hepatic cholesterol concentration (Langdon and Bloch 1952) and therefore the radioactive cholesterol synthesised in these preparations will be subject to considerable dilution by the non-radioactive cholesterol already present. If the specific

activity of the substrate cholesterol pool is lower in the livers from cholesterol fed rats than control rats then the recoveries of radioactivity would also be expected to be lower. The plasma total cholesterol concentration rose slightly in the perfusions of livers from normal rats while the mean concentration doubled in the cholesterol fed group. The specific activity of the plasma cholesterol was almost 3 fold higher in the control group than in the cholesterol fed group. Therefore it is likely that the specific activity of the cholesterol within the parenchymal cell was considerably lower in the livers from cholesterol fed rats; this is supported by the lower specific activity of the bile acids recovered in the latter group. It is clear that the rate of incorporation of radioactivity derived from the injection of [2-¹⁴C]-DL-mevalonic acid into bile acids cannot provide an adequate method of estimating the total rate of bile acid synthesis in the livers from cholesterol fed rats.

Studies on bile acid excretion in bile fistula rats

Studies on the water and electrolyte balance in bile fistula rats indicated that replacement of biliary losses was adequate. There was a small rise in the blood haematocrit following bile drainage which was accompanied by a fall in the potassium concentration but these changes were considered to be sufficiently small to be acceptable. This was confirmed both by the satisfactory condition of these rats following drainage and by the adequate rise in bile flow in response to the increased rates of bile acid excretion. The rise in bile flow is in marked contrast with the lack of such response (Eriksson 1957, Myant and Eder 1961) where no potassium supplementation was used.

The metabolic effects of surgical thyroidectomy and propylthiouracil feeding were confirmed by following both heart rates and body weights prior to the formation of bile fistulae. The effect of thyroidectomy on bile acid excretion in the fistula rat was to increase the rate of total bile acid excretion in the first few hours of drainage and to alter radically the subsequent response in bile acid synthesis rate. Thus, following the 44 hr. period of bile drainage the total rate of bile acid synthesis had increased 6 fold in the control rats and only 2 fold in the thyroidectomised group. It was clear from these experiments that the de novo synthesis rates, as estimated by the lowest rate of total bile acid excretion in phase 3 of the excretion period, showed no significant difference between the thyroidectomised and control groups. The large difference in response to bile drainage was also seen when propylthiouracil fed rats were

studied. In this case the rate of bile acid excretion rose almost 10 fold in the control group and about 4 fold in the propylthiouracil fed group. No difference between the groups was found in the total bile acid excretion in the first hours; while the de novo synthesis rate was higher in the control group than in the hypothyroid group. Thyroid status had an effect on the response of the liver to bile drainage in two ways. Firstly, the rate at which the increase in bile acid synthesis took place was reduced, and secondly the overall magnitude of the response was low. The increased rate of bile acid synthesis in the hypothyroid groups appeared to be fairly constant during the last hours of bile drainage studied suggesting that no further increase in the synthesis rate was likely. The differences in overall size of response are similar to the effects of hypothyroidism found by Eriksson (1957) and Strand (1962); but these workers studied the bile acid content in 24 hr. samples of bile in which the rate of the rise was masked. Strand (1963) showed that the pool size of total bile acids in rats fed propylthiouracil was similar to the control animals. This is supported by the results in these fistula rats but there was a large increase in total pool size in the rats which were subjected to thyroidectomy. The similar de novo synthesis rates in the thyroidectomised and control groups supports the evidence from the perfusion experiments while the slightly reduced synthesis rate in the group treated with propylthiouracil differs from Strand who showed no difference between these groups. The effects of hypothyroidism on the de novo synthesis rates remain

in some doubt but these effects appear to be small in comparison with the marked effects on the synthesis rates in response to biliary drainage which are clearly established (Eriksson 1957, Strand 1962).

Mild hyperthyroidism produced a small increase in the de novo bile acid synthesis rate which supports the results in the liver perfusion experiments and also the findings of Strand (1963). There was also a small rise in the final total synthesis rate in response to bile drainage. Both the 'S max' values and the pool sizes were similar.

Supplementation of the diet with small quantities of cholesterol results (in the rat) in an increased total hepatic cholesterol concentration with only small changes in plasma cholesterol concentration (Langdon and Bloch 1953). When rats were fed with 0.5% cholesterol supplements the rate at which the bile acid synthesis rate responded was increased to such an extent that the maximum synthesis appeared after only 22-26 hr. in the cholesterol fed group in comparison with 36 hr. in the control group. Higher de novo synthesis rates were found in the cholesterol fed rats and this supports both the results from the perfusion studies and the studies on Wilson (1962). There was also an increase in the 'S max' values in the cholesterol fed group.

The rate of cholesterol synthesis in rat liver has been shown

to be inhibited by fasting (Dietschy and Siperstein 1967). Since cholesterol feeding affects the rate of bile acid synthesis and biliary drainage causes stimulation of cholesterol synthesis (Myant and Eder 1961) it was thought that the effect of starvation on the response to biliary drainage might be of interest. The significant effects were the lower pool sizes in the starved rats and the reduced maximum bile acid synthesis rates found. These lower maximum synthesis rates lend support to the theory that control might rest in the cholesterol molecule since, if cholesterol synthesis rates are low in these animals' livers then a reduced stimulus to bile acid synthesis would be present. On the other hand, care must be exercised in interpreting these findings too closely since the rat starved for longer than 24 hr. is clinically no longer an entirely well animal and the lower synthesis rates could be due to their general poor condition.

The studies reported here on bile fistula rats have confirmed that there is a delay of approximately 18 hr. between the start of biliary drainage and the point at which the rise in bile acid excretion (and presumably synthesis) occurs. The studies of Bergström and Danielsson (1958) have shown that the continuous infusion of sodium taurochenodeoxycholate into the intestine largely inhibits the rise in cholic acid synthesis in the fistula rat. Therefore the concentration of bile salt in the portal blood and also in the hepatic parenchymal cell must be a major factor in the control of bile acid synthesis. The early steps in the formation of bile acids are performed in the endoplasmic reticulum of the

parenchymal cell, and these reactions appear to be involved in controlling the rate at which bile acids are synthesised (Danielsson and Einarsson 1964, Mitton and Boyd 1965, Hutton and Boyd 1966). These early steps involve the hydroxylation of the cholesterol molecule at position 7 followed by the conversion of the cholest-5-ene 3β , 7α diol so formed to cholest-4-ene- 7α -ol-3-one (Hutton and Boyd 1965). Since these compounds have not been isolated from extracts of liver tissue it is likely that the formation of the former represents the major rate limiting reaction in the biosynthesis of the bile acids. Since the endoplasmic reticulum of the parenchymal cell is involved in these reactions, the concentration of bile salt there is probably the important factor. The rate of excretion of bile acids falls during the first 12 hr. following the start of biliary drainage; due to the depletion of the pool of bile salts in the enterohepatic circulation, and unless bile salts are strongly bound to parenchymal cell endoplasmic reticulum the concentration within the parenchymal cell probably falls in the same fashion. If bile salt in the parenchymal cell causes inhibition of the overall rate of bile acid synthesis simply by a process of competitive inhibition of the enzyme responsible for the hydroxylation of cholesterol at position 7 then the rate of synthesis should rise at a rate directly related to the fall in excretion of biliary bile acid; and clearly this is not the pattern which is found. It has been suggested (Myant and Eder 1961) that the rate of synthesis of cholesterol in the liver endoplasmic reticulum can be shown to rise earlier than the

rate of bile acid synthesis. Myant and Eder have suggested that it is the increased cholesterol synthesis rate which stimulates bile acid synthesis. Even here there is a delay in the appearance of the increased cholesterol synthesis rate till at least 12 and probably nearly 18 hr. after the start of bile drainage.

Liver microsomes are known to catalyse a number of hydroxylation reactions among which are the oxidative demethylation of various drugs (Brodie et al 1958) in which CO-binding pigment (Klingenberg 1958, Garfinkel 1958, Omura and Sato 1964) is probably involved. Orrhenius et al (1965) have shown that pretreatment of rats with drugs such as phenobarbitone induces an increased rate of drug hydroxylation. At the same time there is an increased rate of synthesis of the CO-binding pigment. An increased rate of steroid hydroxylation in position 7 has also been demonstrated for both testosterone and Δ^4 -androstene-3, 17-dione in microsomes taken from phenobarbitone treated rats (Conney and Klutch 1963). It seemed possible that the reduction in parenchymal cell bile salt concentration was causing an increased rate of synthesis of the CO-binding pigment and that this might be the mechanism for the rise in total bile acid synthesis rate. However the amount of the CO-binding pigment was found to remain constant throughout the 48 hr. biliary drainage during which time the usual rise in bile acid excretion rates was confirmed. While this pigment may be involved in the hydroxylation of the cholesterol molecule to form the bile acids it seems unlikely that it is the factor concerned in regulation of the rate of synthesis.

The rate of hydroxylation of cholesterol at position 7 in rat liver microsomes, is increased by bile drainage or by feeding the resin cholestyramine which binds bile salts in the intestine; thus interrupting the enterohepatic circulation of these compounds (Scholen and Boyd 1967). It seems possible that the control of the process of bile acid synthesis in this situation is produced by the removal of the inhibiting effect of bile salts on the synthesis of the enzyme concerned with hydroxylation at position 7. The feeding of puromycin, a compound which inhibits protein synthesis at the level of ribosome (Gorski et al 1961), has been shown to inhibit the secondary rise in bile acid biosynthesis (Danielsson, personal communication to Dr. G.S. Boyd). The stimulation of liver RNA synthesis in thyroidectomised rats after a single injection of 15 - 22 μ g. of triiodothyronine/100 g. body weight has been demonstrated by Tata and Widnell (1966) and the effects of hypothyroid status on both the rate and absolute quantity of response to bile drainage may represent an effect in reduced synthetic capacity for the rate limiting enzyme in bile acid biosynthesis.

Little is known of the physical form in which bile salts cross the hepatic parenchymal cell. However, it seems possible that some form of micelle formation (Hoffman 1965) may be involved. Cholesterol feeding appears to stimulate bile acid biosynthesis and this process may involve the formation of a 'mixed micellar'

bile salt form within the parenchymal cell which sequesters bile salts and removes them from their site of inhibition of the bile acid biosynthetic rate limiting enzyme. In the bile fistula rat the maximum rate of bile acid synthesis may represent a balance between the effects of the newly synthesised bile acids in inhibiting the synthesis of rate limiting enzyme and the rate at which bile acids are removed from their site of synthesis. Therefore the marked increase in the rate of response seen in the cholesterol fed rats may represent removal of bile acids from their site of synthesis in these postulated 'mixed micellar' forms.

While such endocrine factors as thyroid status may have an effect on the rate of bile acid synthesis, the major controlling factor on this process is undoubtedly the enterohepatic circulation of the bile salts. The studies reported here support the suggestion that the cholesterol molecule itself may play a major role in controlling the rate of its own degradation. The studies of Myant and Eder (1961) have indicated that cholesterol synthesis rates may rise in the bile fistula rat before bile acid excretion rates. While supplementation of the diet with relatively small quantities of cholesterol has been shown to inhibit cholesterol synthesis (Langdon and Bloch 1953, Siperstein and Guest 1960, Dietschy and Siperstein 1967) it is not known whether the rate of cholesterol synthesis is increased in the cholesterol fed rat following bile drainage or whether the increased cholesterol concentration itself is the important factor. Further study is required to determine whether cholesterol plays a role in

"sequestering" bile salts within the parenchymal cell or a more direct role in controlling the rate of bile acid biosynthesis.

APPENDIX

1. The bile acid extraction and estimation procedure

1.1 Hydrolysate extraction procedure

The hydrolysate extraction procedure was studied with a view to determining the optimal pH value for extraction. Identical aliquots of a solution of cholic acid in 2.5 N aqueous sodium hydroxide solution were acidified with hydrochloric acid to pH values of approximately pH 7, 5, 4, 3 and 2. These solutions were then extracted 3 times with chloroform, ethanol:9,1 and the extracts pooled separately. The recoveries of cholic acid were estimated in each sample by the modified Pettenkofer reaction (Fig. 55). The total recoveries were greatest when the extraction pH was either pH 3 or pH 2, while at pH 4 or higher the total recoveries were less than 50% of those found at pH 3 or pH 2.

Strongly acid, ethanolic solutions of cholic acid are suitable conditions for the formation of ester derivatives of the bile acid and since the formation of these esters would interfere with the partition chromatography of the bile acids it was necessary to confirm that these products were not being formed. Fig. 56 shows examples of thin-layer chromatograms which were spotted, with samples of the extracts from the experiment described above. A chromatogram was also run using a sample of cholic acid extracted from the aqueous sodium hydroxide solution following the addition of excess acid. The chromatograms were developed using cyclohexane:ethyl acetate:acetic acid, 7:23:3 (Eneroth 1963). When acidification was carried out to final values between pH 7 and pH 2, a single spot was found with

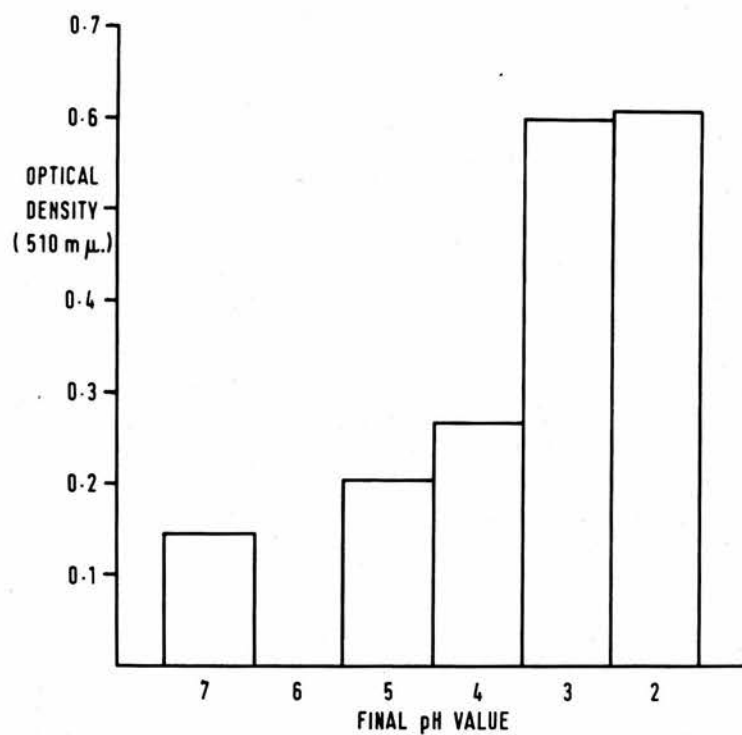

Optical density (510 mμ.) of Pettenkofer reaction performed on extracts from aqueous samples acidified to different final pH values.

Fig. 55

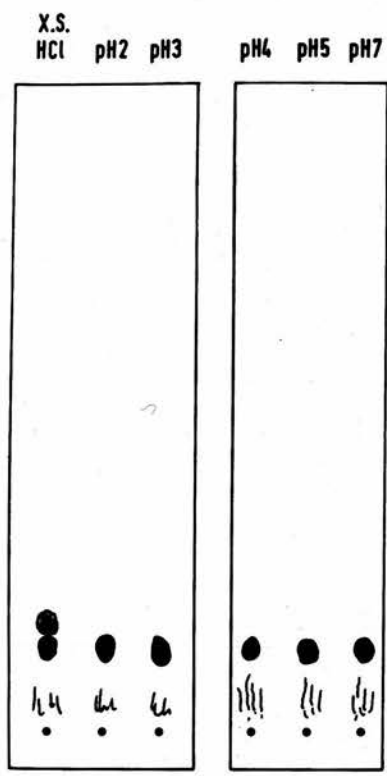

Thin-layer chromatography of extracts from aqueous cholic acid solutions acidified to different final pH values.

Fig. 56

mobility identical to the original cholic acid sample while the sample with the addition of excess hydrochloric acid solution ran as 2 spots, the additional compound being more mobile than the standard cholic acid. Further identification of this compound was not carried out but it seemed likely that it was an ester derivative of cholic acid and acidification of the hydrolysate to pH 2 - 3 seemed desirable in order to obtain maximum extraction efficiency without formation of the ester derivative.

The number of extraction steps required was studied by taking 4 different aliquots of a solution of cholic acid in 2.5 N sodium hydroxide solution and acidifying each to a final pH of approximately 2. Five extractions were then performed each with 5 volumes of chloroform:ethanol, 1:1 and these extractions were taken to dryness separately. The cholic acid content of each was estimated by the modified Pettenkofer reaction. The partition coefficient $\left(\frac{\text{conc. in extracting phase}}{\text{conc. in aqueous phase}} \right)$ was calculated and found to be 0.84. Therefore a 3 stage extraction procedure will provide a 99.9% extraction from the aqueous phase.

1.2 Liquid:liquid partition system

The liquid:liquid partition systems were run in glass columns 1 cm. in diameter and 25 cm. high with perforated glass discs at their lower ends. The stationary phase consisted of 70% aqueous acetic acid (Matschiner 1957, Mosbach 1954 and Reid and Boyd 1959) which had been equilibrated with light petroleum ether (b.p. 60° - 80°). The stationary phase was applied to the Celite support in

the ratio of 6 g. Celite to 4 ml. stationary phase. This quantity was used to pack each column. Column packing was carried out with the coated Celite slurried with light petroleum ether previously equilibrated with 70% aqueous acetic acid. The slurry was gently compressed with a stainless steel packing rod. A short column equilibration was performed by running petroleum ether equilibrated with 70% aqueous acetic acid through the columns.

The bile acid mixture was applied to the column in one of 2 ways:-

(a) A small quantity (about 0.5 g.) of dry Celite was added to the top of the column and the bile acid mixture, in solution in 70% aqueous acetic acid equilibrated with petroleum ether, was pipetted on to the dry Celite.

(b) The acetic acid solution of the bile acid mixture was applied to about 0.5 g. of dry Celite by the addition of the Celite to the solution with constant swirling in a round bottomed flask. This coated Celite was then added to the top of the packed column. No difference between these methods was seen in the elution pattern of bile salts.

Column elution was performed by using petroleum ether, benzene mixtures (Matschiner et al 1957, Reid and Boyd 1959) starting with 100% petroleum ether and progressing to 100% benzene in 20% steps. Both the petroleum ether and the benzene were previously equilibrated with 70% aqueous acetic acid for at least 24 hr. before use. Each step consisted of 25 ml. of eluting phase (except for the 100% benzene step which was 50 ml.)

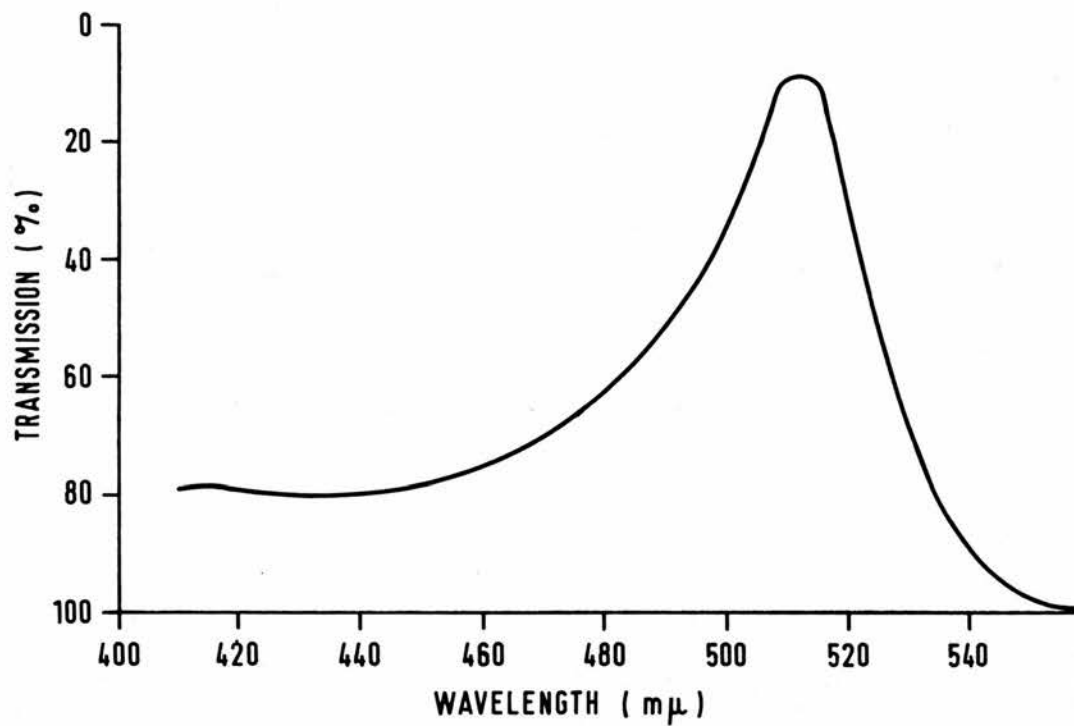

Absorbion spectrum of Pettenkofer colour from cholic acid.

Fig. 57

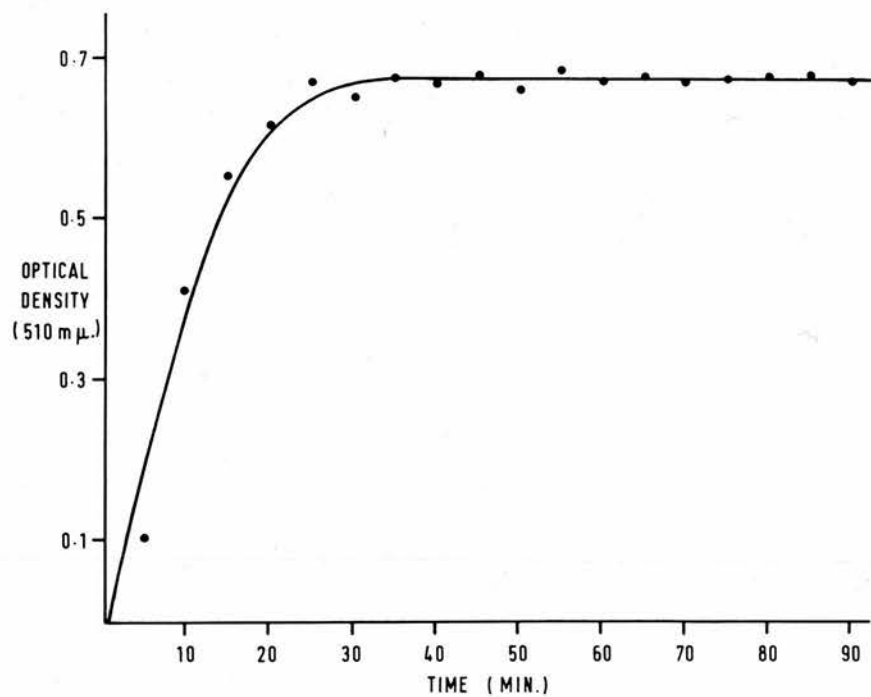

Optical density of Pettenkofer colour (50 µg. cholic acid) measured at 5 min. intervals.

Fig. 58

and the eluate was collected in 12.5 ml. aliquots.

1.3 The modified Pettenkofer reaction

The quantitation of the bile acids eluted from the liquid: liquid column system was performed using a modified Pettenkofer reaction (Reid and Boyd 1959, Boyd, Eastwood and MacLean 1966). The column eluates were taken to dryness in a hot air oven at 120° for at least 12 hr. in order to drive off all acetic acid. The dried residue was then taken up in 5 ml. 70% aqueous sulphuric acid (700 ml. Analar sulphuric acid plus 360 ml. distilled water) and 1.0 ml. of aqueous 0.25% furfuraldehyde solution was added 5 min. after the addition of the sulphuric acid. The mixture was shaken and carefully washed up the sides of the tubes in order to be certain that all of the bile acid content was in solution. Colour development was carried out at room temperature.

Fig. 57 shows a spectrophotometric scan of the pink colour produced when a pure sample both of cholic acid was treated as described above. There is a well defined absorption maximum at 510 m μ . An exactly similar scan was found with chenodeoxycholic acid. Solutions were examined at 510 m μ . at 5 min. intervals following the addition of the furfural. The optical density rose during the first 30 - 40 min. and then reached a plateau value which lasted for about 30 min. This form of colour development was found for both cholic and chenodeoxycholic acids (Fig. 58). In the studies to be described, readings were performed at 510 m μ ., with a 70 min. colour development.

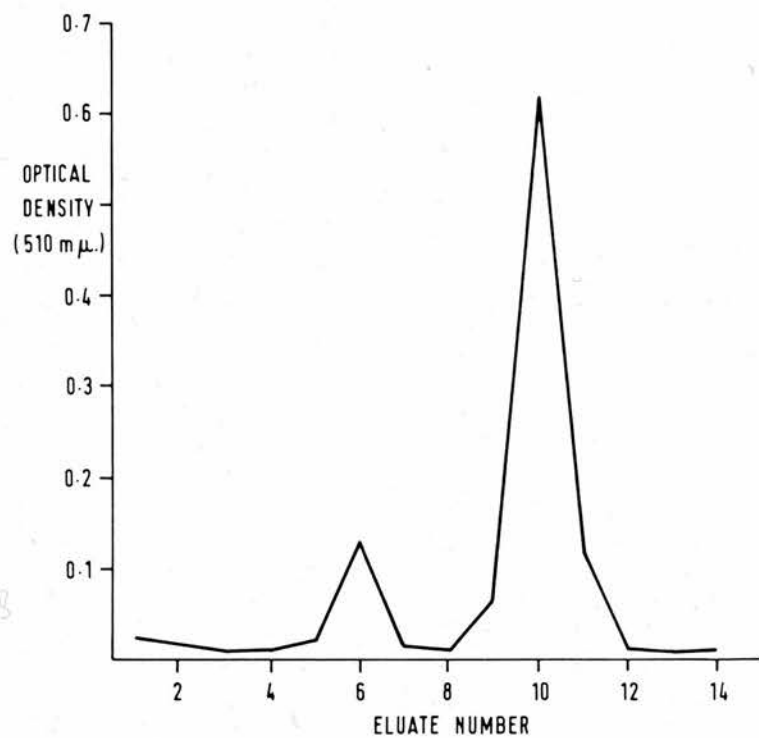

Optical density of Pettenkofer colour in eluates from liquid : liquid partition system.

Both the specificity and sensitivity of the reaction as performed in these studies have been examined by Boyd et al (1966) and Reid (1961). The major primary biliary bile acids in the rat were Pettenkofer positive. It is important to note that the muricholic acids (3α , 6β , 7α -trihydroxy- 5β -cholan-24-oic acid; 3α , 6β , 7β -trihydroxy- 5β -cholan-24-oic acid) do not give a positive Pettenkofer reaction and would not be quantitated in these studies.

1.4 Confirmation of partition column system separation of bile acids

Using the Pettenkofer reaction described above studies were performed to determine the efficiency of separation of the liquid:liquid partition columns. Fig. 59 shows the pattern of the optical density readings when a mixture of cholic acid and chenodeoxycholic acid were separated on a typical column. Two discrete peaks of optical density can be seen; the first being eluted by the 60% petroleum ether 40% benzene step, while the second peak was eluted in the 80% benzene 20% petroleum ether step with some overlap into the 100% benzene step. Pure samples of these bile acids were applied to the column system. The peak of Pettenkofer positive material when pure chenodeoxycholate was run corresponded to the first of the above peaks while when pure cholic acid was run the Pettenkofer positive material was identical with the second peak.

Further confirmation of the compounds present in these peaks was provided by means of thin-layer chromatography of aliquots from the column elutions. Standard samples of pure chenodeoxycholic acid and cholic acid were run and compared with material

from the column eluates. The solvent system used to develop these chromatograms consisted of isooctane:isopropyl ether:glacial acetic acid, 2:1:1 (Kritchevsky et al 1963).

A compound was present in the 60% petroleum ether, 40% benzene elutions from the column which had a mobility identical to that of the standard chenodeoxycholic acid sample. A compound was present in the 80% benzene 20% petroleum ether aliquots with some overlap into the 100% benzene aliquots and in this case the mobility was identical with standard cholic acid. This experiment was repeated using the two other solvent systems (Eneroth 1963) and the findings were confirmed in each case.

When the dihydroxylated bile acid, deoxycholic acid was run as a standard compound on the liquid:liquid partition system the Pettenkofer positive material was eluted as a peak in the 40% benzene 60% petroleum ether area with some overlap into the 60% benzene 40% petroleum ether elution. Thus this liquid:liquid partition system did not separate chenodeoxycholic and deoxycholic acids. Since the technique was to be used for separation of the bile acids from rat bile which consist chiefly of cholic and chenodeoxycholic acids this incomplete separation was not considered to be of importance.

A low non-specific absorption was found when the eluates which did not contain bile acids were subjected to the Pettenkofer reaction. The optical density of this absorption was normally less than 0.010 in each eluate. A mean value for this absorption was calculated from the eluates free from bile acids in each

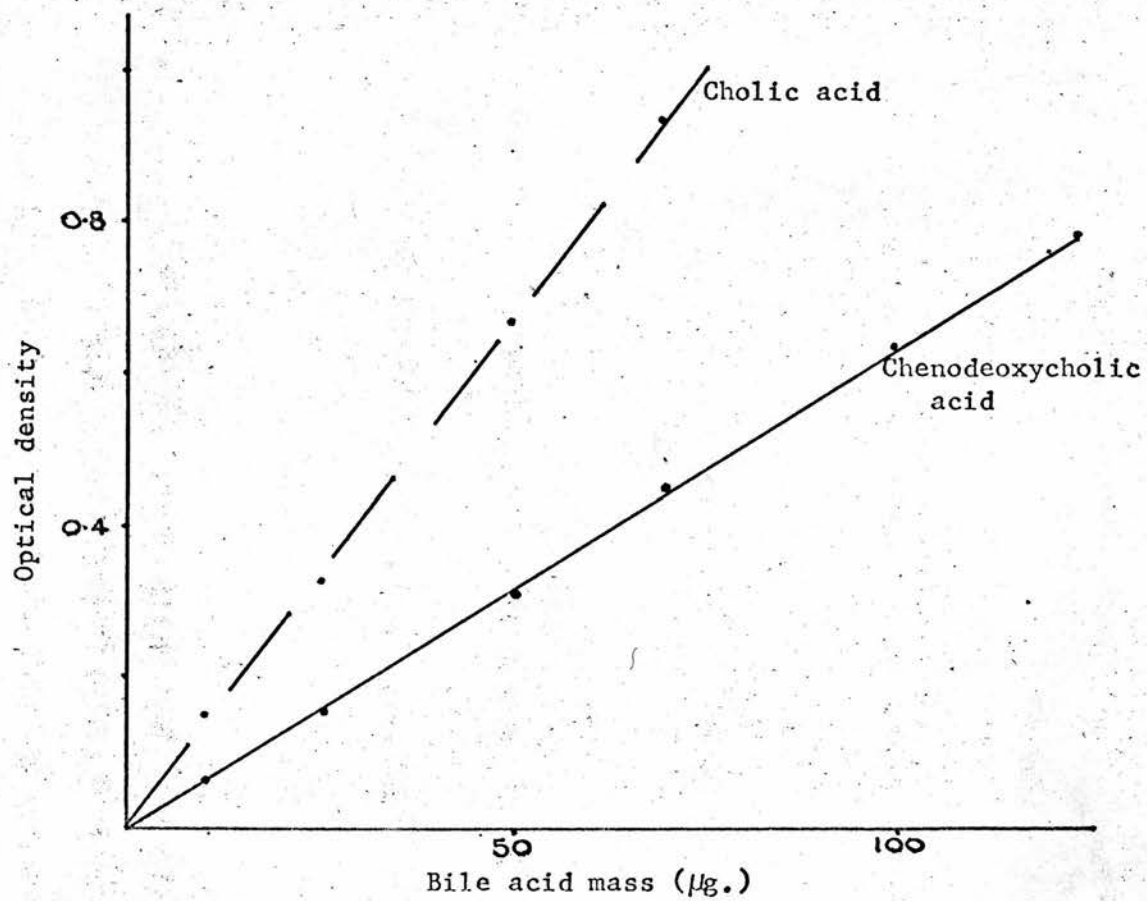

Optical density of the Pettenkofer reaction with standard bile acids.

column and this value was subtracted from the optical density found for the Pettenkofer positive tubes. This calculation was carried out in spite of the relatively small error which would have been introduced by ignoring the non specific absorption since it would be equivalent to approximately 1 μg . of bile acid in each eluate where the total applied to the column system would usually be approximately 100 μg .

1.5 Bile acid extinction values

Samples of cholic acid and of chenodeoxycholic acid were subjected to recrystallisation from a water, acetone solution at -20° . This process was repeated 3 times and subsequent thin-layer chromatography confirmed that each sample ran as a single spot. Both samples were then carefully dried in a dessicator containing anhydrous calcium chloride evacuated for several hours at high vacuum. An aliquot of each sample was accurately weighed and dissolved in ethanol. Suitable aliquots of these solutions were taken to dryness and subjected to the modified Pettenkofer reaction described above.

Fig. 60 shows a plot of optical density at 510 $m\mu$, against mass of bile acid used and it is seen that a straight line relationship exists in the range tested. This holds both for cholic and for chenodeoxycholic acids. Extinction values were repeatedly carried out throughout these studies and confirmed this relationship.

2. Purification and preparation of laboratory reagents

2.1 Celite The Celite (Messrs. Koch-Light Ltd -Celite 535) was mixed with concentrated hydrochloric acid and allowed to stand for at least 3 days. The mixture was then washed with water (tap water followed by distilled water) in a large Buchner funnel until the effluent from the funnel was approximately pH 7.0. The damp Celite was dried in a hot air oven at 120° for 24 hours.

2.2 Benzene "Analar" grade benzene was used throughout.

2.3 Petroleum ether b.p. 60° - 80° was supplied by J.F. Macfarlane and Co. Ltd.

2.4 Sulphuric acid "Analar" grade sulphuric acid was used throughout.

2.5 Furfural Laboratory grade furfuraldehyde was distilled at reduced pressure and at as low temperature as possible. The 0.25% aqueous furfuraldehyde solution was made immediately following the distillation and kept in a dark bottle at 4°. This solution was found to be stable for 3 - 4 weeks.

2.6 Ethanol Commercial absolute ethanol was used throughout.

2.7 Toluene Laboratory grade toluene was washed with concentrated sulphuric acid until the acid no longer developed a yellow discolouration. The toluene was then washed with distilled water until the washings were approximately pH 7.0 and finally dried by standing over calcium chloride for 12 hours.

2.8 Acetic acid "Analar" grade was used throughout.

2.9 Chloroform Supplied by T. & H. Smith Ltd. (no further purification.

2.10 Silica gel The silica gel used throughout these studies was Silica Gel G (according to Stahl) which was supplied by Anderman and Co. Ltd. in a grade for thin-layer chromatography.

2.11 Liquid scintillation phosphors Both of the liquid scintillation phosphors (2,5-diphenyloxazole, PPO and 1,4-bis-[2-(4-methyl-5-phenyloxazolyl)]-benzene, POPOP) were obtained from Packard Instrument Co. Inc. in scintillation grade.

All other chemicals and solvents used were "Analar" grade.

3. Reference bile acids

The following were used as reference compounds:-

- (1) 3 α , 7 α , 12 α -trihydroxy-5 β -cholan-24-oic acid.
(cholic acid) m.p. 198-200°
- (2) 3 α , 7 α -dihydroxy-5 β -cholan-24-oic acid.
(chenodeoxycholic acid) m.p. 141-142°
- (3) 3 α , 12 α -dihydroxy-5 β -cholan-24-oic acid
(deoxycholic acid) m.p. 172-174°

4. Rats

These studies were performed on female adult rats of an inbred Wistar strain maintained in the Biochemistry Department Animal House. They were kept at a constant ambient temperature of 70°F and were allowed free access to water.

On a number of occasions blood donor rats for the perfusion experiments were adult female rats from the inbred colony at the M.R.C. Clinical Endocrinology Research Unit, Edinburgh.

5. Diet

The rats were fed a diet consisting of

70% wholemeal flour

25% skimmed milk

5% brewer's yeast (Boyd and Oliver 1958)

Where supplements were added to this diet the supplementation is described in the text

6. Estimation of bile flow rates in fistula rats

Bile was collected from the bile fistula rats in glass tubes 2 in. by 1/4 in. For the experiments with bile fistula animals these tubes were held in a small fraction collector (capacity 50 tubes) which rotated one place every 60 min. The animals were placed in restraining cages mounted above the fraction collector and the end of the bile duct cannula suitably located above the tubes. The tube plus bile was weighed as soon as possible after the bile collection and the bile washed into centrifuge tubes with ethanol. The tubes themselves were dried in a hot air oven and weighed, the difference between tube weight and weight of tube plus bile was taken as the total bile weight.

7. Estimation of rat heart rates

Heart rate was used as a simple index of the thyroid status to compare groups of animals rendered either hyperthyroid (triiodothyronine injection) or hypothyroid (surgical thyroidectomy or propylthiouracil feeding) with their respective control groups. The animals were lightly anaesthetised with ether and needle electrodes inserted beneath the skin over both scapulae and at the base of the spine. Electrocardiographs were recorded and the heart rates calculated from the recording taken immediately prior to the animal recovering from the effects of the ether anaesthesia.

8. Blood haematocrit estimation

Blood haematocrit estimation was carried out using the Hawkesley microhaematocrit apparatus which requires approximately 0.1 ml. of blood for each estimation. A standard 10 min. centrifugation time was used. Repeated analysis of a sample of blood gave the following results:-

number of estimations	-	20
mean value	-	33.7%
standard deviation	-	0.23%

9. [2. ¹⁴C] DL-mevalonic acid lactone

[2. ¹⁴C] DL-mevalonic acid lactone was obtained in benzene solution from The Radiochemical Centre, Amersham, Buckinghamshire. The stock solution was divided into aliquots in sealed glass ampoules on receipt, and these were kept at -20° until required. The benzene was blown off by a gentle stream of nitrogen and the residue taken up in acetone in preparation for use. The acetone solution was also kept at -20°.

10. Liver from a thyroidectomised rat

As reported in the text (page 61) one of the livers from the thyroidectomised group of rats was found to have bile acid excretion and radioactivity incorporation rates which were much greater than the other 6 perfusions performed in the experiment. The radioactivity recovered in bile acids was 9 - 11 times greater than in the 3 perfusions reported while the bile acid output was approximately 400 µg./hr. throughout. No reason for these differences could be found and the results were therefore excluded from the main report.

Estimation	O. D. 450 m μ - O. D. 490 m μ	
	1 min. CO	2 min. CO
1	0.076	0.074
2	0.074	0.071
3	0.073	0.072
4	0.076	0.071
Mean.	0.075	0.071

Table 18 Optical density (450 m μ - 490 m μ) of reduced difference spectrum found in liver microsomes following carbon monoxide treatment for different time periods.

11. Statistical analysis of data

The standard deviation of a group of results was calculated from the formula:-

$$\text{Standard deviation (SD)} = \frac{1}{n-1} \sum x^2 - \frac{(\sum x)^2}{n}$$

where n = no. of observations

x = individual results

12. Method for estimation of CO-binding pigment

Omura and Sato (1964) have shown that the formation of the CO-binding pigment is affected by the final concentration of carbon-monoxide in the solution and that the binding is reversible. The estimation procedure described above was performed and a further 1 min. period of bubbling was carried out followed by repeat scanning of the cuvette. It was found that the calculated optical density differences did not change (Table 18) and all further estimations were performed with the 1 min. CO saturation period.

ACKNOWLEDGEMENTS

It is a pleasure to acknowledge the expert and enthusiastic supervision given by Dr. G.S. Boyd throughout the work reported in this thesis, and also the interest and encouragement of Professor R.B. Fisher.

My thanks are due to Professor L.G. Whitby who allowed time for the completion of these studies following my appointment to the staff of The University Department of Clinical Chemistry.

Professor G.L. Montgomery kindly gave access to facilities in the Pathology Department of the University of Edinburgh for the processing of tissue for the light microscopic studies and gave advice regarding the interpretation of the histological preparations.

Professor A. Muir, Department of Veterinary Anatomy, performed the electron microscopic studies on perfused liver tissue.

From October 1963 until November 1965 I was in receipt of an Edinburgh University Research Scholarship and a grant from the Carnegie Trust for Scottish Universities. I wish to acknowledge this financial support.

I wish to thank Miss P.M. Ryan who gave valuable technical assistance with this work; in particular with the animal studies.

BIBLIOGRAPHY

- Abell, L.L., Levy, B.B., Brodie, B.B. and Kendall, F.E. (1952).
A simplified method for the estimation of total cholesterol
in serum and demonstration of its specificity.
J.biol.Chem. 195, 357-366.
- Abell, L.L., Mosbach, E.H. and Kendall, F.E. (1956). Cholesterol
metabolism in the dog.
J.biol.Chem. 220, 527-536.
- Andersen, O.S. and Engel, K. (1960). A micro method for
determination of pH, carbon dioxide tension, base excess and
standard bicarbonate in capillary blood.
Scand.J.clin.lab.Invest. 12, 172-176.
- Avigan, J., Steinberg, D. and Berman, M. (1962). Distribution of
labelled cholesterol in animal tissues.
J.lip.Res. 3, 216-221.
- Bauer, W., Dale, H.H., Poulsson, L. and Richards, D.W. (1932).
The control of circulation through the liver.
J.Physiol. (London) 74, 343
- Bergström, S., Rottenberg, M. and Sjövall, J. (1953).
Über den Stoffwechsel der Cholsäure und Desoxycholsäure in der
Ratte.
Z.physiol.Chemie. 295, 278-283.
- Bergström, S. and Norman, A. (1953). Metabolic products of
cholesterol in bile and faeces of rat.
Proc.Soc.exp.Biol.Med. 83, 71-74.
- Bergström, S., Sjövall, J. and Voltz, J. (1953). Metabolism of
lithocholic acid in the rat.
Acta physiol.scand. 30, 22-32.
- Bergström, S. and Sjövall, J. (1954). Occurrence and metabolism
of chenodesoxycholic acid in the rat.
Acta chem.scand. 8, 611-616.
- Bergström, S. (1955) Formation and Metabolism of bile acids.
Record chem.Prog. 16, 63-83.
- Bergström, S. and Lindstedt, S. (1956). The formation of cholic
acid from 3 α , 7 α dihydroxycoprostanone in the rat.
Biochim.biophys.Acta 19, 556-557.
- Bergström, S. and Danielsson, H. (1958). On the regulation of
bile acid formation in the rat liver.
Acta physiol.scand. 43, 1-7.

- Berseus, O. and Danielsson, H. (1963). On the metabolism of coprostane-3 α , 7 α -diol in mouse liver homogenates. *Acta chem.scand.* 17, 1293 - 1298.
- Bloch, K., Berg, B.N. and Rittenberg, D. (1943). The biological conversion of cholesterol to cholic acid. *J.biol.Chem.* 149, 511-517.
- Boyd, G.S. and Oliver, M.F. (1960). Various effects of thyroxine analogues on the heart and serum cholesterol in the rat. *J.Endocrinol.* 21, 25-32.
- Boyd, G.S. (1961). Review. The thyroid, iodothyronines and atherosclerosis. *J.atherosclerosis Res.* 1, 26-35.
- Boyd, G.S. (1962). Determination of cholesterol for clinical purposes. "The Determination of Sterols", Monograph No.2 of The Society for Analytical Chemistry. pp 1 - 9.
- Boyd, G.S., Eastwood, M.A. and MacLean, N. (1966). Bile acids in the rat: studies in experimental occlusion of the bile duct. *J.lip.Res.* 7, 83-94.
- Brauer, R.W. and Rita Pessotti. (1949). The removal of bromsulphthalein from blood plasma by the liver of the rat. *J.Pharm. and exp.Ther.* 97, 358-370.
- Brauer, R.W., Krebs, J.S. and Pessotti, R.L. (1950). Bromsulphthalein as a tool for study of liver physiology. *Fed.Proc.* 9, 259.
- Brauer, R.W., Pessotti, R.L. and Pizzolato, P. (1951). Isolated rat liver preparation. Bile production and other basic properties. *Proc.Soc.exp.Biol.Med.* 78, 174-181.
- Brauer, R.W., Leong, G.F. and Pessotti, R.L. (1953). Vasomotor activity in the isolated perfused rat liver. *Amer.J.Physiol.* 174, 304-312.
- Brauer, R.W., Leong, G.F. and Holloway, R.J. (1954). Effect of perfusion pressure and temperature on bile flow and bile secretion pressure. *Amer.J.Physiol.* 177, 103-112.
- Brauer, R.W., Leong, G.F., McElroy, R.F. and Holloway, R.J. (1956). Circulatory pathways in the rat liver as revealed by [³²P]-chronic phosphate colloid uptake in the isolated perfused liver preparation. *Amer.J.Physiol.* 184, 593-598.

- Brauer, R.W. (1959). Mechanisms of bile secretion.
J.Amer.med.Ass. 169, 1462-1469.
- Bridgwater, R.J. and Lindstedt, S. (1957). On the metabolism of 3 α , 7 α , 12 α -trihydroxycoprostanic acid in the rat.
Acta chem.scand. 11, 409-413.
- Brodie, T.G. (1903). The perfusion of surviving organs.
J.Physiol. (London) 29, 266-275.
- Brodie, B.B., Gillette, J.R. and LaDu, B.N. (1958).
Enzymatic metabolism of drugs and other foreign compounds.
Annual Rev.Biochem. 27, 427-454.
- Bucher, N.L.R., Overath, P. and Lynen, F. (1960). β -hydroxy- β -methyl glutaryl coenzyme A reductase, cleavage and condensing enzymes in relation to cholesterol formation in rat liver.
Biochem.biophys.Acta 40, 491-501.
- Burton, S.D., Shirley St. George and Ishida, T. (1960). Small volume perfusion system of the isolated rat liver.
J.applied Physiol. 15, 128-132.
- Byers, S.O. and Biggs, M.W. (1952). Cholic acid and cholesterol: studies concerning possible intraconversion.
Arch.Biochem. 39, 301-304.
- Campbell, D.G. and Annan, W. (1966). Precision of plasma urea and electrolytes estimated by the AutoAnalyzer.
J.clin.Path. 19, 513-516.
- Cooney, A.H. and Klutch, A. (1963). Increased activity of androgen hydroxylases in liver microsomes of rats pretreated with phenobarbitol and other drugs.
J.biol.Chem. 238, 1611-1617.
- Cuthbertson, W.F.J., Elcoate, P.V., Ireland, D.M., Mills, D.C.B. and Shearley, P. (1960). Effect of compounds related to thyroxine on serum and liver cholesterol and on atherosclerosis and heart weights in rats and mice.
J.Endocrinol. 21, 45-68.
- Danielsson, H. (1960). On the oxidation of 3 α , 7 α , 12 α -trihydroxycoprostanic acid by mouse and rat liver homogenates.
Acta chem.scand. 14, 348.
- Danielsson, H. (1960). On the oxidation of cholesterol in two mitochondrial preparations.
Acta chem.scand. 14, 846-860.
- Danielsson, H. (1961). Studies on the formation of bile acids.
Uppsala.
- Danielsson, H., Insul, Jr. W., Jordan, P. and Strand, O. (1961). Metabolism of 4-C¹⁴-cholesterol in the isolated perfused rat liver.
Amer.J.Physiol. 202, 699-703.

- Danielsson, H. (1962). Conversion of Δ^5 -cholestene-3 α -12 α diol to cholic acid in the rabbit.
Acta chem.scand. 16, 1534-1536.
- Danielsson, H. and Einarsson, K. (1964). The enzymic formation of 7 α -hydroxycholesterol from cholesterol in rat liver homogenates.
Acta chem.scand. 18, 831-832.
- Dietschy, S. and Siperstein, M.D. (1967). Effects of cholesterol fasting on cholesterol synthesis of various tissues in the rat.
J.lip.Res. 8, 97-104.
- Eckles, N.E., Taylor, C.B., Campbell, D.J. and Gould, R.G. (1955). The origin of plasma cholesterol and the rates of equilibrium of liver, plasma and erythrocyte cholesterol.
J.lab.clin.Med. 46, 359-371.
- Elwood, J.C. and Van Bruggen, J.T. (1961). Cholesterol and mevalonate metabolism: a time course study in vivo.
J.lip.Res. 2, 344-349.
- Eneroth, P. (1963). Thin-layer chromatography of bile acids.
J.lip.Res. 4, 11-16.
- Eriksson, S. (1957). Biliary excretion of bile acids and cholesterol in bile fistula rats.
Proc.Soc.exp.Biol.Med. 94, 578-582.
- Eriksson, S. (1957). Influence of thyroid activity on excretion of bile acids and cholesterol in the rat.
Proc.Soc.exp.Biol.Med. 94, 582-589.
- Eriksson, S. (1960). Bile acid pool in the rat.
Acta physiol.scand. 48, 439-442.
- Finlayson, J.S. and Baumann, C.A. (1956). Role of urea in rat proteinuria.
Amer.J.Physiol. 184, 469-472.
- Fletcher, K. and Myant, N.B. (1958). Influence of the thyroid on the synthesis of cholesterol by liver and skin in vitro.
J.Physiol. (London) 144, 361-372.
- Fredrickson, D.S. (1956). The conversion of cholesterol-4-¹⁴C to acids and other products by liver mitochondria.
J.biol.Chem. 222, 109-120.
- Fredrickson, D.S. and Ono, K. (1956). The in vitro production of 25- and 26-hydroxycholesterol and their in vivo metabolism.
Biochim.biophys. Acta 22, 183-184.

- Friedman, M., Bine, R. and Ishida, T. (1956). Removal of excess cholesterol and cholate by the isolated rat liver from its perfusate.
Amer.J.Physiol. 184, 412-414.
- Garfinkel, D. (1958). Studies on pig liver microsomes. Enzymic and pigment composition of different microsomal fractions.
Arch.biochem.Biophys. 77, 493-509.
- Gorski, J., Aizawa, Y. and Mueller, G.C. (1961). Effect of puromycin in vivo on synthesis of protein, RNA and phospholipids in rat tissues.
Arch.biochem.Biophys. 95, 508-511.
- Harold, F.M., Felts, I.M. and Chaikoff, I.L. (1955). Fate of [4-¹⁴C] cholesterol and [26-¹⁴C] cholesterol in the perfused liver.
Amer.J.Physiol. 459-462.
- Harold, F.M., Jayko, M.F. and Chaikoff, I.L. (1955). Metabolism of epicholesterol-4-C¹⁴ in the rat.
J.biol.Chem. 216, 439-447.
- Harold, F.M., Chapman, D.D. and Chaikoff, I.L. (1957). Fate of cholesterol-4-C¹⁴ in the rat. Metabolic interrelations of cholesterol, epicholesterol and Δ^4 cholestenone.
J.biol.Chem. 224, 609-620.
- Haslewood, G.A. (1966). The biological significance of chemical differences in bile salts.
Biol.Rev. 39, 537-574.
- Heimberg, M., Meng, H.C. and Park, C.R. (1958). Effect of sex, fasting and alloxan diabetes on the uptake of neutral fat by isolated perfused rat liver.
Amer.J.Physiol. 195, 673-678.
- Hellman, L., Rosenfeld, R.S. and Gallacher, T.F. (1954). Cholesterol synthesis from ¹⁴C-acetate in man.
J.clin.Invest. 33, 142-149.
- Hellman, L. (1955). Isotopic studies of plasma cholesterol of endogenous and exogenous origins.
J.clin.Invest. 34, 48-60.
- Hofmann, A.F. (1965). Clinical implications of physicochemical studies on bile salts.
Progress in Gastroenterology 48, 484-494.
- Hogeboom, G.H. (1951). Separation and properties of cell components.
Fed.Proc. 10, 640-645.

- Hotta, S. and Chaikoff, I.L. (1955). The role of the liver in the turnover of plasma cholesterol. Arch.biochem. 56, 28-37.
- Hsia, S.L., Elliott, W.H., Matschiner, J.T., Doisy, E.A.Jr., Thayer, S.A. and Doisy, E.A. (1960). Two new acids from rat bile. J.biol.Chem. 235, 1963-1969.
- Hutton, Hilary R.B. and Boyd, G.S. (1966). The metabolism of cholest-5-en-3 β ,7 α -diol by rat liver cell fractions. Biochim.biophys. Acta 116, 336-361.
- Kay, R.E. and Entenman, C. (1961). The synthesis of 'chylomicron-like' bodies and maintenance of normal blood sugar levels by the isolated perfused rat liver. J.biol.Chem. 236, 1006-1012.
- Kay, R.E. and Entenman, C. (1961). Stimulation of taurocholic acid synthesis and biliary excretion of lipids. Amer.J.Physiol. 200, 855-859.
- Klingenberg, M. (1958). Pigments of rat liver microsomes. Arch.biochem.Biophys. 75, 376-386.
- Krebs, H.A. and Henseleit, K. (1932). Untersuchungen uber die Harnstoffbildung im Tierkorper. Z.Physiol.Chemie. 210, 33-66.
- Kritchevsky, D. and Kirk, M. (1952). Detection of steroids in paper chromatography. Arch.biochem.Biophys. 35, 346-351.
- Kritchevsky, D. (1960). Influence of thyroid hormones and related compounds on cholesterol biosynthesis and degradation: a review. Metabolism 9, 984-994.
- Kritchevsky, D., Staple, E. and Whitehouse, M.W. (1961). Oxidation of ergosterol by rat and mouse liver mitochondria. Proc.Soc.exp.Biol.Med. 106, 704-708.
- Kritchevsky, D., Moynihan, J.L. and Sachs, M.L. (1961). Influence of thyroactive compounds on serum and liver cholesterol in rats. Proc.Soc.exp.Biol.Med. 108, 254-257.
- Kritchevsky, D., Dolores Martak and Rothblat, G.H. (1963). The detection of bile acids in thin layer chromatography. Analytical Biochemistry 5, 388-392.

- Kunkel, H.G. and Eisenmenger, W.J. (1949). Increased portal pressure and ascites in rats following ligation of portal vein.
Proc.Soc.exp.Biol.Med. 71, 212.
- Langdon, R.G. and Bloch, K. (1953). The effect of some dietary additions on the synthesis of cholesterol from acetate in vitro.
J.biol.Chem. 202, 77-81.
- Layne, E. (1957).
Methods in Enzymology, ed. Colowick, S.P. and Kaplan, N.O.
3, 450-451.
- Lindstedt, S. and Norman, A. (1956). The turnover of bile acids in the rat.
Acta physiol.scand. 38, 121-128.
- Lindstedt, S. (1957). The formation of bile acids from 7 α -hydroxy-cholesterol in the rat.
Acta chem.scand. 11, 417-420.
- Linn, T.C. (1967). The demonstration and solubilization of β -hydroxy- β -methylglutaryl coenzyme A reductase from rat liver microsomes.
J.biol.Chem. 242, 984-989.
- Luchsinger, K. (1875). *Physiologie und Pathologie des Glykogens*.
Inaug.diss., Zurich.
- Mahowald, T.A., Matschiner, J.T., Hsia, S.L., Richter, R., Doisy, E.A.Jr., Elliott, W.H. and Doisy, E.A. (1957). Bile acids II Metabolism of deoxycholic acid-24-C¹⁴ and chenodeoxycholic acid-24-C¹⁴ in the rat.
J.biol.Chem. 225, 781-793.
- Markowitz, R., Rappaport, A. and Scott, A.G. (1949). Function of hepatic artery in dog.
Am.J.dig.Dis. 16, 344-348.
- Marsh, W.H., Fingerhut, B. and Miller, H. (1965)
Clin.Chem. 11, 624
- Matschiner, J.T., Ratliff, R.L., Mahowald, T.A., Doisy, E.A.Jr., Elliott, W.H., Hsia, S.L. and Doisy, E.A. (1958). Bile acids IX - Metabolites of hyodeoxycholic acid-24-C¹⁴ in surgically jaundiced rats.
J.biol.Chem. 230, 589-601.
- Miller, L.L., Bly, C.G., Watson, M.L. and Bale, W.F. (1951). The dominant role of the liver in plasma protein synthesis.
J.exper.med. 94, 431-449.

- Mitropoulos, K.A. and Myant, N.B. (1965). The metabolism of cholesterol in the presence of liver mitochondria from normal and thyroxine-treated rats.
Biochem.J. 94, 594-603.
- Mitropoulos, K.A. and Myant, N.B. (1965). Evidence that the oxidation of the side chain of cholesterol by liver mitochondria is stereospecific, and that the immediate product of cleavage is propionate.
Biochem.J. 97, 26c.
- Mitropoulos, K.A. and Myant, N.B. (1966). The formation of naturally occurring bile acids from cholesterol by rat liver mitochondria in vivo.
Biochem.J. 99, 51P.
- Mitropoulos, K.A. and Myant, N.B. (1967). The formation of lithocholic acid, chenodeoxycholic acid and α - and β -muricholic acids from cholesterol incubated with rat liver mitochondria.
Biochem.J. 103, 472-479.
- Mitton, J.R. and Boyd, G.S. (1965). The hydroxylation of cholesterol by liver microsomes.
Biochem.J. 96, 60P.
- Morris, B. and French, J.E. (1958). The uptake and metabolism of ¹⁴C labelled chylomicron fat by the isolated perfused liver of the rat.
Quart.J.exper.Physiol. 43, 180-188.
- Mortimore, G.E. (1961). Effect of insulin on potassium transfer in isolated rat liver.
Amer.J.Physiol. 200, 1315 - 1319.
- Mosbach, E.H., Zonzely, C. and Kendall, F.E. (1954). Separation of bile acids by column partition chromatography.
Arch.biochem.Biophys. 48, 95-101.
- Myant, N.B. and Eder, H.A. (1961). The effect of biliary drainage upon the synthesis of cholesterol and the liver.
J.lip.Res. 2, 363-368.
- Norman, A. (1954). On the conjugation of bile acids in the rat.
Acta physiol.scand. 32, 1-10.
- Omura, T. and Sato, R. (1964). The carbon monoxide-binding pigment of liver microsomes.
J.biol.Chem. 239, 2370-2378.

- Orrhenius, S., Eriksson, J.L.E. and Ernster, L. (1965). Phenobarbital-induced synthesis of the microsomal drug metabolising enzyme system and its relationship to the proliferation of endoplasmic membranes. *J.Cell Biol.* 25, 627-639.
- Ostashever, A.S., Gray, I. and Graff, S. (1960). Metabolic characteristics of the isolated perfused rat liver. *Amer.J.Physiol.* 199, 395-399.
- Popjak, G. and Beeckmans, M.L. (1950). Extrahepatic lipid synthesis. *Biochem.J.* 47, 233-238.
- Portman, O.W. and Mann, G.^v (1955). The disposition of taurine-S³⁵ and taurocholate-S³⁵ in the rat: dietary influences. *J.biol.Chem.* 213, 733-743.
- Portman, O.W. and Murphy, P. (1958). Excretion of bile acids and β -hydroxysterols by rats. *Arch.biochem.Biophys.* 76, 367-376.
- Reid, R.H.P. and Boyd, G.S. (1959). A method for the specific differential estimation of cholic and chenodeoxycholic acids in human plasma. *Biochem.J.* 73, 9P.
- Robbins, E.D., Burton, S., Goerke, J. and Friedman, M. (1953). Cholesterol and cholate concentration of perfusate and bile of isolated liver preparation. *Proc.Soc.exp.Biol.Med.* 83, 212-214.
- Schiff, M. (1870). Gallenbildung, abhängig von der Aufsaugung der Gallenstoffe. *Pflug.Arch.ges.Physiol.* 3, 598-609.
- Scholan, N. and Boyd, G.S. (1967). Regulation of cholesterol metabolism by a 7α -hydroxylase. *Nature* In press.
- Siperstein, M.D. and Chaikoff, I.L. (1952). C¹⁴-cholesterol III Excretion of carbons 4 and 26 in faeces, urine and bile. *J.biol.Chem.* 198, 93-104.
- Siperstein, M.D., Harold, F.L., Chaikoff, I.L. and Dauben, W.G. (1954). [¹⁴C] cholesterol Biliary end-products of cholesterol metabolism. *J.biol.Chem.* 210, 181-191.
- Siperstein, M.D. and Guest, M.J. (1960). Studies on the site of the feedback control of cholesterol synthesis. *J.clin.Invest.* 39, 642-652.

Reid
Thesis.

- Sperber, I. (1965). Biliary secretion of organic anions and its influence on bile flow. in *The Biliary System* ed.W.Taylor. A symposium of the NATO Advanced Study Institute. pp. 457-469.
- Strand, O. (1962). Influence of propylthiouracil and D- and L-triiodothyronine on excretion of bile acids in bile fistula rats. *Proc.Soc.exp.Biol.Med.* 109, 668-672.
- Strand, O. (1963). Effects of D- and L-triiodothyronine and of propylthiouracil on the production of bile acids in the rat. *J.lip.Res.* 4, 305-311.
- Suld, H.M., Staple, E. and Gurin, S. (1961). Catabolism of 3 α , 7 α , 12 α -trihydroxycoprostanone by rat liver mitochondria. *Fed.Proc.* 20, 284.
- Tavormina, P.A., Gibbs, M.H. and Huff, J.W. (1956). The utilisation of β -hydroxy- β -methyl- α -valerolactone in cholesterol biosynthesis. *J.Amer.chem.Soc.* 78, 4498-4499.
- Tavormina, P.A. and Gibbs, M.H. (1956). The metabolism of DL- β -dihydroxy- β methyl valeric acid by liver homogenates. *J.Amer.chem.Soc.* 78, 6210.
- Tata, J.R. and Widnell, C.C. (1966). Ribonucleic acid synthesis during the early action of thyroid hormones. *Biochem.J.* 98, 604-620.
- Thompson, J.C. and Vars, H.M. (1953). Biliary excretion of cholic acid and cholesterol in hyper-, hypo-, and euthyroid rats. *Proc.Soc.exp.Biol.Med.* 83, 246-248.
- Tomkins, G.M., Sheppard, H. and Chaikoff, I.L. (1953). Cholesterol synthesis by liver. III Its regulation by ingested cholesterol. *J.biol.Chem.* 201, 137-141.
- Trowell, O.A. (1935). Choline and liver respiration. *J.Physiol. (London)* 85, 356-374.
- Trowell, O.A. (1942). Urea formation in the isolated perfused liver in the rat. *J.Physiol. (London)* 100, 432-458.
- Vanlerenberghe, J., Guerrin, F. and Milbled, G. (1960). Secretion des acides biliaires par le foie de Rat perfuse. *C.R. de la Soc. de Biol. (Paris)* 154, 1240-1243.
- Varley, H. (1962). *Practical clinical biochemistry.* Heinemann Medical Books Ltd., London 3rd Edition. pp. 313-314.

- Weis, S.B. and Marx, W. (1955). The fate of radioactive cholesterol in mice with modified thyroid activities. *J.biol.Chem.* 213, 349-353.
- Wilson, J.D. and Lindsey, C.A.Jr. (1965). Dietary cholesterol in man. *J.clin.Invest.* 44, 1805-1814.
- Wilson, J.D. (1962). Relation between dietary cholesterol and bile acid excretion in the rat. *Amer.J.Physiol.* 203, 1029-1032.
- Windaus, A. and Neukirchen, K. (1919). *Ber.* 52, 1915
- Young, M.K. Prudden, J.F. and Stirman, J.A. (1955). A perfusion technique for the study of liver metabolism. *J.lab.clin.Med.* 46, 155-166.

PUBLICATIONS

[Reprinted from the *Proceedings of the Biochemical Society*, 1-2 April 1965.
Biochem. J., 1965, Vol. 95, No. 3, 54 p.]

The Excretion of Biliary Bile Acids in the Isolated Perfused Rat Liver

By I. W. PERCY-ROBB and G. S. BOYD. (*Department of Biochemistry, University of Edinburgh*)

The conversion of cholesterol to biliary bile acids constitutes the major pathway of cholesterol catabolism in the rat. To date there are no published accounts of successful conversions of cholesterol to bile acids using broken-cell preparations. In order to study certain aspects of bile acid metabolism, experiments have been performed using an isolated liver perfusion technique similar to that of Miller (1951).

Livers from female rats of the Wistar strain were perfused with whole homologous rat blood and the bile was collected hourly by way of a bile duct cannula for 4 hr. The bile acid content of the bile was estimated by the method of Reid & Boyd (1959) and the bile acids identified by thin layer chromatography. A rapid fall off in the quantity of bile acids was found throughout the perfusion period.

In vivo cannulation of rats of the same strain and

estimation of the bile acids in hourly aliquots of bile shows a rapid fall off of the bile acids, followed by a gradual rise in the quantity of bile acids, till levels in excess of the original are found after 36 hr. These findings are in agreement with Eriksson (1957).

Livers (from normal female rats and from similar rats previously subjected to 40-44 hr. biliary drainage) were perfused, as described above. [$^{14}\text{C}_2$]Mevalonic acid was added to the perfusate in each case and the specific activity of the biliary chenodeoxycholic and cholic acids established at hourly intervals throughout the experiment. The specific activity of the plasma, liver and biliary cholesterol was measured at the termination of each experiment. This technique permits a direct assessment of the rate of cholesterol breakdown to bile acids by the liver.

Application of this technique to problems such as the catabolism of plasma lipoproteins will be discussed.

Reid, R. H. P. & Boyd, G. S. (1959). *Biochem. J.* **73**, 9 p.

Eriksson, S. (1957). *Proc. Soc. exp. Biol., N.Y.*, **94**, 578.

Miller, L. L. (1951). *J. exper. Med.* **94**, 431.

Department of Biochemistry, University of Edinburgh

Isolated Rat Liver Perfusion as a Technique for the Study of Hepatic Cholesterol and Bile Acid Metabolism

I. W. PERCY-ROBB and G. S. BOYD

There is evidence that, in the rat, the liver is the main organ involved in the conversion of cholesterol to bile acids. The complete conversion of cholesterol to biliary bile acids using liver slices or broken cell liver preparations has not as yet been accomplished (FREDRICKSON, 1956; KRITCHEVSKY, 1961). Acidic products have been produced in some of these *in vitro* studies, but in no case have these products been shown to be identical with the physiologically occurring biliary bile acids. HAROLD *et al.* (1955) demonstrated the conversion of radioactive cholesterol to taurochenodeoxycholic and taurocholic acids using the isolated perfused rat liver preparation, and they further concluded that taurochenodeoxycholate became labelled before any label appeared in taurocholate. DANIELSSON *et al.* (1962), also using the isolated perfused liver, examined the conversion of ^{14}C -cholesterol in the form of an albumin stabilised emulsion and also in the form of plasma lipoprotein (labelled with ^{14}C -cholesterol) to biliary bile acids and they obtained taurochenodeoxycholic and taurocholic acids from both substrates.

We have perfused livers by a modification of the technique of MILLER *et al.* (1951). The apparatus used is shown in Fig. 1. The perfusate consists of pooled, whole rat blood using heparin as the anticoagulant. The perfusate is equilibrated with 95% O_2 :5% CO_2 in the 'lung' and passed into the liver by way of the portal vein at a pressure of 12-14 cm of perfusate. Bile is collected in hourly aliquots, the perfusions being run for a period of 4 h. The biliary bile acids are extracted, hydrolysed and isolated into dihydroxy and trihydroxy groups by the method of REID AND BOYD (1959) (see also

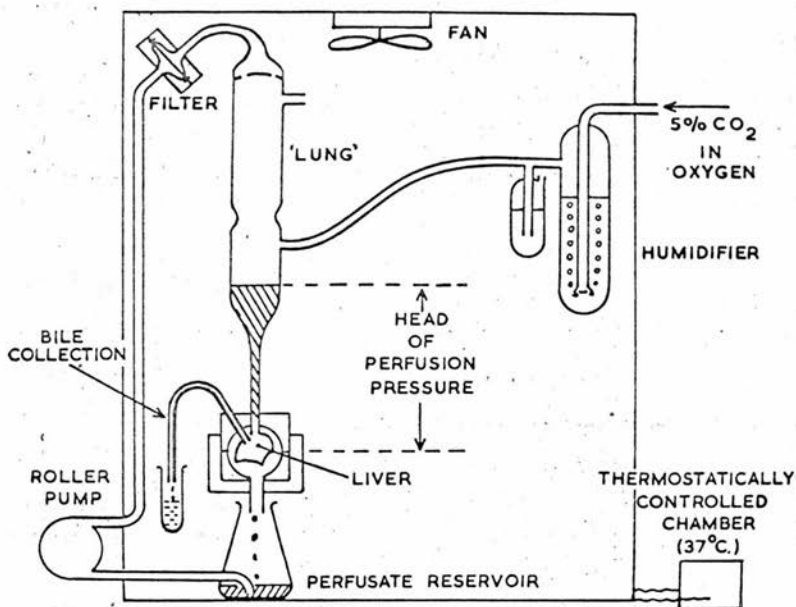

Fig. 1. Arrangement of isolated rat liver perfusion apparatus.

BOYD, EASTWOOD AND MACLEAN, 1966) following which the groups are quantitated by means of a modified Pettenkofer reaction. In order to study the rate of conversion of cholesterol to biliary bile acids the hepatic cholesterol pool has been labelled by the addition of mevalonic acid-2- ^{14}C (5 μC per experiment) to the perfusate and the radioactivity recovered in the biliary bile acids measured. In those experiments in which the bile acids have been labelled the radioactivity has been determined by liquid scintillation counting.

When livers from normal female rats were perfused as described above and the bile acids quantitated, the rate of bile acid excretion fell off very rapidly as shown in Fig. 2. This finding was confirmed in a group of perfusions of normal livers in which the hepatic cholesterol pool was labelled by the addition of mevalonic acid-2- ^{14}C . Again the quantity of biliary bile acids excreted fell off rapidly but the rate of labelling of the bile acids did not decrease, suggesting that the liver preparation was not failing on account of the experimental perfusion technique but that the pre-existing

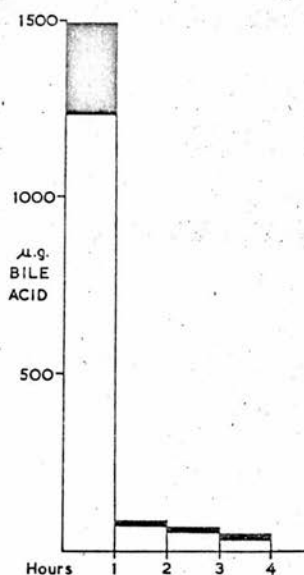

Fig. 2. Biliary excretion of bile acids in isolated perfused rat livers. The open histogram refers to trihydroxy bile acids and the shaded portion to dihydroxy bile acids.

(non-radioactive) pool of bile acids present in the liver and biliary tree at the start of the perfusions was being excreted during the first part of the perfusions and subsequently the excretion rate of biliary bile acids was similar to the rate of *de novo* formation of bile acids in the preparation. Both cholic and chenodeoxycholic acids were excreted by the preparation and both were rapidly labelled during the perfusions in which mevalonic acid-2- ^{14}C was added to the perfusate.

The *in vivo* studies of ERIKSSON (1957), in which the excretion of bile acids in the bile fistula rat was studied, suggested that the rise of bile acid excretion which occurred during the second day following cannulation of the bile duct was due to a very considerable rise in the rate of *de novo* formation of bile acids. We have perfused livers taken from normal animals and from animals subjected to bile duct drainage for 44 h. In each case the hepatic cholesterol pool has been labelled as described above (Fig. 3). The biliary bile acid excretion rate in the livers from animals subjected to biliary drainage was much higher throughout the perfusion period than in the livers from normal animals, also the rate of formation of radioactive bile

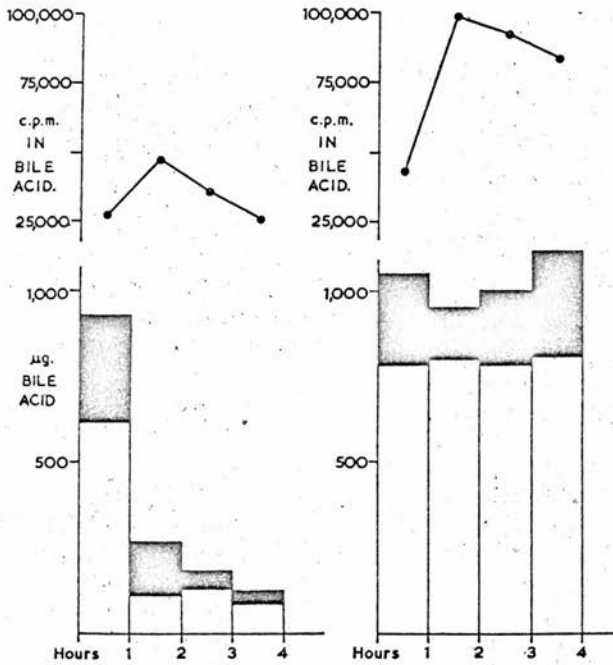

Fig. 3. Comparison between biliary bile acid excretion in normal and previously cannulated livers.

acids was much greater in the former group. These studies confirmed that bile acids were being formed very rapidly in the livers from bile fistula animals and also, since these livers excreted bile acids at a well maintained rate throughout the perfusion period, the validity of the perfusion technique was demonstrated.

When rats are subjected to surgical thyroidectomy there is a tendency for the plasma cholesterol levels to rise during the subsequent weeks (BOYD, 1959). The reason for this rise is not certain but one possible mechanism might be a reduced rate of cholesterol degradation associated with the hypothyroid state. Livers from surgically thyroidectomised and sham surgically thyroidectomised animals were perfused some three months after operation. The hepatic cholesterol pool was labelled with mevalonic acid-2- ^{14}C as described previously. The rate of breakdown of labelled hepatic cholesterol to labelled biliary bile acids was shown to be less in the surgically thyroidectomised group than in the sham operated

group demonstrating at least one effect of hypothyroidism on bile acid excretion (Table I).

Table I. Mean counts per min/100 g body weight recovered in bile acids from perfused livers (4 h perfusions) from thyroidectomised and sham thyroidectomised rats.

Hours	1	2	3	4
Sham Thyroidectomy	3,400	8,700	10,100	7,500
Surgical Thyroidectomy	1,600	4,600	4,800	4,600

The isolated rat liver perfusion technique as described here appears to be a valid method for the study of the degradation of cholesterol to biliary bile acids since those bile acids which are identified in the bile from the isolated perfused preparation are identical with the principal bile acids found *in vivo*. Furthermore the rate of formation of biliary bile acids during at least a 4-hour perfusion period is well maintained, thus indicating the satisfactory status of the perfused organ throughout the procedure.

Acknowledgements

This work was supported by a grant from the Scottish Hospitals Endowment Research Trust (HERT 128). One of the authors (Dr. I. W. PERCY-ROBB) was in receipt of an Edinburgh University Research Scholarship and a grant from the Carnegie Trust for Scottish Universities.

Summary

The *in vitro* conversion of cholesterol to biliary bile acids has, to date, only been possible in the isolated perfused liver preparation. Livers have been perfused with whole rat blood and the rate of the conversion of cholesterol to biliary bile acids studied following the labelling of the hepatic cholesterol pool with radioactive mevalonic acid.

An increased rate of biliary bile acid formation was demonstrated in livers from rats subjected to 44 h biliary drainage. A reduced rate was shown when livers from hypothyroid animals were compared with livers from normal animals.

References

- BOYD, G. S.: Thyroid function, thyroxine analogs, and cholesterol metabolism in rats and rabbits. *Hormones and Atherosclerosis*, 49-62 (1959).
- BOYD, G. S.; EASTWOOD, M. A. and MACLEAN, N.: (in press).
- DANIELSSON, H.; INSULL, W., JR.; JORDAN, P. and STRAND, O.: Metabolism of 4-C¹⁴-cholesterol in the isolated perfused rat liver. *Amer. J. Physiol.* 202: 699-703 (1962).
- ERIKSSON, S.: Biliary excretion of bile acids and cholesterol in bile fistula rats. *Proc. Soc. exp. Biol., N.Y.* 94: 578-582 (1957).
- FREDERICKSON, D. S.: The conversion of cholesterol-4-C¹⁴ to acids and other products by liver mitochondria. *J. biol. Chem.* 222: 109-120 (1956).
- HAROLD, F. M.; FELTS, J. M. and CHAIKOFF, I. L.: Fate of cholesterol-4-C¹⁴ and -26-C¹⁴ in the perfused liver. *Amer. J. Physiol.* 183: 459-462 (1955).
- KRITCHEVSKY, D.; STAPLE, E. and WHITEHOUSE, M. W.: Oxidation of ergosterol by rat and mouse liver mitochondria. *Proc. Soc. exp. Biol., N.Y.* 106: 704-708 (1961).
- MILLER, L. L.; BLY, C. G.; WATSON, M. L. and BALE, W. F.: The dominant role of the liver in plasma protein synthesis. *J. exp. Med.* 94: 431-453 (1951).
- REID, R. H. P. and BOYD, G. S.: A method for the specific differential estimation of cholic and chenodeoxycholic acids in human plasma. *Biochem. J.* 73: 9P (1959).

Authors' address: Drs. I. W. Percy-Robb and G. S. Boyd, Department of Biochemistry, University of Edinburgh, *Edinburgh* (Scotland).