

VOLUME 2.

The hand prosthesis.

Chapter 1. The hand project.

Chapter 2. Experimental hand mechanisms.

Chapter 3. The practical mechanism.

Chapter 4. The glove.

Chapter 5. The controls.

Chapter 6. The results and conclusions.

Technical Appendices.

Publications.



The Design and Development of an Artificial Hand

Incorporating Function and Cosmesis.

Contents.

Volume 2 The hand prosthesis.

	<u>Page</u>
Chapter 1 The hand project	1
" 2 Experimental mechanisms.	19
" 3 The practical mechanism.	29
" 4 The glove.	44
" 5 The controls.	65
" 6 The results and conclusions.	75
Technical Appendices	94
Appendix to Chapter 2	94
Appendices to Chapter 3	96
" " 4	114
" " 5	144
 Publications.	

Chapter 1.

The hand project.

- 1.1 The purpose of the chapter.
- 1.2 The hand-arm relationship.
- 1.3 The influence of the arm prosthesis on the hand project.
- 1.4 The hand prosthesis and factors influencing its design.
- 1.5 Deductions made as a result of the available hand design data.
- 1.6 The implications of the proposed developments and their relationship with the natural system.
- 1.7 The consideration of normal patterns of hand activity.
- 1.8 Experiments to supplement information concerning hand movements.
- 1.9 The results and their implications.
- 1.10 The results reviewed and their influence on hand design.
- 1.11 The definition of projects as a result of the information assembled.

1.

Chapter 1.

The hand project.

1.1 The purpose of the chapter.

The fact that the hand project was required to fit into an existing framework of organisation and experience necessarily influenced the development of the prosthesis to a considerable extent, and it is therefore essential to record the way in which these influences were brought to bear. Thus, this chapter is concerned with the effects of the background outlined previously on the form of the hand development programme, the initial considerations being made by analysing the role of the hand relative to the arm.

1.2 The hand-arm relationship.

The two upper limb sub-systems, arm and hand, may be considered as providing the complementary functions of positioning and prehension respectively. The arm provides the platform upon which the gripping action of the hand may function, and the usefulness of the arm is reduced to the level of a mere dynamic stabiliser if the hand is removed.

However, the relationship of the arm to the hand is more subtle than this, since the way in which the hand is positioned in space, and the way in which the hand is orientated has a considerable effect upon the degree of function which can be achieved by the hand. That this is so is seen by the way in which the function of the commercially available pincer grip type of hand can be improved by means of a permanent wrist flexion on the arm (see Figs. 1.1 and 1.3 in Section 1 of Volume 1). Furthermore, the versatility of the hand can be considerably affected by the introduction of a pronation/supination facility, whilst some workers (Wendt and

Shaperman 1970) have found that a permanent adduction of the wrist provides improved results. Another important illustration of the influence of arm function upon the resulting characteristics of the hand is shown by the effects of the introduction of the stabilised wrist mounting as used in the arm prosthesis, which considerably affects the way in which the hand must approach objects to be grasped.

Conversely, the arm cannot be designed fully without some knowledge of the limitations of the hand, the weight of the hand and the object to be gripped, and the way in which the hand should be aligned for best results in prehension.

Therefore, it was apparent from the outset that the hand project would directly affect the design and development of the arm prosthesis, not only because the programmes were progressing continuously, but also because the two systems must rely so closely upon one another in order to achieve a satisfactory and useful end result.

Thus, the hand project in its wider sense may be divided into two parts which have a considerable degree of influence upon one another, although it is convenient to consider their development separately as (i) the hand prosthesis, and (ii) the arm prosthesis. In addition a third topic encroaches on both mechanisms and is covered by the general title of control.

1.3 The influence of the arm prosthesis in the hand project.

The general aspects of the arm prosthesis having been outlined in Volume 1 in order to indicate the basis of the environment into which the hand must fit, there is no necessity for a detailed

account of its design and development to be recorded at this stage. However, various features of arm design arise at different stages of the hand development, particularly in the results section, and reference will be made to those factors in the appropriate contexts, the detailed work being directed towards the production of a hand prosthesis suitable for use with the arm systems of the type previously described.

1.4 The hand prosthesis and factors influencing its design.

The experience of the fitting of the arm prostheses had produced one major new requirement in terms of hardware - a more effective cosmetic hand prosthesis was required. The specific criteria from this source which could be considered as influencing the design were:

- (1) The hook device had many advantages such as robustness, simplicity and adequate prehensile ability.
- (2) Available hand prostheses were vastly inferior to the hook in terms of function.

In addition to these points, a survey of relevant literature produced several further points of significance:

- (1) The development of hand prostheses had effectively been limited to two types of prosthesis; the simple pincer grip type and the more complex but less robust fully articulated type. Neither could be considered as functionally comparable with hooks.
- (2) Little attention had been directed towards the importance of the act of picking up with a prosthesis, i.e. prehension had been neglected in favour of grip, the hand being designed as a holding device rather than as an active manipulator and comprehensive

grasping tool, the reason for this being the fact that the hands were designed for use by unilateral amputees, the prostheses adopting the role of auxiliary to a normal arm.

(3) A clearly defined and previously untried type of mechanism was postulated which could be considered as taking the form of a type of 'cosmetic hook'.

(4) The importance of a well-designed relationship with the arm was substantiated by the experiences of various workers.

(5) The potential demand for a cosmetic hand prosthesis with improved function was considerable in view of the functional sacrifices made by patients in favour of cosmesis.

(6) The production of cosmetic covers for hand prostheses appeared to provide no particular difficulties.

(7) Extreme robustness was essential for satisfactory results.

Furthermore, a third major source of information directly affected the requirements for the hand prosthesis since the design of the arm prosthesis imposed stringent conditions upon the hand design.

The factors of prime importance from this source were:

(1) The limited number of control sites ruled out active wrist flexion and adduction as factors which may have added to the versatility of any hand prosthesis.

(2) The limited number of control sites also restricted the number of controls available for the hand to the use of a single site.

(3) The stabilised wrist flexion action created a relatively fixed angle of approach for the hand in acts of prehension, only minor adjustments being possible by virtue of gross body movements.

(4) The wrist rotation facility of the arm should be used to the maximum advantage since this was closest to the provision of a second control site for hand action, and considerably influenced terminal device function.

1.5 Deductions made as a result of the available hand design data.

All this information was considered in deciding upon the course of action to be taken in the hand programme. The most significant point of all was that the hand would clearly have to be fundamentally simple, a fact indicated by problems encountered elsewhere with the mechanically complex fully articulated hands, and further substantiated by the success of the extremely simple hook device. In addition the availability of a single control site effectively limited the movement to a single mode of action, since experience with the fitting of prostheses in Edinburgh and elsewhere had established that sequential controls operated by a single site introduced a degree of confusion into the system. The other alternative was to introduce an element of automation into the hand, which was considered to be undesirable (Simpson 1966) since it detracted from the degree of control maintained by the operator.

The second major point made clear by the various sources of information was that the main movement of the mechanism should be a lateral opposition of the thumb to the fingers. Such a movement is a necessary consequence of the attitude of the hand when attached to the arm prosthesis, since, in order for the hand to be able to pick up actively it must operate on a flat surface. This type of action was substantiated by its similarity to the action of the successful split hook devices, where the plane of action of

the mobile blade is parallel to the plane from which the object is to be taken. A particularly appropriate example of the type of action which might be suitable was indicated by the Bottomley hook device (Bottomley 1967).

Remaining points of significance concerned the necessity for a good cosmetic effect to be maintained at all times, without loss of function; and an extremely high level of wear resistance and general toughness was mandatory for the whole device.

Thus, a definite trend was indicated for the general development of a cosmetic, functional, hand prosthesis. However, the details of the mechanism of the device required investigation, in order to establish an optimum mode of action, particularly in view of the difficulties experienced by other workers in providing stable finger joints, for example. In addition, the development of systems for controlling the prosthesis was essential, since Simpson's (1971) work had shown that close attention paid to this area of prosthetics gave many benefits to a practical solution of the problem.

1.6 The implications of the proposed developments and their relationship with the natural system.

Thus, a review of such relevant information as was available indicated an overall trend for the development of the hand prosthesis, based upon the immediate demands and influences of the situation in which the work was to be carried out. In particular, a mode of action was demanded of the prosthesis such that the device be able to pick up objects from a flat surface. However, relatively little information was available concerning the extent to which the versatility of the normal hand could be restricted whilst retaining

an adequate degree of function, particularly in relation to a limitation upon finger activity in view of the maintenance problems arising in prostheses with many finger joints.

Therefore, in order to further specify some design criteria for the hand prosthesis it was desirable that some indication be gained of the extent of the involvement of finger action in a range of everyday tasks.

1.7 The consideration of normal patterns of hand activity.

The probable value of such an investigation was also substantiated by the well accepted fact that the peculiar saddle shaped carpo-metacarpal joint of the thumb conveys a unique importance to the thumb in the normal hand. This versatility is of such an extent that the relative immobilisation or range limitation of fingers as a result of rheumatoid disease for example has a surprisingly slight effect on prehensile ability (e.g. Wynn-Parry 1958).

In general the existing information concerning the mode of action of the hand appears to have been of a distinctly descriptive nature in terms of its application and this type of approach is exemplified by the work of Schlesinger (1919), who postulated six modes of gripping technique performed by the hand:

- (1) Cylindrical - as in grasping strongly round a thick rod.
- (2) Tip - as in picking up a small object.
- (3) Hook - as in carrying a suitcase.
- (4) Palmar - as in holding a pencil.
- (5) Spherical - as in grasping a ball.
- (6) Lateral - as in holding a rigid sheet between thumb and fingers.

Work by Keller et al (1947) using film of the hands in every-day activities used classifications similar to those of Schlesinger, on the basis of which a percentage assessment was given for three types:

		Palmar	Tip	Lateral
Pick up	%	50	17	33
Hold	%	88	2	10

Thus indicating that, qualitatively, prehension is weighted in favour of the palmar type of grip.

These theories remained unmolested until Napier (1956) made rather simpler proposals in the form of two types of grip- power and precision. Napier proposed that normal gripping functions could be explained by a variable mixture of these in suitable proportions. His theory is illustrated by a series of unrehearsed photographs, which unfortunately could be used equally well to argue the point that gripping technique varies very little, except in regard to the pronation/supination angle adopted by the hand. However, Napier's theory has received much attention and seems to have proved to be a useful classification despite its somewhat shaky foundations. The dangers of such classifications are illustrated by Backhouse (1968) when he states that flexion at interphalangeal joints is a phenomenon of power grip, whereas flexion at the metacarpo-phalangeal joints is a phenomenon of precision grip, a patently inaccurate generalisation! Such a rigid division of processes can give an entirely false impression of the behaviour of the hand, a fact which had been recognised by Landsmeer (1962) when he divided prehension into power grip and

precision handling. He clearly distinguished between the two by the dynamic state of the latter as opposed to the ultimate static nature of power grip, thus naturally involving all the joints in prehension in a controlled manner.

The investigation of prehension patterns in a scientific manner has proved to be immensely difficult to achieve, although the improvement in electromyographic analysis has proved to be a useful tool for the supplementation of anatomical knowledge, e.g. Close and Kidd (1969) and Forrest and Basmajian (1965) have used electrodes inserted into thumb muscles to relate particular muscle activities to specific movements.

One of the few non-electromyographic analyses of grip has been carried out by Ramsay and Hueston (1962), who analysed the palm prints produced as a result of the gripping in 'power-grip' fashion of objects smeared with lipstick. Their results showed that all fingers are in use in various forms of power grip, although the distribution between them varies according to the flow of power required when the grip is used.

Probably the most important work on the functional analysis of the hand has been carried out by Landsmeer and Long (1965). By breaking down hand actions into basic joint angle configurations and the changes in these, it was possible to analyse the basic motions electromyographically in order to ascertain the participation or non-participation of individual muscles. As a result of their analysis, a theory of prehension is derived which lays considerable emphasis on the effects contributed by passive visco-elastic forces within the hand. Once again the power grip/precision handling

distinction is supposed to be substantiated, although the difference does not appear to be clearly defined, which it would have to be in order to be convincing, but the assessment of the degree of muscle participation had to be made on a 'yes' or 'no' basis. Further advances in electromyography may make possible a quantitative assessment of the degree of muscle participation, in which case this approach could prove most illuminating.

The aspects of hand behaviour outlined above have been based on the large scale effects of the adaptability of the hand. In addition to these functions, the normal hand possesses two important facilities, which have been much underrated in the past, namely the effects of the fingernails and the pulpy pads of the fingers and palms.

The use of fingernails is an important aspect of the function of the hand in various ways, probably the most frequent use being in forceps-like operations for delicate picking up and removal of small objects such as thorns, drawing pins, etc. In addition the fingernails provide a grip equivalent to that of pliers, by deforming softer smooth objects in order to achieve gripping purchase.

Isherwood (1965) has pointed out that an effect of the increased function due to long fingernails is a reduction in the degree of finger flexion necessary to achieve certain tasks. Yet another important aspect of the nails is their relationship to tactile feedback - by virtue of their attachment to the periosteum and hence to bone they transmit vibrational information extremely well.

One of the most important functions of the normal hand which has been almost completely neglected is the adaptability of the

actual surface of the gripping areas. As Simpson (1971) has shown, the surface is passively modified by its contact with gripped objects, thus permitting an increased area of contact between gripper and gripped. This effect is the converse of the traditional approach to gripping techniques where the gripper deforms the gripped surface such as pliers which have a serrated edge to dig into the object of the gripping process. The natural effect is achieved by means of a surface-tacky layer of skin which encloses pads containing many globules of fat. These globules are free to move a restricted distance within limitations imposed by a matrix or flexible inelastic fibres which bind the fatty tissues to the underlying bone structure, thus allowing a limited free range of motion. The net effect of this system is to allow a certain amount of deformation of the pad, but no more, thereby tending to stabilise the gripped object once deformation is complete. The skin which covers the pads is maintained in a tacky state to improve surface friction by means of the secretion of perspiration which lies in the 'grooves' of the fingerprints.

1.8 Experiments to supplement information concerning hand movements.

This somewhat unsatisfactory state of affairs regarding theories of prehension led to the development of a series of simple experiments to determine just what, if any, sort of pattern of prehension existed. The initial experiments consisted of measuring finger positions and joint angles when the hand was grasping a range of objects. These objects were chosen specifically to represent the six Schlesinger gripping nodes. Since the difference in gripping nodes was supposed to be related to interphalangeal and metacarpo-

phalangeal joint angles, it was considered that the most significant viewing angle would be from the side of the hand, looking past the thumb into the arch formed by the fingers. (Fig. 1.1). The approximate position of the finger and thumb joints were marked with crosses using a ball-point pen and a 'sight' was made for attachment to the wrist, in order to ensure a consistent viewing angle. The sight consisted of a pointer which was clamped to the wrist, the direction being established by location of the pointer over another mark on the skin.

The use of any opaque objects for the grasping experiments would have obscured parts of the fingers and their markings, thereby making measurements impossible and, in order to overcome this problem, the objects were made of perspex, the distortion effects due to refraction being overcome by carrying out the experiments with the hand immersed in liquid paraffin. Since the refractive indices of perspex and liquid paraffin are so close (they differ by only 0.7 per cent) the optical matching is extremely good, making reflections from the paraffin/perspex interface almost non-existent. A special perspex tank was constructed to permit photography from any angle around the hand (Fig. 1.2), and records were made of the hand, correctly orientated by the pointer, grasping the range of objects as laid out in the graph of results. (Fig. 1.3). The photographs were then analysed and metacarpo-phalangeal and interphalangeal joint angles were measured for as many fingers as possible. When illustrated in graph form it was seen that a definite trend of increasing angles related to gripped object existed. The scope of this particular experiment was limited by

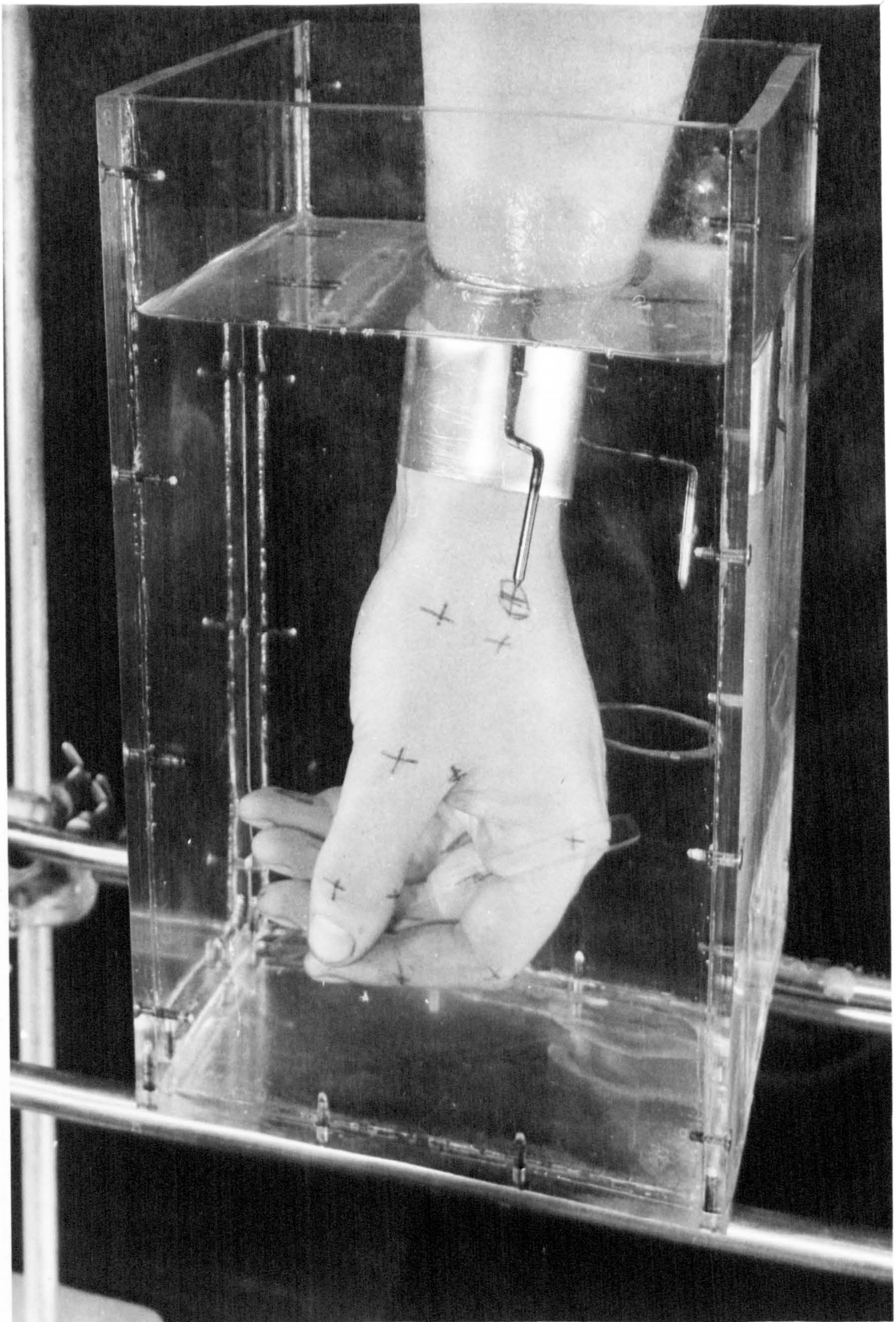

Fig. 1.1 Hand position in grip analysis experiments.

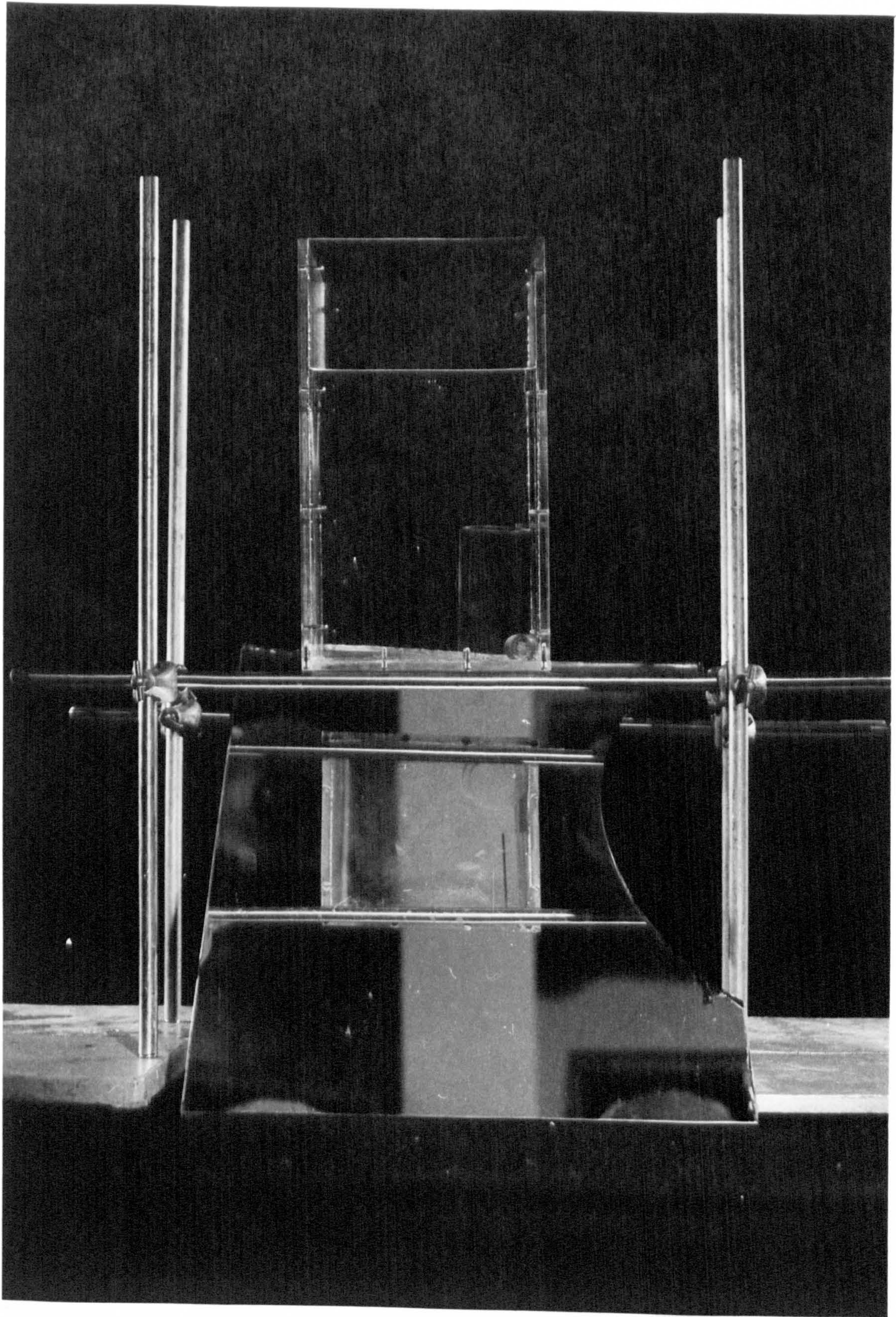
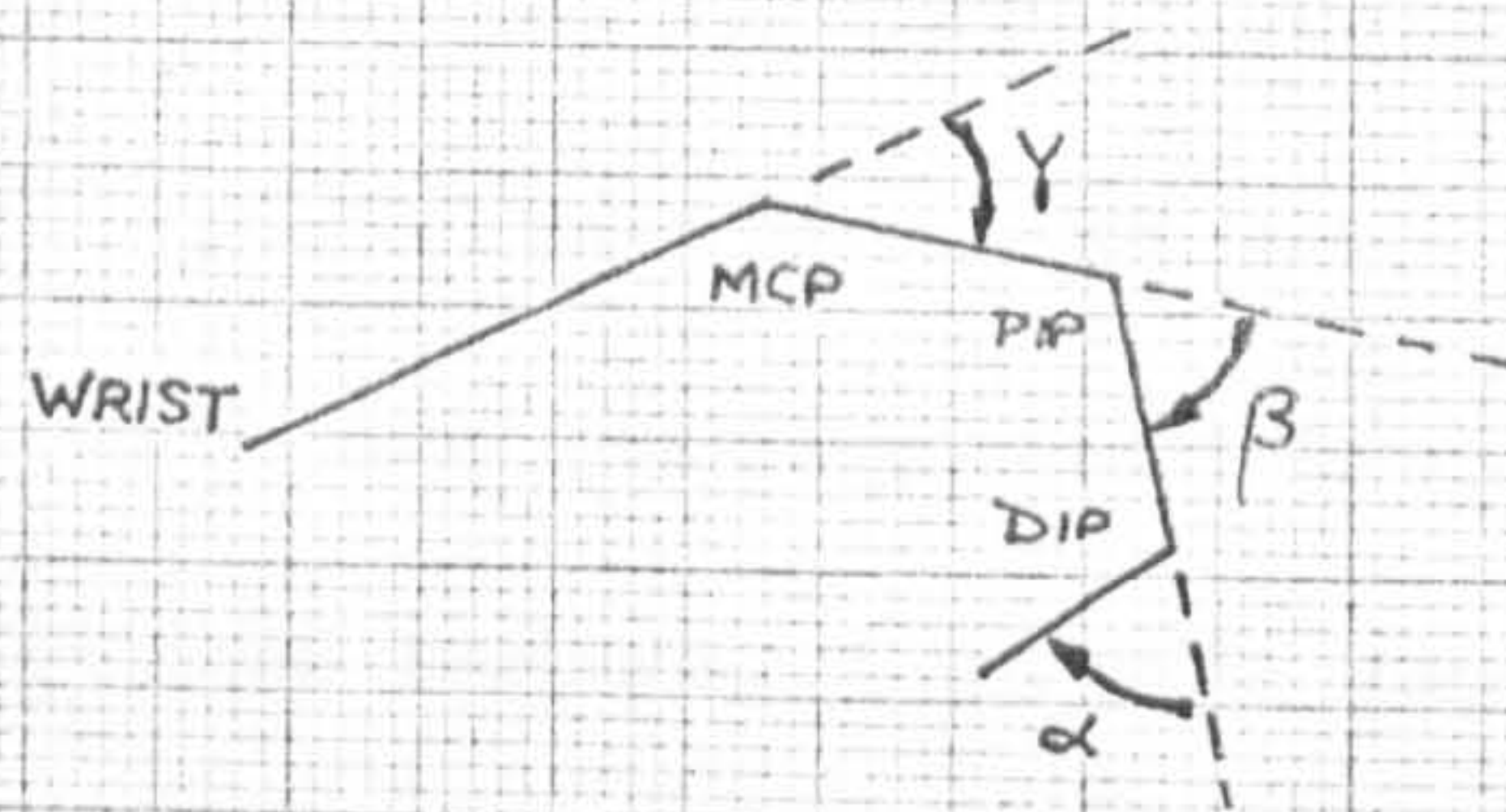
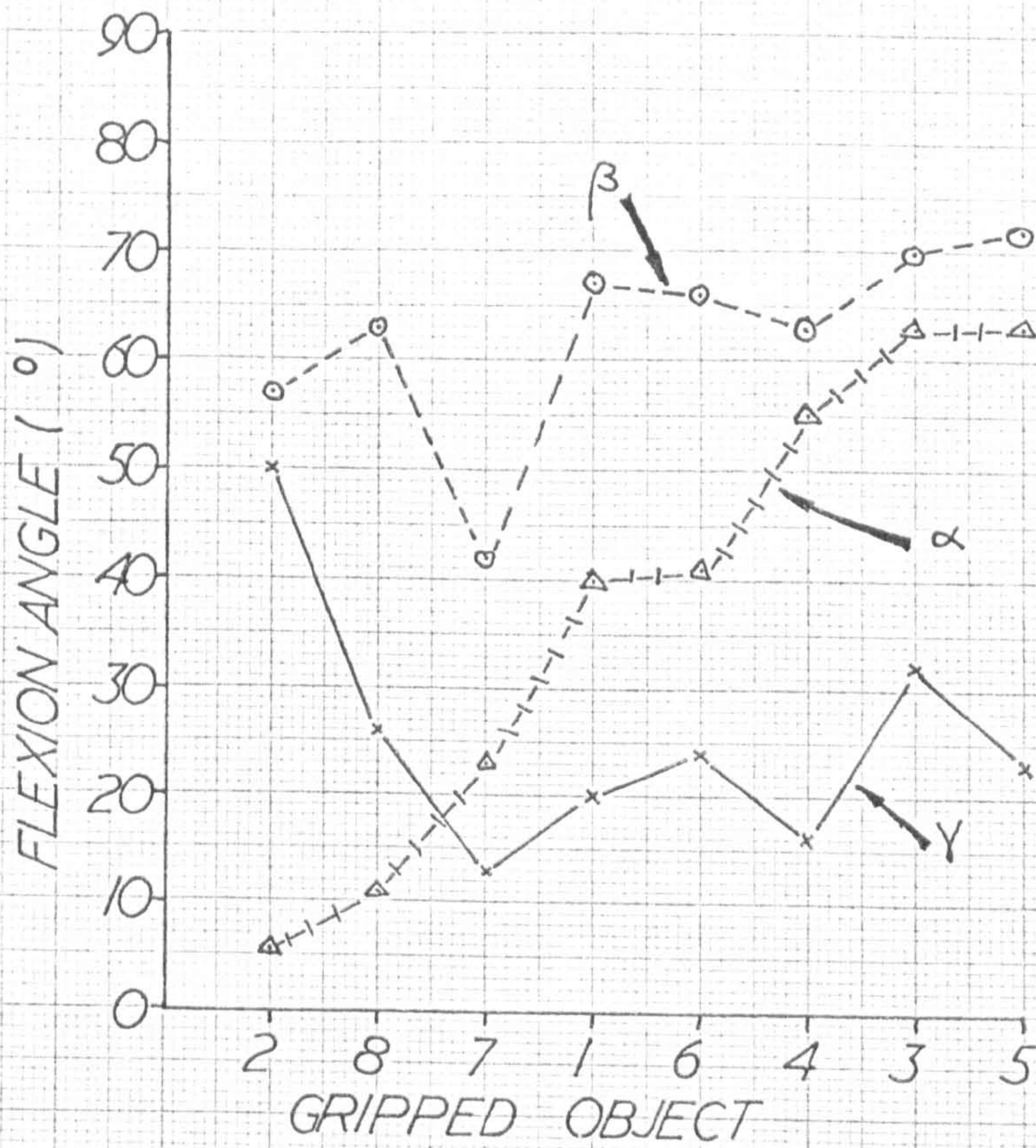

Fig. 1.2 Viewing tank.



1. Pencil.
2. Large round object (a glass).
3. Door handle.
4. Heavy tool (hammer).
5. Hook (case handle).
6. Thin sheet (paper, board, etc.).
7. Knob.
8. Cup handle.

Fig. 1.3 Preliminary results of grip analysis.

the obscuration of one finger by the next in many positions. However, the apparent existence of such a smooth trend for the index finger gave considerable encouragement for further investigations.

The problem of the interruption of the line of sight was overcome by the use of X-ray techniques. In place of the pen markings, coded lead markers were stuck with 'Bostik' adhesive to the approximate positions of the joints of the fingers and thumb. Constant viewing angle was maintained by means of a locating jig which fixed the wrist in the desired attitude by location in a slot. (Fig. 1.4). The sequence of grasping was then repeated using the same range of perspex objects as were used in the initial experiments with each gripping position being recorded on an X-ray film. The results were then analysed as before, using the coded lead markers to locate the joint positions of each finger. As in the previous experiment with the photographic technique, the angles recorded were the flexion angles, i.e. the complements of the angles between the bones forming the joint concerned. An example of the X-ray pictures obtained is shown in Fig. 1.5, illustrating the fact that the angles of all finger joints could be analysed using the X-ray technique.

The results obtained are displayed in the table of Fig. 1.6. This table was then used to establish a second table in which the columns were arranged in increasing order of magnitude of the flexion angle associated with each gripped object (Fig. 1.7), which was used as the basis for establishing an 'average' order of increasing flexion. The average for each row was based upon the

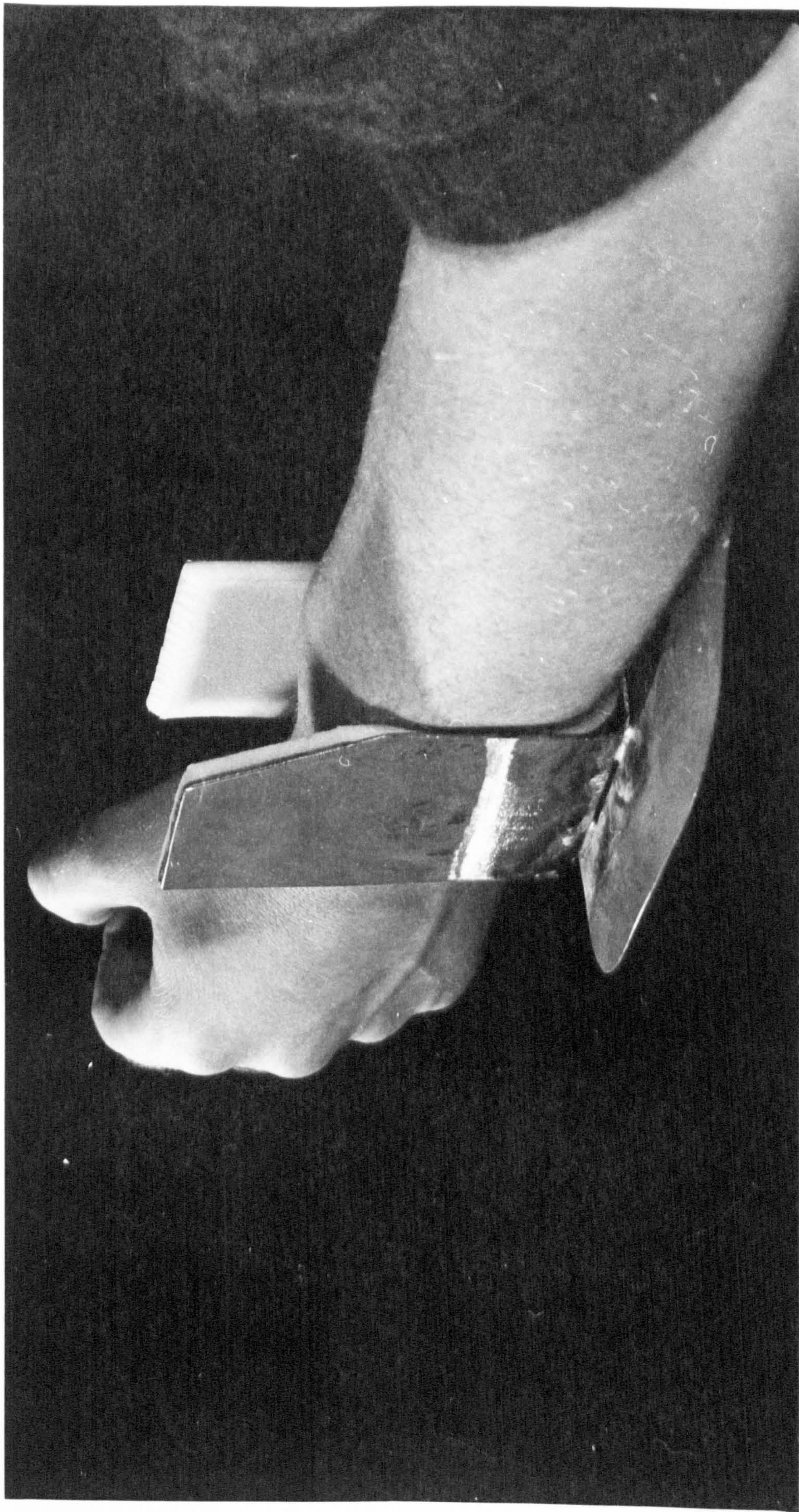

Fig. 1.4 Wrist location jig.

		Index			Middle			Ring			Little		
Positions		α	β	γ	α	β	γ	α	β	γ	α	β	γ
	1	26	66	35	34	63	46	33	69	44	44	66	44
	2	42	65	28	42	62	50	37	52	56	28	48	51
	3	60	93	60	64	95	62	54	95	66	59	86	61
	4	56	85	31	69	95	63	37	98	74	41	84	78
	5	68	81	48	68	97	50	59	96	32	62	85	18
	6	41	56	37	40	74	46	39	73	44	51	73	41
	7	25	49	39	59	83	45	47	93	56	59	90	58
	8	52	53	26	33	82	11	54	88	33	59	90	30

Fig. 1.6 Table of results.

	Index			Middle			Ring			Little		
	α	β	γ	α	β	γ	α	β	γ	α	β	γ
Positions in order of increasing flexion ↓	7	7	8	8	2	8	1	2	5	2	2	5
	1	8	2	1	1	7	2	1	8	4	1	8
	6	6	4	6	6	6	4	6	6	1	6	6
	2	2	1	2	3	1	6	8	1	6	4	1
	8	1	6	7	7	2	7	7	7	8	5	2
	4	5	7	3	4	3	8	3	2	7	3	7
	3	4	5	4	3	4	3	5	3	3	7	3
	5	3	3	5	5	5	5	4	4	5	8	4

Fig. 1.7 Grips tabulated in order of increasing flexion of fingers.

predominance of a particular position in that row, any borderline cases being weighted according to the predominance of the particular position in adjacent rows. In this way the 'average' order of increasing flexion proved to be 8, 1, 6, 2, 7, 4, 3, 5, which corresponds to cup handle grip, pencil, thin sheet, large round grip, knob, heavy tool, door handle and hook. It is interesting that even as the result of a crude analysis of this sort, the spectrum from precision grip to power grip and hook grip follows a logical sequence of increasing power content.

1.9 The results and their implications.

The results, based upon this sequence of grips, are displayed in graph form in Figs. 1.8, 1.9 and 1.10. Although there can be no absolute value attached to these results, due to the complete absence of a statistically significant experimental population, the brief study was sufficient to provide guidelines for future developments of the hand prosthesis, and to provide grounds for speculation and for further experiments concerning the analysis of grip.

Probably the most obvious trend to emerge from the graphs is the relationship between power grip content (as indicated by the type of grip) and the amount of flexion of the fingers. This applies to all three finger joints, flexion of each joint increasing by approximately 30° in the range from pencil grip to door handle grip. However, during this change there is no evidence of a pronounced change of mode in the finger grip characteristics, merely a trend towards a slight increase of flexion.

The most surprising fact to emerge from the data was the relatively small amount of change of flexion angle which occurs,

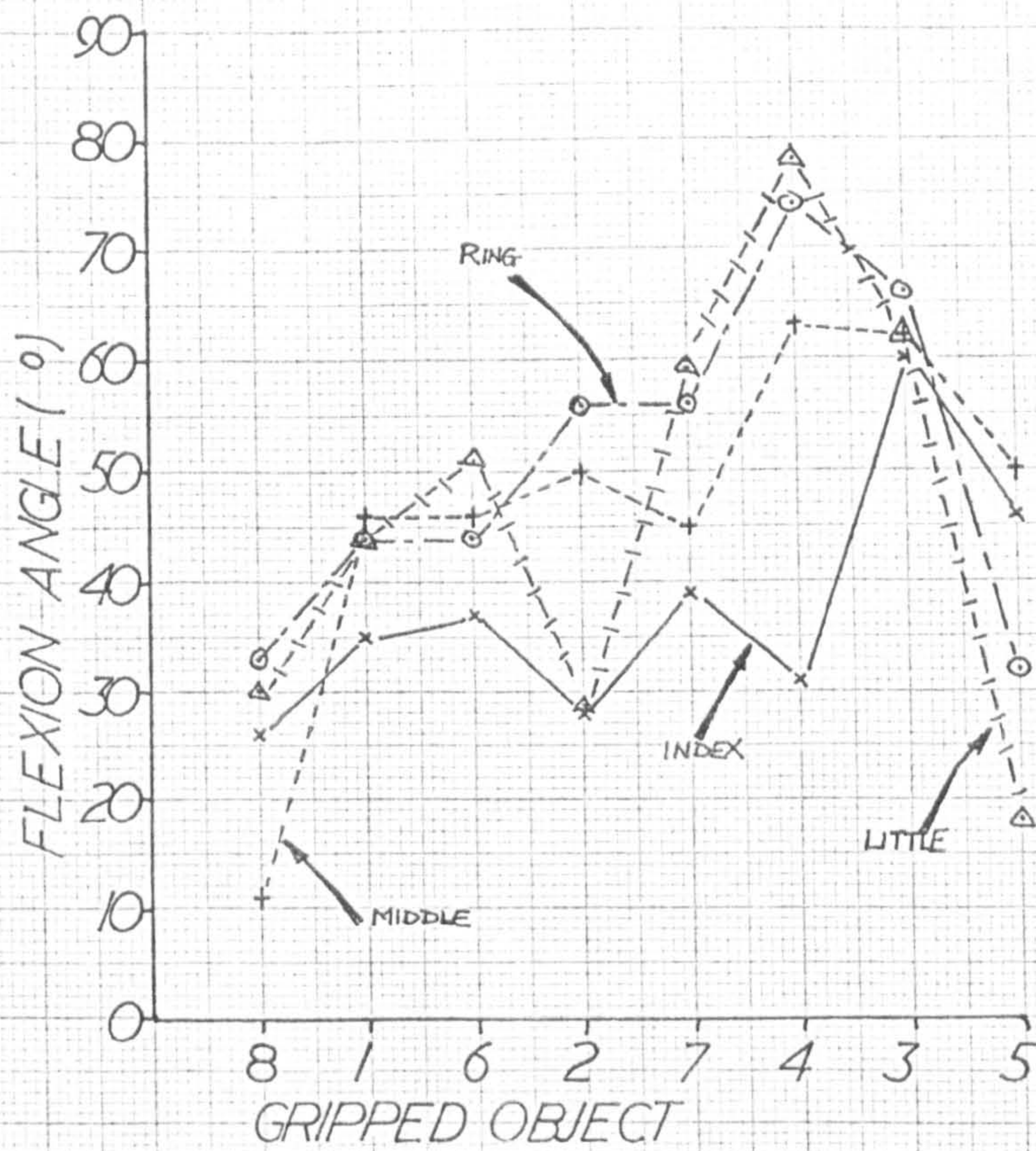

1. Pencil.
2. Large round object (a glass).
3. Door handle.
4. Heavy tool (hammer).
5. Hook (case handle).
6. Thin sheet (paper, board, etc.).
7. Knob.
8. Cup handle.

Fig. 1.8 Results for distal interphalangeal joints.

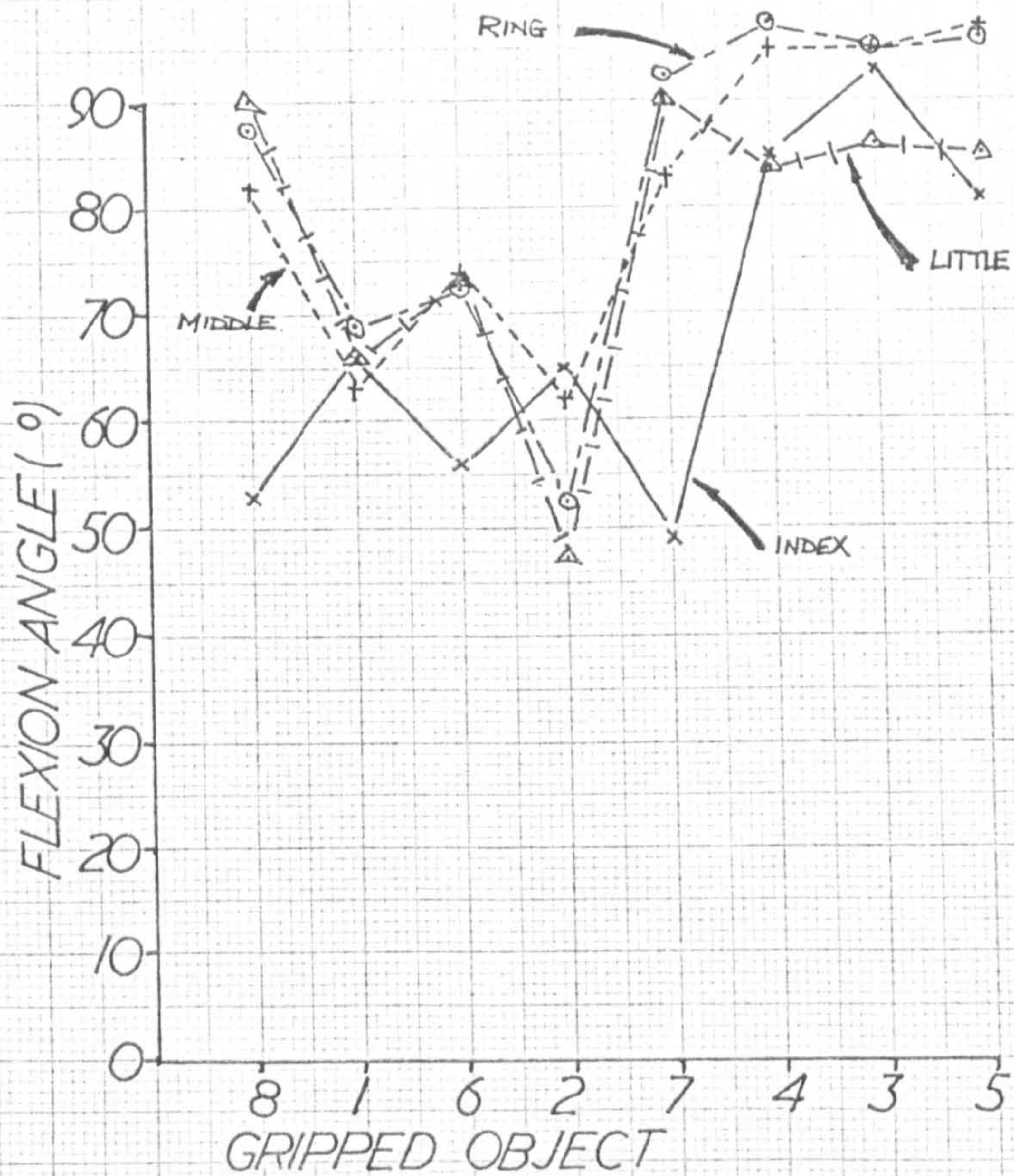

1. Pencil.
2. Large round object (a glass).
3. Door handle.
4. Heavy tool (hammer).
5. Hook (case handle).
6. Thin sheet (paper, board, etc.).
7. Knob.
8. Cup handle.

Fig. 1.9 Results for proximal interphalangeal joints.

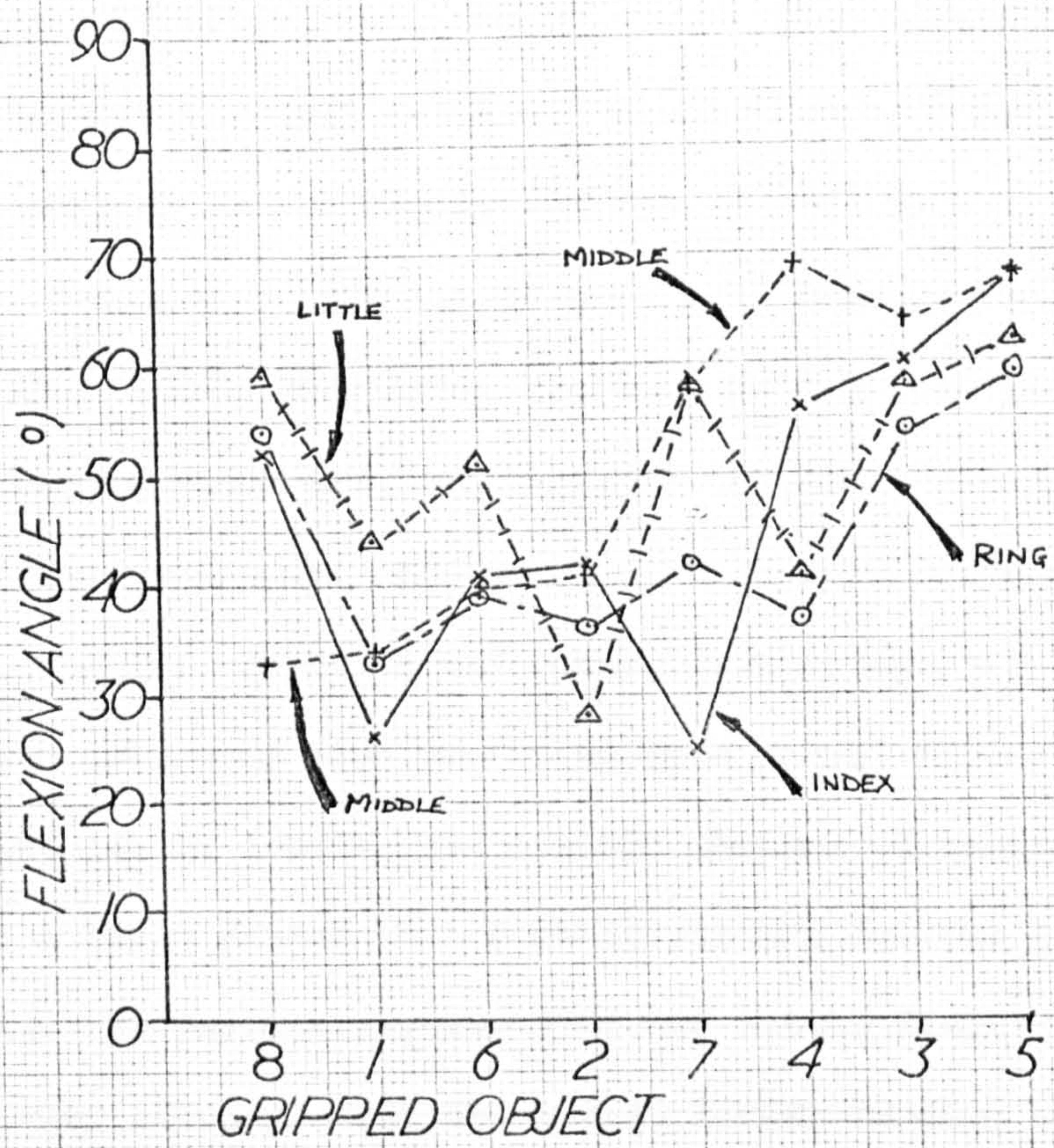

1. Pencil.
2. Large round object (a glass).
3. Door handle.
4. Heavy tool (hammer).
5. Hook (case handle).
6. Thin sheet (paper, board, etc.).
7. Knob.
8. Cup handle.

Fig. 1.10 Results for metacarpophalangeal joints.

the joint angles remaining within $\pm 20^\circ$ or so of a median level. This suggested that the full range of action of the fingers of the hand during everyday activities is limited to less than 50 per cent of the full potential, a point which gave some support to the theory that an adequate prosthesis might be made by careful selection of certain limited functional capabilities, in particular confirming that much of the versatility of the hand in everyday activities must be attributed to the action of the thumb. The versatility contributed by thumb action is also confirmed by a marked tendency for all the fingers to act as a unit, the overall changes of flexion occurring to a large extent in a similar pattern for the same joint in each digit. In particular, the ring and little fingers follow one another very closely, with the middle finger tending to be associated with them, these associations being predictable to a certain extent on a purely anatomical basis. Even the index finger, whose independence is nonetheless evident, follows the overall form of the changes manifested by the other fingers.

Although the close correspondence between the actions of the individual fingers may be explained to a great extent by the necessity to conforming the grasp to the gripped object, this does not apply to grips which involve only index and middle fingers: for example, since the posture adopted by ring and little fingers are then determined by anatomical factors. It is not possible, therefore, to put forward any definite theories of prehension behaviour on the basis of conforming to a gripped object, since the purpose for which the object is intended will determine the initial approach to the grasp. However, by combining a fore knowledge of the

desired amount of 'power grip' content with the required orientation of the object and then the commencement of gripping and conforming (subject to the restrictions of the anatomical arrangements), the pattern of prehension is completed.

Thus the essentially different aspects of the types of grip proposed by the various theories outlined previously, appears to lie in the ultimate purpose of the grip, where the attitude of the hand is different for holding a pencil as opposed to a hammer for example. So, as Napier's illustrations (inadvertently) show, the hand grips are substantially similar, except that the attitude of the wrist differs, this factor being extremely significant in view of the apparent low level of activity in the fingers and serving to highlight the importance of the thumb and wrist actions.

1.10 The results reviewed and their influence on hand design.

The net result of this analysis from a prehension theory point of view must therefore be to state that whereas it may be useful to label distinct types of grip for descriptive purposes, it is not correct to regard these types as being of any particular significance in a prehension pattern, since the variations in finger flexion angles between one type and the next are so slight. The relatively small variations of finger flexion which occur throughout a wide range of grips suggests that more attention should be directed towards a detailed appraisal of thumb and wrist functions as the deciding factors in determining the type of grip which is achieved.

Thus, from a practical point of view, the data conveys sufficient information to suggest that in an adequate prosthesis:

- (1) Fully articulated fingers appear not to be essential.
- (2) Linked little finger and ring finger actions are satisfactory.

(3) Thumb function is very important in view of relatively low activity in fingers.

(4) Wrist rotation is an important factor in determining grip mode.

(5) It is conceivable that static fingers and a mobile thumb may be adequate if used in conjunction with a pronation/supination facility.

3.11 The definition of projects as a result of the information assembled.

The net results of the information which has been correlated in this section was to provide a reasonably detailed basis for the subsequent development of a hand prosthesis which is directly related to a patient fitting programme. Thus, it was possible to formulate a specification for the design and to define specific regions and additional work which would be of significance in the overall prosthetic system, and these criteria are laid out below:

(1) The hand prosthesis generally.

(i) In the interests of reliability to be as simple as compatible with an adequate degree of function (incomparision with a hook prosthesis).

(ii) Cosmesis to be of a high standard, its appearance being satisfactory dynamically as well as statically.

(iii) Control systems to be designed and developed for compatibility with the normal control mechanisms in the human system.

(iv) Feedback to the operator of any additional information such as tactile response to be investigated.

(v) To be compatible with the arm prosthesis.

(vi) The hand to provide its full functional capabilities from combined use of a single control site in the hand and the wrist rotation in the arm.

(2) The hand prosthesis mechanically.

(i) The mechanism to be based upon the action of the thumb.

(ii) In view of the difficulties experienced with 'pincer' grip type prostheses, and the unnatural configurations of wrist flexion and pronation required for any performance on flat surfaces, thumb action to be based upon a lateral opposition to the fingers.

(iii) The extent of activity in the fingers to be limited in the interests of simplicity and reliability.

(iv) The possibility of totally passive action for ring and little fingers to be considered.

(v) The possibility of entirely rigid fingers to be considered, following the results of the X-ray experiments and the observations of Napier's experimental photography.

(vi) Power to be from a pneumatic source initially, for compatibility with the arm prosthesis, but for more general use a ready adaptability to other forms of power to be essential.

Chapter 2.

Experimental hand mechanisms.

- 2.1 Brief specification.
- 2.2 The first exploratory mechanisms.
- 2.3 A 'cosmetic' mechanism.
- 2.4 Results with the 'cosmetic' mechanism.
- 2.5 The practical implications of using active fingers.
- 2.6 Indications for alternatives to the use of mobile fingers.
- 2.7 A mechanism with stationary fingers.
- 2.8 The improvement of gripping surfaces.
- 2.9 Results with the simplified mechanism.
- 2.10 Conclusions drawn from the use of experimental mechanisms.

Chapter 2.Experimental hand mechanisms.2.1 Brief specification.

Following the assessment of the available information concerning hand prostheses and their relationship with arm prostheses in the chapter 'The hand project', an outline specification for the hand was developed. In practical terms the hand of this specification can be summarised effectively as consisting of a thumb laterally opposing fingers which should possess as little mobility as possible whilst retaining a suitable degree of function. In addition, the device was to operate from a single control site, using pneumatic power, and was to be able to perform gripping actions on a flat surface.

This situation formed the basis for the work to be outlined in this chapter, which is concerned with the development and evolution of various mechanisms, leading to the type of mechanism which formed the final prosthesis used in trials on patients.

2.2 The first exploratory mechanisms.

The first design commenced with an appreciation of the natural behaviour of the hand in prone position on a flat surface (Figs. 2.1, 2.2, 2.3 and 2.4) where the total range of movement is largely defined by the flat surface itself. Thus the very first stage in the development was to produce a model of a mechanism which could operate in a hand-like manner on a flat surface. This model is shown in Figs. 2.5, 2.6, 2.7 and 2.8. From these photographs it can be seen that by means of a simple four-bar linkage, the 'fingers' could be made to 'draw in' a small object towards the

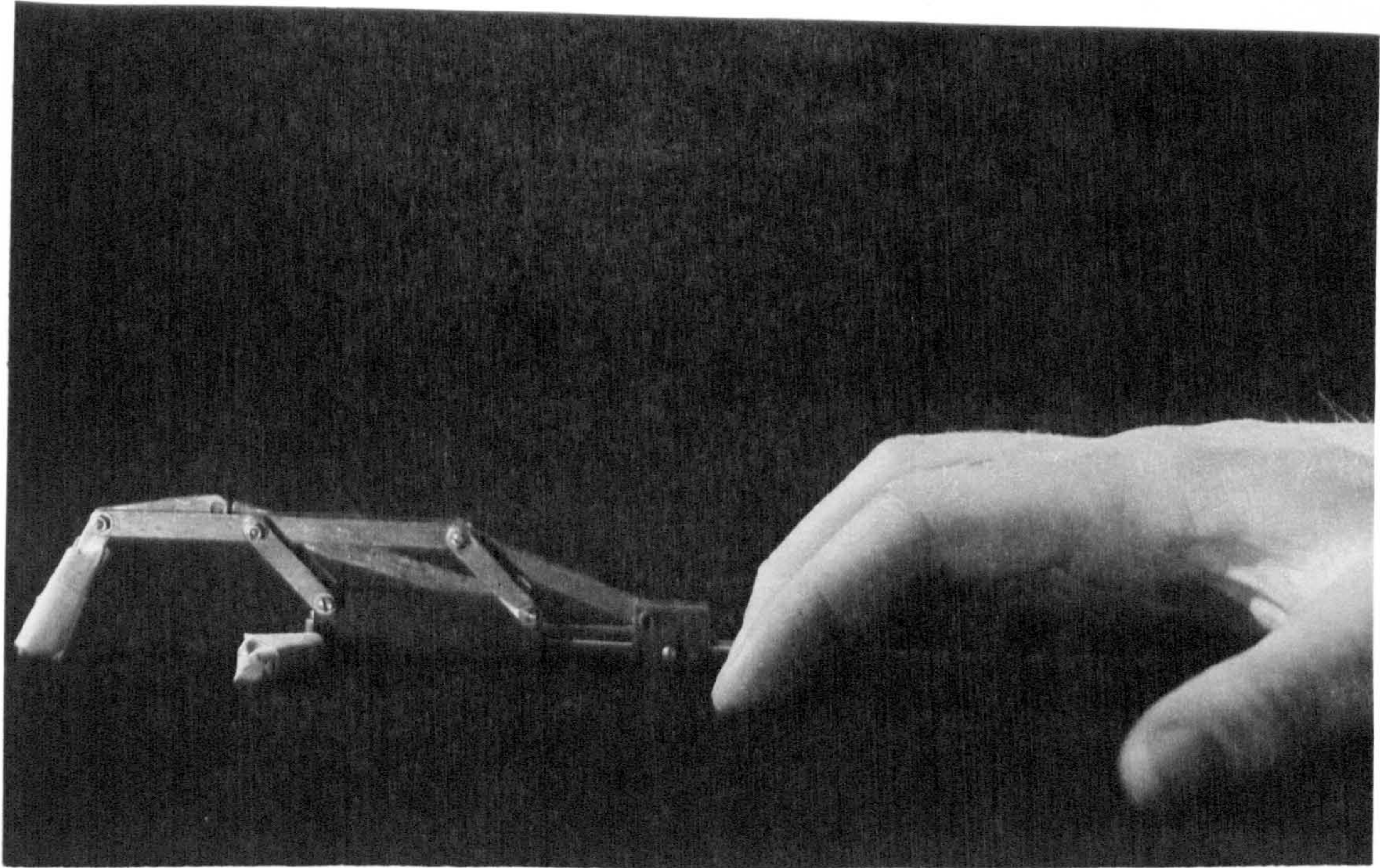

Fig. 2.1

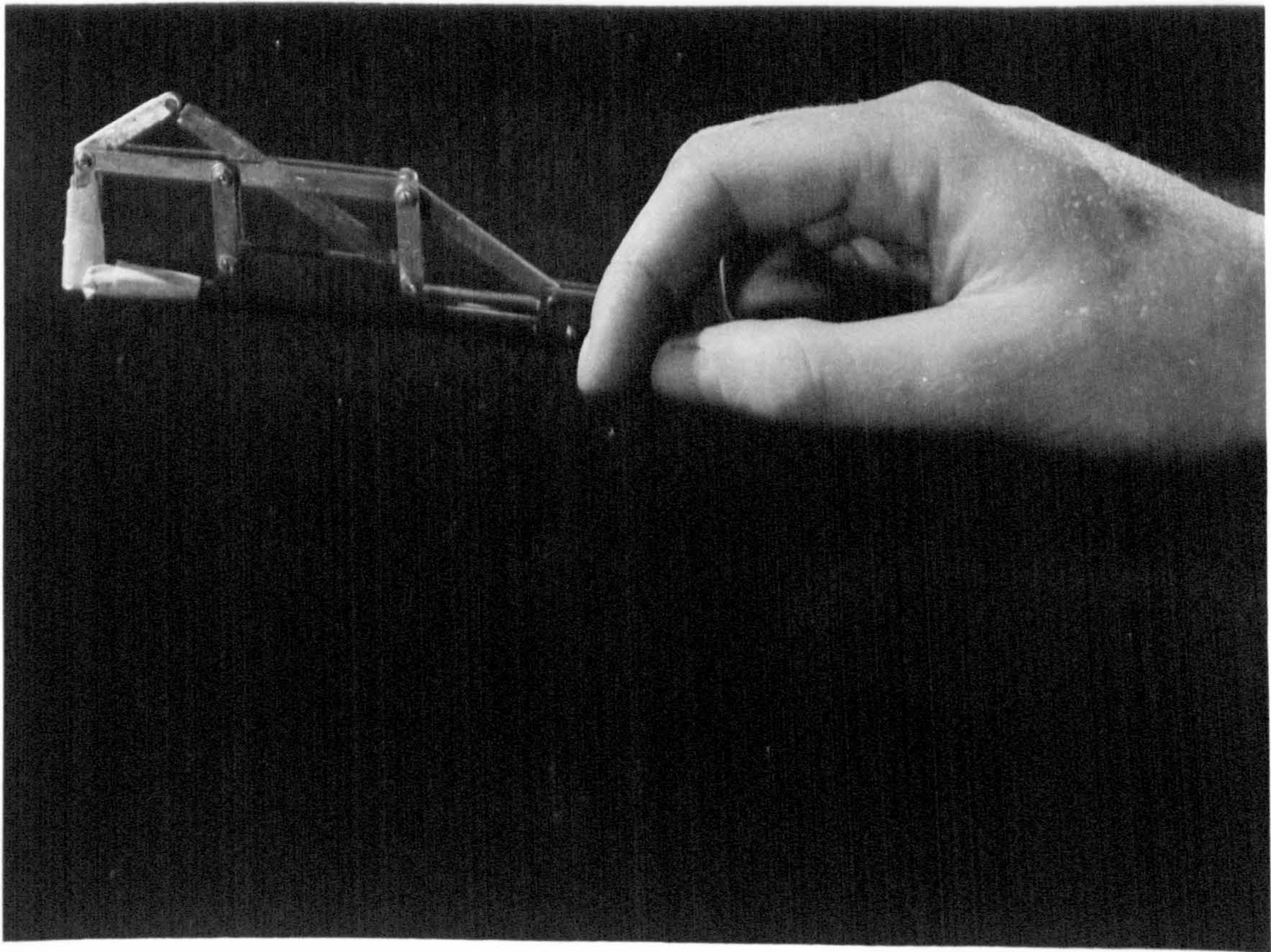

Fig. 2.2

Equivalent position of normal hand and link mechanism, side views.

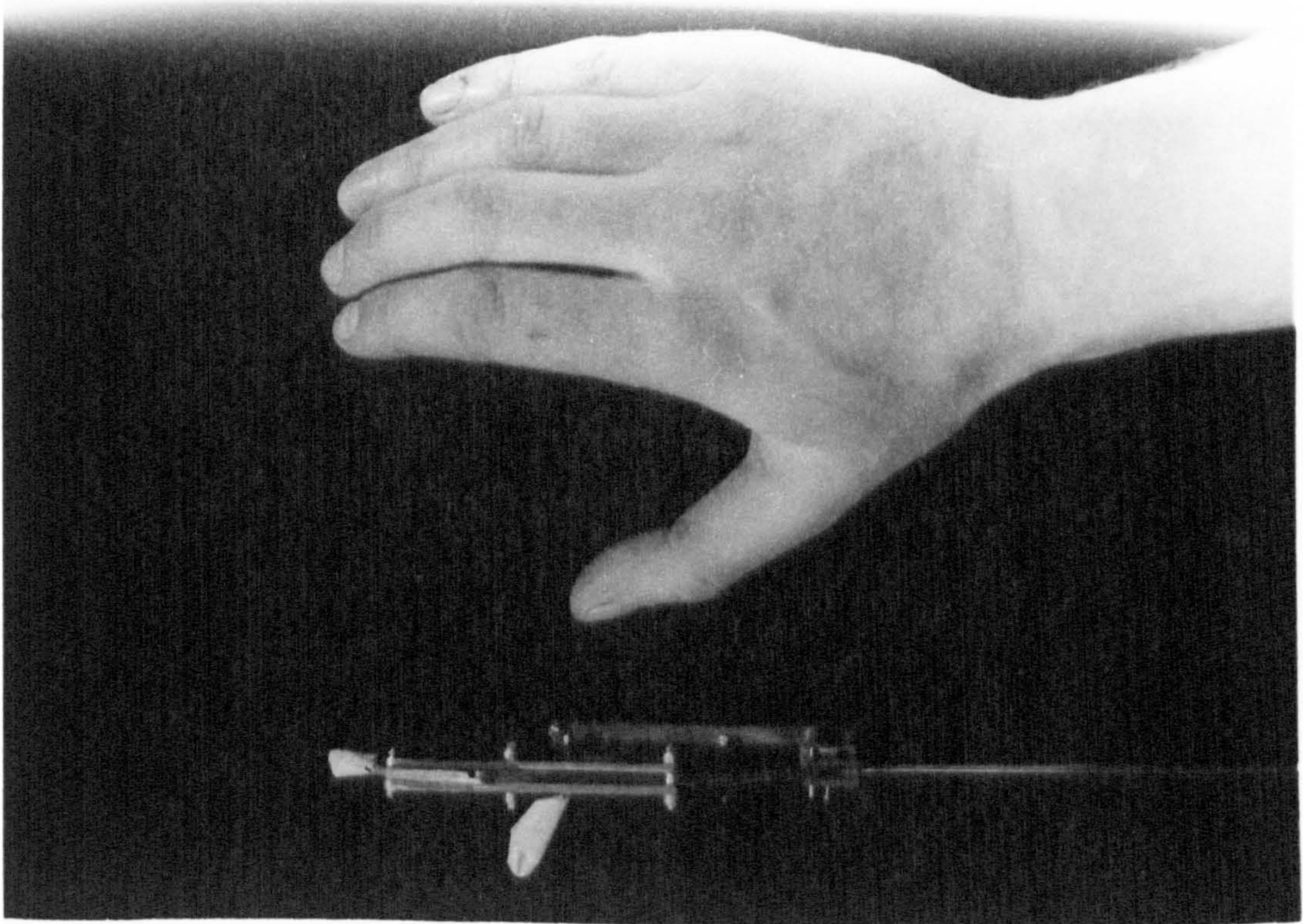

Fig. 2.3

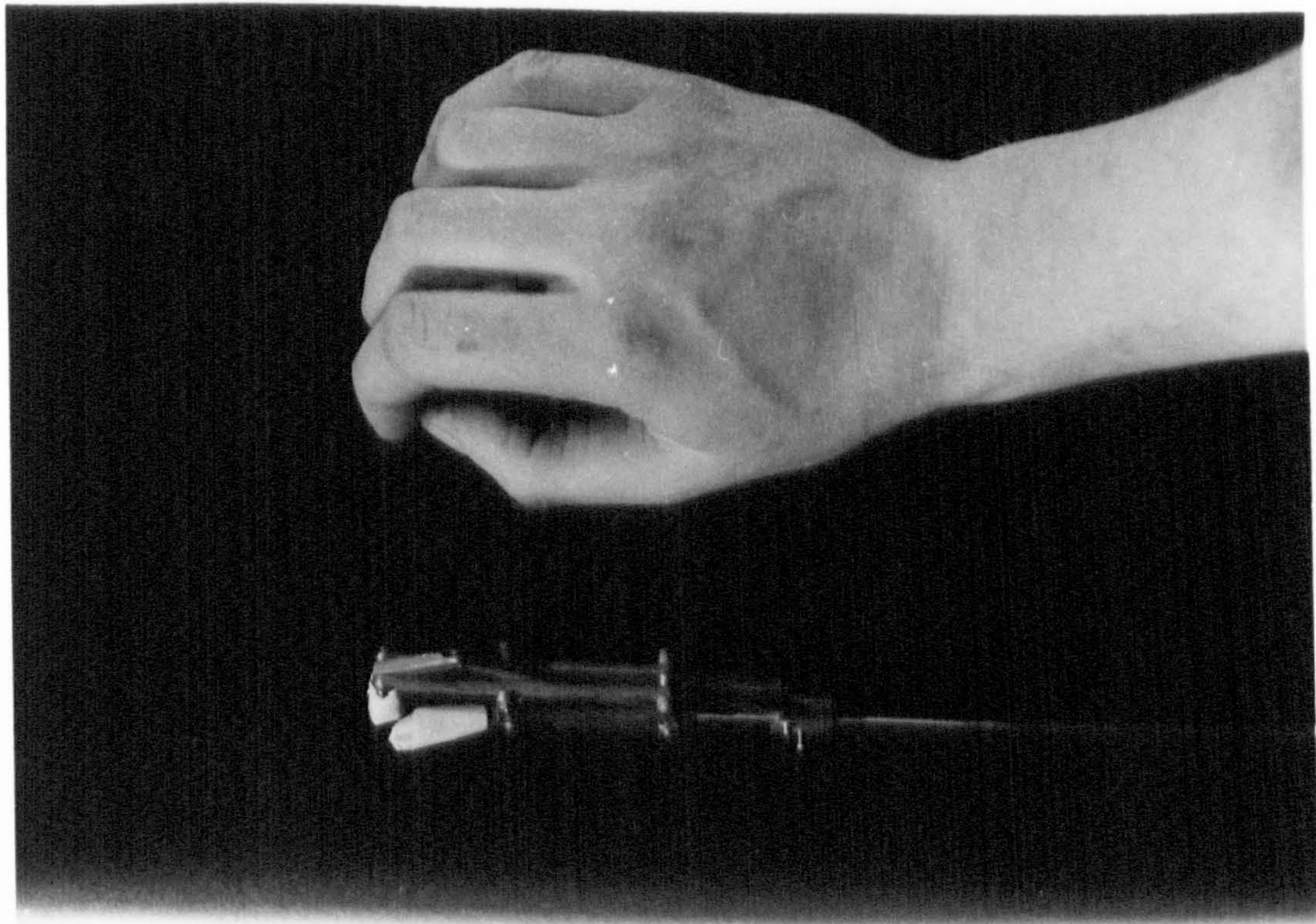

Fig. 2.4

Equivalent positions of normal hand and link mechanism, from above.

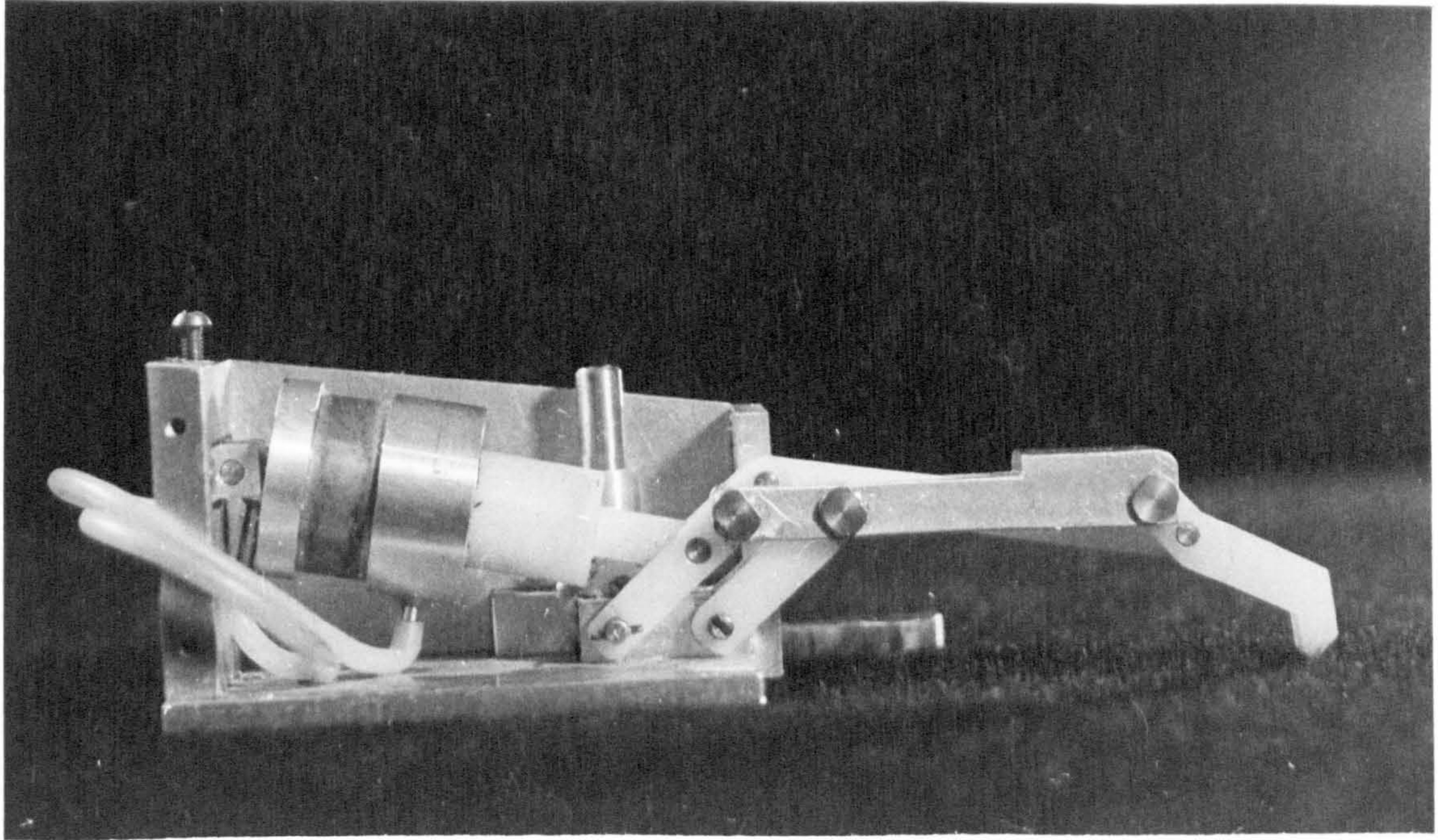

Fig. 2.5

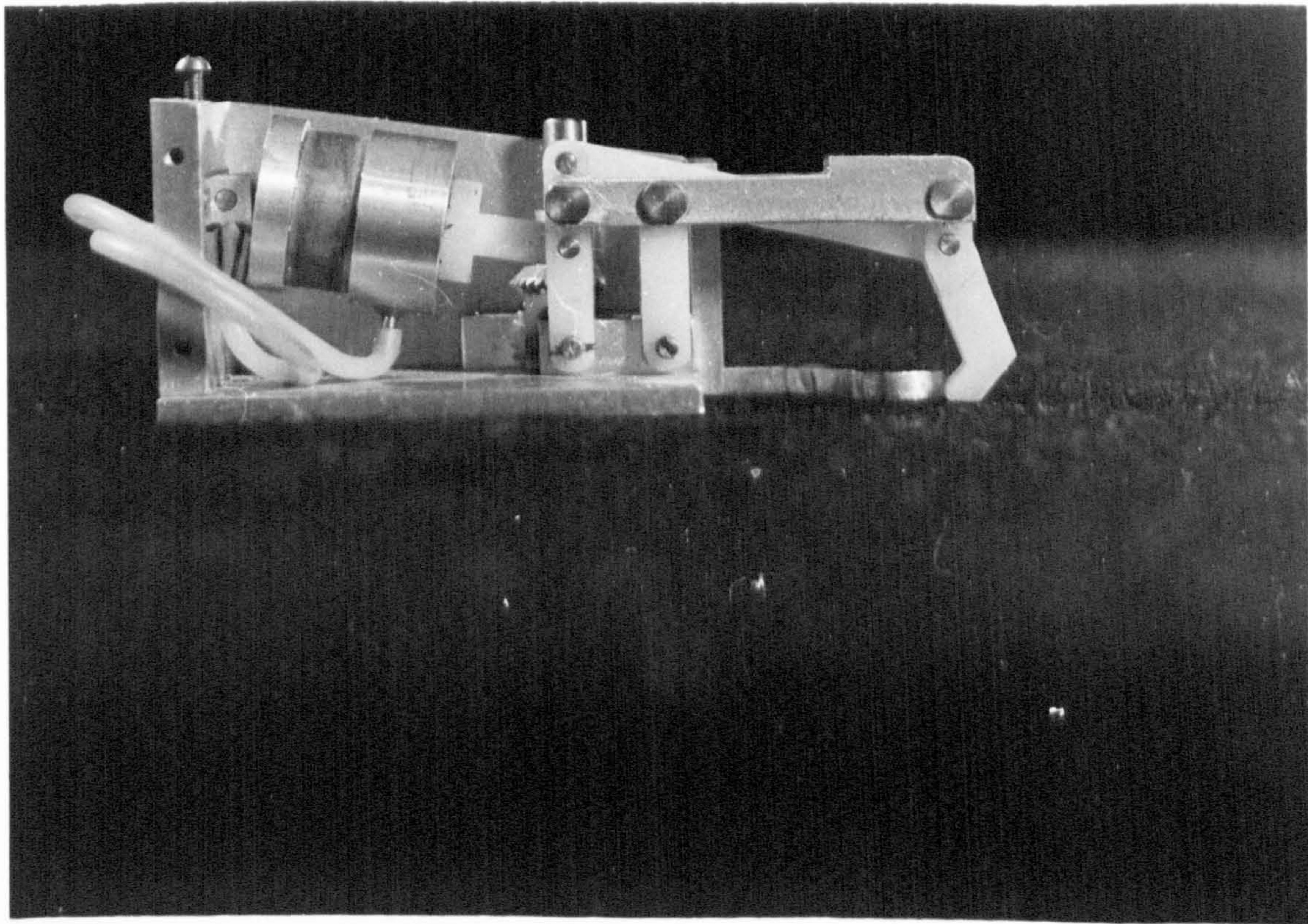

Fig. 2.6

Positions of early mechanism, side view.

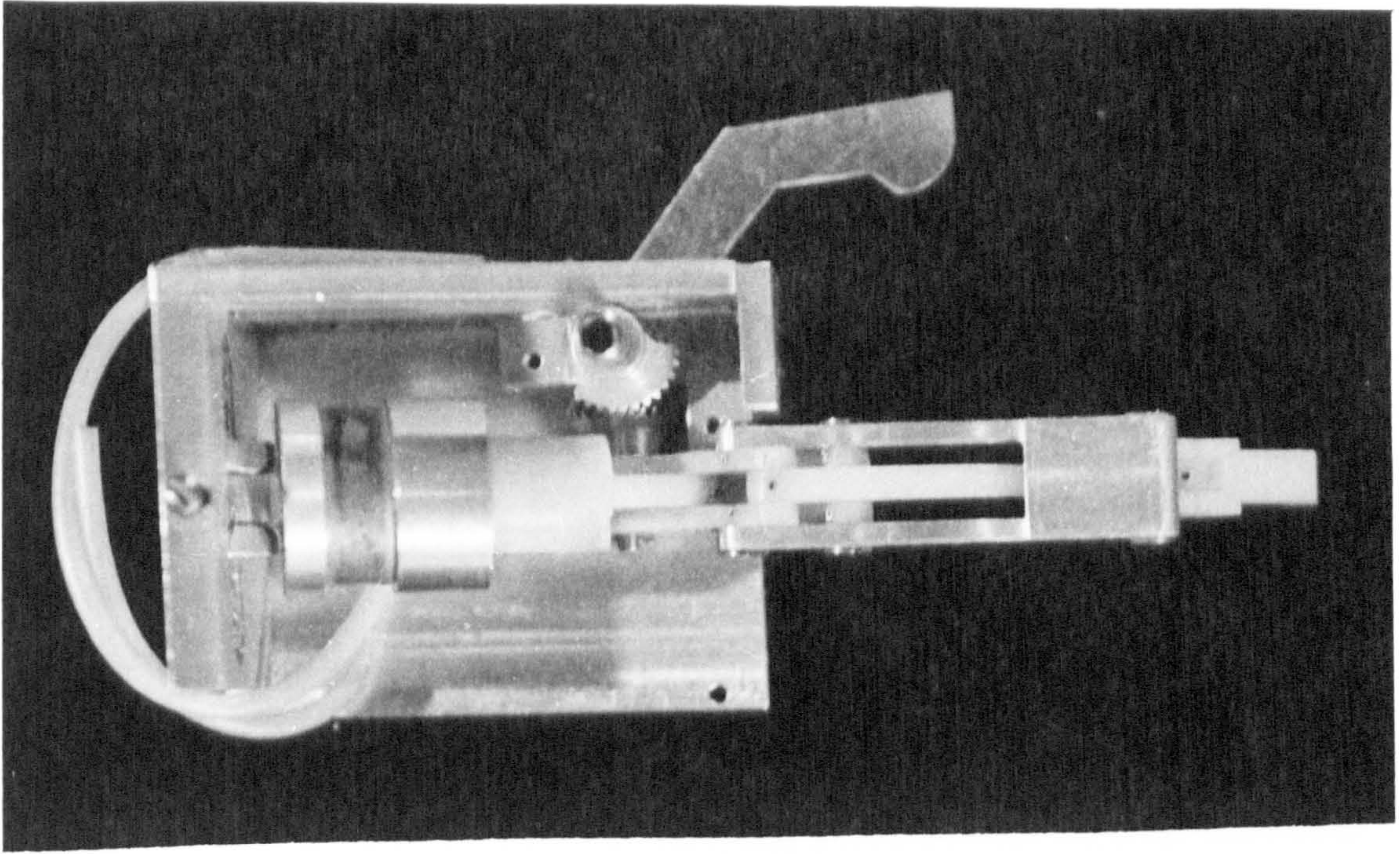

Fig. 2.7

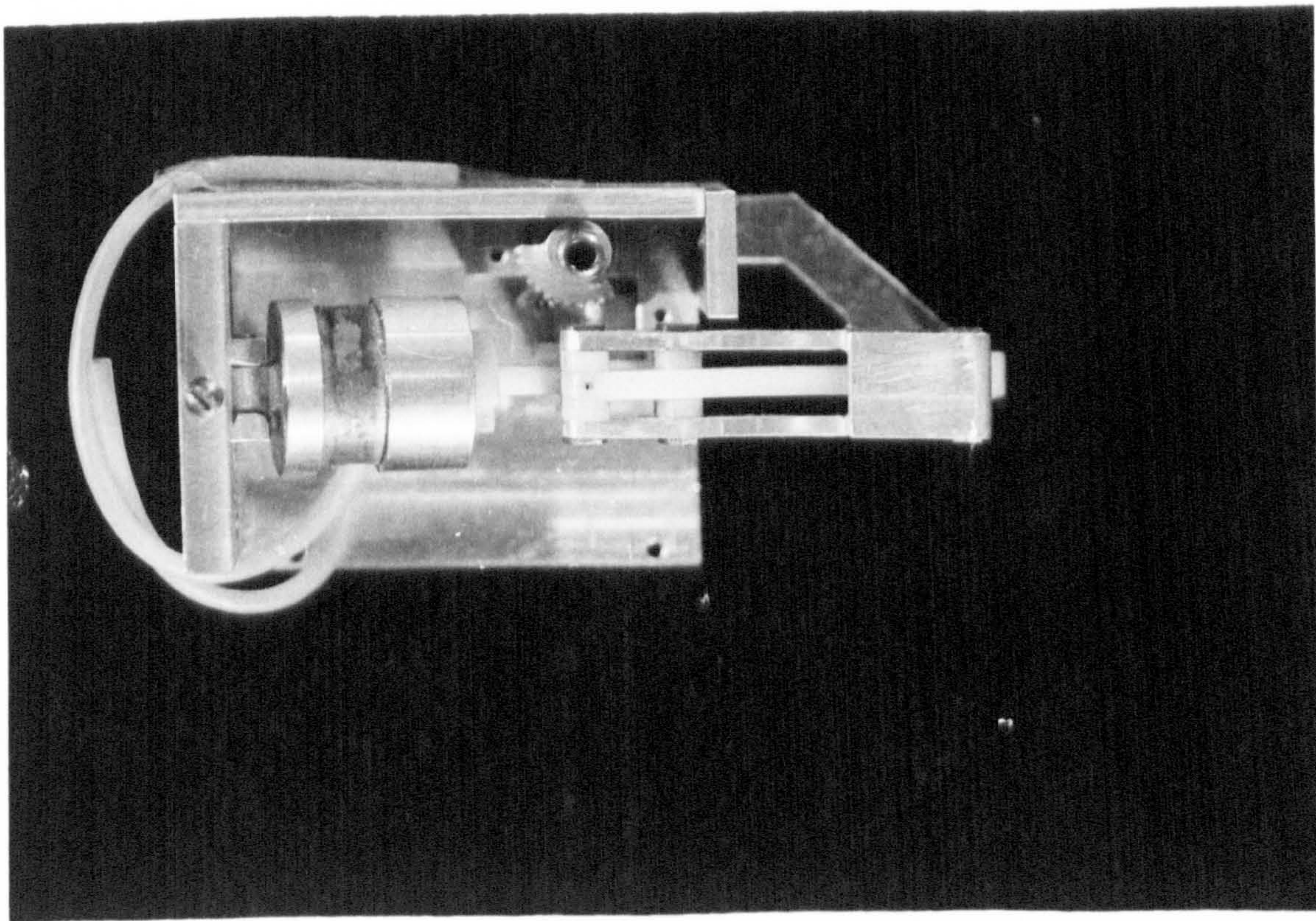

Fig. 2.8

Positions of early mechanism, drom above.

'thumb' motion in synchronism with the 'finger' flexion. The linkages (Fig. 2.9) were designed to create, as closely as possible, a straight line locus for the fingertip, the details of the choice of dimensions of the linkages being determined by scale drawings.

At this stage it was necessary to introduce the power source in order to gain some experience with the device. For compatibility with the arm, this was required to be of a pneumatic nature, and it was necessary to choose between a single acting actuator with a spring return device and the use of a double acting actuator (see control section). In view of the power wastage in working against a spring, with the resulting sluggish operation, the double acting actuator was selected since this permitted the use of a small, faster operating actuator.

Experience in the workshop with this device again showed success in picking up objects from a surface, and considerable success in grasping other objects. Against this, however, there were several serious defects; the overall proportions were anatomically incorrect, the device was fragile and difficult to reassemble, and the large number of pivot points provided a constant source of faults, mainly caused by wear.

2.3 A 'cosmetic' mechanism.

In an attempt to gain experience in producing a device of correct hand shape and proportions, a third mechanism was devised. This device was designed to imitate the movements of a hand moving from flat on the table, into the 'writing' position (Figs. 2.10 and 2.11). In addition, it was necessary to specify that the hand

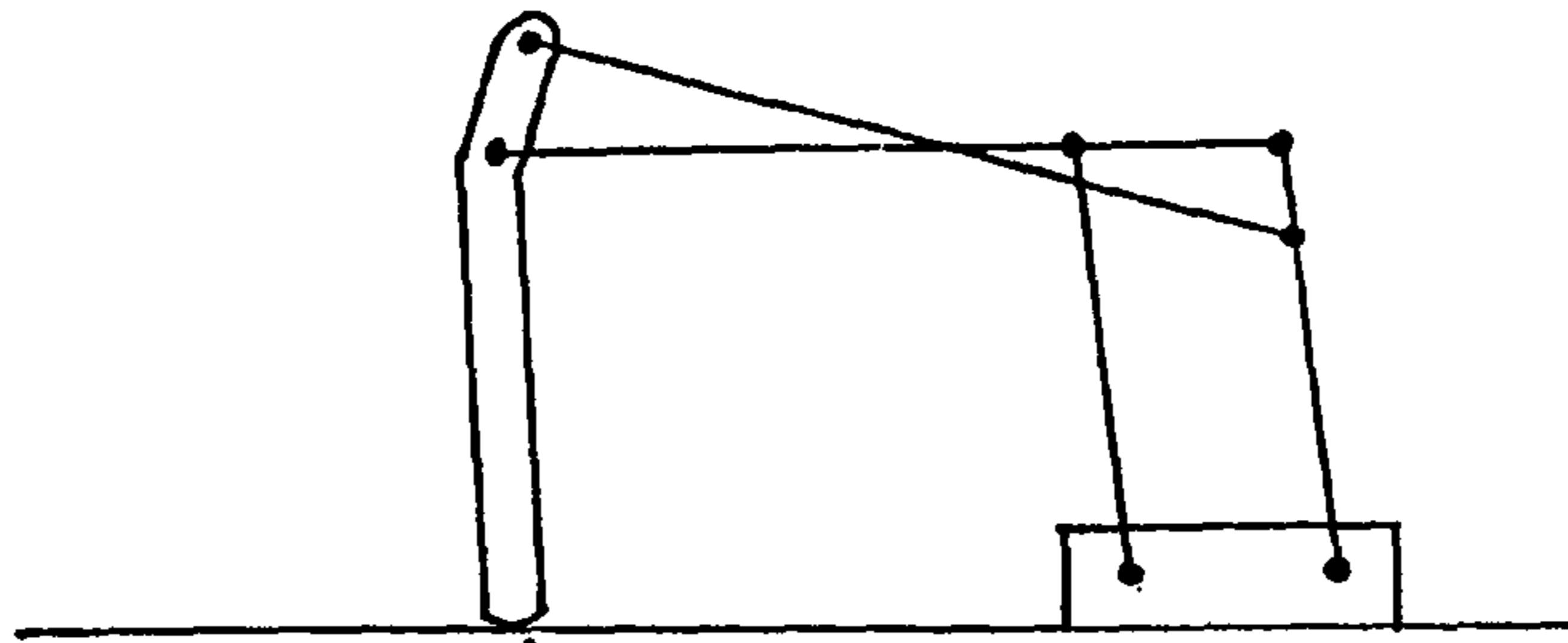

LOCUS OF FINGERTIP APPROXIMATES
TO STRAIGHT LINE

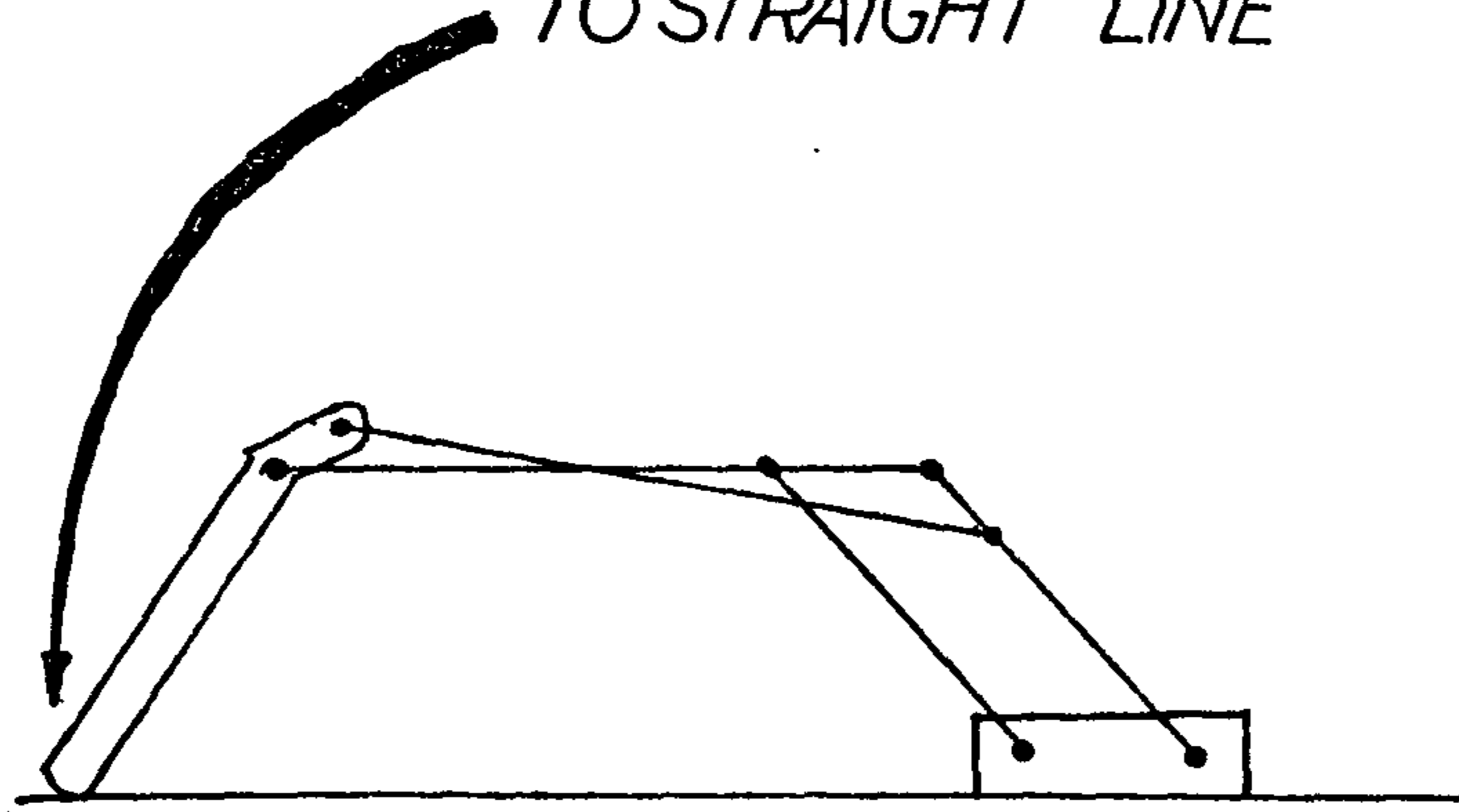

• INDICATES PIVOT

Fig. 2.9

Action of link arrangement.

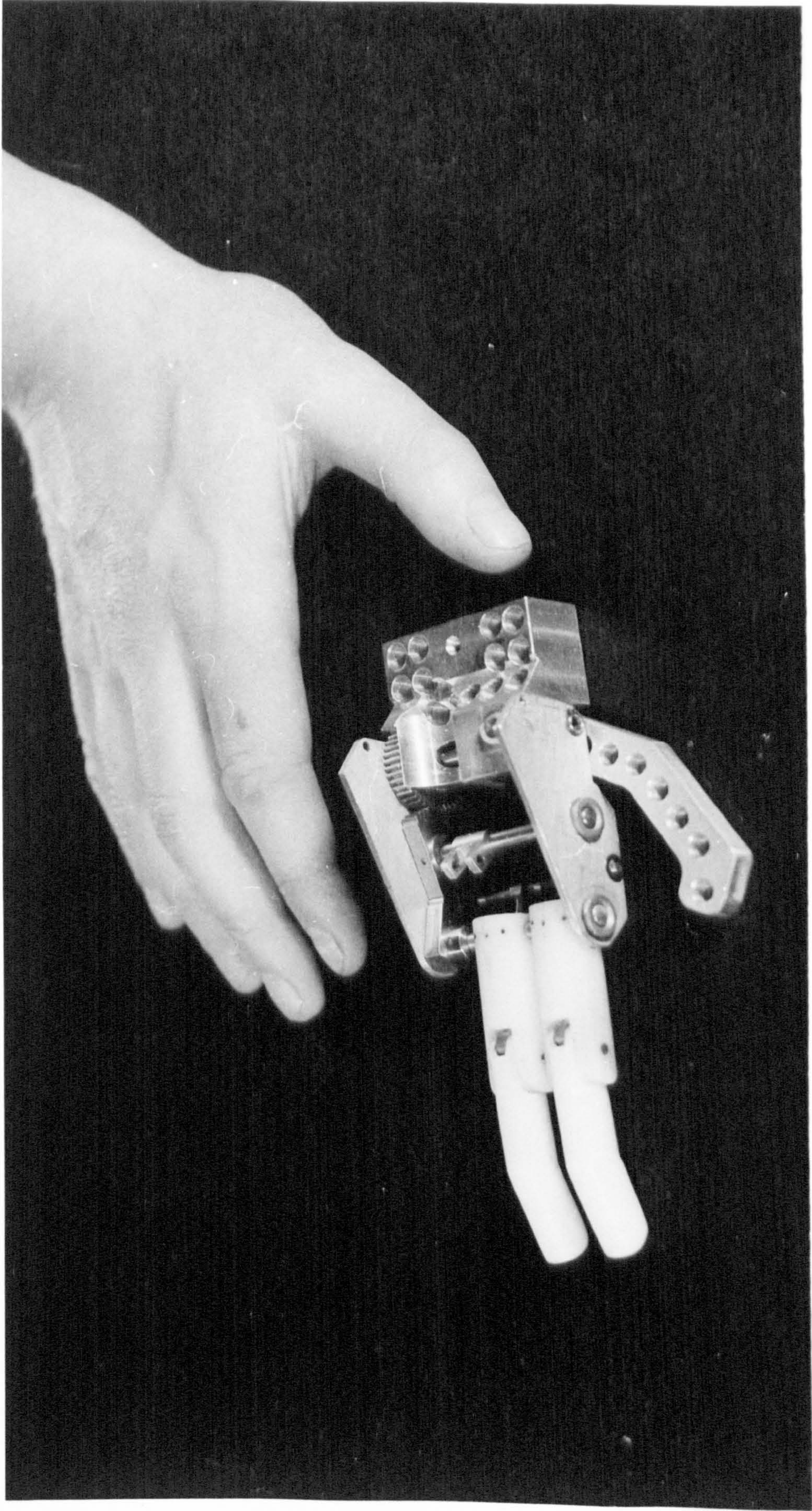

Fig. 2.10

'Cosmetic' mechanism with normal hand, open position.

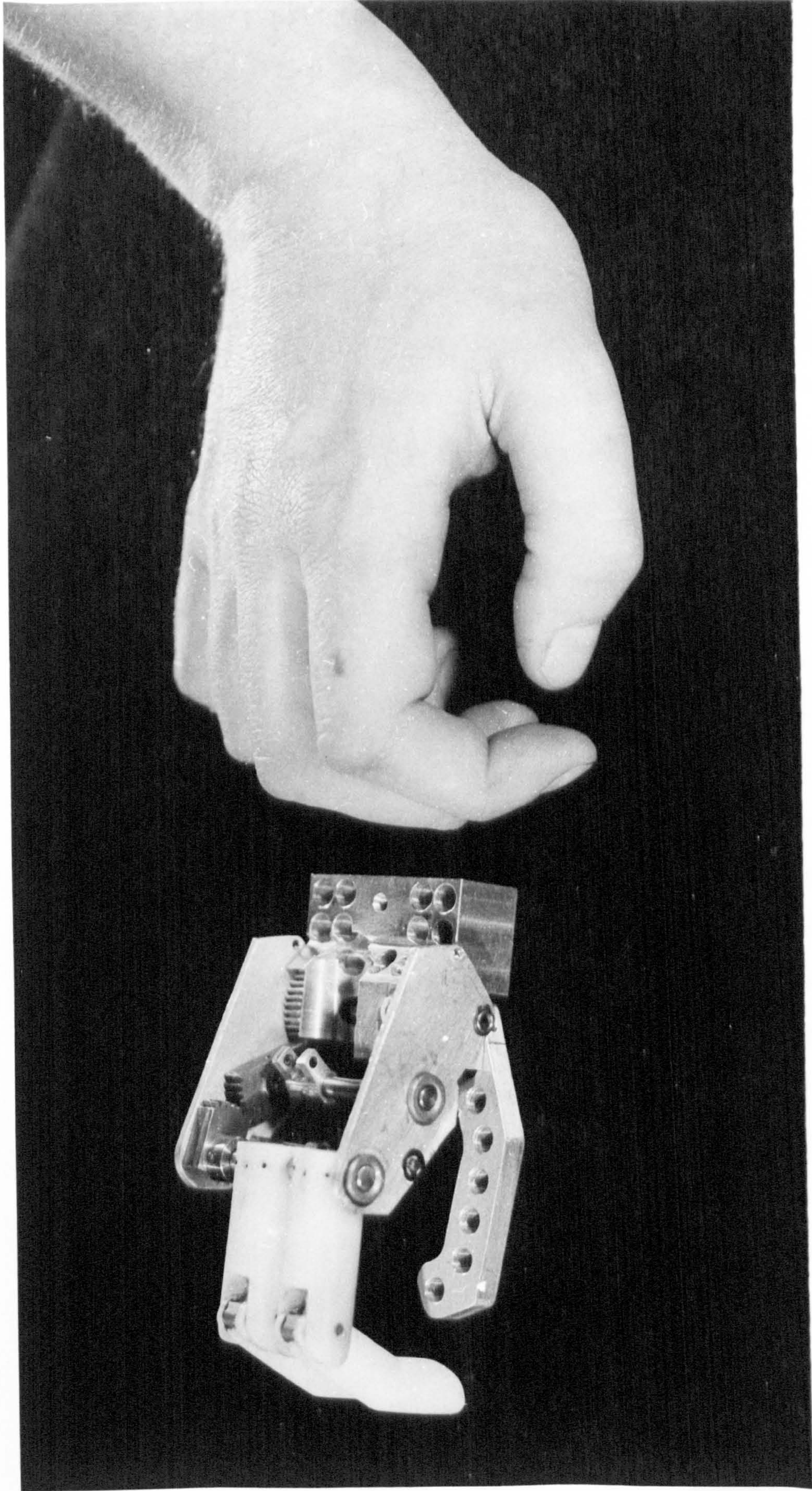

Fig. 2.11

'Cosmetic' mechanism with normal hand, closed position.

should contain its own 'muscles'. No external 'muscle' power was permissible since the alternative would have been to install the muscles in the prosthetic forearm, where space was already at a premium.

The principle of operation of this device was essentially the same as the previous version, except that the parallel linkage part of the mechanism was now equivalent to the palm of a hand. The first and second phalanges were at a fixed angle to one another, manufactured from Delrin, and the tip caused to move on the required locus by a brass rod linked to the proximal inter-phalangeal joint and the palm (Fig. 2.12). The calculation of lever ratios to achieve this effect was essentially the same as for the previous version and the brass link rods were designed to operate within the third phalanges. To achieve the parallelogram linkage effect of the previous version, a gear train was used, since this provided a simple mechanical solution to the problem. (Fig. 2.12). The lower gear was fixed to the 'wrist', the palm acting as the bearing bracket for the other two gears. Rotation of the 'palm' about the centre of gear 1 (gear 1 cannot rotate) causes rotation of gear 2, which in turn caused counter rotation of gear 3 - thus gear 3 maintains a constant angle relative to gear 1, independent of palm angle. Thumb rotation was achieved, as before, via a pair of precision bevel gears linked to the 'palm' movement. Power was provided by a pneumatic piston mounted effectively across the diagonal of the (non-existent) parallelogram. Following the procedure with prosthetic hands elsewhere, this device was provided with only two active fingers.

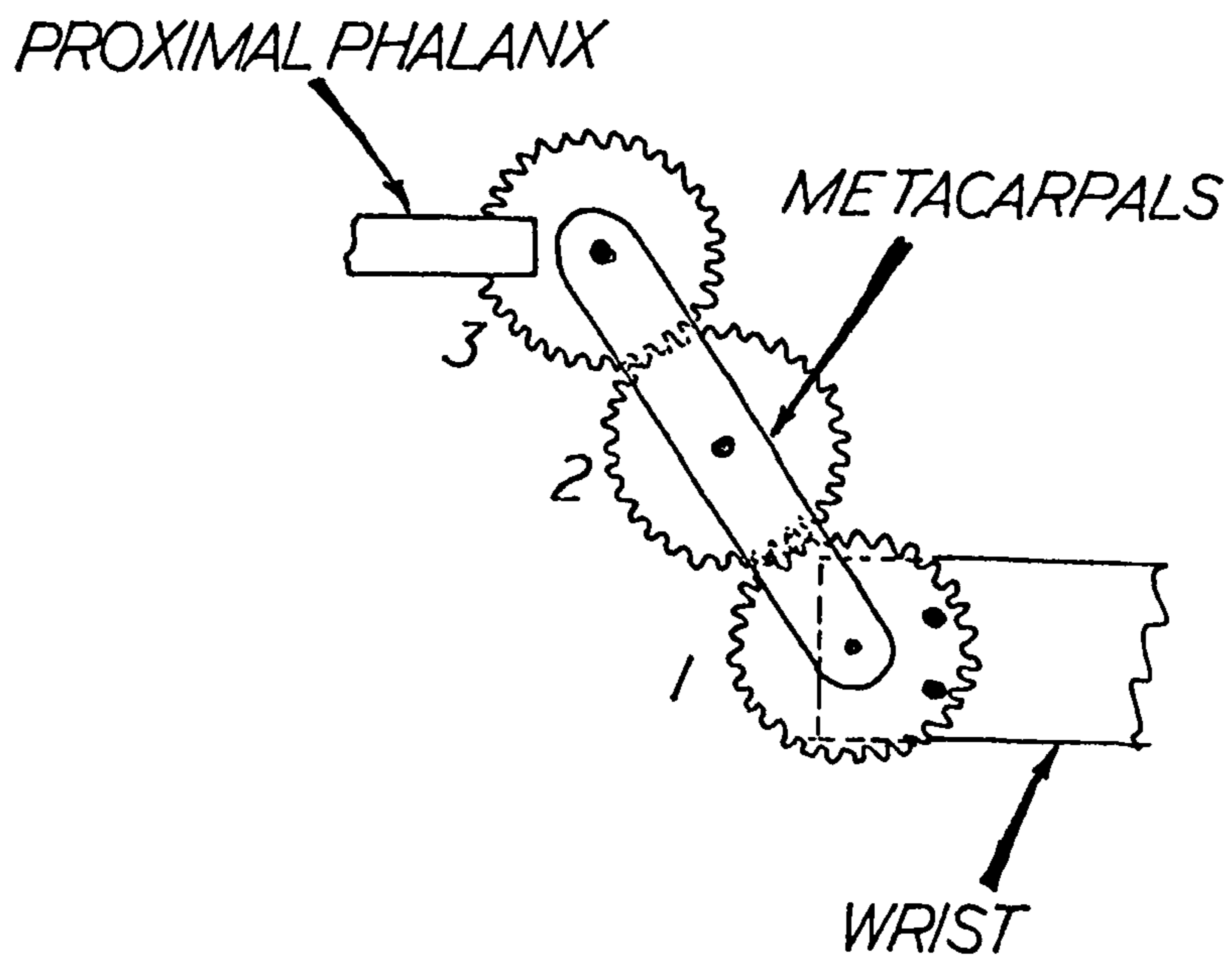
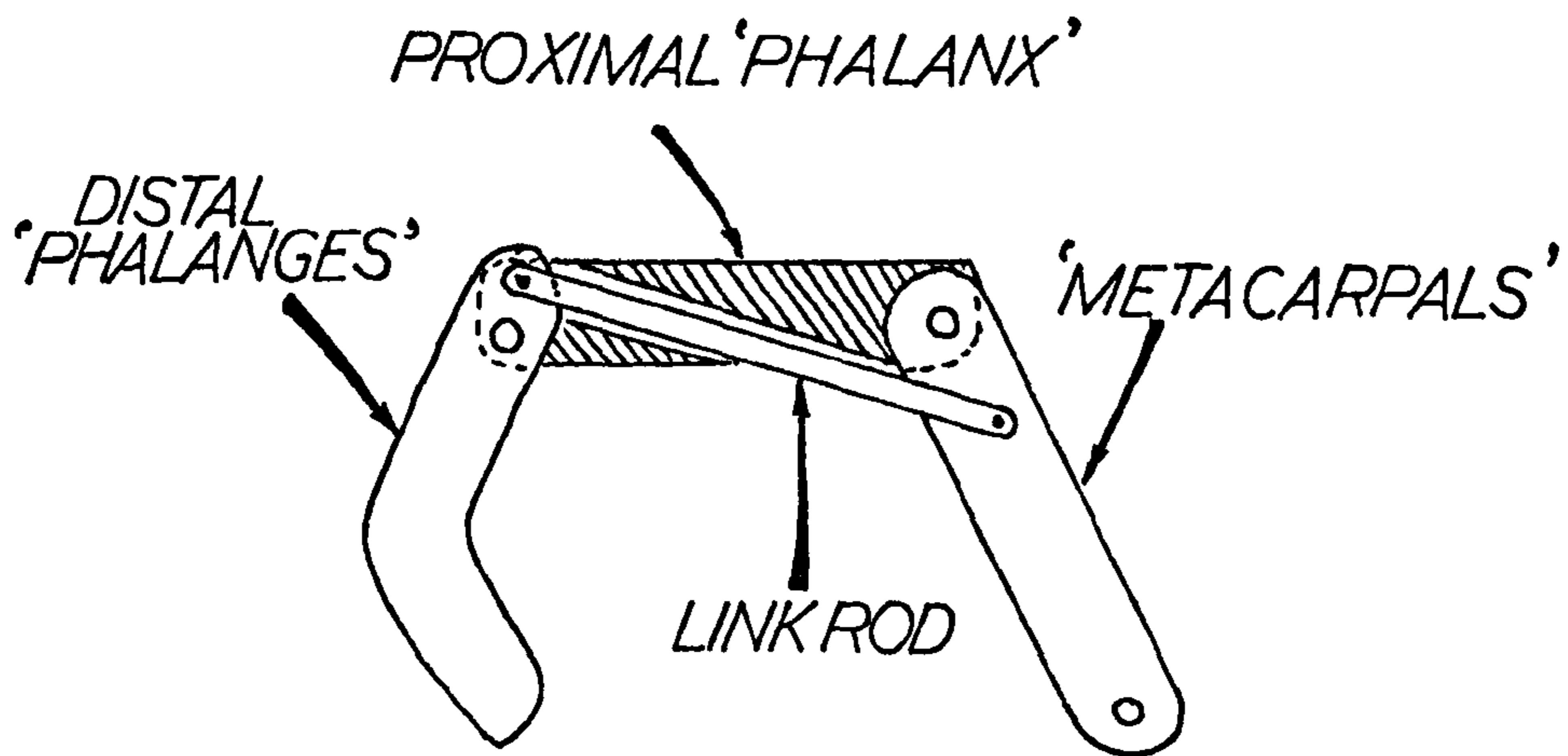

Fig. 2.12

'Cosmetic' mechanism, finger linkage and metacarpal arrangement.

2.4 Results with the 'cosmetic' mechanism.

In action in the workshop, this hand was very realistic in its movement, but proved to be poor functionally. In part this was due to incorrect profiling of finger and thumb parts, together with other factors which were noticed later. The most significant fault, however, was a very noticeable lack of power at the fingertips - a phenomenon which also had been noticed in the previous version. Admittedly, the piston could not be mounted in the most effective mode, but the major fault lay with the leverage at the proximal inter-phalangeal joint. To arrive at the correct anatomical configuration it had been necessary to maintain the brass link rod within the section diameter of the proximal phalanx, creating a small radius-arm about the pivot at this joint. The length of the distal phalangeal section created a 1:8 lever for this part of the mechanism, in the wrong sense - thereby creating a very low pinch force at the fingertips. In addition to this, the jointed fingers were very prone to exaggerate machining errors or wear, manifested as a lateral wobble or instability at the fingertips.

2.5 The practical implications of using active fingers.

At this stage in the programme it seemed necessary to consider ways of increasing the gripping force at the fingertips. The problem of available torque encountered in the devices mentioned above is unavoidable in any system which has flexing fingers and the dimensions of the fingers themselves limit the available torque for any given input force, since the radius arm on which the force may operate can hardly exceed 10cm. The other approach considered was that of increasing the input force in order to compensate for

the unfavourable lever conditions, although it was necessary to bear in mind the fact that the increased forces required corresponding increases in the strength and wear resistance properties of the finger joints. The simplest way of increasing the available force would have been to increase the size of the pneumatic piston actuator or the operating pressure. However, the former was impossible on the grounds of the physical size necessary to achieve a significant force increase and the latter unacceptable on safety grounds. It is generally understood that a pinch force of 15 lbs at the fingertips is a reasonable design criterion, (Peizer 1969), however, for reasons which will follow, the figure of 5 lbs was taken as the design requirement for the production hand. Considering for a moment the conditions which prevailed in the mechanism described above, with an 8:1 lever ratio on the finger, the input requirement would have been 10 lb. ins. at the knuckle, i.e. a thrust of 40 lbs directly along the brass link rod. Thus, unless a number 11 thrust piston were acting directly in line with the third phalanx (such a condition being impossible cosmetically), it would have been necessary to select a piston more than 25mm in diameter to achieve the desired effect, considering the inefficient angle at which the piston has to operate in order to preserve shape. Since the number 11 size piston was too large to incorporate in the finger itself, and the larger sizes too large to install in the palm, an alternative activation mechanism had to be found. A possibility was the incorporation of a gear rack operated by a number 11 piston, turning one of the chain of 3 spur gears as the pinion (Fig. 2.12); but even this would have increased the thickness

of the palm considerably. The possibility of hydraulic power was considered with its associated higher pressures and forces produced by smaller actuators but this form of power when used in prostheses creates problems when any leaks occur; hydraulic fluids often cause dermatoses, quite apart from the mess they create. Therefore this was regarded as a last resort, to be tried only if absolutely necessary.

2.6 Indications for alternatives for the use of mobile fingers.

All these schemes were aimed at dodging an unavoidable fact - mobile fingers just need very strong muscles, and it soon became apparent that perhaps more attention should be directed elsewhere.

In particular, the importance of the phase relationship between thumb and fingers became apparent during workshop evaluation experiments with picking up various objects using the prosthesis.

These experiments showed that whilst the lateral opposition of the thumb appeared advantageous, the action of the fingers was improved if their closing was expedited to permit the thumb to close laterally on the fingers (Fig. 2.13). In other words, in the final stages of closing the grip the thumb should be doing the active gripping, against the static platform of the fingers. Furthermore, if the distal phalanx of the thumb were articulated, the effective grip would be widened considerably and, in addition, a stable three point grip would be established between thumb and two fingertips.

This experimental result showed that in the final stages of closing the grip on small objects, a stable grasp could be achieved relatively simply. However, the same situation could not prevail for

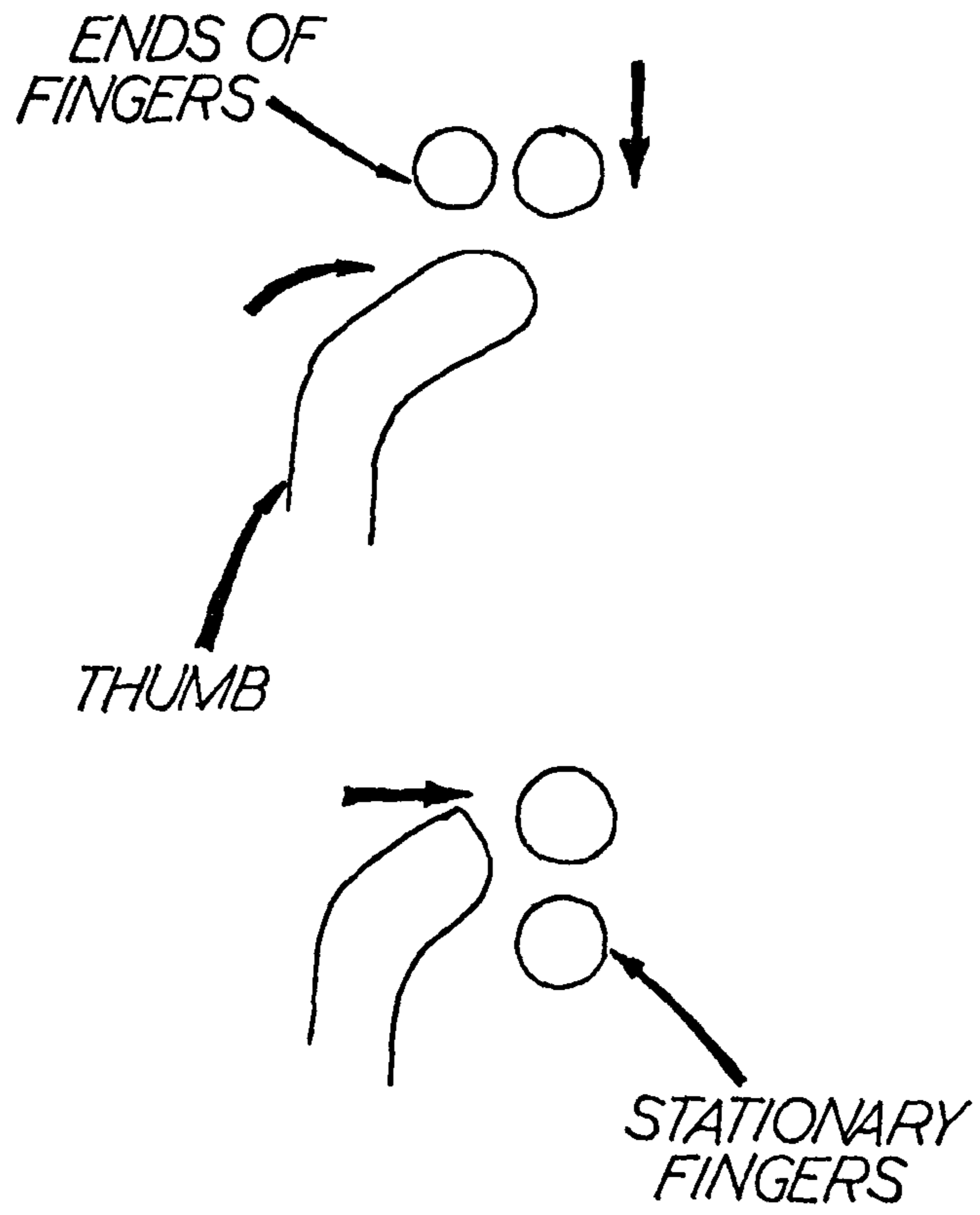

Fig. 2.13

Relative phasing of finger and thumb movements.

wider grips unless the phase relationship was correct for all openings of the grip.

One way in which this could be achieved quite simply was to adopt one of the guidelines resulting from the X-ray experiments - to use stationary fingers for the whole range of the grasp, with the position of the fingers to be optimised for further experiment.

2.7 A mechanism with stationary fingers.

Thus, the initial attempt using this principle was made by adopting stationary fingers positioned approximately as they would be for gripping a pencil, and using an active thumb, articulated at the end to allow accommodation of large objects, while adopting the correct position opposite the fingers when the grip was closed. The construction of this device was exceedingly simple; basically a rigid hand shape, apart from a mobile thumb. The result was as shown in Fig. 2.14, actuation being pneumatic as in previous cases.

The results with this mechanism were extremely significant since small objects could be picked up and gripped satisfactorily, pencils tended to be stabilised by touching the third phalanx on the first finger, and large objects tended to be stabilised across the rigid fingers (Figs. 2.15, 2.16 and 2.17).

2.8 The improvements of gripping surfaces.

At this stage it was decided to incorporate a device to facilitate gripping (Simpson 1971). This idea is an attempt to emulate the adaptive characteristics of human skin and flesh. When any relatively hard object is gripped by a normal hand the flesh deforms beneath the skin to accommodate the shape of the object - until the volume of the skin 'bag' has been decreased to that of

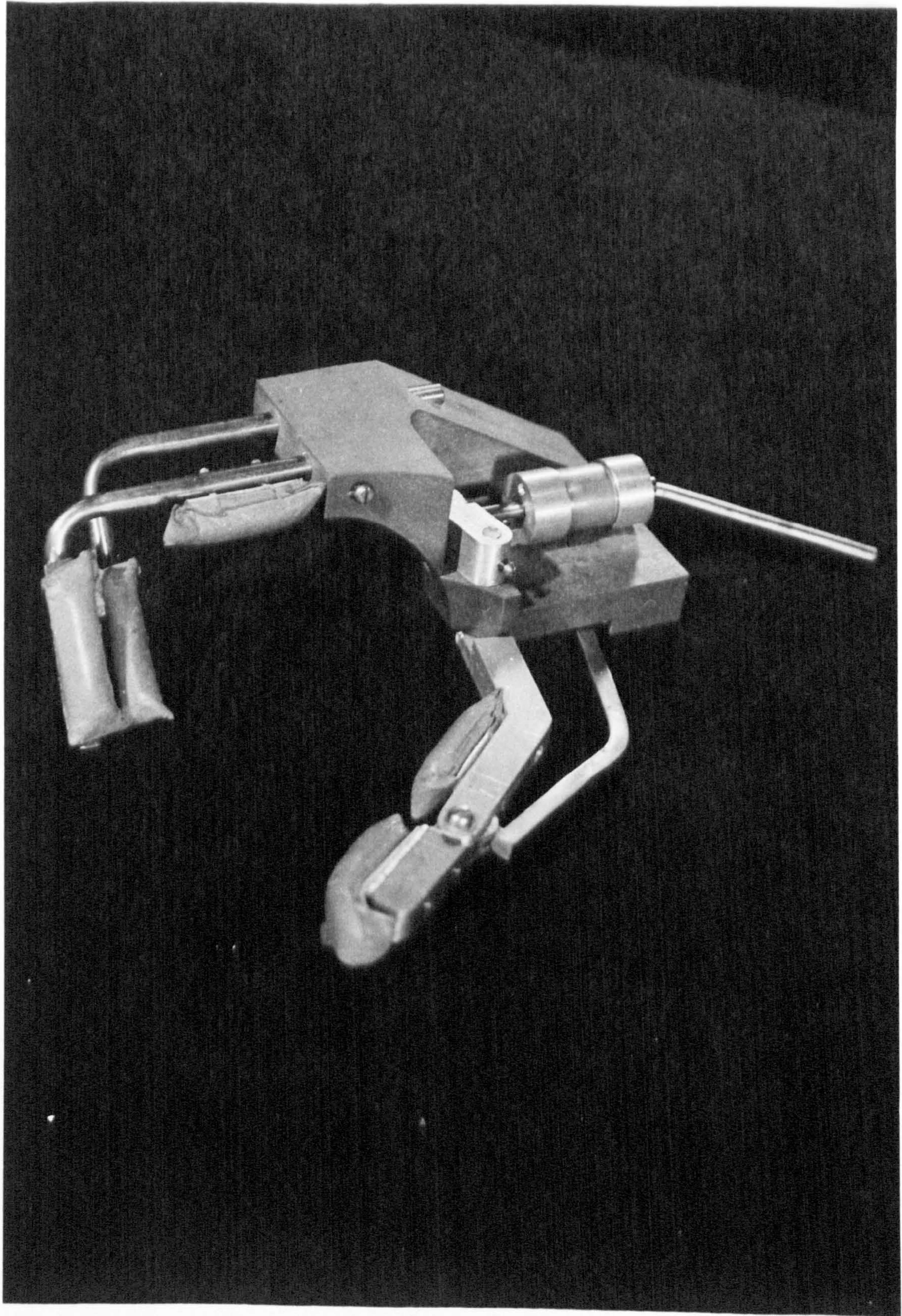

Fig. 2.14

Prototype hand with stationary fingers.

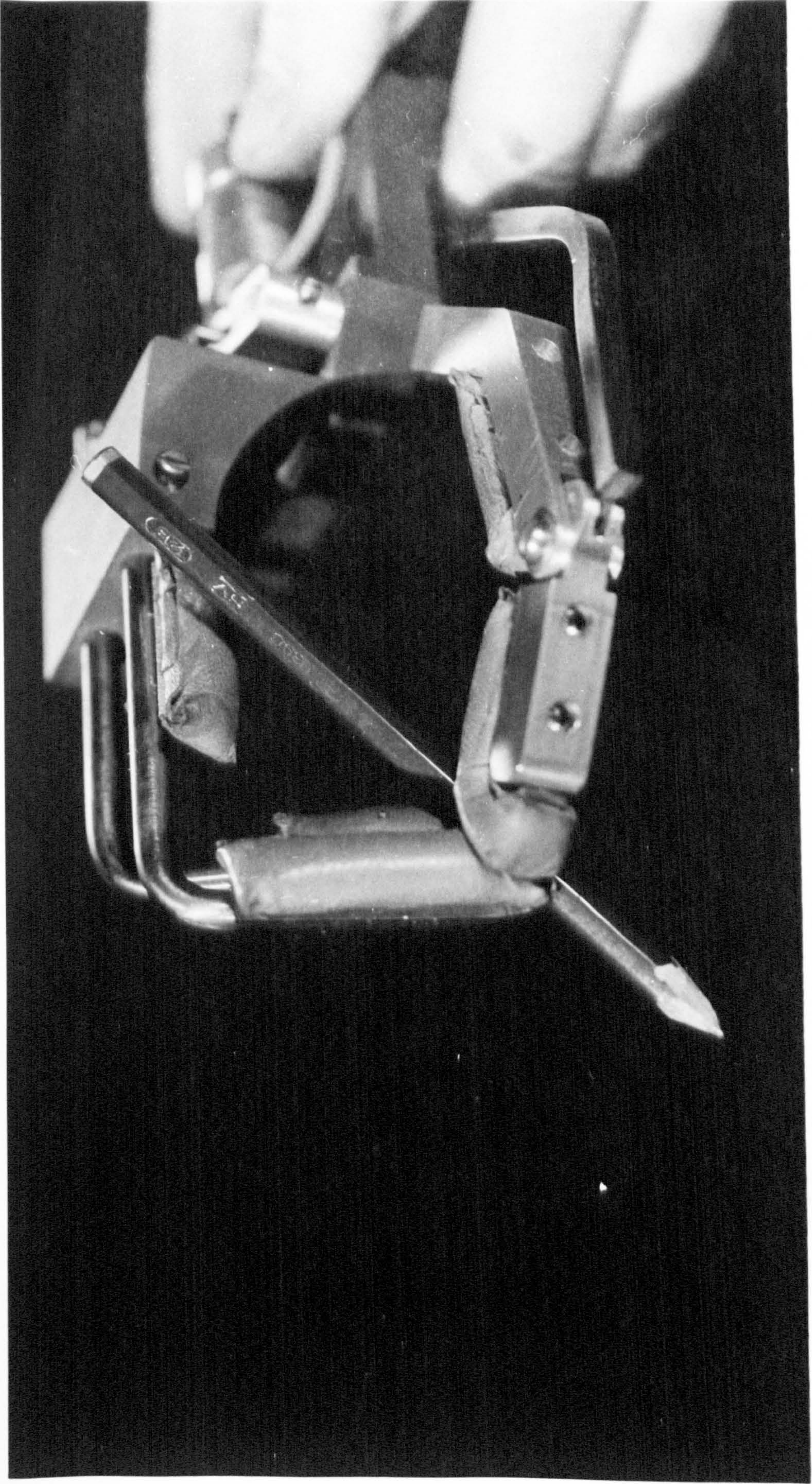

Fig. 2.15

Prototype gripping pencil.

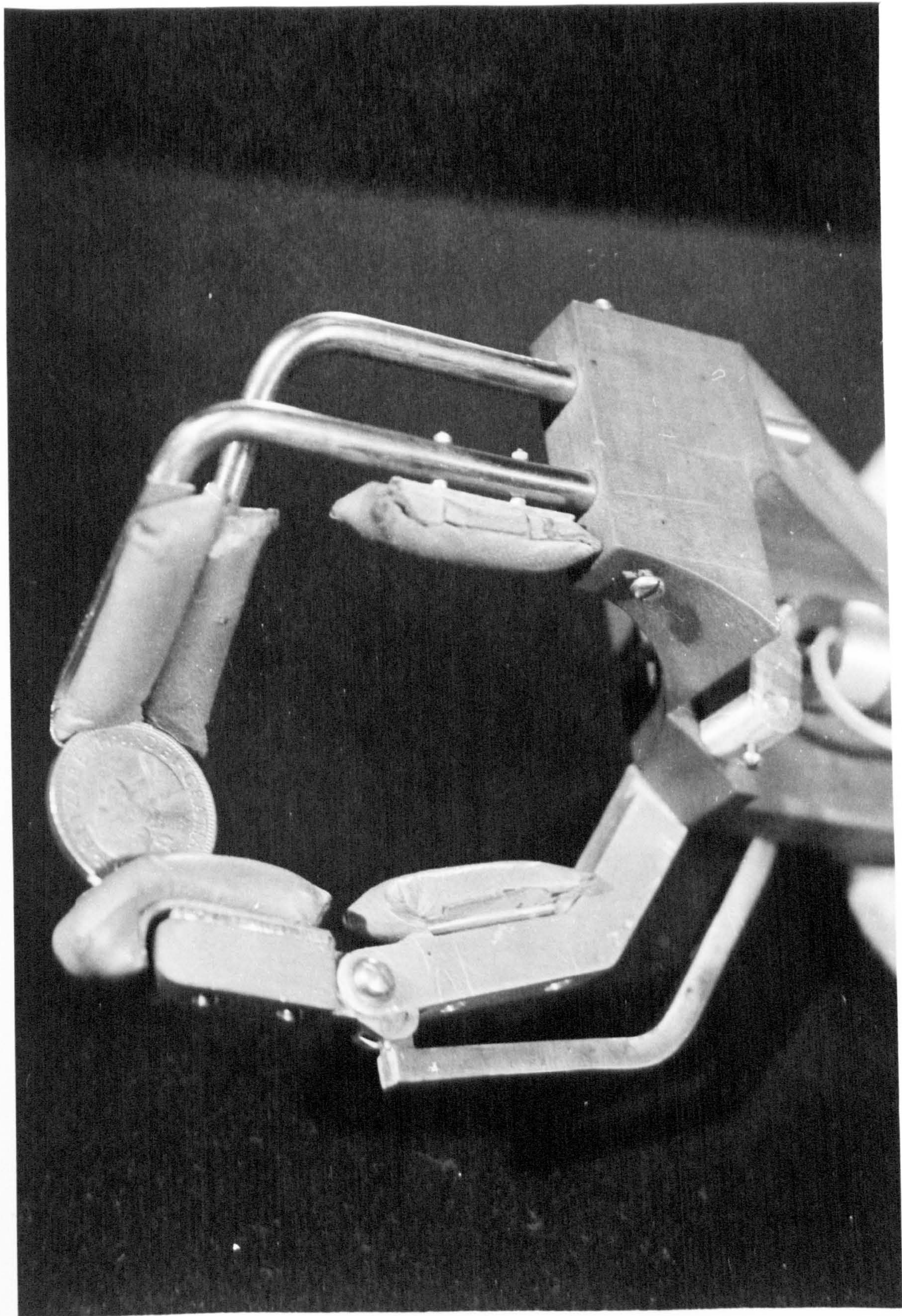

Fig. 2.16

Prototype gripping coin.

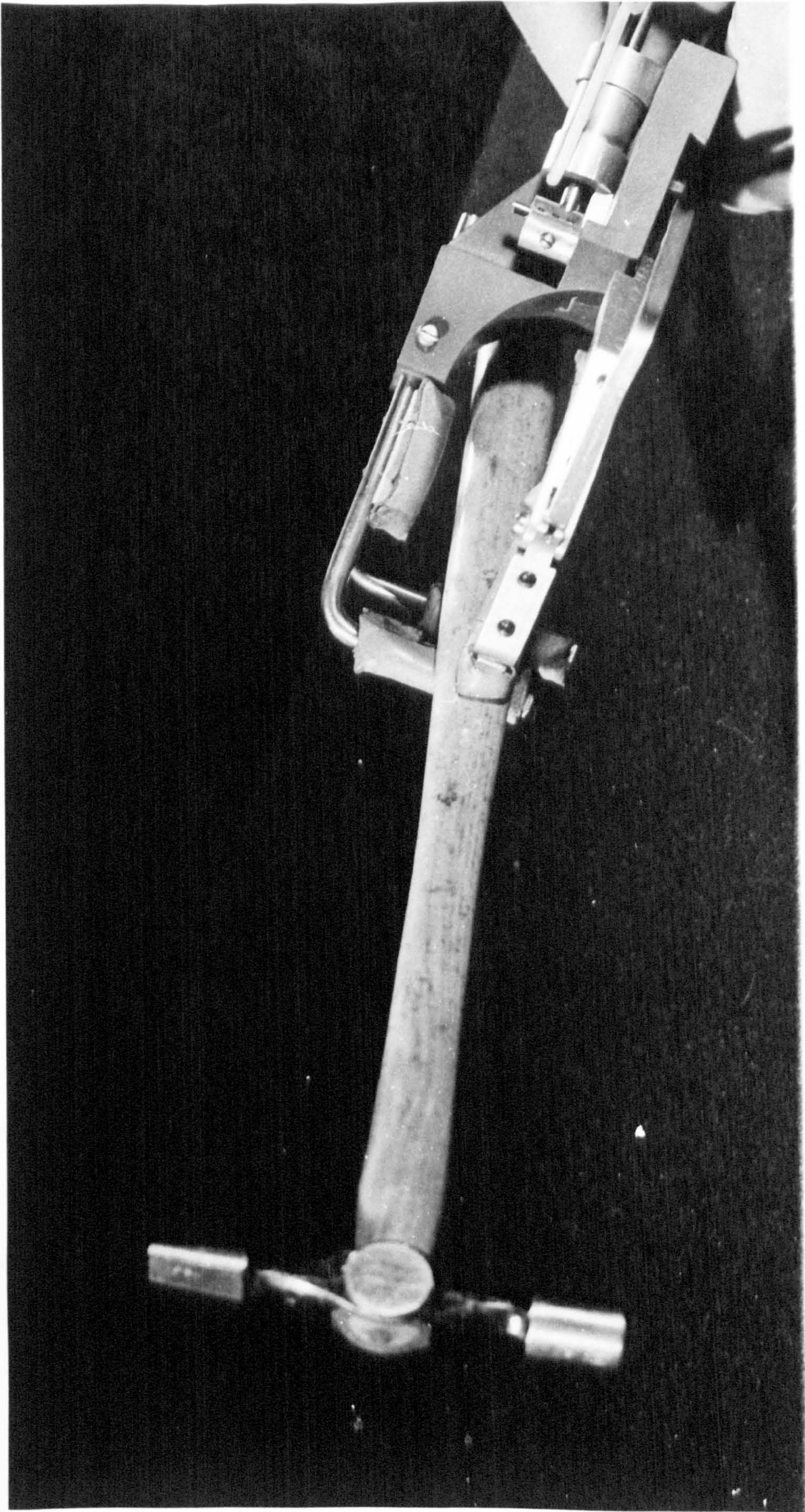

Fig. 2.17
Prototype gripping hammer.

the 'compressed flesh' volume and at this point the system tends to become solid. A simple analogy is a cellophane bag of rice, quite loose and soft until an indentation is made, when the whole bag and contents become relatively hard. This effect can be achieved for use in an artificial hand by loosely containing salt, sand, or any suitable small grain powder, in a non-stretch sac of leather (Fig. 2.15). In practice it was found that the simplest method of construction for experimental purposes was to encapsulate sand in a stretchy latex bag, which was then enclosed in a non-stretch cover of thin leather. Bags of this type provide an automatically resetting self-adaptive grip, which is merely remoulded to a new shape when the next object is gripped.

5.9 Results with the simplified mechanism.

The powder grip bags were attached to the simple mechanism mentioned above, as shown in Fig. 2.15, 2.16 and 2.17. The improvement in function was most impressive, even to the extent of allowing the gripping of a hammer, stabilised against the forefinger sufficiently to drive in a nail, as well as gripping smaller objects easily.

The success of this type of device may be largely attributed to its simplicity of construction. The choice of rigid fingers allowed the adoption of an efficient shape, without any modifications demanded by the engineering requirements for a mobile mechanism. In addition, the rigid finger configuration avoids the instabilities which have been observed in so many hands with jointed fingers (e.g. Arexina and Groth 1964). The articulated thumb movement may be regarded with the same scepticism as the fingers in previous

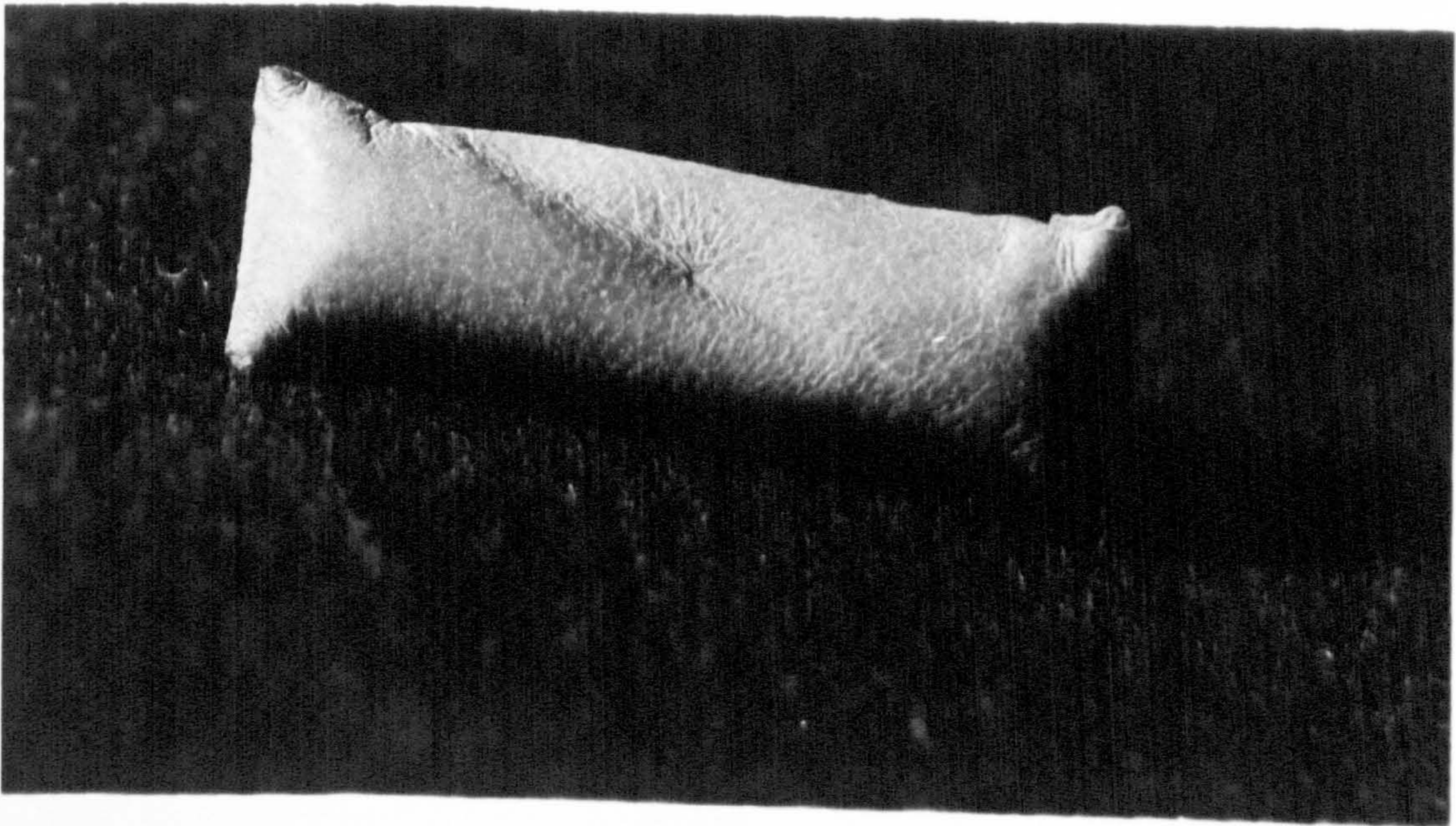
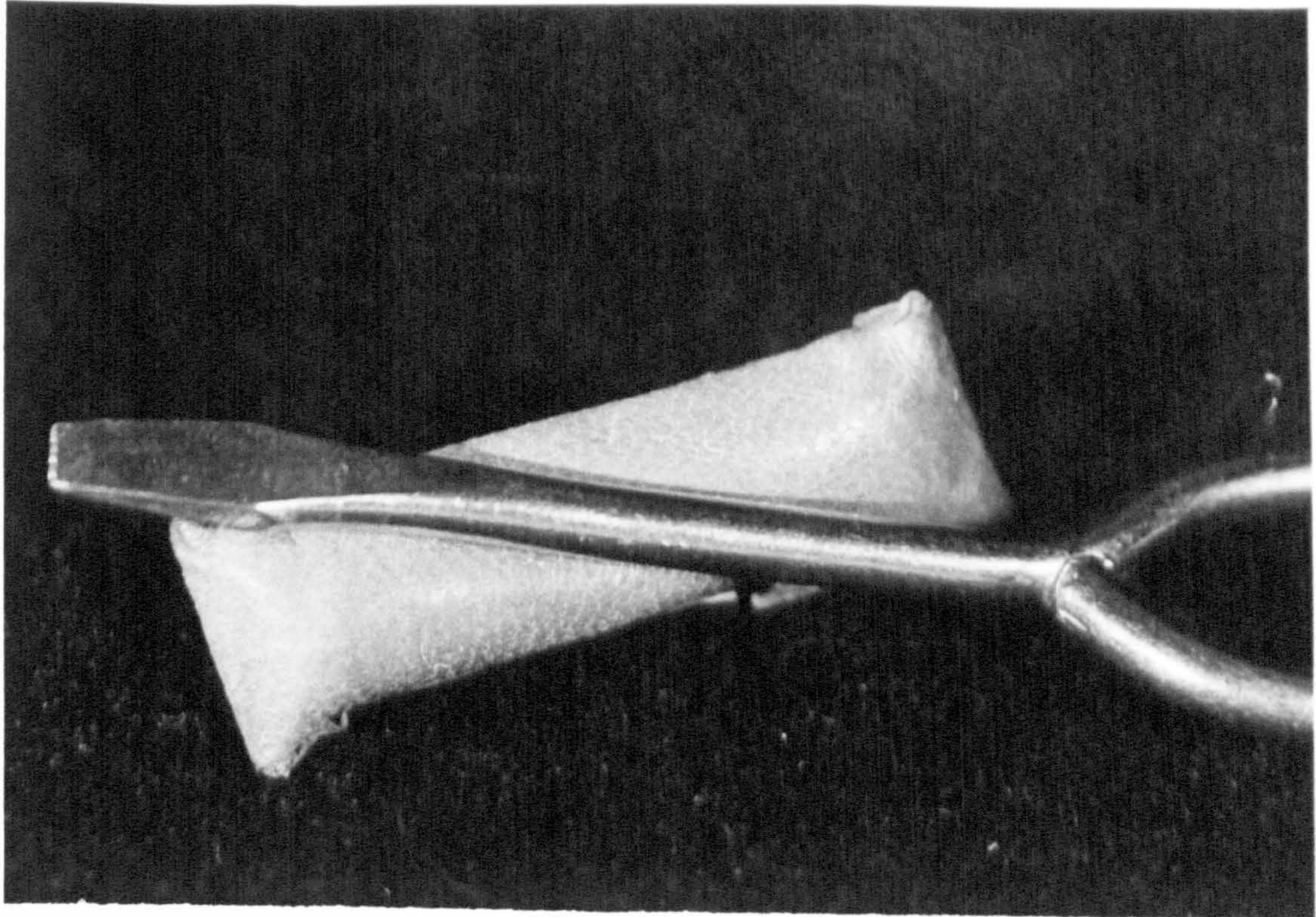

Fig. 2.18

Powder grip sacs.

models, however, the number of joints has been reduced from five to two, and the torque output at the end of the thumb is 60 per cent of that applied to the device as is shown in Appendix I.

This loss of force by virtue of the thumb mechanism was not particularly significant since the use of the powder grip technique provides an effective reduction in the gripping force required, the improvement being represented by a reduction of up to 75 per cent of the force normally required using a conventional rubber faced hook for example.

2.10 Conclusions drawn from the use of experimental mechanisms.

The versatility of this type of mechanism during qualitative assessments with grasping a range of objects in the workshop, showed that a considerable diversity of operation was possible, when used in conjunction with a wrist rotation facility. Furthermore, the extreme simplicity of the mechanism was a very favourable aspect of the design although the selection of an optimum configuration for the static fingers required some initial setting-up procedures.

This type of approach appeared to be most promising, and therefore the principle of stationary fingers and laterally opposing thumb was adopted for the development of devices specifically intended for patient use and subsequent evaluation.

Chapter 3.

The practical mechanism.

- 3.1 Introduction.
- 3.2 The first practical mechanism.
- 3.3 The thumb.
- 3.4 The ring and little fingers.
- 3.5 The index and middle fingers.
- 3.6 The general construction.
- 3.7 The fingers/thumb arrangement.
- 3.8 Results and conclusions with the initial device.
- 3.9 The modified programme of development.
- 3.10 The procedure for obtaining the mechanism shape.
- 3.11 Development of the mechanism.
- 3.12 'Padding' the mechanism.
- 3.13 Powder grip techniques.
- 3.14 Preservation of hand shape without padding.
- 3.15 A summary of the achievements.

Chapter 3.The practical mechanism.3.1 Introduction.

The evolution of the devices described in the previous chapter towards a worthwhile practical mechanism had produced the simple configuration of stationary fingers used in conjunction with an articulated laterally opposing thumb. It is the purpose of this chapter to indicate the development of this principle as a device capable of the prehensile abilities laid down by previous criteria and to illustrate in particular those aspects of the design of the mechanism which affect the relationship between the cosmetic glove and the mechanism. This latter point is of special importance since the success of the device as a hand depends upon a very high level of cosmesis.

3.2 The first 'practical' mechanism.

The first design followed directly as a consequence of the trial mechanisms devised in the previous chapter, with fixed fingers attached to a hand palm shaped 'Tufnol' block, onto which the mechanism for driving the articulated thumb was attached. The hand configuration and dimensions were taken from a wax casting of a child's hand of appropriate size, positioned in the 'writing' configuration. In this way it was hoped that a lifelike hand mechanism could be designed.

3.3 The thumb.

In order to simplify the mechanism as far as possible whilst retaining a wide opening aperture for the thumb, the distal phalanx of the thumb was articulated as in the mechanism devised previously, the phalanx being connected by a link to the pivot point on the body

of the hand. The main thumb member and this link then formed two bars of a four bar linkage whose ratios were designed (by scale drawing) to ensure that the distal thumb phalanx closed the curve of the thumb when opposed to the fingers, whilst allowing a maximally opened aperture when the grip was open.

3.4 The ring and little fingers.

The semi-passive stabilising nature of the ring and little fingers suggested by the results of the X-ray experiments, combined with experiences referred to in the literature concerning the effects of these fingers on the performance of prostheses, led to the hand design being based upon the index and middle finger for active grip, with the ring and little fingers being formed by springs which could act as stabilisers to a certain extent whilst possessing sufficient passive mobility to allow some conforming of the grip when necessary.

3.5 The index and middle fingers.

The design of the index and middle fingers was based upon the hand configuration in the writing position, since the results of the X-ray experiments described in 'the natural phenomenon' indicated that this position was a good average position for active prehension. Another attraction of this configuration is that it is a position which can be readily adopted by an individual on request, which is a considerable advantage in the glove manufacturing process.

3.6 The general construction.

The construction of the fingers and thumb was specifically designed for compatibility with the powder grip sacs, having a U-shaped section in order to provide an adequately rigid backing

for the bags of powder. This U-channel form also gave added strength to the fingers and thumb, allowing the construction to be based upon thin (1/16" thick) stainless steel sheet which was cut to shape and subsequently formed under pressure to the desired U-section profile. The fingers were attached to the 'Tufnol' hand block by means of an epoxy adhesive locating the fingers in machined slots in the fibre material. The thumb was driven by a piston actuator acting on a lever, the details of this system being given in Appendix 3.I. The hand in this form (Fig. 3.1) was then smoothly contoured to prevent damage to the glove by sharp edges, powder grip bags were attached and a cosmetic pvc glove fitted over the device, leaving only the question of the precise alignment of gripping surfaces to be resolved.

3.7 The fingers/thumb arrangement.

Since the reduction of the mechanism of the hand to the use of a simple movement represented such a crude approximation to the wide range of movement achieved by the normal hand, it was necessary to pay considerable attention to the configuration of the static parts of the device in order to achieve optimum function.

The prime criterion for the success of a gripping device being used by a bilateral amputee, apart from the ability to pick up, is the stability of the resulting grip, since the extent to which the device may be used will be directly dependent upon this factor.

The general problem of grip stability is most readily visualised by consideration of the requirements of gripping a spherical object in an inherently stable fashion. In this situation it can be seen that, for an essentially two-jaw device such as that proposed for the hand, four point contact is necessary for stability in all

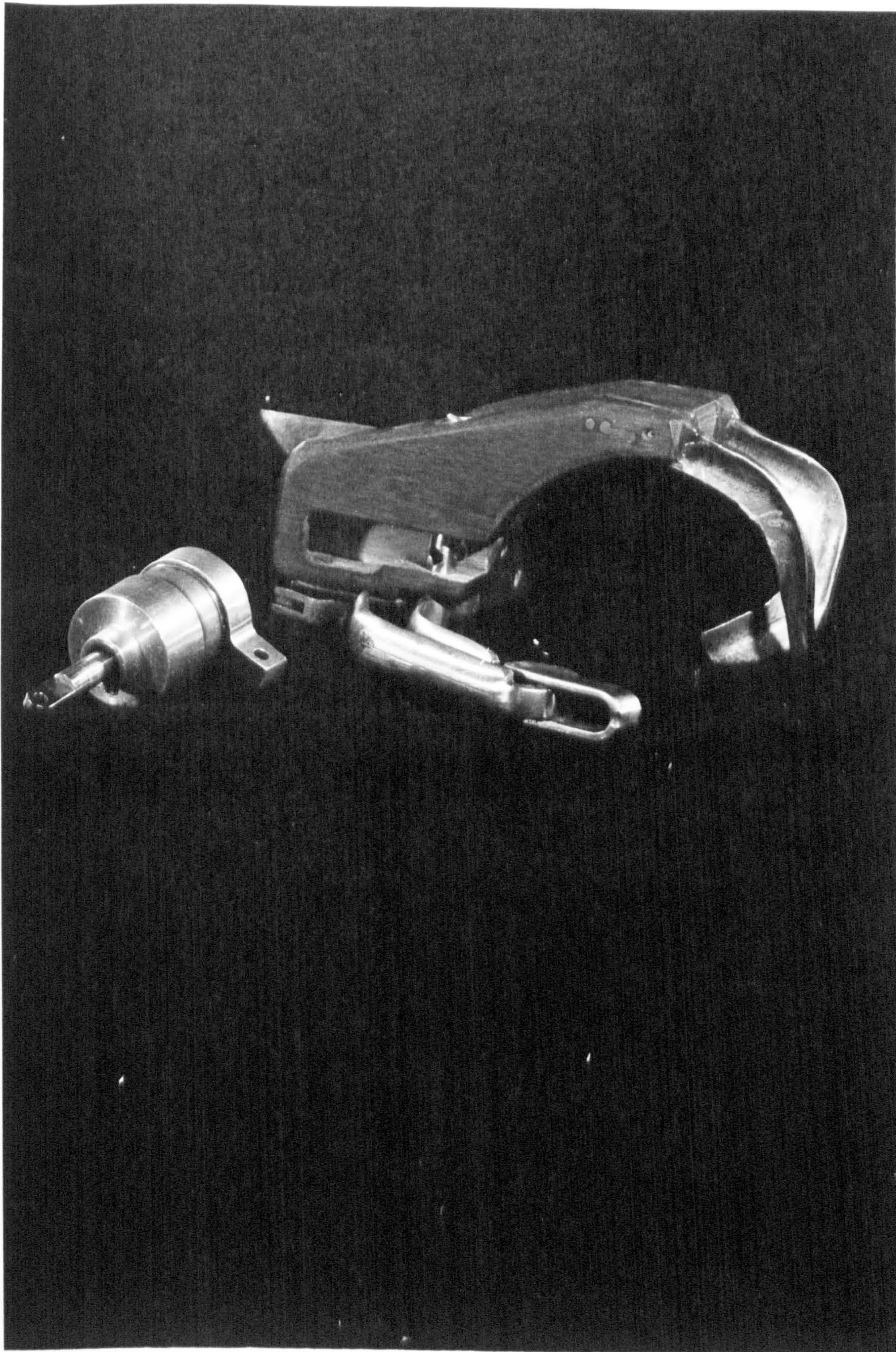

Fig. 3.1

Early 'practical' mechanism.

directions, the four points being represented by a three point contact in tripod fashion being opposed by the fourth point of the active thumb, (Fig. 3.2). This configuration will be inherently stable if the line of action of the effective resultant of the force P lies within the triangle ABC.

In the case of the proposed hand configuration point A would be represented by the proximal phalanx of index finger, point B by the distal phalanx of the index finger, point C by the distal phalanx of the middle finger and point D by the thumb.

However, this arrangement is subject to a further constraint provided by the requirement for operation on a flat surface for the picking up phase of hand activity. This in itself provides no particular problem, but the picking up of small objects requires that, when closed, the thumb D meets the finger tips B and C. In other words the plane in which the thumb moves must pass through B and C. Initially this suggests that the stability criterion of the resultant action within triangle ABC cannot be satisfied. However, consideration of Fig. 3.3 shows that, provided angle AED is less than 90° , the force $P \cos\theta$ will act between A and E, i.e. within the triangle ABC. The force $P \sin\theta$ tends to move the gripped object out of the grip, however, provided θ is reasonably small, $P \sin\theta$ will be effectively neutralised by the frictional properties of the gripping surfaces.

Thus, by ensuring that the proximal phalanx A of the index finger tends to be towards the thumb relative to the finger tips, a stable four point grip will always be achieved for large objects, whilst small objects which do not reach A will be in a three point

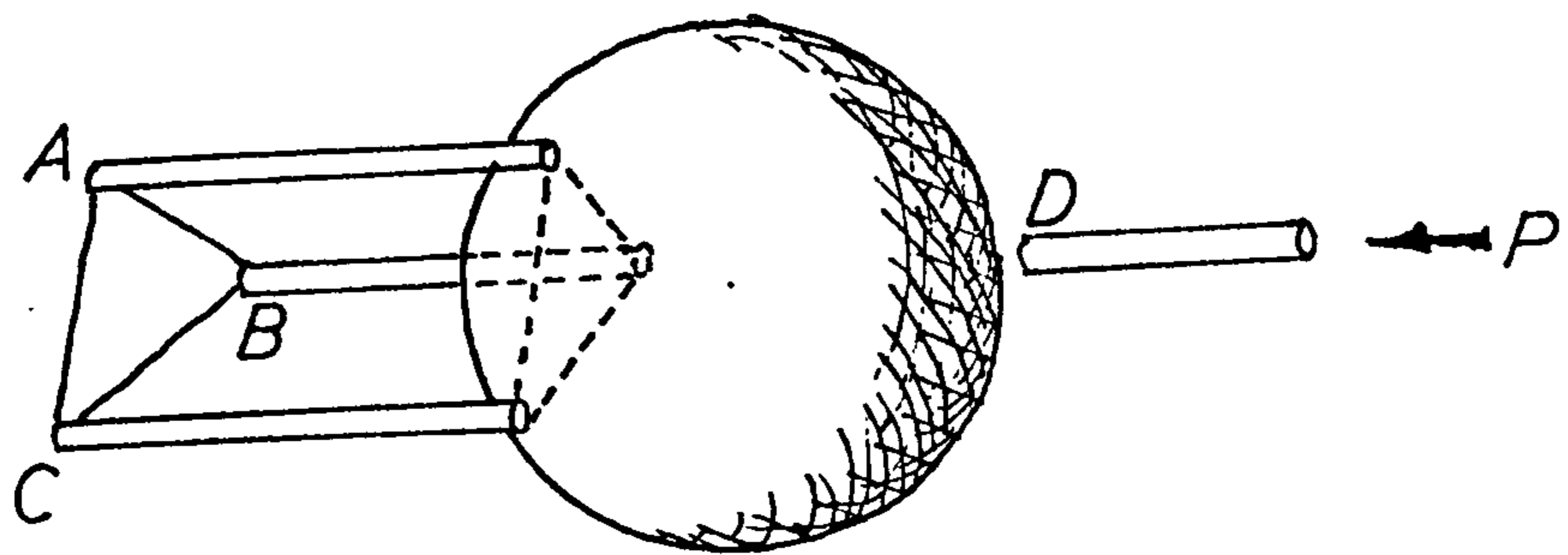

Fig. 3.2

Stable grip configuration.

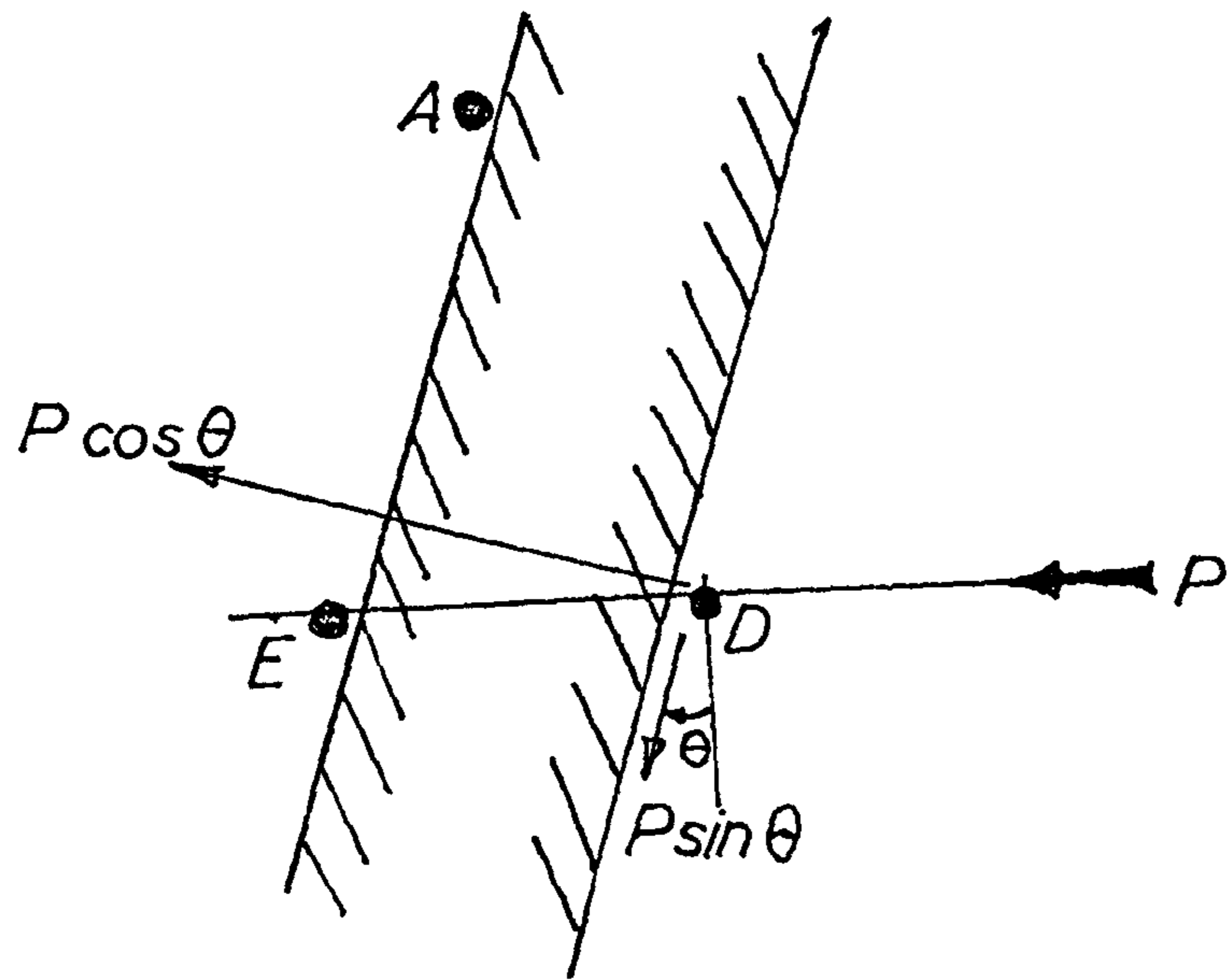
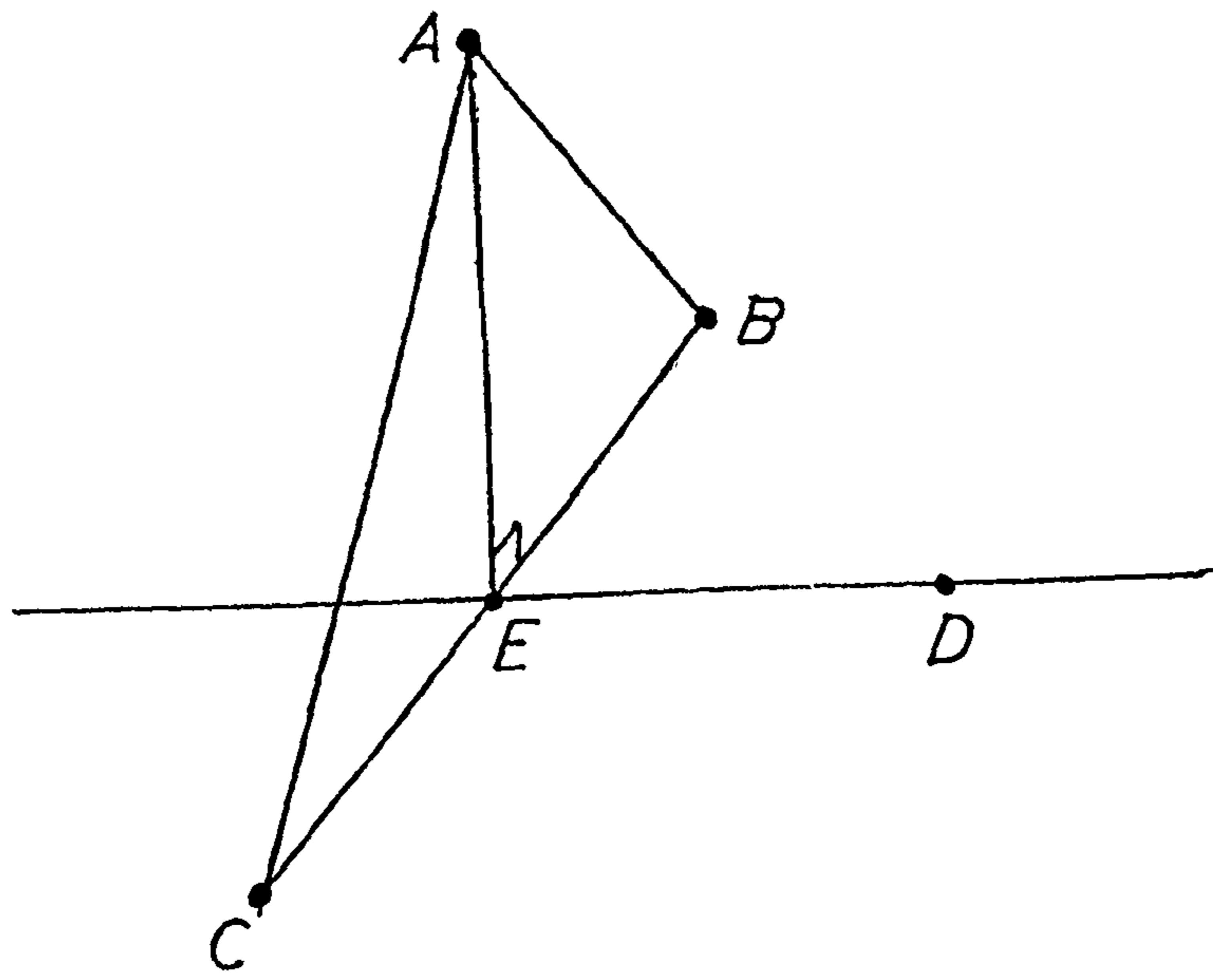

Fig. 3.3

Arrangement for flat surface operation.

grip between D, B and C.

In practice, this arrangement was assured by the general set-up of the fingers, followed by a final alignment carried out by bending the steel fingers and thumb in a jig.

3.8 Results and conclusions with initial device.

The resulting device resembled a hand in its general shape and appearance, and behaved quite satisfactorily from a prehension point of view. However, the level of cosmesis was certainly low, due to the presence of unsightly folds and creases resulting from a poor fit of glove to mechanism.

This point showed that the design procedure for the mechanism would have to be based quite rigidly upon the demands of the cosmetic glove, indeed, the mechanism should be made specifically for a particular glove. This, then, firmly placed the emphasis upon the production of a cosmetic glove of the specific type of configuration demanded by the principles of operation of the mechanism. Following the production of a suitable glove, the mechanism would then be made to fit that glove exactly.

3.9 The modified programme of development.

Thus, the development programme followed a new trend: Mechanism principles → Hand of specific shape → Glove of specific shape → Mechanism to fit glove → Complete prosthesis. Therefore at this stage the work shifted to the development of the glove for the hand, which soon became the major problem of the hand project. Following the successful production of gloves of the particular configuration required, it was possible to commence the production of a mechanism to match the glove.

3.10 The procedure for obtaining the mechanism shape.

This began by obtaining an impression of the inside of the glove in the correct configuration, the impression thus obtained being the desired overall shape of the mechanism in order to obtain a good match between glove and mechanism.

The technique devised in order to obtain the mechanism shape was based on several of the techniques used in the glove production process, and full details of the techniques will be found in the appropriate sections of the chapter "The glove".

The gloves produced as a result of the moulding techniques were of approximately the correct configuration, but some minor adjustments were necessary in order to accentuate knuckle prominences and improve finger positions, etc. These re-adjustments were carried out by ensuring that the glove attained exactly the correct configuration inside a plaster of paris former. (Details of the techniques are given in Appendix 3.II). The glove, retained by the former, was then filled with a low melting point alloy, which, when solidified provided the exact replica of the mechanism configuration for that glove.

In order to make use of this casting it was necessary to section the metal along the lines of the fingers and thumb, this providing profiles of the fundamental shapes for each digit (Figs. 3.4 and 3.5). Tracings of these profiles were then used to determine the shapes of the materials to be used for the various parts of the mechanisms which had now taken on an appreciably improved form due to developments made during the time taken to devise the special glove manufacturing process.



Fig. 3.4

Casting of interior of glove,
sectioned to give profiles for mechanism.

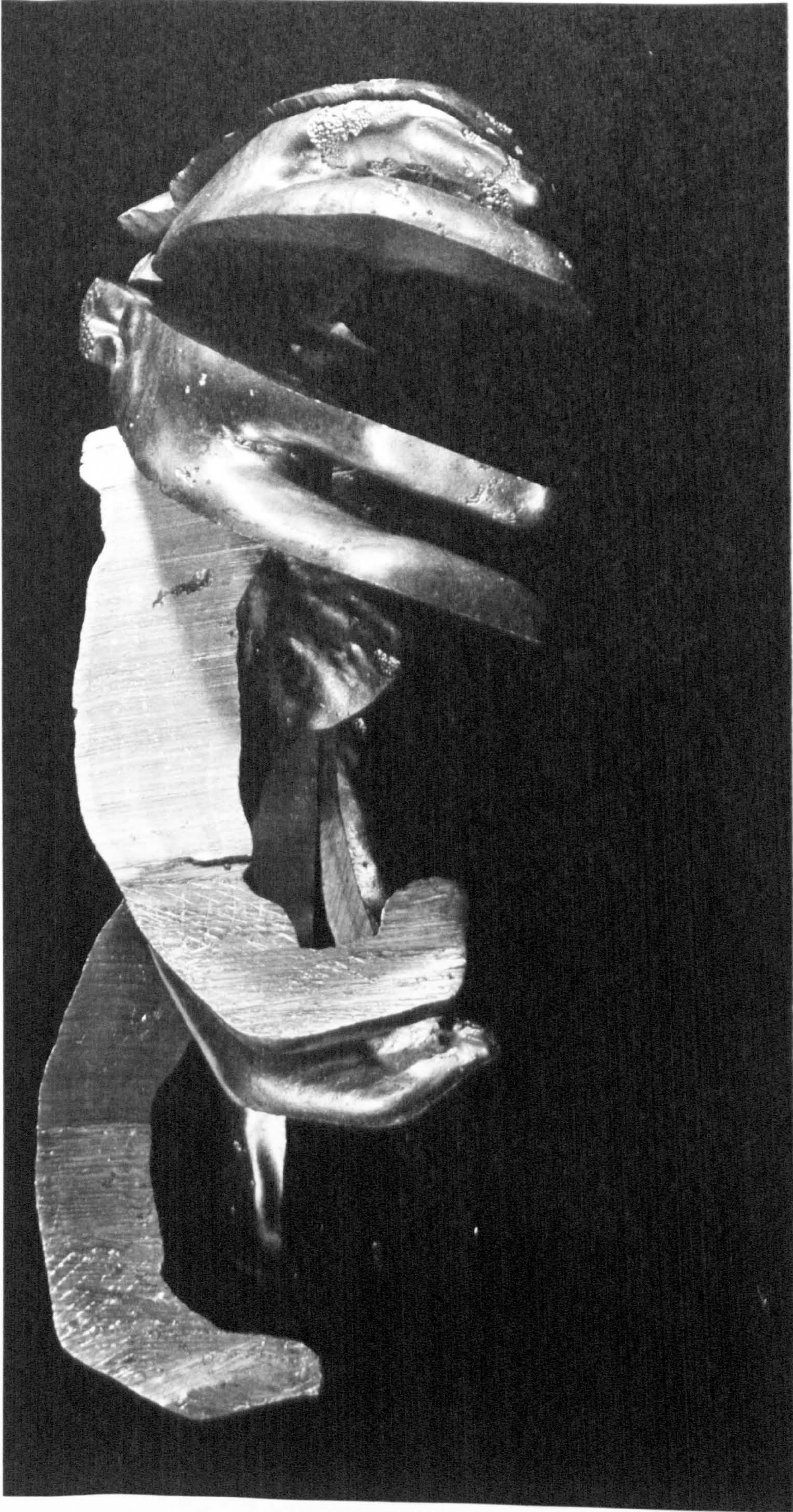

Fig. 3.5

The sectioned casting.

3.11 Development of the mechanism.

These developments in the details of the mechanism were directed specifically towards a design which embodied low weight and high strength, and to these ends certain important changes had been made to the design.

Only one of the alterations represented a deviation in concept from the patterns laid down by the previous two mechanisms, the change being concerned with the thumb action. The two mechanisms, which had provided the basis for the production mechanisms, had embodied thumbs with articulated distal phalanges for the sole purpose of allowing a wide opening of the gripping of large objects.

However, the jointed thumb required the introduction of a suitable inter-phalangeal joint, and a link for driving the joint, with the same attendant problems as experienced previously with the fingers, although the problems were not necessarily prohibitive if such a mechanism were essential for the adequate performance of the device. Therefore, since the articulated thumb could not be considered as supplying a fundamental function in the hand, it was considered that the first production devices should make use of the rigid thumb laterally opposing the rigid fingers, this situation representing the basic functional principle of the device. By approaching the problem in this way it was possible to establish the minimum degree of mechanical complexity necessary to fulfill the desired functions.

Thus, the first practical requirement was to produce a thumb of a suitable weight and strength, and initially the high rigidity of carbon fibre reinforced plastics encouraged investigations of

the possibilities with this material. The thumb was designed with a concave U-channel section as in previous models, thereby fulfilling the dual requirement for high rigidity and compatibility with the powder grip bags.

The use of the carbon fibre reinforced material, however, proved to be of little benefit, since the weight saving was minimal in comparison with the attendant manufacturing difficulties (see Appendix 3.III) and therefore stainless steel was utilised as in previous versions.

The second new design feature of particular importance which was introduced at this stage was a result of an appreciation of the high incidence of breakages which appears to occur in many hand prostheses. The construction of the majority of hand prostheses being such that any failure of the mechanism results in a totally useless prosthesis since the fingers become loose and extended. However, in the case of the hook prosthesis, even total lack of function of the active hook blade leaves some degree of function by virtue of the remaining static hook, which is still capable of many useful functions. A similar degree of 'non-breakability' was easily introduced into the hand prosthesis by a construction which makes the fingers an integral part of the attachment bracket, thereby forming a completely independent static hook prosthesis. This was achieved by attaching the fingers to a formed sheet of thin stainless steel which combined the functions of part of the static hook and the attachment bracket for the thumb and its mechanism.

The sheet of stainless steel which formed the 'backbone' of

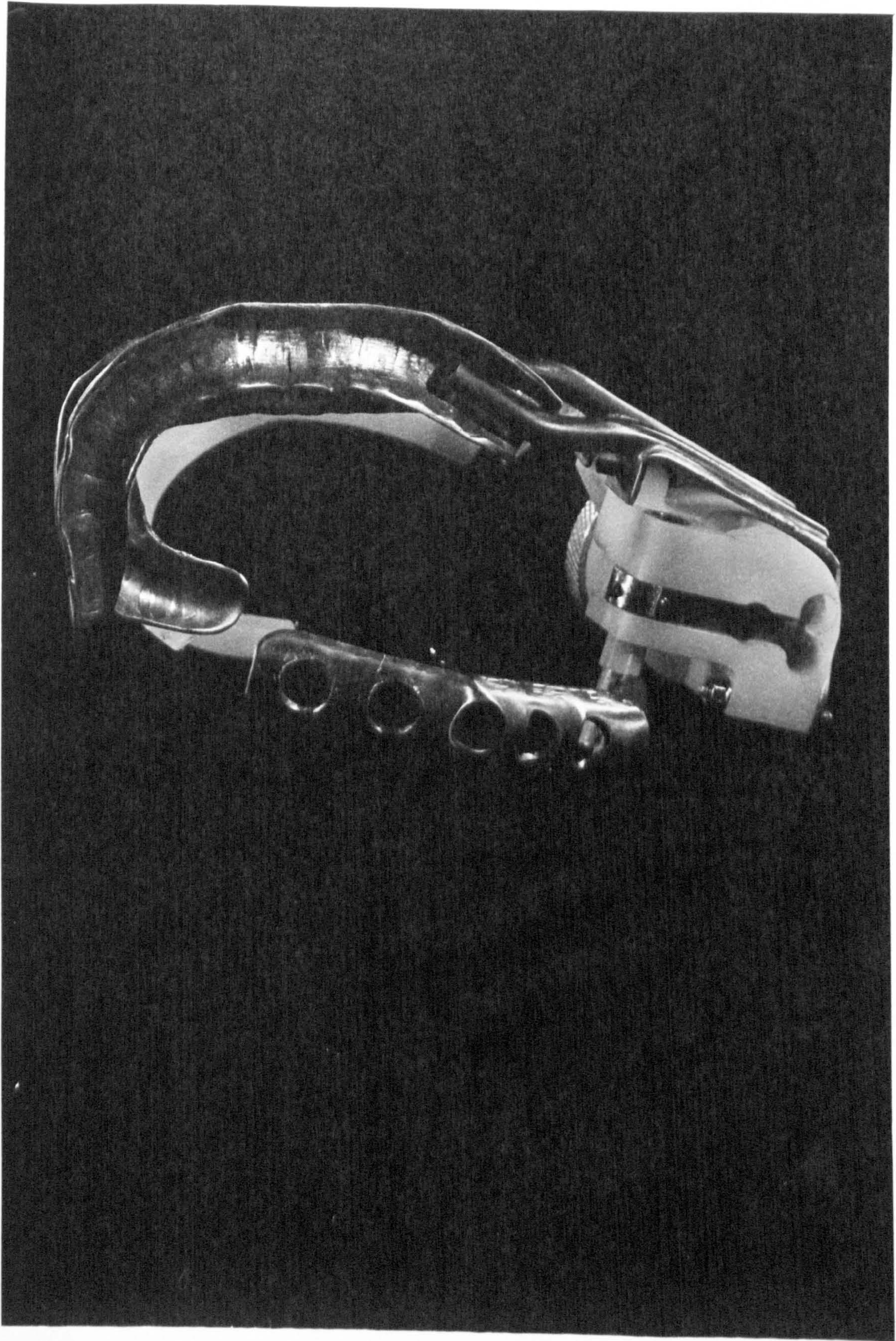

Fig. 3.6

Practical mechanism after weight reduction and re-design, side view.



Fig. 3.7

Actuator and thumb separated from finger sections.

special wrist fitting needed to permit flat surface operation. The weight of the cosmetic glove for the new hand was 25g, thus leaving a total of 45g to cover foam padding and powder grip to the correct shape.

3.12 'Padding' the mechanism.

With the mechanism completed and remaining satisfactorily within the target weight, it was then necessary to complete the cosmetic refinements in order to arrive at the state where fitting would be possible. These refinements concerned the precise matching of the glove to the essentially skeletal structure of the mechanism. In order to achieve this match it seemed necessary to 'pad' the spaces between mechanism and glove, in such a way that the padding filled out the hand to precisely the desired shape. Furthermore, the padding was partly to be constituted by powder grip sections on the appropriate aspects of fingers and thumb. The details of the techniques devised for this process are given in Appendix 3.V, with examples of the resulting foam padding being shown in Fig. 3.8.

3.13 'Powder grip' techniques.

The remaining task before completion of the hand mechanism was to provide the powder grip surfaces for the fingers. Since the powder grip was of such importance to the design of the hand, a considerable amount of work has been necessary in order to arrive at a solution to the problem which could give ease of manufacture and adequate performance in use. In order to assess the capabilities of the various powder grip systems developed before completion of the hand mechanism itself, it was necessary to institute evaluations of the powder grip on hook prostheses, since these provided an ideal test-bed for new systems because of the lack of complications

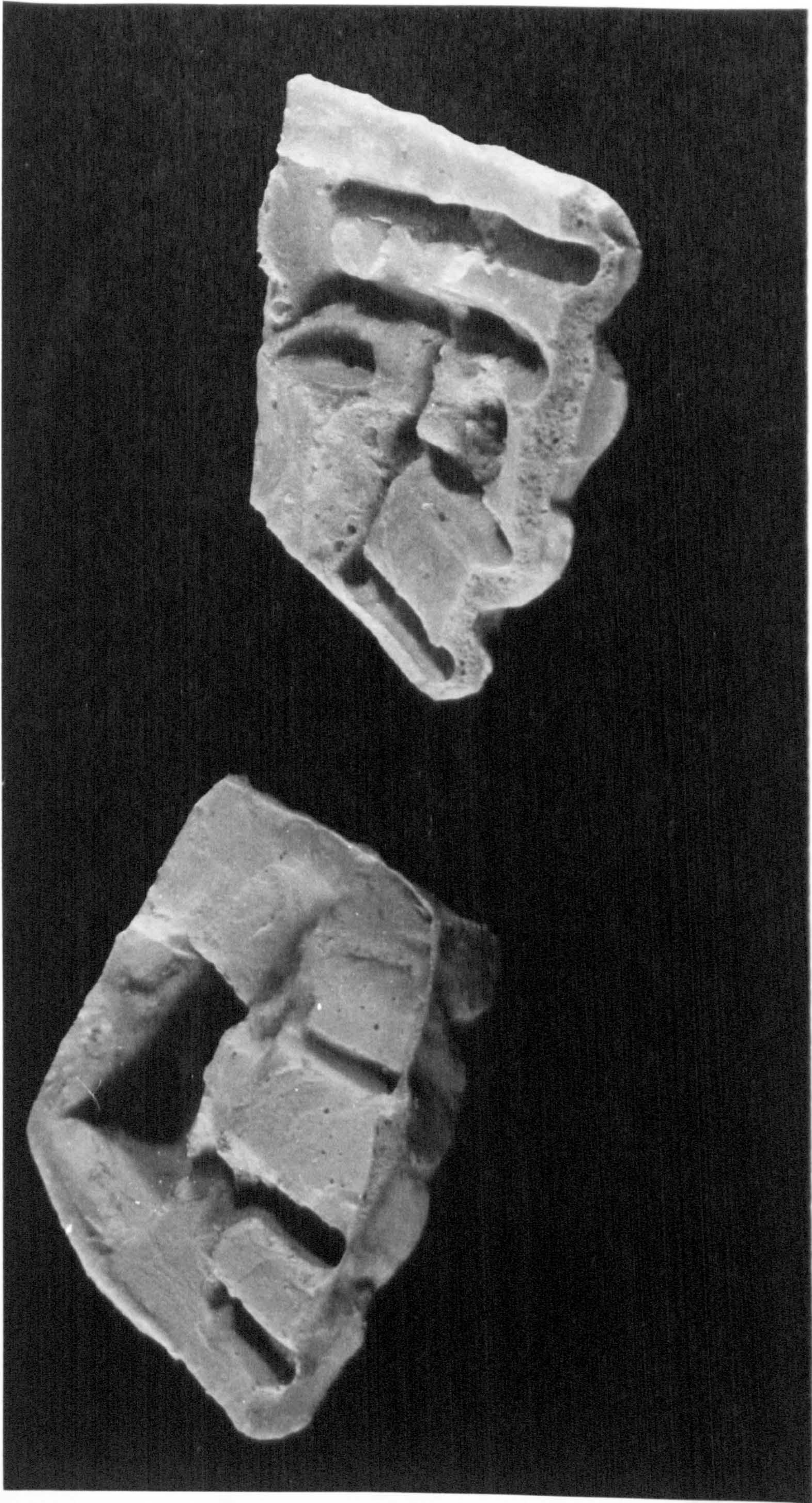

Fig. 3.8

Foam padding.

introduced by cosmetic requirements.

The beneficial effects of using the 'powder grip' principle have been mentioned previously and required no further justification for its use as an improved gripping surface. However, the details of manufacturing procedure and the materials to be used remained entirely open for development.

The powder grip principle demanded two particular properties of the materials to be used:

- (i) A flexible container or sac of non-stretch material bonded to the gripping surface of the relevant digit.
- (ii) A filler for the sac to be of a granular nature, allowing flow of the filler within the containing walls of the sac when the gripping surface is deforming around the grasped object.

These conditions had been satisfied initially by making use of rubber latex bags as primary containers for sand or salt particles, with a secondary non-stretch covering of thin leather. The gripping surfaces in this form had shown that the principle was satisfactory, but the technique presented various practical problems which led to further investigations of possible manufacturing procedures.

The major problems arising from the early manufacturing techniques were:

- (i) The cutting and shaping of the leather cover was extremely time consuming, each requiring the full attention of a technician for a considerable period of time.
- (ii) The preliminary fitting and sealing of the latex sac was equally difficult.

(iii) Long-term bonding of the completed gripping surface to the underlying 'skeleton' was rarely possible.

(iv) The flow properties of angular sand or salt particles left much to be desired resulting in a somewhat hard texture for the powder grip module.

The fourth of these problems was readily solved by subjective comparative assessments of sand filled sacs and sacs filled with small spheres (1mm diameter) of glass or a plastics material (polystyrene), which clearly showed the improved flow characteristics with the spherical particles.

The remaining problems could then be summarised as the development of a process for the manufacture of the 'skin' bag, the process to be of an essentially simple automatic nature such as that resulting from the use of a moulding process which would provide the necessary shape for the gripping surface.

Thus, various developments were carried out in order to devise such a process, the details being given in Appendix 3.VI. The procedure finally adopted being based upon an extremely simple dip-moulding process which required the minimum of attention, whilst providing a strong and reliable powder grip module of the desired shape.

3.14 Preservation of hand shape without padding.

The fitting of a glove over the padded mechanism provided the final test for the achievement of the desired shape for the mechanism, and, to a limited extent, this proved successful in so far as the matching of mechanism to glove was satisfactory. However, the general appearance lacked certain features which were not

apparent in themselves, but the overall effect was not quite correct. Experiments with padding with cotton wool showed that the features which were lacking were the accentuated 'hard' points of the knuckles. In fact, these features were so important to the achievement of a realistic effect for the hand, that it was apparent that the padding of the hand was of secondary importance. Thus, the mechanism was modified to provide the hard 'bumps' in the correct positions for the knuckles, padding being retained in the form of powder grip on the fingers. The softness between the hard aspects of the hand was achieved by thickening the glove itself, so that the basic form of the hand was laid down by the skeleton, the skin (glove) being drawn over the frame achieving the more natural end result.

In order to achieve the precise effect of the skin over the mechanism it was necessary to introduce a degree of tension to the glove over the mechanism, and this was achieved by clamping the stretched glove at the wrist, where the cross-sectional shape was preserved by a fibre-glass former.

The hand prosthesis in this form achieved a realistic appearance, and was therefore considered to be appropriate for application in trial fittings to patients.

3.15 A summary of the achievements.

The satisfactory completion of this stage of the hand mechanism development represented the last of the major problems in the construction of the prototype hand, and the subsequent results of trial fittings of the prostheses are described in a later chapter. However, the achievements at this stage may usefully be summarised by stating that a complete hand prosthesis had been developed in such a way that all the processes involved in its construction

involved the use of a minimum degree of 'craftsmanship', making use of automatic copying processes as frequently as possible, usually in the form of casting and moulding techniques. In this way it has been possible to produce a prosthesis which can be constructed and maintained with the minimum use of specialised techniques based upon years of experience, thereby permitting the device to be used under the non-ideal field conditions which frequently demand impromptu modifications and repairs.

Chapter 4.The Glove.

- 4.1 The role of the glove.
- 4.2 The constraints of the mechanism.
- 4.3 Glove material.
- 4.4 Initial experiments along 'classical' lines.
- 4.5 The use of shell moulds.
- 4.6 The classical process applied to gloves for the new mechanism.
- 4.7 Attempts to modify the classical process.
- 4.8 Alternative materials in the process.
- 4.9 The electroplating process.
- 4.10 Problems due to the electroplating process.
- 4.11 Further problems associated with the shell mould.
- 4.12 The classical procedure reassessed.
- 4.13 The principles underlying the use of pvc reapplied to suit the new conditions.
- 4.14 The new technique.
- 4.15 The advantages of the new process.
- 4.16 The electroplating process reviewed and an alternative proposed.
- 4.17 Mould production.
- 4.18 The use of the mould.
- 4.19 The use of the everted glove.
- 4.20 A comparison between 'classical' and 'new' processes.
- 4.21 Conclusions.

Chapter 4.The glove.4.1 The role of the glove.

The adequate function and appearance of the glove in a cosmetic hand prosthesis is obviously of paramount importance to the success of the device in terms of acceptance by the patient and therefore necessarily requires a considerable amount of attention in the development of a new mechanism. However, the extent to which the practical limitations imposed upon the production of gloves of a specific shape and configuration can influence the development of new mechanisms is a point which is not immediately obvious, but has immense implications for the development of prostheses which differ from the standard pincer-grip type.

4.2 The constraints of the mechanism.

The hand mechanism which was established in the previous chapter as the basis for practical trials required a cosmetic cover of a particularly good fit, since the major part of the hand remained stationary, emphasising all flaws in the glove as a 'skin' and thereby preventing the use of straight fingered gloves modified to fit the mechanism. In addition, the configuration of the mechanism was precisely defined in terms of the positions of the digits, since these required to be in the correct positions relative to one another in order that the functional capabilities be realised.

It is, therefore, the purpose of this chapter to describe the procedures adopted during the experimental production of cosmetic gloves of a specific shape.

4.3 Glove material.

In commencing experiments with glove production it was

necessary to establish the type of material to be utilised for the glove, and thus some consideration was given to the previous experiences of other workers with various materials.

In the early days of prosthetics the attempts at hand cosmesis were provided by making use of the 'acceptable' abnormality of wearing a leather glove at all times in order to cover the mechanism; this approach is still used by many patients. The earlier attempts at making 'cosmetic' gloves, i.e. gloves which simulate the natural hand, made use of the natural rubber then available, in order to provide a thin flexible glove. These gloves, however, were severely limited in their application due to their low strength and wear properties. Factors such as these tended to restrict the use of cosmetic gloves to application on passive hands, worn for appearance purposes only. The advent of the age of plastics technology gave immense new opportunities in this field, providing the researcher with a wide variety of materials possessing an almost infinitely variable range of physical and chemical properties. In the light of such a considerable store of materials, the choice of a suitable type for use as a glove is not trivial, and necessitated a preliminary specification for the glove material before practical work could commence.

The glove must obviously be made of a material which can be suitably coloured. This, however, presents only minor problems with most plastics materials. The most important functional characteristics for use on an active prosthesis is that the glove be highly flexible when used in thin sections of 0.5 - 2mm thickness. The thin section requirement reduces the field considerably to materials such as cellophane, polyurethane, nylons, pvc, and associated

compounds. However, of this group, only two materials may be regarded as being anything like robust and wear-resistant enough to be considered as candidates for future consideration. Previous work (Hodge et al 1971) with polyurethane as a glove material has shown that while it has satisfactory properties in terms of strength and wear resistance, its colour is not good, ageing problems are severe, resulting in a stiffening of the material with age. This leaves pvc as the remaining readily usable material and was therefore chosen as the medium to be used for the work in providing a glove cover for the hand mechanism.

The choice of pvc for the manufacture of cosmetic gloves has been almost universal in the past, with the majority of workers using this material with considerable knowledge and skill. Such a widespread use of the material has led to a ready availability of pvc in suitably pigmented states, and the technology involved in the use of the material has become a simple matter of routine. The well established use of pvc plastisols therefore provided an eminently satisfactory basis for the commencement of glove production work.

One of the major advantages of pvc as a glove material is that it can be plasticised to suit any requirements from the rigid form through to a very soft, sticky, pliable consistency which has limited strength. In practice it was found that a plastisol with suitable properties was available ready for use from the manufacturer (Belplas Ltd.). This plastisol, when cured as a thin film at 150°C for a few minutes forms an extremely strong, flexible membrane whose texture is sufficiently tacky to provide a good gripping surface for a glove. The main disadvantage of pvc in this form

is that, while intact, the membrane is extremely strong, but tears propagate very rapidly and easily once formed. For this reason, the fit of the glove to the mechanism must be exact, in order to avoid local weak spots. The colour of the pvc film can be readily changed by the addition of powder colours to the plastisol in the liquid phase. In fact it is normal prosthetic practice to use clear pvc as the outer layers of the glove with the colour detail beneath. This achieves a more lifelike, slightly transparent effect.

Thus, in view of the well established technology of glove production using pvc materials it was logical to commence the production of gloves for the new mechanism on the basis of the existing classical techniques of glove manufacture.

4.4 Initial experiments along 'classical' lines.

The preliminary work, therefore, consisted of following the standard procedures in use for the manufacture of 'straight fingered' cosmetic gloves (Fig. 4.1). The normal procedure is to choose a volunteer whose (normal) hand is of the correct proportions necessary for cosmetic replacement on the amputee patient. A negative impression is taken of the hand in sodium alginate, a derivative of seaweed used in dentistry as a rapid setting casting material. This material remains flexible for some time after setting, which permits easy withdrawal of the hand, despite undercuts and complex contours. The amount of detail transferred is considerable, fingerprints being faithfully reproduced. In the conventional process, molten wax is now poured into the alginate mould and allowed to solidify. The wax positive thus obtained is



Fig. 4.1

'Straight fingered' glove alongside hand in the position required for the hand mechanism.

then painted or sprayed with a conducting paint before being used as the cathode in a copper sulphate plating bath. After a suitable deposit of copper is obtained the wax is melted out leaving a copper shell negative mould. This shell is strengthened by further external plating with copper or nickel and is then ready for use as a mould.

4.5 The use of shell moulds.

The methods of using the shell mould can take various forms but fundamentally consist of filling the mould with plastisol and pouring out the contents, thereby leaving a thin layer adhering to the inside of the shell. The thickness of this layer may be altered by adjusting the initial temperature of the shell before pouring in order to initiate a 'gel' state near the hot shell. After pouring out the excess pvc plastisol, the shell is inverted and the excess plastisol allowed to drip out for some time, followed by heating at 150°C for a further few minutes. The precise times required depend upon the thickness of the layer desired and this procedure may then be repeated if it is necessary to thicken the glove. When the correct thickness has been achieved the glove is pulled out from inside the shell. The easy release of the glove from the mould is essential in order to avoid either tearing the glove or damaging the mould. Therefore, it is usually necessary to vacuum the glove, in order to draw the closely mating surfaces of the glove and mould apart and for this stage a release agent applied to the mould before use eases these problems to some extent.

4.6 The classical process applied to gloves for the new mechanism.

This then, is the type of process normally used for the

production of seamless straight fingered gloves, the use of split moulds being undesirable for cosmetic reasons. The use of the above process in this form presents problems for the production of gloves with fingers in the natural rest position, i.e. slightly flexed. That this is so, is apparent for two reasons. Firstly, the fingers form a U-tube shape during the pouring phase for the molten wax - which causes an air lock at the fingertips - leading to, at best, loss of detail (Fig. 4.2). The second difficulty occurs at a later phase in the process, namely the release of the glove from the mould itself by the normal means of pulling from the wrist position. Release is not easy under normal conditions, but with curved fingers the problem is exaggerated (Fig. 4.3).

4.7 Attempts to modify the classical process.

The approach taken in the light of these problems was the optimistic one of tackling the air lock fault, and then experimenting with release agents and mould temperatures to facilitate release.

The first major problems in applying these techniques to the new shape of hand arose immediately in the first stage of the process, the casting of the hand of the 'donor'. For the mechanism chosen, an extremely good fit of glove is essential in order to retain the maximum cosmetic effect. Therefore it was necessary to ensure that the 'donor's' hand was in exactly the correct position with regard to finger spacing, curvature, etc. At first the simple approach of illustrating the desired position to the 'donor' was used, and he was asked to retain this position while the hand was immersed in the setting alginate mixture. This procedure was found to be unreliable for two reasons; firstly, there was no guaranteed

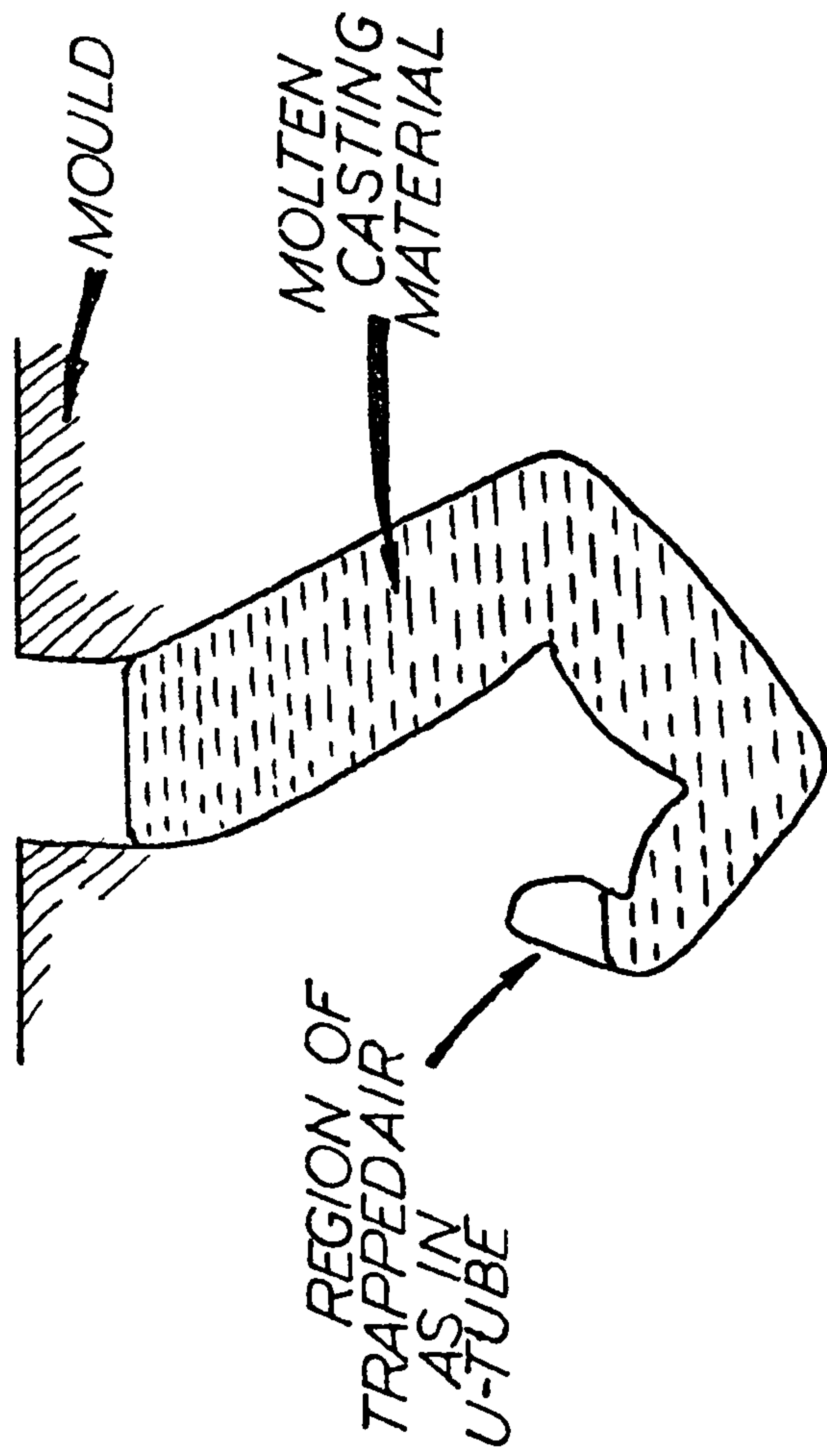

Fig. 4.2

Air-lock casting fault.



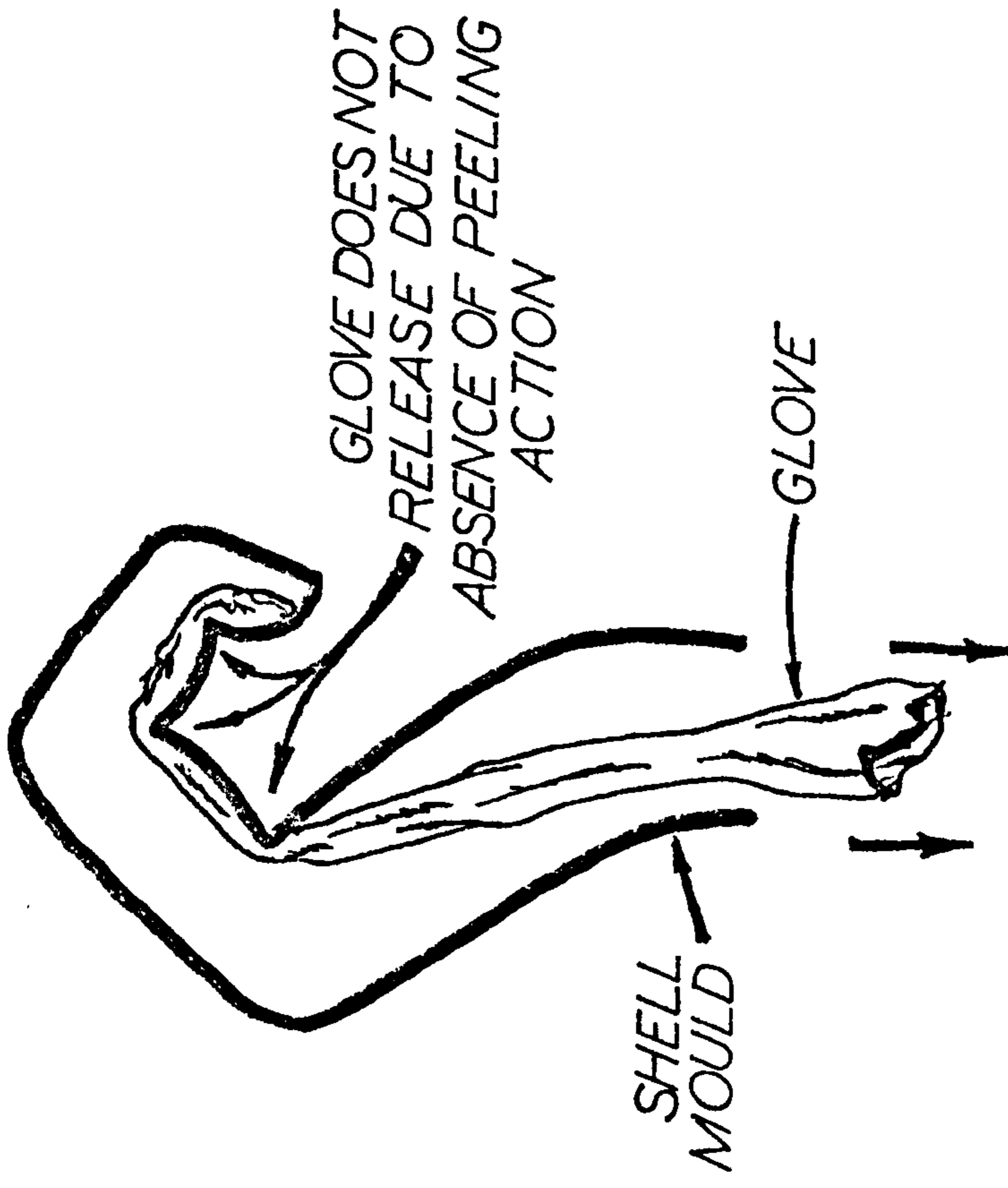

Fig. 4.3

Mechanical release problem in glove removal.

that the initial configuration was precisely correct, and secondly, after the hand had been immersed for a few seconds it became extremely difficult for the donor to sense the position of his fingers in order to make minor adjustments to the configuration of his hand.

Several remedies were tried in order to overcome this problem, with varying degrees of success, and details of the experiments with various techniques are given in Appendix 4.1.

The most satisfactory of these took the form of locating the fingertips on pre-positioned tubes, which then served the dual purpose of location and the release of trapped air whilst pouring the casting material into the mould. (Figs. 4.4, 4.5 and 4.6).

The alternative process of using no position devices presented problems of a different nature. With the absence of air rods at the fingertips, the U-tube air entrapment phenomenon was revived.

However, provided that this problem could be solved, it would then be possible to take a succession of 'free' casts of the donor hand, selecting those of a suitable configuration for further use.

This approach to the casting of the donor hand was attractive from the point of view of simplicity when using young children as donors, where problems arise with fidgeting and displacement of the rods devised previously. However, the use of many casts created new difficulties, since the wax impressions obtained in the usual way were soft and exceedingly susceptible to damage, in addition to the fact that wax castings required considerable attention during the solidification stage due to the large degree of contraction which occurs on solidification.



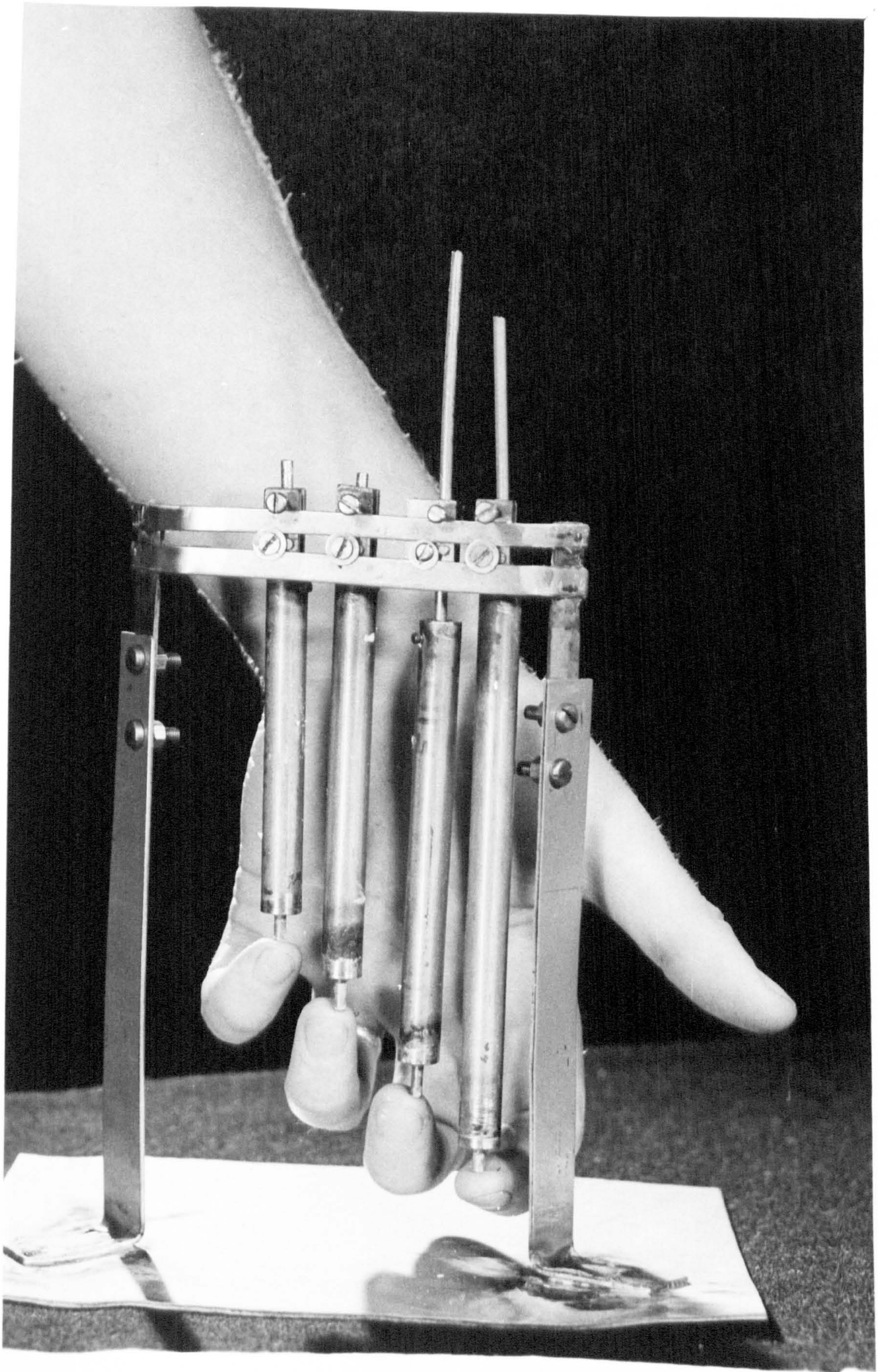

Fig. 4.4

Location of fingertips on tube ends.

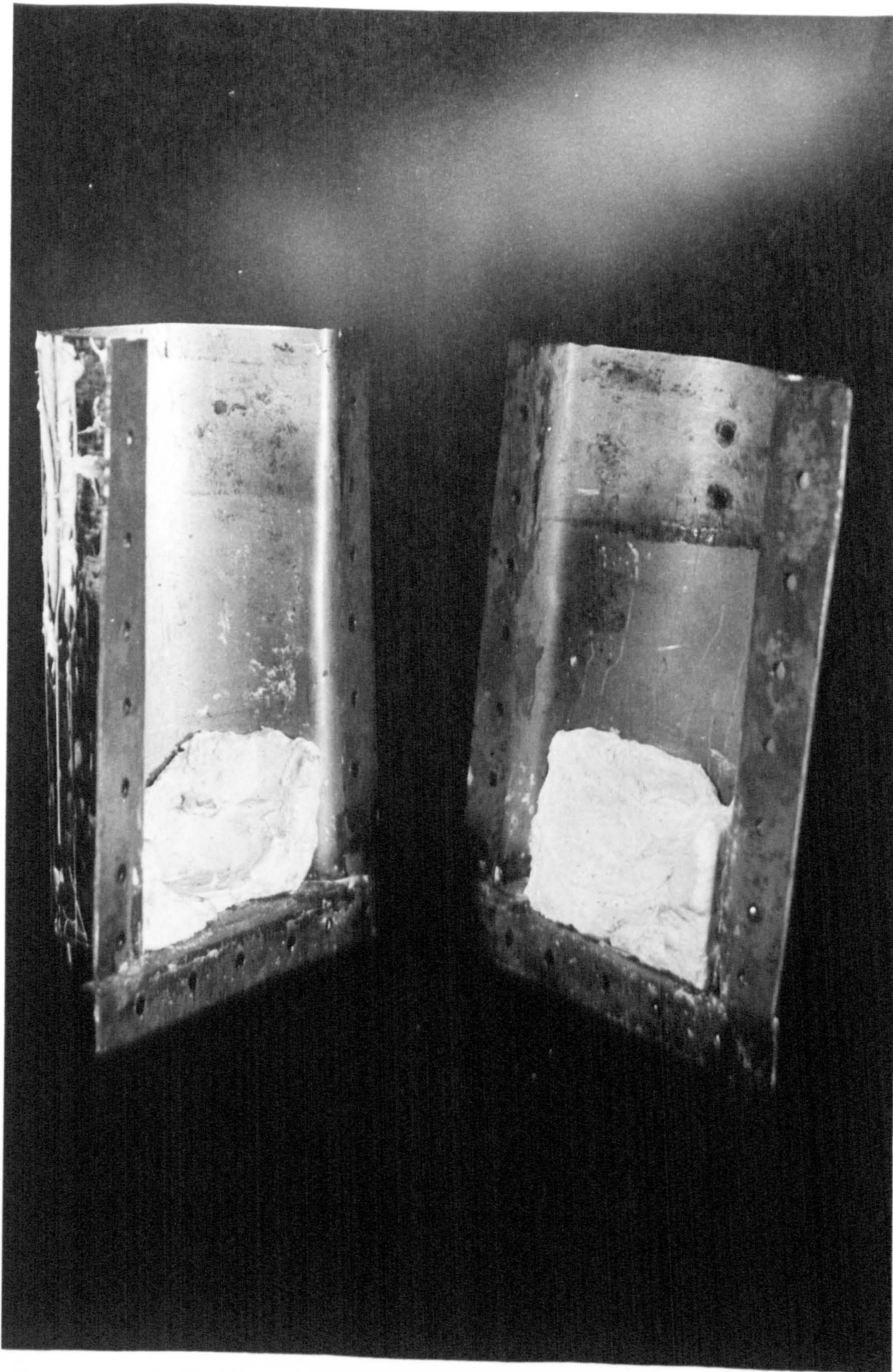

Fig. 4.5

Split casting container.

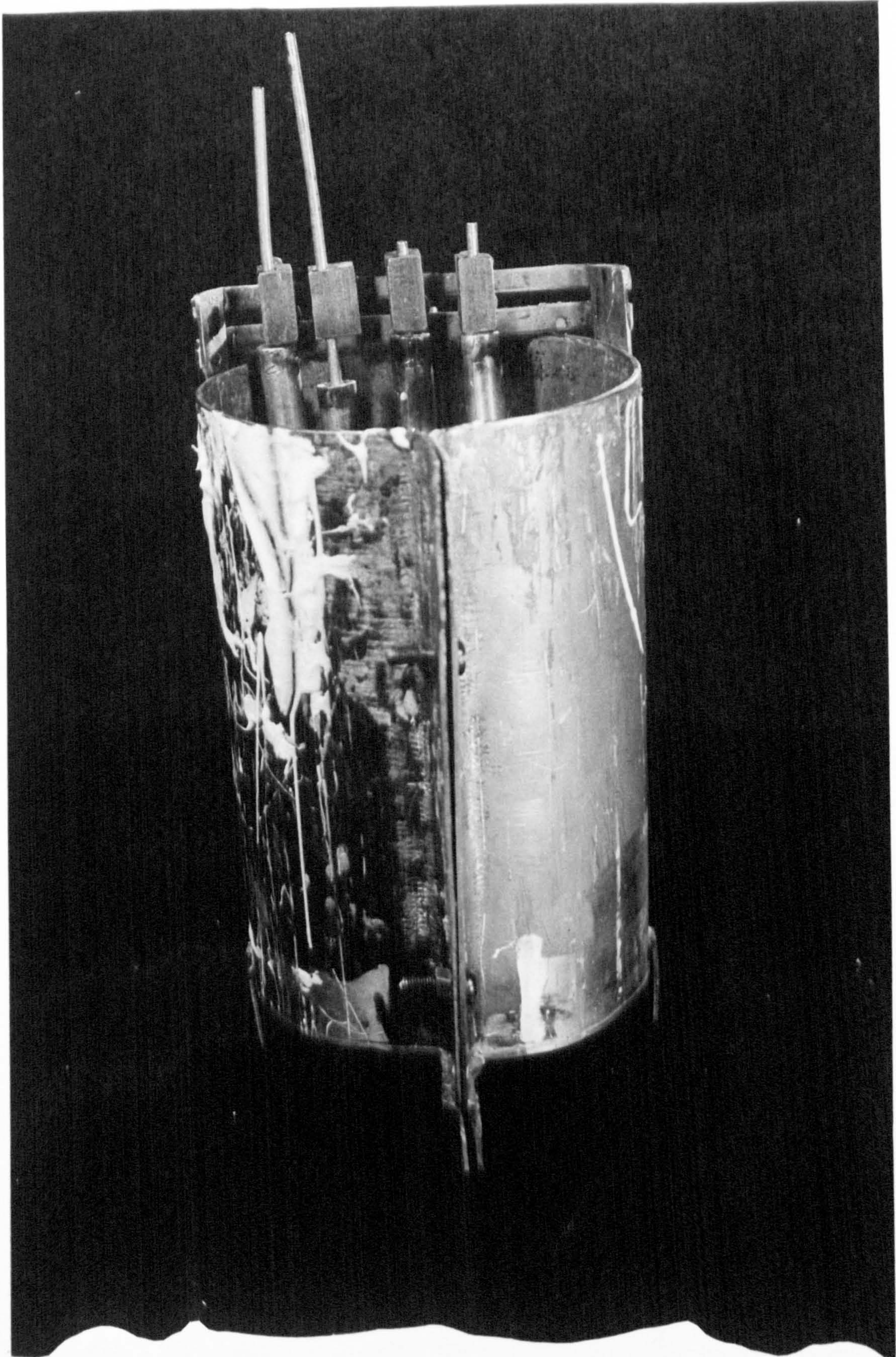

Fig. 4.6

Finger location tube in place in casting container.

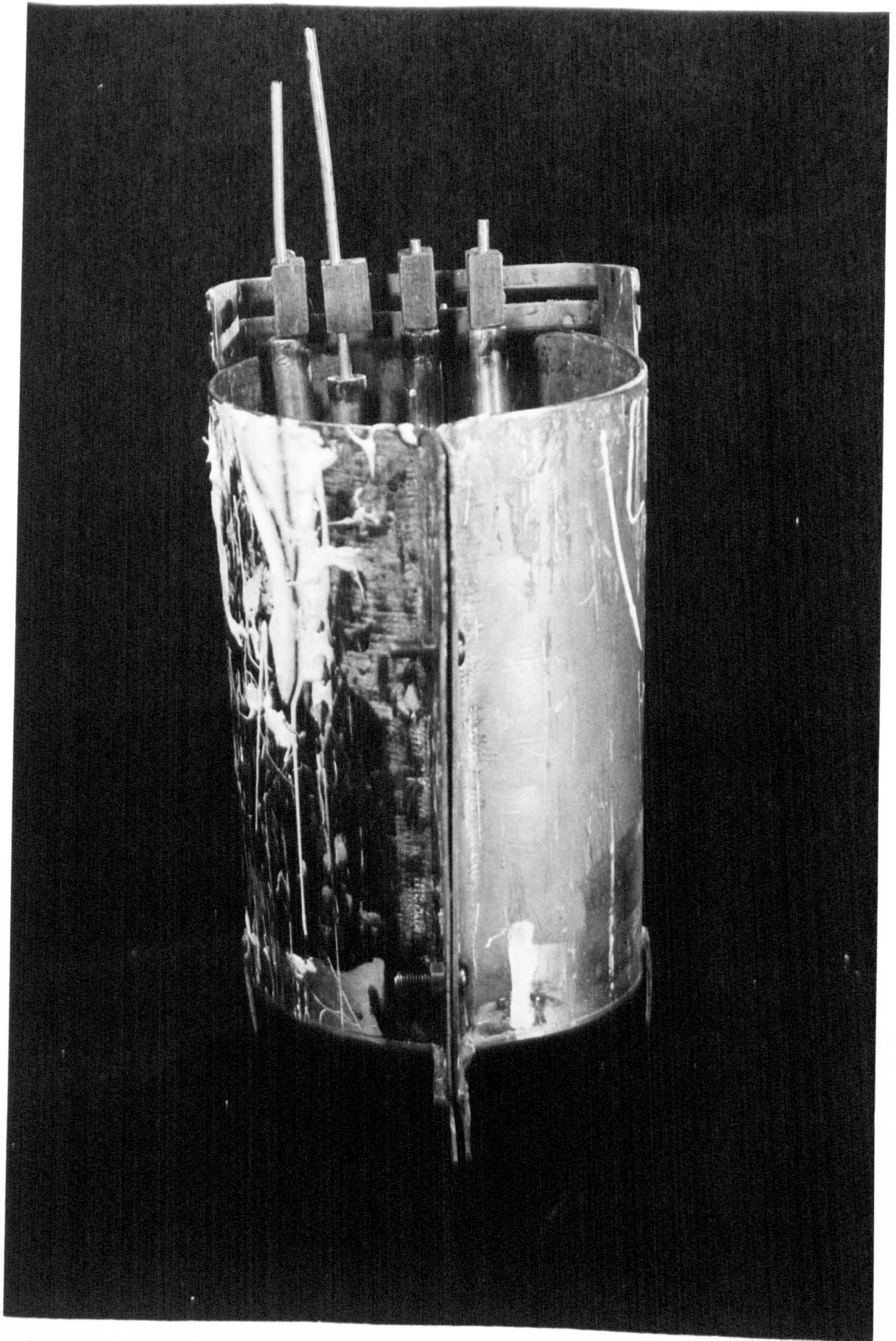

Fig. 4.6

Finger location tube in place in casting container.

4.8 Alternative materials in the process.

An ideal alternative to wax was found in the form of a low melting point metal alloy, which provided a robust casting, and was compatible with a system for avoiding the problem of air being trapped at the fingers. Details of this system, and of further experiences with the use of the alloy, with particular reference to casting problems, are given in Appendix 4.II. The use of this low melting point metal alloy was of particular significance in the context of the standard glove manufacturing process, which required the hand casting to be electroplated with copper, normally after the covering of a wax casting with conductive paint; whereas the metal casting could be plated directly.

4.9 The electroplating stages.

The procedure for electroplating the casting had been established earlier by other workers and was a routine procedure. The plating bath consisted of a tank containing acidified copper sulphate solution with a rectangular 'cylindrical' anode of copper. The cathode was the object to be plated, mounted centrally inside the anode, and driven round slowly by an electric motor in order to ensure even plating. As a further guard against local high spots of plating, the whole electrolyte was agitated by an electric stirrer. The temperature of the bath was maintained at a few degrees above room temperature by means of a fish-tank type heater. The power supply provided a current of up to 500 mA through the electrolyte, and could be varied at will in order to provide a suitable compromise between total time for plating and the porosity of the deposited copper.

In fact, no specific modifications to the apparatus were necessary to allow plating of cerrobend rather than wax, other than those structural reinforcements necessary to support the extra weight of the heavy casting. This was achieved by means of a cross-beam to support the load and a thrust race to permit rotation of the casting as cathode. The adjustment of plating current was made on a trial and error basis, to achieve a fine deposit of copper as rapidly as possible. It was found that plating for up to five days was necessary before the copper could be regarded as self-supporting following the melting out of the cerrobend alloy. The copper shell was then sent to a commercial nickel plating plant for structural thickening for strength.

4.10 Problems due to the electroplating process.

Experience with the plating bath soon showed that at least a week might be taken up by this process alone. For experimental purposes, a mould produced by this technique became a rare and valuable item, and clearly a rapid casting procedure was a desirable feature if suitable means could be found to arrive at an equally faithful reproduction of detail.

Thus, some specific attention was directed towards the requirements for the materials to be used in a casting process, bearing in mind the fact that the finished mould was required to withstand repeated heat cycling up to 150°C in order to cure the pvc plastisol. The details of the requirements for the mould materials are given in Appendix 4.III.

Experience with the use of the hollow copper moulds produced as a result of the electroplating process highlighted various practical

difficulties in addition to the severe mechanical release problem previously mentioned (Fig. 4.3). The particular significance of these problems is that they were direct consequences of the type of process being used, and the realisation of this fact led to the development of a radically different approach to the glove process.

The initial difficulty arose from the melting out of the wax or Cerrobend from the newly plated copper shell. In the case of the wax filled mould, the conductive paint remained adhering to the copper following the melting out procedure, and with the newly devised Cerrobend process, small amounts of Cerrobend remained adhering to the copper. These small amounts of residual material caused no problems until the first glove was extracted, when it was found that layers of the residual material came away from the mould, the layers being strongly associated with the glove, ruining the finish of the glove completely. This procedure had to be repeated as often as ten times before uncontaminated gloves could be extracted. Such a laborious method of removing excess material proved to be exceedingly difficult, particularly since the curved finger configuration made extraction of gloves difficult due to tearing at the fingers.

4.11 Further problems associated with the shell mould.

This problem of extraction was not alleviated by the use of release agents acting between the mould and the pvc layers, since the difficulty was chiefly a mechanical one, as is shown in Fig. 4.3. However, by increasing the thickness of the gloves it was possible to make gloves of sufficient strength to allow intact extractions by virtue of the application of extreme forces pulling the gloves from the mould.

Another time-consuming phase during the glove production process appeared in the form of the dripping out of excess liquid pvc from the shell mould. This step could take as long as 30 minutes for each layer of pvc, the curved finger configuration requiring dripping in several orientations, since a thorough dripping was necessary for the formation of a uniform layer of pvc which was retained in the mould only by surface tension, premature oven curing resulting in the formation of blobs as the decreased viscosity allowed the liquid pvc to flow more readily. In an attempt to overcome this problem a special centrifuge was designed in order to decrease the dripping-out time. The special feature of the centrifuge was that a self-balancing facility was introduced in order that two dissimilar glove moulds could be spun simultaneously, whilst perhaps losing excess pvc at different rates thereby causing an imbalance of the conventional centrifuge. Details of this device are given in Appendix 4.IV.

These problems arising from the use of the classical process were so numerous when the stage of final glove production was reached, that it was necessary to re-assess the whole procedure in view of the experiences outlined above.

4.12 The classical procedure reassessed.

The initial stages of the process had proved relatively successful after suitable modifications to suit the new shape of glove required; the casting in the alginate material was satisfactory, the attainment of the desired configuration was possible by two methods, and the metal hand casting prior to plating was of a highly acceptable standard. In addition, the quality of the gloves

which were successfully withdrawn from the moulds after removal of excess casting material was satisfactory, the pvc having all the necessary properties of flexibility, strength, and colouring.

However, against these points, the latter stages of the process had introduced several problems which detracted considerably from the overall success of the production procedure. These major difficulties could be summarised as follows:

1. The plating process required for the production of a robust mould was excessively time consuming, making the use of a more rapid casting process desirable.
2. Complete removal from the plated shell of the material which formed the positive model for the plating was virtually impossible.
3. Dripping out the excess pvc plastisol was a lengthy process.
4. The withdrawal in an intact state of the completed glove from the mould was difficult, and often impossible.

These faults could be attributed directly to two major factors, the former two defects being due to the necessity for an electroplating process, whilst the latter two were consequences of the use of a hollow shell mould.

Thus, in general, it could be said that the hollow mould process was only suited to the straight fingered hand configuration where the various problems are minimised, although not resolved. This fact may have been of considerable importance in restricting the development of mechanisms of a configuration differing from the standard pincer grip type, a fact which is borne out by a consideration of the literature concerning hand prostheses, showing that, of the mechanisms which are not pincer types, only the Swedish

hand (Lymark and Mohl 1967) has any provision for a cosmetic glove. The glove specified for this fully articulated hand was designed to be thin, elastic and disposable, thus permitting the mechanism to move, the shape of the glove altering by stretching rather than being particularly suited to the mechanism.

The conclusion to be drawn from these considerations was inevitably that the hollow mould process was holding back future developments, not only of the hand prosthesis being developed in Edinburgh, but probably elsewhere too. Thus, it was imperative to seek an alternative which imposed fewer restrictions on the conditions of use.

4.13 The principles underlying the use of pvc re-applied to suit the new conditions.

The production of a glove using a pvc plastisol necessarily operates by virtue of the deposition of a thin layer of pvc onto the mould followed by a curing process. The classical technique had used the immediately obvious technique of using a hollow mould for this purpose, since the detail could be readily transferred from a cast of the donor hand. However, this principle having proved unsuccessful, the alternative procedure of depositing the pvc onto the outside of a mould indicated a possible line of approach. The means for assessing the possibilities of using the outside of a mould was readily available in the form of some of the moulds produced as a result of the copper plating processes. These moulds, in the state prior to the nickel plating strengthening procedure, showed that the reproduction of detail on the outside of the copper shell was perfect in every way. No loss of detail

was incurred by the plating, indeed it was apparently accentuated, the ridges being of a relatively small radius of curvature resulted in a more intense local electric field, thus enhancing deposition of copper at these areas. The copper surface thus produced was clean, free of detachable scale, and possessed extremely satisfactory hand details. Tentative experiments with the dipping of the outside of the copper shell in pvc followed by subsequent curing, showed that a perfect glove could be formed and removed easily without the difficulty experienced using the conventional technique. The obvious problem was for the time being unavoidable - the 'glove' was a negative mould of the hand.

4.14 The new technique.

The most important step in the development of the new technique lay in the everting of the negative glove, thereby producing a glove of the opposite hand, with the surface detail made 'negative'. In other words a normal left hand had become a right hand with ridges and grooves interchanged (Fig. 4.7). The glove in this form was of no direct practical use, but it was apparent that a repetition of the whole procedure, starting from the everted glove as a positive could produce, by surface dipping techniques, a glove representing the original donor's hand. The process then ran as follows:

1. Take a cast of the donor's right hand - leaves a 'negative' mould.
2. Fill negative with Cerrobend to form a positive replica of donor's hand.
3. Copper plate positive in order to create temperature resistant shell, melt out Cerrobend to leave a shell.



Fig. 4.7

Everted finger showing reversal of detail.

4. Dip outside of shell in pvc and cure.
5. Peel off pvc and evert to give a 'left hand' glove with surface detail made 'negative', i.e. grooves have become ridges, ridges have become grooves.
6. Fill this everted glove with wax or plaster and use as the new 'donor' for a repeat of procedure to part 5.
7. After repetition, the glove is a right hand with surface detail made negative once again - thereby returning to the natural state where grooves are grooves and ridges are ridges.

4.15 The advantages of the new process.

Although this procedure as it stood was somewhat lengthy, it immediately removed two of the major obstacles presented by the use of the conventional technique. There was now no problem of flaking of paint or residual Cerrobend, and there were no release problems at all. This fact of easy release of the glove provided an immense stimulus for further investigations of the everting technique, since the whole procedure must become an easy routine before it could be considered successful.

4.16 The electroplating process reviewed and an alternative proposed.

The remaining obstacle, that of the lengthy copper plating process, was, if anything, aggravated by the new process. The copper shell mould had always been strengthened by further external plating with copper or nickel - this possibility was now excluded, but the need for reinforcement was not. It was therefore necessary to reinforce the inside of the copper shell. The possibility of plating in this situation was rejected immediately on two accounts; firstly the time factor would still be excessive, and secondly, the practical complications involved in plating the inside of a

shell would be prohibitive in many ways, namely, specially shaped anodes, problems of circulation of electrolyte in the closed environments, temperature control, etc.

The alternative to plating was to thicken the shell by some form of slush moulding technique. That is, by pouring in a material which would adhere to the walls, pouring off the excess and allowing the wall layer to solidify. This procedure could be possible for molten metals or epoxy resins of the Araldite MY720 type.

Despite the avoidance of strengthening by plating, a process such as that mentioned above, still absorbed a considerable amount of time (3-4 days) at the plating stage. Although the use of a thin-walled shell mould had been necessary for the conventional process, it did not follow that such a mould be essential for the dipping technique. Therefore, tests were made with the dipping of solid moulds, both metallic and non-metallic. Non-metallic moulds were found to be totally unsatisfactory, even after extended curing periods, two hours or more, the pvc remained only partially cured, never attaining full strength. However, using metallic moulds it was possible by extending the curing time from five minutes to 30-40 minutes at a slightly elevated temperature (155°C), to attain very acceptable pvc properties. This discovery opened the way for vast simplifications to the glove manufacturing process - for it was then possible to adopt a simple casting process. A metal with a melting point above $150-160^{\circ}\text{C}$ could be cast direct into the donor hand negative mould, and then be dipped in pvc and cured, thereby producing the glove for the everting stage. A repetition of this

procedure as before would lead to the production of the cosmetic glove itself by a simple dipping technique.

4.17 Mould production.

One problem remained at this stage - the sodium alginate being water-based, could not safely accept molten metals at temperatures greater than 100°C , due to explosive production of steam. However, an alternative was found in the form of a quick setting silicone rubber, resistant to temperatures of up to 250°C . A suitable metal for use with this rubber was tin, with a melting point of 233°C and of sufficient hardness to act as a long lasting master mould. The use of these materials appeared to be straightforward at first, but each developed difficult problems of technique, full details of which are given in Appendix 4.V.

4.18 The use of the mould.

Following the production of this metal casting, only two basic steps remained in the new glove manufacture procedure, namely the dipping and curing of the first pvc glove, followed by the everting phase, which was then to be followed by filling the everted glove for use as the donor for the complete re-cycling of the process. The technique for dipping and curing the pvc was perfected relatively easily, the main difficulty being encountered in maintaining the pvc thickness to a uniform level without the formation of drips. This was achieved by first allowing excess pvc to drip off naturally for ten minutes and then heating the hand by infra-red lamp in a sequence of orientations (Fig. 4.8). The infra-red lamp allows a pre-cure phase in which the surface layer of the pvc cures sufficiently to prevent flow and hence the formation of drips.

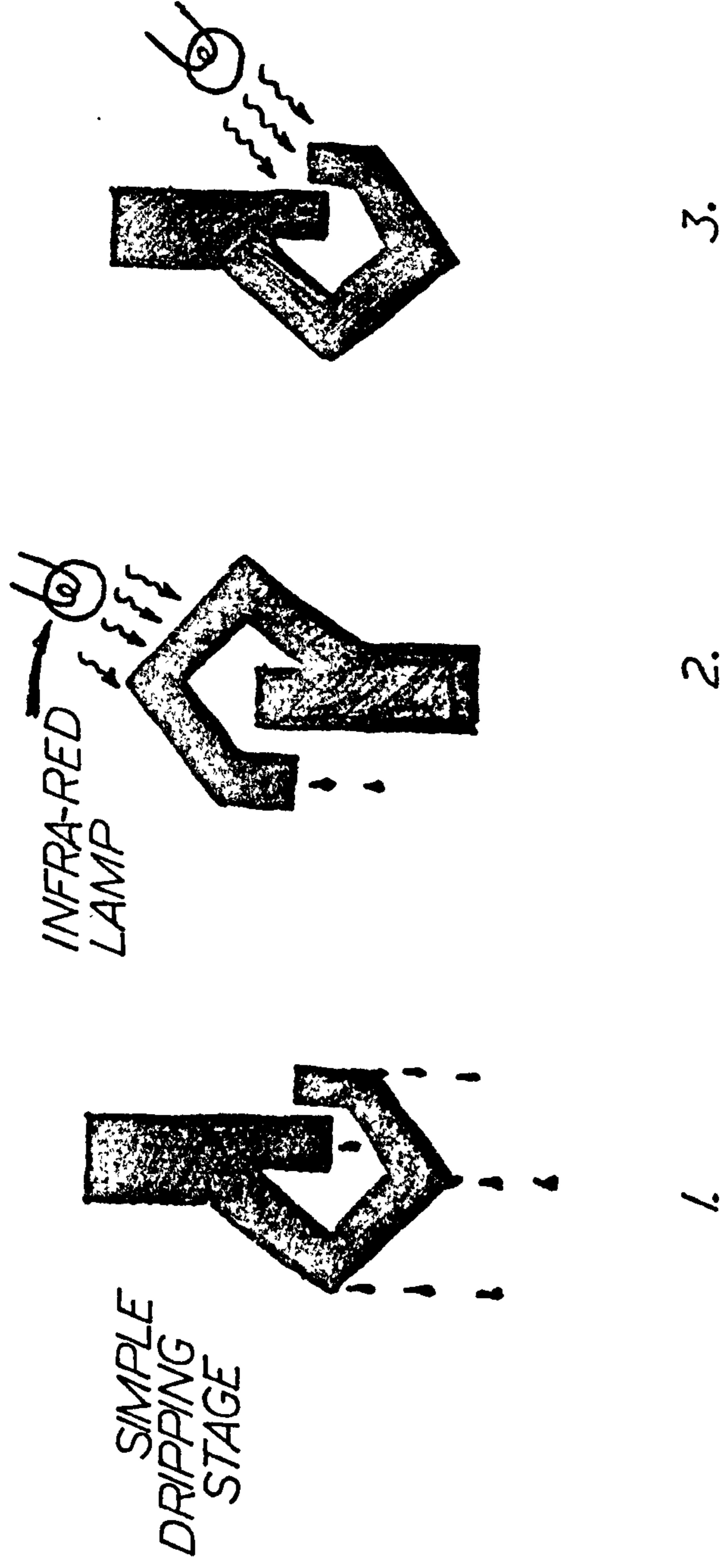

Fig. 4.8

Sequence of operations for removal of excess pvc from moulds.

The actual curing schedule was a simple modification of the normal procedure, merely requiring slightly longer at a higher temperature as mentioned previously.

4.19 The use of the everted glove.

In order to use the everted glove as donor for the second phase of the process, it was necessary to stuff or fill the glove, and to make minor adjustments of configuration to suit the shape desired. A special technique (Appendix 4.VI) was devised in order to achieve this in such a way that the stuffed glove acquired the consistency of stiff clay, thereby permitting a degree of moulding to be made to the correct shape.

The stuffed hand was then used as the 'donor' for a silicone rubber casting and the sprue rods were positioned on the fingertips before pouring the rubber, in order to ensure correct location of the air release holes at the metal casting stage. Following solidification of the rubber, the glove 'stuffing' was removed and the flaccid glove withdrawn from the mould. The metal casting procedure was then carried out as before, leading to the production of an everted detail metal positive hand - the master mould for all hands of that type. (Fig. 4.9).

4.20 A comparison between 'classical' and 'new' processes.

Having arrived at a glove production process suitable for the manufacture of 'rest position' gloves with curved fingers it was logical to compare the new procedure with the more conventional systems. This was simply achieved by listing the various stages individually, and attributing to each stage a loss factor which is a measure of the amount of detail lost by that process, and in this way it was possible to show that the new process was at least as good as the



Fig. 4.9

Master mould, with negative surface detail.

existing procedures in terms of the loss of detail due to the various processes (Appendix 4.VII).

4.21 Conclusions.

As a conclusion to this chapter it may be useful to summarise the complete new glove making procedure and to note some of the particular advantages of the simplicity of the process.

The first stage consists of a direct casting of the donor hand in a silicone rubber material, precautions being taken to ensure that the donor's hand adopts the desired configuration by virtue of location tubes for the fingertips. Following withdrawal of the donor's hand from the mould, a tin replica is made by pouring molten tin into the silicone rubber mould. A pvc glove is then made from this replica by dipping it in pvc plastisol followed by curing. The glove thus obtained on the outside of the mould is removed, everted and stuffed with plastics beads, and vacuumed to provide a negative surface detail hand which has the consistency of stiff clay. This hand is moulded to the desired shape and used as the donor hand for a repetition of the casting procedure in silicone rubber. Following solidification of the rubber, the stuffed glove is removed and a metal casting is made by pouring molten tin into the cavity in the rubber. The tin hand, with negative surface detail thus obtained is the master for glove production, since dipping in pvc followed by curing, glove removal and eversion produces a glove which has the full hand shape and surface detail. (Fig. 4.10).

One of the most significant factors concerning the latter stage of this process, is that the normal procedure of laying down

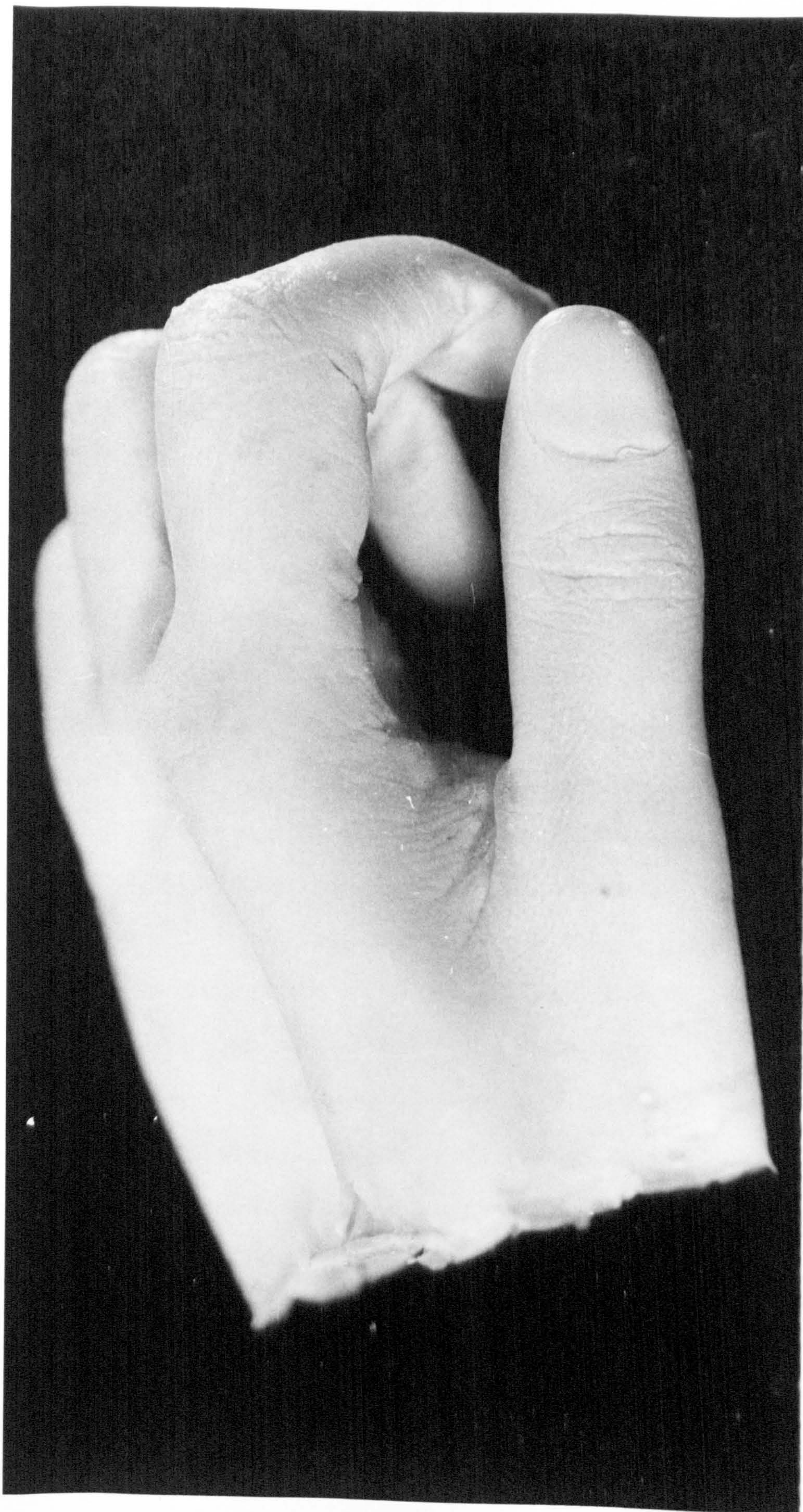

Fig. 4.10

Glove from the master mould.

two or three clear layers followed by the flesh pink layer is easily improved, since local colourings for knuckles and finger nails, etc. can be painted on the outside when desired, and can be sealed inside the glove by subsequent dipping.

Another significant advantage of this process is that the dripping phase can be reduced to a considerable extent by avoiding the physical dipping of the mould by painting the pvc plastisol onto the mould. This may be carried out either by brush painting or by spraying, which considerably reduces the time taken for the process to be completed.

Whilst the advantages outlined above are of importance to the process, the overriding advantage, which has many implications for the development of future mechanisms, is that any configuration of the hand may be reproduced with ease. The moulding process no longer restricts the design of the mechanism and permits a wide variety of gloves to be produced for specialised situations. Furthermore, the principle of moulding by eversion in this way is applicable to any complex shape which requires reproduction with the faithful copying of all the surface detail and overall form.

The ultimate conclusion to this section must therefore be that the new process is at least as good as the conventional one as far as detail transfer is concerned, whilst considerable advantages have been gained in terms of the time required for the process. In addition the extreme versatility of the moulding processes allows the production of hands to any configuration required with the minimum of alterations to the procedure.

Chapter 5.

The controls.

- 5.1 The role of the control system.
- 5.2 Historical.
- 5.3 The values of various control systems.
- 5.4 Hand control v. arm control.
- 5.5 The necessity for the development of new equipment.
- 5.6 Development work with valve systems.
- 5.7 Valve evaluation and testing.
- 5.8 Conclusion to practical developments.
- 5.9 Further improvements.
- 5.10 General assessment of control work.

Chapter 5.The controls.5.1 The role of the control system.

The constraints imposed upon the hand prosthesis by the limited number of control sites normally available present problems of an unusual nature, since the brief for a hand prosthesis must be that it be as versatile as possible, which appears to be contradictory to the availability of only one site for the control of prehension. However, it has been shown in previous chapters that a functionally useful mechanism can be produced, making use of a single functional movement in conjunction with the wrist rotation facility of the arm. The reduction of the activity of the hand to this low level necessarily required some considerable developments in order to establish the optimum mechanical arrangement, and clearly the control channels for hand and wrist had similar requirements for optimisation in order that the whole prosthesis be able to provide the maximum possible degree of function.

Thus the purpose of this chapter is to show the development of the relevant aspects of the various control systems which were applicable to the hand prosthesis. The wrist rotation control system to be described was, of course, applied in the arm prosthesis during the development of the hand mechanism, but this is included here since it is directly applicable to the function of the hand mechanism.

5.2 Historical.

The practical basis for the developments to be described below had been laid down by Simpson (1965) and the Edinburgh group in

the form of a position servo-control system applied to pneumatic actuators. In addition, Simpson (1963), in conjunction with Albutt and Chappell (1965) of Elliott Automation, had introduced the use of the force demand valve as the controller of the pneumatic medium, and subsequently Harborow had considerably modified the S.A.B.U. valve described by Bottomley (1966), the modified valve being intended for use in the Edinburgh prosthesis.

The justification for the use of these control principles has been referred to previously in Volume 1 and may be briefly summarised here by saying that the position servo control principle is desirable for its compatibility with the natural control system, whilst the force demand valve provides an additional feedback pathway which may be particularly appropriate for prehension activities.

Although these guidelines were an essential starting point for the development of controls for the hand, some clarification of the engineering implications was required before commencing the development of hardware, since the subtleties of the control systems have often been missed in systems for many other prostheses.

5.3 The values of various control systems.

The four possible basic control systems, on/off, position, velocity and acceleration, were considered in the light of the information available to the operator from the control of that variable. This appraisal of the control systems showed that, apart from its compatibility with the natural system of control, the control of position by the operator gave the best return of information on a purely mathematical basis (see Appendix 5.1), and

in addition gave control of the full range of dynamic variables for the problem.

The simultaneous control of all the dynamic variables in a servo mechanism adds considerably to the stability of the system, and all relevant additional information which can be presented to the operator is of importance to the degree of control which he can achieve. It is therefore useful to provide the operator with additional information such as details of the load to be moved, in order that the highly adaptable human control centres may modify the 'style' of control to allow for varying load conditions. This may be achieved by the introduction of a force feedback system from the motor to the operator which, when applied to a position servo mechanism, should not be regarded as the controller of acceleration, but rather as the indicator of the load state.

This distinction between force feedback as an indicator of load and the application of the acceleration force has important implications for the dynamic control of prostheses, since the combination of force feedback and position feedback covers the complete range of variables for the dynamic problem (Appendix 5.II).

Therefore, by adopting a position servo type of control, together with feedback of applied force, a degree of stable control should be achieved over all aspects of a dynamic problem, if the operator is made part of the dynamic system. Such detailed control over the various modes of a dynamic system is particularly necessary for the smooth actions required of the arm prosthesis but, more significantly, it matches the normal physiological system, although the reason for the 'matching' may be the fact that the position control system merely provides the most comprehensive source of

information for the human system. These considerations clearly illustrated the benefits to be gained from continuing the development of both the position servo control mechanisms and the force demand valve, the valve being of prime importance since the design and operation of the servo mechanisms depended directly upon the valve characteristics.

5.4 Hand control v. arm control.

Before commencing an account of the development of the control hardware, it is necessary to indicate the fact that the general control philosophy outlined above could not be applied directly to the control of the hand gripping action in its entirety, this fact arising from purely practical considerations, the major factor being the influence of friction in the position feedback systems.

The existence of friction in practical position feedback links of more than a minimal length has the effect of degrading the force feedback content of the returning signal. Thus, pending the evolution of more ideal feedback links, it was essential to consider the relative importance of force and position information content for the motion concerned, and in this situation the different roles of arm and hand are emphasised.

The positioning role of the arm as a mobile platform for the hand is the major part of its function, and as such, the position information feedback pack is absolutely essential. However, as previously explained, the additional use of force information feedback can improve the control of the dynamic phase of arm movement. Therefore, in the feedback systems related to arm movement, position feedback must be the prime factor, with force feedback being included and used as far as the practical

limitations permit.

By contrast, the control of a single movement hand prosthesis need not rely upon the use of position information - the thickness of a cup handle is of no particular significance, but the force required to grip it is crucial, as is knowledge of the force when grasping an egg! Thus, no degradation of force feedback is permissible for hand control, which in turn implies that position information feedback is unlikely to be possible until extensive improvements could be made in the feedback links.

These facts therefore indicated the pattern of control systems development, the initial developments being required in the design of force feedback systems, and of force demand valves in particular, followed by subsequent attempts to improve the existing position feedback mechanisms, all in the context of systems using a pneumatic power source.

5.5 The necessity for the development of new equipment.

A review of commercially available pneumatic equipment showed that there was nothing available which could be considered for use in a prosthesis, on the grounds of the physical size of the commercial pistons and valves, a fact which contributed to the other main problem with proprietary equipment which was an excessively high flow rate, and hence consumption of the gas power source. An example of the problems presented by readily available equipment is provided by the description of a commercial valve: Size 25 x 22 x 22mm, connecting tubes 6mm bore, flow rate several litres per second. By comparison, consider the rough specification for a prosthetics valve: Size (maximum) 12 x 12 x 12mm, connecting

tubes 1mm bore, flow rate at most a few litres per minute. Therefore, the initial problem was to provide the control facilities necessary for the achievement of position-servo control, with force feedback, using the modular cylinders developed by Harborow (1969).

5.6 Development work with valve systems.

As mentioned previously, Harborow had also produced a force demand valve based upon Bottomley's S.A.B.U. valve, and this (Harborow's) valve formed the basis of the technical developments which are described in Appendix 5.III.

The essence of this work was that a total redesign of the valve was necessary, which required the acquisition of a considerable amount of data concerning the flow characteristics of the CO₂ gas under particular conditions. The details of the experiments required in order to accomplish this are also given in Appendix 5.III.

Concurrent with the work on valve design, the development of a double-acting valve system was being pursued, the nature of the double-acting piston actuators being such that either two valves be employed, one for each side of the piston, or a single valve may be used in conjunction with a changeover 'switch' (Fig. 5.1). The degree of success achieved with the force demand valves led to the choice of the former of the alternatives, since the development of a changeover valve would have provided further specialised development work of uncertain duration. At this stage it was felt that the mechanical solution of using two valves would prove to be a relatively simple task, but as subsequent experiments showed, the practical solution required some considerable attention, resulting

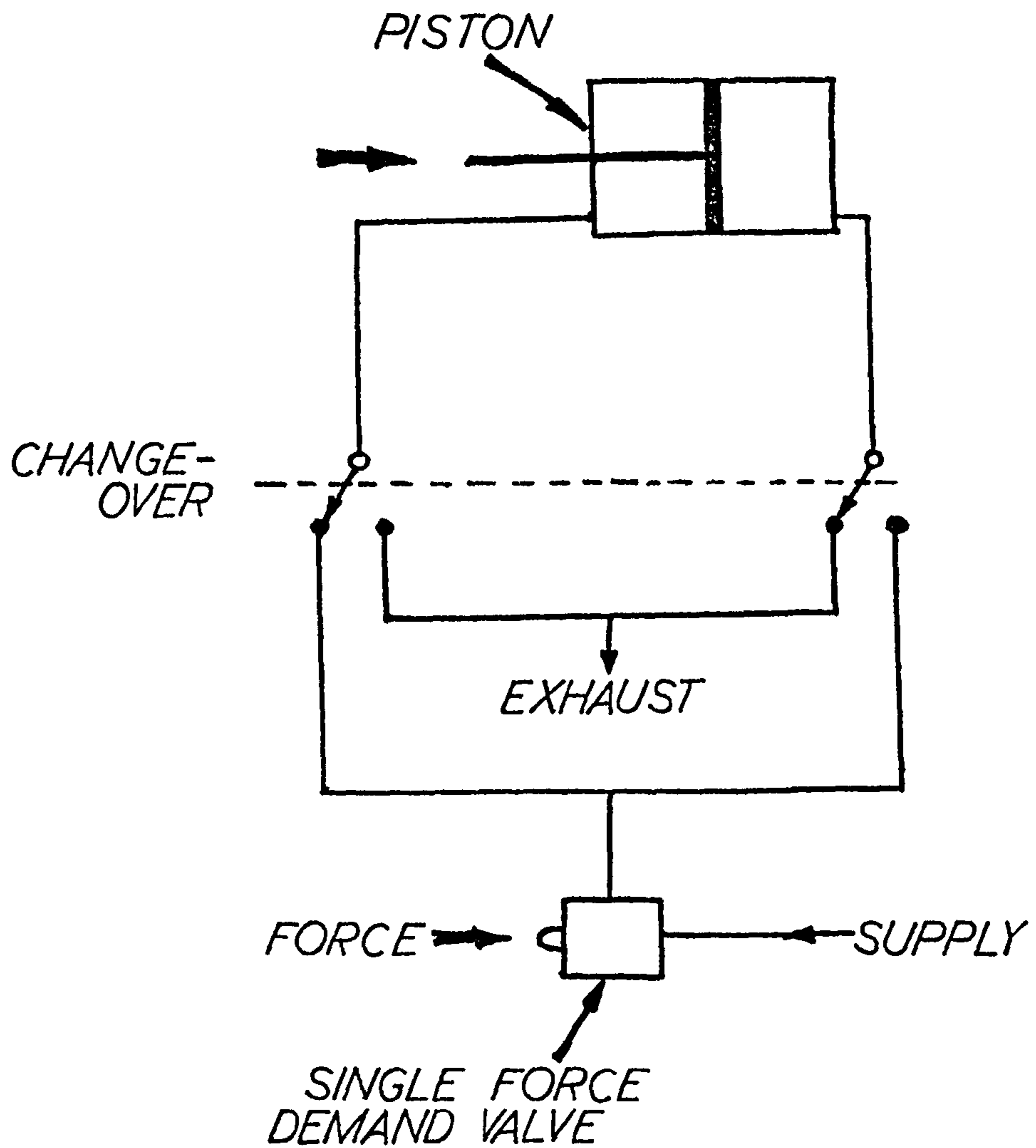

Fig. 5.1

The use of a single force demand valve with a double-acting actuator.

in the production of a special, pre-aligned modular valve assembly which could be readily introduced into the arm mechanism (See Appendix 5.IV) (Fig. 5.IV.5).

5.7 Valve evaluation and testing.

These valve assemblies were evaluated as part of the control systems fitted to the arm prostheses, since these provided an immediate test-bed for the control developments whilst the hand mechanism development was proceeding. The requirements of the arm prosthesis also provided the basis for the development of position control servo mechanisms, making use of the valve assemblies referred to above, and this work consisted of providing an adequately reliable system for supplying the operator with detailed information concerning the positions of the various joints. Details of these developments are given in Appendix 5.V where it is seen that the problem presents many difficulties in terms of reliability and in terms of the lack of well defined design criteria.

5.8 Conclusion to practical developments.

Thus, the controls for the arm and hand prostheses used the same hardware, but in different ways, with accurate force feedback being achieved for the hand prosthesis by means of direct use of the force demand valve at the control site, and the position feedback from the arm movements being transmitted to the control site by the use of compact Bowden cables. In the latter situation the degradation of force feedback was reduced as far as possible by minimising the physical length of the feedback system.

5.9 Further improvements.

One of the major difficulties in improving pneumatic servo

systems lies in the absence of a simple mathematical model which can adequately simulate the system. Such a model would be of considerable use in analysing possibilities for future development, in particular relating to methods of gas economy and the optimisation of system characteristics from the operator's point of view.

Several workers have attempted theoretical analyses of pneumatic servo-systems, and these have been reviewed previously, where it was concluded that the existing work on this topic was inadequate due to an over-indulgence in approximations and a choice of valve systems which ensured that the results would be oscillatory in nature. Therefore, since the previous work on a theoretical analysis of the pneumatic servo system was clearly inapplicable to the highly stable systems encountered in practice with the arm described earlier, it was necessary to carry out an analysis of this system in particular, and this work is covered in Appendix 5.VI. It is hoped that the completion of this analysis will lead to the improvement of the characteristics of the control systems, particularly in reducing force feedback errors in mechanical feedback links, since a fuller understanding of the pneumatic systems may well lead to position feedback via low friction pneumatic links (for example see Appendix 5.VIII).

5.10 General assessment of control work.

Thus, the practical developments outlined in this chapter led to the extensive use of modular valve assemblies in the control systems of the arm prostheses and for the control of the various terminal devices in use during the period of hand design. In

addition this period of experience has led to the use of valves in a modular system, permitting the rapid exchange of faulty assemblies. However, persistent faults originating in the force feedback diaphragm of the valves led to an excessively high incidence of accurate repairs being necessary, and this problem was overcome by the simple expedient of replacing the force feedback diaphragm by a sliding O-ring seal, thereby permitting wear to be taken up by large scale movement of the valve needle rather than by stretch in the diaphragm which had caused the previous high failure rate.

So, by a combination of conventional engineering design procedures and subsequent modifications indicated by experience with the control systems in practice, it was possible to provide control systems which were adequately reliable in use and could be utilised effectively in providing the patient with force and position information feedback from the prostheses. However, the limitations of these systems made it clear that further basic work was essential, with particular emphasis upon the design of low friction feedback links and the theoretical analysis of the pneumatic servo systems in general. These aspects of the work are continuing at the time of writing, and it is anticipated that results will soon be forthcoming in this field which will lead to a considerable improvement in the control of powered prostheses.

Chapter 6.

The results and conclusions.

- 6.1 The assessment of results.
- 6.2 Results with the arm prosthesis.
- 6.3 Experience with the hand prosthesis and its evaluation.
- 6.4 Cosmesis.
- 6.5 Function.
- 6.6 Robustness and reliability.
- 6.7 Weight.
- 6.8 Control.
- 6.9 The continually changing nature of the problem.
- 6.10 The achievements summarised.
- 6.11 Future developments.

Chapter 6.The results and conclusions.6.1 The assessment of results.

The work which has been described in the preceding chapters has been concerned with the various stages of development of a complex system, and as such the results of the intermediate stages of development have been covered in context. Therefore, the purpose of this chapter is to assess the results obtained with the systems as they are at the time of writing.

However, in attempting to assess prostheses it is difficult to formulate an assessment procedure which lends itself to written exposition. This problem arises from the fact that the hardware may be assessed in laboratory tests which may prove that an arm may have a life of 10^4 cycles etc. under certain conditions; but this bears no practical relationship to an environment where the rough and tumble of a school playground is representative of the conditions of operation.

Thus, the important aspect of the assessment is in the form of subjective impressions from patients, combined with evidence of the extent of use by patients. These two categories represent the only valid evaluation procedures for limb prostheses beyond the basic mechanical design stage, and it is fortunate that with externally powered prostheses, the rate of use of the energy source provides an accurate means of assessing extent of use. This situation is not so clearly defined when body powered prostheses are being assessed, although a running record of breakages and repairs provides a useful guideline.

Finally, it must be noted that the interpretation of the patient's subjective response must be made with considerable care, since the response may be described in a manner which is not directly related to the cause; for example, complaints of excessive weight in a prosthesis may often be remedied by the adjustment of harnessing for increased comfort. Similarly, patient comments about the extent of their use of the prosthesis can be unreliable, and in this situation the repair record and power consumption are useful indicators.

6.2 Results with the arm prosthesis.

The results obtained with fitting the arm prosthesis have been encouraging, as the gas consumption figures for 1972 illustrate. The average use being two thirds of a 180g bottle of CO₂ per day for a full arm prosthesis, which represents approximately 400 cycles of elevation actuator activity every day.

This rate of utilisation of the arm prostheses led to the modifications in design which have been described elsewhere (Simpson and Kenworthy 1973, Kenworthy and Simpson 1973), with various major changes in design being required. However, the most persistent fault has been with the control systems, gas leaks and cable breakages being recurrent faults. This has also been the case with the tape and pulley version of the arm prosthesis, there being only three cases of tape failure to date, in comparison with innumerable quantities of faults such as frayed cables and gas leaks.

Thus from a mechanical point of view, considerable attention must be paid to control system design in order to eradicate faults which occur in a manner which does not always result in complete failure but rather as a reduction in performance.

Subjectively, the reaction to the arm prostheses has been generally satisfactory, the influence of mechanical faults being reduced as far as possible by the constant provision of a second set of arms as a back-up in the event of failure. Thus, it can be said that the use of the arms was effectively continuous, and that the reactions to the arms were substantially independent of the various aspects of mechanical failure.

The control principles and movement pattern of the arm prosthesis have been well proven, to such an extent that even a new-comer to the use of powered arms was able to perform sufficiently well to play chess, and win, after a mere forty minutes of use of the arm. This rapid learning process, which is of the order of hours at worst, prevails throughout the fittings of prostheses operating upon the control systems previous described, and is a mark of the compatibility of the concept of position control with the natural system.

The general appearance of the arm prosthesis has been considered satisfactory by the patients, although there are no particularly severe constraints in this area since clothing covers the arm. However, for the amelic patients, certain aspects of the shoulder attachment and the position of the shoulder rotation axis have given some cause for concern.

The chief difficulty at the shoulder occurs because of the necessity for the external attachment of an arm outside the distal end of the clavicle, thereby effectively adding a full arm width to the natural shoulder width. This is in contrast to the natural shoulder joint which fits in beneath the clavicle to a

large extent, there being no external space for this in the thalidomide anatomy. Thus, there is considerable pressure to reduce the width of the arm at the shoulder in order to reduce the 'American footballer' effect.

The other problem arising from the shoulder is that the position of the axis of shoulder rotation is such that when the arm is held out straight in front of the body, the amount of shoulder adduction allowed is limited by the arm interfering with the chest, thereby preventing the hand from reaching the mouth. From a purely mechanical standpoint this could be remedied by moving the shoulder rotation axis forward; however, the extent of this movement is limited by cosmetic considerations.

The short-term remedy for this problem was to introduce a degree of permanent wrist flexion which, when combined with active supination, effectively provides wrist adduction during feeding, thereby bringing the hand round by the required extra amount. However, in this situation the axis of wrist rotation remains in line with the semi-adducted arm, and thus, for a right arm, food and drink tends to be tilted across the mouth from right to left. This problem was overcome by permanently adducting the hand and the wrist rotation axis by 30° , thereby providing the extra adduction and improving the wrist rotation situation for feeding.

The temporary solution of the problem of the restricted movement at the shoulder by means of wrist adduction is not ideal, and serves to highlight the need for an arm design which incorporates a 'crooking' of the elbow when the elbow is flexed - since this is how the interference of upper arm and chest is avoided in the

natural arm, the elbow being raised away from the body during feeding, for example. Another remedy may be to introduce some humeral rotation, which would also alleviate the problem.

One of the most frequently recurring complaints from patients concerns the length of the arm prosthesis, particularly the length in relation to clothing. Thus, if the prosthesis is longer than the clothing used by the patient, the arm is considered as being too long, although the length of the arm itself may be of the correct size for a child of that height. This situation means that information relating arm length to body height is of less practical use than knowledge of the size of shirt, for example. In this situation it is essential to allow for adjustments of arm length, intermediate between the standard sizes already produced, and it is possible to achieve this in the tape/pulley version of the prosthesis by the combination of a simple alteration of side-plate length and a change of tape length.

Thus, in summarising the results achieved in arm prosthesis development, it can be said that very significant advances have been made in the progress towards the rehabilitation of patients requiring externally powered arm prostheses. The extent to which the patients have used the prostheses is indicated by the use of gas supply bottles, and the local success of the prostheses has been such that there has already been one fitting of a set of prostheses in Germany, with further interest being shown from various other overseas countries.

However, this is not to record an absolute success of the prostheses since the success has been due to the establishment

of a working system of prosthesis hardware, control principles and back-up/repair service in such a way that necessary alterations of design and the repair of faults, can be carried out without disruption of the continuity of fitting. Therefore, an arm prosthesis must be considered to be in a state of continuous development, which is still proceeding and will continue to improve as a wider range of experience is gained.

6.3 Experience with the hand prosthesis and its evaluation.

In the case of the development of the hand prosthesis itself, the results are more clearly defined than those with the arm prosthesis, since there is experience with existing hand and hook prostheses which provides a useful basis for comparative assessments of the new device. However, before commencing the analysis of the results, a consideration of the evaluation procedure is necessary, since there has been no formal evaluation in the sense of laboratory tests with cubes of such and such a size and tests of coefficients of friction etc; in place of this approach, the evaluation has been made as the result of 'in the field' use, with an appreciation of the patient's capabilities with the device. Once again, there have been no formal test procedures, the patient has merely been given the prosthesis in a real life environment.

The justification for this approach is quite simply the fact that the relevance of any other tests cannot be assured, since stylised tests lose the intricate detail which characterises the 'living situation'. Similarly, a series of tasks carried out by a patient under laboratory conditions is not representative of normal usage, unless of course the device is completely unusable. Thus, the most effective test is to provide patients with the

prosthesis in a normal environment, and to judge the device by reports from the patient and people observing the patient in normal conditions. In this way, the maximum amount of information is acquired in the minimum time, as there is no more efficient way of discovering faults than satisfying the needs of school children in respect of the continuous maintenance of limb function.

In order to assess the success of the hand project in terms of practical value to the patient, it is useful to reconsider the objectives at the time of commencement, which were as follows:

- (i) Hand to be cosmetically acceptable in shape, colour, texture and general appearance.
- (ii) Function to be at least as good as a hook prosthesis.
- (iii) To be robust and reliable.
- (iv) To be light in weight.

The results obtained with the production version of the hand prosthesis which has been applied in three fittings will be considered in relation to these criteria (Figs. 6.1, 6.2, 6.3, 6.4, 6.5 and 6.6). The fittings have been carried out on the powered arm prosthesis for the thalidomide group (2 fittings) and on a body powered prosthesis for a bilateral upper arm amputee (one fitting).

6.4 Cosmesis.

The hand has been very well accepted by the patients; even before experiencing the functional properties of the device there has been keen interest in obtaining the new hand prostheses in preference to the commercial device. This factor is extremely encouraging from a purely cosmetic standpoint, although the

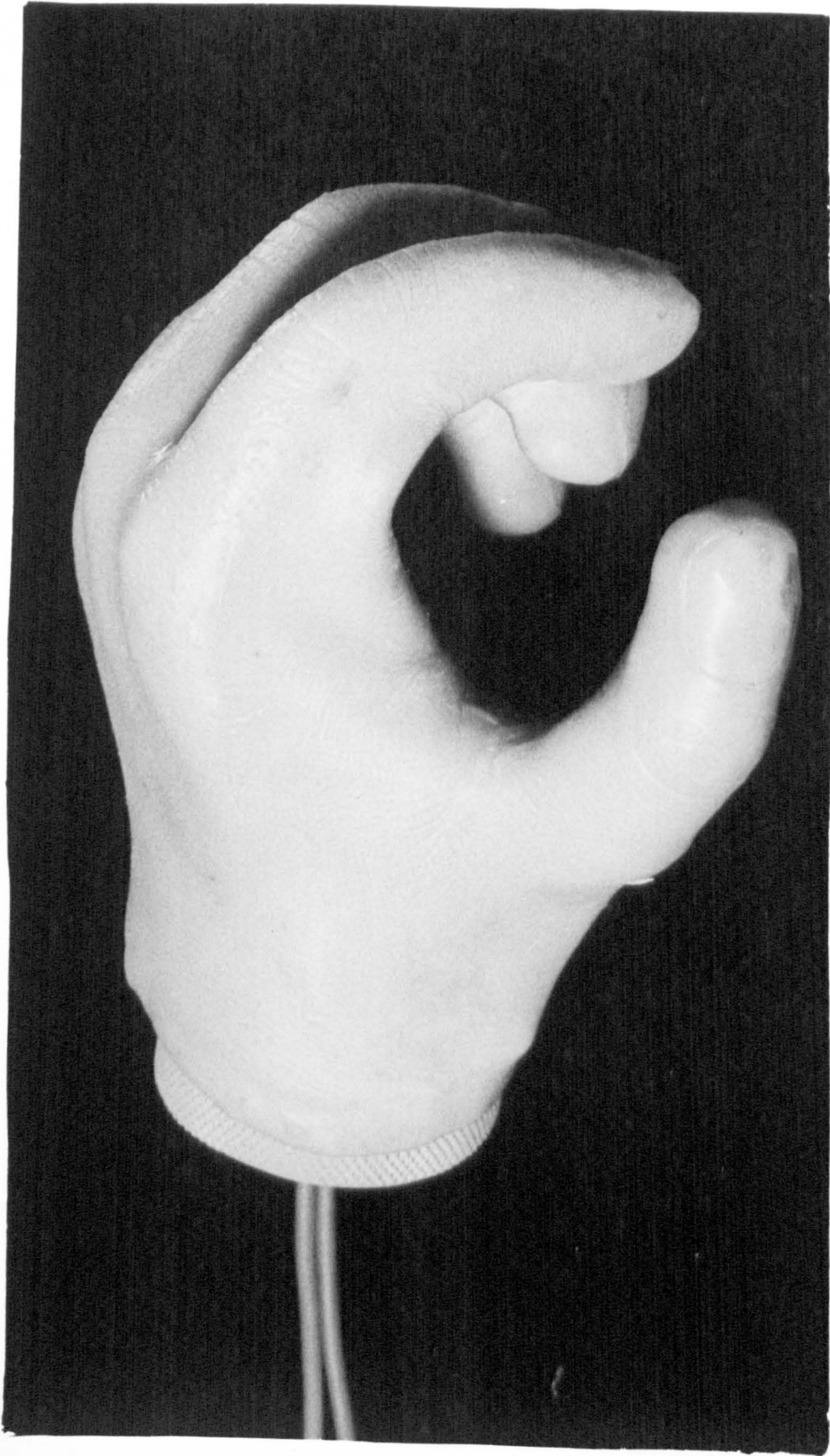

Fig. 6.1

The complete hand prosthesis.

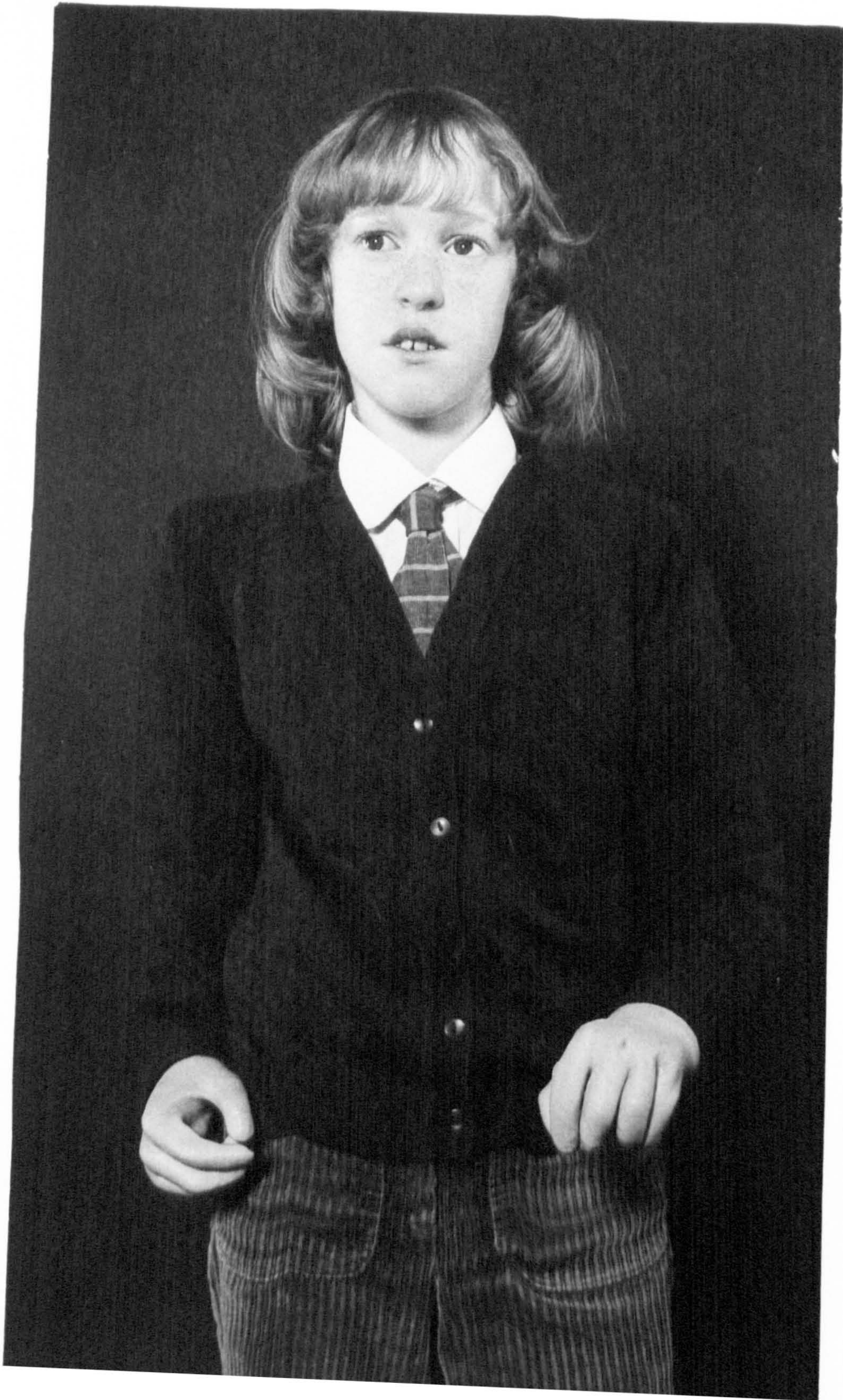

Fig. 6.2

The cosmetic effect.



Fig. 6.3

The cosmetic effect.

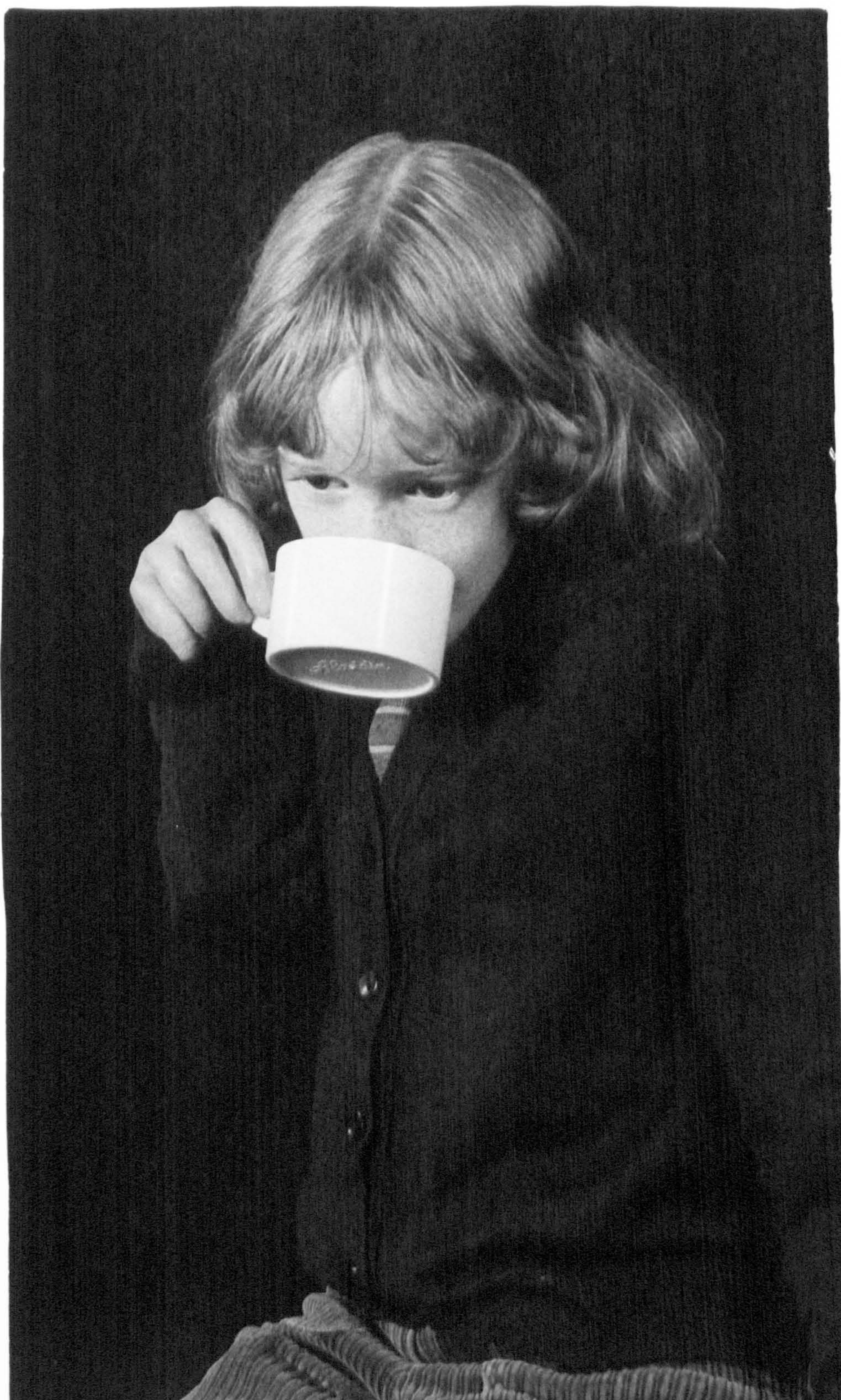

Fig. 6.4
The prosthesis in use.



Fig. 6.5

The prosthesis in use.



Fig. 6.6

The prosthesis in use.

attraction of the appearance appears to be so strong that there must be some concern for the validity of any lack of adverse comments about the functional aspects of the hand. Comments concerning appearance have been very favourable from non-patient sources, although one drawback appears in the form of the attitude of the hand whilst the elbow joint is fully extended, and the arm is down by the side. In this configuration, the hand protrudes forward at right angles to the arm, creating a somewhat unnatural appearance. This problem is sometimes overcome by the patients themselves who tend to hold the arm with the elbow slightly flexed, thereby making the hand attitude appear more realistic. The body powered arm prosthesis has a built-in passive wrist flexion/extension facility by which means the hand can be moved into a natural resting position, and studies have been commenced for the introduction of a similar facility into the powered arm prosthesis.

Certain observers have commented upon the colour of the glove, some suggesting that the hand is too pale, others suggesting that the colour is too deep. This problem has no universal solution, since it is a matter of personal opinion, and until gloves are made in large numbers, it is difficult to provide a wide choice. However, the proposed manufacture of gloves with tinted knuckles, blood vessels and fingernails is expected to have a favourable influence upon the matter of preferences in colour.

Finally, certain parts of the mechanism, on the underside of the hand, causes slight protruberances under the 'skin' to become visible at certain stages of the thumb motion. This problem is readily overcome in larger hands, due to the increase in available

space reducing the extent of protrusion. However, in the child-size hand currently under consideration, the problem will be overcome in future models by the introduction of 'tendons' in the appropriate areas, causing the glove to adopt a more natural profile over the offending lump.

Thus, it has been found that the hand prosthesis represents an intrinsically acceptable device on cosmetic grounds, with such difficulties as have arisen being of a simple nature, apparently requiring only minor modifications to be made in order to provide a hand worthy of no comment at all - the mark of success in this situation.

6.5 Function.

The original specification called for a degree of function comparable with that of the hook device, and in practice the hand appears to be an improvement on the hook in most respects, although there are deficiencies, such as an inability to pick up coins directly from a flat surface and limited access to confined spaces such as pockets, the limit being set by the depth of the space between middle and ring fingers. However, in all other aspects of function which have arisen to date, the hand is at least the equal of the hook.

The most effective illustration of the functional aspects of the hand is its performance in normal 'daily living' tasks such as the handling of cutlery, cups, hair brushes, combs, etc. since the degree of independence of a disabled person is to a large extent represented by the ability to cope with situations such as feeding, grooming and the manipulation of clothing. (Figs. 6.3, 6.4, 6.5 and 6.6).

Clearly, the previous success of the armprosthesis implied that these tasks could be performed to some extent with the then available terminal devices, however the significant drawback was the fact that help was required for the placement of the gripped objects in the correct position in the hand or hook. This procedure was required for the majority of objects, with cutlery, for example, requiring to be forcibly wedged between the fingers of the hand in order to achieve a stable grip. Thus, although the arm prosthesis enabled the patient to perform tasks, considerable assistance was required in the satisfactory setting up of the terminal device and the gripped object; which is a familiar situation with many terminal devices, frequently to the extent that specially modified utensils are required.

The stability criteria inherent in the design of the new hand prosthesis gave rise to a situation which permitted the picking up operations to be performed by the patient himself, subsequent readjustments being possible by making use of arm movements combined with the passive use of adjacent surfaces. This is particularly significant for the use of cutlery and pencils, etc. where it is now possible to grip these objects in a stable and natural configuration with no external assistance.

The manipulative possibilities contributed by the hand design, in conjunction with the extremely stable grip which results, make the function of the hand prosthesis a considerable improvement on that of even the hook device, since the familiar stability problems such as the expulsion effect of the angle between hook jaws have been overcome by the finger configuration and the adaptive gripping surfaces.

Thus, the new hand prosthesis represents a real increase in the degree of independence of the bilateral amputee, since he is now provided with a terminal device which is capable of real prehension, as opposed to a gripping device which is merely a means of holding certain objects.

It is apparent that the competence of the hand in these aspects of function is real, since the observations of the ability of the patients to perform tasks are consistent, whether the information comes from the patient direct or from school teachers, relatives, members of staff, etc.

On the debit side, there has been one mechanical failure to date, this fault took the form of the thumb becoming detached from its driving shaft, the breakage being due to faulty brazing. However, the removal of the mechanism required a few seconds' work, and the thumb was replaced in a matter of minutes; all this without requiring the removal of the glove. Thus, it was apparent that mechanical repairs by substitution should be the most rapid and efficient method of repair.

In addition to the mechanical failure of the thumb, one other drawback has been observed in the form of the limited extent of opening of the thumb. This problem can be remedied very simply by an alteration of the gearing in the thumb mechanism; this will be carried out in future models since the resulting mechanism will retain the simplicity of the existing mechanism. A return to the articulated thumb mechanism, which arose in early experiments, is not contemplated, since the additional mechanisms lead to introduction of two extra active mechanical joints and two extra moving parts.

Probably the most important technical result of all has been the fact that it is essential to achieve precisely the correct relative positions of the fingers and thumb, in order that the versatility of the grip be maintained. This fact had been anticipated in the design stage, but was reaffirmed by practical experience, the most vital point being the position of the tip of the middle finger - this must be in line with the tip of the index and the axis of the thumb rotation. However, this presents no particular difficulty beyond ensuring that the position is satisfactory.

During the experiments which established the hand design, it became apparent that the overall versatility of the hand was dependent upon its being used in conjunction with the wrist rotation. This fact was confirmed by the practical use of the hand, which showed that the existing wrist rotation was inadequate in certain respects. One of these failings has been outlined already, the axis of wrist rotation having required some reorientation. In addition to this, it was apparent that the wrist required to be rotated in either direction from the prone position in order that full function should be realised. This contrasted with the existing wrist rotation system which, for a right hand, rotated the wrist 180° in a clockwise direction (observed from the elbow) from the prone to the supine position. However, it is apparent that if a cup is grasped by the hand in prone position, rotation in an anti-clockwise direction is necessary for the cup to be tilted towards the mouth. Thus, it was necessary to ensure that the prone position of the hand was intermediate between the extremes of the rotation movement.

In conclusion to the assessment of the functional results with the hand prosthesis it can be said that the device performs in a more versatile fashion than does the hook device, and is a vast improvement on the existing hand prostheses. The major functional failing in comparison with the hook device is the limitation on the thickness of objects which can be picked up from a flat surface, the hand being limited in this respect to objects greater than 4mm thick. However, it is anticipated that the introduction of rigid fingernails into the glove will improve this situation.

6.6 Robustness and reliability.

There is every indication that the nature of the construction of the hand is such that mechanical damage is unlikely to be serious in any situation. This is largely due to the integral hook structure of the fingers, being extremely rigid, with no mobile parts subject to wear or breakage. The mechanism of the thumb is such that there are only two moving parts, and any wear which takes place will lead to a degree of backlash in the thumb, which is not serious in the hand since it is a force controlled mechanism.

In the event of a failure in the mechanism, the active parts can be removed in an instant, without disturbing the cosmetic cover in any way, thereby ensuring that repairs are rapidly and simply executed. Furthermore, the replacement of the cosmetic cover may be carried out extremely rapidly, since the removal of the thumb permits the withdrawal of the finger framework without the familiar struggle of forcible glove removal.

6.7 Weight.

Unfortunately, the target weight of 150g was exceeded by 60g, giving a total weight of 210g. This fact was largely due to the

necessity for using glass beads as the filler for the powder grip modules, the glass having a density some five times that of the plastic equivalent.

However, the weight compares favourably with the available hand devices, the closest being the Otto Bock pneumatic hand, which weighs some 310g complete with cosmetic cover. The closest approximation in functional hooks is a pneumatic hook designed for the Series I Edinburgh arm prosthesis, the hook weighing 125g, however, it is considerably smaller than the hand.

6.8 Control.

An additional point which is worth of comment is the control of the hand prosthesis. The choice of a double-acting pneumatic actuator proved extremely favourable, both from the size aspect which allowed a more natural appearance to be achieved, and the speed with which the hand could be opened and closed. The commercially available pneumatic hand has a complex lever system operating the fingers, driven by a single acting piston working against a return spring and therefore an additional amount of gas is required in order to overcome the spring and mechanical resistance. In practice this additional amount of gas is so large that the supply of gas via the valves takes an appreciable time, introducing lags into the opening and closing of the hands, which can only be remedied by using larger valves and connecting tubes. The double-acting control system overcomes this problem automatically since the piston actuator actively drives the mechanism each way, requiring no return spring.

6.9 The continually changing nature of the problem.

The results which have been described above can only be regarded

as temporary, since the nature of the clinically committed environment, in which this work has been carried out, is such that development is continuous, dependent upon the steady flow of information returning from the patients. Therefore, the conclusion to the work will take the form of an appraisal of the role of the complete hardware in the context of continuous future developments.

The 'status quo' at the time of writing is that an externally powered arm system and a cosmetic hand have been developed to fulfill the demands of severely disabled bilateral amputees. As such, these systems represent the early experimental equipment which will provide working information for the design and construction of more effective and reliable prostheses. In addition, these systems are fulfilling a practical purpose in that they work and provide a degree of function for the amputee.

6.10 The achievements summarised.

1. The problems of providing artificial arms having been analysed by Simpson (1965-to date) and others, mechanical systems have been developed in order to provide the means by which the principles could be evaluated and modified.
2. The problems of prehension and cosmesis have been considered in some detail and a theory for providing artificial substitutes has been developed. This theory has been followed by the design and development of a working prosthesis, which has been assessed by fittings on artificial arms.
3. The theoretical basis for items 1 and 2 above has been seen to be sound when applied to a small group of thalidomide children, and the way is now open for wider development on an international basis, which will doubtless provide a wealth of new information.

4. The impressive versatility of the hand prosthesis suggests that it may usefully be applied to degrees of disability less severe than those for which it was specifically developed, and therefore this work may be considered as the basis for the rehabilitation of unilateral amputees, transcarpal amputees, and perhaps as a guideline in surgical corrective techniques.

5. The continuous fitting required by the direct patient commitment has led to the development of mechanical systems which lend themselves to ease of repair and maintenance, and to an awareness of the necessity for a ceaseless monitoring of patient requirements and prosthesis use.

6. The limitations of the application of conventional engineering techniques to a biological system have been illustrated, and an adaptive or flexible approach has developed which enables the mechanical systems to survive severe loads and impacts without catastrophic failure. This has been achieved by adopting design principles which resist potentially difficult situations by allowing the mechanical system to adapt itself to the situation, thus the hand grip is designed so that grasped objects always tend to be stabilised, and the force demand valve automatically takes up wear and compression in the rubber seal by virtue of the sliding poppet action.

6.11 Future developments.

The value of the work which has been covered above may be considered from two aspects, the first being its role in the rehabilitation of severely disabled amputees whilst the secondary aspect of the insight into the mechanisms operating in the normal human system represents a significant method of investigation in

the study of normal patterns of control and movement. It is the continuation of progress in these two spheres which will determine the nature of future development in upper limb prostheses, and therefore it is appropriate to consider the probable future trends from each point of view.

In the immediate future, developments concerning the provision of prosthetic hardware will be concerned with the improvement of the engineering aspects of the device, with the object of improving reliability and reducing weight as the expertise in the use of various light plastics is improved. However, changes of this nature will necessarily be made in conjunction with alterations in the design of arm prostheses themselves as more information is received concerning the best combination of active movements in an arm prosthesis. Similarly, improvements in the techniques for providing position servo mechanisms in the prostheses will have to be made which will require both theoretical analysis and the development of suitable hardware.

These practical developments will all be directly related to a limb fitting programme, and will therefore provide a continuing basis for the acquisition of information concerning the more long-term aspects of the problem such as a gradual appreciation of the finer points of the patterns of arm motion, the precise requirements of the normal control system in terms of the accuracy of position control, the role of force feedback, and possibly the optimum choice of the various coordinate systems of movement in relation to control site behaviour.

Thus it can be seen that whilst it has been possible to replace

normal upper limb function with its 31 degrees of freedom by an artificial system using only five independent control sites, there is a considerable amount of 'tidying up' to do before the system can be considered fully satisfactory. However, the work outlined above has established various important principles which have led to the provision of working prostheses in a short period of time, and the technical improvements are expected to follow with increasing rapidity as the expansion of the limb fitting programme leads to an increased rate of information feedback from users of the prostheses.

T E C H N I C A L A P P E N D I C E S

Appendix to Chapter 2.

2.1 The efficiency of the articulated thumb mechanism.

Appendix 2.IThe efficiency of the articulated thumb mechanism.

Referring to Fig. 2.I.1 the angular movement of the input is 60° , that of the end of the thumb is 100° - by the principle of virtual work this leads to a force 'efficiency' of 60 percent. If a number 11 piston is used to turn a lever arm of $3/4$ " length (24 lb. ins. torque), an effective torque of 14 lb. ins. results. Since the thumb is roughly 2" in length, a prehension force of some 7 lbs results. As has been mentioned elsewhere, the normal recommended prehension force for an adult prosthesis is in the region of 15 lbs. In practice, the use of powder gripping surfaces is found to reduce the force required to grip an object to in the region of one third or one quarter of the normal force applied to a hook prosthesis. Thus, taking account of this approximate equivalence of powder grip, the rigid finger device can theoretically provide an effective grip of 20 - 30 lbs which allows ample leeway for function defects due to the mechanism and the restrictions of a cosmetic cover.

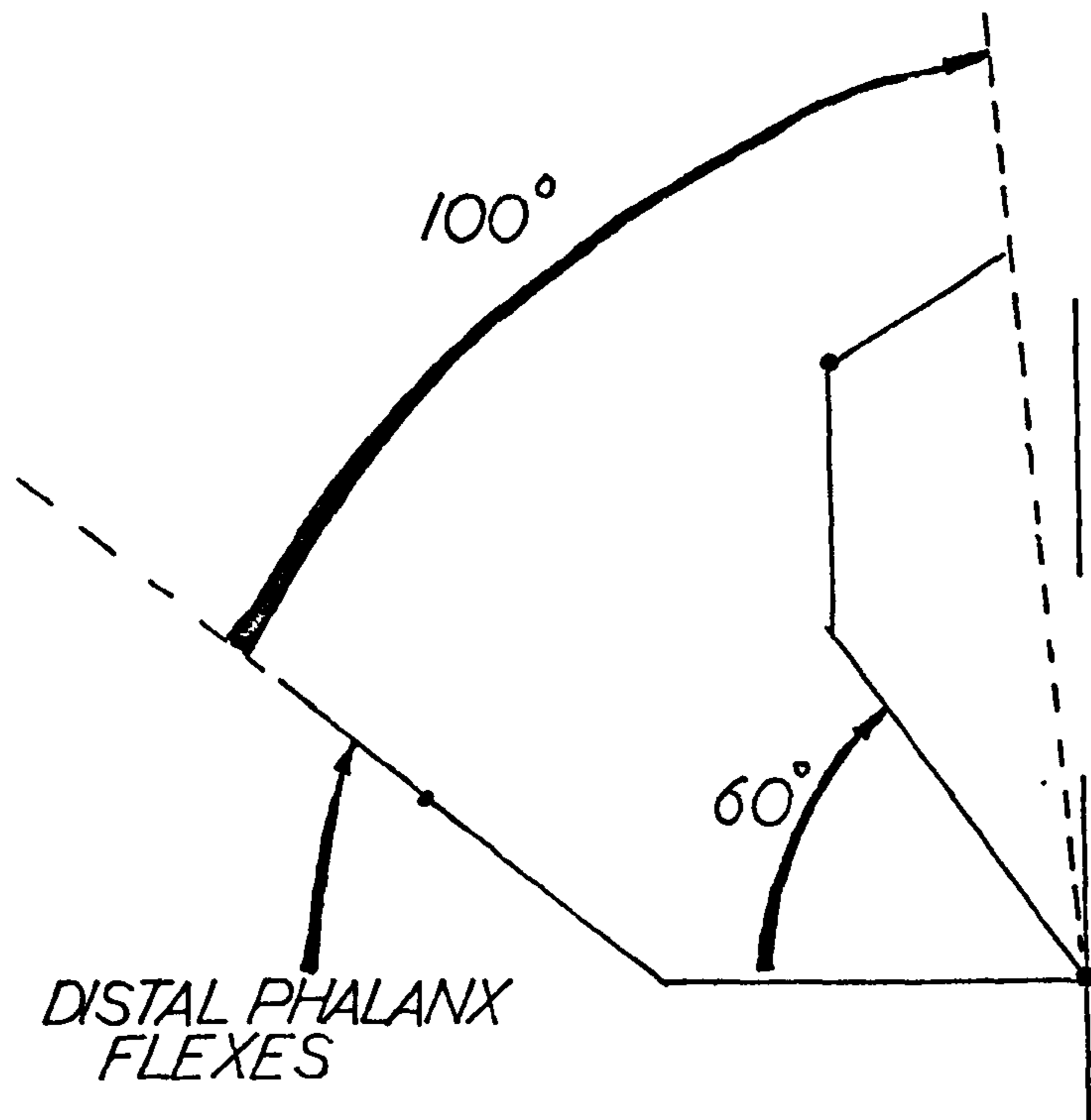

• DENOTES PIVOT

Fig. 2.1.1

The action of the articulated thumb.

Appendices to Chapter 3.

- 3.I The design of the actuation mechanism in the first production device.
- 3.II The production of the mastercopy of the mechanism configuration.
- 3.III The use of carbon fibre reinforced plastics for fingers and thumb assemblies.
- 3.IV The re-design of the thumb actuation mechanisms to improve power and reduce actuator space.
- 3.V The production of the foam padding for the mechanism to perfectly match the glove.
- 3.VI The development of powder grip production techniques.
- 3.VII The theory of powder grip and an appraisal of alternative methods of construction.

Appendix 3.IThe design of the actuation mechanism in the first production device.

Since the thumb was mobile and powered from the hand block, a shaft was brazed onto the proximal end of the main thumb member, the shaft locating in a reamed bearing hole in the hand block (see Fig. 3.1).

The thumb was powered by a piston actuator driving a lever-arm pinned to the thumb shaft. In order to attach the piston to the hand block in the space available, it was necessary to produce a special end fixing for the piston, the point of attachment being at the circumference of the piston rather than the centre. This type of attachment introduces a considerable side-loading to the actuator and is not strictly desirable, however, the situation was relieved by the introduction of an extra long bearing for the piston rod, and the bearing then relieves side loading on the O-ring seals, thus preventing leaks occurring.

Appendix 3.IIThe production of the master copy of the mechanism configuration.

This was achieved by filling the glove with plastic beads and vacuuming until the glove assumed a stiff clay consistency (see glove process for details). The hand was then moulded to provide the extra form details required, and was then placed in a liquid plaster-of-paris mix, with only the wrist section above the surface. Following the solidification of the plaster, the wrist plug was removed after release of the vacuum and the plastic beads poured out, leaving the glove maintained by the plaster in the pre-formed position. Low-melting point alloy (Cerrobend) was then poured into the glove by means of the special filler tank described in the glove process. Since the plaster casing ensured the retention by the glove of the pre-formed shape during the solidification of the alloy and subsequent removal of the plaster and the glove, a Cerrobend replica of the inside of the glove was now available for use as the basis for the design of the mechanism.

Appendix 3.IIIThe use of carbon fibre reinforced plastics for fingers and thumb members.

Firstly, a thumb was made from stainless steel sheet to the shape determined by the Cerrobend template, the section of the thumb structure being a concave U-channel to take the powder grip sacs as in previous models of the hand. This stainless steel thumb was reduced in weight as far as possible by means of holes drilled along the 'spine' and the completed thumb was brazed to a shaft for attachment to the rotation mechanism of the hand. The completed thumb and shaft weighed 17g and was extremely simple to make, but it was felt that a carbon fibre equivalent might provide a significant saving in weight and therefore the steel thumb was used to make a plaster mould for a carbon fibre version. The completed mould was used to shape a carbon fibre epoxy resin lay-up, with the fibres aligned along the thumb. The fully cured moulded thumb was extremely light and strong enough to withstand use as a thumb, apart from one factor - the fixing to the shaft. This proved to be the stumbling block for carbon fibre as a thumb, since the resin did not form a sufficiently strong bond with the metal shaft. Various reinforcement techniques were tried, with metal strips brazed to the shaft interleaving with layers of fibre, tubes of metal brazed normal to the axis of the shaft being filled with the aligned fibres, etc. but all these techniques proved exceedingly difficult and time consuming due to the small areas and radii concerned, the end results being marginally satisfactory and of approximately the same weight as the steel version. Similar experiences were found with experimental carbon fibre fingers.

On reflection it is easy to see why the use of fibre reinforced plastics for the smaller items of prosthetic hardware has been of such limited success (even 'Tufnol' type materials delaminate readily in small components). The reason for the failure seems to be largely a matter of the scale of the operation, as a comparison of sizes will show. The successful applications for fibre reinforcement are in fields such as boatbuilding, where the 'average' dimension is of the order of 1m, in comparison with a carbon fibre diameter of 5×10^{-6} m this gives a size ratio of $2 \times 10^5 : 1$. In prosthetics applications the basic dimensions are of the order of mm, which gives a size ratio of 200:1 for carbon fibres in comparison with some $10^6 : 1$ for pure resin molecules. It is therefore apparent that the use of fibre reinforcement in large applications is akin to the use of pure polymer materials in prosthetics, and that the problems associated with small scale fibre applications are a consequence of too close an approximation of the basic dimensions of the work to the level at which the relative homogeneity of fibre materials breaks down.

Following this experience with the use of fibre reinforced materials, the development of the hand mechanism proceeded along more conventional lines, since the techniques of forming and jointing steel were easy to perform and provided extremely strong parts together with low weight as a major design factor. The thumb, index and middle fingers were constructed from thin (1.2mm thick) stainless steel sheet, cut to the template shape and then formed into the strong gutter section by means of a simple press forming tool.

Appendix 3.IV

The re-design of the thumb actuation mechanism to improve power and reduce actuator space.

This was achieved by introducing a self-contained rack and pinion drive unit, with the rack attached to an integral number 17 piston actuator and the pinion being pinned to the thumb shaft. In order to reduce weight as far as possible, all the constituent metallic parts were subjected to severe weight reduction measures by the removal of all excess material. In addition the complete power unit casing was constructed from lightweight Delrin plastic which was machined to a complex shape due to the removal of all excess material. The complexity of the machining involved in the manufacture of the power unit casing was considerable, however, the material is ideally suited to injection moulding processes and the machining problem is therefore only relevant in the short term until a mould is made.

Appendix 3.V

The production of the foam padding for the mechanism to perfectly match the glove.

The technique devised to obtain the shape of the padding was based upon another moulding process. In this case, a special plug was designed for the end of the glove, the glove being placed over the mechanism. In order to illustrate the various functions of this plug an overall outline of the process is necessary.

The object of the exercise was to obtain the shape of the 'space' between the glove and the mechanism when everything was in order, the overall shape being satisfactory and the mechanism not touching the glove. To obtain an impression of this space it was first necessary to ensure (a) that the mechanism was fixed in the correct position, and (b) that the glove was fixed in the correct position relative to the mechanism. The function of the plug mentioned above was to ensure that these conditions prevailed by locating the mechanism relative to a plaster casing which fixed the glove shape.

In practice the plug took the form of a modified version of the one used for the vacuuming technique in the glove process. The plug was screwed to the hand mechanism, the glove being over the mechanism and hermetically sealed onto the plug. The plastic beads used for the vacuuming technique were then poured into the glove via an inlet hole which was sealed when filling had been completed. The vacuum was then applied, and the overall shape adjusted to give the desired outside effects and to ensure that no part of the mechanism touched the glove. The hand was then clamped in place in a casting

container, finger location tubes positioned (see glove process) and lugs attached to the plug such that they would locate the plug (and hence the mechanism) in the plaster which was subsequently poured around the hand. Thus, in the situation after setting of the plaster the mechanism was located in the plaster via the plug and its lugs, and the glove shape was determined by the plaster casing, thus maintaining the desired spacing between mechanism and glove. The vacuum was then released and the plastics beads removed via the special hole, into which was then attached a tube. Through this tube silicone rubber was then injected following the cutting of air release holes at the finger tips via the location tubes. The high viscosity of the silicone rubber prevented full flow throughout the small spaces between mechanism and glove and therefore required the use of a type of injection moulding process. This was achieved by forcing as much silicone rubber as possible into the wrist portion of the glove, sealing the inlet tube and then applying pneumatic pressure to the tube normally used for vacuuming, this caused the silicone rubber to be forced through the glove, expelling air from the cut fingertips. Once the glove was filled with silicone rubber, the rubber was allowed to harden and the plaster casing then cracked off the hand which was now fully padded with silicone rubber of the correct shape. After the removal of the glove the silicone rubber padding was carefully split away from the palm of the mechanism in two parts, and from each digit in two parts. Each of these sections was now an exact replica of the shape of the padding required between glove and mechanism at any point.

The positive moulds of the padding for the palm and back of the hand were then used to make negative split moulds for the

forming of rubber padding material. This was achieved in the conventional manner of casting the lower half in plaster, painting on a release agent (petroleum jelly) after setting and then pouring on the top portion of plaster. Following setting of the plaster, the top half of the plaster mould was lifted off and the silicone rubber master removed. The two plaster sections then being re-united created a cavity of the form required for the foam padding.

The foam padding used for the prototypes was a Dow Corning medical grade silicone foam, which is exceedingly light, the padding for the complete palm and back of the hand only weighing 25-30g. The liquid foam was then poured into the lower half of the split mould, the top half with an expansion hole drilled in the top placed over the lower and held in place by weights until the foaming and expansion phase was finished and the foam had solidified. This procedure was then repeated for the other section of the hand padding, thus providing a completely moulded padding for the palm and back of the hand. (Fig. 3.6).

Appendix 3.VIThe development of powder grip production techniques.

Preliminary experience with the implementation of the principles of powder grip showed that it was necessary to devise simple procedures by which a flexible, non-stretch covering could be produced in a specific shape to contain the spherical beads which constituted the 'powder' medium. A further requirement was that the cover should be strongly bonded to the stainless steel 'gutter' shaped fingers, which took the form of the blades of a split hook for the purposes of evaluation tests.

The considerable amount of experience gained with the use of pvc as a 'skin' material for the cosmetic covering for the hand prosthesis, showed that in attempts to provide a moulded skin for the powder modules, pvc could provide many of the required properties such as flexibility, strength and simplicity of handling during the production procedure. It was therefore decided that experiments should be directed towards the utilisation of pvc for this purpose.

The first specific problem to be encountered was that of the containment of the 'powder' during the final coating stage, similar to the use of the rubber latex bag as a container during the covering with the final skin of leather used in the original process.

This was achieved by constructing a linen bag of the required shape, the bag being slipped over the hook blade and bonded to the back of the blade with 'Bostik' adhesive. The concave face of the blade was then filled with beads and the bag sealed at the upper end. In order to permit the hook to be subjected to the oven temperatures required for the subsequent curing of pvc plastisol,

glass beads were used rather than the lightweight unexpanded polystyrene beads available as an alternative.

Following the sealing of the linen bag by sewing, the complete hook blade and stuffed linen cover was briefly dipped in pvc plastisol, the excess liquid dripped off, and the whole hook subjected to the oven-curing schedule for the pvc. Successive dippings were then used to build up the pvc thickness to the desired level.

The short term results of applying this technique to the modified (gutter section) blades of a conventional body-powered split hook, showed that the gripping forces could be reduced by a factor of three or four over gripping the same objects with the normal rubber faced hook blades, thus illustrating the considerable benefits of the principle. Furthermore, the versatility of the grip was improved.

The long term effects, however, showed various faults with the details of the construction. The first serious fault which appeared was invariably a failure of the bond between 'skin' and hook blade, thereby permitting the whole grip module to move relative to the 'skeleton', causing instability and failure of grip.

The second fault which usually appeared took the form of punctures in the skin which allowed the contents to progressively leak away, ultimately resulting in failure of the grip. The origin of the punctures was occasionally 'external', being caused by cuts and abrasions in the normal way; but the majority of punctures resulted from fatigue and chafing of the 'skin' over the edges of the stainless steel guttering, where slight movements of the 'skin' due to imperfect bonding allowed sufficient movement to encourage excessive wear at these points.

These causes of failure had a common origin in the inadequacy of the bonding of the skin to the steel, and this was improved by the use of an Araldite adhesive for bonding the linen bag to the metal. However, the rigid nature of the epoxy adhesive led to the tearing of the linen at the sharp edge formed by the bonding of the adhesive.

Despite these problems of bonding, several hook prostheses were produced in this way, and they operated very successfully for a limited period of time. However, the frequency of repairs highlighted the difficulties of using the linen cover, which required to be sewn accurately and then to be bonded on its inside face to the steel blade, all of which required considerable attention to detail.

The successful solution to all these problems was found due to the use of an adhesive primer for pvc, which allowed the direct bonding of the pvc itself (rather than the reinforcement matrix) to the steel. The material used for this process (Vyprime Adhesive, Plastic Coatings Ltd.) was an epoxy based material painted onto the steel as required and then activated by heating, pvc dipping and coating then being carried out in the normal way.

Thus, by painting the back of the hook blade and not the front with adhesive primer, followed by dipping of the whole blade, a continuous pvc cover was produced, bonded to the back and free on the gripping side. The free side was then lifted away from the concave surface and reversed, thereby creating a cavity for the introduction of filler beads. Following the filling with beads, the end was sealed by tying with thread and then further dipping

was used to reinforce the skin in its new shape.

In practice this latter stage required the introduction of a thin covering of cotton tape in bandage form to reinforce the sac during the phase in the oven after sealing, since the expansion of the air trapped in the bag tended to split the bag whilst in the oven.

A further refinement was introduced in the form of a rod temporarily held against the concave face of the hook blade during the initial dipping stage. Following dipping and curing, on removal of the rod, a convenient tube of pvc was available to act as a filler tube for the beads, and in addition provided a simple means of sealing the bag prior to reinforcement.

This process provided the ideal solution to all the problems previously encountered, since no cutting and shaping of the cover was required, the skin being automatically moulded to the blade (finger) shape, the bonding to the steel backing being direct and exceedingly strong, and the whole cover being homogenous and free from local weak spots.

Appendix 3.VIIA theory of powder grip and an appraisal of alternative methods of construction.

The various problems encountered in the production of powder grip modules on the lines described by Simpson (1971), led to some analysis of the principles behind the technique, with a view to investigating possible alternative techniques for achieving the same effect.

The major problems to be overcome were:

1. The existing process did not lend itself to the use of moulding processes.
2. Any damage sustained by the skin of the sac resulted in the loss of the contents, with subsequent grip failure.
3. Migration of the filler towards one end of the sac reduced the effectiveness of the grip at the depleted end.

In order to be able to devise a suitable solution which might overcome these difficulties it was necessary to consider the problems in the light of the principle of operation of powder grip.

The success of the powder grip technique relied upon the fact that the gripping surface deformed to the shape of the gripped object until a stage was reached where no further deformation was possible, the shaped gripping surface then becoming rigid under the effects of the applied gripping forces. This can be summarised by a stress/strain curve as shown in Fig. 3.VII.1. Ideally, the portion AB should be as nearly horizontal as possible, signifying an easily deformed gripping surface, with BC being as nearly vertical as possible, signifying the ultimately stable grip. The

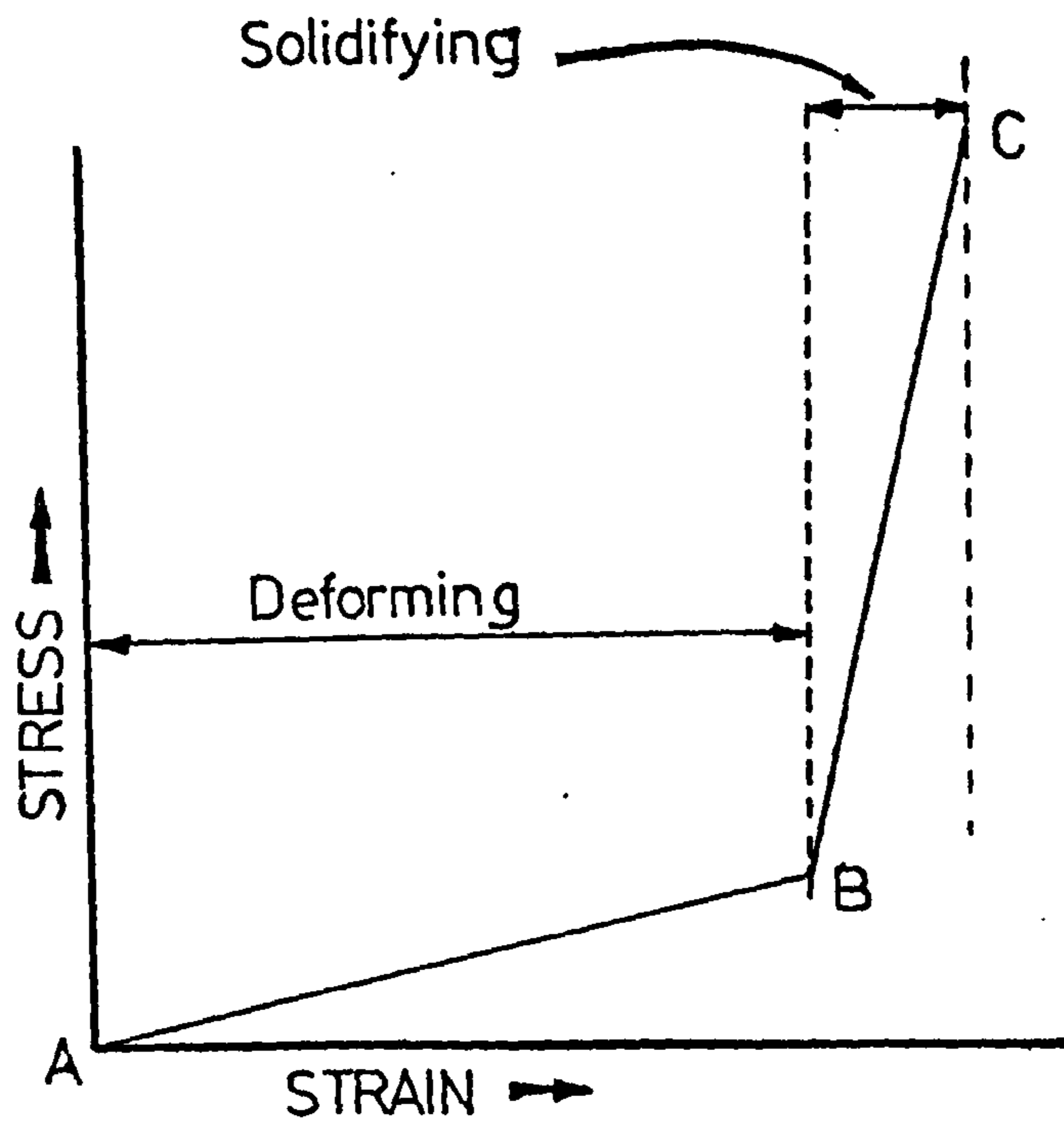

Fig. 3.VII.1

Schematic stress/strain curve for powder grip.

purpose, then, of a powder grip system was to approximate to this type of stress/strain relationship.

The non-stretch bag, partially filled with powder achieved this aim by making use of the tendency of regular particles to pack together under pressure, each particle finding an equilibrium with its neighbours following the slipping and rolling of the particles into a stable configuration of minimum volume. The friction of the slipping and rolling process is in practice kept to a minimum by the use of spherical particles. The pressure required to induce the particles to adopt the minimum volume condition is achieved by virtue of the gripped object progressively reducing the enclosed volume and hence inducing a tension in the restraining skin, which then compresses the contents.

Since the problems encountered with the skin and contents principle were all direct consequences of the need for a retaining skin, various alternative possibilities for reproducing a similar stress/strain relationship were considered.

The simplest direct analogy to the type of characteristic required is provided by the compression of a gas until the critical stage is reached where liquification begins, resulting in a sudden change of compressibility. However, such a system is clearly not simply applicable to gripping modules, since the increase in rigidity is not accompanied by a change in viscosity to the extent of effective solidification under the application of reasonable pressures.

The requirement for a system which does not lose all its contents following a tear or puncture led to the proposal of an

arrangement whose mechanical properties could resemble those demanded of the powder grip.

The prevention of full leakage would be simply achieved by encapsulating the powder in a series of flexible bags of a size intermediate between the powder particles and the overall size of the powder grip module. If these small flexible bags were restrained in some way so that a limited degree of movement were possible, the overall effect of the powder grip module would be achieved, whilst the loss of material due to punctures would be limited to the contents of one or two individual sacs. In addition, the local restraint of each sac would prevent large scale migration of the contents to one end of the container.

This postulation of a desirable construction for the powder grip system bears a remarkable similarity to the description of the naturally occurring system in the pulpy pads of the fingers.

The natural system comprises globules of fat, restrained by a matrix of connective tissue which is ultimately attached to the phalangeal bones, the whole being covered by the 'non-stretch' covering of the skin.

The problem presented in the light of this fact was then to provide a synthetic equivalent system, subject to the proviso that the production of such a system should be easy to achieve, preferably by means of a moulding process.

The first arrangement postulated to simulate such a system envisaged a foam rubber where the compressible gas bubbles were replaced by globules of liquid. In this way the inherent softness of foam rubbers might be modified by the introduction of the

incompressible, but fluid, liquid globules which on deformation under pressure could initially stretch the essentially thin restraining wall around each globule, until, by a suitable choice of the rubber matrix the elastic properties of the rubber prevented significant further deformation.

The procedure envisaged for the creation of this material was to produce an emulsion of filler liquid in the rubber in its liquid pre-cure state. Clearly such a process would involve a considerable knowledge of the properties of the materials concerned, with particular emphasis on their capacity to perform in an emulsion, and thus, such a system could only be devised as the result of a specific long term investigation of the properties of this combination of materials.

The successful operation of the above postulated material would rely upon the correct choice of elastic properties for the matrix material. Since the globules of liquid would be in spherical form, thereby existing in the minimum surface area state for a given volume, any deformation of the sphere results in an increase of surface area of the globule, which can only be made up by a stretching of the surrounding material.

Thus, in order to remove this further constraint upon the properties of the materials to be used, the globules should initially be in a state of large surface area/unit volume, i.e. they should be essentially flat or as in an extreme shape of an oblate spheroid, subsequent deformation causing a re-orientation of the 'flat' axis of the globule. Clearly such an 'emulsion' could not be produced by direct means, but the use of flexibly coated 'lozenges' of liquid as a miniaturised form of the encapsulated pills used in

the pharmaceutical industry, as a filler for a non-stretch rubber matrix could create similar properties.

In order to create a stable grip, such a system would have the matrix bonded to the substrate stainless steel gutter shaped fingers.

The 'powder grip' systems making use of liquid fillers in this way would never attain the total rigidity of the packed powder or granules originally postulated, since each individual globule would remain essentially liquid, however it is quite feasible that an adequate combination of properties could be devised in order to provide useful operational characteristics.

The major advantage of these systems is that the whole module could be moulded directly, no external skin being required.

A solid state equivalent system is also possible, once again by the judicious selection of suitable material properties. Such an arrangement would require the restraint of large numbers of spherical beads in an extremely stretchy and resilient matrix. In order to ensure ultimate 'solidification', either a skin would be required or the matrix would need to possess, in thin sections, elastic properties similar to those of the characteristics ultimately required of the grip module.

Thus, various alternative methods are possible for the production of anatomically deforming gripping surfaces. However, such systems required a considerable degree of investigation before a satisfactory configuration could be established and thus, the more readily available skin/granular filling arrangement was adopted for use on the prototype hands, the more esoteric, but promising systems remaining as subjects for future study.

Appendices to Chapter 4.

- 4.I Systems for obtaining the correct positioning of the 'donor' hand.
- 4.II The use of a low melting point alloy as an alternative to wax.
- 4.III Mould requirements.
- 4.IV The self-balancing centrifuge.
- 4.V Technical aspects of the use of the silicone rubber in conjunction with the casting of molten tin.
- 4.VI The stuffing of the everted glove prior to use as a 'donor' for second phase casting.
- 4.VII Comparison of the overall loss of detail in the new glove manufacturing process with that of the 'classical' procedure.
- 4.VIII Effect of vacuuming the casting on size of trapped air bubbles.
- 4.IX Heating rates required to maintain the molten tin in a liquid state.

Appendix 4.ISystems for obtaining the correct positioning of the 'donor' hand.

The first attempt was to pre-form a piece of aluminium sheet 1mm thick into the approximate outside profile of the donor's hand in the correct position. This former was then taped to the donor's hand, using liberal amounts of tape in order to ensure a smooth shape. The bandaged hand was then cased in plaster, and removed by splitting the plaster mould to form a two-piece female mould to be used as a template for further work. The two halves of the template were then bound together and filled with a runny alginate mix. The donor then forced his hand into the template for the formation of the hand detail, displacing excess alginate.

Upon taking a wax impression of this mould several faults were found. The most obvious of these was the entrapment of air in the fingertips, but as this was anticipated and no attempt had yet been made to solve this problem, this defect was ignored at this stage. The most important fault lay in the fact that the hand position was not sufficiently accurate, and that the fingers had touched the plaster template in various places, causing the alginate material to become dangerously thin in places. These faults, taken together with the fact that the forming of a two dimensional sheet of aluminium into an accurate three dimensional representation of hand contours was extremely difficult to achieve, caused this method as such to be rejected.

As an alternative to the above method a simplification was made by using narrow strips of aluminium alloy bound to the individual fingers and thumb as templates (Fig. 4.I.1). This technique permitted more accurate positioning of the individual

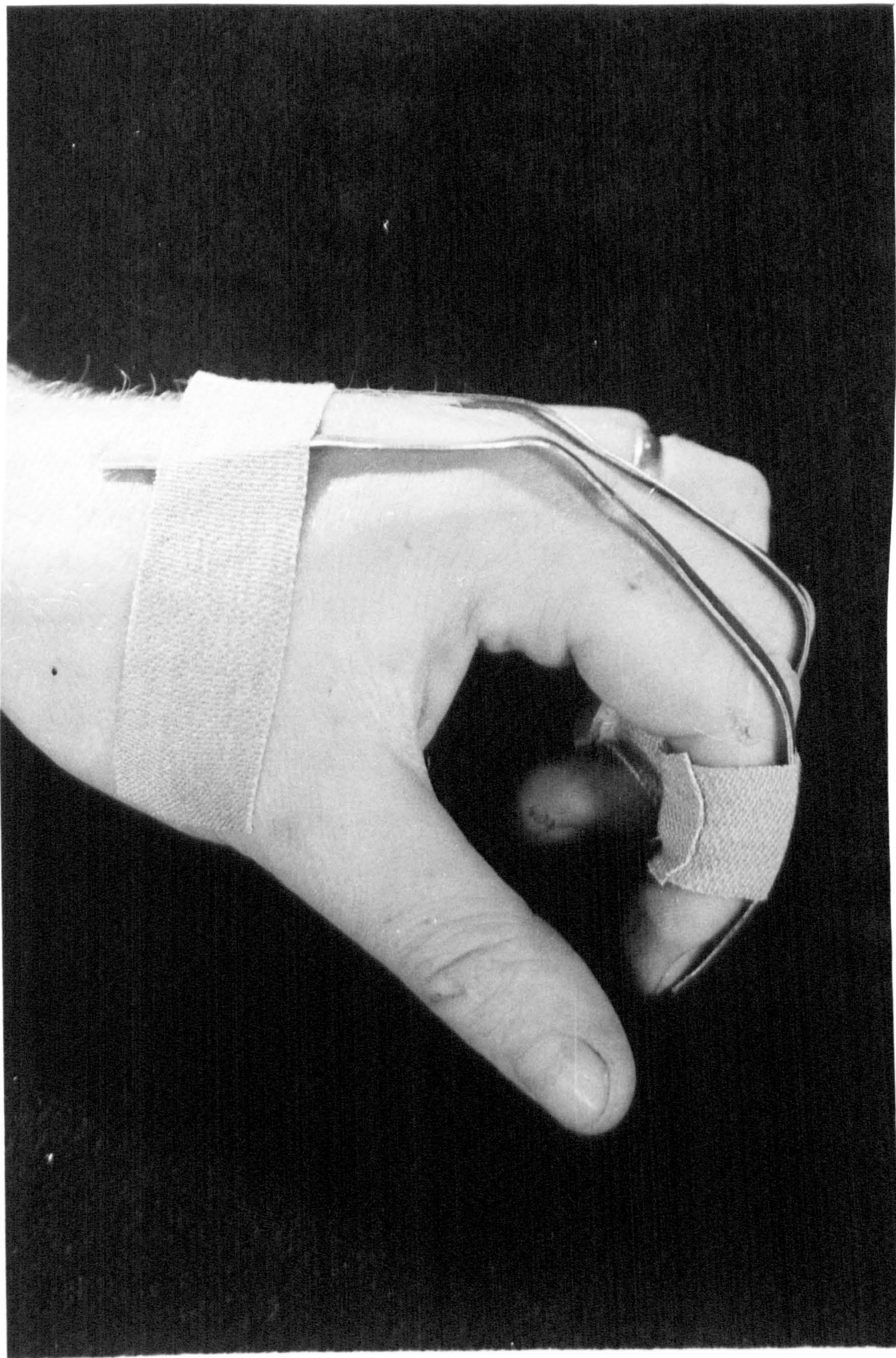

Fig. 4.I.1.

Alloy strips as shape formers.

digits, whilst inter-digital spacing was preserved by using spacers between the digits and then strapping them together. A template was then formed as above. This method was found to be more successful for positional accuracy, but still retained the same problem of the fingers touching the template in places. However, a more important fault arose from the placing of the formers; in order to achieve good stability it had been necessary to situate the alloy strips well down to the ends of the fingers, causing the strips to press onto the fingernails. Even the light pressure due to taping caused considerable pain at the fingernails after a while due to the pressure of the alloy at these points. Under such circumstances, volunteers tend not to be voluntary, and a simple remedy was found by strapping the formers to the inside profile of the hand.

Following several laborious attempts with the above methods, it was decided that such a technique was too time consuming and awkward for ready use in the necessary experiments. The time involved in the process of strapping up and pre-forming the alloy strips caused this step to be a major event in itself. It was essential that the process became more simple and of no special significance as a determining factor in the process.

In order to avoid the complications of various formers it was decided to try a single former, complex in shape, but simple to make. This former consisted of an object to be gripped, which was of such a shape as to ensure the correct position of the hand. The making of the former consisted of taking a stiff plaster mix and grasping a handful of the mixture. There was then sufficient time available to permit accurate positioning of the digits before setting began.

The excess plaster was then scraped away, leaving the precise former necessary for the correct hand position.

It was still necessary to manufacture an oversize template as before, in order to achieve the detail on the concave side of the hand. The hand was made to appear oversize by the wearing of a rubber glove, swelled by filling with water; and then gripping the former. The template was then made as before by casting in plaster with the additional introduction of positioning rods for the location of the fingertips to allow the creation of holes for the release of air from the fingertips during the wax pouring stage. The template was then filled with alginate as before and the hand introduced to achieve casting of full hand detail. After withdrawal of the donor's hand, the positioning rods were pushed through into the finger cavities in order to create sprue holes for the release of trapped air.

The wax positive achieved as a result of pouring wax into the mould with the air holes showed no air bubble defects, but contained flaws due to creasing of the thin alginate layers breaking away from the plaster templates, as had been the case with previous attempts. In addition there were the slight flaws due to the air holes but these were regarded as acceptable. Furthermore, there were various areas of the wax positive which had been damaged during the removal from the mould.

Following the annoying recurring problems due to thin sections of the alginate material being so fragile, it was decided that the template principle would have to be rejected altogether. This left two alternative lines of approach to the problem of establishing the correct hand position namely: either to find a method of achieving

the position exactly, without the use of a template, or to make the process simple enough to permit the taking of so many freely positioned casts that one would eventually be satisfactory. Both of these possibilities were followed up in order to assess their relative merits.

The method devised for the accurate positioning process was a modification of the final template procedure. It consisted of using the sprue rods as the locating points for the fingertips. By initially positioning the rods in a suitable manner, it was possible for the donor to locate his fingertips on the ends of the rods, thus maintaining the hand in the correct preset position (Fig. 4.I.2). These rods then served the dual purpose of both locating the fingers, and permitting the release of air during the casting process. In order to accommodate a variety of donor hand dimensions, the rod positions were made adjustable. The whole rod system was mounted onto a special casting vessel constructed in two halves, in order to permit easier removal from the container (Figs. 4.5 and 4.6). This process worked extremely well, with only minor fingertip defects due to the air holes.

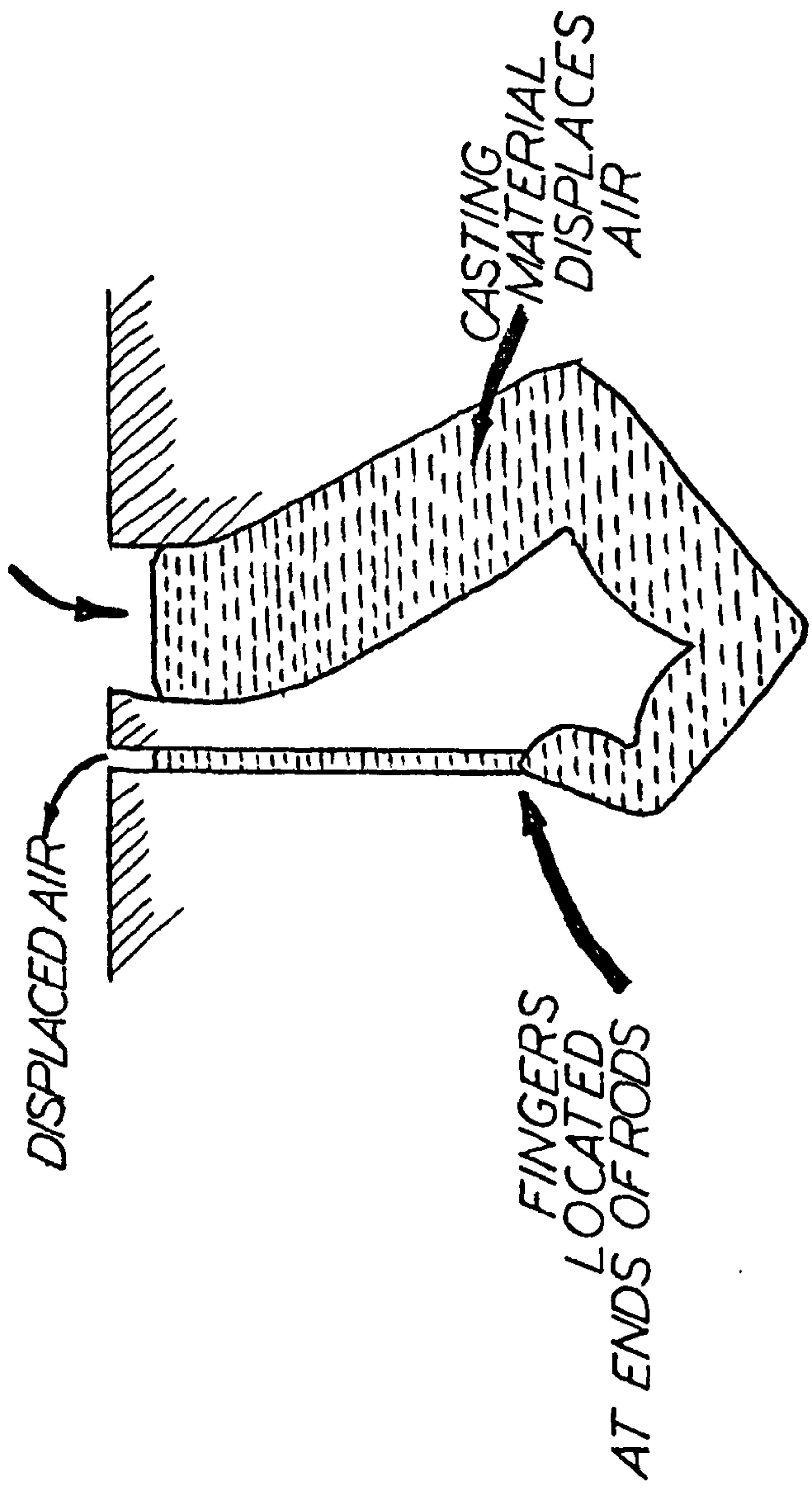

Fig. 4.1.2

The function of finger-tip location rods.

Appendix 4.IIThe use of a low melting point alloy as an alternative to wax.

Bearing in mind that the next stage in the hand process after the production of a positive cast was to be electroplating, a metallic, electrically conducting alternative to wax was found in the form of a low melting point alloy of Pb, Zn, Sb — 'Cerrobond' with a melting point of 78°C. This choice permitted direct plating of copper following casting, with no need for the 'detail loss' stage of painting wax with a conductive paint. The plating would be followed by the melting out of the cerrobond by boiling in water, also the metallic nature of the Cerrobond alloy made it considerably more robust than wax and far easier to handle. The use of this alloy presented no problem if used with the air-breather hole technique but there still remained the trapped air problem with closed fingertips. In order to assess the potential of reducing this phenomenon by vacuuming a simple estimate was made of the bubble size which might be achieved using a standard Edwards pump (See Appendix 4.VIII). This showed that the bubbles could not be reduced to an acceptably small size by this method.

The simple technique of injecting water over the 'hump' of a tilting U-tube (Fig. 4.II.1) seemed to be the most promising alternative, provided that it could be adapted to suit molten metal. Simple tests showed that Cerrobond alone flowing down a flexible plastic tube of 25cm length could not retain its latent heat long enough to prevent solidification and blocking of the tube. In order to overcome this problem, a special filler tank and tube was devised (Figs. 4.II.2 and 4.II.3). Initially the tank is filled

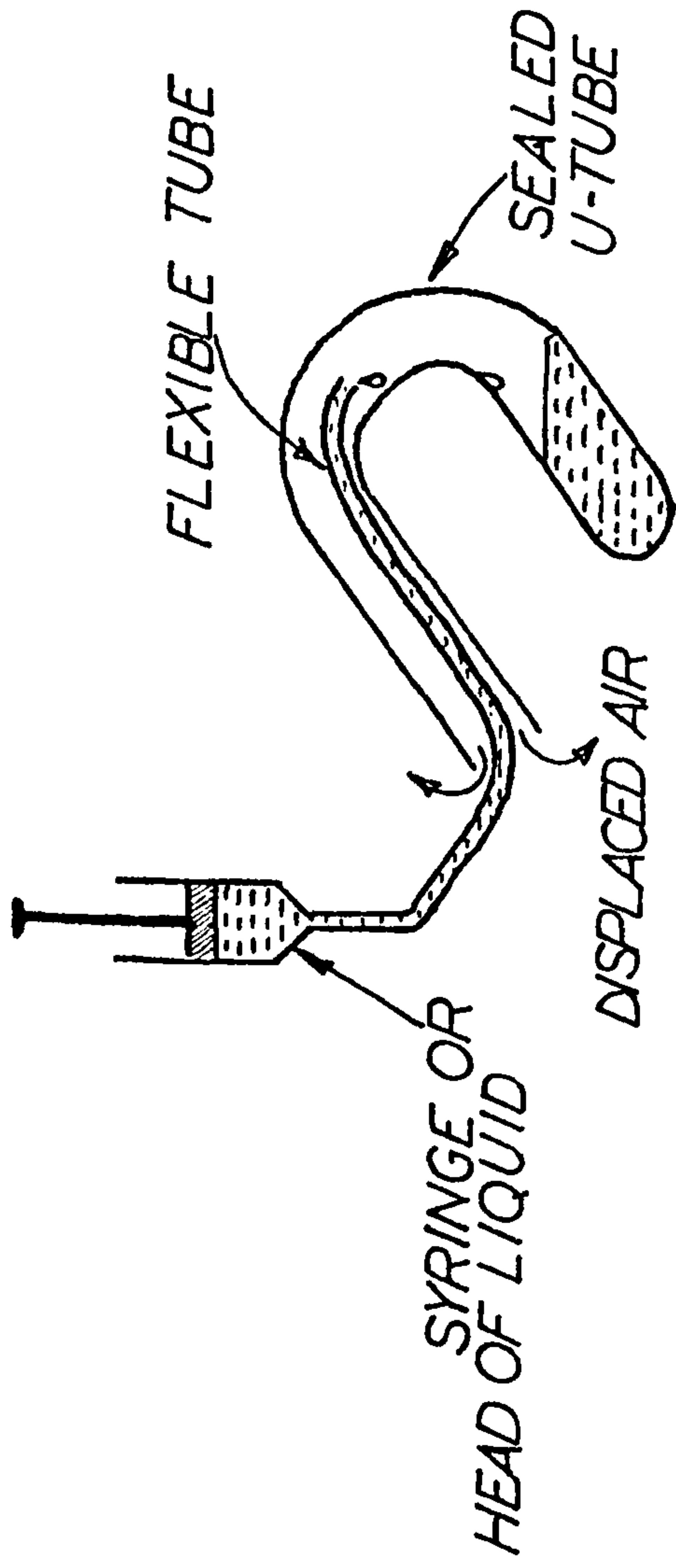

Fig. 4.II.1

Filling a U-tube with liquid.

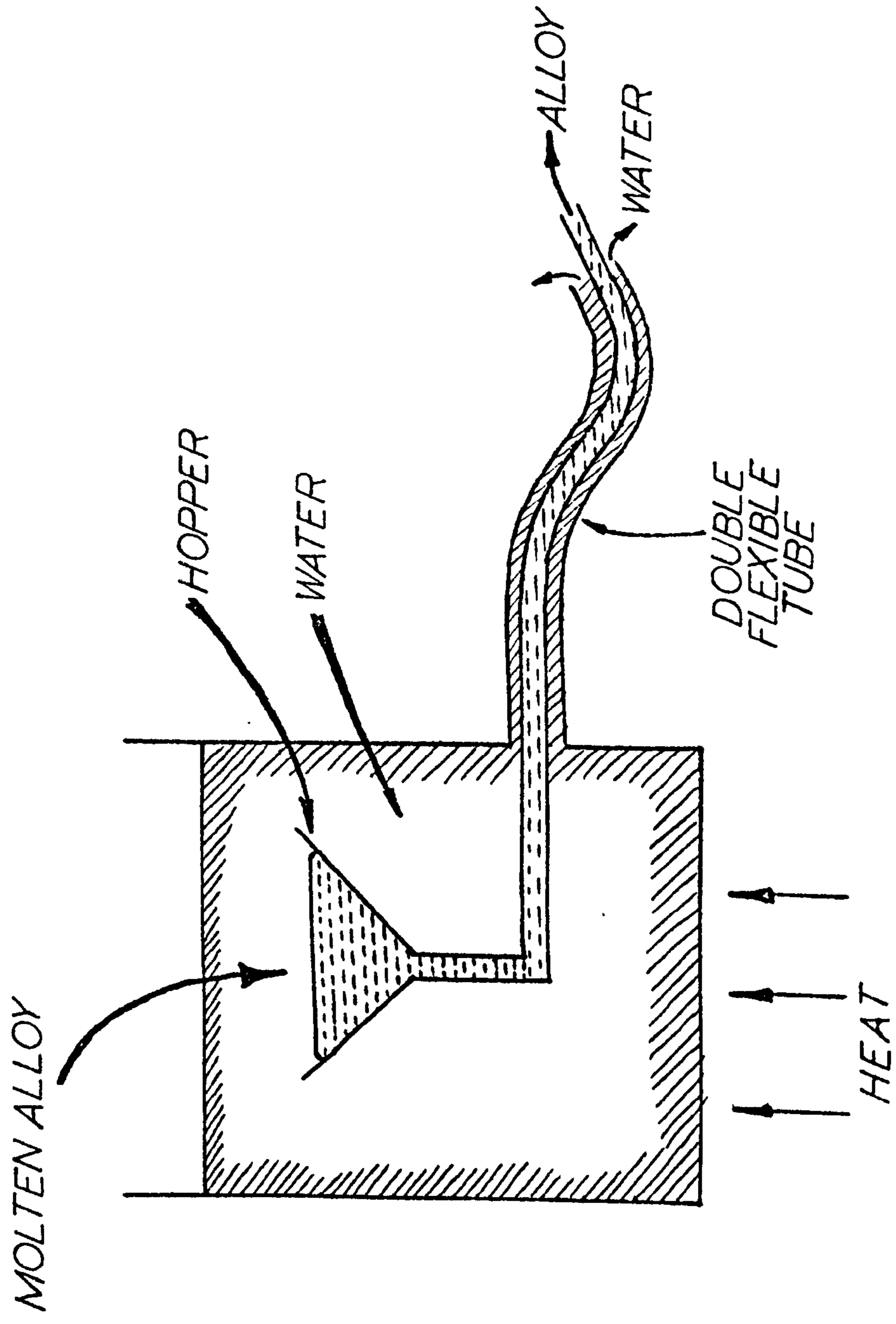

Fig. 4.11.2

Diagram of filler tank.

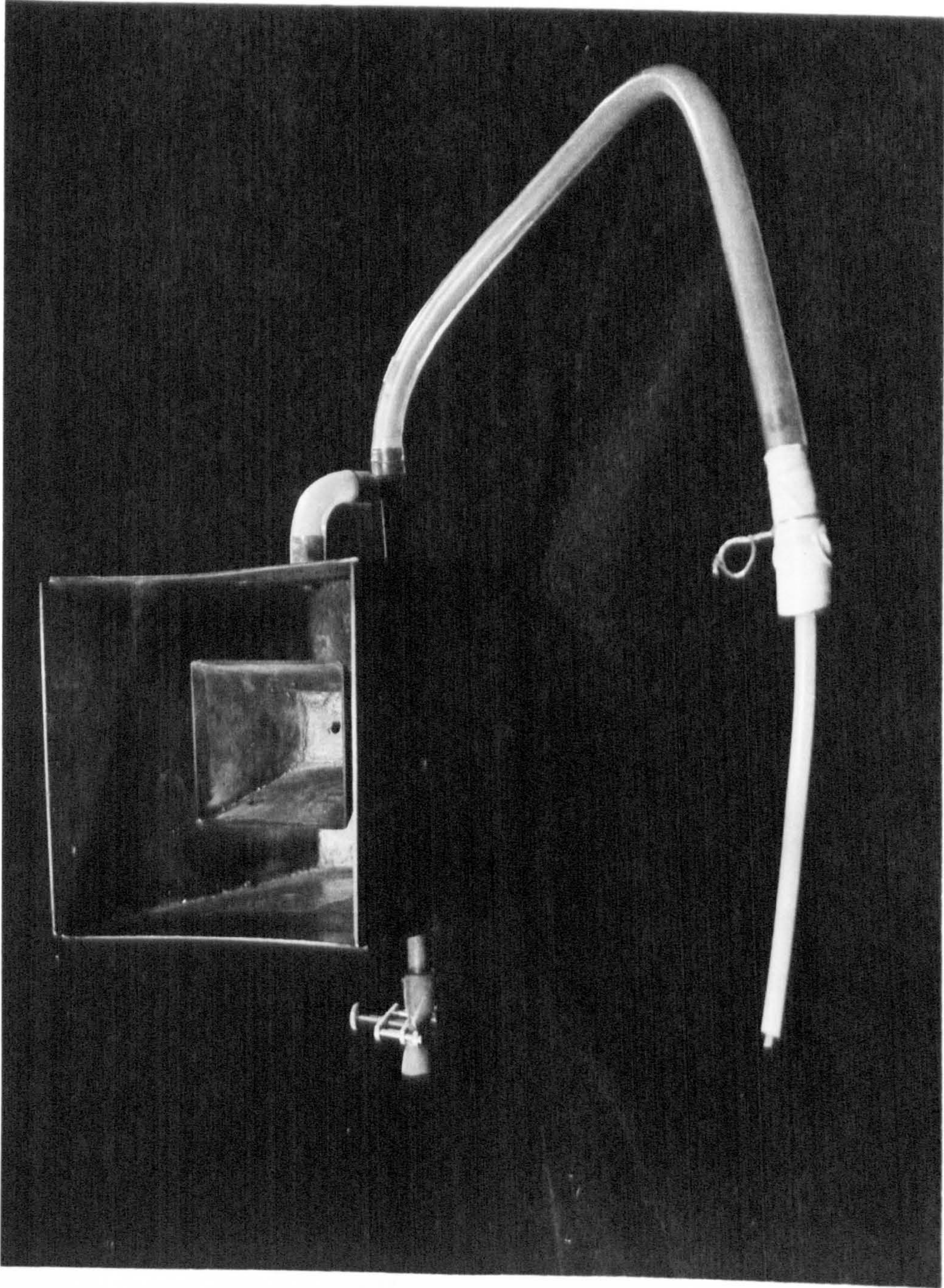

Fig. 4.II.3

Filler tank.

with boiling water and maintained at that temperature, boiling water will flow through inner and outer sections of the double tube if permitted to do so. Cerrobend is maintained molten separately, and when all is ready for delivery, the metal is poured into the hopper. Cerrobend then flows down the inner tube, maintained molten by the flow of boiling water in the heating jacket. By using this device it was possible to deliver the molten metal into the hand mould round the curved fingers. The mould was pivoted in a stand and initially held tilted and as filling progressed, was allowed to rotate into the upright position. This technique ensured that air was displaced at all times by the hot water and molten metal, thus completely filling the mould with the casting alloy.

Having accomplished this process successfully, a further problem immediately presented itself in the form of faults in the metal casting itself. It was apparent that the procedure of rapid cooling by quenching recommended by the manufacturers of the Cerrobend alloy, was not permissible under the circumstances of the hand mould. The quenching process for cooling relies upon a relatively uniform surface chill all over the surface of the casting, in order to avoid surface faults. In that situation the contraction of the molten metal due to cooling must occur within the casting, without causing surface flaws. Unfortunately this situation does not prevail in the case of the hand mould, since the majority of the surface area is well insulated by a thick layer of poorly conducting alginate mould material. As a result, contraction faults are liable to occur absolutely at random, resulting in an unreliable casting. In order

to deal with this problem, cooling tubes were inserted as far as possible into the molten casting, cold water then being passed through in order to accelerate the cooling. This measure merely succeeded in altering the location of the faults - pushing them down into the fingers, presumably because the cold region caused localised sealing off of pockets of molten metal (Fig. 4.II.4), which necessarily resulted in a contraction fault. Further complications were introduced by the difficulty experienced in positioning the cooling devices so that there was no contact with the mould walls, such a case, of course, resulting in loss of detail at the point concerned.

In an effort to achieve something like the manufacturer's recommended policy of quenching an alternative method was tried which consisted of cutting away as much mould material as possible without causing damage to the internal detail. This procedure was extremely laborious and delicate, the major problem lying in the estimation of local wall thicknesses and various elaborate schemes such as X-ray viewing, ultrasonic thickness gauges, etc. were briefly considered but were rejected in favour of the more clinical technique of palpating the still soft mould in order to detect thin areas. The quenching of this thinner mould in cold water resulted in an improved casting, but did not completely eliminate contraction faults and since the process involved in this marginal improvement was so delicate and time consuming, yet another alternative had to be tried.

The above mentioned attempts at the casting of the alloy had been strongly influenced by the manufacturer's instructions for

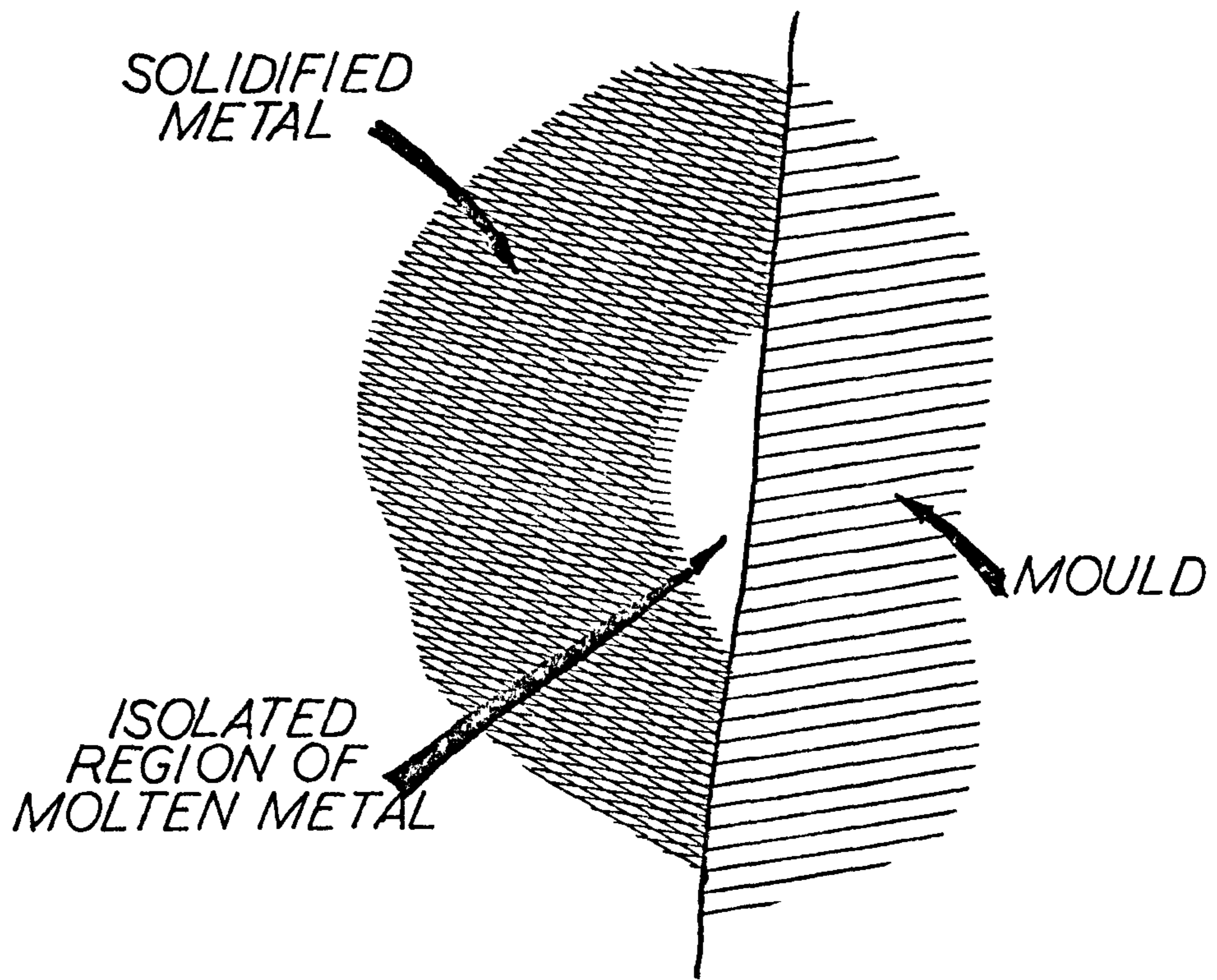

Fig. 4.II.4

Mechanism of contraction faults.

rapid cooling. Since such a procedure met with such lack of success, it was decided to abandon the policy completely in favour of the more conventional, but almost contradictory, approach of maintaining the metal surface at the top of the mould molten for as long a time as necessary for the lower regions to solidify first. Due to the insulating effect of the mould material, this process took a considerable time because of the slow heat loss. Because of the low melting point temperature of the alloy, it was possible to maintain the surface metal molten by means of a large soldering iron with the bit dipping into the metal and by varying the supply voltage via a variable transformer it was possible to apply just enough heat to maintain a reservoir of molten metal to compensate for the contraction of the metal in the cooler regions. Although slow due to the insulation effects, this process provided a flawless casting, with an extremely fine reproduction of detail.

Appendix 4.IIIMould requirements.

The practical aspects of the pvc curing technique made it necessary that the mould material have various properties concerning strength and temperature resistance. The mould material must be able to withstand a temperature of 150°C repeatedly without any deterioration in its mechanical properties, particularly with regard to dimensional stability and strength. It must also be sufficiently strong to retain its shape rigidly when used in thin sections, since the mould must be in the form of a hollow shell. Because this mould is to be formed in one piece, the positive hand mould round which the shell is to be moulded must be manufactured from a material which may either be melted or dissolved away after the shell has solidified. By denoting the material for the hand positive as 'A' and the material for the shell as 'B' it is possible to formulate a simple specification of the materials:-

(A) Properties of 'A' material.

1. Initially must be in a pourable form.
2. Must not be at a temperature greater than 100°C in order to avoid explosive results when pouring into the water-based alginate negative.
3. Must either be readily soluble in a specific solvent, or must melt at a temperature lower than the distortion or melting temperature of 'B' in order to permit removal of the positive to leave a hollow shell mould.

(B) Properties of 'B' material.

1. Must initially be in a fluid form.

2. Must not be at a temperature greater than the distortion or melting temperature of 'A' during the moulding phase.
3. Must be strong in thin sections and dimensionally stable.

The requirements number 3 in case 'A' and 2 in 'B' in both cases are conflicting when applied to the use of molten metals for both materials, since the situation may be written $\theta_A > \theta_B > \theta_A$ where θ is the temperature of the molten metal concerned. This factor leads to the unalterable fact that at least one of the materials must be of a non-metallic setting type which is resistant to the high temperatures either of the pvc stage, or of the complementary metal stage. In other words it was essential to choose a material with a temperature 'hysteresis' between setting temperature and distortion or melting temperature.

The two different alternatives were:- a metal such as Cerrobend for 'A' and a high temperature resistant ($>150^{\circ}\text{C}$), low temperature setting ($<78^{\circ}\text{C}$) resin for 'B', or a low temperature setting ($<100^{\circ}\text{C}$) resin for 'A' which is resistant to the high melting point ($>150^{\circ}\text{C}$) of the metal used as 'B', and is soluble in a specific solvent.

The second of the above alternatives was readily dismissed as impractical following a survey of the available plastics materials. It was found to be impossible to find one material with suitable solubility properties together with adequate temperature durability, although many were found to exhibit ideal properties for either one requirement or the other. Examples of this state of affairs are acrylics, which dissolve in some ketones but are poorly resistant to temperature in contrast with the insoluble resilience and temperature resistance of some silicone rubbers.

The remaining possibility of using a non-metallic material for the manufacture of the shell mould proved only slightly more feasible. Experience with the curing of pvc dipped moulds had shown that a small thermal capacity of the mould was essential for successful processing. Also, the time taken for the mould to reach a uniform oven temperature had to be sufficiently short to ensure that even heat treatment took place. This time factor is not dependent solely on the thermal capacity of the mould, rather on its conductivity. In the case of a dipped mould, the air-pvc interface (Fig. 4.III.1) is at oven temperature, but the pvc-mould interface will take a finite time to attain an adequate curing temperature by conduction through the pvc and the mould. In the case of a thin metal mould, the pvc-mould interface attains the correct temperature very rapidly, ensuring that even curing is allowed to take place. However, if the pvc-mould interface is too cool for too long the air-pvc interface will have become overheated by the time curing throughout is completed.

Work with pvc dipped metal moulds showed that successful curing was feasible even after three or four successive dips. Since the conductivity ratio of copper to pvc is approximately 2500:1 it is apparent that the limiting factor in the case of a metal mould is the conductivity of the first deposited pvc layers. On the assumption that a glove would consist of say three layers of dipped pvc, each on average 0.1mm thick, a useful guide for the effective thermal thickness of the non-metallic mould material would be the equivalent of two pvc layers. The overall effect of this system on the last dip would then be equivalent to four pvc

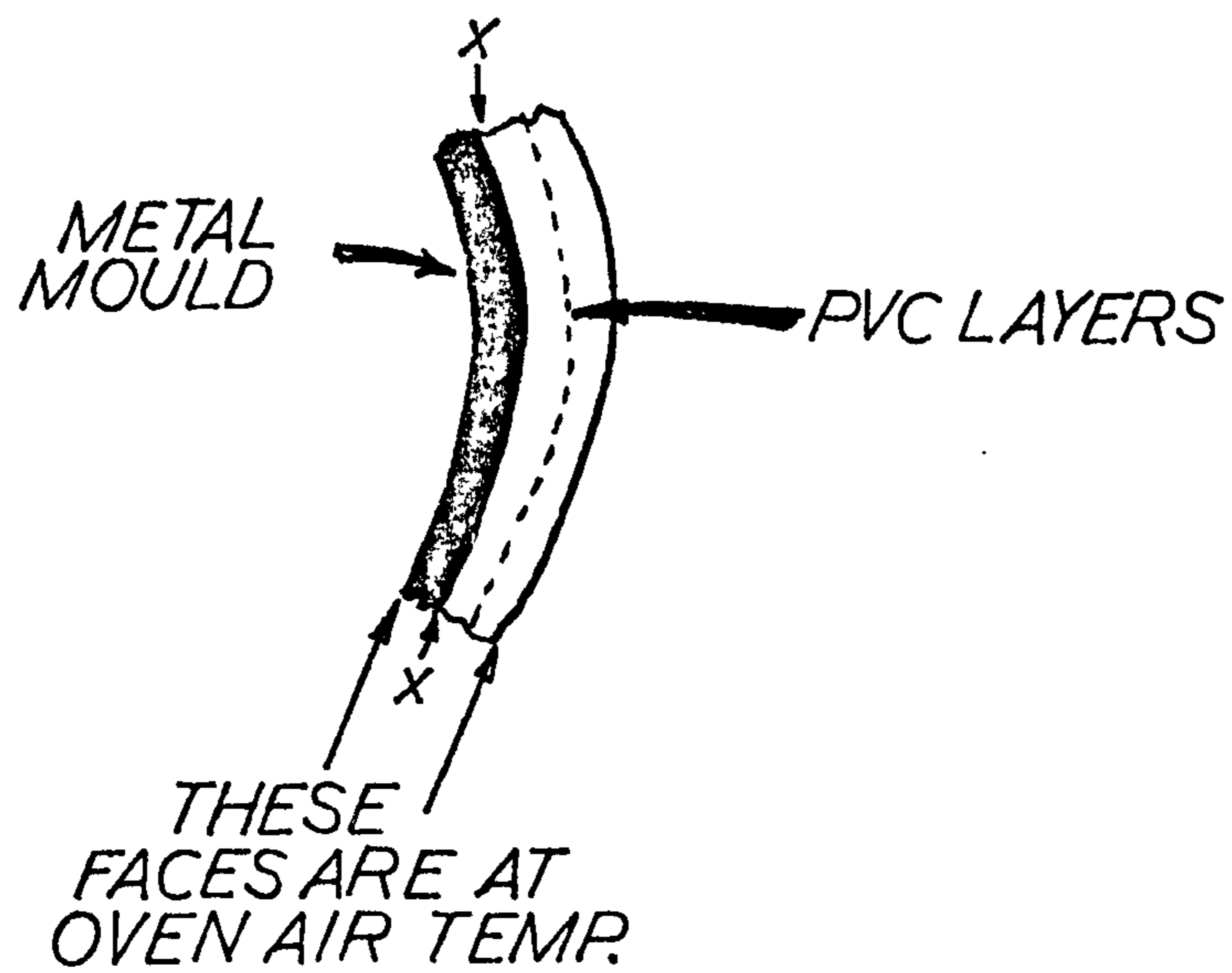

x-x IS PVC-MOULD INTERFACE

Fig. 4.III.1

Temperature effects at mould-pvc interface.

layers on the 'cool' side. Since the conductivity of epoxy resins is approximately three times that of pvc, an epoxy layer 0.6mm thick would be roughly equivalent to two pvc layers. In practice, a thickness of 1mm should be obtainable by dipping or painting of the resin giving sufficient strength for a self supporting shell. A mould such as this would require a slightly longer curing time than its copper counterpart but the increased time should not be sufficient to cause scorching of the pvc.

Appendix 4.IVThe self-balancing centrifuge.

The design was based upon a pneumatic piston actuator which formed the arms of the centrifuge, balancing being achieved by automatic movements of the piston, thereby shortening one arm and lengthening the other. The control system for achieving this took the form of a pair of valves mounted with the rotating piston and arms, with the valve operating points running on the inside of a ring which was fixed to the overall framework of the machine. By means of flexibly mounted bearings for the rotating members it was then possible to achieve automatic operation of the valves in a situation of imbalance, since the heavier arm tended to force the valve on that side against the stationary ring, thereby causing piston motion to occur until the force on the valve operating point was relieved by virtue of the new balanced situation. Details of the design criteria are given below and the device is shown in Fig. 4.IV.1.

The device behaved quite satisfactorily under experimental conditions when driven from an electric drill. However, the advent of new glove manufacturing techniques to be described later unfortunately made the machine obsolete before its official commissioning!

Design of self-balancing centrifuge.

Consider the situation as shown

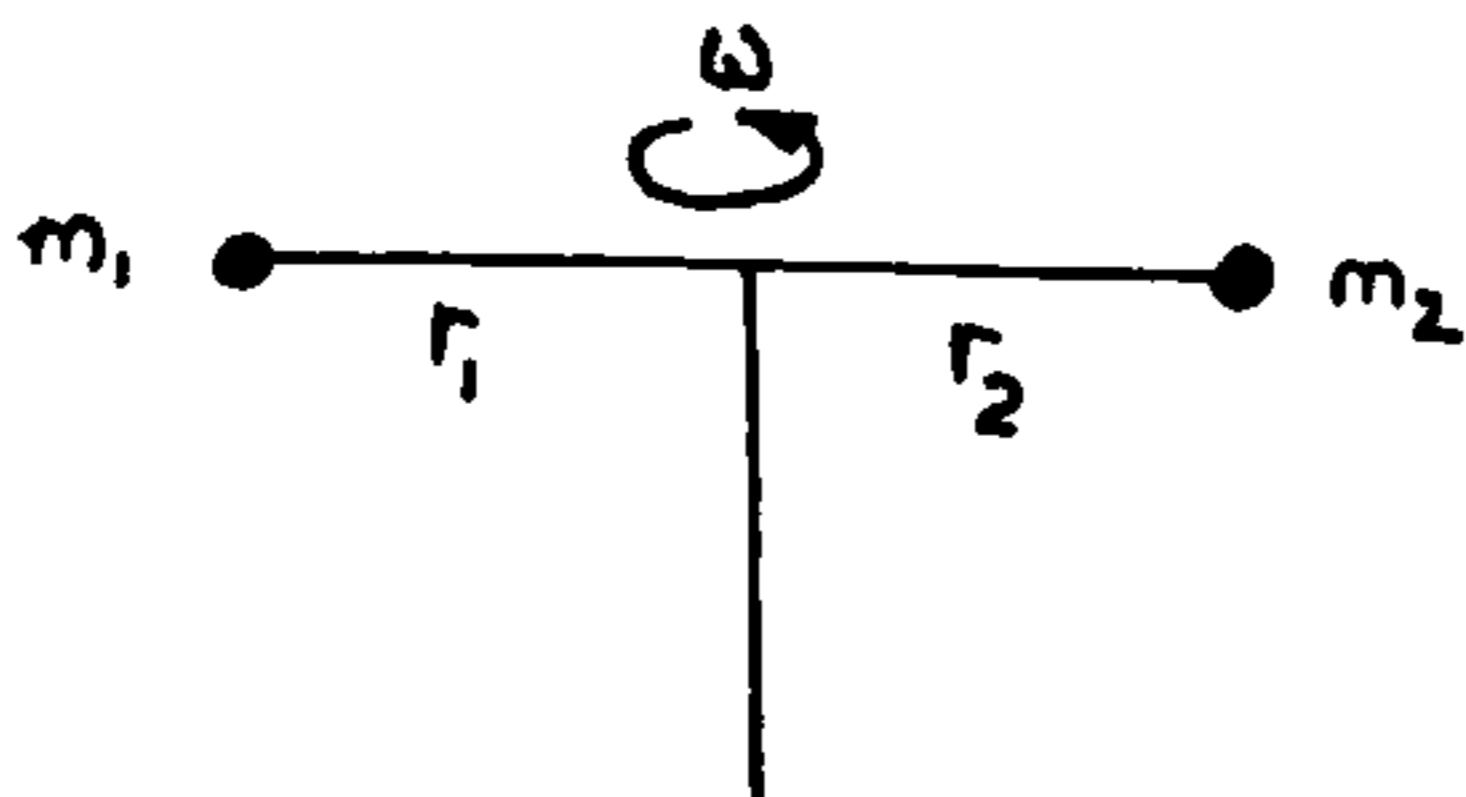

m_1, m_2 are the rotating masses on arms of length r_1 and r_2 .
Angular speed of rotation ω .

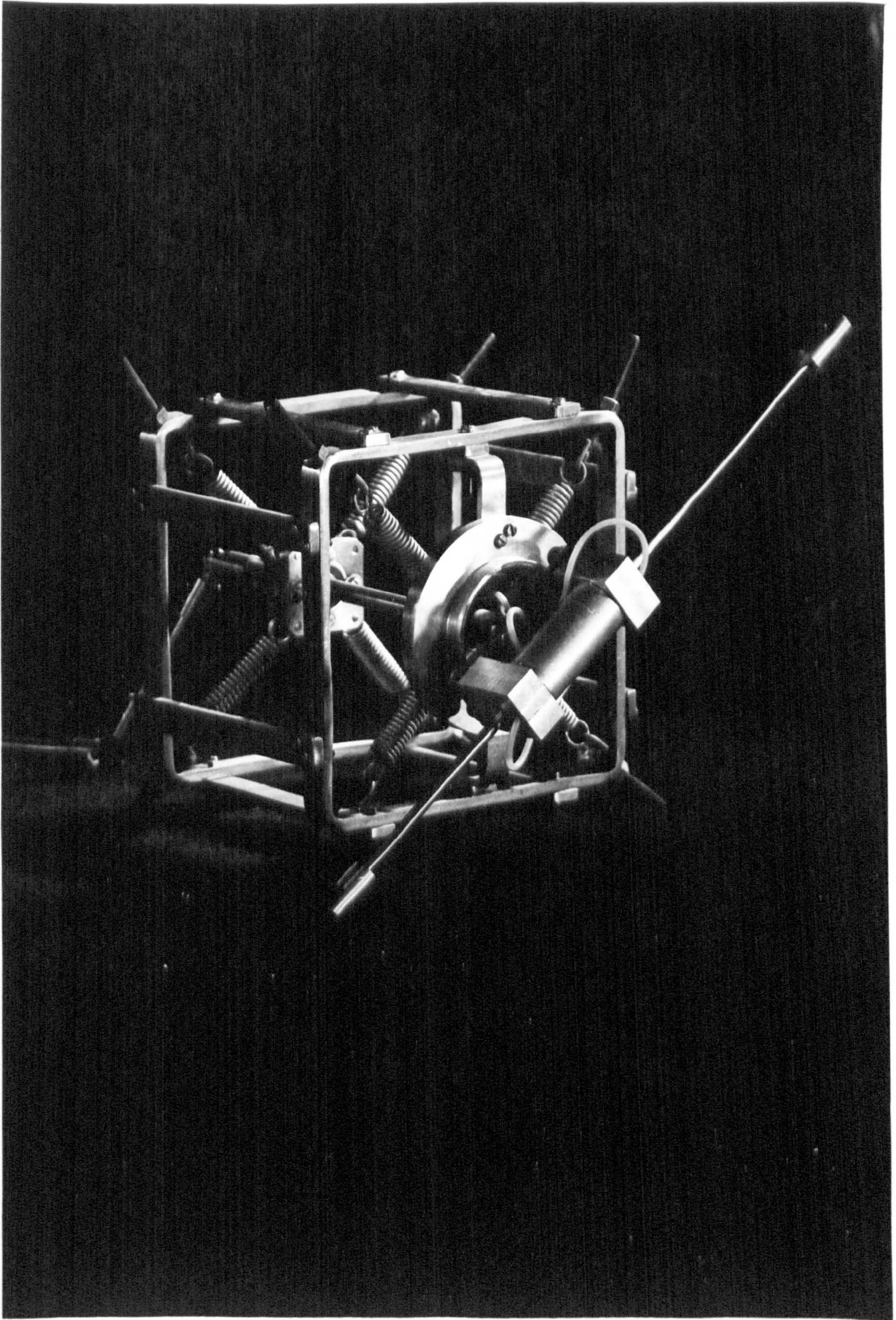

Fig. 4.IV.1

Self balancing centrifuge.

In a state of imbalance, the side thrust at any moment is given by

$$F = (m_2 r_2 - m_1 r_1) \omega^2$$

Assuming 2000 rpm $\omega = \frac{2000}{60} \times 2\pi$

Initially, say $r_1 = r_2 = 15\text{cm}$

This gives a side thrust of 62 lb for a mass imbalance of $1\frac{1}{2}$ oz. which is equivalent to half the total mass of pvc retained at a single slush moulding. This determines the actuator size as number 17 which can provide 74 lb thrust, sufficient to overcome the imbalance and stabilise the centrifuge.

Using moulds of approximately 5 oz. weight each, the alteration in 'r' required to balance the centrifuge under these conditions is approximately 2 cm.

Thus the actuator selected for the centrifuge was a number 17 type, of 5cm stroke length.

Appendix 4.VTechnical aspects of the use of the silicone rubber in conjunction with the casting of molten tin.

The rubber chosen was an ICI silicone rubber Silcoset 105, used with fast curing agent (Stannous octoate) giving a cure time of approximately five minutes. As it was necessary to use this material as the casting material for the donor's hand, it was necessary to check the possible toxicity of the materials concerned. The silicone rubber itself is substantially inert, but the curing agents used with the rubbers are not necessarily innocuous. However, assurances from the manufacturer, combined with information on the subject from Lefaux (1968) "Practical Toxicology of Plastics", and the use by Dow Corning Inc. of stannous octoate as a curing agent for silicone rubbers on open wounds, confirmed the fact that, in the low concentrations required, no ill effects would result from skin absorption of the curing agent stannous octoate. Clearly the use of the U-tube pouring device was not possible with molten tin, since no preheating liquid with a sufficiently high boiling point was readily available as a substitute for water. Therefore, it was necessary to use the finger location rod technique to form air vents at the finger tips.

As a preliminary trial, the author's hand was used for the casting procedure. After various experiments with setting time vs quantity of curing agent it was found that approximately 6g curing agent 'D'/kilo of silcoset 105, gave an adequately long pouring time, compatible with a suitably short overall setting time of seven minutes. It was found that the reproduction of the detail

of the hand was so perfect that release of the skin from the mould was extremely difficult, indeed painful. Furthermore, any attempts to withdraw the hand before full skin release had taken place, resulted in suction bruising caused by the partial vacuum created by the attempted withdrawal. A silicone fluid was rubbed onto the hand as an attempt at a release agent which was sufficiently thin in consistency to prevent loss of detail. However, the use of this material as a release agent aggravated the problem rather than otherwise.

The use of a release agent as such was therefore abandoned in favour of arriving at a procedure which would ensure full skin release before attempting withdrawal. This was achieved by injecting air under low pressure into the fingertips successively, thus creating a release pressure which caused separation of skin and Silcoset along a route up to the wrist. The track of this released area could be increased to some extent by moving the fingertip relative to the tube - thus creating an alternative route by which pressurised air could escape. Following release of all the fingers in this way, the thumb and wrist were released in a similar manner by inserting the air hose at the wrist. Even following this procedure, withdrawal was not easy, due to the extreme dryness of the mould material. It was therefore necessary to follow the air release procedure by the injection of a liquid soap and water solution into the fingertips by means of a syringe. This provided sufficient lubrication to permit easy withdrawal of the hand from the mould without undue discomfort to the donor.

In order to ensure that no air could be trapped at the fingertips, the air holes were then cleared of debris, the mould washed

clean of soap and then dried. The molten tin was then poured into the cavity and allowed to cool, the surface being maintained molten by means of a large 240W soldering iron as before. (The possibility of conductance heating was rejected as an alternative following calculations, see Appendix 4.IX). That this rate of heating would be sufficient had been checked simply from the results of an experimental determination of the cooling rate of molten tin (see Appendix 4.IX). Before solidification began, however, the mould material began to degenerate, forming outcrops of a soft spongy consistency. This fault was due to the fact that high temperature of the tin was so close to the maximum rated temperature of the rubber, causing outgassing of the solvent materials. A slow, heat conditioning process was therefore an essential prerequisite before the casting stage. The next mould was therefore taken in its container and subjected to a gradually increasing temperature over a period of hours. The first attempt resulted in cracking of the mould material, after only allowing nine hours to attain a temperature of 220°C. By extending the time of heating to eleven hours, it was found that no cracking occurred, but some distortion of the mould took place. By taking sections of the mould it was observed that the distortion, almost implosion, of the mould, was due to a foaming tendency in the bulkier parts of the mould material. The expansion of these regions caused cracking and distortion of the well cured surface material. A detailed examination of the distribution of the frothy areas (Fig. 4.V.1) showed that they tended to occur away from the air-silcoset interfaces, the worst regions being in the thick sections and at

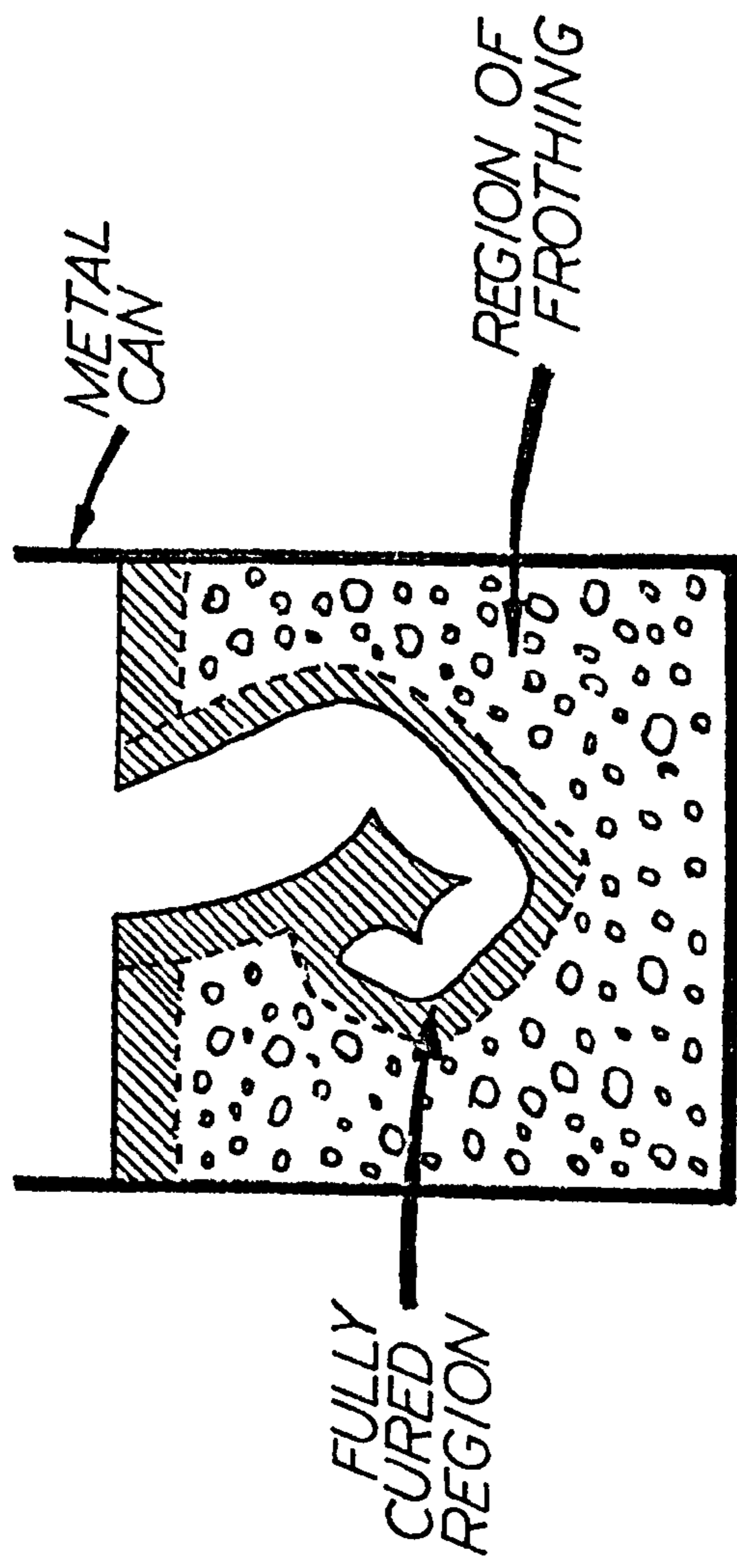

Fig. 4.V.1

Distribution of forthing in silicone mould.

the metal can-silcoset interface. This distribution of 'gassing' suggested that the gassing occurred in places where solvents were prevented from evaporating. The fact that the air-silcoset faces cured first prevented further emission of solvents in that direction, the metal container preventing evaporation from the outer surfaces. In an effort to facilitate release of the gases, the next mould was removed from its metal container before being subjected to the heat conditioning schedule. This resulted in an outwardly perfect mould, totally satisfactory for casting purposes, although subsequent sectioning showed slight porosity at the centre of the thicker sections.

Molten tin was poured into the mould, the upper surface being maintained molten by heating with a large soldering iron as before. The rate of heating was gradually reduced by heater voltage reduction and the mould replaced in its metal canister situated with the lower part immersed in cold water in an effort to ensure solidification of the lower regions first.

After ultimate solidification had taken place, the mould material was cut away in order to expose the casting. The casting showed very good detail at the wrist and palm, but was faulty at the fingers and fingertips. The fingertips were absent, apparently due to contraction away from the sprues (Fig. 4.V.2). The fingers themselves showed many small crystalline contraction-like faults, together with smoother pitting, these with the appearance of air bubble faults.

These results suggested the presence of two types of fault, namely those due to contraction of the hot metal and those bubbles

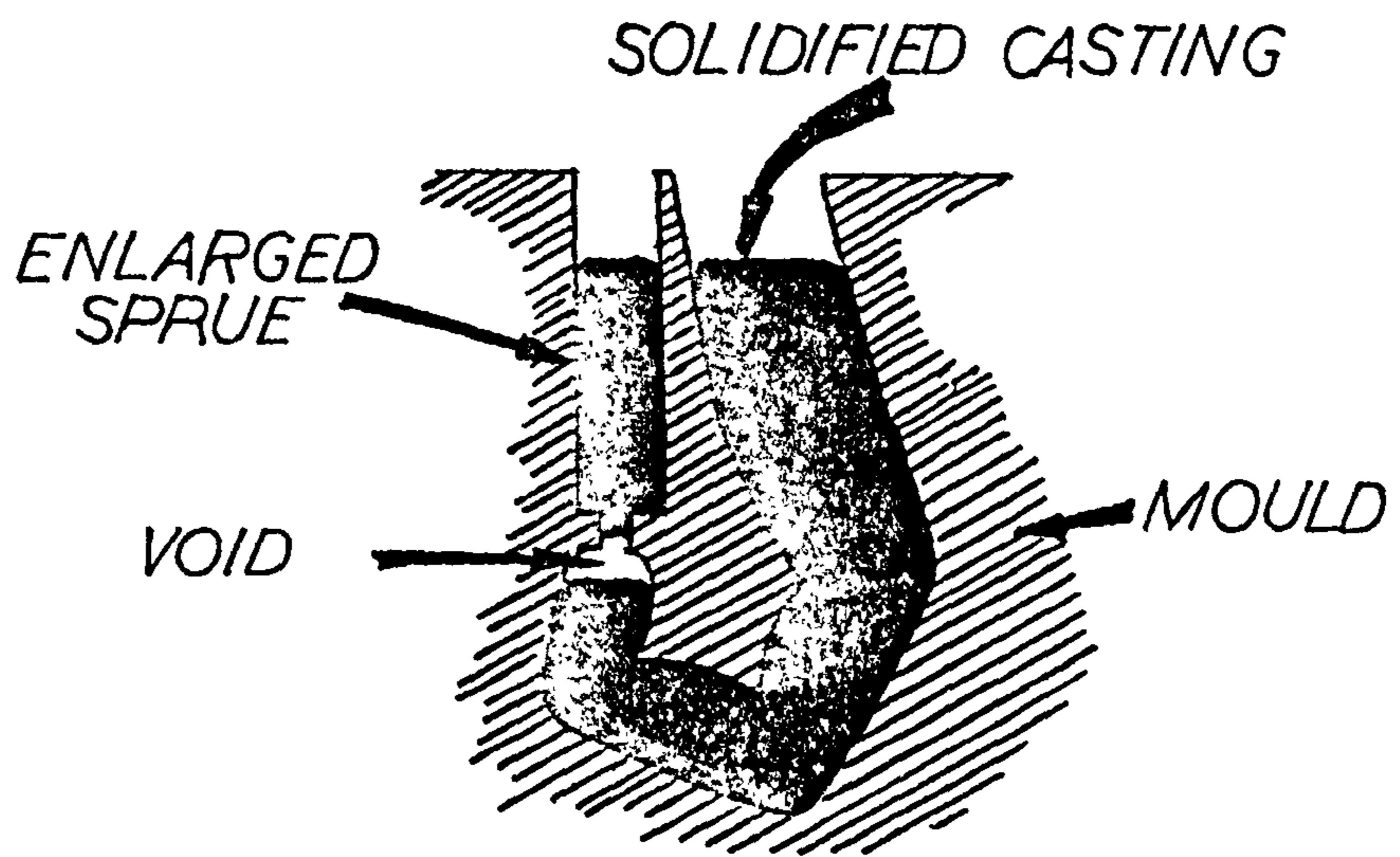

Fig. 4.V.2

Contraction faults at finger-tips.

caused either by trapped air or by further evolution of gases from the mould material when subjected to the extra heat of the molten metal.

Various alterations were made to the process in order to overcome these defects in the casting. In order to decrease the tendency for the formation of locally solidified areas, the heating rate was decreased more slowly. This, however, proved to be unsatisfactory due to supercooling effects, the tin would remain molten below its normal solidification temperature and then tended to solidify very suddenly resulting in larger 'closed off' regions of molten metal, thereby causing larger contraction faults. The considerable contraction away from the fingertip sprues suggested that the narrow portion (Fig. 4.V.3) should be reduced to as short a length as possible in order to reduce the possibility of a blockage due to solidification. This step resulted in a considerably reduced fault at the fingertips, but failed to eliminate the problem completely.

Concurrent with the above measures, steps were taken to reduce the possibility of flaws due to trapped gases. After pouring the molten metal, the mould was agitated and tapped to release trapped air. The agitation was continued for as long as possible. Also, the curing time of the mould material was extended to over 100 hours with a final period of 36 hours at 240°C . It was felt that the time of one hour or so during which the mould was subjected to molten tin at 233°C was insignificant with the time scale of such a schedule and should therefore eliminate the possibility of release of gases from the mould material itself.

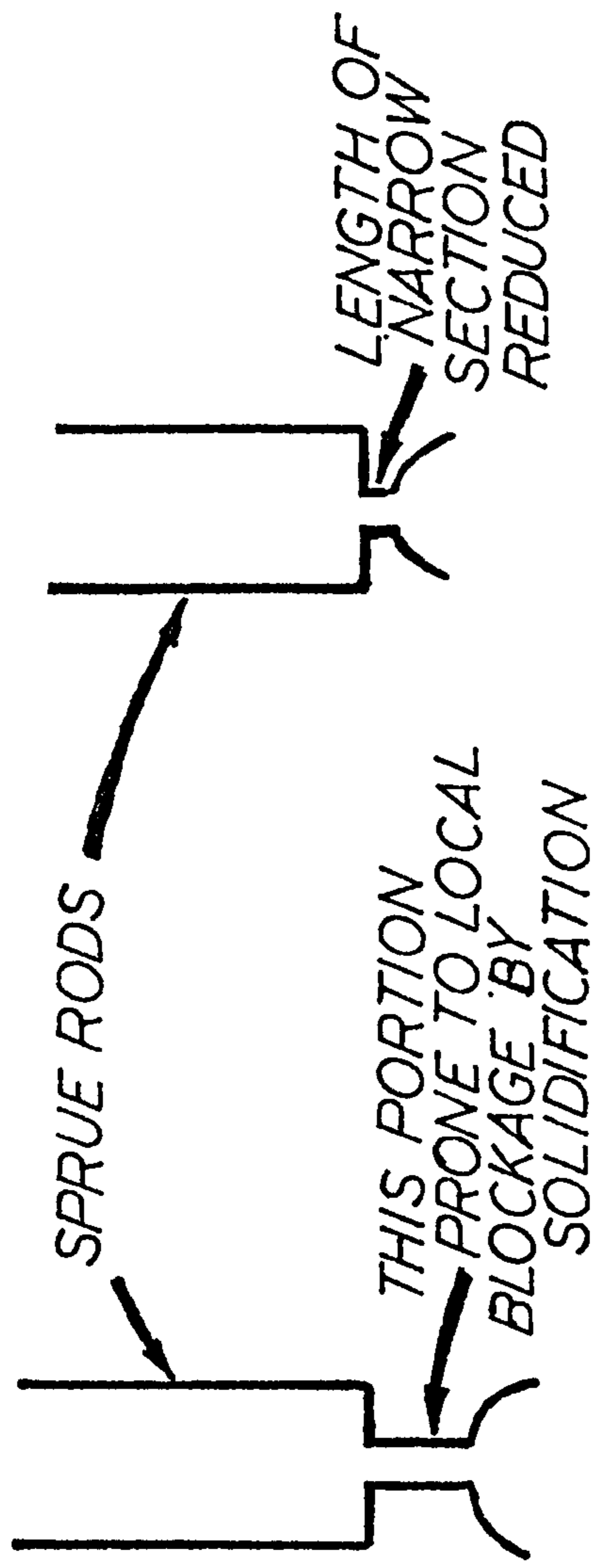

Fig. 4.V.3

Sprue effects.

These steps resulted in a negligible reduction of the incidence of the bubble-like flaws (Fig. 4.V.4) and this suggested that they may not in fact be caused by gases, rather that they were directly associated with the 'normal' contraction faults.

This consideration led to the direction of attention to the type of cooling techniques used in more conventional casting processes. It is usual to cool by quenching, thus ensuring that the outer surface is chilled first, which causes any contraction faults to occur in the bulk of the material. This approach was not directly possible for the hand mould due to the insulating effect of the silicone rubber. However, by modifying the shape of the casting can to suit the profile of the hand more accurately, it was possible to ensure that the mould be only a matter of a few millimetres in thickness at the knuckles. This was achieved by taking an impression of the donor's hand in alginate, reducing the alginate thickness to a minimum after setting by palpation and slow removal of excess material as previously described. This mould was then replaced in the casting can (Fig. 4.V.5), leaving cavities in the 'redundant' regions. These cavities were then filled with a plaster wash, which was allowed to solidify and the alginate discarded. At the time of the next casting in silicone rubber, the plaster fillers were left in place in the can, thereby reducing the amount of silicone rubber necessary for the casting, and also reducing the thickness of insulation at the bottom of the mould. During the cooling process after pouring of the molten metal, the mould was immersed in cold water to enhance cooling from the lower regions first. This again resulted in an improvement in the

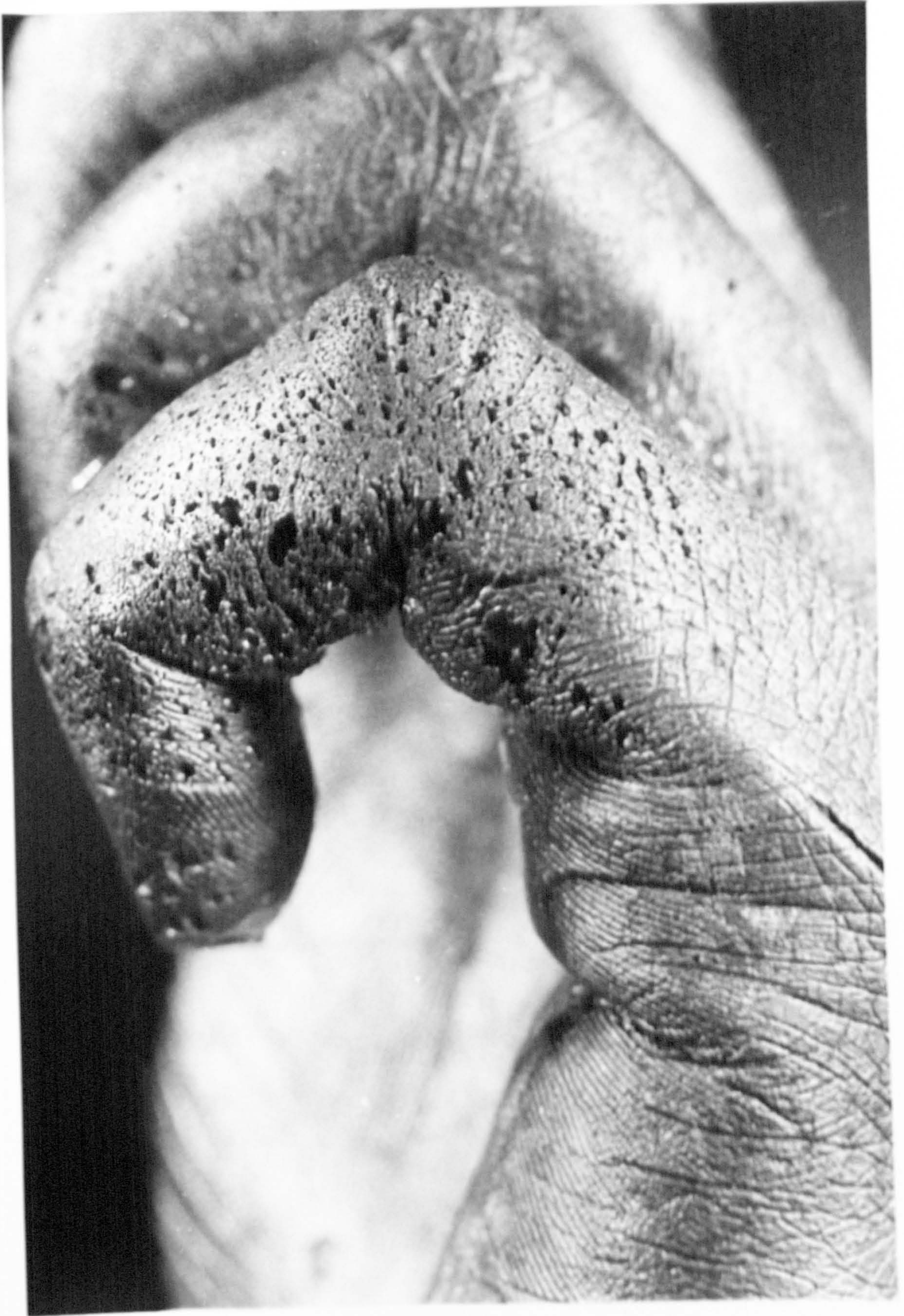

Fig. 4.V.4

Casting flaws.

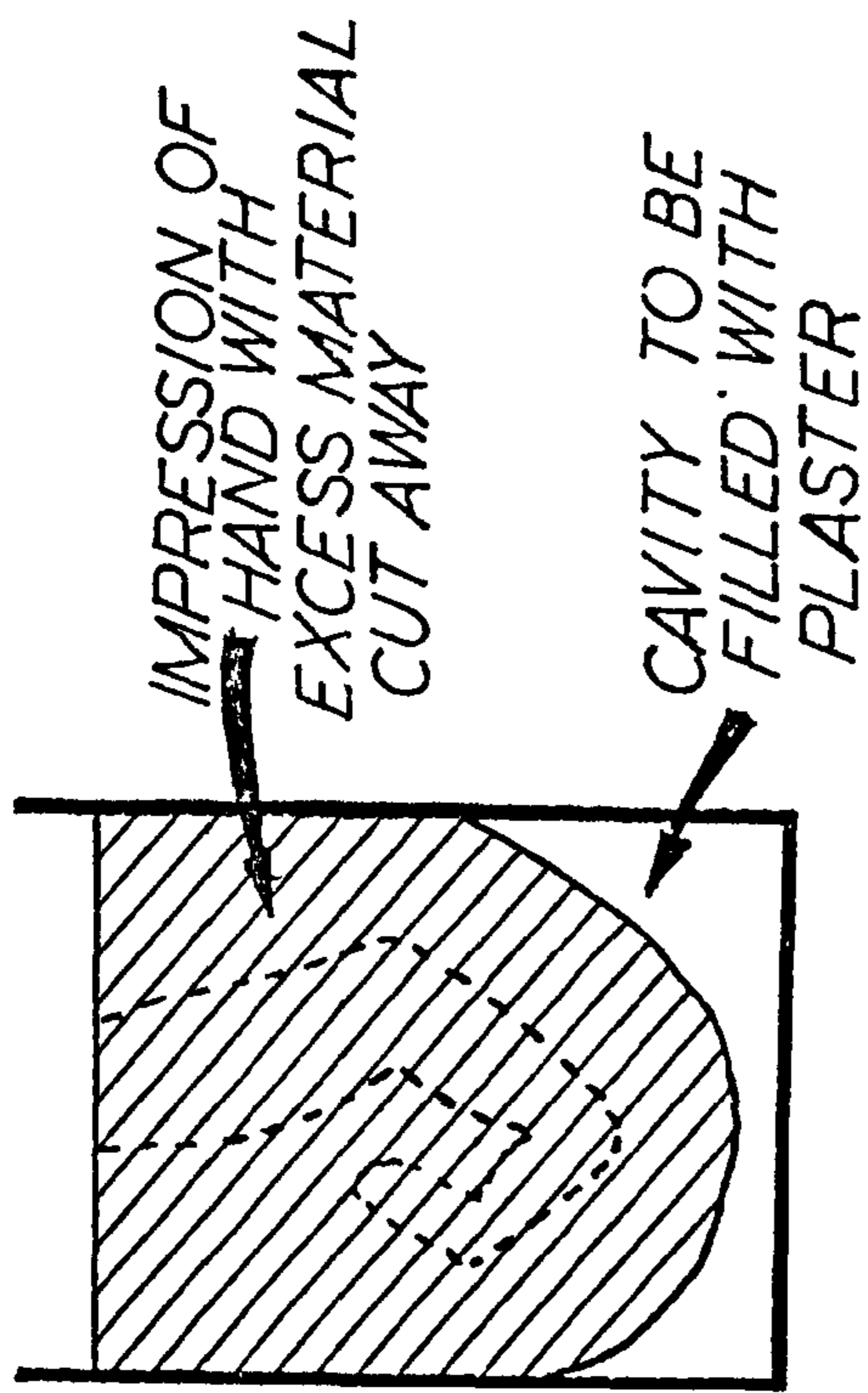

Fig. 4.V.5

Reduction of thickness of mould.

casting but without eradicating all contraction faults.

Two projected schemes, which were in fact unnecessary, were envisaged as remedies for the inhomogenous cooling effects which were evidently causing the formation of contraction regions. The first of these was to 'seed' the molten metal with tetragonal shaped objects in an effort to reduce the possibility of super-cooling by the introduction of nuclei for crystallisation. The second approach was to be made by cooling the mould before pouring, in the hope that surface cooling would then be likely to occur first; although this seemed unlikely to succeed, since the sprue holes would almost certainly seal off before filling had been completed. However, thinking on the lines of the inhomogeneity of the cooling effects led to a similar approach, but directed in a different way.

Hitherto, all attempts at cooling had been made from the surface inwards, the results, not surprisingly being non-uniform due to the varying insulation of the mould material. However, a homogeneous cooling process could be initiated by treating the casting once again as a U-tube. By cooling one end rapidly, and maintaining the other end at a decreasingly high temperature, an interface of solidification should propagate round the U-tube (Fig. 4.V.6) and the process should be relatively uniform, since the metal is highly conductive, and local differences of temperature are less likely to occur.

This technique was put into practice by separating the sprue section from the wrist position of the mould and introducing a water-cooled module into the sprues, and the heater into the

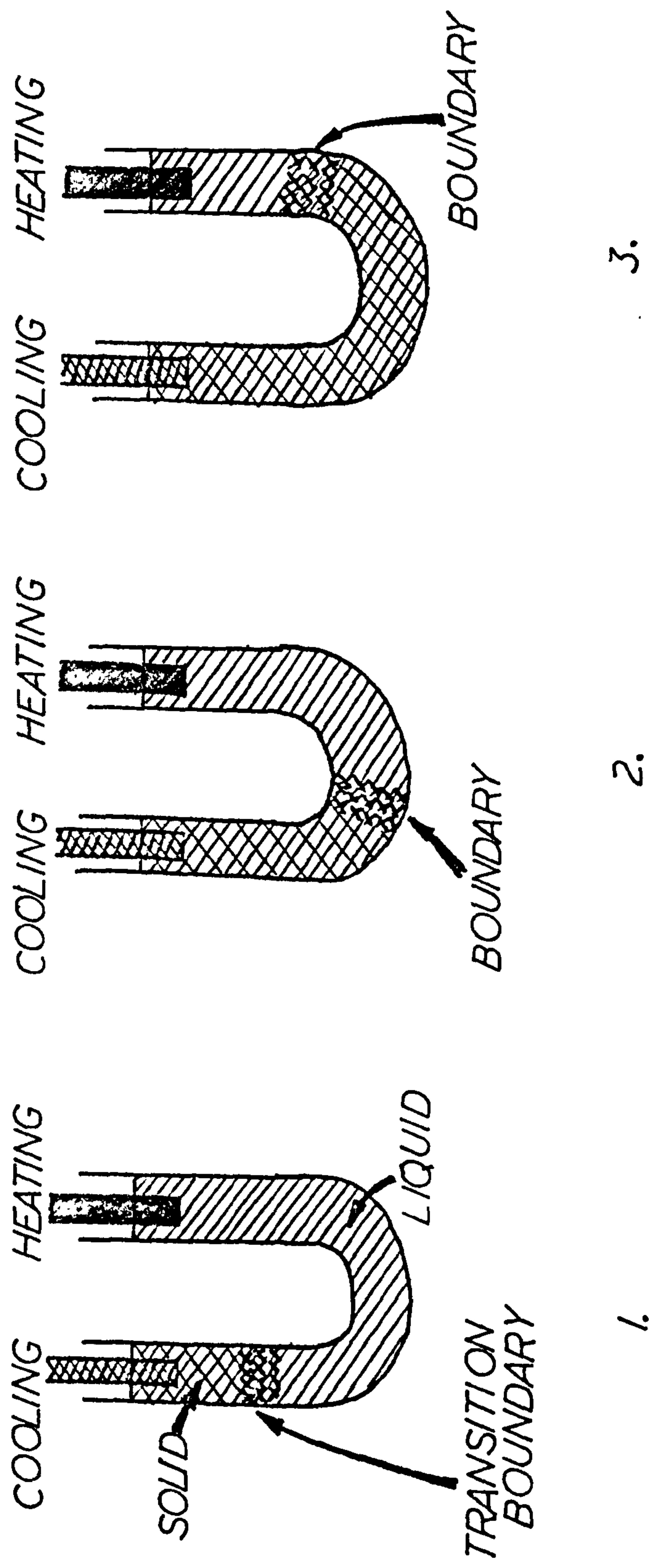

Fig. 4.V.6

Propagation of cooling 'front'.

wrist section. The water cooling was made operative directly after pouring, and the heater initially maintained at maximum. The heater temperature was then gradually reduced as before, the state of solidification being checked by means of a metal rod used as a dipstick feeling for regions of crystallinity at the solidifying interface. In this way the rate of temperature reduction could be accurately matched to solidification rate. After solidification was completed, the mould material was cut away, leaving a perfectly formed flawless casting, without even any bubble-type flaws, showing that they were of contraction origin.

Appendix 4.VIThe stuffing of the everted glove prior to use as a donor for second phase casting.

Early attempts at filling the glove with molten wax or liquid plaster resulted in unnatural ballooning effects which could only be partially overcome by immersion in a water bath during the liquid stage. The immersion in water helped reduce the ballooning to some extent by virtue of the hydrostatic pressure induced, and it is possible that pressurisation of the water bath in some way may have overcome the problem satisfactorily. However, this technique gave little opportunity for the precise setting of finger and thumb positions as desired. Fortunately, by means of a simple adaptation of an existing procedure used in prosthetics, an ideal alternative was found. A standard procedure for the 'casting' of amputation stumps has been to take a flexible bag filled with powder or small spherical granules, and to impress into this bag the stump to be 'cast'. With the stump in position the bag is then vacuumed causing compression of the particles by the action of the atmospheric pressure on the bag. The stump may then be removed, and the particle filled bag retains the stump shape perfectly as long as the vacuum is maintained.

This technique was utilised for the hand stuffing by filling the glove with small, light spheres of plastics material, and then vacuuming. By adjusting a controlled leak, the hardness of the 'hand' could be adjusted, making positioning of the fingers and thumb and any other minor adjustments extremely easy. When the correct configuration had been achieved, the vacuum was made as complete as possible and maintained at that level whilst the

138.

hand was used as the 'donor' for a silicone rubber casting.

Appendix 4.VIIComparison of the overall loss of detail in the new glove manufacturing process with that of the 'classical' procedure.

This is achieved by attributing to each stage of the processes a loss factor which is a measure of the amount of detail lost in that stage. Thus, a stage with a loss factor x (< 1) would cause say a ridge-groove height of l to become lx , two successive stages would result in x^2l etc.

The loss factor x is used to represent the loss due to a casting process, the factor p (almost certainly much smaller than x) due to a painting process, q due to electroplating, and r due to sticking of Cerrobend or wax on removal of same. Thus we have:

<u>Conventional process</u>	<u>New process</u>
x 1. Cast donor hand in alginate	x 1. Cast donor hand in silicone rubber
x 2. Pour in wax or cerrobend positive.	x 2. Pour in tin positive.
p 3. Paint wax with conducting paint.	x 3. Dip in pvc, cure and evert.
q 4. Plate with copper and thicken.	x 4. Fill glove and use as donor.
r 5. Melt out wax or cerrobend.	x 5. Pour in tin positive.
x 6. Pour pvc, cure and remove glove.	x 6. Dip in pvc, cure and evert glove.
Net loss factor $pqr x^3$	Net loss factor x^6

Thus the two procedures have similar sixth order loss factors. Due to the materials used, it is certain that the factor p is considerably smaller than x , since surface tension effects tend to

fill the grooves with excess paint, which later is removed as it adheres to the glove. The factor q is difficult to assess, since the exact mechanism of plating in the grooves is uncertain, however, it seems likely that, if anything, deposition is likely to be less faithful in these regions due to the tendency for the prominent ridges to possess higher field intensities. Thus, on balance it may be guessed that q is no larger than x at any rate. After a period of time the factor r certainly will increase as repeated subjection to high temperatures tends to melt out the excess material. In the case of wax it is likely that r approaches unity after some time. However, in the case of cerrobend some intermingling of the copper and cerrobend is inevitable and r will not approach unit so readily, if at all.

Thus, the new process is at least as good as the conventional process from a detail transfer standpoint, since it has been shown that $pqr \not\approx x^3$.

Appendix 4.VIIIEffect of vacuuming the casting on size of trapped air bubbles.

If the molten metal is poured under vacuum conditions, air bubbles trapped in the metal will be compressed as a result of a subsequent return to atmospheric pressure. Assuming the application of an Edwards EB3 vacuum pump under these conditions a vacuum of 26" of mercury is possible according to the maker's specification.

Thus, a return to atmospheric pressure (30" Hg) will correspond to a decrease in volume by a factor of $\frac{4}{30}$.

Thus, a bubble of diameter d will become a bubble of diameter $d \sqrt[3]{\frac{4}{30}}$ assuming perfect gas behaviour at constant temperature, i.e. the reduced bubble diameter will be approximately half that of the original. This order of magnitude of size change cannot be considered as sufficient to eliminate casting flaws due to bubbles, and the cost and complications of more sophisticated vacuum equipment prohibited more extreme vacuum conditions.

Appendix 4.IXHeating rates required to maintain the molten tin in a liquid state.

Assuming Newton's law of cooling:

$$ms \dot{\theta}_T = kA(\theta_T - \theta_0) \quad \text{where}$$

m is mass of metal
 s is specific heat
 A is surface area
 θ_T is temperature of metal
 θ_0 is temperature of surroundings
 k is the cooling constant.

The constant k was established by experiment, measuring the temperature of a sample of molten tin vs time. (N.B. the sample was impure and therefore did not solidify at the 'tabulated' temperature of 238°C). These experiments gave an approximate linear cooling rate of $0.57^\circ\text{C}/\text{sec}$. over a temperature range with an average $(\theta_T - \theta_0)$ of 215°C , for a sample weighing 445g in an insulating vessel with an exposed surface area of 16cm^2 .

$$\underline{\underline{\text{This gave } k \approx 0.017 \text{ watts}/^\circ\text{C cm}^2}}$$

To assess the possibilities for conductance heating of the tin in order to maintain the metal in a molten state, it was necessary to consider electrodes inserted into the molten tin at the surface.

Consider the segment of metal of length l between electrodes of width w inserted to a depth d

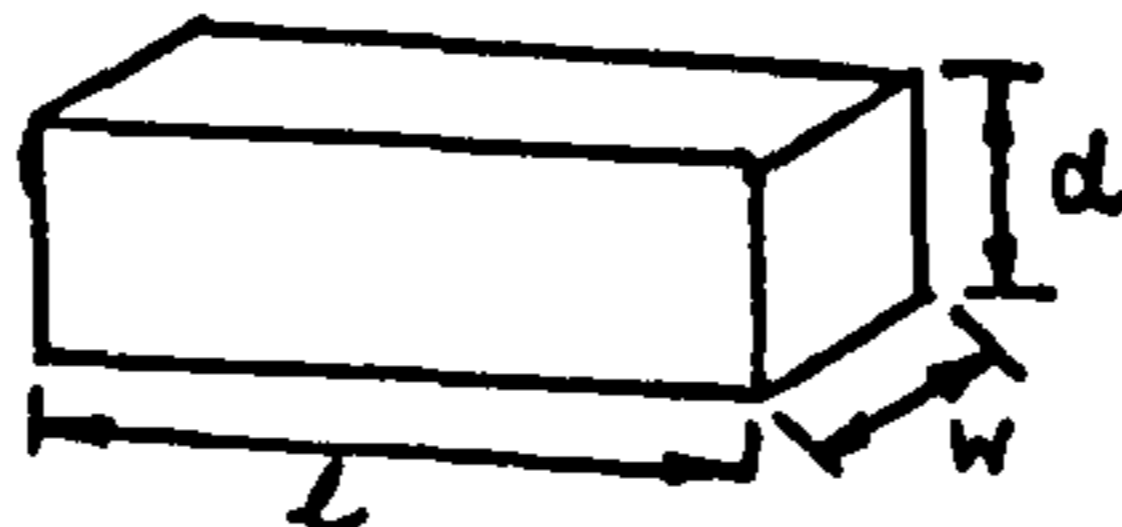

The resistance of this metal is given by $R = \frac{\nu l}{wd}$ where ν is the resistivity.

A current I causes an introduction of energy by resistive heating at a rate $I^2 R$, which in equilibrium is balanced by the Newtonian cooling at the surface.

143.

$$\therefore k \cancel{w} (\theta_T - \theta_o) = \frac{I^2 \cancel{w}}{wd}$$

$$\therefore I^2 = \frac{kw^2 d (\theta_T - \theta_o)}{w}$$

$$\text{Put } \cancel{w} = 12 \times 10^{-6} \text{ ohm cm}^{-1}$$

$$w = 2 \text{ cm}$$

$$d = 1 \text{ cm}$$

$$(\theta_T - \theta_o) = 230^\circ\text{C}$$

$$k = 0.017 \text{ watts } ^\circ\text{C}^{-1} \text{ cm}^{-2}$$

Which gives $I \approx 1000 \text{ AMP}$

This effectively excluded the possibility of using the molten tin as its own heating element. However, the rate of heat loss from the surface is more readily balanced by the use of a heating element:

$$\text{Required heating rate} = kA (\theta_T - \theta_o)$$

$$\text{Put } k = 0.017 \text{ watts } ^\circ\text{C}^{-1} \text{ cm}^{-2}$$

$$A = 20 \text{ cm}^2 \text{ (approx. 5 cm diameter)}$$

$$(\theta_T - \theta_o) = 230^\circ\text{C}$$

$$\therefore \text{Heating rate} = \underline{78 \text{ watts}}$$

Thus the heating could reasonably be supplied by a heating element such as a large soldering iron.

Appendices to Chapter 3.

- 5.I The assessment of possible control systems.
- 5.II The importance of force feedback.
- 5.III Development with the force demand valve.
- 5.IV The development of a double-acting valve assembly.
- 5.V The development of position feedback systems.
- 5.VI A mathematical model of the position servo/force demand controlled pneumatic actuator.
- 5.VII The use of pneumatics in feedback mechanisms.

Appendix 5.IThe assessment of possible control systems.

The standard control procedures are as below:

1. On/off or 'bang-bang' type - the operator switches 'on' and uses visual feedback to acquire position knowledge, he switches 'off' slightly before the desired position in the hope that the deceleration period takes the device to the correct position.
2. Position control - every position of the control input corresponds to a position of the prosthesis.
3. Velocity control - the position of the control input corresponds to a velocity of the mechanism.
4. Acceleration or force control - the position of the control input determines the force output of the prosthesis.

These four types of controls represent the major components of the specifications for a time variable problem in three-dimensional space, since, if the load is known we have t , \underline{x} , $\dot{\underline{x}}$, $\ddot{\underline{x}}$, where \underline{x} is a vector quantity. The choice of which quantity should be under the control of the operator in any such problem should clearly be made from \underline{x} , $\dot{\underline{x}}$, $\ddot{\underline{x}}$, since the duration t of a movement is under the control of the operator in all circumstances.

The selection of the appropriate optimum control variable is so simple, that it is a matter of considerable amazement that the incorrect choices are so frequently made, although the reasons for these choices have probably been based on matters of design convenience rather than on considerations of operator requirements.

Consider control of the variable $\dot{\underline{x}}$, which also embodies control of t .

The operator, in order to obtain position information without the use of optical feedback, must be able to compute

$$\underline{x} = \int_0^t \underline{\dot{x}} dt + \underline{k} \quad \underline{k} \text{ is a constant which depends on the initial position.}$$

This gives a different solution for every starting position \underline{k} , and therefore \underline{k} must be established visually before the commencement of each movement. Thus, under these circumstances, the operator must rely on visual feedback of information for successful control of the system.

Similarly, control of $\underline{\dot{x}}$ and t implies the knowledge of two constants in order to obtain position information.

In contrast with these situations, control of \underline{x} and t implies accurate knowledge of $\underline{\dot{x}}$, $\underline{\ddot{x}}$, $\underline{\ddot{\ddot{x}}}$ etc. by virtue of $\underline{\dot{x}} = \frac{d}{dt} \underline{x}$ which is unique and $\underline{\ddot{x}} = \frac{d}{dt} \underline{\dot{x}}$ (which does not require load information).

Therefore if the operator is given control of position (and hence the time variable t) he is automatically given control of all the dynamic variables in a space-time problem, whereas control of one of the higher derivatives can only lead to partial control of the system. Some workers (Freedy et al 1967) have rejected the position control system on the basis of the high information content which is required, ignoring the fact that the information content works both ways, giving information to the operator as well as requiring it from him.

Appendix 5.IIThe importance of force feedback.

This is an extremely important factor in the problem of the feedback of information from the moving parts of a control system, since a serious trap awaits the unwary, and for this reason, the vital distinctions between active feedback of load information and the force controlled system will be emphasised.

The force controlled system mentioned under the list of control principles is a system by which the control input determines the force which the actuator exerts on the load, but no knowledge of the magnitude of the load is directly available to the operator.

The position servo controlled system controls the acceleration \ddot{x} of the output by virtue of the 1:1 relationship between input and output, and the degree of difference between applied actuator force and load is experienced by virtue of the 'force = mass x acceleration' relationship of the body mass at the control site.

These two control principles show that the operator has no direct knowledge of the load magnitude, in the former case he knows the applied force but has no knowledge of the amount by which he has exceeded the load force since no acceleration information is available, and in the latter case no information about the applied force of the actuator is available and the operator is aware only of the differential between load and applied force by the acceleration experienced by his control site.

Thus we have:

'Force' control \Rightarrow Knowledge of force applied by actuator to load.

Position control \Rightarrow Knowledge of difference between applied force and load.

By combining these it can be seen that the necessary information is then available for the knowledge of load magnitude.

Therefore, in order that the operator may be able to modify his operation technique to suit varying load conditions and thereby optimise his control ability, it is essential to supply, in a position servo system, additional information concerning the force which is being applied to the load. The magnitude of the load will then be appreciated by the difference between applied force and the resulting acceleration.

An additional stabilising factor to the overall behaviour of the system is introduced by the muscle characteristics of the operator, by which the force applied to the control site (i.e. acceleration of control site) is related to the velocity of motion of the control site.

Appendix 5.IIIDevelopment work with the force demand valve.

The first problems encountered with Harborow's valves were largely the results of the construction of the valve assembly. As shown in Fig. 5.III.1(a) the lower seal was achieved by compression of the rubber diaphragm between valve centre and body at points X. The compression was created by the rotation of the top nut, and therefore the only means of achieving consistent diaphragm characteristics would have been to tighten to a pre-determined level using a torque wrench. However, buckling of the diaphragm was a further problem which would not be avoided even by consistent compression. Both of these faults were overcome by the replacement of the lower diaphragm by a loose flap seal of rubber as used by Klasson (1967) in the Swedish valve. The rubber seal was stiffened by a backing of thin steel to provide a consistent seal on the inlet port. The peripheral seal was maintained by the introduction of an O-ring fitting round the valve body. The valve in this form is shown in Fig. 5.III.1(b) with its operating characteristics in Fig. 5.III.2.

The force/pressure characteristics of the valves tested during these experiments were carried out simply by applying a known force to the valve operating point and monitoring output pressure with a standard dial pressure gauge. The known force was applied by holding the valve under test in a special holder, Fig. 5.III.3 and mounting the holder over the pan of an accurate set of spring balance weighing scales, so that the valve operating point was in contact with the scale pan. By means of the adjusting screw the valve was displaced, causing movement of the scale pan and hence an increase in force

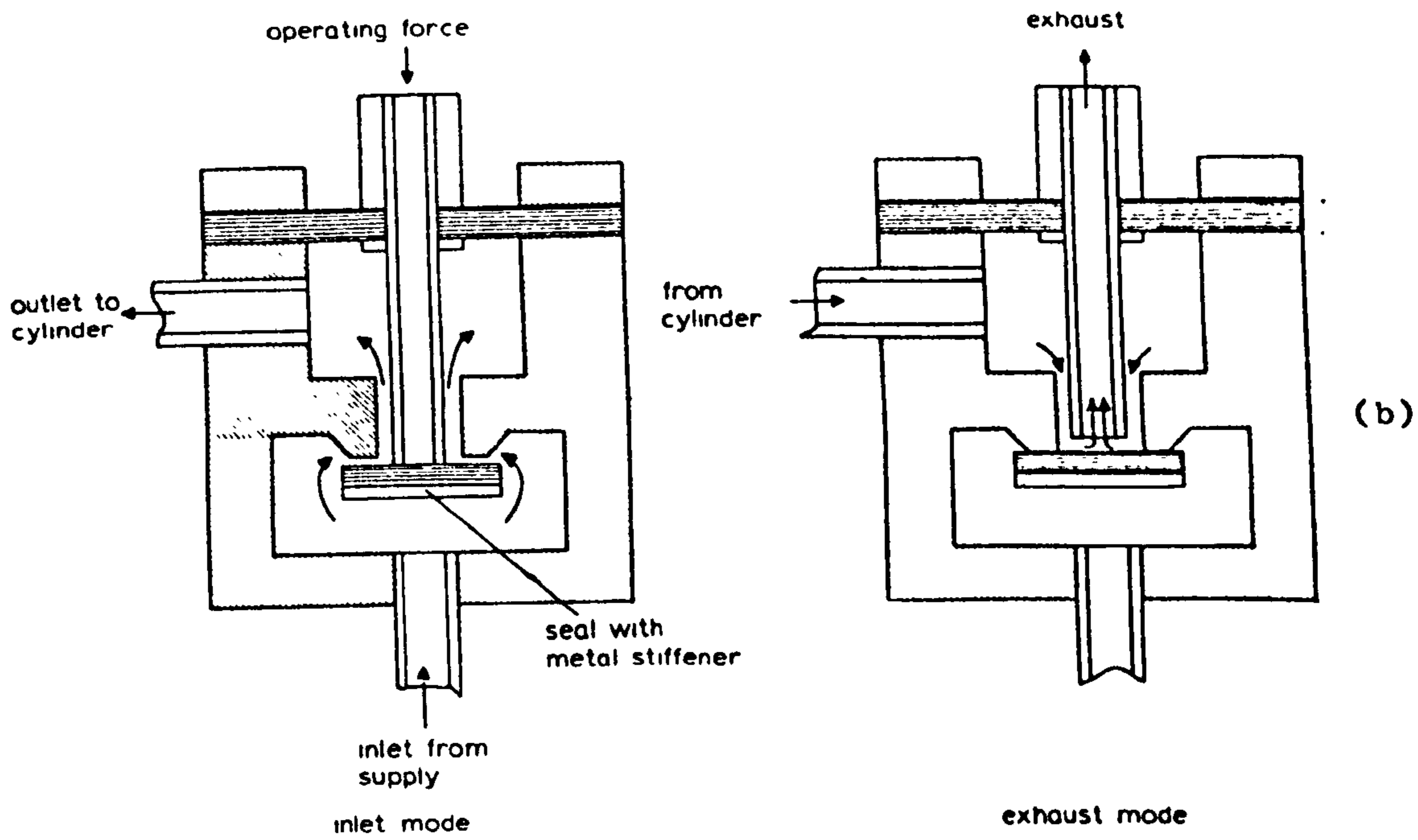
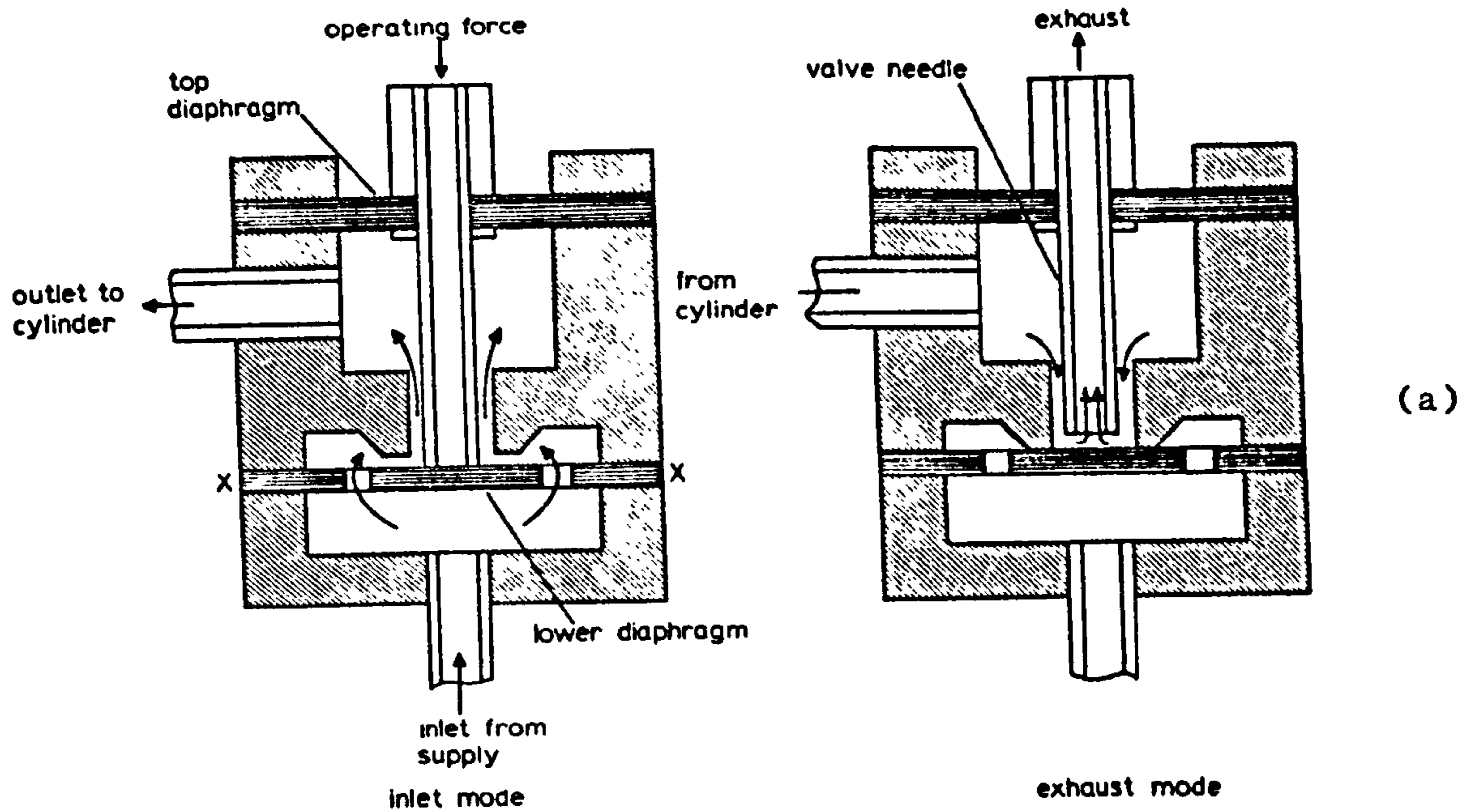

Fig. 5.III.1

(a) Original form of Edinburgh force demand valve.

(b) Valve with modified lower seal.

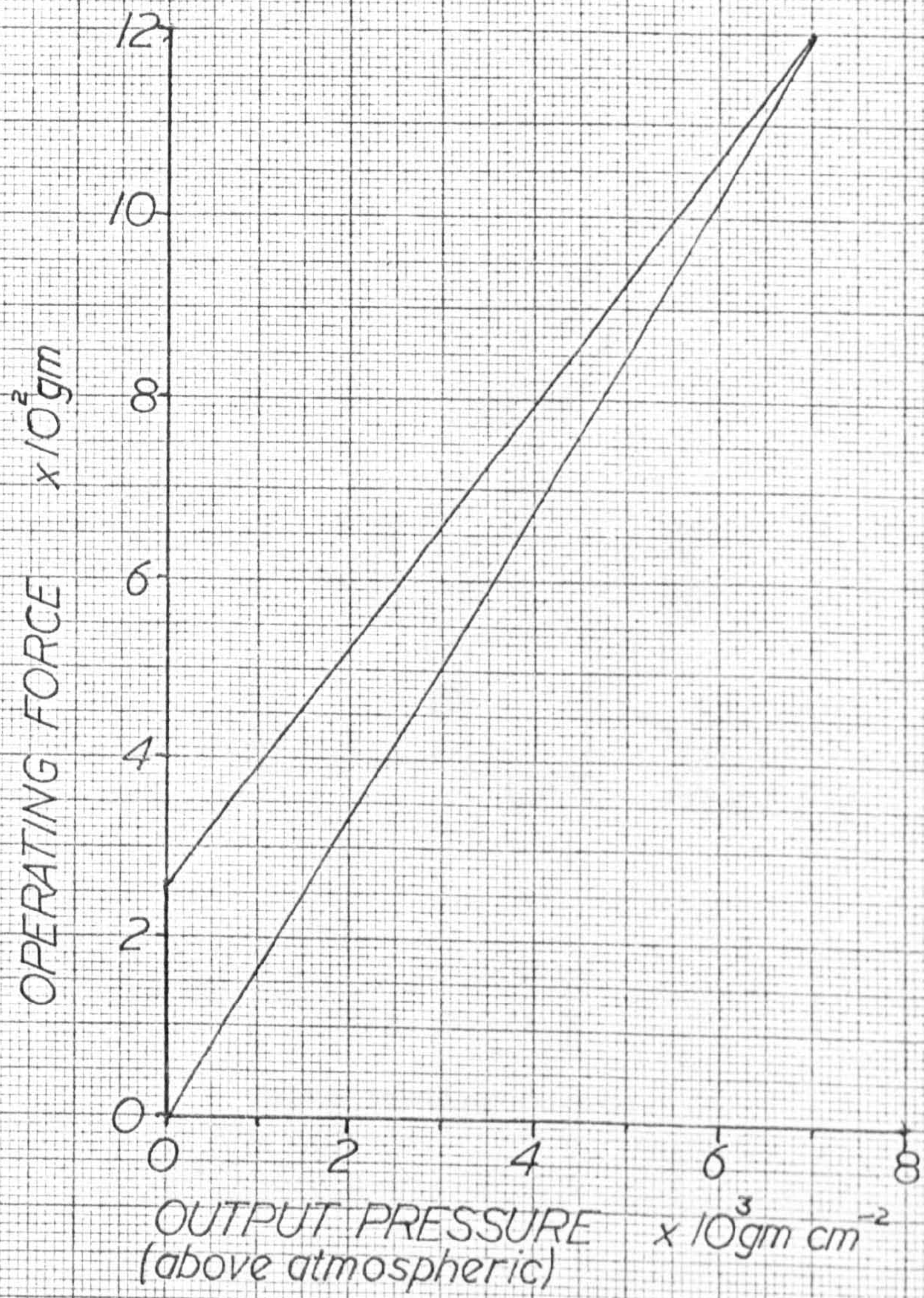

Fig. 5.III.2

Characteristics of valve with flap seal.

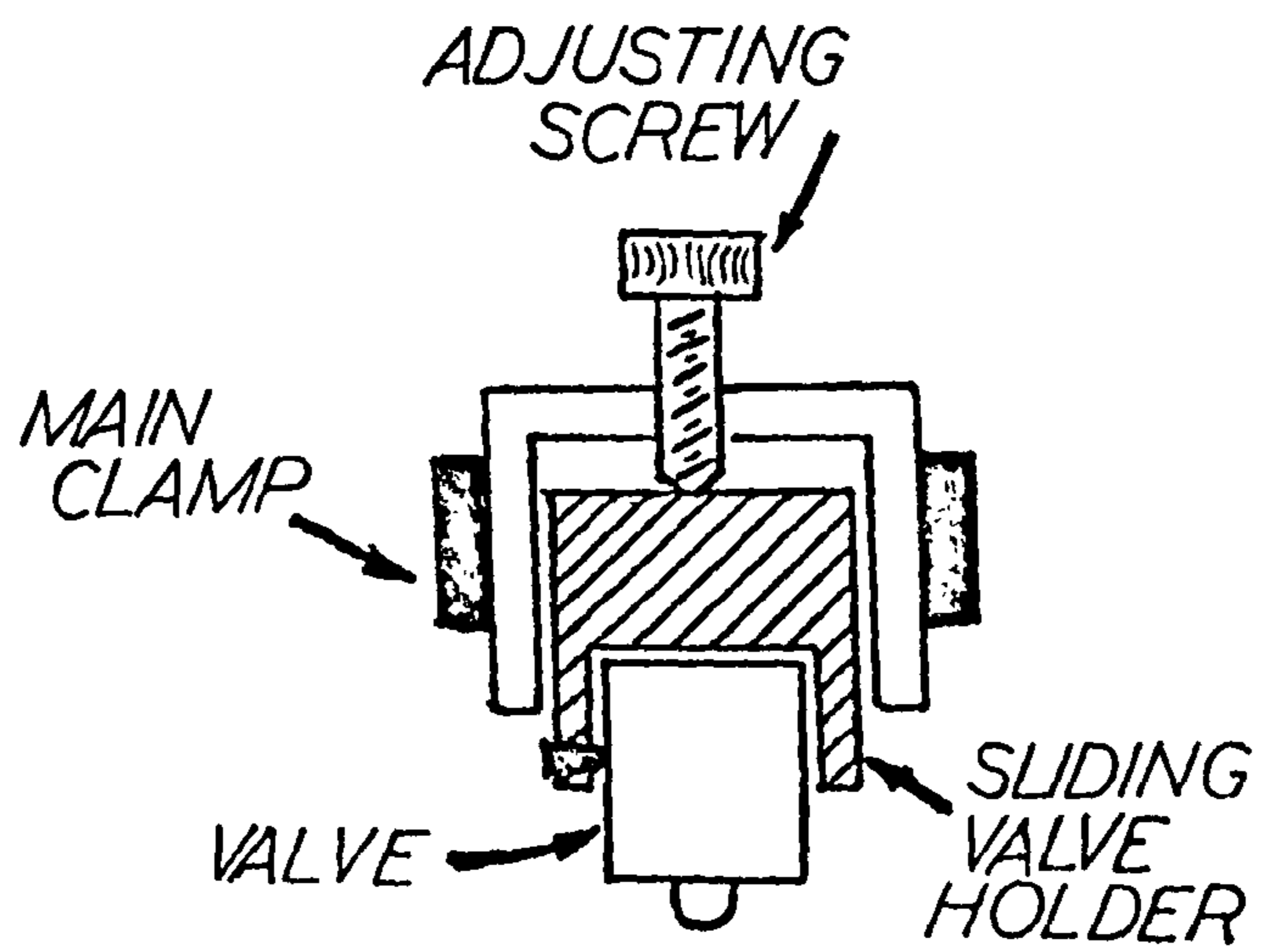

Fig. 5.III.3

Valve testing device.

applied. The applied force could be read at all times from the dial of the spring balance scales. This arrangement made possible a rapid checking facility during the assembly of a large batch of valves, when precautions against contamination by small metal particles cannot be 100 per cent efficient, faults often manifest themselves as excessively high operating forces.

Following the introduction of the loose flap seal the valves were installed in a prosthesis for trial. However, a basic fault soon appeared; whenever the gas supply was switched on, one or two valves would stay open, allowing gas to leak away at a furious rate. Frequently the fault could be cured by operating the controls rapidly, which solved the problem until the supply was disconnected and then re-connected.

The source of this problem was found to be the combined effects of the loose flap seals in all ten valves used in a hand-arm prosthesis. When the gas supply was first connected, all the flap seals would be lying in their natural rest positions due to the effects of gravity, thereby presenting many 'open' valves to the new gas supply. In this situation the pressure, on the inlet side of the seals, fell to such an extent that the pressure difference across the seals was insufficient to initiate closure. The temporary correction afforded by operating the controls was achieved by momentarily displacing the seals to such an extent that closure followed.

This problem was overcome by the introduction of a spring beneath the flap seal in order to maintain light closure under no-pressure conditions. Because of the accurate nature of spring

dimensions which would have been necessary to achieve the requirements of light closure in all valves, the type of spring selected was chosen for its simplicity of size adjustment. In this way it was possible to accurately adjust the closure force to the minimum requirement. The 'spring' selected took for form of a length of silastic rubber tubing, cut to size to suit each valve, since the thickness of the rubber seal could not be specified to any great accuracy. The valves in this form were not subject to the problem of low-pressure leaks, but other problems arise as a result of tests in the arm, the major difficulty showing itself in the form of a high operating force as the compressibility of the silastic rubber affected the operating characteristics as shown in Fig. 5.III.4. However, the prostheses were usable with these valves, without any gas wastage due to leaks, and it was decided that the fitting of the valves in this could continue while more detailed investigations of the valve design were carried out.

In order to assess the possible improvements to the valve it was necessary to consider a simple theory for the action of the mechanism. The theory has been explained elsewhere, Klasson (1967), and is repeated below (referring to Fig. 5.III.5) with the modifications which are necessary in the light of the experience outlined above.

F_a applied force.	A_d effective area of upper diaphragm.
F_s spring force.	A_i area of inlet port bore.
P_o output pressure	A_t area of tube end.
P_a atmospheric pressure.	D diaphragm stiffness.
P_i input pressure.	

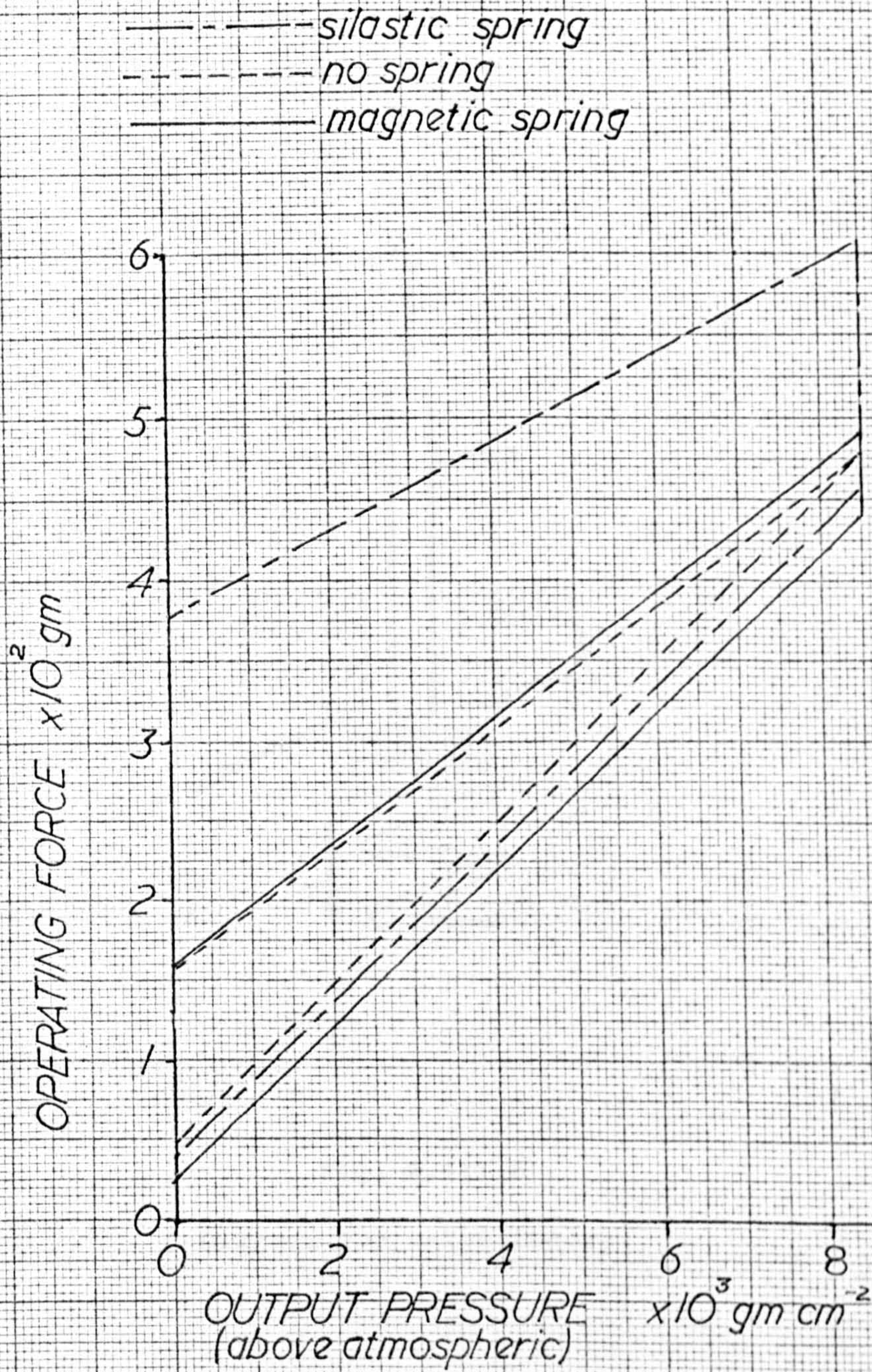

Fig. 5.III.4

Comparative characteristics of valves with spring loaded seals.

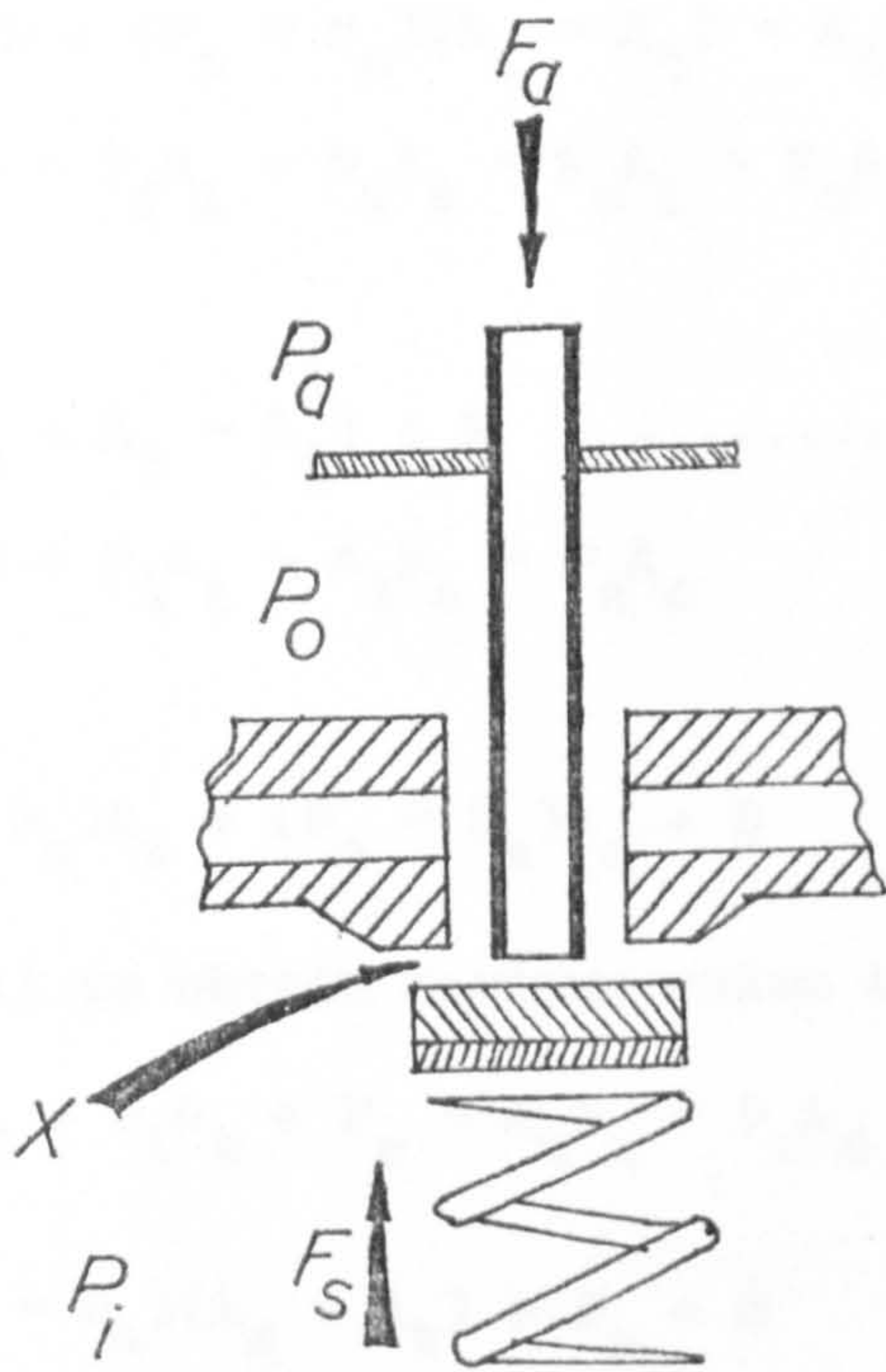

Fig. 5.III.5

Diagram for valve theory.

(1) To commence flow i.e. break seal at bottom flap at X

$$F_{a_1} = F_s + A_1(P_1 - P_a) + D$$

(2) Maintaining output pressure P_o

$$\begin{aligned} F_{a_2} &= F_s + D + (P_1 - P_o)(A_1 - A_t) - A_t P_a - P_a A_d + P_o A_d + P_1 A_t \\ &= F_s + D + P_1 A_1 - P_1 A_t - P_o A_1 + P_o A_t - A_t P_a - P_a A_d + P_o A_d \\ &\quad + P_1 A_t \\ &= P_o (A_d + A_t - A_1) + K \quad \dots \dots \dots (1) \end{aligned}$$

where $K = F_s + D + P_1 A_1 - A_t P_a - P_a A_d$

(3) Exhaust

$$F_{a_3} = (P_o - P_a)A_t + (P_o - P_a)A_d + D$$

Put $P_o = P_1$ in (1) to obtain maximum value of operating force

$$\begin{aligned} F_{a_2 \max} &= P_1 A_d + P_1 A_t + F_s - A_t P_a - P_a A_d + D \\ &= (P_1 - P_a)(A_d + A_t) + F_s + D \end{aligned}$$

i.e. hysteresis of F_s

The interpretation of this simple theory made possible the re-design of the valve to suit the operating experience obtained with previous versions.

Referring to Fig. 5.III.6 it can be seen that the amount of force feedback from the valve depends upon the slopes of the segments BC, DA. This design factor is determined by the line pressure of the gas supply used, and by the maximum permissible valve operating force. Experience with the pneumatic system had shown that a line pressure of 8400 gm cm^{-2} (120 psi) was necessary in order to achieve adequate power in the prosthesis. Also, experience with early control systems showed that a maximum valve operating force of about 500g (1 lb) was desirable. As shown in

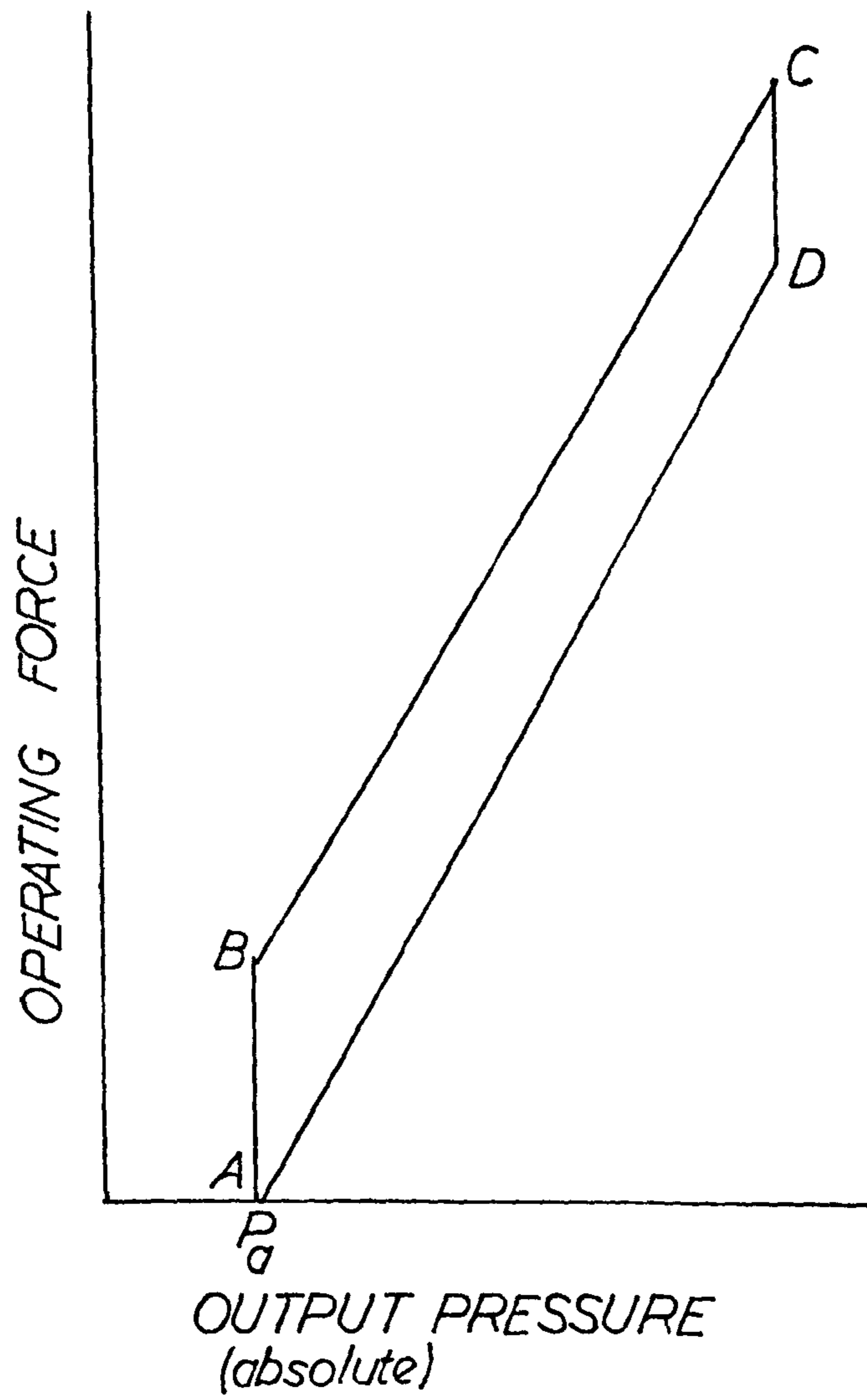

Fig. 5.III.6

Schematic of valve characteristics.

the theory above, the valve factor which determines the slope of segments BC and DA, is the top diaphragm area A_d . Thus by making certain allowances for edge clamping effects (determined by experiments with the small diaphragms used in earlier valves) it was possible to specify the size of diaphragm to be used in the valve.

The segments AB, CD contribute to the operating force of the valve in the inlet mode, and were reduced to a minimal level for this reason. The characteristics desirable for use with another valve in a double-acting system may not necessarily lead to the same requirements, but this was an unknown factor at this stage and therefore was ignored temporarily.

The segment CD was contributed by the force of the spring under the bottom seal, the spring being essential for the reasons outlined above. The desired minimal effect of the spring was achieved by the replacement of the silastic tube by the introduction of a magnetic backing for the rubber seal, and a steel insert for the seating of the seal. Thus, by virtue of the induced attraction between the magnetised plastics material backing and the inlet port valve seat, a light closure was maintained at all times. Since the seal could lift itself a distance of over 1mm onto the valve seat the gas supply was always presented with lightly closed valves, completion of the seal then being achieved by the differential effects of line pressure and output pressure. By ensuring that the seal could not fall more than 1mm away from the seating, there was no possibility of valves being stuck in the open position.

The characteristics of the magnetic 'spring' are exactly suited to the operation of the valve, since the effective force reduces as the seal is pushed away from its seating. This is in complete contrast to the conventional spring effect of the silastic rubber, where the force increases as the valve is operated. The relative effects of the springs are shown in Fig. 5.III.4, thus indicating the minimal effect of the magnetic device.

The segment AB (Fig. 5.III.6) is caused by the effects of the spring together with the pressure reaction due to the inlet pressure acting on the effective area of the bottom seal provided by the inlet port bore area A_1 . Therefore, in order to reduce AB to a minimal level the area A_1 had to be reduced. However, the inlet port size also governed the ultimate flow rate of which the valve was capable, both in the inlet and exhaust modes. Therefore, in order to progress further with the optimisation of valve characteristics it was necessary to investigate the effects of tube sizes and orifice dimensions on the flow rate of CO_2 gas under conditions similar to those in the force demand valve.

In order to establish a design criterion for the operation of the valve in a prosthesis some tests were carried out using the loose flap seal valve before modifications had been made. This valve was capable of delivering approximately 15 l/min of CO_2 to atmosphere from the outlet port, with the inlet pressure at 8400 g cm^{-2} (120 psi). Tests with the valve in a prosthesis, and with the flow rate restricted externally by pinching the gas tubing by means of an adjustable clamp, showed that a valve which could deliver 7 l/min to atmosphere, controlled the prosthesis in a

manner which was indistinguishable from the 15 l/min valve performance. Therefore, an output flow-rate to atmosphere of 7 l/min was taken as the desirable maximum for a practical valve.

The flow-rate investigations were carried out in two forms, each representative of one way in which the valve mechanism governs flow rate. The first of these was to examine the effects of tube diameter on flow rate, representing the effect of the valve needle in the exhaust mode. In addition to this simply analogy, the assumption was made for design purposes that a tube of given cross-sectional area would allow a flow-rate identical to that permitted by an annular orifice in the same area. This annular orifice was representative of the type of port formed between the valve needle and the inlet port bore.

The second type of investigation concerned the flap seal and its effects on flow rate as governed by the opening of the cylindrical orifice created by the proximity of the seal to a simply perforated flat surface. Once again, an assumption was made for design purposes; namely, that a cylindrical orifice of one diameter and a given area of orifice would permit the same flow-rate as another orifice of different diameter but identical area.

The first group of tests was carried out with a series of restrictors of fixed length (12mm) and of various bores. These restrictors were placed successively in the gas line between gas supply and flow meter, the flow being recorded for each restrictor bore diameter, at constant supply pressure (Fig. 5.III.7). The results obtained are shown in Fig. 5.III.8.

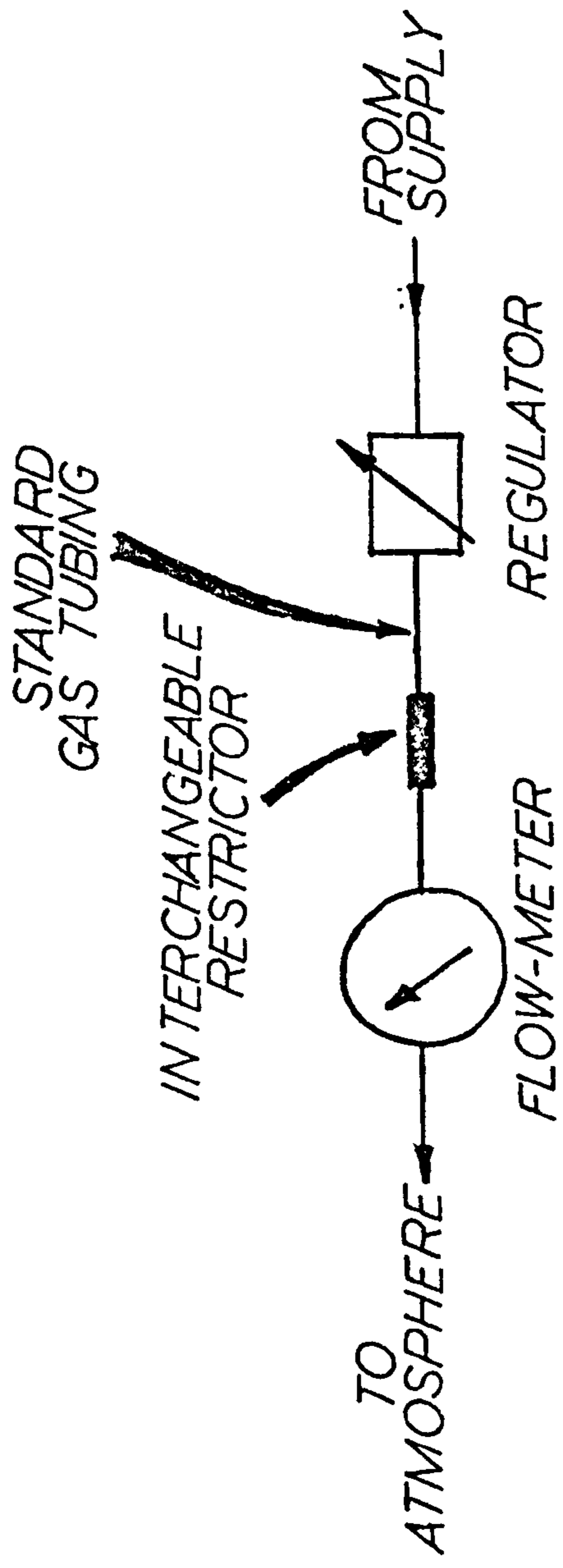

Fig. 5.III.7

Arrangement for tube diameter experiments.

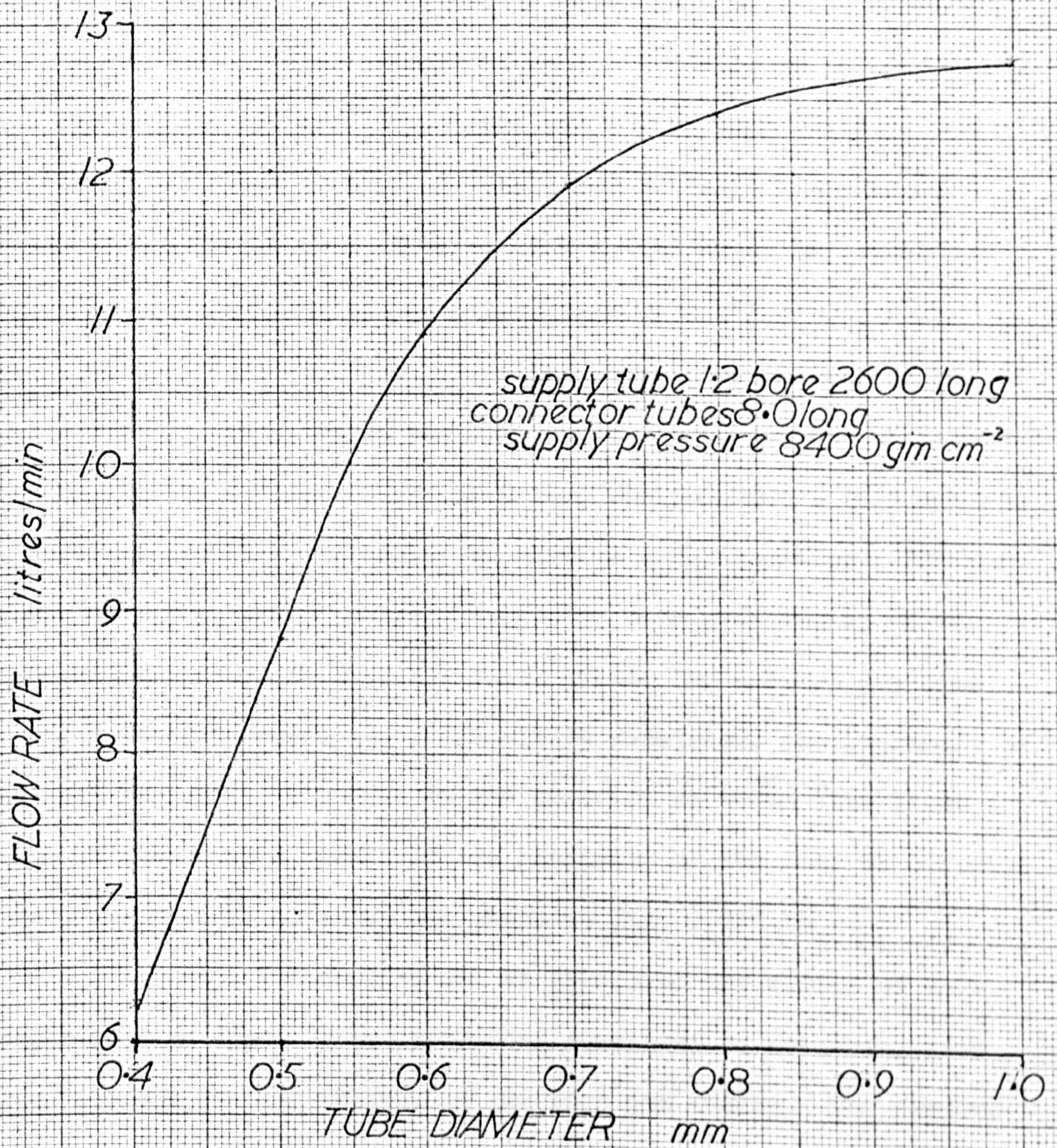

Fig. 5.III.8

Effect of tube diameter on flow rate.

The second group of tests required the use of slightly more complicated equipment which was constructed specially for the task.

The choice of the flat type of seal was confirmed by comparison with the effects achieved with taper pin seals (Figs. 5.III.9 and 5.III.10). As shown in Figs. 5.III.11 and 5.III.12 the rate of change of the degree of sealing was too low to be of any practical use in a valve for use in a position servo controlled prosthesis which requires a minimal position error signal for the attainment of good accuracy. In place of the flat rubber seal, sealing on a raised seating, it was decided to use an O-ring sealing onto a flat surface, an arrangement which was easier to arrange experimentally. The form of the device is shown in Fig. 5.III.13, with a schematic of the experimental set-up in Fig. 5.III.14. Since the precise position at which sealing begins was difficult to determine, the positions of the seal were taken relative to the position at which flow first began to reduce as a result of the proximity of the seal to the flat face. The results obtained are shown in Fig. 5.III.15.

A third test was carried out to determine the effect of tube length on flow rate. This experiment consisted of measuring flow rates through various lengths of 1mm bore gas tubing. The results of this test showed that flow rate was only affected significantly by metre-sized changes in length, and this factor was therefore ignored for the purposes of valve design (Fig. 5.III.16).

The data obtained from these experiments permitted the design of tube and orifice dimension for the operating parts of the force demand valve. In order to ensure that the exhaust tube (valve needle bore) itself did not restrict exhaust flow rate, a bore of 0.5mm (flow rate 8 l/min) was chosen. The minimum wall thickness,

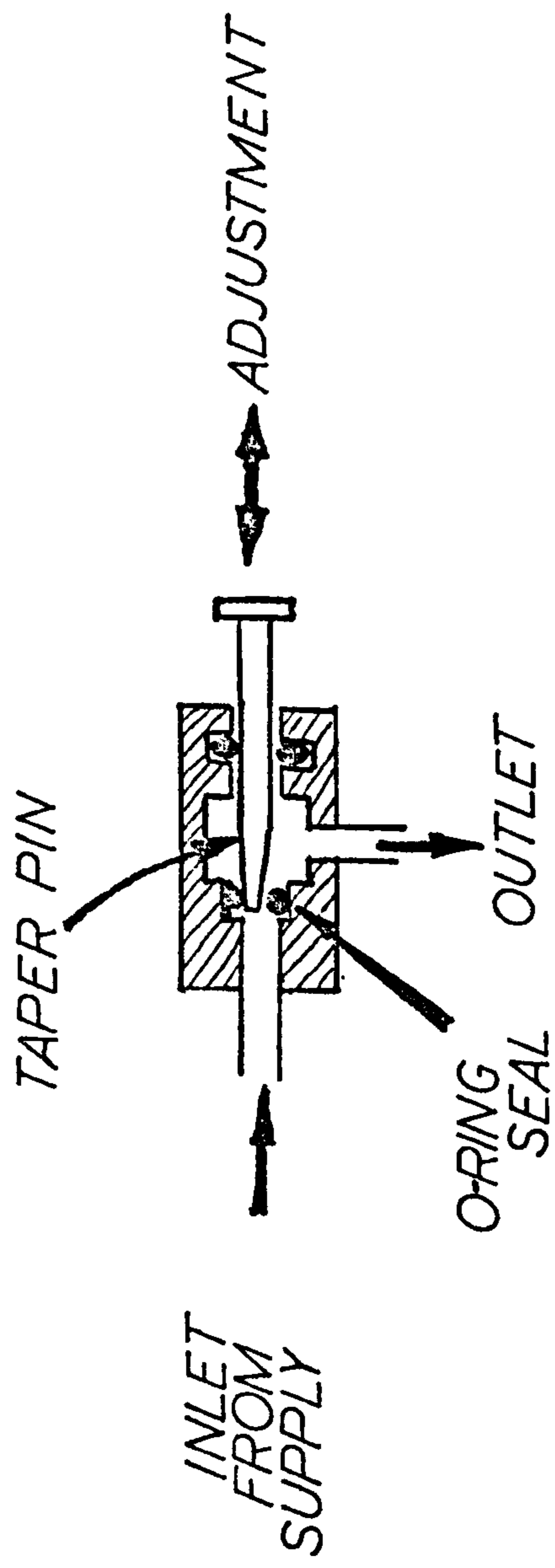

Fig. 5.III.9

Taper pin sealing in O-ring - measuring device.

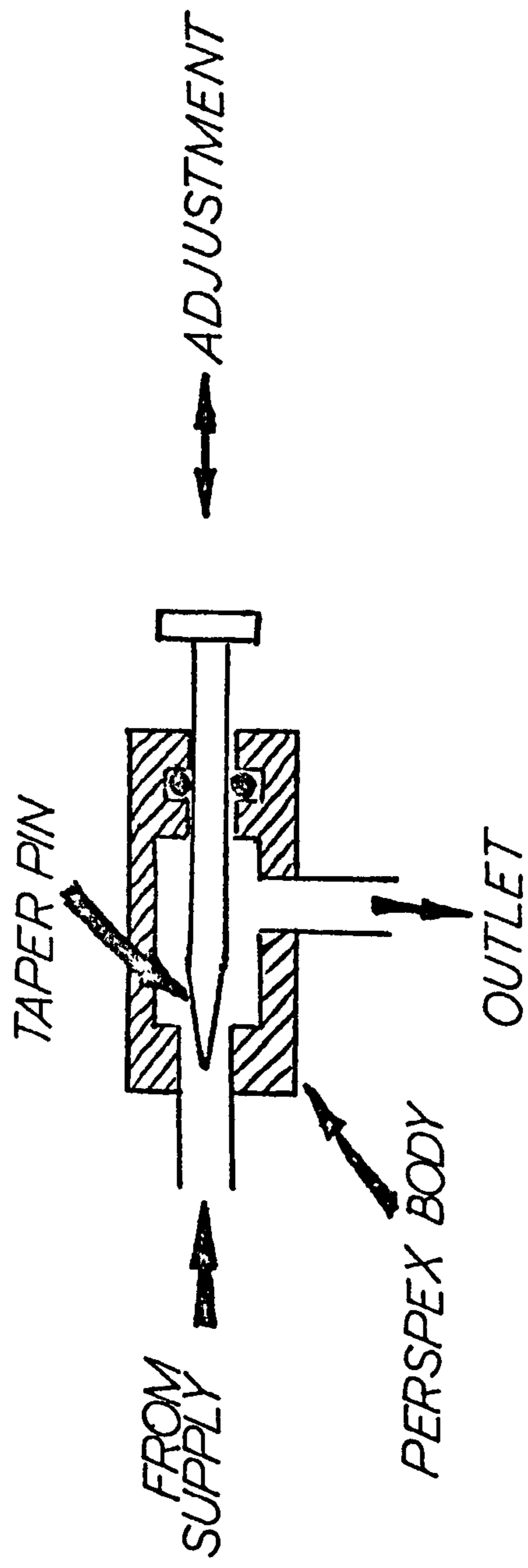

Fig. 5.III.10

Taper pin sealing in hand aperture - measuring device.

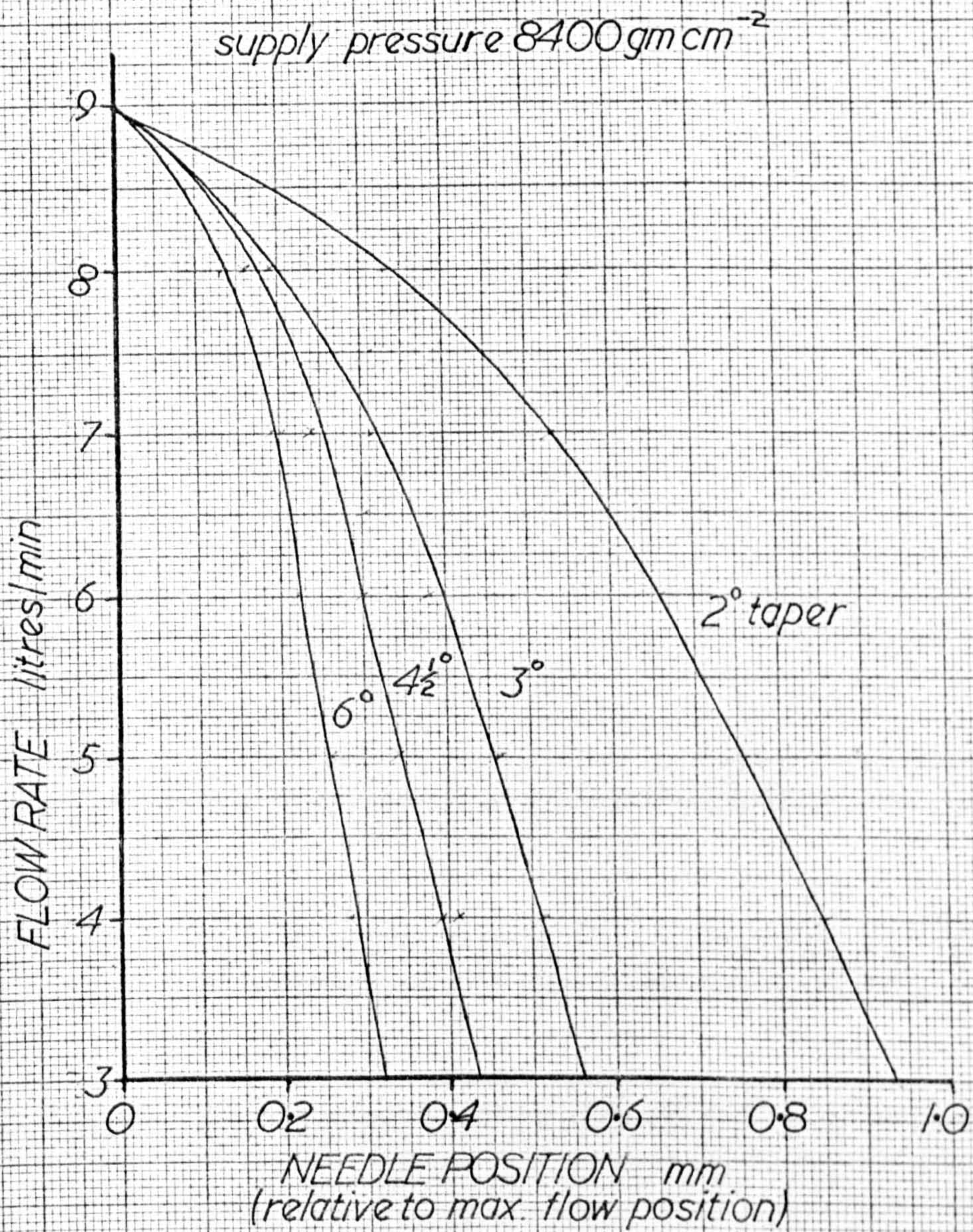

Fig. 5.III.11

Variation of flow rate with position of taper pin into O-ring seal.

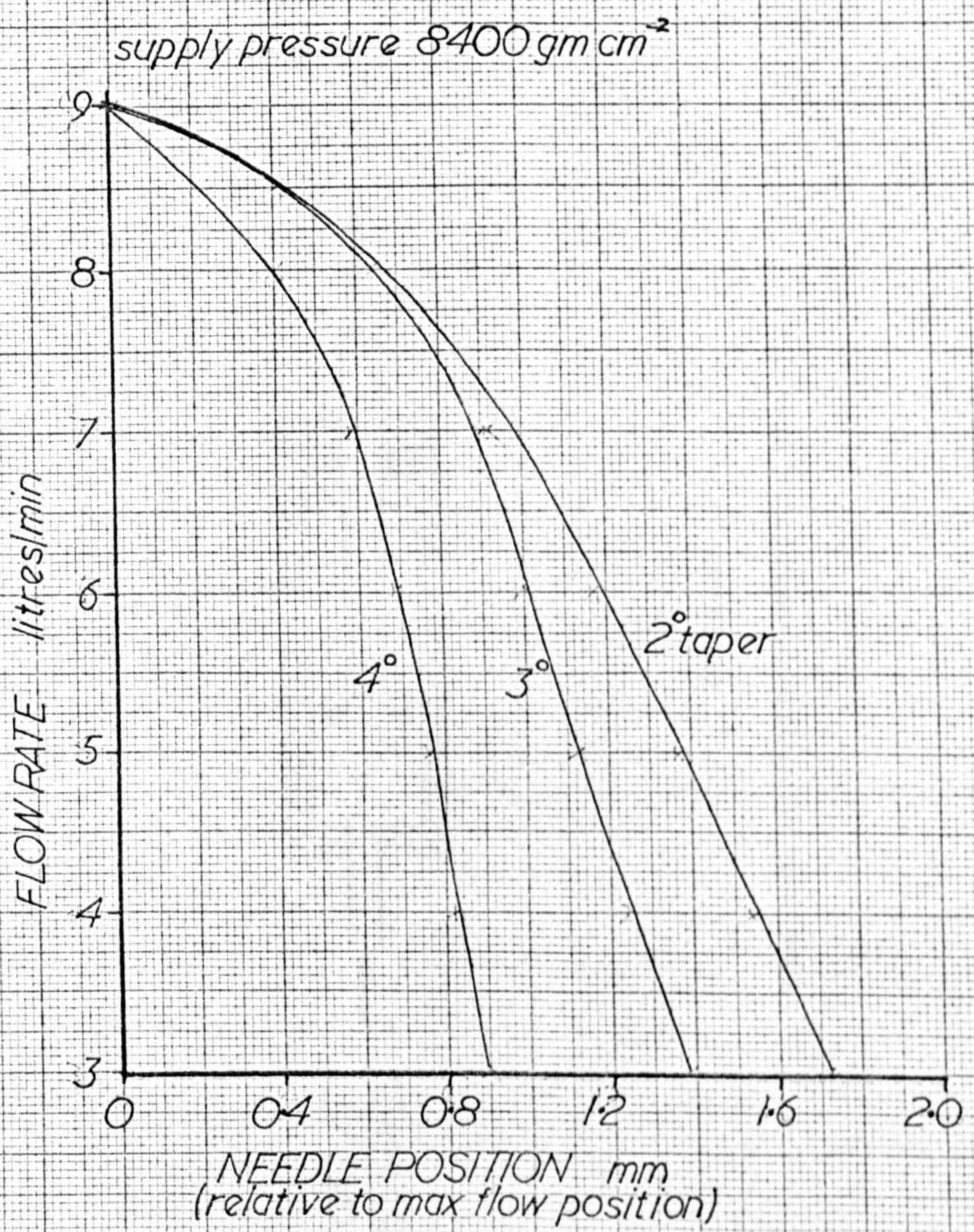

Fig. 5.III.12

Variation of flow rate with position of taper pin into perspex.

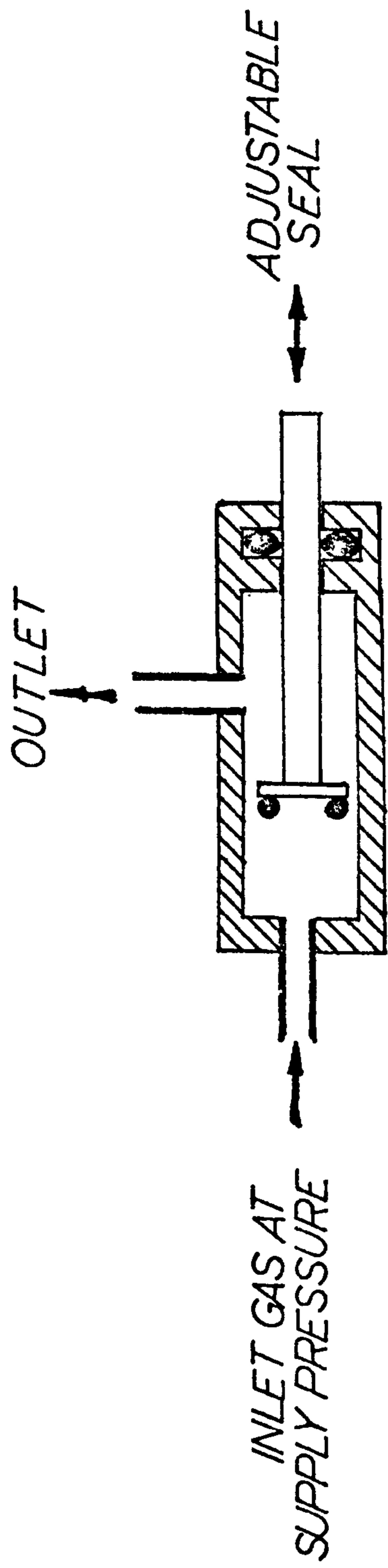

Fig. 5.III.13

Flat sealing O-ring - measuring device.

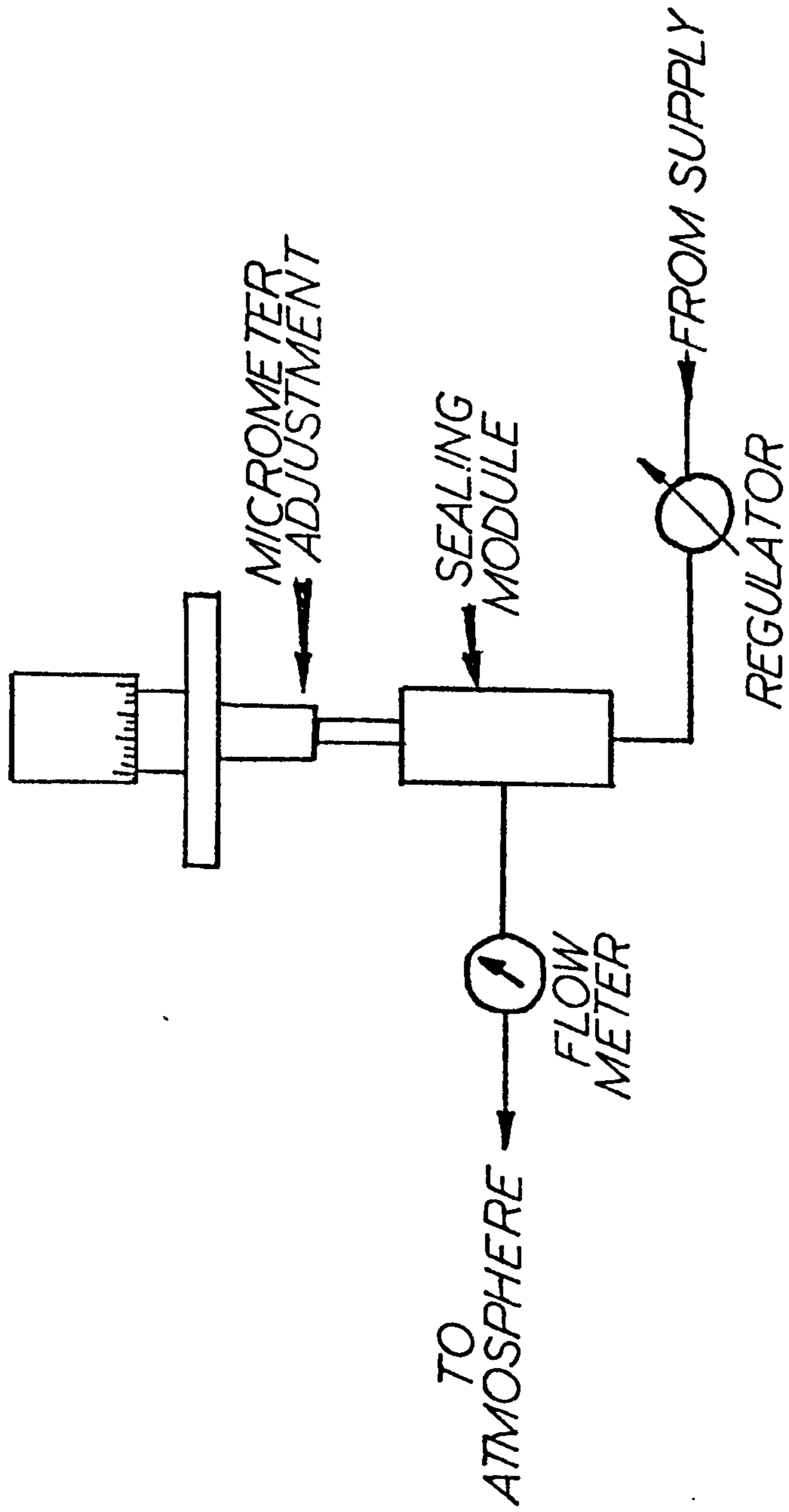

Fig. 6.III.14

Arrangement for seal experiments.

supply pressure 8400 gm cm^{-2}

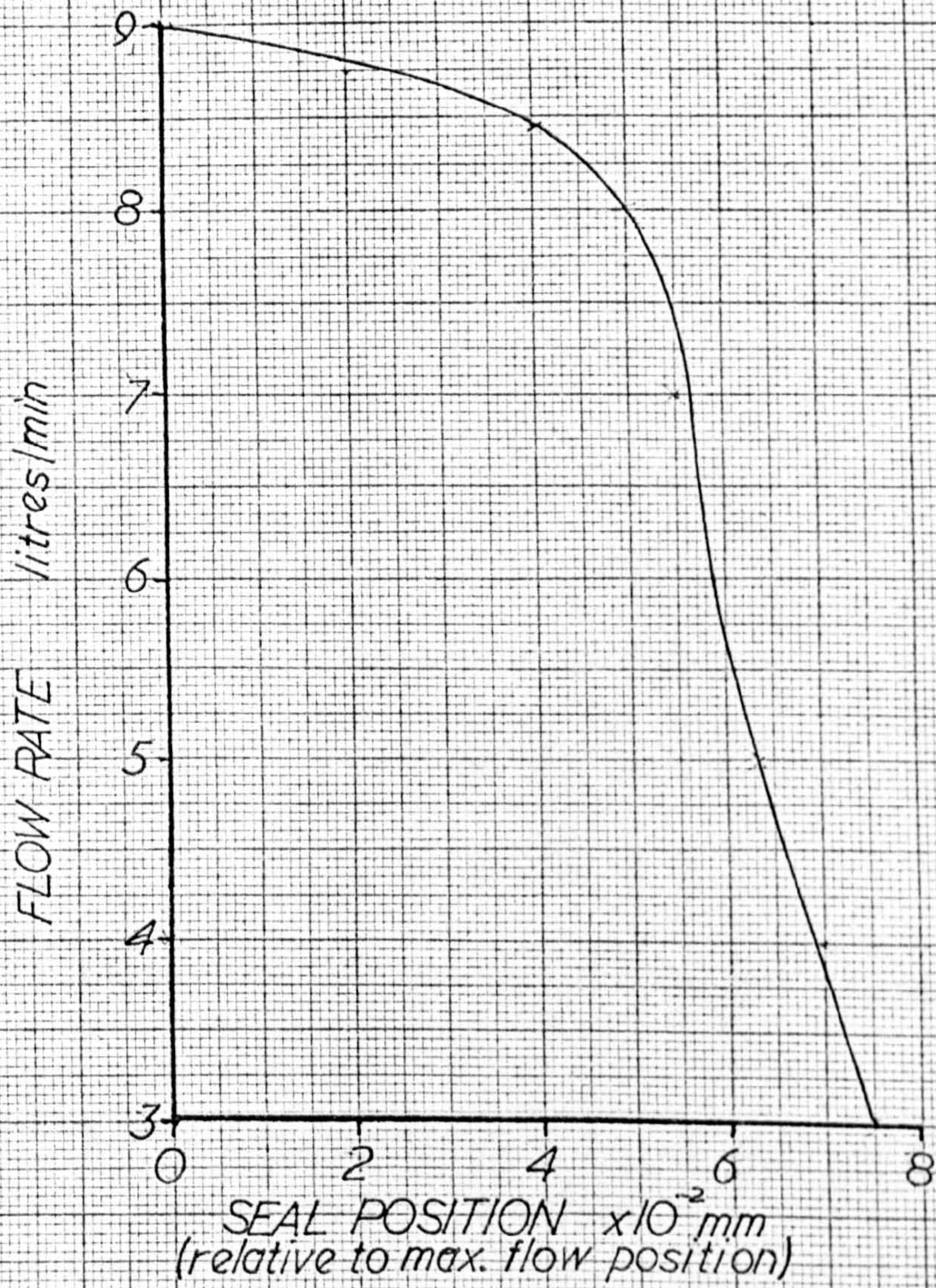

Fig. 5.III.15

Flow rate versus seal position for flat-sealing O-ring.

supply pressure 8400 gm cm^{-2}
tube bore 1.0 mm

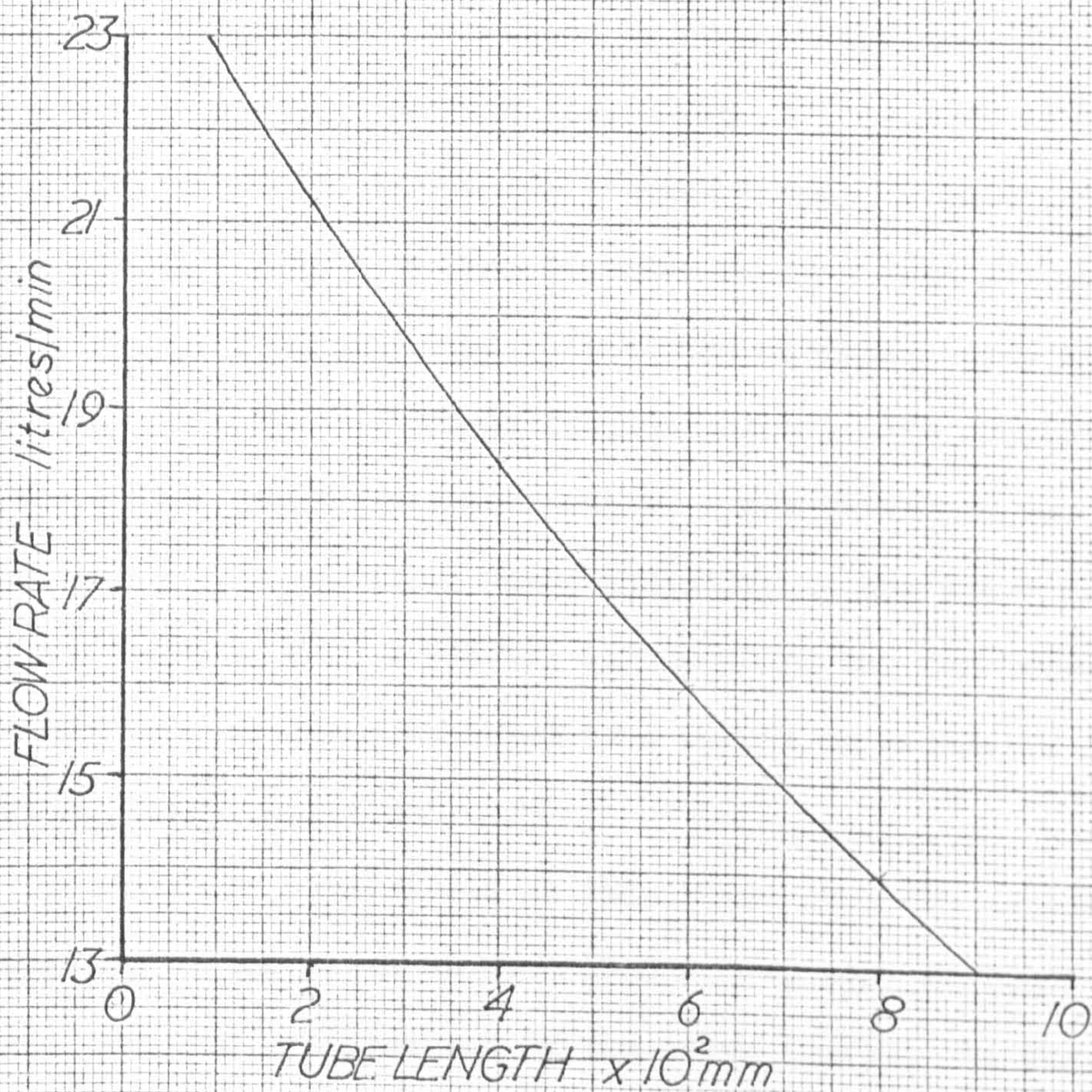

Fig. 5.III.16

Flow rate versus tube length.

permissible as a result of the mechanical strength required of the needle, was 0.1mm, thereby giving an outside diameter of 0.7mm for the tube. This dimension provided the basic size around which the rest of the valve could be designed for minimum hysteresis.

The valve output flow rate to atmosphere was specified to be 7 l/min, and as shown in the theory is dependent on $(A_1 - A_t)$, the area of the annulus formed between inlet port and exhaust tube. From the experimental data obtained above, a flow rate of 7 l/min corresponds to a tube or annulus of area 0.15mm^2 approximately, giving an inlet port of 0.79mm diameter round a tube of 0.7mm diameter for the required annulus area. Since the diaphragm area had been previously determined by force considerations, this completed the optimisation of valve characteristics, and a mechanism was made up accordingly. The operating characteristics of the valve in this form are shown in Fig. 5.III.17, illustrating the considerable reduction in hysteresis achieved as a result of designing for specific operational requirements.

It should be pointed out at this stage that the modifications carried out on the valve as described above, were designed only to improve the ease of operation of the valve itself. At the time of the modifications it was not at all clear whether the changes would be compatible with the best performance of a servo system in terms of stability and accuracy. In addition, no practical allowance was made for the fact that the valves in fact operate in pairs on a double-acting piston arrangement, so that one valve acts as inlet for one side of the piston whilst the other is performing in the exhaust mode for the low pressure side of the piston.

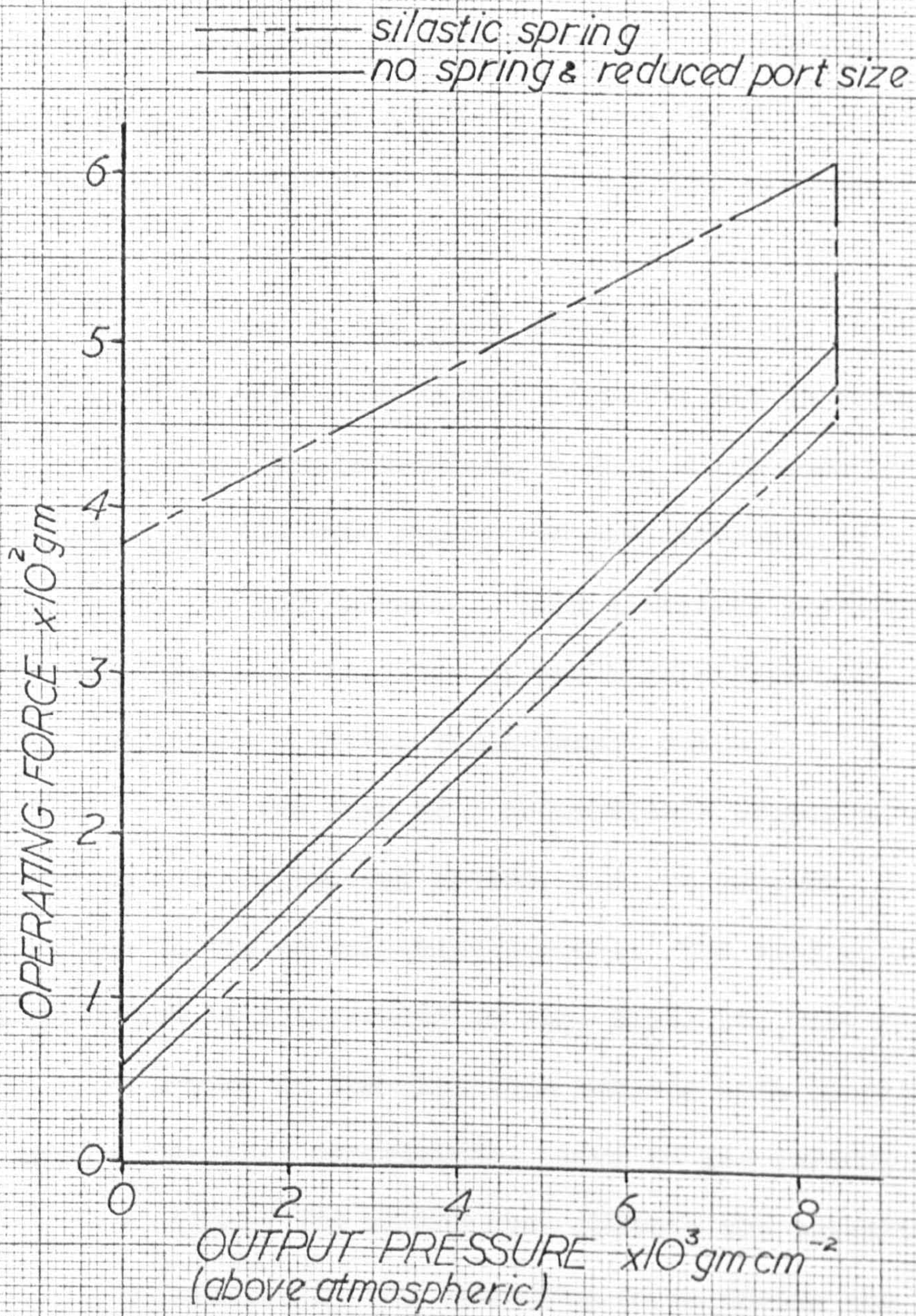

Fig. 5.III.17

Comparative characteristics of early valve and the valve after full modification.

In practice, the force demand valves in this form provided very satisfactory performance in the arm prosthesis, particularly when mounted in blocks which permitted correct operating conditions at all times. The development of the mounting system for the valves and their relationship with the rest of the prosthetic systems will be discussed later.

Despite the small nature of the force demand valve (an 11.0mm cube), the arrangement necessary for a double-acting set up occupied a considerable space in the arm prosthesis, a fact which bore no good omens for installation in the more restricted circumstances of a hand prosthesis, or on the body harness. This situation prompted an attempt to provide a much smaller valve of the simple flow-rate control type for comparison with the force demand valve.

The simple valve took the form of a conventional poppet valve, modified in order to achieve two-way action, i.e. an exhaust facility in addition to the normal inlet control. The configuration and action of the valve is illustrated in Fig. 5.III.18. The main seal is formed by an O-ring in the flat face sealing mode similar to that used in the flow-rate experiments. Loss of gas through the exhaust port is prevented by the rubber seal beneath the operating cap, sealing being maintained by the operating force during the inlet phase. The action of the supply pressure tends to close the valve, but this effect is considerably reduced when the valve is wide open, due to the reduced pressure difference across the main seal. In order to overcome this problem, a small spring was introduced in order to provide a positive return to the sealed state under all conditions.

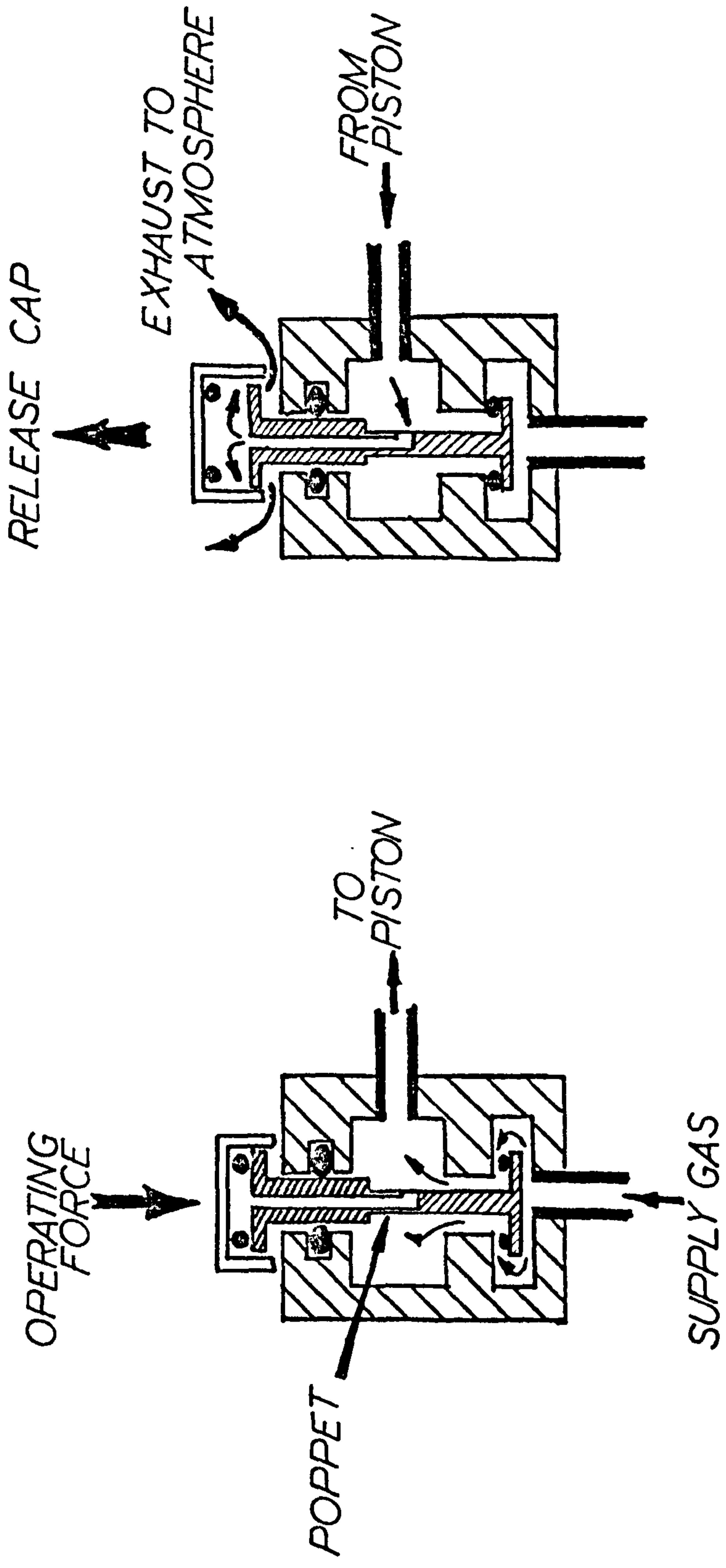

Fig. 5.III.18

The poppet valve in diagram form.

The valve was designed with ease of manufacture as one of the prime considerations. This was achieved by making all parts circular in section, thus permitting manufacture by simple turning operations on a lathe. In addition, the valve was assembled by the use of Araldite adhesives, thus making the device leak free without the need for special seals. This type of construction provided a cheap, throw-away, valve which would be totally replaced in the event of failure. As shown in Fig. 5.III.19, the resulting valve was only 6mm in diameter by 11mm in length, whilst preserving the same flow rate as the force demand valve by virtue of designing with the data obtained in the experiments described above.

This valve, which was used for the control of hook and hand prosthesis action proved to be reliable in the field but lacked the useful force feedback achieved with the force demand valve. In fact, the feedback available in the poppet valve is in exactly the opposite sense to that of the force demand characteristics. This phenomenon is created by the fact that the feedback in the fiv is derived from the difference in pressure between outlet and atmosphere, whereas the poppet valve feedback is due to the difference between inlet and outlet pressure, a quantity which decreases as outlet pressure increases.

The feedback characteristics outlined above virtually prohibit the use of the poppet valve in a position servo system, since a valve of a type which switches 'on' more and more readily as the seal is displaced is the perfect vehicle for oscillatory action. The application of the poppet valve in a double-acting position servo system only proved to be successful under conditions which

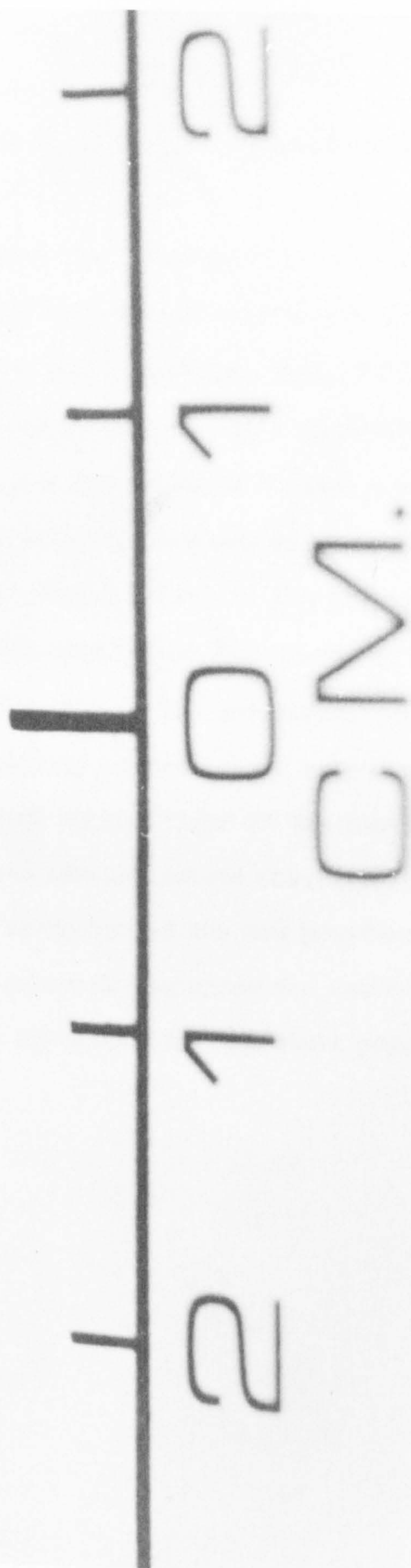
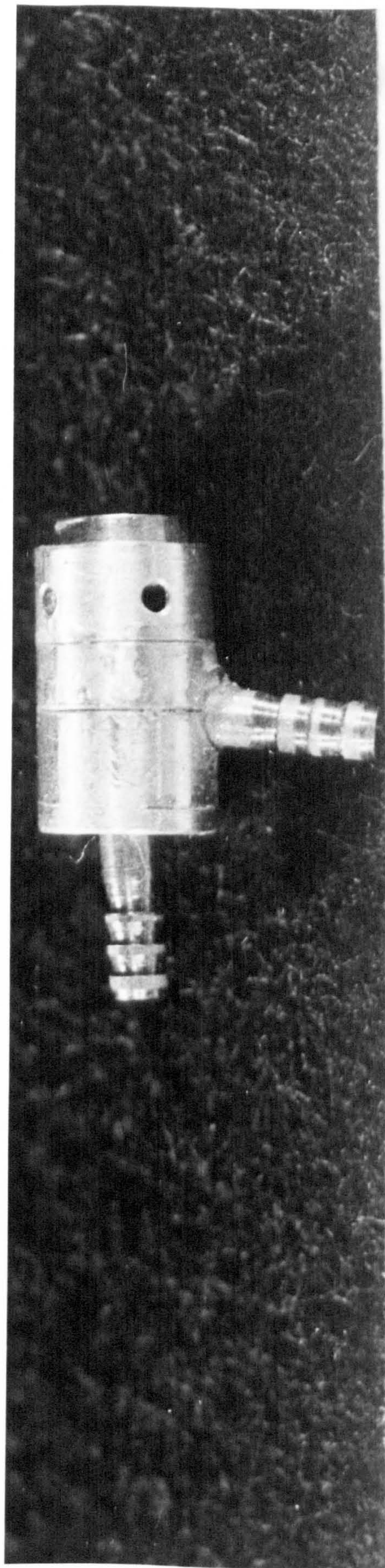

Fig. 5.III.19

The poppet valve.

satisfied both of two requirements:

1. A large dead space between the valves, i.e. the introduction of hysteresis.
2. A mechanical movement of low inertial load.

This second point was well illustrated by the satisfactory performance of a wrist rotation servo mechanism (Fig. 5.III.20) with a large dead space between valve operations and a light load which required only a slight opening of the valve to achieve movement, thus preserving as much positive force feedback as possible. In contrast with this, the use of poppet valves in the shoulder elevation mechanism proved to be highly unstable, due to overrun of the heavy inertial load provided by the weight of the arm alone.

The inherent lack of stability of the poppet valve led to its rejection as a method of control in the light of the improved reliability of the fdv with its ideally suited characteristics of operation. In addition, the re-design of the arm prosthesis had largely overcome the problem of available space for valves, which had been the chief reason for investigating the small poppet valve.

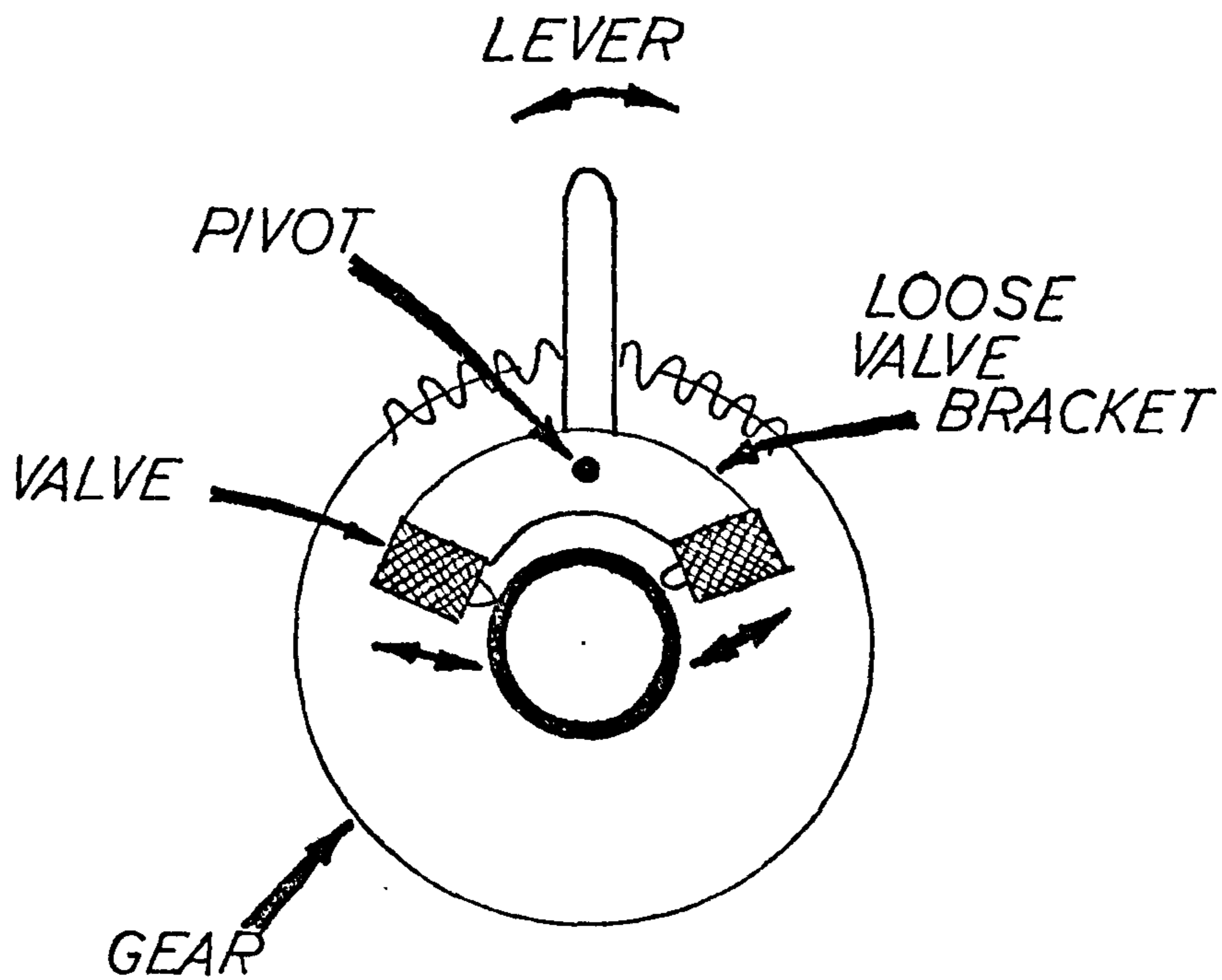

Fig. 5.III.20

Wrist rotator servo arrangement.

Appendix 5.IVThe development of a double-acting valve assembly.

The mechanical changeover facility was theoretically very simple; place two valves facing one another and move a lever between them (Fig. 5.IV.1) activating one valve by movement in one direction, the other direction activating the second valve whilst permitting the first to go into its exhaust mode. The first control attempts with the double-acting actuators adopted this theory quite literally by mounting a pivoted lever between two valves, one being biased in the 'on' position by means of a spring holding the lever onto that valve. This arrangement was first adopted in the arm prosthesis by clamping the two valves into the base of the U-channel by means of screws tapping into the valve blocks, the screws passing through slots in the U-channel, thus allowing adjustment. In order to conserve space in this configuration it was necessary to position the tubing connectors on the valves so that they protruded from the sides of the blocks rather than the base. This change had to be made without any redesign of the valve structure, due to the necessity for using existing valve mechanisms.

The change of position of the outlet tube presented no problems, since the positioning of the tube at the side of the block was a simplification, merely requiring the drilling of a hole in the position indicated in previous valve diagrams. However, the inlet tube passed directly into the base of the valve, beneath the main seal, without sufficient space for a normal connector to be inserted from the side by a simple operation. As shown in Fig. 5.IV.2, an angled hole was a necessary but inconvenient solution. This

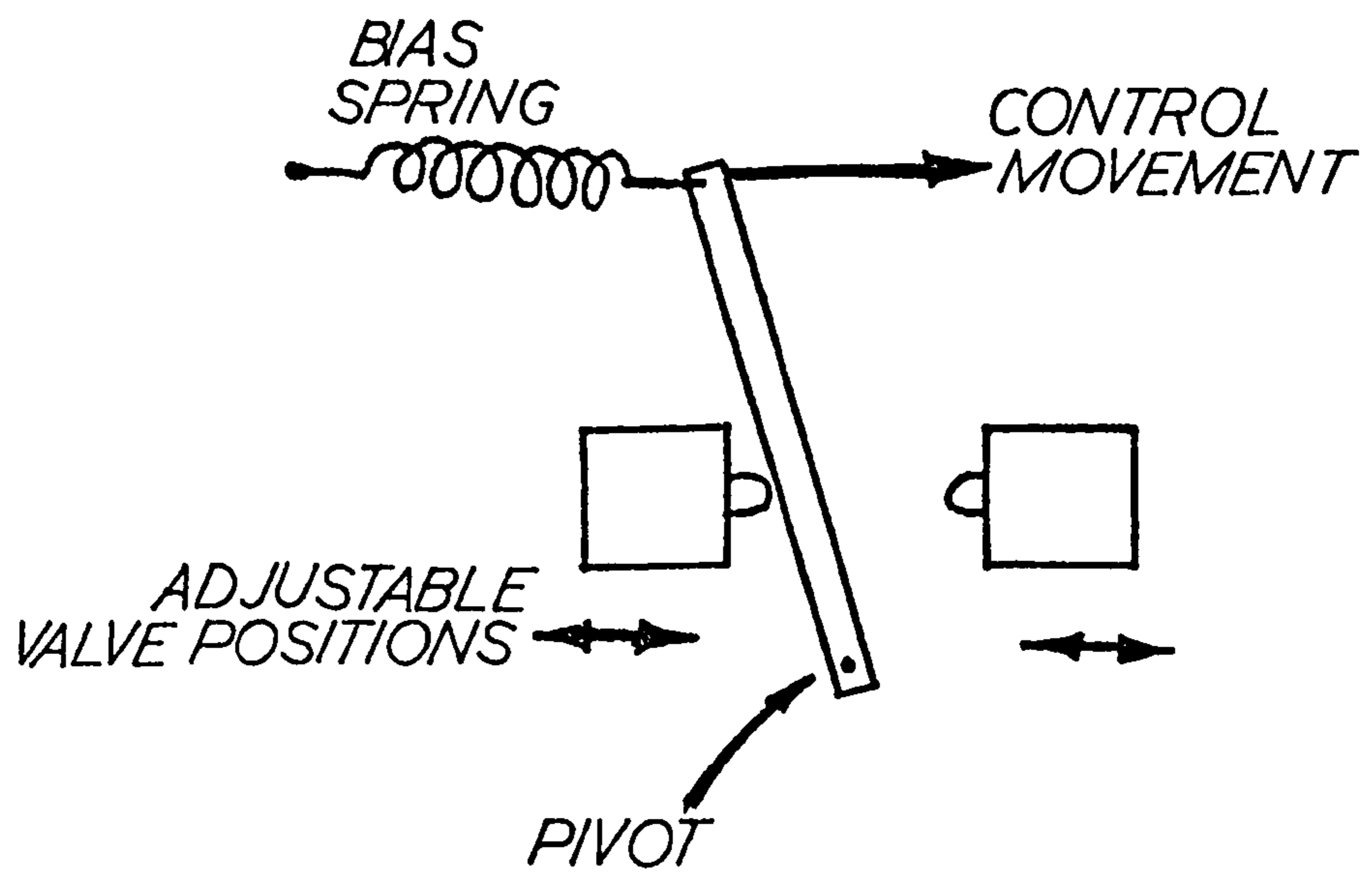

Fig. 5.IV.1

Primitive double-acting valve set-up.

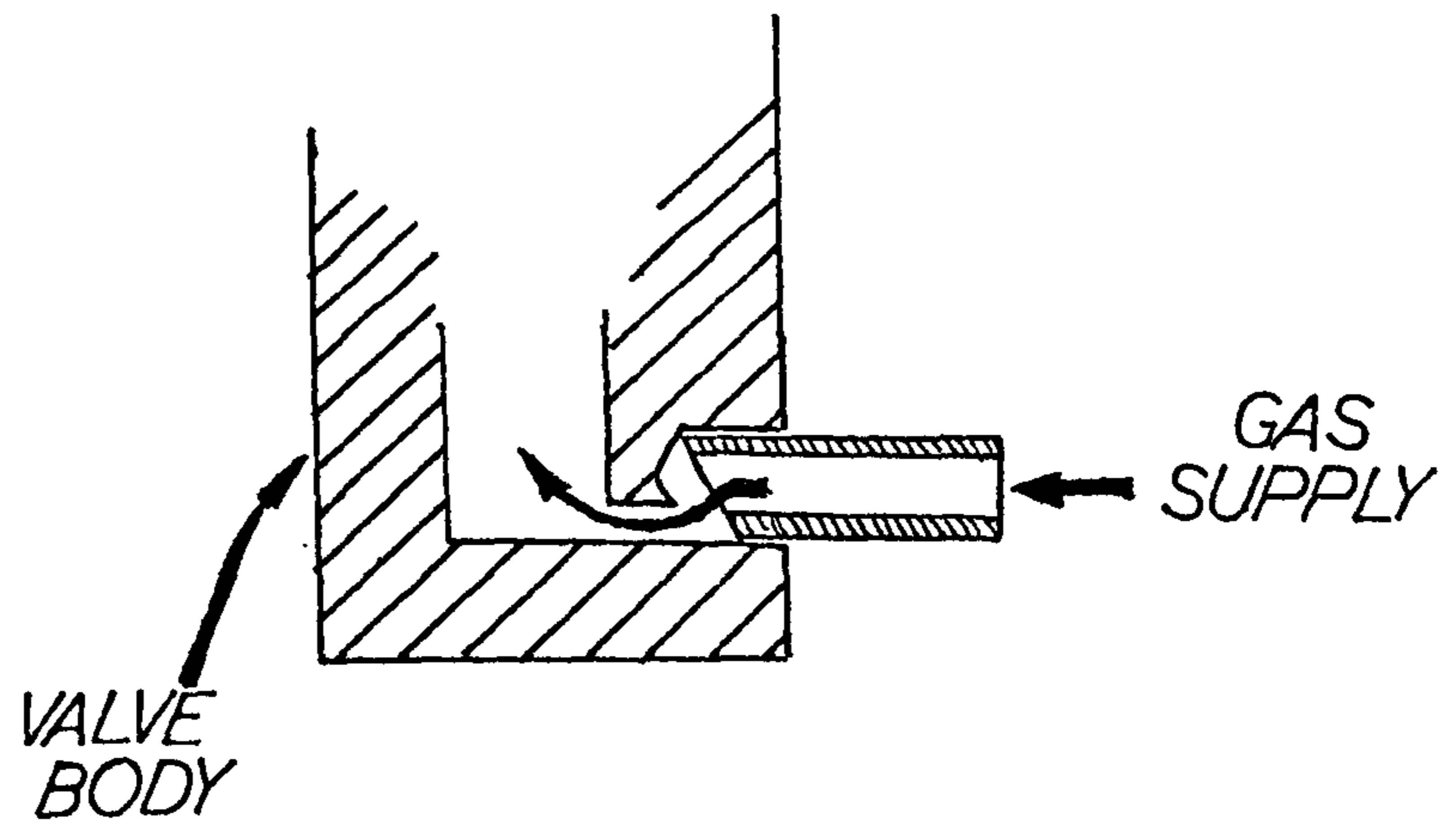

Fig. 5.IV.2

Valve inlet tube arrangement.

problem was overcome by means of the arrangement shown, whereby the effect of an angled hole was created by bevelling the end of the connector inserted into an eccentrically bored hole. In this way, it was possible to reduce the overall length of the double-acting valve system by ensuring that the supply tubing entered the system from the side.

The valve lever was mounted between the valves and pivoted at a short distance (3mm) from the point of contact between lever and valve operating points. Since the use of single Bowden cables as the transmission system for the control signals effectively limited the controls to operation by wire tension in one direction, it was necessary to provide a spring bias in the opposite direction, in order to achieve the return movement. This was achieved by the attachment of a spring between the lever and the U-channel, the tension being adjusted to provide a specific pressure output from the biased valve.

Arm prostheses fitted with this type of valve arrangement were provided for thalidomide amputees for some time. After a period of use amounting to as little as a week, the valve assembly began to exhibit various forms of malfunction. The most common fault was found to be slight alterations in the valve settings in their mountings, requiring frequent readjustment to maintain the 'return to rest position' facility for example. On a slightly longer time scale, of the order of a month or so, the valves themselves began to fail, or become so heavy to operate, that the patient complained of fatigue. It was suspected that the slight tendency for the valve lever to push the valve operating cap away from the in-line position,

may have been the cause of a variation in characteristics as the top diaphragm tended to deform permanently after some time. Various attempts were made to create a more satisfactory in-line push to the valve (Fig. 5.IV.3). These systems were found to be less satisfactory and more complicated and difficult to set up for correct operation. However, during the course of the valve tests for operating force mentioned above, it was noticed that even an almost negligible deviation of the applied force direction from the perpendicular caused a very large increase in operating force. As a result of this observation it was decided that the force applied by the lever must be constrained to act only in the correct direction, with no component of force tending to tilt the valve needle. This effect was achieved by the mechanism shown in Fig. 5.IV.4. The application of this mechanism led to the design of a modular valve block assembly, to be used as a preset unit, easily replaceable in the arm in case of malfunction. The design incorporated the bias spring, with screw adjustment of force, and the valves themselves were arranged so that no movement could take place after the initial setting up (Fig. 5.IV.5). The position of the 'normally on' valve is completely fixed by the backing plate. The other valve is held in position by a screw running in a slot, adjustment being made by the adjuster screw which pushes the valve along the slot - thus preventing any slipping back in use. In addition, lateral movement was prevented by location of the valves between side cheeks. A simple setting-up procedure was followed for these valve blocks:

1. Set the bias spring to give desired output pressure from 'on' valve.

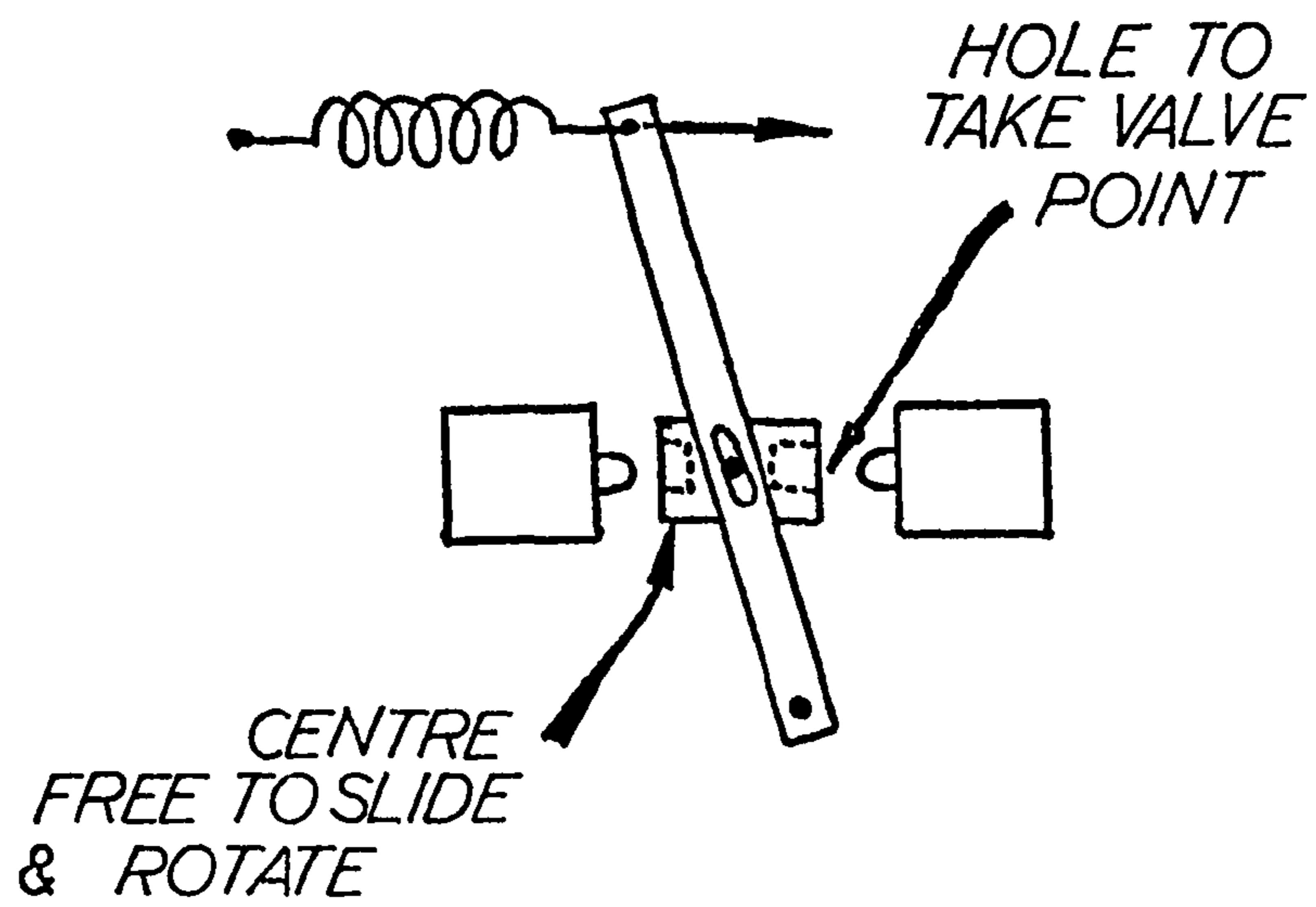

Fig. 5.IV.3

Double-acting valve set-up with floating actuation.

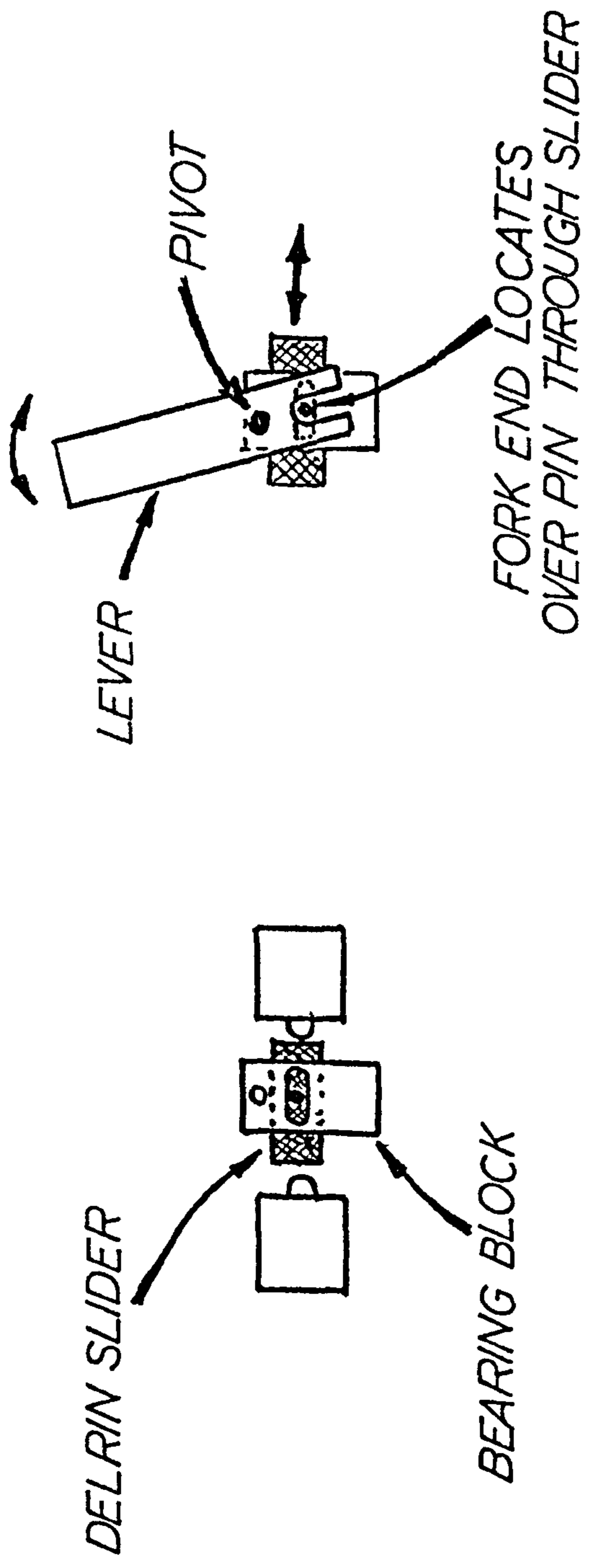

Fig. 5.IV.4

Valve actuation assembly constrained to act directly in line with valve.

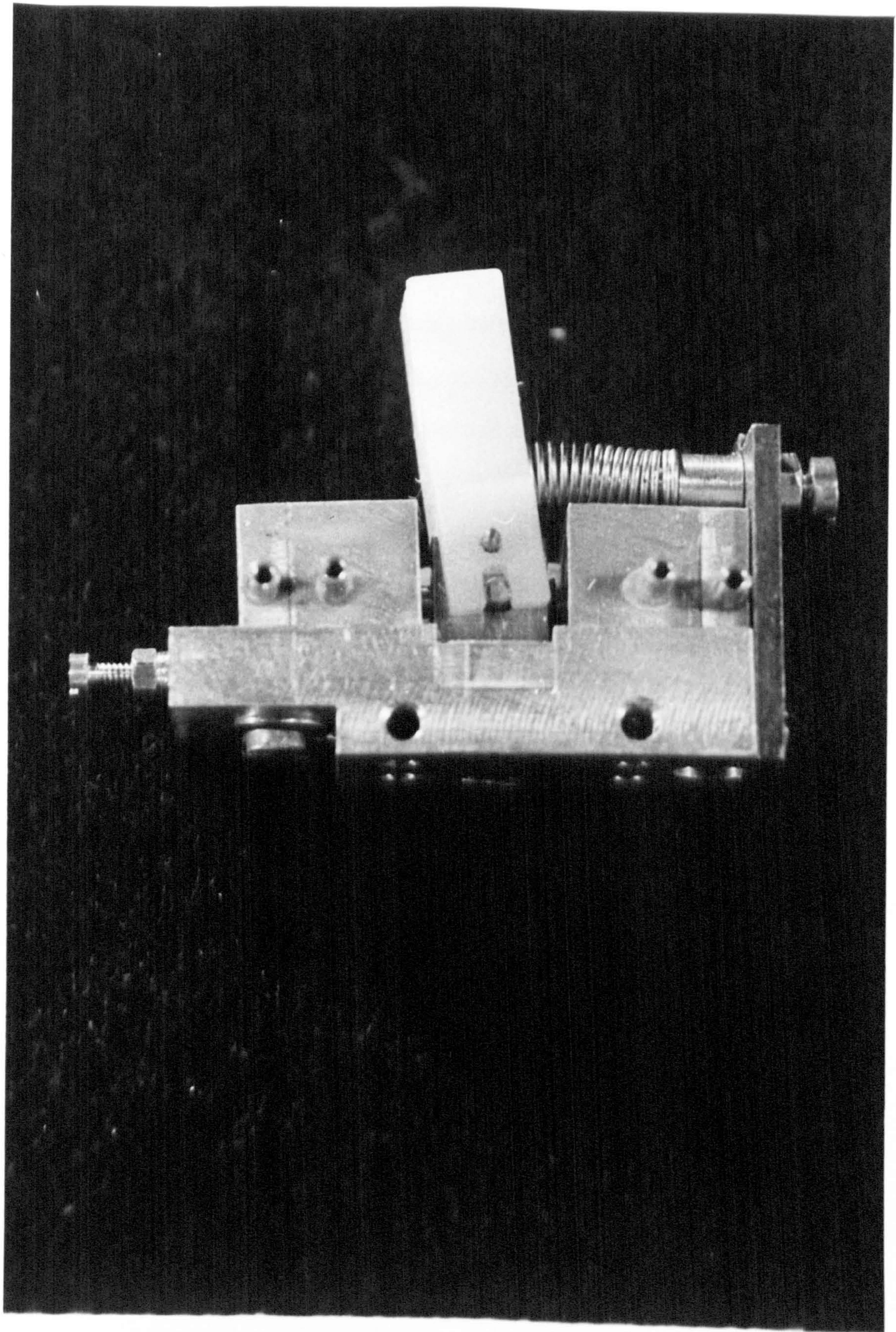

Fig. 5.IV.5

Complete valve assembly.

2. Adjust position of mobile valve to allow exhaust of 'on' valve before onset of action of mobile valve.

3. Tighten lock nuts and tighten clamp screw on mobile valve.

In use, this valve assembly was found to be extremely reliable, arm failures due to valve malfunctions becoming quite uncommon.

The real question mark hanging over this system lies in step 2 of the setting up procedure - this criterion is not necessarily the best comparison between gas consumption and good servo characteristics which demand as small a dead space as possible between the valves at changeover. The need to establish an accurate setting up procedure for the valves prompted two courses of action - firstly to initiate a detailed theoretical appraisal of the position servo, force demand valve operated system, and secondly to investigate in detail the activity of a real servo system in action. It should be noted here that various workers have made analyses of pneumatic servos for prostheses - finding theoretically that instability problems are severe, even prohibitive. This is patently incorrect, and it is believed that the error lies in not considering the operator as part of the servo system, but as a mere initiator of activity.

Appendix 5.VThe development of position feedback systems.

Theoretically the problem was simple enough; merely to provide an adequate degree of position feedback information from the joints of the arm to the operator. The large number of possible solutions to this problem was reduced to some extent by the existence of only one readily available position transmission medium which would be flexible enough to pass through the various joints without undue loss of accuracy in position and force information. This system took the form of the well tried Bowden cable used in the early prostheses with great success (Simpson 1966). Feedback was achieved using this mechanism by moving the inner and outer with respect to one another. For example (Fig. 5.V.1), if, at the prosthesis, the inner is terminated on the moving segment to be monitored, and the outer is terminated on the valve lever, then movement of the inner with respect to the outer at the operator end, will initially result in activation of the valve; the mobile segment will then move towards the valve, thereby reducing the tension in the wire and tending to turn off the valve; further movement of the inner by the operator will cause the process to be repeated, which causes the output to follow the position of the input wire at all times. Thus, the principles of the position servo mechanism are extremely simple. However, the ways in which the output signal were derived provided considerable problems of reliability and accuracy which could only be resolved by testing the various devices in situ in prostheses.

The earlier attempts at the provision of the desired amount of feedback information were more sophisticated than those which were

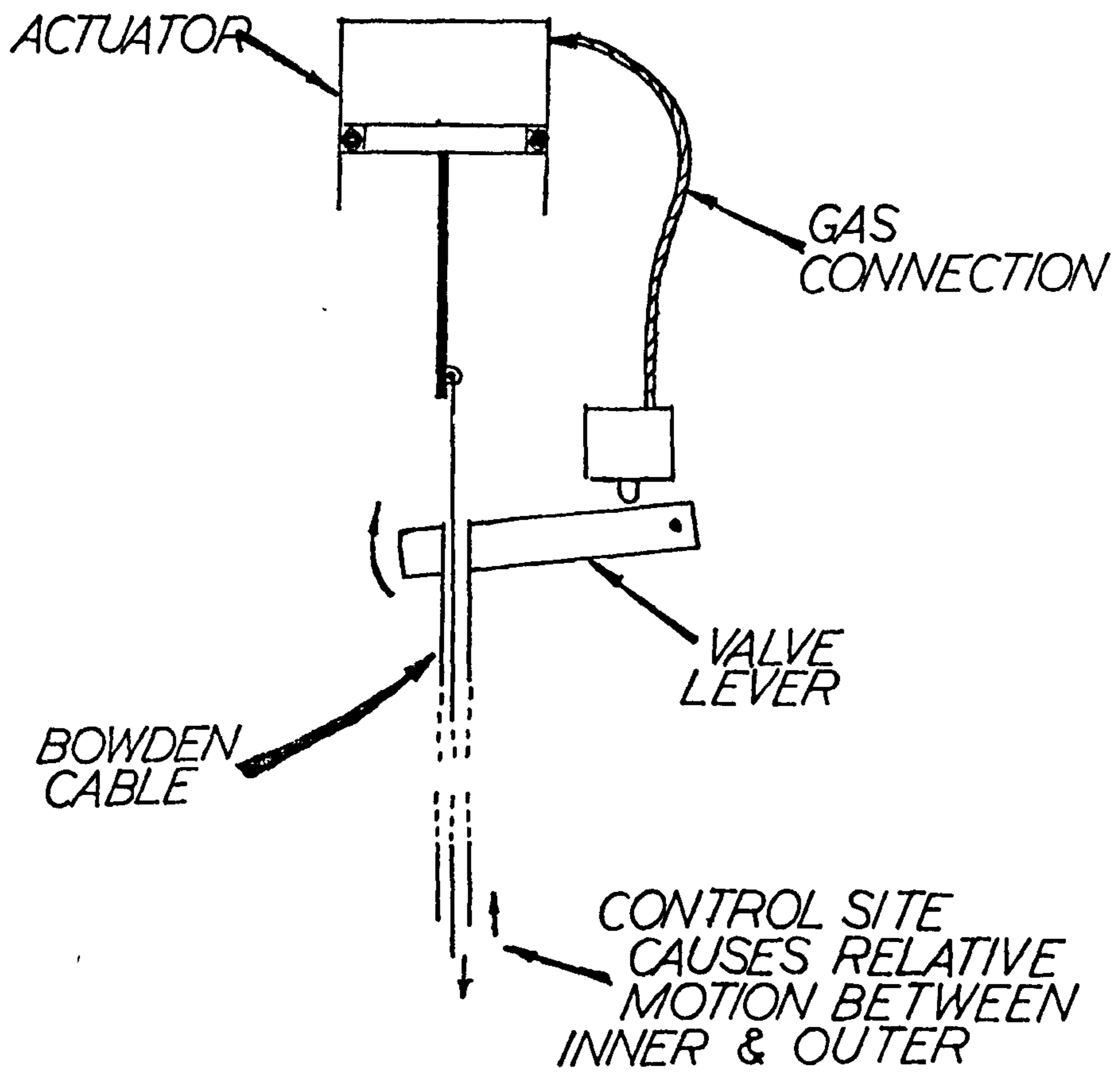

Fig. 5.V.1

Use of Bowden cables in position feedback systems.

to follow because, as has been found with many aspects of prosthetics work, the simplest solution is almost always the only one which will survive the abuse to which it is subjected. However, these exploratory attempts will be described in order to complete the picture of complexity which is presented by this problem.

The initial solutions for the provision of feedback were applied to the simple rotational situations presented by shoulder and wrist rotation mechanisms, the chief difficulty being encountered in the use of Bowden cables for feedback transmission was that the stroke length of the linear actuator was not compatible with the operator requirements. In all cases the actuator movement of 25mm or more was more than double that required by the operator (8 - 12mm). This situation illustrates the fundamental difficulty and complication of the feedback requirements - how to divide the linear actuator stroke length by the necessary factor? The situation prevailing at the time of commencement of the control work lent itself to a particularly compact and accurate solution to the problem. At that time differential area actuators were being used, which only required a single valve in order to provide full control facilities, and in this situation it was possible to make use of cam action to provide control.

The first application was to the modular wrist rotation mechanism mentioned in "The arm prosthesis". In this case a valve was allowed to slide between two cams, one of which was attached to the output rotation, the other being rotated by the Bowden control cable (Fig. 5.V.2). This arrangement caused pinching of the valve between the two cams when the control wire was pulled, the pinching

*OUTPUT SHAFT
DRIVEN BY PISTON ACTUATOR*

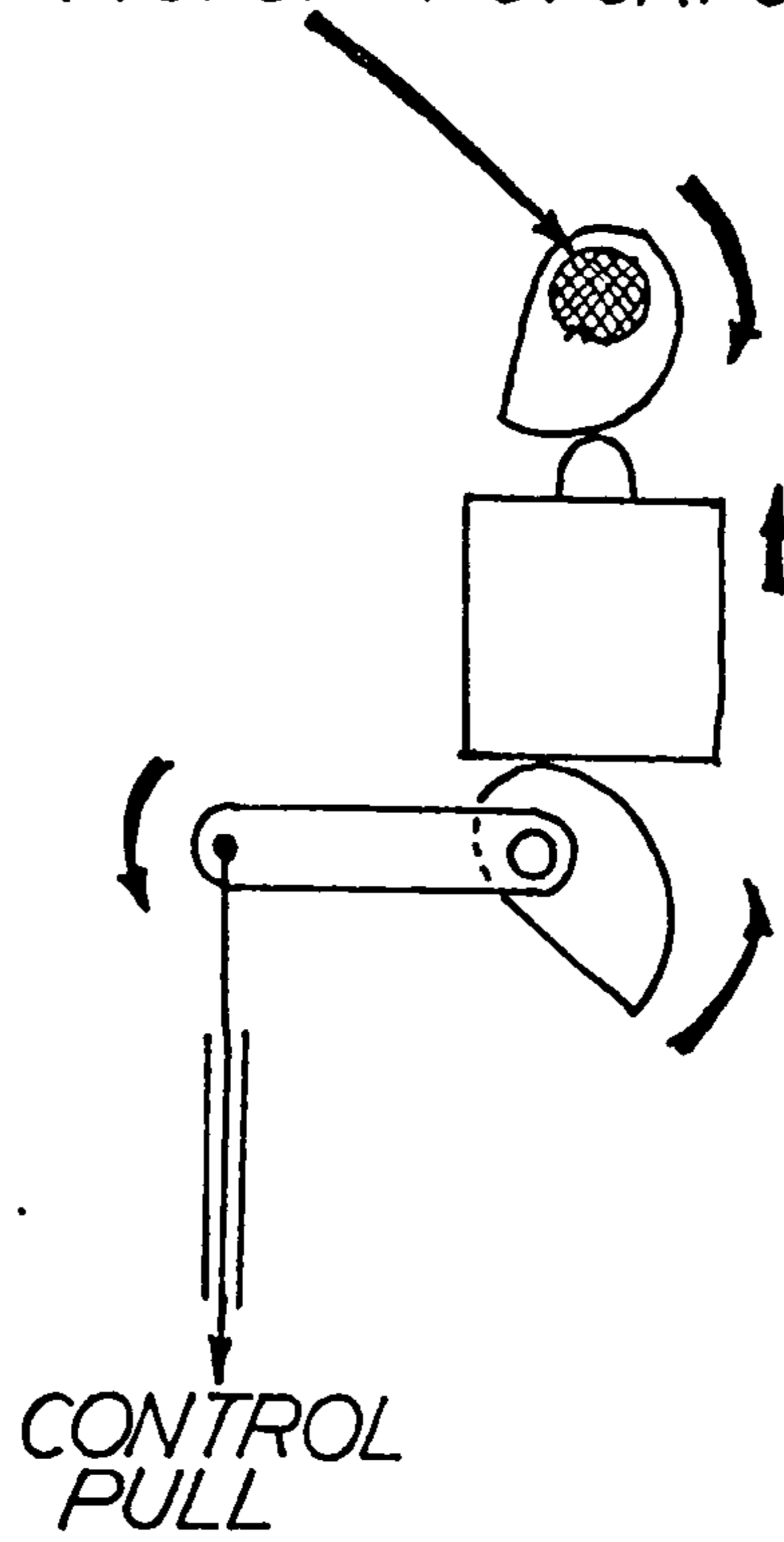

Fig. 5.V.2

Use of cams in position feedback systems.

effect pressed the operating needle of the valve which in turn initiated rotation of the output cam via the actuating piston.

In order to avoid complicated machining of special cam profiles an approximation to the ideal linear lift required was made by the selection of a suitable degree of eccentricity of a circular section of cam. The design was carried out by defining the amount of lift required (8mm) in the degree of rotation required (90° in the case of the rotation of the piston crank shaft). The linear change of lift from 0 to 8mm in 90° was then plotted out starting from a diameter dependent on shaft diameter, and the best approximation of a circular segment to this curve was then drawn in. The design then required the machining of a circular profile eccentric from the shaft mounting bore by an amount measured from the construction described above. The machining of the cams was made an extremely simple process by the construction of an eccentrically mounted jig pin which could be clamped in a dividing head. By rotation of the dividing head, the cam manufacture was reduced to a simple milling procedure. The moving valve was constrained to move in a straight line between the cams by means of smooth needle runners passing through holes bored in the valve body and operator control was achieved by the simple attachment of the Bowden cable inner wire to a lever arm operating the input camshaft, the outer cable being 'earthed' to the mechanism framework.

This type of feedback mechanism operated extremely smoothly and accurately, with a minimal error signal due to the direct nature of the valve operation. Unfortunately it was not possible to evaluate this mechanism under full field trial conditions, since the type of

mechanism to which it applied was superseded by a mechanism not suited to this configuration. Further applications were prohibited by the change to a double-acting valve system, which would have proved excessively bulky for total movement of the valve assembly between cams, although a type of cam-based feedback mechanism was also devised for a rack and pinion shoulder mechanism in the arm prosthesis. The differential area piston arrangement used to power this mechanism once again permitted single valve operation, although the feedback mechanism devised could be easily applied to a double-acting valve assembly, since the valves have a fixed mounting. The cam feedback mechanism was achieved by direct rotation action, consisting of what are effectively two tapered washers initially mating in such a way that a flat double washer is formed. However, if one washer is now rotated with respect to the other, the axes of the washers being maintained in a concentric configuration, separation of the washers occurs along the axis of rotation (Fig. 5.V.3). The practical system consisted of a pair of doubly 'tapered' washers to prevent tilting, one washer being constrained to rotate with the rotation shaft but allowed to slide along the axis of the shaft. Thus, a Bowden cable attached to the second washer, passing up the centre of the rotation shaft was made to move by the cam-lift distance during rotation of the shaft. In order to operate the control valve, the cam washer attached to the arm was allowed a slight axial movement which was sufficient to cause valve operation by a lever movement. Thus, a pull on the control wire caused movement of the feedback slider cam-washer, which moved the cam washer attached to the arm, causing valve operation which in turn caused rotation to commence, allowing feedback of control wire

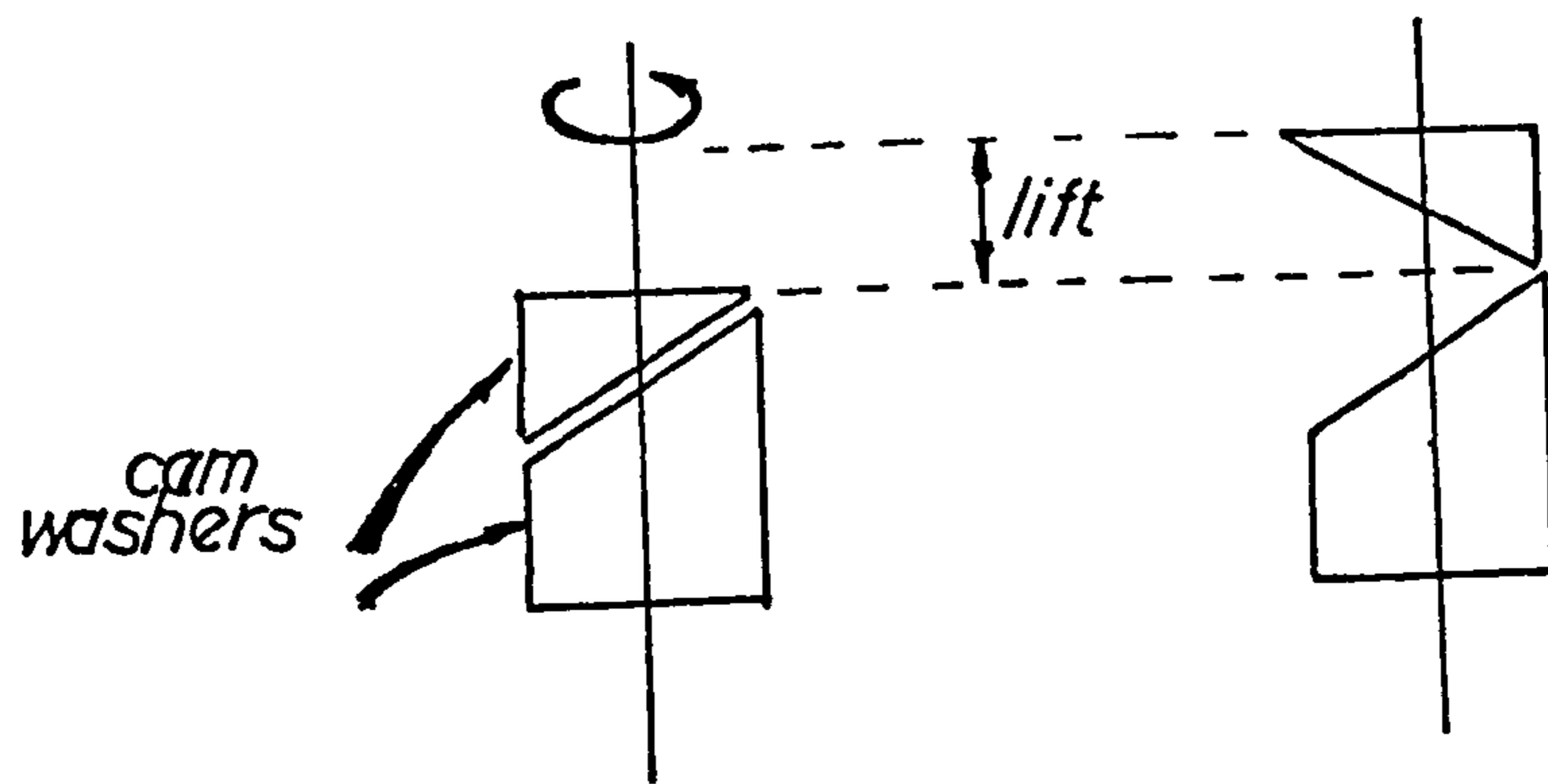

DOUBLE
TAPER
WASHER

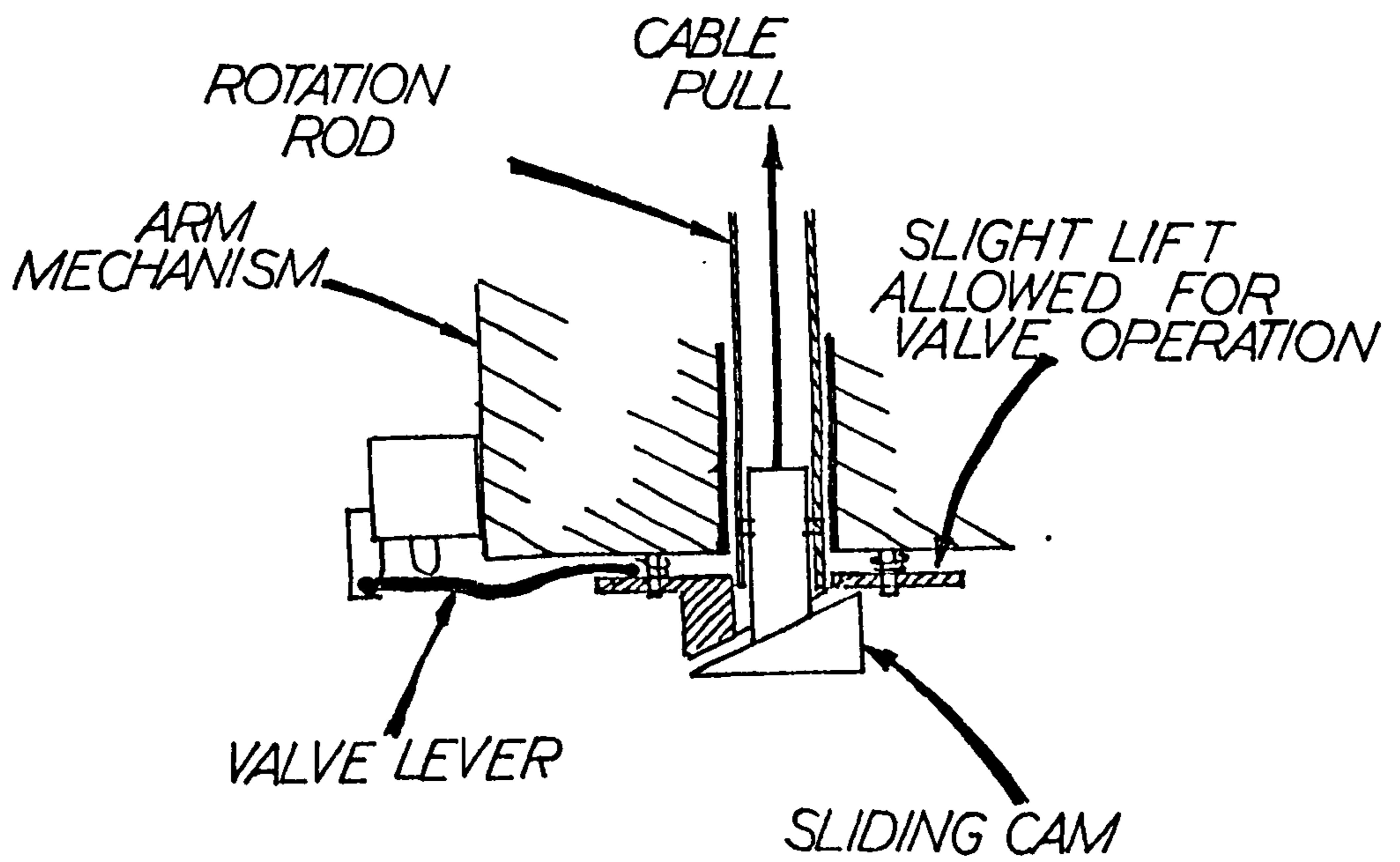
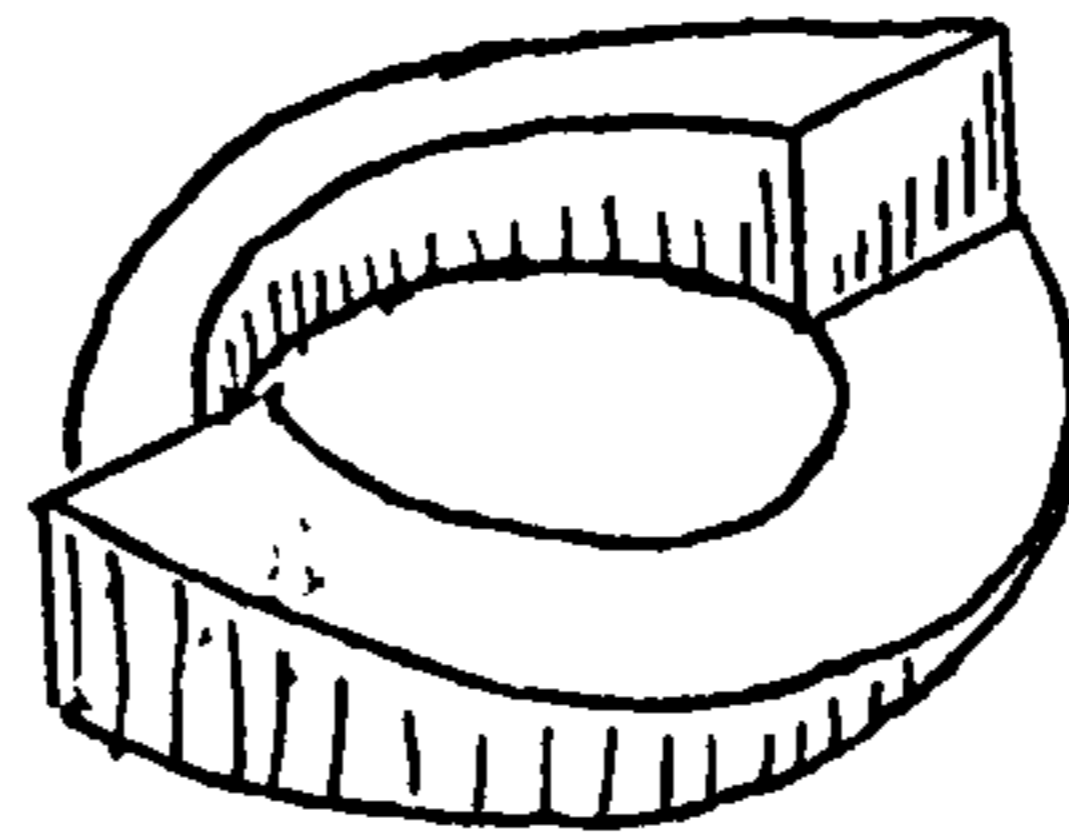

Fig. 5.V.3

Cam-washer mechanism for position feedback.

by the rotary cam action. This mechanism performed extremely smoothly with a cam-lift of approximately 8mm. However, the subsequent introduction of rolling gear/bevel gear rotation mechanisms was not suitable for the cam type feedback configuration since the space available at the end of the rotation shaft was inadequate for the introduction of cams.

The advent of the new rotation mechanisms driven from within the arm prosthesis presented an entirely different feedback problem. Since the input rotations for the mechanisms occurred about axes perpendicular to the length of the arm, the rotary-lift cam was not suitable, and the immediate problem became a matter of reducing the direct movement of the actuating pistons to a level suited to the movements required by the patient control sites. The fact that the piston actuators drove the input gears by a bellecrank action suggested the solution of connecting the Bowden cable outer to a point on the crank which gave the required overall movement. The inner wire of the Bowden cable passed round the shaft at the same radius as that of the connection for the outer, the wire then terminating at the valve lever, the valve block being fixed to the arm frame (Fig. 5.V.4). In this way, movement of the inner wire at the control site caused valve actuation via the pulley action around the input rotation shaft, followed by effective feedback of the wire as the Bowden cable outer rotated with the input gear. Since this mechanism occupied little space and was applicable to all the arm functions except the elevation movement, several prostheses were put into general service with this control mechanism. The controls performed fairly satisfactorily, except that errors and high

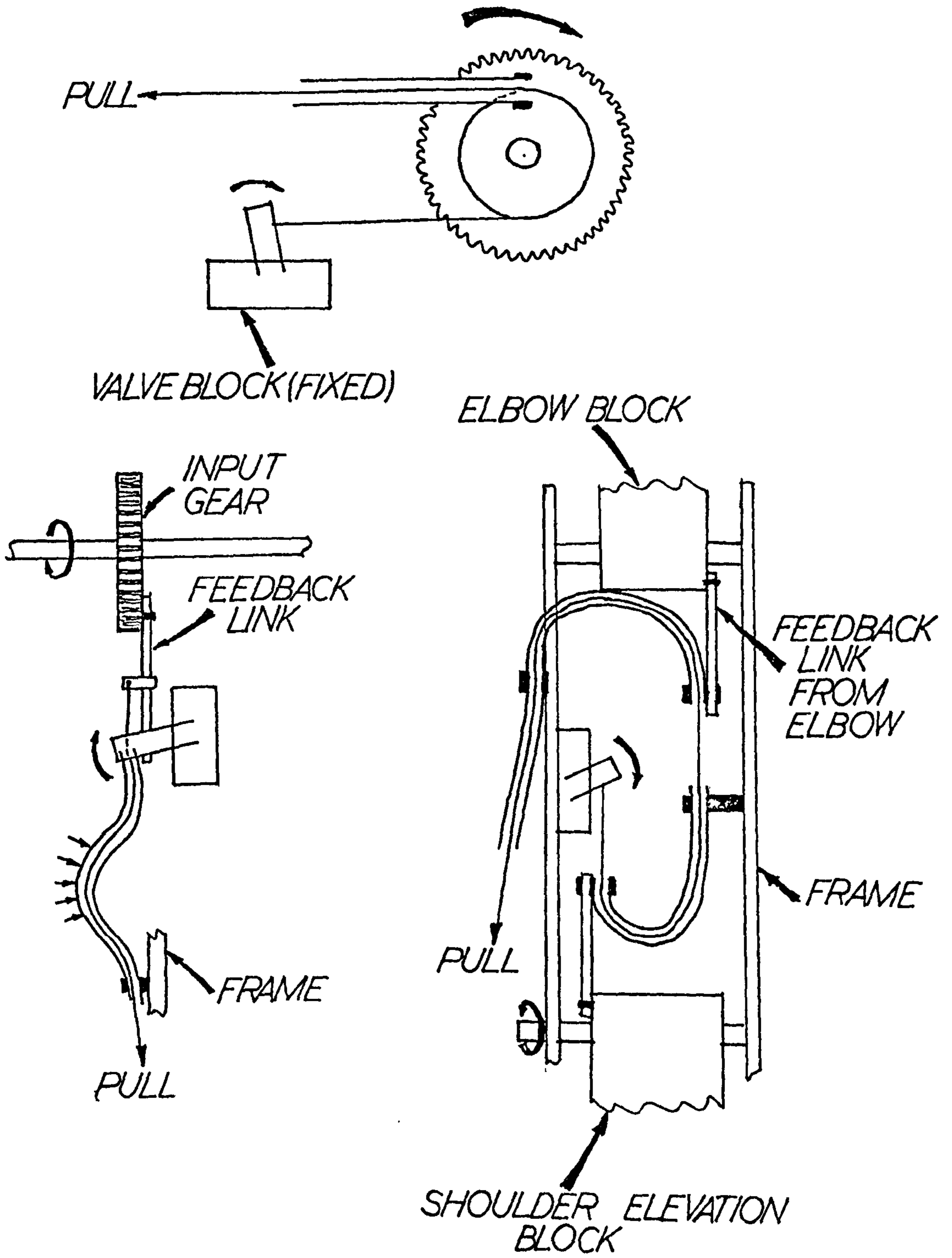

Fig. 5.V.4

Feedback systems using Bowden cables.

friction were introduced by fouling of the Bowden cable because of the mobile termination of the outer cable. The movements which occurred with the piston motion caused the curvature of the cable to alter and the cable to foul the arm covers. This fault tended to make arms rather unreliable and inconsistent in use, and it was eventually decided that an alternative system should be devised in an attempt to facilitate maintenance and, if possible, reduce the high friction being introduced by flexion of the whole Bowden cable.

The first step taken in order to improve servicing consisted of providing a rigid rod link between an accessible point in the arm and the point on the mobile mechanism concerned from which the desired amount of feedback movement was produced. This step avoided the complications of terminating the breakage-prone Bowden cable on an inaccessible part of the mechanism, since the cable could be attached to the feedback link rod at any convenient point. It was expedient to use the valve lever as a runner for the feedback link, valve activation being achieved by terminating the Bowden cable outer in the valve lever, and the inner cable on the feedback lever (Fig. 5.V.4). At this stage it was observed that it was unnecessary for the whole Bowden cable outer to move in order to activate the valve lever, since only a limited amount of motion was required. It was therefore possible to terminate the Bowden cable outer neatly on the arm frame, leaving sufficient outer cable in a loop to provide activation of the valve lever by virtue of the tendency of a pull on the inner wire to straighten the curve of the outer (Fig. 5.V.4). The clumsy nature of the loop of normal Bowden cable outer prompted a change to, for the loop section only,

thin ptfe sleeving as the outer cable. The junction between the conventional spring type outer and the sleeving was achieved by means of taper tapped holes in either end of a brass connector, into which the two types of outer were screwed. This type of actuation mechanism proved extremely satisfactory in use, although overloading of the controls caused a buckling of the thin sleeving, which was replaced by a conventional outer cable once more.

Earlier in this section the point was made that the feedback requirements of the elevation mechanism were rather different from those of the elbow and wrist and shoulder rotations. This difference is a direct consequence of the mechanisms chosen for the 'r' movement of the arm, in particular the use of the shoulder elevation piston as a rigid link during elbow flexion. This fact means that movements of the shoulder elevation link are not uniquely associated with shoulder elevation. Therefore, in order to control shoulder elevation, it is essential to make direct use of the change of elevation piston length alone. However, the stroke of this piston was 25mm, and a 'divide by two' mechanism was therefore necessary. This was achieved by means of a simple lever mechanism, the pivot being attached to the body of the piston and the piston rod driving the input end of the lever. The Bowden cable outer was attached to a suitable point on the lever, giving 12mm of movement during a full piston stroke. The Bowden cable inner was attached to the valve lever, with the valves fixed to the body of the piston. This system works satisfactorily on the bench, but the many pivots and the relative delicacy of the lever mechanism led to frequent breakdowns in service.

During the period in which the feedback link rods were being introduced, a similar system was devised for use with the shoulder elevation piston. In order to be able to make use of a link rod attached at an appropriate radius to the shoulder elevation block, it was essential to remove the 'phantom elevation movements' created during elbow flexion activity. This was achieved by the introduction of another feedback link taken from the appropriate radius at the elbow joint, and this feedback was used to cancel out the phantom movements from the shoulder elevation block. The arrangement for this mechanism is shown in Fig. 5.V.4.

The arm prosthesis, with the controls in the above form, was successfully fitted to several children for over a year. However, during this period, control breakages and high friction provided a constant supply of breakdowns, the one saving grace being the fact that the control system had been designed for ease of replacement of faulty parts. The root cause of the failures appeared to be due to a build up of friction in the control wires because of the somewhat tortuous route taken through the arm by the cables, the consequent high friction requiring the application of quite high forces (0.5 - 1 kg) by the operator.

The use of such high forces was neither good for operator fatigue nor wear and tear on the control system and for this reason it became apparent that the initial criterion for manufacturing the arm as a completely self-contained unit should not apply to the control system. Although it had been appreciated at the commencement of the arm design that the best control practice in servo-mechanisms is to place the valve mechanisms as near to the control site as

possible, it was not anticipated that the Bowden cable losses due to friction would be of such significance. However, the realisation of the necessity for removing the valves from the arm prosthesis and re-siting them on the harness caused another design modification to be commenced.

The work involved in modifications to the existing systems proved to be minimal, since the severe space restrictions of arranging the controls in the arm had been removed thereby making the designs relatively simple. Because the control sites for amelic patients were based on the acromion, it was impossible to situate the valve assembly exactly at the control site where the bulges produced would have been extremely unsightly. This problem was overcome by means of a compromise solution, siting the valves on the back of the harness, linking the valves to the control site by a relatively short and straight section of Bowden cable. The feedback links from each arm movement were provided by Bowden cables as before, but now the whole cable assembly was driven by the power of the arm movement being monitored. This was achieved by pre-tensioning the feedback cable by a spring of strength sufficient to overcome the friction throughout the arm, thus it was possible to extend the feedback signals from within the arm to the harness without the need for the patient to overcome friction. The normal control system was then linked to the feedback cables from the arm rather than to the rod links as before. This system reduced the friction to be overcome by the operator to a level dependent only on the short length of cable from the shoulder to the valve block on the harness, a considerable improvement for the sake of a few slight

bulges on the harness. In an attempt to reduce the size of the valve block bulges, a smaller version of the force demand valve itself was designed, considerable miniaturisation being possible by replacement of the feedback diaphragm by an O-ring of smaller cross sectional area.

The use of Bowden cables as the medium for the transmission of position information was largely a choice determined by simplicity and ready availability. However, the problems encountered with continued use of these cables, the frayed wires, susceptibility to damage by pinching, high friction when bent, etc. have led to some consideration being given to possible alternatives. Since the mechanical aspect of the feedback is of prime importance, the electrical methods of feedback are unacceptable, which leaves the three possible mechanical transmission media; solid, liquid and gaseous. The Bowden cable comes under the category of 'solid', hydraulic transmission being the liquid version, and some form of pneumatic transmission being the gaseous system.

The possible mechanical systems other than the Bowden cable which could be applied to the multiple jointed prosthesis would be prohibitively complex linkage systems which certainly would suffer from defects even more serious than the high friction of the Bowden cable. Therefore, some attention must be given to hydraulic and pneumatic systems in order to find an alternative to the Bowden cable, bearing in mind the fact that, although position backlash errors may occur with the Bowden cable there can be virtually no time delays incurred in feedback via the cable, a point which must be given particular attention in choosing an alternative since as little as

30ms delay in feedback of information can disrupt the control ability of the human operator.

The hydraulic transmission medium is, at first sight, the more attractive proposition, due to the low compressibility of liquids giving an immediate rigidity to any well designed system. However, the conventional hydraulic systems use pistons with O-ring seals, which always have some tendency to leak, whether it be liquid leaking outwards or air contaminating the system and making it 'soft'. Nevertheless the use of wiper rings in conjunction with well designed pistons can keep liquid leaks to a low level, which may be acceptable if the harmless liquid such as water were used. The problem of air contamination is difficult to solve unless a system similar to the car's hydraulic braking system is used, where the driving piston is immersed in a fluid reservoir, air being bled from the system at the slave cylinders. One alternative to this conventional system has been suggested by Simpson who advocates a completely sealed system consisting of two flexible bags connected by a tube, the whole system being partially filled with liquid, but air being excluded. This is extremely difficult to achieve in practice, and it is suspected that the system is extremely 'soft' due to the flexibility of the sac walls. However, the system is under consideration together with the more conventional arrangement.

Pneumatic systems for feedback links would appear, at first sight, to be totally undesirable because of the high compressibility of gases, however some theoretical considerations (see Appendix 5.VII) show that position errors of less than ten per cent are

easily obtained with a relatively low pressure gas filled system consisting of two double acting pistons linked by gas tubing, (Fig. 5.V.5), the desired amount of feedback being introduced by means of matching the input stroke and area to an output of half the stroke (say) and double the cross sectional area. Practical systems of this type appeared to behave quite satisfactorily (on a subjective assessment), the great advantage being that leaks of gas are innocuous and are automatically made up from the supply bottle, since the links between the pistons are supplied, via non-return valves, from the regulator at the supply unit.

A curious fact always remains with pneumatic systems, since, theoretically, all the information required for complete knowledge of the position of an actuator piston, is available at the valve controlling the gas supply, which situation is used to a considerable extent in hydraulic systems. However, due to the compressibility of the gaseous medium it is virtually impossible to disentangle the complications introduced by the spongy characteristics of the medium. Nevertheless, by means of a modification to the pneumatic link described above, it is possible to produce a powered actuator which provides automatic feedback of position to a slave piston (Fig. 5.V.5). This system is really based upon the differential area actuator principle where the powered actuator A is supplied with a pressure P on one side and is driven by a pressure $2P$ from the drive side. The slave cylinder B is supplied with pressure P on one side and pressure $(P + \delta)$ on the other, the additional pressure δ being adjusted to overcome the stiction in actuator B. Thus, when the valve is in the exhaust mode, the pressure P moves piston A to the left, and the differential pressure δ across

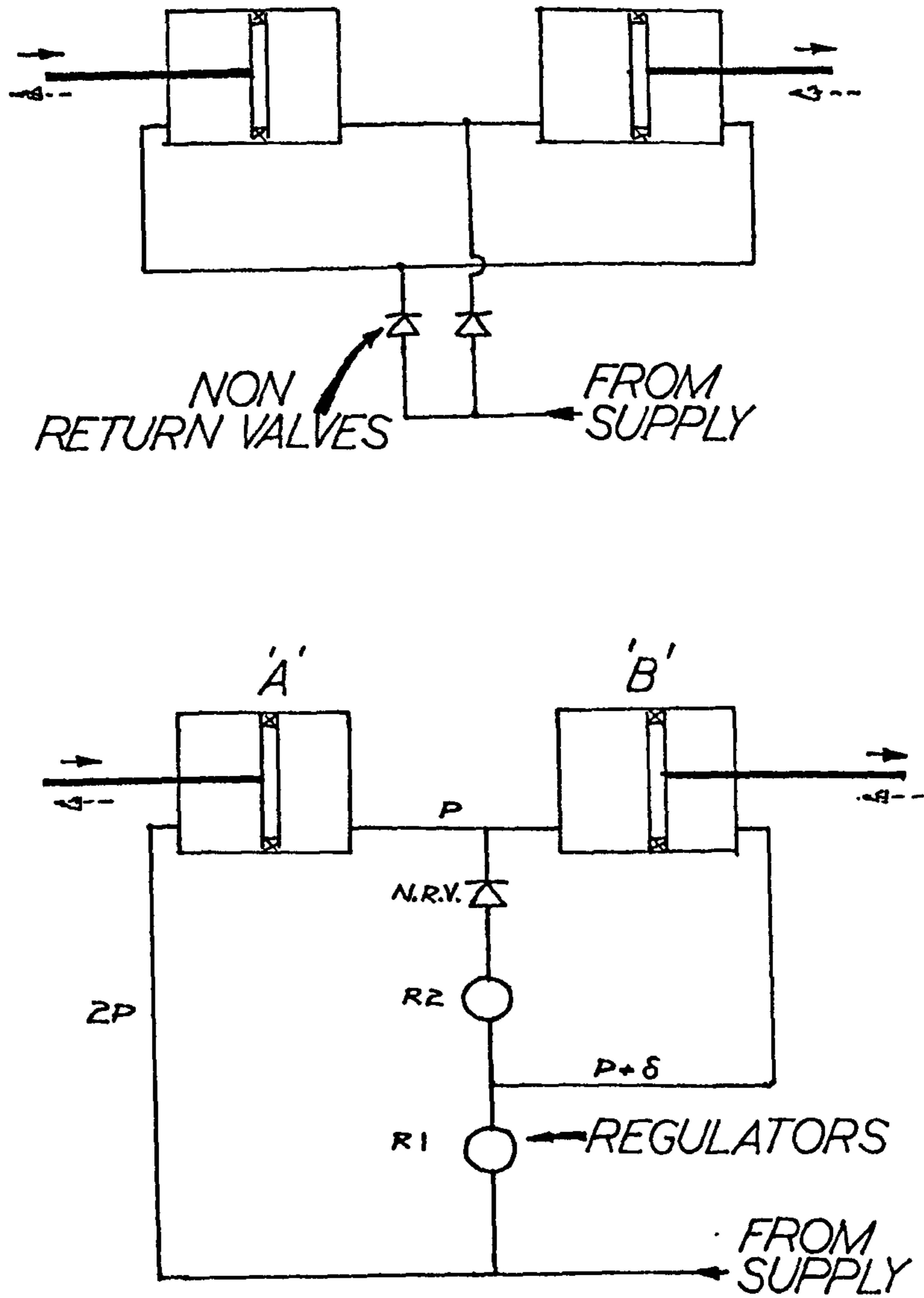

Fig. 5.V.5

Pneumatic feedback systems.

across actuator B moves piston B to the left also. When pressure $2P$ is applied to the drive side of actuator A, the piston moves to the right, causing a build-up of pressure in the link to actuator B, since a non-return valve prevents loss of gas. The pressure in the link and hence on the left hand side of actuator B then builds up until it is sufficient to overcome the effects of δ , when the piston will move to the right.

As with the previous link systems, this was tried and tested subjectively, appearing to behave adequately. However, in order to assess the real possibilities of such links it is necessary to establish the degree of error introduced by such systems. It was therefore decided that tests should be made to compare the characteristics of the various feedback systems, with those of the Bowden cable in current use.

The rig designed for the testing of these systems took a simple form, consisting of a linear drive powered from an eccentric mounted on an electric motor of variable speed. The position of the input was monitored by a potentiometer. The link under test was then attached to the input at one end, the output end of the link being attached to a suitable spring return to simulate the return springs used in practical systems. In order to monitor the output position without unduly loading the link, an optical measuring device was constructed on the basis of a unit developed at the University of Michigan. This device consisted of a shutter obscuring a collimated parallel light beam, the position of the shutter being detected by the amount of light received by a light cell. The calibration curve showed that this system had a useful linear range of operation,

within which it could be used to measure the position of the shutter attached to the output of the link system.

Unfortunately, the pressure of development work with the existing arm systems has not allowed the completion of tests with this apparatus, work only having reached the stage of calibration of the complete system with a rigid bar link between input and output. However, it is envisaged that the tests should take the form of an analysis of input and output positions recorded in analogue form on a pen recorder to establish the relative merits of Bowden cables, hydraulic links of various types and pneumatic links in terms of their accuracy of position and phase lag defects, at various rates of motion determined by the motor speed.

Appendix 5.VIA mathematical model of the position servo force demand controlled pneumatic actuator.

Many of the theoretical analyses previously reviewed based their considerations upon idealised valves which caused step-function inputs to be applied to the piston actuator, and this is regarded as the major stumbling block for these analyses, since successful pneumatic prostheses have been based upon force demand valves. The stability conferred upon a pneumatic system by force demand valves is due to the increasing tendency to close the valve as output pressure builds up, thereby reducing any tendency to overshoot a demanded position. It was therefore apparent that a full set of characteristic curves for the force demand valve would be necessary in order to relate supply and output pressures to the aperture allowed for flow, and to relate the flow rate thus allowed to the applied pressures. Information concerning the relationship between the applied force and output pressure was already available from a knowledge of the valve characteristics previously determined, the relationship being linear for the purposes of theory. It therefore remained to obtain the relationships between aperture, flow rate and pressure difference across the aperture.

This was achieved using the apparatus which was used during previous valve experiments, the seal opening aperture being pre-set by means of a micrometer adjustment and the input flow rates measured for various input pressures, the outlet being directly to atmosphere (Fig. 5.VI.1). However, since the practical system uses a constant input pressure, with a variable output pressure

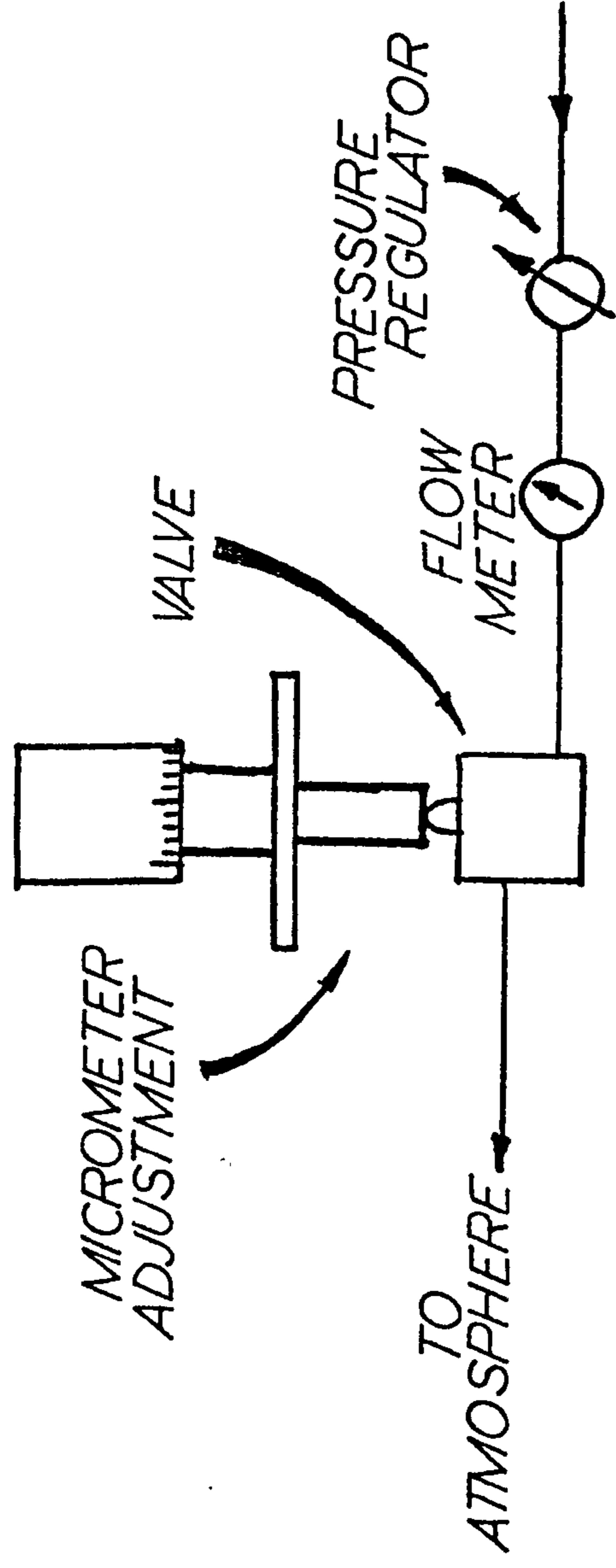

Fig. 5.VI.1

Arrangement for valve aperture pressure/flow rate experiments.

demanded by the operator, it was necessary to normalise the input flow rates to a standard input pressure of 120 psi. These normalised (on a perfect gas model) input flow rates are shown for various apertures in Fig. 5.VI.2. These curves also show that the flow rate is approximately proportional to the aperture opening at constant pressure, which is an adequate approximation for the purposes of a first attempt at a simulation of the system. Similarly it was possible to make straight line approximations to the curves shown in Fig. 5.VI.2 by means of a double straight line approximation with a break point, as shown in Fig. 5.VI.3. The valve characteristics were thus reduced to a form which was directly tractable by an analogue computer.

In order to analyse the behaviour of a piston controlled by valves of this type, various simplifying assumptions were made, all of which were similar in the sense that they effectively ignore the stabilising effects of friction, whether the internal friction of gases or the friction in the actuator seals. In this way, the only 'frictional' effects incorporated in the model were due to the characteristics of the valves which regulate gas flow. The major assumptions were that the gas behaves as a perfect gas and isothermally, and that no stiction was present in the piston actuator.

Thus the model was considered as a piston actuator with its associated inertial load, controlled by a valve, gas-linked to the input side of the piston, with position feedback to the valve assembly. The valve assembly incorporated a second valve connected to the non-driven side of the piston and allowed the non-driven side

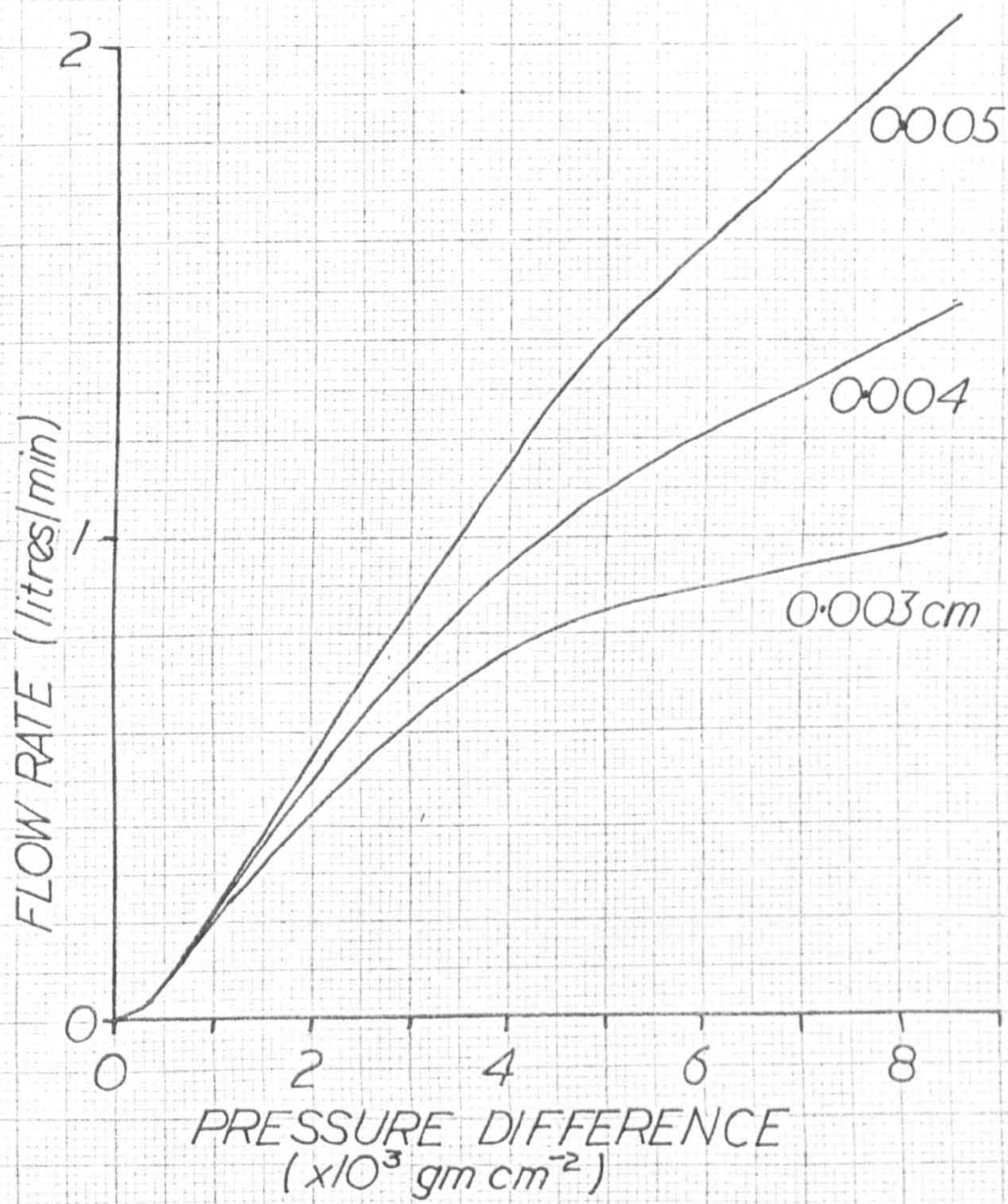

Fig. 5.VI.2

Flow rate and pressure difference
in valves with various opening apertures.

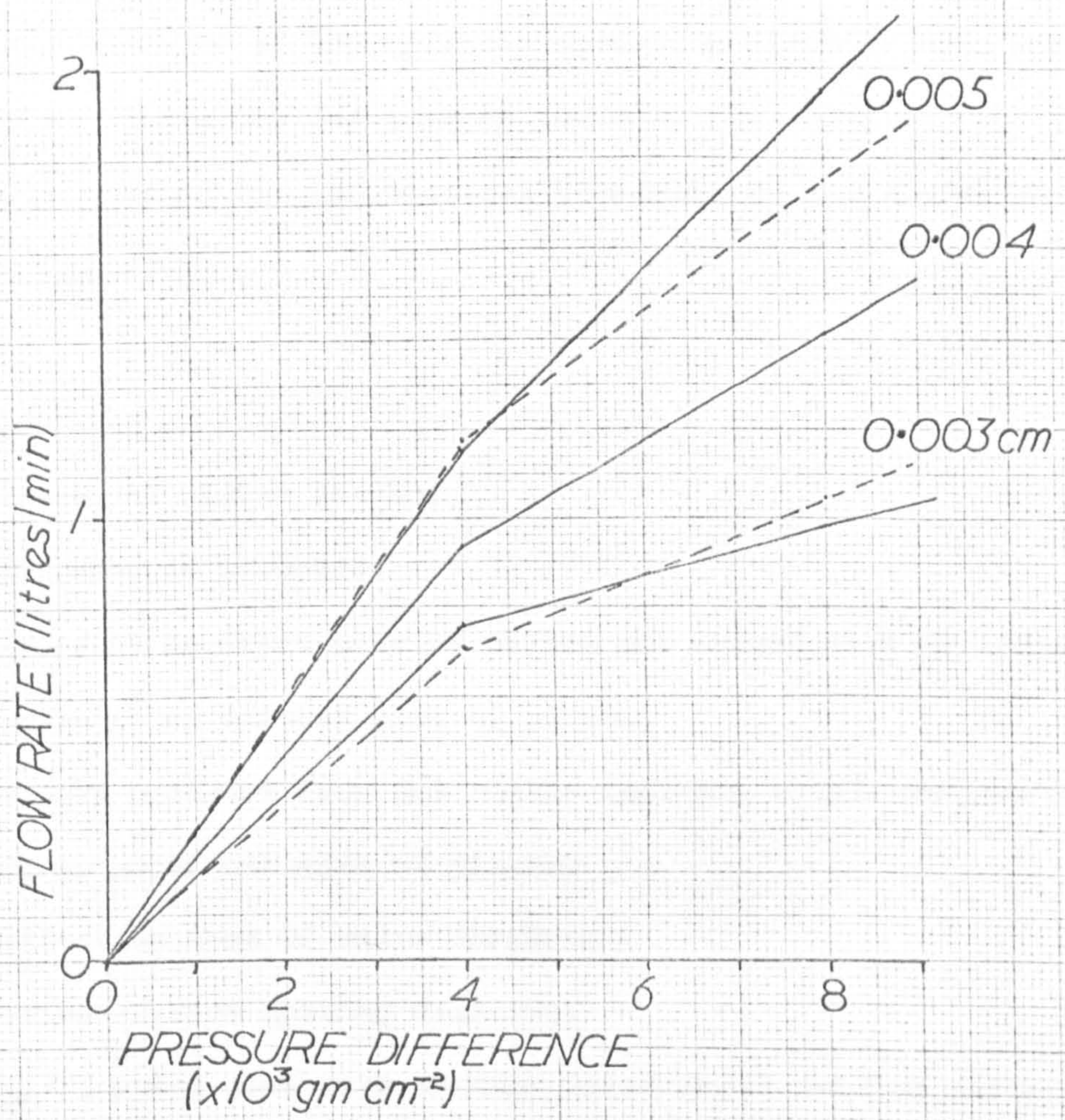

Fig. 5.VI.3

Linear approximations to valve characteristics.

of the piston to operate with the fully open exhaust mode characteristics of the exhaust valve. The input to the system was considered as being the shoulder of the operator operating directly onto the valve needle. The model was then as shown in Fig. 5.VI.4.

Thus simplified the mathematical treatment of the system was quite straightforward:

Notation

x_o position of piston.

l length of piston stroke.

P_a atmospheric pressure.

P_o pressure on drive side of piston and output side of valve.

P_e pressure on exhaust side of piston.

P_B supply pressure from gas bottle (maximum available pressure).

A_o cross-sectional area of piston.

A_d effective area of valve diaphragm.

ε valve orifice opening distance.

$F(P_o, \varepsilon)$ inlet flow rate through inlet valve orifice for pressure difference of $(P_B - P_o)$ across orifice opened distance.

$G(P_e)$ exhaust flow rate through exhaust valve orifice of fixed maximum opening for pressure difference $(P_e - P_a)$ across orifice.

g acceleration due to gravity.

' denotes time derivative.

M effective load.

m effective mass of shoulder.

The gap ε and pressure difference $(P_B - P_o)$ cause an input flow rate $F(P_o, \varepsilon)$ to the inlet valve.

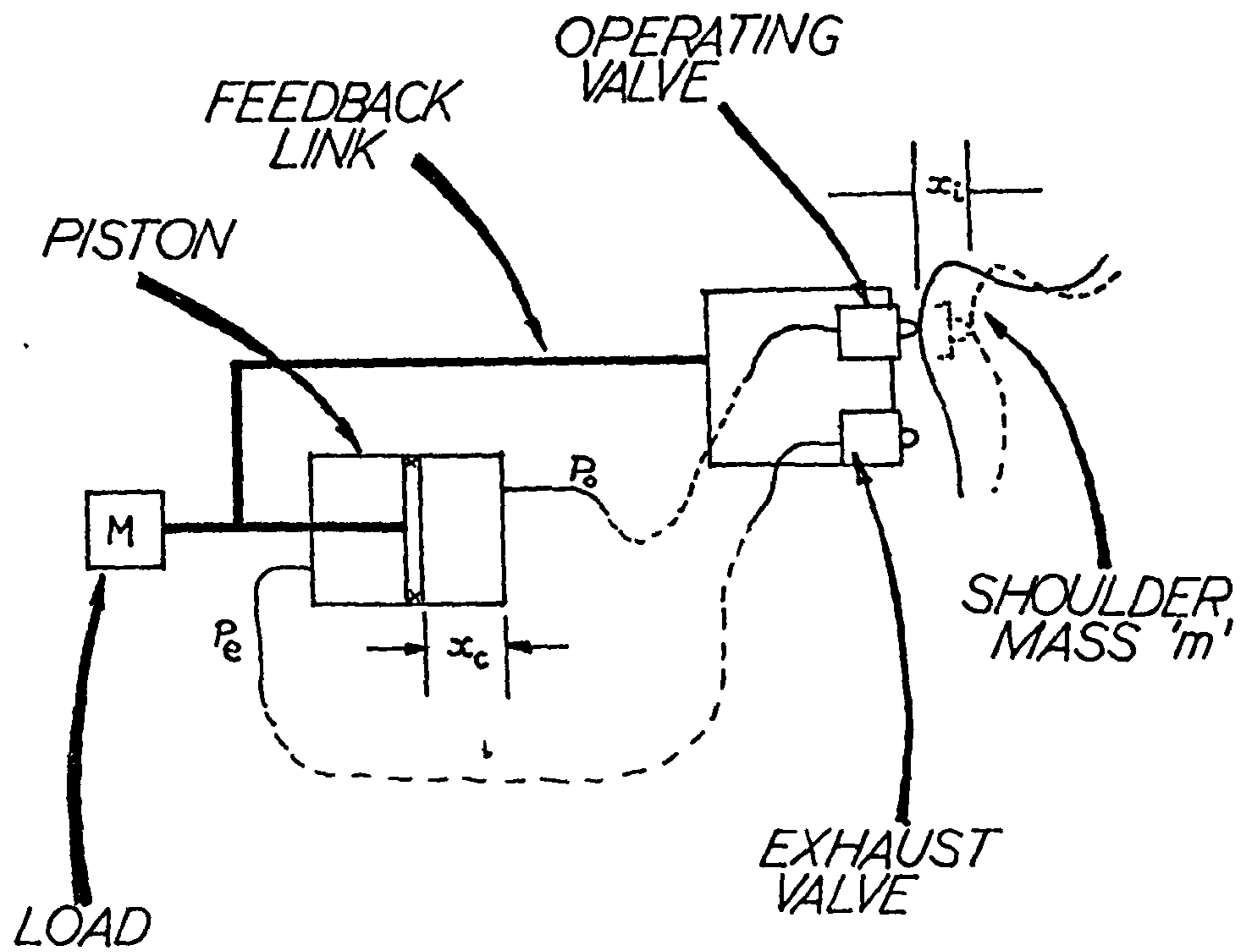

Fig. 5.VI.4

Pneumatic servo-system model.

For a mass q of a perfect gas at temperature T we have

$$pv = qRT \quad \text{where } r \text{ is the gas constant}$$

$$\therefore p \frac{dv}{dt} + v \frac{dp}{dt} = \frac{dq}{dt} rT \quad (1)$$

For the input side of the valve then:

$$\frac{dv}{dt} = F \quad p = P_B = \text{constant} \quad \therefore \frac{dp}{dt} = 0$$

$$\therefore \frac{P_B}{rT} F = \frac{dq}{dt} = \text{the rate of increase of mass of gas in the system.}$$

For the drive side of the cylinder we have:

$$p = P_O \quad v = A_c x_c$$

and $\frac{dv}{dt} = A_c \frac{dx_c}{dt}$

By the conservation of mass $\frac{dq}{dt}$ must be the same as that for the input side

\therefore Equation (1) becomes, in the drive side of the cylinder

$$\underline{P_O A_c \dot{x}_c + A_c x_c \dot{P}_O} = \frac{dq}{dt} rT = P_B F \quad (2)$$

Similarly, for the exhaust side of the piston

$$\underline{-P_e A_c \dot{x}_c + A_c (l-x_c) \dot{P}_e} = -P_e G \quad (3)$$

The pressure difference across the piston causes it to move

$$\underline{(P_O - P_e) A_c g = M \ddot{x}_c} \quad (4)$$

The position servo effect is achieved by generating the distance ϵ as the difference between input and output positions

$$\text{i.e. } \underline{\epsilon = x_i - x_c} \quad (5)$$

The way in which ϵ is generated depends upon the interaction between the shoulder of the operator and the valve operating point, which supplies pressure feedback from the piston.

Then, if the shoulder exerts a force B:

$$\underline{(B - P_o A_d)g} = m\ddot{x}_1 \quad (6)$$

In practice, a further complication should be introduced at this stage, since muscles have a characteristic relationship between force and velocity of contraction, which may well serve as a stabilising influence on the control of a position servo mechanism. However, in the first simulation the applied force will be treated as independent of velocity.

The equations (2), (3), (4), (5) and (6) provide a complete description of the dynamic problem, from which it should be possible to obtain the variation of ϵ with time for various conditions of load M and applied force B. This knowledge is of particular significance to an understanding of gas consumption since ϵ directly determines the flow of gas from the supply.

The time dependent variables were P_o , P_e , x_o , x_1 and ϵ . Apart from the generated functions F and G and the external parameters M and B, the remainder of the characters may be assigned numerical values.

The problem at this stage became a matter of simulating the five equations and the valve characteristics on an analogue computer with the usual difficulties associated with the scaling of the computer variables, and this is progressing at the time of writing.

Appendix 5.VIIThe use of pneumatics in feedback mechanisms.

Consider two actuators linked pneumatically as shown, pressure in each side being maintained from a gas supply via non-return valves.

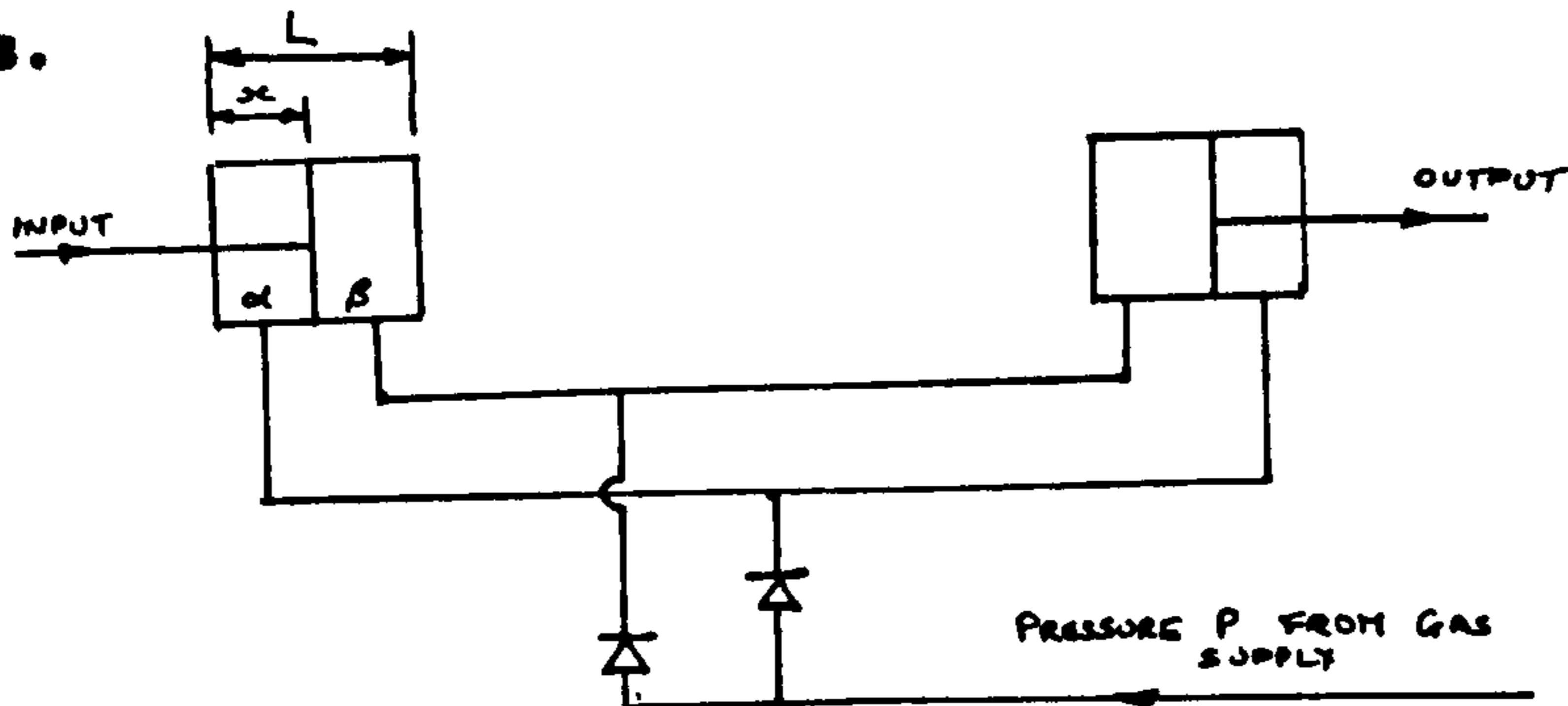

Let the input piston move distance dx .

New volume ' α ' = $A_1 (x + dx)$ A_1 is cross section area of

New volume ' β ' = $A_1 (L - x - dx)$ input actuator.

Assuming perfect gas behaviour at constant temperature

$$pv = k$$

k is a constant

$$vdp + pdv = 0$$

p is pressure

v is volume

$$\therefore dp_{\alpha} = \frac{-PA_1 dx}{A_1 x}$$

This is initially made up from the gas bottle via non-return valve and the system subsequently operates from a standing pressure of $P + dp_{\alpha}$.

$$dp_{\beta} = \frac{Pdx}{(L-x)}$$

$$\text{where } dF = \frac{PA_2 dx}{L-x}$$

This creates a force dF across slave cylinder

A_2 is cross-section area of output actuator.

Now, if Z is the stiction force in the output actuator, then:

$$Z = \int_x^{x+l} \frac{PA_2 dx}{(L-x)}$$

where X is the starting position and l is the minimum displacement necessary for movement of output.

$$\therefore \frac{L-X}{L-X-l} = e^{Z/PA_2}$$

$$\therefore l = (L - x) \left[1 - e^{-Z/PA_2} \right]$$

l is maximal when $x = 0$

$$\text{i.e. } \left\{ \frac{l}{L} \right\}_{\max} = \left(1 - e^{-Z/PA_2} \right)$$

$$\text{Now } A_2 = \frac{\pi d_2^2}{4}$$

where d_2 is the diameter of the output cylinder

$$\therefore \left\{ \frac{l}{L} \right\}_{\max} = f(d_2)$$

Experiment shows $Z \approx 3 \text{ lb.}$

Supply pressure $P \approx 120 \text{ psi.}$

This curve is plotted in the associated graph (Fig. 5.VII .1)

which shows that the errors due to compressibility may be reduced

to a low level (<10%) by the choice of a suitable actuator diameter.

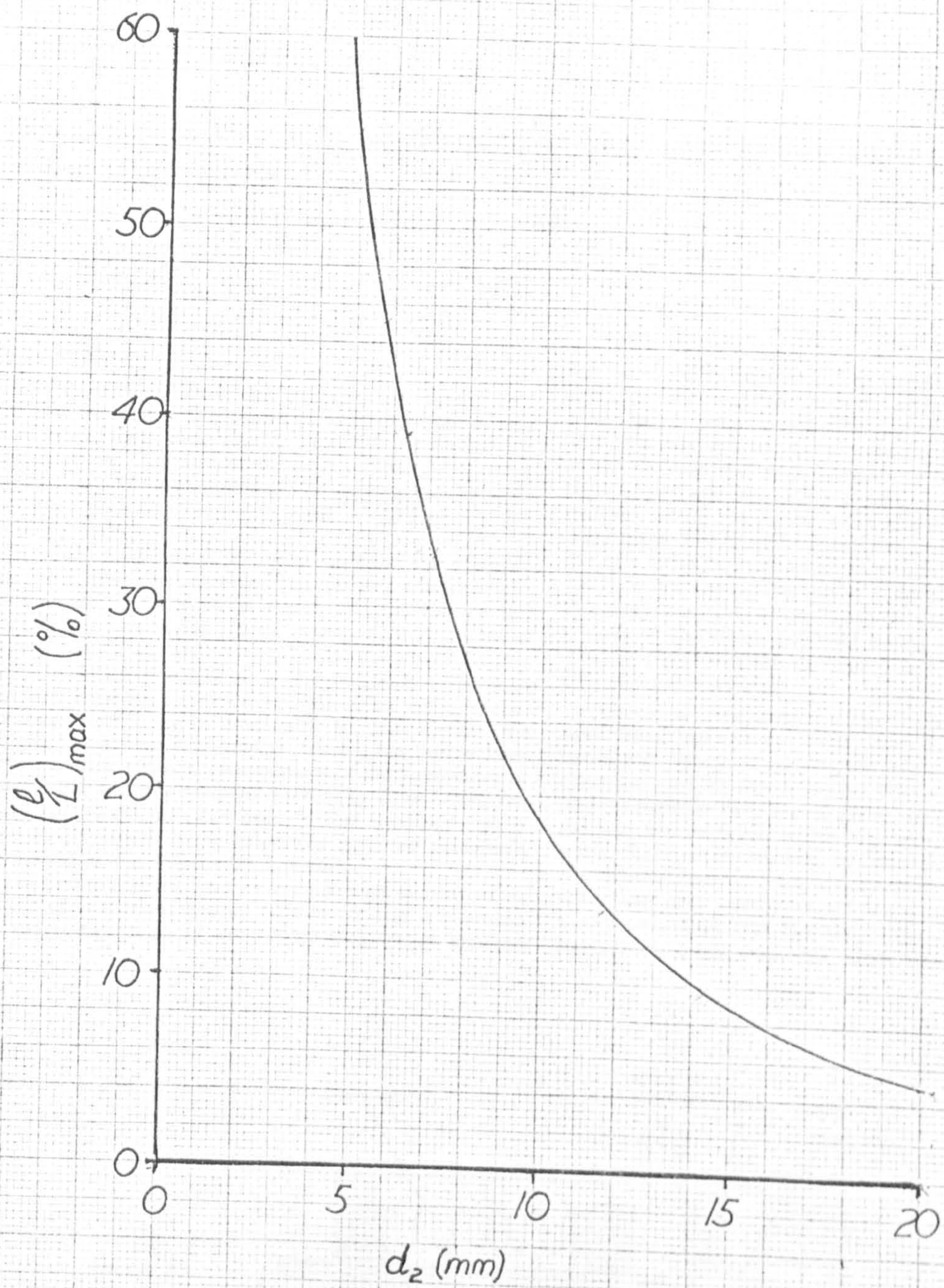

Fig. 5.VII.1

Compressibility errors in pneumatic link systems.

Technical note

Experience with the force-demand valve in controlling a pneumatically powered prosthesis*

Keywords—*Prosthesis, force-demand valve, artificial arm*

Introduction

SINCE THE introduction of the force-demand valve (f.d.v.) into the prosthetics field in 1966, various forms of this valve have been used in the powered artificial arms developed in Edinburgh (SIMPSON, 1966). This note relates some of the modifications and rearrangements that have been necessary to provide a practical solution to the problem.

In 1965, following discussions between the Princess Margaret Rose Orthopaedic Hospital and Elliott Flight Automation Ltd., a metal-metal seal version of the force-demand valve, as shown in Fig. 1, was produced (ALBUTT and CHAPPELL, 1965). Unfortunately, this valve had a tendency to leak slightly under load, but this fault was overcome in a new design (the Sabu valve) incorporating rubber seals developed by the Centre for Muscle Substitutes (BOTTOMLEY, 1966). Harborow later redesigned the physical arrangement of the Sabu valve in Edinburgh, and this modified valve (Fig. 2) provided the basic structure which has been further modified and is now incorporated in the externally powered prosthesis developed at the Edinburgh hospital.

The first alterations that were made were motivated by constructional requirements. The lower seal is achieved by the compression of the rubber diaphragm between

the valve centre and body at points X (Fig. 2). The problem was to achieve equal compression of the edges of the seal to obtain consistent diaphragm characteristics. The only way to achieve the same degree of compression using the existing arrangement would have been to tighten the top nut using a torque wrench, but this method would not necessarily avoid buckling of the diaphragm. The simplest remedy for the problem was the use of a loose flap seal as in the Swedish valve (KLASSON, 1967), where the rubber seal is stiffened by a backing of thin steel to provide a consistent seal on the inlet port, the peripheral seal being achieved by the use of an O ring. This form of the valve is shown in Fig. 3, with its operating characteristics in Fig. 4.

This simple arrangement soon began to show a basic fault when eight to ten valves were used together in a prosthesis. When the gas supply was switched on to the complete arm, it was presented with many open valves, and the pressure drop was so great that the pressure of the gas was not sufficient to lift the seals to close the inlet ports. This effect resulted in intermittent leaks which could sometimes be cured by operating the controls, but sometimes not; when installed in a prosthesis, the valves would sometimes leak furiously after connecting the gas supply; on other occasions, they would seal perfectly.

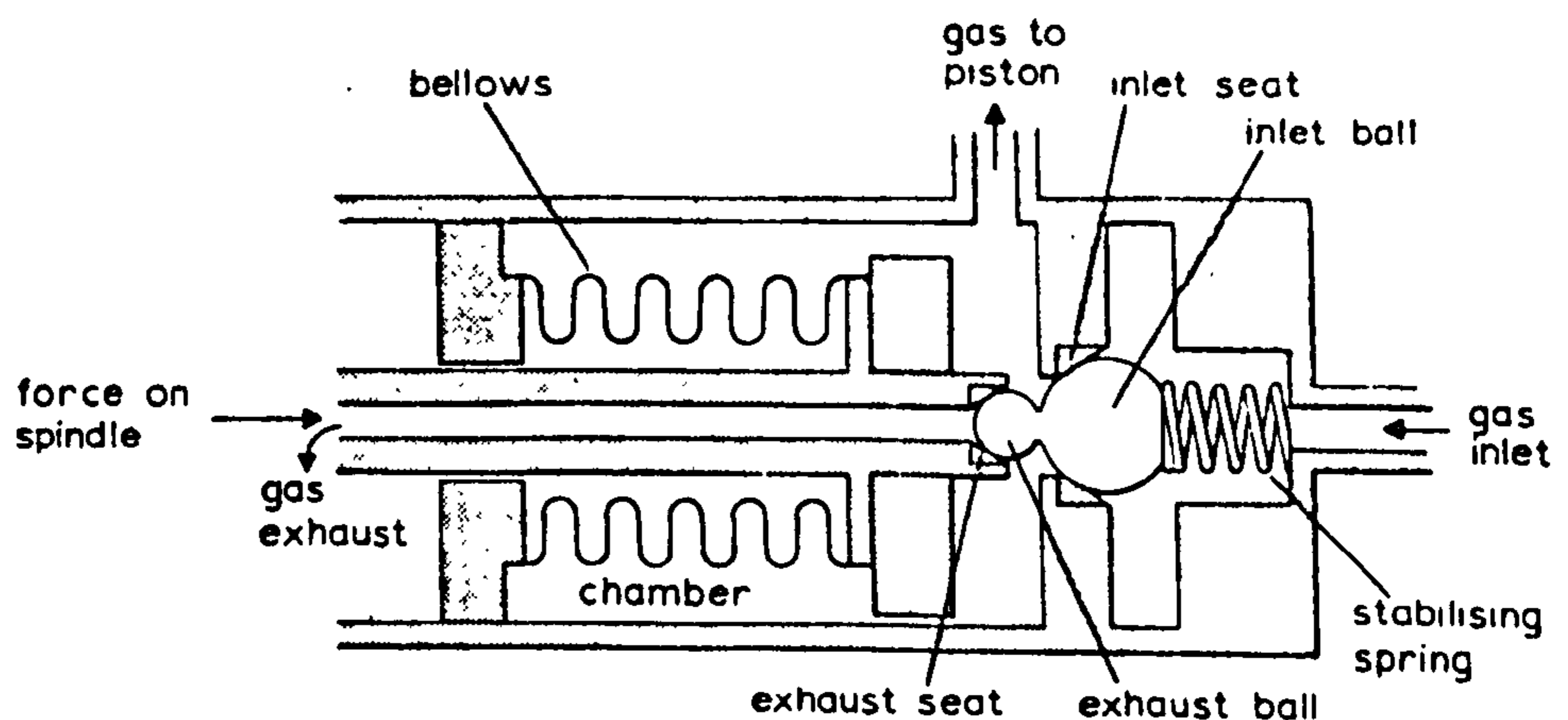

Fig. 1 Metal-metal seal valve

* First received 3rd February and in final form 7th March 1972

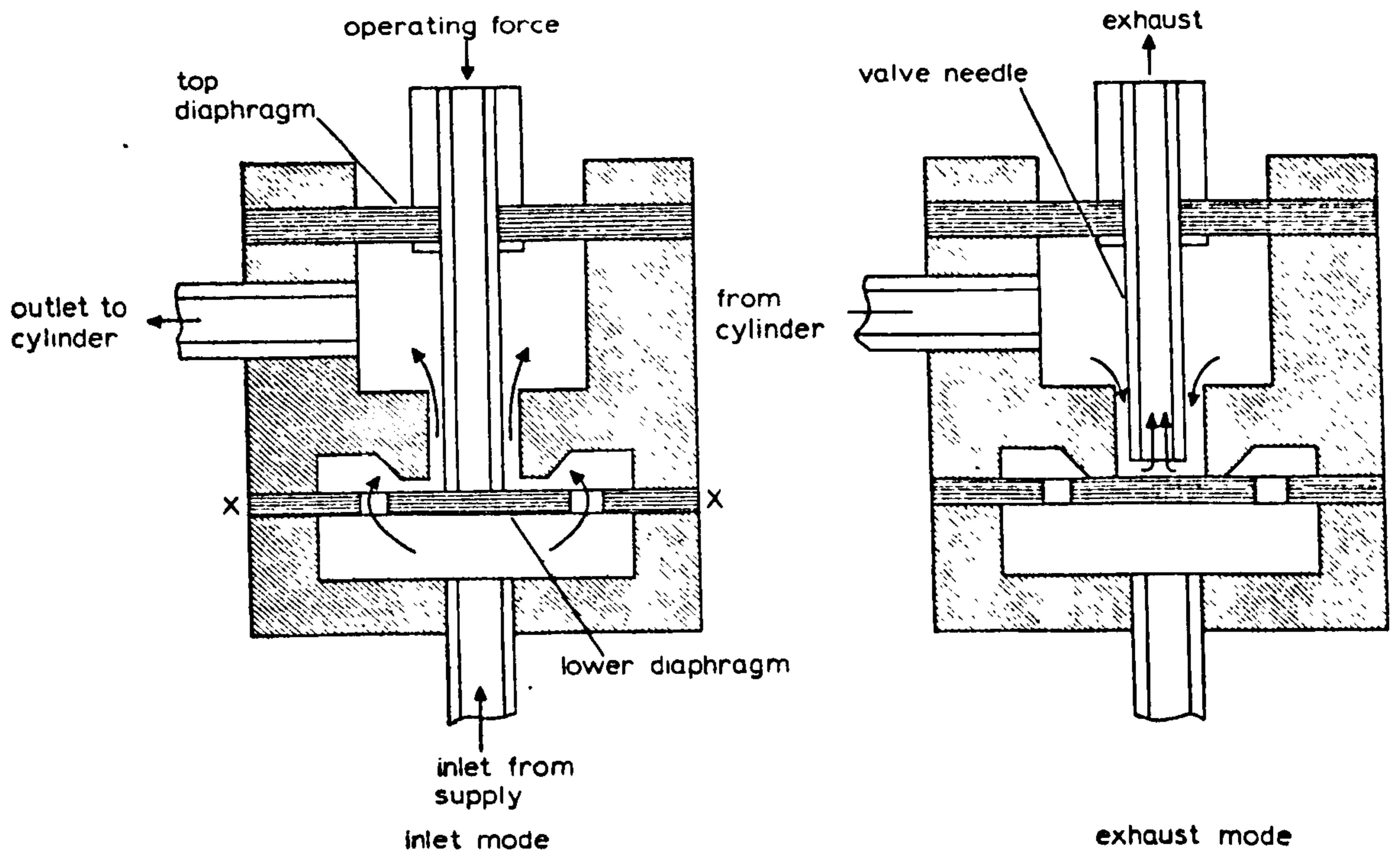

Fig. 2 Schematic of original Edinburgh valve

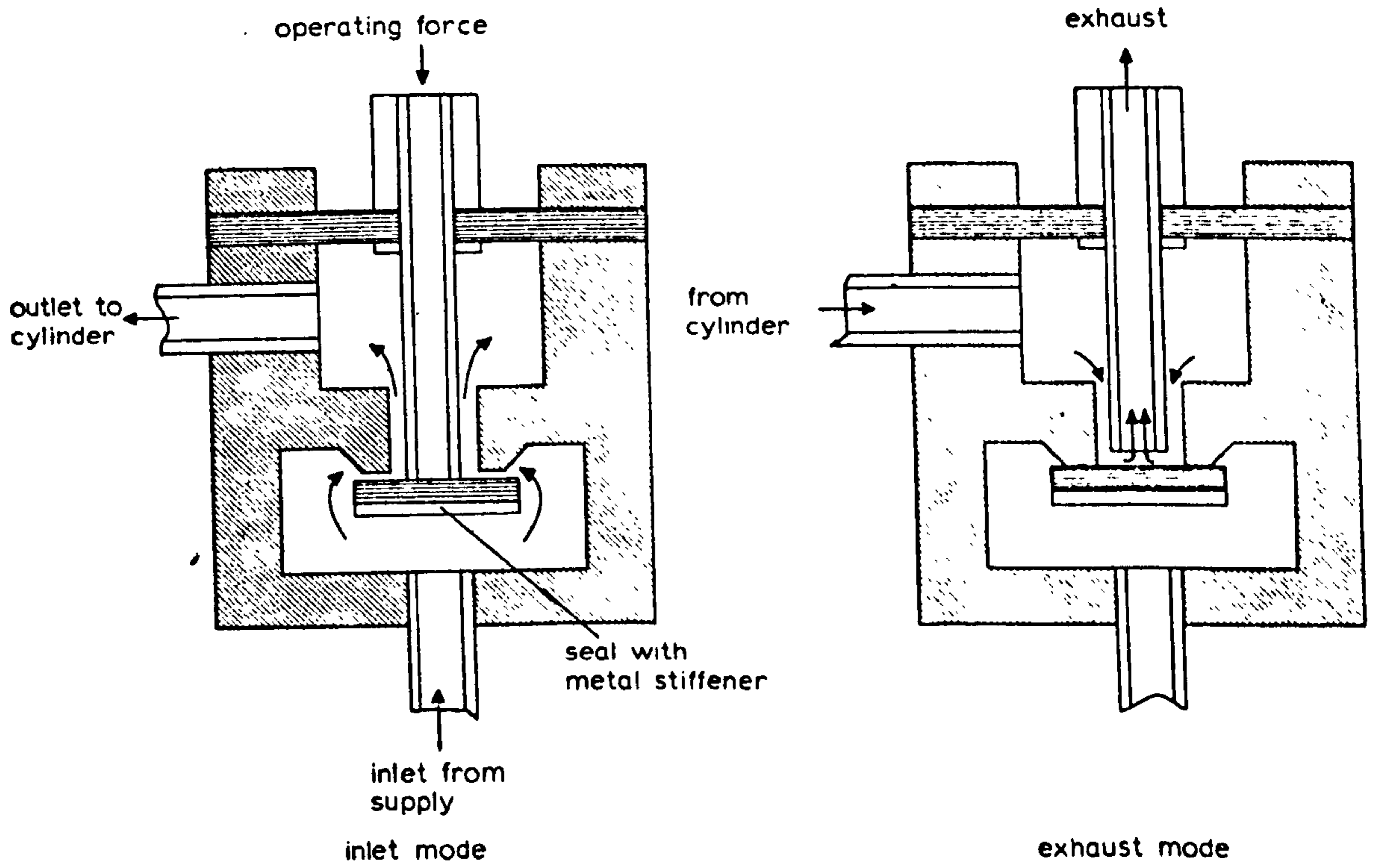

Fig. 3 Schematic of valve with loose lower seal

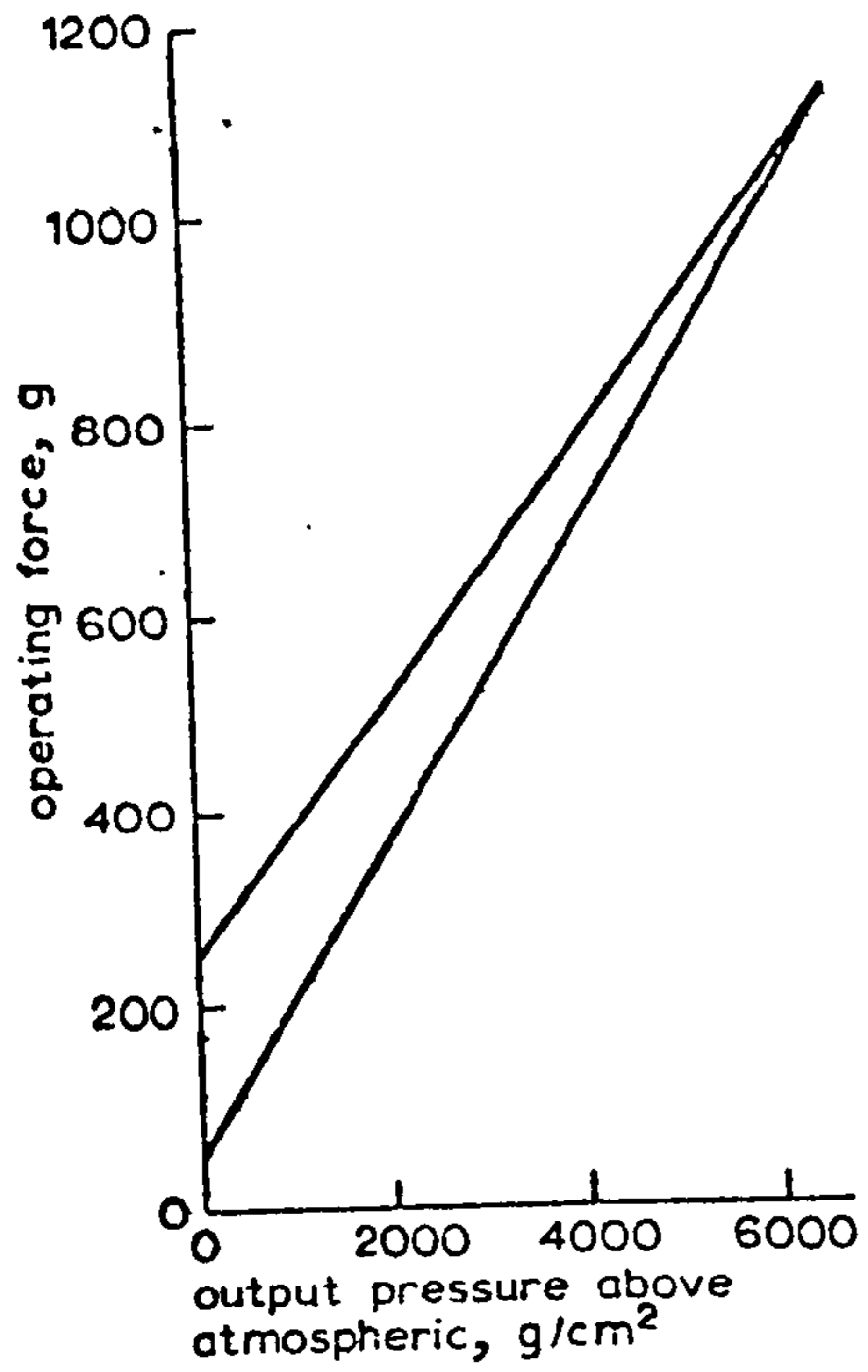

Fig. 4 Characteristics of loose-seal valve

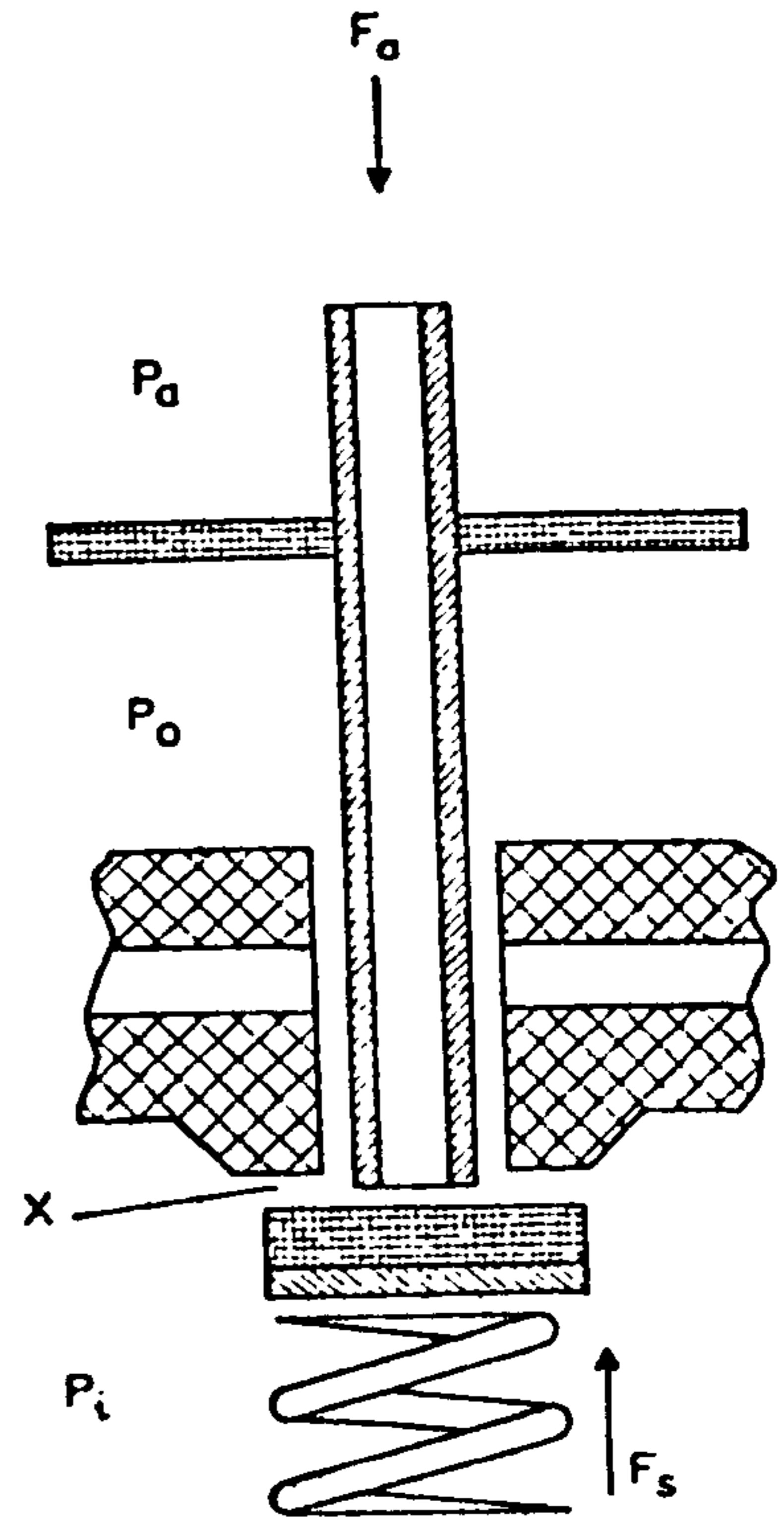

Fig. 6 Schematic of valve in operation

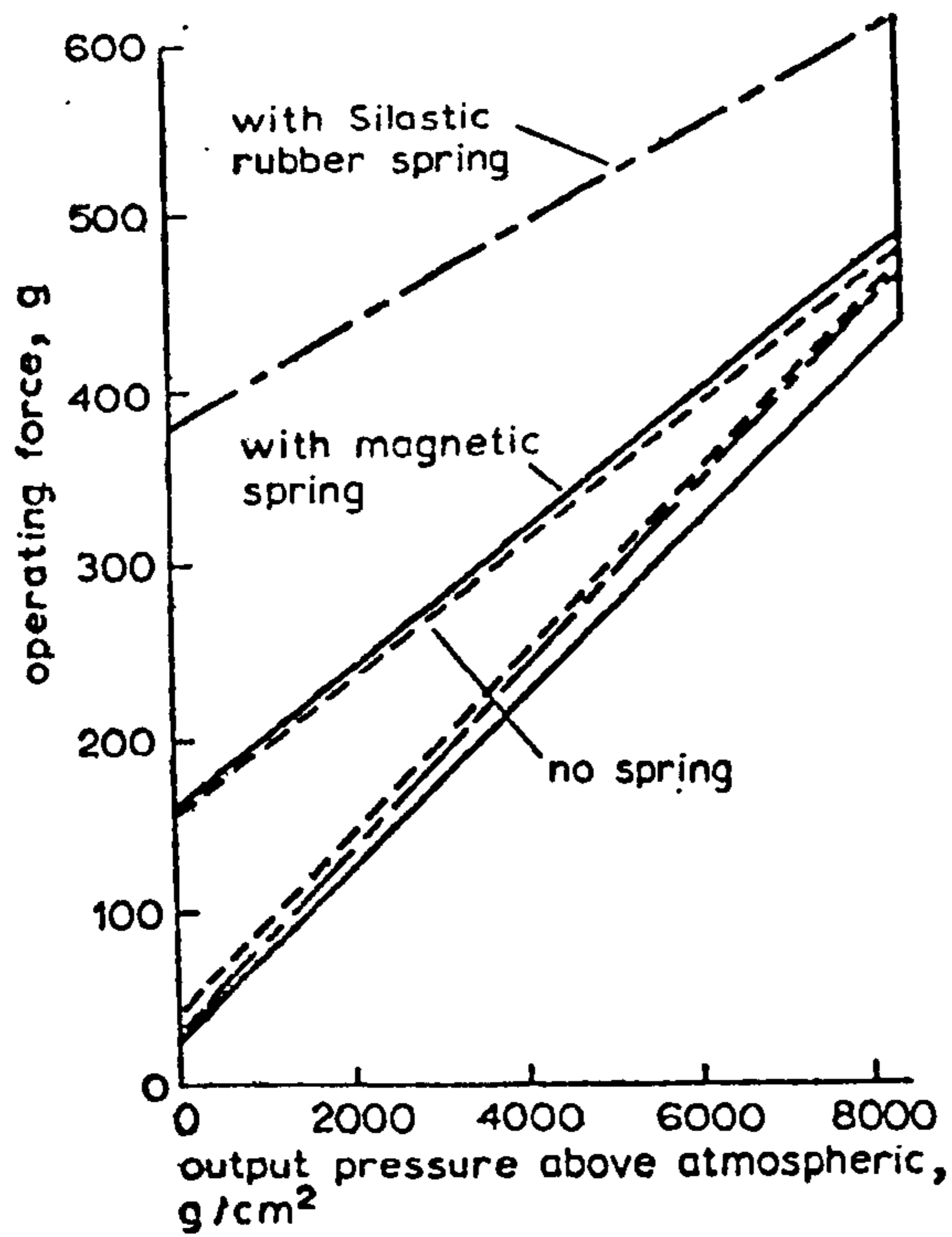

Fig. 5 Valve characteristics

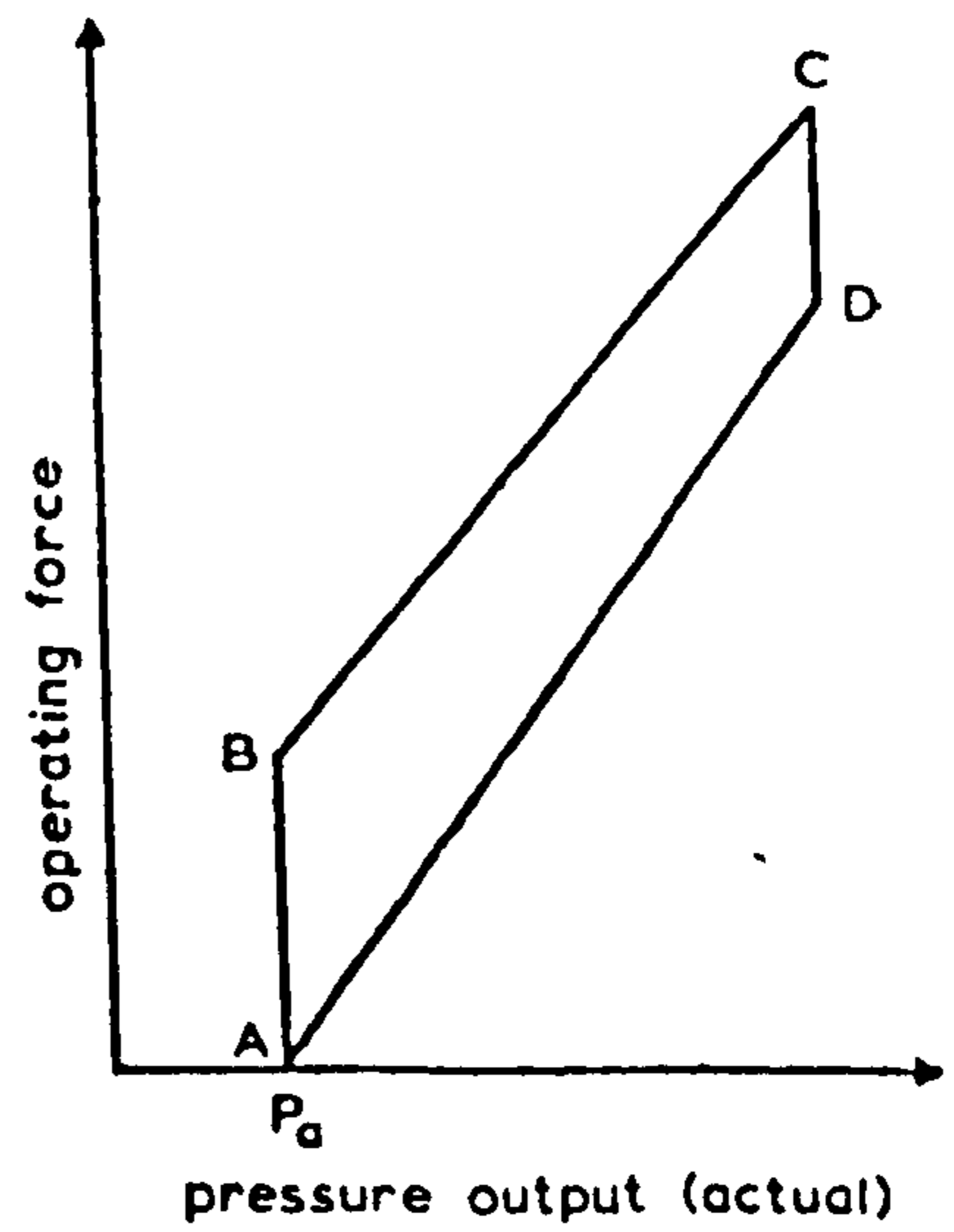

Fig. 7 Schematic of valve hysteresis

This difficulty could be overcome by the introduction of a spring beneath the bottom seal, consisting of a short length of soft Silastic rubber tube cut to size so that sealing was just achieved under low-pressure condition. However, experience with the valves in this conditions showed that, in use, the operating forces were too high. This type of spring was chosen because of its simplicity. The force-pressure characteristics were then as shown in Fig. 5.

These unsatisfactory characteristics necessitated an investigation of the detailed operation of the valve, the theory of which has been explained elsewhere (KLASSON, 1967) and is repeated below with some modifications (Fig. 6).

The following symbols are used:

F_a = applied force A_d = effective area of upper diaphragm
 F_s = spring force
 P_o = output pressure A_i = area of inlet port bore
 P_i = input pressure A_t = area of tube end
 P_a = atmospheric pressure D = diaphragm stiffness

(i) to commence flow, the seal of the bottom flap is broken at point X

$$F_{a1} = F_s + A_i(P_i - P_a) + D$$

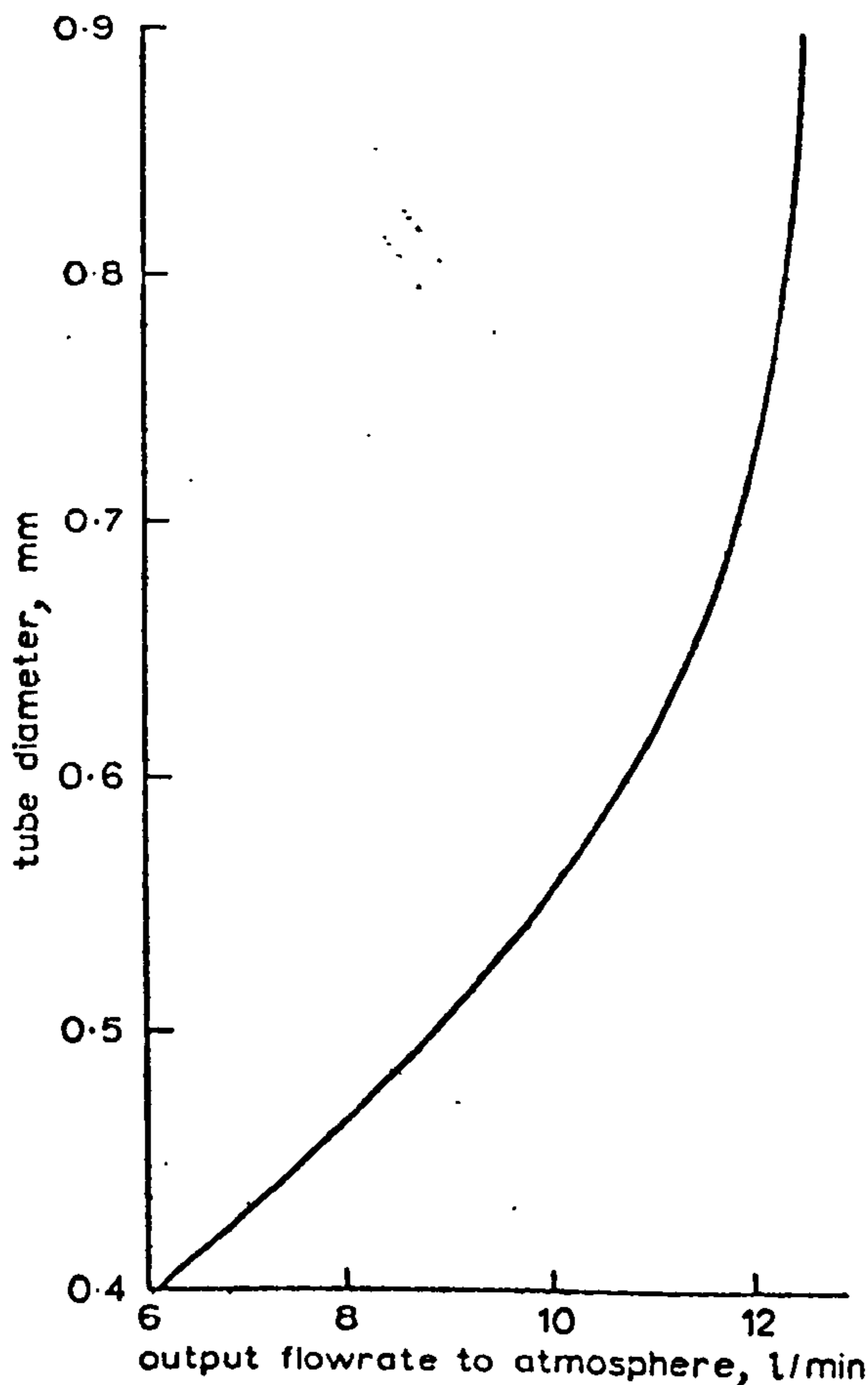

Fig. 8 Effect of tube diameter on flowrate. Supply tube 1.2 mm bore, feeding connectors 8 mm long, with various bores. Input CO_2 gas at 8400 gf/cm^2 (120 lbf/in^2)

(ii) maintaining the output pressure P_o .

$$\begin{aligned} F_{a2} &= F_s + D + (P_i - P_o)(A_i - A_t) \\ &\quad - A_i P_o - P_a A_d + P_o A_d + P_i A_t \\ &= F_s + D + P_i A_t - P_i A_i - P_o A_i \\ &\quad + P_o A_i - A_i P_o - P_a A_d + P_o A_d + P_i A_t \\ &= P_o(A_d + A_t - A_i) + K \end{aligned} \quad (1)$$

where $K = F_s + D + P_i A_t - A_i P_o - P_a A_d$

(iii) exhaust

$$F_{a3} = (P_o - P_a) A_i + (P_o - P_a) A_d + D$$

Substituting $P_o = P_i$ in eqn. 1 to obtain the maximum value of the operating force:

$$\begin{aligned} F_{a2\text{max}} &= P_i A_d + P_i A_t + F_s - A_i P_o - P_a A_d + D \\ &= (P_i - P_a)(A_d + A_t) + F_s + D \end{aligned}$$

i.e. hysteresis of F_s .

From the operator-force point of view, the segments AB and CD (Fig. 7) should be reduced to a minimum. This condition is purely a force requirement and takes no account of the necessary flow and dead space that might be required when using two valves together in a double-acting system.

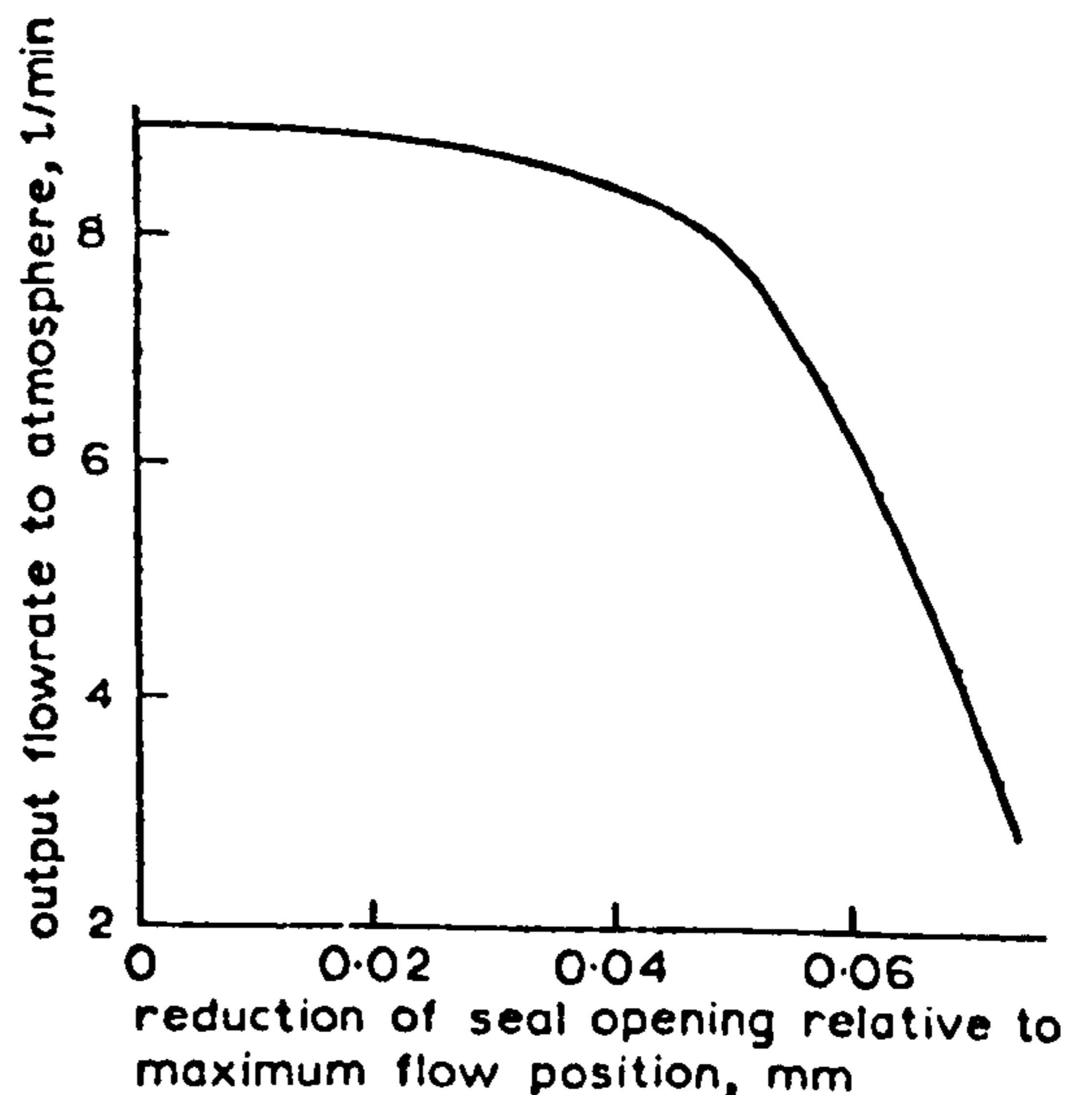

Fig. 9 Flowrate through orifice presented by flat O ring seal. Input CO_2 gas at 8400 gf/cm^2 (120 lbf/in^2). 3 mm diameter

The segment CD is contributed by the force of the spring under the bottom seal, and this force was reduced to a negligible level by using a steel insert as the valve seating, together with a seal made of rubber backed with a magnetically doped plastic. This simple 'spring' achieved the desired effect by maintaining the position of the seal on the valve seating by the induced attraction between the magnetic plastic and the steel. In this form, the seal would lift its own weight more than 1 mm to provide a valve that is normally lightly closed. In this way the initial unpressurised state of several valves in a prosthesis did not produce leaks, and the line pressure built up to the operating level almost immediately. In addition, the dynamic characteristics of the valve were not obviously affected by the 'spring' force, because this

force was now so small, and the force/pressure characteristic was effectively as for a springless valve (Fig. 5).

The other component of the operator force is dependent on the pressure reaction and therefore on inlet-port size, and, to reduce this force, it was necessary to reduce the port size. However, this step was fraught with flow problems, since reduction of A_1 limits both inlet and exhaust flowrates; our experience with prostheses has

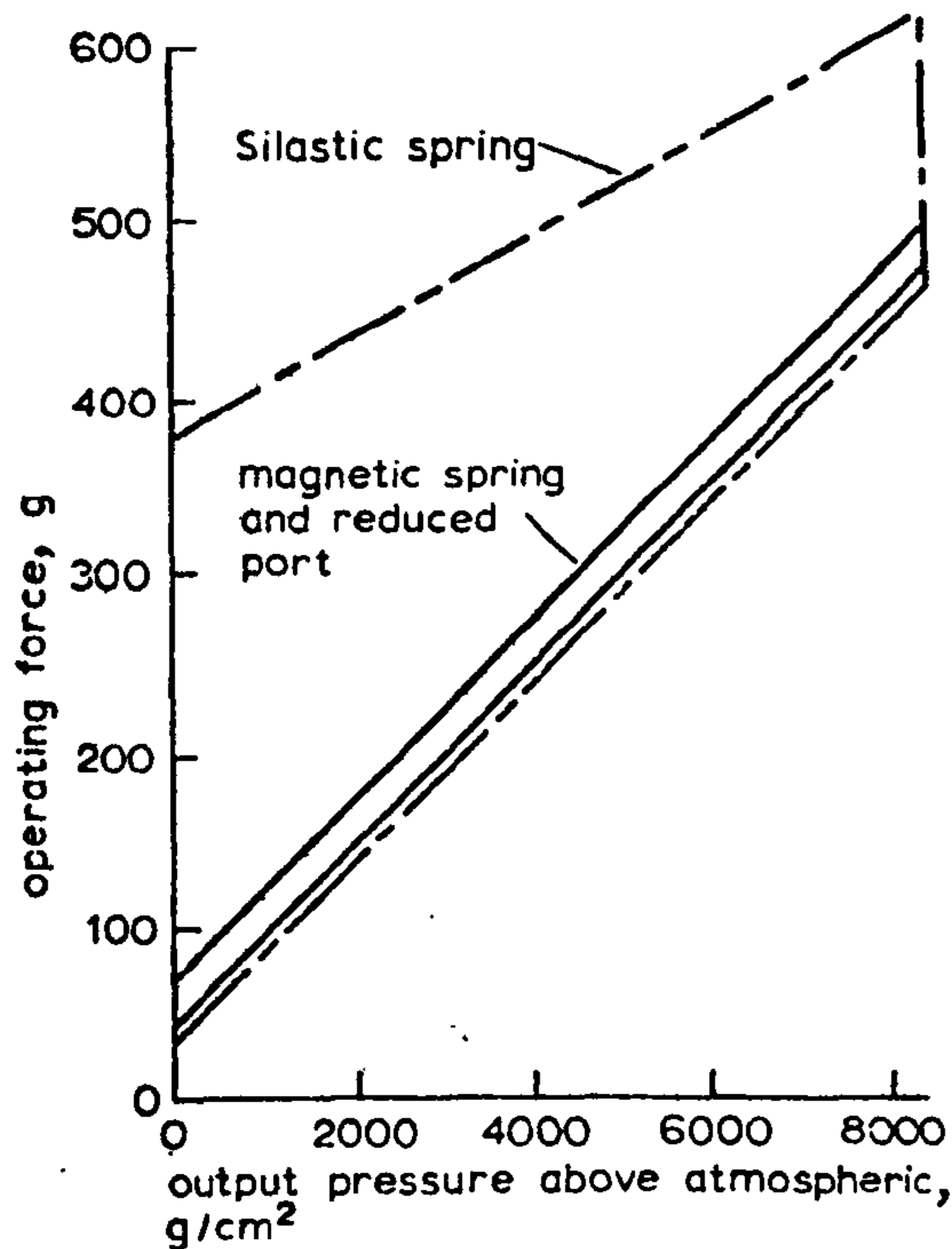

Fig. 10 Characteristic of valve with reduced port size

shown that a valve with a flowrate of 7 l/min is desirable for a sufficiently rapid response of an artificial arm.

Further steps to reduce the operator force required a knowledge of the flow characteristics related to the orifice dimensions in this situation. Two types of orifice were investigated: (a) tubes of varying diameter, and (b), a cylindrical orifice presented by a flat sealing O ring.

The results obtained with CO₂ gas at a pressure of 8400 gf/cm² (120 lbf/in²) were as shown in Figs. 8 and 9, and were employed on the assumption that an annular area has the same flow characteristics as a tube of the same area. To ensure that the exhaust tube itself did not restrict the exhaust flow, a minimum bore of 0.5 mm (flow > 8 l/min) was chosen. The minimum wall thick-

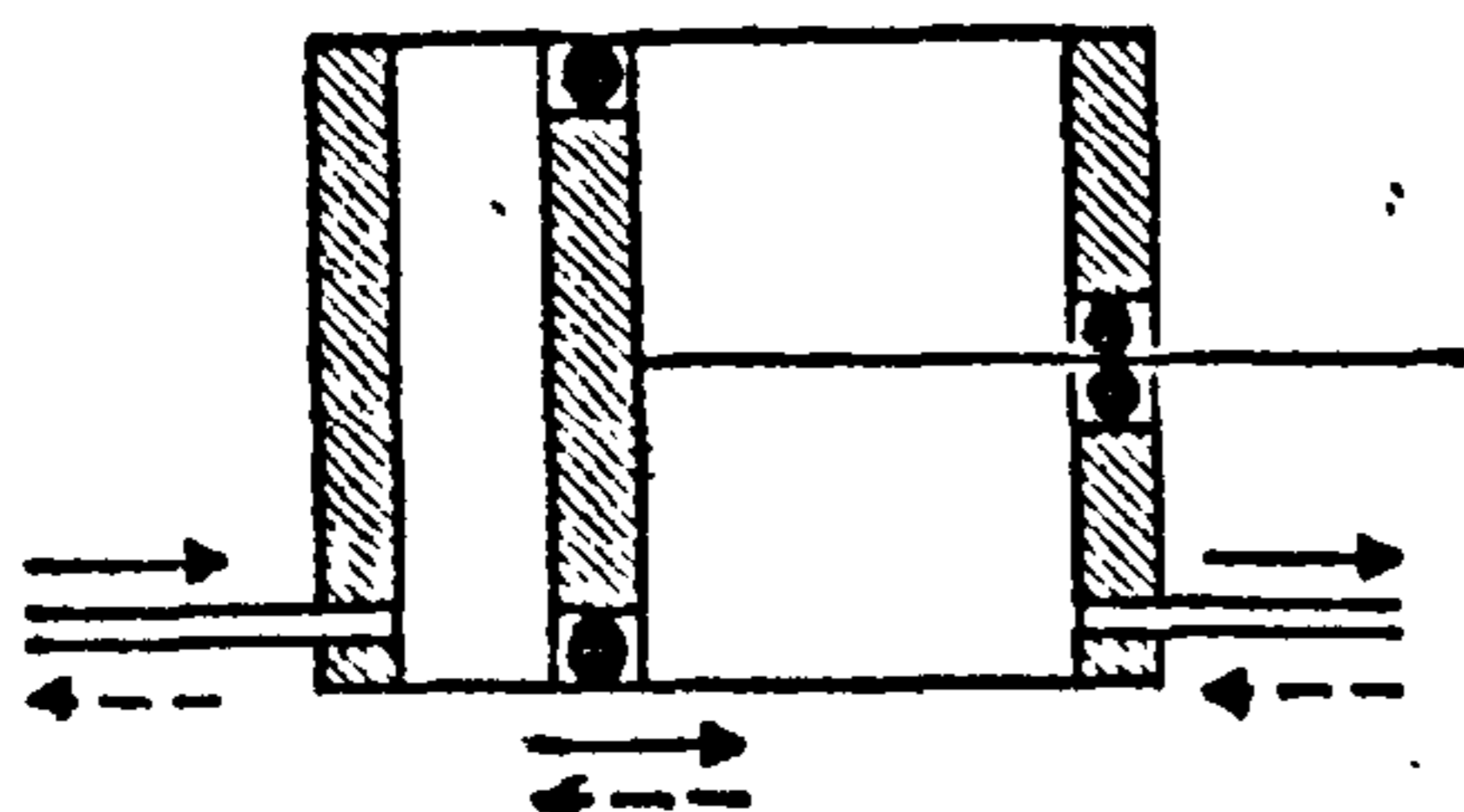

Fig. 11 Schematic of double-acting piston

ness allowable, owing to mechanical considerations, is 0.1 mm, giving a 0.7 mm outside-diameter tube, and this size was taken as the basic value in designing the valve for minimum hysteresis. The inlet flowrate, determined by $(A_1 - A_2)$, was required to be 7 l/min, which implied a value for $(A_1 - A_2)$ of approximately 0.15 mm², giving an inlet-port diameter of 0.79 mm as a practical value. The operating characteristics of the valve in this form are as shown in Fig. 10.

For use in a prosthesis, these valves are used in a double-acting system; i.e. the pneumatic piston is driven in both directions (Fig. 11) by a controlled pressure from one side or the other. To avoid gas wastage owing to

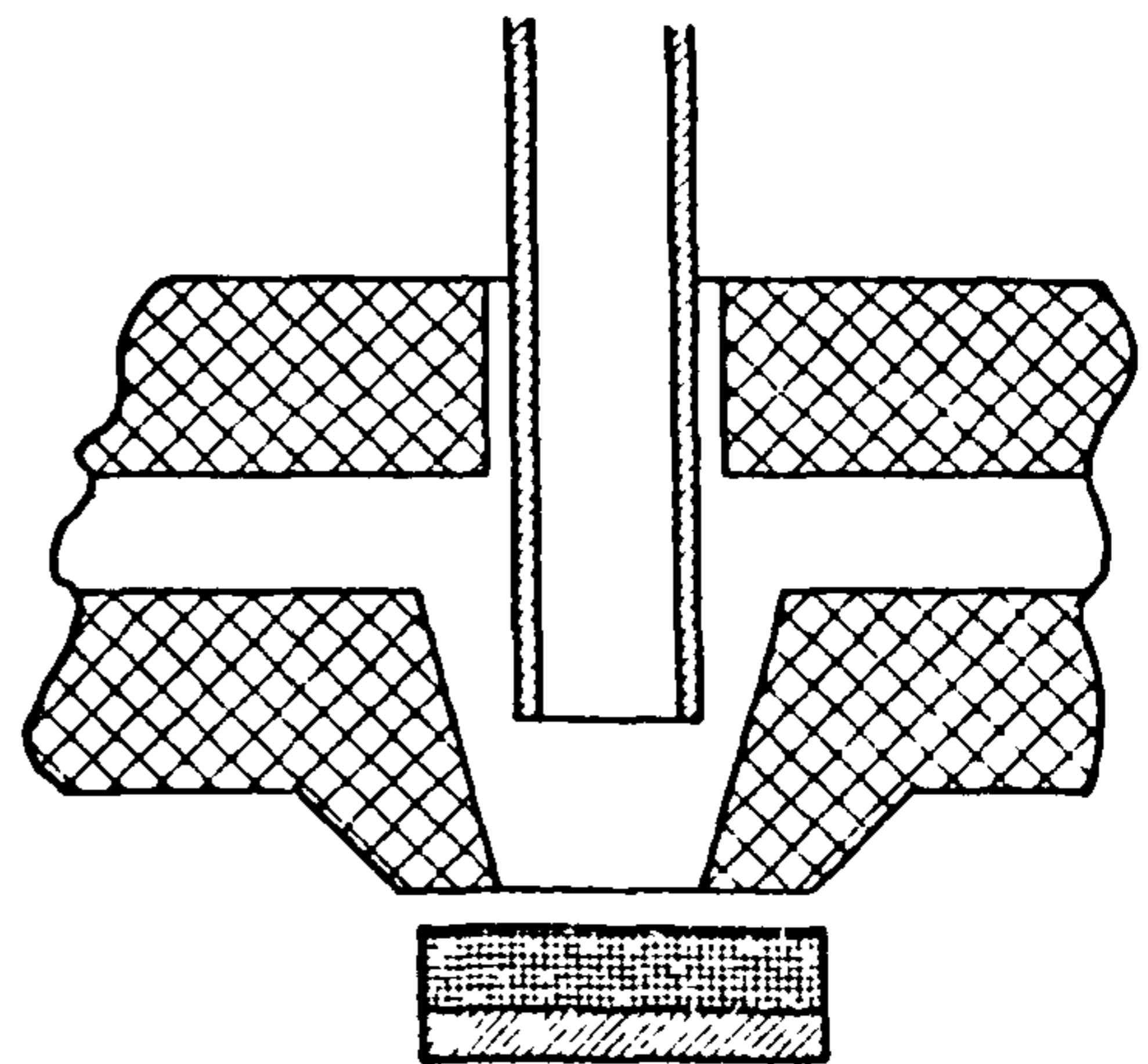

Fig. 12 Improved exhaust rate by tapering port

pressure buildup on the exhaust side, the restriction on exhaust flowrate must be less than that on the inlet. However, in the f.d.v., both inlet and exhaust rates are governed by $(A_1 - A_2)$; but increased exhaust rate can be achieved by tapering the port, as shown in Fig. 12, to allow a larger value of $(A_1 - A_2)$ during exhaust. A taper of 2° is theoretically sufficient to ensure an exhaust rate of 8 l/min.

The experience obtained during the work with these valves has shown that the simple theory fits very well, and has enabled us to modify the device to suit the particular requirements of flow and operator characteristics.

G. KENWORTHY and D. C. JOLLY

Orthopaedic Bioengineering Unit

Princess Margaret Rose Orthopaedic Hospital

Edinburgh

Scotland

References

- ALBUTT, M. G. V. and CHAPPELL, P. L. (1965) Powered artificial arm development. Elliott Flight Automation, laboratory report RR56.
- BOTTOMLEY, A. H. (1966) A pressure demand valve for use in the control of pneumatic powered prostheses. *Biomed. Eng.* 1, 495-497.
- KLASSON, B. (1967) Development on externally powered artificial arms at NBI. Proc. Int. Symp. on external control of human extremities, Dubrovnik, 151-173.
- SIMPSON, D. C. (1966) Powered hand controlled by muscle bulge. *J. Sci. Instrum.* 43, 521-522.

The design of a complete arm prosthesis

D. C. SIMPSON, MBE, BSc, PhD, FRSE* and G. KENWORTHY, BA**

This article describes an externally powered upper limb prosthesis that was designed to meet the following constraints: (a) that the physical dimensions of the arm should not exceed those of the normal arm, including weight; (b) that its joints should be as far as possible in the correct anatomical position; (c) that its sphere of movement should be similar to that of the normal arm; (d) that it should be capable of unconscious control by the user; and (e) that its demands on its energy store should be low enough to allow them to be satisfied simply. The effects of these constraints on the practical design of the prosthesis are discussed under the four main headings: external energy system; mechanical construction and mode of action of the arm structure; control of the actuator or motors; and maintenance of the system.

BIO-ENGINEERING is a complex field by any standards, involving as it does many very different disciplines and problems. When one adds emotion, frustration, guilt, politics, pity, external pressure and the mass media as complicating additional features of the research environment, one begins to see the intimidating background to the programme which was initiated to provide externally powered artificial arms for the children with the severe bilateral limb deficiencies produced by the disastrous effects of thalidomide. These children are now [1972] between eleven and twelve years of age and there is therefore about ten years of experience of supplying them with externally powered prostheses as part of the limb service.

The design studies for the arm described in this paper started in 1965¹, and it was originally hoped to bring the arm into service in 1969. The basic design was therefore scaled for a child of eight years of age. In the event, it was not possible to produce the service version until 1971, but from 1965 till that date about 150 fittings of an arm, based on developments of a simpler system² were made routinely, and the experience which was gained in this programme contributed considerably to the design study of the new arm.

By definition an arm prosthesis for an amputee is an artificial replacement for a normal arm and as a replacement it should therefore, as far as possible, imitate the normal arm in every way. With such a target initially the result

must fall far short of the ideal and compromises must be made in constructing a practical prosthesis, but it is necessary when setting down the specification to always bear the original intention in mind. For this reason the overall constraints of the design were: (1) that the physical dimensions of the arm should not exceed those of the normal arm, including weight; (2) that its joints should be as far as possible in the correct anatomical position; (3) that its sphere of movement should be similar to the normal; (4) that it should be capable of unconscious control by the user; and (5) that its demands on its energy store should be low enough to allow them to be satisfied simply.

There were four main components to be considered in producing the specification for the hardware:

1. External energy system.
2. Mechanical construction and mode of action of the arm structure.
3. Control of the actuators or motors.
4. Maintenance of the system.

External energy system

At present there are only two suitable and convenient modes for the storage of energy for externally powered arms: electrical and pneumatic. Although an electrical system has a weight advantage over a pneumatic one when only a single actuator is involved, an increase in the number of actuators reverses this situation and for a prosthesis involving several actuators the pneumatic system still has a clear advantage³. Electrohydraulic systems now under development may soon allow the use of electrical energy storage without a weight penalty being paid for the convenience

and economy of its recharging, but at present the only feasible energy for multimovement arm prostheses operation is pneumatic.

The pneumatic actuators incorporated in the arm provided at this Centre are all based on the design of Harborow⁴, but are assembled to be double acting. According to Earl⁵ such actuators are the least efficient of the possible configuration when used "open loop". However, if they form part of a position-servo system and the error signal is detected by force-demand valves, we have found they achieve a gas consumption which is primarily load dependent. With this arrangement an arm with four movements and prehension will only consume about 300 grams of carbon dioxide per day.

Mechanical construction and mode of action

For reasons which have been given elsewhere^{1,6,7}, decisions were made at the outset of the study to consider arm movements operating to alter the three co-ordinates of wrist position with respect to the shoulder. The co-ordinate system that was chosen for the frame of reference was the spherical polar system, r , θ , ϕ . In effect, therefore, the wrist will move over the surface of a sphere which is centred on the shoulder joint and whose radius r is determined by the length of the arm at any given moment.

In addition to these three positional degrees of freedom, it was decided to provide control of the rotation of the hand about the horizontal axis in the plane of the arm. Because of the extreme shortage of control sites no attempt was made to provide rotation of the hand about the vertical axis, but it was considered essential, however, to provide automatic stabilisation of the hand about the horizontal axis at right angles to the plane of the arm, so that the hand would not rotate in the vertical plane when the elbow bends in arm shortening and in arm elevation movements. This type of stabilisation enables the user, for example, to carry a cup or a spoonful of soup to the mouth without spilling.

The range of movement of the arm was chosen to be:

- (a) Shoulder (θ), 180° from vertically below to vertically above.

*Bio-Engineering Centre, Princess Margaret Rose Orthopaedic Hospital, Fairmilehead, Edinburgh EH10 7ED.

**MRC Unit for Physical Aids for the Disabled, Princess Margaret Rose Orthopaedic Hospital, Edinburgh.

either. Thus any change produced by an actuator in the angular relationship of such an idler to a strut will be transferred through the rolling joint to the corresponding idler on the far side (Figures 1 and 2).

The rotations required for r , θ and ϕ and wrist rotation are all greater than 90° , and in each joint this is obtained by making the respective actuator act on a crank to rotate it over 90° , 45° on either side of a mid position, and by using gears or linkages to multiply the angle appropriately.

The mechanism to maintain the hand angle must take into account both the change in upper arm angle which occurs when the hand is raised, and the change in upper arm angle which occurs when the hand/shoulder distance (r) alone is altered. For the same movement of the upper arm the wrist is required to flex in opposite directions in these two cases in order to keep level. However, as only one of these movements is accompanied by a change in elbow angle, that change in elbow angle is compensated for the action by the involvement of an extra gear train at the elbow (Figure 3).

The structure of the upper and lower arm members is formed by the rigid spacing of pairs of sideplates which are machined to maintain actuators and gears in the correct positions. This open structure permits ready access to the component parts to facilitate maintenance (Figure 4).

Control of actuators

The choice of pneumatics as the operating system using CO_2 gas at 120 pounds/square inch (approximately 827 k Pa), presents its own specific control problems; in particular the need for gas economy, and the employment of load-dependent actuator systems. This has been achieved by the employment of the actuators in a double acting mode with feedback. Small (11m cubes) force demand valves⁹ are used in pairs in the prosthesis to control the actuators in this mode, each valve being associated with one side of the actuator. Modular assemblies of the valves are employed in order to facilitate servicing.

The servo-mechanism is operated by Bowden cables,¹⁰ the outer sleeve being lined to the arm function concerned, and the inner cable linked to the valve lever. When the inner is pulled relative to the outer at the control end, the valve lever is moved causing a flow of gas to the actuator; the resulting movement causes a proportional feedback of the outer cable returning the valve lever to the neutral position. Stops are introduced on the controls to prevent the actuators reaching what would be effectively an infinite load formed by the piston endcaps. In this way a considerable saving of gas is achieved due to the avoidance of unnecessary pres-

sure build-up at either end of the piston stroke.

The amelic patient operates the controls by moving his clavicles relative to the harness which supports the prosthesis. With a position-servo system it has been shown¹¹ that the proprioception is to some extent extended into the arm providing a position awareness of the artificial limb. This type of control system is known as e.p.p. (extended physiological proprioception). Each clavicle can provide a control movement for two functions, by moving up and down or forward and back thus giving a total of four outputs. Prehension is controlled either by a waist belt control or by a digit if one is present.

The harness takes the form of an open stainless steel yoke which fits across the shoulders. An excellent fit is achieved over the load-bearing areas by means of straps padded by nylon sacs partly filled with granules. The patient's shoulder profile deforms these pads spreading the load over the maximum area of contact. The stabilisation of the yoke is achieved by a member which passes down the back of the patient and is secured round the waist by a belt. Each harness is manufactured to fit the individual patient, standard sizes of prostheses being attached after fitting.

The patient/control interface is arranged to provide as good a match as possible for the natural system. A small cap is moulded to fit the acromial aspect of the amelic shoulders, and this cap is attached to the control wires

from the prosthesis. The cap is constrained to move in simulated clavicular pattern by means of mechanisms attached to the harness (Figure 5).

Provision and maintenance of the system

Potentially the externally powered arm can provide a great deal for the child both directly in terms of his appearance and his function and also in terms of his own body image and personality (Figure 6). Whether the programme is successful or not, it is expensive in terms of personnel and money; if it is undertaken at all it is essential that it is undertaken with care, and that attention is paid to all the details of the procedure.

This is an extremely ambitious project very far removed from the normal prosthetic one of supplying an arm of somewhat limited function to a unilateral amputee; a clinical environment which is adequate for the latter is not necessarily adequate for fitting a powered prosthesis, particularly in these early years of arm prosthesis development. The success or failure of the programme depends, to a very large measure, on the nature of the support programme, and no arm can be expected to be successful clinically unless this support is provided. We have found the following to be essential:

1. The fitting of the harness must be carried out by staff who have been trained in the procedure and are aware of the principles involved.

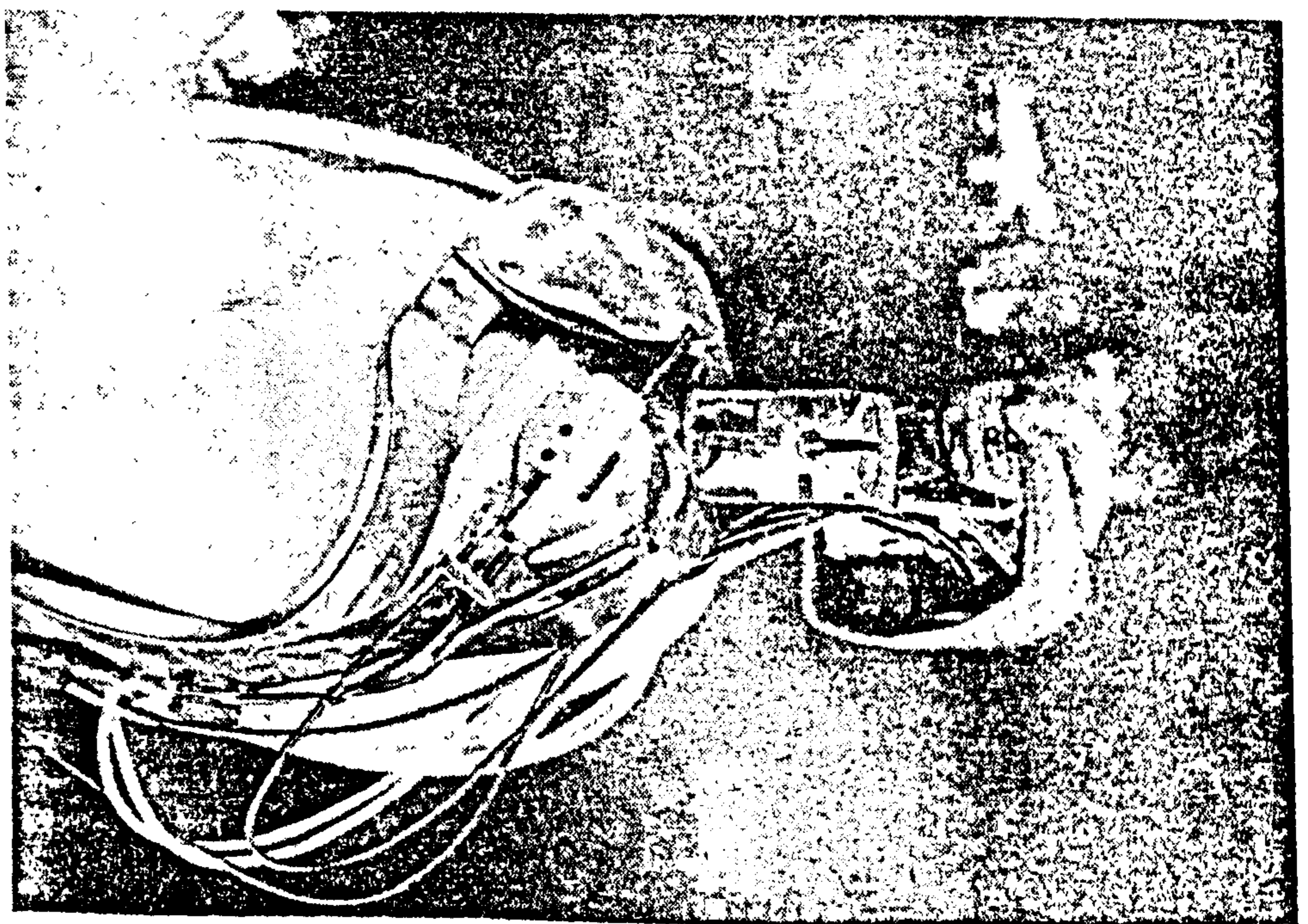

Fig. 5. View of the right shoulder from above showing sliding cap and Bowden cables. This fitting does not include the padded nylon sacs.

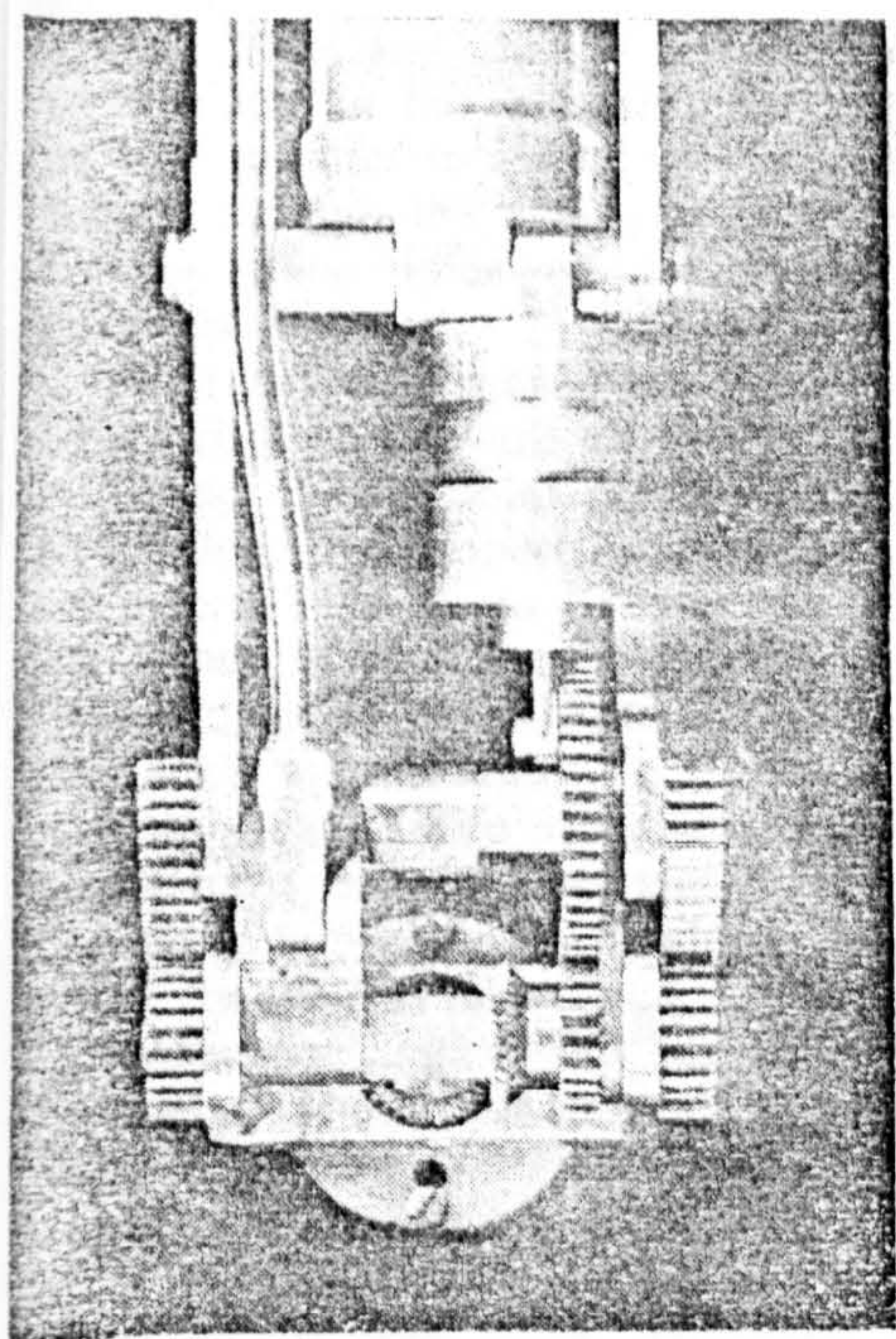

Fig. 1. Wrist mechanism.

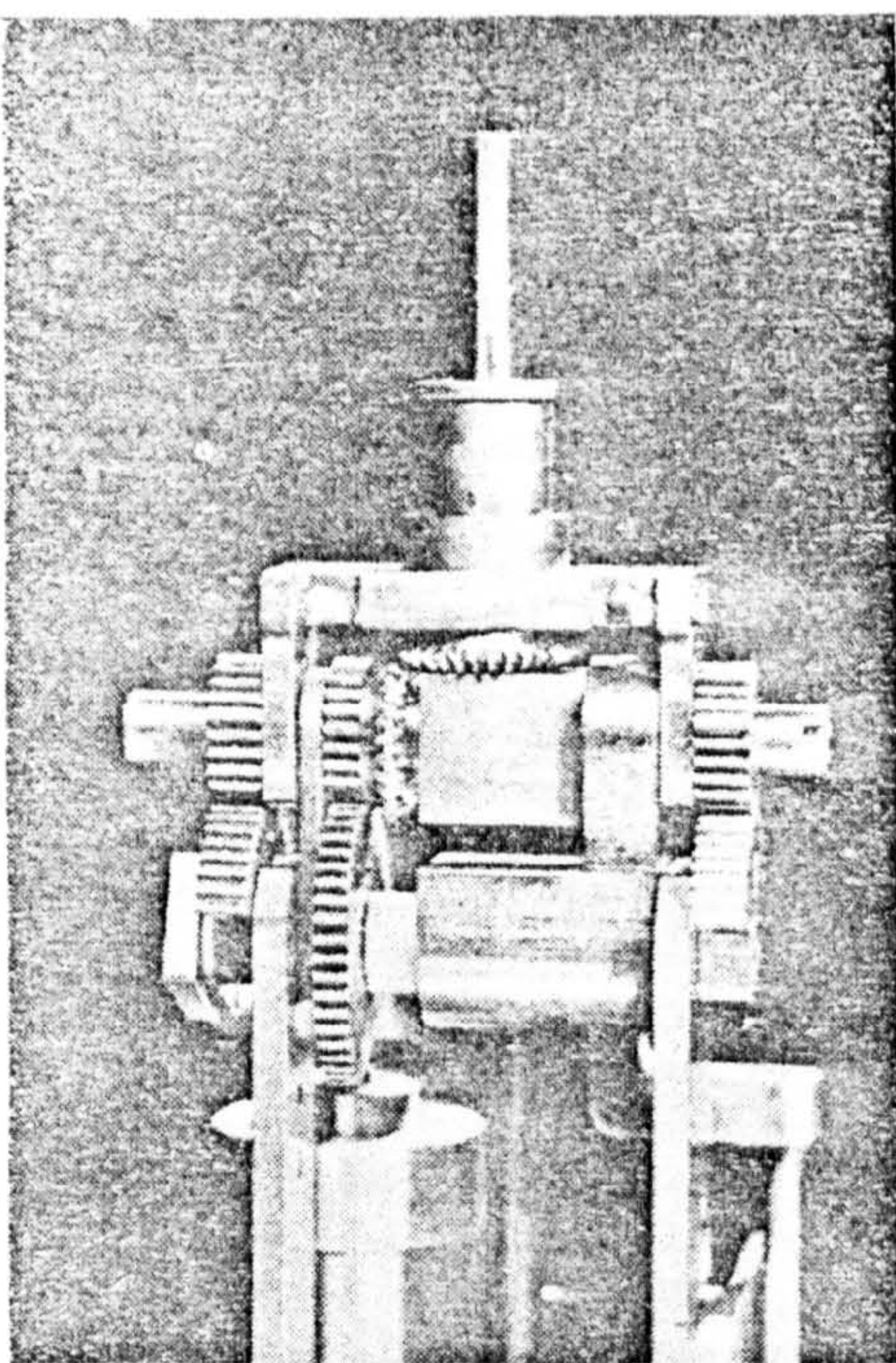

Fig. 2. Shoulder mechanism.

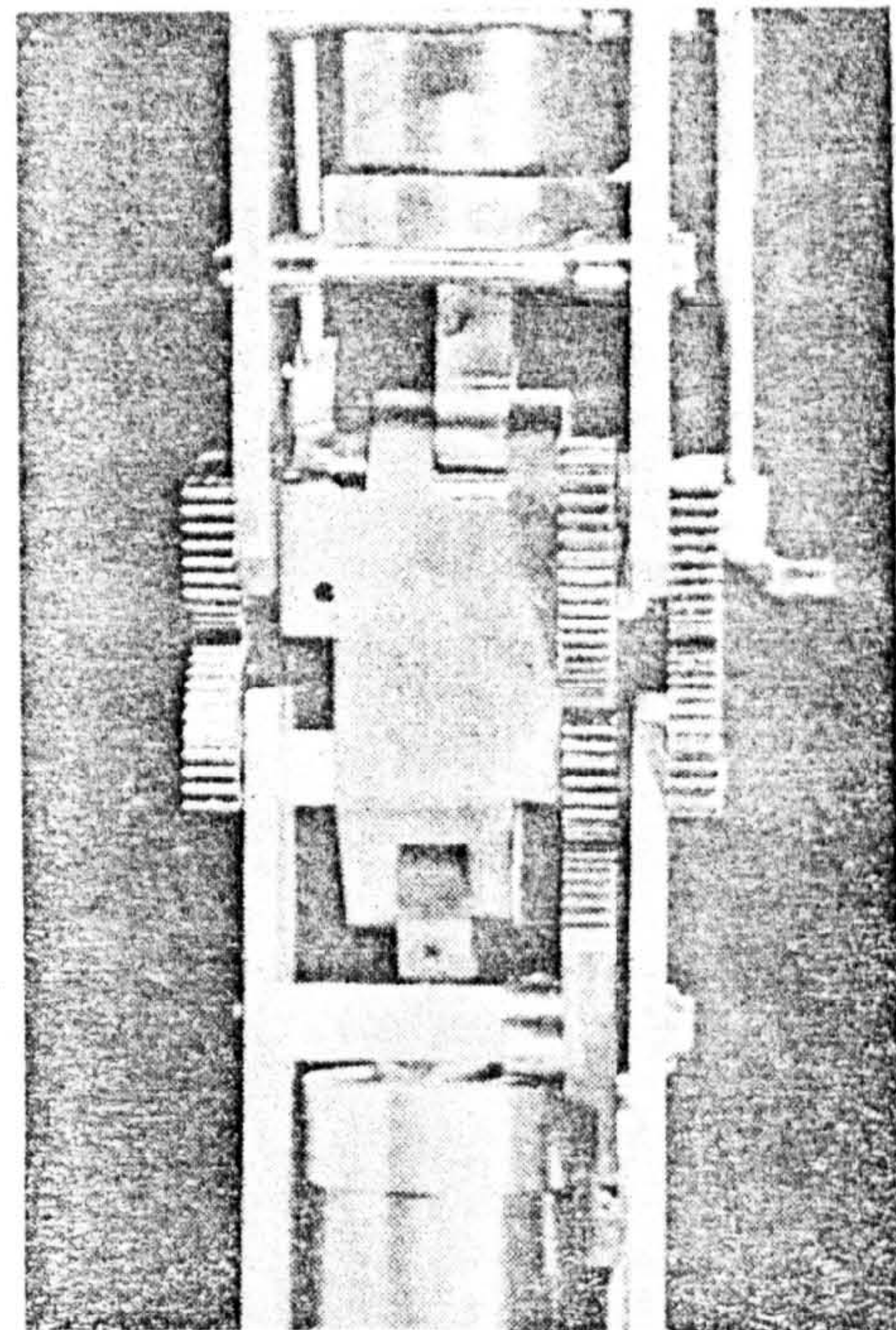

Fig. 3. Elbow mechanism.

- (b) Shoulder (θ), 120° from the shoulder straight in front in the direction of the trunk.
- (c) Hand/shoulder distance (r), from the elbow fully extended to fully flexed.
- (d) Wrist rotation, 180° of rotation.

The requirement of maintaining the wrist level throughout arm movement meant that the wrist must have the same degree of movement as the shoulder in the same plane. However, in addition to the 180° of flexion specified, a further 90° occurs at both shoulder and wrist when r varies from its minimum to its maximum value with elbow flexion.

In order to allow the variation of the co-ordinates of the wrist over the specified range, the joints at the shoulder, elbow and wrist therefore require to have the following range of movement:

Shoulder	(a) 270° ($180^\circ \theta + 90^\circ r$)
	(b) 120° (θ)
Elbow	180° (r)
Wrist	270° ($180^\circ \theta + 90^\circ r$)
	180° pronation/supination.

The need to preserve the normal body outline precludes the mounting on the body harness of the actuators required to produce the θ rotation of the arm about the vertical axis. Therefore, the actuator for this movement had to be mounted internally in the upper part of the arm. Similarly, for mainly cosmetic reasons the actuator to produce hand rotation had to be mounted internally in the forearm rather than between 'wrist' and 'hand' or in the hand itself.

The range of movement required from the arm meant that the rotations

about both hand and shoulder axes must be obtained without being affected by the possible 270° of flexion of the axes from the adjacent arm segment. The solution for both wrist and shoulder which was adapted was the development of a gear train⁸ which depended on the fact that if rolling joints are provided by fixing the main

struts to gear wheels that mesh and roll round each other, any number of other identical gears can be placed on the same shafts alongside the fixed gears and these will also roll around each other. Because the fixed gears are fixed directly to the struts there is no tendency for the identical idler gears to rotate with respect to the struts

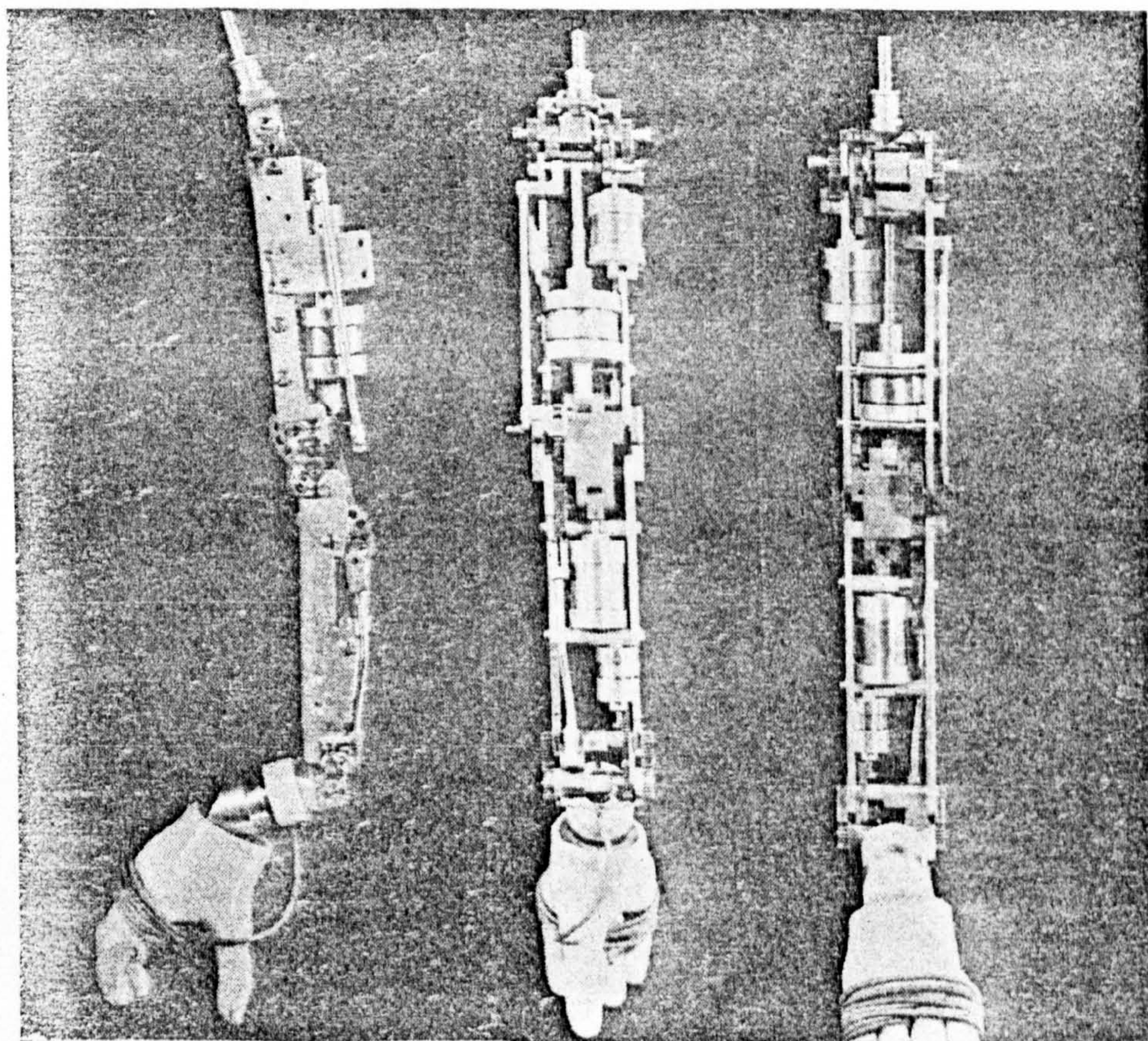

Fig. 4. General views of the arm with the covers removed. To show the mechanism, the valves and cables have also been removed.

either. Thus any change produced by an actuator in the angular relationship of such an idler to a strut will be transferred through the rolling joint to the corresponding idler on the far side (Figures 1 and 2).

The rotations required for r , θ and ϕ and wrist rotation are all greater than 90° , and in each joint this is obtained by making the respective actuator act on a crank to rotate it over 90° , 45° on either side of a mid position, and by using gears or linkages to multiply the angle appropriately.

The mechanism to maintain the hand angle must take into account both the change in upper arm angle which occurs when the hand is raised, and the change in upper arm angle which occurs when the hand/shoulder distance (r) alone is altered. For the same movement of the upper arm the wrist is required to flex in opposite directions in these two cases in order to keep level. However, as only one of these movements is accompanied by a change in elbow angle, that change in elbow angle is compensated for the action by the involvement of an extra gear train at the elbow (Figure 3).

The structure of the upper and lower arm members is formed by the rigid spacing of pairs of sideplates which are machined to maintain actuators and gears in the correct positions. This open structure permits ready access to the component parts to facilitate maintenance (Figure 4).

Control of actuators

The choice of pneumatics as the operating system using CO_2 gas at 120 pounds/square inch (approximately 827 k Pa), presents its own specific control problems; in particular the need for gas economy, and the employment of load-dependent actuator systems. This has been achieved by the employment of the actuators in a double acting mode with feedback. Small (11m cubes) force demand valves⁹ are used in pairs in the prosthesis to control the actuators in this mode, each valve being associated with one side of the actuator. Modular assemblies of the valves are employed in order to facilitate servicing.

The servo-mechanism is operated by Bowden cables,¹⁰ the outer sleeve being lined to the arm function concerned, and the inner cable linked to the valve lever. When the inner is pulled relative to the outer at the control end, the valve lever is moved causing a flow of gas to the actuator; the resulting movement causes a proportional feedback of the outer cable returning the valve lever to the neutral position. Stops are introduced on the controls to prevent the actuators reaching what would be effectively an infinite load formed by the piston endcaps. In this way a considerable saving of gas is achieved due to the avoidance of unnecessary pres-

sure build-up at either end of the piston stroke.

The amelic patient operates the controls by moving his clavicles relative to the harness which supports the prosthesis. With a position-servo system it has been shown¹¹ that the proprioception is to some extent extended into the arm providing a position awareness of the artificial limb. This type of control system is known as e.p.p. (extended physiological proprioception). Each clavicle can provide a control movement for two functions, by moving up and down or forward and back thus giving a total of four outputs. Prehension is controlled either by a waist belt control or by a digit if one is present.

The harness takes the form of an open stainless steel yoke which fits across the shoulders. An excellent fit is achieved over the load-bearing areas by means of straps padded by nylon sacs partly filled with granules. The patient's shoulder profile deforms these pads spreading the load over the maximum area of contact. The stabilisation of the yoke is achieved by a member which passes down the back of the patient and is secured round the waist by a belt. Each harness is manufactured to fit the individual patient, standard sizes of prostheses being attached after fitting.

The patient/control interface is arranged to provide as good a match as possible for the natural system. A small cap is moulded to fit the acromial aspect of the amelic shoulders, and this cap is attached to the control wires

from the prosthesis. The cap is constrained to move in simulated clavicular pattern by means of mechanisms attached to the harness (Figure 5).

Provision and maintenance of the system

Potentially the externally powered arm can provide a great deal for the child both directly in terms of his appearance and his function and also in terms of his own body image and personality (Figure 6). Whether the programme is successful or not, it is expensive in terms of personnel and money; if it is undertaken at all it is essential that it is undertaken with care, and that attention is paid to all the details of the procedure.

This is an extremely ambitious project very far removed from the normal prosthetic one of supplying an arm of somewhat limited function to a unilateral amputee; a clinical environment which is adequate for the latter is not necessarily adequate for fitting a powered prosthesis, particularly in these early years of arm prosthesis development. The success or failure of the programme depends, to a very large measure, on the nature of the support programme, and no arm can be expected to be successful clinically unless this support is provided. We have found the following to be essential:

1. The fitting of the harness must be carried out by staff who have been trained in the procedure and are aware of the principles involved.

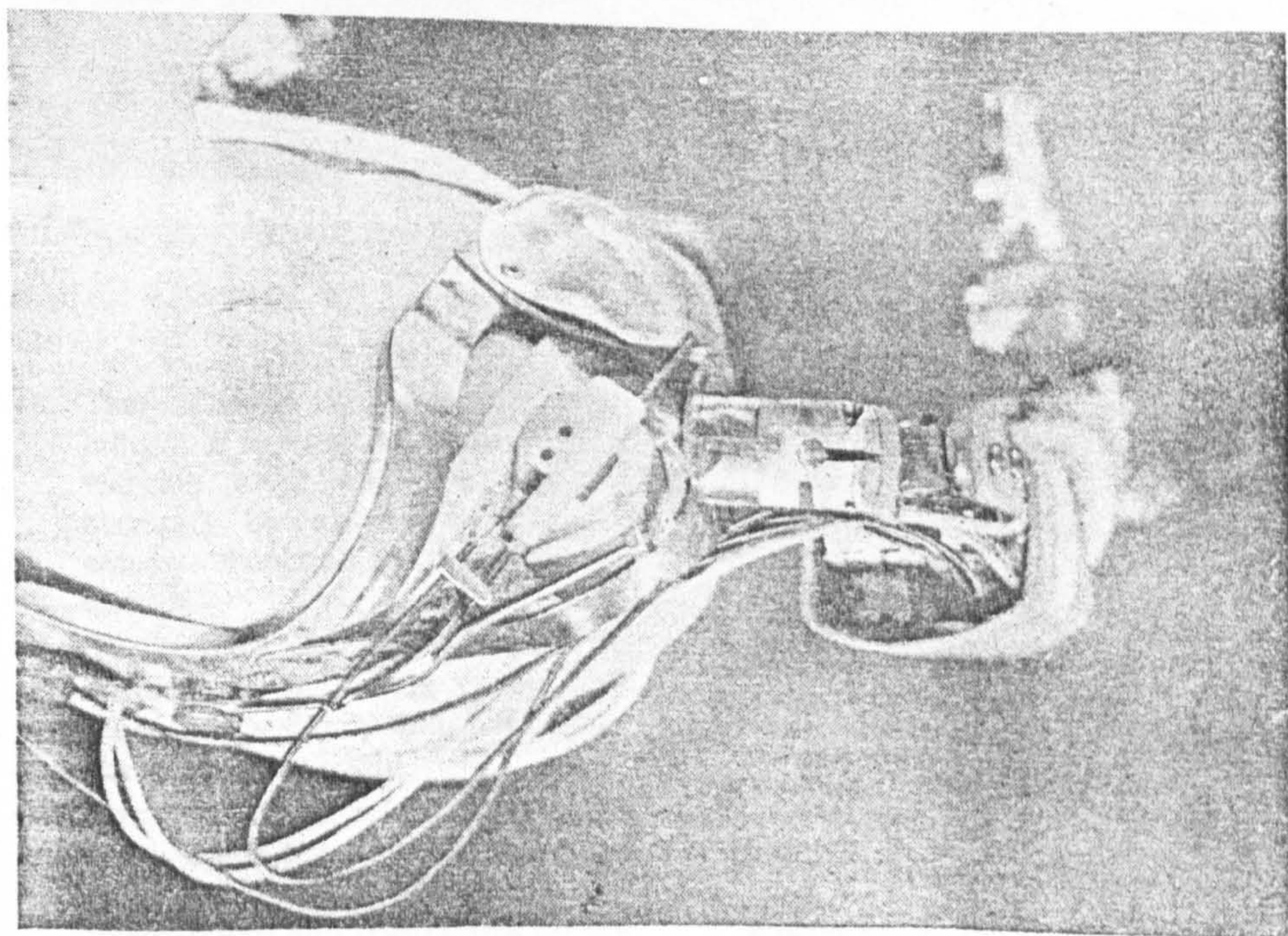

Fig. 5. View of the right shoulder from above showing sliding cap and Bowden cables. This fitting does not include the padded nylon sacs.

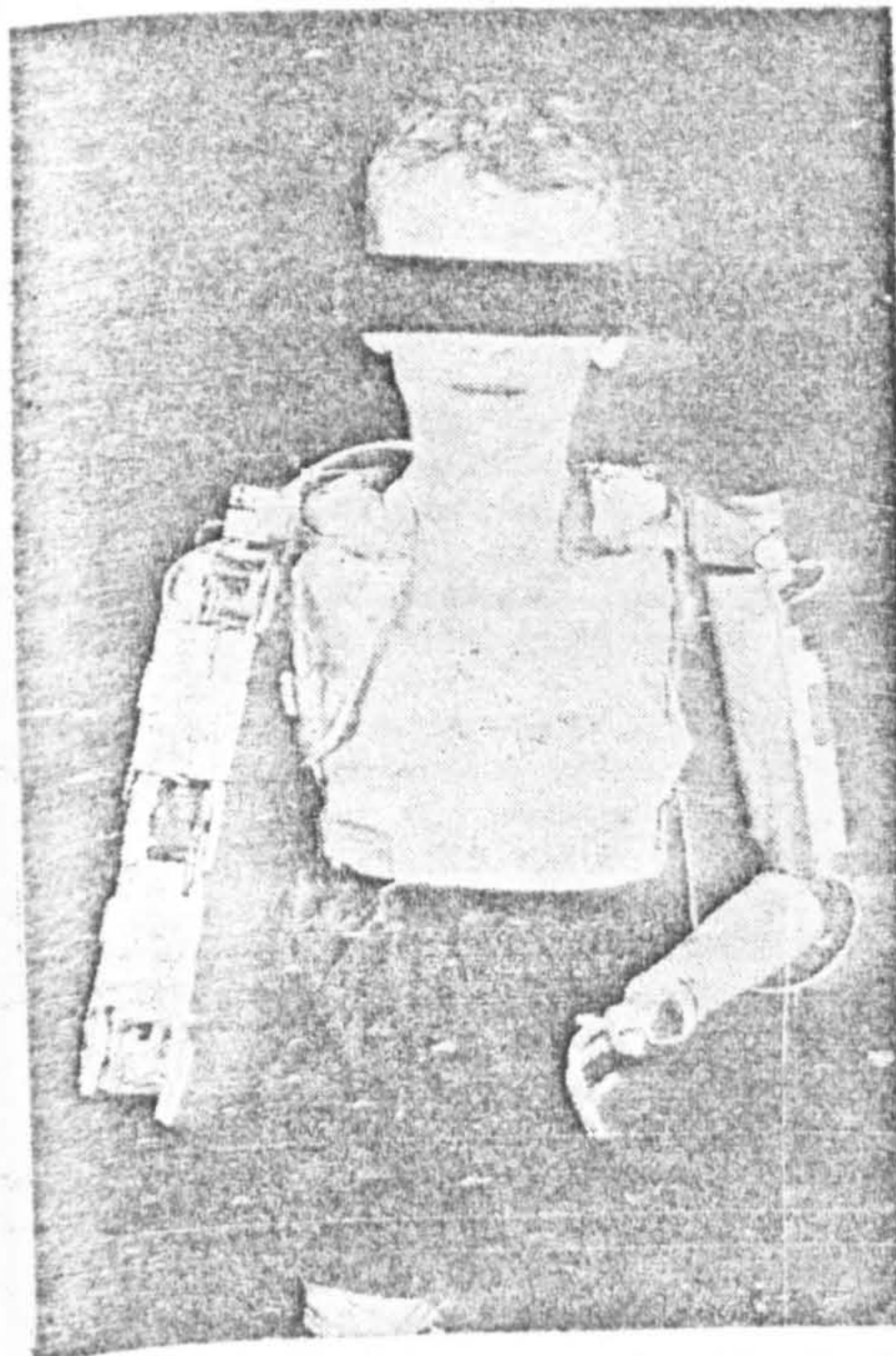
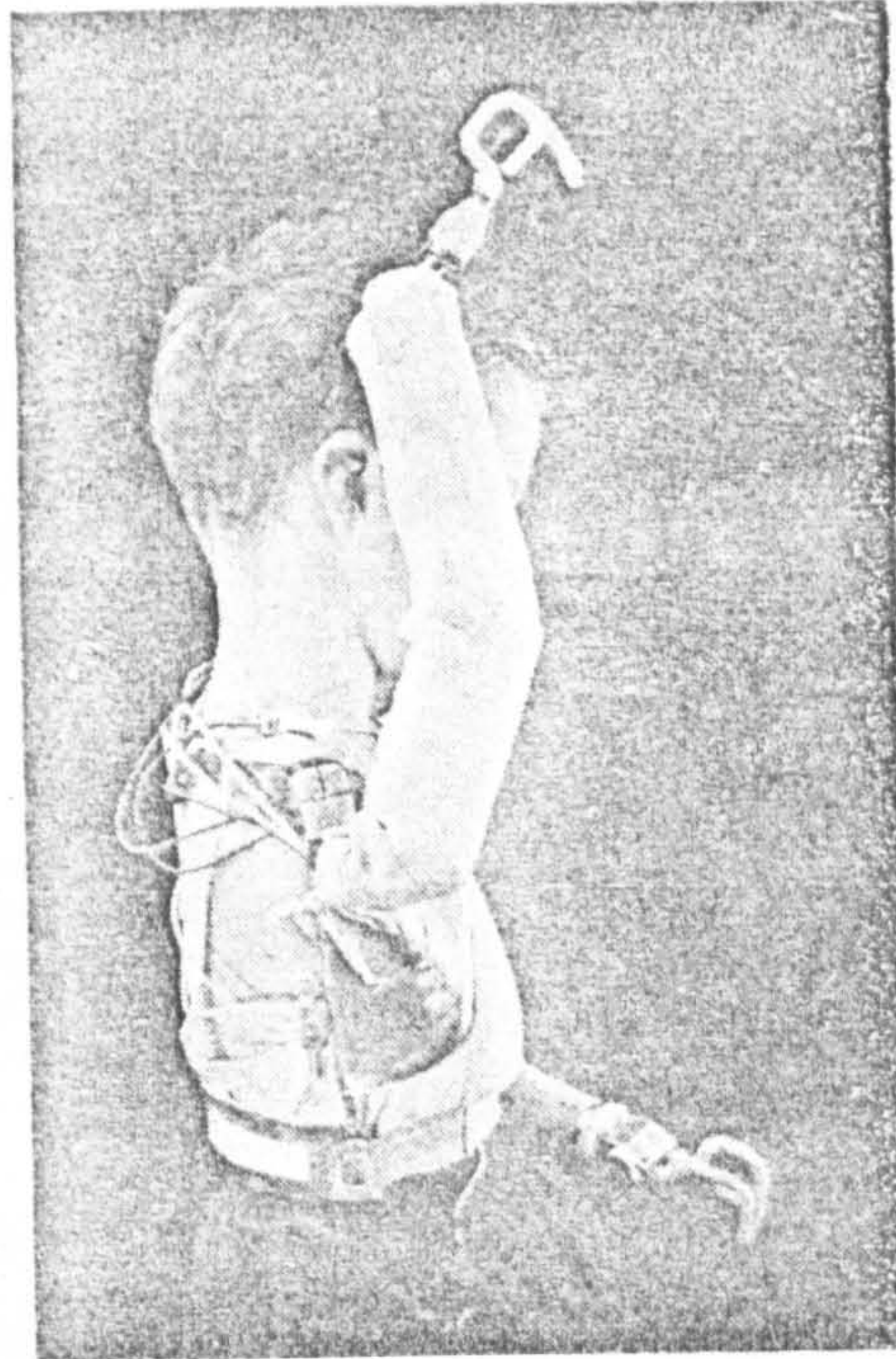
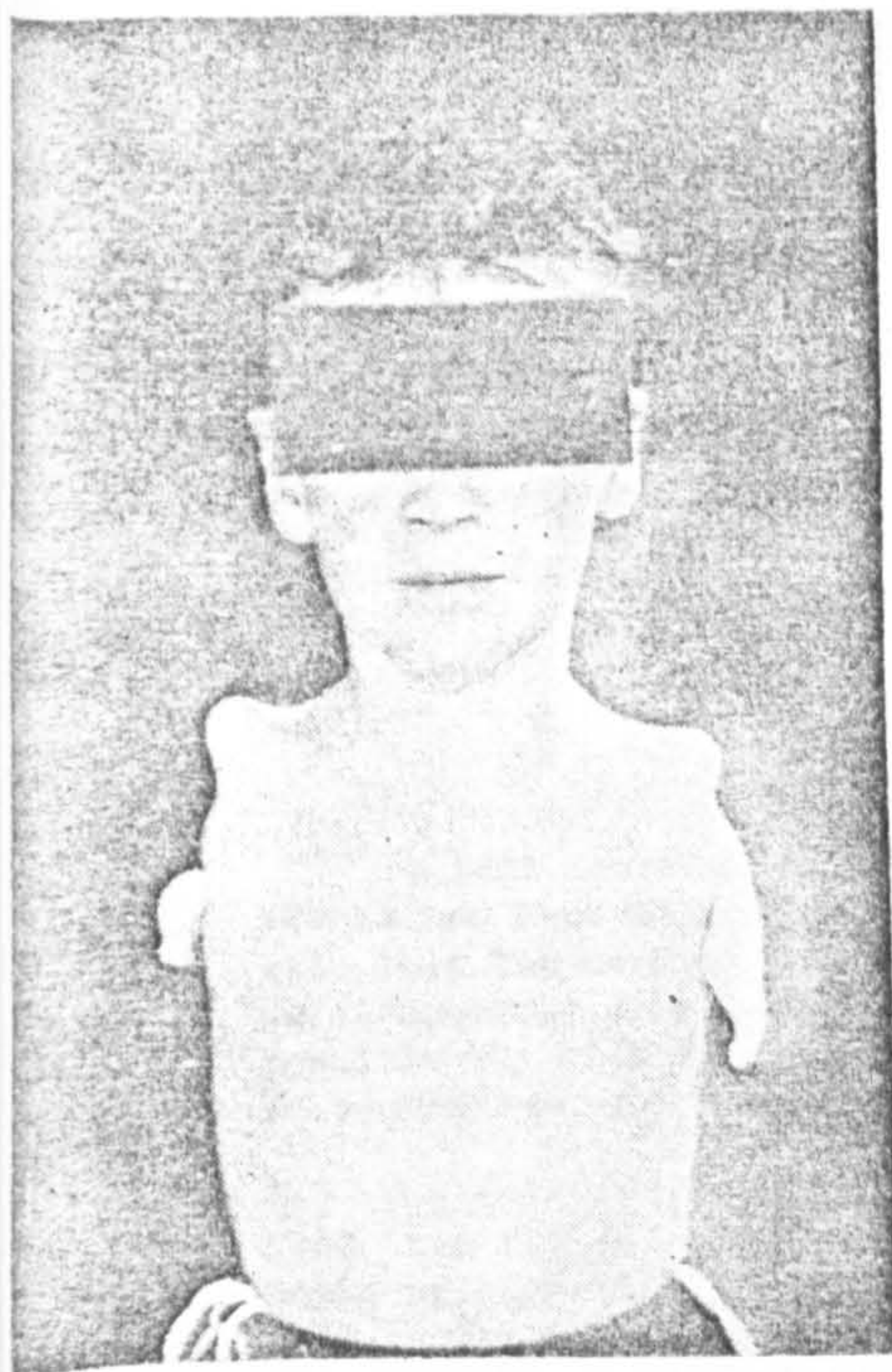

Fig. 6. The patient, the harness and the general cosmetic effect.

2. The siting and arrangement of the controls must be such that the advantages of the extended physiological proprioception (e.p.p.) system can be achieved, that is feedback of appropriate information to the central nervous system is provided.
3. There must be two complete sets of equipment available so that withdrawal of an arm for repair or for maintenance does not mean that the child is without arms.
4. The return of the limb for repair and for maintenance must be facilitated as much as possible by, for example, the provision of a suitable box and prepaid labels so that the return is simple.

5. There must be staff whose responsibility it is to keep the limbs in good working order and who can, if necessary, be contacted by the patient by telephone in the event of queries.
6. There must be close liaison by someone in the fitting group with the patient's family and, if possible, the patient's school.
7. There must be adequate arrangements made for the refilling of gas cylinders so that avoidable petty interruptions and frustrations do not occur with the use of the limb.

The provision of a system such as has been described can be expensive but it is necessary for the proper imple-

mentation of a fitting programme. Unless some form of close support with the patient is achieved, most of the effort which goes into the fitting and provision of the limb will be completely wasted.

FUTURE DEVELOPMENT

With now some experience of fitting this type of limb a project has been started to modify the mechanical structure of the arm with a view to reducing costs and increasing the tolerance of the mechanism to blows and accidental damage to wear and tear. This development has now been advanced to the model stage and it is hoped that it will come into the fitting programme at this Centre in the relatively near future. It is also hoped to introduce an hydraulic control system to replace the Bowden cables.

ACKNOWLEDGEMENTS

We would like to acknowledge the important part played in the development of this limb by Mr. T. D. Dick, the Deputy Director, and by Mr. J. G. Smith, the Chief Technician and Workshop Supervisor, who have contributed greatly to the practical development of this prosthesis. We are also indebted to Mr. A. Greenhorn and his staff who are responsible for the fitting and maintenance of the prosthesis for their contribution and helpful suggestions.

REFERENCES

1. Simpson, D. C. (1965). An experimental design for a powered arm prosthesis. *Health Bulletin*, 23, 75-77.
2. Simpson, D. C. and Lamb, D. W. (1965). A system of powered prostheses for severe bilateral upper limb deficiency. *Journal of Bone and Joint Surgery*, 47B, 442-447.
3. Conference Report (1970). Proceedings of a conference held in Stockholm, September 1970. (In preparation.)
4. Harborow, P. R. H. (1969). Modular Cylinders. *Bulletin of Current Work, B.R.A.D.U. and other collaborating laboratories*. Number 2, p. 22.
5. Earl, A. G. (1968). A review of pneumatic piston type actuators for prosthetics. *Royal Aircraft Establishment Technical Report* 68027.
6. Simpson, D. C. (1965). Functional requirements and systems of control for powered prostheses. *Bio-Medical Engineering*, 1, 250-254, 265.
7. Simpson, D. C. (1969). An externally powered prosthesis for the complete arm. Proceedings of Symposium on the basic problems of prehension movement and control of artificial limbs. 1968. I.Mech.E., reprinted *Bio-Medical Engineering*, 4, 106-110, 119.
8. Simpson, D. C. (1972). Versatile mechanism transmits linear and rotary motion. *Design Engineering*, June 1972, 137.
9. Kenworthy, G. and Jolly, D. (1972). Experience with the force demand valve in controlling a pneumatically powered prosthesis. *Mechanical and Biological Engineering*, 11, 90-94.
10. Simpson, D. C. and Sunderland, G. D. (1965). A position servo control system for powered prostheses. *World Medical Electronics*, 3, 116.
11. Simpson, D. C. (1971). E.p.p. (extended physiological proprioception) control of a complete arm prosthesis. Report of 6th International Course, Schweizerische Arbeitsgemeinschaft für Prothese und Orthosen, Zurich.

38-5

A HIGH PERFORMANCE EXTERNALLY POWERED ARM PROSTHESIS

G. KENWORTHY
MRC UNIT FOR PHYSICAL AIDS
FOR THE DISABLED
PRINCESS MARGARET ROSE
ORTHOPAEDIC HOSPITAL
EDINBURGH, SCOTLAND.

D.C. SIMPSON
MRC UNIT FOR PHYSICAL AIDS
FOR THE DISABLED
PRINCESS MARGARET ROSE
ORTHOPAEDIC HOSPITAL
EDINBURGH, SCOTLAND.

In 1965 the results obtained at this Centre with a new type of control system appeared to indicate that the control of an externally powered multi-movement prosthesis would not only be possible but that the likelihood was that it could be controlled at the unconscious level.

The concept was to control the distance of the hand from the shoulder (r , radius vector), the angle of elevation of the hand position with respect to the shoulder (θ , angle of elevation) and the rotation of the arm about a vertical axis from the shoulder (ϕ , angle of azimuth). In addition the long axis of the hand was to be kept in the same attitude to the horizontal throughout all variations of r and θ , and hand rotation about that axis and prehension were to be provided. (1)

From 1965 onwards while a simpler powered prosthesis was being fitted clinically many variants of the basic design were produced and a series of models were constructed culminating in a production of a prosthesis in the Spring of 1971 which operated, broadly speaking, on the principles which had been outlined in 1965 and which was light and small enough to be fitted to a child of about eight years of age as part of the management of her limb deficiency. (2)

Arms which have developed further, but based on that solution have been in service from 1971 until the present time and in this period many of the faults which revealed themselves in clinical use have been rectified. Nevertheless it was considered to be worthwhile to look once again at the solution to the problems of the mechanical construction of the arm with a view to simplifying its repair and maintenance.

The arm which went into service in 1971 was a precision device and the linking together of the various movements and particularly the arrangement of links through the arm which allowed the wrist to flex so as to keep the hand axis horizontal throughout movement were fundamentally geared mechanisms.

Consequently in order to avoid backlash the tolerances in machining had to be made very small indeed and the quality of the gears very high. While this was feasible not only did it add to the cost but it meant that each injury sustained by the arm throughout what could well be a very tough day in an ordinary primary school, tended to degrade the performance of the limb and the backlash which was thus introduced could not be easily cured without removal of damaged parts even though they were quite serviceable except for the play they introduced. A design based on kinematic principles which would automatically take up the effects of wear and damage would therefore be of considerable advantage.

A design study showed that it was very feasible to replace the existing r and θ mechanisms and the hand stabilisation with this type of system and

that the wrist rotation and ϕ movements could also be replaced on these lines but in not such a direct way. A model was therefore built to study and this in turn led to a very much simpler type of θ and wrist rotation movement. A prototype has now been built of this version.

The attached illustration shows the basic configuration. (Fig. 1). The wrist and ϕ movements are produced by almost the identical mechanism of a simple capstan action produced in a ring band by a cylinder sliding across the arm on a shaft. The θ movement is produced by direct action of a driving band on a pulley at the shoulder whereas the r movement is achieved by combining this action round two pulleys, the one at the shoulder and a further at the elbow (the pulley analogue of the parallel movement in the earlier paper) and by replacing the gears which were at the elbow in the earlier designs by crossed constant length driving bands under tension.

The driving bands which are being employed in the prototype are of beryllium copper. The unit appears to be free from backlash and any which is produced during wear can be taken up by very simple adjustment. The tolerances can be very large indeed without affecting the performance noticeably. The arm, size for size, is much lighter and it is simpler than in the earlier arm to increase the available force with the size of the arm. The structure of the arm also tends to concentrate the weight in the proximal section and to lend itself to compensation for the effects of gravity.

It is hoped to fit a further development of this device to a patient for a trial period in 1973 and that this arm will replace the existing multi-movement arm as soon as possible.

1. Simpson, D. C. (1965) *Hlth. Bull.* 23, pp.75-77. An experimental design for a powered arm prosthesis.
2. Simpson, D. C. and Kenworthy, G. The design of a complete arm prosthesis. *Bio-Med. Engng.* (In press).

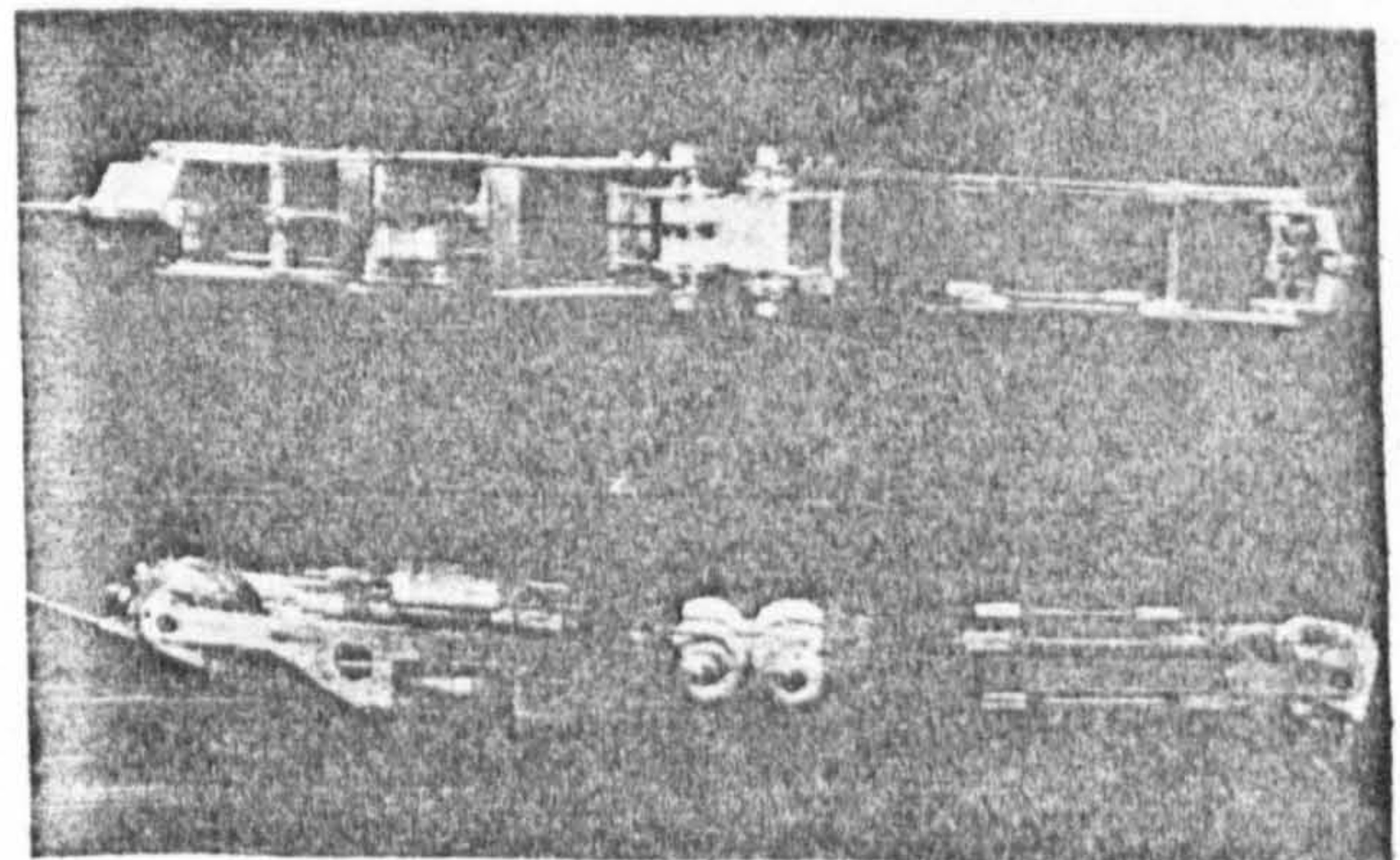

Figure 1. The new arm prosthesis.

New techniques used in the production of cosmetic gloves*

Gordon Kenworthy

Medical Research Council Unit for Physical Aids for the Disabled, Bio-Engineering Centre, Princess Margaret Rose Orthopaedic Hospital, Edinburgh, Scotland

A. D. S. Small

Orthopaedic Bio-Engineering Unit, Bio-Engineering Centre, Princess Margaret Rose Orthopaedic Hospital, Edinburgh, Scotland

Abstract—Owing to inadequacies in conventional procedures for the manufacture of cosmetic gloves it has been necessary to devise a new process for their production. The new process allows the making of cosmetic gloves to a specific shape by means of a simple dipping process and facilitates various other aspects of glove production.

Keywords—Prostheses, hands, cosmesis, manufacture, p.v.c.

THE NEED for a cosmetically satisfactory cover for a hand prosthesis is a well established characteristic of the acceptance/rejection pattern which determines the success or failure of the prosthesis as far as the patient is concerned. The work which provided the basis for most glove-production processes at present in use was carried out just following the Second World War in the USA. These gloves were intended primarily for use with purely cosmetic hands, and attempts at the manufacture of gloves for functional hands have been modifications of the basic process described by CLARKE *et al.* (1947, 1949). [Details of this work are covered in the book by KLOPSTEG and WILSON (1954)].

The number of variations of colour and texture which can be made with the materials used in these processes is considerable, even the small alterations due to slight changes in batches of materials causing noticeable alterations in the quality of the finished articles. This fact, combined with individual requirements such as thick long-lasting gloves for passive hands, thin flexible gloves for fully articulated prostheses, pigmentation variations etc., has led to the development by prosthetics workers of special polyvinylchloride (p.v.c.) plastisol mixes and techniques to suit the prevailing conditions to which they are accustomed.

It is therefore proposed to indicate some new aspects of technique which considerably simplify the overall production process, without giving any hard and fast rules for materials etc., since the choice of these will be governed by the demands of previous

experience in matching materials to specific prosthetics applications.

The conventional glove-manufacture process consists of making a hollow shell mould, usually by means of an electroplating technique, into which is poured the liquid glove material (rubber, latex or p.v.c. plastisol). The fluid is then poured out of the shell, leaving behind a thin film which adheres to the inside of the mould surface. This thin liquid film is then cured to the solid state, usually by means of a carefully controlled heating process. The desired thickness of film is built up by means of successive repetitions of this procedure. Finally, the completed seam-free glove is pulled away from the inside face of the mould by the application of force at the wrist opening.

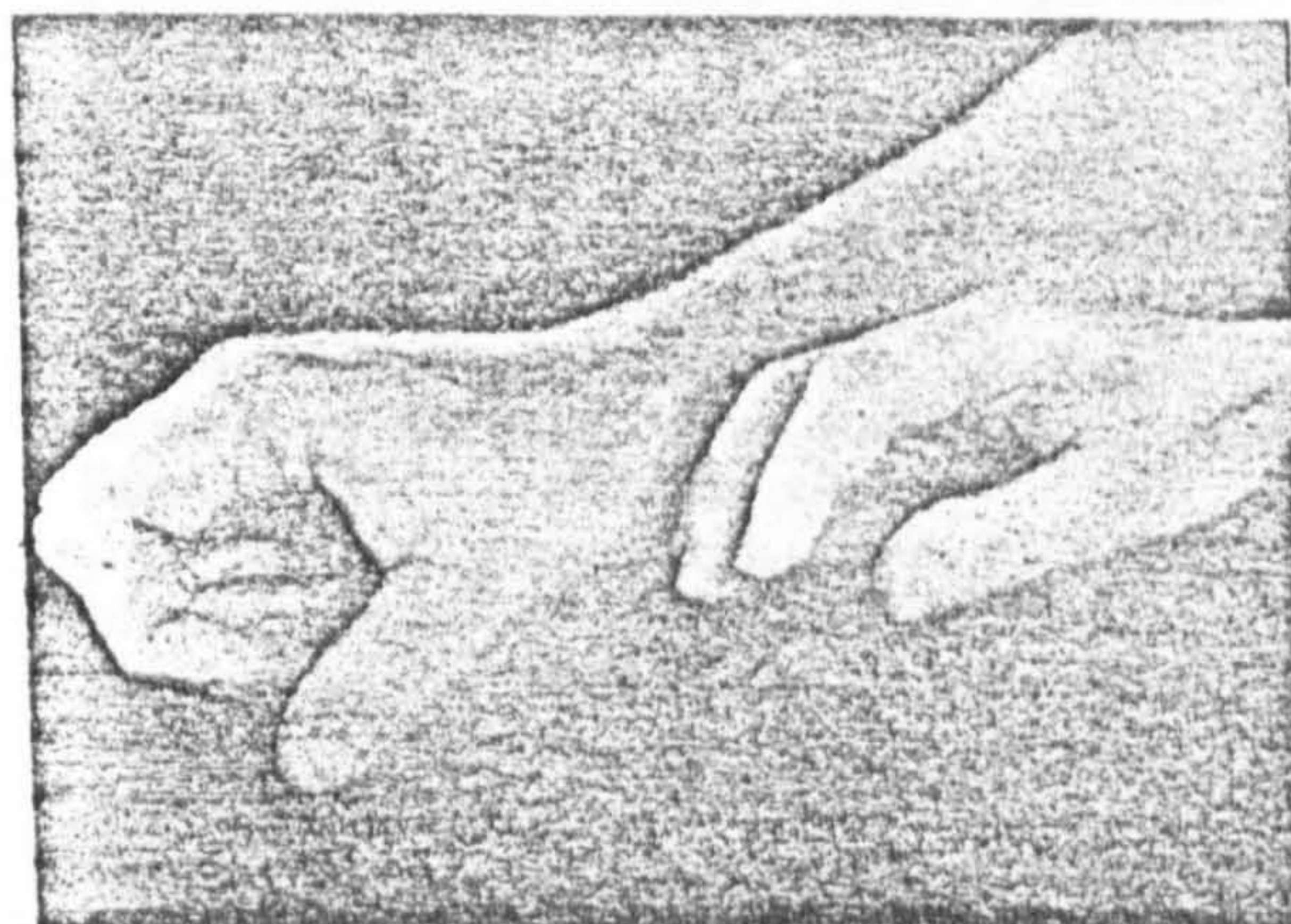

Fig. 1 Straight-fingered hand configuration with rest-position hand

* First received 26th November 1972 and in final form 29th January 1973

This technique has proved quite satisfactory for the straight-finger type of hand configuration (Fig. 1). However, the natural rest position of the hand, though not precisely defined, is certainly more complex than this (Fig. 1). Since the elasticity of both rubber latex and p.v.c. film is limited, it is apparent that only a limited amount of stretching and folding of the glove is cosmetically permissible in the later attempt to reform the straight finger configuration into the more natural rest state. As a result, it is necessary to manufacture the glove itself in approximately the normal functional position, in order to achieve a suitably satisfactory cosmetic effect. This applies in particular to passive cosmetic hands and to the type of functional hand being developed at Edinburgh which has a fixed finger configuration with an active thumb movement. Fig. 2 illustrates one of the major problems encountered in the application of conventional techniques to the situation of a curved finger configuration, the diagram showing the difficulty of withdrawal of a glove from a curved mould. Since no direct peeling action can be applied to the inside of the curve, the application of a pulling force at the wrist merely tends to tear across the fingers at the relatively sharp edges provided by the mouldings of finger-joint details.

In all processes for glove production, the ease of release of the glove from the mould is directly related to the amount of detail required. This phenomenon is due to the keying effect of the contours of the hand detail, and has proved to be something of a problem even for the release of gloves of the straight-fingered type. Experience with a suitably curved finger configuration showed that consistent release of the glove from the mould was impossible since at least one finger usually tore off during extraction, despite the use of various release agents. (It should be noted, in addition, that the use of various types of release agents is undesirable where reproduction of detail is important, since the

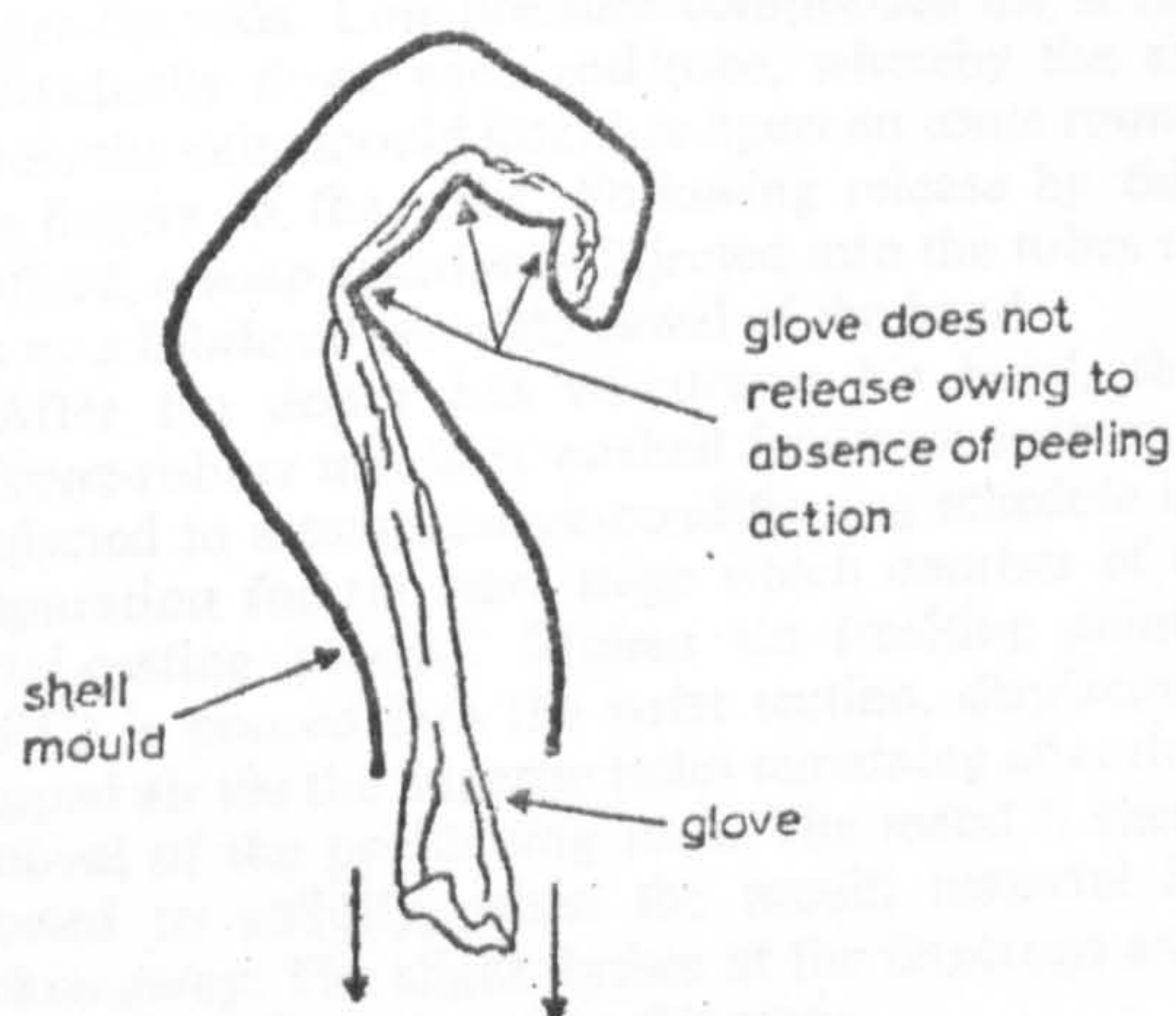

Fig. 2 Glove-extraction diagram

release agent itself fills in a proportion of the detail features.) In an attempt to overcome the release problem, some workers have made use of split mould techniques in order to permit easy release of the glove mouldings, and, in particular, KLASSON (1969) made use of such procedures together with an eversion technique, to make a porcelain mould for

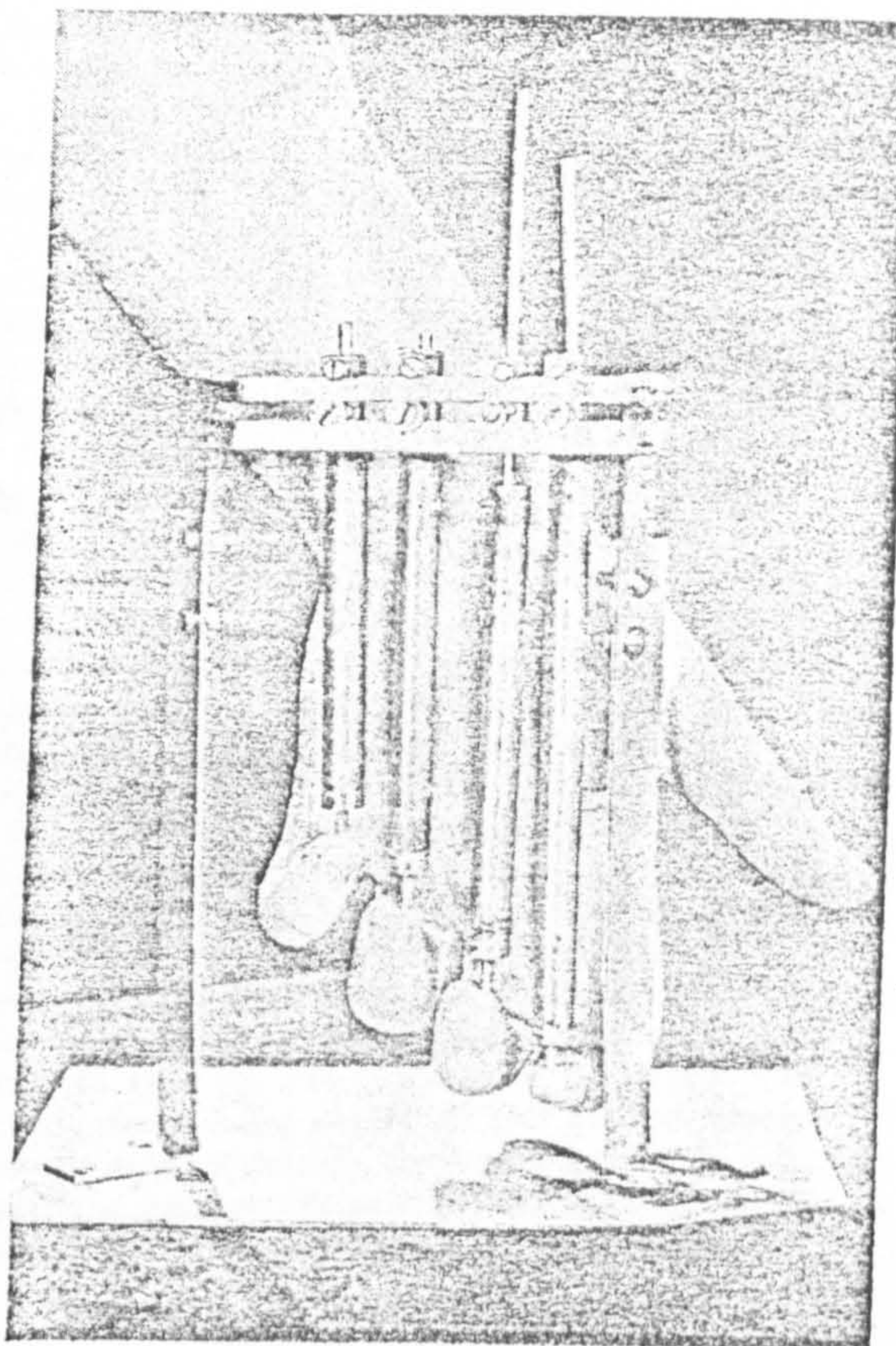

Fig. 3 Fingers located at rod ends

a cosmetic glove of the straight-finger type. However, the 'flash' or seam produced as a result of the mould joints reduces the cosmetic effect of the glove, and only by means of much tedious and skilful sculpture work can such faults be removed; the use of a split mould for a hand of the curved finger configuration would be virtually prohibited by the complex contours of the hand in this form, since no simple line of 'split' can readily be found.

Several other problems arose with the early attempts made on the application of conventional methods to the production of a glove for the new hand configuration, all directly related to the curvature of the fingers. It was therefore apparent that the conventional process was only ideally suited to a somewhat unnaturally shaped hand, and an alternative procedure had to be derived.

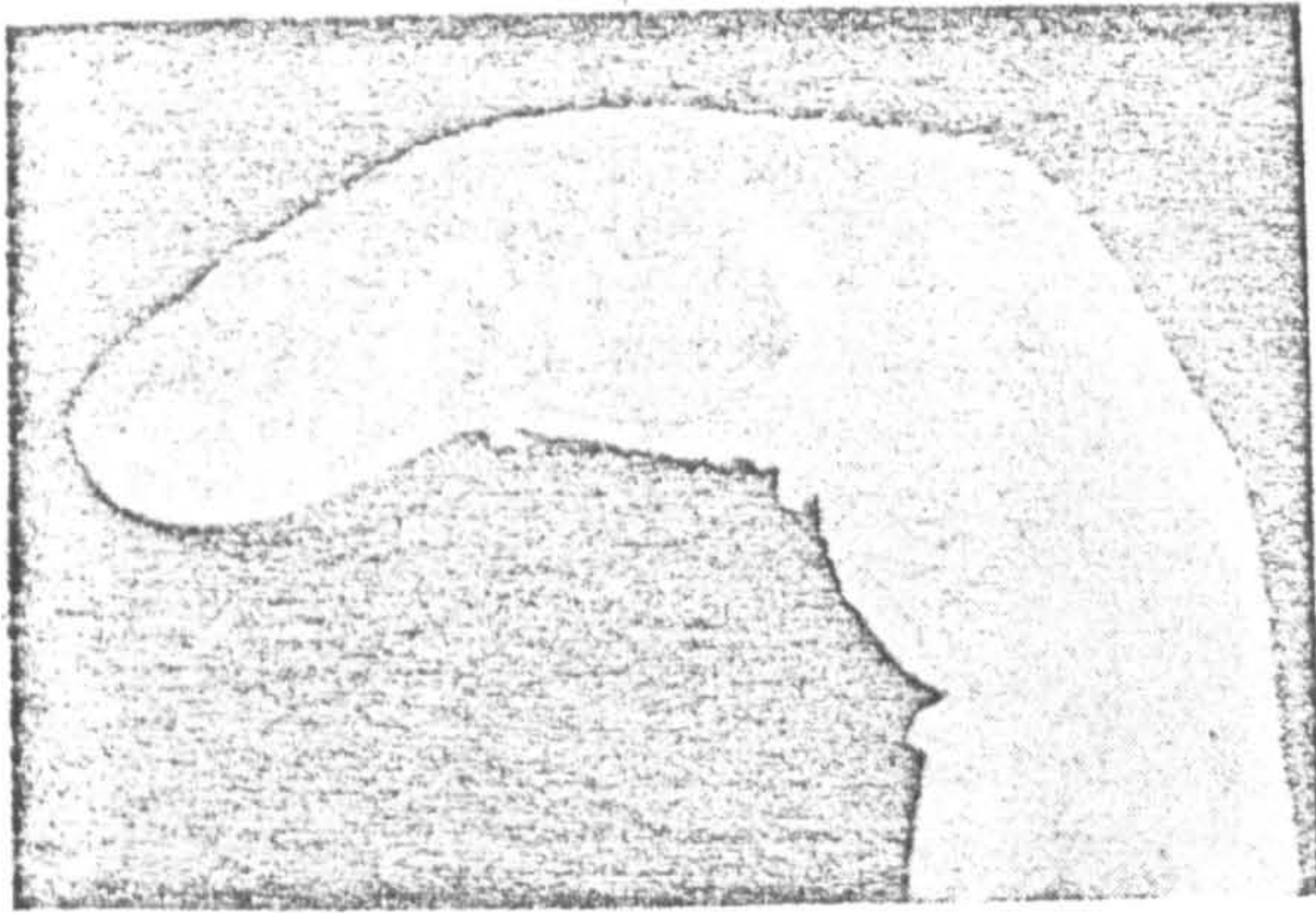

Fig. 4 Everted glove

The new process described below is equally suitable for any hand configuration, and is in practice considerably simpler than conventional methods, since it involves only casting techniques, without the need for time-consuming electroplating techniques which produce, at best, a somewhat fragile shell mould.

The process begins in the normal way by taking an impression of a donor hand in a fast-curing silicone-rubber material, chosen for its fast setting characteristics together with good high-temperature stability. Obtaining a correct donor hand position is imperative for matching a glove to a mechanism, thereby making a position-check facility essential. This is achieved by installing pre-positioned rods in the casting vessel, situated in such a way that the donor's finger tips locate at the rod ends (Fig. 3). By making these rods hollow, several other essential aspects of the process are made feasible.

Following the setting of the silicone-rubber material, the problem of the removal of the donor hand is considerably eased by making use of the finger-tip rods. Low-pressure compressed air is fed individually down each rod/tube, whereby the air forces the skin-mould interface apart en route round the fingers to the wrist. Following release by this method, a soap solution is injected into the tubes to act as a lubricant on withdrawal of the hand.

After the donor has withdrawn his hand, the silicone-rubber mould is washed free from soap and subjected to a temperature-conditioning schedule in preparation for the next stage which consists of a metal-casting process. Molten tin (melting point, 238°C) is poured into the wrist section, displacing trapped air via the fingertip holes remaining after the removal of the positioning rods. The metal is then allowed to solidify, when the mould material is broken away. The slight flashes at the fingertips are small and easily removed at this stage.

The metal positive hand now produced by this process is dipped in p.v.c. plastisol, dripped free of

excess material and oven-cured at 150°C in the usual way. The thin p.v.c. glove is then peeled intact off the metal and everted. This glove is now of the mirror-imaged hand, and has 'inside-out' detail, i.e. ridges and grooves interchanged (Fig. 4).

In order to use this glove as the 'donor' for a repeat of the above procedure, it is necessary for the glove to be in a dimensionally stable state, i.e. in a rigid or semirigid form. This is achieved by filling the glove with lightweight plastics spheres of approximately 1 mm diameter. This low-density filler almost eliminates the bulging usually caused by filling with plaster or wax. The hand is then made rigid by reducing the pressure inside the glove below atmospheric by means of a vacuum pump. The effect of the pressure difference across the glove walls causes the contents to be compressed until the whole hand becomes almost rigid, thereby permitting the glove to be used in subsequent casting processes as long as the vacuum is maintained. At this stage, minor adjustments of configuration can be made since the glove now has the consistency of stiff clay. Following casting in silicone rubber, the vacuum is released and the plastic spheres poured out. The thin limp glove is readily removed from the flexible mould with the aid of air pressure applied at the fingertips—thus leaving a hollow silicone-rubber mould ready for heat conditioning prior to metal casting.

The solid positive, opposite-handed, everted-detail metal casting obtained following this is the master mould for the manufacture of all gloves by a simple dipping process. The excess p.v.c. is dripped off in the usual way and oven-cured; successive layers are repeatedly built up and coloured as necessary. The resulting glove, being peeled off and everted, reproduces the original donor's hand with full detail, with none of the usual problems of release or adherence of small particles of mould material in the glove (Fig. 5).

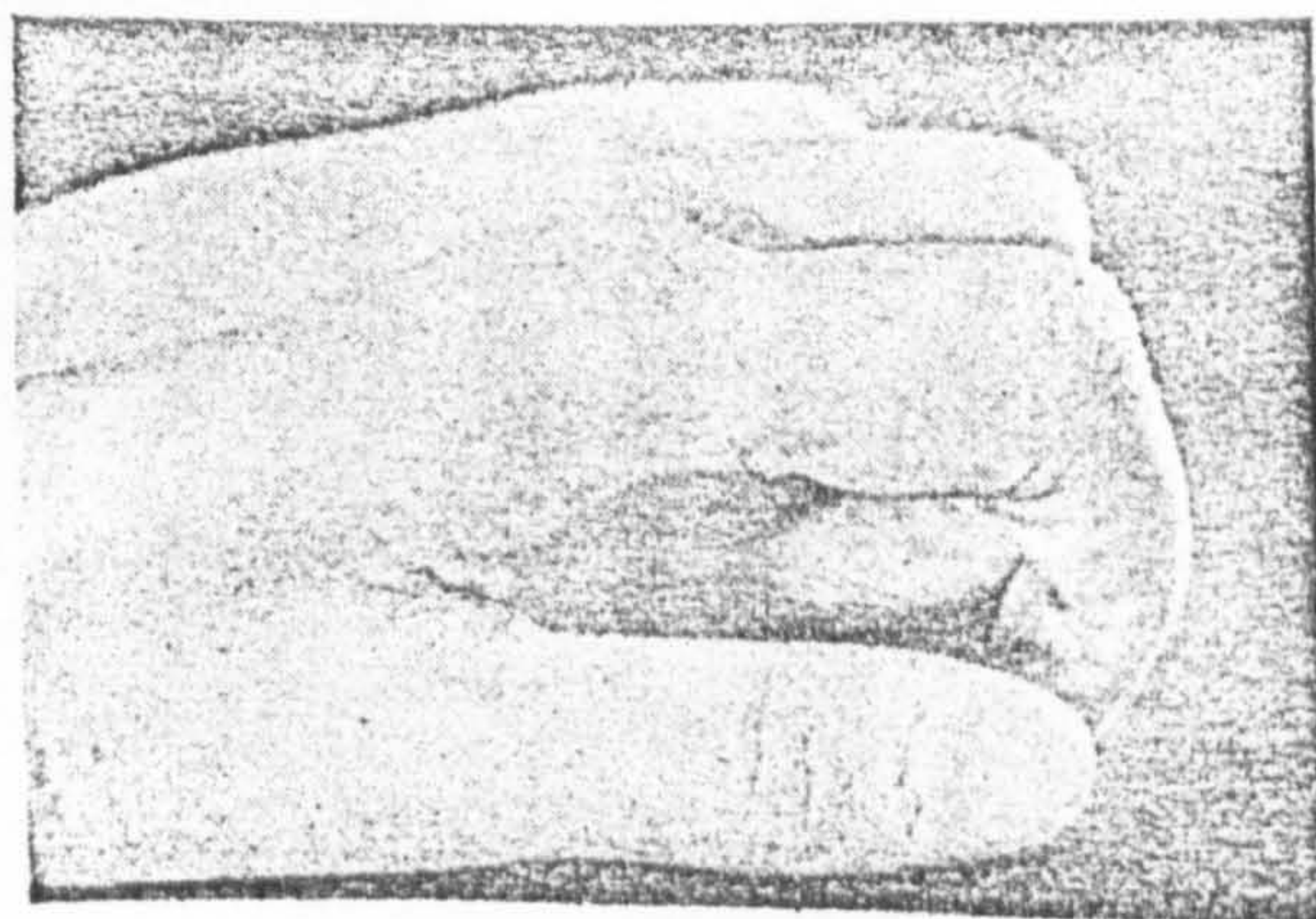

Fig. 5 Final glove

Although this process was derived specifically to produce a particular shape of the hand, it is quite suitable for any other formation and is considerably simpler in all respects of technique. In addition, the avoidance of electroplating and its associated painting processes decreases the loss of detail due to the various stages of the process. The use of this type of technique allows the making of specialised gloves which require a more exact control of hand shape than the conventional process, and permits the introduction of localised colouring between successive p.v.c. layers by means of a simple external painting process before eversion is carried out.

References

- CLARKE, C. D., WEINBERG, F. B. and BLEVINS, G. C. (1947) Seamless prosthetic hands. *Arch. Surg.* 54, 491-516.
- CLARKE, C. D. and WEINBERG, F. B. (1949) New advances in seamless prosthetic hands. *Arch. Surg.* 59, 355-372.
- KLASSON, B. and WINDERLICH, H. (1969) Rapport Über Einleitende Entwicklungsarbeit Für Einen Dünnen Kosmetischen Prothesenhandschuh Aus PVC. Sven Rapport 110 D, Norrbackainstitutet, Stockholm, Sweden.
- KLOPSTEG, P. E. and WILSON, P. D. (1954) *Human limbs and their substitutes*. McGraw-Hill, New York.

Quelques techniques nouvelles pour la production des gants cosmétiques

Sommaire—Les méthodes habituelles de fabrication des gants cosmétiques s'avérant insuffisantes, on a trouvé nécessaire d'inventer un nouveau procédé. Ce nouveau procédé permet la fabrication des gants cosmétiques de forme déterminée, par simple immersion et facilite aussi les autres aspects de la production des gants.

Einige neue Methoden für die Herstellung kosmetischer Handschuhe

Zusammenfassung—Wegen der Unzulänglichkeiten der konventionellen Herstellungsmethoden von kosmetischen Handschuhen war es notwendig, einen neuen Produktionsprozess zu entwickeln. Der neue Prozess ermöglicht die Herstellung von kosmetischen Handschuhen in spezifizierten Formen einfach durch ein Eintauchverfahren und vereinfacht verschiedene andere Aspekte der Handschuhherstellung.