

STUDIES OF GLUTATHIONE METABOLISM IN SHEEP ERYTHROCYTES

by

James D. Young

Ph.D. Thesis,

University of Edinburgh.

September, 1975.



DECLARATION OF ORIGINALITY

I certify that this Thesis represents my work, and was  
composed by me.

### ACKNOWLEDGEMENTS

I am indebted to my supervisor, Dr. I.A. Nimmo, for his help and guidance throughout my period of study. I am grateful to Dr. J.G. Hall for supplying blood samples. I would like to thank Dr. E.M. Tucker for her many helpful comments, and for her assistance with the reticulocyte studies. I am also grateful to Dr. E.M. Tucker and Dr. J.C. Ellory for their help with the amino acid permeability experiments.

I would like to thank Miss C.L. McMinn and Dr. J.H. Ottaway for their assistance with the computer simulation studies, and Miss S.A. Thompson for her help with the GSH regeneration experiments.

This study was made possible by a Graduate Research Scholarship from the Faculty of Medicine of the University of Edinburgh. The amino acid permeability investigations were supported by a project grant from the MRC.

I am obliged to Mrs. J.S. Campbell for typing this Thesis for me.

## CONTENTS

	<u>Page</u>
Abstract	vii
List of Figures	x
List of Tables	xiii
CHAPTER 1	GENERAL INTRODUCTION
Part 1	Preamble 1
Part 2	Sheep erythrocyte GSH deficiency 3
Part 3	GSH metabolism and function in mammalian erythrocytes 8
Section 3.01	Introduction 8
Section 3.02	GSH metabolism in mammalian erythrocytes 8
Section 3.03	The function of GSH in mammalian erythrocytes 16
Part 4	The objectives of the present project and the organisation of the remainder of the Thesis 24
CHAPTER 2	MATERIALS AND GENERAL METHODS
Part 1	Animals 26
Part 2	The preparation of washed erythrocytes 26
Part 3	Reagents 27
Part 4	Enzyme and other essays 27
CHAPTER 3	ANIMAL CLASSIFICATION (GSH type)
Part 1	Introduction 29
Part 2	The estimation of sheep erythrocyte GSH 31
Section 2.01	Introduction 31
Section 2.02	The AutoAnalyser system 31
Section 2.03	The calibration and precision of the system 32

		<u>Page</u>
Part 3	The population distribution of erythrocyte GSH in Finn and Merino sheep	33
Part 4	The detection of erythrocyte ornithine and lysine, and its correlation with GSH type	35
Part 5	Heterozygote erythrocyte GSH concentrations in Finn and Merino sheep	36
Part 6	The analysis of possible relationships between known animal variables and erythrocyte GSH concentration in Finn and Merino sheep	38
Part 7	The selection of animals for further detailed study	42
Part 8	Discussion	43
CHAPTER 4	THE CONCENTRATION OF GSH AND GSSG IN HIGH AND LOW GSH FINN AND MERINO ERYTHROCYTES	
Part 1	Introduction	48
Part 2	The concentration of GSH in high and low GSH Finn and Merino erythrocytes: a comparison of the estimates of erythrocyte GSH by two automated spectrophotometric methods employing alloxan and DTNB as chromogens	50
Section 2.01	Introduction	50
Section 2.02	The AutoAnalyser system	51
Section 2.03	The calibration and precision of the system	52
Section 2.04	The deproteinisation of a sample	52
Section 2.05	The concentration of GSH in high and low GSH Finn and Merino erythrocytes: a comparison of the estimates of erythrocyte GSH by the automated alloxan and DTNB methods	53

		<u>Page</u>
Part 3	The concentration of GSSG in high and low GSH Finn and Merino erythrocytes	55
Section 3.01	Introduction	55
Section 3.02	The estimation of erythrocyte GSSG	55
Section 3.03	The concentration of GSSG in high and low GSH Finn and Merino erythrocytes	57
Part 4	The redox potential of the GSH-GSSG couple in high and low GSH Finn and Merino erythrocytes	58
Part 5	Discussion	60
CHAPTER 5	GSH BIOSYNTHESIS I: THE ACTIVITIES OF THE ENZYMES OF GSH BIOSYNTHESIS IN HIGH AND LOW GSH FINN AND MERINO ERYTHROCYTES	
Part 1	Introduction	62
Part 2	The assay of the enzymes of GSH biosynthesis in sheep erythrocytes	63
Section 2.01	Introduction	63
Section 2.02	The assay of GC-S and GSH-S in sheep erythrocytes	63
Section 2.03	Quench correction	66
Section 2.04	Characteristics of the GC-S and GSH-S assays	67
Part 3	GC-S and GSH-S activities in high and low GSH Finn and Merino erythrocytes	71
Part 4	The concentration of ATP in high and low GSH Finn and Merino erythrocytes	73
Section 4.01	Introduction	73
Section 4.02	The estimation of ATP in sheep erythrocytes	73
Section 4.03	The concentration of ATP in high and low GSH Finn and Merino erythrocytes	75
Part 5	Discussion	76

		<u>Page</u>
CHAPTER 6	GSH BIOSYNTHESIS II: COMPUTER SIMULATION OF GSH BIOSYNTHESIS IN SHEEP ERYTHROCYTES	
Part 1	Introduction	81
Part 2	Computer simulation studies	82
Part 3	Discussion	84
CHAPTER 7	GSH BIOSYNTHESIS III: GSH BIOSYNTHESIS IN HIGH AND LOW GSH FINN AND MERINO FREEZE-THAW HAEMOLYSATES	
Part 1	Introduction	86
Part 2	The incubation systems	89
Part 3	The synthesis of GC by high and low GSH Finn and Merino freeze-thaw haemolysates	91
Part 4	The synthesis of GSH by high and low GSH Finn freeze-thaw haemolysates	92
Part 5	The inhibition of sheep erythrocyte GC-S by GSH	93
Part 6	The inhibition of sheep erythrocyte GC-S and GSH-S by amino acids	94
Part 7	Discussion	95
CHAPTER 8	GSH BIOSYNTHESIS IV: THE CONCENTRATION OF GSH AND THE ACTIVITY OF GC-S IN RETICULOCYTES FROM HIGH AND LOW GSH 'MERINO-TYPE'SHEEP	
Part 1	Introduction	100
Part 2	The concentration of GSH and the activity of GC-S in reticulocytes from high and low GSH 'Merino-type' sheep	102
Part 3	Discussion	104

		<u>Page</u>
CHAPTER 9	THE REGENERATION OF GSH FROM GSSG IN HIGH AND LOW GSH FINN ERYTHROCYTES	
Part 1	Introduction	105
Part 2	The activity of (G-6-PD+6-PGD) and GSSG-R in high and low GSH Finn erythrocytes	107
Section 2.01	Introduction	107
Section 2.02	The assay of sheep erythrocyte (G-6-PD+6-PGD) and GSSG-R	108
Section 2.03	The activity of (G-6-PD+6-PGD) and GSSG-R in high and low GSH Finn erythrocytes	109
Part 3	The regeneration of GSH from GSSG in diamide-treated intact high and low GSH Finn erythrocytes	110
Section 3.01	Introduction	110
Section 3.02	The incubation system and subsequent sample treatment	112
Section 3.03	The regeneration of GSH from GSSG in diamide-treated high and low GSH Finn erythrocytes	112
Part 4	Discussion	114
CHAPTER 10	GENERAL DISCUSSION	
Part 1	The biochemical mechanisms respons- ible for GSH deficiency in sheep erythrocytes	116
Part 2	The biochemical and physiological implications of sheep erythrocyte GSH deficiency	132



	<u>Page</u>
APPENDIX	
THE OXIDATION OF GSH BY A PREPARATION OF GLUCOSE OXIDASE FROM <u>ASPERGILLUS NIGER</u>	137
Part 1	Introduction 137
Part 2	Characterisation of the 'GSH oxidase' activity 139
Part 3	Discussion 141
REFERENCES	142
PUBLICATIONS	152

ABSTRACT

The tripeptide, reduced glutathione (GSH), is present in high concentration in mammalian erythrocytes, where its major role is the protection of the cell against oxidative damage. Sheep exhibit two distinct types of erythrocyte GSH deficiency. In Finnish Landrace sheep (Finns) low GSH is inherited as an autosomal recessive trait, and is associated with a markedly diminished erythrocyte life-span, and the presence of unusually high concentrations of some erythrocyte amino acids, notably ornithine and lysine. In contrast, in Tasmanian Merino sheep (Merinos) the low GSH characteristic is inherited in an autosomal dominant manner and both the erythrocyte life-span and amino acid concentrations are normal. This Thesis describes an investigation of the biochemical mechanisms responsible for the Finn and Merino erythrocyte GSH deficiencies.

The Finn and Merino sheep investigated were maintained by the ARC Animal Breeding Research Organisation, Edinburgh. Both breeds contained substantial numbers of GSH-deficient animals. In agreement with other studies, GSH-deficient Finn erythrocytes were found to contain very high concentrations of ornithine and lysine, a phenomenon not encountered in Merinos.

Sheep were allotted their GSH type on the basis of their erythrocyte total non-protein reduced thiol concentration as determined by the non-specific thiol reagent 5,5'-dithiobis(-2-nitrobenzoate) (DTNB). The validity of equating total DTNB reactive thiol with GSH was established by estimating GSH using novel automated versions of methods employing DTNB and alloxan as chromogens. GSH-deficient erythrocytes of both breeds were also found to have a diminished

GSSG concentration so that they had a diminished total glutathione content (GSH + 2GSSG). The alloxan GSH and GSSG estimates were used to calculate the redox potential of the GSH:GSSG couple in the various cell types. In both breeds the difference in redox potential between normal and GSH-deficient cells was small. It is suggested that the diminished life-span of GSH-deficient Finn cells may not be a direct consequence of their GSH status.

Merino GSH-deficient erythrocytes had a markedly diminished maximum activity of  $\gamma$ -glutamyl cysteine synthetase (GC-S) and computer simulation studies provided evidence that this enzyme is the rate-limiting one for GSH biosynthesis in sheep erythrocytes. The low GC-S activity of these cells may therefore be responsible for the GSH deficiency. Sheep erythrocyte GC-S was markedly inhibited by physiological GSH concentrations. The diminished GSH feedback inhibition in GSH-deficient Merino cells was insufficient to compensate for their low GC-S activity. Reticulocytes from Merinos of both GSH types had similar very high GSH concentrations and GC-S activities. The differentiation into normal and GSH-deficient cells therefore occurs at some stage during reticulocyte maturation.

In contrast to the situation in Merinos, the GC-S activity of GSH-deficient Finn erythrocytes was normal. The activity of GSH synthetase (the second enzyme of GSH biosynthesis) and the ATP concentration of these cells was also normal, and they did not appear to contain an inhibitor of GSH biosynthesis (other than GSH). Their ability to maintain glutathione in the reduced state was unimpaired. However GSH-deficient Finn cells were much less permeable to cysteine and lysine than normal Finn cells. In contrast, the amino acid permeability of normal and GSH-deficient Merino erythrocytes was the

same, and not significantly different from that found in normal Finn cells. It is concluded that the diminished amino acid permeability of GSH-deficient Finn cells represents a membrane transport defect. It further seems likely that diminished availability of cysteine is responsible for the low concentration of GSH in these cells, and that the accumulation of lysine and ornithine is a further reflection of reduced amino acid transport.

During these investigations a novel enzymic activity was discovered by chance in a commercial preparation of glucose oxidase from Aspergillus niger. The reaction catalysed was:



The enzyme was specific for GSH, and could be separated from glucose oxidase by ion-exchange chromatography.

## LIST OF FIGURES

	<u>Facing page</u>
1.01 The $\gamma$ -glutamyl cycle and its postulated role in amino acid transport	15
1.02 Glutathione metabolism in mammalian erythrocytes	16
3.01 The flow diagram for the dialysis DTNB GSH method	31
3.02 A typical calibration curve for the dialysis DTNB GSH method	32
3.03 Erythrocyte GSH concentrations in Finns and Merinos	33
3.04 Erythrocyte GSH concentrations in 4 high GSH and 4 low GSH Finns over a period of 2 years	34
3.05 Erythrocyte GSH concentrations in 3 high GSH and 4 low GSH Merinos over a period of 3 years	34
3.06 Typical ninhydrin staining patterns of high and low GSH Finn and Merino freeze-thaw haemolysates	35
3.07 The relationship between animal age and GSH concentration in high and low GSH Merinos	39
3.08 The relationship between animal age and GSH concentration in high and low GSH Finns	39
4.01 The flow diagram for the DTNB GSH and alloxan GSH methods	51
4.02 Typical calibration curves for the DTNB GSH and alloxan GSH methods	52
4.03 Erythrocyte GSH estimation by the DTNB method: the effect of haemolysis time	53

4.04	A comparison of DTNB and alloxan estimates of the concentration of GSH in high and low GSH Finn and Merino erythrocytes	53
4.05	A comparison of GSH (alloxan method) and GSSG concentrations in high and low GSH Finn and Merino erythrocytes	57
5.01	A typical $[^{14}\text{C}]$ quench correction curve	67
5.02	$[^{14}\text{C}]$ glycine incorporation into GSH in the absence of added GC	68
5.03	The activity of GC-S in high and low GSH Merino erythrocytes	71
5.04	The activity of GSH-S in high and low GSH Merino erythrocytes	71
5.05	The activity of GC-S in high and low GSH Finn erythrocytes	71
5.06	The activity of GSH-S in high and low GSH Finn erythrocytes	71
5.07	A comparison of GC-S and GSH-S activities in high and low GSH Finn erythrocytes	72
5.08	A comparison of GC-S and GSH-S activities in high and low GSH Merino erythrocytes	72
7.01	The synthesis of GC by high and low GSH Finn and Merino freeze-thaw haemolysates	91
7.02	The synthesis of GSH by high and low GSH Finn freeze-thaw haemolysates	92
7.03	The inhibition of high and low GSH Merino GC-S by GSH	93

7.04	The inhibition of high and low GSH Merino GC-S by GSH	93
7.05	The inhibition of low GSH Finn GC-S by GSH	95
8.01	A comparison of DTNB and alloxan estimates of the concentration of erythrocyte GSH in anaemic high and low GSH 'Merino-type' sheep	103
9.01	The activity of (G-6-PD+6-PGD) in high and low GSH Finn erythrocytes	109
9.02	The regeneration of GSH by diamide-treated high and low GSH Finn erythrocytes	112
10.01	Breeding programme for the production of "double" low GSH sheep	136

## LIST OF TABLES

	<u>Facing page</u>
1.01 Amino acid concentrations in high and low GSH Finn erythrocytes	4
1.02 Comparison of the Finnish Landrace, Tasmanian Merino and Australian Merino erythrocyte GSH deficiencies	6
1.03 The effect of substrate availability on the activities of the enzymes of GSH biosynthesis in human erythrocytes	10
2.01 The concentration of haemoglobin in high and low GSH Finn and Merino erythrocytes	27
3.01 The concentration of erythrocyte GSH in Finn and Merino sheep	33
3.02 The presence of ornithine and lysine in high and low GSH Finn and Merino erythrocytes	35
3.03 The effect of potassium type, haemoglobin type and sex on erythrocyte GSH concentrations in high and low GSH Finns and Merinos	38
3.04 Variance ratio test of the relationship between animal age and erythrocyte GSH concentration	40
3.05 The distribution of high and low GSH animals in young ( $\leq$ 13 months) and old ( $>$ 13 months) sheep	41
3.06 Characteristics of the animals selected for further detailed study	42
4.01 Reagents for the DTNB GSH and alloxan GSH methods	51



4.02	The concentration of GSH in high and low GSH Finn and Merino erythrocytes: a comparison of the estimates of erythrocyte GSH by the automated alloxan and DTNB methods	54
4.03	The concentration of GSSG in high and low GSH Finn and Merino erythrocytes	57
4.04	The redox state of the GSH:GSSG couple in high and low GSH Finn and Merino erythrocytes	59
5.01	The effect of precipitate formation on quench correction	67
5.02	The effect of different methods of blank estimation on the estimates of GC-S and GSH-S activity in sheep erythrocytes	69
5.03	Typical dpm/vial for the sheep erythrocyte GC-S and GSH-S assays	70
5.04	Activities of the enzymes of GSH biosynthesis in high and low GSH Finn and Merino erythrocytes	71
5.05	Stability of the activities of the enzymes of GSH biosynthesis in high and low GSH Finn and Merino erythrocytes	72
5.06	Comparison of the activities of the enzymes of GSH biosynthesis in sheep (Finn and Merino) and human erythrocytes	72
5.07	The concentration of ATP in high and low GSH Finn and Merino erythrocytes	75
5.08	Comparison of the activities of the enzymes of GSH biosynthesis in high and low GSH sheep from the present study and from that of Smith <u>et al.</u> , (1973)	78

6.01	Computer simulation of GSH biosynthesis in sheep erythrocytes	82
6.02	The effect of substrate availability on the activities of the enzymes of GSH biosynthesis in sheep erythrocytes	84
7.01	The inhibition of low GSH Finn GC-S and GSH-S by amino acids	94
7.02	A comparison of the rates of GC synthesis in the freeze-thaw haemolysate and dilute haemolysate assay systems	96
7.03	A comparison of the rates of GSH synthesis in the freeze-thaw haemolysate and dilute haemolysate assay systems	97
8.01	GSH concentrations and GC-S activities in high and low GSH 'Merino-type' sheep during anaemia induced by phlebotomy	102
9.01	(G-6-PD + 6-PGD) activities in high and low GSH Finn erythrocytes	109
9.02	GSSG-R activities in high and low GSH Finn erythrocytes	109
9.03	GSH regeneration in diamide-treated high and low GSH Finn erythrocytes	113
10.01	GSH concentrations and amino acid uptake rates in high and low GSH Finn and Merino erythrocytes	127
10.02	Comparison of Finnish Landrace and Tasmanian Merino erythrocyte GSH deficiencies	131

CHAPTER 1

GENERAL INTRODUCTION

PART 1. PREAMBLE

Reduced glutathione (GSH) plays a central role in mammalian erythrocyte metabolism, and in man conditions which lead to a diminished GSH concentration are usually accompanied by a shortened erythrocyte life-span (Beutler, 1972a). Erythrocyte GSH is continuously synthesised from its constituent amino acids (Dimant et al., 1955; Minnich et al., 1971) and removed from the cell by an oxidised glutathione (GSSG) transport system (Srivastava & Beutler, 1969a). The presence of an enzymic system in erythrocytes for GSH degradation has also been suggested (Rouser, et al., 1956; Jackson, 1969; Palekar et al., 1974).

A number of instances of congenital erythrocyte GSH deficiency have been described in man, and attributed to a diminished ability to synthesise GSH (Boivin & Galand, 1965; Prins et al., 1966; Minnich et al., 1971; Konrad et al., 1972). Erythrocyte GSH deficiency results in nonspherocytic haemolytic anaemia, and possibly an increased susceptibility to the haemolytic action of oxidant drugs.

The existence of sheep with genetically controlled low concentrations of erythrocyte GSH was first described by Smith & Osburn (1967) and later by Tucker & Kilgour (1970). The project described in this Thesis is an investigation into the biochemical mechanisms responsible for the erythrocyte GSH deficiency in such animals. During this study a novel enzymic activity was discovered by chance

in a commercial preparation of glucose oxidase from Aspergillus niger. Studies on this enzymic activity are presented separately in the form of an Appendix.

This Chapter is divided into 3 further parts. Relevant aspects of sheep erythrocyte GSH deficiency are considered first (Part 2). This is followed by a discussion of mammalian erythrocyte GSH metabolism and function (Part 3). The objectives of the present project are then outlined in more detail, and the organisation of the remainder of the Thesis is given (Part 4).

PART 2. SHEEP ERYTHROCYTE GSH DEFICIENCY

When the present project was initiated in October 1971, there was little information available on erythrocyte GSH deficiency in sheep. Indeed, only the preliminary studies of Smith & Osburn (1967) and Tucker & Kilgour (1970) had been published, and no serious attempt to investigate the biochemical mechanisms responsible for the GSH deficiency had been described. Since that time, there has been a dramatic increase of interest in this field. Some of the papers published during the course of the present study had an important influence on its direction and scope. These investigations are discussed in this Introduction. Others merely confirmed data already obtained in this project. These studies are not discussed here, but are mentioned in the relevant Chapter of this Thesis. Investigations dealing with the physiological implications of the GSH deficiency are discussed in the General Discussion (Chapter 10, Part 2).

Sheep with low concentrations of erythrocyte GSH were first described by Smith & Osburn (1967). Of 101 sheep (breed unspecified) 3 were found to have erythrocyte GSH concentrations considerably less than those of the rest. It was tentatively suggested that these low concentrations of erythrocyte GSH (less than 20% of normal) were genetically controlled. These investigations were extended by Tucker & Kilgour (1970) who found that the population distribution of erythrocyte GSH in a group of Finnish Landrace sheep (Finns) was

Table 1.01

Amino acid concentrations in high and low GSH Finn erythrocytes

Values are mean  $\pm$  SEM (6) mmol/litre cells (Ellory et al., 1972)

	High GSH	Low GSH
Lysine	0.28 $\pm$ 0.11	7.8 $\pm$ 1.0
Ornithine	0.20 $\pm$ 0.08	5.3 $\pm$ 0.8
Threonine	0	1.13 $\pm$ 0.14
Glutamate	0	0.81 $\pm$ 0.20
Glutamine	0	0.38 $\pm$ 0.14
Serine	0	0.58 $\pm$ 0.32
Glycine	0.28 $\pm$ 0.09	0.45 $\pm$ 0.09
Alanine	0	0.90 $\pm$ 0.16
Tyrosine	0	0.51 $\pm$ 0.09

distinctly bimodal, 22% of the individuals having low concentrations of GSH. Such animals, with erythrocyte GSH concentrations of less than 55 mg/100 ml cells (1.8 mmol/litre cells) were termed low GSH, and the rest high GSH. Genetic data suggested that erythrocyte GSH concentrations were controlled by a single pair of autosomal alleles, the gene for high GSH being dominant to that for low GSH.

A comparison of the cation composition of high and low GSH Finn erythrocytes revealed that low GSH cells of both potassium types (designated HK and LK - see Tucker (1971) and Agar et al. (1971) for reviews of this polymorphism) had a significantly lower  $K^+$  concentration (Tucker & Kilgour, 1970). This reduction in  $K^+$  concentration was paralleled by a reduction in the concentration of erythrocyte  $Na^+$  (Tucker & Ellory, 1971), such that low GSH animals had a diminished ( $Na^+ + K^+$ ) concentration of approximately 20 meq/litre cells. There were no differences in erythrocyte  $Cl^-$  content, mean cell haemoglobin concentration or dry weight between the two GSH types (Tucker & Ellory, 1971). It was therefore suggested that there must be additional cations present in the erythrocytes of low GSH Finn sheep (Tucker & Ellory, 1971).

Low concentrations of erythrocyte GSH in Finns were subsequently found to be associated with extremely high concentrations of intracellular amino acids, particularly ornithine and lysine (Ellory et al., 1972) (Table 1.01). The diminished ( $Na^+ + K^+$ ) content of low GSH Finn erythrocytes is therefore offset by the presence of these cationic amino acids. The correlation between low concentrations of erythrocyte GSH and high concentrations of ornithine and



lysine was not perfect (Ellory et al., 1972). Of 86 low GSH Finns examined, 6 were not ornithine/lysine positive. Because of these exceptions, Ellory et al. (1972) suggested that the association between low GSH and high ornithine and lysine might possibly be attributed to close genetic linkage rather than some form of causal relationship. On this basis the low GSH, ornithine/lysine negative exceptions would be the result of genetic crossing-over. However, if this were the case, the existence of high GSH, ornithine/lysine positive sheep would be expected. No such sheep have yet been found (Ellory et al., 1972; E.M. Tucker, personal communication). The low GSH, ornithine/lysine negative exceptions are more probably the result of misclassification as to GSH type, either as a result of anaemia (Tucker & Kilgour, 1973) or other factors.

Investigations of a different breed of sheep (Tasmanian Merinos) also revealed a substantial number of low GSH animals (Tucker & Kilgour, 1972). Of the Tasmanian Merinos examined, 43% were low GSH. In direct contrast to the situation in Finns, low concentrations of erythrocyte GSH in Tasmanian Merinos were not associated with either a diminished ( $\text{Na}^+ + \text{K}^+$ ) concentration or elevated ornithine and lysine concentrations (Ellory et al., 1972; Tucker & Kilgour, 1972). Furthermore, breeding data suggested that in Tasmanian Merinos, the gene for low GSH was dominant (as opposed to recessive in Finns) (Tucker & Kilgour, 1972). Later investigations revealed a further difference between the Finn and Tasmanian Merino erythrocyte GSH deficiencies. Finn low GSH erythrocytes were found to have a significantly diminished life-span (Tucker, 1974) whereas Tasmanian

Table 1.02

Comparison of the Finnish Landrace, Tasmanian Merino and  
Australian Merino erythrocyte GSH deficiencies

	GSH concentration (% of high GSH)	Frequency (% of population)	(Na <sup>+</sup> + K <sup>+</sup> ) concentration	Ornithine/lysine	Erythrocyte life-span	Inheritance
Finnish Landrace	32	22	diminished	present	diminished	recessive
Tasmanian Merino	28	43	normal	absent	normal	dominant
Australian Merino	40	22	normal	absent	?	recessive

Merino low GSH erythrocytes had a normal life-span ( Tucker, 1975 ). The similarities and differences between the Finn and Tasmanian Merino erythrocyte GSH deficiencies are summarised in Table 1.02.

These studies strongly suggest the existence of two distinct low GSH genes in two different genetic loci, one low GSH gene (h) found predominantly in Finns, and the other (L) in Tasmanian Merinos. On this basis low GSH Finns would have the genotype (hh,11) and high GSH Finns the genotype (Hh,11) or HH,11). Similarly, low GSH Tasmanian Merinos would have the genotype (HH,L1) or (HH,LL) and high GSH Tasmanian Merinos, the genotype (HH,11).

Erythrocyte GSH deficiency has subsequently been described in the Australian Merino, Chokla, Magra and Marwari breeds of sheep (Agar et al., 1972; Kalla et al., 1972). Low GSH in Australian Merinos is inherited in an autosomal recessive manner (Board et al., 1974). Erythrocytes from these animals are not ornithine/lysine positive. This raises the interesting possibility of a third type of GSH deficiency (see Table 1.02). There is no information available on the type of GSH deficiency found in the other 3 breeds.

It might be anticipated that some sheep populations contain more than one type of GSH deficiency. This seems to be the case for the Awassi sheep of Israel (Tucker et al., 1973). Analysis of the population distribution of erythrocyte GSH revealed a substantial number of low GSH animals. Some low GSH individuals had normal erythrocyte ( $\text{Na}^+ + \text{K}^+$ ) concentrations whereas others had diminished ( $\text{Na}^+ + \text{K}^+$ ) concentrations. Only those low GSH animals with a

reduced erythrocyte ( $\text{Na}^+ + \text{K}^+$ ) concentration were ornithine/lysine positive (Tucker et al., 1973). The amino acid compositions of low GSH Finn and Awassi (ornithine/lysine positive) erythrocytes are very similar, with ornithine and lysine the predominant amino acids in both instances.

A recent study has suggested that goats also exhibit erythrocyte GSH deficiency (Agar et al., 1974). However the evidence is not convincing. The difference in GSH concentration between the supposed GSH types is much smaller than that found in sheep.

These studies suggest that there may be three distinct types of erythrocyte GSH deficiency in sheep. The present investigation into the biochemical mechanism(s) responsible for sheep erythrocyte GSH deficiency included the study of both Finns and Tasmanian Merinos.

### PART 3. GSH METABOLISM AND FUNCTION IN MAMMALIAN ERYTHROCYTES

#### Section 3.01 Introduction

In Sections 3.02 and 3.03, current concepts of mammalian erythrocyte GSH metabolism and function are discussed. The studies reviewed in these Sections form the background to both the biochemical investigations described in Chapters 3-9 and to the discussion in Chapter 10 of the physiological implications of the sheep erythrocyte GSH deficiencies.

#### Section 3.02 GSH metabolism in mammalian erythrocytes

GSH is a tripeptide of glutamate, cysteine and glycine ( $\gamma$ -glutamyl cysteinyl glycine) and therefore has a highly reactive thiol group. When oxidised, it forms a disulphide bond between the cysteine groups of GSH. Mammalian erythrocytes contain high concentrations of GSH (approximately 3 mmol/litre cells) (Smith, 1974). Various workers have reported that 2.5 - 15% of the total erythrocyte glutathione is in the oxidised form (GSSG) (Srivastava & Beutler, 1968a). However, with the earlier techniques, a portion of the GSH was oxidised to GSSG during protein precipitation. This GSH oxidation was probably caused by hydrogen peroxide generated by the acidification of oxyhaemoglobin (Lemberg, 1942). Thus most of the GSSG measured in such protein-free filtrates represented an artifact. If precautions are taken to prevent GSH oxidation (by prior alkylation with N-ethylmaleimide (NEM)), it can be demonstrated that GSSG only represents about 0.25% of the total erythrocyte glutathione (Srivastava & Beutler, 1968a).

### The synthesis and turnover of GSH

Mammalian erythrocytes have the enzymic capacity to carry out both the steps of GSH biosynthesis from the constituent amino acids (Boivin & Galand, 1965; Sass, 1968; Jackson, 1969; Minnich et al., 1971; Smith, 1974). The first reaction is catalysed by  $\gamma$ -glutamyl cysteine synthetase (GC-S) (EC 6.3.2.2) and results in the formation of  $\gamma$ -glutamyl cysteine (GC):

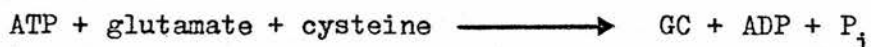

The second reaction is catalysed by GSH synthetase (GSH-S) (EC 6.3.2.3) and results in the formation of GSH:

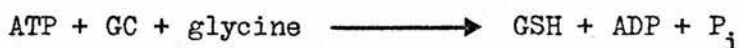

Human erythrocytes have sufficient enzymic capacity to synthesise their entire complement of GSH within 60 min. (Minnich et al., 1971). Attempts to measure the in vivo rate of erythrocyte GSH turnover have relied on the use of [ $^{14}\text{C}$ ] glycine or [ $^{15}\text{N}$ ] glycine (Dimant et al., 1955; Elder & Mortensen, 1956; Mortensen et al., 1956; Smith, 1974). Estimates of erythrocyte GSH turnover using isotopic glycine have been made for a number of mammalian species. There are considerable species differences. For example in the rat, the half-life of erythrocyte GSH is 3 days, compared with a value of 10.9 days in the sheep (Elder & Mortensen, 1956; Smith, 1974).

The use of isotopic glycine to monitor erythrocyte GSH turnover

Table 1.03

The effect of substrate availability on the activities of the enzymes of GSH biosynthesis in human erythrocytes

	$V_{\max}^1$	$K_m^2$	Erythrocyte concentration <sup>3</sup>	$S:(K_m+S)$
	( $\mu\text{mol/gHb}$ per min)	(mM)	(mmol/litre cells)	
	ATP	0.43	1.33 <sup>4</sup>	0.75
GC-S	Glutamate	0.43	0.22	0.09
	Cysteine	0.30	0.014	0.04
	ATP	0.50	1.33 <sup>4</sup>	0.73
GSH-S	Glycine	0.19	0.26	0.42
	GC	0.20	-	-

1. Minnich et al., 1971

2. Majerus et al., 1971

3. Levy, 1971

4. Beutler, 1971.

has been criticised on the grounds that erythrocyte GSH-S may be able to catalyse an exchange reaction between glycine and preformed GSH. Yeast GSH-S can certainly catalyse such an exchange reaction (Snoke & Bloch, 1955). If this were the case in erythrocytes, the use of isotopic glycine would result in an over-estimate of the rate of GSH turnover. However, the validity of using isotopic glycine for erythrocyte GSH turnover studies has been demonstrated by in vivo studies in the rat (Mortensen et al., 1956). Using [ $^{14}\text{C}$ ] glycine, it was found that erythrocyte GSH was labelled in all 3 amino acids (the part conversion of glycine into glutamate and cysteine must have occurred before entry into the erythrocytes). The relative distribution of this radioactivity in each of the 3 amino acids of GSH remained constant throughout the experiment, indicating the absence of exchange reactions.

These turnover studies suggest firstly that mammalian erythrocytes are continuously synthesising GSH (the turnover of GSH is much faster than the turnover of the erythrocytes themselves) and secondly that, in vivo, both the enzymes of GSH biosynthesis are probably operating at well below their maximum capacities. The control of erythrocyte GSH biosynthesis is thought to involve both substrate availability and metabolic inhibition by various cell constituents including GSH itself (Jackson, 1969; Smith, 1973). Assuming simple Michaelis-Menten kinetics (Majerus et al., 1971) it is possible to assess the influence of substrate concentrations on enzyme activity from the ratio  $S:(K_m + S)$  where  $S$  is the substrate concentration and  $K_m$  is the Michaelis constant. The human erythrocyte  $S:(K_m + S)$  values for glutamate, cysteine, glycine and ATP are given in Table 1.03. These



data suggest that the concentrations of cysteine and glutamate are severely rate limiting. The question of substrate availability is discussed more fully in Chapter 6. The rate of GSH synthesis in human erythrocytes may also be controlled by GSH feedback inhibition of GC-S (Jackson, 1969). This inhibition of GC-S by GSH is probably an important regulatory mechanism for maintaining erythrocyte GSH concentrations. GC-S is also inhibited by NADH and to a lesser extent by  $\text{NAD}^+$  and NADPH. GSH-S is inhibited by ADP (Jackson, 1969).

Although the synthesis of GC requires cysteine, it is possible that this amino acid enters the erythrocyte as cystine since the oxidised form of the amino acid predominates in plasma (Lorber *et al.*, 1970). The incorporation of [ $^{35}\text{S}$ ] cystine into GSH in intact human erythrocytes has been demonstrated *in vitro* (Miller & Horuichi, 1962). The mechanism of cystine reduction is unclear, but possibilities include thiol-disulphide exchange with GSH, or reaction with NAD(P)H. These reactions may or may not be enzyme-catalysed (Jocelyn, 1972). It is also possible that glutamate enters the erythrocyte as glutamine since *in vitro* studies with intact human erythrocytes have demonstrated that [ $^{14}\text{C}$ ] glutamine is more rapidly incorporated into GSH than [ $^{14}\text{C}$ ] glutamate (Miller & Horuichi, 1962; Hochberg *et al.*, 1964; Prins *et al.*, 1966). This has been attributed to the low permeability of erythrocytes to glutamate (Winter & Christensen, 1964). The conversion of glutamine to glutamate is achieved by glutaminase (EC 3.5.1.2) which is present in erythrocytes (Rapoport, 1961). It has also been suggested that plasma  $\alpha$ -keto glutarate may serve as a glutamate precursor (Sass, 1963).

GSSG and protein-glutathione mixed disulphide reduction

The major role of GSH in the erythrocyte is probably the protection of the cell against oxidative damage (see Section 3.03). In so doing, GSH is oxidised to GSSG and possibly protein-glutathione mixed disulphides. GSSG may also be generated by GSH autoxidation. GSH is regenerated by the action of glutathione reductase (GSSG-R) (EC 1.6.4.2) (Srivastava & Beutler, 1970 & 1972) which catalyses the reactions:



Although GSSG-R can utilise both NADPH and NADH, the rate of reaction with NADPH is much greater than with NADH, and in intact human erythrocytes, NADPH generated by the hexose monophosphate pathway is the preferred cofactor (Beutler & Yeh, 1963; Rieber et al 1968). Normally, only a small fraction of the glucose metabolised by erythrocytes is utilised by the hexose monophosphate pathway, because its rate is governed by the rate of NADPH oxidation. Substances which stimulate GSH oxidation in erythrocytes cause a marked increase in hexose monophosphate pathway activity (Jacob & Jandl, 1966). Human erythrocytes have the ability to regenerate their entire complement of GSH from GSSG within 30 min (Smith, 1968; Kosower et al., 1969) but erythrocytes with a diminished activity of glucose-6-phosphate dehydrogenase (G-6-PD), the first enzyme of the hexose monophosphate pathway, can only regenerate GSH from

GSSG slowly (Smith, 1968).

Sheep erythrocytes have a low G-6-PD activity compared with human erythrocytes (Smith, 1968). Indeed, the G-6-PD activity of normal sheep erythrocytes as measured in dilute haemolysates is approximately the same as that found in G-6-PD deficient human erythrocytes. However, intact sheep erythrocytes can regenerate GSH from GSSG at a rate similar to that found in normal human cells (Smith, 1968). The possibility has therefore been considered that sheep erythrocyte GSSG-R may utilise NADH (generated by glycolysis) rather than NADPH. However, Smith & Anwer (1971) recently demonstrated that human erythrocyte G-6-PD is inhibited by physiological concentrations of ATP whereas the sheep enzyme is not. It is therefore probable that the activity of G-6-PD in intact human and sheep erythrocytes is similar despite the differences in activity encountered in dilute haemolysates.

#### The active transport of GSSG from erythrocytes

GSSG-R serves to keep the erythrocyte concentration of GSSG low. It has been suggested that an additional mechanism for maintaining low GSSG concentrations is the active transport of GSSG from the erythrocyte (Srivastava & Beutler, 1967, 1968b, 1969a).

Until recently the erythrocyte membrane was believed impermeable to GSH and GSSG (Eldjarn et al., 1962). However, Srivastava & Beutler (1967) demonstrated that oxidation of GSH to GSSG leads to a considerable loss of the latter from the cell. This loss of GSSG can occur against a concentration gradient, and requires the

expenditure of energy (presumably ATP). It has therefore been suggested that erythrocytes possess an active transport mechanism for the extrusion of GSSG. This transport mechanism has been demonstrated in a number of mammalian species including sheep (Srivastava & Beutler, 1969b).

In order to demonstrate GSSG efflux from erythrocytes, it is first necessary to oxidise a substantial portion of the intracellular GSH to GSSG. These investigations have therefore been criticised on the basis that the loss of GSSG from the cell might be the result of oxidative damage to the cell rather than the work of a specific transport system (Jocelyn, 1972). However, if this were the case, it is difficult to understand why such a process should require the expenditure of energy.

#### GSH degradation

The in vivo [ $^{14}\text{C}$ ] glycine studies discussed earlier suggest that erythrocyte GSH is continuously turning over. Since erythrocytes seem to be impermeable to extracellular GSSG and GSH and intracellular GSH, it might be expected that the major contributor to this turnover is GSSG efflux from the cell and that GSH is synthesised only to replace that lost by this process. The feedback inhibition of GSH biosynthesis by GSH is particularly interesting in this respect.

It has been suggested that GSH degradation also contributes to the turnover of erythrocyte GSH (Rouser, <sup>et al.</sup> 1956; Jackson, 1969; Palekar et al., 1974). The catabolism of GSH requires the initial removal of the  $\gamma$ -glutamyl group. This is followed by the hydrolysis of the cysteinyl glycine. The  $\gamma$ -glutamyl group may be

Fig. 1.01

γ-glutamyl cycle and its postulated role in amino acid transport

1. γ-glutamyl transpeptidase
2. γ-glutamyl cyclotransferase
3. 5 - oxoprolinase
4. GC-S
5. GSH-S
6. Peptidase

converted to glutamate, to the cyclic product 5-oxoproline or, by transfer to the amino group of a suitable acceptor, to another

$\gamma$ -glutamyl peptide:

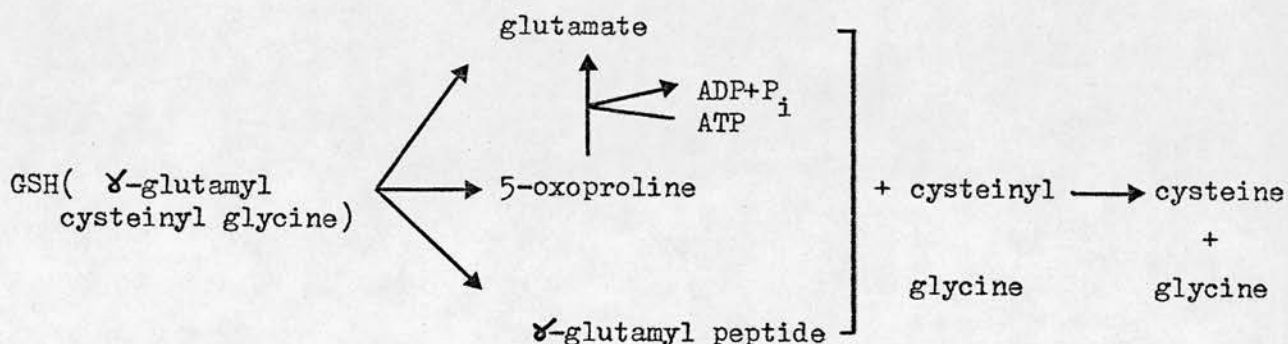

The hydrolysis and transfer reactions are catalysed by  $\gamma$ -glutamyl transpeptidase (EC 2.3.2.2) and the cyclisation by  $\gamma$ -glutamyl cyclotransferase (EC 2.3.2.4). The conversion of 5-oxoproline to glutamate is achieved by 5-oxoprolinase. The enzymes of GSH biosynthesis and degradation form the  $\gamma$ -glutamyl cycle. In some tissues, notably the kidney, intestine and brain, this cycle has been postulated to have a role in amino acid transport (Meister, 1973) (Fig. 1.01).

Jackson (1969) tried to demonstrate the presence of  $\gamma$ -glutamyl transpeptidase in human erythrocytes, but the evidence was not convincing. The enzyme activity reported was very small, representing the breakdown of only a small fraction of the total GSH in the reaction mixture. Although the reaction mixture was gassed with oxygen-free argon, the possibility remains that the disappearance of GSH from the reaction system was the result of GSH oxidation

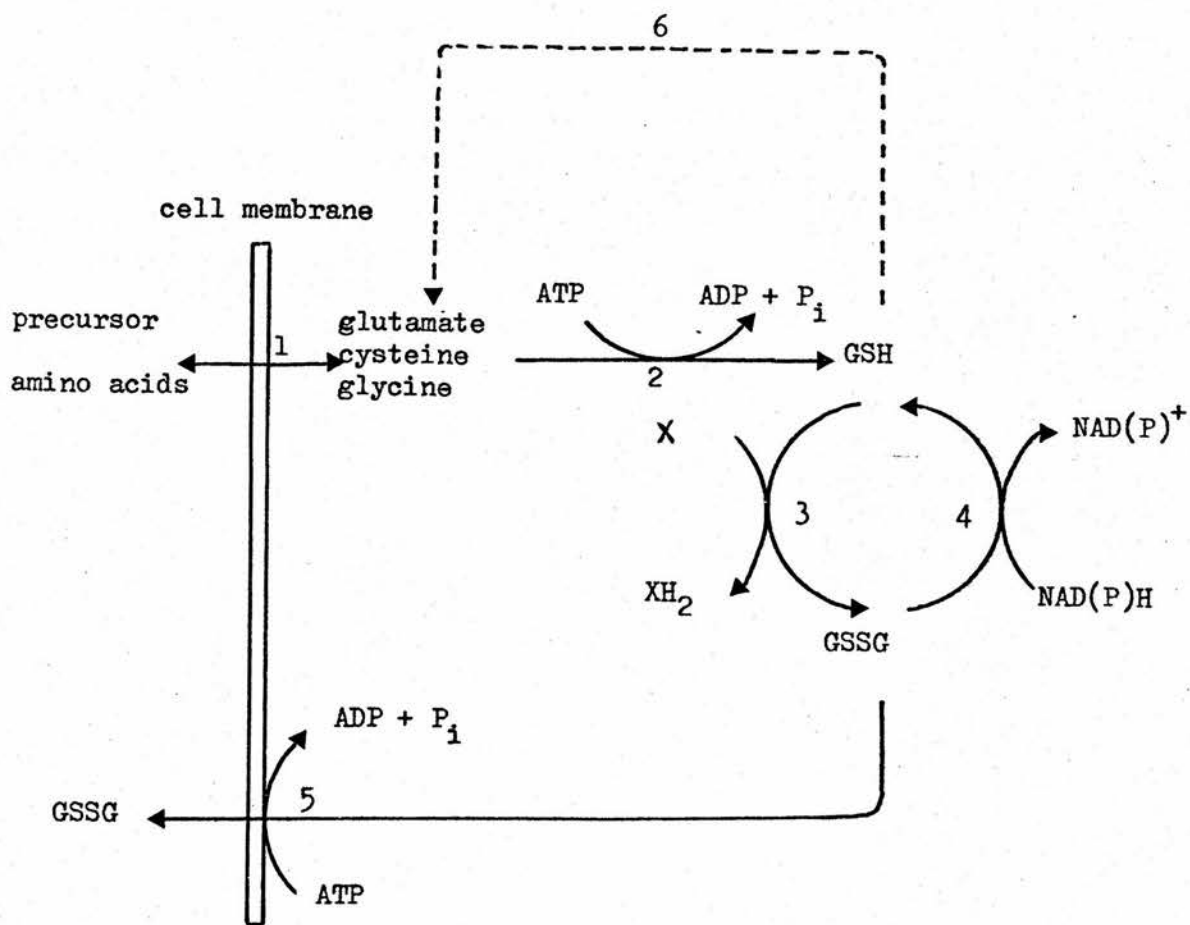

Fig. 1.02

Glutathione metabolism in mammalian erythrocytes

1. Amino acid transport
2. GC-S and GSH-S
3. GSH oxidation
4. GSSG-R
5. ATP dependent GSSG efflux
6. GSH degradation



rather than GSH degradation (incubation GSSG concentrations were not measured). In addition, it is also possible that any GSH degradation was the result of leucocyte contamination of the erythrocyte preparation. Subsequent attempts to demonstrate the presence of  $\gamma$ -glutamyl transpeptidase and  $\gamma$ -glutamyl cyclotransferase in human erythrocytes have been unsuccessful (Majerus *et al.*, 1971; Srivastava, 1971). The situation in human erythrocytes however is in contrast to that in rabbit erythrocytes where substantial activities of the GSH degradation enzymes have been found (Palekar *et al.*, 1974). Further investigations will be required to assess the magnitude of GSH degradation in mammalian erythrocytes and its contribution to GSH turnover.

The metabolism of erythrocyte GSH is summarised in Fig. 1.02.

### Section 3.03 The function of GSH in mammalian erythrocytes

The major role of GSH in the erythrocyte is thought to be the protection of the cell against oxidative damage, the GSH-GSSG couple acting as a redox buffering system. Evidence for this role has arisen mainly from studies of human erythrocytes with a variety of congenital defects.

Such a congenital defect is erythrocyte G-6-PD deficiency. This is the most widely distributed and best known of the erythrocyte congenital defects in man, and over 40 different aberrant forms of the enzyme have been described (Beutler, 1972a). Without this enzyme the hexose monophosphate pathway cannot function, and GSSG once formed cannot be reduced back to GSH. The GSH concentration and

life-span of G-6-PD deficient erythrocytes is generally normal, or nearly so, until the cells are exposed to an abnormal stress (Srivastava & Beutler, 1968c; Beutler, 1969). Such a stress may be provided by the administration of therapeutic doses of a variety of drugs. Under these circumstances there is a marked drop in the cellular GSH concentration and a dramatic shortening of the erythrocyte life-span, resulting in severe haemolytic anaemia. Therapeutic doses of such drugs do not have this effect on erythrocytes with a normal complement of G-6-PD. A large number of drugs are known to induce severe haemolytic anaemia in G-6-PD deficient patients. These include a number of antimalarials, sulphonamides, nitrofurans, antipyretics and analgesics (Hochstein, 1971). These haemolytic agents form a heterogeneous group, but they or their metabolites share a common ability to act as biological oxidants (Emerson *et al.*, 1941; Jandl *et al.*, 1960; Jandl, 1963). The interaction of these agents with either oxyhaemoglobin or free molecular oxygen results in the formation of hydrogen peroxide ( $H_2O_2$ ) in the erythrocyte (Cohen & Hochstein, 1964). Under normal circumstances, this  $H_2O_2$  is decomposed by the action of glutathione peroxidase (GSH-Px) (EC 1.11.1.9) (Mills, 1957; Cohen & Hochstein, 1963) which catalyses the reaction:

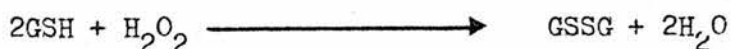

The role of catalase (EC 1.11.1.6) in destroying drug-generated  $H_2O_2$  has been the subject of much discussion and investigation. The available evidence favours the view that GSH-Px with its lower  $K_m$  for  $H_2O_2$  is the predominant route of  $H_2O_2$  decomposition in the

erythrocyte (Aebi & Suter, 1969; Hochstein, 1971). The importance of GSH-Px rather than catalase in this respect is supported by the study of congenital erythrocyte GSH-Px and catalase deficiency in man (Jacob *et al.*, 1965; Necheles *et al.*, 1970). Of the two, only GSH-Px deficiency seems to result in an increased susceptibility to drug-induced haemolytic anaemia. Indeed, no obvious deleterious effects can be attributed to erythrocyte catalase deficiency (Beutler, 1972b). It is possible therefore that catalase in <sup>the</sup>erythrocyte serves only as a second line of defence against  $H_2O_2$  accumulation with GSH-Px acting as the primary defence.

In the absence of adequate G-6-PD and GSH-Px activity, the haemolytic agents discussed earlier cause the accumulation of  $H_2O_2$  in the erythrocyte. This results in the conversion of haemoglobin to methaemoglobin, progressive oxidation of globin sulphhydryl groups, and finally the precipitation of denatured haemoglobin in the cell as spherical refractile inclusions known as Heinz bodies (Jandl *et al.*, 1960; Allen & Jandl, 1961; Harley & Mauer, 1961). Heinz bodies are the final stage of oxidative destruction of haemoglobin. Heinz body-containing erythrocytes have altered plastic properties which result in their being selected for premature destruction by the spleen, reticuloendothelial system, and other organs (Rifkind, 1965). Intra-vascular lysis can also be the fate of oxidatively injured erythrocytes (Dern *et al.*, 1954; Greenberg & Wong, 1961; Tarlov *et al.*, 1962; Weed & Reed, 1966; Salvidio *et al.*, 1967). This lysis does not occur solely due to degeneration of haemoglobin (Harley & Mauer, 1961). The final effect is on the cell membrane (Jacob & Jandl, 1962a; 1962b). Although not understood as well as the sequential

oxidative changes of haemoglobin, an analogous series of reactions probably affects membrane proteins and lipids causing cell lysis (Carson, 1960; Jacob & Jandl, 1962a; Tarlov et al., 1962). One such reaction is lipid peroxidation (Hochstein, 1966).

Besides participating in the GSH-Px reaction, GSH may also protect the erythrocyte by reversing  $H_2O_2$ -induced oxidative changes. For example GSH may reduce protein disulphides by thiol-disulphide exchange (Pihl et al., 1957), perhaps involving GSSG-R since this enzyme can reduce protein-GSH mixed disulphides (including that of haemoglobin) (Srivastava & Beutler, 1970 & 1972). A possible sequence of reactions is

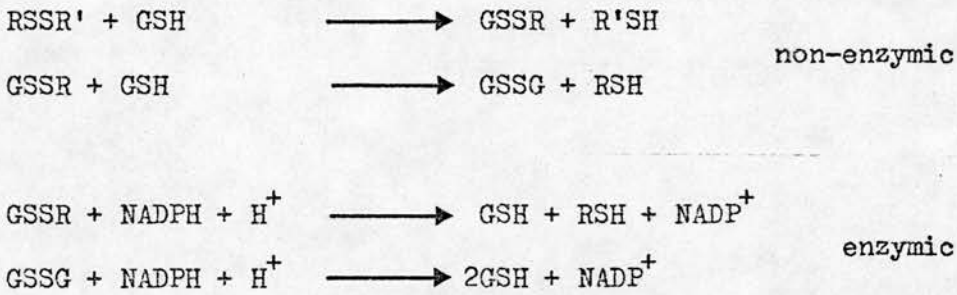

In addition, GSH may reduce lipid peroxides, and it has been suggested that vitamin E ( $\alpha$ -tocopherol) may assist GSH in protecting membrane lipids against peroxidation (Hochstein, 1966). In this connection it is noteworthy that vitamin E-deficient erythrocytes have a greater susceptibility to haemolysis upon exposure to  $H_2O_2$  in vitro than do cells with normal vitamin E contents (Nitowsky et al., 1956). However, the precise relationship between GSH and vitamin E in the defence against peroxidative damage is obscure.

In addition to the effect of  $H_2O_2$ , it is possible that direct oxidation of cellular constituents by the oxidant drugs or their metabolites may contribute to the oxidative damage of the cell (Jacob & Jandl, 1966). GSH may also protect the cell in these circumstances by being preferentially oxidised or by reversing these oxidative changes.

GSH therefore plays an important role in the protection of the cell against the action of oxidant drugs. Studies of G-6-PD deficient erythrocytes have also revealed other ways in which erythrocytes are subject to oxidative stress. In particular, haemolytic episodes in G-6-PD deficient patients have been associated with various types of infection (Beutler, 1965; Burka et al., 1966) and it has been suggested that generation of  $H_2O_2$  by phagocytosing leucocytes may trigger the haemolytic episode (Boehner et al., 1970). In some G-6-PD deficient patients, severe haemolysis occurs on ingestion of fava beans. Although not all G-6-PD deficient individuals develop this disorder (favism), subjects who exhibit favism are usually G-6-PD deficient. It is not clear what the haemolytic principle in fava beans is, but one possible candidate is L-DOPA (L-dihydroxyphenylalanine) (Kosower et al., 1967; Beutler, 1970). Fava beans are a rich source of L-DOPA, and it has been suggested that the enzymic oxidation product of L-DOPA, DOPA-quinone might be the active principle and that sensitivity to the haemolytic effect of the bean may depend on inherited variation in the metabolism of L-DOPA (Beutler, 1970).

The importance of GSH to erythrocyte integrity is further demonstrated by studies of congenital erythrocyte GSH deficiency. In 1961 almost complete absence of erythrocyte GSH (10% or less of normal)

was demonstrated in some members of a Dutch family exhibiting nonspherocytic haemolytic anaemia (Oort et al., 1961). Since that time, a number of additional cases of erythrocyte GSH deficiency in man have been reported (Boivin & Galand, 1965; Prins et al., 1966; Minnich et al., 1971; Konrad et al., 1972). These low concentrations of erythrocyte GSH are inherited in an autosomal recessive manner, and are associated with a diminished activity of one or other of the enzymes of GSH biosynthesis. In direct contrast to the situation with G-6-PD deficiency, GSH deficient erythrocytes show a markedly diminished lifespan even in the absence of obvious oxidant stress. The haemolytic anaemia associated with GSH deficiency is potentiated by the administration of oxidant drugs or the ingestion of fava beans (Prins et al., 1966).

Although the investigation of erythrocyte GSH deficiency has clearly demonstrated the importance of GSH in maintaining erythrocyte viability even in the absence of any obvious oxidant stress, it is by no means clear what the role of GSH is in these circumstances. It is possible that GSH has some additional metabolic function distinct from its redox buffering role. In this connection it is noteworthy that GSH is an obligatory cofactor of the glyoxalase system (EC 4.4.1.5 & 3.1.2.6), and that the activity of this enzyme is considerably reduced in GSH deficient erythrocytes (Prins et al., 1966). However, the precise role of glyoxalase in erythrocytes remains unclear. GSH deficient erythrocytes show a normal glycolytic and hexose monophosphate pathway activity, and the cellular concentration of ATP is also normal (Prins et al., 1966). The normal

metabolic activity of GSH deficient erythrocytes cannot be taken as an unequivocal evidence that GSH has no influence on these processes, since the cells remaining in the circulation are still viable, whereas those which might have been anticipated to show some effect have already been removed from the circulation.

It is also possible that erythrocytes are subject to a continuous background oxidant stress of endogenous origin which is distinct from, and smaller in magnitude than, that induced by oxidant drugs, infection, or ingestion of fava beans. One such source of oxidant stress may be ascorbic acid which interacts with oxyhaemoglobin to form  $H_2O_2$  (Srivastava, 1971). The premature destruction of GSH deficient erythrocytes may result from the inability of the very low concentrations of GSH to protect the cell in these circumstances. The viability of G-6-PD deficient cells in the same circumstances could be attributed to their almost normal GSH concentration and residual G-6-PD activity.

The importance of GSH to erythrocyte integrity in the unstressed state has also been investigated by alkylating virtually all of the GSH in erythrocytes with NEM and then reinfusing such cells back into the circulation and measuring their survival (Allen & Jandl, 1961). It was found that the survival of these cells was not impaired. This is in contrast to the situation in congenital erythrocyte GSH deficiency where there is a marked impairment of erythrocyte survival. However, it has subsequently been demonstrated that the alkylation product of GSH and NEM is rapidly split non-enzymically in the erythrocyte to regenerate GSH and a derivative of

NEM which can no longer bind GSH (Beutler et al., 1970). Consequently these alkylation experiments are invalid.

Therefore although the protective capabilities of GSH are well recognised and documented, it is by no means clear what the role of GSH is under normal circumstances in the absence of known exogenous oxidative stress. Investigations of this problem by artificially depleting erythrocytes of GSH have been unsuccessful, and the most likely source of further progress in this area is the study of erythrocyte GSH deficiency. Unfortunately, erythrocyte GSH deficiency in man is extremely rare. The discovery of sheep with genetically controlled low concentrations of erythrocyte GSH is therefore of particular interest, and it may be anticipated that detailed study of these animals will provide further insights into the role of GSH in the erythrocyte.



PART 4. THE OBJECTIVES OF THE PRESENT PROJECT AND THE ORGANISATION OF THE REMAINDER OF THE THESIS

The major objective of the present project was to ascertain the biochemical mechanism(s) responsible for erythrocyte GSH deficiency in sheep. Evidence presented earlier suggests that there may be three distinct types of deficiency, one found in the Finnish Landrace breed, another in Tasmanian Merinos and a third in Australian Merinos (Part 2 of this Chapter). The present investigation includes a study of both Finnish Landrace and Tasmanian Merino sheep.

The remainder of this Thesis is subdivided into 9 Chapters and 1 Appendix. In Chapter 2 the origins of the sheep used in the present study are described. This Chapter also includes a description of some routine methods. Chapter 3 describes the methods used to classify animals as to GSH type as well as the results of a large scale screening programme to identify GSH deficient animals. The purposes of this screening programme were three-fold. First, to assess the population distribution of erythrocyte GSH concentration in the animals which were available for study. Second, to select individual animals for further detailed investigation; and third, to determine the relationships if any between known animal variables such as sex, age, haemoglobin type and potassium type and erythrocyte GSH concentration.

The method of erythrocyte GSH estimation used here and elsewhere employs the non-specific thiol reagent DTNB (5,5'-dithiobis-(2-nitrobenzoate)). The validity of equating total DTNB-reactive thiol with GSH is established with minor reservations in Chapter 4. The

erythrocyte GSSG concentrations in high and low GSH Finnish Landrace and Tasmanian Merino sheep are also described in this Chapter, and it is established that low GSH erythrocytes of both breeds have a low content of total glutathione (GSH + 2GSSG). The GSH and GSSG estimates are used to calculate the redox potential of the GSH:GSSG couple in high and low GSH Finnish Landrace and Tasmanian Merino erythrocytes. Chapters 5 - 9 describe investigations of the biochemical mechanism(s) responsible for the low concentrations of erythrocyte GSH in these breeds and Chapter 10 is a general discussion of the data presented in the preceding Chapters.

During these investigations, a novel enzymic activity was discovered by chance in a commercial preparation of glucose oxidase (EC 1.1.3.4) from Aspergillus niger (Fermcozyme 653AM, Hughes & Hughes Ltd., Romford, Essex, U.K.). Studies on this enzymic activity are presented separately in the form of an Appendix.

CHAPTER 2

MATERIALS AND GENERAL METHODS

PART 1. ANIMALS

The Finnish Landrace and Tasmanian Merino sheep used in this investigation were maintained by the Agricultural Research Council Animal Breeding Research Organisation, Edinburgh. The Finnish Landrace sheep were descended from 4 rams and 10 ewes brought from widely dispersed places in Finland in 1963. The Tasmanian Merinos originated from 3 rams and 12 ewes of the Tasmanian fine-woolled strain imported from Tasmania in 1955. The two flocks are regarded as genetically distinct populations rather than as representatives of the breeds. In the remainder of this Thesis, Finnish Landrace and Tasmanian Merino sheep are referred to as Finns and Merinos respectively.

PART 2. THE PREPARATION OF WASHED ERYTHROCYTES

Blood was collected by jugular venepuncture into heparinised Vacutainers (Becton, Dickinson & Co., Rutherford, New Jersey, U.S.A.) and kept on ice. All animals were at least 7 months old at the time of bleeding. Erythrocytes were washed 3 times with 4 volumes of 0.9% (w/v) NaCl, and the buffy coat and upper layer of erythrocytes were removed. The erythrocyte: leucocyte ratio of the final cell preparation was never less than 1000:1. Erythrocyte and leucocyte counts were kindly performed by Mr. P.F.J. Newman, Dept. of Haematology, Royal Infirmary, Edinburgh.

Table 2.01

The concentration of haemoglobin in high and low GSH  
Finn and Merino erythrocytes

Animals were selected to be of the same age, sex, potassium type and haemoglobin type (see Chapter 3, Part 7). Values are mean  $\pm$  SEM (3). The means are not significantly different in either breed (Student's t-test).

		Haemoglobin concentration (g/ml cells)
Finn	High GSH	0.332 $\pm$ 0.008
	Low GSH	0.337 $\pm$ 0.015
Merino	High GSH	0.342 $\pm$ 0.011
	Low GSH	0.348 $\pm$ 0.011

PART 3. REAGENTS

[ $^{14}\text{C}$ ] glutamate and [ $^{14}\text{C}$ ] glycine were obtained from the Radiochemical Centre, Amersham, U.K. ( $\gamma$ -glutamyl) $_2$ -cystine was purchased from the Cyclo Chemical Corporation, Los Angeles, California, U.S.A. Enzymes were obtained from the Boehringer Corporation (London) Ltd., U.K. All other reagents were of the highest grade commercially available.

PART 4. ENZYME AND OTHER ASSAYS

In general, enzyme activities were determined by methods established for human erythrocytes. No special attempts were made to optimise assay conditions for sheep erythrocyte enzymes, and activities are expressed as  $\mu\text{mol}$  product formed/g haemoglobin (Hb) per min. The use of haemoglobin for comparing enzyme activities is valid because there is no significant difference in haemoglobin concentration between high and low GSH erythrocytes in either Finns or Merinos (Table 2.01). The concentrations of cell constituents are expressed as mmol or  $\mu\text{mol}$ /litre cells. All estimations were performed within 12 h of bleeding.

Haemoglobin concentrations were estimated by the cyanmethaemoglobin method (Kampen & Zijlstra, 1961; Boehringer Biochemica Test Combination). To 20  $\mu\text{l}$  of blood or equivalent haemolysate was added 5 ml of a solution containing 1 mM  $\text{KH}_2\text{PO}_4$ , 0.75 mM KCN, 0.6 mM  $\text{K}_3\text{Fe}(\text{CN})_6$  and 0.05% (v/v) detergent ("Sterox SE",

Hartman-Leddon Co., Philadelphia, U.S.A.) Mixtures were allowed to stand at room temperature for a minimum of 3 min and read at 546 nm in a Unicam SP500 spectrophotometer (Unicam Instruments Ltd., Cambridge, U.K.) against a reagent blank. One g Hb/ml had an extinction of 2.720. Haematocrits were obtained using a micro-haematocrit centrifuge (10 min spin) (Gelman-Hawksley, Lancing, Sussex, U.K.).

A number of assay methods described in this Thesis employ an AutoAnalyser (Technicon Instruments Ltd., Chertsey, Surrey, U.K.). The principles of the AutoAnalyser were enunciated by Skeggs (1957), and the way in which it is used in this laboratory is described in the Theses of Gilbert (1963), O'Brien (1969) and Nimmo (1970).

CHAPTER 3

ANIMAL CLASSIFICATION (GSH TYPE)



PART 1. INTRODUCTION

Sheep are allotted their GSH type on the basis of their erythrocyte total non-protein reduced thiol concentration as determined by the nonspecific thiol reagent 5,5'-dithiobis-(2-nitrobenzoate) (DTNB) (Smith & Osburn, 1967; Tucker & Kilgour, 1970; Agar et al., 1972; Kalla et al., 1972). The classification of animals on this basis was also followed here. In the next Chapter (Chapter 4, Part 2) the validity of equating total DTNB reactive thiol with GSH is established with minor reservations, and it is demonstrated that for both Finns and Merinos the differences in DTNB reactivity between the two cell types is in fact due to different concentrations of GSH.

The presence of very high concentrations of ornithine and lysine in low GSH but not high GSH Finn erythrocytes allows an additional and independent method of GSH type classification in Finns (Ellory et al., 1972). This method of classification, although not employed routinely, was used to confirm GSH type classification by the DTNB method in a number of animals. Neither high nor low GSH Merino erythrocytes contain appreciable concentrations of ornithine and lysine (Ellory et al., 1972). A number of high and low GSH Merinos were screened for the presence of erythrocyte ornithine and lysine to test these observations. In addition to GSH type classification, animals were also classified as to haemoglobin and potassium type (Tucker, 1971). The classification of animals as

to haemoglobin and potassium type was performed by Dr. J.G. Hall of the Agricultural Research Council Animal Breeding Research Organisation, Edinburgh by established methods (Hall & Hunter, 1973).

Initially, large numbers of Finns and Merinos were screened for low concentrations of erythrocyte GSH. The purposes of this screening programme were threefold:

1. To assess the population distribution of erythrocyte GSH concentration in the animals which were available for study.
2. To select individual animals for further detailed investigation.
3. To determine the relationships if any between known animal variables such as sex, age, haemoglobin type and potassium type and erythrocyte GSH concentration.

In this Chapter the method employed to determine the population distributions of erythrocyte GSH is described (Part 2). This is followed by an analysis of the data obtained for both Finns and Merinos (Part 3). The correlation between GSH type and the presence of erythrocyte ornithine and lysine is then given for a representative group of animals (Part 4). Part 5 of this Chapter consists of an analysis of heterozygote GSH concentrations in both Finns and Merinos, and in Part 6, the relationship between known animal variables and erythrocyte GSH concentration in both breeds is analysed. Finally, the criteria used for the selection of individual animals for further detailed study are given (Part 7). The results of these investigations are discussed in Part 8.

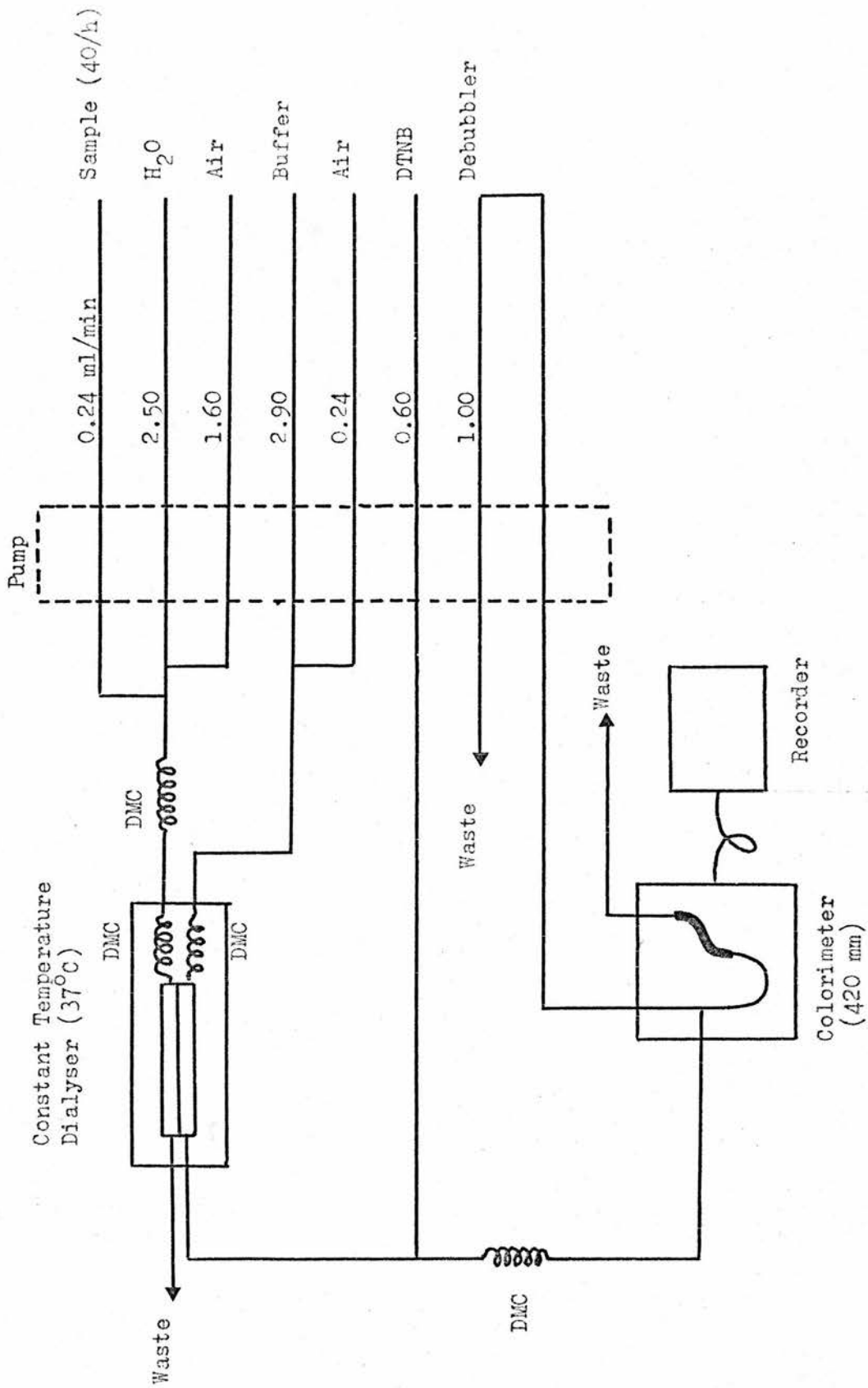

Fig. 3.01

The flow diagram for the dialysis DTNB GSH method

The system employs standard Technicon AutoAnalyser equipment.  
The reagents are described in Chapter 3, Part 2. DMC, double  
mixing coil.

PART 2. THE ESTIMATION OF SHEEP ERYTHROCYTE GSHSection 2.01. Introduction

Whole blood GSH concentrations were estimated by a modification of an existing automated method (Roberts & Agar, 1971) using standard Technicon AutoAnalyser equipment. In this method, whole blood is aspirated, haemolysed and then dialysed against buffer. The resulting protein-free solution is mixed with the disulphide chromogen DTNB, and the extinction of the solution measured at 420 nm. Erythrocyte GSH concentrations were calculated from whole blood values using the whole blood haematocrits. The analysis of whole blood samples without prior deproteinisation facilitated the screening of a large number of animals.

Section 2.02. The AutoAnalyser system

The AutoAnalyser manifold is given in Fig. 3.01, and is with one minor modification, identical to that of Roberts & Agar (1971). In the current manifold, the air flowing into the buffer line was reduced from 1.60 to 0.24 ml/min to facilitate removal of the air bubbles prior to the entry of reagent into the colorimeter flow cell. The reagents used in conjunction with this manifold are:

Buffer: 0.1 M Tris-HCl, pH 8.0 containing 0.1 mM EDTA  
(disodium salt)

DTNB reagent: 1.0 mM DTNB in a buffer containing 0.14 M NaCl  
and 9 mM sodium phosphate, pH 8.5.

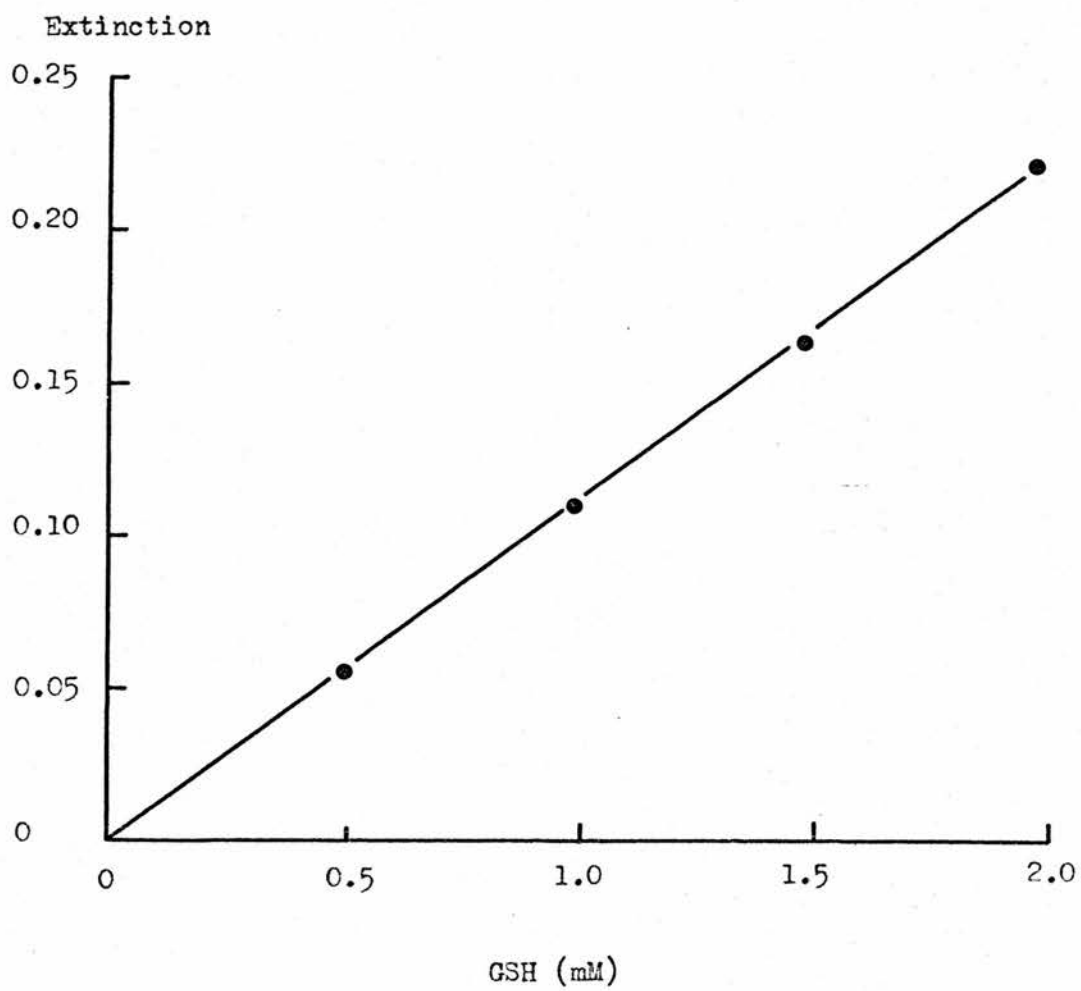

Fig. 3.02

A typical calibration curve for the dialysis DTNB GSH method

The assay method is described in Chapter 3, Part 2. The straight line represents a linear regression of extinction on GSH concentration.

These reagents were modified from those of Roberts & Agar (1971). Specifically, the concentration of Tris buffer was reduced 10 fold to 0.1 M and EDTA (0.1 mM) was added to the buffer to reduce the possibility of metal ion catalysed GSH oxidation. Further, it was found that the 10 mM solution of DTNB recommended by Roberts & Agar (1971) was impossible to achieve because of the low solubility of DTNB. Consequently, the concentration of DTNB was reduced 10 fold to 1.0 mM. No "Brij 35" (Technicon Instruments) was added to any of the reagents.

### Section 2.03. The calibration and precision of the system

The system was calibrated with a minimum of 3 standard solutions containing up to 60 mg GSH/100 ml (1.95 mM) in 0.1 M EDTA (disodium salt). GSH standards were made up fresh in EDTA immediately prior to analysis and kept at 0°C. A typical calibration curve is given in Fig. 3.02. The relationship between extinction and GSH concentration is linear. The coefficient of variation of an individual estimate in the physiological concentration range was 0.75%.



No. of  
Animals

MERINO

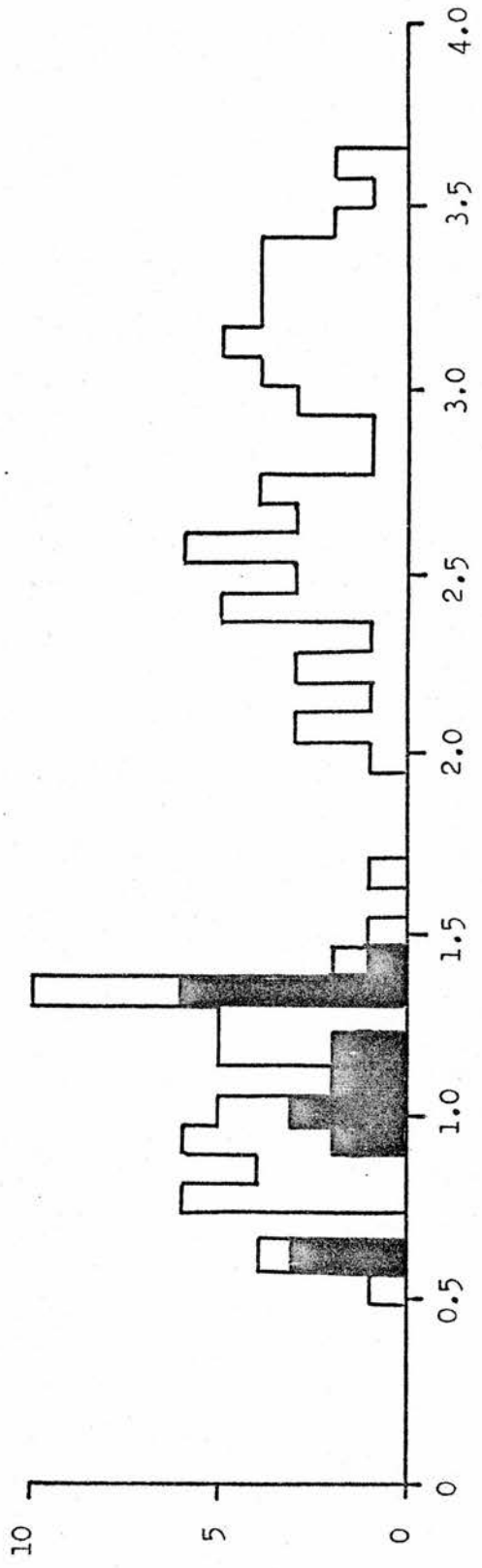

FINN

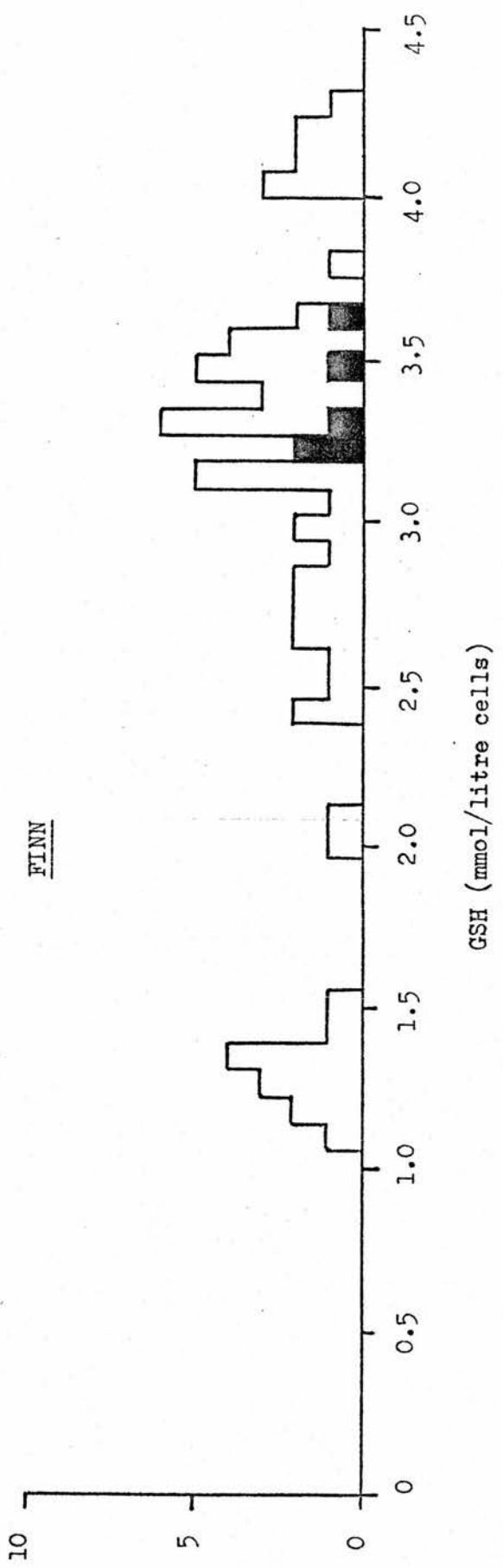

GSH (mmol/litre cells)

Fig. 3.03

Erythrocyte GSH concentrations in Finns and Merinos

GSH was estimated by the automated dialysis method (Chapter 3, Part 2). Presumed heterozygotes are identified as ■ (see Chapter 3, Part 5).

Table 3.01

The concentration of erythrocyte GSH in Finn and Merino sheep

Erythrocyte GSH was estimated by the automated dialysis method (Chapter 3, Part 2). GSH concentrations are mean  $\pm$  SD.

		GSH		No. of	% of
	(mmol/litre cells)	(mg/100 ml cells)	animals	total	
Finn	High GSH	3.26 $\pm$ 0.54	100.1 $\pm$ 16.5	52	81.3
	Low GSH	1.29 $\pm$ 0.11	39.7 $\pm$ 3.3	12	18.7
Merino	High GSH	2.83 $\pm$ 0.45	87.1 $\pm$ 13.8	61	54.0
	Low GSH	1.07 $\pm$ 0.26	32.9 $\pm$ 8.1	52	46.0

PART 3. THE POPULATION DISTRIBUTION OF ERYTHROCYTE GSH IN FINN AND MERINO SHEEP

The population distribution of erythrocyte GSH concentration in 113 Merino sheep is depicted in histogram form in Fig. 3.03. Erythrocyte GSH concentrations ranged from 0.49 mmol/litre cells (15 mg/100 ml cells) to 3.65 mmol/litre cells (112 mg/100 ml cells). The distribution is distinctly bimodal, one group with erythrocyte GSH concentrations in the range 1.95 - 3.65 mmol/litre cells (60-112 mg/100 ml cells) and the other with concentrations in the range 0.49 - 1.69 mmol/litre cells (15-52 mg/100 ml cells). In accordance with the nomenclature of Tucker & Kilgour (1970), animals with GSH concentrations in the lower range were termed low GSH, and those in the upper range, high GSH.

The population distribution of erythrocyte GSH concentration in 64 Finn sheep is also depicted in Fig. 3.03. Erythrocyte GSH concentrations ranged from 1.07 mmol/litre cells (33 mg/100 ml cells) to 4.30 mmol/litre cells (132 mg/100 ml cells). The existence of a small group of animals with GSH concentrations in the low GSH range is evident.

Table 3.01 summarises the data obtained for both Finns and Merinos. For the Finns, the mean GSH concentration in low GSH animals was 39.6% of that found in high GSH animals. The corresponding figure for Merinos was 37.8%. Of the Finn sheep studied 18.7% were low GSH. For the Merinos, the figure was 46.0%.

Tucker & Kilgour (1970, 1972) employed the manual DTNB method of Beutler et al. (1963) to determine erythrocyte GSH concentrations.

GSH  
(mmol/litre cells)

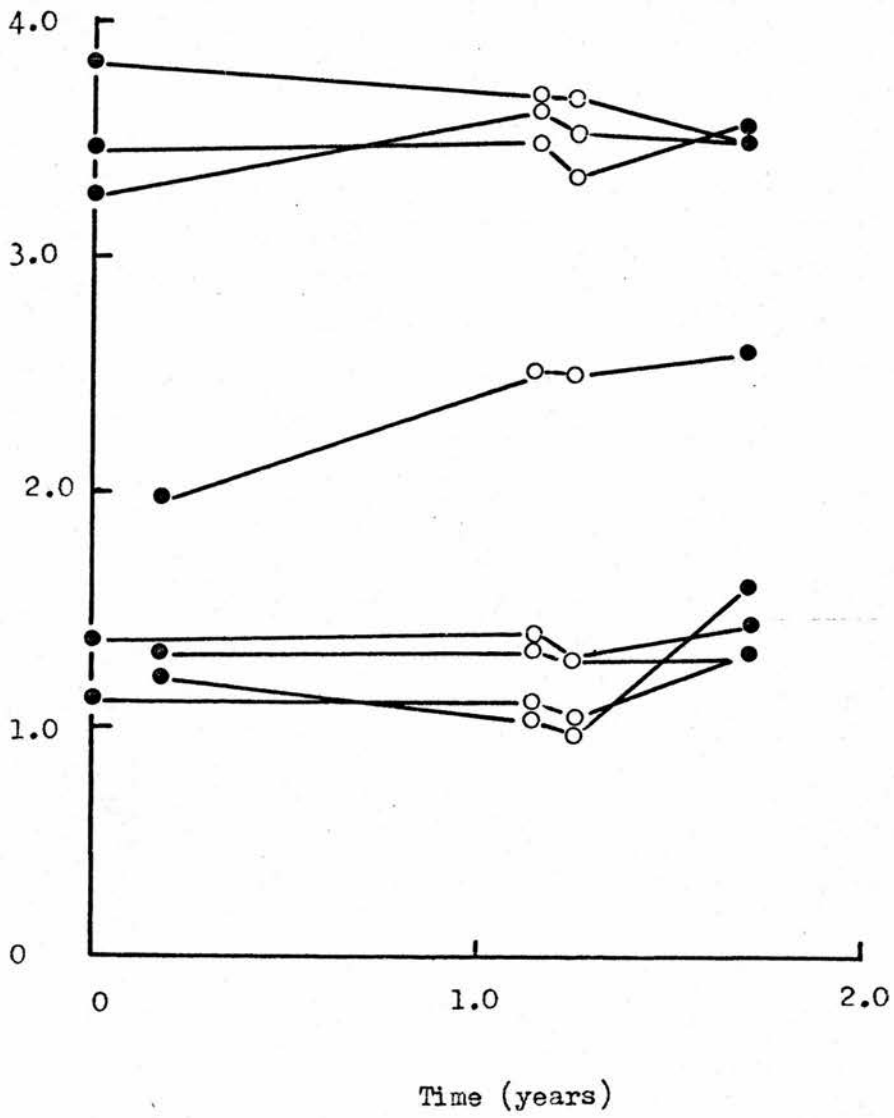

Fig. 3.04

Erythrocyte GSH concentrations in 4 high GSH and 4 low GSH Finns  
over a period of 2 years

GSH was estimated by the automated dialysis method (●, Chapter 3, Part 2) and by the automated method requiring metaphosphoric acid deproteinisation (○, Chapter 4, Part 2). All animals were 10 months old at the beginning of the experiment.

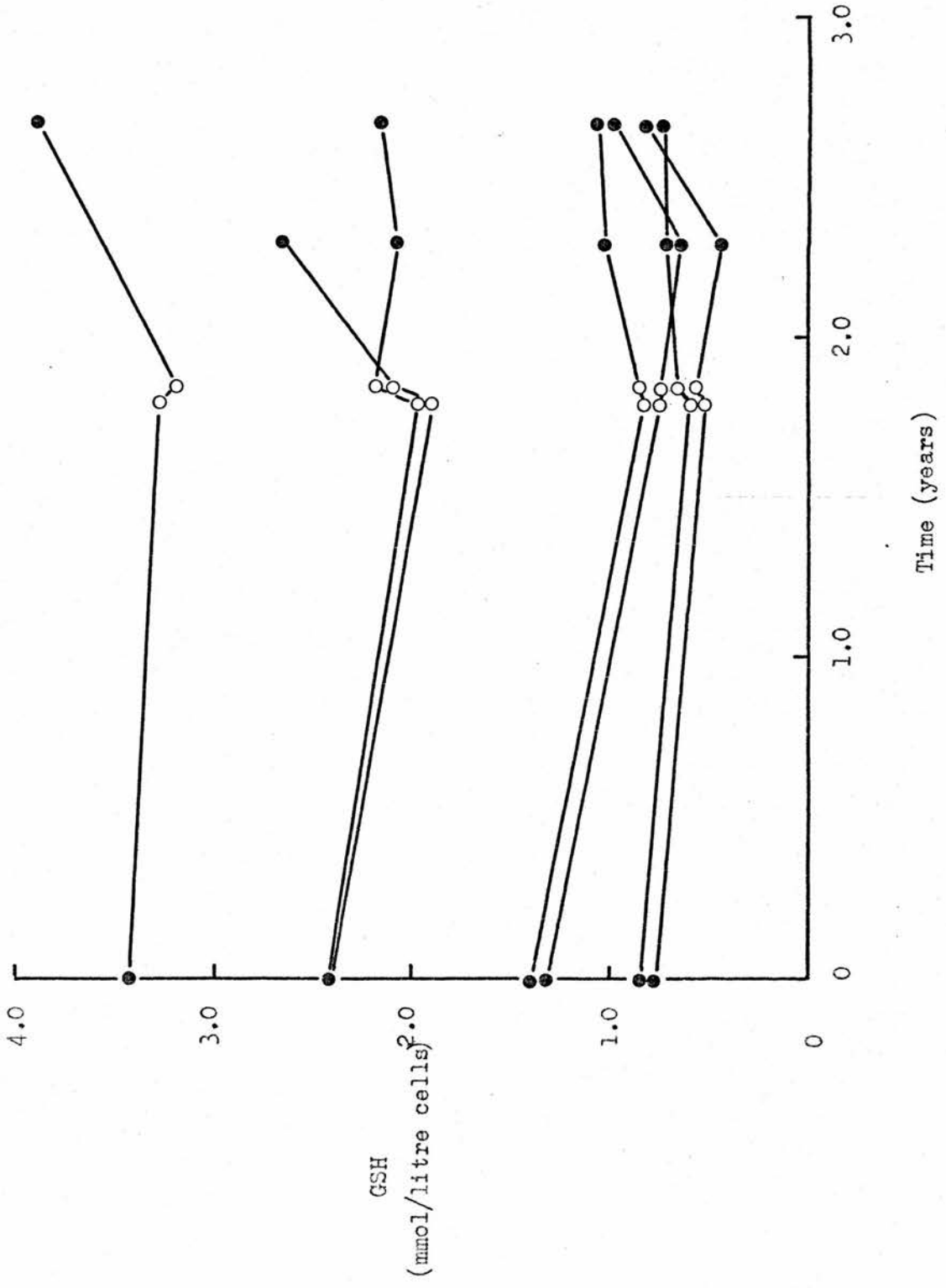

Fig. 3.05

Erythrocyte GSH concentrations in 3 high GSH and 4 low GSH Merinos  
over a period of 3 years

GSH was estimated by the automated dialysis method (●, Chapter 3, Part 2) and by the automated method requiring metaphosphoric acid deproteinisation (○, Chapter 4, Part 2). All animals were 13 months old at the beginning of the experiment.



In this method, the sample is haemolysed, deproteinised with metaphosphoric acid, and subsequently neutralised and reacted with DTNB. Agar et al. (1972) claimed that their automated dialysis method (Roberts & Agar, 1971) gave erythrocyte GSH estimates some 20% higher than those obtained by the manual metaphosphoric acid method. It is difficult to understand why this is so, since both the manual metaphosphoric acid and automated dialysis methods give recoveries of GSH added to whole blood in excess of 97% (Beutler et al., 1963; Roberts & Agar, 1971). In the present study, the modified dialysis method gave Finn and Merino erythrocyte GSH estimates which were essentially the same as those obtained by Tucker & Kilgour (1970, 1972).

The erythrocyte GSH concentrations of a number of Finns and Merinos were monitored over a period of 17 months in the case of the Finns and 27 months in the case of the Merinos. Fig's 3.04 and 3.05 illustrate the variation of erythrocyte GSH during these periods. Clearly, although the erythrocyte GSH concentrations did vary, all individuals of both breeds maintained their GSH type. Some, but not all of the observed variation may be attributable to experimental error (see Part 2 of this Chapter and Part 2 of Chapter 4).

The difference in GSH concentration between high and low GSH animals of both breeds was such that little difficulty was ever encountered in classifying animals as to GSH type on the basis of their erythrocyte GSH concentration.

FINN

MERINO

Low High  
GSH GSH

Low High  
GSH GSH

Haemoglobin  
Ornithine  
+  
Lysine

Origin

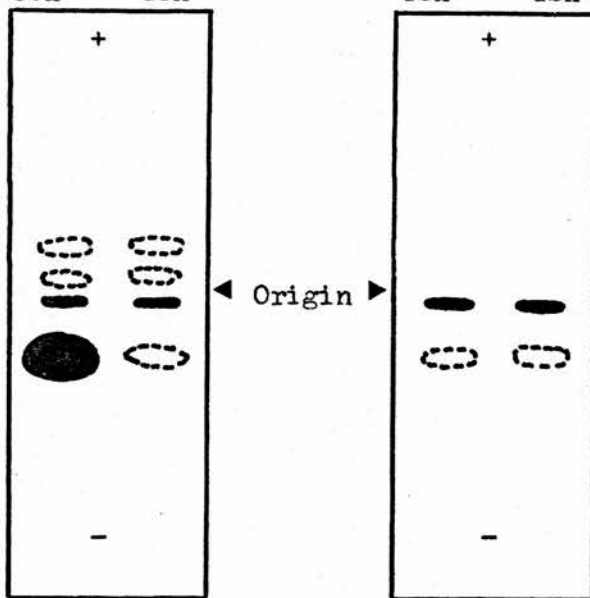

Fig. 3.06

Typical ninhydrin staining patterns of high and low GSH

Finn and Merino freeze-thaw haemolysates

Electrophoresis and subsequent treatment are described in  
Chapter 3, Part 4.

Table 3.02

The presence of ornithine and lysine in high and low GSH Finn  
and Merino erythrocytes

Erythrocyte ornithine and lysine were detected by the method of  
Ellory et al. (1972).

		Ornithine/lysine positive	Ornithine/lysine negative	Total
Finn	High GSH	0	12	12
	Low GSH	10	0	10
Merino	High GSH	0	11	11
	Low GSH	0	13	13

PART 4. THE DETECTION OF ERYTHROCYTE ORNITHINE AND LYSINE,  
AND ITS CORRELATION WITH GSH TYPE

Animals were screened for the presence of erythrocyte ornithine and lysine by the method of Ellory *et al* (1972). Erythrocytes were washed three times in ice cold 0.9% (w/v) NaCl in the usual manner (Chapter 2, Part 2), packed by centrifugation (2000 g for 10 min) and lysed by freezing and thawing twice. Samples (0.3  $\mu$ l) were run on Millipore Phoroslide electrophoresis strips (Millipore (U.K.) Ltd., London) in 0.035 M sodium phosphate buffer pH 6.5 (100 v for 6 min). The strips were oven dried (approximately 100°C), treated with ninhydrin (0.3% (w/v) in diethyl ether), and then replaced in the oven to allow colour development.

On reaction with ninhydrin, a strongly staining band running towards the cathode was observed with lysates from low GSH Finn erythrocytes. This band ran in the same position as authentic ornithine and lysine. The corresponding band from high GSH Finn cells was very faint. Both high and low GSH Finn lysates gave 2 very faint bands running towards the anode. In contrast, erythrocyte lysates from both high and low GSH Merinos gave only one very faint band, running towards the cathode. Typical electrophoretic patterns are shown in Fig. 3.06.

Lysates giving the strong band migrating towards the cathode were classified as ornithine/lysine positive and the rest as ornithine/lysine negative. The results of screening 22 Finn and 24 Merino sheep for the presence of erythrocyte ornithine and lysine are given in Table 3.02. Of the animals tested, only the 10 low GSH Finns were ornithine/lysine positive.

PART 5. HETEROZYGOTE ERYTHROCYTE GSH CONCENTRATIONS IN FINN AND MERINO SHEEP

Tucker & Kilgour (1970, 1972) provided inheritance data which suggested that the gene for low GSH is recessive in Finns but dominant in Merinos. Unfortunately, it was not possible to verify these conclusions with the Finns and Merinos of the present study since although complete family pedigrees were available, all of the rams and some of the ewes from these pedigrees were either dead or otherwise inaccessible for GSH typing.

In addition to the different inheritance patterns in Finns and Merinos, low concentrations of erythrocyte GSH in Finns are associated with high intracellular concentrations of ornithine and lysine, a phenomenon not found in Merinos (Ellory et al., 1972). Both these observations suggest the existence of 2 distinct low GSH genes in 2 different genetic loci, one low GSH gene found in Finns (h) and the other (L) in Merinos (see Chapter 1, Part 2). The question arises as to whether the concentration of erythrocyte GSH in heterozygotes (Hh and Ll) is significantly different from that in homozygotes (HH in Finns and LL in Merinos). Although a complete genetic analysis of the animals used in the present study was not possible for reasons already discussed, it was nevertheless possible to identify a few Finn and Merino heterozygotes. For Finns, a high GSH animal was presumed heterozygous (Hh) if it had either a low GSH parent or offspring. In Merinos, a low GSH animal was presumed heterozygous (Ll) if it had either a high GSH

parent or offspring. In this way, 5 Finn and 19 Merino heterozygotes were identified. These animals are shown in Fig. 3.03. For the Finn and Merino heterozygotes the mean erythrocyte GSH concentrations were  $3.34 \pm 0.20$  (5) and  $1.10 \pm 0.26$  (19) mmol/litre cells respectively (mean  $\pm$  SEM(n)). From Fig. 3.03 it is clear that in Merinos the range of heterozygote GSH concentrations is essentially the same as that of the total low GSH population suggesting that there are no obvious differences between heterozygote and homozygote GSH concentrations. Similarly, in Finns the heterozygotes lie in the middle of the high GSH range (Fig. 3.03) also indicating that there are no obvious differences between heterozygote and homozygote GSH concentrations.

Table 3.03

The effect of potassium type, haemoglobin type and sex on erythrocyte GSH concentrations in high and low GSH Finns and Merinos

Erythrocyte GSH was estimated by the automated dialysis method (Chapter 3, Part 2). Values are (mean  $\pm$  SEM) mmol/litre cells, with the number of animals in parentheses. Means are compared by Student's t-test.

Variable	Finn		Merino	
	High GSH	Low GSH	High GSH	Low GSH
Total	3.43 $\pm$ 0.07(48)	1.34 $\pm$ 0.04(12)	2.93 $\pm$ 0.07(46)	1.09 $\pm$ 0.04(37)
Potassium type				
HK	3.49 $\pm$ 0.09(31)	1.32 $\pm$ 0.03(10)	2.69 $\pm$ 0.10(12)	1.14 $\pm$ 0.07(13)
JK	3.32 $\pm$ 0.13(17)	1.41 (2)	3.01 $\pm$ 0.07(34)	1.07 $\pm$ 0.05(24)
Haemoglobin type				
AA	3.55 $\pm$ 0.09(24)	1.38 $\pm$ 0.06(8)	3.08 $\pm$ 0.10(18)	1.09 $\pm$ 0.09(9)
AB	3.26 $\pm$ 0.11(21)	1.25 $\pm$ 0.04(4)	2.86 $\pm$ 0.08(25)	1.12 $\pm$ 0.05(24)
BB	3.65 $\pm$ 0.37(3)	(0)	2.56 $\pm$ 0.12(3)	0.92 $\pm$ 0.11(4)
Sex				
Female	3.43 $\pm$ 0.07(48)	1.34 $\pm$ 0.04(12)	2.95 $\pm$ 0.07(35)	1.07 $\pm$ 0.05(29)
Male	(0)	(0)	2.88 $\pm$ 0.15(11)	1.17 $\pm$ 0.07(8)

\* P < 0.05



PART 6. THE ANALYSIS OF POSSIBLE RELATIONSHIPS BETWEEN KNOWN ANIMAL VARIABLES AND ERYTHROCYTE GSH CONCENTRATION IN FINN AND MERINO SHEEP

The effect of potassium type, haemoglobin type and sex on erythrocyte GSH concentrations in Finn and Merino sheep is analysed in Table 3.03. Significant differences were detected using Student's t-test. The relatively small total number of animals together with the extremely variable number of animals within the different classes precluded the use of a more comprehensive statistical analysis (see for example Russell, 1973).

The data presented in Table 3.03 clearly indicate that no correlation exists between potassium type, haemoglobin type or sex and GSH type.

Agar et al. (1972) suggested that erythrocyte GSH concentrations in high GSH Australian Merino sheep are influenced by the haemoglobin type of the animal, sheep of haemoglobin type AB having a higher GSH concentration than those of type BB. Although the data for high GSH Merinos in Table 3.03 show a similar trend to that reported by Agar et al. (1972) (AA > AB > BB), the differences are not significant. However, in high GSH Finns, there is a significant effect of haemoglobin type on GSH concentration (AA > AB). No effect of haemoglobin type on erythrocyte GSH concentration is apparent in either low GSH Merinos or Finns.

In high GSH Merinos, LK animals have a significantly higher GSH concentration than HK animals. No similar effect is found in either low GSH Merinos or high and low GSH Finns. As in the Merinos of the

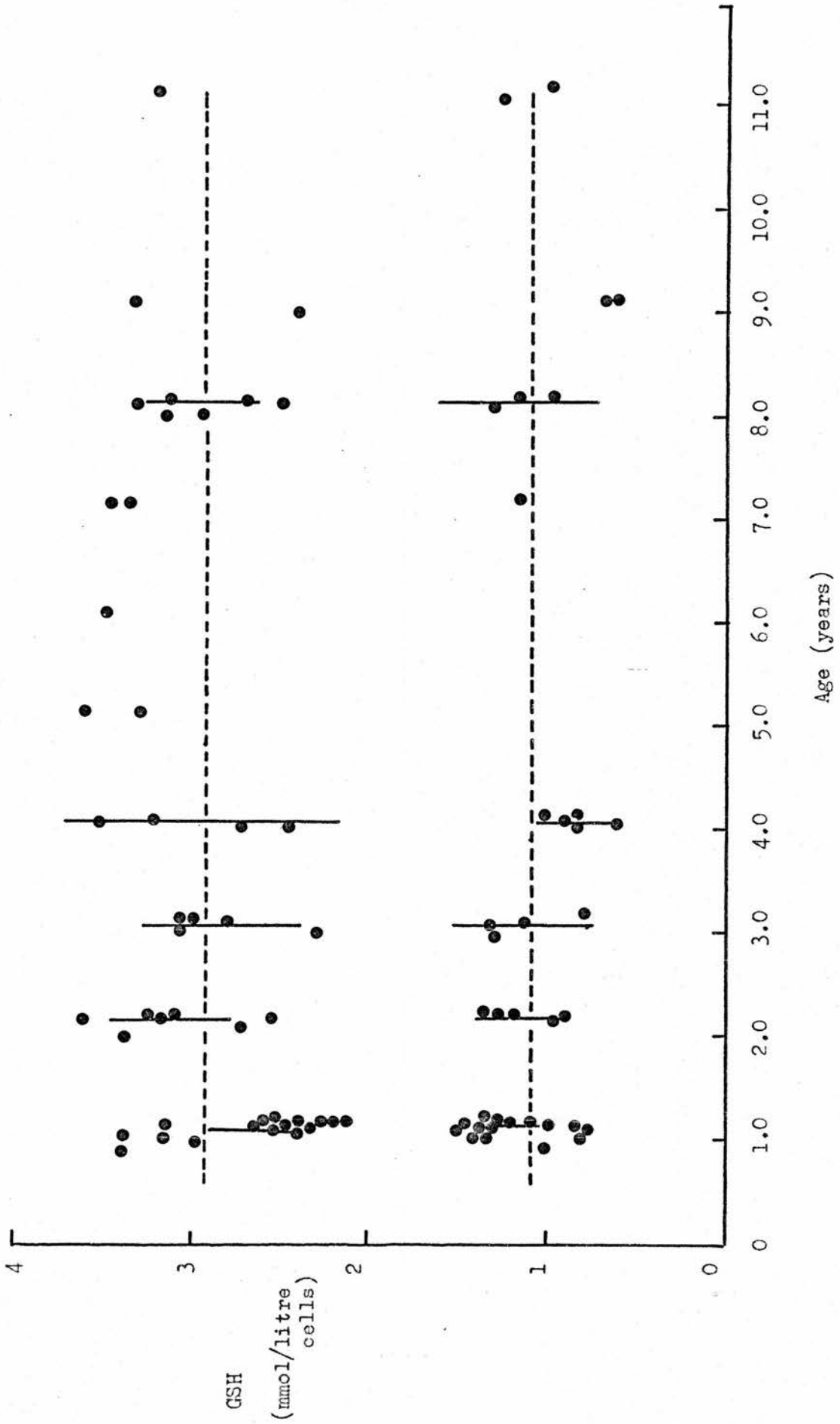

Fig. 3.07

The relationship between animal age and GSH concentration  
in high and low GSH Merinos

Erythrocyte GSH was assayed by the automated dialysis method (Chapter 3, Part 2). The broken lines represent the overall mean GSH concentrations for each GSH type. The solid lines represent 95% confidence limits for each age group mean.



Fig. 3.08

The relationship between animal age and GSH concentration  
in high and low GSH Finns

Erythrocyte GSH was assayed by the automated dialysis method (Chapter 3, Part 2). The broken lines represent the overall mean GSH concentrations for each GSH type. The solid lines represent 95% confidence limits for each age group mean.

present study, Kalla et al. (1972) found a significant effect of potassium type on erythrocyte GSH concentration in the Marwari breed of sheep (LK > HK; high GSH animals only).

All the Finns in the present study were female; however, a number of the Merinos were male. No effect of sex on erythrocyte GSH concentration in either high or low GSH animals is apparent.

In addition to the effects of potassium type, haemoglobin type and sex, the influence of animal age on erythrocyte GSH concentration was also examined. In Fig. 3.07 the GSH concentrations of 37 low GSH and 46 high GSH Merinos are plotted against the respective animal ages at the time of bleeding. The data for 52 high GSH and 12 low GSH Finns are similarly plotted in Fig. 3.08.

To assess if there is any relationship between animal age and erythrocyte GSH concentration, the overall mean GSH concentration for a given GSH class and breed (all age groups) was computed, and a variance ratio test used to find out whether the straight line of gradient zero and ordinate intercept equal to the mean GSH concentration fitted the data (Diem & Lentner, 1970) (see Figs. 3.07 and 3.08). In this test, the variance within the various age groups is compared with the variance between age group means. The straight line is said to fit the data if the variance between age group means is not significantly greater than that within age groups. In addition, 95% confidence limits for each age group mean were calculated and are represented as error bars in Figs. 3.07 and 3.08. Age groups consisting of less than 3 animals were not included in these analyses.

The values of  $F$  (variance ratio =  $s_1^2/s_2^2$ ; where  $s_1^2$  is the

Table 3.04

Variance ratio test of the relationship between animal  
age and erythrocyte GSH concentration

		F ( $v_1, v_2$ )	P
Finn	High GSH	2.822 (7, 44)	< 0.025
	Low GSH	-	-
Merino	High GSH	2.203 (7, 36)	NS
	Low GSH	3.374 (6, 29)	< 0.025

variance between age group means and  $s_2^2$  is the variance within age groups) and the relevant degrees of freedom,  $v_1$  and  $v_2$  (where  $v_1$  and  $v_2$  are the degrees of freedom for  $s_1^2$  and  $s_2^2$  respectively) for high and low GSH Merinos and high GSH Finns are given in Table 3.04.

For the high GSH Merinos the straight line in Fig. 3.07 adequately fits the data, indicating that there is no significant effect of animal age on erythrocyte GSH concentration. For the low GSH Merinos on the other hand, the straight line in Fig. 3.07 is not an adequate representation of the data ( $P < 0.025$ ). However, a visual inspection of the 95% confidence limits for each age group mean suggests no obvious relationship between animal age and erythrocyte GSH concentration. A straight line (Fig. 3.08) is also not an adequate representation of the relationship between animal age and erythrocyte GSH concentration in high GSH Finns ( $P < 0.025$ ) but as with the low GSH Merinos, a visual inspection of the data fails to reveal any obvious relationship between the two parameters. In conclusion, the data presented in Figs. 3.07 and 3.08 suggest no obvious correlation between animal age and GSH concentration in either high or low GSH Merinos or high GSH Finns. The results of the present study contrast markedly with those of Agar et al. (1972). In their study, erythrocyte GSH concentrations in high GSH Australian Merinos were reported to rise linearly from 2.8 mmol/litre cells at the age of 1 year to 3.8 mmol/litre cells at the age of 4 years.

The suggestion that no obvious correlation exists between animal age and erythrocyte GSH concentration in either Finns or Merinos is further supported by the data presented in Part 3 of this Chapter.



Table 3.05

The distribution of high and low GSH animals in young  
( $\leq$  13 months) and old ( $>$  13 months) sheep

Values are no. of animals.

		Age		$\chi^2$	P
		$\leq$ 13 months	$>$ 13 months		
Finn	High GSH	20	32	6.18*	$<$ 0.025
	Low GSH	10	2		
Merino	High GSH	16	30	0.29	NS
	Low GSH	15	22		

\* Since only 2 low GSH Finns were  $\leq$  13 months old, Yates correction was used in the calculation of  $\chi^2$  (Fisher, 1948).

The erythrocyte GSH concentrations of selected high and low GSH animals of both breeds were monitored over a period of 17 months in the case of Finns and 27 months in the case of Merinos. The results are presented in Figs. 3.04 and 3.05. The Finns were all 10 months old and the Merinos 13 months old at the time of the initial bleeding. No effect of animal age on GSH concentration is apparent in either high or low GSH Finns or Merinos.

From Fig. 3.07 it is clear that the relative numbers of high and low GSH Merinos are approximately constant over the whole age range (1 - 11 years). This is in complete contrast to the situation in Finns (Fig. 3.08) where all but two of the low GSH animals were less than 13 months old. The uneven age distribution of low GSH Finns is statistically significant by the chi-squared ( $\chi^2$ ) test (Table 3.05) and is the subject of further discussion in Part 8 of this Chapter.

Table 3.06

Characteristics of the animals selected for further detailed study

		Haemoglobin type	Potassium type	Ornithine/ lysine type	Sex	Date of Birth	No. of animals
Finn	High GSH	AA	HK	-	female	Mar. (1971)	7
	Low GSH	AA	HK	+	female	Mar. (1971)	6
Merino	High GSH	AB	HK	-	female	Mar.-May (1971)	4
	Low GSH	AB	HK	-	female	Mar.-May (1971)	5

PART 7. THE SELECTION OF ANIMALS FOR FURTHER DETAILED STUDY

From the large number of animals available, a small number were selected for further detailed study. To reduce individual animal variation to a minimum, these animals were selected to be of the same sex, age, haemoglobin and potassium type. The different breed frequencies of the various animal and erythrocyte parameters did not allow the selection of the same haemoglobin type for both Finns and Merinos.

GSH type classification was based on erythrocyte GSH estimations. The selected animals were also screened for the presence of erythrocyte ornithine and lysine. Only the low GSH Finns were ornithine/lysine positive. Table 3.06 details the characteristics of the animals selected for further study. All subsequent investigations were carried out with this group of animals except in instances where larger numbers of animals were involved. These additional animals (all female) were also classified on the basis of erythrocyte GSH concentration and ornithine/lysine content (only the low GSH Finns were ornithine/lysine positive); however, they were not necessarily of the same haemoglobin type, potassium type or age. In one series of experiments (Chapter 8), Tasmanian Merino X Clun Forest crosses maintained by the Agricultural Research Council Institute of Animal Physiology, Babraham, Cambridge were used.

PART 8. DISCUSSION

Both the Finns and Merinos investigated in the present study have substantial numbers of low GSH animals. In the case of Finns, 18.7% of the animals were low GSH. This compares with a figure of 46.0% in the case of Merinos. Sheep were allotted their GSH class on the basis of their concentration of erythrocyte total non-protein reduced thiol as determined by the nonspecific thiol reagent DTNB. The validity of equating total DTNB reactive thiol with GSH is established in the next Chapter. The classification of animals as to GSH type on the basis of erythrocyte GSH concentration presented no difficulties since high and low GSH animals were clearly separated, and investigations of a number of high and low GSH Finns and Merinos over a prolonged period of time (17 months in the case of Finns and 27 months in the case of Merinos) indicated that erythrocyte GSH concentrations were relatively stable.

The animals used in the present study initially arose from a small number of sheep (Chapter 2, Part 1). Therefore the relative numbers of low GSH animals in these Finns and Merinos should not be taken as indicative of the frequencies of low GSH animals in the Finn and Merino breeds of sheep in general.

Tucker & Kilgour (1970, 1972) and Ellory et al. (1972) suggested that the erythrocyte GSH deficiency in Finns differs substantially from that found in Merinos in two important ways. First, the gene for low GSH appears recessive in Finns but dominant in Merinos; and second, low concentrations of erythrocyte GSH in Finns are associated

with very high erythrocyte concentrations of certain amino acids, particularly ornithine and lysine, a phenomenon not found in Merinos. Unfortunately, it was not possible to confirm the genetic data of Tucker & Kilgour (1970, 1972) with the Finns and Merinos of the present study for reasons already discussed (Part 5 of this Chapter). However, it was possible to investigate the erythrocyte concentration of amino acids in these sheep. In agreement with Ellory *et al* (1972), only those Finns which were low GSH were found to be ornithine/lysine positive. In addition, none of the high and low GSH Merinos tested were ornithine/lysine positive. These observations confirm those described earlier which suggest that Finns and Merinos exhibit two distinct types of erythrocyte GSH deficiency.

Although a complete genetic analysis of the animals used in the present study was not possible, a number of Finn and Merino heterozygotes could be identified. It was therefore possible to answer the question of whether the concentration of erythrocyte GSH in heterozygotes (Hh in Finns and Ll in Merinos) is different from that in homozygotes (HH in Finns and LL in Merinos). The available data indicate that there are no obvious differences between heterozygote and homozygote GSH concentrations in either breed.

Since sheep exhibit 2 types of ornithine/lysine negative GSH deficiency, one inherited in a dominant manner and the other in a recessive manner (see Chapter 1, Part 2), it may be argued that it is not valid to assume a dominant inheritance pattern for the Merinos of the present study. However, the Tasmanian Merinos investigated by Tucker & Kilgour (1972) originated from The Animal Breeding Research

Organisation, Edinburgh. Furthermore, the author has demonstrated that the Animal Breeding Research Organisation Merinos and those of Dr. E.M. Tucker share a common enzyme defect (Chapter 8).

One of the most noticeable features of the population distributions of erythrocyte GSH in Finns and Merinos is the large range of GSH concentrations within a GSH type. It was therefore of interest to assess the effect of known animal variables such as sex, age, haemoglobin type and potassium type on erythrocyte GSH concentrations. The data presented in Part 6 of this Chapter indicate that animal sex and age have no significant influence. However, this study together with that of Agar *et al.* (1972) suggest that in high GSH animals at least, haemoglobin type may significantly affect erythrocyte GSH concentrations (AA > AB > BB). In high GSH Merinos, potassium type may also influence erythrocyte GSH concentrations (LK > HK). However, both these effects are small, so that most of the intra-type variation in erythrocyte GSH concentration remains unexplained.

The effect of haemoglobin type on erythrocyte GSH concentration deserves additional comment. Haemoglobin type AA cells seem to be more swollen than BB cells (Hall & Hunter, 1973) and therefore, on a volume to volume basis, AA cells have a significantly lower dry weight and smaller dead space than BB cells. Consequently, if the concentration of a cell constituent is expressed per volume of packed cells, that constituent will appear more concentrated in AA cells even though the concentration when expressed per volume of cell water is the same for both types of cell. The magnitude of this

haemoglobin type effect is approximately 7% between AA and BB cells (Hall & Hunter, 1973). Therefore, the effect of haemoglobin type on erythrocyte GSH concentration is at least partially an artifact of the estimation procedure. The influence of potassium type on erythrocyte GSH concentration cannot be explained in this way, since there is no evidence that LK erythrocytes are more swollen than HK ones (Hall & Hunter, 1973).

The relative numbers of high and low GSH Merinos was approximately constant over the whole age range (1-11 years) (Fig. 3.07). This however was in complete contrast to the situation in Finns (Fig. 3.08) where all but 2 of the low GSH animals were less than 13 months old. The uneven age distribution of low GSH Finns was statistically significant by the  $X^2$  test (Table 3.05). This uneven distribution cannot be attributed to the introduction of additional animals into the population (J.G. Hall, personal communication). However, 7 of the 10 low GSH Finns whose age was less than 13 months were the progeny of only 2 rams and 3 ewes. Of the 3 ewes, 2 were identified as low GSH (the two low GSH animals of age greater than 13 months in Fig. 3.08) and 1 was high GSH. Neither of the rams was available for GSH typing. The sudden increase in the number of low GSH animals in the Finn population is therefore probably attributable to the selection of these 2 rams and 3 ewes for breeding purposes in that particular year.

The differences between the 'Finn-type' and the 'Merino-type' erythrocyte GSH deficiencies suggest that the biochemical mechanisms responsible for the GSH deficiency differ in the two breeds. In



the subsequent study of the biochemical mechanisms responsible for the low concentrations of erythrocyte GSH in sheep, both Finns and Merinos were investigated. For this investigation, a relatively small number of animals of each breed were selected (see Part 7 of this Chapter).

CHAPTER 4

THE CONCENTRATION OF GSH AND GSSG IN HIGH AND LOW

GSH FINN AND MERINO ERYTHROCYTES

PART 1. INTRODUCTION

Sheep are allotted their GSH type on the basis of their content of erythrocyte total non-protein reduced thiol as determined by the nonspecific thiol reagent DTNB (Smith & Osburn 1967; Tucker & Kilgour 1970; Agar et al., 1972; Kalla et al., 1972). This raises two fundamental questions: first, the accuracy with which total thiol is a measure of GSH since non-protein thiols other than GSH may be present, and second, whether high and low GSH erythrocytes have different GSSG concentrations. In this Chapter, experiments are described which attempt to answer both these questions.

One solution to the problem of whether all the DTNB reactive thiol in high and low GSH erythrocytes is GSH is to estimate erythrocyte GSH by a more specific method: for example, with alloxan as chromogen (Patterson & Lazarow, 1955). Alloxan is particularly useful in this context since unlike DTNB, this chromogen distinguishes between GSH and its thiol precursors (cysteine, GC) and degradation products (cysteine, cysteinyl glycine). With alloxan the extinction coefficient relative to that of GSH is 0.05 for cysteine and cysteinyl glycine, and 0.16 for GC (Patterson & Lazarow, 1954). The disadvantage of the existing manual alloxan method is that it is cumbersome and gives an unstable product (Patterson & Lazarow, 1955). An automated version of the manual alloxan method was therefore developed to estimate the GSH in protein-free erythrocyte extracts. In addition, an automated DTNB method was also developed for estimating the GSH in the same erythrocyte extracts so that the alloxan and DTNB values could be

directly compared with one another. In this Chapter, both automated methods are described, and their estimates of erythrocyte GSH compared for both high and low GSH Finns and Merinos (Part 2). Erythrocyte GSSG concentrations are also given (Part 3). The alloxan GSH and GSSG estimates are used to calculate the redox potential of the GSH-GSSG couple in high and low GSH Finn and Merino erythrocytes (Part 4).

PART 2. THE CONCENTRATION OF GSH IN HIGH AND LOW GSH FINN AND MERINO ERYTHROCYTES: A COMPARISON OF THE ESTIMATES OF ERYTHROCYTE GSH BY TWO AUTOMATED SPECTROPHOTOMETRIC METHODS EMPLOYING ALLOXAN AND DTNB AS CHROMOGENS.

Section 2.01. Introduction

The AutoAnalyser systems for the alloxan and DTNB methods are described in section 2.02. The estimates of erythrocyte GSH given by these two methods are then compared for high and low GSH Finn and Merino erythrocytes (section 2.03).

The automated alloxan method was developed from the original manual method of Patterson & Lazarow (1955). The alloxan reaction product absorbs maximally at 305 nm which is outwith the range of the standard Technicon colorimeter. Consequently, the extinction was measured in a Unicam SP1800 recording spectrophotometer fitted with a 0.5 cm flow cell and recorded on a Unicam AR 25 flat bed recorder. The rest of the system comprised standard Technicon AutoAnalyser modules. In this method, metaphosphoric acid extracts of whole blood are aspirated, neutralised, buffered and reacted with alloxan. The extinction is measured at 305 nm. Metaphosphoric acid is used in preference to other acidic deproteinising agents because it does not cause any appreciable GSH oxidation during deproteinisation (Srivastava & Beutler, 1968a).

The automated DTNB method was designed to utilise the same metaphosphoric acid whole blood extracts as the alloxan method. Standard Technicon equipment was used. As in the alloxan method,

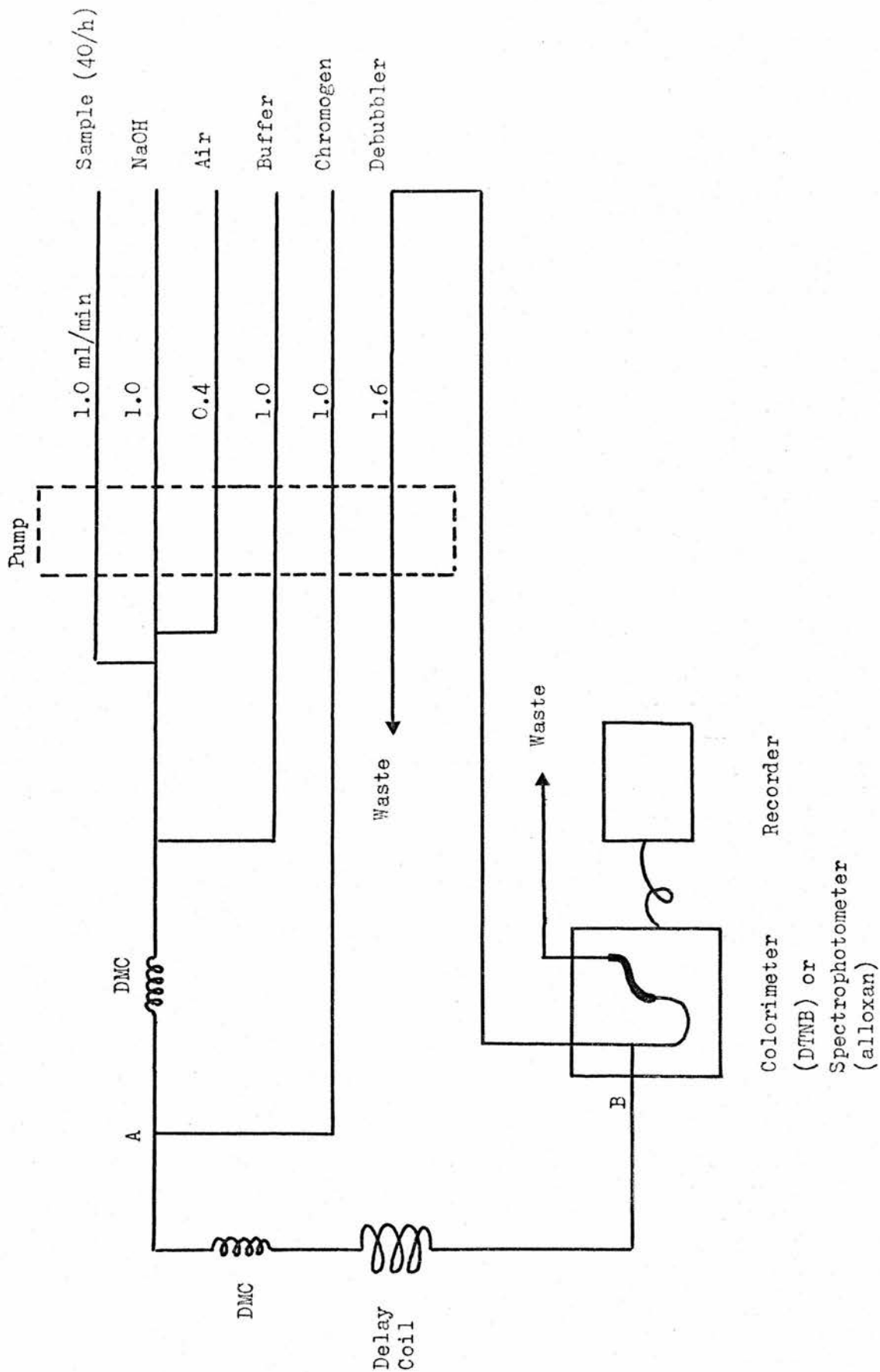

Fig. 4.01

The flow diagram for the DTNB GSH and alloxan GSH methods

Both systems employ standard Technicon AutoAnalyser equipment except for the use of the Unicam SP1800 spectrophotometer and AR25 recorder with the alloxan manifold. The inclusion of a delay coil in the alloxan manifold is the only difference between the two systems. Both sets of reagents are described in the text (Chapter 4, Part 2).

Table 4.01

Reagents for the DTNB GSH and alloxan GSH methods

Metaphosphoric acid-EDTA: 2 vol. 25% (w/v) metaphosphoric acid  
+ 7 vol. 14.3 mM EDTA (disodium salt) + 1 vol. water.  
Since a fine precipitate may form, this reagent was  
prepared 12 h before use and filtered.

Buffer: 0.5 M sodium phosphate, pH 7.5.

DTNB: 160 mg DTNB + 10 g sodium citrate per litre water.

Alloxan: 16 g alloxan per litre water (stored deep-frozen).

NaOH (DTNB method): approx. 1.0 M NaOH adjusted so that 1 vol.  
of it titrated 1 vol. metaphosphoric acid - EDTA +  
1 vol. DTNB to pH 7.5.

NaOH (Alloxan method): approx 1.0 M NaOH adjusted so that  
1 vol. of it titrated 1 vol. metaphosphoric acid -  
EDTA + 1 vol. alloxan to pH 7.5.

GSH standards: 0 - 0.2 mM GSH in metaphosphoric acid -  
EDTA (stored at 4°C for not more than 2 weeks).



the aspirated metaphosphoric acid extracts were neutralised and buffered before reaction with chromogen, in this case DTNB. The extinction was measured at 420 nm.

## Section 2.02. The AutoAnalyser system

### Alloxan method

The AutoAnalyser manifold for the alloxan method is depicted in Fig. 4.01. The reagents employed are detailed in Table 4.01. Apart from the use of the Unicam SP1800 recording spectrophotometer, the alloxan manifold has only one unusual feature: the wash reservoir was filled from a constant-head bottle containing metaphosphoric acid-EDTA. The sampling rate was 40/h with a 2:1 sample: wash ratio, and the extinction was measured at 305 nm. The spectrophotometer reference cell contained air, and the full scale extinction was 0.5 units.

The capacity of the coils and tubing between points A and B (Fig. 4.01) was such that the transit time between these points was 6 min (the time required for complete reaction of GSH with alloxan (Patterson & Lazarow, 1955)). Because the sample itself may absorb at 305 nm, a second aliquot of it was run through the system with water in place of the alloxan reagent. This blank extinction (typically 0.010 - 0.015) was subtracted from that recorded with alloxan. It was not necessary to re-run standards in this way.

### DTNB method

The DTNB manifold is also depicted in Fig. 4.01 and is essentially the same as the alloxan manifold except for the replacement of the



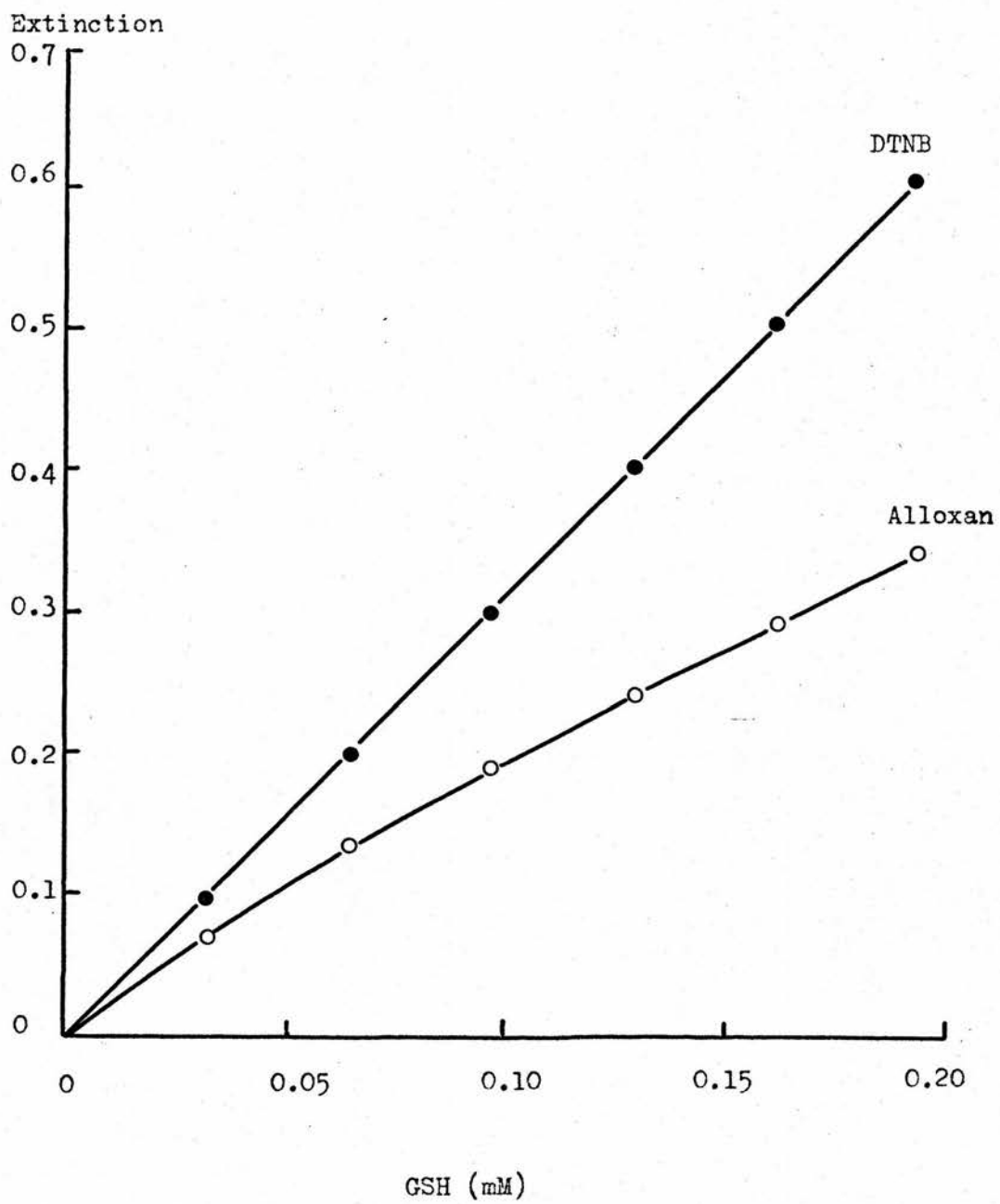

Fig. 4.02

Typical calibration curves for the DTNB GSH  
and alloxan GSH methods

Both assay methods are described in Chapter 4, Part 2. The DTNB straight line represents a linear regression of extinction on GSH concentration. The alloxan curve represents a third order polynomial regression of extinction on GSH concentration.

Unicam SP1800 spectrophotometer and recorder by standard Technicon modules, and the omission of the delay coil. The reagents are detailed in Table 4.01. As in the alloxan system, the wash reservoir contained metaphosphoric acid-EDTA. The sampling rate was 40/h with a 2:1 sample: wash ratio, and the extinction was measured at 420 nm.

Because the sample itself may absorb at 420 nm, a second aliquot of it was run through the system with 1% (w/v) sodium citrate in place of the complete DTNB reagent. This blank extinction, (typically 0.01 - 0.03) was subtracted from that recorded with DTNB.

#### Section 2.03. The calibration and precision of the system

The calibration curve (0-0.2 mM GSH) with DTNB is linear whereas that with alloxan is not (Fig. 4.02). A third order polynomial was routinely fitted to the alloxan calibration data. The coefficient of variation of an individual estimate in the physiological concentration range was 1-2% for both methods. Neither method exhibited appreciable drift or interaction between successive samples.

#### Section 2.04. The deproteinisation of a sample

Whole blood samples were haemolysed by adding 7 vol. ice-cold 14.3 mM EDTA to 1 vol. blood, mixing, and standing at 0°C for 5 min. They were then deproteinised by adding 2 vol. ice-cold 25% (w/v) metaphosphoric acid and centrifuging at 2000 g for 10 min. The

Whole Blood

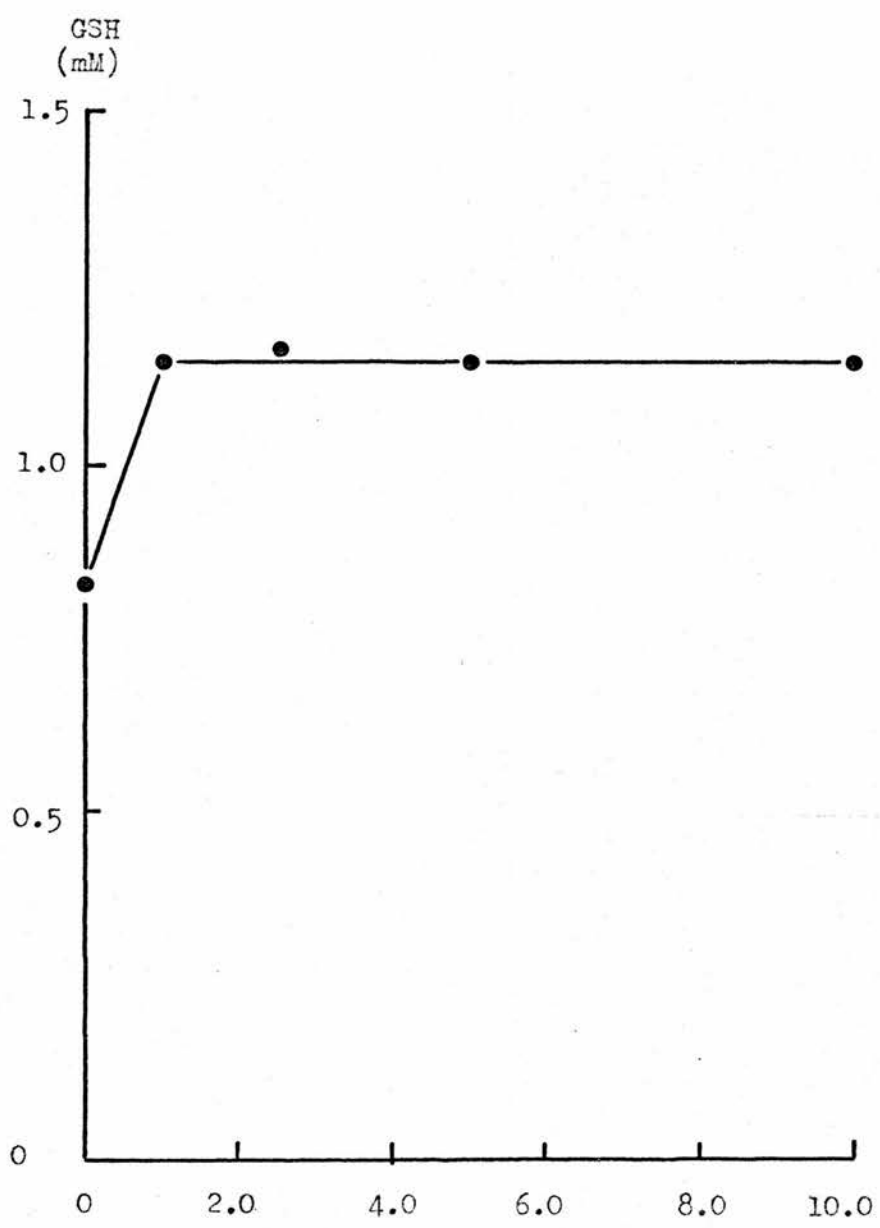

Haemolysis Time (min)

Fig. 4.03

Erythrocyte GSH estimation by the DTNB method:  
the effect of haemolysis time

The assay method is described in Chapter 4, Part 2.

Alloxan GSH  
(mmol/litre cells)

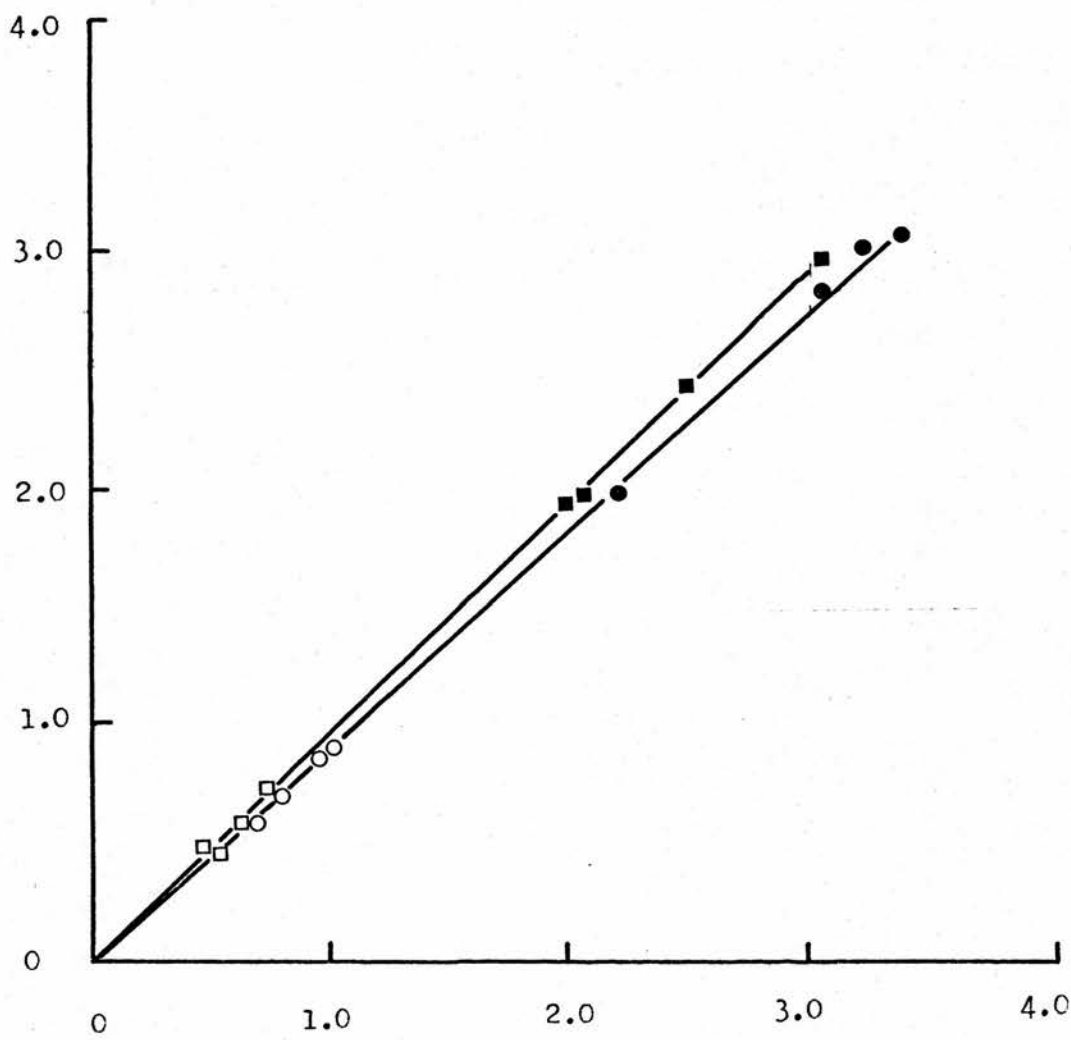

DTNB GSH (mmol/litre cells)

Fig. 4.04

A comparison of DTNB and alloxan estimates of the concentration of GSH in high and low GSH Finn and Merino erythrocytes

Both assay methods are described in Chapter 4, Part 2. Finn: ● high GSH and ○ low GSH. Merino: ■ high GSH and □ low GSH. The straight lines represent linear regressions of alloxan GSH on DTNB GSH.



supernatants were kept at 0°C prior to estimation. Blood samples were deproteinised within 4 h of collection.

Haemolysis of erythrocytes before deproteinisation was essential for complete extraction of the erythrocyte GSH (Fig. 4.03). The actual haemolysis time was not however critical, times of 1-10 min giving essentially identical GSH estimates.

Erythrocyte GSH concentrations were calculated from whole blood values using the whole blood haematocrits.

The recovery of GSH was assessed by deproteinising blood from low GSH Finns with 25% metaphosphoric acid containing GSH. Three experiments gave a mean recovery ( $\pm$  SEM) of  $91.3 \pm 0.8\%$  (DTNB method) and  $92.2 \pm 0.8\%$  (alloxan method). These values are significantly less than 100%, but are so nearly equal to one another that it is valid to compare DTNB-GSH with alloxan GSH.

Section 2.05. The concentration of GSH in high and low GSH Finn and Merino erythrocytes: a comparison of the estimates of erythrocyte GSH by the automated alloxan and DTNB methods.

Fig. 4.04 compares the estimates of erythrocyte GSH by the automated alloxan and DTNB methods for 4 high GSH and 4 low GSH Finns and the same number of high and low GSH Merinos. For each breed the high and low GSH values lie on the same straight line through the origin. In Young et al. (1974) the lines do not pass through the origin because no allowance was made for the extinction

Table 4.02

The concentration of GSH in high and low GSH Finn and Merino erythrocytes: a comparison of the estimates of erythrocyte GSH by the automated alloxan and DTNB methods.

Both methods of GSH estimation are described in the text (Chapter 4, Part 2).

Concentrations are (mean  $\pm$  SEM (4)) mmol/litre cells.

	DTNB GSH	alloxan GSH
Finn		
High GSH	2.95 $\pm$ 0.26	2.73 $\pm$ 0.25
Low GSH	0.83 $\pm$ 0.08	0.78 $\pm$ 0.07
Merino		
High GSH	2.41 $\pm$ 0.25	2.34 $\pm$ 0.24
Low GSH	0.59 $\pm$ 0.05	0.57 $\pm$ 0.06

of the samples themselves at 420 nm. The slopes of these lines ( $\pm$  SE) calculated by the method of least squares are: Finns,  $0.923 \pm 0.012$ ; and Merinos,  $0.971 \pm 0.012$ . Since the alloxan method is much more specific for GSH than the DTNB method, these results, which are summarised in Table 4.02, show that for both breeds of sheep, almost all the GSH in the two classes of cell is GSH. However, since for the Finns in particular, the slope of the line seems to be slightly less than unity, there may be a small but constant percentage of the total non-protein thiol which is not GSH.

PART 3. THE CONCENTRATION OF GSSG IN HIGH AND LOW GSH FINN  
AND MERINO ERYTHROCYTES

Section 3.01. Introduction

Most early investigators reported high erythrocyte concentrations of GSSG. It has subsequently been demonstrated that these high GSSG concentrations are attributable to GSH oxidation during sample deproteinisation (Srivastava & Beutler, 1968a), presumably by hydrogen peroxide (Lemberg, 1942). In the method of erythrocyte GSSG estimation used in the present study, oxidation of erythrocyte GSH to GSSG during trichloroacetic acid (TCA) deproteinisation is prevented by prior alkylation of sulphhydryl groups with N-ethylmaleimide (NEM). TCA and excess NEM are extracted with ether, and the GSSG measured enzymically using glutathione reductase (GSSG-R).

Section 3.02. The estimation of erythrocyte GSSG

Erythrocyte GSSG concentrations were estimated by the method of Srivastava & Beutler (1968a). Whole blood samples were centrifuged at 2000 g for 30 min at 4°C, and the plasma and buffy coat removed. To 2.5ml of packed erythrocytes was added 0.5 ml of 0.25 M NEM. The cells and NEM were thoroughly mixed and allowed to stand at 0°C for 10 min. Samples were then deproteinised by addition of 2 ml of ice-cold 30% (w/v) TCA. After centrifugation at 2000 g for 10 min, 1.5 ml of supernatant was removed and extracted three times with three volumes of ice-cold ether. After the final extraction

excess ether was removed in a stream of nitrogen. The resulting solutions were kept at 0°C prior to estimation.

The GSSG concentrations of the erythrocyte extracts were determined enzymically using GSSG-R. To 0.5 ml of the erythrocyte extract in a 1 ml cuvette was added 0.4 ml water, 0.08 ml of 1 M potassium phosphate buffer pH 6.8 containing 4 mM EDTA (disodium salt), and 0.01 ml of 12 mM NADPH in 5% (w/v) sodium bicarbonate. Cuvettes were allowed to equilibrate in a Unicam SP800 recording spectrophotometer (room temperature), and extinction measurements were made for several minutes at 340 nm (full scale extinction 0.1 units) using a Servoscribe I flat-bed recorder (Baird & Tatlock, Chadwell Heath, Essex, U.K.). The reaction was initiated by adding 0.01 ml of 1 mg/ml GSSG-R (Boehringer). The extinction was monitored until any remaining rate of change became constant. After the initial rapid decrease in extinction a slow constant decrease was usually observed, presumably due to NADPH instability and/or GSH oxidation providing additional GSSG for the GSSG-R reaction. For this reason the change in extinction following enzyme addition was calculated after back extrapolation of the extinction curve to the time of GSSG-R addition. The change in extinction was corrected both for the decrease in extinction resulting from the dilution of the cuvette contents by the addition of enzyme and for the extinction of the enzyme solution itself.

Erythrocyte GSSG concentrations ( $\mu\text{mol/litre cells}$ ) were calculated assuming a molar extinction coefficient of  $6.22 \times 10^3$  for NADPH.

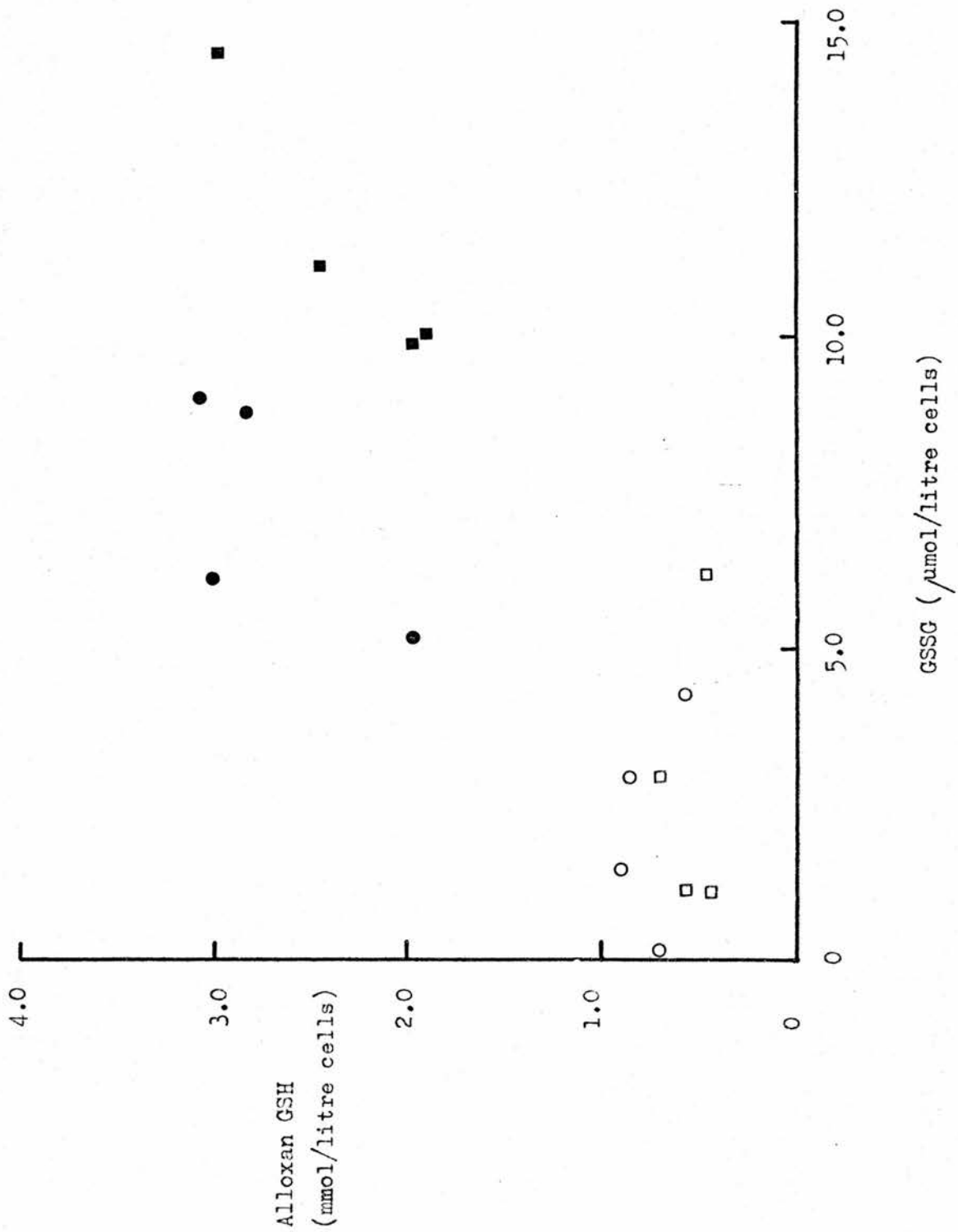

Fig. 4.05

A comparison of GSH (alloxan method) and GSSG concentrations  
in high and low GSH Finn and Merino erythrocytes

Both assays are described in the text (Chapter 4, Part 2 for the GSH method and Chapter 4, Part 3 for the GSSG method). Finn:

● high GSH and ○ low GSH. Merino: ■ high GSH and □ low GSH.

Table 4.03

The concentration of GSSG in high and low GSH Finn  
and Merino erythrocytes

Erythrocyte GSSG was estimated by the method of Srivastava & Beutler (1968a). Values are (mean  $\pm$  SEM (4))  $\mu\text{mol/litre cells}$ . Means are compared by Student's t-test.

		GSSG concentration	P
Finn	High GSH	7.23 $\pm$ 0.95	< 0.01
	Low GSH	2.15 $\pm$ 0.92	
Merino	High GSH	11.38 $\pm$ 1.08	< 0.01
	Low GSH	2.86 $\pm$ 1.19	



Section 3.03. The concentration of GSSG in high and low GSH Finn and Merino erythrocytes.

The erythrocyte GSSG concentrations of 4 high GSH and 4 low GSH Finns and the same number of high and low GSH Merinos are plotted against their respective erythrocyte alloxan GSH concentrations in Fig. 4.05. Low GSH erythrocytes of both breeds have a low concentration of GSSG. The GSSG concentrations in high and low GSH Finn and Merino erythrocytes are summarised in Table 4.03. The mean GSSG concentration in low GSH erythrocytes is only 29.7% of that found in high GSH erythrocytes in the case of Finns and 25.1% in the case of Merinos. Recovery of GSSG added to erythrocyte extracts was identical for high and low GSH erythrocytes of both breeds indicating that the low concentrations of GSSG encountered in low GSH erythrocytes could not be attributed to the presence of a GSSG-R inhibitor in these cells.

As in other mammalian species, (Srivastava & Beutler 1969b), the concentration of GSSG in sheep erythrocytes is very much less than the corresponding GSH concentration, the GSH:GSSG ratio being greater than 200:1 in high and low GSH erythrocytes of both breeds.

PART 4. THE REDOX POTENTIAL OF THE GSH-GSSG COUPLE IN HIGH AND LOW GSH FINN AND MERINO ERYTHROCYTES

As discussed earlier, (Chapter 1, Part 2) the major role of GSH in the erythrocyte is thought to be the protection the cell against oxidative damage, the GSH-GSSG couple acting as a redox buffering system. Consequently, it is the redox potential of the GSH-GSSG couple as well as the actual GSH concentration which is important in assessing whether this role can be adequately performed in low GSH erythrocytes. The redox potential of the GSH-GSSG couple in high and low GSH Finn and Merino erythrocytes has therefore been calculated from their respective GSH (alloxan method) and GSSG concentrations.

The redox potential,  $\underline{E}$  (volts) of a redox couple is given by the equation:

$$\underline{E} = \underline{E}_0' + \frac{RT}{nF} \ln \frac{[\text{ox}]}{[\text{red}]}$$

where

$\underline{E}_0'$  = Standard redox potential (volts). Temperature and pH specified.

R = Gas constant (8.32 joules/mol. degree)

T = Absolute temperature (degrees)

n = Number of equivalents involved in the reaction

F = The Faraday (96,500 joules/volt. equivalent)

$[\underline{\text{ox}}]$  and  $[\underline{\text{red}}]$  are the concentrations of the oxidised and reduced forms of the redox couple.

Table 4.04

The redox state of the GSH:GSSG couple in high and low GSH Finn and Merino erythrocytes

Concentrations are mean  $\pm$  SEM (4).

	Alloxan GSH (mmol/litre cells)	GSSG ( $\mu$ mol/litre cells)	$\frac{[GSSG]}{[GSH]^2}$ (litres/mol)	$\bar{E}$ (volts)*	$\Delta \bar{E}$ (volts)
Finn					
High GSH	2.73 $\pm$ 0.25	7.23 $\pm$ 0.95	0.97	- 0.240	
Low GSH	0.78 $\pm$ 0.07	2.15 $\pm$ 0.92	3.53	- 0.224	- 0.016
Merino					
High GSH	2.34 $\pm$ 0.24	11.38 $\pm$ 1.08	2.08	- 0.230	
Low GSH	0.57 $\pm$ 0.06	2.86 $\pm$ 1.19	8.94	- 0.211	- 0.019

\*  $\bar{E}'_O = 0.24$  volts at 40°C and pH 7.0 (Host & Rapoport, 1964).

The oxidation of GSH to GSSG can be written:

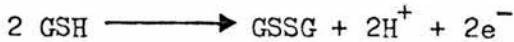

Thus, the redox potential ( $\underline{E}$ ) of the GSH-GSSG couple at 37°C is given by the equation:

$$\underline{E}_o = \underline{E}' + 0.03 \log_{10} \frac{[\text{GSSG}]}{[\text{GSH}]^2}$$

The  $[\text{GSH}]$  term is squared, two molecules of GSH being involved in the reaction.

The values of  $\underline{E}$ , assuming an  $\underline{E}'_o$  of - 0.24 volts (pH 7.0, 40°C) (Rost & Rapoport, 1964), for high and low GSH Finn and Merino erythrocytes are given in Table 4.04. Although in both Finns and Merinos high and low GSH animals differ widely in their erythrocyte  $[\text{GSSG}] : [\text{GSH}]^2$  ratios, their values of  $\underline{E}$  are remarkably similar. The difference in redox potential  $\Delta \underline{E}$  ( $\underline{E}_{\text{high GSH}} - \underline{E}_{\text{low GSH}}$ ) was - 0.016 volts in Finns and - 0.019 volts in Merinos. The absolute values of  $\underline{E}$  given in Table 4.04 can only be regarded as approximate because of the uncertainty of  $\underline{E}'_o$  under physiological conditions. However, when comparing the redox state of high and low GSH erythrocytes, the important parameter is  $\Delta \underline{E}$  which is not influenced by the estimate of  $\underline{E}'_o$ .

PART 5. DISCUSSION

The close correspondence between the alloxan and DTNB estimates of erythrocyte GSH in high and low GSH Finns and Merinos demonstrates that virtually all of the non-protein thiol in both cell types and breeds is in fact GSH. However, there may be a small but constant proportion of the total non-protein thiol (3-8%) which is not GSH. The identity of this thiol (75-200  $\mu\text{mol/litre cells}$ ) remains to be elucidated, but a possible candidate is GC since its concentration might be expected to increase with that of GSH. The thiol is unlikely to be cysteinyl glycine because sheep erythrocytes do not seem to have any significant ability to degrade GSH (Chapter 7, Part 3). Nor is likely to be cysteine: Smith (1973) has estimated that the cysteine concentration in sheep erythrocytes is less than 20  $\mu\text{mol/litre cells}$ .

These experiments establish with minor reservations the validity of equating DTNB reactive thiol with GSH. Consequently, unless otherwise stated, all subsequent GSH estimates were obtained using DTNB as chromogen. The dialysis DTNB method (Chapter 3, Part 2) was employed for routine analyses, since in this method, the protein precipitation step is circumvented by the use of a dialyser. The protein precipitation DTNB method described in this Chapter was however used when it was necessary to follow changes in erythrocyte GSH concentration with time: for instance, in studies of the time-course of GSH regeneration (Chapter 9, Part 3).

High and low GSH erythrocytes from both breeds have GSSG

concentrations of less than  $12 \mu\text{mol/litre}$  cells. Consequently, Finn and Merino low GSH erythrocytes have a low total glutathione content (GSH + 2GSSG). Furthermore, low GSH erythrocytes of both types have a significantly lower GSSG concentration than high GSH cells. The possibility that low GSH erythrocytes have a diminished GSSG concentration has also recently been suggested by Agar et al., (1973), although no values were given.

The alloxan GSH and GSSG estimates were used to calculate the redox potential of the GSH-GSSG couple in high and low GSH Finn and Merino erythrocytes. In Finns, the difference in redox potential between high and low GSH cells is - 0.016 volts. The corresponding figure for Merinos is - 0.019 volts. The significance of these values is discussed in Part 2 of the General Discussion.

CHAPTER 5

GSH BIOSYNTHESIS I : THE ACTIVITIES OF THE ENZYMES OF GSH  
BIOSYNTHESIS IN HIGH AND LOW GSH FINN AND MERINO ERYTHROCYTES

PART 1. INTRODUCTION

Synthesis of GSH in mammalian erythrocytes occurs in two enzymic steps (Minnich et al., 1971):

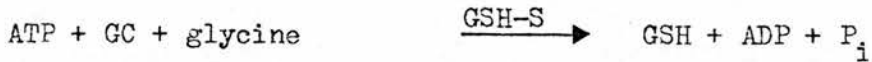
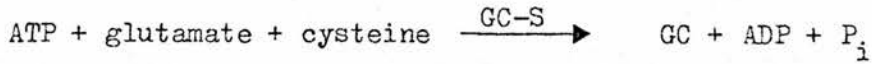

The first reaction is catalysed by  $\gamma$ -glutamyl cysteine synthetase (GC-S) and results in the formation of  $\gamma$ -glutamyl cysteine (GC). The second reaction is catalysed by GSH synthetase (GSH-S).

One possible explanation for the low concentrations of total glutathione (GSH + 2GSSG) in low GSH erythrocytes is a diminished ability to synthesise GSH. In this connection it is noteworthy that a diminished ability to synthesise GSH has been implicated in a number of instances of erythrocyte GSH deficiency in man. Decreased activities of both GC-S and GSH-S have been described (Boivin & Galand, 1965; Minnich et al., 1971; Konrad et al., 1972). Consequently, the capacity of high and low GSH Finn and Merino erythrocytes to synthesise GSH was examined.

The methods used to assay sheep erythrocyte GC-S and GSH-S are described in Part 2 of this Chapter. The activities of these enzymes in high and low GSH erythrocytes from both breeds are presented in Part 3 and discussed in Part 5.

Both the enzymes of GSH biosynthesis require ATP. The possibility that GSH-deficient sheep erythrocytes might have a diminished ATP concentration is considered in Part 4.



PART 2. THE ASSAY OF THE ENZYMES OF GSH  
BIOSYNTHESIS IN SHEEP ERYTHROCYTES

Section 2.01. Introduction

Erythrocyte GC-S and GSH-S have been assayed by a variety of spectrophotometric and isotopic techniques. The spectrophotometric methods include the measurement of ATP hydrolysis (Sass, 1968; Konrad et al., 1972) or the detection of the thiol reaction products GC and GSH (Sass, 1968; Jackson, 1969; Konrad et al., 1972). The isotopic methods have the advantages of greater sensitivity and specificity, and rely on the isolation of reaction products either by precipitation as insoluble mercaptides (Minnich et al., 1971; Paniker & Beutler, 1972) or less conveniently by electrophoresis (Wendel & Flohé, 1972). In the present study, sheep erythrocyte GC-S and GSH-S were measured in dilute haemolysates by a modification of the isotopic method of Paniker & Beutler (1972). This method is derived from the original one of Minnich et al. (1971). The assay of both GC-S and GSH-S depends on the precipitation of the thiol reaction products as cadmium mercaptides. Since these mercaptides are insoluble at neutral pH, but soluble in acid, the precipitates can be washed free of radioactive substrates ( $\text{[}^{14}\text{C]}$  glutamate and  $\text{[}^{14}\text{C]}$  glycine), dissolved in acid, and counted by liquid scintillation spectrometry.

Section 2.02. The assay of GC-S and GSH-S in sheep erythrocytes

Immediately prior to analysis, 10 - 30% (v/v) erythrocyte haemolysates (containing approximately 30 - 90 mg haemoglobin/ml)

were prepared from NaCl - washed sheep erythrocytes by addition of ice-cold distilled water. Aliquots were assayed for haemoglobin and enzyme activity.

The reaction mixture for GC-S contained 100  $\mu\text{mol}$  imidazole-HCl buffer, pH 8.25, 20  $\mu\text{mol}$   $\text{MgCl}_2$ , 4  $\mu\text{mol}$  ATP, 10  $\mu\text{mol}$  each of cysteine, [ $^{14}\text{C}$ ] glutamate (0.05  $\mu\text{Ci}/\mu\text{mol}$ ) and dithiothreitol, and 0.1 ml haemolysate in a total volume of 1.00 ml. Reaction mixtures minus haemolysate were pre-incubated at 37°C for 15 min to ensure temperature equilibration and complete reduction of the cysteine. The reaction was initiated by adding the haemolysate. At the end of 30 min incubation (37°C), 1 ml of 10% (w/v) trichloroacetic acid (TCA) was added, and the samples were centrifuged at 2000 g for 10 min. To 1.5 ml of supernatant were added 0.1 ml of freshly prepared 0.2 M GSH, 0.1 ml of 0.75 M  $\text{CdSO}_4$ , and 0.1 ml of indicator (containing equal volumes of 0.04% (w/v) aqueous solutions of bromocresol green and bromocresol purple). The mixture was titrated by dropwise addition of 0.5 M NaOH until the colour changed from yellow to aqua (pH 5.25). If excess NaOH was added (blue colour) the reaction mixture was backtitrated to aqua with 10% (w/v) TCA. The cadmium mercaptide precipitate was sedimented by centrifugation (2000 g for 5 min) and washed 4 times with 2 ml aliquots of water. The final washed precipitate was dissolved in 0.5 ml of 7% (w/v) TCA and transferred to 5 ml of Bray's fluid (Bray, 1960) in low-potassium glass scintillation vials. After mixing, the samples were counted in a Packard Tri-Carb liquid scintillation spectrometer (Packard Instrument Co. Inc.,

Illinois, U.S.A.). The instrument settings are detailed in the next Section. Counting times were adjusted to give in excess of 5000 counts/sample. Blank values were obtained by adding TCA before haemolysate to the complete reaction mixture. Blanks were not incubated.

The reaction mixture for GSH-S contained 100  $\mu\text{mol}$  of imidazole-HCl buffer pH 8.25, 20  $\mu\text{mol}$   $\text{MgCl}_2$ , 4  $\mu\text{mol}$  ATP, 10  $\mu\text{mol}$  each of [ $^{14}\text{C}$ ] glycine (0.1  $\mu\text{Ci}/\mu\text{mol}$ ) and dithiothreitol, 0.6  $\mu\text{mol}$  of GC and 0.1 ml haemolysate in a total volume of 1.00 ml. GC was obtained as the disulphide (Cyclo Chemical Corp, Los Angeles, U.S.A.) and was reduced before addition to the reaction mixture by incubation at a concentration of 3.0 mM in 100 mM dithiothreitol for 20 min at 37°C. Reaction mixtures minus haemolysate were pre-incubated at 37°C for 15 min to ensure temperature equilibration and complete reduction of the GC. The reaction was started by adding the haemolysate. At the end of 30 min incubation (37°C), the reaction was stopped by adding 1 ml 10% (w/v) TCA. Subsequent sample treatment was identical to that for GC-S. Blank values were obtained by adding TCA before haemolysate to the complete reaction mixture.

Enzyme activities ( $\mu\text{mol}$  product formed/g Hb per min) were calculated from the dpm/vial and hence dpm/incubation, the specific activity of the precursor amino acid (the activity quoted by the supplier was assumed to be accurate), the content of haemoglobin in the incubation, and the incubation time. The dpm/vial was computed from the cpm/vial by the channels ratio method of quench correction (Section 2.03).

These GC-S and GSH-S assays are substantially the same as those of Paniker & Beutler (1972). However, a number of minor modifications were made. In the current study, imidazole-HCl buffer was used in the assay of both GC-S and GSH-S whereas Paniker & Beutler chose imidazole-HCl for the assay of GC-S but Tris-HCl for the assay of GSH-S. Since the activity of GSH-S is similar in both buffer systems (Majerus et al., 1971), imidazole-HCl buffer was employed in both assays for the sake of convenience. In Paniker & Beutler's method, blank values were obtained by omitting cysteine or GC from reaction mixtures. In the present study, blank values were obtained by adding TCA before haemolysate to complete reaction mixtures. This is similar to the method employed by Minnich et al. (1971), who added TCA to reaction mixtures before the radioactive amino acid. The relative merits of the two methods of blank estimation are discussed in Section 2.04. In the current assay methods and in those of Minnich et al. (1971), the cadmium mercaptide precipitates were washed free of radioactive substrates with water whereas Paniker & Beutler (1972) used 0.9% (w/v) NaCl. Water was found to be adequate for this purpose. Finally, the 60 min incubation period recommended for the assay of GC-S by Paniker & Beutler was halved, sufficient amounts of reaction product having formed in this time.

#### Section 2.03. Quench Correction

Instrument settings on the Packard Tri-Carb liquid scintillation spectrometer (Blue channel; gate width 50-1000; gain 7.0%) which gave a counting efficiency in excess of 80% for unquenched [ $^{14}\text{C}$ ] samples only

Counting Efficiency  
of Blue Channel (%)

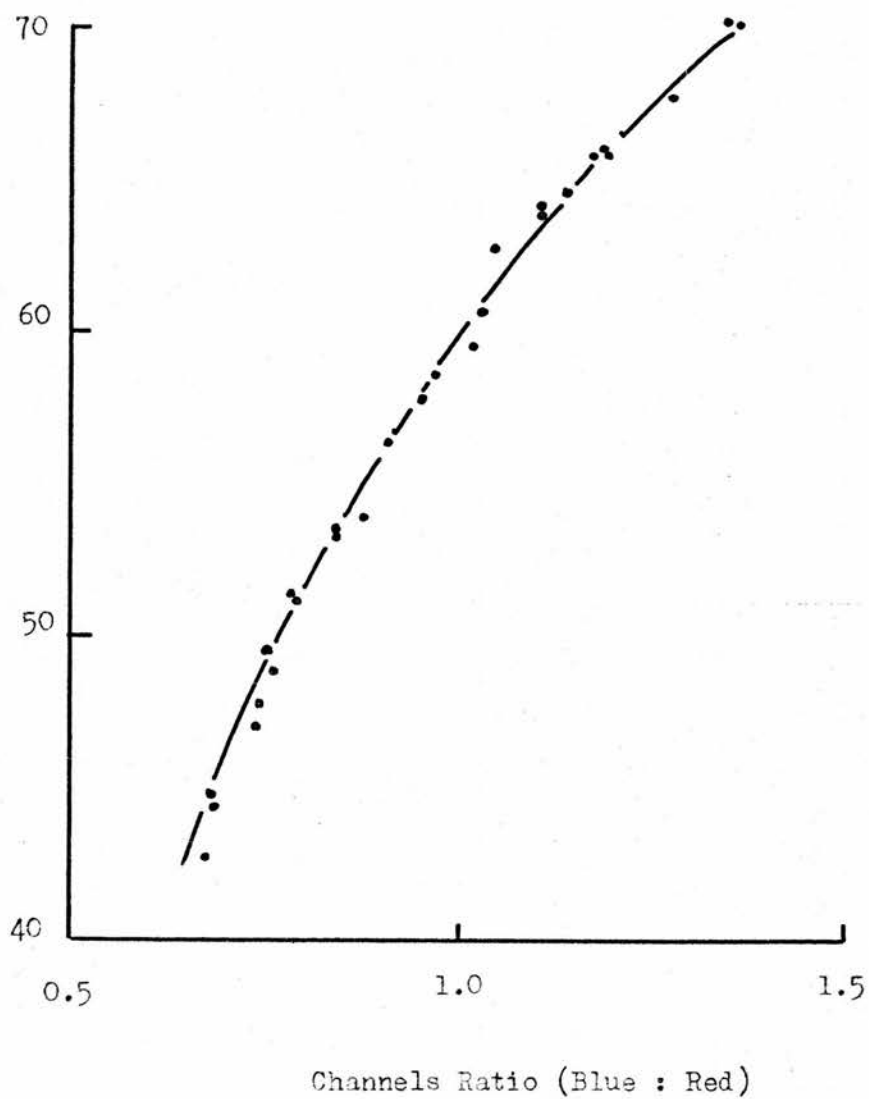

Fig. 5.01

A typical  $^{14}\text{C}$  quench correction curve

Progressive quenching of  $^{14}\text{C}$  glutamate in Bray's fluid was produced with TCA (Chapter 5, Part 2). The curve is a third order polynomial regression of Counting Efficiency (Blue Channel) on Channels Ratio (Blue:Red).

Table 5.01

The effect of precipitate formation on quench correction

	cpm*	cpm*	Channels Ratio
	(Red Channel)	(Blue Channel)	(Blue:Red)
Vial A <sup>+</sup>			
ppt.settled	1944	1881	0.968
ppt.suspended	2000	1888	0.944
Vial B <sup>+</sup>			
ppt.settled	2611	2761	1.058
ppt.suspended	2552	2711	1.062

\* 5 min counts

+ GC-S assays

gave counting efficiencies of between 50 - 60% for GC-S and GSH-S assay samples which had been prepared as described in the previous Section. The necessary quench correction to convert cpm to dpm was achieved using the channels ratio method of quench correction (Baillie, 1960). The Red (gate width 50-1000; gain 55%) and Blue (gate width 50-1000; gain 7.0%) channels were employed. Before calculation of the channels ratio for each sample (cpm (Blue channel): cpm (Red channel)), the counts in each channel were corrected for 'non-isotopic' background, obtained by counting empty vials. This 'non-isotopic' background was equivalent to approximately 80 cpm for the Red channel and 30 cpm for the Blue channel.

A quench correction curve of channels ratio against counting efficiency (Blue Channel) was constructed from a series of vials containing various volumes of 7% (w/v) TCA (0.3 - 0.7 ml), 0.01  $\mu$ Ci ( $U^{14}C$ ) glutamate and 5 ml Bray's fluid. The curve (a third order polynomial regression) is depicted in Fig. 5.01.

A white precipitate tended to form and subsequently settle in scintillation vials prepared as described in Section 2.02. Scintillation vials were therefore necessarily counted with the precipitate in variable degrees of suspension. However, this was not a source of error, since the precipitate either fully settled, or suspended, caused no appreciable alteration in either the cpm (Blue or Red channels) or the channels ratio (Table 5.01).

#### Section 2.04 Characteristics of the GC-S and GSH-S assays

For human samples, the GC-S assay is linear with time for at



$\sqrt{U^{14}C}$  glycine  
Incorporation  
(nmol/g Hb per min)

% GC-S Activity

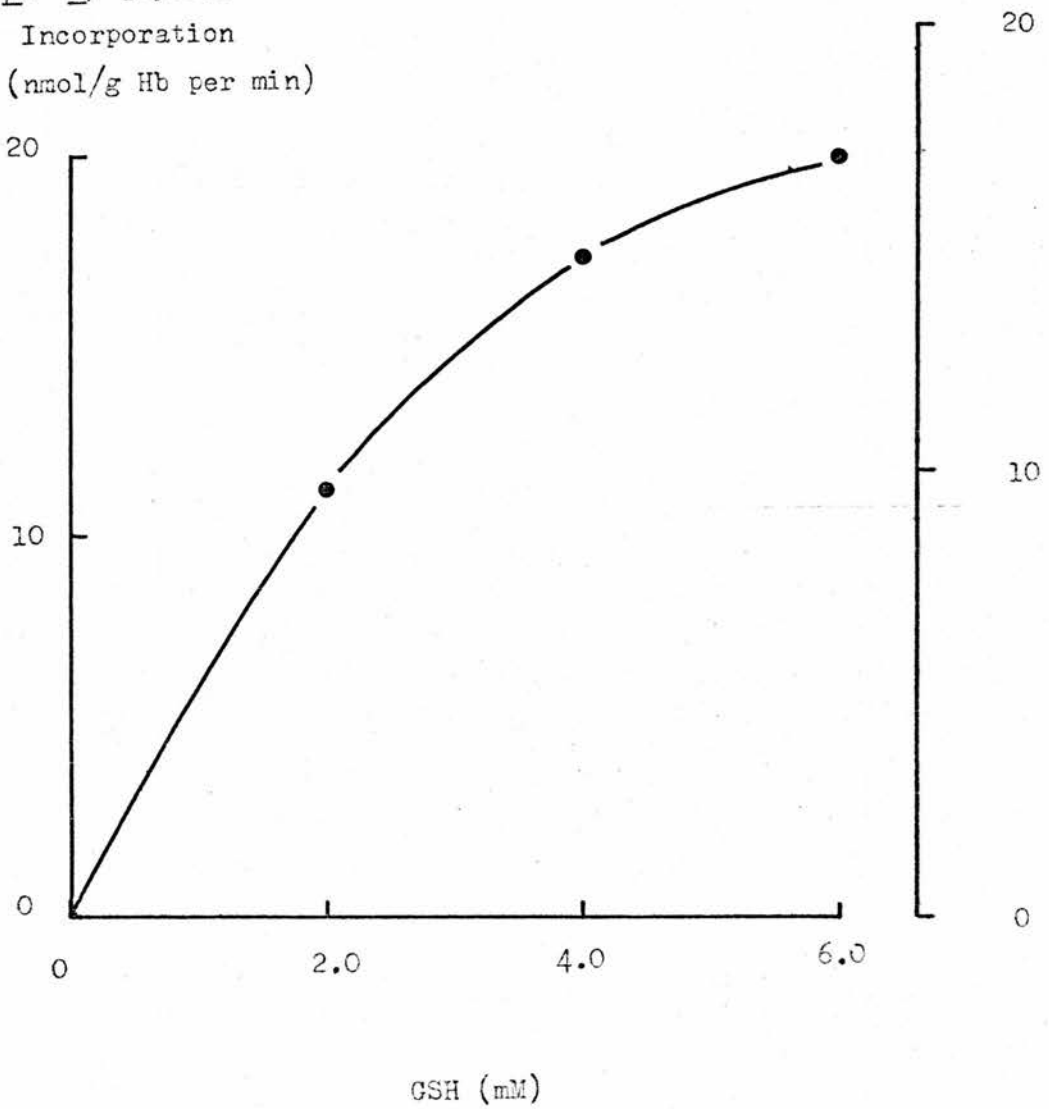

Fig. 5.02

$[U^{14}C]$  glycine incorporation into GSH in the absence of added GC

$[U^{14}C]$  glycine incorporation into GSH was measured by the dilute haemolysate GSH-S assay method (Chapter 5, Part 2). High GSH Merino erythrocytes were used.

least 60 min and is also linear with respect to the haemolysate concentration up to 9 mg haemoglobin/incubation. The GSH-S assay is linear with time for at least 30 min and is also linear with respect to haemolysate concentration up to 18 mg haemoglobin/incubation (Minnich et al., 1971). In the present study, for both human and sheep samples, GC-S and GSH-S incubations were for 30 min with haemolysate concentrations in the range 3-9 mg haemoglobin/incubation.

GSH-S, apart from catalysing the synthesis of GSH, also catalyses an exchange reaction between glycine and preformed GSH (Snoke & Bloch, 1955; Minnich et al., 1971). In the GSH-S assay system, [ $^{14}\text{C}$ ] glycine incorporation into GSH could therefore reflect this exchange rather than GSH synthesis. To evaluate the magnitude of this exchange reaction in the standard GSH-S assay system with sheep erythrocyte haemolysate, the incorporation of [ $^{14}\text{C}$ ] glycine into GSH in the absence of GC but in the presence of varying concentrations of GSH (0-6 mM) was determined. In Fig. 5.02 the incorporation into GSH is plotted against the concentration of added GSH. At 6 mM GSH, the rate of [ $^{14}\text{C}$ ] glycine incorporation into GSH is some 17% of the enzymic capacity for GSH synthesis from glycine and GC. However, in the standard GSH-S haemolysate assay the maximum concentration of GSH (derived from haemolysate) is approximately 0.1 mM. Consequently in a typical GSH-S haemolysate assay, the exchange reaction would account for less than 1% of the observed [ $^{14}\text{C}$ ] glycine incorporation into GSH, and can therefore be ignored.

The specificity of the GC-S and GSH-S assays was investigated in detail for human erythrocytes when the assays were initially developed

Table 5.02

The effect of different methods of blank estimation on the estimates of GC-S and GSH-S activity in sheep erythrocytes

Both enzymes were assayed in dilute haemolysates (3.0 mg Hb/ incubation). Values are  $\mu\text{mol/g Hb per min.}$  High GSH Merino erythrocytes were used.

	GC-S	GSH-S
Complete system	0.791	0.071
- cysteine	0.025	
- GC		0.016
TCA blank	0	0

(Minnich et al., 1971). The formation of the reaction product in the GC-S assay was found to be completely dependent on the presence of ATP and  $MgCl_2$  and largely dependent on the presence of cysteine. The formation of the reaction product in the GSH-S assay was completely dependent on the presence of ATP,  $MgCl_2$  and GC. In addition, the reaction products of both assays were isolated and identified as GC and GSH for the GC-S and GSH-S assays respectively. Furthermore, the isolated reaction product of the GC-S assay replaced chemically synthesised GC as substrate for the GSH-S assay.

In the present study, blank values for both the GC-S and GSH-S assays were determined by adding TCA before haemolysate to the complete incubation system. This is similar to the method of Minnich et al. (1971) but differs from that of Paniker & Beutler (1972) where blank values were obtained by carrying out incubations in the absence of cysteine or GC. For sheep erythrocytes, these two methods gave different blank values, the blanks without added substrates being consistently higher than the TCA blanks (Table 5.02).

In the case of GC-S, the difference between the two blank values has only a marginal effect on the estimated GC-S activity. However, because of the low GSH-S activity in sheep erythrocytes, the estimate of GSH-S activity is much more dependent on the type of blank employed.

The difference in blank values obtained by the two methods presumably reflects GC and GSH synthesis in the absence of added cysteine and GC, the substrates responsible for this blank activity deriving either from the haemolysate itself or from other incubation components. In these circumstances the use of blanks without added substrates results in an underestimate of enzyme activity.

Table 5.03

Typical dpm/vial for the sheep erythrocyte GC-S and GSH-S assays

	dpm/vial	mg Hb/ incubation	enzyme activity ( $\mu\text{mol/g Hb per min}$ )
GC-S			
(High GSH Merino)			
assay	9085		
TCA blank	251		
		5.22	0.684
GSH-S			
(High GSH Finn)			
assay	3222		
TCA blank	243		
		5.13	0.117

Consequently, TCA blanks were used in the present study. Typical dpm/vial for sheep erythrocyte GC-S and GSH-S assays and TCA blanks are given in Table 5.03. The coefficient of variation of an individual estimate was 6.4% in the case of the GC-S assay and 4.3% for the GSH-S assay.

Finally, it should be emphasised that the GC-S and GSH-S activities obtained using the assay systems described here represent maximum activities ( $V_{\max}$ ), the substrate concentrations presumably being sufficiently high to saturate both enzymes (Majerus et al., 1971).

GSH  
(mmol/litre cells)

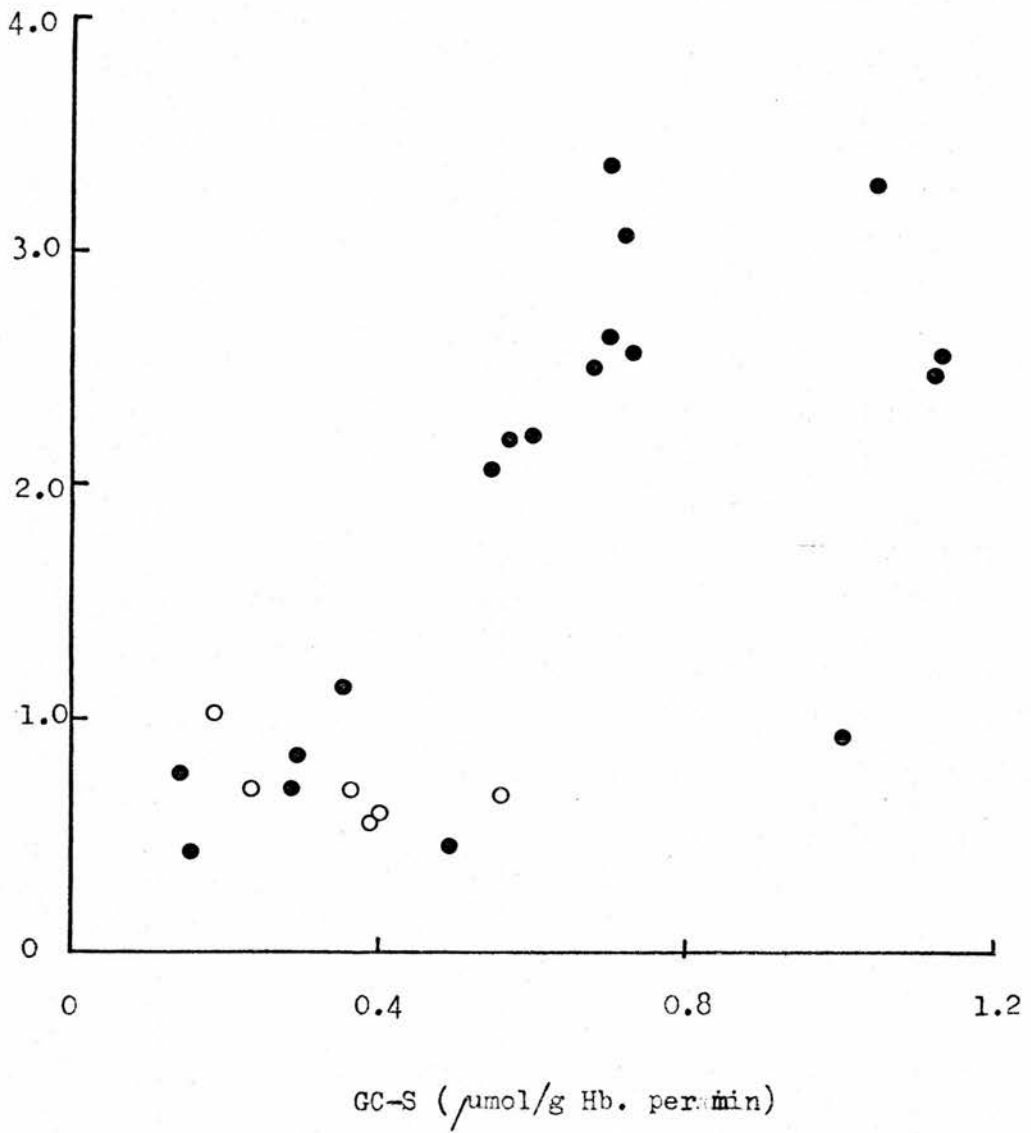

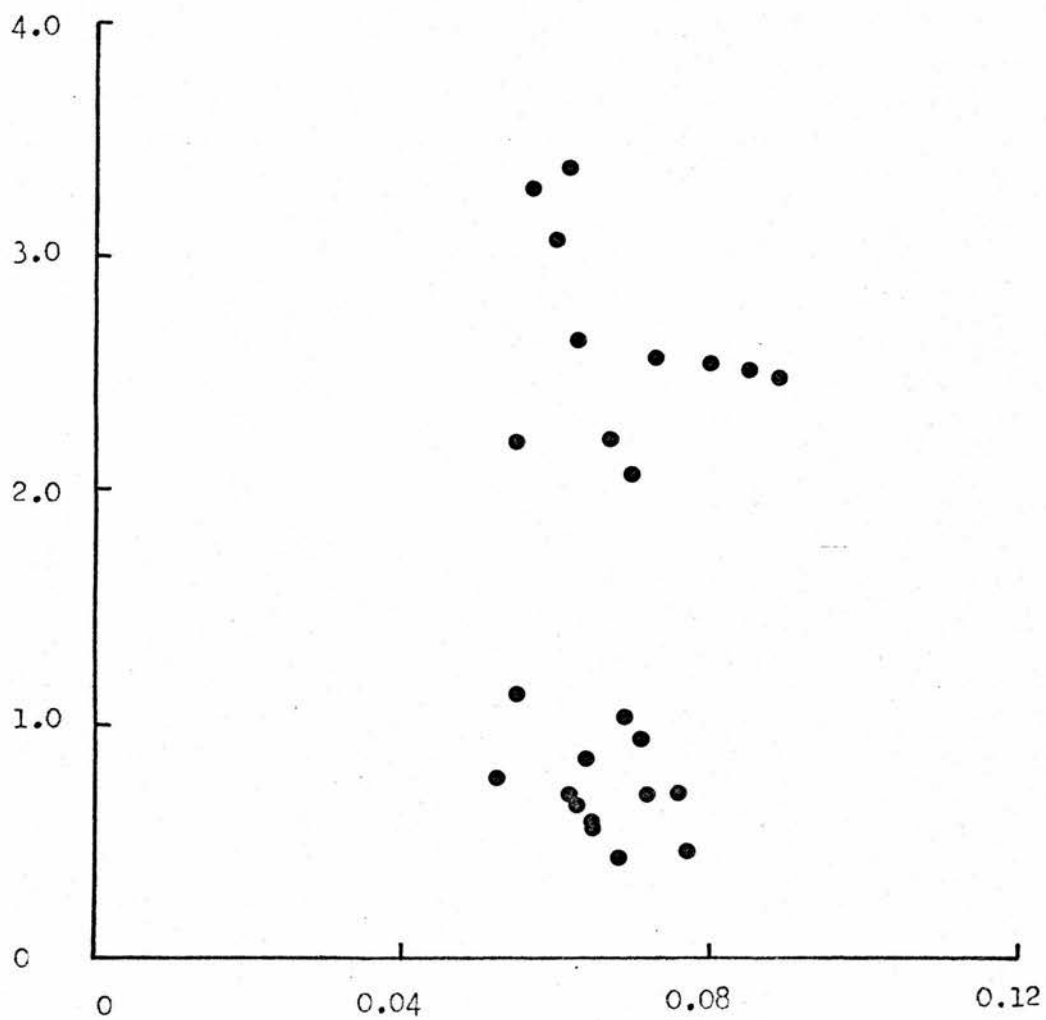

Fig. 5.03

The activity of GC-S in high and low GSH Merino erythrocytes

GC-S was assayed in dilute haemolysates by the method described in Chapter 5, Part 2. GSH was estimated by the automated dialysis method (Chapter 3, Part 2). Presumed heterozygotes are identified as O.

GSH  
(mmol/litre cells)



GSH-S (µmol/g Hb per min)

Fig. 5.04

The activity of GSH-S in high and low GSH Merino erythrocytes

GSH-S was assayed in dilute haemolysates by the method described in Chapter 5, Part 2. GSH was estimated by the automated dialysis method (Chapter 3, Part 2).

GSH  
(mmol/litre cells)

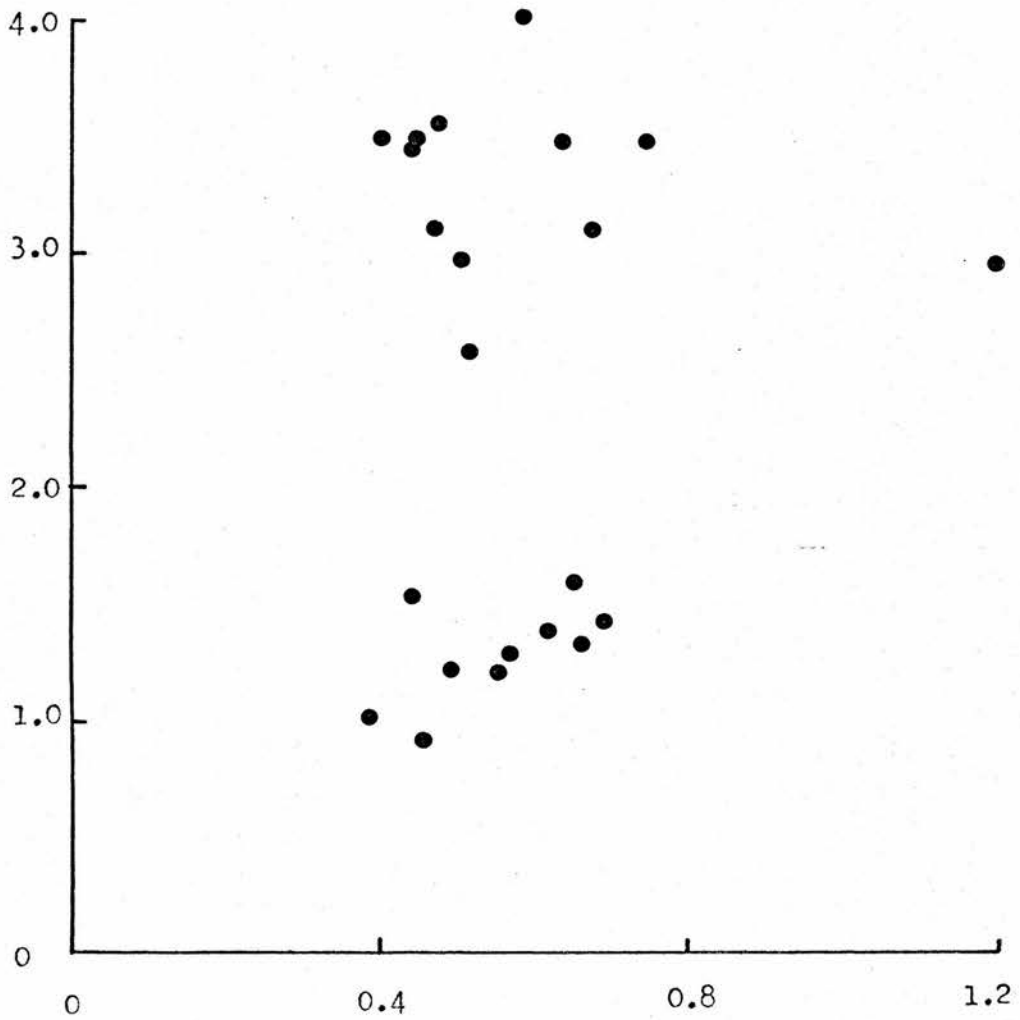

GC-S ( $\mu\text{mol/gHb per min}$ )

Fig. 5.05

The activity of GC-S in high and low GSH Finn erythrocytes

GC-S was assayed in dilute haemolysates by the method described in Chapter 5, Part 2. GSH was estimated by the automated dialysis method (Chapter 3, Part 2).

GSH  
(mmol/litre cells)

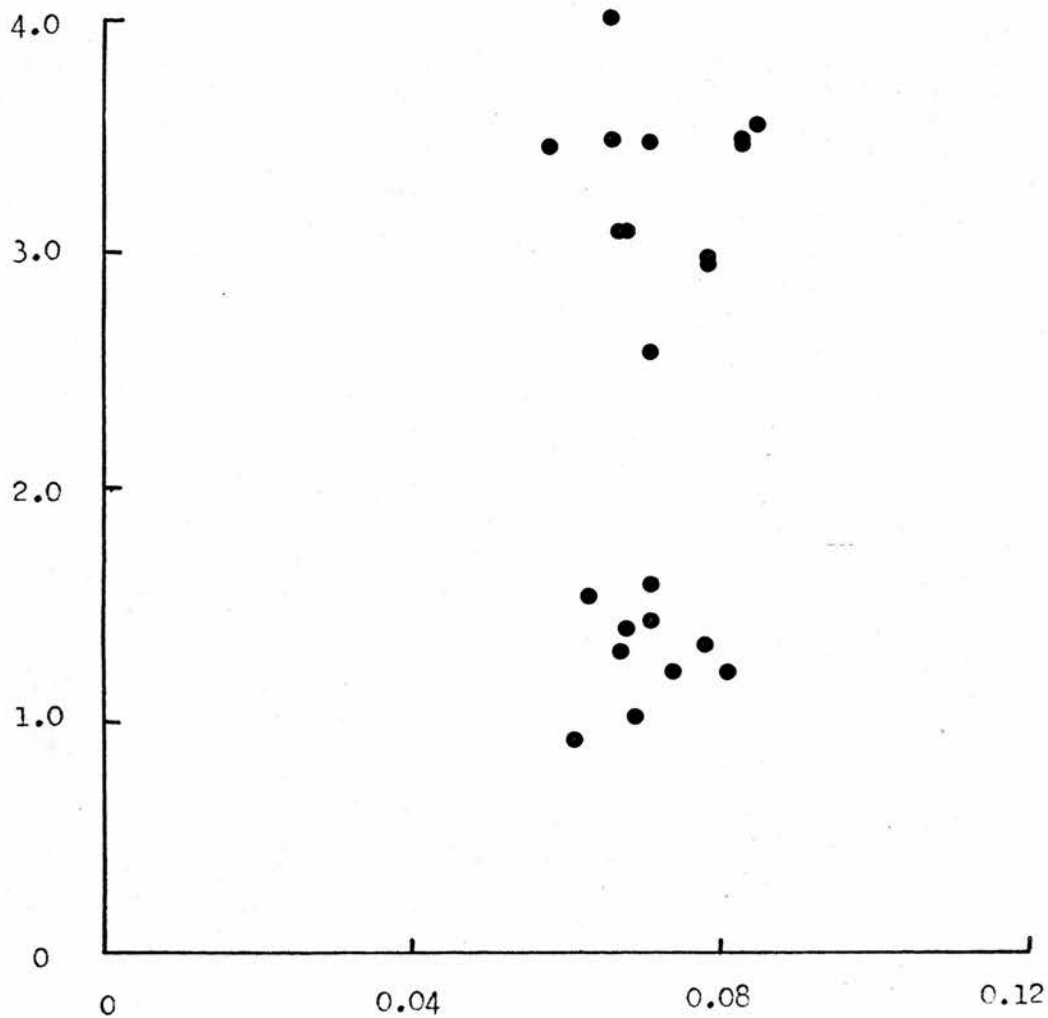

GSH-S ( $\mu\text{mol/gHb per min}$ )

Fig. 5.C6

The activity of GSH-S in high and low GSH Finn erythrocytes

GSH-S was assayed in dilute haemolysates by the method described in Chapter 5, Part 2. GSH was estimated by the automated dialysis method (Chapter 3, Part 2).

Table 5.04

Activities of the enzymes of GSH biosynthesis in high and  
low GSH Finn and Merino erythrocytes

GC-S and GSH-S were assayed in dilute haemolysates by the method described in Chapter 5, Part 2. Values are (mean  $\pm$  SEM)  $\mu\text{mol/g}$  Hb per min. Means are compared by Student's t-test.

		GC-S	GSH-S	No. of Animals
Finn	High GSH	0.595 $\pm$ 0.063	0.073 $\pm$ 0.002	12
	Low GSH	0.555 $\pm$ 0.033	0.070 $\pm$ 0.002	10
Merino	High GSH	0.776 $\pm$ 0.065	0.069 $\pm$ 0.003	11
	Low GSH	0.375 $\pm$ 0.063	0.066 $\pm$ 0.002	13

\* P < 0.001



PART 3. GC-S AND GSH-S ACTIVITIES IN HIGH AND LOW GSH FINN AND  
MERINO ERYTHROCYTES

In Figs. 5.03 and 5.04 the erythrocyte GC-S and GSH-S activities of 11 high GSH and 13 low GSH Merinos are plotted against their respective erythrocyte GSH concentrations. A clear correlation exists between erythrocyte GC-S activity and GSH concentration, high GSH erythrocytes having a higher maximum enzymic capacity than low GSH erythrocytes. The difference in activity between the two GSH types is highly significant by Student's t-test ( $P < 0.001$ ) (Table 5.04). There is no significant correlation between GC-S activity and GSH concentration within either GSH class. Unlike GC-S, the GSH-S activities of high and low GSH Merino erythrocytes were essentially the same (Fig. 5.04: Table 5.04).

In Figs. 5.05 and 5.06 the erythrocyte GC-S and GSH-S activities of 12 high GSH and 10 low GSH Finns are similarly plotted against their respective erythrocyte GSH concentrations. In marked contrast to the situation in Merinos, Finn high and low GSH erythrocytes have the same GC-S activity (see also Table 5.04). As with Merinos, no class differences in GSH-S activity are apparent (Fig. 5.06: Table 5.04).

Plots of GC-S activity against GSH-S activity revealed no significant correlation in either Finns (Fig. 5.07) or Merinos (Fig. 5.08).

The activities of erythrocyte GC-S and GSH-S in a number of high and low GSH animals were again determined after an interval of 14 days (Merino GC-S), 28 days (Merino GSH-S) and 44 days (Finn GC-S

GSH-S  
( $\mu\text{mol/gHb per min}$ )

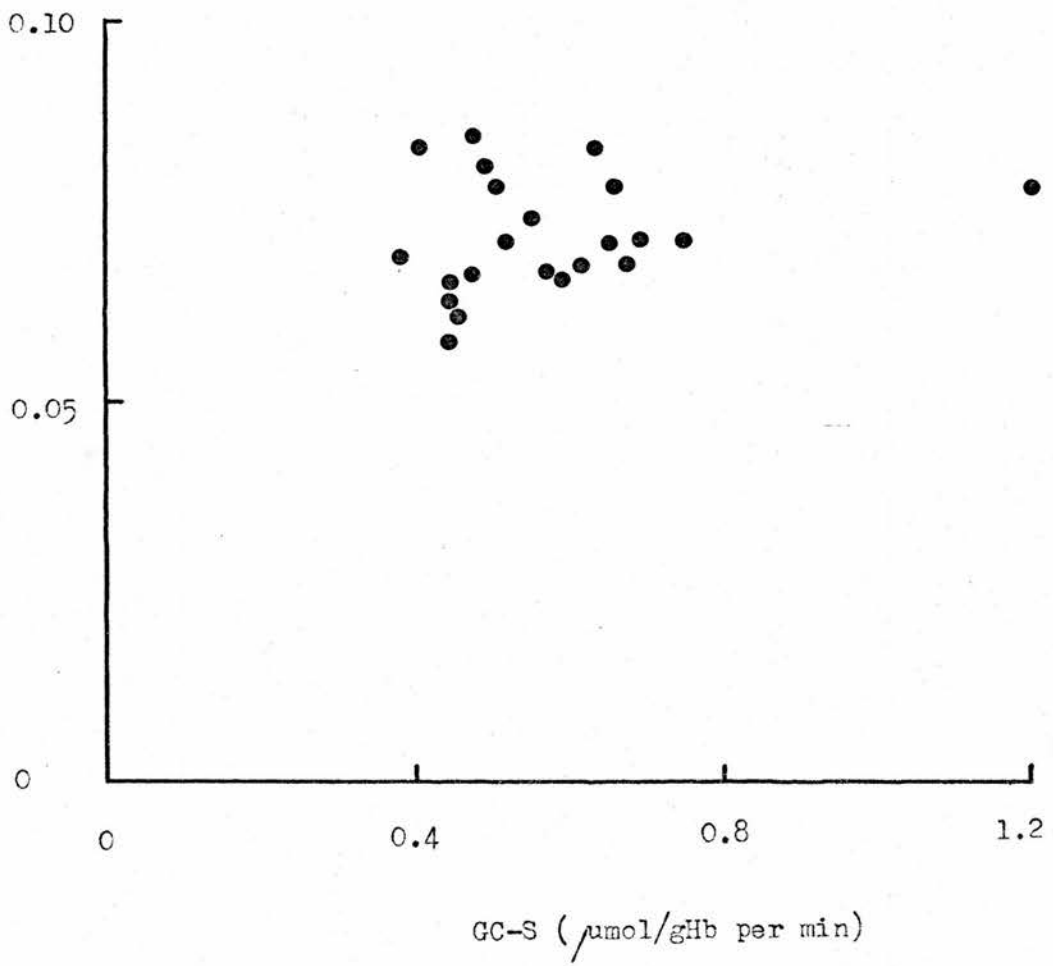
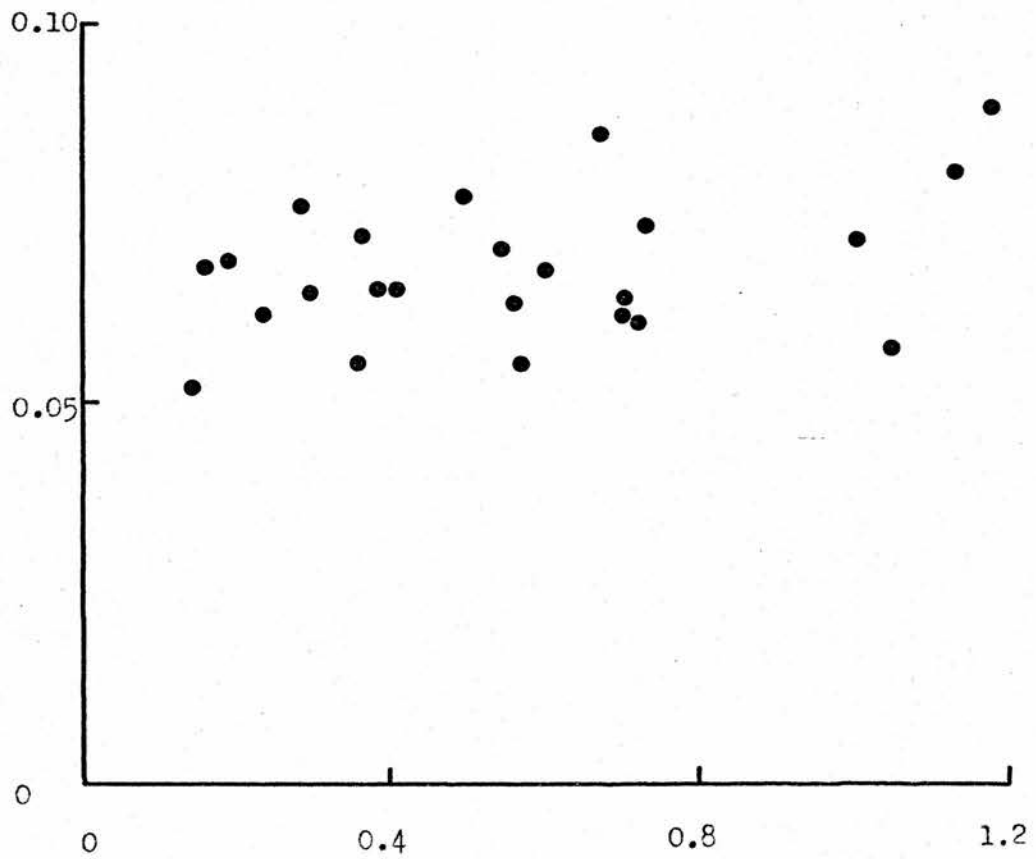

Fig. 5.07

A comparison of GC-S and GSH-S activities in high and low  
GSH Finn erythrocytes

The GC-S and GSH-S activities are those given in Figs. 5.05 and 5.06.

GSH-S  
( $\mu\text{mol/gHb per min}$ )



GC-S ( $\mu\text{mol/gHb per min}$ )

Fig. 5.08

A comparison of GC-S and GSH-S activities in high and  
low GSH Merino erythrocytes

The GC-S and GSH-S activities are those given in Figs. 5.03 and 5.04.

Table 5.05

Stability of the activities of the enzymes of GSH biosynthesis  
in high and low GSH Finn and Merino erythrocytes

GC-S and GSH-S were assayed in dilute haemolysates by the methods described in Chapter 5, Part 2. Values are  $\mu\text{mol/gHb}$  per min.

	Animal Identity	GC-S		GSH-S			
		DAY 1	DAY 44	DAY 1	DAY 44		
Finn	High GSH	1L1560	0.637	0.640	0.063	0.083	
		1L1589	0.407	0.521	0.055	0.071	
	Low GSH	1L1573	0.660	0.656	0.070	0.071	
		1L1615	0.659	0.693	0.057	0.071	
	Merino	High GSH		DAY 1	DAY 14	DAY 1	DAY 28
			D474	0.909	0.701	0.061	0.063
		D482	0.941	1.118	0.071	0.089	
Low GSH		D448	0.241	0.287	0.059	0.076	
		D479	0.383	0.156	0.071	0.068	

Table 5.06

Comparison of the activities of the enzymes of GSH biosynthesis  
in sheep (Finn and Merino) and human erythrocytes

GC-S and GSH-S were assayed in dilute haemolysates (Chapter 5, Part 2).  
Values are (mean  $\pm$  SEM)  $\mu\text{mol/gHb}$  per min.

	GC-S	GSH-S	GSH-S:GC-S	No. of Animals/ humans	
Finn	High GSH	0.595 $\pm$ 0.063	0.073 $\pm$ 0.002	0.123	12
	Low GSH	0.555 $\pm$ 0.033	0.070 $\pm$ 0.002	0.126	10
Merino	High GSH	0.776 $\pm$ 0.065	0.069 $\pm$ 0.003	0.089	11
	Low GSH	0.375 $\pm$ 0.063	0.066 $\pm$ 0.002	0.176	13
Human (I.A.N.)*	0.783(0.746, 0.820)	0.167(0.174, 0.160)	0.213	1	
Human (Minnich <u>et</u> <u>al.</u> , 1971)	0.43 $\pm$ 0.01	0.19 $\pm$ 0.01	0.442	25	

\* mean of two independent estimates (given in parentheses)

and GSH-S). Table 5.05 compares these estimates of erythrocyte GC-S and GSH-S activity with those obtained on day 1. The enzyme activities of individuals of both breeds and classes are relatively constant.

In Table 5.06, the GC-S and GSH-S activities of sheep erythrocytes from the present study are compared with the erythrocyte enzymic activities of a human subject (I.A.N.) assayed under identical conditions, and with estimates of human erythrocyte GC-S and GSH-S activities obtained by Minnich et al. (1971). It would appear that human and sheep erythrocytes contain approximately the same GC-S activity, but that sheep erythrocytes contain a much lower GSH-S activity than do human erythrocytes. Thus in human erythrocytes the ratio of GSH-S:GC-S activities is approximately 0.44 compared with values of 0.12 and 0.13 for high and low GSH Finn erythrocytes respectively and 0.09 and 0.18 for high and low GSH Merino erythrocytes respectively.



PART 4. THE CONCENTRATION OF ATP IN HIGH AND LOW GSH

FINN AND MERINO ERYTHROCYTES

Section 4.01. Introduction

Both the enzymes of GSH biosynthesis require ATP. The possibility was therefore considered that sheep erythrocyte GSH deficiency might be the result of a diminished cell ATP concentration. The concentration of ATP in high and low GSH Finn and Merino erythrocytes was determined using the Boehringer Test Combination (Diagnostics) U.V. method which depends on the sequential action of 3-phosphoglycerate kinase (PGK) (EC 2.7.2.3), glyceraldehyde-3-phosphate dehydrogenase (GAPD) (EC 1.2.1.12), triosphosphate isomerase (TIM) (EC 5.3.1.1) and glycerol-3-phosphate dehydrogenase (GD) (EC 1.1.99.5). The disappearance of NADH is monitored at 340 nm.

Section 4.02. The estimation of ATP in sheep erythrocytes

Whole blood samples (kept on ice prior to analysis) were deproteinised within 3 h of collection by adding 0.5 ml to 2.0 ml ice-cold perchloric acid (0.6 M) and centrifuging at 2000 g for 10 min. The supernatants were retained and kept on ice.

The concentration of ATP in the erythrocyte extract was determined enzymically as discussed above. To 0.2 ml of erythrocyte extract in a 3 ml cuvette was added 2.0 ml of a solution containing 0.5 M triethanolamine buffer pH 7.6, 4 mM MgSO<sub>4</sub>, and 6 mM 3-phosphoglycerate,

and 0.2 ml of 2.5 mM NADH. It was important to mix these reagents immediately since contact of the unbuffered NADH with perchloric acid caused a rapid drop in the extinction at 340 nm, presumably because of the instability of NADH at acid pH. Cuvettes were allowed to equilibrate at room temperature in a Unicam SP800 recording spectrophotometer, and extinction measurements were made for several minutes at 340 nm using a Servoscribe recorder (full scale deflection 0.1 units). The reaction was initiated by adding 0.02 ml of enzyme solution containing 7 mg GAPD, 1 mg PGK and 2 mg each of GD and TIM per ml. After the initial rapid decrease, the extinction was monitored until any remaining rate of change of extinction was linear. A slow constant decrease in extinction was usually observed, possibly due to the instability of NADH in the presence of the  $H_2O_2$  generated during deproteinisation (Lemberg, 1942). For this reason, the change in extinction following enzyme addition was calculated after back-extrapolation of the extinction curve to the point of enzyme addition. This change in extinction was corrected both for the decrease in extinction resulting from the dilution of the cuvette contents by the addition of enzyme, and for the extinction of the enzyme solution itself.

Whole blood ATP concentrations (mM) were calculated assuming a molar extinction coefficient for NADH of  $6.22 \times 10^3$ . Erythrocyte ATP concentrations (mmol/litre cells) were obtained using the whole blood haematocrits. The ATP content of whole blood is derived almost entirely from erythrocytes, the contribution from plasma and other cell elements being negligible (Bishop *et al.*, 1959; Gross *et al.*, 1963).

Table 5.07

The concentration of ATP in high and low GSH

Finn and Merino erythrocytes

The method of erythrocyte ATP estimation is described in Chapter 5, Part 4. Values are (mean  $\pm$  SEM (3) ) mmol/litre cells. Means are compared by Student's t-test.

		ATP Concentration	P
Finn	High GSH	0.882 $\pm$ 0.040	NS
	Low GSH	0.833 $\pm$ 0.019	
Merino	High GSH	0.831 $\pm$ 0.036	NS
	Low GSH	0.909 $\pm$ 0.125	

Section 4.03 The concentration of ATP in high and low GSH  
Finn and Merino erythrocytes

The concentrations of ATP in high and low GSH Finn and Merino erythrocytes are given in Table 5.07. There is no significant difference in the concentration of ATP between high and low GSH erythrocytes in either breed. The concentrations of ATP reported here agree well with those previously found in sheep erythrocytes (Smith, 1973).

PART 5. DISCUSSION

The striking association between low concentrations of erythrocyte GSH and a diminished activity of GC-S (48% of normal) suggests that this diminished enzymic activity is responsible for the GSH deficiency seen in Merinos. A reduced ability to synthesise GSH has also been implicated in a number of instances of erythrocyte GSH deficiency in man. Decreased activities of both GC-S and GSH-S have been reported (see Part 1 of this Chapter).

For the low concentrations of erythrocyte GSH in Merinos to be attributable to a 52% reduction in GC-S activity, GC-S must be the rate limiting enzyme of GSH biosynthesis in sheep erythrocytes. The relative activities of GC-S and GSH-S as measured in dilute haemolysates suggest that this may not be the case. Even in low GSH Merino erythrocytes, the maximum capacity for GC synthesis is in excess of that for GSH synthesis, the ratio of GSH-S:GC-S activities being 0.18. However, *in vivo*, both the enzymes of GSH biosynthesis in sheep erythrocytes are probably operating at well below their maximum activities. This is suggested by the observation of Smith (1974) that glutathione in sheep erythrocytes turns over with a half-life of 11 days whereas the GC-S and GSH-S activities reported here indicate that normal sheep erythrocytes have the enzymic capacity to synthesise the cell's entire complement of GSH in approximately 100 min. A similar situation exists in human erythrocytes (Dimant *et al.*, 1955; Minnich *et al.*, 1971) where control of GSH biosynthesis is thought to involve both substrate availability

and metabolic inhibition by particularly GSH and perhaps also by NADH, NADPH,  $\text{NAD}^+$  and ADP, (Jackson, 1969). In view of the stringent control of GSH biosynthesis in vivo, the relative maximum activities of GC-S and GSH-S as determined in dilute haemolysates under optimal conditions may bear little relation to the relative rates of the two enzymes in vivo. In Chapters 6 and 7 the effects of substrate availability and GSH inhibition on the relative activities of sheep erythrocyte GC-S and GSH-S are assessed. Evidence is presented which indicates that GC-S is the rate limiting enzyme of GSH biosynthesis in sheep erythrocytes in vivo. This is consistent with the suggestion that the low concentrations of GSH in low GSH Merino erythrocytes are attributable to a reduced GC-S activity.

Studies of purified human erythrocyte GC-S indicate that sulphhydryl groups are important for enzyme activity (Majerus et al. 1971). This suggests an alternative explanation for the relationship between low concentrations of erythrocyte GSH and low GC-S activities, namely that the reduced GC-S activity in low GSH cells is a result of increased sulphhydryl group oxidation caused by the lower intracellular GSH concentration. This postulate is unlikely for a number of reasons. First, the redox potential of the GSH-GSSG couple in low GSH Merino erythrocytes seems to be almost normal (Chapter 4, Parts 4 and 5). Secondly, in Finns, low concentrations of erythrocyte GSH are not associated with a reduced GC-S activity. Thirdly, human erythrocytes with a virtual absence of GSH resulting from a GSH-S deficiency have normal GC-S activities (Minnich et al., 1971). Finally, the GC-S assay medium contains dithiothreitol, a very effective reagent for maintaining sulphhydryl groups in the reduced state (Cleland, 1964).

Table 5.08

Comparison of the activities of the enzymes of GSH biosynthesis  
in high and low GSH sheep from the present study and from that  
of Smith *et al.* (1973)

values are (mean  $\pm$  SEM)  $\mu\text{mol/gHb per min.}$

	GC-S	GSH-S	No. of animals	
Merinos (present study)	High GSH	0.776 $\pm$ 0.065	0.069 $\pm$ 0.003	11
	Low GSH	0.375 $\pm$ 0.063	0.066 $\pm$ 0.002	13
?breed (Smith <i>et al.</i> , 1973)	High GSH	0.537 $\pm$ 0.029	0.104 $\pm$ 0.010	6
	Low GSH	0.285 $\pm$ 0.020	0.085 $\pm$ 0.003	6

Although a decreased ability to synthesise GC may be responsible for the low concentrations of erythrocyte GSH in Merinos, the low concentrations of GSH in Finns cannot be explained in this way, high and low GSH erythrocytes having the same GC-S activity. The suggestion that the biochemical mechanisms responsible for the GSH deficiency differ in Finns and Merinos is supported by a number of additional observations discussed in detail earlier (Chapter 1, Part 2). These include the different inheritance patterns observed in the two breeds (low GSH recessive in Finns but dominant in Merinos) (Tucker & Kilgour, 1970, 1972) and the finding that low concentrations of erythrocyte GSH in Finns are associated with high concentrations of ornithine and lysine, a phenomenon not observed in Merinos (Ellory *et al.*, 1972).

Both the enzymes of GSH biosynthesis require ATP. The possibility was therefore considered that low GSH Finn erythrocytes might have a diminished ATP concentration. However, investigations described in Part 4 of this Chapter indicate that these cells have a normal complement of ATP.

The suggestion that a decreased ability to synthesise GC may be responsible for the low concentrations of erythrocyte GSH in Merinos has recently been confirmed by the independent investigations of Smith *et al.* (1973), who also found a low GC-S activity in low GSH erythrocytes. Unfortunately, in their study, neither the breed of sheep nor the type of GSH deficiency investigated were specified. The Merino erythrocyte GC-S and GSH-S activities found in the present study are compared with the activities reported by Smith *et al.* (1973) in Table 5.08. Both sets of data agree closely, the estimates of GC-S activity reported by Smith *et al.* being slightly lower than



those of the present study and the estimates of GSH-S activity slightly higher. The mean GC-S activity in low GSH erythrocytes was 55% of that found in high GSH erythrocytes according to Smith et al. compared with 48% in the present study. Smith et al. employed the unmodified assay methods of Minnich et al. (1971).

A complete genetic analysis of the animals used in the present study was not possible for reasons already discussed (Chapter 3, Part 5). However, of the 13 low GSH Merinos whose erythrocyte GC-S activity were measured, 6 could be identified as heterozygotes (Ll). These individuals are shown in Fig. 5.03. The remaining 7 unclassified low GSH animals will also probably contain a number of unidentified heterozygotes as well as homozygotes (LL). Consequently, the mean low GSH Merino GC-S activity reported in Table 5.04 probably reflects the heterozygote enzyme activity. It is therefore possible that the homozygote GC-S activity is lower than the value of  $0.375 \mu\text{mol/g Hb per min}$  quoted here for low GSH Merinos.

In the present study one low GSH Merino did not conform to the overall pattern. This individual, although having an erythrocyte GSH concentration of less than 1 mmol/litre cells and no detectable erythrocyte amino acids, had a high GC-S activity ( $1.01 \mu\text{mol/gHb per min}$ ). This animal was possibly misclassified as to GSH type (see for example Ellory et al. (1972) and Tucker & Kilgour (1973)).

A decreased ability to synthesise GSH has also been implicated in a number of instances of low erythrocyte GSH in man. In most instances this is associated with a reduced GSH-S activity (Boivin & Galand, 1965; Minnich et al., 1971).

However in one study a reduced activity of GC-S was implicated

(Konrad et al., 1972). In contrast to the situation in sheep, heterozygotes with intermediate GC-S activities (58% of normal) had normal erythrocyte GSH concentrations. Homozygotes with GC-S activities 11% of normal had erythrocyte GSH concentrations only 3% of normal. Thus in human erythrocytes, a reduction in GC-S activity of 42% is not accompanied by any alteration in the erythrocyte GSH concentration, whereas in sheep, a reduction in GC-S activity of approximately the same order results in a dramatic drop in the GSH concentration. This difference between sheep and human erythrocytes deserves investigation.

CHAPTER 6

GSH BIOSYNTHESIS II: COMPUTER SIMULATION STUDIES OF GSH BIOSYNTHESIS  
IN SHEEP ERYTHROCYTES

PART 1. INTRODUCTION

In Merinos a low concentration of erythrocyte GSH is associated with a diminished maximum activity of GC-S. It is therefore tempting to conclude that for these sheep a low concentration of GSH is caused by a diminished activity of GC-S. If this is true, GC-S rather than GSH-S must be the rate-limiting enzyme of GSH biosynthesis. However, the relative maximum activities of GC-S and GSH-S as measured in dilute haemolysates suggest the opposite, for even in low GSH erythrocytes the activity of GC-S exceeds that of GSH-S. On the other hand, in vivo both the enzymes operate at well below their maximum capacities. Normal high GSH sheep erythrocytes have sufficient enzymic capacity to synthesise their entire complement of GSH in approximately 2 hours, whereas it has been estimated that in sheep erythrocytes in vivo, GSH has a half-life of 11 days (Smith, 1974). A similar situation exists in human erythrocytes, in which control of GSH biosynthesis is thought to involve both substrate availability and metabolic inhibition (particularly GSH inhibition of GC-S) (see Chapter 1, Part 3).

This Chapter considers the effect of substrate availability on the relative activities of GC-S and GSH-S. The influence of substrate availability was investigated by simulating GSH biosynthesis at physiological substrate concentrations using a digital computer. These studies were carried out in collaboration with Miss C.L. McMinn and Dr. J.H. Ottaway, Dept. of Biochemistry, University of Edinburgh.

Table 6.01

Computer simulation of GSH biosynthesis in sheep erythrocytes

See Chapter 6, Part 2 for explanation

GC-S( $\mu\text{M}$ )	GSH-S( $\mu\text{M}$ )	Steady-state GC concentration( $\mu\text{M}$ )	Rate of GSH synthesis at steady-state ( $\mu\text{M}/\text{min}$ )
12.5	1.00	211	13.4
10.0	1.00	113	11.1
5.0	1.00	31	5.6
10.0	1.25	68	11.2
10.0	1.00	113	11.1
10.0	0.75	231	10.3

PART 2. COMPUTER SIMULATION STUDIES

For the purposes of this study both GC-S and GSH-S were treated as examples of the sequential "Ter-Ter" mechanism postulated for glutamine synthetase (EC 6.3.1.2) (Meister (1962) as modified by Iqbal & Ottaway (1970) ). Rate constants for the intermediate steps were computed by inserting experimental values of  $K_m$  (human erythrocyte values (Majerus et al., 1971) - see Table 6.02) and  $K_{eq}$  ( $1.8 \times 10^4$  for both enzymes (Snoke & Bloch, 1955)) into the Haldane and other relationships (Plowman, 1972), and then optimising all these relationships by a SIMPLEX package (Davis & Ottaway, 1972). The behaviour of the complete system was simulated by the computer programme now called CHEK (Chance & Curtis, 1971; Curtis & Chance, 1974). It was assumed that the molar concentration of GC-S enzyme protein was 10 times that of GSH-S protein in the case of high GSH Merino cells, and 5 times greater in low GSH Merino erythrocytes. The concentrations of substrates were kept constant at values equal to those in sheep erythrocytes (see also Table 6.02) as were the concentrations of the products ADP and  $P_i$  (0.026 and 1.8 mmol/litre cells respectively (Bartlett, 1970; Agar & Smith, 1973a)). The simulations were run until the concentration of GC became constant, and the steady-state GC concentration and net GSH flux rate were then noted. Runs were repeated at various concentrations of GC-S while GSH-S was held constant and vice versa. The results of these simulations are summarised in Table 6.01.

The steady-state net rate of GSH synthesis was halved by reducing the GC-S concentration (i.e. activity) by 50%. A GC-S

concentration increase of 25% resulted in a 21% increase in the rate of GSH synthesis. The steady-state GC concentration rose from  $31\ \mu\text{M}$  to  $211\ \mu\text{M}$  as the GC-S concentration was increased from  $5\ \mu\text{M}$  to  $12.5\ \mu\text{M}$ . In contrast, the rate of GSH synthesis was relatively insensitive to changes in the concentration of GSH-S.

Table 6.02

The effect of substrate availability on the activities of the enzymes of GSH biosynthesis in sheep erythrocytes

	$V_{\max}^1$ ( $\mu\text{mol/gHb per min}$ )	$K_m^2$ (mM)	Erythrocyte concentration <sup>3</sup> (mmol/litre cells)	S:( $K_m + S$ )
ATP		0.43	0.810	0.65
GC-S	Glutamate	0.776	0.116	0.05
	Cysteine	0.30	0.013	0.04
ATP		0.50	0.810	0.62
GSH-S	Glycine	0.069	0.568	0.61
GC		0.20	-	-

1. High GSH Merino values (Chapter 5, Part 3)

2. Majerus et al., 1971

3. Smith, 1973



PART 3. DISCUSSION

The computer simulation studies presented in Part 2 of this Chapter suggest that physiological substrate concentrations could cause GC-S to be the rate-limiting enzyme of GSH biosynthesis in sheep erythrocytes. The diminished GC-S activity of low GSH Merino erythrocytes may therefore be responsible for the GSH deficiency in these cells.

Assuming simple Michaelis-Menten kinetics (Majerus et al., 1971) it is possible to assess the effect of substrate concentrations on enzyme activity from the ratio  $S:(K_m + S)$  where  $S$  is the substrate concentration and  $K_m$  is the Michaelis constant. Estimated sheep erythrocyte  $S:(K_m + S)$  values for cysteine, glutamate, glycine and ATP are given in Table 6.02. These data suggest that the erythrocyte concentrations of glutamate and cysteine may severely restrict the catalytic activity of GC-S. It is the limiting effects of these amino acids which are responsible for GC-S becoming the rate-limiting enzyme of GSH biosynthesis in the simulation studies.

The simulation studies predict that the steady-state GC concentration in low GSH Merino erythrocytes is very much less than that found in high GSH cells. GC may therefore be the non-GSH thiol whose identity was discussed in Part 5 of Chapter 4.

The simulations estimate that the steady-state net GSH flux rate in normal high GSH cells is approximately  $10 \mu\text{M}/\text{min}$ . This rate of synthesis would be sufficient to synthesise the cells entire

complement of GSH in 5 hours. This compares unfavourably with the estimated in vivo half-life of GSH in sheep erythrocytes of 11 days (Smith, 1974). It is therefore not imagined that these simulations even approach a complete description of physiological reality. Many of the parameters which would be necessary to predict the situation accurately remain unspecified.

CHAPTER 7

GSH BIOSYNTHESIS III: GSH BIOSYNTHESIS IN HIGH AND  
LOW GSH FINN AND MERINO FREEZE-THAW HAEMOLYSATES

PART 1. INTRODUCTION

Human erythrocyte GC-S is subject to feedback inhibition by GSH (Jackson, 1969). The degree of inhibition at physiological GSH concentrations (35% at 3 mM) is of sufficient magnitude to suggest that this may be an important regulatory mechanism for maintaining erythrocyte GSH concentrations.

The evidence presented in Chapter 5 and 6 suggests that a diminished activity of GC-S is responsible for the low concentrations of GSH in low GSH Merino erythrocytes. The validity of this argument depends on whether the relative activities of high and low GSH Merino GC-S as measured in dilute haemolysates are similar to those encountered in the intact cell. If sheep erythrocyte GC-S behaves in a similar manner to the human enzyme with respect to GSH inhibition, the possibility must be considered that the diminished GC-S activity in low GSH cells may be partially or completely compensated by a diminished GSH feedback inhibition resulting from the lower GSH concentration in these erythrocytes. In addition, it is possible that other unspecified factors may influence the relative GC-S activities in intact high and low GSH Merino erythrocytes. Therefore it is desirable to measure the GC-S activities of these cells under more physiological conditions than those encountered in the dilute haemolysate assay system. Consequently, the ability of high and low GSH Merino freeze-thaw haemolysates to synthesise GC was determined under assay conditions

where the cell constituents were virtually undiluted (compared with a 30 - 50 fold dilution in the other assay system). Details of the freeze-thaw haemolysate incubation system are given in Part 2, and the rates of GC synthesis by high and low GSH Merino freeze-thaw haemolysates are reported in Part 3. In addition to these freeze-thaw haemolysate investigations, the effect of physiological concentrations of GSH on the activity of high and low GSH Merino GC-S was assessed directly using the dilute haemolysate GC-S assay system (Part 5).

Although a decreased activity of GC-S may be responsible for the low concentrations of GSH in Merinos, the low concentrations of GSH in Finns cannot be explained in this way. That the biochemical mechanisms responsible for the GSH deficiency differ in Finns and Merinos is further suggested by the observation that low GSH Finn erythrocytes have high concentrations of certain amino acids including ornithine, lysine, alanine, serine and threonine, a phenomenon not observed in Merinos (Ellory *et al.*, 1972). One possible explanation for the low concentrations of erythrocyte GSH in Finns is an inhibition of GSH biosynthesis by these amino acids. Alternatively, low GSH Finn erythrocytes may contain an inhibitor of GSH biosynthesis which is not an amino acid. It is possible to test for the presence of a GC-S inhibitor by employing the freeze-thaw haemolysate incubation system described in Part 2 of this Chapter (cell constituents virtually undiluted). A similar freeze-thaw haemolysate incubation system, designed to measure overall GSH biosynthesis from glutamate, cysteine and glycine, was also developed (see also Part 2) to test

for the presence of a GSH-S inhibitor.

The rates of GC and GSH synthesis by high and low GSH Finn freeze-thaw haemolysates are given in Parts 3 and 4. In addition, the effects of ornithine, lysine, alanine, serine and threonine on low GSH Finn GC-S and GSH-S at various substrate concentrations are described in Part 6.

PART 2. THE INCUBATION SYSTEMS

The freeze-thaw haemolysate assays described here are based on the dilute haemolysate GC-S and GSH-S assays (Chapter 5, Part 2). Freeze-thaw haemolysates were prepared from saline-washed erythrocytes. After the final wash, the cells were packed at 2000 g for 15 min, and the supernatant was removed. The packed cells were lysed by freezing and thawing twice. To provide sufficient material, assays were performed on pooled haemolysates (equal volumes of erythrocytes from 3 animals of the same GSH type).

The incubation system for GC synthesis contained 20  $\mu\text{mol}$   $\text{MgCl}_2$  and 10  $\mu\text{mol}$  each of ATP, cysteine,  $[\text{U}^{14}\text{C}]$  glutamate (0.1  $\mu\text{Ci}/\mu\text{mol}$ ) and dithiothreitol and 0.9 ml pooled freeze-thaw haemolysate in a total volume of 1.00 ml. Due to its low solubility, glutamate was added to the assay system as solid. The complete system was assembled at 0°C, and the reaction was started by transferring the incubation tubes to a 37°C water bath. After a 5 min preincubation period, 0.2 ml aliquots were removed at 5 min intervals and immediately deproteinised by the addition of 1.8 ml of 5.6% (w/v) TCA containing 56 mM imidazole followed by centrifugation at 2000 g for 10 min. The supernatants were removed for further analysis. GC in the TCA-imidazole extract was precipitated as the cadmium mercaptide, washed free of  $[\text{U}^{14}\text{C}]$  glutamate, and counted by liquid scintillation spectrometry as previously described (Chapter 5, Part 2).

The incubation system for GSH synthesis contained 20  $\mu\text{mol}$   $\text{MgCl}_2$ , 10  $\mu\text{mol}$  each of ATP, cysteine, glutamate,  $[\text{U}^{14}\text{C}]$  glycine (0.1  $\mu\text{Ci}/$

$\mu\text{mol}$ ) and dithiothreitol and 0.9 ml freeze-thaw haemolysate in a total volume of 1.00 ml. Sample incubation and subsequent treatment were as described above.

Neither the GC nor the GSH incubations contained any added buffer. The buffering capacity in both instances was provided by the high concentration of haemoglobin in the assays. Sheep erythrocyte freeze-thaw haemolysates have a pH of 7.2 (Hilpert et al., 1963).



GC produced  
( $\mu\text{mol/gHb}$ )

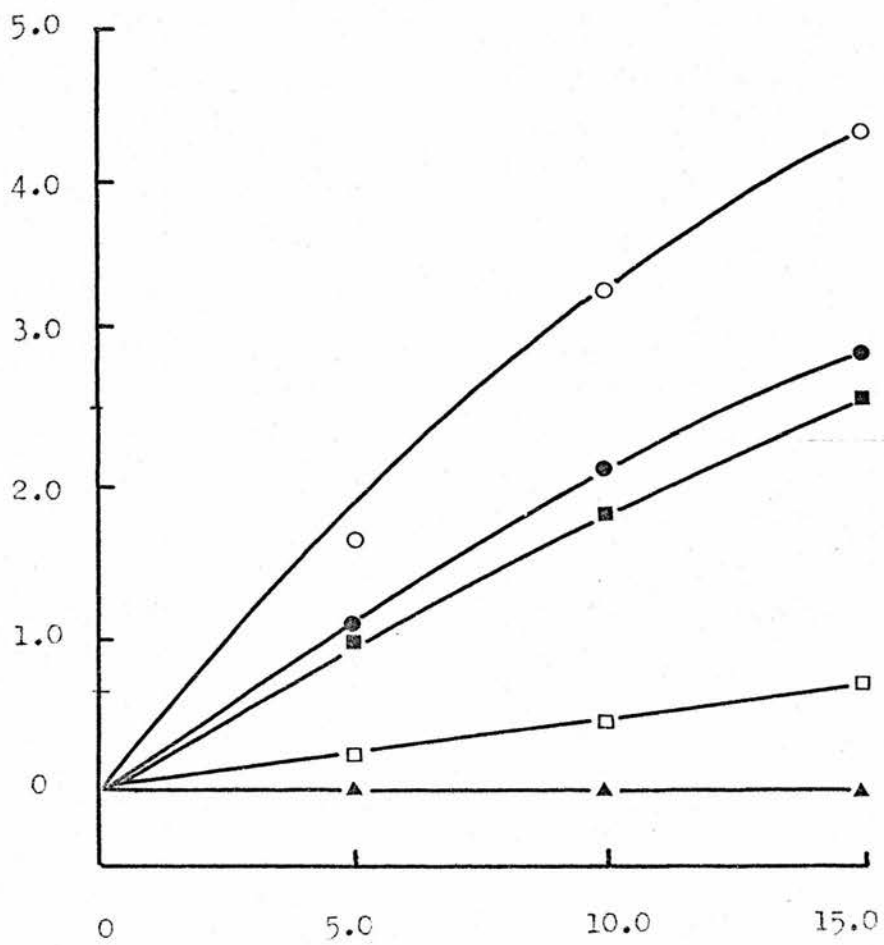

Time (min)

Fig. 7.01

The synthesis of GC by high and low GSH Finn and Merino  
freeze-thaw haemolysates

The incubation system and subsequent sample treatment are described in Chapter 7, Part 2. Pooled haemolysates (equal volumes of erythrocytes from 3 animals of the same GSH type) were employed. Finn: ● high GSH and ○ low GSH. Merino: ■ high GSH and □ low GSH. Incubations of all haemolysate types in the absence of cysteine, ▲ .

PART 3. THE SYNTHESIS OF GC BY HIGH AND LOW GSH FINN AND  
MERINO FREEZE-THAW HAEMOLYSATES

The synthesis of GC by pooled high and low GSH Merino freeze-thaw haemolysates is depicted in Fig. 7.01. In both cases the rate of GC synthesis over the 15 min incubation period was close to linear. In the absence of added cysteine neither haemolysate demonstrated any detectable GC synthesis. The rate of GC synthesis in the low GSH haemolysate was very much less than that found in the high GSH haemolysate, the respective initial rates of GC synthesis being 0.046 and 0.192  $\mu\text{mol/g}$  Hb per min.

The synthesis of GC by pooled high and low GSH Finn freeze-thaw haemolysates is also depicted in Fig. 7.01. As for Merinos, the rates of GC synthesis over the 15 min incubation period were close to linear, and no detectable GC synthesis was observed in either haemolysate in the absence of added cysteine. However, in direct contrast to the situation in Merinos, the initial rate of GC synthesis was greater in the low GSH haemolysate than in the high GSH one. The initial rates of GC synthesis were 0.328 and 0.220  $\mu\text{mol/g}$  Hb per min for low and high GSH freeze-thaw haemolysates respectively.

The rates of GC synthesis in high GSH Finn and high GSH Merino haemolysates were similar (0.220 and 0.192  $\mu\text{mol/gHb}$  per min respectively).

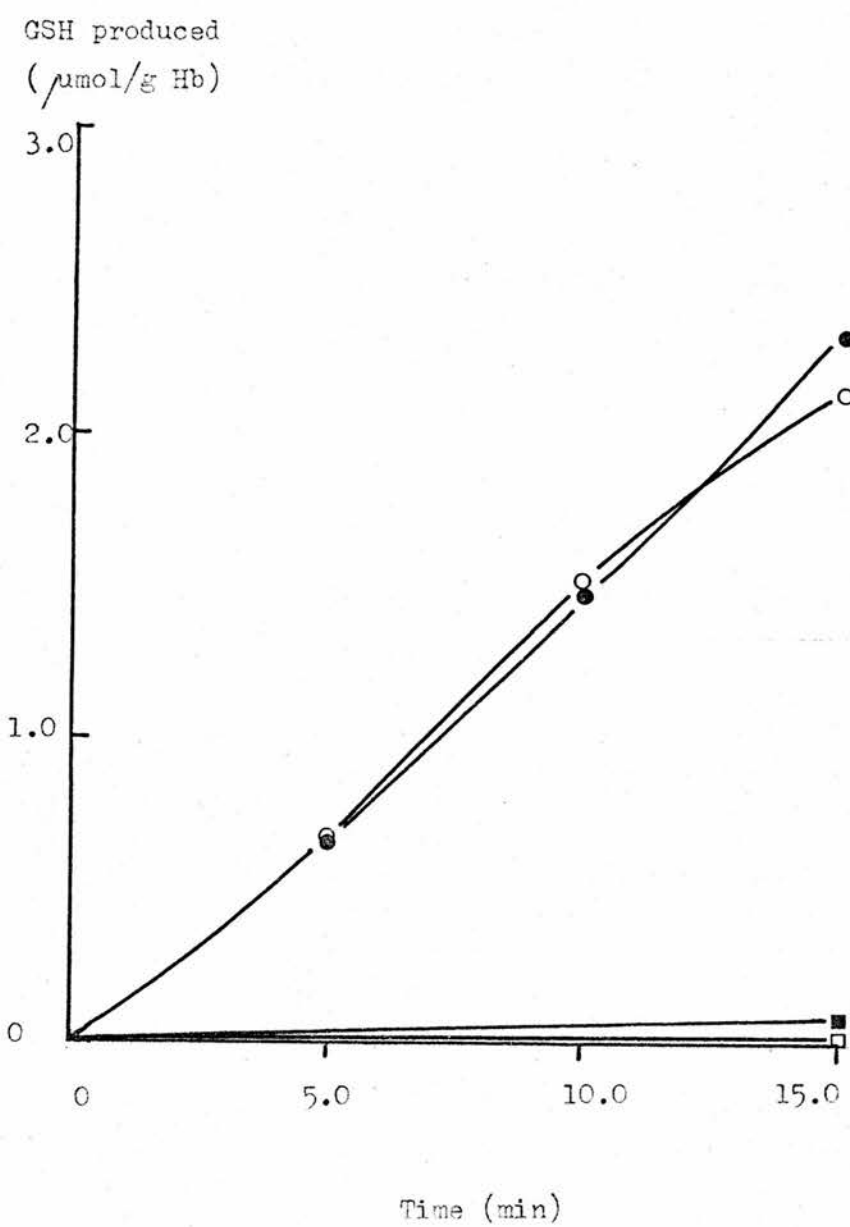

Fig. 7.02

The synthesis of GSH by high and low GSH Finn freeze-thaw haemolysates

The incubation system and subsequent sample treatment are described in Chapter 7, Part 2. Pooled haemolysates (equal volumes of erythrocytes from 3 animals of the same GSH type) were employed.

- high GSH and ○ low GSH. Incubations in the absence of cysteine:
- high GSH and □ low GSH.

PART 4. THE SYNTHESIS OF GSH BY HIGH AND LOW GSH FINN FREEZE-  
THAW HAEMOLYSATES

The synthesis of GSH by pooled high and low GSH Finn freeze-thaw haemolysates is depicted in Fig. 7.02. It should be emphasised that in these experiments GSH was synthesised from glutamate, cysteine and glycine and not from GC and glycine. The rate of GSH synthesis in both haemolysates was close to linear over the 15 min incubation period. The initial rates of GSH synthesis were 0.148 and 0.157  $\mu\text{mol/g Hb per min}$  for the high and low GSH haemolysates respectively.

There was a small amount of  $\sqrt{U^{14}C}$  glycine incorporation into GSH in the absence of added cysteine. This was particularly noticeable in the high GSH haemolysate, and presumably reflects an exchange reaction between glycine and preformed GSH (Snoke & Bloch, 1955). Since this incorporation was less than 5% of that recorded in the presence of cysteine, its effect on the latter was ignored.

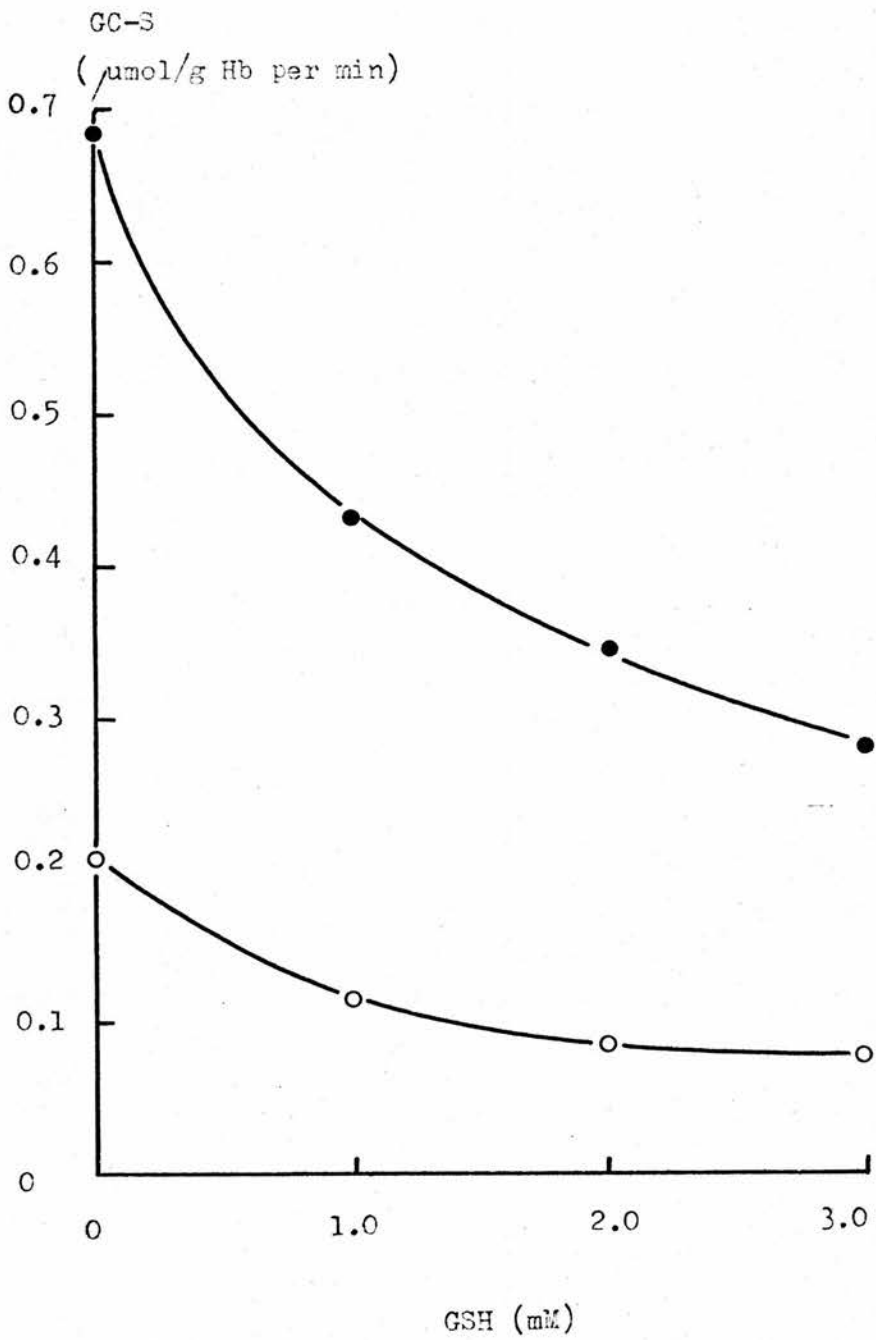

Fig. 7.03

The inhibition of high and low GSH Merino GC-S by GSH

GC-S was assayed in pooled dilute haemolysates (equal volumes of erythrocytes from 3 animals of the same GSH type) by the method described in Chapter 5, Part 2. ● high GSH and ○ low GSH.



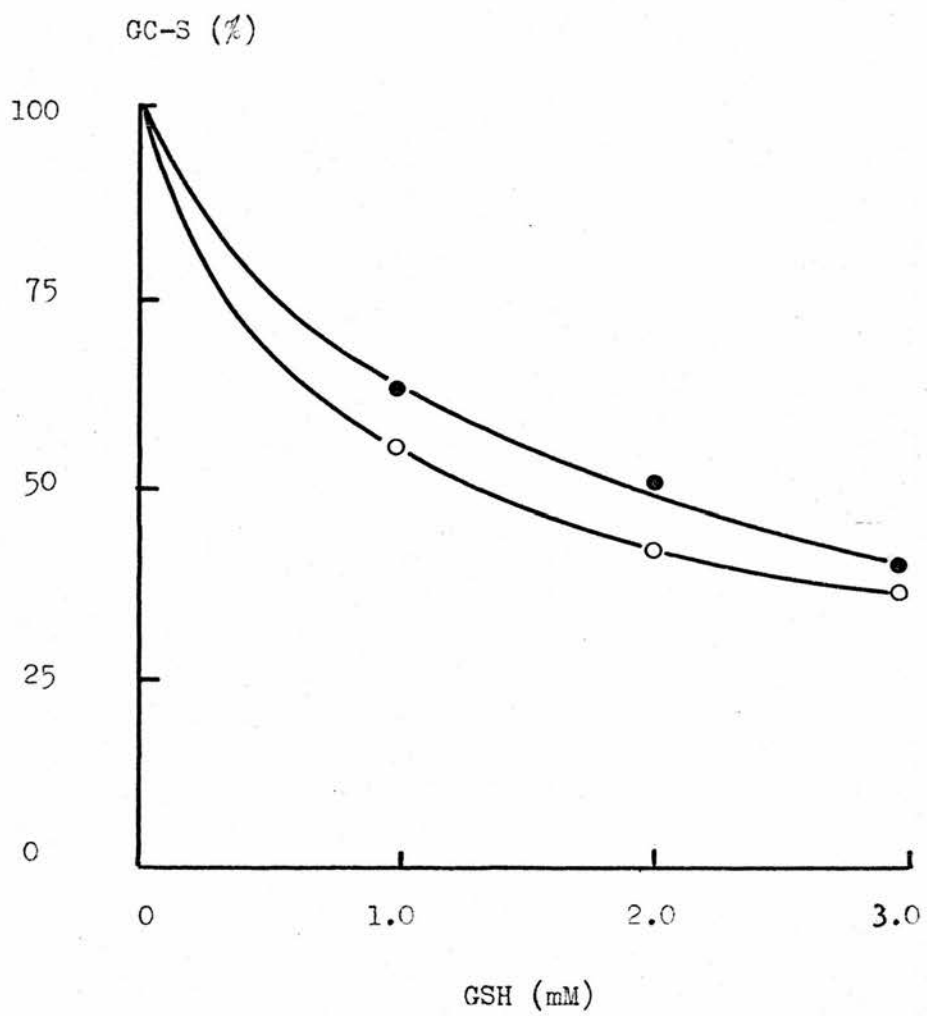

Fig. 7.04

The inhibition of high and low GSH Merino GC-S by GSH

GC-S was assayed in pooled dilute haemolysates (equal volumes of erythrocytes from 3 animals of the same GSH type) by the method described in Chapter 5, Part 2. ● high GSH and ○ low GSH.

PART 5. THE INHIBITION OF SHEEP ERYTHROCYTE GC-S BY GSH

Erythrocyte GC-S was assayed in pooled dilute haemolysates (equal volumes of erythrocytes from 3 animals of the same GSH type) as previously described (Chapter 5, Part 2), except that varying amounts of GSH were included in the incubation medium.

The effect of physiological concentrations of GSH on high and low GSH Merino GC-S is shown in Fig. 7.03. Clearly, GSH is a potent inhibitor of sheep erythrocyte GC-S. Furthermore, both high and low GSH Merino GC-S are affected. The large difference in GC-S activity between high and low GSH Merino haemolysates makes it difficult to assess from Fig. 7.03 whether the pattern of GSH inhibition is the same for GC-S from both sources. These data were therefore replotted as % inhibition against GSH concentration (Fig. 7.04). The inhibition patterns for high and low GSH Merino GC-S are very similar.

Using the data in Figs. 7.03 and 7.04 it is possible to assess the influence of cellular GSH concentrations on the relative activities of GC-S in high and low GSH Merino erythrocytes. In the presence of 2.37 mM GSH (the mean erythrocyte GSH concentration of the 3 high GSH animals), the high GSH Merino GC-S activity is reduced by 54% from 0.685 to 0.315  $\mu\text{mol/g Hb per min}$ . Similarly in the presence of 1.24 mM GSH (the mean erythrocyte GSH concentration of the 3 low GSH animals), the low GSH Merino GC-S activity is reduced by 49% from 0.205 to 0.105  $\mu\text{mol/g Hb per min}$ . Therefore, even allowing for the effect of cellular GSH concentrations, the low GSH Merino GC-S activity is still substantially less than the high GSH Merino GC-S activity.

Table 7.01

THE INHIBITION OF LOW GSH FINN GC-S AND GSH-S BY AMINO ACIDS

GC-S and GSH-S were assayed in pooled dilute haemolysates (equal volumes of erythrocytes from 3 animals) by the methods described in Chapter 5, Part 2. Both assays were linear for 30 min at all substrate concentrations.

Substrate concentrations (mM)		Percentage inhibition in the presence of 10 mM amino acid						
ATP	cysteine	glutamate	ornithine	lysine	alanine	serine	threonine	$\alpha$ -amino-n-butyric acid
	1.0	10.0	-	7.0	0.1	2.3	3.9	-
GC-S	0.1	0.1	10.2	7.7	6.8	5.8	7.6	73.6
	0.018	0.089	10.4	9.0	-	-	-	-
ATP	GC	glycine						
GSH-S	0.018	0.089	20.6	18.5	-	-	-	-

PART 6. THE INHIBITION OF SHEEP ERYTHROCYTE GC-S AND GSH-S  
BY AMINO ACIDS

The effects of ornithine, lysine, alanine, serine and threonine on sheep erythrocyte GC-S (low GSH Finn) and ornithine and lysine on GSH-S (low GSH Finn) were investigated. The cysteine analogue  $\alpha$ -amino-n-butyric acid was included in one series of GC-S inhibition studies.

Sheep erythrocyte GC-S and GSH-S were assayed in dilute haemolysates as described earlier (Chapter 5, Part 2) except that varying substrate concentrations were employed (Table 7.01). The rate of product formation under all assay conditions was linear for at least 30 min. The inhibition studies were performed on pooled low GSH Finn haemolysates (equal volumes of erythrocytes from 3 animals). Ornithine, lysine, alanine, serine, threonine and  $\alpha$ -amino-n-butyric acid were present at a final concentration of 10 mM.

The effects of the above mentioned amino acids on low GSH Finn GC-S at various substrate concentrations are summarised in Table 7.01. None of the amino acids tested with the exception of  $\alpha$ -amino-n-butyric acid inhibited the enzyme by more than 11% even when, in the case of ornithine and lysine, substrate concentrations were reduced to approximately physiological levels.

At approximately physiological substrate concentrations, ornithine and lysine inhibited low GSH Finn GSH-S by 21% and 19% respectively.

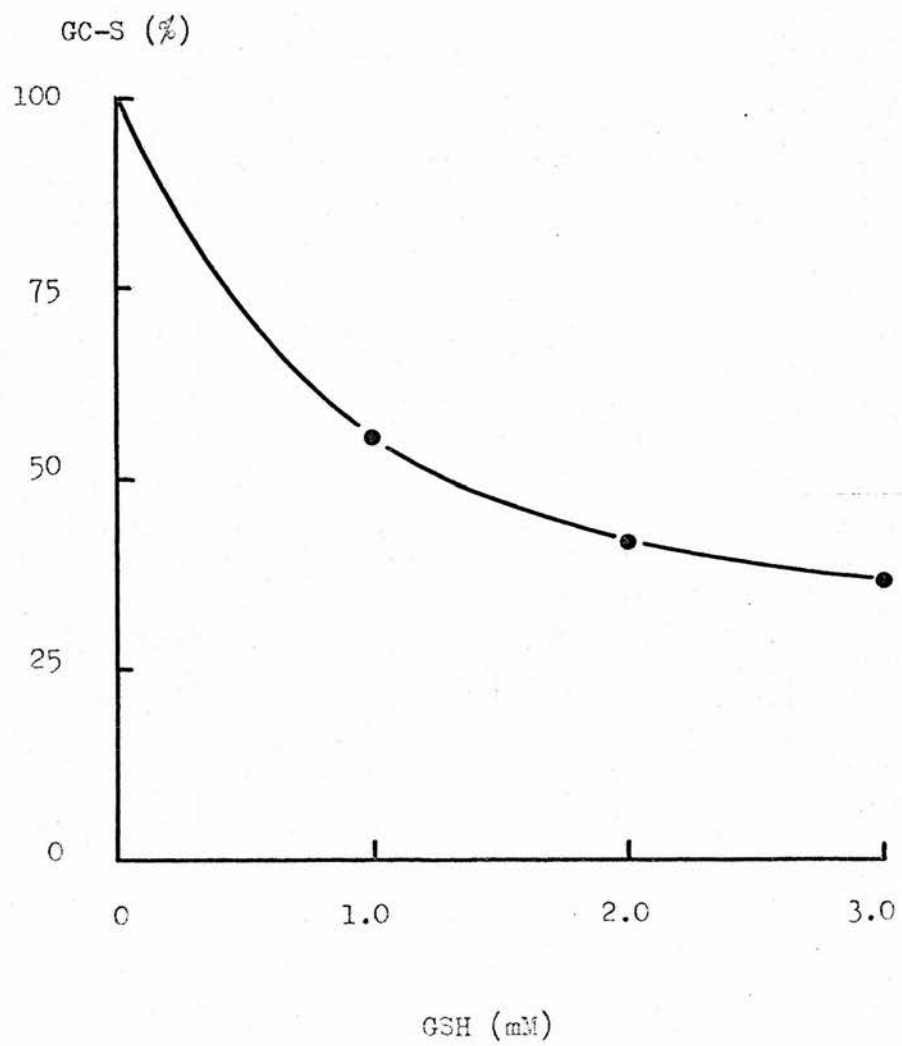

Fig. 7.05

The inhibition of low GSH Finn GC-S by GSH

GC-S was assayed in a pooled dilute haemolysate (equal volumes of erythrocytes from 3 animals) by the method described in Chapter 5, Part 2.

PART 7. DISCUSSION

The dilute haemolysate GC-S assays (Chapter 5) suggest that low GSH Merino erythrocytes have a reduced ability to synthesise GC. However, there is the possibility that the diminished GC-S activity in low GSH Merino cells may be partially or completely compensated by a diminished GSH feedback inhibition. The ability of high and low GSH Merino freeze-thaw haemolysates to synthesise GC was therefore assessed under conditions where the cellular constituents (including GSH) were virtually undiluted (compared with a 30 - 50 fold dilution in the other assay system). The effects of GSH on high and low GSH Merino GC-S were also investigated using the dilute haemolysate assay system. Although high and low GSH Merino GC-S are inhibited by GSH, both investigations suggest that the diminished GSH feedback inhibition in low GSH erythrocytes is insufficient to compensate for their low GC-S activity.

In complete contrast to the situation in Merinos, the rate of GC synthesis in the low GSH Finn freeze-thaw haemolysate was substantially greater than that found in the high GSH Finn freeze-thaw haemolysate. Since the mean dilute haemolysate GC-S activities of the 3 high GSH and 3 low GSH animals used in this experiment were essentially identical ( $0.637$  and  $0.670 \mu\text{mol/gHb per min}$  respectively) the question arises as to why there is such a large difference in freeze-thaw haemolysate activities. The differing rates of GC synthesis can be mainly attributed to differing degrees of GSH feedback inhibition, since low GSH Finn GC-S has a similar GSH inhibition pattern to that described earlier for high and low GSH



Table 7.02

A comparison of the rates of GC synthesis in the freeze-thaw haemolysate and dilute haemolysate assay systems

The freeze-thaw haemolysate GC-S activities are those reported in Part 3 of Chapter 7. The dilute haemolysate GC-S activities are the mean GC-S activities of the animals used in the preparation of the freeze-thaw haemolysates (equal volumes of erythrocytes from 3 animals of the same GSH type). The freeze-thaw haemolysate assay GSH concentrations and the GC-S inhibition curves (Figs. 7.04 and 7.05) were used to correct the dilute haemolysate GC-S activities for GSH inhibition. Values are  $\mu\text{mol/gHb}$  per min.

	dilute haemolysate GC-S activity( $\pm$ SEM)	dilute haemolysate GC-S activity (corrected for GSH inhibition)	freeze-thaw haemolysate GC-S activity
Finn	High GSH	0.637 $\pm$ 0.065	0.233
	Low GSH	0.670 $\pm$ 0.020	0.335
Merino	High GSH	0.620 $\pm$ 0.093	0.295
	Low GSH	0.208 $\pm$ 0.041	0.136

Merino GC-S (Fig. 7.05). In the presence of 1.30 mM GSH (the GSH concentration of the low GSH Finn freeze-thaw haemolysate incubation), the low GSH Finn GC-S activity would be reduced to 50.0% of its value in the absence of GSH. Similarly, in the presence of 2.86 mM GSH (the GSH concentration of the high GSH Finn freeze-thaw haemolysate incubation), the high GSH Finn GC-S activity would be reduced to 36.5% of its value in the absence of GSH (assuming a similar GSH inhibition pattern to that for low GSH Finn GC-S). GSH inhibition would therefore be expected to give rise to a GC-S (High GSH): GC-S (Low GSH) ratio of 0.69. This compares favourably with the observed freeze-thaw haemolysate ratio of 0.67.

The rates of GC synthesis in freeze-thaw haemolysates are substantially less than those observed in the dilute haemolysate assay. Although a large number of factors may be expected to influence the GC-S activities in the two assay systems, the differences can be largely attributed to the effect of GSH inhibition (Table 7.02).

Although a diminished GSH feedback inhibition is insufficient to compensate for the low GC-S activity in low GSH Merino erythrocytes, it seems probable that GSH feedback inhibition is an important regulatory mechanism for maintaining erythrocyte GSH concentrations, particularly in view of the indications that GC-S and not GSH-S is the rate limiting enzyme of GSH biosynthesis in sheep erythrocytes.

In addition to an investigation of GC synthesis in freeze-thaw haemolysates, the ability of high and low GSH Finn freeze-thaw haemolysates to synthesise GSH from cysteine, glutamate and glycine

Table 7.03

A comparison of the rates of GSH synthesis in the freeze-thaw haemolysate and dilute haemolysate assay systems

The freeze-thaw haemolysate GSH-S activities are those reported in Part 4 of Chapter 7. The dilute haemolysate GSH-S activities are the mean GSH-S activities of the animals used in the preparation of the freeze-thaw haemolysates (equal volumes of erythrocytes from 3 animals of the same GSH type). Values are  $\mu\text{mol/g Hb per min.}$

	dilute haemolysate GSH-S activity( $\pm$ SEM)	freeze-thaw haemo- lysate GSH-S activity
High GSH	0.080 $\pm$ 0.004	0.148
Finn		
Low GSH	0.070 $\pm$ 0.001	0.157

was also assessed (Part 4). Under the experimental conditions employed it would be expected that the GC synthesised during the 5 min preincubation period would be sufficient to saturate GSH-S with respect to GC. This is indicated both by the rates of GC synthesis found under similar conditions (Table 7.02), and by the absence of any appreciable initial lag in GSH synthesis (Fig. 7.02). Therefore these freeze-thaw haemolysate incubations represent GSH<sup>-S</sup> assays at saturating substrate concentrations. In agreement with the dilute haemolysate GSH-S assays (Chapter 5, Part 3), the rates of GSH synthesis in high and low GSH Finn freeze-thaw haemolysates were virtually identical.

In contrast to GC-S, GSH-S appears to be more active in freeze-thaw haemolysates than in the dilute haemolysate assay system (Table 7.03). The elevated GSH-S activity in freeze-thaw haemolysates is not due to  $\text{[}^{14}\text{C]}$  glycine exchange with preformed GSH since incubations in the absence of added cysteine show only slow rates of  $\text{[}^{14}\text{C]}$  glycine incorporation.

Since the activity of GC-S in freeze-thaw haemolysates is less than that found in the dilute haemolysate assay system whereas the converse is true for GSH-S, the ratio of GSH-S:GC-S activities in freeze-thaw haemolysates is very much greater than that found by the other assay system. For example, the dilute haemolysate assays give a GSH-S:GC-S ratio of 0.13 for high GSH Finn erythrocytes (Tables 7.02 and 7.03), whereas the freeze-thaw haemolysate assays give a ratio of 0.67. Of the two assays, the freeze-thaw haemolysate system more closely reflects the enzyme environment in the intact cell and therefore the freeze-thaw haemolysate GSH-S:GC-S ratio is probably a truer reflection of the relative enzyme capacities in the intact erythrocyte.

This being the case, it is all the more clear that GC-S and not GSH-S is the rate limiting enzyme of GSH biosynthesis in sheep erythrocytes, since the simulation studies described earlier (Chapter 6) assumed the much lower dilute haemolysate assay GSH-S:GC-S ratios.

The possibility was considered that low GSH Finn erythrocytes may contain an inhibitor of GC-S or GSH-S. Possible candidates for such a role were those amino acids found in high concentrations in low GSH Finn erythrocytes. The freeze-thaw haemolysate data presented in Parts 3 and 4 offer no evidence of any such inhibition. In addition, the amino acid inhibition studies (Part 6) indicate that ornithine, lysine, alanine, serine and threonine have little effect on the activity of sheep erythrocyte GC-S (low GSH Finn), even when, in the case of ornithine and lysine, the substrate concentrations were reduced to near physiological levels. It would therefore seem unlikely that the low concentrations of erythrocyte GSH in Finns can be attributed to an amino acid inhibition of GC-S. It is interesting that whereas ornithine, lysine, alanine, serine and threonine have little effect on sheep erythrocyte GC-S activity,  $\alpha$ -amino-n-butyr $\bar{c}$  acid is an effective inhibitor of the enzyme. Of particular interest is the relative effectiveness of alanine, serine, threonine and  $\alpha$ -amino-n-butyr $\bar{c}$  acid, all of which can be regarded as cysteine analogues. The ability of these amino acids to inhibit sheep erythrocyte GC-S closely parallels their relative effectiveness as  $\gamma$ -glutamyl acceptors in dipeptide synthesis catalysed by GC-S from other

sources (Strumeyer, 1959; Rathbun, 1967).

Ornithine and lysine are more effective inhibitors of GSH-S, each inhibiting the enzyme by about 20% at approximately physiological substrate concentrations. However, since GC-S and not GSH-S is probably the rate limiting enzyme of GSH biosynthesis in sheep erythrocytes, this inhibition is of doubtful significance, and would be expected to have little influence on erythrocyte steady-state GSH concentrations.

The inability to detect GC synthesis in high and low GSH Finn and Merino freeze-thaw haemolysates in the absence of added cysteine indicates that sheep erythrocytes probably do not have a significant ability to degrade GSH since GSH degradation would generate cysteine which in turn would support GC synthesis. Therefore it seems unlikely that the low GSH concentrations in low GSH Finn erythrocytes are the result of elevated GSH degradation.

The investigations presented in this Chapter confirm those described earlier which suggested that low GSH Merino erythrocytes have a diminished maximum activity of GC-S. Furthermore, it is demonstrated that the diminished GSH feedback inhibition in low GSH Merino erythrocytes is probably insufficient to compensate for their low GC-S activity. The freeze-thaw haemolysate assays also confirm that low GSH Finn erythrocytes have a normal activity of both GC-S and GSH-S. In addition, no evidence was found for the presence of an inhibitor of GSH biosynthesis in low GSH Finn cells. Finally, the freeze-thaw haemolysate assays offer indirect evidence that sheep erythrocytes of either breed or GSH type do not have any significant ability to degrade GSH.

CHAPTER 8

GSH BIOSYNTHESIS IV: THE CONCENTRATION OF GSH AND THE ACTIVITY OF  
GC-S IN RETICULOCYTES FROM HIGH AND LOW GSH 'MERINO-TYPE' SHEEP

PART 1. INTRODUCTION

When sheep are subjected to a sudden anaemia, induced by phlebotomy, there is a massive influx of immature erythrocytes and reticulocytes into the circulation. Using the centrifugation technique developed by Drury & Tucker (1963), modified to reduce leucocyte contamination (Tucker & Kilgour, 1973), it is possible to collect a young cell fraction containing 20-40% reticulocytes from the blood of these animals. Tucker & Kilgour (1973) examined the GSH concentrations of such reticulocyte rich fractions from high GSH (Clun Forest) and low GSH (Finn) sheep. These investigations suggested that reticulocytes from both normal and low GSH Finn sheep have very high GSH concentrations, and that the differentiation into the two GSH types occurs some time during reticulocyte maturation.

In this Chapter, these studies are extended to an investigation of the GSH concentrations and GC-S activities of reticulocyte fractions from normal and low GSH 'Merino-type' sheep. This investigation was carried out in collaboration with Dr. E.M. Tucker (Agricultural Research Council Institute of Animal Physiology, Babraham, Cambridge). The animals used in this experiment (1 high and 1 low GSH) were not pure bred Tasmanian Merinos, but Tasmanian Merino-Clun Forest crosses, and were maintained at Babraham. Both sheep had stable erythrocyte GSH concentrations, were ornithine/lysine negative, and had dilute haemolysate GC-S activities typical of their GSH types (0.511 and 0.126  $\mu\text{mol/g Hb per min}$  for the high



and low GSH animal respectively).

The experimental procedure employed was essentially the same as that of Tucker & Kilgour (1973). Both animals were made anaemic by phlebotomy (500 ml blood was withdrawn from each animal twice daily for 3 days). This reduced the haematocrit of both animals from around 36% to approximately 19%. Small blood samples were removed at selected intervals during the anaemic episode, and the erythrocytes fractionated into young and old populations. This was carried out by dividing the packed column of washed centrifuged cells into 4 fractions. Fraction 1, the top quarter, contained the youngest cells including reticulocytes, and fraction 4, the bottom quarter contained the oldest cells (Drury & Tucker, 1963). To reduce leucocyte and platelet contamination, the blood samples were first filtered twice through glass wool, and the uppermost layer of cells in Fraction 1 was discarded.

Leucocyte and reticulocyte counts (Archer, 1965) and estimates of GSH concentration and GC-S activity were made for fractions 1 and 4. The phlebotomy, cell separations, cell counts and DTNB GSH estimations (Beutler et al., 1963) were performed by Dr. Tucker at Babraham. A comparison of the estimates of GSH concentration by the automated DTNB and alloxan methods (Chapter 4, Part 2) and the GC-S assays (Chapter 5, Part 2) were performed by the author in Edinburgh. Samples (on ice) were transported overnight from Babraham to Edinburgh by train.

Table 8.01

GSH concentrations and GC-S activities in high and low GSH  
'Merino-type' sheep during anaemia induced by phlebotomy

DTNB GSH was estimated by the method of Beutler et al. (1963).  
 GC-S was assayed as described in Chapter 5, Part 2.

	High GSH				Low GSH			
	Fraction 1		Fraction 4		Fraction 1		Fraction 4	
	Day 1	Day 7	Day 1	Day 7	Day 1	Day 7	Day 1	Day 7
DTNB GSH (mmol/litre cells)	2.90	4.30	3.16	2.64	0.94	2.83	0.49	0.55
GC-S ( $\mu$ mol/ g Hb per min)	0.533	1.595	0.497	0.507	0.232	1.204	0.089	0.111
% Reticu- locytes	0	29	0	2	0	32	0	0

PART 2. THE CONCENTRATION OF GSH AND THE ACTIVITY OF GC-S IN  
RETICULOCYTES FROM HIGH AND LOW GSH 'MERINO-TYPE' SHEEP

In the present study, the peak reticulocyte counts in both the high and low GSH animals were observed on day 7 (phlebotomy commencing on day 1). The DTNB GSH concentrations, GC-S activities and reticulocyte counts of fractions 1 and 4 on day 1 and day 7 for both animals are given in Table 8.01. In both animals, the DTNB GSH concentrations and GC-S activities of fraction 1 rose dramatically in parallel with the appearance of reticulocytes in that fraction, whereas the fraction 4 DTNB GSH concentrations and GC-S activities remained relatively constant. Virtually no reticulocytes were apparent in fraction 4 of either animal throughout the experiment. In both animals, the same pattern of events was obtained whether the DTNB GSH concentrations and GC-S activities were related to the haematocrit or haemoglobin concentration of the samples. The possibility that the changes in GSH concentration and GC-S activity just described were the result of leucocyte contamination was eliminated by performing leucocyte counts. Erythrocyte:leucocyte ratios were never less than 900:1.

To ascertain whether the elevated fraction 1 DTNB GSH concentrations (day 7) in both animals represented an elevated GSH concentration or the presence of some other DTNB reactive thiol, cell samples from day 7 were assayed for GSH by the automated DTNB and alloxan methods (Chapter 4, Part 2). The data from these

Alloxan GSH  
(mmol/litre cells)

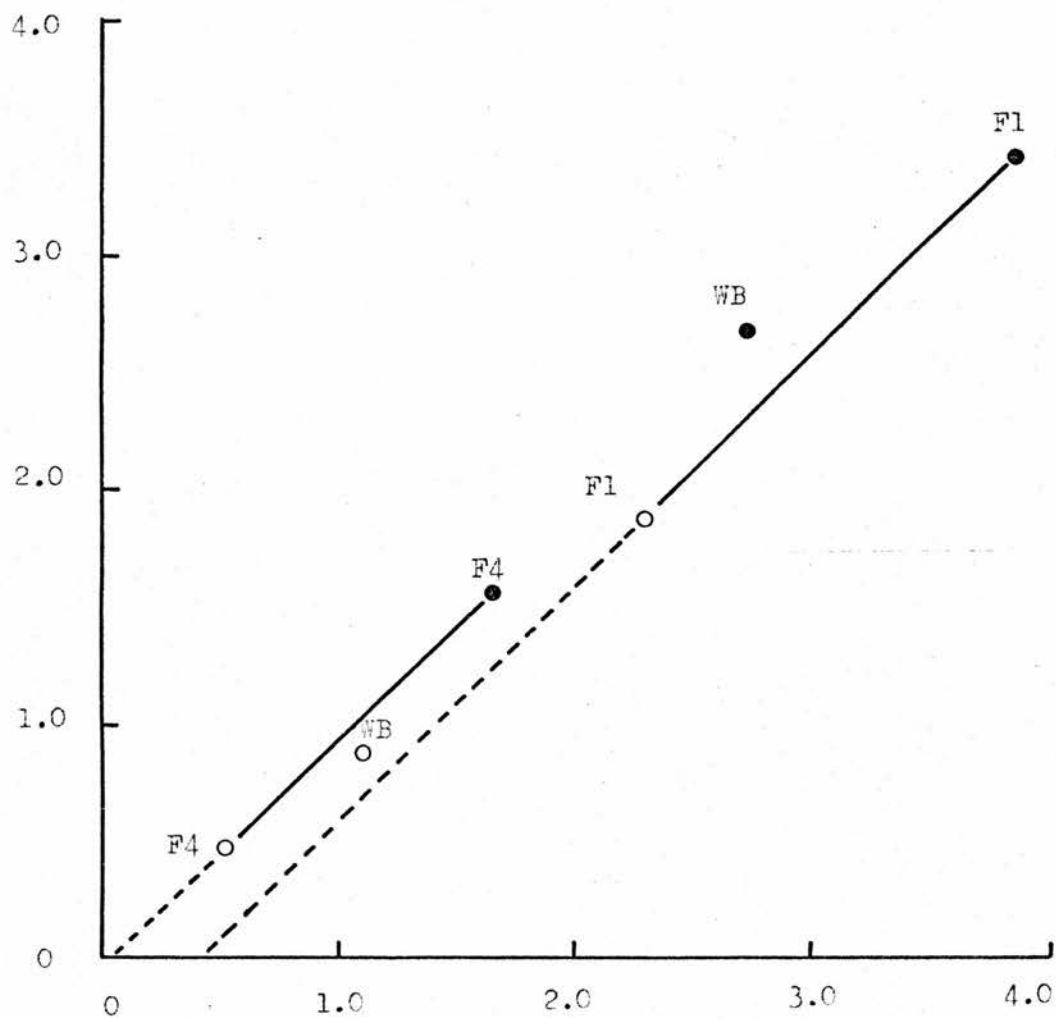

DTNB GSH (mmol/litre cells)

Fig. 8.01

A comparison of DTNB and alloxan estimates of the concentration of erythrocyte GSH in anaemic high and low GSH 'Merino-type' sheep

Whole blood (WB), fraction 1 (F1), and fraction 4 (F4) GSH concentrations were estimated by the methods described in Chapter 4, Part 2. ● high GSH and ○ low GSH.

analyses are presented in Fig. 8.01 and clearly indicate that the differences in DTNB reactivity between fractions 1 and 4 are due to different concentrations of GSH in both the high and low GSH animals. However, in addition to an elevated GSH concentration, fraction 1 of both animals does appear to contain a lesser quantity of DTNB reactive thiol which is not GSH, and which can be estimated from the intercept on the abscissa to be approximately equal to 0.39 mmol/litre cells.

This experiment demonstrates that considerable changes occur in the GSH concentrations and GC-S activities of fraction 1 under conditions of anaemia, the rise in GSH concentration and GC-S activity in both the high and low GSH animals being associated with the appearance of large numbers of reticulocytes. This suggests that the reticulocytes produced by both animals in response to the anaemic stress have substantially higher GSH concentrations and GC-S activities than mature erythrocytes. Furthermore, the increase in fraction 1 GSH concentration and GC-S activity is similar in both animals, suggesting that reticulocytes from high GSH and low GSH 'Merino-type' sheep have the same GSH concentration and GC-S activity (both animals produced the same number of reticulocytes).

PART 3. DISCUSSION

The data presented in this Chapter suggest that reticulocytes from both the high GSH and low GSH 'Merino-type' animals have substantially the same GSH concentration and GC-S activity and that these concentrations and enzyme activities are much higher than those encountered in mature erythrocytes. Since GC-S appears to be the rate-limiting enzyme of GSH biosynthesis in sheep erythrocytes, the elevated GSH concentrations in reticulocytes may at least in part result from the high GC-S activity of these cells. An additional factor may be an increased substrate availability, since a number of reticulocyte amino acid transport systems are lost during maturation (Christensen, 1969 & 1975).

If reticulocytes from both high GSH and low GSH 'Merino-type' sheep have the same GSH concentration and GC-S activity, the differentiation into high and low GSH 'Merino-type' cells must occur at some stage during the reticulocyte maturation process. It may be anticipated that the primary event in the process is a greater loss of GC-S activity in cells from low GSH animals ('Merino-type') than in cells from high GSH individuals. Therefore, although the biochemical mechanisms responsible for erythrocyte GSH deficiency differ in Finns and Merinos, the differentiation into high and low GSH cells seems to occur at the same stage of erythrocyte development.

CHAPTER 9

THE REGENERATION OF GSH FROM GSSG IN  
HIGH AND LOW GSH FINN ERYTHROCYTES



PART 1. INTRODUCTION

The investigations described in the preceding Chapters suggest that GSH-deficient Finn erythrocytes have an undiminished ability to synthesise GSH. A further possible explanation for the low GSH concentration of these cells is an inability to maintain glutathione in the reduced state, since this might lead to a more rapid efflux of GSSG from the cell (Fig. 1.02).

A diminished ability to maintain glutathione in the reduced state could arise either from a diminished availability of a hydrogen donor for glutathione reductase (GSSG-R), or from a reduced activity of GSSG-R itself. The identity of the hydrogen donor for sheep erythrocyte GSSG-R is not completely certain, but the balance of the available evidence suggests that NADPH (generated by glucose-6-phosphate dehydrogenase (G-6-PD) and 6-phosphogluconate dehydrogenase (6-PGD) of the hexose monophosphate pathway) rather than NADH (generated by glycolysis) is the preferred cofactor (see Chapter 1, Part 3 for a discussion of this question).

Part 2 of this Chapter describes the combined activities of G-6-PD and 6-PGD in high and low GSH Finn erythrocytes. In addition, the activity of GSSG-R (<sup>NADPH and</sup> NADH dependant) in the two cell types was measured. The ability of intact high and low GSH Finn erythrocytes to regenerate GSH from GSSG after oxidative challenge was also investigated (Part 3).

The investigations described in this Chapter were carried out in collaboration with Miss S.A. Thompson. The enzyme assays described in Part 2 were performed by the author, while the regeneration

experiments (Part 3) were carried out by Miss Thompson as part of an Honours Degree Biochemistry Project (Edinburgh University, 1974).

PART 2. THE ACTIVITY OF (G-6-PD + 6-PGD) AND GSSG-R IN HIGH  
AND LOW GSH FINN ERYTHROCYTES

Section 2.01. Introduction

G-6-PD catalyses the oxidation of glucose-6-phosphate (G-6-P) to 6-phosphogluconolactone which hydrolyses spontaneously to 6-phosphogluconate (6-PGA):

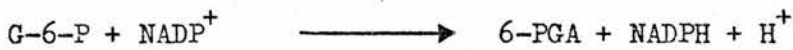

6-PGD catalyses the oxidation of 6-PGA to ribulose-5-phosphate and  $\text{CO}_2$ :

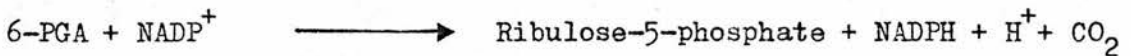

Addition of G-6-P to haemolysate in the presence of  $\text{NADP}^+$  will therefore result in NADPH generation by both enzymes. This allows an estimate of the combined activities of G-6-PD and 6-PGD. The combined (G-6-PD + 6-PGD) assay used in the present study was that of Beutler (1971). The reduction of  $\text{NADP}^+$  was followed spectrophotometrically at 340 nm.

GSSG-R catalyses the reduction of GSSG by NADPH and NADH:



The GSSG-R assay used in the present study was also that of Beutler (1971). Both the NADPH and NADH dependent GSSG-R activities were determined. The activity of the enzyme was measured by following the oxidation of NADPH or NADH at 340 nm.

Section 2.02. The assay of sheep erythrocyte (G-6-PD + 6-PGD)  
and GSSG-R

For the assay of (G-6-PD + 6-PGD), 0.2 ml of packed NaCl-washed erythrocytes was added to 3.8 ml of a solution containing 2.7 mM EDTA (disodium),  $10\ \mu\text{M}$   $\text{NADP}^+$  and 0.05% (v/v)  $\beta$ -mercaptoethanol. The resulting haemolysate was kept on ice until required.

The reaction mixture for the combined (G-6-PD + 6-PGD) assay contained  $100\ \mu\text{mol}$  Tris-HCl buffer pH 8.0,  $10\ \mu\text{mol}$   $\text{MgCl}_2$ ,  $0.2\ \mu\text{mol}$   $\text{NADP}^+$ ,  $0.6\ \mu\text{mol}$  G-6-P, and  $50\ \mu\text{l}$  haemolysate in a total volume of 1.00 ml. Reaction mixtures minus haemolysate were preincubated at  $37^\circ\text{C}$  for 15 min in 1 ml cuvettes in the water-jacketed cuvette holder of a Unicam SP800 recording spectrophotometer. The reaction was initiated by adding the haemolysate, and the extinction was monitored at 340 nm using a Servoscribe I flat-bed recorder (full scale extinction 0.1 units. The reaction was linear for at least 30 min. Blanks were performed by omitting G-6-P from the incubation medium. Enzyme activities were expressed as  $\mu\text{mol}$  NADPH formed/gHb per min.

For the assay of GSSG-R, 0.2 ml of packed NaCl-washed erythrocytes was added to 3.8 ml of water. The resulting haemolysate was kept on ice until required.

The reaction mixture for the assay of GSSG-R contained  $50\ \mu\text{mol}$  Tris-HCl buffer pH 8.0,  $2\ \mu\text{mol}$  EDTA (disodium),  $3.3\ \mu\text{mol}$  GSSG,  $0.1\ \mu\text{mol}$  NADPH or NADH (spectrophotometrically standardised), and  $50\ \mu\text{l}$  haemolysate in a total volume of 1.00 ml. The subsequent experimental procedure was as described for the assay of (G-6-PD + 6-PGD). The reaction was linear for at least 30 min. Blanks were

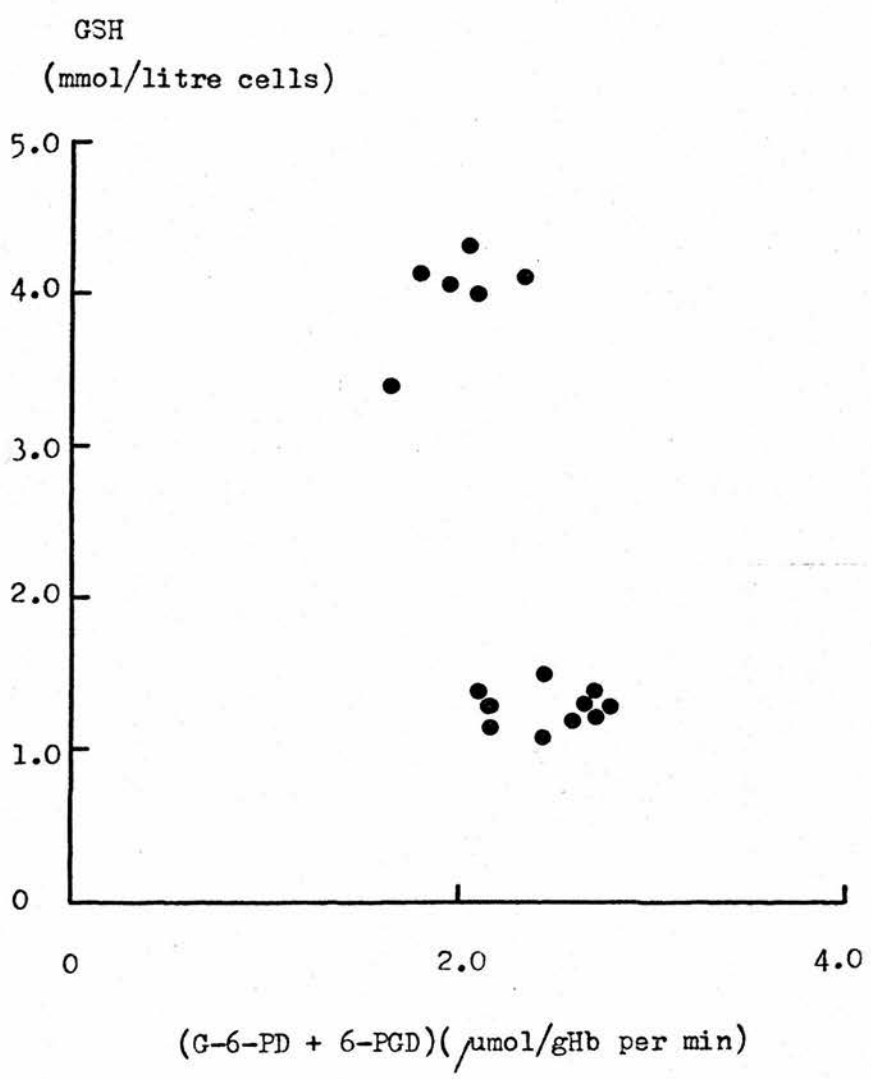

Fig. 9.01

The activity of (G-6-PD + 6-PGD) in high and low GSH Finn erythrocytes

The (G-6-PD + 6-PGD) assay is described in Chapter 9, Part 2.

GSH was estimated by the automated dialysis method (Chapter 3, Part 2).

Table 9.01

(G-6-PD + 6-PGD) activities in high and low GSH Finn erythrocytes

(G-6-PD + G-PGD) were assayed by the method described in Chapter 9, Part 2. Values are (mean  $\pm$  SEM)  $\mu\text{mol/gHb}$  per min. Means are compared by Student's t-test.

	(G-6-PD + 6-PGD)	No. of animals	P
High GSH	1.96 $\pm$ 0.10	6	
Low GSH	2.48 $\pm$ 0.08	10	< 0.05

Table 9.02

GSSG-R activities in high and low GSH Finn erythrocytes

GSSG-R was assayed by the method described in Chapter 9, Part 2.

Values are (mean  $\pm$  SEM(3))  $\mu$ mol/gHb per min. Means are not significantly different by Student's t-test.

	NADPH activity	NADH activity	NADPH:NADH
High GSH	2.06 $\pm$ 0.18	0.39 $\pm$ 0.03	5.3
Low GSH	2.19 $\pm$ 0.10	0.46 $\pm$ 0.10	4.8



performed by omitting GSSG from the incubation medium. Enzyme activities were expressed as  $\mu\text{mol NAD(P)}^+$  formed/gHb per min.

Section 2.03. The activity of (G-6-PD + 6-PGD) and GSSG-R in high and low GSH Finn erythrocytes

In Fig. 9.01, the erythrocyte (G-6-PD + 6-PGD) activities of 6 high GSH and 10 low GSH Finns are plotted against their respective erythrocyte GSH concentrations. These data are summarised in Table 9.01. Low GSH animals have a significantly higher erythrocyte (G-6-PD + 6-PGD) activity than high GSH animals. This may be explained by the observations that in Finns, low GSH erythrocytes have a shorter lifespan and are therefore on average younger than high GSH cells (Tucker, 1974), and that G-6-PD activity decreases as the sheep erythrocyte ages (Maronpot, 1972).

The activity of GSSG-R (NADPH and NADH dependent) in high and low GSH Finn erythrocytes is given in Table 9.02. There is no significant difference in GSSG-R activity (NADPH or NADH dependent) between the two GSH classes. The ratio of NADPH dependent activity/NADH dependent activity is approximately equal to 5 for both high and low GSH animals.

PART 3. THE REGENERATION OF GSH FROM GSSG IN DIAMIDE-TREATED  
INTACT HIGH AND LOW GSH FINN ERYTHROCYTES

Section 3.01. Introduction

To measure the ability of intact high and low GSH Finn erythrocytes to regenerate GSH from GSSG, erythrocyte GSH was partially oxidised with diamide (diazenedicarboxylic acid bis (N,N-dimethylamide)) (Kosower et al., 1969). Diamide reacts with GSH rapidly and stoichiometrically as follows:



After treatment with diamide at 0°C, the cells were incubated at 37°C in the presence of glucose, and aliquots were removed at regular intervals for GSH estimation by the automated DTNB method described in Part 2 of Chapter 4.

Diamide has the advantage over azoester (methyl phenylazoformate), formerly used in GSH regeneration studies, that, unlike the latter, it does not undergo other reactions forming free radicals (Kosower et al., 1969). Thus artifacts due to non-specific cell damage may be avoided.

The GSH specificity claimed for diamide has recently been challenged: studies with Ehrlich ascites tumour cells have demonstrated that diamide reacts with protein thiol groups, NADH, and NADPH, although the rates of reaction are at least an order of magnitude less than with GSH (Harris & Biaglow, 1972). In the

present study, small fixed amounts of diamide causing only partial oxidation of GSH were employed. Under these conditions it may be anticipated that diamide will react preferentially with GSH.

There are several additional advantages of using small fixed amounts of diamide, causing only partial GSH oxidation, rather than large amounts of diamide causing complete GSH oxidation. First, with total GSH oxidation, high intracellular concentrations of GSH would be converted into high concentrations of GSSG, low concentrations of GSH to low concentrations of GSSG. Therefore high and low GSH sheep erythrocytes would have vastly different initial GSSG concentrations. The use of small fixed amounts of diamide however, results in high and low GSH cells having the same initial GSSG concentration. Second, it is always possible to add inadvertently a slight excess of diamide while attempting total GSH oxidation. Excess diamide, in addition to encouraging non-specific reactions, also precludes the accurate measurement of the initial rate of GSH regeneration, since reoxidation of GSH by excess diamide will continue during the initial period of regeneration. This is particularly likely to occur in low GSH erythrocytes. The use of small carefully controlled fixed amounts of diamide overcomes this difficulty.

The incubation system and subsequent sample treatment are given in Section 3.02. The ability of intact high and low GSH Finn erythrocytes to regenerate GSH from GSSG is described in Section 3.03.

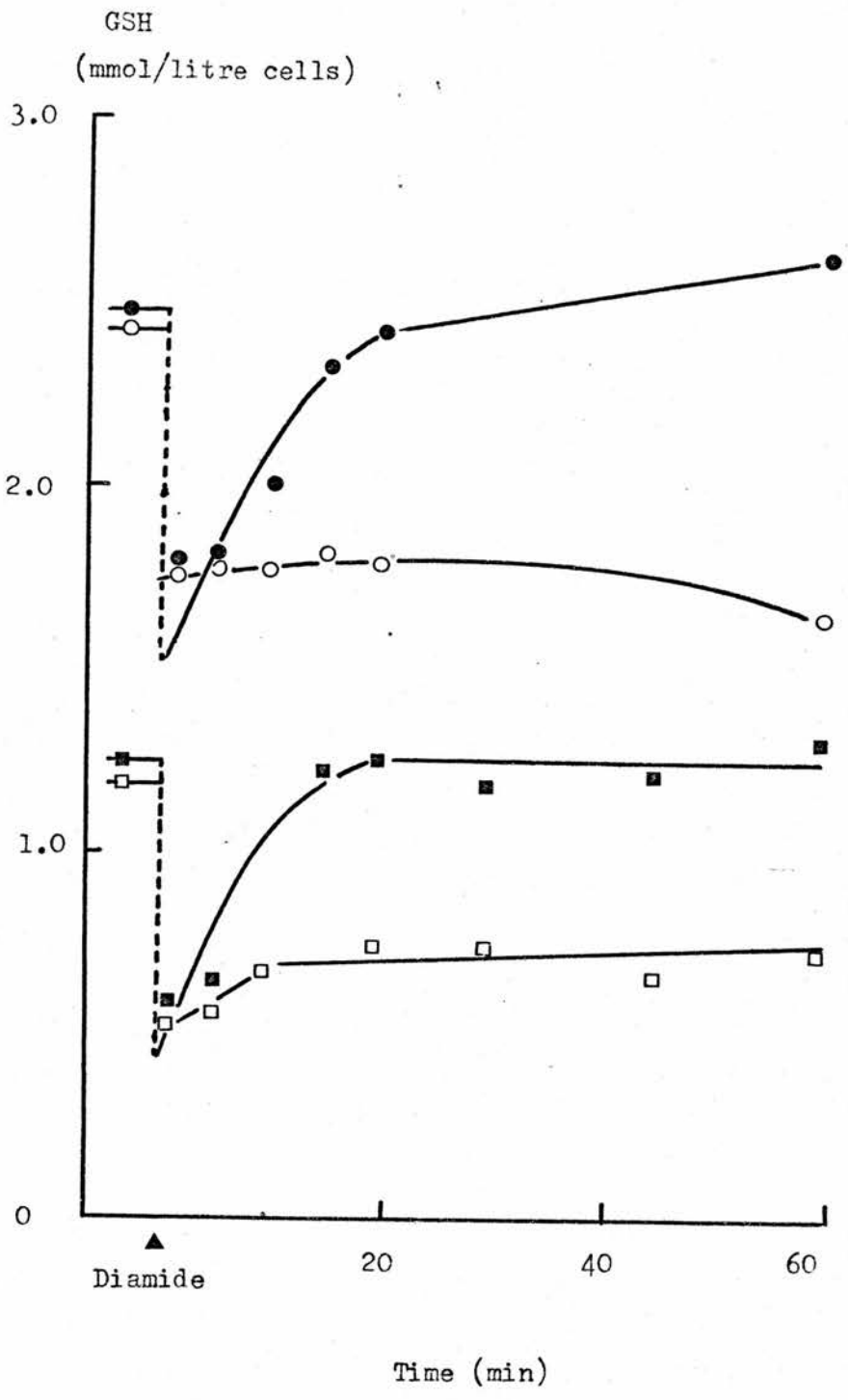

Fig. 9.02

The regeneration of GSH by diamide-treated high and low GSH  
Finn erythrocytes

The experimental procedure is described in Chapter 9, Part 3.  
Pooled erythrocytes (equal volumes of cells from 3 animals of the  
same GSH type) were employed. In the presence of glucose:  
● high GSH and ■ low GSH. In the absence of glucose: ○ high  
GSH and □ low GSH.

Section 3.02. The incubation system and subsequent sample treatment

Washed sheep erythrocytes were prepared as previously described (Chapter 2, Part 2) except that the cells were washed in a buffered salt solution containing 130 mM NaCl, 5 mM KCl, 1 mM MgCl<sub>2</sub>, and 25 mM sodium phosphate (pH 7.4). To obtain sufficient material, equal volumes of washed erythrocytes from 3 animals of the same GSH type were pooled.

The incubation medium for the regeneration experiments contained 130 mM NaCl, 5 mM KCl, 1 mM MgCl<sub>2</sub>, 25 mM sodium phosphate (pH 7.4), and 10 mM glucose. Erythrocytes were added to the incubation medium at 0°C (incubation volume, 10 ml; haematocrit, 40%), and zero-time samples (1 ml) were removed for GSH estimation (automated protein precipitation DTNB method, Chapter 4, Part 2). To the remaining 9 ml of cell suspension at 0°C was added 1 ml of 2 mM diamide (dissolved in incubation medium). The diamide was added slowly, and with constant mixing. After 1 min at 0°C, a further aliquot of the cell suspension was removed for GSH estimation. The diamide-treated cells were then incubated at 37°C for 60 min. Aliquots were removed at regular intervals for GSH estimation. Additional incubations were performed in the absence of added glucose.

Section 3.03. The regeneration of GSH from GSSG in diamide-treated high and low GSH Finn erythrocytes

Fig. 9.02 shows typical GSH regeneration time courses for high and low GSH Finn erythrocytes in the presence and absence of added glucose. For both types of cells in the presence of glucose,

Table 9.03

GSH regeneration in diamide-treated high and low GSH

Finn erythrocytes

The experimental procedure is described in Chapter 9, Part 3. Values are (mean  $\pm$  SEM)  $\mu\text{mol}$  GSH regenerated/litre cells per min. Means are not significantly different by Student's t-test.

	GSH regeneration rate	No. of experiments
High GSH	57 $\pm$ 4.6	4
Low GSH	55 $\pm$ 8.7	4

regeneration was essentially completed by 20-30 min, and was linear for the first 10 min. The mean initial regeneration rates for high and low GSH Finn erythrocytes are given in Table 9.03. There is no significant difference in regeneration rate between the two cell types.

In the absence of added glucose, slight but variable regeneration of GSH did occur, the initial rate in every case being less than  $10 \mu\text{mol/litre cells per min.}$  This regeneration was presumably supported by endogenous substrates.



PART 4. DISCUSSION

The investigations described in this Chapter indicate that low GSH Finn erythrocytes have a normal activity of GSSG-R (NADPH and NADH dependent), and a slightly elevated activity of (G-6-PD + 6-PGD). In addition, intact high and low GSH Finn erythrocytes have a similar ability to regenerate GSH from GSSG in the presence of extracellular glucose. These studies suggest that low GSH Finn erythrocytes have an undiminished ability to maintain glutathione in the reduced state. Therefore it seems unlikely that an inability to reduce GSSG is responsible for the erythrocyte GSH deficiency in Finns. This is also suggested by the observation that low GSH Finn erythrocytes have very low GSSG concentrations (Chapter 4, Part 3), since G-6-PD deficiency in human erythrocytes is associated with elevated GSSG concentrations (Srivastava & Beutler, 1968c).

The dilute haemolysate GSSG-R assays described in Part 2 of this Chapter demonstrate that sheep erythrocyte GSSG-R can utilise NADH as well as NADPH. However, the activity with NADPH is some 5 fold higher than the activity with NADH. This observation is consistent with the suggestion that NADPH rather than NADH is the preferred cofactor for sheep erythrocyte GSSG-R in vivo (Chapter 1, Part 3).

Low GSH Finn erythrocytes were found to have a significantly higher (G-6-PD + 6-PGD) activity than high GSH Finn erythrocytes. Maronpot (1972) demonstrated that sheep erythrocyte G-6-PD activity

decreases with cell age. This elevated enzyme activity may therefore be a further indication that low GSH Finn erythrocytes have a reduced life-span (see also Tucker, 1974).

In the whole cell regeneration experiments (Part 3), the recovery of GSH from diamide-treated high and low GSH Finn erythrocytes was approximately 100%. Therefore little GSSG was lost from the cells during the course of GSH regeneration as a result of the GSSG transport system. This is because the capacity of sheep erythrocytes for GSH regeneration is greater than their capacity for GSSG transport (Srivastava & Beutler, 1969b).

CHAPTER 10

GENERAL DISCUSSION

PART 1. THE BIOCHEMICAL MECHANISMS RESPONSIBLE FOR GSH  
DEFICIENCY IN SHEEP ERYTHROCYTES

Sheep with low concentrations of erythrocyte GSH were first described by Smith & Osburn (1967) and later by Tucker & Kilgour (1970) who suggested that the erythrocyte GSH deficiency in these animals was genetically controlled. The objective of the present investigation was to ascertain the biochemical mechanism(s) responsible for GSH deficiency in sheep erythrocytes.

Whilst this project was in progress, independent investigations suggested the existence of two distinct types of sheep erythrocyte GSH deficiency. The first was found in Finnish Landrace sheep (Finns) where low GSH was inherited in an autosomal recessive manner (Tucker & Kilgour, 1970). This was in contrast to the situation in Tasmanian Merino sheep (Merinos) where low GSH seemed to be inherited in an autosomal dominant manner (Tucker & Kilgour, 1972). These genetic differences were supported by the observation that low concentrations of erythrocyte GSH in Finns were associated with high intracellular concentrations of certain amino acids particularly ornithine and lysine, a phenomenon which was not seen in Merinos (Ellory *et al.*, 1972).

Studies by the author demonstrated the existence of low GSH animals in both the Finn and Merino flocks of the Agricultural Research Council Animal Breeding Research Organisation, Edinburgh (Chapter 3, Part 3). Although it was not possible to verify the genetic studies of Tucker & Kilgour (1970 and 1972) for reasons

already discussed (Chapter 3, Part 5), it was possible to screen these animals for the presence of erythrocyte amino acids. In agreement with the observations of Ellory *et al.* (1972), only the low GSH Finns were ornithine/lysine positive (Chapter 3, Part 4). All the high GSH Finns and high and low GSH Merinos tested were ornithine/lysine negative. Subsequent investigations were carried out on both the Finn and Merino GSH deficiencies.

One of the prominent features of the Finn and Merino population distributions of erythrocyte GSH is the wide range of GSH concentrations within a GSH class. It was therefore of interest to assess the influence of known animal variables on erythrocyte GSH concentration (Chapter 3, Part 6). Animal sex, age, haemoglobin type and potassium type were found to have little influence on erythrocyte GSH concentration. From the limited family data which was available on the Animal Breeding Research Organisation flocks, it was possible to identify a small number of Finn and Merino heterozygotes (Chapter 3, Part 5). For both breeds the available evidence suggests that there are no obvious differences between heterozygote and homozygote erythrocyte GSH concentrations. Therefore most of the intra-type variation in erythrocyte GSH concentration remains unexplained.

In this and other studies, sheep are classified as to GSH type on the basis of their content of total non-protein reduced thiol as determined by the non-specific thiol reagent DTNB. This raises two questions: first, the accuracy with which total thiol is a measure of GSH, since sheep erythrocytes may contain thiols other than GSH; and second, whether low GSH erythrocytes have a normal GSSG concentration. Investigations to answer both these questions are

described in Chapter 4. To assess the non-GSH thiol content of high and low GSH erythrocytes, cells from selected animals were assayed for GSH by both the non-specific DTNB method and also by a method employing the GSH-specific chromogen alloxan. Alloxan is particularly useful in this context since, unlike DTNB, it distinguishes between GSH and its thiol precursors and degradation products (cysteine, GC and cysteinyl glycine). A disadvantage of the existing manual alloxan method (Patterson & Lazarow, 1955) is that it is cumbersome and gives an unstable product. An automated version of this method was therefore developed (Chapter 4, Part 2). In addition, an automated DTNB method was also devised for estimating GSH in the same erythrocyte extracts so that alloxan and DTNB values could be directly compared with one another (Chapter 4, Part 2). These studies demonstrated that more than 92% of the non-protein thiol in high and low GSH Finn and Merino erythrocytes is in fact GSH.

The automated DTNB and alloxan methods described in Chapter 4 may have other applications. Although it is accepted that in healthy man erythrocytes contain a negligible concentration of non-GSH thiol, so that it is valid to equate GSH with DTNB-reactive thiol (Beutler et al., 1963), the same may not be true in abnormal states. Thus claims that erythrocyte GSH is elevated in some patients with anaemias (Macdougall, 1968; Hopkins & Tudhope, 1973), myelofibrosis (Goswitz et al., 1966) or leukaemia (Sabine, 1964; Özsoylu, 1970) could be criticised on the grounds that the assays measured total thiol and not just GSH. The automated DTNB and alloxan methods may prove useful in these and other similar situations.

Sheep erythrocytes were found to have very low concentrations of GSSG (less than 0.5% of the GSH concentration). Furthermore, low GSH erythrocytes of both breeds were found to have a lower than normal GSSG content. Therefore Finn and Merino low GSH erythrocytes have a low content of total glutathione (GSH + 2GSSG).

As discussed in detail earlier (Chapter 1, Part 3), the major role of GSH in the erythrocyte is thought to be the protection of the cell against oxidative damage, the GSH-GSSG couple acting as a redox buffering system. Consequently it is the redox potential of the GSH-GSSG couple as well as the actual GSH concentration which is important in assessing whether this role can be adequately performed in GSH-deficient erythrocytes. The redox potential of the GSH-GSSG couple in high and low GSH Finn and Merino erythrocytes was therefore calculated from their respective GSH (determined by alloxan) and GSSG concentrations (Chapter 4, Part 4). It was found that despite their wide divergence in GSH and GSSG concentrations, high and low GSH erythrocytes of both breeds have remarkably similar redox potentials. The significance of these observations is discussed in the second part of this Chapter.

One possible explanation for the low concentrations of total glutathione in low GSH erythrocytes is a diminished ability to synthesise GSH. The ability of sheep erythrocytes to synthesise GSH was therefore examined. Initially, GC-S and GSH-S assays were carried out on dilute haemolysates (Chapter 5, Part 3). These studies clearly demonstrate that mature sheep erythrocytes have the enzymic capacity to synthesise GSH from its precursor amino acids glutamate, cysteine and glycine. Indeed high GSH erythrocytes have sufficient

enzymic activity to synthesise their entire complement of GSH in less than 100 min.

Low GSH Merino erythrocytes were found to have a markedly diminished maximum activity of GC-S (48% of normal), and a normal activity of GSH-S. The association between low GSH and a diminished capacity for GC synthesis suggests that this reduced enzymic activity is responsible for the GSH deficiency in Merinos. Computer simulation studies described in Chapter 6 indicate that GC-S is the rate limiting enzyme of GSH biosynthesis in sheep erythrocytes.

GSH was found to be a potent inhibitor of sheep erythrocyte GC-S (Chapter 7, Part 5). This GSH feedback inhibition may be an important regulatory mechanism for maintaining erythrocyte GSH concentrations. The possibility was therefore considered that the low GC-S activity in GSH-deficient Merino erythrocytes might be partially or completely compensated by a diminished GSH feedback inhibition resulting from the lower GSH concentration in these cells. GSH inhibition studies (Chapter 7, Part 5) demonstrate that this diminished feedback inhibition is insufficient to compensate for the reduced GC-S activity.

A complete genetic analysis of the animals used in the present study was not possible for reasons already discussed (Chapter 3, Part 5). However of the 13 low GSH Merinos whose GC-S activity was measured, 6 could be identified as heterozygotes (Ll). The remaining 7 unclassified low GSH Merinos also probably contained a number of unidentified heterozygotes as well as homozygotes (LL). Therefore, the GC-S activity reported here for low GSH Merinos (48%



of normal) represents the heterozygote rather than the homozygote GC-S activity. Further investigations will be required to ascertain whether homozygote (LL) and heterozygote (Ll) GC-S activities differ.

The dilute haemolysate GC-S and GSH-S assays therefore suggest that low GSH Merino erythrocytes have a diminished GC-S activity and that this is responsible for the GSH deficiency in these cells. The validity of this argument depends on whether the relative activities of high and low GSH Merino GC-S as measured in dilute haemolysates are similar to those encountered in the intact cell. The possibility of GSH feedback inhibition affecting the relative GC-S activities has already been considered. However, it is possible that other factors may influence the relative activities of high and low GSH Merino GC-S. It was therefore desirable to measure sheep erythrocyte GC-S activities under more physiological conditions than those encountered in the dilute haemolysate assay system. Consequently, the ability of high and low GSH Merino freeze-thaw haemolysates to synthesise GC was determined under assay conditions where the cell constituents were virtually undiluted (compared with a 30-50 fold dilution in the other assay system) (Chapter 7, Part 3). In agreement with the dilute haemolysate GC-S assays, low GSH Merino freeze-thaw haemolysates were found to have a markedly diminished ability to synthesise GC (25% of normal). The freeze-thaw haemolysate investigations also demonstrate that high and low GSH Merino erythrocytes do not seem to have any significant ability to degrade GSH.

Evidence is presented in Part 2 of Chapter 8 which suggests that sheep reticulocytes have much higher GSH concentrations and GC-S

activities than mature erythrocytes, and that reticulocytes from high and low GSH 'Merino-type' sheep have essentially identical GSH concentrations and GC-S activities. Thus the differentiation into high and low GSH cells occurs at some stage during reticulocyte maturation. The primary event in this differentiation may be a more rapid loss of GC-S activity in low GSH cells. Since the reticulocyte-mature erythrocyte transition is also associated with a cessation of protein synthesis, it is tempting to speculate that reticulocytes from low GSH animals may contain a species of GC-S which is inherently more unstable than the native enzyme. One unanswered question is whether the residual GC-S in low GSH erythrocytes is the same as the GC-S found in high GSH cells. It is perhaps suggestive that the enzymes from both cell types have very similar GSH inhibition patterns (Chapter 7, Part 5). However, more detailed kinetic analyses and possibly electrophoretic mobility studies are required.

The situation in GSH-deficient Merinos is similar to that encountered in one type of erythrocyte GSH deficiency in man, where a diminished GC-S activity has also been implicated (Konrad et al., 1972). A second type of GSH deficiency, associated with a diminished GSH-S activity, has also been described in human erythrocytes (Boivin & Galand, 1965; Minnich et al., 1971). This type of GSH deficiency shows an interesting anomaly which may provide further insights into erythrocyte GSH metabolism. GSH-S deficient erythrocytes have a normal complement of GC-S, yet their non-protein reduced thiol content is negligible. This is surprising since it might be anticipated that these cells would accumulate GC in place

of GSH. Since GC, at least in sheep erythrocytes, does not seem to inhibit its own formation (Chapter 7, Part 3), there must be a mechanism in human erythrocytes for the removal of this thiol. One possibility is GC oxidation (GSSG-R cannot utilise ( $\gamma$ -glutamyl-)<sub>2</sub>-cystine (Icén, 1967)) with either disulphide accumulation in the cell or efflux by the GSSG transport system. GC or ( $\gamma$ -glutamyl-)<sub>2</sub>-cystine degradation is another possibility.

Although a decreased maximum activity of GC-S may be responsible for the GSH deficiency in Merinos, the low concentrations of GSH in Finns cannot be explained in this way since high and low GSH Finn erythrocytes have essentially identical GC-S activities (dilute haemolysate assay system) (Chapter 5, Part 3). Low GSH Finn erythrocytes were also found to have normal GSH-S activities (Chapter 5, Part 3). These observations therefore suggest that the biochemical mechanisms responsible for GSH deficiency differ in Finns and Merinos. As discussed earlier, this suggestion is supported by other independent studies (Tucker & Kilgour, 1970 and 1972; Ellory *et al.*, 1972). The normal GC-S activity of low GSH Finn cells indicates that the diminished GC-S activity of low GSH Merino erythrocytes is not a consequence of their low GSH status.

The GC-S and GSH-S assays employed in the present study were performed at what were probably saturating substrate concentrations (Majerus *et al.*, 1971). Therefore these investigations do not rule out the possibility that low GSH Finn erythrocytes contain a species of GC-S or GSH-S with a normal  $V_{max}$  but with an elevated  $K_m$  for one or more of its substrates. However, if this were the case, it would

be difficult to explain the association between low GSH and high intracellular amino acid concentrations. On the other hand, it is possible that low GSH Finn erythrocytes contain an inhibitor of GSH biosynthesis. Obvious candidates for this role are those amino acids found in low GSH Finn cells, particularly ornithine and lysine. The presence of such an inhibitor would not necessarily be detected in the dilute haemolysate assay systems (cell constituents diluted 30-50 fold). The development of freeze-thaw haemolysate GC-S and GSH-S assays, where the cell constituents are virtually undiluted, allowed this possibility to be tested (Chapter 7, Parts 3 and 4). No evidence of any inhibition of GSH biosynthesis (other than by GSH) in low GSH Finn freeze-thaw haemolysates was found. The freeze-thaw haemolysate studies also indicate that high and low GSH Finn erythrocytes do not have any significant ability to degrade GSH. This is particularly interesting in the case of low GSH Finn erythrocytes since these cells contain high concentrations of amino acids which are potential  $\gamma$ -glutamyl acceptors (see Chapter 1, Part 3). The freeze-thaw haemolysate investigations were extended to a study of amino acid inhibition of GC-S and GSH-S under dilute haemolysate assay conditions (Chapter 7, Part 6). Ornithine, lysine, alanine, serine and threonine (10 mM) were found to have little effect on low GSH Finn GC-S even when, in the case of ornithine and lysine, the substrate concentrations were reduced to near physiological levels. Ornithine and lysine (10 mM) were more effective inhibitors of low GSH Finn GSH-S, each inhibiting the enzyme by about 20% at approximately physiological substrate concentrations. However, since GC-S and not GSH-S is probably the rate limiting enzyme of GSH biosynthesis in sheep erythrocytes, this inhibition is of doubtful

significance and may be expected to have only a marginal influence on erythrocyte steady-state GSH concentrations. Both the freeze-thaw haemolysate and dilute haemolysate studies therefore indicate that low GSH Finn erythrocytes do not contain an inhibitor of GSH biosynthesis. Further investigations revealed that low GSH Finn erythrocytes have a normal ATP content (Chapter 5, Part 4), and that their ability to reduce GSSG both in dilute haemolysates and intact cells is unimpaired (Chapter 9, Parts 2 and 3).

One remaining possible explanation for the low concentrations of erythrocyte GSH in Finns is a diminished amino acid availability for GSH biosynthesis. Subsequent investigations by the author, carried out at Babraham in collaboration with Drs. E.M. Tucker and J.C. Ellory, have revealed that this is indeed the case (Young et al., 1975). In these studies, the permeability of high and low GSH Finn erythrocytes to the GSH-precursor amino acids glutamate, cysteine and glycine was measured, and results compared with those obtained for high and low GSH Merino cells.

The data are presented in Table 10.01 together with values for  $\alpha$ -amino-n-butyrlic acid glutamine, /( $\alpha$ AB), cystine and lysine uptake by high and low GSH Finn cells. The uptake of cysteine by Finn erythrocytes was rapid, and 6 fold greater in high GSH cells than in low GSH ones. In contrast, the uptake of cysteine by high and low GSH Merino erythrocytes was the same, and not significantly different from that found in high GSH Finn cells. As with cysteine, glycine uptake was significantly lower in low GSH Finn erythrocytes although both the absolute fluxes and the difference between the GSH types were smaller. There was

Table 10.01

GSH concentrations/<sup>amt</sup>amino acid uptake rates in high and low GSH  
Finn and Merino erythrocytes

	High GSH Finn	Low GSH Finn	Significance level for difference P
No. of animals	5	5	
GSH (mmol/litre cells)	2.97 ± 0.24	1.25 ± 0.08	
Amino acid uptake (µmol/litre cells per h)			
cysteine	236 ± 21	38.7 ± 4.0	< 0.001
glycine	12.7 ± 1.8	7.3 ± 0.4	< 0.002
glutamate	<1	<1	NS
glutamine	11.9 ± 1.3	13.5 ± 3.1	NS
α-amino-n-butyrate	656 ± 69	56.4 ± 8.6	< 0.001
cystine	8.6 ± 0.4	9.9 ± 0.5	NS
lysine	19.4 ± 3.0	6.4 ± 0.8	< 0.01

	High GSH Merino	Low GSH Merino	
No. of animals	6	6	
GSH (mmol/litre cells)	3.19 ± 0.04	0.87 ± 0.04	
Amino acid uptake (µmol/litre cells per h)			
cysteine	298 ± 12	242 ± 20	NS
glycine	10.4 ± 0.8	11.7 ± 0.6	NS

Data presented as mean ± S.E.M. NS, not significant.

Table 10.01. Washed sheep erythrocytes were incubated at 10% haematocrit in a medium containing (mM) NaCl 135, KCl 5, tris-HCl (pH 7.1 at 37°C) 15, MgCl<sub>2</sub> 3.1, EDTA 0.1, <sup>and</sup> amino acid 0.2 (containing [<sup>14</sup>C] amino acid at 0.2 μCi/ml). Since cysteine oxidises rapidly in solution at neutral pH, cysteine uptake was measured in the presence of 10 mM dithiothreitol. Control experiments showed no effect of 10 mM dithiothreitol on αAB influx or efflux. At fixed time intervals (10-30 min for glycine, αAB, lysine, cysteine; 30-90 min for cystine, glutamine, glutamate) 1 ml aliquots were taken and the cells washed 4 times in 10 volumes of a medium containing (mM) MgCl<sub>2</sub> 106, trisHCl (pH 7.4 at 4°C) 10, by centrifugation (10 s, 10,000 g) in an Eppendorf 3200 micro-centrifuge. Finally, the packed cells were lysed in 0.5% (v/v) Triton X-100 in water (0.5 ml), 33% (w/v) trichloroacetic acid added (0.5 ml), and the precipitate removed by centrifugation. An aliquot of supernatant (0.9 ml) was transferred into Bray's fluid (10 ml) and counted in a β-Scintillation spectrometer with quench correction.

no significant difference in glycine permeability between high and low GSH Merino erythrocytes. Attempts to demonstrate glutamate uptake by sheep erythrocytes gave very low values, not linear with time. The impermeability of sheep erythrocytes to glutamate is consistent with observations on human erythrocytes (Winter & Christensen, 1964). Glutamine may act as a GSH precursor (Prins *et al.*, 1966), and measurements of glutamine uptake showed fluxes of the same order as for glycine, but with no significant difference between Finn GSH types.

In certain reactions including that catalysed by GC-S,  $\alpha$ AB can substitute for cysteine (Strumeyer, 1959; Rathbun, 1967) and may therefore provide a convenient alternative to cysteine for uptake studies. The uptake of this amino acid by Finn cells was therefore measured, and found to be rapid, with the flux in high GSH cells some 10 fold greater than that encountered in low GSH cells. In contrast to the situation with cysteine and  $\alpha$ AB, cystine showed a slow rate of uptake with no significant difference between high and low GSH Finn cells.

Finally, the uptake of lysine by high and low GSH Finn erythrocytes was measured. High GSH cells showed a 3 fold greater lysine permeability than low GSH cells.

The above results show that differences in amino acid permeability, particularly for cysteine,  $\alpha$ AB and lysine exist between high and low GSH Finn erythrocytes. In contrast to glutamate and glycine, the concentration of cysteine in sheep erythrocytes is very low ( $13 \mu\text{mol/litre cells}$ ) (Smith, 1973). Thus a diminished cysteine availability may be responsible for the low concentrations of GSH in low GSH Finns.



The reduced amino acid transport in low GSH Finn erythrocytes is not a direct consequence of a low intracellular GSH concentration since low GSH Merino erythrocytes show normal amino acid uptake values. Further experiments were designed to determine whether the diminished uptake by low GSH Finn cells resulted from a membrane transport defect or whether it was a function of the high lysine and ornithine content of these cells. Uptake of  $\alpha$  AB (0.2 mM) by high GSH Finn erythrocytes was unaffected by the presence of extracellular lysine or ornithine (10 mM). Similarly,  $\alpha$  AB efflux from the same cells (pre-loaded by incubation in the presence of 1 mM  $\alpha$  AB for 2 h at 37°C) was unaffected by extracellular lysine or ornithine at a concentration of 5 mM. In contrast, 10 mM cysteine inhibited  $\alpha$  AB uptake by 50% and stimulated  $\alpha$  AB efflux by 30% under equivalent conditions. Finally, high GSH Finn erythrocytes were pre-loaded with lysine by incubation in the presence of 10 mM lysine for 20 h at 20°C. Uptake of  $\alpha$  AB by these cells (intracellular lysine concentration 3.0 mmol/litre cells) was identical to that of control high GSH cells which had been incubated for the same length of time in the absence of lysine (intracellular lysine concentration 0.1 mmol/litre cells).

It is therefore concluded that the diminished amino acid uptake of low GSH Finn erythrocytes represents a membrane transport defect which is not a consequence of the diminished GSH or elevated lysine and ornithine concentrations in these cells. It further seems likely that diminished availability of cysteine is responsible for the low concentrations of erythrocyte GSH in these animals, and that

the accumulation of lysine and ornithine is a further reflection of reduced amino acid transport.

Amino acid transport in mammalian erythrocytes is carrier mediated and non-concentrative (Winter & Christensen, 1964 and 1965; Yunis & Arimura, 1965; Antonioli & Christensen, 1969; Gardner & Levy, 1972; Hoare, 1972a and b). A number of possibly distinct transport systems with differing specificities have been described: two for neutral amino acids (one specific for glycine and alanine, and the other for larger members of the group) and one for the dibasic amino acids ornithine, lysine and arginine. In contrast to the situation in some other tissues, cystine does not seem to share the dibasic transport system (Gardner & Levy, 1972). Further investigations will be required to define the amino acid transport systems in sheep erythrocytes and to ascertain how many of these are impaired in low GSH Finns.

Recently, the studies of Palekar et al. (1974) have provided evidence that rabbit erythrocytes have the enzymic ability to degrade GSH, the GSH degradation and biosynthesis enzymes forming an almost complete  $\gamma$ -glutamyl cycle (see Chapter 1, Part 3 and Fig. 1.01). It has been suggested that the  $\gamma$ -glutamyl cycle may play a role in amino acid transport in erythrocytes (Agar et al., 1974; Palekar et al., 1974). This postulate offers an additional explanation for the relationship between low GSH concentrations and defective amino transport in Finn erythrocytes. However, as discussed earlier, sheep erythrocytes do not seem to have an active GSH degradation system. Furthermore, the normal amino acid transport of low GSH Merino erythrocytes indicates that defective amino acid transport is

not a direct consequence of GSH deficiency. Additional studies of amino acid transport in sheep erythrocytes should provide further insights into amino acid transport mechanisms.

It was suggested earlier (Chapter 1, Part 3) that cysteine for GSH biosynthesis might enter the erythrocyte as cystine. The present data suggest that this is not the case for sheep erythrocytes which are relatively impermeable to cystine. At an amino acid concentration of 0.2 mM, high GSH Finn erythrocytes are 30 fold more permeable to cysteine than they are to cystine.

The defective amino acid transport in low GSH Finn erythrocytes is unique. All investigated instances of congenital erythrocyte GSH deficiency in man have been attributed to a diminished activity of either GC-S (similar to the situation in Merinos) or GSH-S. No case of erythrocyte GSH deficiency associated with defective amino acid transport has been reported. Indeed, although a variety of amino acid transport defects have been described for other tissues (Scriver, 1969), this may be the first documented instance of defective amino acid transport of any kind in mammalian erythrocytes. Of special note in this regard is the metabolic disorder cystinuria which is attributed to a defective common transport system for dibasic amino acids and cystine in the kidney and intestine (Rosenberg *et al.*, 1966). Erythrocytes from cystinuric patients exhibit normal ornithine, lysine and cystine transport (Gardner & Levy, 1972).

To summarise, there are two distinct types of erythrocyte GSH deficiency in sheep. The first is found in the Tasmanian Merino breed where low concentrations of erythrocyte GSH are inherited in an autosomal dominant manner. In these animals, low GSH is a

Table 10.02

Comparison of Finnish Landrace and Tasmanian Merino erythrocyte GSH deficiencies

	GSH concentration (% of high GSH)	(Na <sup>+</sup> + K <sup>+</sup> )	Ornithine/Lysine	Erythrocyte Life-span	Inheritance	GC-S activity	Amino acid transport
Finn	39.6	diminished	present	diminished	recessive	normal	diminished
Merino	37.8	normal	absent	normal	dominant	diminished	normal

consequence of a diminished activity of the first enzyme of GSH biosynthesis (GC-S). The second type of GSH deficiency is found in Finnish Landrace sheep where low GSH is inherited in an autosomal recessive manner. Low GSH Finn cells have high concentrations of certain amino acids particularly ornithine and lysine, a phenomenon not observed in Tasmanian Merino sheep. In Finns, low erythrocyte GSH and high ornithine and lysine concentrations are a consequence of defective amino acid transport. The differences between the Finn and Merino types of erythrocyte GSH deficiency are summarised in Table 10.02.

Recently, Board et al. (1974) reported that erythrocyte GSH deficiency in Australian Merino sheep is inherited in an autosomal recessive manner. Erythrocytes from these animals are not ornithine/lysine positive. This raises the interesting possibility of the existence of a third type of erythrocyte GSH deficiency in sheep.

PART 2. THE BIOCHEMICAL AND PHYSIOLOGICAL IMPLICATIONS  
OF SHEEP ERYTHROCYTE GSH DEFICIENCY

Numerous studies have indicated that GSH is important for erythrocyte integrity (see General Introduction, Part 3). This section is devoted to an evaluation of the biochemical and physiological implications of sheep erythrocyte GSH deficiency.

A number of biochemical differences between high and low GSH erythrocytes have been described. The most dramatic difference is the presence of high concentrations of certain amino acids, particularly ornithine and lysine in Finn GSH-deficient erythrocytes (Ellory *et al.*, 1972). As discussed earlier (Part 1 of this Chapter), this is attributed to defective amino acid transport and is presumably a reflection of the same biochemical lesion as that causing defective cysteine transport and hence low GSH concentrations. Low GSH Finn erythrocytes also have a diminished ( $\text{Na}^+ + \text{K}^+$ ) content (Tucker & Ellory, 1971). This phenomenon is not observed in Merinos and therefore probably reflects the presence of ornithine and lysine in these cells. An increased passive permeability to  $\text{K}^+$  may also be a contributory factor (Tucker & Ellory, 1971). Investigations described in this Thesis suggest that low GSH Finn erythrocytes have a higher (G-6-PD + 6-PGD) activity than high GSH erythrocytes. Maronpot (1972) demonstrated that sheep erythrocyte G-6-PD activity decreases markedly with cell age so that the elevated enzymic activity is probably a reflection of the diminished lifespan of low GSH Finn erythrocytes.

In Australian Merino sheep (with an unknown biochemical lesion),

low GSH erythrocytes were found to have elevated membrane  $Mg^{2+}$  and  $Na^+/K^+$  ATPase activities (Agar et al., 1973). It was suggested that these increased activities were caused by the lower than normal erythrocyte GSSG concentration in low GSH cells since GSSG has been reported to be an inhibitor of  $Na^+/K^+$  ATPase (Dick et al., 1969). However, this explanation is unlikely because the minimum concentration of GSSG employed by Dick et al. was some 100 fold in excess of that encountered in sheep erythrocytes under normal circumstances (see Chapter 4, Part 3).

Agar & Smith (1973a) conducted an extensive survey of 19 different enzymes and 16 glycolytic intermediates and nucleotides in high and low GSH (GC-S deficient) erythrocytes. Of the various parameters studied, only glutathione peroxidase activity showed any significant difference between the two cell types, with high GSH erythrocytes having the higher activity. Even this one difference may not be meaningful since the number of "significant differences" expected by chance at  $P < 0.05$  is 1 in 20.

One of the most important criteria for evaluating the biochemical and physiological implications of sheep erythrocyte GSH deficiency is the erythrocyte life-span. Low GSH individuals in all breeds do not show any clinical symptoms of haemolytic anaemia; however, the study of Tucker (1974) demonstrated that low GSH Finn erythrocytes have a markedly diminished life-span. This is not the case in Merinos (Tasmanian) where low GSH cells have a normal life-span (Tucker, 1975). Agar & Smith (1973a) also suggested that GC-S deficient low GSH erythrocytes have a normal life-span.

The major role of GSH in the erythrocyte is thought to be the

protection of the cell against oxidative damage, the GSH-GSSG couple acting as a redox buffering system. Consequently it is the redox potential of the GSH-GSSG couple as well as the actual GSH concentration which is important in assessing whether this role can be adequately performed in low GSH erythrocytes. In Part 4 of Chapter 4 the redox potential of the GSH-GSSG couple was calculated for high and low GSH Finn and Merino erythrocytes from their respective alloxan GSH and GSSG concentrations. These analyses indicate that high and low GSH erythrocytes of both breeds have remarkably similar redox potentials. In Merinos the difference in redox potential between high and low GSH animals was only - 0.019 volts. The corresponding figure in Finns was - 0.016 volts. Therefore it would seem that from a thermodynamic standpoint, low GSH cells of both types are at little disadvantage. Consequently it is not surprising that low GSH Merino erythrocytes have a normal life-span (Tucker, 1974). Furthermore, since low GSH Finn and Merino erythrocytes have similar redox potentials and GSH concentrations, it is possible that the diminished life-span of GSH-deficient Finn cells is not a direct consequence of their GSH status. There is therefore no evidence to suggest that the GSH status of low GSH cells/per se has any significant influence on erythrocyte viability under normal circumstances.

The situation in sheep is in contrast to that encountered in congenital erythrocyte GSH deficiency in man. There, low concentrations of erythrocyte GSH are associated with clinical symptoms of haemolytic anaemia which are attributed to a markedly diminished erythrocyte life-span (Prins et al., 1966). However, erythrocyte GSH concentrations in human erythrocyte GSH deficiency are



generally less than those encountered in sheep. This may well account for the differences between the two species.

One type of human erythrocyte GSH deficiency, like that encountered in Tasmanian Merinos, is attributed to a diminished activity of GC-S (Konrad *et al.*, 1972). Recent studies have demonstrated that the enzyme deficiency in man is not restricted to the erythrocyte. The GSH content of leucocytes and muscle is also markedly diminished. These patients also exhibit evidence of central nervous system disease (mental retardation, psychosis, spinocerebellar degeneration) and aminoaciduria (Meister, 1973). It will be of interest to investigate whether the sheep GSH deficiency is restricted to the erythrocyte.

In man, GSH deficient erythrocytes are more susceptible to the haemolytic action of oxidant drugs or fava beans (see Chapter 1, Part 3). GC-S deficient sheep erythrocytes on the other hand do not seem to be more susceptible to oxidant drugs or to the toxic effects of copper (Agar & Smith, 1973b; Smith *et al.*, 1973). However, low GSH Finns are more prone to haemolytic anaemia induced by eating kale (Tucker & Kilgour, 1973). No information is available on the effects of haemolytic drugs or copper on low GSH Finns or the effect of kale on Merinos so that it is not possible to draw any overall conclusions particularly in view of the differences in erythrocyte life-span in the two types of sheep erythrocyte GSH deficiency.

In the General Introduction it was suggested that an investigation of low GSH sheep erythrocytes might provide valuable insights into the role of GSH in mammalian erythrocytes. The overall conclusion of this section must be that under normal circumstances GSH-deficient Finn and Merino erythrocytes have sufficient GSH to maintain

Fig. 10.01

Breeding programme for the production of "double" low GSH sheep

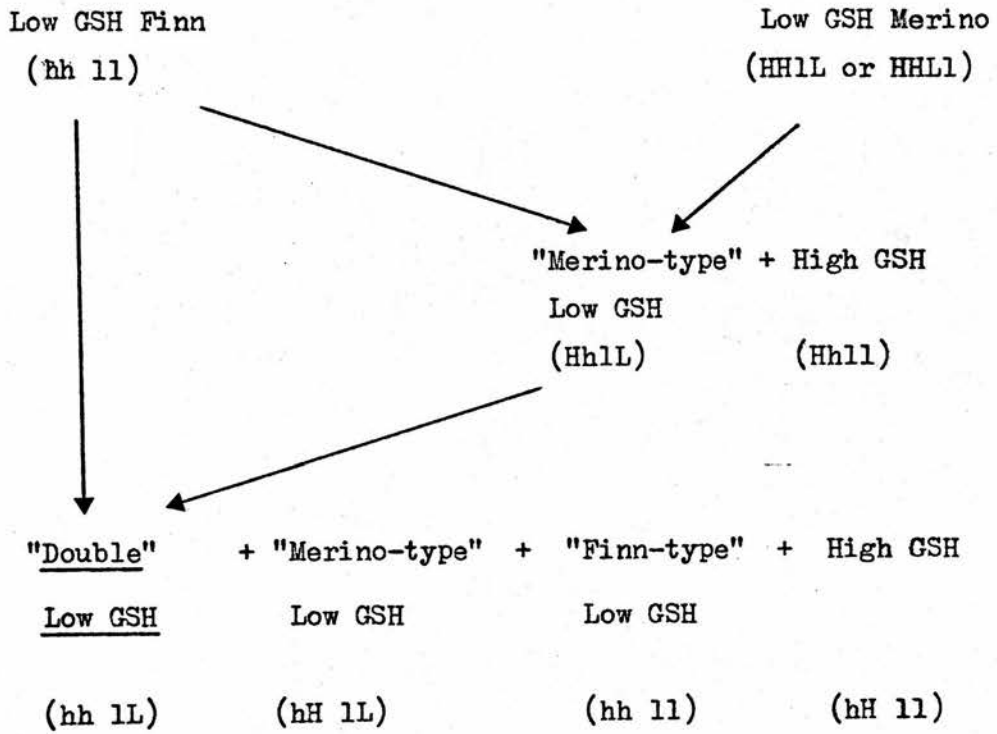

erythrocyte viability. Therefore the GSH concentration in normal sheep erythrocytes is probably substantially in excess of that required for normal erythrocyte function. The demonstration of two distinct types of sheep erythrocyte GSH deficiency with two different biochemical lesions, one associated with a diminished membrane permeability to cysteine, and the other with a diminished activity of the first enzyme of GSH biosynthesis, raises the possibility of finding animals with both lesions present together. These animals may occur naturally in the Awassi breed (see Chapter 1, Part 2). However it should also be possible to produce such "double" low GSH animals by back-crossing the low GSH progeny of low GSH Finns and low Merinos with low GSH Finns (Fig. 10.01). If the effects of the "Finn-type" and "Merino-type" lesions are in any way additive, then "double" low GSH animals may have an erythrocyte GSH concentration below that encountered in normal low GSH animals. If this were the case, these animals would provide further valuable information on erythrocyte GSH metabolism, and would be useful models for human erythrocyte GSH deficiency.

APPENDIX

THE OXIDATION OF GSH BY A PREPARATION OF GLUCOSE OXIDASE

FROM ASPERGILLUS NIGER

## PART 1. INTRODUCTION

The coupled enzymic reactions catalysed by glucose oxidase (EC 1.1.3.4) and peroxidase (EC 1.11.1.7) are commonly used to assay glucose in biological samples. Glucose is first oxidised by molecular oxygen to  $\delta$ -gluconolactone with the concomitant formation of  $H_2O_2$  which is used to oxidise a suitable chromogen ( $XH_2$ ):

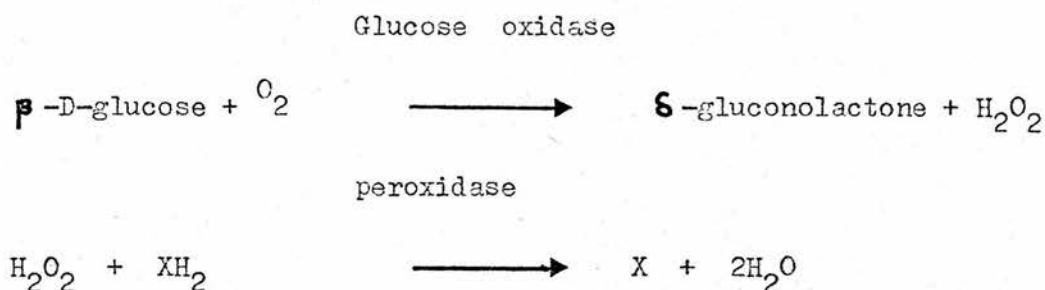

It is generally supposed that GSH causes an underestimate of glucose concentration by competing with the chromogen for  $H_2O_2$  (Fales *et al.*, 1961; Hjelm & Verdier, 1963; Morley *et al.*, 1968). However the glucose oxidase/peroxidase assay system used routinely in this laboratory (gum guaiacum as chromogen; O'Brien, 1969) did not behave in this manner. Instead of inhibiting the system, GSH was found to cause a marked overestimate of glucose concentration. This observation is explained by the finding that the commercial preparation of glucose oxidase from Aspergillus niger (Fermcozyme 653 AM, lot no. 1917; Hughes & Hughes Ltd., Romford, Essex, U.K.) contained an enzymic contaminant ("GSH oxidase") which catalyses the reaction:

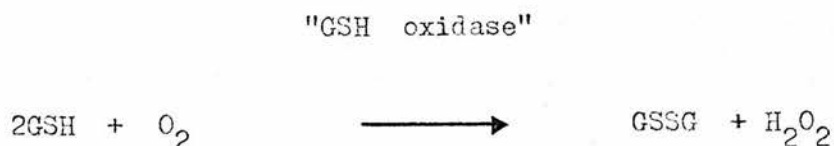

This Appendix describes the experiments which were carried out to characterise the enzymic activity. A brief account of the work has already been published (Young & Nimmo, 1972).

PART 2. CHARACTERISATION OF THE "GSH OXIDASE" ACTIVITY

Measurements with an oxygen electrode demonstrated that the addition of Fermcozyme (20  $\mu$ l/ml) to phosphate-citrate buffer, pH 5.6 (20 mM  $\text{Na}_2\text{HPO}_4$ ) containing 50 mM EDTA and 0.5 mM GSH at 37°C resulted in a rapid consumption of  $\text{O}_2$ . No  $\text{O}_2$  disappearance was observed in the absence of GSH, and in the presence of excess catalase (EC 1.11.1.6) (50  $\mu$ g/ml; Boehringer) 0.25 mol of  $\text{O}_2$  was consumed per mol of GSH added. The consumption of  $\text{O}_2$  was associated with the disappearance of free thiol (estimated using 5'5-dithiobis-(2-nitrobenzoate)). All the added GSH was recoverable as GSSG as assayed by a modification of the glutathione reductase method of Srivastava & Beutler (1968).  $\text{H}_2\text{O}_2$  production was demonstrated by the peroxidase/gum guaiacum assay of O'Brien (1969). In the presence of peroxidase, Fermcozyme catalysed the oxidation of gum guaiacum by GSH. The maximum extinction of the resulting blue compound at 610 nm was 40% of that given by an equimolar amount of glucose. These findings are consistent with the suggestion that Fermcozyme catalyses the reaction:



The catalytic activity was unaffected by dialysis or the presence of EDTA, but was abolished by heating at 90°C for 10 min.

The apparent Michaelis-Menten parameters of Fermcozyme for GSH, estimated by the procedure of Wilkinson (1961) from the initial rates of  $\text{O}_2$  uptake (37°C) in the presence of excess catalase, phosphate-citrate buffer, pH 5.6 (20 mM  $\text{Na}_2\text{HPO}_4$ ), 50 mM EDTA and approximately

230  $\mu\text{M}$   $\text{O}_2$  are:  $K_m$   $0.97 \pm 0.04$  (10) mM;  $V_{\text{max}}$   $16.3 \pm 0.3$  (10)  $\mu\text{mol O}_2/\text{ml}$  of Fermcozyme per min. In these conditions the rate of uptake with 5 mM cysteine was less than 10% of that with an equimolar concentration of GSH. Glutamate and glycine (both 5 mM) gave no  $\text{O}_2$  uptake.

When Fermcozyme was saturated with glucose (110 mM) or GSH (5 mM) the ratio of the initial rate of oxygen uptake in the presence of glucose to that in the presence of GSH was 11. The corresponding ratio for a purer preparation of glucose oxidase from Aspergillus niger (Glucose oxidase 250, lot 6X; Hughes & Hughes Ltd.) was 440. These observations suggest that Fermcozyme contains an enzyme ("GSH oxidase") which specifically oxidises GSH and is not glucose oxidase.

The "GSH oxidase" and glucose oxidase activities of Fermcozyme were separated by DEAE ion-exchange chromatography. To a 50 ml column of Whatman microgranular DE 52 resin (W. & R. Balston Ltd., Maidstone, Kent, U.K.) equilibrated with 0.01 M sodium acetate buffer, pH 5.6, was added 15 ml of Fermcozyme which had been extensively dialysed against the same buffer. Eighty per cent of the applied "GSH oxidase" activity was eluted in one peak with 0.1 M sodium acetate buffer, pH 5.6. This "GSH oxidase" fraction did not contain any significant glucose oxidase activity. Glucose oxidase was eluted from the column with 1 M sodium acetate buffer, also pH 5.6.



PART 3. DISCUSSION

The experiments described in this Appendix demonstrate that Fermcozyme, a commercial preparation of glucose oxidase from Aspergillus niger, contains an additional enzyme which specifically catalyses the oxidation of GSH by O<sub>2</sub>. The evidence is consistent with the equation:

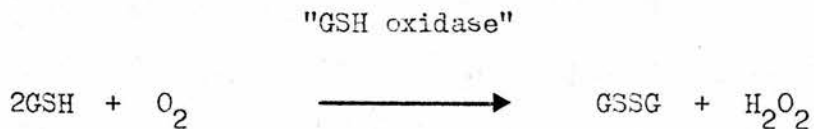

This enzymic activity does not seem to have been previously described in the literature (see for example Jocelyn, 1972). A more detailed investigation of "GSH oxidase" may therefore provide further insights into the biochemical roles of GSH.

Cysteine was found to be a poor substrate for the enzyme. This together with the development of a simple DEAE ion-exchange purification procedure which eliminates glucose oxidase activity raises the possibility of using "GSH oxidase" for the specific estimation of GSH.

One further implication of these findings is that the glucose oxidase/peroxidase assay cannot be regarded as specific for glucose unless a "GSH oxidase"-free glucose oxidase preparation is used.

- Beutler, E. (1965) *Seminars Haematol.* 2, 91-138.
- Beutler, E. (1969) *Pharmacol. Rev.* 21, 73-103.
- Beutler, E. (1970) *Blood* 36, 523-525.
- Beutler, E. (1971) Red Cell Metabolism (A Manual of Biochemical Methods).  
Grune & Stratton, New York and London.
- Beutler, E. (1972a) *Advan. Metab. Disord.* 6, 131-160.
- Beutler, E. (1972b) *Biochimie* 54, 759-764.
- Beutler, E. & Yeh, M.K.Y. (1963) *Blood* 21, 573-585.
- Beutler, E., Duron, O. & Kelly, B.M. (1963) *J. Lab. Clin. Med.* 61,  
882-888.
- Beutler, E., Srivastava, S.K. & West, C. (1970) *Biochem. Biophys. Res.*  
*Commun.* 38, 341-347.
- Bishop, C., Rankine, D.M. & Talbott, J.H. (1959) *J. Biol. Chem.* 234,  
1233-1237.
- Board, P.G., Roberts, J. & Evans, J.V. (1974) *J. Agric. Sci., Camb.* 82,  
395-398.
- Boivin, P. & Galand, C. (1965) *Nouv. Rev. Franc. Haemat.* 5, 707-720.
- Bray, G.A. (1960) *Anal. Biochem.* 1, 279-285.
- Burka, E.R., Weaver, Z., Marks, P.A. (1966) *Ann. Intern. Med.* 64, 817-825.
- Carson, P.E. (1960) *Fed. Proc.* 19, 995-1006.
- Chance, E.M. & Curtis, A.R. (1970) *FEBS LETT.* 7, 47-50.

- Christensen, H.N. (1969) *Advan. Enzymol.* 32, 1-20.
- Christensen, H.N. (1975) in Current Topics in Membranes and Transport (Eds. Bronner, F. & Kleinzellar, A.), Academic Press, New York. pp.227-258.
- Cleland, W.W. (1964) *Biochemistry* 3, 480-482.
- Cohen, G. & Hochstein, P. (1963) *Biochemistry* 2, 1420-1428.
- Cohen, G. & Hochstein, P. (1964) *Biochemistry* 3, 895-900.
- Curtis, A.R. & Chance, E.M. (1974) CHEK and CHEKMAT: two chemical reaction kinetics programs. Computer Science & Systems Div. AERE Harwell (AERE - R7345).
- Davis, R.H. & Ottaway, J.H. (1972) *Math. Biosci.* 13, 265-282.
- Dern, R.J., Weinstein, I.M. Le Roy, G.V., Talmage, D.W. & Alving, A.S. (1954) *J. Lab. Clin. Med.* 43, 303-309.
- Dick, D.A.T., Dick, E.G. & Tosteson, D.C. (1969) *J. Gen. Physiol.* 54, 123-133.
- Diem, K. & Lentner, C. (Eds.) (1970) Scientific Tables (7th Edition), Geigy, Basle, pp.174-177.
- Dimant, E., Landsberg, E. & London, I.M. (1955) *J. Biol. Chem.* 213, 769-776.
- Drury, A.N. & Tucker, E.M. (1963) *Res. Vet. Sci.* 4, 568-579.
- Elder, H.A. & Mortensen, R.A. (1956) *J. Biol. Chem.* 218, 261-268.
- Eldjarn, L., Bremer, J. & Borrensen, H.C. (1962) *Biochem. J.* 82, 192-197.

- Ellory, J.C., Tucker, E.M. & Deverson, E.V. (1972) *Biochim. Biophys. Acta.* 279, 481-483.
- Emerson, C.P., Ham, T.H. & Castle, W.B. (1941) *J. Clin. Invest.* 20, 451.
- Fales, W.F., Russel, A.J. & Fain, J.N. (1961) *Clin. Chem.* 7, 389-403.
- Fisher, R.A. (1948) Statistical Methods for Research Workers (10th Edition), Oliver & Boyd, Edinburgh.
- Gardner, J.D. & Levy, A.G. (1972) *Metabolism* 21, 413-431.
- Gilbert, J.C. (1963) Ph.D. Thesis, Edinburgh University.
- Greenberg, M.S. & Wong, H. (1961) *J. Lab. Clin. Med.* 57, 733-746.
- Goswitz, F., Lee, G.R., Cartwright, G.E. & Wintrobe, M.M. (1966) *J. Lab. Clin. Med.* 67, 615-623.
- Gross, R.T., Schroeder, E.A.R. & Brounstein, S.A. (1963) *Blood* 21, 755-763.
- Hall, J.G. & Hunter, E.A. (1973) *Heridity* 31, 325-337.
- Harley, J.D. & Mauer, A.M. (1961) *Blood* 17, 418-433.
- Harris, J.W. & Biaglow, J.E. (1972) *Biochem. Biophys. Res. Commun.* 46, 1743-1749.
- Hilpert, P., Fleishmann, R.G., Kempe, D. & Bartels, H. (1963) *Am. J. Physiol.* 205, 337-340.
- Hjelm, M. & Verdier, C.H. (1963) *Scand. J. Clin. Lab. Invest.* 15, 415-428.
- Hoare, D.G. (1972a) *J. Physiol. (Lond.)* 221, 311-329.

- Hoare, D.G. (1972b) *J. Physiol. (Lond.)* 221, 331-348.
- Hochberg, A., Rigbi, M. & Dimant, E. (1964) *Biochim. Biophys. Acta* 90, 464-471.
- Hochstein, P. (1966) 3rd International Conference on Hyperbaric Medicine, Nat. Acad. Sci. p.61.
- Hochstein, P. (1971) *Exp. Eye Res.* 11, 389-395.
- Hopkins, J. & Tudhope, G.R. (1973) *Scottish Med. J.* 18, 177-181.
- Icen, A. (1967) *Scand. J. Clin. Lab. Invest.* 20: Suppl. 96, 1-67.
- Iqbal, K. & Ottaway, J.H. (1970) *Biochem. J.* 119, 145-156.
- Jackson, R.C. (1969) *Biochem. J.* 111, 309-315.
- Jacob, H.S. & Jandl, J.H. (1962a) *J. Clin. Invest.* 41, 779-792.
- Jacob, H.S. & Jandl, J.H. (1962b) *J. Clin. Invest.* 41, 1514-1523.
- Jacob, H.S. & Jandl, J.H. (1966) *J. Biol. Chem.* 241, 4243-4250.
- Jacob, H.S., Ingbar, S.H. & Jandl, J.H. (1965) *J. Clin. Invest.* 44, 1187-1199.
- Jandl, J.H. (1963) *Ann. Intern. Med.* 58, 702-709.
- Jandl, J.H., Eagle, L.K. & Allen, D.W. (1960) *J. Clin. Invest.* 39, 1818-1836.
- Jocelyn, P.C. (1972) Biochemistry of the SH Group: the Occurance, Chemical Properties, Metabolism and Biological Function of Thiols and Disulphides. Academic Press, London and New York.
- Kalla, S.D., Ghosh, P.K. & Taneja, G.C. (1972) *Anim. Blood. GPS. Biochem. Genet.* 3, 121-123.

- Kampen, E.J. van & Zijlstra, W.G. (1961) *Clin. Chim. Acta* 6, 538-544.
- Konrad, P.N., Richards, F., Valentine, W.N. & Paglia, D.E. (1972) *New. Eng. J. Med.* 286, 557-561.
- Kosower, N.S. & Kosower, E.M. (1967) *Nature (Lond.)* 215, 285-286.
- Kosower, N.S., Kowower, E.M., Wertheim, B. & Correa, W.S. (1969) *Biochem. Biophys. Res. Comm.* 37, 593-596.
- Lemberg, R. (1942) *Aust. J. Exp. Biol. Med. Sci.* 20, 111-115.
- Levy, H.L. & Barkin, E. (1971) *J. Lab. Clin. Med.* 78, 517-523.
- Lorber, A., Chang, C., Masvoka, D. & Meacham, I. (1970) *Biochem. Pharm.* 19, 1551-1560.
- MacDougal, L.G. (1968) *J. Pediat.* 72, 303-318.
- Majerus, P.W., Brauner, M.J., Smith, M.B. & Minnich, V. (1971) *J. Clin. Invest.* 50, 1637-1643.
- Maronpot, R.R. (1972) *Can. J. Comp. Med.* 36, 55-60.
- Meister, A. (1962) in *The Enzymes* 2nd edn. (Eds. Boyer, P.D., Lardy, H. & Myrback, N.), Vol. 6. London: Academic Press. pp.443-468.
- Meister, A. (1973) *Science* 180, 33-39.
- Miller, A. & Horiuchi, M. (1962) *J. Lab. Clin. Med.* 60, 756-764.
- Mills, G.C. (1957) *J. Biol. Chem.* 229, 189-197.
- Minnich, V., Smith, M.B., Brauner, M.J. & Majerus, P.W. (1971) *J. Clin. Invest.* 50, 507-513.
- Morley, G., Dawson, A. & Marks, V. (1968) *Proc. Assoc. Clin. Biochem.* 5, 42-45.

- Mortensen, R.A., Haley, M.I. & Elder, H.A. (1956) *J. Biol. Chem.* 218, 269-273.
- Necheles, T.F., Steinberg, M.H. & Cameron, D. (1970) *Br. J. Haemat.* 19, 605-612.
- Nimmo, I.A. (1970) Ph.D. Thesis, Edinburgh University.
- Nitowsky, H.M., Cornblath, M. & Gordon, H.H. (1956) *Am. J. Dis. Child.* 92, 164.
- O'Brien, J.A. (1969) Ph.D. Thesis, Edinburgh University.
- Oort, M., Loos, J.A. & Prins, H.K. (1961) *Vox. Sang.* 6, 370-373.
- Ozsoylu, S. (1970) *Acta Haematol.* 44, 233-239.
- Palekar, A.G., Tate, S.S. & Meister, A. (1974) *Proc. Nat. Acad. Sci, U.S.A.* 71, 293-297.
- Paniker, N.V. & Beutler, E. (1972) *J. Lab. Clin. Med.* 80, 481-487.
- Patterson, J.W. & Lazarow, A. (1954) in *Glutathione* (Eds. Colowick, S. et al.) Academic Press, New York, pp.63-78.
- Patterson, J.W. & Lazarow, A. (1955) *Methods Biochem. Anal.* 2, 259-278.
- Pihl, A., Eldjarn, L. & Bremer, J. (1957) *J. Biol. Chem.* 227, 339-345.
- Prins, H.K., Oort, M., Loos, J.A., Zurcher, C. & Beckers, T. (1966) *Blood* 27, 145-166.
- Plowman, K.M. (1972) *Enzyme Kinetics* New York: McGraw-Hill.
- Rapoport, S. (1961) *Folia Haematol.* 78, 364-381.
- Rathbun, W.B. (1967) *Archs. Biochem. Biophys.* 122, 73-84.

- Rieber, E.E., Kosower, N.S. & Jaffe, E.R. (1968) *J. Clin. Invest.* 47, 66-71.
- Rifkind, R.A. (1965) *Blood* 26, 433-448.
- Roberts, J. & Agar, N.S. (1971) *Clin. Chim. Acta.* 34, 475-480.
- Rosenberg, L.E., Downing, S., Durant, J.L. & Segal, S. (1966) *J. Clin. Invest.* 45, 365-371.
- Rost, N. & Rapoport, S. (1964) *Nature* 201, 185.
- Rouser, G., Jelinek, B. & Samuels, A.J. (1956) *Fed. Proc.* 15, 342.
- Russell, W.S. (1973) No. 19.250.118 of the Scientific and Social Sciences Programme Library, University of Edinburgh.
- Sabine, J.C. (1964) *Br. J. Haematol.* 10, 477-484.
- Salvidio, E., Pannacciulli, I., Tizianello, A. & Ajmar, F. (1967) *New Eng. J. Med.* 276, 1339-1344.
- Sass, M.D. (1963) *Nature (Lond.)* 200, 1209-1210.
- Sass, M.D. (1968) *Clin. Chim. Acta.* 22, 207-210.
- Scriver, C.R. (1969) *Br. Med. Bull.* 25, 35-41.
- Skeggs, L.T. (1957) *Am. J. Clin. Path.* 28, 311-322.
- Smith, J.E. (1968) *J. Lab. Clin. Med.* 71, 826-833.
- Smith, J.E. (1973) *Am. J. Vet. Res.* 34, 847-848.
- Smith, J.E. (1974) *J. Lab. Clin. Med.* 83, 444-450.
- Smith, J.E. & Anwer, M.S. (1971) *Experientia* 27, 835-836.



- Smith, J.E. & Osburn, B.I. (1967) *Science* 158, 374-375.
- Smith, J.E., Lee, M.S. & Mia, A.S. (1973) *J. Lab. Clin. Med.* 82, 713-718.
- Snoke, J.E. & Bloch, K. (1955) *J. Biol. Chem.* 213, 825-835.
- Srivastava, S.K. (1971) *Exp. Eye Res.* 11, 294-305.
- Srivastava, S.K. & Beutler, E. (1967) *Biochem. Biophys. Res. Commun.* 28, 659-664.
- Srivastava, S.K. & Beutler, E. (1968a) *Anal. Biochem.* 25, 70-76.
- Srivastava, S.K. & Beutler, E. (1968b) in Metabolism and Membrane Permeability of Erythrocytes and Thrombocytes. 1st International Symposium, Vienna, June, 1968. pp.17-20.
- Srivastava, S.K. & Beutler, E. (1968c) *Lancet* 2, 23-24.
- Srivastava, S.K. & Beutler, E. (1969a) *J. Biol. Chem.* 244, 9-16.
- Srivastava, S.K. & Beutler, E. (1969b) *Biochem. J.* 114, 833-837.
- Srivastava, S.K. & Beutler, E. (1970) *Biochem. J.* 119, 353-357.
- Srivastava, S.K. & Beutler, E. (1972) *Exp. Eye Res.* 17, 33-42.
- Strumeyer, D.H. (1959) Ph.D. Thesis, Harvard Univeristy.
- Tarlov, A.R. Brewer, G.J., Carson, P.E. & Alving, A.S. (1962) *Arch. Intern. Med.* 109, 209-234.
- Tucker, E.M. (1971) *Biol. Rev.* 46, 341-386.
- Tucker, E.M. (1974) *Res. Vet. Sci.* 16, 19-22.
- Tucker, E.M. (1975) *Res. Vet. Sci.* in press.
- Tucker, E.M. & Ellory, J.C. (1971) *Res. Vet. Sci.* 12, 600-602.

- Tucker, E.M. & Kilgour, L. (1970) *Experientia* 26, 203-204.
- Tucker, E.M. & Kilgour, L. (1972) *J. Agric. Sci., Camb.* 79, 515-516.
- Tucker, E.M. & Kilgour, L. (1973) *Res. Vet. Sci.* 14, 306-311.
- Tucker, E.M., Ellory, J.C. & Kilgour, L. (1973) *Comp. Biochem. Physiol.* 46A, 103-107.
- Weed, R.I. & Reed, C.F. (1966) *Am. J. Med.* 41, 681-698.
- Wendel, A. & Flohe, L. (1972) *Hoppe-Seyler's Physiol. Chem.* 353, 523-530.
- Wilkinson, G.N. (1961) *Biochem. J.* 80, 324-332.
- Winter, C.G. & Christensen, H.N. (1964) *J. Biol. Chem.* 239, 872-878.
- Winter, C.G. & Christensen, H.N. (1965) *J. Biol. Chem.* 240, 3594-3600.
- Young, J.D. & Nimmo, I.A. (1972) *Biochem. J.* 130, 33p.
- Young, J.D., Nimmo, I.A. & Hall, J.G. (1974) *Biochem. Soc. Trans.* 2, 314-317.
- Young, J.D., Ellory, J.C. & Tucker, E.M. (1975) *Nature (Lond.)* 254, 156-157.
- Yunis, A.A. & Arimura, G.K. (1965) *J. Lab. Clin. Med.* 66, 177-186.

[Reprinted from the Proceedings of the Biochemical Society, 4-5 July 1972.  
Biochem. J., 1972, Vol. 130, No.1, 33p.]

### The Oxidation of Glutathione by a Preparation of Glucose Oxidase from *Aspergillus niger*

By JAMES D. YOUNG and IAN A. NIMMO (*Department of Biochemistry, University of Edinburgh Medical School, Teviot Place, Edinburgh EH8 9AG, U.K.*)

A commercial preparation of glucose oxidase from *Aspergillus niger* (Fermcozyme 653 AM, lot no. 1917; Hughes and Hughes Ltd., Romford, Essex, U.K.) catalyses the reaction:

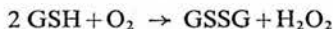

The catalytic activity is unaffected by dialysis or the presence of 50 mM-EDTA, but is abolished by heating at 90°C for 10 min.

Measurements with an oxygen electrode show that in phosphate-citrate buffer, pH 5.6 (20 mM- $\text{Na}_2\text{HPO}_4$ ), containing 1.6% (v/v) of Fermcozyme, 50 mM-EDTA and 0.005% (w/v) of catalase, 0.25 mol of  $\text{O}_2$  is consumed/mol of GSH added. The concomitant disappearance of free thiol can be demonstrated by using 5,5'-dithiobis-(2-nitrobenzoate) (Roberts & Agar, 1971). All the added GSH is recoverable as GSSG, as assayed by a modification of the method of Srivastava & Beutler (1968). The evidence for  $\text{H}_2\text{O}_2$  as another reaction product is that in the presence of Fermcozyme and peroxidase GSH oxidizes gum guaiacum to a blue compound, the maximum extinction at 610 nm being 40% of that

given by an equimolar amount of glucose. These findings are consistent with the equation given above.

The apparent Michaelis-Menten parameters of Fermcozyme for GSH, estimated by the procedure of Wilkinson (1961) from initial rates of  $\text{O}_2$  uptake in the presence of excess of catalase and 50 mM-EDTA at pH 5.6, 37°C and about 230  $\mu\text{M-O}_2$ , are:  $K_m = 0.97 \pm 0.04$  (10) mM;  $V = 16.3 \pm 0.3$  (10)  $\mu\text{mol of O}_2/\text{min per ml of Fermcozyme}$ . In these conditions, the rate of  $\text{O}_2$  uptake with 5 mM-cysteine is less than 10% of that with an equimolar concentration of GSH.

When Fermcozyme is saturated with glucose (110 mM) or GSH (5 mM), the ratio  $v$  (glucose)/ $v$  (GSH) is 11. The corresponding ratio for a purer preparation of glucose oxidase from *Aspergillus niger* (Glucose Oxidase 250, lot no. 6X; Hughes and Hughes Ltd.) is 440. Therefore Fermcozyme may contain an enzyme that oxidizes GSH and is not glucose oxidase.

One implication of our finding that may be of practical importance is that, when glucose in the diffusate from a typical haemolysate is measured by using Fermcozyme-peroxidase-gum guaiacum, the GSH also present raises the estimate by about 5%.

- Roberts, J. & Agar, N. S. (1971) *Clin. Chim. Acta* **34**, 475-480  
Srivastava, S. K. & Beutler, E. (1968) *Anal. Biochem.* **25**, 70-76  
Wilkinson, G. N. (1961) *Biochem. J.* **80**, 324-332

Table 1. *Metabolism of testosterone by adenocarcinoma*

Results are given as means  $\pm$  s.e.m. for ten tumours, except for \* mean for eight tumours and † mean for six tumours. % 5 $\alpha$ -reduction is calculated as combined production of 5 $\alpha$ -dihydrotestosterone and 5 $\alpha$ -androstandiol.

	% testosterone metabolized	% 5 $\alpha$ -dihydrotestosterone produced	% 5 $\alpha$ -androstandiol produced	% 5 $\alpha$ -reduction	% $\Delta$ -4-androstenedione produced
Dimethylbenzanthracene alone	34.06 $\pm$ 3.81	10.54 $\pm$ 2.42	4.00 $\pm$ 1.17	14.55 $\pm$ 2.91	0.42 $\pm$ 0.10*
Dimethylbenzanthracene + perphenazine	48.58 $\pm$ 4.33	15.58 $\pm$ 2.27	15.32 $\pm$ 2.43	31.90 $\pm$ 3.97	1.84 $\pm$ 0.37†
Significance	$P = 0.01$	$P = 0.10$	$P < 0.0005$	$P < 0.0025$	$P = 0.05$

By combining the production of  $5\alpha$ -dihydrotestosterone and  $5\alpha$ -androstandiol and expressing the result as %  $5\alpha$ -reduction, an estimate of total  $5\alpha$ -reductase activity was obtained. This was significantly higher in the perphenazine-treated group as compared with the control group.

The conversion of testosterone into  $\Delta$ -4-androstenedione was also investigated. Although the mean amount of oxidation into  $\Delta$ -4-androstenedione was significantly higher in the perphenazine group, this was accounted for by two tumours, in which the amount of oxidation was markedly raised. These two tumours had the lowest  $5\alpha$ -reductase activity of the perphenazine group.

It is possible that the increased  $5\alpha$ -reductase activity demonstrated in tumours from perphenazine-treated animals is caused by differences in tumour cellularity. The findings of similar metabolism of another C-19 steroid precursor, dehydroepiandrosterone, and the similar conversion of testosterone into  $\Delta$ -4-androstenedione in both groups of tumours would, however, indicate that the effects on  $5\alpha$ -reduction of testosterone are relatively specific. Further evidence for this has come from preliminary studies in which ovine prolactin (50  $\mu$ g/ml) has been added to incubation mixtures of dimethylbenzanthracene adenocarcinomas *in vitro* with similar effects on testosterone metabolism.

Prolactin has been shown to influence the metabolism of testosterone in other steroid-metabolizing organs. For example, Boyns *et al.* (1972) have demonstrated that prolactin not only increased uptake of testosterone in rat prostatic cultures but changed the ratio of  $5\alpha$ -dihydrotestosterone to testosterone in favour of the non-reduced form. This effect upon  $5\alpha$ -reduction in the prostate is opposite to that demonstrated in the present study of rat mammary tissue.

Boyns, A. R., Cole, E. N., Golder, M. P., Danutra, V., Harper, M. E., Brownsey, B., Cowley, T., Jones, G. E. & Griffiths, K. (1972) in *Prolactin and Carcinogenesis* (Boyns, A. R. & Griffiths, K., eds.), pp. 207–216, Alpha, Omega, Alpha Publishing Co., Cardiff

Fahmy, D., Griffiths, K., Turnbull, A. C. & Symington, T. (1968) *J. Endocrinol.* **41**, 61–68

Jones, D., Cameron, E. H. D., Griffiths, K., Gleave, E. N. & Forrest, A. P. M. (1970) *Biochem. J.* **116**, 919–921

King, R. J. B., Gordon, J. & Heffenstein, J. E. (1964) *J. Endocrinol.* **29**, 103–110

King, R. J. B., Panattoni, M., Gordon, J. & Baker, R. (1965) *J. Endocrinol.* **33**, 127–132

---

## Glutathione Metabolism in Sheep Erythrocytes with High and Low Concentrations of Reduced Glutathione

JAMES D. YOUNG and IAN A. NIMMO

*Department of Biochemistry, University of Edinburgh Medical School, Teviot Place, Edinburgh EH8 9AG, U.K.*

and JOHN G. HALL

*Agricultural Research Council Animal Breeding Research Organisation, The King's Buildings, West Mains Road, Edinburgh EH9 3JQ, U.K.*

Sheep with low levels of erythrocyte GSH were first found by Smith & Osburn (1967) and later by Tucker & Kilgour (1970). Animals with less than 55 mg of GSH/100 ml of cells (1.79 mmol/litre of cells) have been termed low GSH and the rest high GSH. Tucker & Kilgour (1970) suggested that in Finnish Landrace sheep (Fins), GSH concentration is controlled by a single pair of autosomal alleles, the gene for high concentrations of GSH being dominant to that for low GSH. These animals do not appear to be affected by their low concentrations of erythrocyte GSH although they may be more susceptible to kale anaemia (Tucker & Kilgour, 1970). In contrast, in man, haemolytic disorders are generally associated with low concentrations of erythrocyte GSH (Beutler, 1972).

Sheep are usually allotted their GSH class on the basis of their content of erythrocyte total non-protein reduced thiol as determined by the non-specific thiol reagent 5,5'-dithiobis-(2-nitrobenzoate) (Smith & Osburn, 1967; Tucker & Kilgour, 1970; Agar *et al.*, 1972). This raises two questions: firstly, the accuracy with which total thiol is a measure of GSH; and secondly, whether a low concentration of GSH is paralleled by a low concentration of GSSG. We attempt to answer these questions and also describe observations on GSH metabolism in erythrocytes with high and low GSH from two breeds, Finns and Tasmanian Merinos, which are relevant to the biochemical mechanisms responsible for the GSH polymorphism seen in these animals.

Whole blood was drawn from selected sheep into heparinized Vacutainers, immediately chilled, deproteinized with metaphosphoric acid and assayed for GSH by the 5,5'-dithiobis-(2-nitrobenzoate) method (Beutler *et al.*, 1963) and also by the GSH-specific Alloxan '305' method (Patterson & Lazarow, 1955). Fig. 1 compares the estimates of GSH concentration given by these two methods for 16 animals representing both breeds and classes. It can be seen that for either breed, the high and low values of GSH lie on the same straight line (correlation coefficient = 0.999 in both instances). Therefore the difference in 5,5'-dithiobis-(2-nitrobenzoate) reactivity between the two cell types is in fact due to different concentrations of GSH. Further, both classes of cell have the same concentration of non-GSH thiol, estimated from the intercept on the abscissa as 0.11 and 0.29 mmol/litre of cells for Merinos and Finns respectively.

Blood samples from the same 16 animals were assayed for erythrocyte GSSG

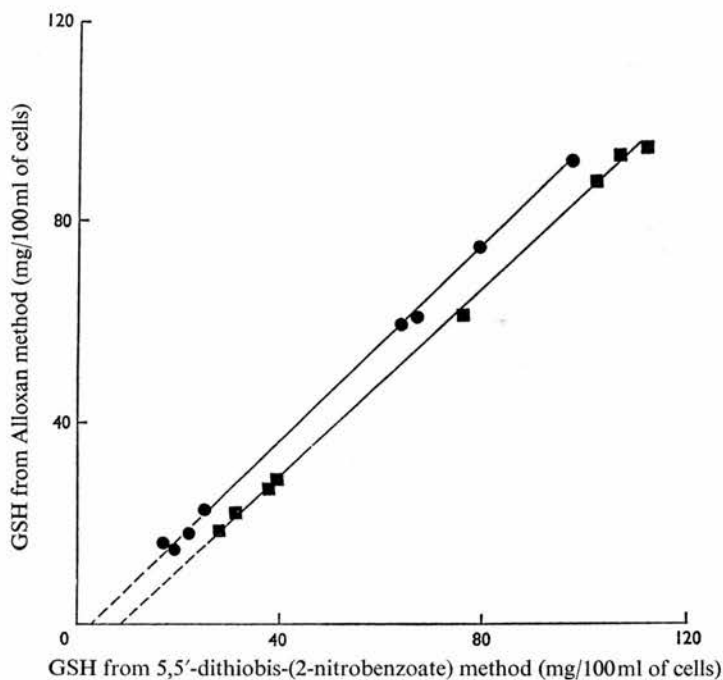

Fig. 1. A comparison of the estimates of GSH concentration in erythrocytes with high and low GSH from Finn and Merino sheep by the 5,5'-dithiobis-(2-nitrobenzoate) and Alloxan '305' methods

The lines represent linear regressions of GSH from the Alloxan method on that from the 5,5'-dithiobis-(2-nitrobenzoate) method. Finns, ■; Merinos, ●.

Table 1. *Activities of the enzymes of GSH biosynthesis in erythrocytes with high and low GSH from Finn and Merino sheep*

Values are (mean  $\pm$  s.e.m. with no. of animals in parentheses)  $\mu$ mol of product formed/min per g of haemoglobin as assayed by the method of Paniker & Beutler (1972).

		$\gamma$ -Glutamyl cysteine synthetase	GSH synthetase
Finn	{ High GSH	0.595 $\pm$ 0.063	0.073 $\pm$ 0.002 (12)
	{ Low GSH	0.555 $\pm$ 0.033	0.070 $\pm$ 0.002 (10)
Merino	{ High GSH	0.776 $\pm$ 0.065	0.069 $\pm$ 0.003 (11)
	{ Low GSH	0.375 $\pm$ 0.063	0.066 $\pm$ 0.002 (13)

(Srivastava & Beutler, 1968). GSSG concentrations were 7.23  $\pm$  0.95 and 2.15  $\pm$  0.92  $\mu$ mol/litre of cells for Finns with high and low GSH respectively and 11.38  $\pm$  1.08 and 2.86  $\pm$  1.19  $\mu$ mol/litre of cells for Merinos with high and low GSH respectively [mean  $\pm$  s.e.m. (4)]. Thus for both breeds animals with low GSH have a lower concentration of GSSG and therefore of total glutathione. Their value of the ratio [GSSG]/[GSH]<sup>2</sup>, which influences the redox potential of the glutathione couple, is about four times that of the animals with high GSH.

One possible explanation for the low values of total glutathione found in animals with low GSH is a diminished ability to synthesize GSH. Consequently the capacity of erythrocytes from Finn and Merino sheep to synthesize GSH was examined. Synthesis of erythrocyte GSH is known to occur in two enzymic steps (Minnich *et al.*, 1971):

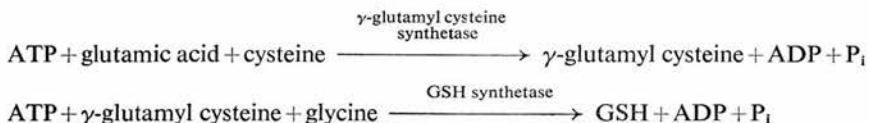

The first reaction is catalysed by  $\gamma$ -glutamyl cysteine synthetase (EC 6.3.2.2) and the second by GSH synthetase (EC 6.3.2.3).

Sheep erythrocyte  $\gamma$ -glutamyl cysteine synthetase and GSH synthetase were measured in haemolysates by the method of Paniker & Beutler (1972). In Merinos, low values of erythrocyte GSH were associated with a markedly diminished capacity to synthesize  $\gamma$ -glutamyl cysteine, the mean activity of animals with low GSH being only 48% that of ones with high GSH (Table 1). In marked contrast, erythrocytes with low and high GSH from Finn sheep had the same  $\gamma$ -glutamyl cysteine synthetase activity. For both breeds, there were no class differences in GSH synthetase activity. The association between erythrocytes with low GSH and a diminished activity of  $\gamma$ -glutamyl cysteine synthetase suggests that this diminished enzymic capacity is responsible for the GSH polymorphism seen in Merinos. In this connexion it is noteworthy that a decreased ability to synthesize GSH has also been implicated in a number of instances of erythrocytes with low GSH in man. Decreased activities of both  $\gamma$ -glutamyl cysteine synthetase and GSH synthetase have been described (Beutler, 1972).

Although a decreased capacity to synthesize  $\gamma$ -glutamyl cysteine may be responsible for the low amounts of erythrocyte GSH found in Merinos, the low GSH concentrations in Finns cannot be explained in this way. That the biochemical mechanisms responsible for GSH polymorphism may differ between Finns and Merinos is further supported by the observation that Finns erythrocytes with low GSH have high intracellular concentrations of certain amino acids, particularly ornithine and lysine, a phenomenon which is not observed in Merinos (Ellory *et al.*, 1972). The precise nature of the association between low concentrations of erythrocyte GSH and high concentrations of intracellular amino acids remains to be elucidated.

J. D. Y. thanks Edinburgh University Faculty of Medicine for a Graduate Research Scholarship.

- Agar, N. S., Roberts, J. & Evans, J. V. (1972) *Aust. J. Biol. Sci.* **25**, 619–626  
 Beutler, E. (1972) *Advan. Metab. Disord.* **6**, 131–160  
 Beutler, E., Duron, O. & Kelly, B. M. (1963) *J. Lab. Clin. Med.* **61**, 882–888  
 Ellory, J. C., Tucker, E. M. & Deverson, E. V. (1972) *Biochim. Biophys. Acta* **279**, 481–483  
 Minnich, V., Smith, M. B., Brauner, M. J. & Majerus, P. W. (1971) *J. Clin. Invest.* **50**, 507–513  
 Paniker, N. V. & Beutler, E. (1972) *J. Lab. Clin. Med.* **80**, 481–487  
 Patterson, J. W. & Lazarow, A. (1955) *Methods Biochem. Anal.* **2**, 259–278  
 Smith, J. E. & Osburn, B. I. (1967) *Science* **158**, 374–375  
 Srivastava, S. K. & Beutler, E. (1968) *Anal. Biochem.* **25**, 70–76  
 Tucker, E. M. & Kilgour, L. (1970) *Experientia* **26**, 203–204

### Increased Hepatotoxicity of Paracetamol in Rats Fed on Low-Protein Diets or Phenobarbital, and Protection by Selenate

ANDRE E. M. McLEAN and PAULINE DAY

*Department of Experimental Pathology, University College Hospital Medical School, University Street, London WC1E 6JJ, U.K.*

Paracetamol, like carbon tetrachloride and many other toxins, seems to require activation in the mixed-function oxidase system centred on cytochrome *P*-450 before it can exert its toxic effects (Mitchell *et al.*, 1973; McLean & McLean, 1966, 1969; Garner & McLean, 1969).

Mitchell *et al.* (1973) have suggested that the toxic metabolite reacts first with glutathione, and only when glutathione has been exhausted are other nucleophilic groups attacked with resulting cell damage.

We find that paracetamol has an unusual dose-response relation. As the dose is increased, there is not a gradual increase in the amount of liver injury, but rather there is an increase in the proportion of animals that show massive necrosis of the liver. Sometimes small patches of injury or single damaged lobes are seen, but the response is much more of an 'all-or-none' situation than is found with hepatotoxins like carbon tetrachloride, dimethylnitrosamine or pyrrolizidine alkaloids, where amount of injury is closely related to dose.

This 'all-or-none' situation has some resemblance to dietary liver necrosis (Schwarz, 1962; McLean, 1960), which is a combined selenium and  $\alpha$ -tocopherol deficiency.

Table 1. *Effect of diet and phenobarbital on the lethal effects of paracetamol*

Paracetamol was given by gastric intubation as a 20% suspension. LD<sub>50</sub> was determined by the method of Weil (1952) on five to eight groups containing four rats each. The 95% confidence limits are between 10 and 20% either side of the LD<sub>50</sub> value. Low-protein (3% Casein) diets were made as described by McLean & McLean (1966). Phenobarbital was given for 1 week in the drinking water as a 1 mg/ml solution (Marshall & McLean, 1971).

Diet	Treatment	LD <sub>50</sub> (g/kg)
Stock pellets	—	5.2
Stock pellets	Starvation, 18h	2.8
Stock pellets	Phenobarbital	2.0
Low-protein, 7 days	—	2.1
Low-protein, 7 days	Phenobarbital	0.9



Table 2. *Effect of phenobarbital and selenate on liver injury after oral administration of paracetamol (1g/kg)*

Rats were given paracetamol (1g/kg) orally as a 20% suspension. Sodium selenate (10 $\mu$ mol/kg) was given intraperitoneally at the same time ( $\alpha$ -tocopherol acetate, 40mg, was given orally 24h before paracetamol). Rats were killed 24h later and liver injury assessed as previously described (McLean & McLean, 1966). Deaths are the proportion of dosed rats dead at 24h. Necrosis means visible necrosis in any part of the liver as assessed by eye and checked by histological examination. In normal control rats plasma isocitrate dehydrogenase was less than 5 nmol/min per ml of plasma and liver water was 2.61  $\pm$  0.1 g/g of fat-free dry weight.

Treatment	Deaths	Proportion of surviving rats showing signs of liver injury		
		Necrosis	Isocitrate dehydrogenase > 15 nmol/min per ml	Liver water > 3g/g
Stock rats	0/10	3/10	2/10	3/10
+Phenobarbital	5/23	16/18	15/18	12/18
+Phenobarbital +selenate	0/13	3/13	2/13	2/13
+Phenobarbital + $\alpha$ -tocopherol	0/4	4/4	4/4	3/4

Table 1 shows that starvation, low-protein diets and phenobarbital all increase the lethal effects of paracetamol, perhaps because phenobarbital increases the rate of metabolism to a rate faster than the detoxication pathway can manage, and because in protein deficiency the fall in glutathione levels makes the detoxication pathway unavailable (Leaf & Neuberger, 1947). Starvation could be effective because an increased rate of absorption leads to higher plasma amounts (Nimmo *et al.*, 1973).

Table 2 shows that in the phenobarbital-treated animal, selenate (10 $\mu$ mol/kg) gives a very considerable protection against paracetamol liver injury, but  $\alpha$ -tocopherol does not.

The sole known biochemical role of selenium is as part of the enzyme glutathione peroxidase (Rotruck *et al.*, 1973). It is possible that where rapid metabolism of paracetamol is taking place, a detoxication pathway involving glutathione peroxidase becomes rate-limiting. Giving selenium can then increase the rate at which the detoxication pathway can trap the toxic metabolites. In the absence of glutathione, such a pathway would not be effective. As predicted animals fed on low-protein diets are not protected by selenium. Another possibility is that the selenate blocks metabolism of paracetamol, since this dose of selenate causes a fall in the amount of cytochrome P-450 in the liver of phenobarbital-treated rats.

Garner, R. C. & McLean, A. E. M. (1969) *Biochem. Pharmacol.* **18**, 153-157

Leaf, G. & Neuberger, A. (1947) *Biochem. J.* **41**, 280-287

Marshall, W. G. & McLean, A. E. M. (1971) *Biochem. J.* **122**, 569-573

McLean, A. E. M. (1960) *Nature (London)* **185**, 936-937

McLean, A. E. M. & McLean, E. K. (1966) *Biochem. J.* **100**, 564-571

McLean, A. E. M. & McLean, E. K. (1969) *Brit. Med. Bull.* **25**, 278-281

Mitchell, J. R., Jollow, D. J., Gillette, J. R. & Brodie, B. B. (1973) *Drug. Metab. Disposition*, **1**, 418-423

Nimmo, J., Heading, R. C., Tothill, P. & Prescott, L. F. (1973) *Brit. Med. J.* **i**, 587-589

Rotruck, J. T., Pope, A. L., Granther, H. E., Swanson, A. B., Hafeman, D. G. & Hoekstra, W. G. (1973) *Science*, **179**, 588-590

Schwarz, K. (1962) *Vitam. Horm. (New York)* **20**, 463-484

Weil, C. S. (1952) *Biometrics* **8**, 249-263

Reprinted from

*Biochimica et Biophysica Acta*, 404 (1975) 124–131

© Elsevier Scientific Publishing Company, Amsterdam — Printed in The Netherlands

BBA 27727

## THE RELATIONSHIP BETWEEN GSH, GSSG AND NON-GSH THIOL IN GSH-DEFICIENT ERYTHROCYTES FROM FINNISH LANDRACE AND TASMANIAN MERINO SHEEP

J.D. YOUNG<sup>a\*</sup>, I.A. NIMMO<sup>a</sup> and J.G. HALL<sup>b</sup>

<sup>a</sup> *Department of Biochemistry, University of Edinburgh Medical School, Teviot Place, Edinburgh, EH8 9AG (U.K.)* and <sup>b</sup> *Agricultural Research Council Animal Breeding Research Organisation, The King's Buildings, West Mains Road, Edinburgh, EH9 3JQ (U.K.)*

(Received February 24th, 1975)

### Summary

1. Two automated colorimetric methods have been developed for assaying the GSH and total thiol in protein-free extracts of erythrocytes. They employ as chromogens 5,5'-dithiobis-(2-nitrobenzoate) (DTNB) and alloxan.

2. The concentrations of GSH, GSSG and total non-protein thiol have been estimated in high and low GSH erythrocytes from Finnish Landrace and Tasmanian Merino sheep.

3. In both breeds of sheep low GSH cells were found to have low concentrations of total non-protein thiol and GSSG as well as of GSH.

4. Nevertheless high and low GSH cells have similar values for the oxidation-reduction potential of the GSH : GSSG couple.

---

### Introduction

Sheep exhibit genetic polymorphism in erythrocyte GSH [1–5]. At least two distinct sorts of GSH deficiency have been described. In Finnish Landrace sheep (Finns), low GSH is inherited as an autosomal recessive trait, and is associated with a markedly diminished erythrocyte life-span and the presence of unusually high concentrations of some erythrocyte amino acids, notably ornithine and lysine [2,6,7]. In contrast, in Tasmanian Merino sheep (Merinos), the low GSH characteristic is probably inherited in an autosomal dominant manner and both the erythrocyte life-span and the concentrations of amino

---

\* Present address: Agricultural Research Council Institute of Animal Physiology, Babraham, Cambridge, CB2 4AT, U.K.

Abbreviation: DTNB, 5,5'-dithiobis-(2-nitrobenzoate).

acids are normal [3,6,8]. Australian Merino sheep may exhibit a third type of GSH deficiency. In this breed, low GSH seems to be inherited in an autosomal recessive manner, and yet is associated with normal erythrocyte ornithine and lysine concentrations [9].

The assays used to classify sheep as to GSH type can be criticised because they employ the non-specific thiol reagent 5,5'-dithiobis-(2-nitrobenzoate) (DTNB) [10,11]. It is therefore possible that the observed differences are due to some thiol other than GSH. Furthermore, since erythrocyte glutathione is also present in the oxidised form (GSSG), a diminished concentration of GSH does not necessarily mean total glutathione (GSH + 2 GSSG) is also diminished.

In this paper we attempt to resolve both these criticisms for the Finn and Tasmanian Merino types of GSH polymorphism. Erythrocyte GSH has been estimated by novel automated versions of methods employing as chromogens either DTNB or alloxan. Since both methods are precise, and since alloxan is much more specific for GSH than is DTNB, the difference between the DTNB and alloxan estimates is a measure of the amount of non-GSH thiol present. GSSG has been determined enzymically. The data show that for both Finns and Merinos the majority of the DTNB-reactive thiol in high and low GSH erythrocytes is in fact GSH. Furthermore, low GSH erythrocytes of both breeds have a diminished GSSG concentration. The alloxan GSH and GSSG estimates have been used to calculate the redox potential of the GSH : GSSG couple in high and low GSH Finn and Merino erythrocytes.

Some of these results have already appeared in preliminary form [12].

## Methods and Materials

### *Animals*

The Finnish Landrace and Tasmanian Merino sheep used in this study were maintained by the Agricultural Research Council Animal Breeding Research Organisation, Edinburgh, U.K. The origins of these animals are described in Eagleton et al. [13]. All sheep were at least 8 months old.

Whole blood was collected into heparinized Vacutainers by jugular venepuncture and kept on ice. Erythrocyte GSH and GSSG were estimated within 6 h of bleeding.

### *GSH estimations*

The population distributions of erythrocyte DTNB GSH were determined on whole blood by an automated dialysis method [11] with minor modifications.

To permit comparison of DTNB and alloxan GSH in a single protein-free extract of whole blood, automated versions of existing manual methods [10,14] were devised, employing similar arrangements of Technicon Auto-Analyser equipment (see Fig. 1). The reagents for these methods were: metaphosphoric acid/EDTA: 2 vol. 25% (w/v) metaphosphoric acid + 7 vol. 14.3 mM EDTA (disodium salt) + 1 vol. water. Since a fine precipitate may form, this reagent was prepared 12 h before use and filtered. Buffer: 0.5 M sodium phosphate, pH 7.5. DTNB: 160 mg DTNB + 10 g sodium citrate per l water. Alloxan: 16 g alloxan per l water (stored deep-frozen). NaOH (DTNB method):

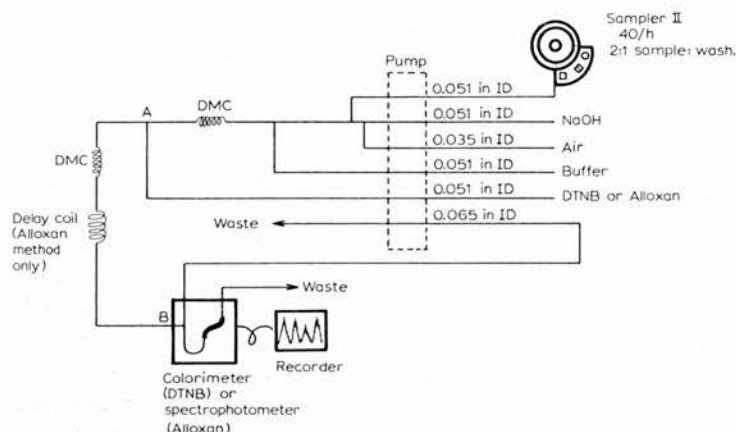

Fig. 1. The flow-diagrams for the automated DTNB and alloxan GSH methods. Both systems employ standard Technicon AutoAnalyser equipment except for the Unicam SP1800 spectrophotometer and AR25 recorder used with the alloxan manifold. The inclusion of a delay coil in the alloxan manifold is the only other difference between the two systems. The reagents for both methods are described in the text.

approx. 1.0 M NaOH adjusted so that 1 vol. of it titrated 1 vol. metaphosphoric acid/EDTA + 1 vol. DTNB to pH 7.5. NaOH (alloxan method): approx. 1.0 M NaOH adjusted so that 1 vol. of it titrated 1 vol. metaphosphoric acid/EDTA + 1 vol. alloxan to pH 7.5. GSH standards: 0–0.2 mM GSH in metaphosphoric acid/EDTA (stored at 4°C for not more than 2 weeks).

To prepare the protein-free extract, 1 ml blood was haemolysed by adding 7 ml ice-cold EDTA (14.3 mM), allowed to stand at 0°C for 5 min, and deproteinised with 2 vol. ice-cold 25% (w/v) metaphosphoric acid.

The flow diagram for the DTNB method is shown in Fig. 1. The wash reservoir was filled from a constant-head bottle with metaphosphoric acid/EDTA, the sampling rate was 40/h with a 2 : 1 sample : wash ratio, and the extinction was measured at 420 nm. Because the sample itself may absorb at 420 nm, a second aliquot of it was run through the system with 1% (w/v) sodium citrate in place of DTNB reagent, and this blank extinction (usually 0.01–0.03) was subtracted from that recorded with DTNB. Standards were not re-run.

The alloxan method also has the flow diagram in Fig. 1. Since the reaction product absorbs maximally at 305 nm, the Technicon colorimeter and recorder were replaced with a Unicam SP1800 spectrophotometer fitted with a 0.5 cm flow cell and a Unicam AR25 recorder. As in the DTNB method, the wash reservoir contained metaphosphoric acid/EDTA, and the sampling rate was 40/h with a sample : wash ratio of 2 : 1. The transit time between points A and B was 6 min. (This delay coil is the only difference between the DTNB and alloxan manifolds). The samples absorb at 305 nm, so they were re-run with water in place of alloxan reagent; this blank extinction was typically 0.01–0.02.

#### GSSG estimation

GSSG was estimated by a glutathione reductase method [15].

## Results

Fig. 2 shows the distribution of erythrocyte DTNB GSH in Merinos. The distribution is distinctly bimodal, one group having a concentration in the range 0.49–1.69 mmol/l cells and the other a concentration in the range 1.95–3.65 mmol/l cells. In accordance with the nomenclature of Tucker and Kilgour [2], animals with a DTNB GSH concentration in the lower range were termed low GSH, and those with one in the upper range, high GSH. The distribution of erythrocyte DTNB GSH in Finns is also shown in Fig. 2. These concentrations ranged from 1.07–4.30 mmol/l cells. The existence of a small group of animals with a concentration in the low GSH range is evident. The mean erythrocyte DTNB GSH concentrations (in mmol/l cells,  $\pm$  S.D.) were  $2.83 \pm 0.45$  (61) and  $1.07 \pm 0.26$  (52) for high and low GSH Merinos, respectively, and  $3.26 \pm 0.54$  (52) and  $1.29 \pm 0.11$  (12) for high and low GSH Finns, respectively. Of the Merinos, 46% were low GSH compared with 19% of the Finns. The erythrocyte DTNB GSH of a number of animals was monitored over a period of 27 months in the case of Merinos and 17 months in the case of Finns. All individuals of both breeds maintained their GSH type.

Selected animals (12 high GSH and 10 low GSH Finns, and 11 high GSH and 13 low GSH Merinos) were screened for the presence of high erythrocyte concentrations of ornithine and lysine [6]. Of the 46 animals tested, only the 10 low GSH Finns were amino acid positive.

Assuming the gene controlling low GSH to be recessive in Finns [2] and dominant in Merinos [3] it was possible to identify a number of presumed heterozygotes in both breeds from the limited breeding data available. In Finns, a high GSH animal was presumed to be heterozygous if it had either a low GSH parent or offspring. Conversely, in Merinos, a low GSH animal was presumed to be heterozygous if it had either a high GSH parent or offspring. These

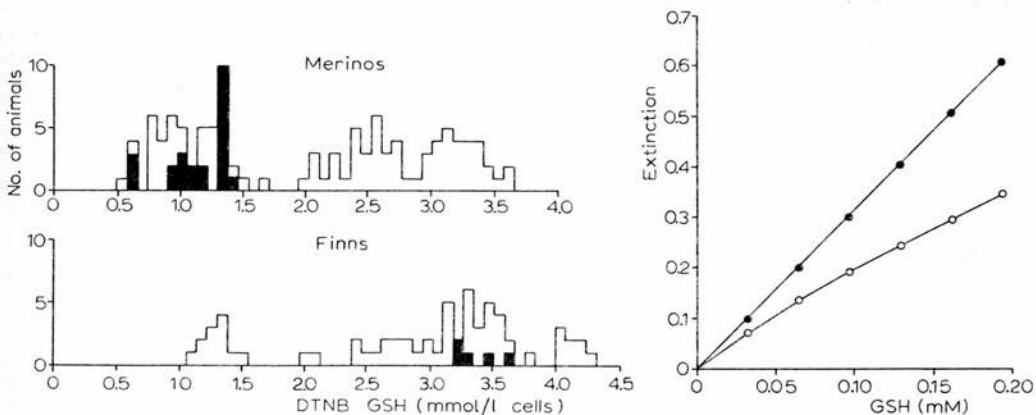

Fig. 2. The population distributions of erythrocyte DTNB GSH in Finn and Merino sheep. GSH was assayed by an automated dialysis method [11]. Presumed heterozygotes are identified as ■.

Fig. 3. Typical standard curves for the automated DTNB and alloxan GSH methods. The DTNB curve (●) represents a linear regression of extinction on GSH concentration. The alloxan curve (○) represents a third-order polynomial regression of extinction on GSH concentration.

animals are shown in Fig. 2. Their mean DTNB GSH concentrations ( $\pm$ S.D.) were  $3.34 \pm 0.20$  [5] and  $1.10 \pm 0.26$  [19] mmol/l cells for Finns and Merinos respectively. In Merinos, the range of heterozygote DTNB GSH concentrations was essentially the same as that of the total low GSH population, and in Finns, the heterozygotes lay in the middle of the high GSH range, showing that in both breeds there are no obvious differences between heterozygote and homozygote DTNB GSH concentrations.

The standard curve for the assay method using DTNB after metaphosphoric acid treatment was linear, whereas that using alloxan was not (see Fig. 3). A third-order polynomial routinely fitted the alloxan standard data. The coefficient of variation was 1–2% for both methods, and for neither of them was there appreciable drift or interaction between successive samples. The recovery of GSH, assessed by deproteinising blood from low GSH Finn sheep with 25% (w/v) metaphosphoric acid containing GSH, was (mean  $\pm$ S.E.M., 3)  $91.3 \pm 0.8\%$  (DTNB method) and  $92.2 \pm 0.8\%$  (alloxan method). These values are less than 100%, but are so nearly equal to one another that it is valid to compare DTNB GSH with alloxan GSH.

This comparison was made for 8 animals of each breed. These animals were selected to be of the same sex (female), age (1 year), haemoglobin type (AA in Finns and AB in Merinos) and potassium type (HK). The correspondence between the DTNB and alloxan estimates is shown in Fig. 4. For each breed the high and low GSH values fall on a single straight line through the origin. (Note that in Fig. 1 of Young et al. [12] the two lines do not pass through the origin. This is because no allowance was made for the extinction of the samples themselves at 420 nm, see above). The slopes of the lines ( $\pm$ S.E.), calculated by the method of least squares, are: Finns,  $0.923 \pm 0.012$  and Merinos,  $0.971 \pm 0.012$ . These results show that for both breeds of sheep almost all the non-protein thiol in the two types of cell is indeed GSH. However, since for Finns in particular the slope of the line seems to be slightly less than unity, there may be a small but constant percentage of the total non-protein thiol which is not GSH.

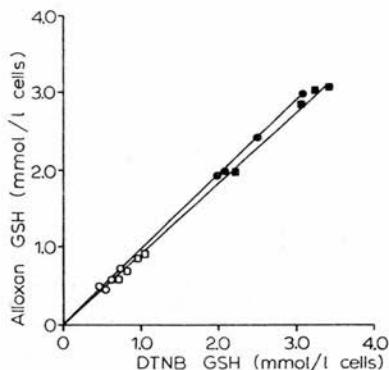

Fig. 4. A comparison of the DTNB and alloxan estimates of the concentration of GSH in high and low GSH erythrocytes from Finns and Merinos. The lines represent linear regressions of alloxan GSH on DTNB GSH. Both assays are described in the text. Finns: ■, high GSH and □, low GSH. Merinos: ●, high GSH and ○, low GSH.

TABLE I

THE CONCENTRATION OF GSSG IN HIGH AND LOW GSH FINN AND MERINO ERYTHROCYTES

Concentrations are mean  $\pm$  S.E.M. [4]  $\mu\text{mol/l}$  cells as assayed by a glutathione reductase method [15]. Mean values are compared by Student's *t*-test.

		GSSG concentration	<i>P</i>
Finn	High GSH	7.23 $\pm$ 0.95	<0.01
	Low GSH	2.15 $\pm$ 0.92	
Merino	High GSH	11.38 $\pm$ 1.08	<0.01
	Low GSH	2.86 $\pm$ 1.19	

The estimates of erythrocyte GSSG for the same 16 animals are summarised in Table I. For both breeds low GSH individuals have significantly less GSSG than do the high GSH individuals. Recovery experiments demonstrated that extracts of low GSH erythrocytes did not interfere with the GSSG assay. Consequently these low GSSG concentrations cannot be attributed to the presence of a glutathione reductase inhibitor in low GSH cells.

Although in both Finns and Merinos, high and low GSH animals differ widely in their erythrocyte GSH and GSSG concentrations and  $[\text{GSSG}] : [\text{GSH}]^2$  ratios, their values for the redox potential (*E*) of the GSH : GSSG couple are remarkably similar (Table II). The absolute values of *E* given in Table II can only be regarded as approximate because of the uncertainty of the standard redox potential ( $E_o'$ ) of this couple under physiological conditions. However, when the redox state of high and low GSH erythrocytes are compared, the important parameter is  $\Delta E$  ( $E_{\text{high GSH}} - E_{\text{low GSH}}$ ) which is independent of  $E_o'$ . The value of  $\Delta E$  is  $-16$  mV in Finns and  $-19$  mV in Merinos.

## Discussion

These automated DTNB and alloxan methods allow the concentrations of total non-protein thiol and GSH to be compared in the same erythrocyte extract. Alloxan is a particularly useful chromogen since it distinguishes between GSH and its thiol precursors (cysteine and  $\gamma$ -glutamyl-cysteine) and

TABLE II

THE REDOX STATE OF THE GSH:GSSG COUPLE IN HIGH AND LOW GSH FINN AND MERINO ERYTHROCYTES

Concentrations are mean  $\pm$  S.E.M. [4].

		Alloxan GSH (mmol/l cells)	GSSG ( $\mu\text{mol/l}$ cells)	$[\text{GSSG}] : [\text{GSH}]^2$ (l/mol)	<i>E</i> (V)*	$\Delta E$ (V) (High GSH - Low GSH)
Finn	High GSH	2.73 $\pm$ 0.25	7.23 $\pm$ 0.95	0.97	-0.240	-0.016
	Low GSH	0.78 $\pm$ 0.07	2.15 $\pm$ 0.92	3.53	-0.224	
Merino	High GSH	2.34 $\pm$ 0.24	11.38 $\pm$ 1.08	2.08	-0.230	-0.019
	Low GSH	0.57 $\pm$ 0.06	2.86 $\pm$ 1.19	8.94	-0.211	

\*  $E_o' = -0.24$  V at  $40^\circ\text{C}$  and pH 7 [23].

degradation products (cysteine and cysteinyl glucine) [14]. Although it is accepted that in healthy man erythrocytes contain a negligible concentration of non-protein non-GSH thiol, so that it is valid to equate GSH with DTNB-reactive thiol [10], the same may not be true in abnormal states or in sheep. Thus claims that erythrocyte GSH is elevated in some patients with anaemias [16,17], myelofibrosis [18] or leukemia [19,20] could be criticised on the grounds that the assays measured total thiol and not just GSH. The automated DTNB and alloxan methods described here may prove useful in these and other similar situations.

It is clear that in the high and low GSH Finn and Merino sheep we examined, GSH accounts for most of the non-protein thiol, but perhaps not quite all of it. It is possible that the residual thiol is  $\gamma$ -glutamyl cysteine as its concentration might be expected to increase with that of GSH [21]. Since the low GSH erythrocytes of both breeds also have a low concentration of GSSG, they have a diminished concentration of total glutathione (GSH + 2 GSSG).

It is apparent from Fig. 2 that there is a wide variation in GSH concentration within each GSH type, and that this cannot be accounted for by the presence of heterozygotes with an intermediate concentration. It has been suggested that erythrocyte GSH concentration in adult sheep may be influenced by an individual's age, haemoglobin type or potassium type [4,5]. However, none of these variables has a marked effect on erythrocyte GSH concentration in the Finns and Merinos used in the present investigation [22], so that most of the intra-type variation remains unexplained.

The redox potential data (Table II) indicate that high GSH cells have a more reducing potential than do low GSH ones. However, in both breeds the difference between the two cell types is small (less than 20 mV). If it is accepted that the prime role of GSH in the erythrocyte is to act as a redox buffer, it would seem that, from a thermodynamic standpoint at least, low GSH cells are at little disadvantage. It is therefore not surprising that low GSH Merino erythrocytes have a normal life-span [8]. In contrast, low GSH Finn erythrocytes have a life-span shortened by some 30% [7]. Since the low GSH erythrocytes from the two breeds have similar redox potentials and GSH concentrations, it is possible that the diminished life-span of the Finn cells is not a direct consequence of their low GSH status.

### Acknowledgement

J.D.Y. thanks the Faculty of Medicine of the University of Edinburgh for a Graduate Research Scholarship.

### References

- 1 Smith, J.E. and Osburn, B.I. (1967) *Science* 158, 374-375
- 2 Tucker, E.M. and Kilgour, L. (1970) *Experientia* 26, 203-204
- 3 Tucker, E.M. and Kilgour, L. (1972) *J. Agric. Sci. Camb.* 79, 515-516
- 4 Agar, N.S., Roberts, J. and Evans, J.V. (1972) *Aust. J. Biol. Sci.* 25, 619-626
- 5 Kalla, S.D., Ghosh, P.K. and Taneja, G.C. (1972) *Anim. Blood Grps. Biochem. Genet.* 3, 121-123
- 6 Ellory, J.C., Tucker, E.M. and Deverson, E.V. (1972) *Biochim. Biophys. Acta* 279, 481-483
- 7 Tucker, E.M. (1974) *Res. Vet. Sci.* 16, 19-22



- 8 Tucker, E.M. (1975) *Res. Vet. Sci.*, in the press
- 9 Board, P.G., Roberts, J. and Evans, J.V. (1974) *J. Agric. Sci. Camb.* 82, 395-398
- 10 Beutler, E., Duron, O. and Kelly, B.M. (1963) *J. Lab. Clin. Med.* 61, 882-888
- 11 Roberts, J. and Agar, N.S. (1971) *Clin. Chim. Acta* 34, 475-480
- 12 Young, J.D., Nimmo, I.A. and Hall, J.G. (1974) *Biochem. Soc. Trans.* 2, 314-317
- 13 Eagleton, G.E., Hall, J.G. and Russell, W.S. (1970) *Anim. Blood Grps. Biochem. Genet.* 1, 135-143
- 14 Patterson, J.W. and Lazarow, A. (1955) *Method Biochem. Anal.* 2, 259-278
- 15 Srivastava, S.K. and Beutler, E. (1968) *Anal. Biochem.* 25, 70-76
- 16 Macdougall, L.G. (1968) *J. Pediat.* 72, 303-318
- 17 Hopkins, J. and Tudhope, G.R. (1973) *Scot. Med. J.* 18, 177-181
- 18 Goswitz, F., Lee, G.R., Cartwright, G.E. and Wintrobe, M.M. (1966) *J. Lab. Clin. Med.* 67, 615-623
- 19 Sabine, J.C. (1964) *Brit. J. Haematol.* 10, 477-484
- 20 Özsoylu, S. (1970) *Acta Haematol.* 44, 233-239
- 21 Young, J.D. and Nimmo, I.A. (1975) *Biochim. Biophys. Acta* 404, 132-141
- 22 Young, J.D. (1975) Ph.D. Thesis, Edinburgh University
- 23 Rost, N. and Rapoport, S. (1964) *Nature* 201, 185

Reprinted from

*Biochimica et Biophysica Acta*, 404 (1975) 132–141

© Elsevier Scientific Publishing Company, Amsterdam — Printed in The Netherlands

BBA 27728

## GSH BIOSYNTHESIS IN GLUTATHIONE DEFICIENT ERYTHROCYTES FROM FINNISH LANDRACE AND TASMANIAN MERINO SHEEP

J.D. YOUNG\* and I.A. NIMMO

*Department of Biochemistry, University of Edinburgh Medical School, Teviot Place, Edinburgh, EH8 9AG (U.K.)*

(Received February 24th, 1975)

### Summary

1. The maximum activities of the enzymes for the biosynthesis of GSH ( $\gamma$ -glutamyl-cysteine synthetase and GSH synthetase) have been assayed in high GSH and low GSH erythrocytes from Tasmanian Merino and Finnish Landrace sheep.

2. For the Merinos, the activities ( $\mu\text{mol product/g haemoglobin per min} \pm \text{S.E.M. (n)}$ ) in the high and low GSH erythrocytes respectively were:  $\gamma$ -glutamyl-cysteine synthetase:  $0.776 \pm 0.065$  (11) and  $0.375 \pm 0.063$  (13); and GSH synthetase:  $0.069 \pm 0.003$  (11) and  $0.066 \pm 0.002$  (13).

3. For the Finnish Landrace sheep the activities in the high and low GSH erythrocytes respectively were:  $\gamma$ -glutamyl-cysteine synthetase:  $0.595 \pm 0.063$  (12) and  $0.555 \pm 0.033$  (10) and  $\gamma$ -glutamyl-cysteine synthetase:  $0.073 \pm 0.002$  (12) and  $0.070 \pm 0.002$  (10).

4.  $\gamma$ -Glutamyl-cysteine synthetase was markedly inhibited by physiological GSH concentrations. No evidence was found for the presence of an inhibitor of GSH biosynthesis (other than GSH) in low GSH erythrocytes from Finnish Landrace sheep.

5. Although for the Merinos the low GSH trait can be explained in terms of a diminished activity of  $\gamma$ -glutamyl-cysteine synthetase, no such explanation is tenable for the Finnish Landrace sheep.

---

### Introduction

The major role of GSH in the erythrocyte is thought to be the protection of the cell against oxidative damage, the GSH:GSSG couple acting as a redox

\* Present address: Agricultural Research Council Institute of Animal Physiology, Babraham, Cambridge, CB2 4AT, U.K.

buffering system. GSH is continuously synthesised in the mammalian erythrocyte from its constituent amino acids [1-3] and removed from the cell by a GSSG transport system [4]. The presence of an enzymic system in erythrocytes for GSH degradation has also been suggested [2,5].

A number of instances of congenital erythrocyte GSH deficiency associated with non-spherocytic haemolytic anaemia have been described in man. These low concentrations of erythrocyte GSH have been attributed to a diminished ability of the cell to synthesise GSH, the reactions involved being [3]:

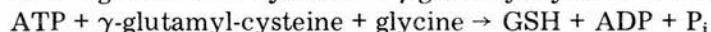
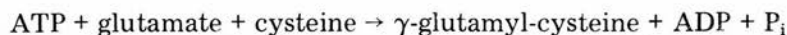

The first reaction is catalysed by  $\gamma$ -glutamyl-cysteine synthetase and results in the formation of  $\gamma$ -glutamyl-cysteine. The second reaction is catalysed by GSH synthetase. Severe deficiencies of both enzymes have been reported [3,6,7].

The existence of sheep with low concentrations of erythrocyte GSH was first described by Smith and Osburn [8]. Subsequent investigations have revealed that there are at least two distinct types of GSH deficiency. The first is found in Finnish Landrace sheep (Finns) where low GSH is inherited in an autosomal recessive manner and is associated with a diminished erythrocyte life-span and elevated erythrocyte concentrations of certain amino acids, particularly ornithine and lysine [9-11]. Tasmanian Merino sheep (Merinos) exhibit a second type of GSH deficiency. In these animals, low GSH is probably inherited in an autosomal dominant manner and both the erythrocyte life-span and amino acid concentrations are normal [10,12,13]. GSH deficiency in Australian Merino sheep is also associated with normal erythrocyte amino acid concentrations but seems to be inherited as an autosomal recessive trait [14]. This breed may therefore exhibit a third type of GSH deficiency. In contrast to the situation in man, low GSH individuals of all these breeds appear to be clinically normal.

This paper describes an investigation of the biochemical mechanism(s) responsible for the Finn and Tasmanian Merino types of erythrocyte GSH deficiency. It is demonstrated that low GSH Merino erythrocytes have a diminished maximum activity of  $\gamma$ -glutamyl-cysteine synthetase which could explain their low GSH concentration. On the other hand, low GSH Finn erythrocytes are shown to have normal activities of both  $\gamma$ -glutamyl-cysteine synthetase and GSH synthetase, so the reason for their low GSH concentration has still to be elucidated.

Some of these results have already appeared in preliminary form [15].

## Materials and Methods

### *Animals*

The Tasmanian Merino and Finnish Landrace sheep used in this investigation were maintained by the Agricultural Research Council Animal Breeding Research Organisation, Edinburgh. Sheep were classified as to GSH type on the basis of their erythrocyte concentrations of GSH and, for the Finns, of ornithine and lysine [16]. All investigations except those involving more than 4

animals of each GSH type were carried out with animals of the same sex (female), age (2 years), haemoglobin type (AA in Finns and AB in Merinos) and potassium type (HK).

Whole blood was drawn from sheep into heparinized Vacutainers and immediately chilled. Erythrocytes were washed 3 times in ice-cold 0.9% (w/v) NaCl. The buffy coat and upper layer of erythrocytes was removed. The erythrocyte:leucocyte ratio of the final cell preparation was never less than 1000 : 1.

### *Materials*

[U-<sup>14</sup>C] Glutamate and [U-<sup>14</sup>C] glycine were obtained from the Radiochemical Centre, Amersham, England. ( $\gamma$ -Glutamyl)<sub>2</sub>-cystine was purchased from Cyclo Chemical Corporation, Los Angeles, California, U.S.A.

### *GSH biosynthesis*

$\gamma$ -Glutamyl-cysteine synthetase and GSH synthetase were assayed in dilute haemolysates by the method of Paniker and Beutler [17]. Blanks were performed by adding trichloroacetic acid and then haemolysate to the complete incubation medium. Enzyme activity was expressed as  $\mu$ mol product formed/g haemoglobin/min.

The ability of sheep erythrocytes to synthesise  $\gamma$ -glutamyl-cysteine and GSH was also determined in freeze-thaw haemolysates under conditions where the cell constituents were virtually undiluted (compared with a 30–50-fold dilution in the other assay system). Freeze-thaw haemolysates were prepared from packed NaCl-washed erythrocytes by freezing and thawing twice.

The incubation system for  $\gamma$ -glutamyl-cysteine synthesis contained 20  $\mu$ mol MgCl<sub>2</sub>, 10  $\mu$ mol each of ATP, cysteine, [U-<sup>14</sup>C] glutamate (0.1 Ci/mol) and dithiothreitol, and 0.9 ml freeze-thaw haemolysate in a total volume of 1.0 ml. Due to its low solubility, glutamate was added to haemolysate as solid, and the complete incubation system was assembled at 0°C. Incubations were at 37°C, and after 5 min pre-incubation, 0.2 ml aliquots were removed at 5-min intervals and deproteinised with 1.8 ml of 5.6% (w/v) trichloroacetic acid containing 56 mM imidazole.  $\gamma$ -Glutamyl-cysteine in the trichloroacetic acid-imidazole supernatant was precipitated as the cadmium mercaptide, washed free of [<sup>14</sup>C] glutamate and counted by liquid scintillation spectrometry with quench correction by the method of Paniker and Beutler [17].

The incubation system for GSH synthesis was identical to that for  $\gamma$ -glutamyl-cysteine except for the inclusion of glycine (10 mM). Glycine rather than glutamate was isotopically labelled. Incubations and subsequent sample treatment were also as described for  $\gamma$ -glutamyl-cysteine. In both the incubation systems with freeze-thaw haemolysates, blanks were performed by omitting cysteine.

### *ATP estimation*

The concentration of ATP in sheep erythrocytes was determined using the Boehringer Test Combination (Diagnostics) UV method.

## **Results**

### *GSH biosynthesis in dilute haemolysates*

In Fig. 1, the erythrocyte  $\gamma$ -glutamyl-cysteine synthetase and GSH syn-

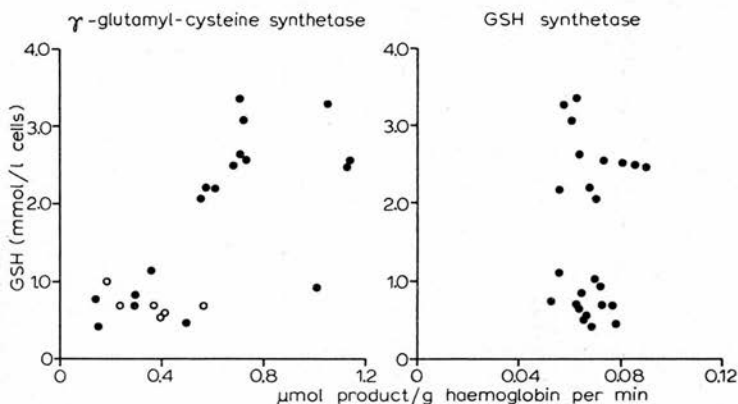

Fig. 1. Activities of the enzymes of GSH biosynthesis in high and low GSH Merino erythrocytes.  $\gamma$ -Glutamyl-cysteine synthetase and GSH synthetase were assayed in dilute haemolysates [17]. Erythrocyte GSH was estimated by the method of Roberts and Agar [18], with minor modifications. The  $\gamma$ -glutamyl-cysteine synthetase activities of presumed heterozygotes are shown as O.

thetase activities of 11 high GSH and 13 low GSH Merinos are plotted against their respective erythrocyte GSH concentrations (as determined by the method of Roberts and Agar [18], with minor modifications). The mean  $\gamma$ -glutamyl-cysteine synthetase activity of the low GSH cells is 48% of that of the high GSH cells, this difference being statistically significant (Student's *t*-test;  $P < 0.001$ ). High GSH erythrocytes therefore have a greater maximum enzymic capacity for  $\gamma$ -glutamyl cysteine synthesis than do low GSH erythrocytes. (Note that one low GSH animal did not conform to the overall pattern. This individual had a low GSH concentration (less than 1.0 mmol/l cells) and no detectable erythrocyte ornithine or lysine, but it had a high  $\gamma$ -glutamyl-cysteine synthetase activity (1.01  $\mu\text{mol/g}$  haemoglobin/min). It could have been misclassified as to GSH type if additional factors had influenced its erythrocyte GSH concentration (see refs 10 and 19). There is no significant correlation between  $\gamma$ -glutamyl-cysteine synthetase activity and GSH concentration within either GSH type. From the limited breeding data available, it was possible to identify 6 of the 13 low GSH Merinos as heterozygotes (see ref. 16). These animals are identified in Fig. 1. Although they have different activities of  $\gamma$ -glutamyl-cysteine synthetase, high and low GSH Merino erythrocytes have the same activity of GSH synthetase.

In Fig. 2, the erythrocyte  $\gamma$ -glutamyl-cysteine synthetase and GSH synthetase activities of 12 high GSH and 10 low GSH Finns are plotted against their respective erythrocyte GSH concentrations. In marked contrast to the situation in Merinos, these high and low GSH erythrocytes have the same  $\gamma$ -glutamyl-cysteine synthetase activity. As with Merinos, no inter-type difference in GSH synthetase activity is apparent. There is no significant correlation between  $\gamma$ -glutamyl-cysteine synthetase and GSH synthetase activity in either type of cell or breed of sheep.

#### *GSH biosynthesis in freeze-thaw haemolysates*

Fig. 3 shows the time-course of  $\gamma$ -glutamyl-cysteine synthesis by high and

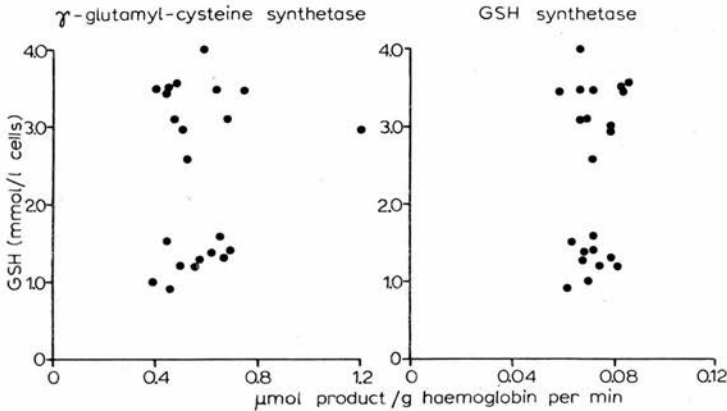

Fig. 2. Activities of the enzymes of GSH biosynthesis in high and low GSH Finn erythrocytes.  $\gamma$ -Glutamyl-cysteine synthetase and GSH synthetase were assayed in dilute haemolysates [17]. Erythrocyte GSH was estimated by the method of Roberts and Agar [18], with minor modifications.

low GSH Finn and Merino freeze-thaw haemolysates. As for the dilute haemolysate assays, the rate of  $\gamma$ -glutamyl-cysteine synthesis is markedly diminished in low GSH Merinos but not in low GSH Finns. Indeed, under these conditions, low GSH Finns show a greater capacity for  $\gamma$ -glutamyl-cysteine synthesis than do high GSH Finns. In no case was  $\gamma$ -glutamyl-cysteine synthesis observed in the absence of added cysteine.

The time-course of GSH synthesis by high and low GSH Finn freeze-thaw haemolysates is shown in Fig. 4. The rate of GSH synthesis is similar in the two types of cell. There was a small amount of [ $^{14}$ C]glycine incorporation into

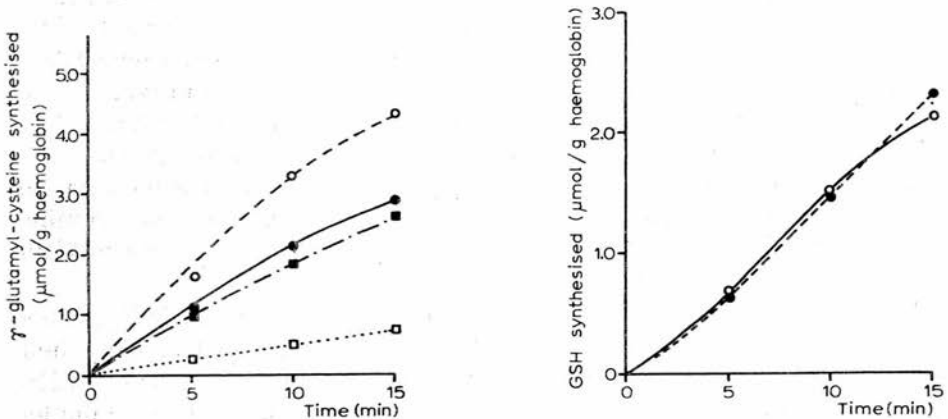

Fig. 3. The synthesis of  $\gamma$ -glutamyl-cysteine by high and low GSH Finn and Merino freeze-thaw haemolysates. The incubation system and subsequent sample treatment are described in the text. Pooled freeze-thaw haemolysates (equal volumes of erythrocytes from 3 animals of the same GSH type and breed) were employed. Finns: high GSH,  $\bullet$ ; low GSH,  $\circ$ . Merinos: high GSH,  $\blacksquare$ ; low GSH,  $\square$ .

Fig. 4. The synthesis of GSH by high and low GSH Finn freeze-thaw haemolysates. The incubation system and subsequent sample treatment are described in the text. Pooled freeze-thaw haemolysates (equal volumes of erythrocytes from 3 animals of the same GSH type) were employed. High GSH,  $\bullet$ ; low GSH,  $\circ$ .

GSH in the absence of added cysteine. This was particularly noticeable in high GSH haemolysates and presumably reflects an exchange reaction between glycine and preformed GSH [20]. Since this incorporation was less than 5% of that recorded in the presence of cysteine, its effect on the latter has been ignored.

#### *The effect of GSH on sheep erythrocyte $\gamma$ -glutamyl-cysteine synthetase*

The effect of physiological concentrations of GSH on  $\gamma$ -glutamyl-cysteine synthetase from high and low GSH Merinos is shown in Fig. 5. GSH is a potent inhibitor of  $\gamma$ -glutamyl-cysteine synthetase, and the plots of percentage inhibition against GSH concentration demonstrate that the pattern of GSH inhibition is similar for both types of cell.

It is possible to assess from these data the influence of cellular GSH concentrations on the relative  $\gamma$ -glutamyl-cysteine synthetase activities of high and low GSH Merino erythrocytes. In the presence of 2.37 mM GSH (the mean erythrocyte GSH concentration of the three high GSH animals used in this experiment), the  $\gamma$ -glutamyl-cysteine synthetase activity of the high GSH Merinos is reduced by 54% from 0.69 to 0.32  $\mu\text{mol/g}$  haemoglobin/min. Similarly, in the presence of 1.24 mM GSH (the mean GSH concentration of the three low GSH animals used), the low GSH activity is reduced by 48% from 0.21 to 0.11  $\mu\text{mol/g}$  haemoglobin/min. Therefore even allowing for the effect of in vivo GSH concentrations, low GSH Merinos have substantially less  $\gamma$ -glutamyl-cysteine synthetase activity than high GSH Merinos.

GSH inhibition may explain why the activity of  $\gamma$ -glutamyl-cysteine synthetase in freeze-thaw haemolysates was substantially less than that found in dilute haemolysates.

#### *The effect of amino acids on sheep erythrocyte $\gamma$ -glutamyl-cysteine synthetase and GSH synthetase activity*

Ornithine, lysine, alanine, serine and threonine are amongst the amino acids found in high concentration in 'Finn-type' low GSH erythrocytes [10, 21]. The effects of these amino acids on  $\gamma$ -glutamyl-cysteine synthetase and of

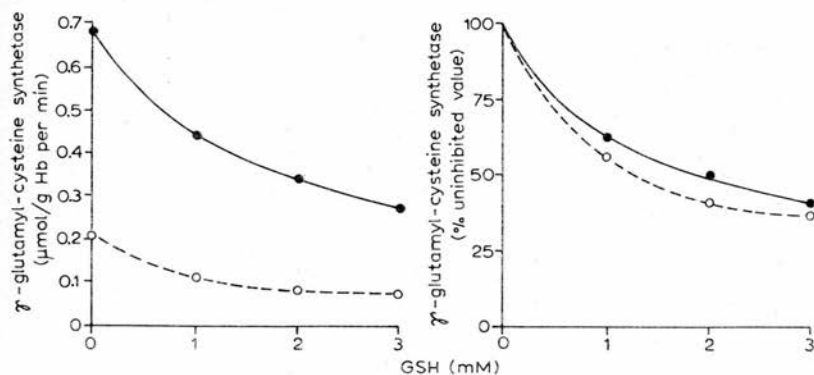

Fig. 5. The inhibition of high and low GSH Merino  $\gamma$ -glutamyl-cysteine synthetase by GSH.  $\gamma$ -Glutamyl-cysteine synthetase was assayed in pooled dilute haemolysates (equal volumes of erythrocytes from 3 animals of the same GSH type) [17]. High GSH,  $\bullet$ ; low GSH,  $\circ$ . Hb, haemoglobin.

TABLE I  
THE INHIBITION OF LOW GSH FINN  $\gamma$ -glutamyl-cysteine synthetase AND GSH synthetase BY AMINO ACIDS

$\gamma$ -Glutamyl-cysteine synthetase and GSH synthetase were assayed in pooled dilute haemolysate (equal volumes of erythrocytes from 3 animals) (17). Both assays were linear for 30 min at all substrate concentrations.

Substrate concentrations (mM)		Percentage inhibition in the presence of 10 mM amino acid						
ATP	Cysteine	Glutamate	Ornithine	Lysine	Alanine	Serine	Threonine	$\alpha$ -Amino- $\beta$ -butyric acid
$\gamma$ -glutamyl-cysteine synthetase	1.0	10.0	—	7.0	0.1	2.3	3.9	—
	0.1	0.1	10.2	7.7	6.8	5.8	7.6	73.6
0.89	0.018	0.089	10.4	9.0	—	—	—	—
ATP	$\gamma$ -glutamyl-cysteine	glycine						
GSH synthetase	0.89	0.018	0.089	20.6	18.5	—	—	—



TABLE II

THE CONCENTRATION OF ATP IN HIGH AND LOW GSH FINN AND MERINO ERYTHROCYTES

Values are (mean  $\pm$  S.E.M. (3)) mmol/l cells, as assayed by the Boehringer Test Combination (Diagnostics) U.V. method. Means are compared by Student's *t*-test.

		ATP concentration	<i>P</i>
Finn	High GSH	0.882 $\pm$ 0.040	>0.05
	Low GSH	0.833 $\pm$ 0.019	
Merino	High GSH	0.831 $\pm$ 0.036	>0.05
	Low GSH	0.909 $\pm$ 0.125	

ornithine and lysine on GSH synthetase from low GSH Finns are summarised in Table I. The cysteine analogue  $\alpha$ -amino-*n*-butyric acid was also included in one series of  $\gamma$ -glutamyl-cysteine synthetase inhibition studies.

When present at a concentration of 10 mM, none of the amino acids tested with the exception of  $\alpha$ -amino-*n*-butyric acid inhibited low GSH Finn  $\gamma$ -glutamyl-cysteine synthetase by more than 11% even when, in the case of ornithine and lysine, the substrate concentrations were reduced to physiological levels. At approximately physiological substrate concentrations, 10 mM ornithine and lysine inhibited low GSH Finn GSH synthetase by about 20%.

#### *The concentration of ATP in high and low GSH Finn and Merino erythrocytes*

There was no significant difference in erythrocyte ATP concentration between the high and low GSH animals of either breed (Table II).

## Discussion

In Merinos a low concentration of erythrocyte GSH is associated with a diminished maximum activity of  $\gamma$ -glutamyl-cysteine synthetase. It is therefore tempting to conclude that for these sheep a low concentration of GSH is caused by a diminished activity of  $\gamma$ -glutamyl-cysteine synthetase. If this is true,  $\gamma$ -glutamyl-cysteine synthetase rather than GSH synthetase must be the rate limiting enzyme of GSH biosynthesis. However, the relative maximum activities of  $\gamma$ -glutamyl-cysteine synthetase and GSH synthetase as measured in dilute haemolysates suggest the opposite, for even in low GSH erythrocytes the activity of  $\gamma$ -glutamyl-cysteine synthetase exceeds that of GSH synthetase. On the other hand, *in vivo* both these enzymes operate at well below their maximum capacities. Normal high GSH sheep erythrocytes have sufficient enzymic capacity to synthesise their entire complement of GSH in approximately 2 h, whereas it has been estimated that in sheep erythrocytes *in vivo*, GSH has a half-life of 11 days [22]. A similar situation exists in human erythrocytes, in which control of GSH biosynthesis is thought to involve both substrate availability and metabolic inhibition (particularly GSH inhibition of  $\gamma$ -glutamyl-cysteine synthetase) [1-3].

A computer simulation study of GSH metabolism was therefore made, to establish whether or not a change in the activity of  $\gamma$ -glutamyl-cysteine synthetase really could change the rate of synthesis of GSH, and hence its steady-state

concentration. This study has been described in detail elsewhere [23], but its relevant conclusions are as follows. First, the rate of GSH synthesis at physiological substrate concentrations and enzyme activities does indeed increase with  $\gamma$ -glutamyl-cysteine synthetase activity. Secondly, the concentration of  $\gamma$ -glutamyl-cysteine increases with that of GSH.  $\gamma$ -Glutamyl-cysteine may therefore be the non-protein non-GSH thiol that Young et al. [16] found in sheep erythrocytes.

If sheep erythrocyte  $\gamma$ -glutamyl-cysteine synthetase is similar to the human enzyme with respect to GSH inhibition, it is possible that the diminished  $\gamma$ -glutamyl-cysteine synthetase activity of low GSH cells is partially or completely compensated for by a diminished GSH feedback inhibition. The data in Fig. 5 suggest that GSH is in fact a potent inhibitor of sheep erythrocyte  $\gamma$ -glutamyl-cysteine synthetase, but that the diminished GSH feedback inhibition resulting from the low GSH concentration in low GSH erythrocytes is insufficient to compensate for the diminished  $\gamma$ -glutamyl-cysteine synthetase activity in these cells.

High and low GSH Merino  $\gamma$ -glutamyl-cysteine synthetase activities were also measured in freeze-thaw haemolysates, under conditions which are more physiological than those encountered in the other assay system. In particular, the freeze-thaw system allowed  $\gamma$ -glutamyl-cysteine synthetase to be assayed in the presence of virtually undiluted cell constituents, including GSH. As in the dilute haemolysate assays, low GSH Merinos were found to have a markedly diminished ability to synthesise  $\gamma$ -glutamyl-cysteine. We have therefore concluded that the low GSH characteristic of our Merinos can be explained in these terms. Smith et al. [24] have also suggested that a diminished ability to synthesise  $\gamma$ -glutamyl-cysteine is responsible for GSH deficiency in sheep. Unfortunately, they specified neither the breed of sheep nor the type GSH deficiency they investigated.

Although a decreased activity of  $\gamma$ -glutamyl-cysteine synthetase may be responsible for the GSH deficiency in Merinos, no such explanation is tenable for the Finns, high and low GSH erythrocytes having the same  $\gamma$ -glutamyl-cysteine synthetase activity. That the biochemical mechanisms responsible for the GSH deficiency in Finns and Merinos are different is consistent with the genetic and amino acid analyses summarised in the introduction. The normal  $\gamma$ -glutamyl-cysteine synthetase activity of low GSH Finn erythrocytes implies that the diminished  $\gamma$ -glutamyl-cysteine synthetase activity in Merinos is not a consequence of the low GSH status of these cells.

Low GSH Finn erythrocytes also have a normal GSH synthetase activity and ATP concentration, and the freeze-thaw haemolysate assays offer no evidence for the presence of a  $\gamma$ -glutamyl-cysteine synthetase or GSH synthetase inhibitor in these cells. Indeed, the ability of low GSH Finn freeze-thaw haemolysates to synthesise  $\gamma$ -glutamyl-cysteine was greater than that of high GSH Finn haemolysates. This is in contrast to the dilute haemolysate assays where both cell types had the same  $\gamma$ -glutamyl-cysteine synthetase activity. The differences between the two assay systems in this respect will require further investigation, although it is possible that the elevated activity of low GSH freeze-thaw haemolysates is at least in part a consequence of diminished GSH feedback inhibition.

The amino acid inhibition studies also failed to provide evidence for the presence of an inhibitor of GSH biosynthesis in low GSH Finn erythrocytes. Ornithine, lysine, alanine, serine and threonine have little effect on low GSH Finn  $\gamma$ -glutamyl-cysteine synthetase. This is in contrast to  $\alpha$ -amino-*n*-butyric acid which is an effective inhibitor of the enzyme. Ornithine and lysine are more effective inhibitors of low GSH Finn GSH synthetase, each inhibiting the enzyme by about 20% at approximately physiological substrate concentrations. However, since  $\gamma$ -glutamyl-cysteine synthetase rather than GSH synthetase is probably the rate limiting enzyme of GSH biosynthesis, this inhibition is of doubtful significance and may be expected to have only a marginal influence on the steady-state GSH concentration [23].

These investigations therefore suggest that the erythrocyte GSH deficiency in Tasmanian Merino sheep is a consequence of a diminished activity of the first enzyme of GSH biosynthesis ( $\gamma$ -glutamyl-cysteine synthetase). In contrast, erythrocyte GSH deficiency in Finnish Landrace sheep is associated with normal activities of both the enzymes of GSH biosynthesis. Furthermore, low GSH Finn cells do not seem to contain an inhibitor of GSH biosynthesis (other than GSH), and have a normal complement of ATP. Further studies will be required to elucidate the biochemical mechanism responsible for this type of GSH deficiency.

### Acknowledgements

We are grateful to Dr J.G. Hall for supplying us with blood samples, and to Miss C.L. McMinn and Dr J.H. Ottaway for carrying out the computer simulation study. J.D.Y. thanks the Faculty of Medicine of the University of Edinburgh for a Graduate Research Scholarship.

### References

- 1 Dimant, E., Landsberg, E. and London, I.M. (1955) *J. Biol. Chem.* 213, 769–776
- 2 Jackson, R.C. (1969) *Biochem. J.* 111, 309–315
- 3 Minnich, V., Smith, M.B., Brauner, M.J. and Majerus, P.W. (1971) *J. Clin. Invest.* 50, 507–513
- 4 Srivastava, S.K. and Beutler, E. (1969) *J. Biol. Chem.* 244, 9–16
- 5 Palekar, A.G., Tate, S.S. and Meister, A. (1974) *Proc. Natl. Acad. Sci. U.S.A.* 71, 293–297
- 6 Boivin, P. and Galand, C. (1965) *Nouv. Rev. Fr. Haematol.* 5, 707–720
- 7 Konrad, P.N., Richards, II, F., Valentine, W.N. and Paglia, D.E. (1972) *N. Engl. J. Med.* 286, 557–561
- 8 Smith, J.E. and Osburn, B.I. (1967) *Science* 158, 374–375
- 9 Tucker, E.M. and Kilgour, L. (1970) *Experientia* 26, 203–204
- 10 Ellory, J.C., Tucker, E.M. and Deverson, E.V. (1972) *Biochim. Biophys. Acta* 279, 481–483
- 11 Tucker, E.M. (1974) *Res. Vet. Sci.* 16, 19–22
- 12 Tucker, E.M. and Kilgour, L. (1972) *J. Agric. Sci. Camb.* 79, 515–516
- 13 Tucker, E.M. (1975) *Res. Vet. Sci.* in press
- 14 Board, P.G., Roberts, J. and Evans, J.V. (1974) *J. Agric. Sci. Camb.* 82, 395–398
- 15 Young, J.D., Nimmo, I.A. and Hall, J.G. (1974) *Biochem. Soc. Trans.* 2, 314–317
- 16 Young, J.D., Nimmo, I.A. and Hall, J.G. (1975) *Biochim. Biophys. Acta* 404, 124–141
- 17 Paniker, N.V. and Beutler, E. (1972) *J. Lab. Clin. Med.* 80, 481–487
- 18 Roberts, J. and Agar, N.S. (1971) *Clin. Chim. Acta* 34, 475–480
- 19 Tucker, E.M. and Kilgour, L. (1973) *Res. Vet. Sci.* 14, 306–311
- 20 Snoke, J.E. and Bloch, K. (1955) *J. Biol. Chem.* 213, 825–835
- 21 Tucker, E.M., Ellory, J.C. and Kilgour, L. (1973) *Comp. Biochem. Physiol.* 46A, 103–107
- 22 Smith, J.E. (1974) *J. Lab. Clin. Med.* 83, 444–449
- 23 Young, J.D. (1975) Ph.D. Thesis, Edinburgh University
- 24 Smith, J.E., Lee, M.S. and Mia, M.S. (1973) *J. Lab. Clin. Med.* 82, 713–718

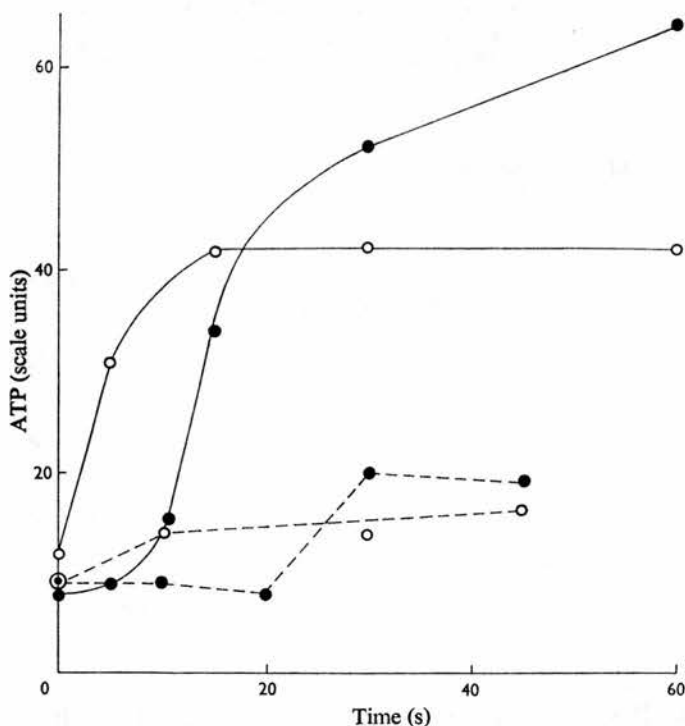

Fig. 2. ATP synthesis in rat liver mitochondrial suspensions preincubated anaerobically for 3 min or 20 min at 30°C with or without the addition of  $D_{Na}$

Conditions were as in Fig. 1. —: ●, 3 min preincubation; ○, 3 min preincubation + 30 mg of  $D_{Na}$ ; ----: ●, 20 min preincubation; ○, 20 min preincubation + 30 mg of  $D_{Na}$ .

therefore the protonmotive force resides preponderantly in the electrical term,  $\Delta\psi$ . It has been estimated (Mitchell, 1968) that for a protonmotive force of 250 mV an electrogenic movement of 1 ng of  $H^+$ /mg of mitochondrial protein is required; this corresponds to a movement of 30 ng of  $H^+$  in our incubations, and this in turn to a  $-\Delta pH$  of approx. 0.02 pH unit. This is a readily detectable change when it is not masked by a prior and larger  $-\Delta pH$  due to electroneutral proton movement; but when this condition is fulfilled, in mitochondrial systems given an oxygen pulse after a 3 min anaerobic preincubation in the presence of  $D_{Na}$ , no spike of this size is found. We interpret this as further and direct evidence that the electrogenic movement of protons is never manifested in the bulk phase, that it is confined to the  $p$ -zone by the opposite fixed charge on the membrane, and that the bulk-phase parameters  $\Delta p$ ,  $\Delta\psi$  and  $\Delta pH$  have no validity in assessing the functional protonmotive force through which the electrogenic proton pump is coupled to phosphorylation.

When  $-\Delta pH$  is 0.02 pH unit the potential across the membrane caused by the pH term would be about 5 mV and therefore a very minor factor (2%) in the chemiosmotic equation; this will also be true for the pH term in the 3 min anaerobiosis studies without  $D_{Na}$  additions where, as shown in Fig. 1, synthesis may be taking place when the  $-\Delta pH$  curve shows alkalization in the medium. In contrast, 10 min anaerobic preincubation

periods, for reasons already suggested, have given misleading  $Z\Delta pH$  values ranging from 13 to 64% of  $\Delta p$  (Mitchell & Moyle, 1969).

We assume that with 3 min anaerobic periods  $Z\Delta pH^p$  will also be very small compared with  $\Delta\psi^p$ . Since

$$\Delta\psi^p > \Delta\psi$$

it follows that for the same proton movement

$$\Delta p^p > \Delta p$$

and eqn. (1) indicates a more efficient energy-transduction process than the original chemiosmotic equation. It also implies that no realistic measurement has yet been made experimentally of the magnitude of the protonmotive force.

G. P. R. A. was the holder of a Medical Research Council Studentship. C. L. F. holds a Northern Ireland Ministry of Education Studentship.

Archbold, G. P. R., Farrington, C. L., Gill, D. J. O. & Malpress, F. H. (1974) *Biochem. Soc. Trans.* **2**, 751-754

Coster, H. G. L. (1973) *Biophys. J.* **13**, 133-142

Mitchell, P. (1968) *Chemiosmotic Coupling and Energy Transduction*, Glynn Research Ltd., Bodmin

Mitchell, P. & Moyle, J. (1965) *Nature (London)* **208**, 147-151

Mitchell, P. & Moyle, J. (1969) *Eur. J. Biochem.* **7**, 471-484

Thomas, R. C., Manger, J. R. & Harris, E. J. (1969) *Eur. J. Biochem.* **11**, 413-418

### Reduced Glutathione Regeneration in Glutathione-Deficient Erythrocytes from Finnish Landrace Sheep

JAMES D. YOUNG,\* SARAH A. THOMPSON and IAN A. NIMMO

*Department of Biochemistry, University of Edinburgh Medical School, Teviot Place, Edinburgh EH8 9AG, U.K.*

Some breeds of sheep exhibit genetic polymorphism in their concentration of erythrocyte reduced glutathione (GSH), animals with less than 55mg of GSH/100ml of cells (1.79mmol/litre of cells) being termed low-GSH and the rest high-GSH (Smith & Osburn, 1967; Tucker & Kilgour, 1970, 1972; Agar *et al.*, 1972). In one breed, the Tasmanian Merino, low-GSH erythrocytes have a diminished maximum activity of  $\gamma$ -glutamyl-cysteine synthetase (the first enzyme of GSH biosynthesis), which could account for their low concentration of GSH. In contrast, low-GSH erythrocytes from Finnish Landrace sheep have a normal maximum activity of both  $\gamma$ -glutamyl-cysteine synthetase and GSH synthetase (the other enzyme of GSH biosynthesis), so their low GSH concentration presumably has another explanation (Young *et al.*, 1974).

In erythrocytes, GSH is continuously being converted into its oxidized form, GSSG, which can either be reduced back to GSH by glutathione reductase or be extruded from the cell (Srivastava & Beutler, 1969). If low-GSH erythrocytes from Finnish Landrace sheep have a decreased capacity to reduce GSSG back to GSH the rate at which they lose GSSG could increase and their steady-state concentration of GSH therefore fall.

To test this possibility, we have measured the activity of glutathione reductase (with both NADPH and NADH as cofactor) and the combined activities of the NADPH-generating enzymes glucose 6-phosphate dehydrogenase and 6-phosphogluconate dehydrogenase in high- and low-GSH erythrocytes from Finnish Landrace sheep. Since low-GSH erythrocytes from these animals contain unusually high concentrations of

\* Present address: Department of Immunology, A.R.C. Institute of Animal Physiology, Babraham, Cambridge CB2 4AT, U.K.

some amino acids (Ellory *et al.*, 1972) which could conceivably influence the activities of the above enzymes *in vivo*, we have also compared the rates at which the two types of cell regenerate GSH from GSSG after oxidative challenge.

The activities of glutathione reductase and of glucose 6-phosphate dehydrogenase+6-phosphogluconate dehydrogenase, assayed by the methods of Beutler (1971), are shown in Table 1. There is no difference in glutathione reductase activity between the two types of cell, but the low-GSH ones have an elevated activity of the NADPH-generating enzymes. This could be explained by the observations that in Finnish Landrace sheep low-GSH erythrocytes have a shorter lifespan and are therefore on average younger than high-GSH cells (Tucker, 1974), and that glucose 6-phosphate dehydrogenase activity decreases as the sheep erythrocyte ages (Maronpot, 1972).

The GSH-regeneration experiments were performed on pooled cells (from three animals of the same GSH type) which had been washed three times with suspension medium (130mM-NaCl, 5mM-KCl, 1mM-MgCl<sub>2</sub> and 25mM-sodium phosphate buffer, pH7.4) and preincubated at a haematocrit of about 40% in suspension medium plus 10mM-glucose. GSH was oxidized by adding 1ml of incubation medium containing 2mM-diamide (Kosower *et al.*, 1969) to 9ml of the cell suspension. This lowered the GSH concentration in both cell types by about 0.9mmol/litre of cells. Regeneration was followed at 37°C for the next 60min, the GSH being assayed by an automated version of the method of Beutler *et al.* (1963). Regeneration was essentially completed by 20-30min, and its rate was linear for the first 10min in both types of cell.

The linear rates were  $57 \pm 5$  and  $55 \pm 9$   $\mu$ mol of GSH/min per litre of cells for high- and low-GSH erythrocytes respectively (means  $\pm$  S.E.M. of four experiments). In the absence of added glucose, regeneration was low and variable. These data, together with those on the enzyme activities, therefore show that high- and low-GSH erythrocytes from Finnish Landrace sheep have almost the same capacities for reducing GSSG to GSH. Consequently some other explanation must be sought for their difference in GSH concentration.

That NADPH is the preferred coenzyme for glutathione reductase in sheep erythrocytes is suggested by the data in Table 1 and by those of Smith (1968). To test this notion, the production of lactate and pyruvate by washed cells regenerating GSH was measured, by the method of Tfelt-Hansen & Siggaard-Andersen (1971). The rate of regeneration of GSH was paralleled by the rate of production of lactate, but there was no detectable production of pyruvate. This indicates that NADH generated via glycolysis was not being used to reduce GSSG. The production of <sup>14</sup>CO<sub>2</sub> by washed cells incubated for 60min with 10mM-[U-<sup>14</sup>C]glucose and with or without 0.2mM-diamide was also measured essentially as described by Beutler & Guinto (1974). For both high- and low-GSH cells, the presence of diamide increased the amount of <sup>14</sup>CO<sub>2</sub> liberated by three-

Table 1. *Glutathione reductase and glucose 6-phosphate dehydrogenase+6-phosphogluconate dehydrogenase (G6PDH+6PGDH) activities in high- and low-GSH erythrocytes from Finnish Landrace sheep*

Values are (means  $\pm$  S.E.M. with numbers of animals in parentheses)  $\mu$ mol/min per g of haemoglobin as assayed by the methods given in Beutler (1971). Mean values were compared by Student's *t* test. n.s., Not significant.

	Glutathione reductase		G6PDH+6PGDH
	NADPH	NADH	
High-GSH	2.06 $\pm$ 0.18 (3)	0.39 $\pm$ 0.03 (3)	1.96 $\pm$ 0.10 (6)
Low-GSH	2.19 $\pm$ 0.10 (3)	0.46 $\pm$ 0.01 (3)	2.48 $\pm$ 0.08 (10)
<i>P</i>	n.s.	n.s.	<0.05

to four-fold. Thus it seems that diamide stimulated the hexose monophosphate pathway, implying that it increased the demand for NADPH. We have therefore concluded that NADPH is indeed the preferred coenzyme for glutathione reductase in intact erythrocytes from Finnish Landrace sheep.

We thank Dr. J. G. Hall of the A.R.C. Animal Breeding Research Organisation, Edinburgh for supplying us with blood samples. J. D. Y. thanks Edinburgh University Faculty of Medicine for a Graduate Research Scholarship.

- Agar, N. S., Roberts, J. & Evans, J. V. (1972) *Aust. J. Biol. Sci.* **25**, 619–626  
 Beutler, E. (1971) *Red Cell Metabolism (A Manual of Biochemical Methods)*, pp. 62–66, Grune and Stratton, New York  
 Beutler, E. & Guinto, E. (1974) *J. Clin. Invest.* **53**, 1258–1264  
 Beutler, E., Duron, O. & Kelly, B. M. (1963) *J. Lab. Clin. Med.* **61**, 882–888  
 Ellory, J. C., Tucker, E. M. & Deverson, E. V. (1972) *Biochim. Biophys. Acta* **279**, 481–483  
 Kosower, N. S., Kosower, E. M., Wertheim, B. & Correa, W. S. (1969) *Biochem. Biophys. Res. Commun.* **37**, 593–596  
 Maronpot, R. R. (1972) *Can. J. Comp. Med.* **36**, 55–60  
 Smith, J. E. (1968) *J. Lab. Clin. Med.* **71**, 826–833  
 Smith, J. E. & Osburn, B. I. (1967) *Science* **158**, 374–375  
 Srivastava, S. K. & Beutler, E. (1969) *J. Biol. Chem.* **244**, 9–16  
 Tfelt-Hansen, P. & Siggaard-Andersen, O. (1971) *Scand. J. Clin. Lab. Invest.* **27**, 15–19  
 Tucker, E. M. (1974) *Res. Vet. Sci.* **16**, 19–22  
 Tucker, E. M. & Kilgour, L. (1970) *Experientia* **26**, 203–204  
 Tucker, E. M. & Kilgour, L. (1972) *J. Agr. Sci.* **79**, 515–516  
 Young, J. D., Nimmo, I. A. & Hall, J. G. (1974) *Biochem. Soc. Trans.* **2**, 314–317

## The Effect of Ethylene on the Synthesis of Endoplasmic Reticulum in Etiolated Pea Stems

ROBIN F. IRVINE and DAPHNE J. OSBORNE

*Agricultural Research Council, Unit of Developmental Botany, 181A Huntingdon Road, Cambridge CB3 0DY, U.K.*

We reported earlier that the application of the plant growth hormone ethylene (at 10  $\mu$ l/litre) to shoots of etiolated pea plants decreases the incorporation of [1- $^{14}$ C]glycerol into trichloroacetic acid-precipitable phospholipids and that an increase in endogenous ethylene production can induce a similar response (Irvine & Osborne, 1973).

In view of the fact that we have observed structural changes induced by ethylene in the endoplasmic reticulum under the electron microscope (J. A. Sargent & D. J. Osborne, unpublished work) and in rough endoplasmic reticulum extracted from the tissue (R. F. Irvine & D. J. Osborne, unpublished work), we considered it important to clearly establish that this decrease in [1- $^{14}$ C]glycerol incorporation represents a real decrease in phospholipid synthesis *de novo* in membranes, and in the rough endoplasmic reticulum in particular.

Because the percentage lowering of [1- $^{14}$ C]glycerol incorporation is the same in the major phospholipid fractions (Irvine & Osborne, 1973), a decrease in the flux of molecules through the phospholipid-synthesis pathway should be reflected by an equal percentage decrease in incorporation of other precursors, for example, choline. In double-labelling experiments involving [methyl- $^{14}$ C]choline and [2- $^3$ H]glycerol this was found to be so (Table 1).

That the decrease in incorporation is not due to a decrease in uptake was established by direct measurement of precursor entering the tissue: with [methyl- $^{14}$ C]choline, 780 c.p.m. was taken up per segment of which 78 c.p.m. was in phospholipids. After 3 h treatment with ethylene, the corresponding values were 733 and 45 c.p.m. respectively. Data for [1- $^{14}$ C]glycerol uptake have been published (Irvine & Osborne, 1973).

## Amino acid transport defect in glutathione-deficient sheep erythrocytes

THE tripeptide, reduced glutathione (GSH), is present in high concentration in mammalian red blood cells, where its major role is thought to be the protection of the cell against oxidative damage. Congenital red cell GSH deficiency has been reported in man, and attributed to a decreased activity of either of the two enzymes ( $\gamma$  glutamyl cysteine synthetase (GCS) or GSH synthetase (GSHS)) involved in GSH biosynthesis<sup>1</sup>. Such GSH-deficient red cells have a markedly diminished lifespan, and an increased susceptibility to the haemolytic action of oxidant drugs<sup>1</sup>.

Sheep with low concentrations of red cell GSH were first found by Smith and Osburn<sup>2</sup> and subsequent investigations have revealed at least two distinct types of congenital sheep red cell GSH deficiency<sup>3-5</sup>. The first is associated with a diminished activity of the first enzyme of GSH biosynthesis (GCS) and is found in Tasmanian Merino sheep ("Merino-type")<sup>6</sup>. The second, found in Finnish Landrace sheep ("Finn-type"), is characterised by normal activities of both GCS and GSHS<sup>6</sup>, and results in a shortened red cell lifespan<sup>7</sup>, and an increased susceptibility to kale poisoning<sup>8</sup>. Significantly, in the latter, but not in the former type of deficiency, the red cells contain high concentrations of certain amino acids, particularly lysine and ornithine<sup>3</sup>. It is therefore possible that the low concentrations of GSH in these animals may result from a reduced amino acid permeability limiting the availability of GSH precursors, or from a direct effect of the accumulated amino acids on the enzymes of GSH biosynthesis.

To test the first possibility we have measured the permeability of normal (high GSH) and GSH-deficient (low GSH) Finn red cells to the GSH-precursor amino acids (cysteine, glutamate, glycine) and compared the results obtained with those for high and low GSH Merino cells. The data are presented in Table 1 together with values for glutamine,  $\alpha$ -amino-*n*-butyric acid ( $\alpha$ AB), cystine and lysine uptake by high and low GSH Finn red cells. The uptake of cysteine was rapid in Finn red cells, and sixfold greater in high GSH cells than in low GSH ones. In contrast, the uptake of cysteine by high and low GSH Merino red cells was the same, and not significantly different from that found in high GSH Finn cells. As with cysteine, glycine uptake was significantly lower in low GSH Finn red cells, although both the absolute fluxes and the difference between the GSH types were smaller. There was no significant difference in glycine permeability between high and low GSH Merino red cells. Attempts to demonstrate glutamate uptake by sheep red cells gave very low values, which were not linear with time. The impermeability of sheep red cells to glutamate is consistent with observations on human red cells<sup>9</sup>. Glutamine may act as a GSH precursor<sup>10</sup> and measurements of glutamine uptake showed fluxes of the same order as for glycine, but with no significant difference between Finn GSH types.

In certain reactions (including that catalysed by GCS),  $\alpha$ AB can substitute for cysteine<sup>11,12</sup> and may therefore provide a convenient alternative to cysteine for uptake studies. The uptake of this amino acid by Finn red cells was therefore measured, and found to be rapid, with the flux in high GSH cells some tenfold greater than that encountered in low GSH cells. In contrast to the situation with cysteine and  $\alpha$ AB, cystine (the oxidised form of cysteine) showed a slow rate of uptake, with no significant difference between high and low GSH Finn cells. The uptake of lysine, which is found at concentrations of up to 20 mmol per litre packed cells in low GSH Finn red cells was measured in high and low GSH Finn cells. High GSH cells showed a threefold greater lysine permeability than low GSH cells.

**Table 1** GSH levels and amino acid uptake rates in red cells from high and low GSH Finnish Landrace and Tasmanian Merino Sheep

	High GSH Finn		Low GSH Finn		Significance level for difference (P)
	5	5	5	5	
No. of animals					
Red cell GSH (mmol per l packed cells)	2.97 ± 0.24		1.25 ± 0.08		
Amino acid uptake (μmol per l packed cells per h)					
Cysteine	236 ± 21		38.7 ± 4.0		<0.001
Glycine	12.7 ± 1.8		7.3 ± 0.4		<0.002
Glutamic acid	<1		<1		NS
Glutamine	11.9 ± 1.3		13.5 ± 3.1		NS
$\alpha$ -amino- <i>n</i> -butyric acid	656 ± 69		56.4 ± 8.6		<0.001
Cystine	8.6 ± 0.4		9.9 ± 0.5		<0.1
Lysine	19.4 ± 3.0		6.4 ± 0.8		<0.01
	High GSH Merino		Low GSH Merino		
	6	6	6	6	
No. of animals					
Red cell GSH (mmol per l packed cells)	3.19 ± 0.04		0.87 ± 0.04		
Amino acid uptake (μmol per l packed cells per h)					
Cysteine	298 ± 12		242 ± 2		NS
Glycine	10.4 ± 0.8		11.7 ± 0.6		NS

Data presented as mean ± s.e.m.

NS, not significant.

Washed sheep red cells were incubated at 10% haematocrit in a medium containing (mM): NaCl 135, KCl 5, Tris-HCl (pH 7.1 at 37 °C) 15, MgCl<sub>2</sub> 3.1, EDTA 0.1, amino acid 0.2 (containing <sup>14</sup>C-amino acid at 0.2 μCi ml<sup>-1</sup>). Since cysteine oxidises rapidly in solution at neutral pH, cysteine uptake was measured in the presence of 10 mM dithiothreitol. Control experiments showed no effect of 10 mM dithiothreitol on  $\alpha$ AB influx or efflux. At fixed time intervals (10-30 min for Gly,  $\alpha$ AB, Lys, Cys/2; 30-90 min for Cys, Gln, Glu), aliquots (1 ml) were taken and the cells washed four times in ten volumes of a medium containing (mM): MgCl<sub>2</sub> 106, Tris-HCl (pH 7.4 at 4 °C) 10, by centrifugation (10 s, 10,000g) in an Eppendorf 3200 microcentrifuge. Finally, the packed cells were lysed in 0.5% Triton X-100 in water (0.5 ml), 33% trichloroacetic acid added (0.5 ml) and the precipitate removed by centrifugation. An aliquot of supernatant (0.9 ml) was placed into Bray's solution<sup>14</sup> (10 ml) and counted in a  $\beta$  scintillation spectrometer with quench correction.

The above results show that differences in amino acid transport, particularly for cysteine,  $\alpha$ AB and lysine exist between high and low GSH Finn red cells. In contrast to glutamate and glycine, the concentration of cysteine in sheep red cells is very low (13 μmol per litre packed cells)<sup>13</sup>. Thus a diminished cysteine availability may be responsible for the low concentrations of GSH in low GSH Finns.

The reduced amino acid transport in low GSH Finn red cells is not a direct consequence of a low intracellular GSH concentration, since low GSH Merino red cells show normal amino acid uptake values. Further experiments were designed to determine whether the diminished amino acid uptake by low GSH Finn red cells resulted from a membrane transport defect or whether it was a function of the high lysine and ornithine content of these cells. Uptake of  $\alpha$ AB (0.2 mM) by high GSH Finn red cells was unaffected by the presence of extracellular lysine or ornithine (10 mM). Similarly,  $\alpha$ AB efflux from the same cells (preloaded by incubation in the presence of 1 mM  $\alpha$ AB for 2 h at 37 °C) was unaffected by extracellular lysine or ornithine at a concentration of 5 mM. In contrast, 10 mM cysteine inhibited  $\alpha$ AB uptake by 50% and stimulated  $\alpha$ AB efflux by 30% under equivalent conditions. Finally, high GSH Finn red cells were preloaded with lysine by incubation in the presence of 10 mM lysine for 20 h at 20 °C. Uptake of  $\alpha$ AB (0.2 mM) by these cells (intracellular lysine concentration 3.0 mmol per litre packed cells) was identical to that of control high GSH cells which had been incubated



for the same length of time in the absence of lysine (intracellular lysine concentration 0.1 mmol per litre packed cells).

We therefore conclude that the diminished amino acid uptake of low GSH Finn red cells represents a membrane transport defect which is not a consequence of the low GSH or elevated lysine and ornithine concentrations in these cells. It further seems likely that diminished availability of cysteine is responsible for the low concentrations of red cell GSH in these animals, and that the accumulation of lysine and ornithine is a further reflection of reduced amino acid transport.

This work was supported by a project grant from the MRC.

J. D. YOUNG  
J. C. ELLORY  
ELIZABETH M. TUCKER

*ARC Institute of Animal Physiology,  
Babraham, Cambridge CB2 4AT, UK*

Received December 13, 1974.

- 1 Beutler, E., *Adv. Metab. Disord.*, **6**, 131-160 (1972).
- 2 Smith, J. E., and Osburn, B. I., *Science*, **158**, 374-375 (1967).
- 3 Tucker, E. M., and Kilgour, L., *Experientia*, **26**, 203-204 (1970).
- 4 Tucker, E. M., and Kilgour, L., *J. agric. Sci., Camb.*, **79**, 515-516 (1972).
- 5 Ellory, J. C., Tucker, E. M., and Deverson, E. V., *Biochim. biophys. Acta*, **279**, 481-483 (1972).
- 6 Young, J. D., Nimmo, I. A., and Hall, J. G., *Biochem. Soc. Trans.*, **2**, 314-317 (1974).
- 7 Tucker, E. M., *Res. vet. Sci.*, **16**, 19-22 (1974).
- 8 Tucker, E. M., and Kilgour, L., *Res. vet. Sci.*, **14**, 306-311 (1973).
- 9 Winter, C. G., and Christensen, H. N., *J. biol. Chem.*, **239**, 872-878 (1964).
- 10 Prins, H. K., Oort, M., Loos, J. A., Zurcher, C., and Beckers, T., *Blood*, **27**, 145-166 (1966).
- 11 Strumeyer, D. H., thesis, Harvard Univ. (1959).
- 12 Rathbun, W. B., *Archs Biochem. Biophys.*, **122**, 73-84 (1967).
- 13 Smith, J. E., *Am. J. vet. Res.*, **34**, 847-848 (1973).
- 14 Bray, G. A., *Analyt. Biochem.*, **1**, 279-285 (1960).