

Studies in Metrical Phonology:

German and English

Heinz Joachim Giegerich

Ph D

University of Edinburgh

1983



Gerhard Wahrig, *in memoriam*.

## Acknowledgements

Some of the ideas that I express in this study have a recorded history. The notion of the zero syllable, for example, was given a first airing in my M.A. thesis (1978b) and the subsequent publication of part of that thesis (1980). In summer 1980, I read a paper on zero syllables at the 4th International Phonology Meeting in Vienna, which was published in the proceedings of the meeting (1981c). In two articles (1981a, 1982), I have given preliminary versions of my account of German compound stress. What I have to say on this issue in the present study is a substantial revision of these earlier attempts. Lastly, I have in three further papers dealt with metrical transformations in English (1978a, 1981b, 1983). Again, what is said on this subject in the present thesis is rather different, in spirit and in letter, from the earlier statements.

I gratefully acknowledge financial support from *Studienstiftung des Deutschen Volkes* during the early stages of this project.

My work has been encouraged and criticised by a number of people and I am indebted to all of them. For special thanks, I would like to single out the following students and colleagues who have given me their critical comments on earlier versions of parts or all of the manuscript: John Anderson, Siegfried Beierlein, Ruth Campbell, Grzegorz Dogil, Roger Lass, Edmund Mardon, Paul Nieuwenhuis, Nina Pinkerton, Menekse Suphi. John Anderson, the supervisor of this thesis, has been of immeasurable help to me, as a scholar as well as friend. On re-reading this thesis, I feel that whatever may be interesting in what I have written may well have been his idea in the first place.

This thesis is dedicated to the memory of my teacher Gerhard Wahrig, Professor of General Linguistics at Mainz University from 1972 until his death in 1978.

## Abstract

This thesis is concerned with establishing a model of metrical phonology that deals with various aspects of phonological prominence in German and English. Based on the initial proposal concerning such models by Liberman and Prince (1977), it is offered as an alternative to previous models that deal with phonological prominence in the two languages under discussion, notably Wurzel (1970, 1980), Chomsky and Halle (1968), and certain aspects of Liberman and Prince (1977).

Chapter 1 gives an outline of the particular model of metrical structure that is employed in this study. Chapters 2 and 3 contain a detailed investigation of the prominence relations that hold within German words, morphologically simple or complex. It is shown that an account of German inflexional morphology is simplified if it makes reference to metrical structure. I assume in these chapters that the German lexicon is organised in the way proposed by Siegel (1974); in particular, I assume that prominence relations within words are defined in the lexicon and that affixation takes place in two stages, one preceding and the other preceded by the assignment of metrical structure. 'Lexicalised compounds' are analysed, in terms of metrical phonology, as words derived via suffix rather than compound words. In chapter 4 I propose a number of metrical transformations for German and English. Sited in the metrical component of the phonology, they adapt the metrical structures produced previously in the derivation to the requirements of rhythmic alternation, timing, and phrasing in performance. The metrical component constitutes an alternative to certain readjustment rules as suggested by Chomsky and Halle (1968) and others.

The model of metrical phonology advocated in this thesis makes no reference to prosodic categories, as proposed by Selkirk (1980), or to segmental stress features.

## Table of Contents

Chapter 1 - Introduction	1
Chapter 2 - Metrical structure and morphology, part 1: the metrical structure of German words	33
2.1 The metrical structure of nonnative words	33
2.1.1 The location of primary stress	33
2.1.1.1 Final stress	34
2.1.1.2 Penultimate stress	36
2.1.1.3 Prepenultimate stress	38
2.1.2 Primary stress in Class I suffixes	40
2.1.3 The metrical structure of simple nonnative words	43
2.1.4 Class I suffixes and metrical structure	53
2.1.5 A note on vowel length and tense- ness	61
2.2. The metrical structure of native words	75
2.2.1 Remarks on nativity	75
2.2.2 On epenthetic shwa and inflexional morphology	79
2.2.3 Some speculative remarks on syllab- ification	100
2.2.4 Class II suffixes and stress	110
2.2.5 Native words, Class II suffixes, and metrical structure	118

Chapter 3 - Metrical structure and morphology, part 2: compound stress and related issues	127
3.1 Introduction	127
3.2 The problem	
3.3 On lexicalisation and obscured compounds	140
3.4 The metrical structure of German compound nouns	151
3.4.1 A basic rule	151
3.4.2 Lexicalised compounds as parts of larger structures	161
3.4.2.1 Stress shift in A[BC] structures	
3.4.2.2 A point of difference between English and German	168
3.4.2.3 [AB]C structures with ad- jectival constituents	170
3.4.3 Eliminating structure: <i>Defooting</i> in German compounds	177
3.4.4 Some 'exceptions' and their 'explan- ations'	188
3.5 Borderline cases: metrical effects of compounding and prefixation in German	193
3.5.1 Verbs	193
3.5.2 Adjectives and nouns	217

Chapter 4 - Metrical transformations, or: on the scope of the metrical component	223
4.1 Introduction	223
4.2 German <i>Defooting</i>	230
4.2.1 The distribution of S S W structures	230
4.2.2 <i>Defooting</i> : form and scope	239
4.3 <i>Iambic Reversal</i> in English and the metrical grid	253
4.4 A note on <i>Iambic Reversal</i> in German	273
4.5 On flattening and rhythmic alternation in English	277
4.5.1 Right-branching structures, part 1: <i>W-Pairing</i>	282
4.5.2 Right-branching structures, part 2: <i>Defooting</i> and <i>Footing</i>	287
4.5.3 Left-branching structures: <i>S-Pairing</i> and <i>W-Pairing</i>	309
References	321



## Chapter 1: Introduction

Phonologists of numerous schools, persuasions, and sects - autosegmental, metrical, dependency, and others - have argued in recent years that phonological representations are more highly structured than was assumed in the 'standard model' of generative phonology. The segment and the phonological phrase, the only phonological constituents recognised by Chomsky and Halle (1968; hereafter SPE) are not in fact the only phonological units that recurrently figure in the structural descriptions of phonological processes. And while these units - syllables, feet, tone groups, and possibly more - tend to be rather clearly defined in phonetic terms, they tend to be equally clearly undetermined by morphosyntactic structure. This enrichment of phonological structure has been, I would think, the major revision that phonological theory has enjoyed, or suffered, after SPE. Phonological representations are, like syntactic representations, now viewed as hierarchical structures and the categories that phonological structures appeal to are largely distinct from those that figure in syntactic representations. A variety of models of phonological representation have been proposed in the recent past that share this rather general characteristic (see the surveys in Anderson and Ewen 1980a; Ewen 1980); an infinite number of such models would be possible.

Phonologists have also learned that prominence should be treated as a relational notion, defined on phonological constituents. This conviction, cautiously voiced as early as 1948 by Eli Fischer-Jørgensen, was rather dominant in pre-SPE distinctive feature theory. Thus, Jakobson and Halle (1956: 22) draw a distinction between inherent and prosodic features:



A prosodic feature is displayed only by those phonemes which form the crest of a syllable and it may be defined only with reference to the relief of the syllable or of the syllable chain, whereas the inherent feature is displayed by phonemes irrespective of their role in the relief of the syllable, and the definition of such a feature does not refer to the relief of the syllable or of the syllable chain.

No such distinction is drawn in the feature system proposed in SPE. Along with the notion of the syllable, the notion of relational features is abandoned: SPE's n-ary feature [stress], for example, which governs phonological prominence, is assigned locally to vowels. While all features employed in SPE share this property of local assignment, the rather special character of [stress] is expressed by cyclic application of stress rules. The categories that are referred to in the cycle, however, are morphosyntactic.

It was only in the past five years or so that scholars have, in a sense, reverted to pre-SPE phonology in this respect. The larger-than-segment phonological constituents proposed in recent models also serve to express the regularities relating to relative prominence. As a consequence, the n-ary stress feature of SPE can be done away with; the role of the cycle can at least be queried; reference to morphosyntactic categories can be greatly reduced. Generalisations relating to phonological prominence can be expressed more elegantly and, in a lot of cases, more adequately.

Given, then, the more general need for phonological constituent structure and the more specific relational character of phonological prominence, one of the possible models embodying both claims is the one first proposed by Rischel (1972), Liberman (1975), and Liberman and Prince (1977; hereafter LP), since then rather unfortunately

nick-named 'metrical phonology'. This is the model, roughly, on which the following study of phenomena relating to phonological prominence in German and English is based, although various revisions will be proposed which, it seems to me, will be of some theoretical interest.

I shall, in what follows, not discuss a number of important issues, either because they have been discussed elsewhere, or because they deserve book-size inquiry in their own right. Among those are the justification of phonological constituent structure in general (see Anderson and Jones 1974 and the references I gave above), the comparison of metrical phonology with competing models like, say, dependency phonology, and the arguments why metrical phonology deals more adequately with relative prominence than SPE does. For the latter, the reader is referred to LP (pp. 261 ff.); I have nothing to add to LP's arguments.

Instead, I shall spend the remainder of this chapter introducing the reader to my particular model of metrical structure, without any attempts towards a historiography of metrical phonology, 1972 (?) to 1983, and only in order to make it possible, or easier, for the reader to understand what I will be talking about in the later chapters.

Take, for example, the prominence patterns of bisyllabic units like simple words ((1.1a) below), compound words (1.1b), and syntactic phrases (1.1c). The one clear observation that can be made here is that one syllable will be more prominent than the other; let us make no attempt to give an absolute stress value and restrict ourselves to a purely relational statement. One way of expressing this simple observation would then be this:

(1.1) a.

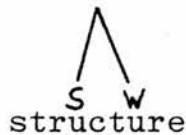

b.



c.



What is expressed in the notation used in (1.1) is this: of a pair of syllables, the one labelled S (for strong) is more prominent than the one labelled W (for weak). Moreover, the two syllables between which this prominence relation holds form a phonological constituent: they are represented as sister nodes in a phonological structure.

Say we want to give what is an observation in (1.1) the status of a general condition on prominence structure. Let there be no branching of prominence trees that is not binary and let pairs of sister nodes always be labelled [S W] or [W S]. This restriction on our representation bears out the claim most rigidly that the nature of prominence is relational, although it should be pointed out that binarism does not necessarily follow from relationality: a ternary structure like, say, [S W W] might also be used for the expression of relational properties. This structure would simply imply that no relation is defined among the two nodes labelled W but that each of them is weaker than the one labelled S.

The model proposed here makes stronger claims and is more highly constrained than any model permitting ternary branching. The constraint of binarity reduces drastically the number of possible structures. It should, therefore, be adopted, needless to say, if it expresses adequately all the generalisations that we wish to make.

Under this principle, the metrical structure of units comprising more than two syllables would then look, for example, like this:

(1.2) a.

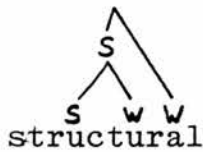

b.

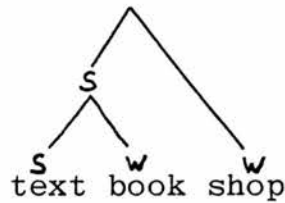

c.

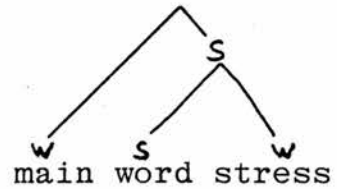

Rather than allowing ternarily branching trees, a sequence of three syllables is broken down into binary constituents between which prominence relations can then be established.

This is, in a nutshell, metrical phonology. It is claimed that a model constructed along these lines is capable of expressing and predicting all the regularities relating to phonological prominence in a given language.

A number of important questions arise. First of all, if the trees given in (1.2) above are claimed to be correct, on what grounds are the ones in (1.3) below to be ruled out?

(1.3) a.



b.

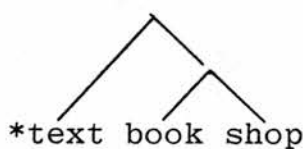

c.

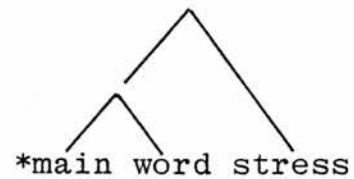

Second, what are the principles that govern the distribution of S and W in a given tree? Why are the trees in (1.4) below also ill-formed?

(1.4) a.

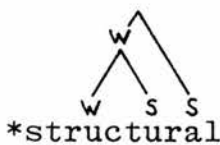

b.

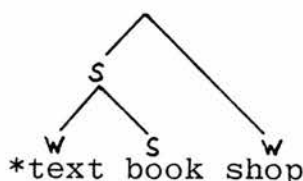

c.

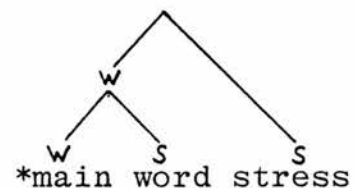

Third, given that we want metrical structures to be available for phonetic interpretation, at what point, or points, in the derivation of a sentence are the mechanisms sited that erect them? In the phonological component, or in the lexicon? Or in both? Or, for that matter, in neither?

And fourth, how exactly are metrical structures to be interpreted phonetically? If a hierarchical phonological representation is eventually mapped onto the sequential representation of the phonetic string, what are the phonetic correlates of prominence and what is the algorithm that converts the metrical tree into them? Is there such a thing as the 'relative stress levels' of speech and, if so, how do they correspond to the phonological structure?

It is neither possible nor, I think, particularly desirable to treat these questions in isolation.

Substantial evidence has of late been given which suggests that the scope of the lexicon should be greater than was originally assumed in the 'standard theory' of generative grammar (Chomsky 1965; SPE). Thus the proponents of the 'lexicalist hypothesis', who are largely responsible for this evidence, claim that along with the customary list of lexical entries the lexicon should contain, for example, the regularities governing processes of word formation (Chomsky 1970) and also those governing word stress (Siegel 1974; Selkirk 1980b). In particular, Siegel argues that these two are ordered with respect of each other in such a fashion that certain processes of word formation via affix precede and others are preceded by the assignment of word stress. I take up this argument and apply it to the body of German words in section 2.2.2 and *passim*; what is important for our present purposes is that this model answers, to some extent, the first and the third question I raised above. As for the first question, metrical

structure is to some extent a projection of morphological structure.

Take, for example, the German verb *fahren* and the prefix *ab-*. *ab-* is a stress-neutral affix; in the model advocated here it gets attached to *fahren* after *fahren* has received metrical structure and its attachment does not alter the existing structure. The result is a tree like the one in (1.5a):

(1.5) a.



b.



The tree in (1.5b) is ill-formed because it fails to preserve the metrical structure of *fahren* under embedding.

While metrical structure is in some instances a projection of morphological structure, in other instances it is not. Independent principles are necessarily at work in polysyllabic morphemes and also in those formations via affix that are produced prior to the erection of metrical structure. To take just one example of a polysyllabic lexeme, consider the metrical tree of *Paläozoikum*. The strength relations within this tree will interest us at a later point.

(1.6)



I assume that this word cannot be broken down into morphological constituents that are productive in German and that, therefore, we cannot appeal to any morphological structure in this case in order to determine metrical structure. Nevertheless, the tree is uniquely determined. I give the principles that govern the shape of metrical trees for German words, in the absence of relevant morphological bracketing, in section 2.2.3 of this study.

This leads us on to metrical structure above the level of the word, more precisely: in compound words and syntactic phrases. Consider the compound noun *labour party conference* and the noun phrase *seven little girls*:

(1.7) a.

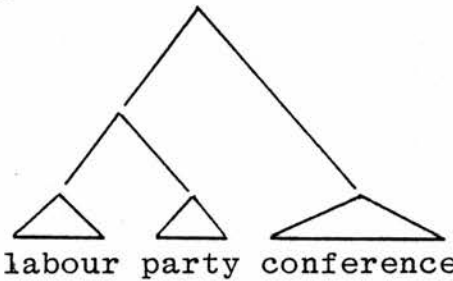

b.

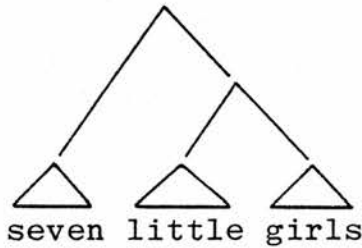

(1.7a) is a particularly clear case. The metrical structure corresponds precisely to the internal structure of the compound; this internal structure may be called syntactic or, under the lexicalist hypothesis, morphological: more on this issue will be said in chapter 3. The situation is very similar in (1.7b): the metrical tree copies the syntactic structure expressed in terms of, say,  $\bar{X}$  syntax (Jackendoff 1977). Let us assume, without going into the details of syntactic analysis, that syntactic structure with exclusively binary branching can be motivated throughout and that, at this level, metrical structure is a copy of a binarily branching syntactic structure.

So much, very briefly, for the overall shape of metrical

trees and the principles according to which they are built. Obviously, a great deal more needs to be said about this aspect of metrical structure. We shan't be able to get away from this question throughout this dissertation, not even in the remainder of this chapter.

What are the principles that govern the distribution of S and W in the metrical tree? Within the (morphologically noncomplex) word, this question has to be divided up into two, partially independent decisions: one concerning the placement of the word's primary stress, the other concerning the establishment of a prominence contour round the primary stress. And neither of the two can be separated from the preceding question, the form of the tree.

I shall argue in chapter 2 that for the placement of primary stress in German words, a rule is responsible that bears many similarities to the English main stress rule. It works from right to left and skips up to two light syllables. It thus assigns the label S to the final, or the penultimate, or the prepenultimate syllable of the word. In the word *Paläozoikum*, the syllable selected by the main stress rule will be the prepenult. The principles of tree construction then determine that this syllable forms a 'foot': a metrical constituent of

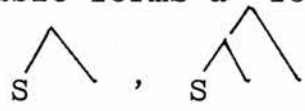
the form  with any material on its right. Similarly, one or more feet are formed with material on the left of the main stress. The roots of the resulting trees are joined.

(1.8)





The reader who is familiar with LP will at this point note an important difference between their approach to the assignment of the main stress and mine. In their account of English word stress, crucial use is made of a binary segmental feature [stress]. This feature is assigned to vowels prior to the erection of word trees and the tree depends on the distribution of [stress] in the string in question. The reason why LP introduce this feature in the first place is that tree structure on its own is not rich enough a notation to capture all the possible prominence contours in English words. Compare *happy* and *rabbi*, *balloon* and *pontoon*. *rabbi* has a final tense vowel which diphthongises in the course of the phonological derivation; *pontoon* has a lax vowel in the first syllable which fails to reduce. To account for both of these phenomena, it is necessary to give some 'residual stress' to the vowels in question. Giving the metrical structures S W and W S, respectively, to *rabbi* and *pontoon* is therefore not sufficient to differentiate all four words. Here is LP's analysis:

(1.9)

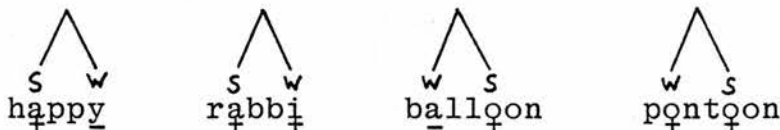

One of the more interesting discoveries presented in chapter 2 below, I think, will be that no segmental stress feature is needed for the metrical analysis of German words. The tree is entirely sufficient and no enrichments of this structure have to be considered. For this reason, I shall not dwell on any of the questions and problems particular to models that do make use of the stress feature; the interested reader is referred to LP and, for further discussion, Kiparsky (1979).

So far we have only accounted for one strength relation in the tree of *Paldozoikum* and that is the one involving the word's main stress (and the sister node of that syllable). In order to be the main stress (or, as it is sometimes called in the literature, the Designated Terminal Element (DTE) of the word), this syllable has to be the strongest in all prominence relations that it figures in; it has to be dominated by S nodes all the way up the tree. We achieve this result, and also the correct placement of a secondary stress on the first syllable of *Paldozoikum*, if we posit a Lexical Category Prominence Rule (LCPR) that makes the right-hand one of two sister nodes strong if it branches. This rule is identical with the one LP propose for English; and like the English LCPR, it holds within the simple word as well as among the constituents of a compound. In brief: the domain of LCPR is any (morpho-)syntactic constituent labelled noun, verb, or adjective but not, as we shall see, constituents labelled as syntactic phrases.

We can now give the complete metrical structure for *Paldozoikum* ((1.10a) below). In (1.10b) I give some examples of English compounds; some German ones follow in (1.10c):

(1.10) a.

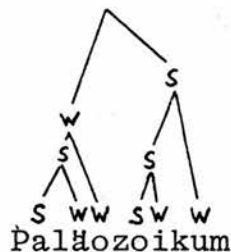

b.

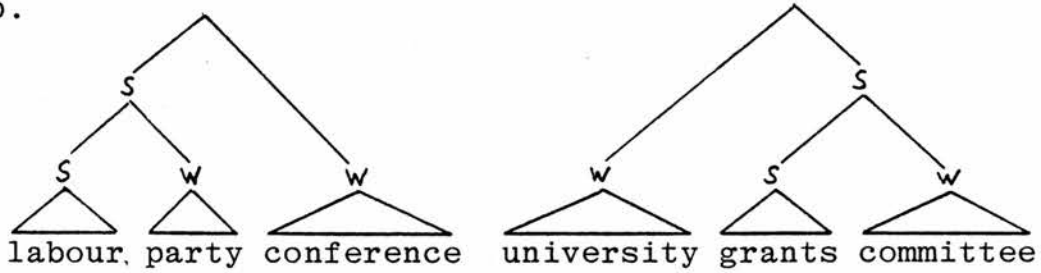

c.

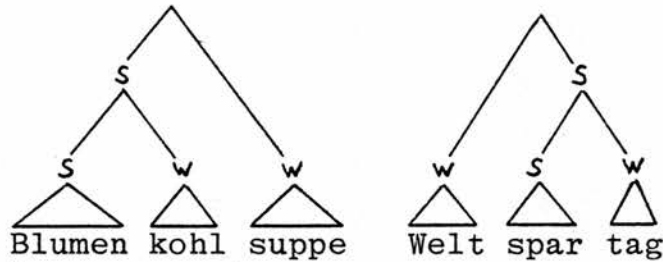

The observation that LCPR holds within single words as well as compound words is one of the most interesting generalisations made by LP. What makes it even more attractive is the fact that it equally works in the analysis of German. However, this generalisation can only be made if a rather important enrichment of metrical structure is made. Let us look at *labour party conference* in more detail:

(1.11) a.

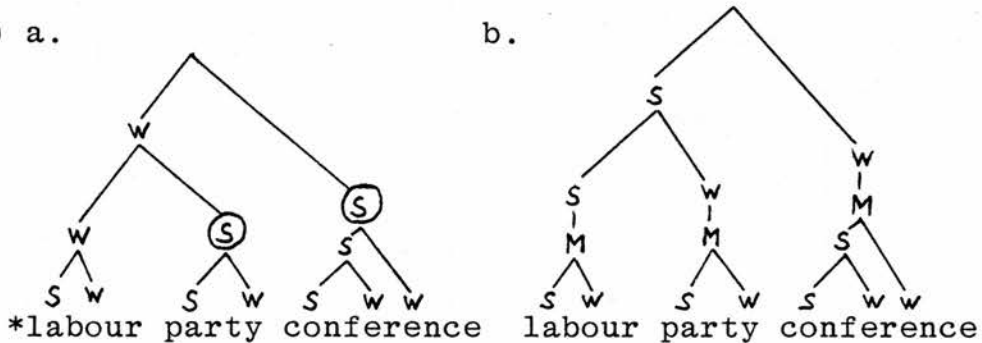

As stated, LCPR produces the metrical structure (1.11a) above. The circled nodes branch; therefore they are strong by virtue of our rule. The trouble is that in order to reflect correctly the perceived prominence pattern of this word, they have to be weak: something seems to be systematically amiss. Again, credit has to go to

LP for discovering a solution to this problem. LCPR correctly determines the prominence relations among the constituent words of a compound if assignment of compound stress is insensitive to word-internal metrical structure. LP solve this problem, and I subscribe to their proposal, by positing a node M (for *mot*) automatically on top of every word tree and by ruling that LCPR be sensitive to branching 'on the same prosodic level' only: above M if applied to compound structure, below M (and above the level of the syllable, but that needn't concern us here) if applied within the simple word. With this provision, made explicit in (1.11b) above, LCPR assigns correct prominence relations in all the compounds that I gave in (1.10).

In a more recent revision of the metrical analysis of English, Selkirk (1980a; 1980b) takes up the idea of 'prosodic levels' like M and additionally introduces, among others, the stress foot and the phonological phrase. The most important one of these is the stress foot: Selkirk claims that by introducing the notion of the stress foot as a phonological prime, the segmental feature [stress], as used by LP and Kiparsky (1979), can be abolished. As for German, it will become clear in chapter 2 that we don't need the stress foot just as we can do without the segmental stress feature. Nor do Selkirk's other prosodic levels come into use anywhere in this study. It is my opinion that the significance of categories like the phonological phrase has been overrated. In chapter 4, where I deal with phrase-level metrical structure, I simply find no evidence for the need of this notion. Wherever notions like the foot or the phonological phrase are of interest in the formalisation of phonological processes, they turn out to be either relationally defined or to coincide with syntactic structure. Along similar lines, Kiparsky (1981) argues that the constituents of the syllable (onset, rhyme,

nucleus, and coda) can be relationally defined in the metrical phonology of the syllable and don't have, as Selkirk proposes, the status of phonological primes. I subscribe to his analysis where I talk about syllable-internal metrical structure.

M, however, is a phonological prime; but it is rather different from the ones that Selkirk proposes. Her stress foot, for example, is an 'absolute prime': it is not derived from any structural properties of the string, phonological, syntactic, or semantic. It simply has to be part of the lexical representation of a given word. M, on the other hand, is a 'phonological prime' in a narrow sense: it is not derived from any phonological properties of the string. I shall argue in chapter 3 that the criteria that we appeal to in assigning M nodes to metrical structures are semantic in nature. In metrical terms, a lexical item is treated as a two-M compound only if the semantic relations that hold between its constituents are transparent. If they are in any way obscured, the item in question is dominated by a single M and has the metrical properties of a noncompound word.

Thus, *tax man* is treated as a motivated compound, with two M nodes in its metrical representation, while *Norman*, in diachronic terms an obscured compound, is of course synchronically a monomorphemic item with one M node in its metrical structure. It is the borderline cases between the two extremes that are interesting. I shall argue, for example, that *milkman* is, for semantic reasons, metrically analysed as a noncompound with one M node only. One of the phonological effects of this analysis is the reduction of the second vowel: *milkman*, too, is an obscured compound in the sense of Faiss (1978).

It is not just the presence or absence of vowel reduction

and other processes of the segmental phonology that crucially depend on the assignment of one or two M nodes in the metrical structure; M nodes also play, as we have seen, a crucial part in the assignment of compound stress patterns. And with respect to these patterns, M receives a lot of attention in this study. To give just one example, the German compound noun *'Hauptbahnhof* has its main stress on the first constituent while *Stadt'bauamt*, superficially rather like the former in its internal structure, stresses the second constituent. *Bahnhof* is, for semantic reasons, dominated by one M node only while *Bauamt* has two M nodes. A metrical analysis that expresses this difference also automatically produces the two distinct stress patterns for *Hauptbahnhof* and *Stadtbauamt*:

(1.12) a.

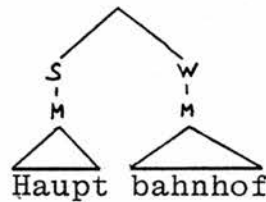

b.

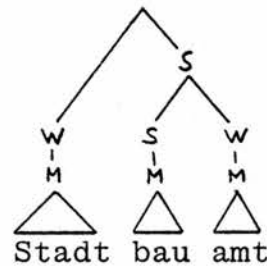

In (1.12b), the metrical tree branches above M; the node dominating *Stadt* is weak according to LCPR. In contrast, the node dominating *Bahnhof* in (1.12a) doesn't branch above M and is therefore weak.

Let us return to metrical structure underneath M. It is assumed in most of the literature on the subject, notably SPE (pp. 16 ff.) that stress rules (wherever in the derivation they are sited) affect all and only members of lexical categories. Thus, SPE automatically assign a primary stress to monosyllabic nouns, verbs, and adjectives. LP form an exception in this tradition: consider a compound noun consisting of two monosyllabic lexical items:

(1.13)

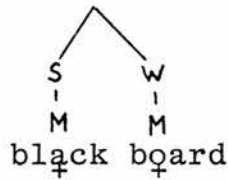

While both constituents have vowels with [+ stress] in their segmental representation, the only metrical structure that LP propose for this compound is in fact the supra-word one; there is no structure between the levels of M and the syllable. Compare now *blackboard* with *rabbi*, analysed in (1.9) above. Apart from the difference in the number of M nodes, the metrical structure as well as the distribution of [stress] is identical in both. SPE, on the other hand, assign the stress patterns 1-2 to a compound and 1-3 to items like *rabbi*. This generalisation - a valid one, it seems to me, despite the objections that we are levelling against the SPE notation - goes uncaptured in LP's model.

So do other generalisations. Nakatani and Shaffer (1978) have observed that monosyllabic lexical items are distinguished from the syllables, stressed or unstressed, of polysyllabic words in terms of greater duration; and Selkirk (1980b) takes account of this observation by automatically assigning a monosyllabic stress foot to monosyllabic lexical items. In her model, M always dominates at least one stress foot. This is an important revision of the metrical model and brings it into line with the lexicalist assumption that the mechanisms assigning prominence relations within the word operate in the lexicon so that, without reference to the labelled bracketing of the syntactic surface structure, all and only lexical items are subject to these mechanisms.

It is, of course, rather difficult to make a relational statement about the prominence of a monosyllabic lexical items and it seems inevitable to lapse back into a 'localist' model of stress of the type proposed by SPE, where a feature is assigned to a vowel in isolation. This is in fact what Selkirk does by automatically assigning a nonbranching stress foot to lexical monosyllables, which by convention 'implies some degree of prominence' (Selkirk 1980b:565). Similarly, we might decide to incorporate Nakatani and Shaffer's observation about the duration of lexical monosyllables into LP's model by generalising that every M node has a certain duration that makes a monosyllabic M distinct from the syllables of a bisyllabic M. But again, this convention would be local in character. Moreover, it would imply the claim that M has direct phonetic correlates. In the model that I am proposing here, M has no such correlates. Its only function is that of demarcating prosodic levels; M is, in that sense, not a 'node' in the proper sense to which local properties can be attributed.

Let us, instead, pursue the idea of making relational statements about the prominence of a lexical monosyllable, odd as this idea might seem. Consider the well-known fact that, in English and German, unstressed syllables in some way hang on to preceding stressed ones and become enclitics. This is probably a generalisation that holds for all 'stress-timed' languages. Thus, we are familiar with *bread'n butter*, *Drinka pinta milka day*, and so forth. Note that this process of cliticisation works across syntactic boundaries and seems, in fact, altogether unrelated to syntactic bracketing.

If we assume, with Abercrombie (1965), that it is a basic property of lexical items to attract enclitics then it is



in fact possible to propose a word-level metrical structure for lexical monosyllables which automatically makes this syllable strong (thus bearing out SPE's and Selkirk's generalisation) and which also motivates cliticisation. Let us state the following well-formedness condition on metrical structure:

(1.14) Strength Provision

Each M dominates at least one  S W.

What does the metrical structure of lexical items look like if this condition is realised, and what innovations does it entail? Consider the examples in (1.15):

(1.15) a.                              b.                              c.

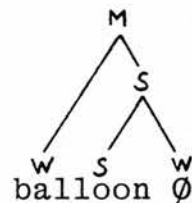
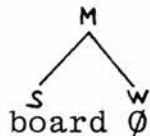
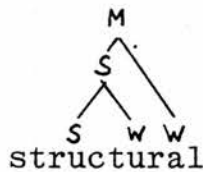

(1.15a) automatically meets the condition if we analyse it in terms of LP: it contains a structure of the required kind anyway. Lexical monosyllables have supra-syllabic structure under the new analysis: (1.15b). Giving them two bottom-level nodes, the left-hand one being strong, allows us to treat prominence relationally even in these items. It could, of course, be said here that I have used a formal trick to achieve this: the right-hand node dominates a zero syllable. But recall that we already have some motivation for this empty syllable as an indicator of duration (Nakatani and Shaffer 1978); shortly, we shall see that it also accounts for encliticisation.

But first consider (1.15c). Condition (1.14) requires

that this word contain an S W foot. The only way of introducing this structure and, at the same time, maintaining the observed prominence among the two syllables is the one chosen in (1.15c); again, the word is followed by a zero syllable. Compare this structure with the one assigned in LP's model, given in (1.9) above. The structure LP offer constitutes an exception to the Lexical Category Prominence Rule: the right-hand node is strong although it doesn't branch. Under the new analysis, the exceptional status is removed from this word.

I won't say more about the impact of provision (1.14) on the metrical analysis of English words. In particular, I leave open the question to what extent this provision may render superfluous the employment of segmental stress features or, alternatively, Selkirk's prosodic levels. Among the many questions that this study leaves unanswered, this is possibly the most interesting one.

Let us turn to the phenomenon of cliticisation that I mentioned above. It seems like a reasonable assumption that *bread and* in *bread'n butter*, *cup of* in *cuppa tea* should form the kind of metrical constituent otherwise characteristic of bisyllabic words: S W. This means that the unstressed syllable that follows the stressed one should automatically form an enclitic. Thus, we want to produce structures like the following:

(1.16)

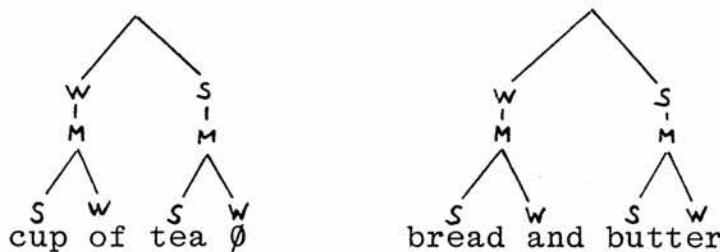

Notice that what has been said about metrical structure so far doesn't actually produce these trees. All I have stated is that metrical structure on the level of the phrase copies syntactic structure and that every M branches in the form  $S \wedge W$ . This would produce (1.17):

(1.17)

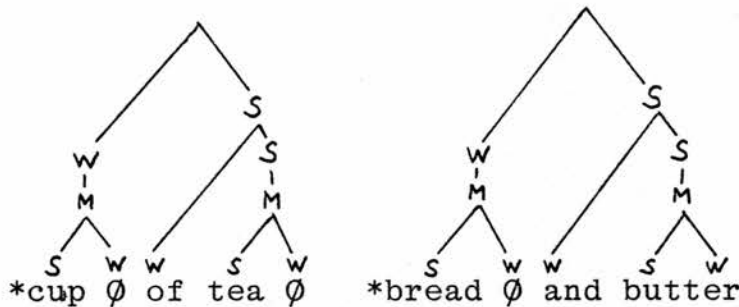

Clearly, this is not what we want. In order to produce (1.16) and rule out (1.17) we need to posit another well-formedness condition on metrical structure, one that restricts the environments in which zero syllable are allowed to occur. The condition, I suggest, should read like this:

(1.18) Zero Syllable Constraint

Of two adjacent terminal W nodes, neither occupies a zero syllable.

This well-formedness condition has the automatic effect of cliticisation. Whenever a nonzero terminal W node follows a terminal S, it will form an enclitic; only in the absence of such a syllable can we get zero syllables. And since conditions (1.14) and (1.18) have the joint effect of ruling out  $W \wedge S$  structures on the terminal level altogether, our model quite naturally bears out the claim frequently found in the literature that there are no proclitics in English, only enclitics (Abercrombie 1965: Selkirk 1972).

What is the background for this claim? English and German are said to be stress-timed languages (Pike 1946; Abercrombie 1967; 1976; Roach 1982): stressed syllables tend to recur, in connected speech, at roughly isochronous intervals. I shall review the literature on this subject in some more detail in chapter 4; for our present purposes this statement will do. Speech is thus divided up into 'feet', where each foot begins at the onset of a stressed syllable and ends just before the onset of the next one. Foot boundaries are prosodic boundaries.

The foot, as I mentioned before, is a phonological constituent, which figures recurrently in the structural descriptions of processes in the segmental phonology. The flapping of alveolar stops in some English dialects, for example, can be attributed (in part) to their foot-medial position (Anderson and Ewen, forthcoming). In this model, the foot is a particularly clear example of a relationally defined constituent: it is simply any configuration of

the form  $\begin{array}{c} \diagup \\ S \quad W \\ \diagdown \end{array}$ ,  $\begin{array}{c} S \\ \diagup \quad \diagdown \\ S \quad W \quad W \end{array}$ . The need to introduce the foot as a phonological prime does not arise. What is also implied in the claim of foot isochrony in English is that monosyllabic feet have roughly the same duration as bisyllabic ones. In our model, this is borne out in the feature that both monosyllabic and bisyllabic feet share the structure  $\begin{array}{c} \diagup \\ S \quad W \\ \diagdown \end{array}$ . Compare the structures given in (1.16) above and (1.19):

(1.19)

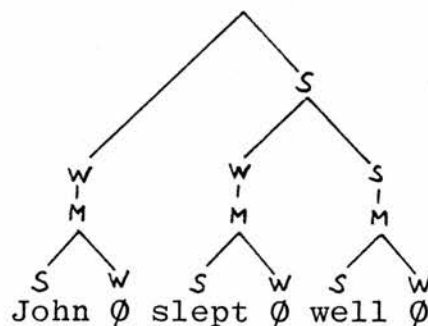

Unstressed syllables get encliticised; zero syllables occur only in feet that don't contain unstressed syllables. Common to both structures is the occurrence of  $\overset{\wedge}{S} W$  feet. The zero syllable represents the pause, or the lengthening of the stressed syllable, characteristic of monosyllabic feet. (1.16) and (1.19) are motivated by the specific type of rhythmic organisation ('stress-timing') found in English and German.

This observation has further consequences for metrical structure. If zero syllables have the phonetic motivation that I've been claiming they have, then structures with adjacent terminal S nodes (without intervening zero syllables) should either not get produced or, if they are produced, there should be some objective way in which the claim that they are unpopular for performance can be substantiated. A lot of what I have to say in chapter 4 concerns this issue. The metrical phonology of German is such that through certain processes of word formation, structures with adjacent terminal S nodes can be produced;

$\overset{\wedge}{S} S W$  is the only structure of this kind that our constraints on metrical trees permit. And significantly, it is exactly this structure, and no other metrical structure, that undergoes transformations producing a rhythmically alternating output, thus doing away with awkward adjacent S nodes. The degree to which mechanisms seem to exist in the metrical phonologies of German and English that bring about prominence shifts in order to avoid this kind of configuration provides us, it seems to me, with excellent backing for the notion of the zero syllable.

The notion of 'metrical transformation' is the sole concern of chapter 4. What are the general properties of such transformations, and at what point of the derivation are they sited? If we assume that word-level metrical struct-

ure, possibly including the metrical structure of compounds, gets erected in the lexicon, then it is also reasonable to assume that phrasal stress gets assigned soon after the completion of the syntactic surface structure. The phrasal stress rule for English is rather simple: of two metrical sister nodes, the right-hand one is strong. Examples are given in (1.20) below; note that this rule was also applied in (1.19) above.

(1.20)

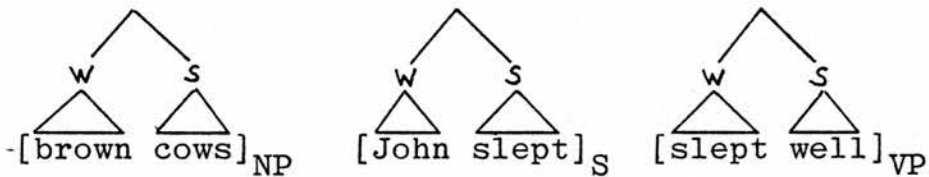

This rule, working on the binary branching of the syntactic surface, assigns prominence relations throughout any given syntactic domain up to, presumably, the node S(entence). It makes reference to the syntactic category labels and replaces them with strength relations.

There are various aspects in which the metrical structures thus produced can be shown to be rather ill-suited for performance, given principles like 'stress-timing' that govern performance in English and German. Metrical processes in the lexicon may have produced adjacent terminal S nodes; there may be long stretches of linguistic material without rhythmic alternation; there may be too many monosyllabic feet. The bi- or trisyllabic foot, with higher-level rhythmic alternation on the beats of feet, seems to be the metrical pattern best suited for fluent performance. Just as the absence of zero syllables between terminal S nodes indicates pressure for change, so does their presence in certain contexts: there is a strong tendency to convert monosyllabic feet into bisyllabic ones.

This is where metrical transformations come in. I shall outline in chapter 4 a 'metrical component' for the grammars of English and German which takes as input the metrical structures produced through the application of word-level rules and the phrasal stress rule. This structure then undergoes a series of transformations which, step by step, produce structures that conform with the principles of rhythmic performance. The necessity of such processes was observed in SPE (pp. 371 f.), where Readjustment Rules were suggested (elaborated by Langendoen 1975) that perform a similar task. Langendoen's Readjustment Rules re-arrange the labelled bracketing of the syntactic surface structure in such a way that multiply embedded constructions gets transformed into parallel constituents. A syntactic structure of the type [W[X[Y[Z]]]] gets re-bracketed as [[WX][YZ]]. With this adjusted syntactic structure, the string in question then enters into the phonological component, where the stress cycle produces rhythmically alternating stress numbers.

Under the present model, Readjustment Rules of this kind become superfluous. The syntactic structure enters into the metrical component without previous adjustments; the pairing of parallel constituents (among other things) is done by metrical transformations.

What the structures produced in the metrical component have in common is the fact that they make reference to the syntax but, in the course of the derivation, become more and more remote from syntactic structure. One instance where metrical structure differs from syntactic structure I have already referred to: recall the enclitics in (1.6) above. More, and more drastic, instances of basically the same kind of phenomenon will be found in chapter 4.

In summary, I shall assume in the following chapters that

word-level metrical structure originates in the lexicon, that phrase-level metrical structure is produced after the completion of the syntactic surface structure and that the total of the two then undergoes a series of changes in a separate metrical component. I shall also assume that the metrical structure which eventually undergoes phonetic interpretation is completed before the rules of the segmental phonology come into operation. This latter assumption, however, will not be defended in this study.

Let me conclude this introduction by expressing some thoughts on the fourth question I raised above: how are metrical structures interpreted phonetically? It would be necessary at this point to discuss the various phonetic parameters that reflect 'stress levels' in speech: pitch, duration, loudness, and so forth. These are the parameters, I assume, that the metrical structure is ultimately mapped on if metrical structure is assumed to be fully part of a model of speech production. This, however, doesn't necessarily have to be the case, as SPE (p. 25) argue:

... there is little reason to suppose that the perceived stress contour must represent some physical property of the utterance in a point-by-point fashion; a speaker ... should "hear" the stress contour of the utterance that he perceives and understands, whether or not it is physically present in any detail. In fact, there is no evidence from experimental phonetics to suggest that these contours are actually present as physical properties of utterances in anything like the detail with which they are perceived.

I shall not embark on a discussion of this position. It is, however, at least a helpful preliminary to such a discussion to wonder about the extent to which, in any given metrical representation, possible strength relations among syllables are actually expressed. Take, for example, a trisyllabic string with the syllables A, B,



C and assume for it the metrical structure given in (1.21):

(1.21)

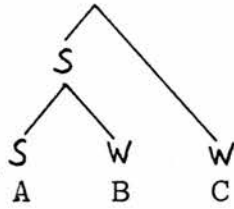

LP claim possession of an algorithm that converts any metrical representation into a sequence of numerical stress levels. Here it is:

(1.22) If a terminal node  $t$  is labelled  $\underline{w}$ , its stress number is equal to the number of nodes that dominate it, plus one. If a terminal node  $t$  is labelled  $\underline{s}$ , its stress number is equal to the number of nodes that dominate the lowest  $\underline{w}$  dominating  $\underline{t}$ , plus one.

(LP, p. 259)

Applied to the structure in (1.21) above, this algorithm produces the sequence of stress levels 1-3-2. But are there actually as many defined prominence relations in the tree as this sequence of levels suggests? Does metrical structure warrant the extraction of information as rich as that? Let us look at the strength relations that the tree in (1.21) expresses. A is stronger than B. [AB] is stronger than C but whether both A and B are stronger than C, or whether A is stronger and B is weaker than C as the algorithm implies, is not actually stated in the tree. This means that any algorithm that produces 1-3-2 for the structure (1.21) begs the question of what the empirical motivation is for doing so. The tree structure expresses the strength relations  $A > B$ ,  $A > C$  but does not inherently define a relation between B and C. We must ask ourselves whether we have any

principled reasons to claim that via some additional convention, contained in the algorithm, the structure in (1.21) expresses a strength relation between B and C.

I see no reason why such a claim should be supported, and I am not the first one to point out this problem of LP's algorithm. Carlson (1978), Hayes (1981), and Kiparsky (1981) argue that LP's proposal is overly differentiated and adopt, instead, the following weaker convention for the interpretation of metrical trees:

- (1.23) The beat of a subtree labelled S is stronger than the beat of its sister subtree labelled W,

(Kiparsky 1981:245)

where the 'beat' of a subtree is the DTE of this subtree. Here is another example, borrowed from Kiparsky (1981), that should make clear the rather more limited scope of this new convention. Assume that a string consisting of the syllables A, B, C, D have the following metrical structure:

- (1.24)

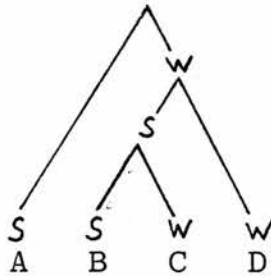

Prominence relations hold in this structure in such a way that A is stronger than [BCD], B is stronger than C, and [BC] is stronger than D. These relations can, with the aid of the new convention (1.23), be itemised like this:  $A > B$ ,  $A > C$ ,  $A > D$ ,  $B > C$ , and  $B > D$ . No relation is assumed to hold between C and D. It is therefore impossible for any algorithm, given the interpretive convention

(1.23), to determine stress levels for each one of the syllables in (1.24). Note that LP's algorithm produces in this case 1-2-4-3. In the presence of convention (1.23), however, there is nothing to rule out the readings 1-2-3-4 and 1-2-3-3.

It should be the aim of any inquiry into metrical structure to eliminate, as far as is possible and actually desirable, areas of undetermined strength relations. Of two possible analyses, the one is superior that is more highly structured (if the structure that it reflects is actually attested phonetically). This simple principle has in the past not always been observed; notably LP and Kiparsky (1979) are at fault in this respect. (To be fair, note that both papers were published before (1.23) was first proposed; both authors felt it possible to extract more information from metrical trees than we now consider justified.)

Kiparsky (1979) attacks LP's analysis of *sensationality*, which I give in (1.25a) below, and defends instead an analysis that assigns metrical structure cyclically, resulting in (1.25b). I am not bothered here with the question of whether metrical structure assignment in English ought to be cyclic or not; what interests me is the end-result of LP's and Kiparsky's respective derivations and how they interpret it.

(1.25) a. LP

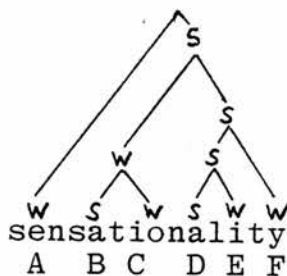

b. Kiparsky

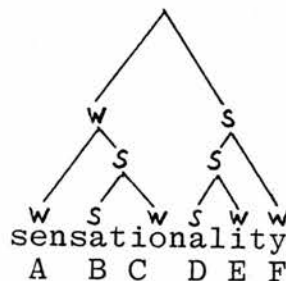

Element D is the DTE in both analyses, thus far they agree. In (1.25a), A, B, C, E, and F are all weaker than D and C is weaker than B. In Kiparsky's analysis (1.25b), A, B, C, E, and F are weaker than D but both A and C are weaker than B. Under convention (1.23), Kiparsky's analysis is more richly structured than LP's in that it establishes a strength relation between A and B. Let us assume that this relation is, along with the ones that the two proposals have in common, observationally adequate.

Relying on the algorithm that I gave in (1.22), Kiparsky then proceeds to argue against (1.25a) by rejecting on empirical grounds the pattern that the algorithm produces for this structure: 2-3-4-1-4-3. For his own structure, the algorithm gives 3-2-4-1-4-3. The algorithm is, of course, excessively productive and cannot therefore be relied on in the evaluation of tree structures; I have made this point above. Nevertheless, Kiparsky is right in preferring his own tree to the one LP propose, if on different grounds: LP's structure, in the presence of convention (1.23), fails to determine the placement of the secondary stress of the word; with the interpretation of metrical structure adequately constrained, there is no way of telling whether A is stronger than B or B is stronger than A. Kiparsky's tree doesn't have this problem.

And if it was indeed A that was empirically the stronger of the two - disregarding for the moment that the phonetics seems to go against this - then we would be faced with the extremely awkward situation where a terminal W node has a higher stress level than a terminal S node. There is nothing in the structure of the algorithm to prevent this; the problem rests in the nature of LP's model.

The reader will by now have noticed how problematic an algorithm is that converts a metrical representation into numerical stress levels. Firstly, it was precisely because of the problems that a numerical representation of stress levels faces anyway that hierarchic models were proposed. Why then go back to numbers when the question of interpretation arises? Secondly, the algorithm proposed by LP fails because the metrical tree cannot be claimed to contain as much information as the algorithm is able to extract. And if this algorithm is stripped of its excessive power, it doesn't really do anything any more, apart from handling terminal S nodes and their terminal weak sisters. A dispute of the observational adequacy of either (1.25a) or (1.25b) is meaningless if it is based on stress numbers.

In my analysis of German word stress in chapter 2 I shall, therefore, not appeal to any conversion of tree structure into numbers. I shall concern myself with the placement of the DTE and with the placement of subordinate stresses which are undistinguished amongst themselves, thus basically returning to the traditional concept of word stress used, for example, by Jones (1964; 1977) and Gimson (1980). Three levels of stress are distinguished: full stress, subordinate stress, and no stress. All stresses, full and subordinate, have terminal S nodes in the model that I shall propose; the main stress of the word (the DTE) is dominated by S nodes all the way up the word tree.

This restriction, I realise, robs me of the means to evaluate in observational terms the structures in (1.25) with respect to each other. But I feel justified in making this rather more modest claim of what metrical structure ought to express, for three reasons. First, because whatever means have been used to distinguish

observationally the structures in (1.25) are in themselves inadequate anyway and nothing better has been (and, I suspect, can be) suggested. Second, I believe that distinctions in the word finer than the ones I use are phonetically unrealistic.

Third, and this is the main reason. Giving a terminal S node to each syllable that has (some degree of) prominence will enable us to make local reference to metrical structure in the statement of rules that control processes in the segmental phonology. I shall demonstrate in section 2.2.5, for example, that the length of vowels in German is to some extent governed by suprasegmental structure: vowels can only be long if they have some degree of prominence - in terms of this model: if the syllable that contains them carries a terminal S node.

Generalisations like that are impossible to make in LP's (and, by implication, Kiparsky's 1979) model. If a model of metrical structure requires (or permits) for its interpretation an algorithm which potentially gives a terminal W node a 'higher degree of stress' than a terminal S node, then the terminal nodes must needs be unavailable for local reference by phonological processes. LP don't have this problem, of course: for them, the segmental stress feature is available for such reference; recall, for example, that in *rabbi* the diphthongisation of the final vowel is triggered by the segmental stress feature and not by metrical structure.

The absence of a segmental stress feature in the model of German word stress that I shall defend below clearly requires that metrical structure be available for local reference. This requirement constrains rather drastically the number of possible metrical trees for any given word. And as a result of the preceding, rather lengthy,

discussion of how to interpret metrical structures, we now have some idea of the extent to which the power of a metrical phonology gets curtailed if [stress] as a segmental feature is abolished.

The preceding pages were designed to perform two tasks. I intended to make explicit the main assumptions as well as the characteristics inherent in any metrical phonology of any language. And I tried to acquaint the reader with the particular model that I shall be advocating in the following chapters. As all this was meant to be (nothing but) an introduction to what is still to come, a lot of what I said will have lacked conclusiveness or, worse still, will have been completely obscure. I hope this will change for the better before the end of chapter 4.

## Chapter 2

### Metrical structure and morphology, part 1: the metrical structure of German words

#### 2.1 The metrical structure of nonnative words

##### 2.1.1. The location of primary stress

Ever since the advent of SPE linguists have known what regularities to look for in the stress patterns of certain 'European' polysyllabic words. Along with the lexical items themselves, a Latinate stress rule has entered into the borrowing Germanic language, which distributes primary stress in a way familiar to the reader of SPE, making reference to certain vowel features, sometimes called tenseness (SPE), sometimes length (LP), as well as the placement of syllable boundaries (Anderson and Jones 1977). Compare *América*, *aróma*, and *veránda* as results of SPE's main stress rule.

One of the reasons for the survival of this Latinate stress rule, and indeed for its productivity, may be its compatibility with native Germanic vocabulary. Note that the SPE rule copes with native and nonnative words alike and no such distinction has to be maintained in the phonology of English. As for German, this question will be taken up again after more central issues have been discussed. By drawing this distinction throughout the best part of the present chapter, I follow what seems to be a reasonable expository strategy rather than making rash assumptions about the phonological structure of German. Let us see, then, where the main stress falls in German words.



### 2.1.1.1 Final stress

The bulk of the data with final stress have either 'long' vowels (or 'tense' vowels: this is another problem that will be taken up later - see section 2.1.5) in their final syllables, or short vowels plus consonant clusters, regardless of whether they are nouns or adjectives. Examples are given in (2.1) and (2.2) below, respectively; some exceptions are listed in (2.3).

- (2.1) Magazin, Disziplin, Miliz, Indiz, Offizier, Konsum, Paket, Dekan, Moral, Fraktion, Rasur, Skandal, Salat, Fasan, Organ, Ökonom, Peru, Büro, Chemie, Trikot, Allee, Frikassee; konfus, solid, abstrus, naiv.
- (2.2) Konzert, Konzept, Infarkt, Instanz, Instinkt, Talent, Element, Präsent, Präsenz; korrupt, korpulent, abstrakt, intakt, präsent, grotesk, rasant.
- (2.3) Metall, Pedell, Rebell, Diagramm, Fagott, Kompott, Schafott, Skelett, Prozeß, Regreß, Kongreß, Katarrh, Tyrann, Galopp, Hotel, Karussell, Duell.

The items listed in (2.1) and (2.2) are fairly straightforward; a formal statement doesn't need to be given before some more data has been discussed.

As for the exceptions to the final-stress rule, given in (2.3), where final stress gets assigned in the absence of either a long vowel or a consonant cluster, it seems obvious that, in line with SPE tradition, some lexical representation should be chosen for the items in question which does meet the input requirements for the rule that handles (2.1) and (2.2). Representing

idiosyncrasies like this one in terms of lexical representations seems preferable to stating messy rules or operating with exception features. Thus, SPE (pp. 82 f.) operate with underlyingly geminate consonants in cases like *morbillous* in contrast to *céphalous*. The single vs. geminate contrast then accounts for the difference in stress placement (also Anderson and Jones 1977). In the absence of phonetic evidence for this contrast outwith the area of stress placement, these authors put up with absolute neutralisation for the sake of elegance where the rules of the phonology are concerned.

If we pursue the same idea for our treatment of stress in German, we might be in a position rather better than that. Von Essen (1979:173 f.) argues that it does make sense, on purely phonetic grounds, to speak of geminate consonants in Modern German (especially in dialects like Swiss and Baltic German). There would thus appear to be some phonetic evidence that might be held against the accusation of absolute neutralisation. Moreover, Von Essen points out that geminate consonant clusters following short vowels - and this would be the context in which they occur - are ambisyllabic, compare *Rate* and *Ratte*, *Gote* and *Fagotte* etc. I shall discuss gemination and ambisyllabicity in greater detail, if rather tentatively, in section 2.2.3 below. Suffice it to say at this point that there seems to be some sense in talking about geminate consonants for the reasons given above. Although a more detailed investigation will have to wait until later, I feel rather safe in regarding the problem that shows up in the data in (2.3) above as solved, or at least solvable, especially since the objections that Benware (1980b) raises against gemination rather work as arguments in its favour: Benware rejects gemination but then proceeds to assign final stress to the words in (2.3) on the basis of their double consonant spellings(!),

which, according to Von Essen (1979:174) is a reliable indicator of phonological geminates in all instances.

#### 2.1.2.2 Penultimate stress

The reader may have noticed that the data given in (2.1) to (2.3) above almost exclusively consists of morphologically simple items: the list contains no derivations via suffix with final stress (as *Dekanat*, *Prokurist* etc.); nor are there words that have inflexional endings added on to them. The exclusion of the former class will below turn out to be an arbitrary decision; it will turn out that derived items of this kind follow the rule that we are here developing just like simple words do. Nevertheless, the fact that this is so will be interesting enough to merit a special section devoted to these cases: it tells us a great deal about the organisation of the lexicon.

As for the latter, the absence of inflected forms in (2.1) to (2.3) is not really surprising. Inflexional endings in German rarely consist of segmental sequences that we can expect to attract stress, given what we know by now about the placement of final stress. Exceptions are the present participle, e.g. *marschier+end*, and the superlative, e.g. *korrump+est*, both ending in consonant clusters. And what is more telling, no inflexional ending in German ever bears stress. I shall argue below that these endings are not present in the shape of strings of segments at the point of the derivation where metrical structure gets erected on simple words. For that reason they cannot possibly get stress whatever their segmental make-up may be; they are, in a sense, 'extrametrical', or 'unstressable' in terms of

Wurzel (1970a; 1980) and Benware (1980b). Characteristically, any vowel contained in German inflexional morphemes will always be shwa.

There is, however, a class of endings in nonnative words which are inflexional endings in their native language, notably *-us*, *-a*, *-um* in Latin loans, *-o*, *-i* in Italian ones and such like. Under the model proposed here, these morphemes are part of the derivational morphology of German in such a way that they are present when metrical structure gets erected. Native inflexional endings, containing shwa if they constitute syllables, are not.

In (2.4) and (2.5) below are listed such items which are probably monomorphemic and have penultimate stress:

(2.4) Amok, Arrak, Atlas, Fazit, Herpes, Konsul, Kognak, Slalom, Tēnor, Limes, Kustos.

(2.5) Baby, Gummi, Hobby, Nazi, Profi, Auto, Akku.

The examples given in (2.6) and (2.7) below contain the nonnative inflexions mentioned above. It will be seen shortly that the rules of stress operate when these morphemes are present.

(2.6) Franziskus, Chiasmus, Orgasmus, Organismus, Epidermis, Logarithmus, Epitaxis, Epos.

(2.7) Angina, Arena, Korona, Konto, Saldo, Dementi, Esperanto, Agenda, Veranda.

Regardless of internal morphological structure, the examples given in (2.4) to (2.7) now allow a new generalisation. A short vowel - (2.5) and (2.7) - which is optionally followed by not more than one consonant - (2.4) and (2.6) - constitutes a syllable that gets skipped in right-to-left stress assignment, Latin style.

Formally speaking, this means that the environment for a word's main stress as displayed in (2.1) to (2.7) is something like this:

$$\text{---} ( [ \begin{array}{c} \text{V} \\ - \text{long} \end{array} ] \text{C}_0^1 ) ]$$

But there are some regularities in this set of data which suggest that there is more to it. Note that the syllables that do receive stress are, without exception, either of the type short vowel plus two consonants, or contain a long vowel. Interestingly, this observation holds true for bisyllabic words as well as those with three or more syllables. It will be seen presently that this is no coincidence.

#### 2.1.1.3 Prepenultimate stress

To establish the last expansion of our rule that predicts the placement of primary stress, consider the following words:

- (2.8) Drosophila, Harmonika, Idiotikon, Pandæmonium, Kompositum, Uvula, Uterus, Claudius.
- (2.9) Akkordeon, Homunkulus, Polyptoton, Analeptikon, Lexikon, Onomastikon, Opuskulum, Ultima.

It is, once again, quite obvious that the penultimate syllable, if it is to be skipped by the stress rule, must contain a short vowel and not more than one consonant. This is, as could be expected, exactly in line with the main stress rule for English, proposed in SPE. The vexed question whether the final syllable constitutes a morpheme of the type discussed in the previous section doesn't appear to be of importance again; we therefore don't need to specify a morpheme boundary in the right-

hand environment for primary stress. Here is a formal statement of this environment:

(2.10) Primary stress

$$\text{---} \left( \left( \begin{bmatrix} \text{V} \\ - \text{long} \end{bmatrix} C_0^1 \right) \begin{bmatrix} \text{V} \\ - \text{long} \end{bmatrix} C_0^1 \right)$$

Notice that, in the examples discussed so far, the syllable that bears the primary stress is heavy. Apart from the examples (2.1) to (2.3), where the stress rule requires it to be the case, this also holds for cases where the stress rule doesn't require it, as in (2.6) and (2.7) as well as (2.8) and (2.9). There are a few exceptions to this observation, listed in (2.11):

(2.11) Análysis, Génesis, Metáthesis, Antídoton,  
Viola, Bálatá.

Interestingly, these items, stressed on short prepenultimate vowels, are unstable and alternate with forms stressed on long penultimate vowels, e.g. *Analýse*, *Genése*, etc. *Antidoton* alternates with *Antidót*. I shall discuss these, naturally in connection with their morphological alternations, in a later section. For our present purposes, clearly, we can call them exceptions and record that, as a rule, all syllables bearing primary stress are heavy while those that don't are light.

Now this distribution of syllable quantity is either a massive coincidence (which I would prefer to rule out), or it is a direct consequence of (some aspect of) the phonological structure of these words. Indeed, it will be shown later how the quantity of vowels in open syllables is governed by metrical structure. We shall leave this question, not relevant to the present discussion, for the time being.

2.1.2 Primary stress in Class I suffixes

German derivational morphology employs both native and nonnative suffixes. Benware (1980b), on whose data the inventory below is based, recognises that native suffixes don't attract primary stress whereas many of the nonnative ones do. I shall in what follows, once again, draw this distinction without assuming that we will eventually end up with a feature [native] as a formal dichotomiser.

## (2.12) Native suffixes

-chen, -ler, -heit, -(ig)keit, -isch, -lein,  
-ling, -los, -bar, -mäßig, -nis, -sam,  
-schaft, -ung, -tum, -sel.

## (2.13) Nonnative unstressed suffixes

-ian, -ien, -ier, -is, -iter, -us, -a, -um,  
-o, -i.  
-or (unstressed only word-finally, cf. *Senatören*)  
-ik (unstressed in certain environments, cf.  
*Musik*)

## (2.14) Nonnative stressed suffixes

-ábel	variabel	-euse	Friseuse
-age	Kolportage	-iáde	Olympiade
-(i)al	bronchial	-íbel	kompressibel
-and	Habilitand	-ie	Apathie
-ant	Musikant	-ier-	musizieren
-anz	Ignoranz	-ik	Mathematik (cp.(2.13))
-ar	Archivar	-ine	Blondine
-är	Funktionär	-iön	Inspektion
-at	Dekanat	-ist	Essayist
-ell	funktionell	-ität	Solidarität
-ement	Arrangement	-iv	ultimativ
-end	Subtrahend	-oid	schizoid
-ei	Barbarei	-oş/-ös	dubois/ruinös
-ent	Korrespondent	-uál	prozessual
-enz	Korrespondenz	-uéll	sexuell
-esk	balladesk	-ur	Dozentur

In this section I shall investigate in detail the non-native suffixes only; the native ones will be looked at later. The reason for this is that the behaviour of the two classes is systematically different.

Members of the native class (2.12) evidently fail to attract primary stress, and this despite their segmental composition: *-icht*, *-heit*, *-lein*, for example, would get the main stress if we gave the stress rule with the environment (1.10) a chance to apply to them. The non-native suffixes, on the other hand, follow this stress rule without fail. This rather suggests that suffixation happens in German in two stages, before the application of the stress rule and after. The same proposal was made for English by Siegel (1974), and considerable time will be spent in the remainder of this study to elaborate this idea. But let us first look more closely at those suffixes that undergo the stress rule.

Stress on the suffixes in (2.14) is predicted by (2.10): the stressed vowel in each item on the list is either long, as in *-ābel*, *-ār*, *-ei* etc., or it is followed by two consonants, *-end* *-esk* *-and* for example. In *-ell* I assume the presence of a geminate consonant. Conversely, the stress rule predicts correctly for the suffixes in (2.13) above that they are unstressed. They all consist of one or two light syllables, which get skipped in right-to-left stress assignment.

Let us assume, then, that derivation via this kind of suffix takes place in the lexicon before stress is assigned. Henceforth, I shall call the suffixes in (2.13) and (2.14) above Class I suffixes, assuming with Siegel (1974) that there are two systematically different classes of suffixes. I shall turn to Class II suffixes in section 2.2.4 below.



Like in English, the Class I suffixes discussed here attach to words and stems: compare *Ignor+anz*, where [*Ignor*] is a stem which doesn't carry boundary symbols or lexical category labels, and *Archiv+ar*, [#Archiv#]<sub>N</sub> being a word with boundary symbols and category specification. Suffixes are specified in the lexicon with respect to the kind of item they attach to.

Another interesting point can be raised here which backs our assumption about the ordering of Class I suffixation with respect to stress assignment. German words have stress patterns if they surface underived which are systematically different from the ones they have in Class I derivations. Compare *Archív* and *Àrchivár*, *Dekán* and *Đekanát*. There are, it seems to me, two possibilities for dealing with this phenomenon. Firstly, we could adopt a model in which *Archiv* has suprasegmental structure, which gets modified, possibly in a cyclic fashion as Kiparsky (1979) suggests for English, after morphological derivation has taken place, thus shifting the main stress onto the suffix. This implies, of course, that stress assignment has to take place twice: once before, once after Class I suffixation. There is no evidence for this in German.

I shall demonstrate in the two sections that follow that Class I derivations of the type word plus suffix have in their suprasegmental structure no trace of the suprasegmental structure which the single word contained in them displays in isolation. Moreover, no Class I suffix requires information, for its distribution, about the suprasegmental structure of the embedded simplex, so that any assignment of stress before Class I suffixation seems utterly pointless. I shall therefore argue for a much simpler alternative model which assigns stress in the lexicon after Class I suffixation has taken place, to

items which have been subjected to this kind of word formation and to those that haven't alike. This means that *Archiv* has no suprasegmental structure when *-ar* gets attached to it.

### 2.1.3 The metrical structure of simple nonnative words

Let us go back to the nonderived words listed in (2.1) to (2.9) above. We have managed, so far, to predict the placement of these words' main stresses. It is common knowledge in phonology, however, that words, just as phrases, have stress contours through which syllables are not only characterised by the presence or absence of ('primary', if this term isn't redundant in this context) stress but by various degrees of prominence. Benware (1980b) doesn't concern himself with anything but the location of primary stress within the word; Wurzel (1980), in the model of a somewhat watered-down SPE, assigns a numerical stress feature to each vowel, though in a fashion that is formally suspect even in comparison with SPE. Take, for example, his last rule: 'a vowel in a nonnative morpheme which has not yet been assigned stress receives [2 stress].' (Wurzel 1980: 306) Allowing this kind of rule means abandoning one of the more appealing features of SPE, the restriction that only [1 stress] be assigned by rule and that all lower stress levels be produced through the cycle (in connection with a Stress Lowering Convention).

Furthermore, it seems to me that Wurzel's distribution of subordinate word stress is far too generous in terms of relative stress levels, for example: *Chémte*,  
*póstálish*, *gástlerén*, *Törnádó*, *Músikér*. I simply find this degree of finesse unrealistic; I don't hear a

difference between the prominence patterns of *postalisch* and *Tornado*; and even in *gastieren* I register that the final syllable contains a shwa but I don't find this vowel particularly less 'stressed' (whatever that means) than *-isch* in *postalisch*. I suspect, with other authors in the field (cf. Schane 1979), that what we really ought to be talking about when we make distinctions as fine as these is a variety of segmental phenomena - vowel reduction, shortening, lengthening and such like - which may depend on certain prominence structures (among other factors) but which don't constitute these prominence structures.

This is not just a notational alternative; it seems to me that there is more to it. To give an example: the difference in  $p\overset{2}{o}st\overset{1}{a}l\overset{3}{i}sch$  and  $g\overset{2}{a}st\overset{1}{i}er\overset{0}{e}n$  is brought about in Wurzel's terms by a rule which says that /ε/ receives [0 stress] if it occurs, among other locations, in a suffix (Wurzel 1980: 302 f.). Other vowels in suffixes don't get [0 stress]. Only /ε/ can reduce. Now, clearly, the perceived difference between the two syllables in question is one of vowel reduction and not of prominence. And it's the quality of the underlying vowel that brings that about, not the prominence structure.

Having said that, I don't need to point out any more that the prominence structures that I shall propose below will be rather less rich than Wurzel's.

The formal model that I shall employ in the analysis of German prominence patterns will be the one outlined in the introductory chapter 1. Apart from the binary strength relations that hold between phonological constituents, I wish to remind the reader of a well-formedness condition on metrical structure that we called Strength Provision (1.14), thanks to which every lexical

item contains at least one structure of the form  $S \wedge W$ , that is, a bisyllabic foot. Through this condition a bisyllabic item with final stress will have the metrical structure (2.15b) rather than (2.15a):

(2.15) a.



b.

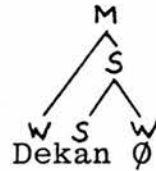

The terminal S node of  $-\bar{a}n$ , in (2.15b), is determined by the internal structure of that syllable, as an effect of the stress rule that we developed in the preceding sections. This rule can now be fully spelled out.

(2.16) Main Stress Rule

$$v \rightarrow \overset{S}{\underset{V}{\vee}} / \text{--- } C_0 \left( \left( \left[ \begin{array}{c} V \\ - \text{long} \end{array} \right] C_0^1 \right) \left[ \begin{array}{c} V \\ - \text{long} \end{array} \right] C_0^1 \right)$$

The rightmost terminal S node may be followed by one or two light syllables only. Without the parentheses, (2.16) correctly predicts a terminal S node on the final syllables of *Dekan*, *Talent*, *korrupt*, *Paket*, *Rasur*, *Skandal*, *Salat* etc., in each case followed by a zero syllable as a right-hand weak sister of that S node, through Strength Provision (1.14). The Main Stress Rule (2.16) predicts the placement of the terminal S node in (2.15) above. Some principle of tree construction, to be discussed shortly, is responsible for the higher-level S and its weak sister. The terminal W node at the end is able to accommodate a zero syllable or, alternatively, additional syllables (provided they aren't stressed Class I suffixes). /-ə/, /-ən/ plural allomorphs fit in there, for example, without bringing about any changes in the metrical

structure:

(2.17)



As can be expected, the metrical structure of trisyllabic items where (2.16) predicts penultimate stress is the same, so that we get, for words like *Dementi*, *Genese*, *Franziskus*, *Agenda*:

(2.18)

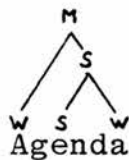

Once more, the terminal S node is determined by (2.16), the S above it by the principles of tree building, yet to be discussed.

Bisyllabic items with nonfinal stress have simple  $\overset{\wedge}{S \ W}$  patterns:

(2.19)



also *Fazit*, *Slalom*, *Konsul*, *Epos* etc.

Moving on to items with prepenultimate stress - (2.8) to

(2.10) above - it is now clear that they should end in a trisyllabic 'foot', so that *Kompositum*, *Drosophila*, *Akkordeon* etc. are analysed as (2.20):

(2.20)

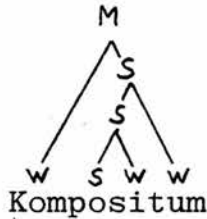

If they are trisyllabic (*Musikus*, *Lexikon*, *Kamera* etc.) they are simply

(2.21)

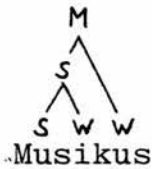

and once again the location of the terminal S node on the prepenultimate syllable is determined by (2.16) and the entire rest by the principles of tree construction.

What are these principles? Informally speaking, it is clear from the examples given so far that the syllable bearing the main stress, be it the final one, the penult, or the prepenult, has to be 'footed', that is, it must have a weak sister on its right (by virtue of Strength Provision) and in fact all material on its right is footed onto the stressed syllable:

(2.22)



Furthermore, in all the words under discussion the stress assigned by (2.16), the rightmost stress of the word, is the strongest one. If a word has subordinate stresses they will be on some syllable(s) on the left of the main stress. Translated into metrical notation, this means that the rightmost stressed syllable is the Designated Terminal Element (DTE) in terms of LP: it must be dominated by S nodes all the way up the tree. Our principles of tree construction will have to account for this.

Here are some words that actually have subordinate stresses. (None of the ones analysed so far did.)

(2.23)

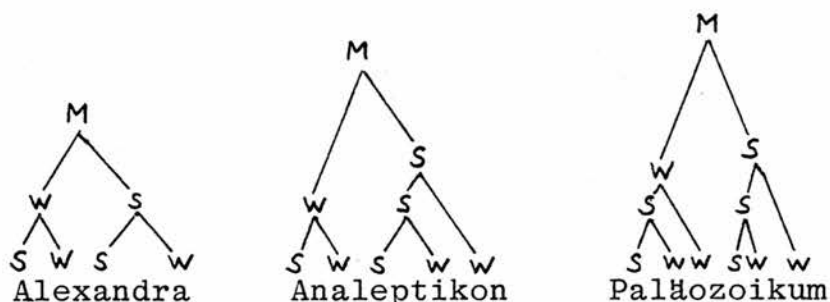

The regularity to be captured here is this: if the main stress is preceded by more than one syllable, then the first syllable of the word has a secondary stress. In terms of metrical structure it is quite clear that these secondary syllables are produced by an operation of 'footing', which produces a left-strong right-branching tree of the material to the left of the DTE. This is,

of course, impossible if there is only one syllable available for such an operation, as in *Dekan*, *Dementi*, and *Kompositum*. As can be expected, these words don't have secondary stresses on their initial syllables.

There are a few words in the language which have rather a lot of syllables on the left of the Designated Terminal Element. Consider, for example, *Enzyklopädie* and *onomatopoetisch*. These words, characterised by four syllables on the left of the DTE, have either one or, optionally, two subordinate stresses: one on the first and possibly another one on the third syllable. What is happening here is quite clear: a 'foot' containing four syllables can get broken up into two feet containing two syllables each, so that the metrical structure of *Enzyklopädie* would be either (2.24a) or (2.24b):

(2.24) a.

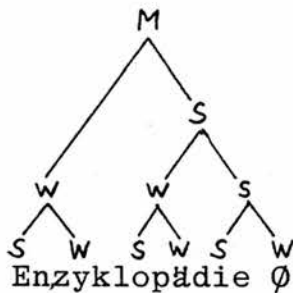

b.

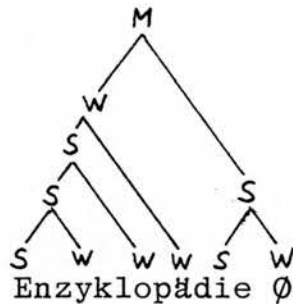

Limitations of foot length are a common feature in metrical phonology. One important instance we have come across before: notice that the effect of the Main Stress Rule (2.16) is the formation of a foot of the maximal size

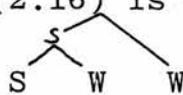

. A similar limit seems to exist, in certain performance situations at least, on the left of that foot. Similar limitations have been discussed extensively by Selkirk (1980b) and Hayes (1981) for English; see Hayes (1981) on universal tree geometry where this feature also figures



rather prominently.

We are now in a position to spell out the principles in a concise form which govern the metrical trees for the German words discussed so far.

Along with the Main Stress Rule (2.16), which determines the placement of the DTE, these principles are:

(2.25) Metrical structure of German words

- (a) The DTE and all syllables on its right form a left-branching tree. Syllables on the left of the DTE are organised into left-branching trees.
- (b) The syllable-dominating trees of provision (a) are organised into a right-branching tree whose root M is associated with the syntactic node immediately dominating the entire word.

Compare LP (p.266) on the metrical structure of English words.

Provision (2.25) produces the following metrical structures:

(2.26)



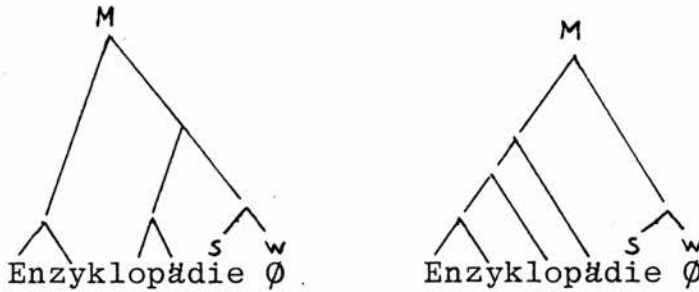

Note that (2.25a) is formulated in such a way that, optionally, either one or two syllable-dominating trees can be formed on the left of the DTE in *Enzyklopädie*. Both options are given in (2.26) above.

Through the formalisms stated in (2.16) and (2.25), only one pair of nodes in each M-dominated structure has received labels expressing prominence relations so far: the node associated with the DTE receives S and its sister, according to general principle, W. What still remains to be determined is the strength relations that hold between all other pairs of nodes.

The generalisation to be made here is straightforward but rather striking: as the DTE is required to be dominated by S nodes all the way up the tree and as, on the other hand, the syllable-dominating trees of provision (2.25a) are to be left-strong, we can simply state the following rule:

(2.27) Word Rule

In a pair of sister nodes  $[N_1, N_2]$ ,  $N_2$  is strong iff it branches.

This rule is identical with the one devised by LP for English. As LP's rule, it will in chapter 3 below be generalised so that its domain is larger than just the tree below M. As it will turn out, this generalisation



will imply the change of the rule's name but not of its form.

(2.27) fills in correctly the prominence labels into the slots left empty in the examples given in (2.26) above. The complete trees have been given before but I repeat them here with the  $N_2$  nodes in question circled:

(2.28)

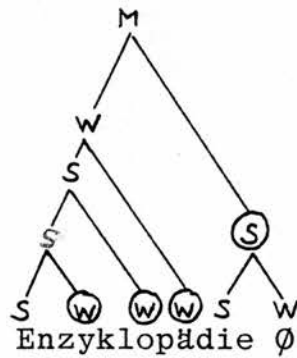
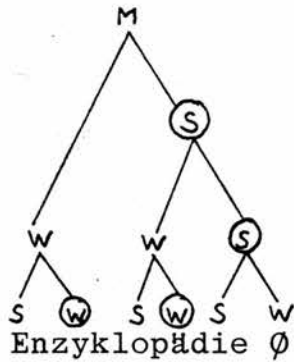
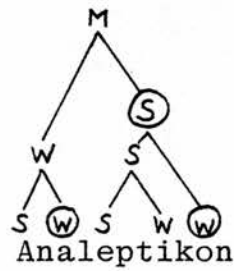
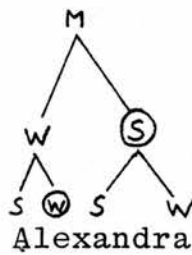
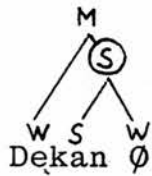

#### 2.1.4 Class I suffixes and metrical structure

Previous discussion of metrical structure has been limited to nonnative German words which could have some sort of inflexional ending or not - this, it was noted, didn't make any difference to the working of the Main Stress Rule (2.16) - but excluded morphologically complex items, derivations via suffix, to be more precise. Although the stress behaviour of derivational suffixes has been listed - (2.12) to (2.14) above - the metrical structure of the words formed with these suffixes has not been discussed. In particular, we have still to look at the ways in which the metrical structures of complex items, like *Dekanat*, can be related to those of simple ones, like *Dekan*.

In this section I shall concern myself with what I called Class I suffixes before; data was given in the lists (2.13) and (2.14). It will be seen in this section that nothing new has to be added to the principles of tree construction as we know them to account for Class I formations. The metrical structures of this class of complex words are without fail correctly predicted by the principles spelled out in the preceding section. But it will turn out that, by looking at this area in detail, we will get a tighter grip on two domains which have so far remained somewhat unclear: the structure of the lexicon and the rules of the phonology which, making reference to metrical structure, govern the length of certain vowels.

I'll start this analysis of lexical items derived via Class I suffix by looking at a simple example: an initially stressed bisyllabic item to which a stressed suffix gets added:

(2.29)

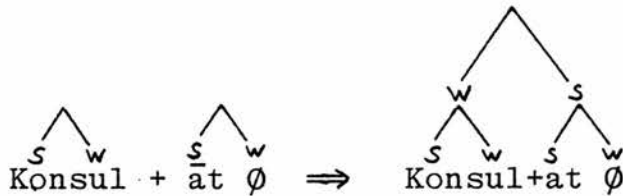

The suffix *-at* is listed above as stressed. We have noted before that this is the result of our Main Stress Rule (2.16), here stressing a word-final heavy syllable. The rest of the tree is determined by the principles of tree construction (2.25) in a rather straightforward way. Notice that the morpheme *Konsul* under embedding surfaces with a metrical structure identical to the one it would have if it wasn't embedded. This is, as will be seen presently, a coincidence, brought about by the fact that *Konsul* has a segmental make-up that would make the Main Stress Rule predict a structure of the form  $\begin{matrix} \text{S} & \text{W} \\ \diagdown & / \\ \text{Konsul} \end{matrix}$ . This rule, however, doesn't apply to simplexes if they are embedded in a Class I derivation.

Consider the embedding of a simplex with final stress:

(2.30) a.



b.

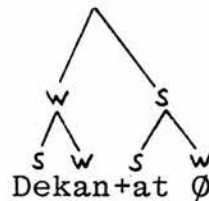

There are, as I mentioned in passing before, two possibilities to account for the difference in metrical structure between *Dekan* as a nonderived simplex and *Dekan* under morphological embedding. One possibility would be a genuine stress 'shift': the final stress of *Dekan* gets

moved leftwards, guided by some mechanism that is sensitive to the word formation process involved, and becomes a secondary stress in the morphologically complex item. This operation would be rather complicated and, as we now see, entirely unnecessary.

The product of the derivation, (2.20b) above, follows in its metrical structure precisely the principles of tree construction given in section 2.1.3 which predict, in particular, the word-initial secondary stress. In other words, this secondary stress is predicted by existing mechanisms and no additional rule has to be invoked to produce it. Not a trace is left in this structure of the metrical tree (2.30a) of *Dekan* in isolation; as I shall discuss in section 2.1.5 below, even the length of the vowel in the final syllable has vanished. These observations suggest quite clearly that *Dekan* doesn't have metrical structure at all when the morphological derivation takes place; *Dekan* and *Dekanat* receive their metrical structures independent of each other, and not through a series of processes whereby *Dekan* first gets metrical structure, then undergoes morphological derivation, and then adjusts its metrical structure. This kind of derivation could be justified if the embedded item showed some trace of the metrical structure of the simplex. In the absence of such traces, there is no need to give metrical structures to *Dekan* and *Dekanat* at different points of the derivation. Metrical structure, under this proposal - and the same was suggested by Siegel (1974) for English - is erected once, and that is after Class I derivations have taken place.

This goes, of course, also for those Class I suffixes, listed in (2.13) above, which don't receive stress through the Main Stress Rule. Consider the following examples:

(2.31)

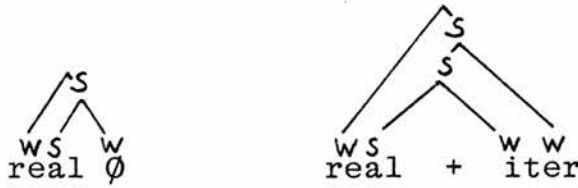

In this instance, rather like (2.29) above, we don't get the kind of stress 'shift' which betrays the structure of the lexicon that I have outlined. Metrical structure might, in this particular case, be erected step by step along with the morphological derivation. My suggestion about the ordering of metrical structure assignment with respect to Class I suffixation doesn't gain any advantage in terms of simplicity in this particular instance. But consider the group of morphologically derived items in (2.32):

(2.32) a.

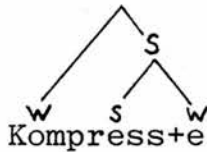

b.

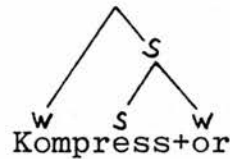

c.

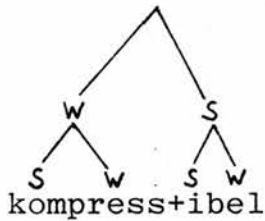

I take [kompress] to be a stem, noncomplex for the sake of this argument. I take it to have a final geminate consonant cluster; hence the metrical structures (2.32a. b.). But this structure can't be maintained in (2.32c)

as it is made impossible by virtue of the Main Stress Rule; instead, we get the DTE on the first syllable of the suffix. Now if we choose an analysis whereby suffixes attach to items after these have received some metrical structure then the question immediately arises just what this structure is in the case of such stems that never surface without some suffix, as [kompres]. This whole problem doesn't arise if we assign metrical structure after all Class I suffixations have taken place.

To illustrate the main point made in this section, let us look at some more 'stress-shifting' suffixations:

(2.33) a.

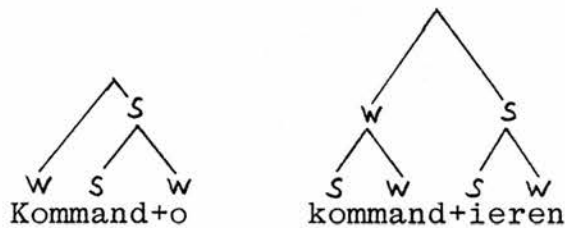

b.

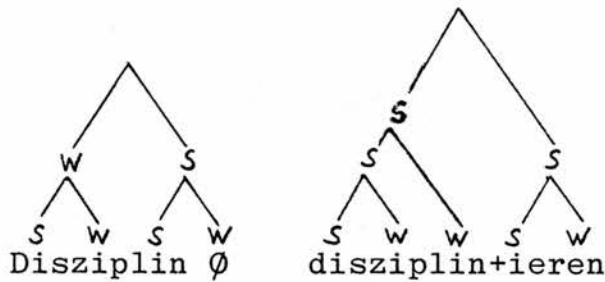

c.

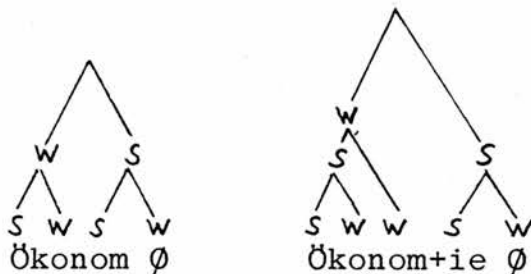

Cont'd



(2.33) cont'd

d.

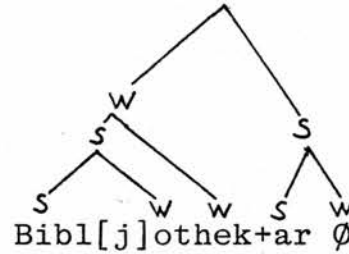
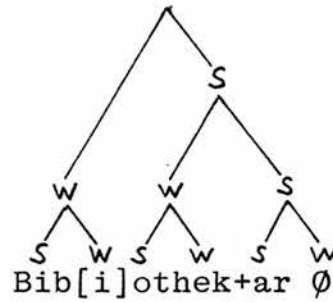
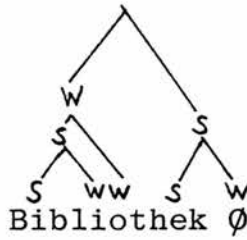

e.

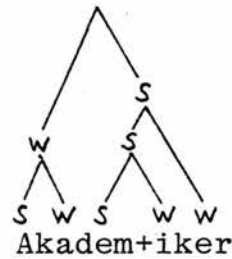
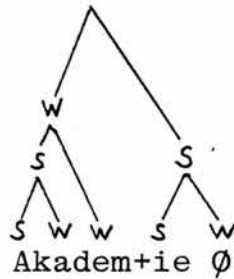

The first example, (2.33a), gives me an opportunity to make a more detailed statement about the status of noun-final *-o*. [kommand] is a stem in German; it is not a word. Just like *-us*, *-a*, *-um*, *-i*, and all the other endings that I described earlier as nonnative inflexions, it is now clear that this one should be analysed as a Class I suffix which forms nouns out of stems. A suffix like this only attaches to stems; I mentioned above that suffixes are specified in the lexicon with respect to the status of the item that they attach to: stem or word (Siegel 1974). The stem has no metrical structure before the word is formed via suffixation. (2.33a), then, gives us two different word formations from [kommand] with different metrical structures, depending

on the particular result the Main Stress Rule and the principles of tree construction. It should be noted, incidentally, that *-ieren* is in itself morphologically complex, consisting of the verb-forming Class I suffix *-ier* and the infinitive suffix *-en*. I assume here that the latter simply fills the zero syllable on the right of *-ier*. More will be said about the role of metrical structure in the inflexional morphology of German in section 2.2.2 below.

[#Disziplin#], in (2.33b), is a complete word, or a stem plus zero derivation suffix, if we want to take this kind of morphological analysis to its logical conclusion. Again, we can see two alternating metrical structures in the two surface words formed with this stem.

The same is the case with *Ökonom* and *Bibliothek*, (2.33a) and (2.33b) respectively. In both cases the stem is able to surface as a word of its own. The trees on the right are predictably different from the left-hand ones and alternate in stress patterns through different effects of the Main Stress Rule. Additionally, two variant structures are given for *Bibliothekar*, depending on whether the sequence spelled <io> is monosyllabic or bisyllabic.

(2.33e), finally, provides another example of a 'stress-shifting' unstressed suffix or, in the terms used here: an unstressed Class I suffix. *-iker* is, as Benware (1980b) convincingly shows (also Wellmann 1975:78 f.), one suffix and not analysable as *-ik+er*. There are at least some words ending in *-iker* which aren't derived from ones ending in *-ik*, cf. *Syphilitiker*, where no such word as *\*Syphilitik* exists in German. The same holds for the example analysed here: *\*Akademik* is not a possible derivation. The two derivations from the

stem [akadem] in (2.33e), then, end up with metrical structures predicted by the principles of metrical structure given so far.

Our examples make it quite clear, once again, that the lexicon should be organised in the way I have been advocating. [kommand], obviously, shouldn't get a metrical structure assigned to it since its surface metrical structures alternate in a fashion which makes it impossible to decide nonarbitrarily which one should be postulated as the underlying one. Metrical structure, then, gets assigned when a word has been formed by means of a Class I suffix, *-o* or *-ier(en)* in this case. Analogously, [disziplin] doesn't have metrical structure before Class I suffixation has taken place, by means of a noun-forming zero formative or, again, *-ier(en)* for example. This would seem to imply that this zero formative is also a Class I suffix.

I do not intend to get involved in a detailed analysis of German derivational morphology in this study; morphological issues only get raised in as far as they are relevant to the metrical analysis I am really pursuing. The reader will have wondered, however, whether the zero syllables, provided by Strength Provision (1.14) and exemplified in (2.33b.c.) above, have anything to do with the zero formatives which I have been invoking for the derivation of nouns from identical stems. They don't. The co-occurrence of zero formatives and zero syllables in these examples is a coincidence, brought about entirely by the working of the Main Stress Rule. There are numerous cases which, although derived via zero formative, don't have a zero syllable in their metrical structure. Consider, for example, *Amok*, *Fazit*, and all the others given in (2.4) and (2.5) above. Conversely, zero syllables do occur in cases where no morphological zero

derivation can sensibly be postulated, as in *Akademie* and many others.

#### 2.1.5 A note on vowel length and tenseness

It is common practice in generative phonology to differentiate certain pairs of vowels in terms of a segmental feature [tense] or, alternatively, [long]. Thus, SPE operate with the former, stating that

In tense sounds, ... , the period during which the articulatory organs maintain the appropriate configuration is relatively long, while in non-tense sounds the entire gesture is executed in a somewhat superficial manner.

(SPE, p. 324)

This statement, vague as it is, implies that the vowels in English *beat* and *bit*, while differentiated in terms of tenseness, do not show up a nonredundant length distinction. If a feature [long] were to be used at all in such a framework (which SPE don't) it would be redundant in such a way that [ $\alpha$  tense]  $\rightarrow$  [ $\alpha$  long]. In the SPE framework, phonetic surface length is instead brought about by off-glides which get inserted behind tense vowels in the course of the phonological derivation and, crucially, after stress assignment. Leaving aside the particular problems that this particular analysis raises for English (for which the reader is referred to Lass 1976, Lass and Anderson 1975, and others), it can be shown that it doesn't work that way for German.

First of all, there is at least one phonemic contrast between a short lax, a long lax, and a long tense vowel:

consider *Betten* /ɛ/, *bĕtten* /ɛ:/, and *beten* /e:/. To be sure, the contrast of *beten* - *bĕtten* is somewhat marginal; it isn't present in all dialects but on the other hand I would dispute the statement that it is actually "for most speakers" that /ɛ:/ "merges with /e:/ in all but the most exaggerated speech styles" (Lass 1976:48). I shan't go any further into this particular problem and shan't offer a solution to it in what follows - the reader is referred to Moulton (1947: note 3), Philipp (1970:22 ff.), and Sanders (1972). If nothing else, the mere existence of this problem in German phonology indicates that there might be more to the relation between tenseness and length than meets the eye (or ear).

Meinhold and Stock (1980:82) give the following chart of distinctive vocalic segments in German:

(2.34) / a: a i: ɪ e: ε ε: y: Y ø: œ u: υ o: ɔ ə /

vocalic	+	+	+	+	+	+	+	+	+	+	+	+
high	-	-	+	+	-	-	+	+	-	+	-	-
low	+	+	-	-	-	-	-	-	-	-	-	-
front	-	-	+	+	+	+	+	+	+	-	-	-
back	-	-	-	-	-	-	-	-	-	+	+	+
round	-	-	-	-	-	-	+	+	+	+	+	+
tense	0	0	+	-	+	-	+	-	+	-	+	- 0
long	+	-	+	-	+	-	+	-	+	-	+	- 0

An SPE-style pairing of [+ tense, + long] and [- tense, - long], then, doesn't work for German: it fails in the case of the segments /ɛ:, e:, ε/ and it is somewhat fictitious in the pair /a, a:/ where stating a contrast in terms of tenseness would be phonetically rather unrealistic.

And there are more problems. Lass (1976:44 ff.) addresses himself to the question whether a vowel system like the one in (2.34) above (disregarding the existence of /ɛ:/) constitutes a set comprising two subsets, namely

{V:} = {/i:/; /e:/; /y:/; ...} and {V} = {/ɪ/; /ɛ/; /Y/; ...} or, alternatively, whether we ought to be talking about a set consisting of pairs of vowels, something like {V} = {( /i:/; /ɪ/); (/e:/; /ɛ/); (/y:/; /Y/); ...}. In either case the dichotomising operator may be said to be the feature [tense]. Now if the latter alternative were to be adopted, which represents a more tightly structured system, Lass argues, one would have to find evidence for the pairing of the vowels in morphophonemic or phonological terms. There is in fact evidence against this form of pair-wise structure: when long vowels are shortened they do not necessarily take on the lax quality of the, supposedly corresponding, short vowel but may remain tense. Compare *'Übersetzen* ('carry across') where [y:] retains its length under full stress and *Über'setzen* ('translate'), where the corresponding vowel, though shortened through the absence of full stress, nevertheless remains tense [y] (Lass 1976:48 f.; Philipp 1970:120 f.; Meinhold and Stock 1980:81).

Once again, picking out of Lass's argument only what is useful for dealing with our present one, we see that vowels may surface as [+ tense, - long] in German.

It turns out that in the part of the vocabulary of German that we have been looking at, short tense vowels occur with considerable frequency, and that metrical structure has something to do with their distribution, just as Lass's example of *Übersetzen* with alternating stress patterns suggests.

Thus, Heidolph *et al.* (1981:914 ff.), Meinhold and Stock (1980:81, 90), and Wurzel (1970) point out that in non-native words, essentially Greek and Latin loans, unstressed syllables may contain short tense vowels. Some

examples are given in (2.35) below where short tense vowels are underlined:

(2.35) Medizin, Psychologie, Ökonomie, Rudiment,  
Republik

Meinhold and Stock also point out that these vowels frequently get adjusted to the system given in (2.34) above in that they undergo a process of laxing; in the case of [e], there is even alternation with shwa: *Mathematik*, *Katechet* for example.

The question arises how these short tense vowels observed by the authors I mentioned above get into the phonology of German. Are they, as Lass's case of *Über'setzen* suggests, low-stress variants of underlyingly long tense vowels, or are there instances where they are part of the lexical representations of certain words? Let us look at the contexts in which they turn up.

First of all, there is little doubt about the representation of vowels in closed (nonfinal) syllables, vowels followed by (at least) two consonants: they are invariably lax and short. Some examples are given in (2.36) below - I'm using, as far as possible, examples of mid vowels as these show up the difference between tense and lax articulation most clearly:

(2.36) a. b. c.

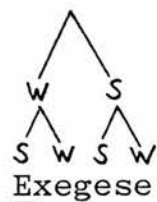

cont'd

(2.36) cont'd

d.

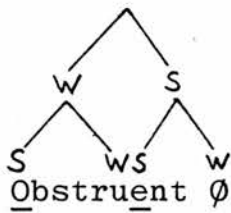

e.

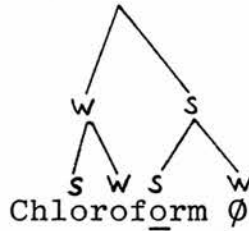

f.



In all these cases the underlined vowels surface as  $[\varepsilon, \text{ɔ}]$ , regardless of their position in the metrical structure. They may bear the main stress, subordinate stress, or no stress at all and never vary - sufficient reason to posit a redundancy rule that specifies vowels before consonant clusters as short and lax. This rule will be given later.

Consider now the vowels in the Designated Terminal Elements of metrical trees, as specified by our Main Stress Rule (2.16). These are either short lax (if followed by a consonant cluster) or, as in (2.36a.c.f.), they are long and tense. Again, there seem to be no exceptions.

But what about those vowels in open syllables that don't end up as Designated Terminal Elements in the metrical structure because they either get skipped by rule (2.16) or are on the left of the DTE? I pointed out above, it will be recalled, that they are frequently short and tense but have a tendency to surface, alternatively, as short and lax. Are these vowels underlyingly tense or lax? This question is crucial if we want to state the redundancy relations between tenseness and length that hold in the German lexicon.

Consider the following pair of words:



(2.37) a.

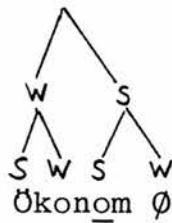

b.

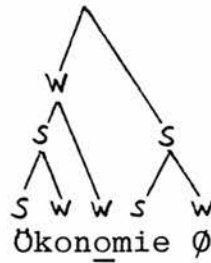

The underlined vowel is clearly long and tense (or either of the two) in the underlying representation. If it wasn't we wouldn't be able to explain the fact that the final syllable in (2.37a) is the DTE. In (2.37b) it surfaces short (and possibly lax, see above). This would seem to imply that at least some vowels in open syllables which surface as short are derived from underlyingly long and tense ones. But again, this can't be true for all of them.

Take, for example, the vowels in open syllables that get skipped by the Main Stress Rule in the words given in (2.8) and (2.9) above, *Drosophila*, *Akkordeon* etc. These words never engage in any of the alternations, caused by Class I suffixations, which could surface with the DTE on the vowels in question. The vowels are, without exception, short. Whether they are underlyingly tense or lax I don't know: in *Uterus*, the *e* tends to be realised as shwa and in *Polyptoton* [o] and [ɔ] seem equally possible in the penultimate syllable. Fortunately, we don't have to base any further decision on this extremely hazy area. We shall simply call these vowels underlyingly short, for the time being, and thus allow short vowels in open syllables.

Let us turn now to vowels in final syllables. On the face of it, things seem to be rather straightforward there. Compare *Auto* and *Plateau*, *Akkordeon* and *Nation*. In the cases with final stress, *Plateau* and *Nation*,

the vowels in question are once again long and tense. This is not surprising since one of these two features, presumably length, is what the Main Stress Rule is sensitive to. Let us take it, then, that *Auto* and *Akkordeon* have underlyingly short vowels. Admitting short vowels in both open and closed syllables is in line with what we have found so far. In *Auto* (also *Dementi*, *Akku*, *Motto*, and others), there would then be a later phonetic rule which makes the final vowels tense. These vowels are often referred to as half-long in pronouncing dictionaries. I think a statement like this can quite safely be interpreted as 'tense and unstressed', similar to the vowels underlined in (2.35) above. Word-final tensing rules are well known in the phonology of English (SPE, p.181) and have been posited for German before (Wurzel 1970a:91 f.). It might make some sense, then, to take these vowels as underlyingly lax (and thereby short).

There is a sizeable class of words, however, which look like *Auto* and *Akkordeon* but are involved in stress alternations which the machinery introduced previously cannot deal with. Consider (2.38):

(2.38) a.

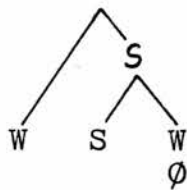

Kanu  
Cafe  
Partie  
Dämon  
Altar  
Haschee

b.



Kanu  
Kaffee  
Party  
Dämon  
Altar  
Haschee

cont'd

(2.38) cont'd

c.

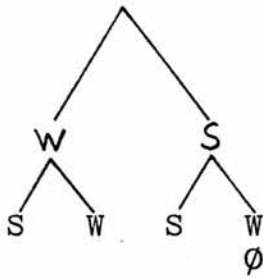

Frikassee  
 Majoran  
 Marzipan  
 Leguan  
 Dromedar

d.

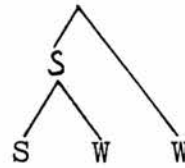

Frikassee  
 Majoran  
 Marzipan  
 Leguan  
 Dromedar

The items in (2.38) above all alternate freely between the metrical patterns that do and those that don't contain zero syllables. In one or two cases, this alternation has been lexicalised, e.g. in *Párty* vs. *Partie* *Káffee* and *Café* (but note the Austrian pronunciation *Kaffée* for the beverage and *Café* for the restaurant).

In principle, there are two different ways of giving a formal account of these alternations. The lexical matrix can either be specified in such a way that in (2.38a.c.) the stress rule skips the final syllable. This can be done by making the underlying vowels alternate between long and short. Alternatively, these words could have constant segmental representations (long vowels in their final syllables) and be marked as optional exceptions to the Main Stress Rule.

These two alternatives look like rather inconsequential notational variants - but I don't believe they are. Consider another set of alternations:

(2.39)	Pláto	-	Platónik
	Kánu	-	Kanúten
	Charáker	-	Charaktére
	Jápan	-	Japáner
	Dámon	-	Dámónen
	Neútron	-	Neutrónen
	Áfrika	-	Afrikáner
	Amérika	-	Amerikáner
	Cicero	-	cicerónisch

(more examples in Wurzel 1970b:91)

*Dámon* and *Kanu* also occur in our list of varying metrical structures in (2.38) above. Assume we adopted the first alternative of representation for those and made them alternate between long and short vowels in their lexical representations, short for initial, long for final stress. Again, we would have two alternatives for formalising the new alternations in (2.39): firstly, we could say that the vowel in the left-hand cases is short and acquires length, through some sort of rule, before suffixation takes place, thus causing the stress alternation. This rule would have to be located in a rather unlikely place of the derivation and would be rather hard to motivate. Let us consider the second possibility. We could say that in these cases, quite regularly, a lexical representation yielding structures of the type (2.38b) gets selected for the simple word and one of the type (2.38a) for the morphologically complex word. But why? The answer lies in the kind of metrical structure that the words in question surface with. *Dámōn* contains a zero syllable and a considerably simpler structure is possible if we shift the stress to the left. For *Dámonen*, on the other hand, such a stress shift doesn't simplify the metrical structure.

This could be a good reason for the selection of different lexical representations. But it could also be given as a reason for exceptional behaviour on the part of the Main Stress Rule, thus allowing for nonalternating

lexical representations. Thus, the stress rule could be seen to skip a long vowel, in certain cases, and produce metrical structures of the type (2.40a) below rather than (2.40b):

(2.40) a.

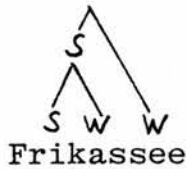

b.

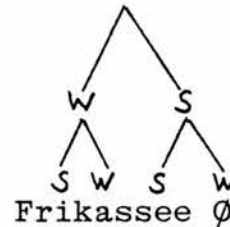
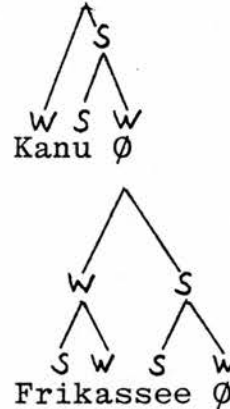

The effect (and function) of this process is obviously the avoidance of the zero syllable, which complicates the metrical structure, at the end of the word. Hence this process doesn't apply in *Kanuten* etc. where there is no zero syllable which could be avoided by such an operation.

I suggest that we posit long vowels in the final syllables of all the words in (2.39) which alternate in derivations, regardless of whether they have varying stress patterns as simple words or not. In all these cases the long vowel can get skipped by the stress rule if it is in the word-final syllable.

Before concluding the question of alternations, I would like to look, briefly, at the environments in which 'stress shifts' of the kind witnessed in (2.38) and (2.39) are likely to occur. Examples are few and scattered but the contexts in which they can occur - and even saying they 'tend to' would be an exaggeration - do seem

to follow some kind of pattern.

There is one group of cases where the shift is compulsory and predictable, and that is the case of the masculine agent suffix *-or*. Here are some examples:

- (2.41)
- |           |   |                                |
|-----------|---|--------------------------------|
| Léktor    | - | Lektóren                       |
| Autor     | - | Autoren                        |
| Pastor    | - | Pastoren (also <i>Pastór</i> ) |
| Revisor   | - | Revisoren                      |
| Tabulator | - | Tabulatoren                    |
| Inspektor | - | Inspektoren                    |

This suffix is regularly unstressed in word-final position but bears the main stress if followed by the plural suffix. *Charákteř* - *Charaktéře* fits in the same category.

All the other cases cited in (2.38) and (2.39) above end in vowels (e.g. *Kaffee*, *Plato*, *Afrika*) or vowels plus /n/, like *Neutron*, *Marzipan* etc. In some cases the shift is optional (*Dämon*), in others compulsory (*Jápan*) - but even among the ones ending on *-an* there are counter-examples that never shift: *Dekán*.

A word-final syllable that may be skipped by the stress rule thus has the form given in (2.42):

(2.42) Stress Shift

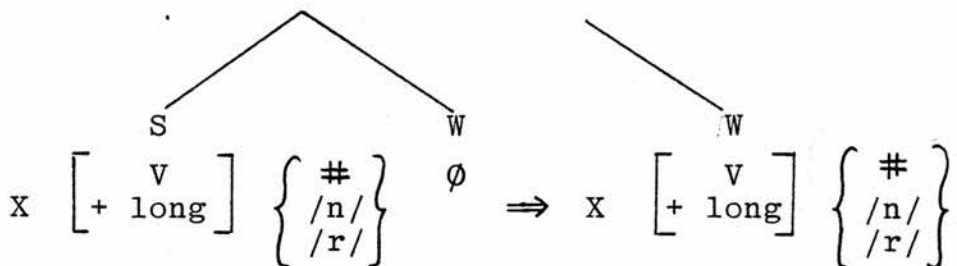

Another point is that the lexical items in question all seem to be morphologically unanalyseable, despite the

recurrence of, for example, *-or*. For a start, *Afrika* is not a feminine noun, which it would have to be if we were to analyse the *-a* as a suffix. Where *-or* is concerned, Fleischer (1974) argues that nouns ending in this cluster are usually monomorphemic:

... Bildungen auf *-or* [sind] zum größten Teil innerhalb des Deutschen unanalysierbar (*Autor...*, *Lektor...*, *Pastor...*). Auch *Direktor* kann man semantisch nicht auf *direkt* beziehen, *Faktor* nicht auf *Fakt*.

(Fleischer 1974:195)

If we accept this argument we can make a similar case where the recurrent ending *-on* is concerned, as in *Neutron*, *Elektron*. Are *Neutron*, *Neutrum*, *neutral* morphologically related in such a way that the average speaker can be expected to express this relation in his grammar? *Elektron* and *elektrisch*? Note the pair *elektrisch* and *elektronisch*.

One might wish to argue on these grounds that *Neutron* and *Elektron* are morphologically simple and that, as a general rule, the stress shift given in (2.42) above must not operate across a morphological boundary. One might, possibly, wish to speculate even further about this peculiar conditioning of a rather sporadic process but then, again, one might not ...

Instead, let us return to the real issue of this section, that of tenseness and length in the German vowel system, and let us see how these features interact with each other and with metrical structure.

We found out above that vowels before two consonants are short and lax and that they remain so throughout the derivation. Secondly, we found that in open syllables

long and short vowels occur. Long vowels are tense. Long vowels may be shortened if prominence gets shifted away from them and retain their tenseness. This is in line with what Lass (1976) found to be the case in *über'setzen*. In word-final syllables, ending in not more than one consonant, vowels may be short or long underlyingly.

I think I have given sufficient evidence that the distribution of vowels in the lexicon is quite straightforward: vowels are underlyingly long tense or short lax. There are no instances where any rule requires a vowel to be underlyingly short tense. This gives us the following (reversible) redundancy rule:

(2.43)            [α long] → [α tense]

We have to bear in mind, of course, that /ε:/, a marginal member of the German vowel system, is underlyingly long and lax. As I said at the beginning of this section, I offer no solution to the problem that the existence of this vowel poses.

In the course of the derivation, underlyingly long vowels can lose their length and retain tenseness. Wurzel (1970a), overlooking the fact that these vowels in fact derive from long tense ones, states the following set of redundancy rules for nonnative words only. (The one I gave in (2.43) above handles native words only in Wurzel's model.)

(2.44)            [- tense] → [- long]  
                   [+ long ] → [+ tense]

(Wurzel 1970a:90)



Having to make lexical redundancy rules sensitive to a feature [native] is, of course, highly undesirable for any phonological model. I think I have shown on these pages that the metrical model doesn't require this distinction - not for redundancy rules governing length and tenseness, in any case.

We still need to look at some regularities involving length and tenseness that, as I hinted before, occur in the course of the phonological derivation. There is, for example, the final tensing rule for words like *Akku*, *Hobby* etc., words that never get involved in prominence alternations of the type *Pláto* - *platónisch* and therefore end in an underlyingly short vowel. They surface with tense vowels which also occasionally get referred to as half-long:

(2.45) Word-final tensing

$$V \rightarrow [+ \text{ tense}] / \text{ \_\_\_\_\_\_ } \#$$

Furthermore, we require a rule that laxes the long vowels in those syllables that, by exception, have been skipped by the Main Stress Rule, as the ones before /n/ and /r/ in (2.38), (2.39) and (2.41) above. These models lax (and shorten via redundancy rule) if they constitute a terminal W of the metrical tree and if they are in a word-final syllable. This process, given in (2.46) below, brings them into line with all unstressed vowels in closed word-final syllables.

(2.46) Final syllable laxing

$$V \rightarrow [- \text{ tense}] / \text{ \_\_\_\_\_\_ } \begin{array}{c} W \\ | \\ C_1 \end{array} \#$$

This rule, along with (2.45) creates a surface opposition

between long tense and short lax vowels, regardless of stress, in final syllables. The same opposition holds, as we have seen, in stressed nonfinal syllables.

As for nonfinal open syllables, if they are unstressed, their vowels can be either short tense or short lax. This situation is rather messy. Following Meinhold and Stock (1980) and other authors, one might assume some sort of laxing rule for short vowels in these contexts. This rule would be optional in words like *Ökonom* etc. but it would, wherever it applies, reinstate the redundancy rule that holds in the lexicon. Details on this question are unavailable at the present time and, fortunately, irrelevant to our present discussion.

## 2.2. The metrical structure of native words

### 2.2.1 Remarks on nativity

The terms 'native' and 'nonnative' have been figuring too prominently in this discussion to be left undefined. Without saying what my criteria for this dichotomy were, I have divided the bulk of German lexical items into native and nonnative ones, and in section 2.1 given a metrical analysis of the latter. Also, a number of suffixes have been analysed in the same way and we found that the nonnative ones among them, given in (2.13) and (2.14) above, receive metrical structure in the lexicon. A model of the lexicon has been outlined which accounts for this behaviour and which will also, once a bit more has been said about it below, accommodate the so-called native or stress-neutral suffixes given in (2.12) above.

Moreover, we have had a look at some segmental phenomena attributed to nonnative German words, notably the occurrence of short tense vowels. We found that in the discussion of these phenomena, contrary to the belief of scholars like Wurzel (1970a), Meinhold and Stock (1980), no feature [native] is required for a formal account.

The question remains whether, in the type of analysis presented here, this feature is necessary at all to categorise lexical items, be they stems, words, or affixes of some sort, and what this feature is anyway. I shall at this point express some thoughts (and doubts) about its identity. A final statement on this issue cannot be made before the metrical phonology of German has emerged more completely than it has so far.

Undoubtedly, some nonnative German words have segmental and phonotactic properties which are ruled out for native items: the occurrence of nasal vowels in words like *Ensemble*, *Pointe* etc., of [ʒ] in *Blamage*, *Ingenieur*, of word-internal [h] in *Mahagoni*, *Alkohol*, of prevocalic glides in *Dossier*, *Familie* (Dressler 1973), to name but a few. (See Benware 1980b for a more exhaustive list.) It would seem that [- native] makes a lot of sense in these cases as an exception feature. Mathesius (1934), who as far as I am aware was the first to recognise the value of this feature in a synchronic grammar, also points out the crucial problem that it poses: it has a nonarbitrary content only in a diachronic grammar. This makes it a dubious entity in any linguistic theory that attempts to be purist enough to draw a distinction between synchrony and diachrony. Not surprisingly, experiments have shown that native speakers are often unable to recognise such items as nonnative in which the segmental and phonotactic clues mentioned above are absent and even categorise as nonnative some lexical items

whose history clearly makes them native (Heller 1966).

If the content of this feature, then, is inaccessible to the native speaker, and if it has no phonetic content if used in a phonological analysis, then its status is that of an entirely arbitrary dichotomiser, which the linguist might wish to call 'native' for purely mnemonic reasons. As such, it might still have its merits but it would be preferable if, for any given problem, it weren't needed.

The problem for us is that [native] is current in modern analyses of German word stress, in Benware's analysis (1980b) as well as in the work of Wurzel (1970a, b; 1980). Both authors operationalise this distinction in, roughly, the same way. Wurzel (1980b:170) points out that 'monosyllabicity is one of the main criteria of native German morphemes', in their underlying representations, that is. Similarly, Benware (1980b) restricts his analysis of nonnative word stress to items which have unreduced vowels in at least two syllables, thus excluding words like *Baum*, *Fritz*, etc. as well as *Vogel*, *Butter*, *Atem*, *Schule*. Arbitrarily excluded (from the historical point of view) from the inventory of native words are the items in (2.47) below, which don't conform with Benware's (and Wurzel's) operational definition of native words:

(2.47)	Ameise	Heirat	Monat
	Antwort	Hering	Mumpitz
	Antlitz	Iltis	niemand
	Arbeit	jemand	Urlaub
	Brosame	Kiebitz	Wisent
	Girlitz	Kleinod	Zierat
	Heimat	Leichnam	

Furthermore, a number of historically clearly nonnative words end up in the native category as defined by Benware

and Wurzel, namely all those loans which are monosyllabic in Modern German or have only one full vowel: *Bus*, *Club*, *Datsche*, *streiken*, etc.

But even if we don't worry too much about this mutual overlap of the two categories, the one crucial question is still unanswered: if native and nonnative words differ in terms of the internal structure of their morphemes, do our principles of metrical structure handle both categories or are native and nonnative words subject to different metrical principles? If the latter is the case, we have to spell out two different sets of metrical structures, with a dichotomising feature [native] to distinguish between them. If the former is true, then [native] is not part of the vocabulary of the metrical phonology of German.

In what follows, I shall attempt to show that there can be one single metrical phonology which correctly predicts the prominence behaviour of both native and nonnative words, in the categorisation given above, and that, therefore, [native] has no formal import in this section of the phonology of German. The following account will, in that respect, be significantly simpler than the most recent one in the literature (Wurzel 1980), where two seemingly incompatible sets of stress rules are given whose selection is governed by each lexical item's lexical specification in terms of nativity.

As a by-product, this account will shed some light on the occurrence of those epenthetic vowels [ə] which, in terms of Wurzel (1970b), are absent in the underlying representation of words like *Vogel* and get inserted in the course of the derivation. This vowel insertion, as well as the occurrence of shwa in the inflexional

morphology, will be seen to have a lot to do with metrical structure.

### 2.2.2 On epenthetic shwa and inflexional morphology

Benware (1980b) and Wurzel (1970b) agree, it will be recalled, that morphologically simple native German words only have one full vowel. If these items contain another vowel it will always be to the right of the full vowel and it will always be shwa. A few exceptions to this observation, recognised by both authors, were given in (2.47) above.

Concentrating, for the time being, on monomorphemic words (thus excluding inflected forms as well as derivations), we get monosyllabic and bisyllabic words of the following, rather characteristic, segmental structures:

(2.48)	Kerl	Keller
	Wurm	Eimer
	Horn	Donner
	Halm	Hammel
	Köln	Tunnel
	gelb	übel
	Fahrt	Vater
	Amt	Atem

What is interesting about these pairs of words is that they conform with a rather simple pattern which makes the occurrence of shwa in the ones in the second column entirely predictable. Wurzel (1970b:170 ff.) recognises this and concludes that the underlying representations of the morphemes in (2.48) should be something like this: /kɛrl/, /kɛlr/, vʊrm/, /aɪmr/, and so forth. The shwas missing in this representation are inserted by rule in the course of the derivation. We shall investigate the contexts in which they occur towards the end of this

section; before, let us look at the metrical structures that we expect the items in question to have.

One of the formal building blocks of this model is a well-formedness condition, given in (1.14) in the introductory chapter, by virtue of which each lexical item of the categories noun, verb, adjective is metrically analysed as containing at least one terminal S node with a right-hand weak sister. This condition amounts to saying that the minimal metrical structure for a lexical item is  $S \begin{smallmatrix} \wedge \\ W \end{smallmatrix}$ . Under this kind of analysis, the items given in (2.48) above would emerge from the lexicon in the following representations:

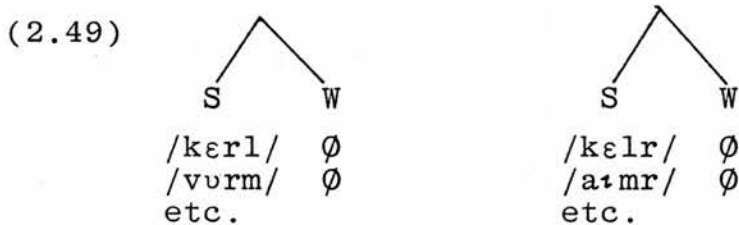

What are the advantages of having the output of the lexicon look like this? Notice, first of all, that if we are to assign metrical 'structure' to a monosyllabic item - and the arguments for attempting to do this were given in chapter 1 - then this (or the reverse:  $W \begin{smallmatrix} \wedge \\ S \end{smallmatrix}$ , but I have already argued against this) is the only way of doing it. If we just said that every lexical item is S this would be a statement rather peculiar in a relational model of phonological prominence. Admittedly, that every lexical monosyllable is stronger than a neighbouring zero syllable looks a bit like a formal trick, used to change a local property into a relational one. I have, however, given a variety of arguments in chapter 1 that show that this device is more than just a trick. Instead of going through these arguments again, I shall, in what follows, add another one: the zero

syllables that monosyllabic lexical items carry play an interesting part in the regularities that govern the inflexional morphology of German.

The distributional properties of the epenthetic shwa, which occurs as the only possible vowel in the inflexional morphology of German, have been studied extensively by Wurzel (1970b) and Issatschenko (1974). I shall give the reader a rough idea of the approaches taken by these authors before I proceed to present my own.

Wurzel (1970b:28) handles the derivation of the dative plural *Spiegeln*, to choose a fairly clear-cut example, in two basic steps: a rather general *e*-epenthesis rule, sensitive to the segmental environment only, and a more specific *e*-deletion rule, which takes into account morphological properties also. Without giving the statements of the two rules, here are the outputs of the steps of this derivation:

- |        |     |                      |            |
|--------|-----|----------------------|------------|
| (2.50) | (1) | lexical entry        | sp̄igl     |
|        | (2) | inflexion            | sp̄igl+n   |
|        | (3) | <i>e</i> -epenthesis | sp̄igel+en |
|        | (4) | <i>e</i> -deletion   | sp̄igel+n  |

What is striking about this solution is the complexity of the rules involved as well as the fact that segments have to get deleted which have previously been inserted, without doing any work during the brief period they spend in the derivation. Furthermore, Wurzel's account exhibits some of the limitations and weaknesses of the SPE era such as the use of the 'minus next rule' convention and, more importantly, the complete lack of reference to syllable structure; even stress figures only marginally in the *e*-deletion rule. Below, I shall argue that these two levels of phonological structure, syllable structure



and relative prominence, indeed play the main part in the account of epenthetic shwa.

In contrast, Issatschenko (1974) objects to Wurzel's assumption of monosyllabic underlying forms (on rather spurious historical grounds, not relevant to a synchronic analysis) and argues that instead those words that surface containing shwa are underlyingly represented with one of two types of shwa morphophonemes that he claims are part of the structure of German: 'shwa constans' and 'shwa mobile'.

Shwa constans always surfaces as shwa. Consequently, it gets posited as part of all those inflexional endings that don't alternate between syllabic and nonsyllabic forms. Shwa mobile, on the other hand, is a morphophoneme that surfaces as shwa in alternation with a zero segment. The surface form of shwa constans and the nonzero surface form of shwa mobile are phonetically identical. Needless to say, this approach to the problem is rather excessively abstract in that it entails instances of absolute neutralisation as well as zero segments.

Here is a sample analysis in Issatschenko's terms. In German adjective and noun inflexions, /-(ə)s/ may occur in two different paradigms: as the nominative/accusative singular of neuter adjectives, and as the genitive singular of certain masculine and neuter nouns. Morphologically determined (which Wurzel only expresses in a very roundabout way), it always surfaces as [əs] in the former paradigm whereas it alternates with [s] in the latter. Thus we get for adjectives:

(2.51)	nah	-	nah+es	
	hell	-	hell+es	
	frisch	-	frisch+es	
	teuer	-	teur+es	) Note the shwa mobile ) in the stems.
	nobel	-	nobl+es	

In the noun paradigm, the realisation of the endings depends on the segmental context:

(2.52)	a.	Maß	-	Maß+es
		Haus	-	Haus+es
		Witz	-	Witz+es
		Kitsch	-	Kitsch+es
		Beweis	-	Beweis+es
		Marsch	-	Marsch+es
	b.	Vogel	-	Vogel+s
		Vater	-	Vater+s
		Atem	-	Atem+s
		Professor	-	Professor+s
		Vakuum	-	Vakuum+s
		Sofa	-	Sofa+s
	c.	Werk	-	Werk+es/Werk+s
		Tag	-	Tag+es/Tag+s
		Bau	-	Bau+es/Bau+s
		Vieh	-	Vieh+es/Viehs

Issatschenko observes that /əs/ is obligatory after sibilants (2.52a), that /s/ is obligatory after unstressed vowel plus sonorant (2.52b), and that /əs/ and /s/ alternate after monosyllabic stems except those in (2.52a). He doesn't come up with a generalisation where the nonnative words in (2.52b) are concerned - *Sofa*, for example, doesn't end in a vowel plus sonorant and nevertheless takes /s/ - but concludes that the adjective ending in (2.51) contains a shwa constants and the nominative ending in (2.52) contains a shwa mobile.

The generalisation that Issatschenko misses in (2.52b) is in fact crucial. We can simply say that the genitive ending attached to the masculine and neuter nouns in

question is /s/, attached to a segmentally fully fleshed-out  $S \wedge W$  structure, i.e. a bisyllabic string with this metrical structure containing no zero syllable. The adjective ending in (2.51), on the other hand, always is the W of an  $S \wedge W$  structure. This brings about the difference between *nobl+es* and *Vogel+s*. The distribution of the alternating shwa in *nobel* - *nobles*, shwa mobile in Issatschenko's terms, which is not part of the inflexional morphology, will concern us towards the end of this section. What is important here is that the adjective ending, call it  $\{-es\}_1$ , and the noun ending  $\{-es\}_2$ , follow roughly this rule:

(2.53)

$$\{-es\}_1 \rightarrow \begin{array}{c} \wedge \\ S \quad W \\ \phantom{S} \phantom{W} /əs/ \end{array}$$

$$\{-es\}_2 \rightarrow \begin{array}{c} \wedge \\ S \quad W \\ \phantom{S} \phantom{W} /s/ \end{array}$$

What poses a small problem in this account is the type of alternation displayed in the examples (2.52c). (2.53) predicts for these *Werk+es*, *Tag+es* etc. In terms of metrical structure, they may thus be either (2.54a) or (2.54b) below:

(2.54) a.

	$\wedge$	
	S	W
Werk	+es	
Tag	+es	
Vieh	+es	
Bau	+es	

b.

	$\wedge$	
	S	W
Werk	+s	∅
Tag	+s	∅
Vieh	+s	∅
Bau	+s	∅

It seems to me that *Werk+es* and *Tag+es* are preferred, on

the one hand, conforming with (2.53), whereas on the other hand stems ending in a vowel tend to prefer /s/, like *Vieh+s*, *Bau+s*. The reason may be the avoidance of vowels in hiatus, or simply the possibility of lengthening the stem-final vowel to fill up the zero syllable following it.

Another observation is of interest here. In the next chapter, I shall argue that certain compound nouns can get 'lexicalised' and change their metrical structure, so that we get (2.55a) below as a compound proper and (2.55b) as a lexicalised one:

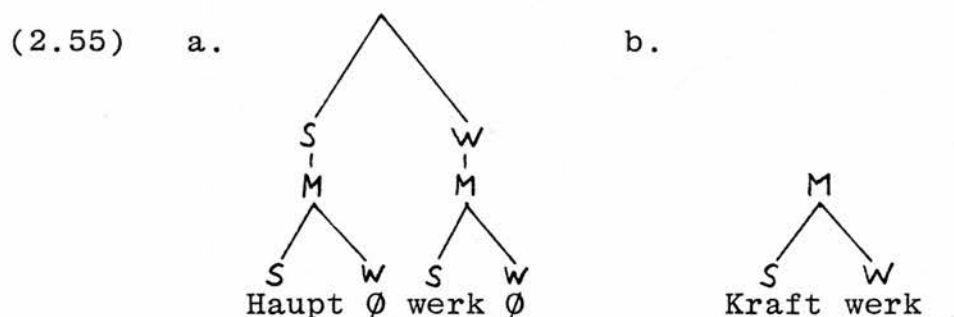

The reader is asked to take this analysis for granted, for the time being. The point is that I would say *Hauptwerk*es but *Kraftwerk*s, where, again, the distribution of /es/ and /s/ follows the rule (2.53) precisely.

To summarise my approach to the distribution of shwa in inflexional endings, then, we have seen that the non-derived native words discussed here crucially have a metrical structure  $\overbrace{S \quad W}$ , produced in the lexicon, whether they surface monosyllabic (in their uninflected forms) or not. Inflexional morphology makes reference to that structure in that, in the two examples discussed so far, one kind of ending fills the W of the lexical metrical structure while the other adds on to it an /s/ and fills the W with a shwa if it isn't already

filled. This saves us the postulate of dubious morphophonemes, bears out Wurzel's generalisation that native stems are monosyllabic in their underlying forms and does without the problems that Wurzel's SPE-type analysis runs into. Inflexional morphology is thus sensitive to the metrical structure provided in the lexicon; later, we shall see that this is easily compatible with the structure that we assume the lexicon to have. The next step in this investigation is the question whether inflexional morphology can in fact add metrical structure or whether all it can do is fill out existing metrical structure and add extrametrical bits.

I shall look at a small selection of cases from the inflexional morphology without attempting to give a complete account. Data will be drawn from Helbig and Buscha (1979), whose account of inflexional morphology is naturally much more detailed.

Let us first of all look at a few instances of word-final shwa, as in *Bote*, *Gäste*, *blöde* etc. To start with a somewhat marginal example, shwa is optional as a dative singular ending with certain masculine and neuter nouns. We don't need to give any further morphosyntactic specification here; what is more interesting is the metrical structure of the words that can take shwa. It is permissible in *dem Hause*, *Kinde*, *Manne*, *Arzte* etc. but clearly ungrammatical in *\*dem Gärtner*, *Vatere*, *Segele*, *Ateme* etc. Shwa is only allowed as an optional filler of a zero syllable:

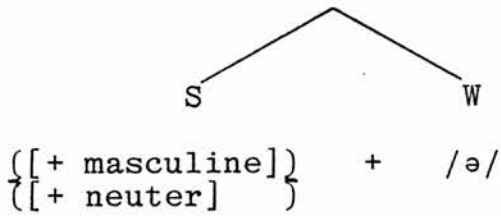
(2.56) Dative singular (optional)

In other instances, the occurrence of optional word-final shwa may be more severely restricted. Issatschenko (1974:142) discusses shwa in predicate adjectives, stating that it is 'exclusively determined by the quality of the stem-final sound'. Thus, we can get *böse, blöde, feige, leise* etc., but not *\*schnelle, rote, grüne*, in constructions like *er ist böse, blöde*, etc. The generalisation to be captured here is that shwa is possible after voiced obstruents only. In these contexts, the addition of shwa avoids word-final devoicing of obstruents. But this is not all: *\*traurige, blendende* etc. don't go either, despite their voiced obstruents. Once again we recognise shwa as a filler of a zero syllable only, this time with an additional restriction in terms of segmental context:

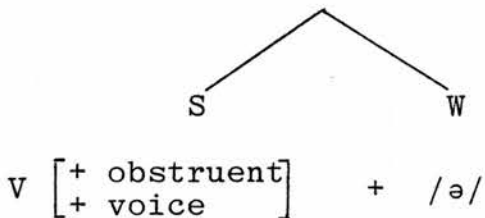
(2.57) Predicate adjective -e

There are cases where the occurrence of word-final shwa is purely morphologically determined, with or without the metrical restrictions well-known by now. Thus, one class of masculine nouns end in shwa in the nominative singular, where shwa fills a zero syllable, another class

doesn't. The one that does comprises nouns like *Bote*, *Döhne*, *Falke*, *Biologe* etc.; the one that doesn't contains *Christ*, *Bärr*, *Held*, *Hut*, *Mensch* etc. I am not aware of any nonmorphological regularities here, except that shwa in the former class always fills a zero syllable. The environment for nominative singular masculine shwa can be stated like this:

(2.58) Nominative singular masculine -e

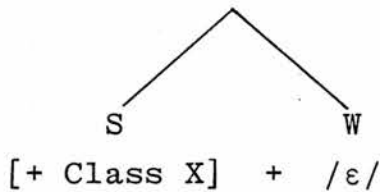

where [+ Class X] stands for a certain morphological class of nouns. Notice that this class is synchronically arbitrary whereas the morphological specification expressed in (2.56) above seems to capture all masculine and neuter nouns.

In other instances of word-final shwa, metrical structure can be completely absent from the context specification. This is the case in the -e plurals. The class of nouns that select shwa as a plural marker is morphologically determined; it comprises masculine nouns (*Ärzte*, *Aale*, *Schuhe* etc.), feminine nouns (*Ärte*, *Nüsse*, *Mäuse* etc.), and also neuter nouns (*Beine*, *Jahre*, *Geschäfte* etc.). Moreover, the nouns that take plural -e may or may not have the metrical structure that keeps recurring in (2.56) to (2.58) above. Consider *Ärzte*, *Beine*, *Geschäfte* on the one hand and *Käfige*, *Kürbisse*, *Zeugnisse* on the other. Clearly, this type of inflexional shwa is not required to fill a zero syllable. It can - within the limits of the morphological class in which it turns up - attach to any kind of metrical

structure:

(2.59) Nominative plural -e

[+ Class Y] + /ə/

This is, in fact, one of the cases where the inflexional morphology simply adds on to existing metrical structures, without reference to what is already there.

Let us look at another set of examples of how metrical structure plays a part in the description of inflexional processes. One of the plural allomorphs of German, along with the shwa discussed above, *-en*, *-er*, etc., is zero. In the standard handbooks, e.g. Helbig and Buscha (1979:208), the corpus given comprises the following groups:

1. Masculine nouns ending in *-el* *-en* *-er* (with or without umlaut): *Tadel*, *Tunnel*, *Balken*, *Verfahren*, *Apfel*, *Gräben*, *Acker*.
2. Certain derivations: *Techniker*, *Berliner*, *Schwimmer*.
3. Neuter nouns ending in *-el*, *-en*, *-er*, *-chen*, *-lein*, *-sel*, *Kabel*, *Kissen*, *Gewässer*, *Häuschen*, *Büchlein*, *Streusel*.

What all these items have in common is surface polysyllabicity in the singular, roughly like this:

(2.60) Nominative plural zero allomorph

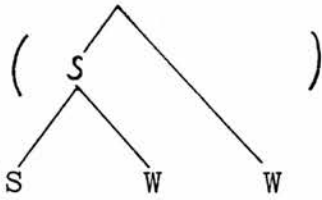

[+ Class Z] +  $\emptyset$  where  $X \neq \emptyset$



Compare Bech (1963) for a similar analysis. Again, there are certain members of different morphological classes which take shwa or /n/ as plural markers although they meet the metrical requirement for the occurrence of the zero allomorph. Examples are *Muskeln*, *Stacheln*, *Verhältnisse* etc. The point is, however, that the metrical structure once again is a necessary (if not sufficient) condition for the distribution of a plural allomorph.

Perhaps even more interesting than the statement in (2.60) above are the implications that this data bears regarding the structure of the grammar. *Häuschen*, *Büchlein* etc. suggest that the derivational morphology happens (presumably in the lexicon; more on that issue will be said later) before inflexional endings get distributed. On top of that, certain items which are represented as /apfl/, /balkn/, /akr/ in the lexicon, must have become bisyllabic by the time inflexional endings are attached. This lends some support to the claim made by Anderson and Jones (1977:107) that syllabification happens via redundancy rules. Notice, in this context, that these authors have demonstrated the importance of syllable boundaries for stress assignment in English. If stress assignment (or, in this model, metrical structure assignment) takes place in the lexicon, then syllabification must take place in the lexicon also, presumably before metrical structure is erected.

What is it, then, that makes /apfl/ and /akr/ bisyllabic on the phonetic surface or, in other words, what is it that makes Wurzel (1970b:170 f.) claim that *Apfel* and *Acker* have monosyllabic underlying forms? In the absence of a phonological model that recognises the syllable as a constituent, he can only investigate the

possibility of 'combining' certain consonants. His results are summarised in the following table:

(2.61)	/r/	/l/	/m/	/n/	[+ obs]
/r/	-	Kerl	Wurm	Horn	Ort
/l/	Keller		Halm	Köln	Zelt
/m/	Eimer	Hammel		-	Samt
/n/	Donner	Tunnel	-		Front
[+ obs]	Vater	Segel	Atem	Segen	Kraft

(Wurzel 1970b:170)

According to this table, epenthetic shwa occurs between /l/ and /r/, in that order, between nasals and liquids, and between obstruents and sonorants. But why? It is quite clear that the answer to this question lies in the principles of German syllabification. Wurzel's point can be made more interesting by saying that the ordered pairs of segments given above fail to co-occur in the same syllable. Syllabification works in such a way that a syllable boundary is placed between them.

A number of authors, among them Pike and Pike (1947), Fudge (1969), Selkirk (1980), and Kiparsky (1981), have argued that the syllable has an internal constituent structure of the form given in (2.62):

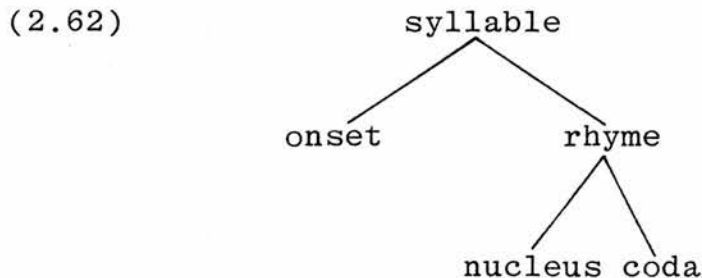

In Selkirk (1980) and Kiparsky (1981), prominence profiles of the syllable have been proposed within the

respective author's particular model of metrical phonology. I don't wish to get involved here in the debate that is still going on between various models of metrical structure at this particular point; the problem at hand does not in my impression provide this debate with fresh insight. Instead, I shall refer only to Kiparsky (1981), for the simple reason that his model, like the one I am advocating in this study, is a strictly relational one while Selkirk (1980) proposes that 'onset', 'rhyme', 'nucleus', and 'coda' be treated as phonological primes. In Kiparsky's model, these labels are relationally defined within the following prominence profile of the syllable:

(2.63)

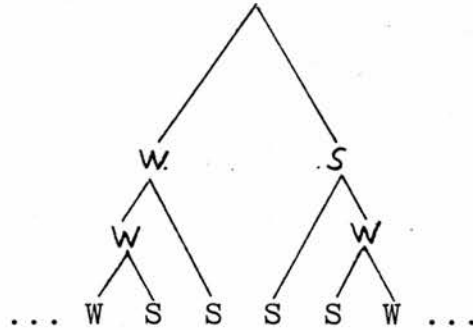

The rhyme, for example, would be the subtree underneath the highest S, etc. I leave aside the question of whether the nucleus can branch or whether any off-glide, or non-syllabic vowel, is part of the coda. Also of no importance are complexity restrictions on onset and coda; the picture of the coda given here is quite sufficient.

The point is that prominence in the syllable decreases from the nucleus towards the margins. What is referred to as 'prominence' here is in fact the sonority of segments: sonority is "simply the intrasyllabic counterpart of stress" (Kiparsky 1981:250).

Segments, as a number of authors have established, can

be ranked in terms of a universal sonority hierarchy. Thus, Hooper (1976:205) proposes a strength hierarchy (where 'strength' is the reverse of 'sonority') in which the segments under discussion here are ranked in the following way:

(2.64) Sonority hierarchy (fragment)

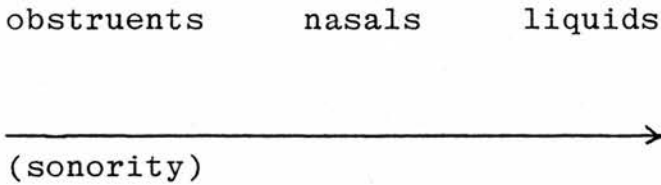

Not a lot is known about how sonority is measured in phonetic terms and I am relying entirely on the statements found in Hooper (1976). For each given language, the sonority hierarchy has to be fleshed out with the specific phonetic and phonological properties of that language's particular segments. For /r/, to choose just one example that is relevant to our discussion, Ulbrich (1972) has stated that it is 'vocalic' in post-vocalic, i.e. coda-initial position and some kind of fricative in prevocalic position in Standard German. This would imply that the allophone of /r/ in the contexts we are discussing here are more sonorous than /l/.

To return to Kiparsky's model of syllable structure, the bottom nodes of the tree (2.63) get mapped onto the segments of a string in such a way that sonority decreases from the nucleus towards the margins and no other mapping is possible. Thus, strings of segments of equal sonority cannot be the terminal elements of the coda, nor can strings of segments of increasing sonority.

To illustrate this mapping procedure, I give a well-formed monosyllabic mapping of *Halm* in (2.65a) below, and ill-formed ones of *Hammel* and *Brunnen* in (2.65b.c.).

(2.65) a.

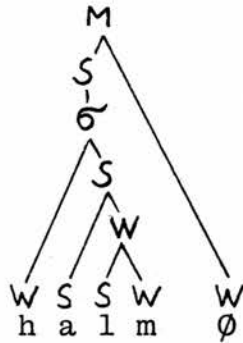

b.

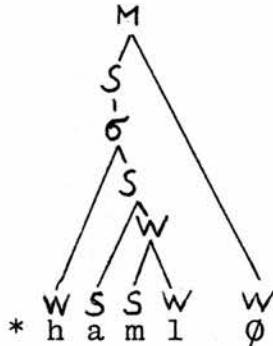

c.

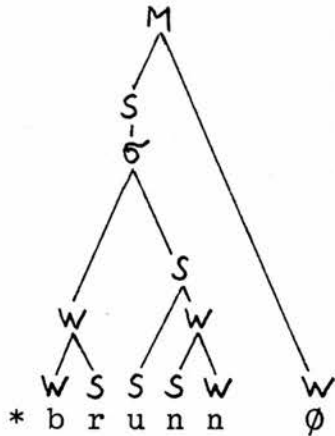

(2.65b) is ill-formed because an  $S \wedge W$  coda cannot be mapped onto the /ml/ cluster - the reason for this is to be found in Hooper's sonority hierarchy; /l/ is more sonorous than /m/. Similarly, (2.65c) is an impossible mapping because the  $S \wedge W$  structure of the coda cannot

be mapped onto segments of equal sonority, in this case /nn/. I shall not pursue this problem any further at this point. A lot more needs to be said about the German sonority hierarchy as well as, possibly, phonotactic constraints that are independent of this hierarchy. Instead of going into these problems, I think it is fairly safe to conclude here that certain mappings of codas onto segments are ill-formed, like those in (2.65b.c.), that therefore the final segment becomes part of a separate syllable and a vowel gets inserted to flesh out this syllable.

The question arises why the vowel that gets inserted in these structures, and indeed in all cases of vowel insertion in the inflexional morphology as well, is always shwa. Hooper (1972;1976) claims that all vowels that are inserted in phonetic environments are predictable in terms of two universal principles. The epenthetic vowel is either the minimal vowel shwa or one whose features are copied from a nearby segment. Stress languages, according to Hooper, insert shwa, whereas some tone languages and all vowel harmony languages insert vowels identical with nearby vowels. German is, like English, a stress language, so that all epenthetic vowels can be expected to be shwa.

An interesting point raised by Wurzel (1970b) is that, conversely, all shwa occurrences are the result of insertion processes. This, as we shall see later, has interesting consequences on metrical structure: it means that no vowel reduction processes have to be accounted for in terms of metrical structure as none of the shwas in the language are the surface forms of underlyingly unreduced vowels.

I would like to return to inflexional morphology for a

few paragraphs. Syllabification, as we have seen, is constrained by certain phonetic properties of the segments involved in such a way that the sonority pattern of the syllable, given in a metrical tree of the form (2.63), has to match the intrinsic sonority pattern of the string. If this matching doesn't work out then the string in question can't be monosyllabic and the result is, frequently, shwa epenthesis. Exactly the same phenomenon can be shown to govern the occurrence of shwa in certain inflexional endings - another item on the list of governing factors in the distribution of inflexional allomorphs. I shall discuss just a few pairs of such allomorphs here, all of the phonetic form [ən]/[n].

Consider the distribution of *-(e)n* in the adjective paradigm as the dative singular, genitive, dative, and accusative plurals, on the one hand, and in the verb paradigm as the infinitive marker:

(2.66) a. Adjectives                      b. Verbs

gut+en	schlag+en
blau+en	komm+en
groß+en	schreib+en
neu+en	bau+en
eitl+en	vereitel+n
makabr+en	zitter+n
bescheidn+en	segn+en
komfortabl+en	atm+en

The adjective and verb endings in question aren't in fact as similar as they seem at first sight. In terms of the analysis offered by Issatschenko (1974), the adjective ending in (2.66a) contains a shwa constant. It always surfaces as [ən], entirely regardless of the segmental structure of the stem it gets attached to, especially regardless, as it were, of any kind of sonority criteria

and of the possibility, on those grounds, to form a monosyllabic unit instead. Thus, we get *blauen* where *braun* exists in the language as a monosyllable, *neuen* despite the existence of *neun*. Stating that the ending in question is invariably /-ən/ captures this point.

But what Issatschenko can't account for in a straightforward way is the non-occurrence of stem-internal shwa in at least four examples in (2.66a): compare *eitel* and *eitlen*, *makaber* and *makabren*, etc. It is quite clear that adjectival /-ən/ not only has a certain metrical (or syllabic) structure, it also presupposes a certain regularity in terms of metrical structure on the part of the stem it attaches to. It has, in fact, the same properties as /-əs/ in adjectives - compare (2.51) and (2.53) above.

(2.67) -en in adjectives

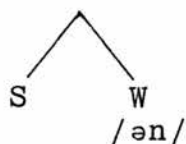

In other words, it always acts as a filler of the zero syllable that these adjectives carry in the output of the lexicon.

The infinitive endings in (2.66b), on the other hand, contain shwa mobile in Issatschenko's analysis; in terms of the present model, well-known by now, the ending is /n/ which adds on to the metrical structure given by the lexicon. Thus, we get the structures below:

(2.68) a.



b.

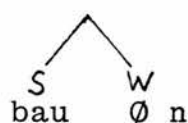

cont'd



(2.68) cont'd

c.

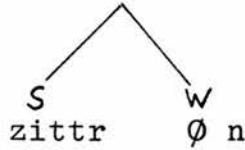

d.

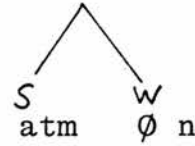

(2.68a) is straightforward: the zero syllable gets filled by an epenthetic shwa. Case (2.68b) is more complex since, as mentioned above, *braun* also occurs so that the /n/ isn't forced into the next syllable by a purely phonological constraint. What is to be learned from this example is that the infinitive ending /n/ attaches to a bisyllabic structure of the metrical form  $S \wedge W$ . Next, (2.68c) always surfaces as *zittern*, never as \**zittren* (which would be another way of fleshing out the segmental string while conforming with the constraints on syllable structure). Evidently, the ending attached is /n/ and not /-ən/ underlyingly and is syllabic only when this is necessary to fill the  $S \wedge W$  structures it attaches to. But why, then, do we get *atmen* in (2.68d) and not, parallel to (2.68c), \**atemn*? Because /mn/ is not a possible cluster in the coda of the syllable. *atmen* is thus the only possibility of attaching /n/ to a bisyllabic structure containing the stem /a:tm/. All these different structures are accounted for if we state the infinitive ending as in (2.69) below, parallel to the way -(e)s for nouns was formalised earlier:

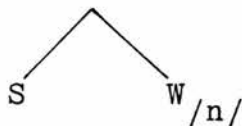
(2.69) Infinitive

I shouldn't leave the topic of inflexional morphology and epenthetic shwa without giving a synopsis of the various analyses I have proposed. Metrical structure, in particular our postulate that all lexical items contain a structure  $S \hat{W}$ , has been found to play an important part in our account. It simplifies greatly a statement of why, for example, *Amt* is monosyllabic while *Atem* contains an epenthetic vowel. It helps account for what Issatschenko distinguishes in terms of shwa mobile and shwa constans: shwa mobile endings attach to the W node of an  $S \hat{W}$  structure while shwa constans endings constitute the W of such a structure.

In determining the eventual shape of inflexional endings, metrical structure interacts with a variety of features that are present in the underlying representation of the stem. Thus, reference may be made to segmental features in two different ways. In some cases, epenthetic vowels are produced where a well-formed mapping of segment sequences onto syllable structures would otherwise be impossible; in other cases, shwa is added in certain environments characterised by segmental features: the example given was optional shwa in predicate adjectives, possible only after voiced obstruents.

In a variety of instances, metrical structure interacts with morphological features: dative *-e* attaches only to masculine and neuter nouns; masculine nominative singular *-e* attaches to a synchronically arbitrary class of nouns, and so forth. While there are endings in the inventory that make no reference to metrical structure at all - plural *-e* is such a case - the main point I wanted to make in this section was that metrical structure does play a part in a large section of the inflexional morphology, interacting with other factors.

An adequate model of inflexional morphology, to my mind, isolates these determining factors clearly rather than trying to eliminate individual ones and attempting 'monocausal' accounts, like Wurzel's purely segmental ones or the morphologically-based ones found in some handbooks of German grammar.

### 2.2.3 Some speculative remarks on syllabification

We haven't so far answered the question of how, exactly, an intrasyllabic prominence structure like the one given in (2.63) above can get mapped onto strings like /haml/ and /brunn/; all I have stated so far is that a monosyllabic mapping is ill-formed for these strings and that, therefore, they surface as bisyllabic structures containing epenthetic vowels (or syllabic sonorants) in their second syllables. Recall the ill-formed mappings in (2.65b.c.).

I would like to outline in this section what seems to me a possible answer to this question. This sketch of an argument - and it isn't meant to be more than that - will involve some issues which have previously cropped up and which, at first sight, seem rather unrelated to the problem at hand. They are the problem of geminate consonants and that of zero syllables. In an attempt to unite these problems into one, I feel rather tempted to think along the following lines.

As stated in (2.65) above, a monosyllabic mapping of *Brunnen*, repeated in (2.70) for convenience, is ill-formed:

(2.70)

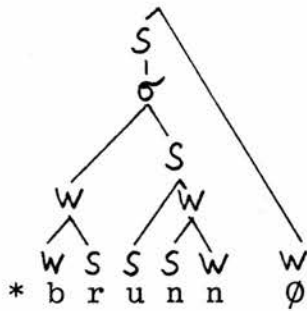

The reason for a monosyllabic tree's failure to map onto /brunn/ is, as I stipulated earlier, our commitment to a decrease of sonority in the coda, which in the case of a geminate consonant isn't met. Thus, a intrasyllabic  $S \wedge W$  tree cannot be mapped onto a string /nn/. This constraint, clearly responsible for a bisyllabic mapping of the string in question, poses a problem for the model that I have been defending in this study. The problem is that in section 2.1.1.1 above I have been proposing geminate consonants - recall (2.3) for example - which gave us the CC clusters in the final syllable of a word required to attract stress, whereas I am now saying that the coda of a syllable can't contain geminate consonants. Why is *Metall* well-formed as a bisyllabic word with final stress and /brunn/ ill-formed as a monosyllable?

In justifying my postulate of geminate consonants, it will be recalled, I made reference to Von Essen (1979) who, in summary, says that it makes sense to speak of geminate consonants in German because frequently a consonant belongs to two adjacent syllables at the same time. One way of representing this fact formally would be the statement of geminates with the syllable boundary going through the middle of this geminate cluster. This is the way which I have tacitly chosen so far.

Alternatively, one could do without gemination and permit

a single consonant to form (part of) the coda of one and the onset of the next syllable. This analysis, involving overlapping syllabification and the ambisyllabicity of certain consonants, is essentially the one adopted by Anderson and Jones (1974: 1977) although, as I mentioned above, these authors additionally permit geminate clusters.

Anderson and Jones's approach of 'maximalist syllabification', allowing for the overlap of syllables, actually makes a lot of sense for a model where a prominence tree is mapped onto a string, subject only to well-formedness conditions which appeal to properties of segments like sonority. For example, if *Matte* contains two syllables, and if one well-formed syllable is [mat] and another one is [tə], then the mapping in its most straightforward way will be one that makes the word-medial consonant belong to both. To stay with this example for a moment, we have been assuming that the shwa is added on to the string later rather than being part of the lexical representation. This would mean that the structure that emerges from the lexicon, complete with metrical tree, would be something like this:

(2.71)

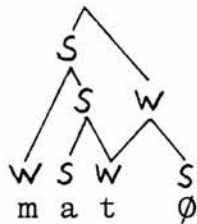

The adjective *matt* would have exactly the same structure, the surface difference being brought about by the fact that the noun is subject to a morphological rule that fleshes out the zero syllable while the adjective isn't.

This analysis implies, rather paradoxically on the face of it, that we can have ambisyllabic consonants in word-final position. How crazy is this claim really?

One of the essentials of my model is the assumption that lexical monosyllables have a phantom syllable attached to them which gives them a suprasyllabic  $\begin{matrix} \wedge \\ S & W \end{matrix}$  structure. All I'm saying now is that the zero syllable, previously represented simply as ' $\emptyset$ ', has an internal structure like any other syllable and that, if analysed in more detail, a zero syllable is in fact a zero rhyme. And this result is not really surprising, given that it has long been known that it is the rhyme of the syllable that figures in phonological representations of quantity ('morae') and related issues.

The next step in this argument would be the claim that the occurrence of zero rhymes isn't the effect of a seemingly arbitrary well-formedness condition on metrical structure, as stated in chapter 1 above, but predictable from the segmental composition of the lexical item it is attached to. This claim, I think, is justified.

It is a well-known fact that lexical monosyllables in German contain in their rhymes either long vowels or short vowels plus at least one consonant. These structures are usually referred to as 'heavy syllables'. Light syllables, on the other hand, comprising (C) $\check{V}$ #, are systematically absent among German - and English - lexical monosyllables. If we assume that long vowels and diphthongs are represented as two segments, the second one possibly as a glide, and that the second one is part of the coda (Kiparsky 1981), then the conclusion is that lexical monosyllables always have a nonzero coda. Under the principle of maximalist syllabification, this

coda would then be the ambisyllabic onset of the zero syllable. Here are some examples:

(2.72)

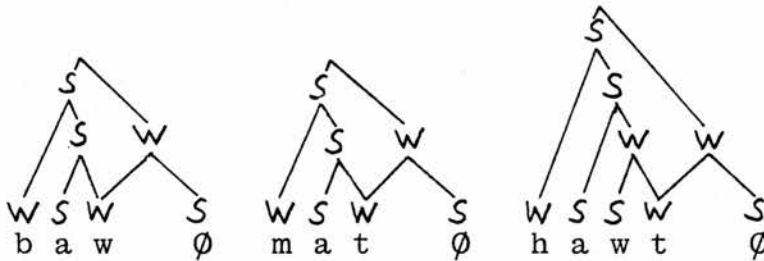

Absent among lexical monosyllables are structures like *zu*, ending in a short vowel. *zu* exists as a nonlexical item in German. The situation would be perfectly clear and obvious if we could generalise that lexical monosyllables always have a coda whereas nonlexical ones never do. Unfortunately, only the first statement is true. But the spelling conventions of German seem to suggest, in some way, that there is a generalisation to be made. In spelling, lexical monosyllables end in a vowel (*Bau*), a consonant (*Hut*), or two consonants (*mat*, *Saft*). Before two consonants, geminate or cluster, the vowel is pronounced short; before zero or one consonant, the vowel is long. This convention doesn't hold among nonlexical items: *mit*, *in* etc. have short vowels in pronunciation and nongeminate consonants in spelling. What this convention seems to suggest is that word-final consonants are either geminate or ambisyllabic in lexical words but nongeminate (and non-ambisyllabic) in nonlexical words.

I believe that the following two analyses of *mat* are notational variants of each other:

(2.73)

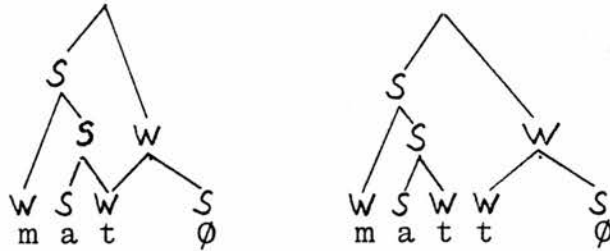

Let us, quite arbitrarily for the moment, adopt the former of the two, involving ambisyllabicity. We can then represent *Kongreß*, a word with final stress for which we have previously posited a geminate consonant, and *Limes* (penultimate stress) in the following way:

(2.74) a.

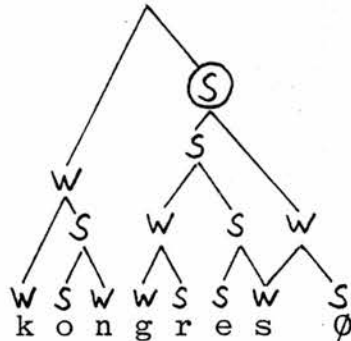

b.

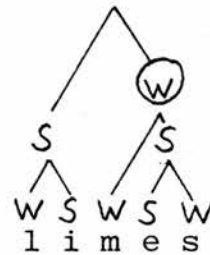

The circled node in (2.74a) dominates two syllables and is therefore S, essentially in the same way as it did when it was analysed previously. The difference between the old analysis and the new one is that the new one predicts suprasyllabic branching on the basis of syllabic structure, while the old one dealt with this question by making reference to a well-formedness condition. In a word like *Kongreß*, the final consonant is marked as ambisyllabic; it therefore gets a zero rhyme attached to it. It receives stress on the penultimate one of the resulting two syllables: the node above, circled in (2.74a), is S because it branches.

Unfortunately, we can't do without marking this structure



as special in the lexicon. Lexical items can - and often will - have word-final consonants which are not ambisyllabic, which for that reason don't get a zero rhyme, and which therefore don't get final stress. An example is *Limes* in (2.74b) above.

We are, to say it again, faced with a situation where lexical items can have either single or double final consonants or, alternatively, either non-ambisyllabic or ambisyllabic ones. Whichever of the two applies has to be specified in the lexical representation; and the way in which this dichotomy is going to be expressed in this model, whether we use geminates or ambisyllabicity, has still to be established.

If we choose the notation that employs the notion of ambisyllabicity, then we find that we can analyse *Brunnen* in a rather elegant way. Assume, therefore, that geminates don't exist and that /brunn/ can't have a monosyllabic mapping. Its syllabic structure will then look like this:

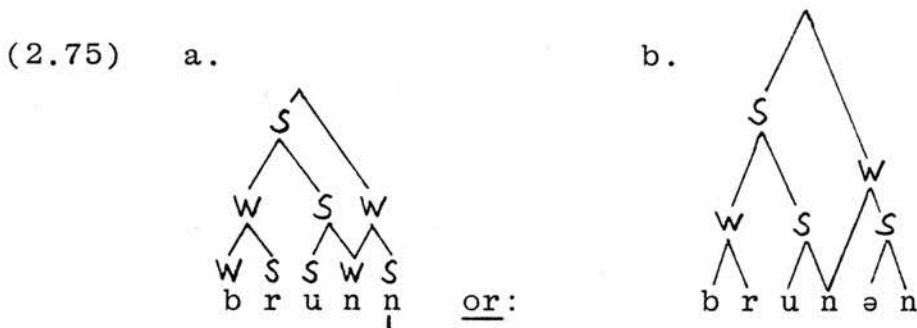

The first /n/ is ambisyllabic, the second one either syllabic - this is possible in German - or preceded by an epenthetic shwa in order to push it into the coda of that syllable.

The same analysis works for *Hammel*:

(2.76) a.

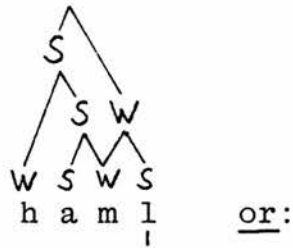

or:

b.

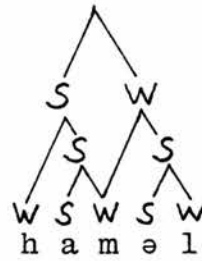

On closer inspection, we find once again that an analysis operating with geminate consonants instead of ambisyllabicity, will be able to do the same job, although at a price. We only have to give *Brunnen* a metrical representation like this:

(2.77) a.

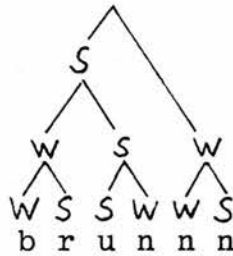

b.

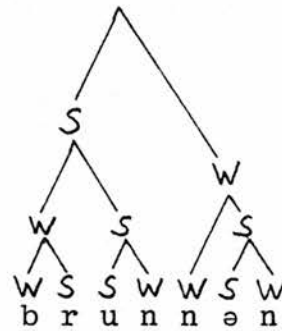

The problem is that in (2.77a) we would have a rather unattractive second syllable, namely  $\begin{array}{c} \text{S} \\ \text{W} \\ \text{n} \quad \text{n} \end{array}$ . I don't know how to deal with this but some convention, no doubt, would do the trick. No such convention is needed for an analysis that allows for ambisyllabicity. Sonority is - at least in the cases we are discussing here - the only criterion that is decisive in syllabification. Ambisyllabic word-final consonants, admittedly something rather strange, have under the alternative model to be replaced by word-final geminates. I think we can conclude that, on these grounds, the 'ambisyllabic' version of our model is somewhat superior. And more importantly, I think I have shown in this section that we have to

employ the notions of either ambisyllabicity or geminates, but not both.

What have we learned in this section anyway? We have seen that zero syllables are in fact zero rhymes - this captures certain structural properties of lexical monosyllables -, that an analysis like that accounts for epenthetic vowels in words like *Brunnen*; and, finally, we have learned that we are stuck with having to mark items like *Kongreß* in the lexicon whichever variant of the model we choose: as ending in a geminate consonant cluster under one analysis, or as ending in an ambisyllabic consonant under the analysis that I have tentatively adopted here.

What is important to bear in mind is the fact that the rules governing the prominence relations within words, in particular the Main Stress Rule (2.16) and the Word Rule (2.21), make reference to intrasyllabic metrical structure. As for the Main Stress Rule, we have adopted an analysis whereby the final syllable will be S if it contains, among other possibilities, a consonant marked as ambisyllabic in the lexicon. As this is the only feature I have changed since I first gave this rule, I maintain the specification given there.

As concerns the Word Rule (2.21), we have to specify that branching only gets taken into account if it occurs above the level of the syllable; intrasyllabic branching (which will always be present) doesn't count, so that the rule that assigns prominence relations among syllables makes reference only to branching among syllables, that is, on the same prosodic level. It will be recalled that in the introductory chapter I made a similar statement about the compound rule, which only takes into account branching among nodes dominating words: again,

that is, on the same prosodic level. We introduced nodes called M there to separate prosodic levels. Assume that, similarly, a node that dominates a syllable is marked ' $\sigma$ '. Thus we get the following complete structures for *Kongreß* and *Limes*:

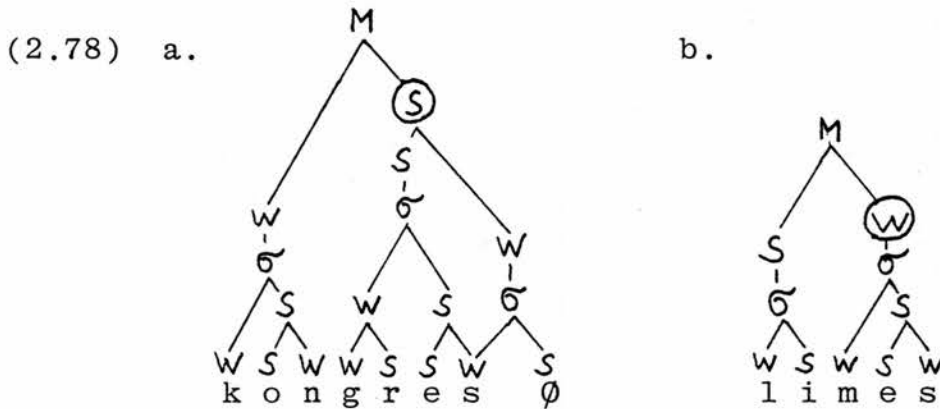

The circled node in (2.78a) branches above the level marked ' $\sigma$ '; the one in (2.78b) doesn't. The Word Rule makes the former strong and the latter weak. The question of prosodic levels, in connection with this rule, will be taken up again when the compound rule is discussed. Here, the question arises whether the category ' $\sigma$ ' that I have just introduced has the status of a phonological prime, as discussed in chapter 1, or whether it can be relationally defined. Notice that in the structure of the syllable that Kiparsky (1981) suggests, and that I have been employing so far, the root of the syllable has a recurrent property which can be uniquely relationally defined: recall (2.63) above where this structure is given. The root ' $\sigma$ ' is the only node in that structure that dominates an S which, in turn, dominates an S. In other words, the root of the syllable is exactly two nodes above the nucleus (which in turn is relationally defined). The structures of all syllables have this property; ' $\sigma$ ' is therefore relationally defined. To go back to the Word Rule, then, we can simply state that the right-hand node (the node called  $N_2$  in (2.21)

above) is strong if 'it dominates S which dominates S which dominates S'.

#### 2.2.4 Class II suffixes and stress

Quite a while back, in sections 2.1.2 and 2.1.4 I started to investigate in some detail the metrical behaviour of German derivational suffixes. A number of different issues have been discussed meanwhile and it is probably appropriate to go back, briefly, to the beginnings of this rudimentary morphological investigation and to recapitulate what we have found so far.

In section 2.1.2 it was shown that nonnative suffixes in German either bear the main stress of the word or no stress at all. Their stress behaviour was shown to be governed by the Main Stress Rule: if the suffix contains a heavy syllable then it is stressed, if it doesn't then the stress rule skips over it. Examples for the two groups would be *Dekán* - *Dèkanát* and *reál* - *reáliter* respectively.

Based on this finding, section 2.1.4 contained some proposals concerning the structure of the lexicon, which account for the stress behaviour of these suffixes and enable us to capture it in terms of a metrical phonology. At the same time, stress alternations between simple and derived words were automatically accounted for; recall *Dekán* and *Dèkanát*. I shall briefly repeat these proposals here, as they lead us quite smoothly into an area of suffixation that has remained untouched so far.

The lexicon is assumed to contain a component that assigns metrical structure to words. In particular, the sequence

of 'events' that a lexical item undergoes before entering into the syntactic derivation is as follows. The lexical entry consists of a stem, presumably in a morphophonemic representation. Stems undergo morphological derivations involving the suffixes that I listed in (2.13) and (2.14) above, where applicable. Following Siegel (1974), I called these suffixes Class I suffixes (tacitly assuming that at some point I'd be introducing a Class II: we have now reached this point).

Some stems may surface as words without receiving a suffix in that section of the derivational morphology. Whichever is the case, having received a Class I suffix or not, a given lexical item gets metrical structure assigned to it after it has gone through Class I suffixation. This means that all Class I suffixes are present when metrical structure is assigned and that therefore they all undergo the Main Stress Rule. But it also means that no selection of a Class I suffix can ever be sensitive to features of the metrical structure of the stem it attaches to - simply because the stem won't have metrical structure at the point where the suffix gets attached. This is essentially the model developed for English by Siegel (1974), since then applied to Dutch in a study by Booij (1977).

Let us now turn to the suffixes informally labelled as 'native' in (2.12) above. I repeat them here for convenience.

(2.79)	a.	-chen	Häuschen	b.	-heit	Neuheit
		-ler	Künstler		-(ig)keit	Neuigkeit
		-isch	kindisch		-lein	Kindlein
		-ling	Neuling		-los	atemlos
		-bar	ehrbar		-mäßig	saumäßig
		-nis	Zeugnis		-schaft	Seilschaft
		-sam	seltsam		-tum	Brauchtum
		-ung	Schiebung		-icht	Dickicht
		-sel	Füllsel			
		-er	Säufer			

I am going to claim in this section that the suffixes listed in (2.79) above are to be categorised as Class II - not only because their behaviour is systematically different from that of the suffixes that I have above called Class I but also because this group of suffixes conforms exactly in their behaviour with that of Siegel's Class II.

Instead of using these labels it would, of course, be legitimate to stick to the mnemonically convenient terms 'native' and 'nonnative'. But it is part of my argument to show that there is more involved than just etymology, and in that sense 'native' might be misleading. Moreover, this label might lead one to believe that it acts as some kind of filter in word formation processes so that native suffixes attach to native stems only and vice versa. This is the case to some extent but not entirely. Both native and nonnative stems (and it will be remembered that where the metrical phonology of German is concerned this distinction has already been given up) take native and nonnative suffixes. Thus, the Class I suffix *-ei* can occur with native stems: *Sauferei*, *Kartei* etc. Similarly, a number of Class II suffixes can occur with nonnative stems: *Akzentuierung*, *generierbar*, *strukturlos* etc. It would be a nice generalisation if the feature [native] acted in that way in word formation processes. Since it doesn't it would only be misleading to retain it.

Siegel (1974) argues that there are two classes of suffixes in English and that, furthermore, suffixation takes place in two distinct stages so that Class I suffixation precedes Class II suffixation. Metrical structure (in her model: an n-ary stress feature but this difference is immaterial to the argument) gets assigned between the two stages. One of the consequences of this model I have already indicated: Class I suffixes are subject

to the Main Stress Rule and their distribution is never sensitive to the metrical behaviour of the stem.

The characteristics of Class II suffixes follow from this. Class II suffixes aren't stressed through the same process as their stems (if at all: this remains to be seen) and their distributional properties may make reference to the metrical structure of the stems they attach to. I am saying they may: they obviously don't have to; the possibility exists simply because the stem has a metrical structure at the point of the derivation where Class II suffixes get attached. A further piece of evidence for Siegel's model is her observation that, in cases of multiple suffixation, no Class I suffix ever follows a Class II suffix in the same word. I believe that this can be verified in German but I don't wish to elaborate this point in the present study as it has nothing to do with the object of inquiry, the metrical structure of German words.

Let us, instead, look at the question of whether, and how, Class II suffixation in German is sensitive to the metrical structure of the stem. Here are two examples from Siegel's thesis. *-al*, an English Class II suffix deriving nouns from verbs, attaches only to verbs with final stress (and ending in a certain segment cluster, of no interest here). Thus, *reversal*, *rental*, *survival*, *appraisal* are possible but *\*abandonal*, *fidgetal* are not (Ross 1972; Siegel 1974). It looks, then, as if the structural description of this suffixation process contains the statement that *-al* has to fill a zero syllable. Similar properties have been found among inflexional suffixes of German (section 2.2.2 above).

Secondly, *-(t)eria* and *-eteria* are suffixes productive in American English, usually denoting commercial estab-



lishments of some sort. *Marketeria*, *radioteria*, *honey-teria*, *caketeria* are quite common but *\*marketeteria*, *honeyeteria* are ill-formed, as are *\*cakeria*, *cleaneria*. The distribution of the two allomorphs is governed by the simple rule that *-eteria* attaches to nouns with final stress (as *cake* and *clean*) and *-(t)eria* to nouns ending in an unstressed syllable (*market*, *honey* etc.) (Siegel 1974). In metrical terms, *-eteria* attaches to metrical structures in such a way that the first syllable of the suffix fills a zero syllable; in the absence of such a syllable, the other allomorph is selected.

So much for the characteristics of English Class II suffixes. Let us now look at the German suffixes in (2.79) above and ask whether they are in fact of a kind that allows us to call them Class II in Siegel's sense.

First of all, notice that none of the suffixes in (2.79) ever bear the primary stress of the word. This wouldn't be surprising - some Class I suffixes don't either - if it wasn't for the fact that their segmental composition may well be such that we would expect them to be the DTE of the word under the metrical principles I gave in section 2.1.3; consider the ones in (2.79b). These do actually bear some stress but they never qualify for the Designated Terminal Element. Compare *hínderlich* and *kínderlòs*, *Schíebung* and *Bráuchtùm*, *Kíndchen* and *Kíndlèin*. Quite clearly, the second member of each of these pairs has some degree of subordinate stress on the suffix. It seems to me that the suffixes listed in (2.79b) have some stress and the ones in (2.79a) don't. What is interesting is that this is exactly what our Main Stress Rule predicts: the structures in (2.79b) are heavy syllables, the ones in (2.79a) light ones and if the vowel is /ɛ/ it reduces to shwa.

This means that they get handled, in a way yet to be described, by the Main Stress Rule (2.16). The metrical structures for Class II suffixes will, then, look like this:

(2.80) Class II suffixes

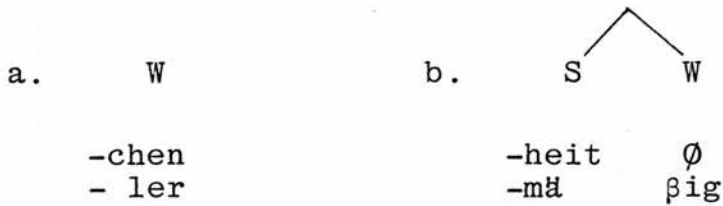

It is, then, our Main Stress Rule that assigns an S (with a W on its right) or a W to Class II suffixes. What is peculiar, though, is that the  $S \wedge W$  structure in (2.80a) is not dominated by S nodes all the way up the word tree, which would make this S node the DTE of the word. I shall demonstrate in detail in section 2.2.5 below that the metrical structures of Class II suffixes, unlike those of Class I ones, get attached to existing metrical trees of stems without modifying those, so that trees of the form given in (2.81) emerge:

(2.81)

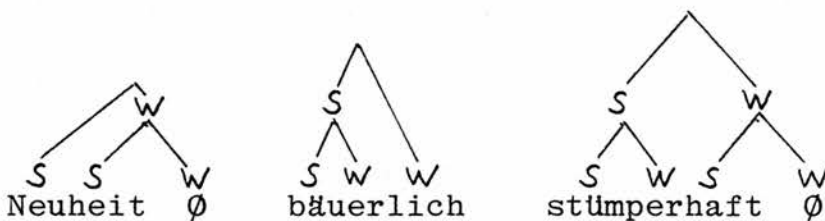

Just what the principles are that underlie these trees will concern us later; let us here concentrate on the behaviour of the suffixes themselves and postpone the question how a stressed Class II suffix can enter into a word tree without becoming the DTE of that tree.

I must add here that I am not entirely certain about the

stressing of each individual one of the suffixes given in (2.79); it may well turn out that some have to be moved from (2.79a) to (2.79b) and vice versa, depending on whether their vowels are always long or always short. What is important, and this claim I do maintain, is that they are governed by the Main Stress Rule.

Let us turn to Siegel's observation that Class II suffixes may be sensitive to the stress behaviour of the item they attach to. There is at least one case where the same observation can be made for German. Consider the distribution of *-heit*, *-keit* and *-igkeit* in German de-adjectival nouns. While the distribution of *-heit* is free with respect to the metrical structure of its base (compare *Derbheit* and *Geschliffenheit*), *-keit* and *-igkeit* are in complementary distribution in an interesting way. To start with the simple cases, *-keit* never attaches to monosyllabic adjectives: *\*Dreistkeit*, *Hellkeit* are impossible. Instead we get *Helligkeit*, *Dreistigkeit*. This generalisation, however, is not exhaustive: *-igkeit* also attaches to adjectives that already contain certain suffixes and *-keit* attaches to ones that contain others. The distribution is given in (2.82):

(2.82)		-keit		-igkeit
	-bar	Ehrbarkeit		
	-haft			Lebhaftigkeit
	-isch	Bäurischkeit		
	-lich	Lieblichkeit		
	-los			Lieblosigkeit
	-sam	Furchtsamkeit		

(See also Fleischer 1974:152)

It turns out that *-igkeit* attaches precisely to those suffixes that we have in (2.79b) listed as stressed; *-keit* attaches to unstressed suffixes of the type given

in (2.79a).

The metrical structures to which *-igkeit* can get attached can be generalised in a very simple way: it attaches only to such metrical trees that have a final zero syllable. Thus, we get structures like the ones in (2.83a) and the ones in (2.83b) are ill-formed:

(2.83) a.

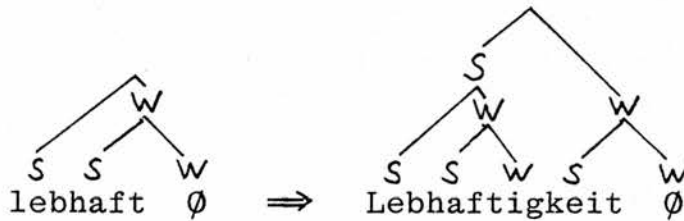
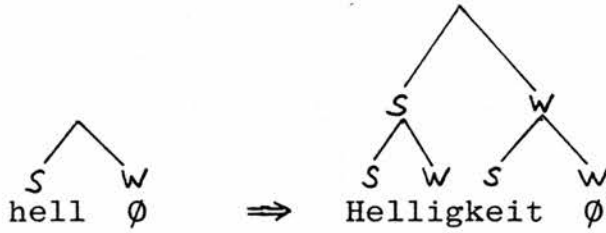

b.

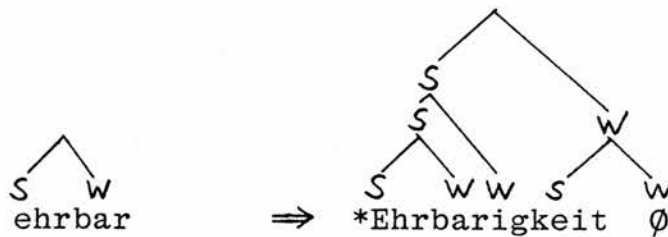
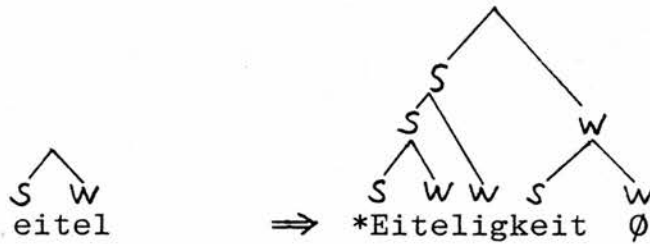

*-igkeit* simply attaches to items only which contain a

zero syllable. This zero syllable will get taken up by this allomorph's expansion *-ig*. *-keit*, on the other hand, occurs only with items whose metrical trees end in a nonzero W node. The two are clearly allomorphs of the same morpheme and the expansion *-ig-* is nothing but the filler of a zero syllable.

I have discussed the distribution of *-(ig)keit* in such detail for two reasons. First, it is clearly sensitive to the metrical structure of the item that it attaches to, thus providing us with evidence that German has Class II suffixes, defined in the sense of Siegel (1974), and that this is one of them. Siegel's analysis thus applies to German with all its consequences. Second, the distribution chart given in (2.82) above backs up what I have said earlier about the differences in stress behaviour found among German Class II suffixes. The distinction drawn in (2.79a.b.), formalised in (2.80), evidently has some backing outwith the (in some cases disputable) perception of stress on my part.

#### 2.2.5 Native words, Class I suffixes, and metrical structure

What remains to be discussed in this section is the metrical structure of native words, complete with inflexional endings where applicable, as well as the metrical structure of words derived via Class II suffix. As these suffixes usually attach to native stems (this point was made in 2.2.4 above) it seems appropriate to handle all this material in one section of this study.

Let us develop the metrical structures that emerge in this part of the German lexicon step by step. The metri-

cal structures of simple (nonderived) words are - as is well-known to Germanicists - strikingly simple: they have initial stress. The question is to what extent this initial stress is compatible with the Latinate Main Stress Rule (2.16); the reader will recall that Wurzel (1980) considered it necessary to deal with native and nonnative words in different sets of stress rules. It now turns out that, apart from a very limited set of exceptions that I shall deal with later, native words are adequately handled by exactly those rules that assign metrical structure to nonnative items. The reason for this can be found in a morphological regularity of native words, pointed out by Wurzel (1970b) and Benware (1980): native German words are underlyingly monosyllabic. The implications of this important generalisation were discussed in section 2.2.2 above.

Thus, a metrical component that operates before Class II suffixes and inflexional endings get attached will handle simple words in a straightforward way. Take, for example, items like *Affe*, *Segel*, *saufen*, *schlafende*, *segelt*, *schön*, *schnellere*. The metrical structures of the stems of these words are given in (2.84):

(2.84)

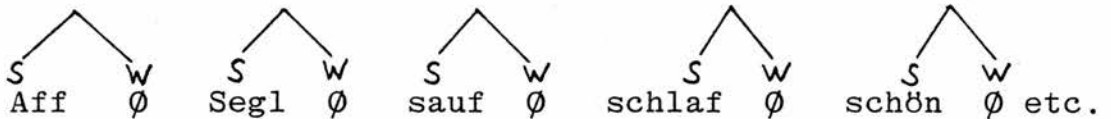

All inflexional endings are absent at the time when metrical structure is erected; surface-bisyllabic items (like *Segel*) are at that point monosyllabic - the shwa is inserted by rule later in the derivation. This process and the metrical behaviour of inflexional endings were discussed in detail in section 2.2.2 above. The metrical structures in (2.84) above are produced by existing

rules: they are the output of the shortest expansion of the Main Stress Rule; no new rule has to be introduced to assign initial stress to the item listed above.

At the point of the derivation where metrical structure is erected on stems, Class II suffixes are absent just as inflexional endings are. The addition of these suffixes is what happens next. Consider, first of all, the unstressed Class II suffixes given in (2.79a) above. They simply get added on to the existing metrical structure, which presents no problem since they are all metrically weak. Thus, we get for derivations like *affig*, *Sdufer* etc. structures like the ones in (2.85):

(2.85)

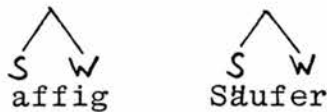

It would be rather tempting to conclude from these structures that unstressed Class II suffixes - like some inflexional endings, recall section 2.2.2 - don't have any metrical structure but are specified so as to fill zero syllables. This is actually not the case. Consider one of the rather frequent instances where Class II suffixes get stacked onto one another in multiply derived words, *Sduferchen* for example. The first suffix, *-er*, fills a zero syllable; but the second one doesn't. *-chen* adds another W node to the structure. The difference between the two suffixes doesn't actually have to be specified anywhere in the grammar; it falls automatically into place. Recall that in the introductory chapter I introduced a well-formedness condition on metrical trees that allow zero syllables to occur only between terminal S nodes; this condition is called Zero Syllable Constraint (1.18).

In the case under discussion here, it has the effect of automatically slotting an unstressed Class II suffix into an existing zero syllable, simply because an unstressed Class II suffix next to a zero syllable would be ruled out. The Zero Syllable Constraint, then, allows us to state the metrical properties of unstressed Class II suffixes in a very simple way: they constitute terminal W nodes. No further provision has to be made concerning the way in which these units get attached to metrical word trees.

Let us now turn to the problems of attaching stressed Class II suffixes to the metrical trees of stems. I have briefly touched upon this question before (section 2.2.4) and said that these suffixes - listed in (2.79b) above - get handled by the Main Stress Rule so that they receive an  $S \wedge W$  structure but don't become the DTE of the word. This fact alone is sufficient evidence for not having these items present at that point of the derivation where a syllable of a given word gets singled out for becoming the DTE. In other words, Class II suffixes get attached to the metrical tree without altering it. If they were present when the stem receives metrical structure then they would, through our principles of tree construction (given in (2.25) above) become the word's main stress. In that case their metrical trees would look like this:

(2.86)

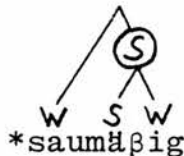

What is wrong with this tree is the label of the circled node. The problem is avoided if Class II suffixes, com-



plete with metrical structure, get attached to stems which also have metrical structure, so that (2.87b) gets added on to (2.87a) to yield (2.87c):

(2.87) a.



b.





c.

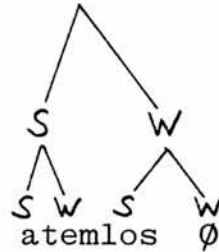
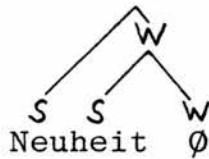

Similarly, we can derive *Neuheit* and *atemlos*:

(2.88)



We are now in a position where we can make a more specific statement about metrical structures containing Class II suffixes. Rather than looking at the metrical structures of these suffixes in isolation, let us discuss the end product of a derivation via Class II suffix. There, we can see a rather straightforward pattern: they are all dominated by a W node, circled in (2.87) and (2.88) above. In the case of a stressed suffix, as *-los*, *-mðβig* and the others given in (2.79b), this W node will dominate an  structure. The Main Stress Rule evidently handles these suffixes in isolation, independent from its application to word trees (with or without Class I suffixes).

The circled nodes in (2.87) and (2.88) are in apparent contradiction with a basic principle that is operative

in word-level metrical trees: the Word Rule, spelled out in (2.27) above. This rule would be expected to make the nodes in question strong because they branch. I shall discuss this problem in more detail in the next chapter, where a greater range of similar phenomena will be available for discussion. Here, I'll only say this much: the Word Rule doesn't apply in instances where bits are added to existing trees. It applies only in the simultaneous erection of an entire tree within a given domain, not in instances of later amendments to such a tree. For example, the Word Rule applies throughout when a word tree gets erected, including Class I suffixes. Two examples for this process are repeated in (2.89):

(2.89)



In both cases, the metrical tree gets erected simultaneously over the entire domain and the rule applies. The same will be seen to be the case in compounds. Here is a rather premature example, just for the purpose of making this particular point clear:

(2.90)

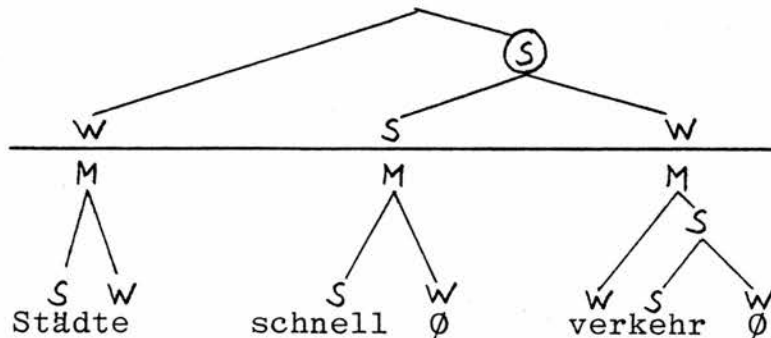

The metrical structures underneath the horizontal line are there first and constitute the input for the rule governing the strength relations among the members of compounds, along with the labelled bracketing of the syntactic surface structure. These strength relations above the level of the word (M) are defined by a compound rule which, as I shall argue in chapter 3 below, is exactly identical with the Word Rule. Again, the circled node becomes strong because it branches on the same prosodic level. And again, the tree in which this rule is operative is erected simultaneously in its entire domain, just like the trees underneath the level M.

Both cases, (2.89) and (2.90), are thus in contrast with items involving Class II suffixation (and other processes, as we shall see in chapter 3). The difference is that in the case of Class II suffixes, bits get added on to a tree that exists prior to this process of word formation on the same prosodic level (underneath M). In these cases the Word Rule fails to apply. But more will be said about this in later part of this study where it

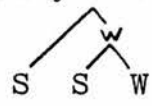
will also become clear that the resulting  structures are extremely unstable. All structures of this kind tend to get transformed into more 'performable' ones in the course of the phonological derivation, to be more precise: in the metrical component of the phonology. It is one of the aims of the next chapter to make a comprehensive 'collection' of structures of the

form  . It will turn out that these structures can be produced in the metrical phonology of German as

a result of a variety of different processes of word formation. And all of these have in common that they contain material that has been added on to existing metrical trees.

There is just one more problem that I would like to discuss in this section. I have so far been working only with monosyllabic native stems. Let us recall now that not all native stems are actually monosyllabic: some exceptions, including *Ameise*, *niemand*, *Arbeit*, *Urlaub*, etc. were listed in (2.47) above.

Some of these words, including the ones I have just given, have some residual stress on their second syllables, others don't. Compare *Iltis* and *Arbeit*. The former, it seems, should be represented metrically as a simple  $\begin{array}{c} \diagup \\ S \quad W \\ \diagdown \end{array}$  structure while the latter has some degree of prominence on *-beit*. The stress behaviour of the second syllables of these words is identical with that of Class II suffixes: they have some residual stress or no stress depending on their segmental make-up and the DTE of the whole word invariably falls on the first syllable of the word.

If we treat *-is* in *Iltis* and *-beit* in *Arbeit* in the same way as we have been treating Class II suffixes then we get metrical trees which conform with our expectations concerning the observed prominence patterns of these words:

(2.91)

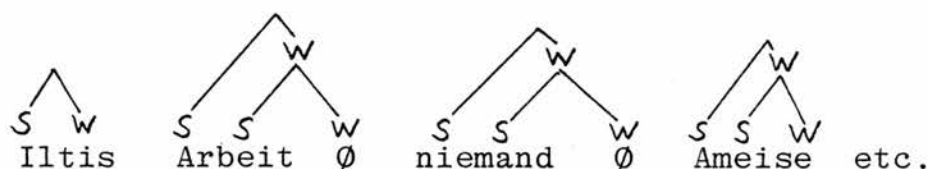

It is quite clear that these words have some sort of

exceptional status in the German lexicon anyway: unlike the bulk of native words, they are underlyingly polysyllabic. The question is just how we mark these items as exceptions. We could, for example, assign idiosyncratic metrical structures to them which would look like the ones given in (2.91) above. This procedure would miss the generalisation that the metrical structures assigned idiosyncratically are exactly like the ones our model produces for complex words containing Class II suffixes.

This generalisation can be captured if the words listed in (2.47) above are equipped with the same kind of morphological boundary as is used within complex words involving Class II suffixes. Each of these words would then be analysed as a complex item containing two non-recurrent morphological units - note that *-mand* is in some way recurrent in *jemand* and *niemand* although it doesn't in my impression have any meaning in its own right. The morphological boundary inserted into these words would, of course, be in some way fictitious but I nevertheless favour this solution. It allows two independent generalisations in that it bears out the claim that native 'morphemes' are monosyllabic (thus treating *niemand* as a bimorphemic unit) as well as making all the words in (2.47) analyseable as Class II suffixations metrically. I may add that this trick has been used before in generative phonology in order to account for exceptional behaviour: SPE, for example, invoke a boundary '=' to account for the stress placement and other facts in words like *contra=diect*, *re=semble* etc. and we have good reason to believe that this boundary is in fact identical with the one I have placed in items like *Arbeit*; see Siegel (1974) for a discussion of this symbol in relation to Class II suffixation. Similarly, LP and Kiparsky (1979) appeal to fictitious boundaries to account for exceptional behaviour.

## Chapter 3

### Metrical structure and morphology, part 2: compound stress and related issues

#### 3.1 Introduction

"Morphology is the study of word formation," writes Dorothy Siegel in the opening paragraph of her dissertation (1974). A statement like that comes as a surprise to at least two schools of thought. Students of Marchand's work on word formation (1969) are inclined to draw a distinction between formations via affix and formations via compounding, where only the former are handled in the (derivational) morphology and the latter are syntactically derived in that underlying sentences for different compound types are proposed (also Faiss 1978).

In the early period of transformational syntax, following seminal work by Lees (1963), the scope of syntactic derivations widened and a transformational approach to both compounding and derivations via affix was adopted. While Marchand recognised derivational morphology as one out of several aspects of word formation, Lees moved all word formation processes into the syntax. In this model, the power of the lexicon was severely limited (Chomsky 1965): it merely listed idiosyncrasies of lexical items and all generalisations that could be observed in the relations between linguistic constituents were expressed in the transformational component. Transformations, sited in a component of the grammar specially designed for them, were the only means of expressing relatedness among linguistic constituents. Thus, in Lees (1963) all productive processes of word forma-

tion, compounding as well as derivation via affix, were accounted for transformationally.

The syntactic (transformationalist) approach to word formation has been under attack within the framework of the 'lexicalist hypothesis'. (For a summary of work under this hypothesis see Hoekstra *et al.* 1981a.) Thus, a number of writers in the wake of Chomsky (1970) - notably Siegel (1974), Jackendoff (1975), Aronoff (1976), and Allen (1980) - either claim or assume that a morphological solution to the problems of word formation (and compounding in particular) is the superior one and that compounds are to be treated as morphological rather than syntactic entities.

Various arguments have been put forward in favour of this approach, and most of them don't need to concern us in this study as they are nonphonological in nature. Nevertheless I shall in what follows be operating under the lexicalist hypothesis, if in a rather vague way and without attempting a defense of this hypothesis, for two reasons. First, the structure of the lexicon that I proposed in the preceding chapter is clearly 'lexicalist'; recall that I frequently referred to Siegel's work in issues concerning the lexicon. And second, having subscribed to that aspect of lexicalism, I shouldn't now ignore the phonological arguments in favour of a morphological approach to compounding - another aspect of lexicalism (Allen 1980). This set of arguments, which essentially concerns the diachronic transition from primary compound to morphological simplex, in stages roughly reflected by items like *tax man*, *chairman*, *Norman*, figures rather centrally in what I have to say in this chapter.

I shall not be adding new arguments in favour of the morphological analysis of compounds. But it will turn out that the suprasegmentals of the proposed chain of transition can be very neatly expressed in terms of a metrical phonology. This, I believe, will add some strength to the lexicalist arguments proposed previously (Allen 1980). On the other hand, the reader who is unconvinced by the morphological approach will be able to take the metrical analysis that follows as quite independent from either morphological or syntactic considerations: I merely offer to tie it in with morphology.

In the existing literature on metrical phonology, and generative phonology in general, compound stress looks like a fairly straightforward issue (LP; SPE pp. 91 ff.; Halle and Keyser 1971:15 ff.). Here is, for example, what LP (p. 257) offer as their Compound Stress Rule (henceforth CSR) and Nuclear Stress Rule (NSR) for English:

(3.1) In a configuration [<sub>C</sub> A B <sub>C</sub>]:

- a. NSR: If C is a phrasal category, B is strong.
- b. CSR: If C is a lexical category, B is strong iff it branches.

The place-holders A and B, in this formulation, stand for the metrical trees that dominate lexical items. Consider, for example, the famous pair *blackbird* - *black bird*:

(3.2) a.

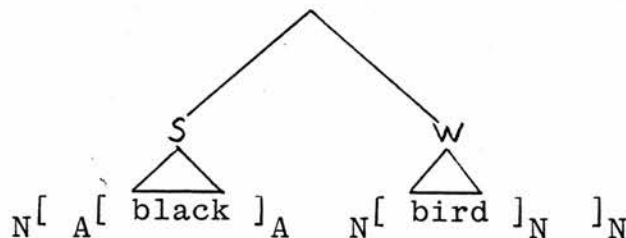

cont'd



(3.2) cont'd

b.

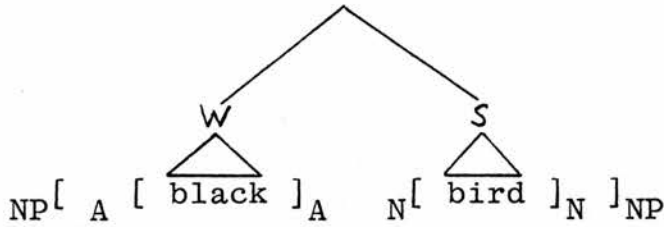

The place-holder C, in (3.2a), stands for the lexical category N, therefore B (*bird*) is weak as it doesn't branch. Conversely, C stands for NP in (3.2b); consequently, B is strong in that tree.

Next, take structures that consist of more than two lexical items, for example the compounds [[[ labour ] [ party ]] [ president ]] and [[ university ] [[ grants ] [ committee ]]], where all brackets are labelled N.

(3.3) a.

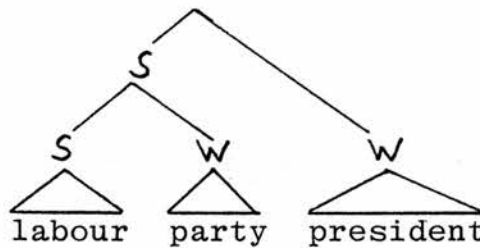

b.

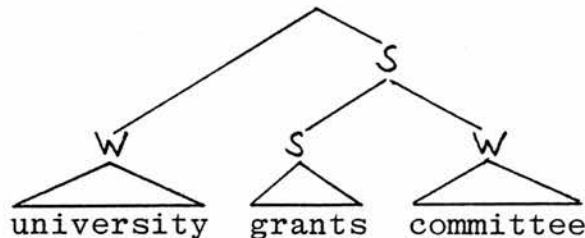

The examples in (3.3) show quite clearly how a metrical phonology above the level of the simple word 'works'. A binarily branching tree is erected which copies the

internal structure of the compound. In (3.3a), for example, we are talking about the president of the labour party and not the party president of labour. In (3.3b), on the other hand, we have the grants committee for universities. These internal structures are reflected in the (unlabelled) metrical tree. The Compound Stress Rule then defines the strength relations that hold between sister nodes of this tree, so that in (3.3a) *party* is weak since it is, in terms of CSR, a nonbranching B. *President* is weak, too, as it also constitutes a nonbranching B. In (3.3b), on the other hand, *committee* is weak for the same reasons as above but the node dominating *grants committee* is strong as it branches.

In the preceding chapter I have been assuming, without discussion, that a word tree is dominated by a node M (for *mot*). It turns out now that this label is more than a notational convenience that indicates where the word tree ends and where the compound tree begins. Consider (3.4):

(3.4)

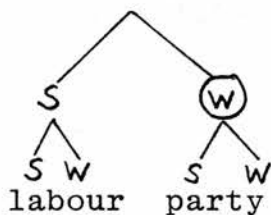

LP (p. 269) observe that their CSR labels the circled node in (3.4) correctly as W only if the metrical structure underneath it is inaccessible to the CSR. In other words, only branching above word level gets taken into account by the CSR. LP introduce M as a blocking device, shown in the revised structures given in (3.5):

(3.5) a.

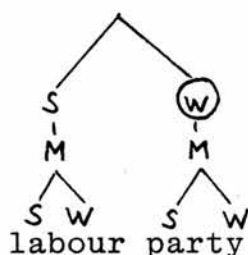

b.

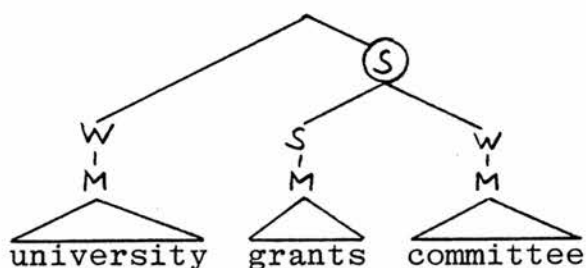

The circled node in (3.5a) doesn't branch above the level M; it is therefore weak. In contrast, the circled node in (3.5b) does branch and is strong.

The reader will recall that a similar phenomenon was observed in connection with the Word Rule that I gave in (2.27) of the preceding chapter. This rule defines prominence relations within the word, underneath M, that is Thus, the circled node in German *Kommunist*, (3.6) below, is strong as it branches:

(3.6)

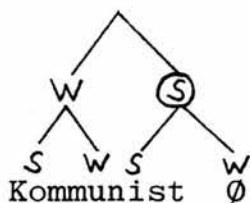

The rule says, it will be remembered, that in a pair of metrical sister nodes, the right-hand one is strong if it branches. LP propose the same rule for English.

I would like to point out three things. First, the Word Rule is, as we discussed in section 2.2.3 above, also sensitive to a prosodic category, namely the syllable: it doesn't take into account intrasyllabic branching just as the CSR doesn't take into account word-internal branching of the metrical tree. I suggested a relational

definition of the prosodic category of the syllable in section 2.2.3; the definition of the node M will be a major concern of this entire chapter. Second, the Compound Stress Rule and the Word Rule are identical. Evidently, the same rule assigns strength relations among the sister nodes everywhere below the highest syntactic node labelled by a lexical category symbol, here N. This is a very interesting generalisation, I think, and it is the reason why LP call this rule Lexical Category Prominence Rule. And third, this brings me back to what I said in the opening paragraphs of this section. If compounding is a morphological rather than a syntactic process, and if - as I have been claiming in the preceding chapter - all morphology gets handled in the lexicon, then the Lexical Category Prominence Rule can be confined to the lexicon. It is only through this step, I feel, that the collapse of the Compound Stress Rule and the Word Rule into one becomes a truly interesting generalisation. Not much is gained if two rules are collapsed into one because of their formal identity but if then one of them operates in the lexicon and the other one in the phonological component. This generalisation makes the morphological approach to compounding rather attractive, even if it doesn't force any conclusions on us.

### 3.2. The problem

The problem is that the *blackbird* pattern, correctly produced by our CSR, which I gave in (3.1) above, is not the only one that writers on the subject have found in what they called compounds in English.

Thus, Sweet (1879), distinguishing strong, medium and

weak stress (here indicated by 1, 2, 0 respectively), records five different accentuations for compounds. I give some examples in (3.7) below, not all of them taken from Sweet's paper:

- (3.7) a. 1 - 1      steel pen  
                     sponge cake  
                     town clock  
                     evening star  
                     May flowers
- b. 1 - 2      snow ball  
                     rainbow  
                     tobacco-smoke  
                     flowerpot  
                     homeland
- c. 1 - 0      England  
                     mainland  
                     woodland  
                     policeman  
                     tradesman  
                     chairman
- d. 2 - 1      mankind  
                     North Berwick  
                     West Midlands  
                     South London
- e. 0 - 1      Saint John  
                     Saint Andrew  
                     South Africa  
                     Midlothian

The contrast that has been queried most by subsequent investigators is the one between 1-1 and 2-1, exemplified in (3.7a.d.) respectively. Sweet himself seems to have some doubts about it and mentions "the tendency to regard the second of two equally stressed syllables as the stronger" (1879:4). The matter was investigated in more detail in an experimental study by Lutstorf (1960), whose results show that level stress and end-stress are indeed so hard to distinguish (if at all) that the contrast between the two classes should be abolished. In his findings,

... there is nothing really to prevent the level stress pattern from being opposed to the fore stress pattern, along with the two end stress variants.

(Lutstorf 1960:152; my emphasis)

This is the amount of pattern variation that the authors of current handbooks on the pronunciation of English agree on. The *English Pronouncing Dictionary* (Jones 1977) distinguishes fore-stress and end-stress, where the constituent not bearing the main stress may or may not reduce, as in *homeland* vs. *England*, *mankind* vs. *St. John*. In the introduction to Jones (1977), Gimson writes that in the so-called level-stressed compounds, "the first ... is subsidiary to the second" (p. xxiii); essentially the same is stated in Gimson's text-book (1980:230).

To conclude this review, I think we are justified in assuming, henceforth, that Sweet's five categories in (3.7) above can be reduced to four. (3.7a) and (3.7d) can be collapsed into one category. This leaves us with the patterns 1-2, 1-0, 2-1, and 0-1.

There are various possibilities of systematising these four patterns. The one that is the most simple and attempts to capture most generalisations would be this: first, give a principled account of the distribution of fore-stress and, in contrast, end-stress. Second, account for the reduction of subsidiary stress. Splitting up the whole procedure into these two steps requires, of course, that we make a few hypotheses about the internal structure of this set of patterns that are far from trivial. There is, above all, the hypothesis that that reduction of stress on the initial syllable in the 0-1 pattern and that on the final syllable in the 1-0 pattern are governed by the same principle. I shall

look into this problem in section 3.3 below and concentrate in the remainder of this one on this distribution of fore-stress and end-stress.

The set of rules that I gave in (3.1) above caters for the two unreduced patterns 1-2 and 2-1. Fore-stress is produced by the CSR and end-stress by the NSR. Nevertheless, this distinction is one of the most troublesome in the whole area, made virtually impossible to resolve by the additional complication that the NSR also constitutes the only rule that defines prominence relations in English phrases.

The distinction between compound and phrase is not easy to draw in English and I do not intend to get involved in this demarcation dispute. Only one thing is certain: that the difference in prominence patterns does not serve as a sufficient criterion in this distinction, so that we can't say that whatever gets handled by the CSR is a compound and whatever gets handled by the NSR is a phrase. This would, of course, be a neatly circular argument, given that the two rules make reference to morphosyntactic labels. Whatever the criteria for compoundness are - and the reader is referred to Marchand (1969: 20 ff.) and especially to Faiss (1981) - they certainly have to be sought outside the domain of phonology.

Assuming, then, that there is a nonphonological difference between compounds and phrases - semantic, syntactic, or whatever - the problem is that there doesn't seem to be any systematic difference among compounds that makes it predictable which of them undergo CSR and which NSR. This problem hasn't of course passed unnoticed in the more recent phonological literature. SPE (p. 156) note the problem and propose, very tentatively, that items to

which CSR applies be equipped with a special boundary between the constituents, in which case the rule only applies in the presence of this boundary. But how, then, does this boundary get there in the first place? Chomsky and Halle realise that this proposal does not solve the problem but are happy to see it at least eliminated from the phonology.

In contrast, Halle and Keyser (1971:22) simply decide to mark end-stressed compound nouns, like *Madison Road*, as exceptions to the Compound Stress Rule. But this, although it is more 'honest' than SPE's 'solution', creates new problems. We can't tell just where, exactly, this exception feature gets attached. Halle and Keyser's example of *Madison Road* is one of the very few that seems reasonably straightforward: compounds on *road* have end-stress.

Schmerling (1971) demonstrates that the feature [- CSR], or whatever we call it, is sometimes sited with the second constituents ("All compounds ending in *road* have end-stress."), sometimes with the first ("All compounds beginning in *south, north* etc. have end-stress.") and sometimes, completely idiosyncratically, with entire compounds. Consider *potato salad* (1-2): neither *potato* nor *salad* are on their own capable of predicting that the compound has this stress pattern - compare *potato soup* (2-1) on the one hand and *fruit salad* (2-1) on the other. The examples given here are taken from Schmerling's paper (1971) and based on her dialect; British speakers may disagree with her stressing but that is beside the point. What is important here is that the distribution of 2-1 and 1-2 patterns is a mess in any one dialect, and comparisons across dialect make things worse.

Schmerling is the only one of the authors cited who



actually admits that her attempt to predict compound stress patterns is abortive. Whatever has been offered, in the literature that I am aware of, as a solution to the problem is in fact nothing but a non-solution in disguise, managing at best to shift the problem from one component of the grammar into another, where it still remains unsolved. Pseudo-solutions like that aren't actually superior to non-solutions. In the absence of a real solution, anyway, I think we simply have to admit that we haven't got one.

Further back I have claimed that CSR and NSR produce 1-2 and 2-1 patterns respectively but not the reduced patterns 1-0 and 0-1. It is quite clear why this is so, in the notational framework I am advocating, but I would like to get a few building blocks of this model back into focus. A compound, to paraphrase a familiar definition (Marchand 1969:11), is a morphological unit combining two (or more) morphological units that in themselves constitute words. Through this combination, the words involved enter into a *determinans/determinatum* relationship. It is the word status of the constituents that I would like to concentrate on; the relationship between them will come into the discussion in the next section.

It follows that the metrical structure of a compound, as I stated in section 3.1 above and in the introductory chapter, contains two or more metrical subtrees each dominated by a node M; we have seen that CSR requires these M nodes in order to make correct predictions about the placement of the DTE in compounds. As another effect, M nodes block the reduction of the subordinate constituents of compounds, thus fixing the stress patterns of bipartite compounds as 1-2 and 2-1 but preventing 1-0 and 0-1. Consider the following examples:

(3.8) a.

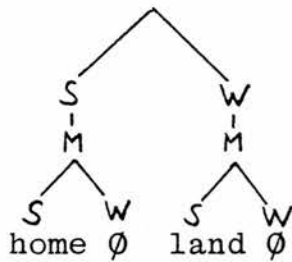

b.

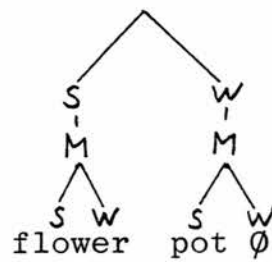

c.

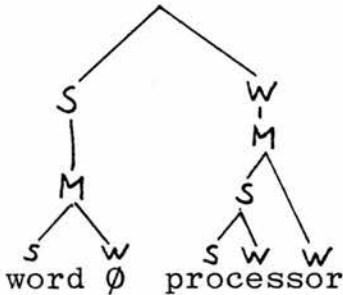

d.

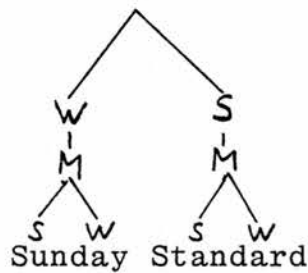

e.

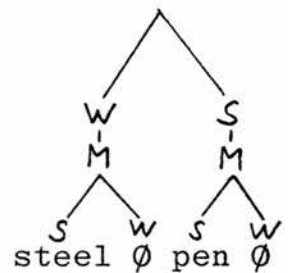

The sample trees in (3.8) are, in the light of what has been said so far, straightforward but quite revealing. The word trees of the constituents are dominated by M nodes, among which prominence relations are governed by CSR (3.8a.b.c.) or NSR (3.8d.e.). Through Strength Provision (1.14), every word tree is granted a minimal metrical structure  $\begin{array}{c} \diagup \\ S \quad W \\ \diagdown \end{array}$ . It is important to note that this condition is in operation in compounds; and it is especially important in the case of monosyllabic constituents. Notice that in (3.8a.e.) both constituents have terminal S nodes. It is in fact a consequence of the structural constraint (1.14) that the subordinate constituent of a compound - the second one in (3.8) and the first one in (3.8e.) - will always have at least one terminal S and will, therefore, never reduce.

It will be seen later that this type of metrical structure, as in *homeland* (1-2), contrasts with the one in *England* (1-0). Before looking at the phonological properties of this contrast, I should like to review some of the

attempts that have been made to link it up with non-phonological properties, thus trying to predict the contexts in which reduction occurs.

### 3.3 On lexicalisation and obscured compounds

The contrast between *tax-man* and *chairman*, *farm-land* and *highland*, *river-mouth* and *Portsmouth* has been frequently observed in the literature on word formation as well as stress. A variety of statements can be cited, diachronic and synchronic, concerning the conditions under which the reduction of the second constituents of these compounds can occur. Thus, Sweet (1879:5 f.) writes that

... compounds, in which the stress is still handled with full consciousness, must be distinguished from purely traditional ones, such as *forgive*, *Christmas* ... Wherever there is obscuration of the unaccented vowel, the compound is a traditional one, and has no interest for the student of living English: thus *tradesman* ... is a dead compound, as opposed to the living *ladies' man*, the identity of /mæn/ and /mɛn/ admitting of historical proof only.

Along similar lines, Marchand (1969:4 f.) argues that

... the phenomenon [of reduction. HG] is explained by the fact that the words *man*, *land*, and *berry* have been frequent as second-words from the oldest times of the language known to us. They have thus acquired a semi-suffixal character.

A number of claims are made in these two excerpts; let us try to isolate the important ones. First, 1-2 compounds can change into 1-0 'compounds' over time.

Second, this process affects only certain compounds. Third, the product of this change is not a compound: synchronically, the second element of this kind of item is a (semi-)suffix rather than a lexeme.

None of these statements is in fact trivial. An alternative possibility exists for each one that would be at least conceivable. Firstly, it would be possible that the reduced form /mən/ of *chairman* is not the historical residue of /mæn/ and thus not the product of a diachronic process happening along the lines sketched here. I shall argue below, however, that the two forms are related. Secondly, assuming that the first claim is correct, it would be possible that this kind of thing happens to all compounds. I shall show that it doesn't. And thirdly, one might still analyse *chairman* and other 1-0 structures as synchronic compounds, whether related to forms with unreduced constituents or not. The metrical analysis will reveal, however, that the items in question can't possibly be compounds, thus bearing out Sweet's and Marchand's claim on independent grounds. I shall start with this last point, developing the metrical structure of *chairman* and contrasting it with *tax-man*. It will then become apparent that the two structures can be motivated on nonphonological grounds, that this motivation fits in with the morphological model which I am following in this study, and that the whole analysis finds diachronic support.

Consider the metrical structure of *tax-man* (repeated for convenience in (3.9) below): one of the characteristics of this tree is, as I have pointed out before, the branching structure of each of the constituents. Now if we want the vowel in *man* to reduce we have to give it a terminal W node. There is only one way of doing this: the appropriate structure is given in (3.9b):

(3.9) a.

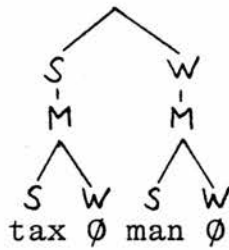

b.



In the light of our conditions on metrical structure, all other structures of *chairman* would be ill-formed. The claim implied here is that *man* in (3.9b), not dominated by a separate M, is not a word (or 'lexeme') but, if a separable morphological unit, which its recurrence in the vocabulary of English suggests, some kind of suffix. Marchand (1969:5) calls these morphological entities semi-suffixes, by which he means such

... elements as stand midway between full words and suffixes. Some of them are used only as second-words of compounds, though their word character is still recognisable.

(Marchand 1969:356)

The question is what formal status can be given to a linguistic unit that stands midway between word and suffix. Marchand's statement that semi-suffixes are used only as second-words in compounds means, short of being a circular argument, that they attach to words only and not to stems. Moreover, our metrical analysis in (3.9b) shows that these units are stress-neutral in that they don't alter the stress behaviour of the item they attach to. We interpret 'midway', then, as being a suffix on the one hand and having lexemic counterparts on the other.

This is not meant to be a full-scale morphological investigation and I therefore don't want to commit

myself to any kind of classification of suffixes. Rather tentatively, however, I suggest that reduced *-man* (along with *-mouth*, *-land* and others) is a member of the category of suffixes labelled Class II by Siegel (1974). Their behaviour with respect to stress rather suggests this and there are precedents of free words joining this class of suffixes in the history of English: *-dom* (as in *kingdom*) and *-hood* (*motherhood*) were free words in Old English and are categorised as Class II in Siegel's model of morphology. In section 3.4.3 below, where the metrical behaviour of this kind of structure in German is examined in detail, I shall elaborate this proposal. We shall see at that point that it makes sense in a lot of respects to analyse these units (I shall call them 'lexicalised compounds') synchronically as the products of Class II suffixation.

The one problem with this kind of analysis is that if *man* is suffixal in certain words, it is still linked with the lexical word *man* in such a way as to retain its inflexional irregularities: the plural of *chairman* is *chairmen*. These two forms aren't necessarily phonologically distinct; still, the irregularity that suffix and lexeme share is the absence of plural *-s*. This generalisation goes uncaptured if a formal link between the two is absent, as it is in this analysis, in a synchronic grammar. Nevertheless I would like to maintain this analysis; for this particular problem the reader is referred to Allen (1978).

The comparison of the two metrical structures in (3.9) above shows that all we are talking about, basically, is the difference between a compound and a simplex; the difference between a word derived via suffix and a simplex doesn't show up in this particular metrical structure. The diachrony of certain lexical items in English shows

that this transition from one structure to another can easily be attested. Compounds can in fact change in such a way through the history of the language that they end up even one step further than *chairman*: as monomorphemic words. The results of such processes are, in the literature on the diachronic aspect of word formation, usually called 'obscured compounds' (Götz 1971; Faiss 1978).

To pick out just one example: the word *cupboard*, an obscured compound in Modern English, interpreted monomorphemically by most writers just like *orchard*, *woman*, *chaffer*, etc., goes back to ME *cuppe-board*, a fully motivated compound. The MED records *cuppeborde* (1391), *copard* (1400), *copberd* (1450), and *coberd* (1474). For ME *bord*, only *borde*, *bourde*, and *burd(e)* are recorded as spelling variants. Two observations are of some relevance here, it seems to me. First, the spelling of the vowel varies a great deal in the second element of the compound while it is practically constant in the related simplex. This, it seems to me, indicates the reduction of the vowel in the complex form, so that we would have, as early as Middle English, a metrical structure of the form (3.9b) for *cupboard*; the forms extracted from the MED that I gave above are, therefore, Class II suffixations rather than compounds proper. Second, the /pb/ cluster, indicative of a morpheme boundary, vanishes at (roughly) the same time. I submit, on this evidence, that the change of the metrical structure from (3.9a) to (3.9b) is part of, and probably rather early in a whole series of changes towards, the evolution of 'obscured compounds'. (See Götz 1971 for an elaborate diachronic argument along these lines.)

The question arises just what it is that sets this evolutionary chain into motion. A number of authors hold

semantic obscuration of the *determinans/determinatum* relationship among the constituents ultimately responsible. Thus, Luick (1964:§645) states:

Wenn bei Kompositis das Gefühl für die einzelnen Glieder verblasste und sich mit der gesamten Lautmasse ein einziger Begriff verknüpfte, wurde der ursprünglich starke Nebenakzent auf den zweiten Kompositionsliedern schwächer, so dass sich das Wort dem Habitus eines phonetisch einfachen Wortes, das heisst eines Wortes mit nur einem starken Akzent, näherte und ihn oft ganz erreichte. ... Dies ist ein Vorgang, der sich seit den ältesten Zeiten immer wieder vollzogen hat, wenn sich seine Voraussetzungen ergaben. Und diese konnten sich leicht ergeben, weil immer wieder ursprüngliche Komposita zu einfachen Wörtern werden oder sich ihnen nähern.

Luick fails to testify what exactly the semantic obscuration consists of; he is therefore, strictly speaking, unable to state precisely what happened first. This weakness is inherent in all diachronic investigations that I am aware of - see Berndt (1960) for statements similar to Luick's in that respect.

Let us return to the synchrony of the structures in question. Margaret Allen (1978; 1980) proposes a set of principles to account for the semantics of primary (unobscured) compounds. I do not wish to go into the details of these mechanisms; what is important is that 'semantic amalgamation' (Allen's term for meaning formation not derivable by general principle) and phonological obscuration - in particular the weakening of the second constituent - are formally linked by the Strong Boundary Condition:

(3.10) Strong Boundary Condition

In the morphological structure X B<sub>S</sub> Y, No



Rule may involve X and Y, where  $B_s$ , the strong boundary, is  $\#$  and where *rule* refers to both 'semantic amalgamation process' and 'phonological rule'.

(Allen 1980:26)

In our terms, double word boundaries occur only between metrical constituents with M status but not within them. What Allen is saying, then, is that in a structure containing two M nodes neither semantic nor phonological obscuration takes place between the M domains; both are possible in the absence of this structural property. They don't necessarily occur. To give some phonological examples, *tax-man* never reduces whereas *chairman* and *milkman* tend to (but don't have to); *river-mouth* never does while place-names like *Portsmouth*, *Bournemouth* etc. do in R.P. but not with Scots speakers. Scottish place-names like *Eyemouth*, *Grangemouth* never reduce in local pronunciation.

The optional character of all weakening processes that we are likely to encounter here poses a serious problem for Allen's analysis. (3.10) only rules that no semantic amalgamation and no phonological weakening may take place in the presence of a 'strong boundary', that is, in a structure of the type (3.9a). The Strong Boundary Condition doesn't predict either process in the absence of a strong boundary, it merely allows both. An unweakened compound may, as far as the Strong Boundary Condition is concerned, have the metrical structure (3.9a) or (3.9b) and there is no principled way of telling which one of the two is actually present.

It seems to me that there is only one way out of this dilemma and that is the one for which, so far as I am aware, empirical evidence has not been produced. It

is a solution basically along the lines proposed by Luick (1964), quoted above: make semantic distortion the criterion for the reduced metrical structure (3.9b), so that as soon as expressions like *Madame Chairman* are found you analyse *chairman* as (3.9b) and expect the vowel in *man* to reduce.

That this assumption is problematic hasn't passed unnoticed in the literature. Lipka (1977), who as far as I can see gives the most detailed account of what he calls 'lexicalisation', talks about the semantic and phonological distortion of the compound syntagm but doesn't in fact posit either of the two as a condition of the occurrence of the other. The one writer who commits herself in this respect is Ursula Stötzer (1975) in her account of compound stress in German. She observes deviant stress behaviour on the part of those compounds which, in terminology taken from Fleischer (1974), are 'demotivated' (*entmotiviert*, meaning essentially the semantic aspect of Lipka's lexicalisation; cf. Lipka 1977 for an attempt to define these terms). It has to be admitted, though, that Stötzer's view of lexicalisation as the causing factor for weakening is essentially based on speculation.

And a further *caveat* has to be given at this point. I may have been giving the impression that lexicalisation has always some kind of diachronic process behind it in the course of which the meaning of the whole syntagm stops being derivable by general principle. This is not necessarily the case; some items are actually born that way. German *Handschuh*, for example, must always have been a metaphorical expression; the meaning of *Schuh* and related forms throughout the history of that word has always been 'shoe' and that previous generations of German speakers used to wear shoes on their hands is

equally inconceivable. What 'metaphoric compounds' like this one have in common with lexicalised ones is that they fail to conform with the Strong Boundary Condition in that their meaning is not derivable by general principle. Again, the metrical analysis for these items will be (3.9b).

Let us return to the problem outlined in section 3.2 above. We have been discussing the metrical structures reflected by Sweet's 1-2 and 1-0 stress patterns respectively and we have speculated about the factors that motivate these structures. This leaves us with the patterns 2-1 (*South London*) and 0-1 (*South Africa*).

After all that has been said about the relations between weakened and nonweakened forms (assuming, of course, that they are related but I think I have given enough reasons why this should be assumed) the metrical structures corresponding to these patterns fall into place quite easily. *South London* is governed by NSR; the structure is given in (3.11a) below. The only way of producing a terminal W on *South*, required to facilitate reduction in *South Africa*, is the one in (3.11b) - with one M only:

(3.11) a.

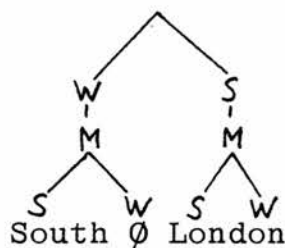

b.

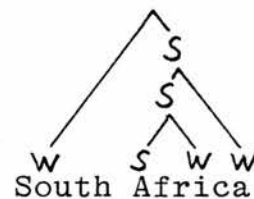

I believe that the distribution of structures like (3.11a.b.) is basically governed by principles identical to those suggested above for the mirror images of these structures. The fact that *South Africa* is a proper name

may account for a lot; the same is found in place-names like *Northumberland*, *Southampton* and, quite strikingly, in all names beginning with *Saint* (*St. Andrews*, *St. John* etc.). *South*, as an unreduced form, analysed in (3.11a), is a constituent of a compound; the reduced form is a (semi-)prefix, probably - as the related suffixes - a member of the Class II of affixes in Siegel's morphological model. (3.11a) represents a compound, (3.11b) a lexicalised item.

Let us conclude this somewhat inconclusive argument. I have been discussing the metrical behaviour of compounds, lexicalised (and metaphoric) compounds, and obscured compounds. While only the first of these categories was found to be analysed in terms of the Compound Stress Rule (or the Nuclear Stress Rule), the latter two were analysed morphologically as derivations via affix or as morphologically simple items. This morphological distinction doesn't necessarily show up in the metrical analysis; indeed whether a given item is called morphologically complex or simple is largely a question of how much phonological distortion one permits in a historically complex item to call it synchronically complex. This problem is inherent in all synchronic analyses of obscured compounds; thus, whether one calls *chairman* complex and *Norman* simple is a rather arbitrary decision, based on criteria like the identifiability of the individual constituents by the native speaker. It is not surprising, therefore, that the metrical analysis doesn't come up with anything new in this respect. As for the factors causing phonological distortion, here mainly the transition from a double-M metrical structure to a single-M one, I have tentatively posited rule-governed semantic analysability as the main criterion: whatever is analysable in

that fashion is a compound and not subject to obscuration. I emphasise that this is the view shared by a number of scholars and that I have not even attempted to produce evidence to support this claim - although there is a clear dearth of such evidence in the literature on the subject.

Finally, let us question briefly the model of compounding that I have been tacitly assuming in this section, In what respect do the analyses I have been giving lend support to a model of compounding that is morphological rather than transformational? Support for this model doesn't so much come from the metrical structures of the items under discussion as from their behaviour in all kinds of respects. There is pressure for compounds to get lexicalised, to take on idiosyncratic meanings, along with which the internal structure disintegrates and the identity of the constituents gets obscured. This is particularly apparent in the metrical structure. Now if primary compounds were transformationally derived while lexicalised ones were treated as frozen morphological forms, argues Allen (1980:26),

... then the move from productive to lexicalized compounds would appear to be a radical one, involving the loss of a whole transformational rule (or a set of them) and the establishment of a new lexical item. The type of morphological analysis which I have proposed predicts that the move from productive compound to lexical item is a simple one ...

It involves nothing but the weakening of the boundary between the two constituents, or, in terms of our metrical analysis, abandoning the metrical identity of the two constituents as M-dominated structures. All other metrical differences between compound and lexicalised structures are brought about by general conditions on metrical

structure which have good motivation outwith this particular area. In that respect, it seems to me, metrical analysis does lend some support (if indirectly) to a morphological approach to compounding.

### 3.4 The metrical structure of German compound nouns

#### 3.4.1 A basic rule

In the preceding sections of this chapter I have attempted to give the reader a rough idea of how to deal with the prominence structures of compounds. I have also anticipated and discussed some of the problems that the analyst is likely to run into when he investigates the compound stress patterns of a language - in that case English - in more detail.

In this chapter, I shall give one of those more detailed analyses, attempting to cover all - or most - the variation that can be found in the stress patterns of German compound nouns. Not a lot seems to exist in the way of literature on this particular subject. Kiparsky (1966) and Wurzel (1980), two papers which have been mentioned before in this study, are not primarily concerned with compounds but devote brief sections to them, giving, at best, outlines of how they feel compound stress could be analysed in an SPE-type model of phonology. On the other hand, there is the work of Ursula Stötzer (1975; 1977), which covers practically all the detail one might wish to cover but does not subscribe to any formal model of linguistic structure. Her rules, as we shall see, are essentially rules of thumb, aimed at the foreign learner and unfit for formalisation in any model of

generative phonology. Nonetheless, what follows owes a great deal to the wealth of detail found in Stötzer's studies.

Let us, to begin with, look at the more basic structures of German compounds, briefly characterised as [AB] (where A, B are lexical constituents). It will be recalled that there are some minimal requirements on the metrical trees dominating words and that these requirements also hold where the constituents of (primary) compounds are concerned: each word is dominated by a node M and each M dominates a structure of the type  $S \widehat{W}$ , where the W may be a zero syllable. Arguments for this requirement were given in chapters 1 and 3.1 above.

All accounts given in textbooks of German phonology agree that in [AB] compounds the A constituent bears primary and the B constituent some sort of subordinate stress (Kohler 1977:193 ff.; Meinhold and Stock 1980:228 ff.). These authors assume that this pattern constitutes the rule and everything else, like a primary stress on the B constituent, the exception. Kohler also observes that a monosyllabic B constituent bears a secondary, i.e. nonzero, stress as in *Birkhuhn*, *Schleppkahn*. The stress level of *-huhn*, *-kahn* is thus the same as that of the first syllable of a bisyllabic B constituent, for example *-ritze* in *Stimmritze*, *-könig* in *Wachtelkönig*. It is, of course, distinct from that of the second syllables of these items.

It is interesting to note that this observation is only borne out by the metrical structure if an analysis is adopted that makes use of the notion of zero syllable. Here are some examples:

(3.12) a.

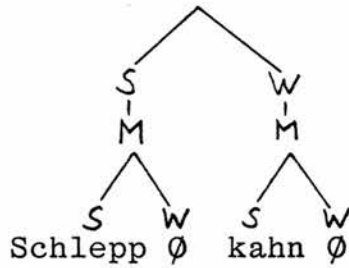

b.

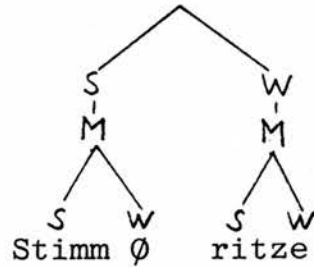

c.

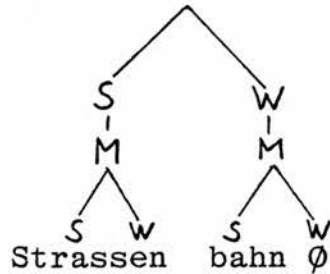

d.

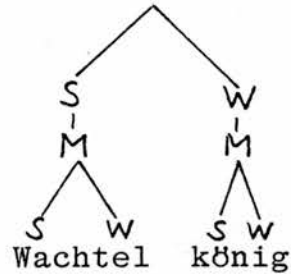

e.

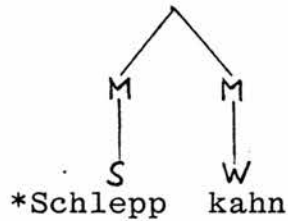

Suppose we decide not to adopt an analysis using zero syllables for German. Then *Schleppkahn* would be analysed as (3.12e) and we would require a special convention through which the W node on *-kahn*, sole daughter of M, gets assigned to it phonetic properties distinct from those of, say, *-en* in *Strassen* (3.12c). I have given my position on this question in chapter 1. It will become clear below that in the area of German compounds my zero syllable analysis makes a great deal of sense.

The examples given above show that the usual stress pattern of German [AB] compounds is the same as that found in English. German compounds of that size are



thus handled by a CSR that is identical with the one posited for English - see (3.1) above.

As in English, this pattern contrasts with the one characteristic of phrasal stress. I do not intend to go into the problems of German phrasal stress in this study but restrict myself here, for illustration, to what seems to be absolutely basic: if in a pair of constituents  $[AB]_C$ , C is a phrasal category such as NP or S, B will be strong. Examples are:

(3.13) a.

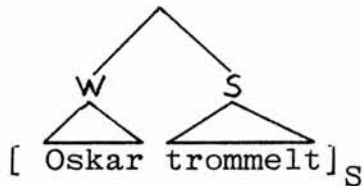

b.

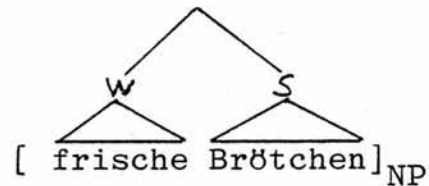

c.

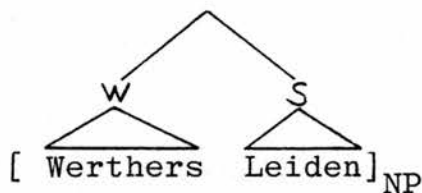

The reason why I'm giving these examples here is that there exists, just like in English, a class of German compounds that conforms with the pattern of phrasal rather than compound stress. It seems, though, that this class is smaller and to some extent predictable. Thus, some of the exceptions to CSR would appear to be lexicalisations of adjective-plus-noun phrases; note the preservation of inflexional endings in the adjectives: *Hohen'staufen*, *Hoher'priester*, *Lebe'wohl* (verb plus noun). A further class are copulative combinations of the type *Marxismus-'Leninismus*, *schaurig-'schön*.

Adjectival compounds tend to quite generally have nuclear stress, not only in copulative constructions like the one just mentioned. Thus we get *blau'grün* (which might refer to an object which is partially blue and partially green but also to one of a composite colour, something like turquoise). Only in the former case would this adjective be a copulative combination, in the latter it is a compound proper. Of those, more can be found: consider, for example, *jammer'schade*, *nagel'neu*, *bild'hübsch*, *pott'hässlich*. It seems, then, that the Compound Stress Rule doesn't apply to a lot of compound adjectives; I shall ignore compound adjectives in the remainder of this chapter.

Returning to compound nouns, it seems to me that there is a further class that follows the Nuclear Stress Rule. Members of this class are *Pfingst'sonntag*, *Oster'montag*, *Jahr'hundert*, *Jahr'zehnt* etc., all of them apparently lexicalised contrastive patterns which have in some way to be marked as exceptions to CSR.

So much for exceptions to CSR. Let us disregard them from now on, bearing in mind that they exist and that compound adjectives don't tend to follow the rule discussed here either.

Let us turn to tripartite compounds. There are two possibilities of internal structure, briefly described as [AB]C (as in *Blumenkohlsuppe*) and A[BC] (*Weltspartag*) respectively. It turns out that the former class bear the main stress on the A constituent, expressed in metrical terms in (3.14):

(3.14)

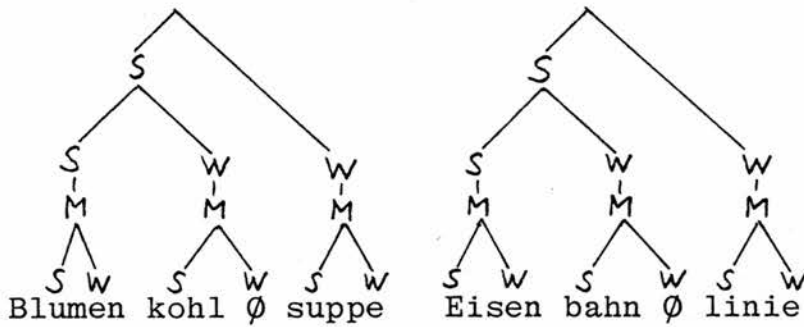

These structures are in line with what the CSR given in (3.1) above predicts for English compounds of the same internal structure.

The stress patterns of [AB]C compounds contrast with those that have internal structures of the type A[BC]. For reasons that will become clear shortly, we have to be careful with our choice of examples in this category as there are exceptions. I'll turn to them later; here are the regular ones:

(3.15) a.

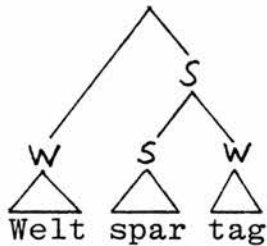

b.

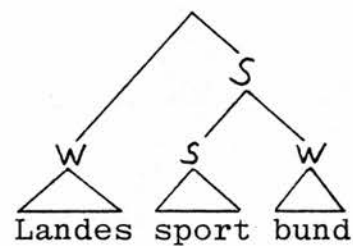

c.

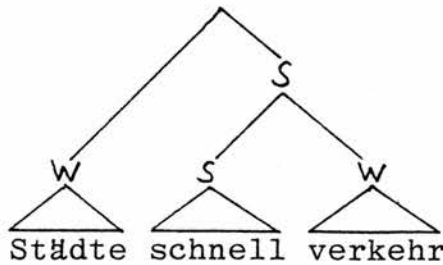

d.

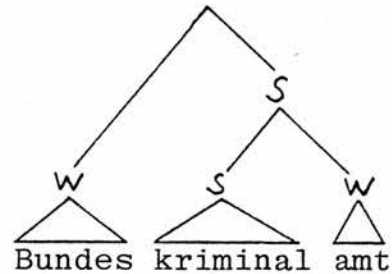

Stötzer (1975) points out that motivated A[BC] structures regularly bear the main stress on the B constituent, as

is borne out in the metrical analyses in (3.15) above. This, once again, conforms with the English CSR; recall that English A[BC] compounds like *government working party* and *university grants committee* follow exactly the same pattern. The circled nodes in (3.15) above branch and are therefore strong.

Here is, then, the rule that defines the strength relations that hold between the constituents of German compound nouns. As I pointed out before, it is identical with the rule that does the same job in English:

(3.16)

CSR for German nouns:

In a pair of sister nodes  $[A B]_N$ , B is strong iff it branches.

Merely to confirm the result of the past few pages of investigation, I would have a brief look at some compound structures that consist of more than three lexical constituents. There is, of course, a great number of possibilities where the internal structure of constructions that size is concerned; I'm just picking a few random examples:

(3.17) a.

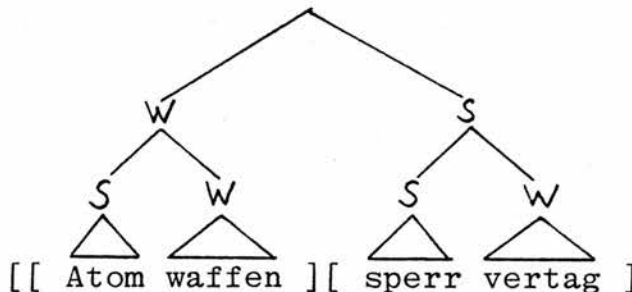

cont'd

(3.17) cont'd

b.

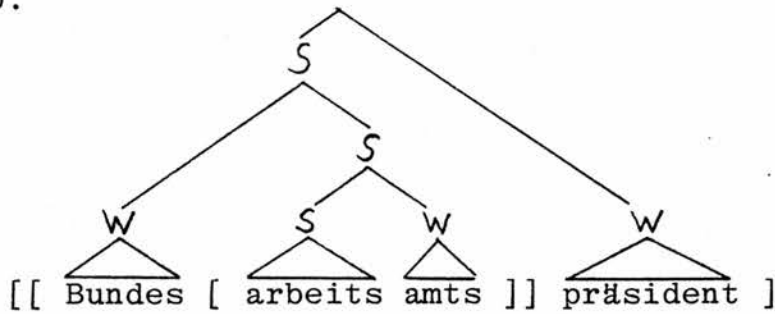

c.

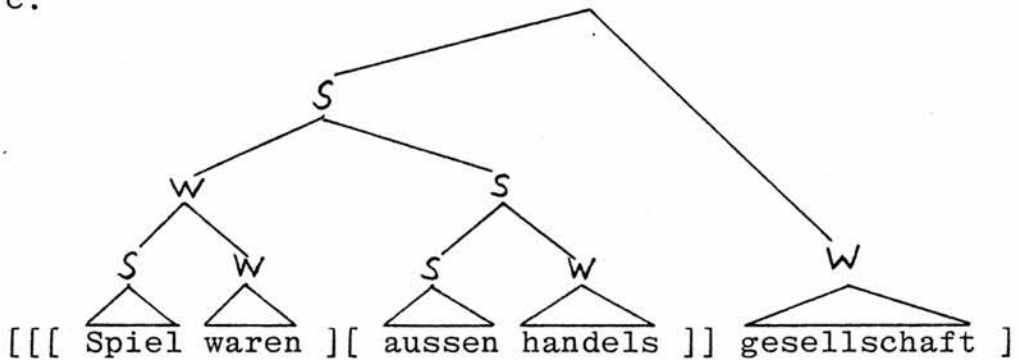

A word about my use of brackets and tree structures in (3.17) above. The brackets (all labelled N) reflect the internal structure of the items in question; I have omitted the innermost brackets as they are of no interest here. The metrical tree corresponds to this bracketing - it will be recalled from chapter 1 that this is one of the basic principles of metrical tree structure. I don't think that I have to go through the strength relations in those structures point by point; the reader will find out for himself that they are in accordance with (3.16). They result, correctly, in the placement of the DTE on *sperr* in (3.17a), *arbeits* in (3.17b), and *ausen* in (3.17c).

This last example is actually structurally ambiguous. It can be paraphrased either as *Gesellschaft für Spielwarenaussenhandel* (as in the analysis above) or as

*Aussenhandelsgesellschaft für Spielwaren* - I'm afraid it is impossible to give renderings into English for these two structures that show the ambiguity. I give the second possibility below:

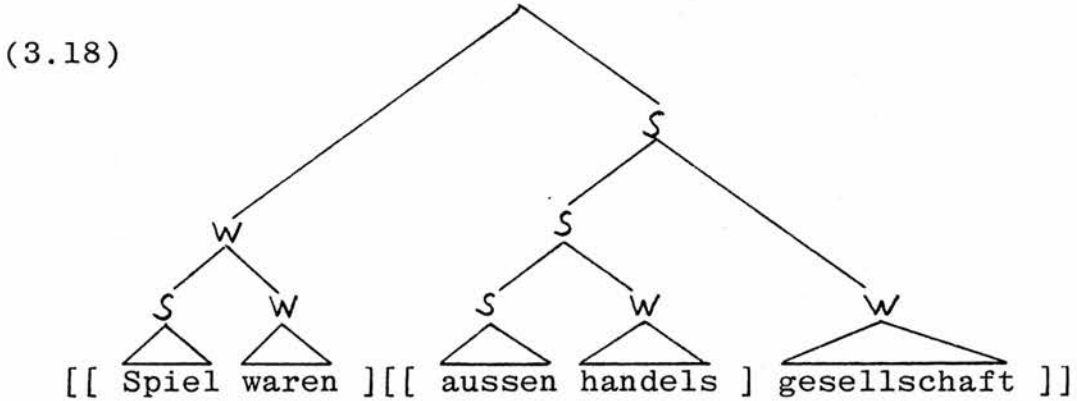

Once again, our principles of metrical structure make *aussen* the DTE of the whole construction. This is, of course, precisely why this compound is ambiguous; there would be no ambiguity in this case if there were a difference in stress placement, and the differences in subordinate stress are probably too fine to disambiguate this structure. (See SPE, pp. 24 f., for a more general discussion of the problem of seemingly excessive finesse in this area of phonological analysis.)

So much for German compound stress that sticks to a simple rule. This analysis wouldn't be very interesting if we had now exhausted the data. We haven't; in fact, what we have found so far isn't more than what Wurzel (1980) discusses and gets nowhere near the wealth of data in Stötzer's work. It must be noted, however, that Wurzel's rule is quite different from mine: he invariably assigns a primary stress to the A constituent, regardless of the total number of constituents and the internal structure of the construction. For [Haupt [[ schiffahrts ] weg ]], for example, Wurzel produces the pattern 1-2-4-3. This result is ill-formed, both in

terms of Stötzer's survey and my analysis; correct would be a primary stress on *schiff*, as predicted by (3.16).

What we still have to investigate is a number of tripartite compounds whose behaviour is in apparent contradiction to what their internal structure and our rule (3.16) predict. Such cases exist galore, among [AB]C as well as A[BC] structures. For the former, we expect a primary stress on the A constituent and get, instead, for example *Drei'groschenoper*, *Alt'weibersommer*. And in the latter class, cases like *'Hauptbahnhof*, *'Tüpfelsumpfhuhn* go against our prediction of primary stress on the B constituent. A new attempt to solve these problems follows below; it should come as some consolation that we won't need to modify (let alone abandon) rule (3.16). This rule will remain the central one in this whole account; what appears to be an exception to the rule will turn out to be quite clearly motivated and derivable from the basic pattern by fairly simple steps.

It will also become clear that a converse derivation makes far less sense. If, for example, we subscribed to an analysis after the fashion of Wurzel (1980) and decided - arbitrarily - that initial stress is the basic rule, *'Hauptbahnhof* thus a basic pattern, then the structures in (3.15) above would have the status of exceptions. Benware (1980a) proposes a derivation in this direction. I shall demonstrate in the following section that Benware's (and, by implication, Wurzel's) analysis is in some ways inferior to the one proposed here.

### 3.4.2 Lexicalised compounds as parts of larger compound structures

#### 3.4.2.1 Stress shift in A[BC] structures

This section is the first one of two in which I shall propose modifications of the metrical structure of compounds. All the structures given in section 3.4.1 were unmodified ones, direct reflexes of the compounds' internal morphosyntactic structures, with the nodes labelled according to CSR and with each lexical constituent equipped with an M node.

It turns out now that that is not always an appropriate analysis for complex lexical items which on the face of it look like compounds. Consider the following A[BC] items (assuming, for the moment, that that is what they are):

- (3.19) Hauptbahnhof  
 Hallenschwimmbad  
 Fausthandschuh  
 Zentralflughafen  
 Qualitätsmaßstab  
 Hauszeitschrift  
 Volkshochschule  
 Farbfernsehen

The metrical structures generated for these items by the mechanisms developed in the preceding section appear to be those in (3.20) below; they fail to reflect the fact that the examples in (3.20) have their main stress on the A constituents. This means that our metrical analysis fails in these instances:



(3.20) a.

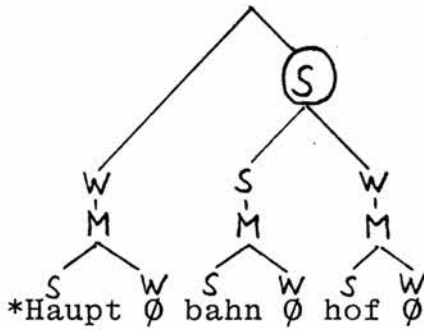

b.

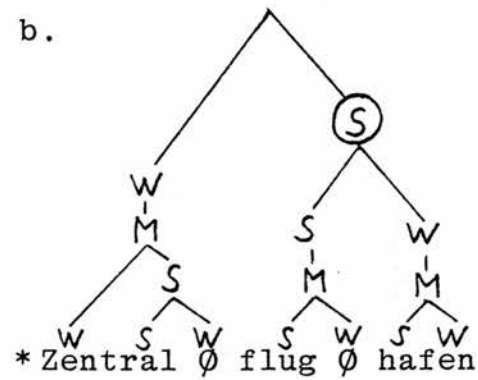

What is wrong with these structures is quite clear. In order to reflect correctly the actual stressing of these nouns, the circled nodes in (3.20) would have to be weak. This is in apparent contradiction to what CSR predicts. But is it really?

A closer look at the [BC] constituents of the items in (3.20) reveals that the compound status of these entities is in fact rather dubious: they are clearly not as well-motivated, in terms of their internal semantic relations, as *Schnellverkehr* (recall *Städte'schnellverkehr*, (3.15c) above) and *Kriminalamt* (as in *Bundes'kriminalamt*, (3.15d)) are.

I have discussed in section 3.3 above what the problems of analysis are when the loss of semantic motivation in compounds and the - presumably concomitant - loss of stress on the second constituent are observed. I said there that the two processes can be safely handled only if they are treated as independent of each other and that establishing a causal relation between them, for example taking lexicalisation as a causing factor for stress loss, doesn't seem to be supported by overwhelming evidence. Nonetheless, a number of writers either propose or assume this causal link between the two phenomena, among them Stötzer (1975).

Stötzer proposes that A[BC] compounds have their main

stress on A only if the [BC] constituent is lexicalised (she uses the term *idiomatisiert*, following Fleischer 1974), thus seeking the cause of the stress shift in the change of the semantic structure of the item. Whether it can be substantiated empirically or not, it turns out that her case can be argued quite strikingly on metrical grounds.

Recall that in section 3.3. I proposed that in English, compounds 'proper' should be analysed as in (3.21a) below, lexicalised compounds as in (3.21b). This, I argued, allows for vowel reduction on the second element in (3.21b) and is at the same time a necessary consequence of our postulate that an M node dominates a 'word'.

(3.21) a.

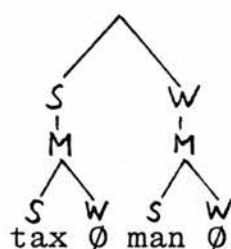

b.

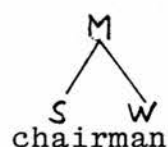

I also proposed in that section, rather tentatively, that the diachronic structural change brought about by the process of lexicalisation can be captured in a synchronic grammar by re-analysing the historic B element of a compound as a Class II suffix - recall the arguments given by Allen (1980).

The placement of primary stress in German A[BC] compounds with lexicalised [BC] constituents supports this analysis. Consider, for example, (3.22):

(3.22) a.

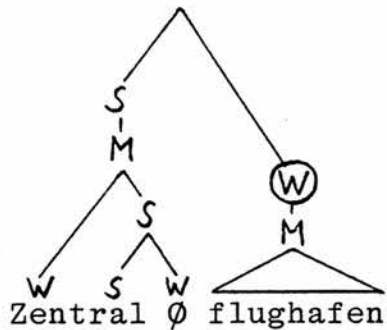

b.

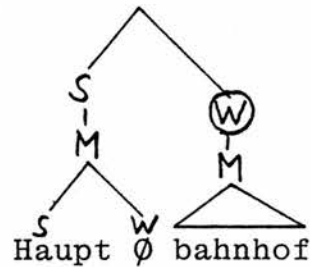

A lexicalised compound is dominated by one M only. As a consequence, *-bahnhof* and *-flughafen* in (3.22) have no metrical branching above M and the Compound Stress Rule makes the circled node weak. This means, of course, that A[BC] compounds with lexicalised [BC] are not, metrical speaking, A[BC] compounds at all: they are simply [AB]. As such, they have their DTE on the first constituent.

Let us look at the unanalysed triangles in the trees of (3.22) in more detail - we are actually in a position now to give a full metrical analysis of lexicalised German compounds. I suggest that the items represented as triangles should be analysed as words derived via Class II suffix. Recall sections 2.2.4 and 2.2.5 of the previous chapter, where the properties of nominal Class II suffixes were discussed with respect to stress and metrical structure. I argued there that Class II suffixes for nouns are either stressed or unstressed; examples were given in (2.79a) and (2.79b) respectively. They receive prominence through the Main Stress Rule (3.16); thus, if a Class II suffix contains a heavy syllable it will be stressed (as *-heit*, *-mässig*, *-schaft*) and if it contains a light syllable it will be unstressed (*-chen*, *-nis*). (3.23a) below contains a stressed suffix of Class II, (3.23b) an unstressed one:

(3.23) a.

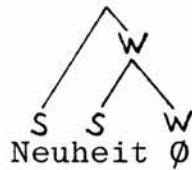

b.



If a lexicalised compound is to be analysed as a lexical item plus Class II suffix then this suffix will be a stressed one, like the one in (3.23a) above. Recall that in section 2.3.2 I argued that a monosyllabic lexical item always consists of a heavy syllable. The B constituent of a lexicalised [AB] compound is in fact a former lexeme; it may, once it has been re-analysed as a suffix (as a consequence of lexicalisation) undergo changes in its segmental composition which could cause its loss of stress - this would be the process of obscuration referred to by Götz (1971) and Faiss (1978) - but the second element in a lexicalised compound that isn't obscured (yet) will always be a stressed Class II suffix. We can now complete the metrical structures of (3.22) like this:

(3.23) a.

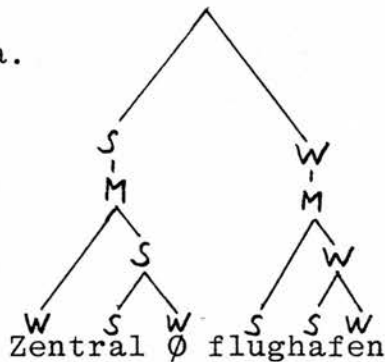

b.

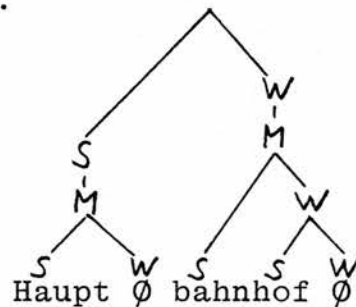

Model-internally this analysis makes a lot of sense. Analysing *Bahnhof* as a unit dominated by a single M is the only way of achieving a prominence structure that bears out the facts. Also, historical evidence rather supports the claim I am making here, in a few instances

at least: a number of present-day Class II suffixes in both German and English are in fact historically free morphemes, to be precise: the second elements of compounds. Examples are *-dom* and *-ship* in English, *-tum*, *-schaft*, *-los* etc. in German. In terms of this model, these items must have lost their M nodes at some point in their history, presumably through frequent occurrence as second elements of compounds that lacked semantic motivation. And presumably, the decisive next step in this development was the one from (3.24a) to (3.24b) below:

(3.24) a.

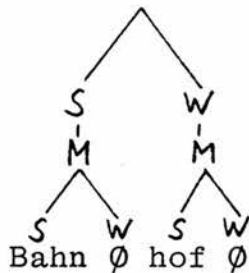

b.

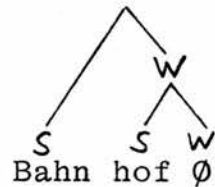

c.



(3.24c) represents a final, and in this particular case hypothetical, step. *-hof* has lost its residual stress; its vowel has lost its length and eventually the /h/, morpheme boundary signal, disappears (see also Götz 1971). But this is, of course, speculation. The development of this word hasn't got as far as that and (3.24c) reflects a prediction about the possible future of this particular word.

Nevertheless, the reader cannot be blamed if he is dissatisfied with the empirical motivation of the change from (3.24a) to (3.24b). The semantic criteria of lexicalisation are somewhat vague and segmental changes, which would be easier to attest, are not predicted before stage (3.24c) is eventually reached. In English, this final stage has been reached by words like *chairman*, where the reduction

of the vowel presupposes a terminal W node. We have to content ourselves, it seems to me, with the following motivations for the tree structures in (3.24): (3.24a) - fully motivated compound; (3.24b) - lexicalised compound which fails to meet Allen's Strong Boundary Condition ((3.10) above); (3.24c) - obscured compound which fails to meet Allen's condition and has undergone segmental reductions. This sequence of events assumes implicitly that the semantic amalgamation sets in before the phonological distortion of any such item. I reported in section 3.3 above that this position, although held by many authors on the subject, has to my knowledge never been substantiated by conclusive evidence. I hope to be forgiven for subscribing to it, as it simply makes sense in this model, without supplying the missing diachronic evidence.

The question arises at this point whether the metrical trees of (3.24) above are in any way related derivationally in a synchronic grammar. It should have become clear by now that the answer is no: there is no reason to assume that, in a synchronic derivation, the underlying form of (3.24b) or (3.24c) is (3.24a). The change outlined there is a diachronic one but in a synchronic grammar of present-day German, *-hof* will be a Class II suffix which attaches to *Bahn*, just as in English *-man* is a Class II suffix which attaches to *chair*, *gentle*, etc. Both cases have free lexical counterparts in their respective language; the English example shares with the (historically related) free morpheme *man* certain properties in the inflexional morphology.

This is precisely what writers like Sweet and Marchand have in mind when they say that words like *gentleman*, although historically compounds, aren't compounds in synchronic terms. There is no need to burden the grammar

with an unnecessary operation like deriving *gentleman* synchronically from a compound.

Having said that, I find it hard to follow the argument for a derivation that produces (3.24b) synchronically out of (3.24a). This is essentially what Benware (1980a) does when he claims that in German, A[BC] compounds used to have their main stress on the A constituent until, quite recently, they shifted it to B. This would equal the claim, in the present framework, that [BC] constituents undergo a process of 'delexicalisation'. This claim is, of course, implausible and Benware doesn't make such a claim anyway. But his data and statistics, at closer inspection, lend no support to his hypothesis either.

#### 3.4.2.2. A point of difference between English and German

Having established a Compound Stress Rule that is identical for German and English, and having formalised the metrical reflexes of lexicalisation in compounds in the same way in both languages, it is now rather tempting to expect the latter process to have the same effect on the metrical behaviour of larger structures in German and in English.

Thus, we have seen that in a German compound [AB], the B constituent is strong if and only if it branches, as in *Städte'schnellverkehr*. Now if B doesn't branch (above the metrical level M) it is weak. This is the case also in B constituents that are lexicalised compounds; that is, our rule holds, as can be expected, regardless of the individual history the B constituent may have undergone,

so long as the diachronic development hasn't left any synchronic traces. Hence the initial stress of *Hauptbahnhof*.

In English, things aren't quite as straightforward; in fact they haven't been all along. Recall that the stress patterns of English [AB] compounds are, to put it harshly, unpredictable. We found in section 3.2 above that the CSR and the NSR compete in this domain and that there is no principled way of telling just why *steel pen* is governed by NSR and *snowball* by CSR (Schmerling 1971). This implies that English has compound structures with noncomplex B constituent that have end-stress - unlike German where such cases are severely restricted and, as I argued in section 3.4.1 above, on the whole predictable.

It is a consequence of this rather irritating fact that the stress shifts, observed for German in the previous section, don't turn up with the same degree of predictability in English. Thus, we seem to encounter *'night watchman* as well as *'car salesman*, where in both cases *man* is reduced and we expect the metrical structure of a noncompound. The metrical representations of the two items are given in (3.25):

(3.25) a.

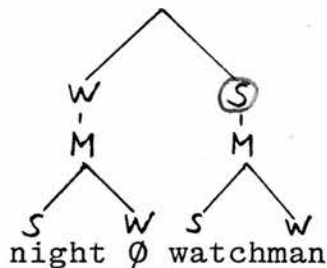

b.

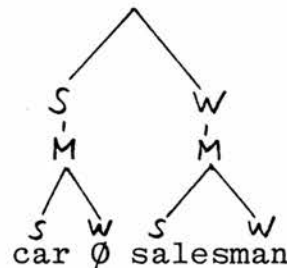

I have not come across the same kind of variation in German. The reason is, of course, that the English NSR



is operative in (3.25a), hence the strength of the circled node, and CSR handles (3.25b). In German, on the other hand, it is predictably CSR that accounts for the prominence relation among the constituents in *Hauptbahnhof*; there is no reason to expect the same variation.

#### 3.4.2.3 [AB]C structures with adjectival constituents: lexicalisation and stress alternation

I have so far failed to point out a further observation that might shed some more light on the upward shift of M nodes. Note that in each of the cases cited in section 3.4.2.1 above, the upward shift of the M node results in the elimination of metrical structure, that is, in the deletion of zero syllables. This holds for *Schwimmbad*, *Bahnhof*, etc.: in all instances the lexicalised metrical structure is simpler than the nonlexicalised one. This phenomenon might be suspected of encouraging the change of structure (along with the other, essentially semantic, factor discussed above); what is more, it will be seen to be the sole motivation of further changes in metrical structure that will be discussed in a later section and to which the structures provided thus far constitute the input. This kind of process, suspected of being involved in what happened in the previous section, will be instrumental in what follows.

Having operated with the notion of lexicalisation in an attempt to account for stress variation in, seemingly, A[BC] compounds, we now turn to some problems in the metrical analysis of [AB]C structures. Our Compound Stress Rule predicts for these structures stress on the A constituent, regardless of whether lexicalisation is

present or not. The reason for this is, of course, that the CSR is insensitive to left-hand branching; thus, whether [AB] branches metrically or not is immaterial for the Compound Stress Rule. Here are two examples, the first one with a lexicalised [AB] constituent:

(3.26) a.

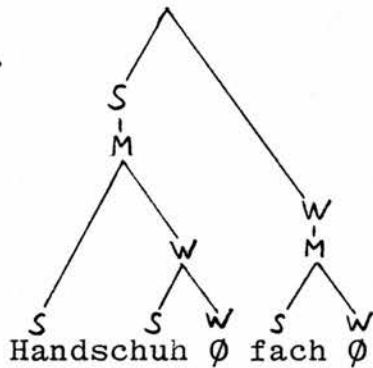

b.

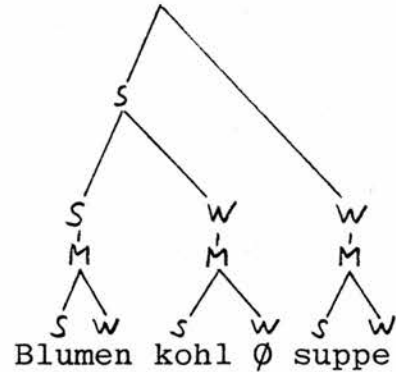

This implies that we won't be able to hold lexicalisation responsible for deviant stress behaviour in [AB]C structures. Nonetheless, we encounter variation in the placement of the DTE in compounds of this structure, which the Compound Stress Rule doesn't seem to predict. Here are some examples:

(3.27)	Alt'weibersommer	Mehr'familienhaus
	Drei'zehenmöve	Drei'groschenoper
	Fünf'zimmerwohnung	Dreissig'jahrfeier
	Lieb'frauenmilch	Ein'mannbetrieb
	All'parteienregierung	All'heilmittel

All these examples have their main stress on B rather than A, against our original predictions - recall (3.26) above. In all cases the A constituents are adjectives, often numerals. Yet it would be just too simple if that was the reason for the unexpected behaviour of these words; we can easily find counterexamples which have regular stress patterns despite a morphological structure identical with the one found in (3.27).

- (3.28) 'Altwarenhändler  
 'Dreifarbstift  
 'Zehnganggetriebe  
 'Allstromgerät  
 'Mehrzweckmöbel

Benware (1980a) accounts for the variation exemplified in (3.27) and (3.28) in terms of a conflict of two rules, a Compound Stress Rule and a Phrasal Stress Rule (both in the form suggested by Kiparsky 1966). It doesn't seem possible, however, to speculate in any way about the possible outcome of this conflict: sometimes one rule will win, sometimes the other. More can evidently not be predicted in this model of phonology, essentially that of SPE. Let us bear the conflict in mind and turn to an attempt to explain the phenomenon without appealing to phrasal stress rules.

Stötzer (1975), restricting her data to such [AB]C structures whose A elements are numerals, gives the following summary of her detailed investigation; I am simplifying her results slightly:

- (3.29) If in an [AB]C compound -
- a. - A a numeral from 1 to 4 and B a noun in the singular: ['AB]C
  - b. - A a numeral from 2 to 4 and B a noun in the plural: [A'B]C
  - c. - A a numeral greater than 5 and B a noun: [A'B]C
  - d. - A an indefinite numeral and B a monosyllabic noun: ['AB]C
  - e. - A an indefinite numeral and B a polysyllabic noun: [A'B]C

This collection of rules of thumb fails, obviously, to give us formal, or even formalisable, criteria for metrical structures; what is more, it isn't free of

exceptions either: compare *Ein'mannbetrieb* and *'Einmannwagen*, *'Zehnganggetriebe*, *Dreissig'jahrfeier* and *All'heilmittel*. Nevertheless, this is an interesting attempt - especially where the syllabic structure of constituents is brought into the discussion.

Let us assume, for the sake of this argument and without further discussion, that adjective plus noun combinations have the underlying metrical structure  $\begin{matrix} & \wedge & \\ W & & S \end{matrix}$ ; whether they are the [AB] constituent of an [AB]C compound or isolated doesn't matter: underlyingly, these structures are here assumed to be noun phrases. We apply the phrasal stress rule, as Benware (1980a) does, in the underlying metrical structure. It would follow that, at this particular point of the derivation at least, both constituents are dominated by separate M nodes: their morphosyntactic characteristics are those of phrases and their stress behaviour doesn't suggest anything else. This gives us basic structures like those in (3.30):

(3.30) a.

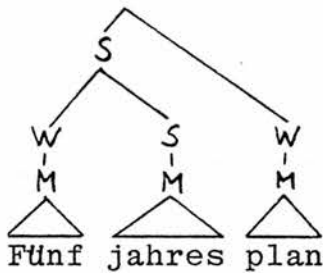

b.

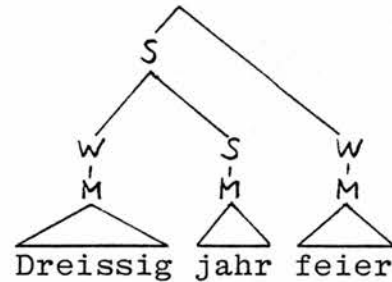

This accounts for the data given in (3.27) above: the compounds given there share the feature that their [AB] constituents are underlyingly noun phrases and they are therefore, as Benware (1980a) suggests, stressed as noun phrases. But why, then, do the examples in (3.28) deviate from this structure while they have the same syntactic characteristics?

We shall have to approach this question from two different angles, considering the possible morphosemantic contents of M nodes as well as independent metrical criteria. In particular, we shall have to face the following two questions: first, is lexicalisation relevant in this area, as it was in section 3.4.2.1 above, and can, conversely, the 'regular' cases in (3.27) be sufficiently characterised by the absence of lexicalisation? And second, are there independent phonological criteria for a difference in stress between *Dreissig-jahrfeier* and *Ein'mannbetrieb* on the one hand and *'Einmannwagen* on the other?

We remember that, thanks to the way CSR is stated, a shift of the M node automatically shifts the stress in A[BC] structure; this was the topic of section 3.4.2 above. In compounds of the type [AB]C this is not automatically the case; some sort of formal link between M and the strength relations that hold underneath it has to be established first if we want to answer the former of the two questions I asked above. Let us have a look at the metrical configurations that can constitute the [AB] part of an [AB]C compound.

(3.31) a.



b.

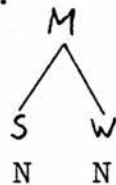

c.



d.

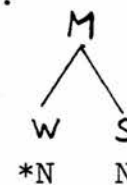

e.



f.

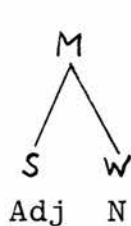

g.

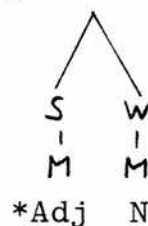

h.

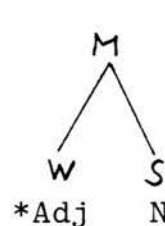

The list of possible and impossible configurations among noun plus noun structures (3.31a.-d.) is merely a summary of what has been argued, repeatedly, in previous sections. Examples are found in (3.26) above.

(3.31e.-h.) are more interesting. Strictly speaking, I have applied a formal trick there in order to link M structure and prominence relations in adjective plus noun combinations. Paraphrasing (3.31e.f.), I postulate that the underlying structure (3.31e) can be modified in two different ways, both leading to the same result (3.31f). Either the M node can be raised, for some reason, which would cause a simultaneous reversal of prominence structure, or a reversal of prominence structure, motivated independently, can bring about the raising of M. Neither of the two can happen on its own. The configurations (3.31g.h.), reflecting either of the two changes without the other, are ill-formed. It will be seen below that the examples I gave in (3.27) and (3.28) provide backing for this postulate; in a different grouping, they reappear in (3.32):

- |        |    |   |    |   |
|--------|----|---|----|---|
| (3.32) | a. | 'Altwarenhändler<br>'Grosshandelspreis<br>'Oberleitungsomnibus<br>'Neiderdruckheizung | b. | Alt'weibersommer<br>Lieb'frauenmilch<br>All'parteienregier-<br>ung                                |
|        | c. | 'Dreifarbstift<br>'Einfarbstar<br>'Mehrzweckmöbel<br>'Einmannwagen<br>'Einbahnstrasse | d. | Drei'zehenmöve<br>Drei'groschenoper<br>Mehr'familienhaus<br>Ein'mannbetrieb<br>Dreissig'jahrfeier |
|        | e. | 'Zehnganggetriebe<br>'Allstromgerät<br>All'heilmittel<br>Rot'kreuzschwester           |    |   |

Let us compare the structures in (3.32a.b.). (3.32a), I would suggest, contains items in which the raising of the M nodes is quite clearly motivated. The stress shift

follows. *Altwaren*, to go through the examples one by one, is not the same as *alte Waren* ('old goods') - age is not the important criterion for goods called *Altwaren* but useless or scrap value. Similarly, *Grosshandel* isn't necessarily trade characterised by its volume but by the fact that the trader, or wholesaler, doesn't sell directly to the consumer. *Oberleitung* is not an agency ultimately in charge but an overhead source of electric power. And finally, *Niederdruck* is not, as one might expect, a noun derived from the verb *niederdrücken* but stands for low pressure. Both *ober* and *nieder* are rather isolated in the contexts they occur in here. It is quite clear that the [AB] constituents in all the examples given in (3.32a) are lexicalised compounds, dominated by a single M. What is more, they actually occur in the language on their own, having the same meaning in isolation as they do under embedding.

On the other hand, the [AB] constituents of the words in (3.32b) are fully motivated and transparent, referring to *alte Weiber*, *liebe Frauen*, and *alle Parteien* respectively. They do not, as Benware (1980a) points out, occur in isolation: *Altweiber*, *Liebfrauen*, *Allparteien* aren't German words.

This gives us sufficient reason to use the metrical structures of lexicalisations, given in (3.31e), in each of the items (3.32a) and the phrasal structures (3.31f) in (3.32b). The stress behaviour of the two groups can thus be accounted for in terms of the presence or absence of lexicalisation:

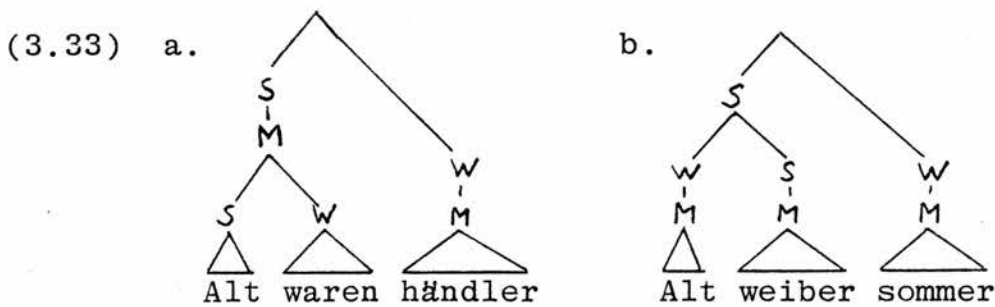

To summarise the results of this section, then, I have demonstrated that at least some instances of stress variation among [AB]C compounds (where A is an adjective) can be explained in terms of the presence or absence of lexicalisation. This explanation is based on the assumption that non-lexicalised adjective plus noun combinations have two M nodes and a weak-strong pattern, which is identical with the pattern of noun phrases. If the M structure changes through lexicalisation, then the metrical structure underneath M reverses automatically.

Above I have spoken of the possibility of independently motivated stress reversals which may cause the M shift, in other words, of a change in metrical structure that may have nothing to do with lexicalisation. In this category belong cases like (3.32c.d.) above. I shall discuss them in the following section.

### 3.4.3 Eliminating structure: Defooting in German compounds

In section 3.4.2 I pointed out that the metrical tree of a lexicalised compound is not a product derived from a non-lexicalised (compound) tree in a synchronic grammar. Why this is so is implied in the term 'lexicalisation' itself. Assume that compounds are formed, through whatever mechanism (recall section 3.1 and the literature cited there), in the word formation component of the lexicon,



which probably handles Class II affixation as well. Prominence relations get defined in compound trees by rule (3.16) subsequent to their formation and presumably also in the lexicon. The position held here is that compound and affix stress get assigned in the lexicon and that phrasal stress gets assigned in a separate metrical component, which, sited between the syntax and the segmental phonology, also absorbs all kinds of metrical transformations. More will be said about the position of the Compound Stress Rule and of metrical transformations, as well as the character of the metrical component, in the next chapter of this study.

It is my aim in this section to introduce one particular metrical transformation which flattens, or simplifies, metrical structure. I'm not committing myself yet as to whether this transformation is part of the lexicon or of the above-mentioned metrical component. I shall not consider all the details of this process either but merely give as much as is necessary at this point. A full account follows in section 4.2.2 below.

Recall, once again, that the difference in metrical structure between a non-lexicalised compound and a lexicalised one is assumed not to be brought about by means of a synchronic derivation. The only link that exists between the two is a diachronic one. In contrast, let us go back to the examples I gave in (3.32) above. (3.32a.b.) we have accounted for; what remains is (3.32 c.d.e.). Compare, for example, *Drei'groschenoper*, *Dreissig'jahrfeier*, and *'Dreifarbstift* - metrical structures for these are given in (3.34) below:

(3.34) a.

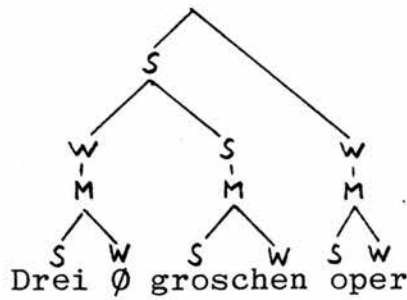

b.

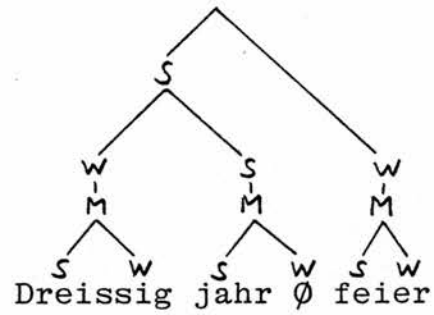

c.

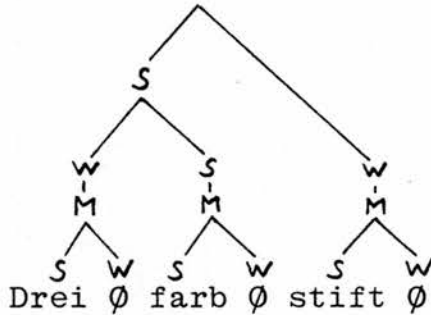

The structures (3.24a.b.) reflect the actual stressing of the items given there: both have three rhythmic beats, here indicated by three  $S \wedge W$  structures, and their main stress falls on the B constituent.

(3.34c) is also well-formed. But unlike the case of the other structures, an alternative stress pattern is available, and in my impression preferred, that has the main stress on the first constituent. There are three things to be observed here: first, there is nothing in the internal semantic structure that suggests that the changing stress pattern is that of a lexicalised item and those of the constant ones are not. *Dreifarbstift* is no more lexicalised than *Dreigroschenoper*. Second, that the alternative stressing of *Dreifarbstift* - and the same goes for the other items in (3.32c) - is optional. And third, that in metrical terms these structures are distinct from the ones that don't alternate in that they

contain two zero syllables.

These observations make it quite clear that what we are faced with here is something quite different from the diachronic diversification of metrical structures that we discussed in previous chapters. Clearly, *Dreifarbstift* and *Dreigroschenoper* have metrical structures that are synchronically related. The initial-stress pattern of 'Dreifarbstift can be derived from the ones given in (3.34) above by an optional rule that makes reference to nothing but metrical structure. Here is a formal statement of this rule:

(3.35)

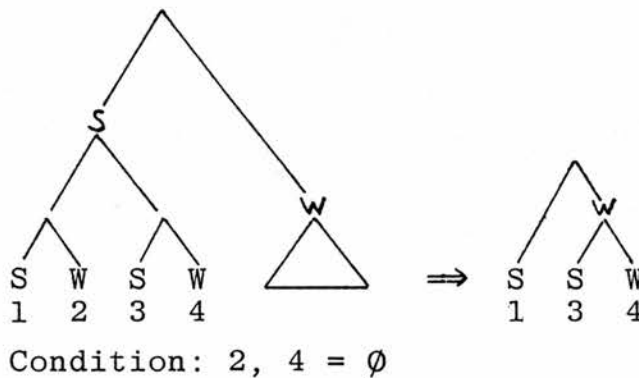

Rule (3.35) deletes a zero syllable following a monosyllabic adjective in this particular structure. Thus, *Dreifarbstift* undergoes the change depicted in (3.36):

(3.36)

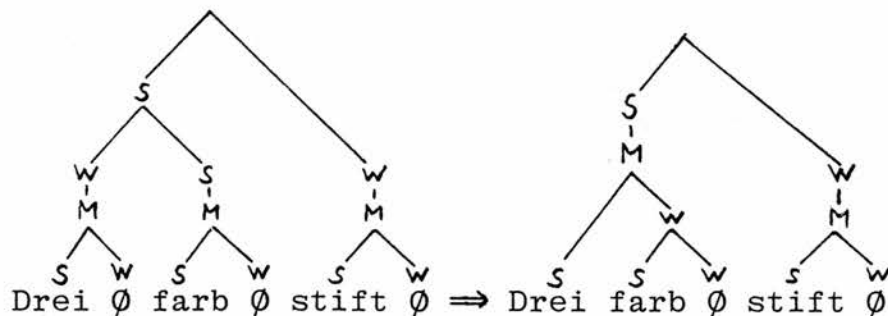

Following our conditions on the placement of zero syllables, *Dreifarb-* is now dominated by a single M node:

*Drei* can't retain its own M status unless it also retains its zero syllable. In accordance with the set of possible structures given in (3.31) above, the M node now immediately dominates an  $S \begin{matrix} \diagup \\ \diagdown \end{matrix} W$  structures.

Rule (3.35) is rather tightly constrained by the condition that nodes 2 and 4 have to be zero syllables. This condition, along with the principles of distribution that govern zero syllables, makes precisely the right predictions as to what items (3.35) applies to. Consider the structures in (3.37):

(3.37) a.

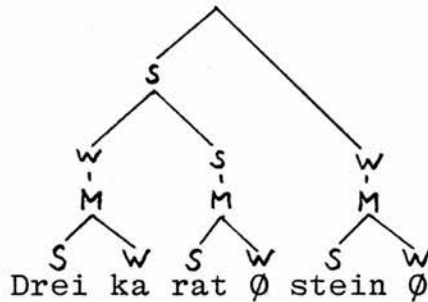

b.

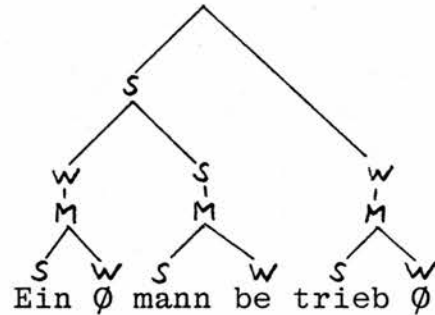

c.

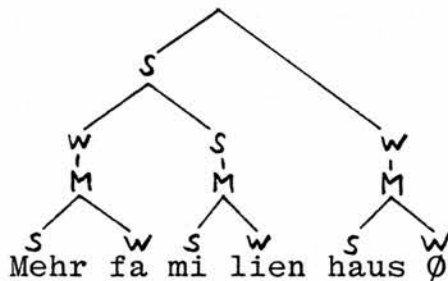

*drei-* (3.37a), *mann-* (3.37b) and *mehr-* (3.37c) are not accompanied by zero syllables although they are monosyllabic lexical items. Following a well-formedness condition on metrical structure given in (1.18) above, the W position of the bisyllabic foot is in each of these cases taken up by the unstressed initial syllable of the following word. This principle of metrical

structure evidently proves rather useful in capturing the correct environment in which (3.35) applies.

*Ein'mannbetrieb* constitutes an exception to Stötzer's rule that I gave in (3.29d) above. Her rule is thus observationally inadequate if stated in her terms ('B a monosyllabic noun'). Rather interestingly, in our model *mann* doesn't have the properties of a monosyllabic noun in this construction. Couched in the present metrical model, then, *Ein'mannbetrieb* would get handled by Stötzer's rule (3.29e), which indeed produces the right result. Whether Stötzer had anything like this in mind I don't know; the rather curious failure of her rule to account for cases like this one might be either an oversight on her part or the failure of her model to express what she means.

Rule (3.35) reflects a process of synchronic metrical derivation. More of these can be found in the grammar; as I mentioned above, the next chapter of this study will be devoted entirely to this kind of derivation. It is necessary, however, to introduce one more of these rules at this point as it figures quite prominently in the stress patterns of German compound nouns.

Consider the [AB]C compound *Bauamtsleiter*. *Bauamt* is not a lexicalised compound; we can assume this because of its behaviour as the [BC] constituent in *Stadt'bauamt*, where *bau* takes the main stress. The semantic structure shows no trace of amalgamation. The metrical structures of both items are given in (3.38):

(3.38) a.

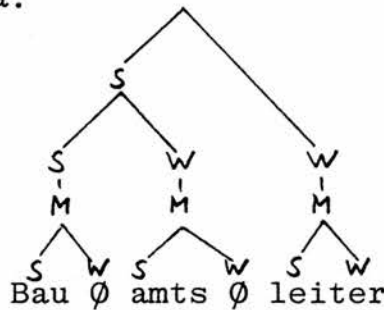

b.

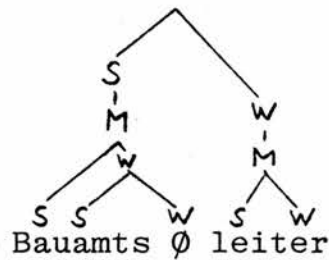

c.

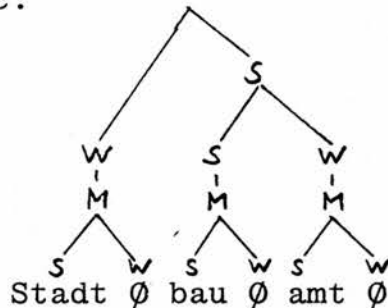

There are two reasons that prevent the underlying structure (3.38a) from surfacing as it is. Firstly, this word tends to have two rhythmic beats only and not three, as the triple  $S \begin{smallmatrix} \wedge \\ W \end{smallmatrix}$  structure suggests. Secondly, consider the distribution of glottal stops in the onset of vowels in German (*fester Volkaleinsatz*). Eva Krech (1968) states that a vowel in the onset of a stressed syllable is usually preceded by a glottal stop - in our model a vowel that bears a terminal S node. (See also Hans Krech *et al.* 1969; Wurzel 1970b). Prevocalic glottal stop is thus a boundary signal preceding our  $S \begin{smallmatrix} \wedge \\ W \end{smallmatrix}$  structure. Interpreted as that, it is predicted by our model in the capitalised vowels of, say, *TheAter*, *SpielwarenAussenhandel* etc. The distribution of glottal stops doesn't, of course, 'prove' anything in terms of the correctness of these structures. But it does provide interesting external motivation for the  $S \begin{smallmatrix} \wedge \\ W \end{smallmatrix}$  structures wherever they occur. This model, then, doesn't only predict the correct stress patterns of words and compounds

- it also predicts the placement of prevocalic glottal stops.

The point of the present argument is that in (3.38a), *amts* tends not to have a glottal stop whereas it does in (3.38c).

(3.38a) is subject to a derivation by rule (3.35) - the output is given in (3.38b). This structure meets the criticisms raised against it to some extent in that it removes one of the zero syllables. It still predicts a glottal stop on *amts* and leaves us in doubt as to the division of the whole item into rhythmic beats.

Does a structure of the type



have one beat or

two? Clearly, this kind of structure is at variance with the performance principles under which, as I argued in chapter 1, zero syllables get inserted into strings. The absence of a zero syllable in this structure thus motivates further change, which I shall demonstrate shortly.

All this makes the status and use of rule (3.35) rather dubious: it produces a structure that indicates pressure for further change while before the application of (3.35), this pressure is absent. Why have a two-step derivation when the first step produces a structure that seems less agreeable than the input structure? Let us postpone this discussion until later, when more of the scope of this kind of metrical derivation process will have come to light. I shall then argue that rule (3.35), although essentially nothing but a readjustment rule, makes a lot of sense and that not having it would allow interesting generalisations to go uncaptured.

For the moment, we are dealing with (3.38b). Notice

that rule (3.35) has neutralised three underlyingly different structures: that of *Dreifarbstift* (recall (3.36) above) and that of *Bauamtsleiter* (3.38b) are now identical with the initial structure of items of the type [AB]C where [AB] is a lexicalised compound. An example is *Handschuhfach* (where *Handschuh* is a metaphoric compound). I repeat the structure that all three now share in (3.39a); for later use, I give the structure of *Fausthandschuh* in (3.39b):

(3.39) a.

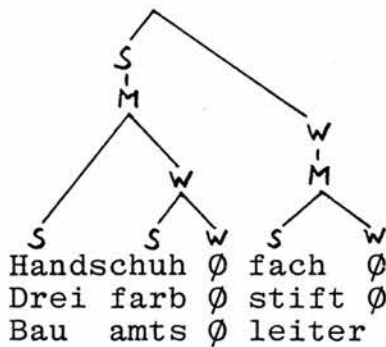

b.

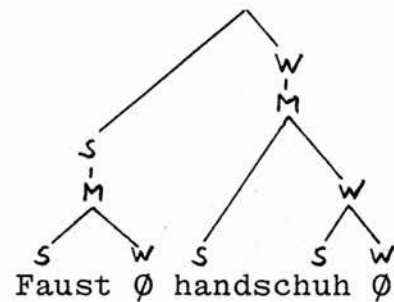

Let us now take the next step. It has occasionally been observed in the literature that the neutralisation of compound stress patterns in German has a range even wider than that covered by rule (3.35). Thus, Wurzel (1980) and Kiparsky (1966) note that certain [AB]C and A[BC] structures display identical stress patterns of the kind 'AB,C. The ones that undergo this neutralisation process are actually the four structures that I gave in the preceding paragraph, i.e. metrical structures of the types (3.40):

(3.40) a.

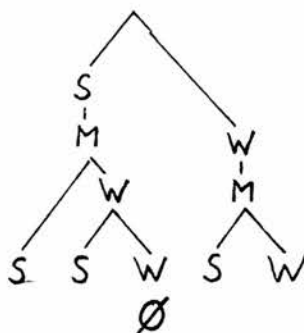

b.

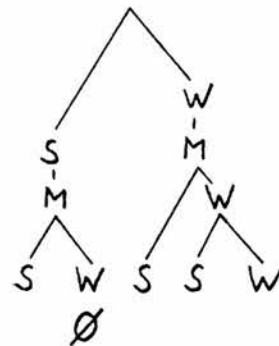



What is happening here is a process which collapses these two structures into one that reflects two rhythmic beats (the B constituents surface unstressed in all cases). The first beat is stronger than the second one. The resulting structure, then, looks like this:

(3.41)

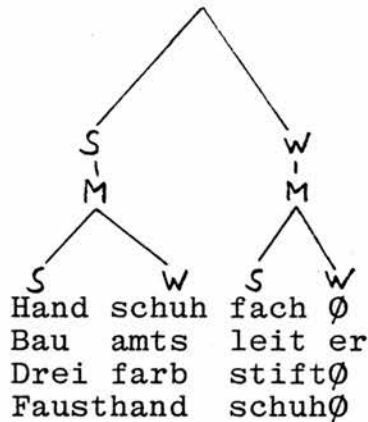

What are the formal characteristics of the structures that get transformed into (3.41)? First of all, they have three terminal S nodes dominated by the same root; in other words, all three S nodes are part of the same structure. Second, the first of the three nodes is the strongest stress of the structure (its DTE). And third, one terminal W, representing a zero syllable, may occur between the rightmost and the leftmost S, in either of the two possible positions. Here is a formal statement that bears out these characteristics:

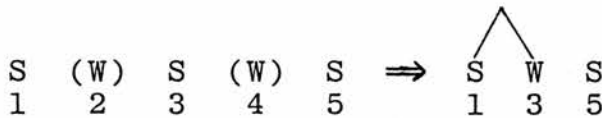
(3.42) German Defooting

- Conditions:
1. 1-5 are dominated by R
  2. 1 is DTE
  3. 2, 4 =  $\emptyset$
  4. If 2: ~ 4  
If 4: ~ 2

I shall investigate the adequacy of the constraints on this rule in detail in the following chapter, where we shall see that there are even more structures that undergo this rule, not just the ones I have dealt with here. Here, I point out just one structure that is correctly barred from this neutralisation process. It is the structure characteristic of an A[BC] compound with non-lexicalised [BC] constituent, as *Stadt'bauamt* and *Welt'spartag*:

(3.43)

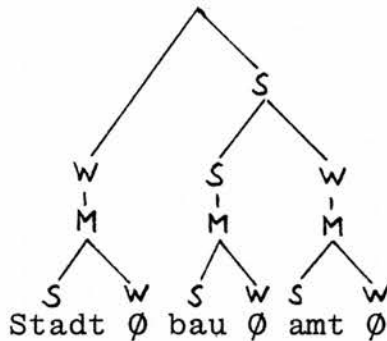

(3.43) violates the conditions imposed on the application of Defooting in that node 1 isn't its DTE and also in that there are more than one W between nodes 1 and 5.

Kiparsky (1966), in his discussion of this neutralisation process, points out a number of instances where neutralisation tends not to occur. Here are some of his examples: *'End,wortschatz*, *'Stadt,mundart*, *Re'likt,landschaft*. All these compounds are, in our model, compounds with lexicalised [BC] constituents, clearly candidates for Defooting. The rule fails to apply, as Kiparsky suggests, in rare or specialised compounds. While *Mundart* is so common that it has been lexicalised, *Stadtmundart* is a sociolinguistic term. It could be argued that speakers are inclined to avoid the neutralisation rule in a case like this in order to maintain a stress pattern that shows up the internal morphological structure of the item. Defooting is an optional rule.

To sum up this rather complex derivation, then, let us repeat the list of items once more that get defooted and end up with the same metrical structures:

1. [AB]C compounds undergo rule (3.35) and subsequently get defooted: *Bauamtsleiter* (3.38a.b.).
2. [AB]C compounds with adjectival A of the type *Dreifarbstift* (3.36) undergo (3.35) and subsequently get defooted.
3. [AB]C structures where [AB] is a lexicalised compound get defooted: *Handschuhfach* (3.39a).
4. A[BC] structures where [BC] is a lexicalised compound get defooted: *Fausthandschuh* (3.39b).

The fifth possible structure in this list, A[BC] with non-lexicalised [BC], doesn't defoot: *Welt'spartag*, *Stadt'bauamt* (3.43).

More has to, and will, be said about Defooting in chapter 4 below. The discussion there will include an exhaustive listing of the possible input structures of this rule (and it will turn out that the compounds we have just dealt with only form a small section of this list), a detailed scrutiny of the constraints on Defooting and why they are needed, a discussion of the status and use of rule (3.35), and an attempt to locate the site of rules like (3.35) and Defooting in the grammar: are these rules part of the lexicon or are they situated elsewhere?

#### 3.4.4 Some 'exceptions' and their 'explanations'

The reader will have noticed that the account of compound stress proposed in this chapter occasionally fails. A few instances were given at the end of the last section

where I suggested (following Kiparsky 1966) that at least some rules of a metrical derivation should be optional.

Calling a rule optional makes instances of its non-application less troublesome for the analyst. Strictly speaking, however, an explanatory strategy that allows for free variation - and this is essentially what is meant by entirely optional processes: application and non-application of a rule X are in free variation - creates about as many problems as it solves. For what is implied in the notion of 'free variation' is nothing less than variation at random, without reason. The problem is that as soon as a strategy like the one employed here is allowed free variation it loses its falsifiability.

Take, for example, our Defooting rule (3.42). This rule is said to apply under (and, in a model that tries to be explanatory, "because of") certain conditions that are expressed in the structural description of the rule's input. Only in circumstances like that can a rule be falsified; in fact, it is automatically falsified if one of the following two events occurs: the conditions specified in the structural description are met and the rule fails to apply (this is what seems to happen in the case of (3.42)), or: the rule applies although the structural description isn't met. In a way, we are faced with the latter problem in this model, too: note that 'lexicalisation' occasionally helps to defoot items which, according to rule (3.42), can't really be defooted.

To be sure, this is a problem only if either of these disruptions of a cause-and-effect relation happens without reason, and the existence of hitherto undiscovered reasons is what I would like to pin my hopes on, occasion-

ally, in this particular model. I have argued above that lexicalisation should not be taken as a fancy label for 'something without reason' although I had to appeal to phenomena, mainly semantic, that are at the moment outwith the formal model developed here. To account for exceptions in metrical structure, then, I have to be allowed, at this stage in any case, to appeal to causes that lie, essentially, outwith the scope of metrical structure as we know it. Sometime later, it is hoped, we will be able to formalise the reasons that now we can only informally appeal to, and amend the structural descriptions of our rules in such a way as to account for these phenomena in a formal way.

Bearing this in mind, let us turn to some more 'exceptions', especially the examples given in (3.32e) above, here repeated for convenience:

- (3.44) 'Zehnganggetriebe  
 'Allstromgerät  
 All'heilmittel  
 Rot'kreuzschwester

Recall that our model predicts *All'stromgerät* and *Zehn'ganggetriebe* as the stress patterns of the first two instances. (*Zehn'ganggetriebe* I have actually heard.) The only reason for these items' failure to follow the rule is that of a lexicalised contrastive stress, similar to *Pfingst'sonntag*, *Jahr'zehnt* etc. discussed in section 3.4.1 above. Note that a ten-speed gearbox contrasts with any gearbox with a number of gears others than ten (and those seem to be in the majority) and that an electrical appliance that can use all kinds of current is in contrast with equipment that can use alternating current - again the majority, it seems. The weakness of this explanation is, of course, that it can't be falsified as we are not attempting to give a formal cause-and-effect

argument for the occurrence of 'contrastive' patterns (but see Dogil 1979 for such an attempt).

*All'heilmittel* and *Rot'kreuzschwester* require different approaches. I suspect that our metrical analysis fails to produce the right pattern for the former (it produces '*Allheilmittel*' instead) because this analysis assumes an internal compound structure [AB]C. But how can we be sure about this? Bracketing this item as A[BC] isn't nonsensical and, what is more, *Heilmittel* is a rather common compound in German. It seems to me that the underlying structure of an item like this may be subject to varying interpretation on the part of the speaker. Some similar cases will be discussed in section 4.5.3 below.

*Rot'kreuzschwester*, on the other hand, cannot possibly be a case of structural ambiguity or misinterpretation. Contrary to our expectation, it fails to get defooted. But why? Possibly for the same reason for which the following bird names pose problems.

(3.45) a. 'A[BC]

b. ['AB][CD]

Küstenseeschwalbe  
Schmarotzerraubmöve  
Prachteiderente  
Tüpfelsumpfhuhn  
Regenbrachvogel

Weissbindenseeadler  
Weissflügelseeschwalbe  
Goldhähnchenlaubsänger  
Weissbürzelstrandläufer

c. [AB]['CD]

Blauwangenbienenfresser  
Schwarzschnabelsturmtaucher  
Keilschwanzregenpfeifer  
Schwarzflügelbrachschwalbe

(3.45a) is easily explained. *Seeschwalbe*, *Raubmöve*, *Sumpfhuhn* etc. are fairly common family terms and

probably lexicalised. The same argument saves our analysis in (3.45b): the [CD] constituents are lexicalised and the metrical structures are those of the [AB]C type. But why, then, do the members of (3.45c) have their main stress on the C constituent, or at least some of them (I have found a great deal of variation in this group)?

It has to be borne in mind that in all instances where metrical structure deviates from what is produced by the Compound Stress Rule it in fact obscures the internal structure of the compound. I have argued in chapter 1 and elsewhere that CSR is a straightforward re-coding of the syntactic (or morphological) structure of any given constituent. Whatever happens to a metrical compound structure of that kind later in the derivation, or during the historical evolution of a compound, serves essentially not to make the structure more transparent but to mess it up - recall that even the neutralisation of entirely different structures is possible.

It seems to be the function of metrical transformations - or of a 'prosodic component' in general, see Wurzel (1980), Selkirk (1980b), and Dogil (to appear) - to change a syntactic surface structure into something that is easy to perform, i.e. that complies with certain rhythmic requirements, for example. This happens at the expense of 'logical' (in a loose sense, synonymous with 'syntactic') structure. Given that, it is quite clear that a metrical derivation can only take place where the speaker can actually afford the obscuration that this derivation brings about. In the case of lexicalisation, he can afford it by virtue of the commonness of the items in question and the possible idiosyncrasies in the semantic relations among the constituents. Conversely, in (3.45c) the speaker may not be able to afford it for two possible reasons: either, because the item is of an

internal structure so complex that all possible information about this structure has to be given, or because the segmental make-up of the item forces the speaker to pronounce very clearly, i.e. slowly. Kohler (1977:195) suggests this as a reason for the stressing of *Rot'kreuzschwester*. In (3.45c), it would be tongue-twisters like *Schwarzschnabelsturmtaucher* that force the speaker to speak 'clearly', that is, to give all the information about internal structure that he can give.

Notice that all the cases of 'exceptions' that I have given here are 'exceptional' in that certain metrical structure simplifications are possible but absent. We did not encounter any unpredicted simplifications of the underlying structure. This, I hope, has shed some light on what metrical derivations are about. In chapter 4 below, I shall investigate the character of metrical derivations in more detail, using data from German and English. In that chapter, it is hoped, a clearer picture of the nature and scope of metrical structure should emerge.

### 3.5 Borderline cases: metrical effects of compounding and prefixation in German

#### 3.5.1 Verbs

German verbs may be derived from other verbs by, among other things, compounding or prefixation. Quite clearly in the former category are combinations of verb plus verb, adjective plus verb, and noun plus verb, like *kennenlernen*, *blankbohnern*, and *haushalten* respectively. On the other hand, it is beyond doubt that verbs like



*befragen*, *entladen*, and *verfallen* are the products of derivation via prefix. The stress patterns of these two groups appear to be equally straightforward: compounds have forestress (after what has been said in this chapter we wouldn't have expected anything different), derivations via prefix don't stress the prefix but the verb they are attached to.

What makes this domain worth investigating is the existence of a number of cases whose derivational morphology isn't as trivial as that of the verbs given above, or of cases whose stress pattern isn't the one their morphology seems to suggest, or indeed both.

Consider, for example, verbs like *'argwöhn*en, *'früh*-*stücken*, *'ohrfeigen* etc. - verbs whose semantic structure is highly idiosyncratic and doesn't really justify an analysis as compounds. Or take the well-known pairs *'Übersetzen* - *über*'setzen, *'durchfahren* - *durch*'fahren, *'untergraben* - *unter*'graben. Are there independent morphological (or syntactic) criteria that can be held responsible for the stress alternation found in these doublets? Finally, how do we account for the stress difference between *miss*'achten and *'miss*verstehen?

I would like to show in this section that the metrical model that I have been advocating throughout this study makes it possible to account for this array of data in a reasonably straightforward fashion.

As it will be of some relevance to the argument that follows, I should mention at this point a detail of the syntactic behaviour of the verbs in question. In finite forms in main clauses, some of them separate and reverse their morphological constituents; others don't. Examples of separating ones are *'kennenlernen* - *er lernt* kennen,

'*abkürzen* - *er kürzt ab*. There is also '*durchfahren* - *er fährt durch*, which contrasts with its apparent double '*durchfahren* - *er durchfährt*. Like the latter behave '*entladen* - *er entlädt*, '*befragen* - *er befragt*. It would appear, then, that separability and stress placement have something to do with each other, as indeed the writers of the standard handbooks suggest (for example Helbig and Buscha 1979:188, who give forestress as the main criterion for separability). As we shall see, however, things aren't quite as simple as that.

A related phenomenon is the placement of *zu* in infinitive constructions. Sometimes it gets inserted between the two constituents (this is usually the case if they are separable), sometimes it precedes the whole unseparated item. Compare *zu entladen*, *zu argwöhnen*, '*abzukürzen* and '*kennenzulernen*.

If one attempts to capture this fairly obvious (if not trivial) relation between syntactic and metrical behaviour, three possibilities come to mind. One could either derive the syntactic behaviour from the metrical one (this is the way Helbig and Buscha handle the case); one could do it the other way round; or one could derive both behavioral aspects from certain morphological, or lexical, properties of these verbs. The second and third options are more in line with our general picture of the organisation of the grammar: it would be rather odd if, following the first possibility, the phonological (or metrical) component were found to be feeding into the syntax. This makes the second and third options the more promising ones. I shall demonstrate later that a morphological process aids the decision that we have to make in this respect: sometimes, the past participle is formed with the prefix *ge-*, sometimes it isn't. Consider *gefahren*, *abgekürzt*, *kennengelernt* on the one hand and *trompetet*, *entladen*,

*missglückt* on the other. The addition of *ge-* is sensitive to metrical structure. This will give us additional evidence that the lexicon is organised in the way outlined in chapters 1 and 2 above. The assignment of metrical structure intervenes between certain morphological processes, some of which may determine and others may be sensitive to metrical structure.

In table (3.46) below I give a categorisation of verbs that seems appropriate to the present argument, along with the stress behaviour of these verbs and their attitude towards separability, *zu* insertion and *ge-* prefixation.

Let us start with verbs like the one in (3.46a): '*kennenlernen*, also '*sitzenbleiben*, '*blankbohnern*, '*haushalten*, '*Übelnehmen*. Some items in this category turn up as two separate words in German orthography: '*segeln lernen*, '*schön machen*, '*Hof halten*. To be quite clear, this is not what is meant by the criterion of separability. What is meant by this term is reflected in the second column in (3.46): the separation and reversal of the constituents, like *er lernt kennen*, *er lernt segeln*. Orthographic separation or connection in the infinitive has no bearing on the metrical behaviour of these items. It isn't a criterion for anything discussed in this section.

It is quite clear that verbs like '*kennenlernen*, in terms of their morphology, are compounds (Fleischer 1974:308 f.). They have nouns, verbs, or adjectives as first constituents and the semantic relations that hold between the constituents are such that the Strong Boundary Condition (3.10) is met - no trace of lexicalisation or obscuration seems to be present in these items. Having said that, their metrical behaviour doesn't surprise us: in section 3.1 above I stated that the constituents of

a.	'kennen, lernen	er lernt kennen	kennenzulernen	kennengelernt
b.	'durch, fahren	er fährt durch	durchzufahren	durchgefahren
c.	durch'fahren	er durch'fährt	zu durchfahren	durchfahren
d.	ent'nehmen	er ent'nimmt	zu entnehmen	entnommen
e.	ver'suchen	er ver'sucht	zu versuchen	versucht
f.	miss'glücken	es miss'glückt	zu missglücken	missglückt
g.	'missbe'hagen	es 'missbe'hagt	zu missbehagen	missbehagt
h.	'missver, stehen	er 'missver, steht	zu 'missver, stehen	'missver, standen
i.	'arg, wöhnen	er 'arg, wöhnt	zu 'arg, wöhnen	ge'arg, wöhnt

(3.46)

compounds are dominated by individual M nodes. Here are some sample trees:

(3.47)

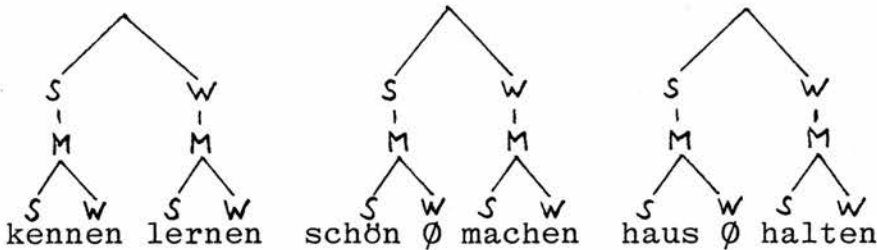

The stress behaviour of these items conforms exactly with what the Compound Stress Rule (3.16) predicts for nouns. It seems that the same rule holds for nouns as well as verbs.

Rather curiously, however, verbal compounds with more than two constituents appear to be systematically absent from the vocabulary of German. For that reason, I am not in a position to test the validity of (3.16) for verbal compounds in full. All I can say is this:

(3.48) CSR for German verbs

In a pair of sister nodes [A B], A is strong.  

$$\begin{matrix} \text{V} \\ \text{V} \end{matrix}$$

Note that, in the absence of verbal compounds with more than two constituents, this statement is equivalent to the one given in (3.16) above, where B was said to be strong if it branches. Whoever first utters a verbal compound with a branching B constituent will have to decide whether (3.48) then remains valid or whether (3.16) holds for verbal compounds as well as nominal ones.

What seems to lend external support to the analysis of

*kennenlernen* with two M nodes is the fact that compound verbs in German get separated and reversed in certain contexts (*er lernt kennen*, *er macht schön* etc.). We shall see below, however, that there are noncompound verbs which have the same characteristic although, in historic and synchronic-semantic terms these items are related to compounds in an interesting way.

Before continuing the discussion of the items on the list (3.46), I must add a further observation (although this potentially leads us rather far afield). When compounds like the ones in (3.47) above get separated and reversed in finite forms, they also reverse their metrical structure. ('Reverse' in a loose sense: I am not actually claiming that metrical structure has to get carried through syntactic transformations; nor am I claiming the opposite. The relations between metrical and syntactic structure in German will require detailed study, which I am not undertaking here.) Thus, we get metrical trees like the ones in (3.49):

(3.49)

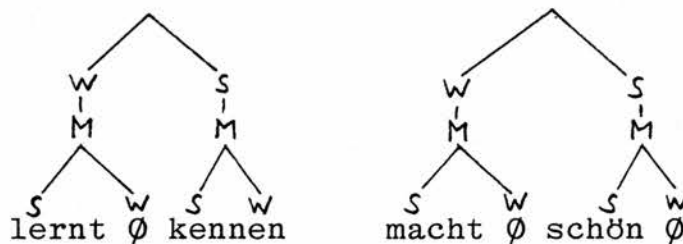

This falls in with what seems to be (one aspect of) the phrasal stress pattern in German: rather like in English, we get phrasal stress on the right-hand constituent in *die dicke Berta*, *Oskar trommelt*, *schnell laufen* etc.

Compare now *er sucht Pilze* (with final stress) and *er will [Pilze suchen]*, where the bracketed constituent has its main stress on *Pilze* - a prominence pattern rather

like that of a compound. Similarly, we get *er lernt schwimmen* and *er muss [schwimmen lernen]*. Now what is a verbal compound and what is a verb phrase? If *kennenlernen* is a compound, isn't *schwimmen lernen* one as well? I offer no hypotheses or solutions here and merely draw the reader's attention to some rather interesting problems. I'll only say this: if we generalise our definition of compound and analyse an object plus verb combination like *Pilze suchen*, *schwimmen lernen* as a compound, which would then have to be produced transformationally in the syntactic derivation of the sentence, then two further observations can be made. One is that the morphological account of compounding, tentatively supported in previous sections, is seriously threatened. The other one is that in that case we actually have verbal compounds with branching B constituents - consider (3.50):

(3.50)

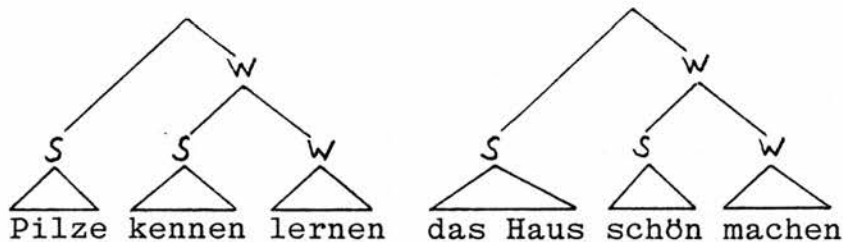

This would mean that (3.48) is valid for verbal compounds of any degree of complexity and not just for the bipartite structures for which it was designed. However, I do have strong reservations against the analysis of the items in (3.50) as A[BC] compounds and believe that at least object plus verb combinations should be excluded from the domain of compounds, if only on the grounds that the object will get an accusative marker whenever the inflexional morphology makes one available. Under that analysis, then, *kennenlernen* would be a compound and *segeln lernen* wouldn't. Instead of pursuing this

question, not a relevant one to the present argument, let us turn to (3.46b).

*Durchfahren* (3.46b) has initial stress like the compound verbs in (3.46a). It is separable like those (*er fährt durch*). These two facts appear to suggest that (3.46b) and (3.46a) are in fact one and the same category and *durchfahren* a compound verb with an adverbial first constituent (Kiparsky 1966). However, there are some good arguments against this analysis and as they have direct bearing on metrical structure I repeat them here. Fleischer (1974:310f., 325f.) argues that in items like '*durchfahren*, '*anfahren*, '*übersetzen*, '*zusammenschlagen* etc., the first constituents should be interpreted as prefixes rather than (directional or other) adverbs. He argues further that the semantic relations holding between the constituents in these combinations are not the same as those holding between adverbs and verbs, like *hindurchfahren*, *hinzufliegen* etc. In our terms, they don't meet the Strong Boundary Condition. Consider, for example, '*anlaufen* (for engines: 'begin to run'). If an item like this has anything to do with compounds it is clearly a (historically or idiomatically) lexicalised one; and the same holds for all such items to a greater or lesser extent. The reader is referred to the details in Fleischer's argument. Suffice it to say here that verbs like *hereinfahren*, *hinzufliegen* are compounds and that words of the type (3.46b) are lexicalised compounds, synchronically analysed as prefixed verbs:

(3.51)

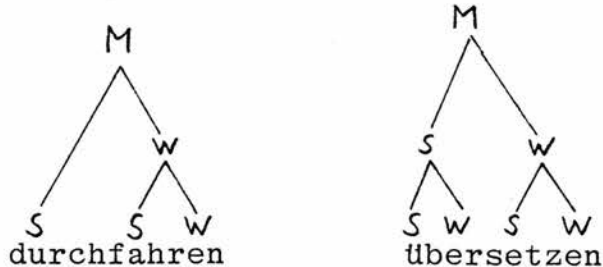



On the other hand, these verbs are separable and get reversed in finite forms in main clauses: *er fährt durch* etc. I shall take up this point below when I analyse (3.46i). It will be shown there that metrical behaviour and this aspect of the syntax are only rather indirectly related.

What confuses the issue slightly is the well-known fact that some of the verbs in this category have counterparts that take the main stress on the stem. I have mentioned *Über'setzen* - *'Übersetzen*, *durch'fahren* - *'durchfahren*; the same happens to *untergraben*, *Überziehen* and others. Without exception, the member of each pair that stresses the stem has the syntactic behaviour indicated in (3.46c): it doesn't separate in finite forms and *zu* precedes the construction: *zu durchfahren*.

It appears, then, that formatives like *durch-*, *über-*, *unter-* etc. figure in two distinct classes of prefixes in German, characterised by different syntactic and metrical behaviour. I shall say more about the classification of verbal prefixes shortly, when a more exhaustive list has been drawn up. Let us at this point just give a metrical tree for *durch'fahren* and its class and then move on to the next item on the list (3.46).

(3.52)

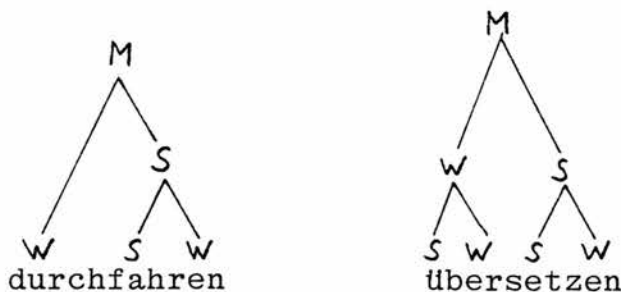

As can be expected, not all German prefixes turn up in

stressed and unstressed variants. There is a large number that never take the main stress, never separate from their heads, and that are preceded by *zu* in infinitive constructions. Two examples are given in (3.46d.e.) above: *ent-* in *entnehmen* (also *entmagnetisieren*, *entnazifizieren*), *ver-* in *versuchen* (also *verkalkulieren*, *versimplifizieren* etc.).

The reader will wonder why I have put *ent-* and *ver-* into two different categories in (3.46) although neither of them takes the main stress and both behave alike syntactically. There is a reason for that but it doesn't show up in the simple examples given in (3.46). Here are some in which it does:

(3.53) a. (= 3.46d)	b. (= 3.46e)
entmagnetisieren	verkalkulieren
disqualifizieren	versimplifizieren
infiltrieren	zerdividieren
rekonstruieren	zerargumentieren (?)
subklassifizieren	zerinterpretieren (?)
entnazifizieren	eranalysieren (?)
reinterpretieren	

The difference between the two classes of prefixes given in (3.53) is this: the ones in (3.53a) bear a secondary stress and the ones in (3.53b) don't. The latter are, in the words cited here, followed by a secondary stress: *verkalkulieren*, for example, has a secondary stress on the second syllable.

Let us recapitulate at this point the principles that govern the metrical structure of German words, discussed in section 2.2.1, especially where the placement of secondary stresses was concerned. In brief, the Main Stress Rule (2.16) puts a terminal S node on the right-most heavy syllable of the word. If there is more than

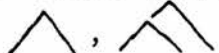
one syllable to the left of that syllable, these will get 'footed', i.e. structures of the form 

get erected. The particular way in which these syllable-dominating trees get connected up in one word tree, as well as the Word Rule (2.27), defining prominence relations in the tree, make sure that the rightmost terminal S is the DTE of the word and any terminal S on its left a subordinate stress. Here are three examples:

(3.54)

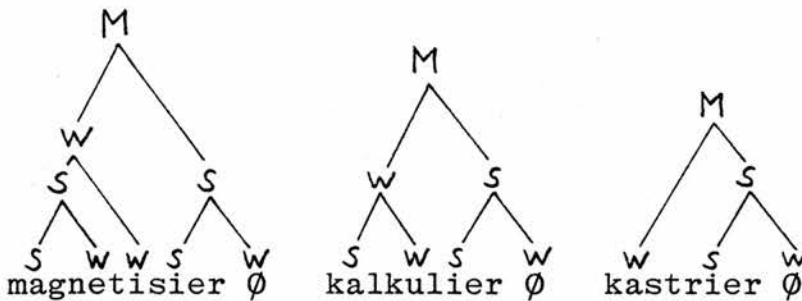

The circled nodes are strong because of the Main Stress Rule. What is of interest for our present discussion is the S node that automatically appears on the initial syllable provided it is more than one syllable away from the DTE.

The difference between the items in (3.53a) and (3.53b) is that the prefixes in the former get included in the process of footing whereas the ones in the latter don't. If we ask where, exactly, this difference in behaviour is sited, in the prefix or in the stem, we see quite clearly that the prefix is responsible. Compare *,reinterpre'tieren* and *zer,interpre'tieren*, for example, where the stress pattern of *interpretieren* is variable.

One might argue, once again, that the difference in behaviour is connected with the specific characteristics of native morphemes on the one hand and nonnative ones on

the other. But once again, this is clearly the wrong track to be on. There appears to be a general tendency by virtue of which nonnative prefixes, like *dis-*, *in-*, *re-* etc., don't combine with native words and conversely native prefixes, *be-*, *ent-*, *er-*, *ver-*, *zer-*, are reluctant to combine with nonnative verbs. *ent-* seems to be an exception in that respect; the formations on the right-hand side (3.53b) are all more or less spontaneous, especially the ones marked '(?)'. Nevertheless, their prominence patterns are predictable.

A slight problem is that if native prefixes are combined with native verbs then the difference in stress behaviour never shows up. Native verbs aren't long enough to have 'footable' syllables on the left of the DTE, as *entnehmen* and *versuchen*. This is a characteristic of native morphemes - recall the discussion of this phenomenon in section 2.2.1 above. Once again, we are in a situation where [native] is probably a feature used in the selectional restrictions that hold between verbs and affixes but not in the metrical phonology of the verbs in question. The two groups of prefixes, as I shall show, don't have to be marked with a nativity feature in order to account for their difference in metrical behaviour (especially as this strategy would have to face the native *ent-* as an exception anyway).

In the sections 2.1.4 and 2.2.4 above I have argued that the stress patterns of complex German words lend support to a hypothesis about the structure of the lexicon first put forward for English by Siegel (1974). There are two classes of suffixes. Class I suffixes get attached before metrical structure gets assigned, Class II suffixes after. The former are sometimes called 'stress-shifting suffixes', the latter are stress-neutral in that they don't affect the stress pattern of

the item they are attached to.

Siegel (1974) also shows that exactly the same can be said about English prefixes. And again, it would seem that the German lexicon falls in with this organising principle. I propose that the prefixes given in (3.53a) are members of Class I and those in (3.53b) members of Class II.

Take, for example, the verb stem *interpretier-*. Metrical structure gets assigned after the verb stem has gone through that component of the lexicon where Class I prefixes get attached, regardless of whether it has actually received a Class I prefix or not. In (3.55a) below it hasn't; in (3.55b) it has:

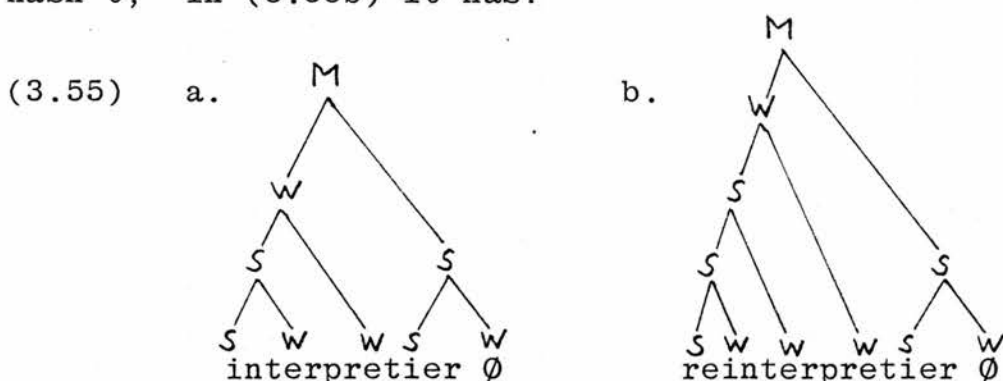

In both cases, the principles of word tree construction result in a structure that places correctly both the primary and the secondary stress.

After Class I prefixation and metrical structure assignment, the item passes through a component of the lexicon that attaches Class II prefixes. The ones we are dealing with at this point (*be-*, *ver-*, *er-* etc.) are weak. Say *interpretier-* is now to receive a Class II prefix. The metrical result will be this:



Thus I would tend to accept, as a spontaneous formation, *ver-entnazifizieren* while the reverse order of the two prefixes wouldn't be possible. But again, this is a morphological question and one that concerns the metrical phonology of German only indirectly. Suffice it to say that Siegel's hypothesis gets support from the stress patterns of German prefixed verbs. Whether it does from the morphology is a different matter.

Now if there are two classes of prefixes, premetrical (Class I) and postmetrical ones (Class II), the question arises how we categorise the ones in (3.46b.c.):

*'durchfahren* vs. *durch'fahren*. Note that Siegel's hypothesis implies that there are two and only two classes of prefixes. Again, I do not intend to enter into a full-scale morphological investigation but restrict myself to a classification of prefixes according to their behaviour in the metrical phonology only. And there, it seems that both stressed and unstressed *durch-* conform with Class II.

Consider stressed *durch-*. Does its attachment alter the metrical structure of the stem it attaches to? The answer is no. In particular, the secondary stress on the first syllable of the stem stays where it is. Thus, we get *'durch,divi,dieren*, *'durch,interpre,tieren* etc. Here are two sample metrical structures:

(3.57)

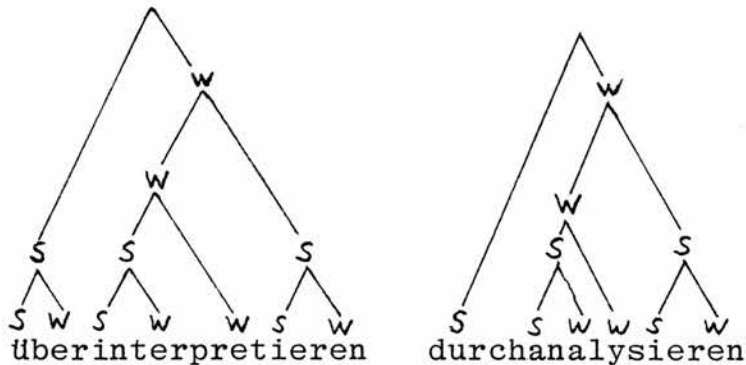

This is, of course, weak evidence. The fact that the main stress of the item does not remain on the penultimate syllable but goes onto the prefix makes a better case for Class II membership of the prefixes: if they got attached before metrical structure assignment, then the main stress would invariably have to fall on the penultimate syllable.

This is what happens in the case of the prefixes *unter-*, *über-*, *durch-*, etc. if they are stressed. But remember the discussion of *ent-* and *ver-*: *ent-* is a member of Class I and *ver-* of Class II (unstressed). *unter-* may belong to either class. Unstressed *unter-* (and the same holds for the other prefixes in that group) doesn't seem to attach to verbs that are sufficiently long (that are nonnative, that is) to show up any significant behaviour in terms of the placement of subordinate stress. Recall that we ran into the same problem in (3.53b) above, where we saw that Class II prefixes are reluctant to attach to nonnative words. Purely on the basis of this selectional constraint I would guess that unstressed *durch-* is an unstressed Class II prefix. Whatever evidence can be found for this will have to be morphological and outwith the scope of this study. Let us conclude this classification by stating, very tentatively, that there are Class I prefixes and Class II prefixes, that the latter class are sub-categorised into a stressed and an unstressed group, and that this subclassification is not governed by phonological criteria: *durch-*, for example, is stressed if it occurs in a lexicalised compound (*'durchfahren*), in other cases it is unstressed (*'durch'fahren*). The one important lesson to be learned here is, it seems to me, that Siegel's hypothesis about the structure of the lexicon finds some support in the metrical behaviour of German verbal prefixes. The last word on this issue (and probably quite a few before it) will have to be spoken by morphologists.



Just how messy this whole area is becomes apparent once again when we turn to (3.46f.g.h.). These three categories on the list demonstrate the behaviour, or misbehaviour, of the prefix *miss-*. By far the most productive category of the three is (3.46f): *miss-*, as in *miss'glücken*, behaves similarly to (3.46c.d.e.) - the prefix doesn't take the main stress. Once again, the question arises whether *miss-* is a Class I or an unstressed Class II prefix. Let us look at (3.46g). There, *miss-* bears a secondary stress which rather suggests that the prefix must have been present when metrical structure was assigned (barring the possibility of a later footing rule, which I am assuming throughout to be absent from this kind of metrical derivation). Here is a metrical structure for *missbehagen*:

(3.58)



Once again, *miss-* is a prefix that doesn't combine freely with nonnative verbs. For that reason we are, again, short of data which might tip the scales in favour of either Class I or Class II. The one nonnative item that *miss-* does combine with is *interpretieren*. In *missinterpretieren*, *miss-* has a secondary stress and, what is more telling, *in-* doesn't. This would imply that *miss-* is attached before footing takes place, which would make it a Class I prefix. Unfortunately, I can only find this one example.

Occasionally - and unpredictably, it seems to me - *miss-* bears the main stress, as it does in *missverstehen* (3.46h). Given that this item is not a compound (*stehen*

and *verstehen* can occur but neither *miss-* nor *missver-* can), the metrical tree for this word would be something like this:

(3.59)

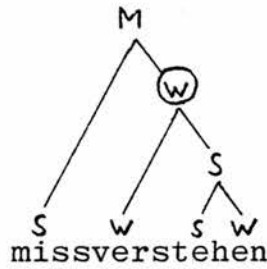

In this context, *miss-* would be interpretable as a stressed Class II prefix: it gets attached after metrical structure assignment has taken place, hence the weak circled node. Looked at in isolation this is no problem. What raises slight suspicions is the alternation between stressed and unstressed *miss-* in (3.46f.g.h.). Note that in similar cases above (*durch-* etc.), both the stressed and the unstressed variant are members of Class II. Here we have variation across classes. Now stressed *miss-* cannot possibly be Class I in this model - in view of the weakness of the evidence on which I assigned unstressed *miss-* to Class I one might wish to re-open that case. But as I said before, further evidence either way would have to be nonmetrical in nature. I leave the case closed, therefore.

There is one category of verbs left on our list: (3.46i). Examples for this category are *'argwöhnén*, *'brandmarkén*, *'fachsimpeln*, *'mutmassén*, *'ohrfeigen*, (more in Helbig and Buscha 1979:193). In synchronic terms, these verbs can't be analysed as complex items containing two constituents. This is why they don't separate in finite forms: *\*er wöhnt arg*, *er feight ohr* etc. are all equally ungrammatical as *wöhnen*, *feigen* aren't German verbs. For the same reason, *zu* precedes them: *zu argwöhnén*

and not *\*argzuwöhnen*.

I suggest that these items be treated in the same way as *niemand*, *Ameise* etc. in section 2.2.5 above. The words in question are exceptional in that they are native but polysyllabic, while at the same time they don't consist of easily isolatable morphological constituents. We can make them conform with our metrical principles if we insert a (rather fictitious) boundary between *arg* and *wöhnen*, thus making *arg-* some kind of (stressed) Class II prefix. The metrical structure would then look like this:

(3.60)

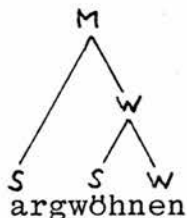

More on this question will be said in section 4.2.1 below.

I would like to return to the syntax and morphology of the verbs in (3.46) for a few paragraphs. We have found that only (3.46a.b.) separate and reverse in finite forms in main clauses; the rest don't. What are the criteria for this distribution of behaviour? Quite clearly, there are two independent criteria. One is the metrical structure of the verbs in question: in order to be separable they have to have forestress. But this criterion doesn't work in (3.46i): *argwöhnen* has forestress but doesn't separate. It doesn't because *\*wöhnen* doesn't exist on its own. Now if we turn back to (3.46a.b.) we see that *kennenlernen* is a compound, by definition consisting of two lexemes, and *durchfahren*

is a prefixed verb whose prefix, as we observed earlier, also happens to function as a preposition in isolation. This holds for all members of category (3.46b).

It would be rather tempting to analyse *durchfahren*, on those grounds, as a compound. This would yield a metrical structure like the one in (3.61a); I give the one that we agreed on earlier in (3.61b):

(3.61) a.

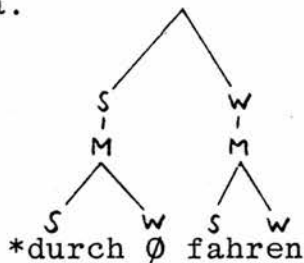

b.

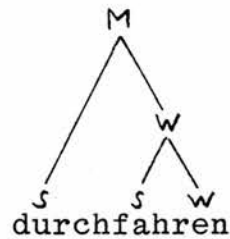

I have argued against (3.61a) above on the grounds that '*durchfahren*' is semantically not a compound and that the placement of two M nodes in this structure would violate the Strong Boundary Condition. I shall come up with some more arguments in the next chapter where it will become clear that a very important generalisation would go amiss if we adopted a compound structure of the type (3.61a) for items like '*durchfahren*'. However, accepting (3.61b) makes us miss a rather attractive generalisation here. Suppose '*durchfahren*' was accepted as a compound. Then we could say that only compounds (double-M structures) separate in finite forms and have *ge-* inserted between the constituents. Instead, we are faced with a hybrid category. '*durchfahren*' has the metrical structure of a prefixed verb (rather like a lexicalised compound, which is in fact what these items are). It has retained, however, the syntactic behaviour of a compound proper as the two constituents still have certain characteristics of independent lexemes. In '*argwöhnchen*', on the other hand, this criterion is not fulfilled (any more) although

the metrical structures of *'argwöhnen* and *'durchfahren* are identical.

Metrical structure, we have seen, interacts rather closely with the derivational morphology of the words we have been looking at. In section 2.2.2 above, it was shown that the same interaction exists between metrical structure and the inflexional morphology. To revive just one example: dative singular *-e* can get attached to masculine and neuter nouns only if it fills a zero syllable. Stating the process in that way gives us a rather elegant description of the context in which this particular ending occurs. And also, more importantly in the present study, it provides independent motivation for the notion of the zero syllable.

I shall conclude this section by giving another instance of inflexional morphology (without actually claiming that inflexional and derivational morphology are totally unrelated processes. I simply take no position at all on this issue.). I'm talking about the distribution of the prefix *ge-* in the past participle. Again, a description of the context in which *ge-* occurs gives additional motivation for the metrical machinery I have been using to account for the material in this section.

For a start, *ge-* attaches to the verb stem that also carries the *-t*, *-et*, *-en* of the past participle ending. This is a trivial statement for morphologically simple verbs: we get *gefahren*, *gebaut*, *gehustet*. But what is more interesting is that, according to this specification, it gets attached to the second element of verbs that separate in finite forms - see (3.46a.b.). We get *kennengelernt* and not *\*gekennenlernt*, *'durchgefahren* and not *\*gedurchfahren*. Clearly, separable verbs separate in these contexts as well although they don't

reverse. They simply get *ge-* inserted between their constituents. *ge-* insertion and separation, then, depend on the same criteria: *ge-* precedes in inseparable items, it gets inserted between the constituents of separable ones.

But that is not all. In a lot of cases, *ge-* is absent altogether. Consider verbs like *gegeben*, *durchgefahren* on the one hand and *entnommen*, *versucht*, *missglückt*, as well as *trompetet*, *akzeptiert* on the other.

*ge-* fails to attach to verbs which have either an unstressed (inseparable) prefix or which begin with a syllable that doesn't bear the main stress. Thus, metrical structures like the ones in (3.62) reject *ge-*:

(3.62) a.

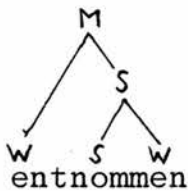

b.

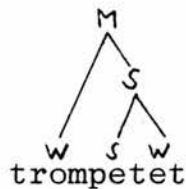

c.

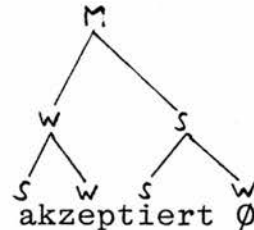

Note that (3.62c) has a secondary stress on the first syllable. In order to qualify for *ge-* attachment, the first has to be the DTE of the word.

A statement of the rule of *ge-* attachment is rather simple. I attempt one in (3.63) below, analysing *ge-* and the inflexional suffix that comes along with *ge-* as two formatives rather than one discontinuous morpheme:

(3.63) ge- attachment

$$\{\emptyset\} \rightarrow \{ge-\} / \text{--- S X } \left\{ \begin{array}{c} \{t\} \\ \{n\} \end{array} \right\}$$

where S = DTE

Let us return briefly to *'missverstehen* in (3.46h). I remarked earlier that the behaviour of *miss-* in this category is exceptional, in a number of ways. It is stressed but fails to separate. It has a Class I counterpart and not, like the other stressed prefixes that have unstressed counterparts, a Class II one. And here is another instance of irregular behaviour: it doesn't take *ge-* although its DTE is on the first syllable. In point of fact, *'missverstehen* does occasionally separate, as in *versteh mich nicht miss* - as a joke, right enough, but its mere occurrence is quite interesting. I have never come across *\*es glückt miss*. The point is that even if speakers misinterpret *missverstehen* morphologically as a separable item they nevertheless never insert *ge-* in the past participle: *missverstanden*. And this, again, is predictable in terms of our model as *ver-* precedes the main stress of the second element and rule (3.63) fails to apply for that reason. The failure of *ge-* attachment to apply, then, is derivable from other features of the behaviour of *missverstehen*. Unlike separation, *ge-* attachment is a process of the inflexional morphology. Unlike separation, it makes reference to metrical structure, exactly like the variety of processes of the inflexional morphology discussed in section 2.2.2 above were found to refer to metrical structure.

3.5.2 Adjectives and nouns

I would like to conclude this chapter with a short analysis of some adjectives and nouns which show symptoms in connection with prefixation and stress rather similar to the verbs discussed in the preceding section. On the other hand, this area is different enough from the former to merit separate discussion.

Where the derivation of adjectives is concerned I'll look at just one prefix: *un-*. The list below gives an impression of the varying behaviour of this prefix: it is stressed in (3.64a) and unstressed in (3.64b):

- |        |    |                         |    |                                |
|--------|----|-------------------------|----|--------------------------------|
| (3.64) | a. | ' <i>unsanft</i>        | b. | <i>un</i> ' <i>glaublich</i>   |
|        |    | ' <i>unbewusst</i>      |    | <i>unver</i> ' <i>gesslich</i> |
|        |    | ' <i>unlogisch</i>      |    | <i>un</i> ' <i>säglich</i>     |
|        |    | ' <i>unklar</i>         |    | <i>un</i> ' <i>heimlich</i>    |
|        |    | ' <i>unbefriedigend</i> |    | <i>unent</i> ' <i>wegt</i>     |
|        |    | ' <i>unmenschlich</i>   |    | <i>un</i> ' <i>menschlich</i>  |

Kiparsky (1966) has pointed out that the items in (3.64a), characterised by initial stress, are negations of the adjectives *un-* is attached to; in each example, the embedded adjective exists independently: *sanft*, *bewusst*, *logisch* etc. A word boundary can therefore be assumed between *un-* and the respective adjective. The question is whether this has any bearing on the metrical analysis of these items, in particular, whether it makes any difference where the number of M nodes is concerned that dominate each of the items in (3.64a). Recall, for comparison, what was said about combinations like '*kennenlernen* and '*durchfahren* in section 3.5.1. While the former has a separate M node on each of its constituents, the latter has one M only, on the basis that combinations like '*durchfahren*, '*anfahren* etc. tend not to meet the Strong Boundary Condition. This is



despite the fact that the constituents are capable of occurring on their own.

Here, we have got a somewhat different case. *sanft* can stand on its own but *un-* is a prefix which never has lexemic status. Can a prefix be M? Unfortunately, our formal criteria for the status of M don't enable us to make a conclusive statement on this question. For the moment, we have to rely on heuristic devices like the question whether it works out metrically if we operate with two M nodes. Below, I shall attempt to break through the obvious circularity of this argument. I give two possible analyses in (3.65):

(3.65) a.

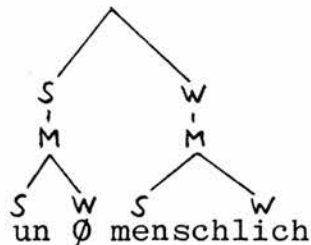

b.

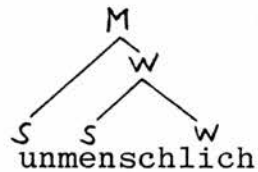

Let us leave this question open for a few paragraphs and turn to the analysis of *un-* in (3.64b). In this column, most of the items that *un-* is attached to don't exist as single adjectives. Thus, *\*glaublich*, *sdglich*, *entwegt* are impossible. *vergesslich* and *heimlich* are possible but *un-* doesn't form their negation: *unheimlich* is semantically independent from *heimlich*. This should be a good enough reason not to analyse (3.64b) as metrical structures containing two M nodes: semantically, the two units are completely amalgamated. The problem that our analysis ran into in (3.65) doesn't arise here.

(3.66) a.

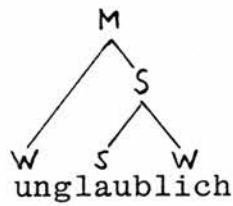

b.

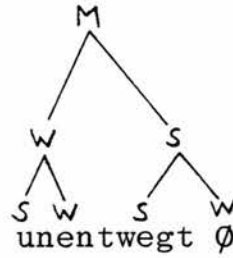

No comment is needed on these structures. *un-* is treated as a prefix, different from the ones in (3.64a) in that only a morpheme boundary, not a word boundary, intervenes between it and the stem. Nevertheless, (3.66) is interesting in that it gives us some information about the class of prefixes that this *un-* belongs to. Notice that it gets footed. It is obviously present before word-level metrical structures get assigned. This is exactly in line with what Siegel (1974) has to say about prefixes: it has all the characteristics of Class I in that it is 'stress-determining' (Siegel's term) and introduced with a morpheme boundary.

The reader will have noticed that *unmenschlich* occurs in both (3.64a) and (3.64b). This is no error on my part; *unmenschlich* constitutes a stress doublet just like *Übersetzen*. '*unmenschlich*' is the negation of *menschlich*, hence an internal word boundary. *un-*'*menschlich*, on the other hand, means 'super-human' and *un-* is a Class I prefix.

We are left with the question whether the items in (3.64a) are the products of (#-level) prefixation or of compounding, in metrical terms (in morphological terms there is of course no doubt at all that *un-* is a prefix). If they are the former then they might be Class II suffixes in Siegel's terms (if her terms apply in the area of German adjectival prefixes, that is): Class II affixes are 'stress-neutral' and, following another

observation of Siegel (1974), they attach to words. All these criteria make them rather strong candidates for this category but we still haven't found any evidence that they are not compounds in terms of their metrical structure. Are there any reasons not to give them two M nodes?

In order to get an answer to this question, let us turn to nouns with similar characteristics. Consider, for example, 'Abfahrt, 'Ausfall, 'Unwetter. These three items (and more can, of course, be found) have primary stress on their prefixes. They also have an internal word boundary as *Fahrt*, *Wetter* etc. exist on their own.

*Um'fahrun*g, *Über'setzung*, on the other hand, would appear to have internal morpheme boundaries only. That these latter ones are not metrical compound structures is quite clear. As to the class of prefixes that *um-*, *über-*, in the words just given, belong to, there are several possibilities of analysis. Either, they could be Class I prefixes, as they are followed by morpheme boundaries and \**Fahrun*g, *Setzun*g aren't possible words (the latter actually is but it seems to me unrelated to *Übersetzung*). The problem with this analysis is that the prefixes are members of Class II, as I argued in the preceding section. The answer, it seems to me, is that *um-* in *Um'fahrun*g isn't a nominal prefix at all but a verbal one. *-un*g is a Class II suffix for verbs, deriving the noun *Umfahrun*g from the verb *umfahr-*. This verb, in turn, is derived from the verb *fahr-* via Class II prefixation. In this step-by-step derivation of *Umfahrun*g from *fahr-*, metrical structure gets added to the basic one whenever an affix is attached; neither of the affixes involved is a member of Class I and therefore present before word level metrical structure is assigned.

Let us return to 'Ausfahrt and 'Unwetter. One or two M nodes? Consider compound constructions of the type [AB] where *Abfahrt*, *Ausfall*, and *Unwetter* constitute the B part: *Ski-Abfahrt*, *Stromausfall*, *Seeunwetter*. Are these items, in metrical terms, [AB] or A[BC] compounds? Two or three M nodes? Without exception, a metrical analysis based on three M nodes produces the wrong stress pattern:

(3.67) a.

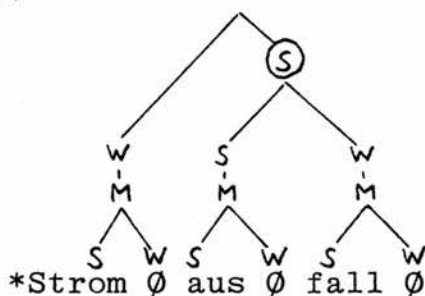

b.

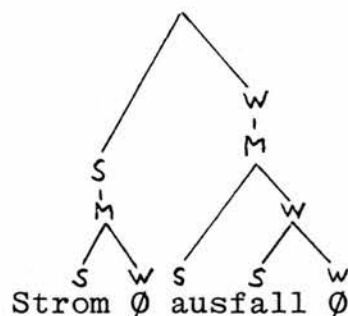

(3.67a) wrongly makes *aus* the DTE, as a result of the Compound Stress Rule: the circled node branches above the level M and for that reason has to be strong. (3.67b) reflects the right stressing, *Strom* is the DTE. The one way of producing this pattern in our analysis is the one chosen here: *ausfall* can only have one M node so that the Compound Stress Rule, working above the level M, makes the left-hand node strong. What is important here is that this stress pattern is systematic in morphological structures of this kind, where a derivation via prefix constitutes the second element of a nominal [AB] compound. Here are some more examples: 'Haarausfall, 'Stromabnehmer, 'Geldanlage, Kapit'alanlage, 'Verbumstellung, 'Schulaufsicht. I am not aware of a single counter-example.

I think we can take this as sufficient evidence that items like 'Ausfall etc. are, in metrical terms, distinct from compounds. They are in fact derivations via Class II

prefix, where the prefixes in question are stressed, rather like their verbal counterparts 'abnehmen etc. How metrical structure interacts with derivations like *Abnahme* from *abnehmen*, I shall not discuss in this study. Probably, *ab-* is, again, a verbal prefix and not a nominal one. But it is quite clear that this question is of no immediate relevance to our metrical analysis.

Going back a few pages, we can now resume the discussion of 'unsanft etc. One or two M nodes? Of the two possibilities, given in (3.65), I now favour the one using one M node only, although unfortunately the kind of model-internal evidence that we found for the parallel case involving nouns seems to be unavailable for adjectives. I don't think that the kind of embedding given in (3.67) for nouns is possible for adjectives. But it is the parallelness of the two cases that leads me to favour this option. The result is a structure of the



form S S W . I shall show in section 4.2 below that all items that have this metrical structure have in common that they undergo the metrical transformation of De-footing, preliminarily given in (3.42) above. We shall see there that the adjectives that we are discussing here ought to have this structure too.

## Chapter 4

Metrical transformations, or:  
on the scope of the metrical component

I think we must look for a mechanism within English phonology that enhances the probability that equal intervals occur, some rule that allows speakers of English to either move a stress around in time so that it occurs at the right place or suppress stresses that come at the wrong time.

(George Allen 1968)

### 4.1 Introduction

In this chapter I shall concern myself with some of the metrical transformations of German and English. In the model of metrical phonology that I am presenting in this study, metrical transformations are rather powerful devices. They change existing structures in order to adapt them to the temporal patterns of speech, timing as well as phrasing. And they add structure to existing metrical trees in such places where no prominence relations are defined among adjacent nodes, again taking account of the temporal organisation of speech.

Let me start off with a few remarks on this temporal patterning. It is commonly assumed in phonetics that rhythmic organisation is a performance universal, a principle of linguistic behaviour that is probably common to speakers across all languages (Catford 1977, Allen 1975). Thus, Pike (1946) has argued that the languages of the

world have either of two basically different types of rhythmic organisation: in syllable-timed languages like French, the event that is perceived as recurring rhythmically in performance is the syllable. In English and German, on the other hand, stressed syllables recur at regular intervals in time, more or less regardless of the number of unstressed syllables that intervene between them. Such languages are called 'stress-timed'; their basic unit of timing is the 'foot' (Abercrombie 1967), stretching from the onset of one stressed syllable to the onset of the next one.

The dichotomy of stress-timing and syllable-timing has been under attack from (at least) two angles. In an early instrumental investigation, Classe (1939) failed to find exactly isochronous stress-timing in English. Nevertheless, he did not dismiss the notion out of hand but initiated a long-standing controversy by postulating an underlying tendency towards isochrony. More recently, Lehiste (1977) has shown that isochrony, while it cannot be interpreted as an objective measure in speech production, is nevertheless valid as a linguistic reality somewhat obliterated by the psychology of time perception. As a perceptual parameter, this concept may qualify for a place in phonological theory (see SPE p.25 on phonological reality). We can thus, following Classe, Lehiste, and also Halliday (1967: 12) speak of 'phonological isochrony', without stronger claims towards acoustic exactness.

The second issue under attack concerns the typological status of the notion of 'stress-timed language'. Are stress-timing and syllable-timing strictly dichotomous notions or do they, rather, represent opposite ends of a linear scale? Roach (1982) has argued that the latter is true and that there are languages, Spanish being one of them, that stand somewhere half way between the two

extremes in that they display a certain degree of rhythmic organisation on both the level of the foot and that of the syllable. But Roach also confirms that English and German are as stress-timed as any language. While the usefulness of stress-timing in linguistic typologies is debatable, this debate doesn't need to concern us in this study since I am careful not to make typological statements.

How does stress-timing relate to the metrical phonology of German and English? From the assumption that feet (in the sense of Abercrombie 1967) are in some way isochronous, it follows that adjacent stressed syllables are separated by pauses: the 'ideal foot' for stress-timed performance contains one or two unstressed syllables, following a stressed one; if a foot contains less material than that, this material gets stretched in order to reach normal duration (Classe 1939; Ladefoged 1975; Jespersen 1962).

This much of stress-timing, it will be recalled, has already found entry into our metrical phonology: through Strength Provision (1.14), each lexical monosyllable has



a metrical structure of the form  $S \begin{array}{c} \wedge \\ W \end{array}$ , where the W node occupies a zero syllable unless an unstressed syllable is available at that point of the string to fill it. Strength Provision, along with the Zero Syllable Constraint (1.18), was introduced not just in order to give some sort of illustration of stress-timing in the phonological representation - this would be a rather pointless exercise - but because these two well-formedness conditions on metrical structure perform important tasks in the phonologies of German and English. They are, for example, instrumental in giving a rather straightforward account of cliticisation. Again, enclitics like *pinta*, *bread'n* (*butter*), etc. aren't just performance phenomena, with no bearing on phonological



structure. What is interesting about them and gives them the status of a phonological regularity is that their mirror images, proclitics, have been shown to be systematically absent in English (Abercrombie 1965; Selkirk 1972).

And there is even more to it. In the preceding chapter, where I dealt with the stress patterns of German compounds of the structure [AB]C, I showed that the difference in stress between *'Einbahnstrasse* and *Ein'mannbetrieb* is due to the fact that in the latter the B constituent is, in metrical terms, bisyllabic: *mannbe* forms a metrical constituent, regardless of morphological structure, which attracts the main stress of that compound while *bahn* in the former forms one that doesn't. This is, at least, one example where the formation of enclitics has a phonological effect outwith the domain of segmental processes (weakening, assimilation etc.). The case in point suggests that encliticisation, in turn connected with stress-timing, plays a rather crucial part in the suprasegmental phonology rather than being a low-level process. In this model, the link between stress-timed performance and one of the principal working areas of metrical phonology, the placement of the main stress in compounds, is established by the notion of the zero syllable.

W S structures (where W, S are nodes immediately dominating syllables) do not occur in this model. The Abercrombian foot as a timing unit has the status of a phonological constituent, relationally defined and represented

as terminal  , , etc. I have given evidence for the validity of the foot as a phonological constituent in the preceding chapter (also Selkirk 1980a,b).

It would follow, then, that in a fully fleshed-out metrical representation the syllables of a given string are entirely organised in

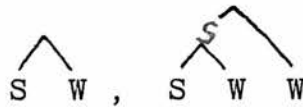

etc. structures.

In the metrical structures we have developed so far, this is not necessarily the case. As I shall demonstrate below, the rule governing phrasal stress in English (NSR) produces structures of the form



(where the right-

hand node is nonterminal) wherever the two weak nodes dominate nonlexical items, as in ... *is a crook*. A metrical transformation will be devised in this chapter that maps a structure like this onto one of the form

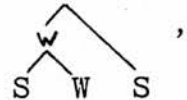



where a foot is formed out of two underlyingly parallel constituents.

Similarly, I have shown in the preceding chapter that in the structure of German words, occasionally trees of the

form  appear, where again the bottom-level nodes immediately dominate syllables. If our assumptions about the phonetic correlates of zero syllables are valid, then a structure like that must be highly undesirable for performance as it contains terminal S nodes not kept apart by a zero syllable and therefore not, as the principle of stress-timing would demand, initial to individual feet. The

transformation that converts this structure into 

 has already had a first airing in section 3.4.3 above. In this chapter, I take up this subject again and argue

that all structures of the form  are subject to

this transformation.

Let us turn to the second one of the functions of metrical transformations that I mentioned initially, that of adding structure to existing trees. I argued in chapter

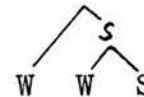
one that in a metrical tree of the form , no prominence relation is defined among the weak nodes. By

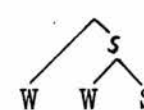
converting this tree into a  structure, we actually add structure to it: prominence relations are defined among all the terminal nodes of the new tree. If this operation takes place on a level of the tree where the bottom nodes of  immediately dominate syll-

ables, the effect is twofold: feet are formed - I mentioned this in the preceding paragraph - and structure is added. If it happens on higher levels of the tree, its effect is also twofold: apart from the enrichment of structure and the rule-governed rhythmic alternation of the beats of feet, multiply embedded structures are automatically broken down into phonological phrases. The resulting structure is 'flattened' in comparison to the underlying one and predicts intonation breaks. In previous models, based on SPE, this task had to be performed by certain Readjustment Rules (Langendoen 1975), which were sited between the syntax and the phonology and belonged to neither: in this model, it is done by metrical transformations which take as input the labelled bracketing of the syntactic surface structure and belong to the phonology.

To be more precise, they are sited in the metrical component of the phonology: they constitute that part of the

phonology where the mapping of the syntax onto the segmental phonology is carried out. The set of metrical transformations takes as its input the labelled bracketing of the syntactic surface structure. In the initial rule of this component, prominence relations are defined among the sister nodes of a binarily branching representation of the syntactic surface. The rule that handles this initial step is the phrasal stress rule (in English the NSR). Through the application of metrical transformations, metrical structure becomes more and more remote from syntactic structure until, finally, a structure results that is adapted to the performance requirements of timing and phrasing, taking into account criteria of speech style (Dressler 1972; Dogil, to appear).

The idea of a separate metrical, or prosodic, component is nothing new. The same has been postulated, for example, by Dressler (1977) and Wurzel (1980) and implied by Selkirk (1980b). But unlike the former two proposals, mine is in line with the lexicalist hypothesis in that it excludes the processes governing word stress (and probably compound stress) from the metrical component. These are sited in the lexicon; the metrical component operates on an input structure in which word-level metrical structures are already completed.

I leave open the question of whether the metrical component and the segmental phonology constitute non-intersecting blocks or whether rules governing segmental phenomena are interspersed with those governing metrical structure. Wurzel (1980) points out that such segmental rules may exist. Those might, however, be best sited in the lexicon so that the integrity of the metrical component might be preserved after all. What I refer to as the metrical component, then, is a set of rules that change metrical structure rather than just making reference to it (as do,

for example, the rules of the external sandhi). This set of rules is distinct from those of the segmental phonology with respect to form and function, and possibly also with respect to their location in the derivation.

#### 4.2 German Defooting

##### 4.2.1 The distribution of S S W structures

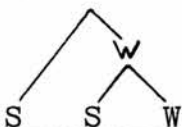

My remarks on the temporal organisation of English and German speech in section 4.1 above suggest that not all the metrical structures produced in the course of a derivation are necessarily equally suited for performance. Particularly ill-suited is a structure whose bottom-level S nodes are not kept apart by W nodes. Recall my proposal in chapter 1 whereby metrical constituents dominated by an M node always branch. As an effect of this provision we get, for example, zero syllables intervening between the monosyllabic constituents of compounds:

(4.1)

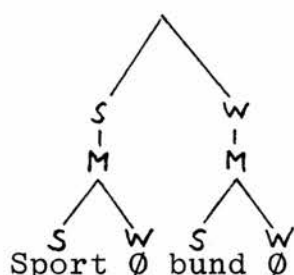

Thanks to this feature of the model employed here, the syllables of any string of speech get to a great extent organised into  $\begin{matrix} \wedge \\ S \quad W \end{matrix}$  structures ('feet'), which, as various writers suggest, represent a favourite unit in

stress-timed performance.

Such a link between metrical structures and performance features like timing is of course only valid if it can be shown that other structures, for example ones containing adjacent S nodes, are noticeably ill-suited for performance. This is in fact the case.

In the metrical phonology of German, structures in which terminal S nodes are not kept apart by zero syllables (or, for that matter, weak nonzero syllables) occasionally crop up. Thus, there were various instances in the preced-

ing two chapters where  $\begin{array}{c} \diagup \quad \diagdown \\ \quad \quad \quad \text{W} \\ \diagdown \quad \diagup \\ \text{S} \quad \text{S} \quad \text{W} \end{array}$  structures were produced. No other structure characterised by adjacent terminal W nodes ever came up; in fact, the principles outlined in chapter 1 of this study make this the only possible structure of this kind. Recall that terminal  $\begin{array}{c} \diagup \quad \diagdown \\ \quad \quad \quad \text{S} \\ \diagdown \quad \diagup \\ \text{W} \quad \text{S} \end{array}$  is ill-

formed and that therefore  $\begin{array}{c} \diagup \quad \diagdown \\ \quad \quad \quad \text{W} \\ \diagdown \quad \diagup \\ \text{W} \quad \text{S} \quad \text{S} \end{array}$ , the only possible

alternative to  $\begin{array}{c} \diagup \quad \diagdown \\ \quad \quad \quad \text{W} \\ \diagdown \quad \diagup \\ \text{S} \quad \text{S} \quad \text{W} \end{array}$  which has adjacent S nodes, won't get produced.

I shall argue in the next section that  $\begin{array}{c} \diagup \quad \diagdown \\ \quad \quad \quad \text{W} \\ \diagdown \quad \diagup \\ \text{S} \quad \text{S} \quad \text{W} \end{array}$  structures - and, what is important, only these - constitute the input for a metrical transformation which produces neatly altern-

ating  $\begin{array}{c} \diagup \quad \diagdown \\ \quad \quad \quad \text{W} \\ \diagdown \quad \diagup \\ \text{S} \quad \text{W} \end{array} \begin{array}{c} \diagup \quad \diagdown \\ \quad \quad \quad \text{W} \\ \diagdown \quad \diagup \\ \text{S} \quad \text{W} \end{array}$  patterns. Furthermore, all instances of that we came across in chapters 2 and 3 above can

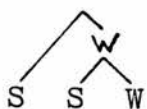

be shown to be subject to this transformation, which, it will be recalled, received a first airing in section 3.4.3

above. But before continuing the discussion of this transformation, let us recapitulate the instances of

 and see what the particular circumstances are under which our metrical phonology of German produces this structure.

Rather superficially speaking, the structure turns up in derivations via certain kinds of affixes, in lexicalised compounds, and in a limited class of native monomorphemic words. Looked at in greater depth, however, all three of these groups turn out to be analysable as derivations via

affix. Here is the list of  structures in detail.

First of all, we found in section 2.3.5 that Class II suffixes for nouns and adjectives may or may not have some stress, subordinated to the main stress of the word. Stress gets assigned by the main stress rule; hence *-heit* is a stressed Class II suffix and *-chen* is an unstressed one, *-haft* is stressed and *-lich* unstressed. The metrical structures are given in (4.2) below - the one we are looking for shows up in (4.2a):

(4.2) Class II suffixes for nouns and adjectives

a. stressed

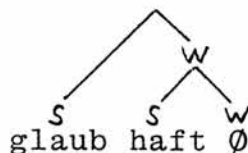

cont 'd

Class II suffixes for nouns and adjectives - cont'd.

## b. unstressed

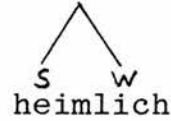

Interestingly, the same structure is produced for a variety of derivations via prefix. Staying with nouns and adjectives for the moment, we recall that in section 3.5.2 we talked about Class II prefixes, which were shown to be always stressed and to contrast, in that way, with Class I prefixes. Here are the respective metrical structures - note that the structure we are interested in shows up in (4.3b):

(4.3) Prefixes for nouns and adjectives

## a: Class I

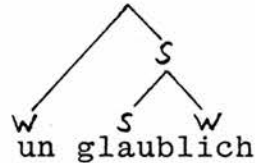
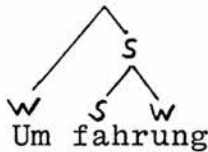

## b. Class II

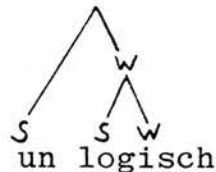
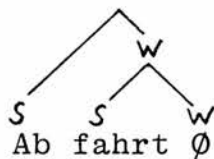

Among adjectives, the same structure will also occur in items like 'abhängig', 'anständig' etc. I didn't discuss these in section 3.5.2 as they are deverbal and denominal



derivations via suffix, respectively. Thus, *abhängig* is derived from *abhängen* and *anständig* from *Anstand*. This raises the question whether there actually are any adjectival prefixes apart from the two types of *un-*, analysed in section 3.5.2. Similarly, *Umfahrung* is a deverbal noun, derived from *um'fahren*. I shall not pursue this question here; for the interaction of various word formation processes, the reader is referred to Faiss (1982). Let us simply state at this point that a fully fleshed-out metrical phonology of German would produce a metrical structure for *abhängig* which is identical with that of *unlogisch*.

Let us turn to verbal prefixes. In section 3.5.1 I argued that, judged by their metrical behaviour, German verbs have Class I prefixes as well as stressed and unstressed Class II prefixes. Examples are given in (4.4):

(4.4) Prefixes for verbs

a. Class I

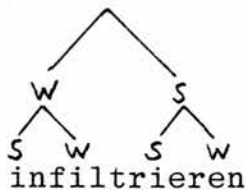

b. Class II (stressed)



c. Class II (unstressed)

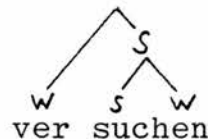

In (4.4b), the particular structure we are looking for

shows up again.

Next. In section 3.4.2 I argued that the metrical structure of motivated compounds is distinct from that of items usually called lexicalised compounds. Allen's Strong Boundary Condition (3.10) in section 3.3) holds between the constituents of the former but not the latter. I proposed there that lexicalised compounds be analysed as Class II suffixations. The second elements of these entities, analysed as Class II suffixes, will always have (subordinate) stress, owing to their segmental composition, which will invariably be that of a heavy syllable. The metrical structure of a lexicalised compound will therefore be identical with (4.2a) above. I give two

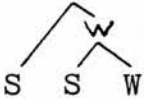
examples in (4.5); once again they have  structures:

(4.5) Lexicalised compounds

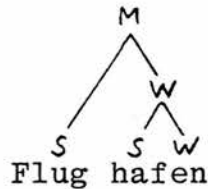
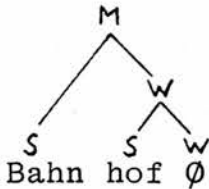

Finally, we have on various occasions come across polysyllabic words which were either native monomorphemic items (recall the list (2.47), given in section 2.3.1 and analysed in 2.3.5) or which resisted a bimorphemic analysis because their constituents, although intuitively distinct, are like the B constituents of lexicalised compounds not recurrent in the language as morphemes.

Instances of the former group may or may not have the

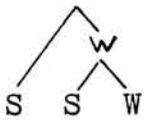

structure we are looking for; the distinguishing

criterion is once again the structure of the second syllable. Examples are given in (4.6):

(4.6) Native monomorphemic polysyllables: nouns

a.

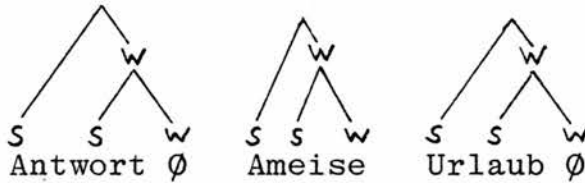

b.

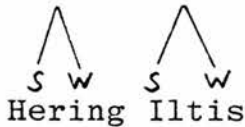

On the basis of this distribution I argued that this class of words, exceptional in that they are native but not underlyingly monosyllabic, be analysed as Class II suffixations. Their metrical behaviour gets handled by existing formalism if we equip them with an (arguably fictitious) internal morphological boundary which makes *-wort*, *-meise* Class II suffixes (or, alternatively, *Ant-*, *A-* stressed Class II prefixes).

In the same way I analysed verbs of the latter group in section 3.5.1. Thus, verbs like *argwöhn*, *mutmassen* etc. receive in our analysis an internal boundary which makes these verbs conform with existing regular ones. In the present framework, they would be Class II prefixations

like *anziehen* etc. (recall (4.4b)). Here is, for the

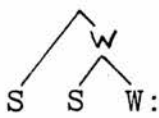
last time, the metrical structure :
 
$$\begin{array}{c} \wedge \\ / \quad \backslash \\ S \quad W \\ / \quad \backslash \\ S \quad W \end{array}$$

(4.7) Native monomorphemic (?) polysyllables: verbs

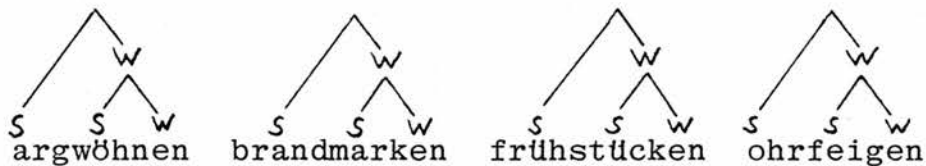

Once more, it might be argued that these items are denominal verbs, derived from *Argwohn*, *Frühstück*, *Ohrfeige* etc. These nouns are lexicalised compounds. In that case the internal boundary would be rather well motivated; the only problem is that there are a few cases which don't seem to conform with this analysis: *fachsimpeln*, *mutmassen*, *liebäugeln* aren't denominal derivations. In any case, while this question is certainly worth pursuing (along with *abhängig*, *anständig* mentioned above) I shall leave it here.

I argued in section 2.3.5 that  structures are produced in the metrical phonology only in special circumstances. According to the Lexical Category Prominence Rule, comprising both the Word Rule (2.27) and the Compound Rule (recall the discussion in section 3.1) a branching node must not be weak. We see now that this apparent violation of a basic rule of metrical structure always involves word formation processes via Class II affix. The rule holds within monomorphemic structures (with the exception of (4.6) above but recall the solution proposed there), in Class I affixations, and in

motivated compounds. This is significant. Recall that, in the model of the lexicon proposed by Siegel (1974) and adopted here, Class I affixation precedes Class II affixation and word-level metrical structure gets erected once, namely between the two affixation processes. This means that metrical structure assignment in simple words and Class I derivations is one unitary process, in which the Word Rule is operational. In the case of Class II derivations, affixes (and their metrical structure, which is partially governed by rule, as is the case with Class II suffixes for nouns, and partially simply listed) get added on to existing metrical structures. In these cases existing structures don't get altered - this is why Siegel calls these affixes 'stress-neutral'. A lexical word tree is dominated by a node M. In this model, the Class II additions to word trees get attached underneath M.

Next, individual trees dominated by M nodes get connected by higher-level metrical structures, governed by the rules of compound and phrasal stress. I take no position here on the question where compound stress gets assigned; in a morphological model of compounding, compound stress would presumably get assigned in the lexicon and phrasal stress in the phonological component. Alternatively, compound and phrasal stress could get assigned in the same operation. I have no evidence that enables me to make a sensible choice between these two alternatives, and it doesn't make any difference to this argument anyway. What is important is that compound stress, wherever the rule is sited, is once again assigned in one process involving all eligible (M-level) constituents simultaneously. Nothing gets added on later, and once again the rule that makes branching right-hand nodes strong holds without exception.

Now it is worth noting that it is exactly those added-on

pieces of metrical structure that display features which are ill-suited for performance. Rhythmic alternation in German is automatically realised within (unamended) word trees and within compounds while Class II amendments to



word trees produce structures of the form  $S \ S \ W$ . The metrical transformation that I shall discuss in the following section affects all and only structures containing

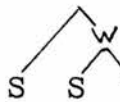

(in certain configurations) and all  $S \ S \ W$  structures involve Class II affixes. This observation, I believe, sheds some light on the way metrical structure is governed by the principles of timing (and phrasing) in performance.



#### 4.2.2 Defooting: form and scope

Recall the Defooting Rule that I gave in section 3.4.3 above:

#### (4.8) (= (3.42)) German Defooting

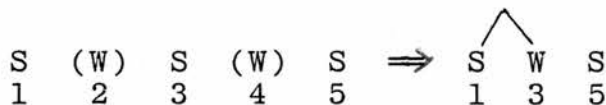

- Conditions:
1. 1-5 are dominated by R
  2. 1 is DTE
  3. 2, 4 =  $\emptyset$
  4. If 2:  $\sim$  4  
If 4:  $\sim$  2

As I indicated before, Defooting crucially involves

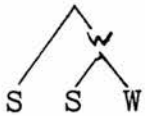

structures. This is borne out by the condition that nodes 2 and 4 are zero syllables and that only one of the two may be present in a structure that is eligible for Defooting.

The motivation of the conditions on Defooting, it may have been noticed, wasn't actually discussed in full when the rule was first introduced. Of the structures discussed as potential candidates for Defooting, only motivated A[BC] compounds with monosyllabic A,B,C were explicitly barred from Defooting (as the structure of *Welt'spartag* in (3.43), for example). On closer inspection, both condition 2 and condition 4 block Defooting in this structure. Does that mean that one of the two conditions is redundant?

Suppose we drop condition 4. In this case, *Welt'spartag* is still barred from Defooting by condition 2 (as node 3 is the DTE) while [AB]C compounds like *'Bauamtsleiter* (3.38a), on the other hand, are eligible. The derivation that I proposed for *Bauamtsleiter* in section 3.4.3 is rather more complex: this compound undergoes the re-adjustment rule (3.35) first, which changes the structure of the [AB] constituent into



eligible for Defooting under condition 4.

Now rule (3.35) is needed anyway in the derivation to adjust structures like *Dreifarbstift* (3.34c) although it could, of course, be constrained in such a way that it only handles *Dreifarbstift* and not *Bauamtsleiter*. We are thus faced with two alternative solutions: one, we can have a rather loose rule (3.35) and a highly constrained Defooting rule so that both *Bauamtsleiter* and *Dreifarbstift* undergo rule (3.35) and then Defooting.

Two, we can have a highly constrained rule (3.35) and drop condition 4 on Defooting. In that case *Dreifarb-stift* undergoes (3.35) and Defooting while *Bauamtsleiter* is handled by Defooting directly but is at the same time barred from rule (3.35). I shall demonstrate in this section that the first alternative, adopted in section 3.4.3, is in fact the correct one: both conditions 2 and 4 on Defooting are needed to capture fully the scope of this process.

Defooting (4.8), then, so far operates on two different structures, given in (4.9a.b.) below. In its present form, (4.8) also predicts Defooting for cases where both constituents 2 and 4 of the structural description are absent, as in (4.9c) below. We shall have to see whether this prediction is correct.

(4.9) a.

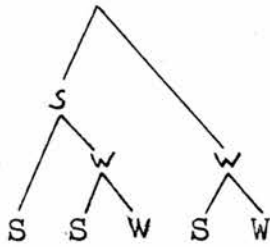

b.

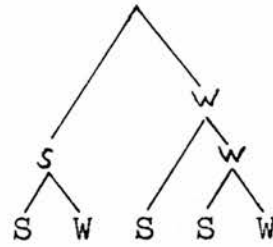

c.

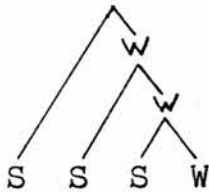

Defooting changes a string containing three stressed syllables into one containing two. In (4.9a), the second one is suppressed (evidenced by the loss of certain segmental characteristics like vowel length etc.; more on that below) while the first stress remains stronger than



the third. In the case of (4.9b), the second stress is suppressed, too, although it is underlyingly stronger than the third. The effect is a kind of *Akzentumsprung*, whereby *'Handschuh*, embedded as in *Fausthandschuh*, becomes *-hand'schuh*. This is in fact what is usually identified as the German Rhythm Rule, or *Rhythmischer Nebenakzent* (Kiparsky 1966; Austin 1976). The same would happen in case (4.9c): the second stress gets suppressed so that the third, underlyingly subordinate to the second, shows up as stronger. But we shall have to see whether structures like (4.9c) actually undergo Defooting or whether the rule has to be changed in order to exclude them.

As for the morphology of the metrical structures in (4.9), we had in section 3.4.3 occasion to look at those involving compounds and lexicalised compounds and found that our Defooting rule works satisfactorily for all of them. Since then, a number of different morphological structures have been identified, all of which have the underlying structure

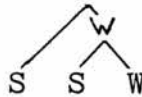

All of these, in turn, can undergo further metrical embedding so that the question arises whether rule (4.8) actually makes correct predictions as to the morphology of the constructions that get defooted. Does (4.8) predict defooting anywhere where it doesn't actually happen; does it happen where (4.8) doesn't predict it? Let us look at the different cases given in section 4.2.1 above and let us try to answer these questions (although it is, of course, impossible to give a conclusive answer to the second one). We shall first concentrate on manifestations of the structures (4.9a.b.) -

on compounds, that is, in which either A or B is 

- and later turn to the type (4.9c).

Consider stressed Class II suffixes for nouns ((4.2a) above). Examples are *Freiheit*, *Neuheit*, etc.; as constituents of compounds they occur in '*Presse,freiheit*', '*Buchneu,heit*', '*Freiheits,kampf*'. Here are the appropriate metrical structures:

(4.10) a.

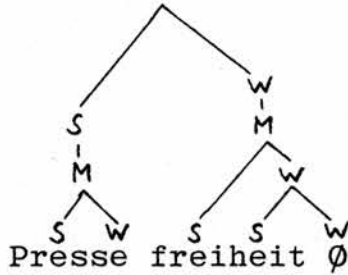

b.

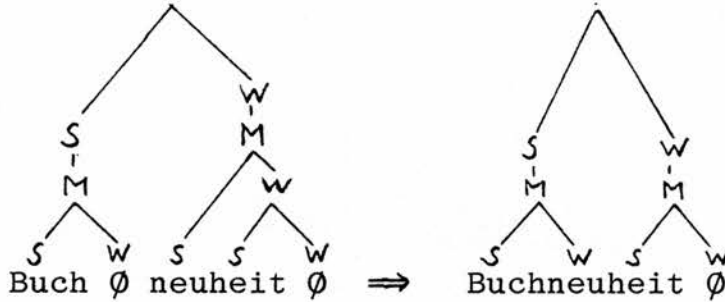

c.

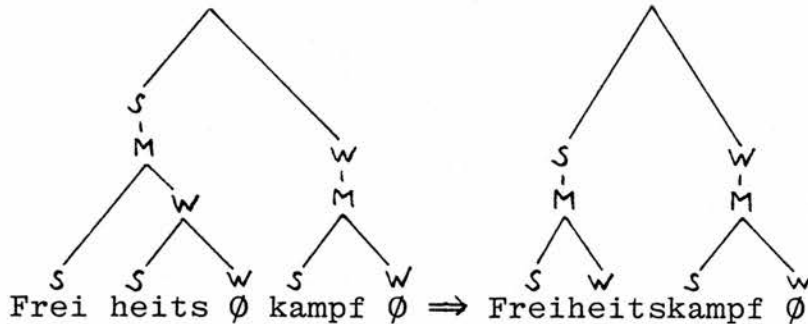

(4.10a) is correctly barred from Defooting by the condition that constituent 2 has to be a zero syllable. In

(4.10b) it is and Defooting happens. And in (4.10c), where the suffix is part of the A constituent, the rule applies too: compare the 'full' pronunciation of *-heit* in *Pressefreiheit* and its reduction in *Freiheitskampf*.

In contrast, compare the behaviour of an unstressed Class II suffix in this context, *-chen* in *Mädchen* for example. Quite clearly, *Hausmädchen* does not in any way get affected by the Defooting rule whereas *Buchneuheit*, of the same morphological structure, does. Rule (4.8), then, not only makes correct predictions about the cases (4.10a.b.c.) - it also provides additional motivation for the analysis of nominal suffixes that I presented in section 2.2.4.

Consider now the behaviour of nouns with stressed Class II prefixes under embedding (see (4.3b) above). As A constituents, they turn up in *Abfahrtslauf*, *Einflugschneise*, *Unfallstelle* etc., as B constituents in *Geldanlage*, *Kapitalanlage*, *Akzentableitung*, *Schulaufsicht*:

(4.11) a.

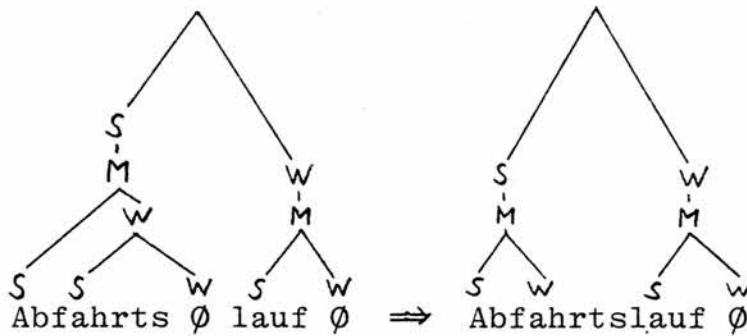

b.

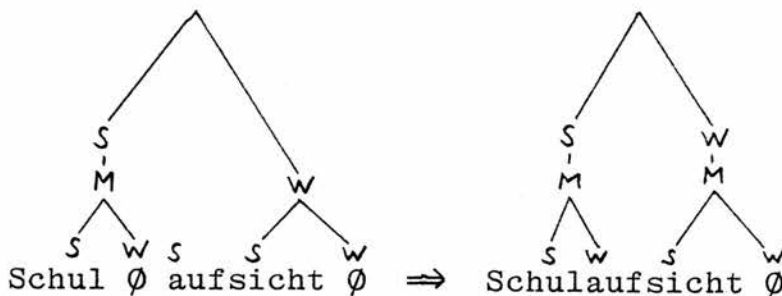

cont'd

(4.11) cont'd

c.

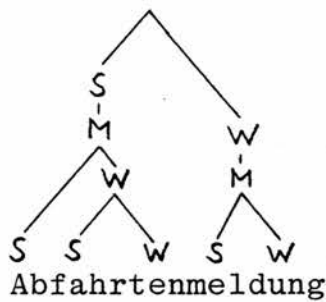

d.

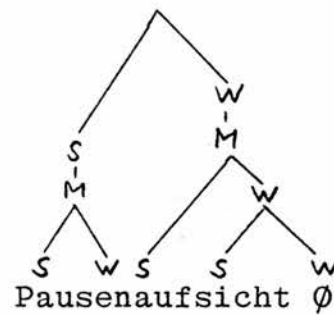

The comparison between (4.11a) and (4.11c) shows quite clearly that (4.11a) gets defooted: *-fahrts* is reduced and *-fahrt* in (4.11c) isn't. It isn't because the W node following it (constituent 4 in terms of rule (4.8)) is not a zero syllable. Similarly, (4.11b) gets defooted and (4.11d) doesn't: again, the internal W node has to be a zero syllable in order to legitimate Defooting.

Notice that the prefix has to be a member of Class II. If it is Class I (as in *Umfahrung*, (4.3c)), Defooting is not called for:

(4.12)

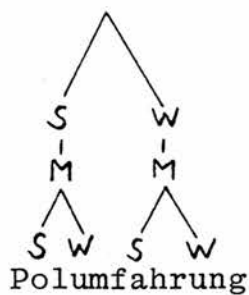

For a justification of this structure, see chapter 1.

Next, let us test the monomorphemic polysyllabic items given in (4.6) above for Defooting. There are, for example, *Skiurlaub*, *Waldameise*, *Rückantwort*, *Hausarbeit*

on the one hand and *Urlaubsreise*, *Arbeitsamt*, *Antwort-schreiben* on the other, represented metrically in (4.13a) and (4.13b) respectively:

(4.13) a.

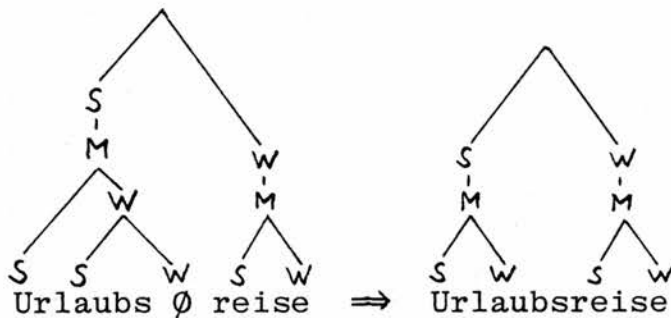

b.

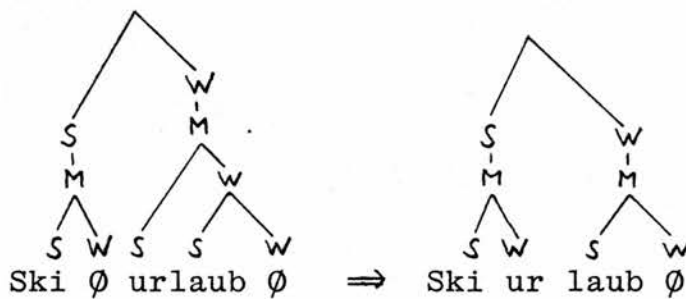

c.

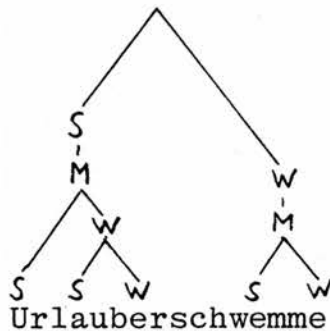

d.

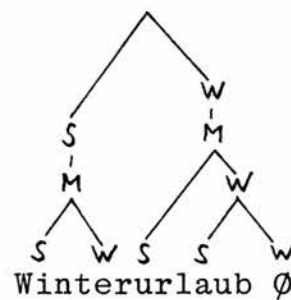

The evidence is exactly the same as in (4.12): *-laubs* in (4.13a) reduces, *ur-* loses its stress in (4.13b). Defooting is correctly blocked in (4.13c.d.) where the internal W nodes aren't, as the rule demands, zero syllables.

Once again, Defooting provides a rather interesting test for the correctness of our analysis of words like *Antwort*. Recall that, on somewhat shaky grounds, I proposed that native underlyingly bisyllabic nouns be analysed either as

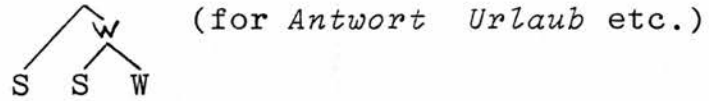

or as  $\begin{array}{c} \diagup \quad \diagdown \\ S \quad W \end{array}$  (for *Hering Iltis* etc.), depending on whether or not the second syllable is heavy. In the first case they are analysed as items with (fictitious) stressed Class II suffixes, in the second case as ones with unstressed Class II suffixes. This analysis now pays off: items like *Hering* and *Iltis* show no sign of defooting (which they would have to if they had the same metrical structure as *Antwort*) under appropriate embedding. Here are two examples:

(4.14) a.

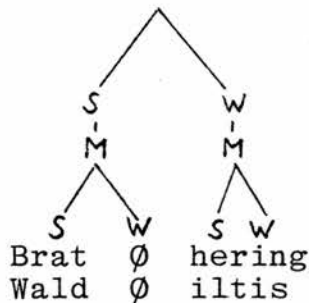

b.

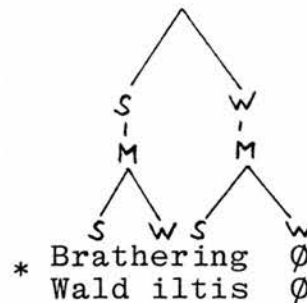

(4.14a) reflects the structure produced for *Brathering*, *Waldiltis* in this model. (4.14b) shows what these items would have to look like if they had undergone Defooting, and this analysis is clearly ill-formed. Once again, Defooting serves rather well as a test for the wellfoundedness of previous analyses in this dissertation.

Let us now turn to  $\begin{array}{c} \diagup \quad \diagdown \\ \quad \quad \quad W \\ S \quad S \quad W \end{array}$  configurations that occur

with stressed Class II prefixes ((4.4) above): *anziehen*, *überziehen*, *abnehmen* etc. It is a peculiarity of German phrasal stress that in constructions like the ones in (4.15) below, the noun is the DTE (Kiparsky 1966; Jacobs, to appear):

- (4.15) a. den Hut abnehmen  
den Rock anziehen
- b. die Jacke anziehen  
den Rock überziehen
- c. das Haus schönmachen  
die Theorie klarmachen  
die Treppe freimachen

The behaviour of these phrases with respect to Defooting is rather interesting: as (4.16) below shows, only (4.15a) can defoot:

(4.16)

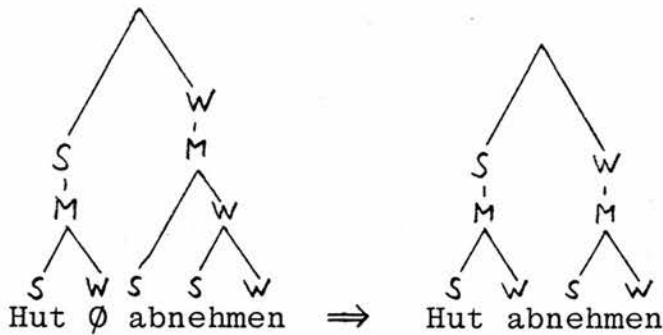

Why, on the other hand, don't (4.15b.c.) get defooted? Here is the structure of the phrases in (4.15b):

(4.17) a.

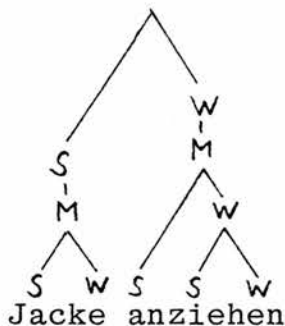

b.

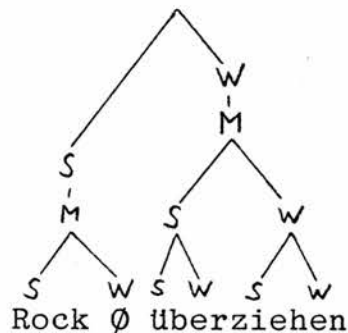

The reason for the blocking of Defooting in (4.17a) is by now well-known to us: the internal terminal W is not a zero syllable. In (4.17b) we have a bisyllabic stressed Class II prefix, which makes the tree violate conditions 3 and 4 of rule (4.8) - it contains a nonzero internal W node and both nodes 2 and 4 (in terms of (4.8)) are present. Once again, our rule copes.

But what about (4.15c)? I argued in section 3.5.1 above that of *abnehmen* and *schönmachen*, although they have a lot of syntactic behaviour in common, the former should be analysed as a verb derived via stressed Class II prefix and the latter as a compound verb. This analysis now gets additional support - consider the structures in (4.18):

(4.18) a.

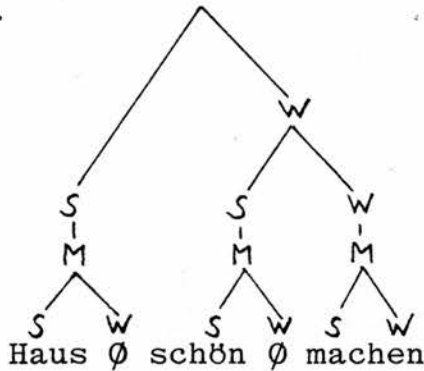

b.

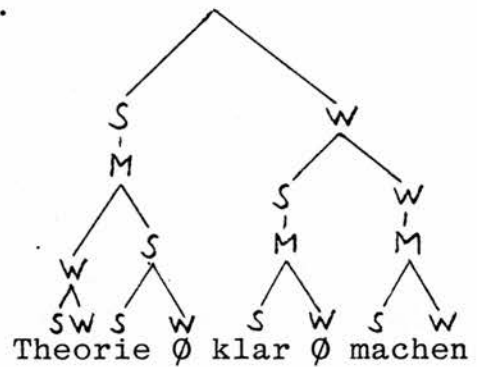

c.

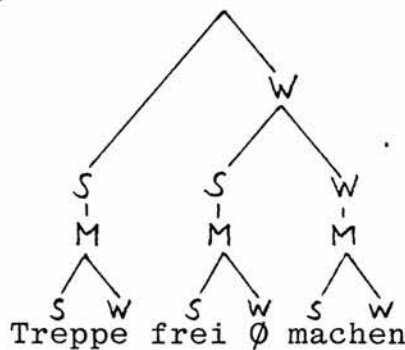

In all three cases, the verbal constituents are analysed as compounds with double-M structures. As a consequence,



all three cases violate condition 4 of the Defooting rule: constituents 2 and 4 are both present. Additionally, (4.18c) violates condition 2 in that it has a non-zero internal W. It turns out, then, that *abnehmen* and *klarmachen* are metrically distinct in that the former is a candidate for Defooting and the latter isn't.

Referring back a few pages in this section, this also shows that condition 4 on Defooting should not, as I suggested earlier, be dropped. Recall that if we drop this condition then words like *Bauamtsleiter* can undergo Defooting directly, without prior application of rule (3.35). The trouble is that if we do this, then there is no way of barring cases like the ones in (4.18) from Defooting. I suggest, therefore, that we leave rule (3.35) and the Defooting rule as they are and, especially, that we don't alter the conditions on Defooting.

Staying with verbal constructions for the moment, let us look briefly at *frühstücken*, *ohrfeigen* etc. in (4.7) above. Defooting is here correctly predicted as well, although transitive constructions involving these verbs are somewhat hard to find. But compare (4.19a) and (4.19b):

(4.19) a.

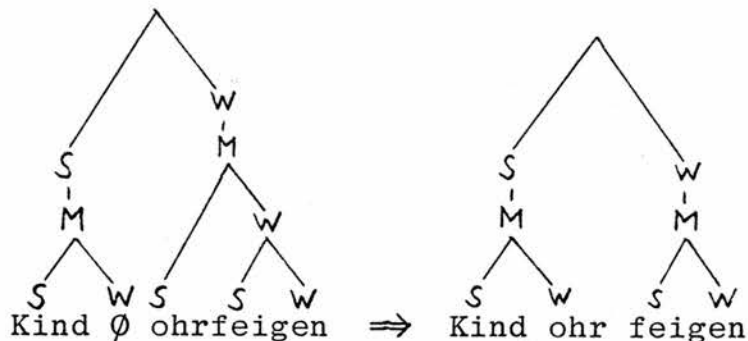

cont'd

(4.19) cont'd

b.

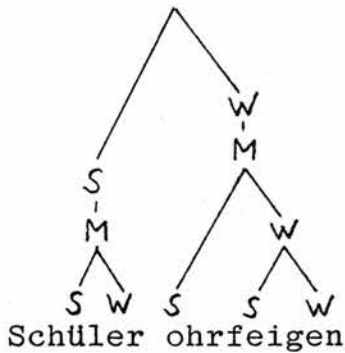

Again, (4.19a) defoots and (4.19b), as it has an internal nonzero W, doesn't.

So far, then, our Defooting rule makes precisely the right predictions. Let us see, finally, whether there are any structures in which, in terms of rule (4.8), both constituents 2 and 4 are absent - recall that this is possible in terms of the conditions - and if there are, whether they do in fact defoot.

There are actually two possibilities for this kind of structure to arise. It is possible to have adjectives with two stressed Class II prefixes (like *unabhängig*, *unanständig* as well as adjectives with a stressed Class II prefix and a stressed Class II suffix (*unstatthaft*, *unbeugsam*, *unsichtbar*). Metrical analyses are given in (4.20a) and (4.20b) respectively:

(4.20) a.

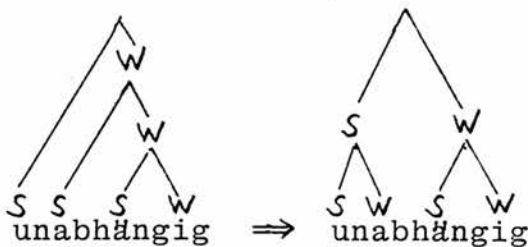

cont'd

(4.20) cont'd

b.

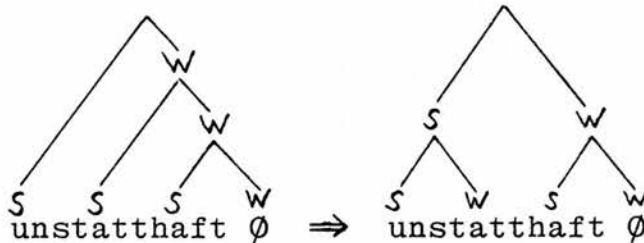

Once again, both morphological varieties of this structure get defooted. I am not aware of any other metrical structures of this kind, where both W nodes are absent, and can't therefore provide further tests. Note, for completeness' sake, that adjectives with Class I prefixes (unstressed *un-*) don't get defooted. Thus, *unheilbar* has a metrical structure that is incompatible with rule (4.8) and is correctly barred from Defooting. This case will be taken up again in section 4.4 below.



We have now exhausted the  $S \ S \ W$  structures that have come up in the course of this study. They all get defooted if appropriately embedded. Moreover, I am not aware of any instances of Defooting in German which don't have the structure that rule (4.8) demands for this process to happen.

It is the function of this rule, then, to facilitate performance in structures which contain adjacent S nodes. These structures get transformed into ones that have

rhythmically alternating  $S \ W \ S \ W$  units. The question arises where in the grammar this rule is sited. Is it in

the lexicon, or is it located at a later point of the derivation? The verbal constructions in (4.16) and (4.19) clearly suggest that this rule does not solely apply within the lexicon: it also has applications after the syntactic component has operated. In fact, I have no evidence that the rule should operate in the lexicon at all: in principle, all the applications discussed above could take place within the phonological component. If evidence for lexical application of rule (4.8) can get produced then we have to conclude that the rule applies twice, in the phonology and in the lexicon; in the absence of this evidence, we can state that Defooting is not a lexical rule but part of the phonology.

I shall argue below that there are more rules like this one and investigate in greater detail the ones that operate in English. I shall argue that all these rules are in fact part of a metrical component, which follows the syntax and precedes the segmental phonology, and that the lexical metrical structures that I have been proposing - above all the notion of the zero syllable - play an important part in motivating late metrical derivations.

#### 4.3 Iambic Reversal in English and the metrical grid

It is an almost commonplace assumption in the phonological literature on English - and, incidentally, German: Kiparsky 1966 - that what is traditionally called 'sentence stress' is essentially a further contouring of the primary stresses assigned to lexical items in isolation and that, conversely, a sentence stress contour is defined on no syllables other than the ones that bear word stress. This assumption has in the SPE tradition given rise to the transformational cycle in phonology, a principle of

rule application that, in the case of stress rules, preserves prominence patterns under embedding.

But there is one process, also frequently observed and discussed, that runs counter to this assumption concerning the constituency of sentence stress contours. The example usually cited in connection with this process is that of *thirteen*, whose stress shifts from the final syllable onto the first one if the word occurs in an attributive position: ,*thirteen* 'men. A wide range of similar data is given in Jones (1964).

A number of attempts were made in the cyclic model to cope with this stress shift (for example Wollmann 1971, Bresnan 1972, Kiparsky 1975). The problem is that any stress shift is hard to reconcile with the cyclic principle; the attempts that have been made handle the phenomenon, explicitly (Bresnan 1972) or implicitly, as some kind of exception to a more general principle and tend to play down its importance and/or frequency of occurrence. The fact that it is a very frequent phenomenon, which is just as predictable as those stress contours that the cycle does cope with, rather calls into question the entire principle of the cycle. As Schmerling (1976:15) puts it,

... a grammar containing the Nuclear Stress Rule and a variety of ad hoc remedies certainly violates the spirit, if not the letter, of the SPE approach.

In a metrical phonology, stress shifts can be given the status they deserve. Metrical trees get erected simultaneously in the whole domain and no cycle is necessary to account for sentence stress contours. Stress shift rules can apply at whatever point in a metrical tree their conditions are met.

Let us look at the *thirteen men* rule and its conditions. LP (p.319) give the following formal statement:

(4.21) LP's Iambic Reversal

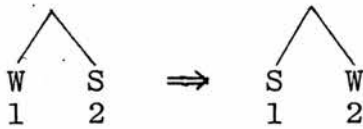

- Conditions:
1. Constituent 2 does not contain the DTE of an intonational phrase
  2. Constituent 1 is not an un-stressed syllable

Given the vagueness of the notion 'intonational phrase', LP propose an additional condition on Iambic Reversal in terms of a specific configuration ('clash') in a specially invented formal structure, derived from metrical tree structure: the 'metrical grid'.

I shall briefly outline the characteristics of the metrical grid and how it triggers Iambic Reversal in LP's model. Subsequently, I shall argue that the grid is not only not needed to describe accurately the context in which Iambic Reversal occurs, but that the grid in itself is an excessively powerful device which, if constrained adequately, becomes rather useless.

In LP (p.313) and in subsequent work on metrical phonology in which the device is used (Dogil 1979, Thompson 1980 and notably Prince 1983), a metrical grid is defined as

... an ordered set of levels  $L_1$  through  $L_n$ , each level being itself an ordered set of elements  $E_1$  through  $E_m$ ; and a function  $F$  that maps each ...



(where 'metrical strength' is a property expressed in the grid only) than its sister - hence grid elements 4,5 in (4.23). In general terms, a strong constituent of a metrical tree is represented on a higher level of the grid than (any of the subconstituents of) its weak sister - hence elements 4,5,6 in (4.23a). Any proportional increase of metrical strength is possible under RPPR, so that the grid in (4.23b) is equally well-formed. As we shall see, this is a necessary provision in LP's model while at the same time it gives the grid uncontrollable power.

Defined, and aligned with metrical trees, in this fashion the grid performs the following task in LP's account: certain configurations of grid elements are defined as 'clashing', such as the starred elements in (4.23a) above - they are adjacent and their counterparts one level down are adjacent. The occurrence of a grid clash provides the sufficient condition for Iambic Reversal, for whose expression the metrical grid was invented in the first place. Notice that the application of Iambic Reversal in (4.23a) resolves the grid clash. A property of one structure (the grid) thus triggers a change in another structure (the metrical tree).

In its present formulation, RPPR allows for additional metrical strength in free variation, that is, in cases where it is not predicted by the tree structure. Examples are the starred elements in (4.24) below where metrical trees are again given in LP's notation:

(4.24) a.

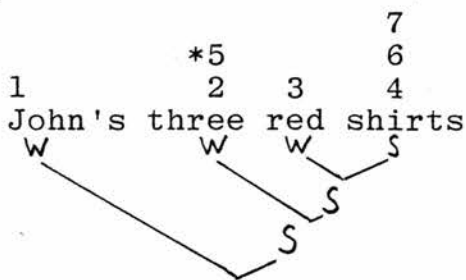

b.

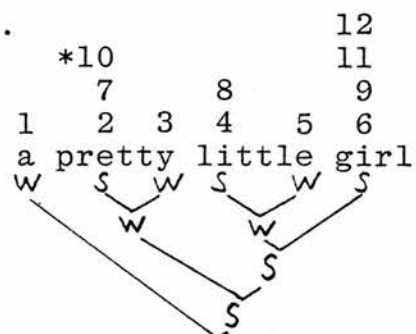



LP in fact welcome this freedom as it expresses the rhythmic alternation perceived in these phrases. I return to this in a later section and argue that it is, instead, to be expressed in the metrical tree.

Working with an RPPR of the form (4.22b) above, LP are forced to make an adjustment to their mechanism of grid alignment that has rather far-reaching consequences. In order to maintain the grid's function of indicating pressure for Iambic Reversal, they are compelled to give, by convention, extra metrical strength to lexical monosyllables in phrases like (4.25) - again, their notation:

(4.25)

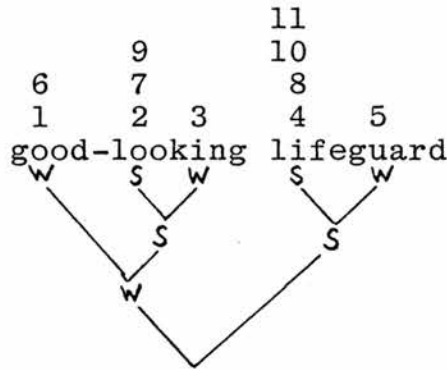

After adding grid element 6 through this convention, RPPR provides 9 and 11, thereby creating a grid clash which motivates Iambic Reversal of the circled nodes. Without the extra metrical strength for the lexical monosyllable *good*, there would be no grid clash and the application of the Reversal rule couldn't be motivated via the grid (LP, pp. 322 ff.). What LP don't say is that *guard* in (4.25) and *red* in (4.24) are lexical monosyllables, too. Grid representation would have to be pushed up by yet another level if one wanted to implement fully this convention in the structures under discussion.

This is not to say, of course, that a convention which gives more strength to lexical items than it does to nonlexical

ones has no empirical motivation - recall the discussion of this issue in chapter 1. And consider (4.26):

(4.26)

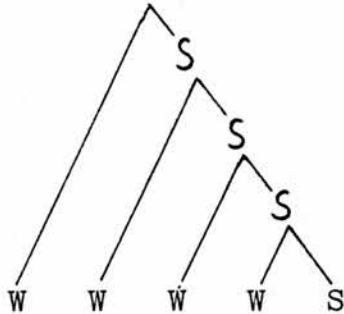

If we obey nothing but RPPR, there is an infinite number of possible grids for this structure, including those in (4.27):

(4.27) a.

				6
1	2	3	4	5

b.

				8
6				7
1	2	3	4	5

c.

				8
				7
1	2	3	4	5

d.

				8
		6		7
1	2	3	4	5

e.

				9
6		7		8
1	2	3	4	5

f.

				11	
9				10	
6		7		8	
1	2	3	4	5	etc.

The structure (4.26), in turn, will in an LP-type analysis correspond to a large amount of linguistic material including sentences like *he works on a book*, *John is a nice guy*, *Fred bought two black cats* etc. The grids in (4.27) provide feasible strength contours for these sentences only in the presence of the convention that gives extra metrical strength to monosyllables; without this amendment, RPPR

produces an excessive number of (rather undesirable) grids.

Useful as it may be, LP's ad hoc repair to the metrical grid has unacceptable consequences. It implies that the grid needs access to morphosyntactic information not borne out in the metrical tree, namely word boundaries. This in turn would imply that the metrical tree is incapable of expressing adequately the prominence relations that hold among the syllables of a given string.

We have already got the solution to this problem. Recall that our Strength Provision, proposed in chapter 1 and used ever since in this study, does exactly what LP recognise as a necessity, both in empirical terms and as a feature of the model: it gives extra strength to lexical monosyllables. The difference is that Strength Provision enriches the metrical tree rather than the grid. And the result of this enrichment is that there is nothing in the grid that isn't also expressed in the tree. No additional strength has to be given by convention and, as we shall see, no free variation has to be allowed for it either.

Here is a new version of RPPR, based on Strength Provision, which rules out any possibility of extra metrical strength for individual elements, whether by convention or by free variation:

(4.28) Relative Prominence Projection Rule (new version):

In any constituent in which the strong-weak relation is defined, the DTE of the strong subconstituent is metrically stronger by one degree than the DTE of the weak subconstituent.

To demonstrate how the new tree structure and the new RPPR work in comparison with LP's model, let us re-analyse the sentences that I gave above as possible candidates for

the structure (4.26) under LP's analysis:

(4.29) a.

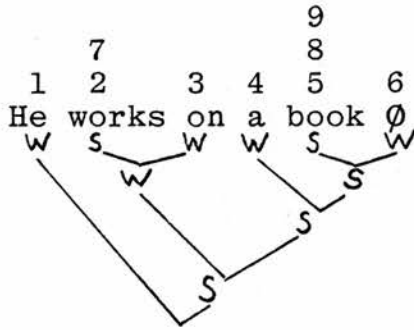

b.

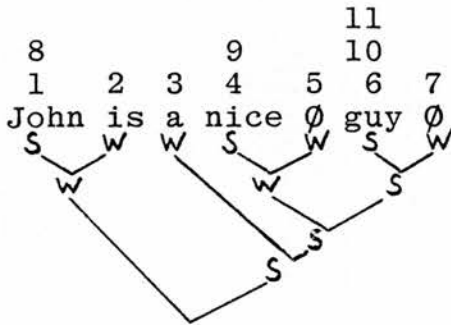

c.

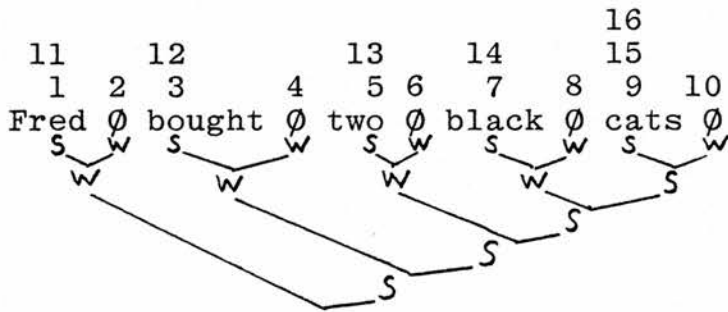

Instead of the one structure in (4.26), we now get three different ones, with three different grids. The grids show correctly the strength contours of the three sentences and no additional strength has to be allocated by convention.

But let us see how this model and its grids, without the 'extra strength' convention, copes with Iambic Reversal. *Thirteen men and good-looking lifeguard* are re-analysed in (4.30):

(4.30) a.

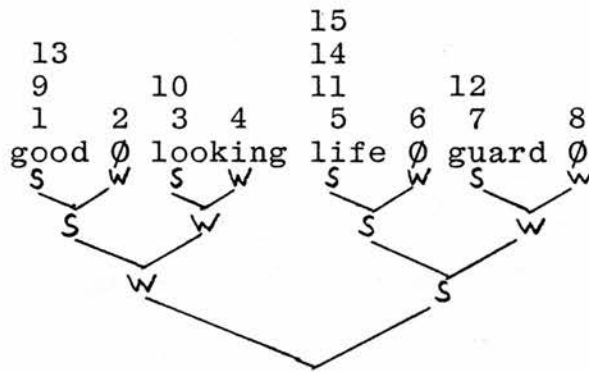
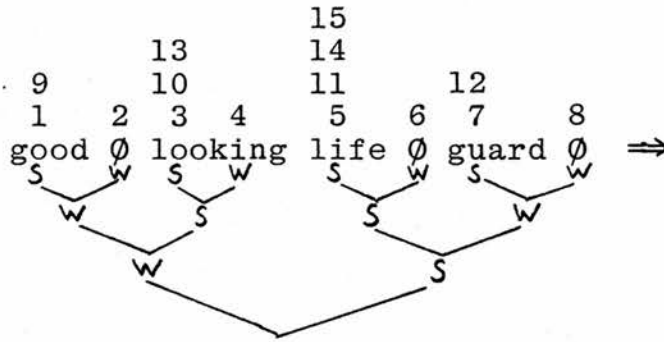

b.

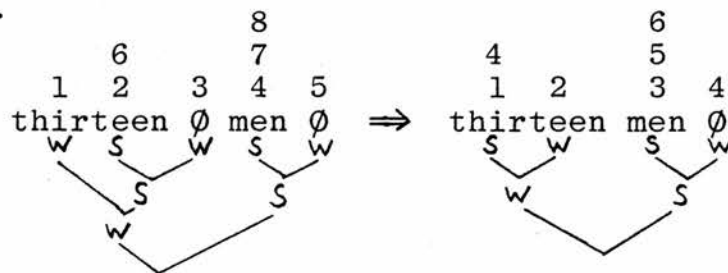

While (4.30a) still contains the grid clash that LP's

model requires to trigger Iambic Reversal, a zero syllable (represented on grid level one) keeps the clashing elements in (4.30b) apart. This means that under our new analysis - Strength Provision in the tree and no extra strength for any grid element - the grid loses its potential as a trigger for Iambic Reversal. The situation is rather tempting: if we can find a new sufficient condition for Reversal in the tree itself we can discard the grid as a formal device in our metrical mode. This would be an interesting and unexpected effect of the metrical structures that I have been advocating in this study.

In order to make a new generalisation about the structures in which Iambic Reversal applies, let us look at a couple more examples:

(4.31) a.

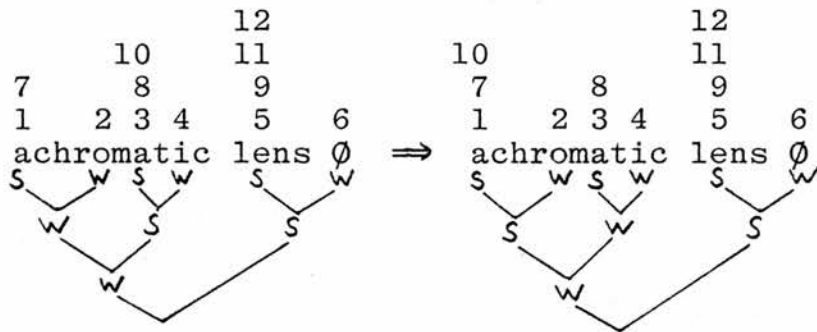

b.

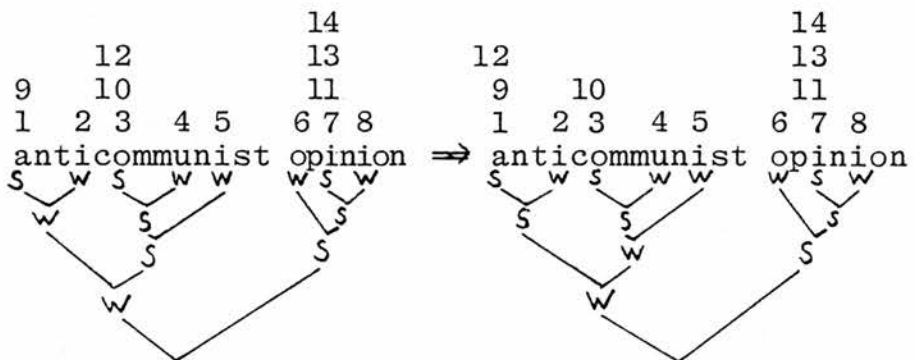

What all instances of Iambic Reversal have in common, (4.30a) to (4.31b), is the configuration

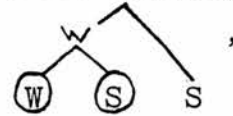

where the circled nodes get reversed (Kiparsky 1979).

This, I would stipulate, is the sufficient condition we have been looking for. There is no need to invoke features of the metrical grid in its place. In our model the grid clash, LP's sufficient condition, is systematically absent when the shifted S is word-final (as in (4.30b) above, also in *Princess Anne*, *Skegness Pier* etc.), arguably those cases where Iambic Reversal is most likely to occur.

In LP's terms, Iambic Reversal is the less likely to occur the more widely a grid clash is spaced out by intervening unstressed material: *thirteen men* is more likely to reverse than *anticommunist opinion*. Or, in other words, the latter requires greater speech tempo for Iambic Reversal to happen. But again, for a statement like this no reference to the grid is necessary as the distance between the shifted syllable and the head from which it shifts away is expressed in the tree with equal precision.

I propose the following statement of Iambic Reversal:

(4.32) Iambic Reversal

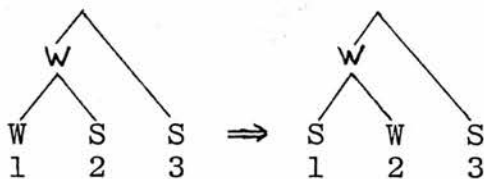

- Conditions:
- a. 2 is not the head of a syntactic phrase.
  - b. 1 is not an unstressed syllable.

Unlike in previous treatments (LP, Giegerich 1980, Selkirk 1980a, Thompson 1980, Gussenhoven ms.), condition (4.32a) makes reference to syntactic rather than intonational or any other phonological phrasing. All the writers just cited more or less tacitly assume that phonological phrasing has to be invoked at this point, without actually giving evidence that the DTE, or 'nucleus', of an intonational phrase is not automatically produced by metrical structure defined on syntactic phrases. In the absence of this evidence I assume that what I called above the 'head of a syntactic phrase', the DTE in the metrical tree of a syntactic phrase, is automatically the nucleus. I actually doubt whether the 'phonological phrase' and the 'intonational phrase' ought to have the formal status of 'prosodic categories' in a metrical phonology, as Selkirk (1980a) claims. Selkirk's observation that Iambic Reversal fails to apply in strings like *the theorem*

that  $\begin{array}{c} \wedge \\ w \quad s \end{array}$  *Marcel proved* doesn't in fact prove anything: *Marcel* is simply the head of a noun phrase and as such, under condition (4.32a), not eligible for Iambic Reversal. I shall have an opportunity to say more on this issue in section 4.5.2 below.

Let us turn to condition (4.32b). In a metrical phonology of English word stress as advocated by LP and Kiparsky (1979), a binary segmental stress feature is assigned to vowels and metrical trees are constrained

in such a way that the configuration  $\begin{array}{c} S \\ | \\ [- \text{stress}] \end{array}$  is ill-formed. Condition (4.32b) blocks the occurrence of this configuration as a result of Iambic Reversal in the following cases:



(4.33) a.

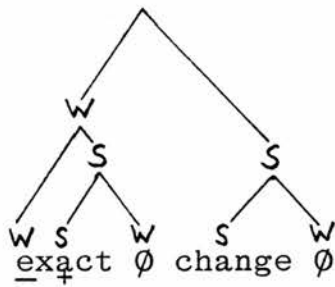

b.

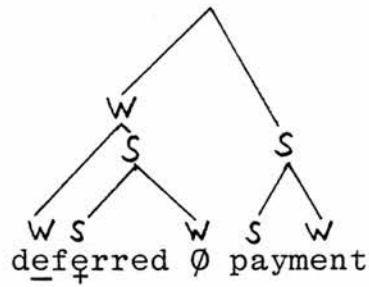

In items like *thirteen*, *Princess*, *Skegness* etc. both syllables are [+ stress]. Note that condition (4.32b) doesn't strictly speaking need to be stated: the constraint that rules out terminal S nodes filled by unstressed syllables has the status of a general well-formedness condition on metrical trees.

The reader will have noticed that I haven't given a full derivation of *thirteen men* under the new model. This derivation requires further comments.

(3.34) a.

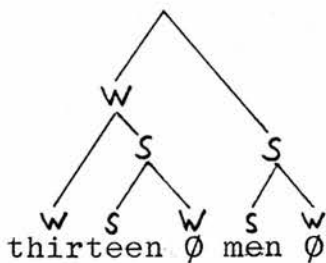

b.

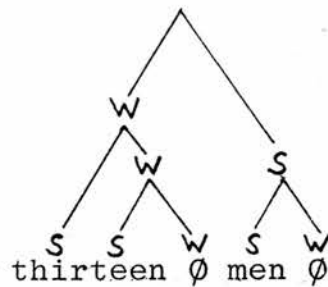

c.

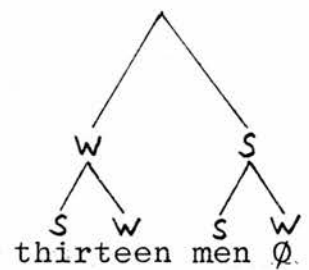

Notice that Iambic Reversal, carried out on (3.34a), pro-

duces a structure as in (3.34b), containing  $S \ S \ W$ . This structure, familiar from previous sections of this study, contains two terminal S nodes while the phonetic facts suggest that there should only be one. Clearly, what we would want to produce is the structure in (4.34c). We

need an additional mechanism that removes the

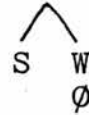

structure on *-teen*.

This process is actually extremely widespread in the prosodic structure of English and clearly not restricted to cases where Iambic Reversal produces undesirable results. I shall demonstrate below that it can be formalised as a Defooting rule which, sensitive to zero syllables, has the effect of producing rhythmic alternation similar to the German Defooting rule that I discussed in section 4.2. At this point, we only need it as a mechanism that handles (4.34b). Here is a preliminary version of Defooting, sufficient for our present purposes:

(4.35) English Defooting (preliminary)

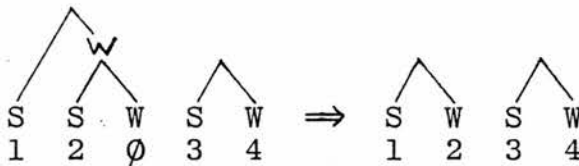

Condition: 1-4 do not branch.

Notice the striking similarity between this rule and its German counterpart. We shall later revise English Defooting so that it produces rhythmic alternation in cases like (4.29c) above. For the moment, the version given in (4.35) will be sufficient. What is interesting is that

once again the structure  $S \quad S \quad W$  is shunned in certain contexts. It turns out that in a case like *thirteen men*, Iambic Reversal produces an



structure which

subsequently gets removed by Defooting. Interestingly,

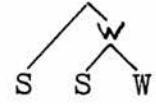

Reversal is blocked where it would produce an structure that is not subject to Defooting. Consider phrases like *sensational claim* and *Montana Bank*. LP, it will be remembered, block Iambic Reversal in these cases by the absence of a grid clash. We can't resort to this device since we are trying to do without the metrical grid altogether.

(4.36) a.

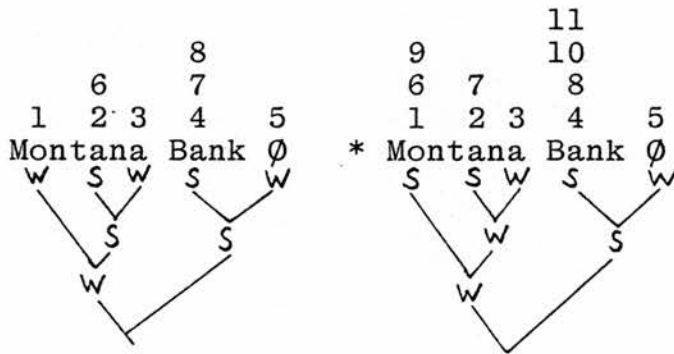

b.

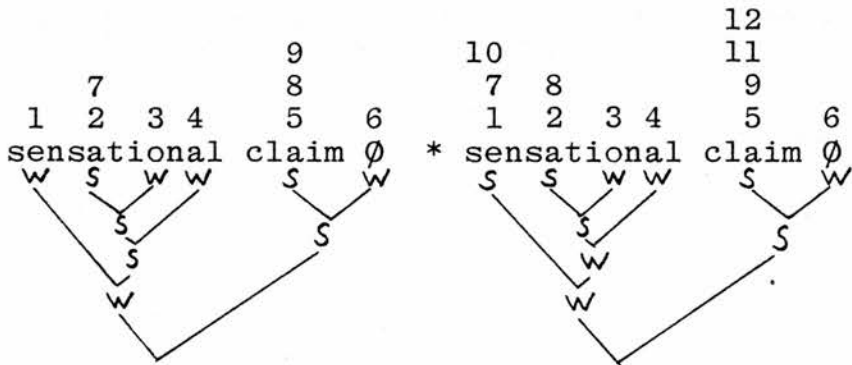

Kiparsky (1979: 425) observes that Iambic Reversal "... usually does not apply when it would create a word-internal

structure of the form  $S \begin{matrix} / \\ \backslash \end{matrix} \begin{matrix} S \\ W \end{matrix}$ , where the first S is non-

branching". This constraint seems well-founded and sufficient to block Reversal in these cases without reference to the metrical grid. What is more, it appears that it can be simplified in a model that makes use of zero syllables. Kiparsky has to specify that the

 structure has to be word-internal in order to block Reversal; in other words, he has to appeal to nonmetrical information (word boundaries) in order to allow Iambic Reversal in (4.37) below but block it in (4.36).

(4.37) a.

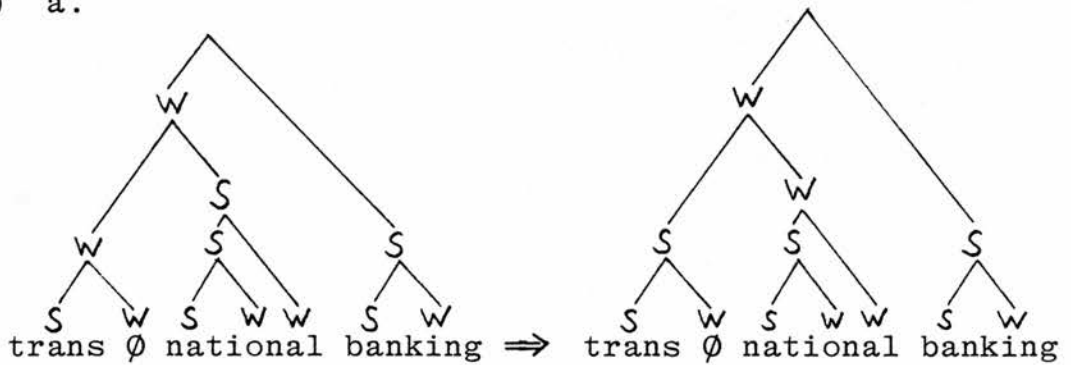

b.

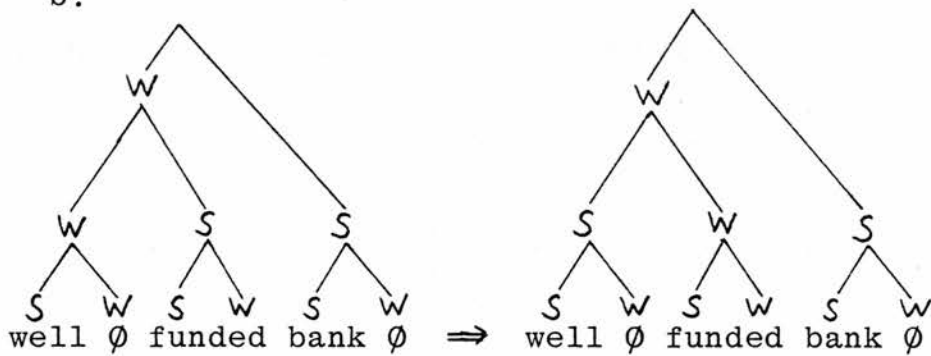

 In S S W structures with a word boundary between the two S nodes, the first S will be branching under the present model and thus be automatically excluded from Kiparsky's constraint anyway. At least, this would be

the case in compounds proper, like *well-funded* and, presumably, *trans-national*: it will be recalled that these items have two M nodes, each dominating an



structure. There are some cases in which I am not certain whether the first S branches. Consider *bisexual*, *trilateral*, *prefabricate*:

(4.38) a.

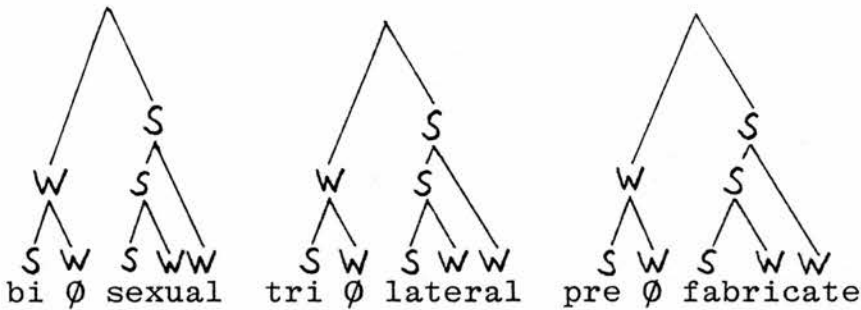

b.

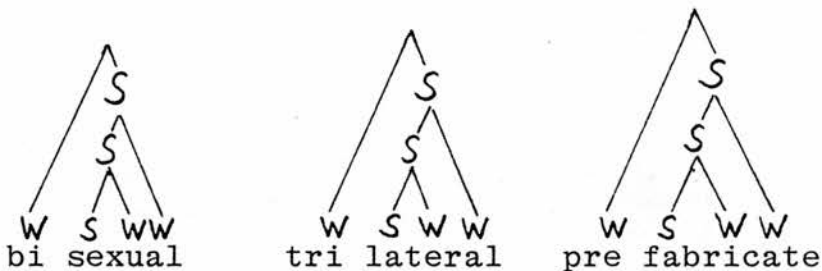

It is possible that *bi-*, *tri-*, *pre-* have to be given the metrical structure of Class II prefixes (in terms of Siegel 1974) rather than that of lexemes. *Bisexual*, then, wouldn't have the metrical structure of a compound (4.38a) but that of a word derived via Class II prefix instead (4.38b). If this is correct - and I am not claiming it is, merely suspecting - then Kiparsky's constraint would have to remain as stated above. A more detailed investigation is necessary at this point. Suffice it to say that motivated compounds, with internal

double word boundaries, like *well-funded*, are automatically taken care of in this model. That single word boundaries also allow

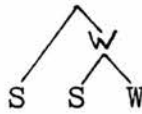

structures to be produced by Iambic Reversal in this model may or may not have to be made explicit.

In conclusion, it can be said that Iambic Reversal does not need to get triggered by any configuration specified in the metrical grid. All the constraints on this rule can be adequately stated in terms of the tree structure. Having constrained RPPR suitably to stop it from producing free variation (recall 4.28) above) we must now ask ourselves whether the grid is in fact good for anything at all. What justifies the existence of the grid in a theory of metrical structure? The answer is, strictly speaking, nothing. It is not needed for Iambic Reversal and the rhythmic alternation shown in (4.24) above will in a later section be produced by Defooting and related rules. As it stands, the revised RPPR (4.28) allows us to read off the rhythmic patterns of speech in a way similar to, say, the way metrical structure may be mapped onto the abstract patterns of poetry (Kiparsky 1977) or set to music (Jackendoff and Lehrdahl 1981). Metrical structure itself is entirely autonomous of the grid.

Finally, the question arises once again where the Reversal rule is located in the grammar. The answer seems simple: not in the lexicon because *thirteen* only gets reversed under a certain embedding. Iambic Reversal is therefore part of the metrical component (which has yet to be fully outlined), just like German Defooting.

There seems to be some reason, however, to make Iambic Reversal also operate in the English lexicon, at least if we subscribe to Kiparsky's (1979) model of word-level

metrical structure. In his account, the structures in (4.39b) below are derived from the corresponding ones in (4.39a) through Iambic Reversal; LP, incidentally, use different means for the derivation of (4.39b).

(4.39) a.

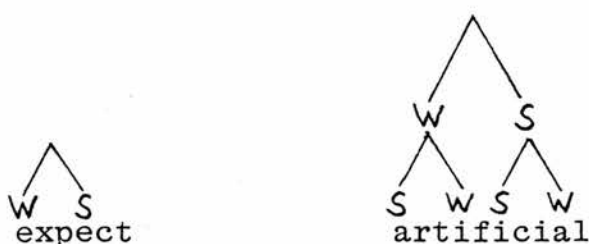

b.

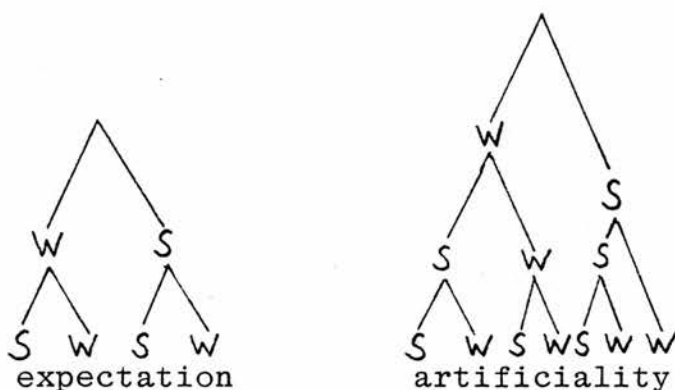

The point is that LP's and Kiparsky's rule of Initial Destressing can be shown to apply before the phrasal applications of Iambic Reversal (as we would otherwise get Reversal in exact change) but, and this is the problem, after the word-internal ones, both so as to not bleed Reversal and so as to be bled by it. I shall not go into this question any further. In Kiparsky's model two locations of Reversal are needed, one in the lexicon and one after the operations of the syntax, and the two cannot be collapsed into one. In LP, on the other hand, lexical Reversal doesn't seem to be required but certain generalisations seem to get missed. Which of the two models is the better one is a question outwith the scope of this discussion. Suffice it to say that in either case Iambic Reversal definitely has a place in the phonological

(metrical) component.

#### 4.4 A note on Iambic Reversal in German

A rule remarkably similar to the Iambic Reversal rule (4.32) seems to exist in the grammar of German. Consider, for example, the metrical structures of *Paderborn* and *hundertzwanzig* and what happens to them under embedding:

(4.40) a.

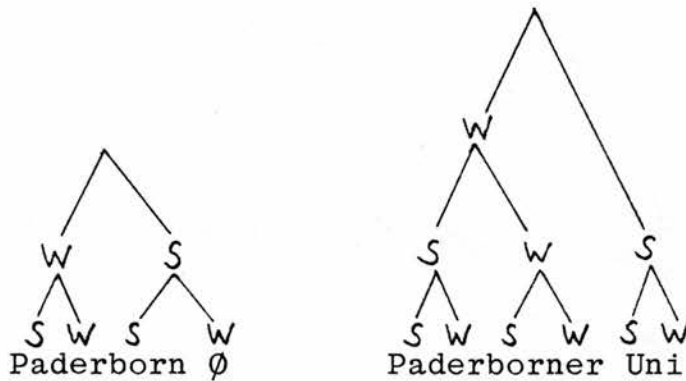

b.

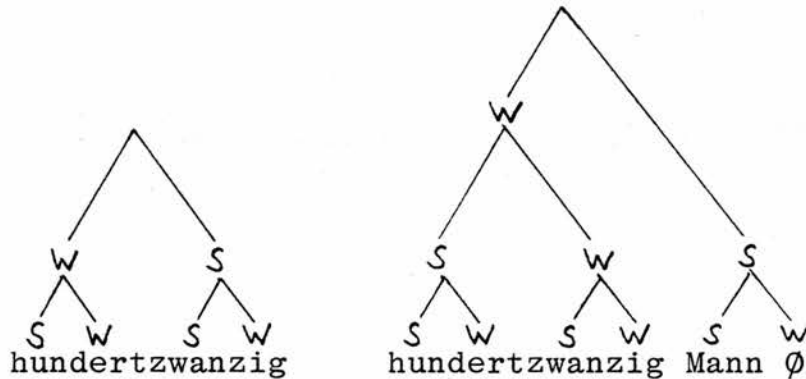

Similarly, Reversal applies within word trees (assuming that the ones in (4.40) above have internal morphological boundaries): take, for example, *legendär*, *funktionell* etc., items which have Class I suffixes attached before the assignment of metrical structure. These words are also reversible under embedding, if maybe not quite as frequently as the ones in (4.40) above.



(4.41)

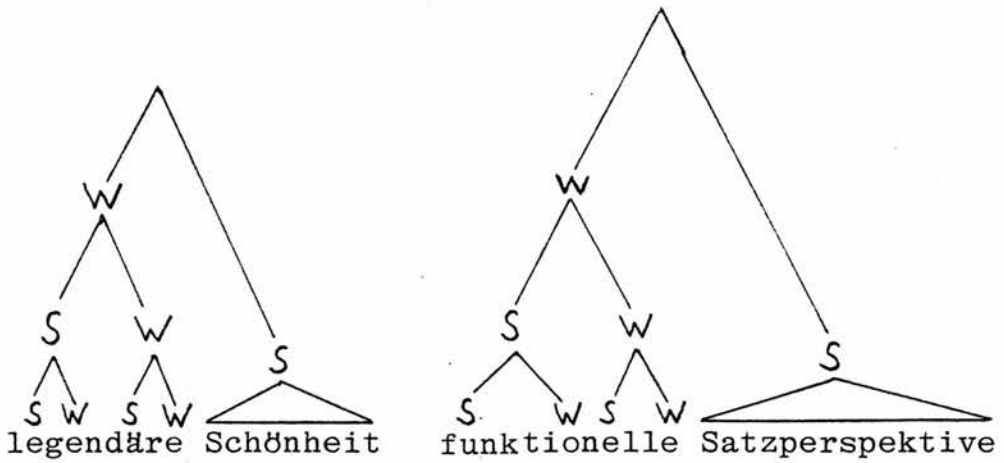

I do not intend to embark on a full-scale study of this process in German; it seems too similar to its English counterpart to merit lengthy discussion. But one question, I think, ought to be raised here. What happens to Iambic Reversal's condition (4.32b) in German? How can the constraint that constituent one (in terms of (4.32)) may not be an unstressed syllable be expressed in a model that does not make use of the segmental feature [stress]? Does this constraint have to be stated anyway?

Consider the first syllable in, say, *Dekan*. Significantly, *Dekan Müller* is not subject to Iambic Reversal while *Herr Dekan Müller* clearly is:

(4.42) a.

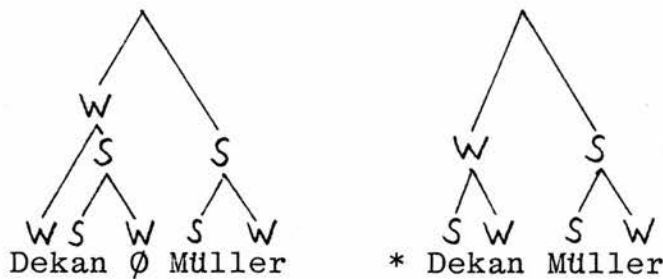

b.

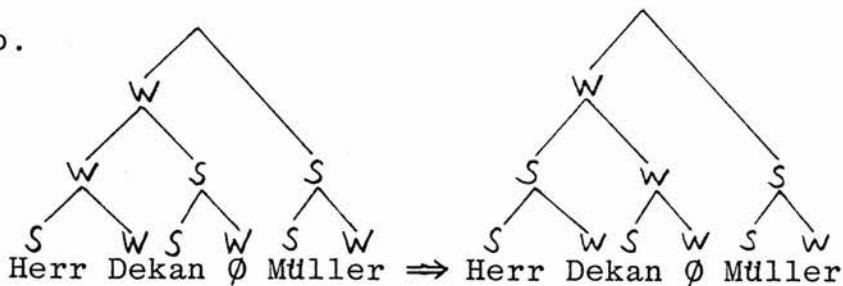

(Recall that *Herr De-* forms a foot thanks to the Zero Syllable Constraint (1.18). The examples given in (4.40) to (4.42) show one thing quite clearly: Iambic Reversal applies liberally where constituent one branches. In these cases, it makes a syllable the DTE of the word that has previously had a subordinate stress.

In contrast, Reversal is reluctant to apply in structures where constituent one is nonbranching. In other words, terminal W nodes like the first syllable in *Dekan* don't get involved in Reversal operations that would make them the DTE of the word. Now notice that an 'unstressed' first syllable, in terms of the model of German metrical structure that I have been defending, will be either one like the first syllable in *Dekan*, which we have just discussed, or an unstressed Class II prefix. And these don't undergo Iambic Reversal either:

(4.43)

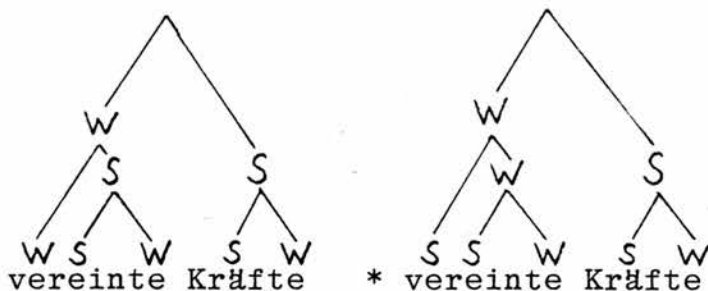

This example should be sufficient. Unstressed Class II prefixes don't get involved in Reversal just like word-initial terminal W nodes of simple words. It seems to me, then, that in German Iambic Reversal is in general restricted to structures with branching constituent one.

But consider the behaviour of *un-* as a Class I prefix (recall the discussion of this prefix in section 3.5.2 above):

(4.44) a.

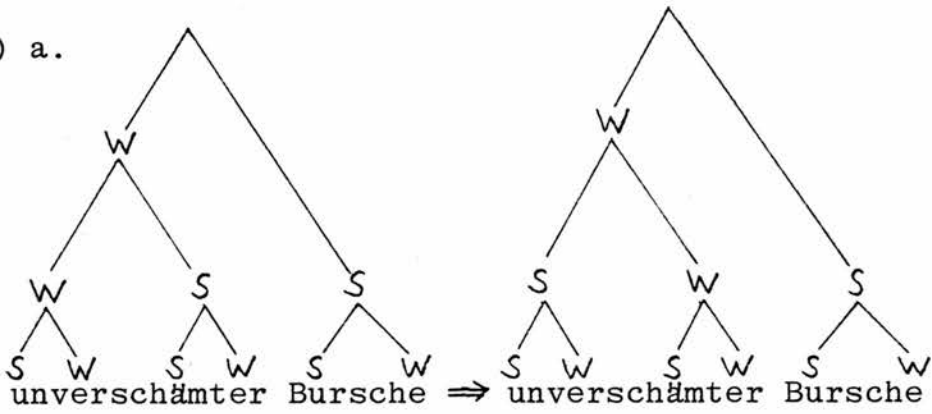

b.

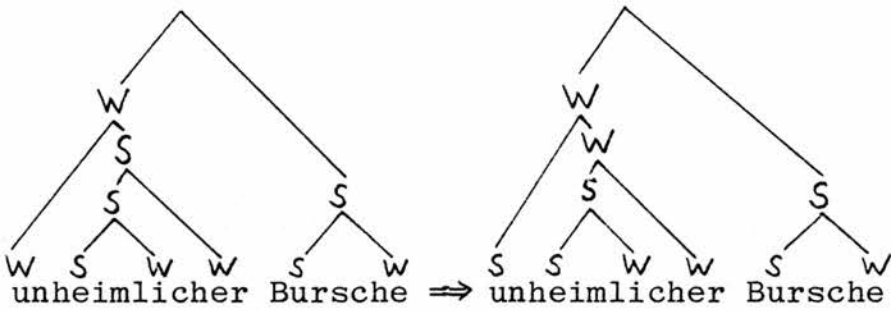

c.

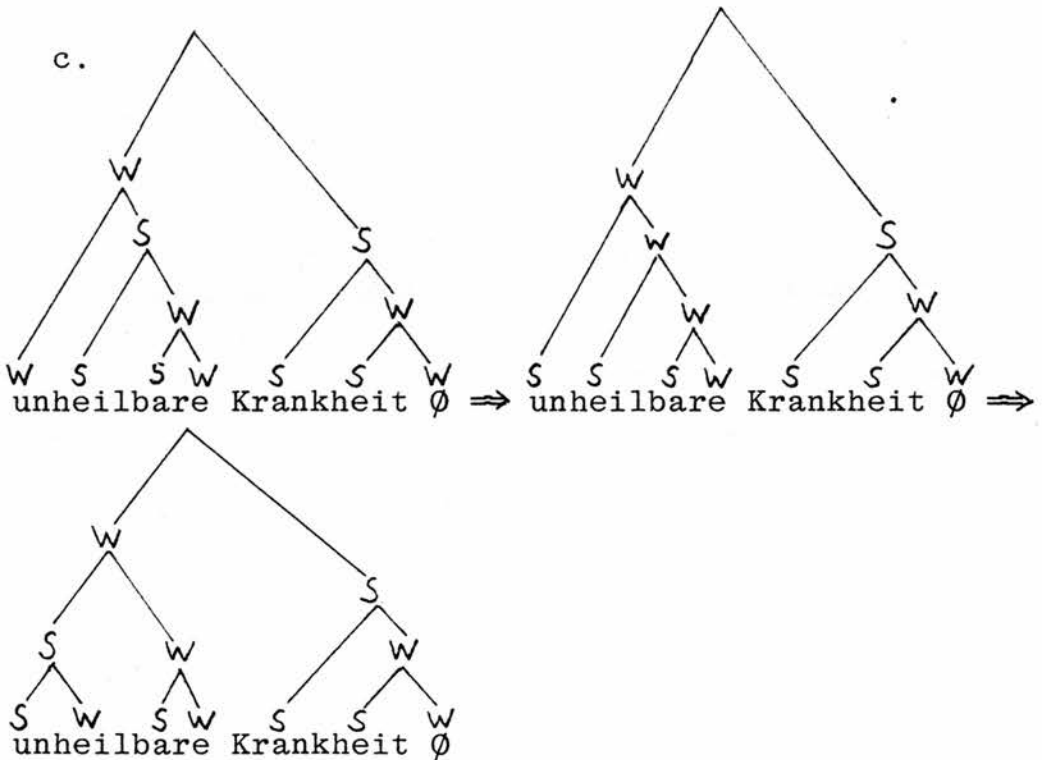

A few words on the morphology of these adjectives are in order. *unverschäm*t has *un-* as a Class I and *ver-* as a

Class II prefix; *unver-* therefore gets footed. *unheimlich* has *un-* as a Class I prefix and *-lich* as an unstressed Class II suffix. *-bar* in *unheilbar* is a stressed Class II suffix.

All three items are subject to Reversal, even those that have, underlyingly, initial terminal W nodes. At least this prefix, then, is capable of becoming the word's DTE through Reversal. In (4.44c), Reversal creates a structure which is a possible candidate for Defooting - and as predicted, this process applies as well.

The question is why *un-* is capable of becoming the DTE where it is underlyingly weak, thus violating a constraint that bars (4.42a) and (4.43) from Reversal. Tentatively, I remind the reader of the fact that *un-* can be the DTE of a word if it is a stressed Class II prefix, as in '*unsanft* etc. (recall (3.64)). This, one might speculate, enables unstressed *un-* to break the rule.

I shall not go into more detail. It seems, anyway, that Iambic Reversal has a rather secure place in the metrical phonology of German. And it also seems that the interaction with other metrical transformations, like Defooting, which the metrical model predicts, works out correctly.

#### 4.5 On flattening and rhythmic alternation in English

It has been recognised by various authors that the syntactic surface structure provides a domain unsuitable for a straightforward cyclic assignment of stress and intonation contours at the phrase level. In particular, problems occur with the stressing and the placement of intonation breaks in multiply left-branching structures like (4.45a)

and multiply right-branching structures like (4.45b):

- (4.45) a. Andrew's father's brother's dog's house  
 b. This is the cat that caught the rat that stole the cheese

(Chomsky 1965; Cooper 1980; Langendoen 1975; Lieberman 1967; SPE; LP).

Within the cyclic tradition, Readjustment Rules have been suggested in SPE (pp. 371 f.) and elaborated by Langendoen (1975) which, prior to any application of phonological rules, 'flatten' the syntactic surface by sister-adjoining embedded constructions. As a consequence of the equal hierarchical status that would result for the constituents under consideration, an excessive range of stress numbers is avoided in (4.45a) and intonation breaks can be inserted appropriately after *cat* and *rat* in (4.45b).

Readjustment Rules of this kind are suspect for a number of reasons. Their theoretical status differs from that of syntactic as well as phonological rules. Their only effect is a rebracketing of syntactic structure: they have no immediate empirical consequences. It could in fact be argued that they only serve to patch up a mismatch between the syntax and the phonology.

In LP an interesting attempt is made to show that metrical phonology has the potential of rendering Readjustment Rules of the above kind superfluous. Processes of 'flattening', which at the same time create rhythmic alternation, are taken care of by a variety of rules and adjustments, including the following:

1. Iambic Reversal, triggered by grid clashes, in the metrical tree of (4.46):

(4.46)

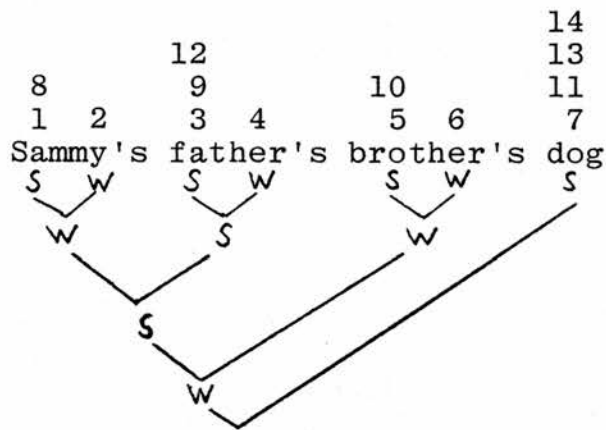
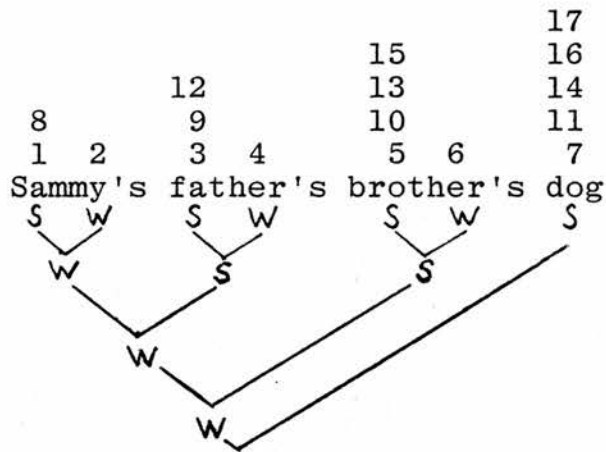

2. Reinterpretation of the morphological structure of words, reflected in the metrical structure like this:

(4.47)

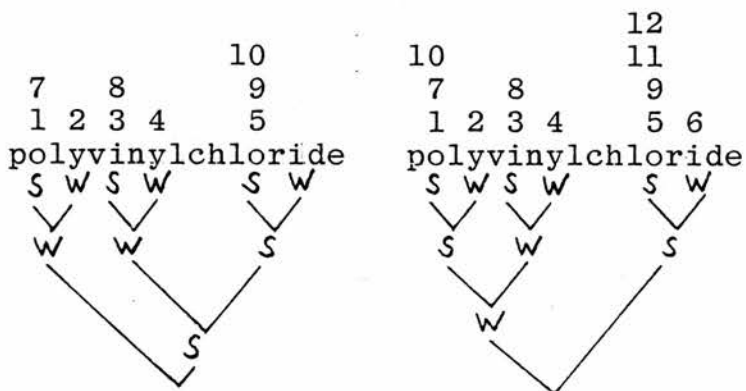

3. Adjustments in the metrical grid, taking advantage of the liberties that LP's RPPR permits (here: strengthening of *three*):

(4.48)

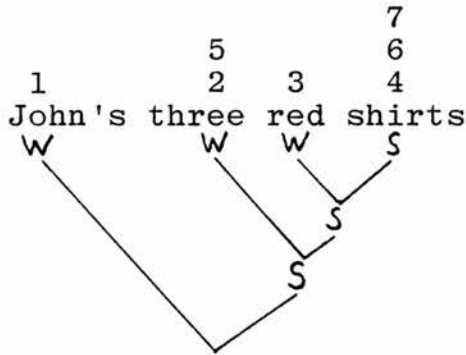

A number of arguments can be raised against this collection of solutions. For a start, LP resort to different devices to tackle what are clearly aspects of the same phenomenon. It would be better to give a unitary and general account. Also, LP are inconsistent in that the grid adjustment of (4.48) would also be possible in the other cases, where they choose instead much costlier operations. Moreover, the reader will have noticed that solutions one and three above are no longer available in the new model presented here: condition (4.32a) of Iambic Reversal rules out this operation in (4.46) as *brother's* is in fact the head of a noun phrase. And solution three, adjustment of the grid, is no longer possible under the revised version of RPPR. (Note, too, that LP's grid alternation in (4.48) is apparently produced by a relaxation of their metrical strength guarantee for lexical monosyllables. I see no realistic possibility of formalising this, given that LP's grid is allowed free variation in principle.)

I would like to claim that a unitary account of these phenomena is possible rather along the lines of the Defooting processes that we have looked at already. Just as Defooting produces rhythmic alternation on the terminal level of the metrical tree, it will become clear shortly that the 'readjustments' suggested above are nothing but operations that pair parallel constituents.

Consider the structure that I gave in (4.48) above. Essentially, this is the structure produced by the phrasal stress rule, characterised by parallel W constituents dominating the modifiers. It will be recalled that I argued in chapter one that no prominence relations are defined among parallel W constituents; compare the terminal nodes in (1.24). My claim is that metrical trees are more highly structured than this by the time they surface and that prominence relations of a predictable kind get defined among the parallel W branches of the underlying metrical structure.

These operations have in common that they represent rather radical departures from the syntactic bracketing; we shall see below that the pairing operations that take place in the metrical phonology to some extent go across syntactic boundaries. In that respect they do the work, and indeed more than that, of Langendoen's Readjustment Rules. Viewed as a whole, they demonstrate an important generalisation of what the 'metrical component' is: that section of the grammar where the mapping of the syntax onto the phonology is done (Selkirk 1980a).

In what follows, not using the grid will give us further evidence against the necessity for this formal structure in metrical phonology.



4.5.1 Right-branching structures, part 1: W-Pairing

Consider the metrical structure of phrases like *seven little girls*. The underlying structure, with prominence relations defined by NSR, would be something like this:

(4.49)

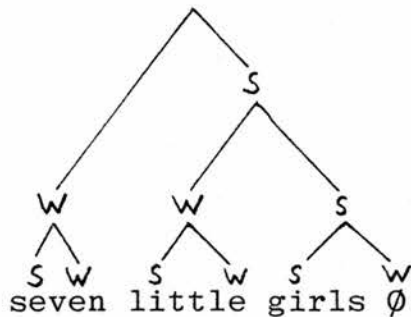

The metrical analysis shows no strength relation defined between *seven* and *little* while in a cyclic analysis after the fashion of SPE, a Stress Lowering Convention produces

a pattern of rhythmic alternation (<sup>2</sup>*seven* <sup>3</sup>*little* <sup>1</sup>*girls*). Now if we wanted to reflect this pattern, which is readily attested empirically (see, for example, Ladefoged 1975: 102), in the model of LP it would have to be done via the metrical grid; mechanisms which show up strength relations between underlyingly parallel constituents are absent in LP. This is what I would like to concern myself with in this section.

The phrase under discussion, I suggest, should be mapped onto the one given in (4.50):

(4.50)

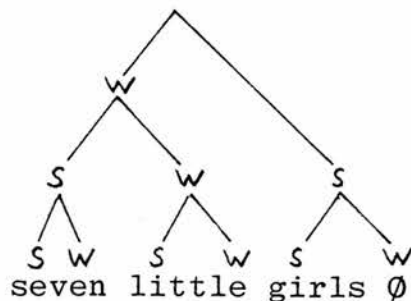

Let us call the operation which involves the pairing of parallel weak constituents W-Pairing. Here is a preliminary version:

(4.51) W-Pairing

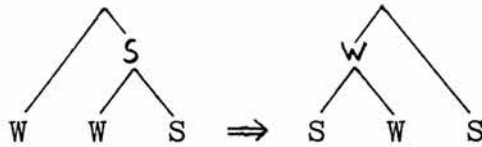

If we now extend the domain of (4.49) to the left we reach a point where a cyclic analysis does not produce an alternating pattern (as it did, rather by coincidence, in (4.49)) but a linear downgrading of the stresses on

the modifiers: <sup>2</sup> *seven* <sup>3</sup> *pretty* <sup>4</sup> *little* <sup>1</sup> *girls*. Further expansion of the phrase would exceed the limit of possible stress numbers in an SPE-type system. The application of a Readjustment Rule would then be required which would sister-adjoin the embedded constituents before the operation of the stress cycle. W-Pairing produces the desired alternation:

(4.52)

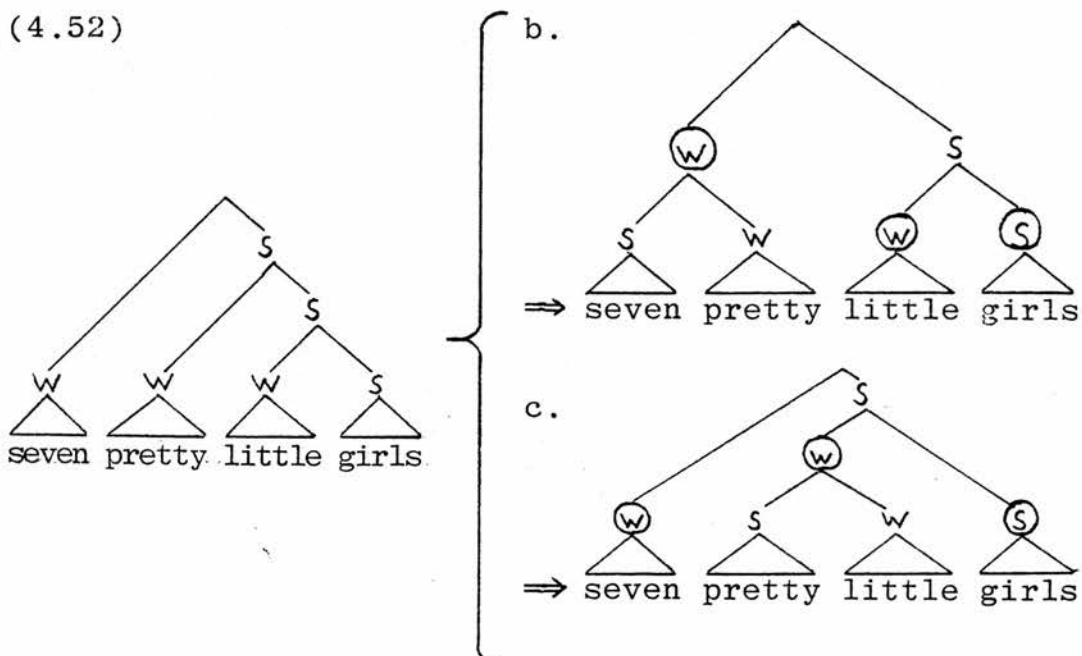

There are two possible applications. We can either join *seven pretty* (as in (4.52b)) or *pretty little* (4.52c). What is important is that in each case *girl* remains the DTE of the phrase. In that sense, W-Pairing doesn't change structure, it adds structure. This, I believe, is the only real constraint on this kind of metrical transformation. The contours of subordinate stresses are to a large extent subject to variation. Notice that (4.52b.c.) still constitute suitable input structures for further W-Pairing - the appropriate nodes are circled. Let us apply the rule again. Out of (4.52b) we get (4.53a) below, out of (4.52c) (4.53b):

(4.53)

a.

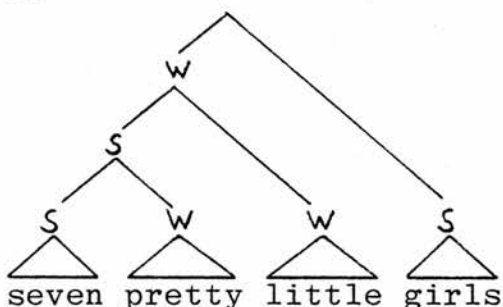

b.

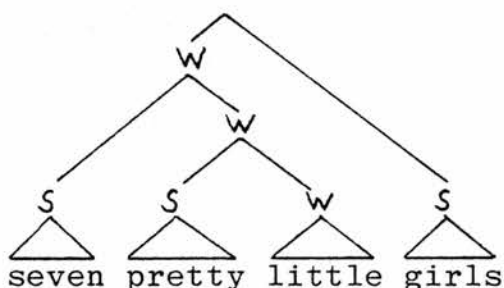

(4.53b) is the one of the four output trees that is most highly structured: prominence relations are defined among all the nodes above word level.

The question arises whether, in the light of this large number of possible outputs, W-Pairing has to be further constrained. I don't actually believe it does. Let me put it this way: W-Pairing is an optional process, (4.52a.b.c.) and (4.53a.b.) are possible surface structures. Of these, the one that alternates (4.52c) (although it still has some variability) is possibly the one that will be favoured, characterised by the alternation of S and W nodes on the word level and within words. But all

the other structures are also permissible and will, I'm sure, be observed so long as *girls* remains the DTE. Any structure in which *girls* is not DTE can be assumed to be contrastive or emphatic, produced by different operations (Dogil 1979).

A few remarks have to be added at this point to demonstrate the strength of existing constraints on the two metrical transformations discussed so far, Reversal and W-Pairing. First, any attempt to produce rhythmic alternation in a phrase like (4.52a) - or any of the subsequent ones - through Iambic Reversal would affect an S dominating *girls*, the head of the phrase, and would therefore be ruled out. Neither of the two transformations allow the DTE of a phrase to be weakened in the course of the derivation.

For the same reason, neither Iambic Reversal nor W-Pairing are available to produce alternation in structures like *Big Ben struck* and *wee Jimmy smokes*. Reversal can't apply because *Ben* and *Jimmy* are the heads of noun phrases and W-Pairing can't because there aren't any W nodes to pair. I think that the perceived stressing of these two structures gives us quite a good indication of the correctness of our constraints.

W-Pairing must not (and, in the way it has been formalised, will not) weaken the heads of phrases but occasionally they get strengthened in the process. Consider (4.54) below, where a noun phrase consists of a single item (*Derek*). Through NSR, we get the structure (4.54a). W-Pairing produces (4.54b):

(4.54) a.

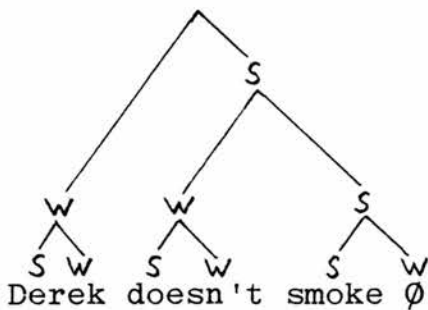

b.

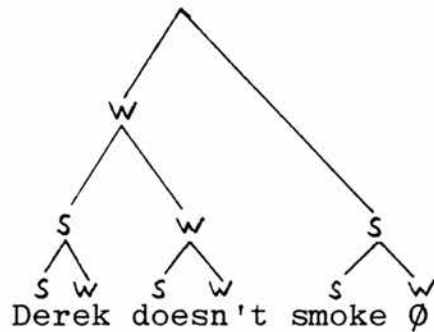

It is a general feature of this model that metrical constituents extend to the right of syntactic constituents, 'encliticising', as it were, metrical weak elements onto the last strong element of the preceding syntactic phrase. Thus, *doesn't* in (4.54) gets sister-adjoined to *Derek*. The same happens on a lower level of the metrical tree, thanks to the Zero Syllable Constraint (1.18). Examples are given in (4.55):

(4.55)

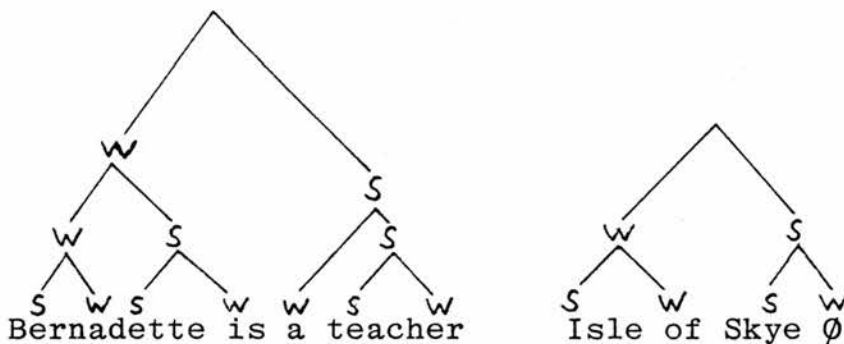

Furthermore, imagine a structure where, in *seven pretty little girls*, the word *pretty* was to be interpreted as an adverb modifying *little*. The underlying structure of this phrase would be the one in (4.56a) below. One application of W-Pairing is possible, but once again none that in any way affects the strength of either of the two heads of syntactic phrases, *little* and *girls*:

(4.56)

a.

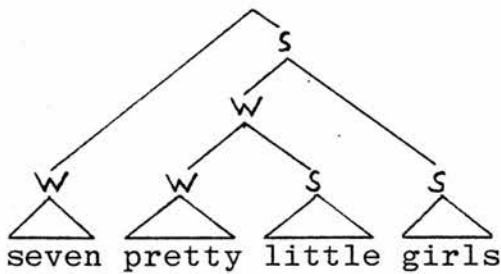

⇒

b.

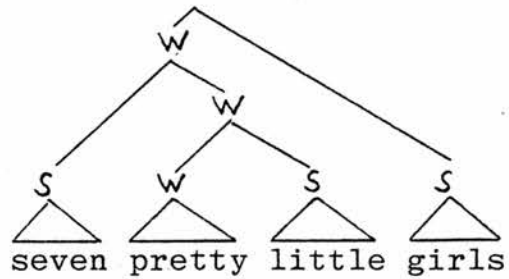

#### 4.5.2 Right-branching structures, part 2: Defooting and Footing

The reader may have noticed that in the discussion of W-Pairing in the preceding section, all exemplification was done using polysyllabic lexical items. The W nodes that got paired were never terminal ones. Let us see what happens if we analyse strings of monosyllables.

It is one of the principles of this model that members of lexical categories - nouns, verbs, adjectives, and adverbs - get at least one terminal S node assigned to them in the lexicon while nonlexical items - usually called function words: pronouns, auxiliaries, prepositions and such like - emerge without any metrical structure of their own. This principle was also present in the SPE model where the domain of word stress rules was restricted to lexical categories; recall the discussion in chapter 1 of this study. No such provision was spelled out in LP, it will be remembered, except for the rather problematic convention that gave lexical monosyllables 'a certain metrical strength' in the grid (but not in the metrical tree). In the present model, the distinction between

lexical and nonlexical monosyllables shows up in the metrical tree. Consider (4.57):

(4.57) a.

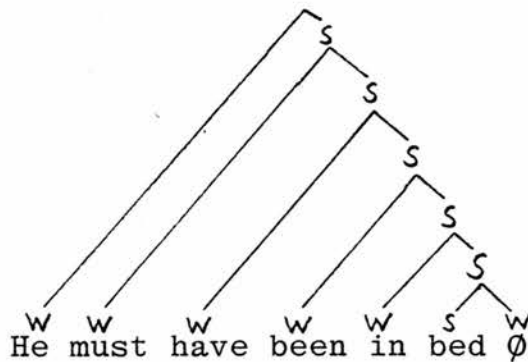

b.

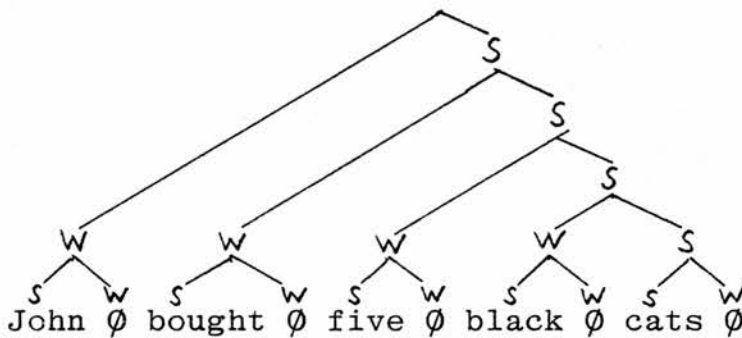

The two trees in (4.57) are characteristic of what is produced in this model as 'underlying metrical structures'.

The principles of word level structure give  $\overset{\wedge}{S}$   $\overset{\wedge}{W}$  structures to lexical items, higher level structure is determined by the syntax in conjunction with the NSR. In terms of performance, both trees are rather suspect: the left-hand one because it contains a long string of items between which no prominence relations are defined, the right-hand one because it contains copious zero syllables, along with undefined strength relations on a higher level. I shall discuss possible adjustments of the latter structure first and afterwards turn to the former one.

Terminal S nodes, adjacent or flanked by zero syllables, are favourite candidates for metrical structure trans-

formations. Thus, we have already seen that the domain of German Defooting is characterised by both adjacent S nodes and the occurrence of zero syllables in certain places; and our first version of English Defooting ((4.35) above) has virtually the same structural description. My first claim in this section is that a structure like (4.57b) is actually subject to Defooting as not all the monosyllabic items will bear a rhythmic 'beat' in performance. To achieve this, only a minor adjustment to rule (4.35) is necessary.

Here is a metrical derivation of (4.57b), using the one eligible transformation developed so far:

(4.58) a.

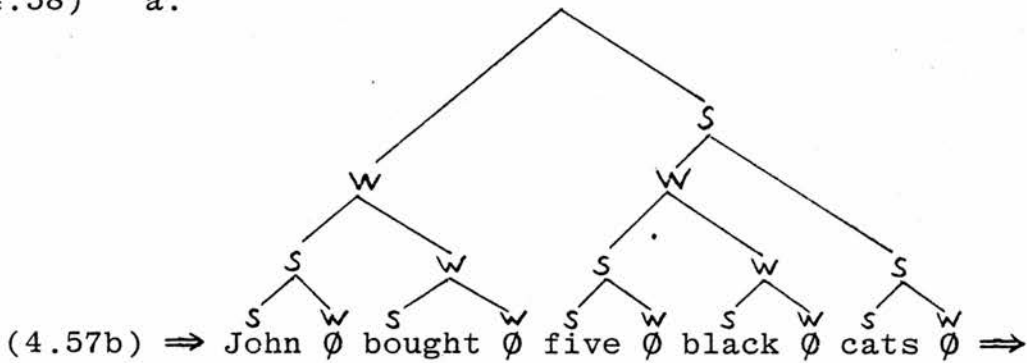

b.

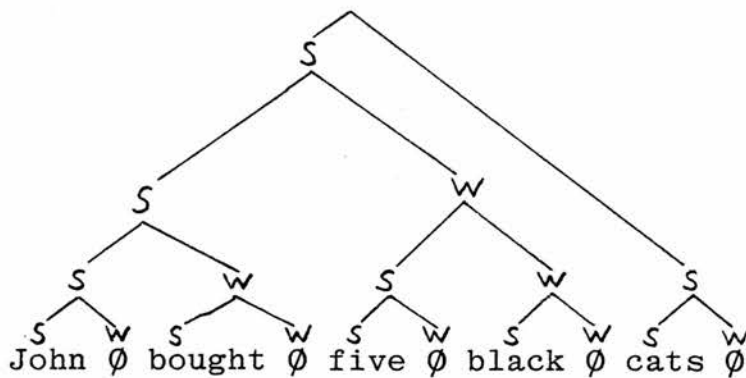

(4.58a.b.) are produced by a series of W-Pairing operations. There are, of course, different possibilities for applying this transformation to (4.57b) but it appears that the



derivation given in (4.58) will be the one that is favoured as it produces rhythmic alternation most efficiently.

As I mentioned above, utterances are in performance broken down into (stress-timed) 'feet', roughly like this:

*/John bought /two black /cats.* Now if this type of

rhythmic measure, the Abercrombian 'foot' (1967; 1976)

has any correspondence with our terminal structure  $\begin{array}{c} \wedge \\ S \quad W \end{array}$

(which is what I have been assuming throughout this study) then the derived structures in (4.58), while displaying some kind of rhythmic alternation on a higher metrical level (among stressed syllables), are on the level of syllables still scanned with each one bearing a beat: */John /bought /five /black /cats.* This scansion ought to be allowed in this model but a provision has to be made for the alternating one given above.

I propose that Defooting be adapted to this task and spelled out in its final form like this:

(4.59) English Defooting

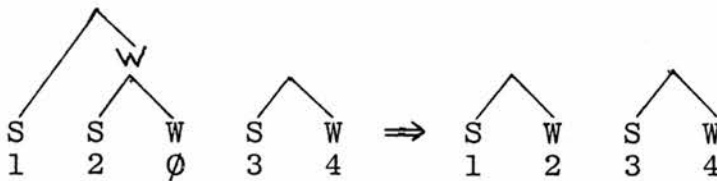

Condition: Constituent 1 may branch  $\begin{array}{c} \wedge \\ S \quad W \\ \emptyset \end{array}$

The only aspect of Defooting that has been changed is the condition. In applications like the one we are discussing here, constituent one branches in the form allowed by the condition. No other branching is allowed: constituents two and three aren't allowed to branch at all and

constituent one must not branch in any other way.

The first version of the rule, (4.35), was a compulsory transformation. Recall that I suggested, rather tentative-

ly, that Iambic Reversal is only allowed to produce  structures if these are subsequently going to be defooted. In contrast, the application of Defooting in *John bought five black cats* is optional. This appears to be a problem - but on closer inspection it isn't. Notice that in those instances where the rule is optional, the input string is adjusted to stress-timed performance in that all terminal S nodes are kept apart by zero syllables. In other words, this structure realises Abercrombian feet, unlike structures with adjacent terminal S nodes, and therefore has some degree of stability, or 'performability'. This is not the case in the other domain of this rule, characterised by a nonbranching node one. The



structure that turns up at that point necessitates Defooting, as indeed it does, wherever it occurs, in German.

As a final demonstration, let me give two more examples. In (4.60a.b.) below, the possible derivations of (4.57/4.58) are completed. (4.60c.d.e) gives another case of Defooting after Iambic Reversal, this time optional since the first constituent branches:

(4.60) a.

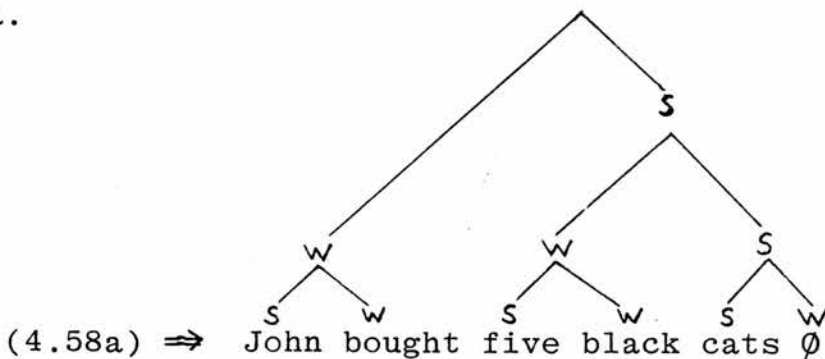

cont'd

(4.60) cont 'd

b.

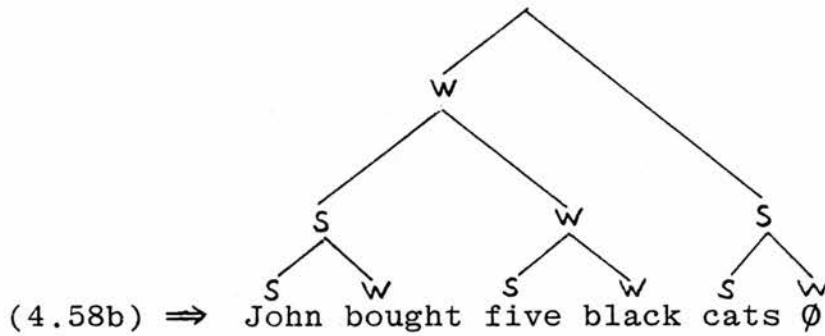

c.

d.

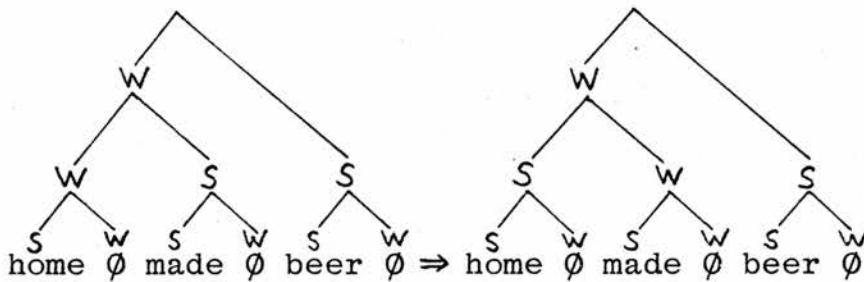

e.

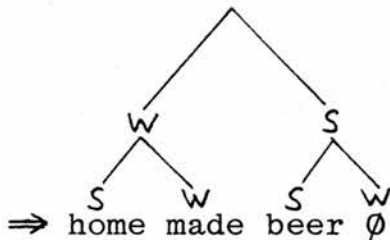

In its present form, Defooting presupposes applications of W-Pairing in strings like *John bought five black cats*. The effect of this is that the 'flattening' of the metrical tree takes place from top to bottom: first above the level of the word tree (recall that the separation of these levels has been found to be significant before), and then below that level. If Defooting is formulated in such a way that it presupposes paired constituents, W-Pairing and Defooting produce a partially ordered series

of structures, each one a possible phonetic surface and each one in this succession, it seems to me, more suited to casual speech than the previous one. For that reason I would be reluctant to relax the constraint on Defooting which makes it inapplicable before Pairing.

Let us now turn to metrical trees of the kind exemplified in (4.57a) above. As mentioned there, underlying metrical structures like that are produced in this model thanks to the principle that only lexical categories are sensitive to the rules that assign word-level metrical structure. This principle, part of generative phonologies since SPE, is most naturally borne out in a grammar that actually assigns word-level metrical structure in the lexicon, thus automatically affecting all lexical items and automatically excluding nonlexical ones.

In (4.57a), *bed* is the only lexical item. It is the only item in this structure that has a word tree. It is the only terminal S of the structure - all other terminal nodes are in fact the nodes of phrasal structure; consequently, they are weak.

Metrical trees like that are not very satisfactory in that they are not sufficiently highly structured. They allow scansion, with the whole string of terminal W nodes unstressed, which one would not come across in speech - in other words, trees like that are (at least potentially) observationally inadequate. I shall in what follows discuss some ways in which rhythmically alternating patterns can be produced for strings like the one in (4.57a).

What are the facts? Likely scansions of (4.57a) would be the ones given in (4.61) below. All alternative placements of secondary stresses, while the poorly structured tree in (4.57a) permits them, are ungrammatical except as

contrastive or emphatic stressings.

(4.61) He ,must have been in 'bed  
           He ,must have ,been in 'bed

To be more precise, the rhythmic beats to be found in strings of nonlexical items are determined by two principles: firstly, they never fall on two adjacent items; some of these items are more likely to receive a beat than others are. In this particular case, for example, a beat on *have* would be highly unlikely, with an adjacent beat on *must* but also in the absence of such a beat.

I have argued in previous studies that nonlexical items ('function words') are hierarchised in such a way that some of them are very likely to receive a rhythmic beat in performance (if they are surrounded by unstressed syllables), others are less likely to receive a beat and others again aren't likely to get a stress at all (Giegerich 1978; 1980). In our example, the modal is more likely to get a stress than the preceding personal pronoun. The same can be observed in, say, *you ,must be 'joking, she ,will not be 'there* etc.

Moreover, in a sentence like *he is a crook, he is* a better candidate for a secondary beat than *is*; similarly we tend to get *,I am a 'linguist* rather than *I ,am a 'linguist*. Personal pronouns receive a beat before non-modal auxiliaries do.

Next, consider a sentence like *he has been in the pub. He,* as I have just said, will receive a beat. The next one in this string will fall on *been* rather than *in*. Again, this seems to reflect a general regularity: prepositions are less likely to have a secondary stress than auxiliaries - tensed or tenseless - are.

The order in which function words are selected for rhythmic beats is then, roughly, like this:

(4.62) Modal > Pronoun > Auxiliary > Preposition

Take a metrical structure of the type (4.63a) below and assume that it gets converted into (4.63b):

(4.63) Footing

a.

b.

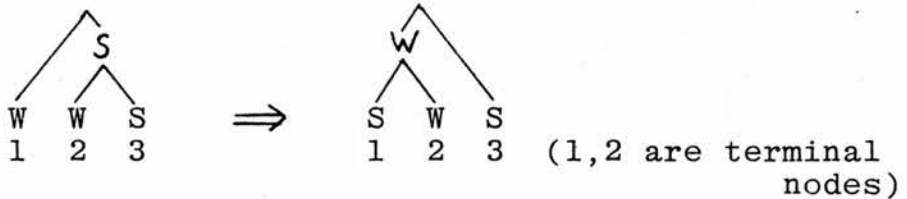

This structure occurs in numerous instances in (4.64):

(4.64)

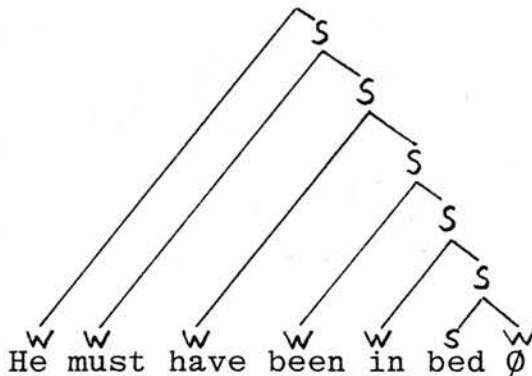

Various applications of Footing are possible. Following the hierarchy given in (4.62), the structure that has *must* as its leftmost terminal W will get selected first; in a second application, the one with *been* as its leftmost W is selected. (4.63), then, applies iteratively from

left to right. This mode of application, along with the form in which the rule has been stated, has the consequence that, first, no nonlexical item becomes strong unless it is followed by a terminal W. Second, in all subsequent applications no nonlexical item becomes strong unless it is preceded by a terminal W. If it is preceded by a terminal S it will itself be that S's sister and therefore incompatible with the structural description given in (4.63a).

The question arises how the left-hand environment of the structure in (4.63a) has to be specified for the first application of Footing. Do we require a terminal W node on its left? Consider the stressing of sentences like *Alex must be joking* and *John must be joking*. In the former, *must* is surrounded by terminal W nodes but in the latter it isn't, owing to the Zero Syllable Constraint, which disallows terminal W on the right of a zero syllable. In fact, under this condition this structure is no candidate for Footing at all:

(4.65) a.

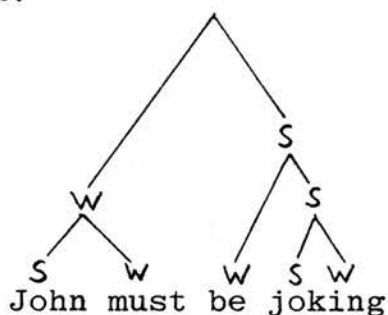

b.

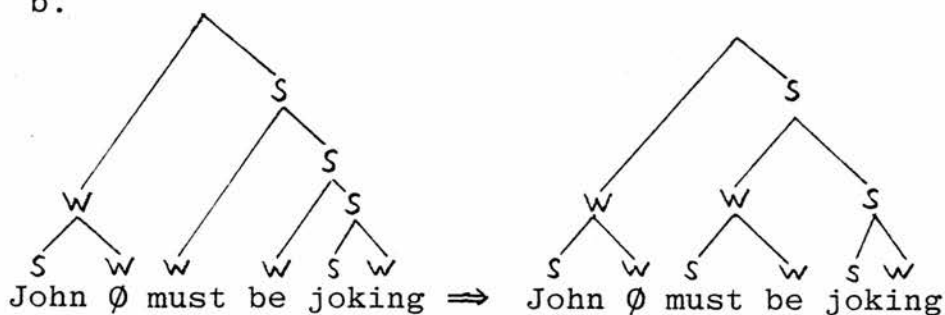

(4.65a) is the structure that the model produces which I have been advocating so far. Under this model, (4.65b) is ill-formed and so is, consequently, (4.65c) with Footing carried out. The trouble is that (4.65b.c.) ought to be allowed as they are just as likely to turn up as (4.65a). Similarly, we can easily get a rhythmic beat on, say, *is* in *Pete is a crook* or on *has* (rather than *been*) in *Mike has been asleep*.

What these structures have in common is a phrase boundary of the type  $]_{NP} VP[$  between *John* (as well as *Mike* and *Pete*) and the following nonlexical item. It seems to me that we have to modify the condition that forbids zero syllables to occur on the left of terminal W nodes. Cliticisation may fail to occur across a back-to-back phrase boundary so that a structure like (4.65b) may in fact occur. I propose that the well-formedness condition that accounts for cliticisation (1.18) in chapter 1 above, be modified in the following way:

(4.66) Zero Syllable Constraint

Of two adjacent terminal W nodes not separated by a  $]_P P[$  boundary, neither occupies a zero syllable.

This implies that in the presence of a phrase boundary, cliticisation may or may not happen. The structures in (4.65a.b.) are both permissible under the new version of the Zero Syllable Constraint.

For *Mike has been asleep*, we can now produce the following structures:



(4.67) a.

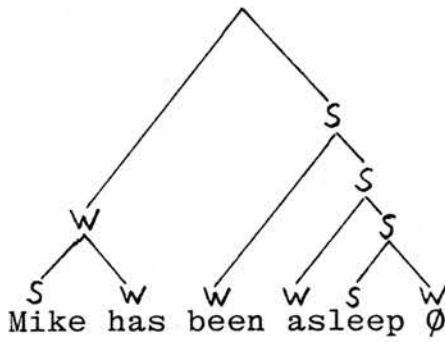

b.

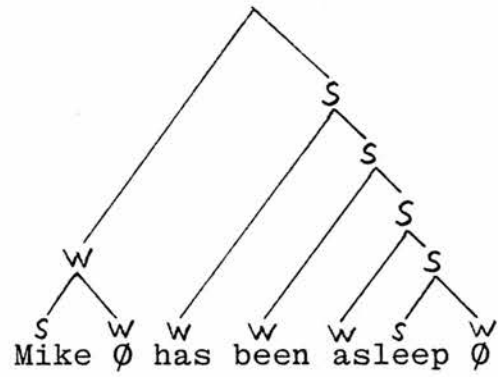

c.

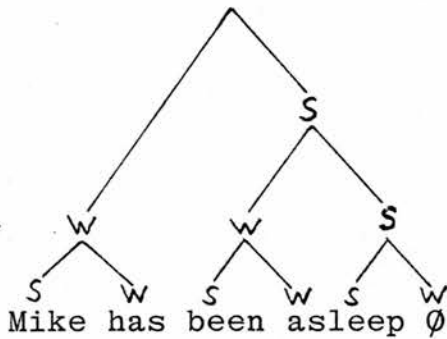

d.

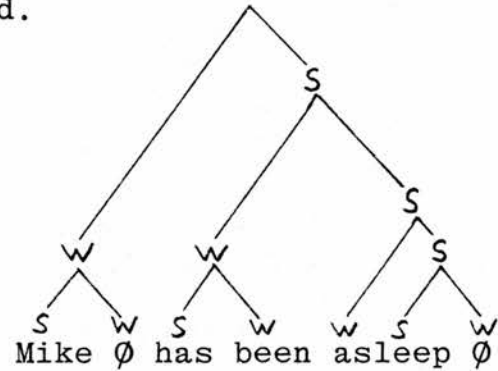

e.

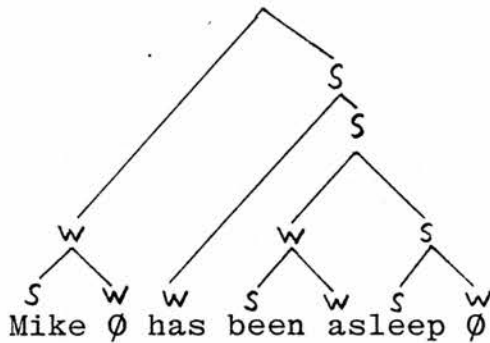

(4.67a.b.) are the two options that we have for underlying metrical structures, given (4.66). (4.67c) shows the only possible instance of Footing carried out on (4.67a). (4.67d.e.) are two possible derivations based on (4.67b).

Given that our Footing rule applies from left to right along the hierarchy of function words sketched in (4.62) above, it might be suggested that iterative application

starts with the leftmost element of a phrase, VP in the cases discussed here, and works its way rightwards, producing rhythmic alternation, and that the hierarchy could be scrapped. Given the possibility of cliticisation, we could make some provision that, in (4.67), places the 'metrical VP boundary' either before *has* (4.67b) or before *been* (4.67a). Footing could then take the first element of that 'metrical phrase' and pair it with the next; if there are two more terminal W nodes, the same could apply again, and so forth. Take for example the case that we started off with:

(4.68)

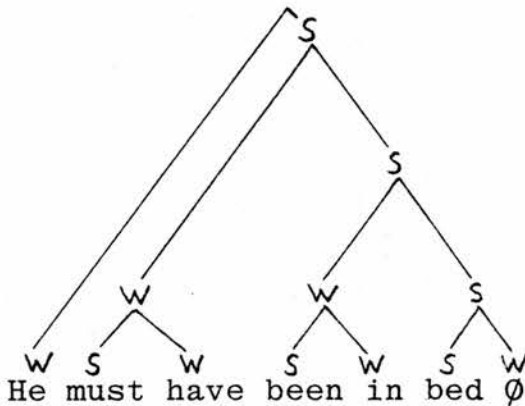

*He* and *must* cannot be paired as *he* is nonlexical to start with (hence there won't be an underlying S W) and *must* is the first constituent of VP. Having applied Footing on *must*, another application is possible for *been in*. Both applications have been made in (4.68) above. Our alternative proposal seems to work, then; indeed it would seem to produce correct results in all the cases discussed so far except that it doesn't produce the structure given in (4.67e).

But consider a sentence like *James must have been teaching*. The only acceptable structures are given in (4.69):

(4.69) a.

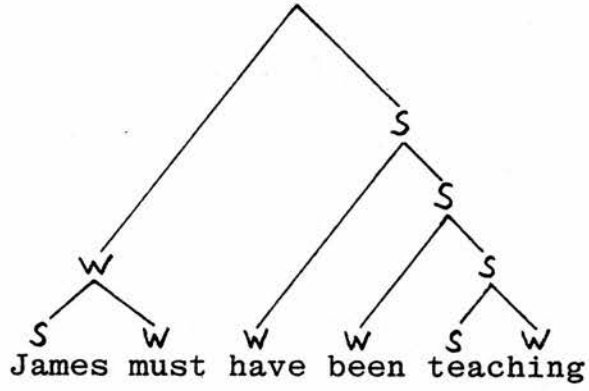

b.

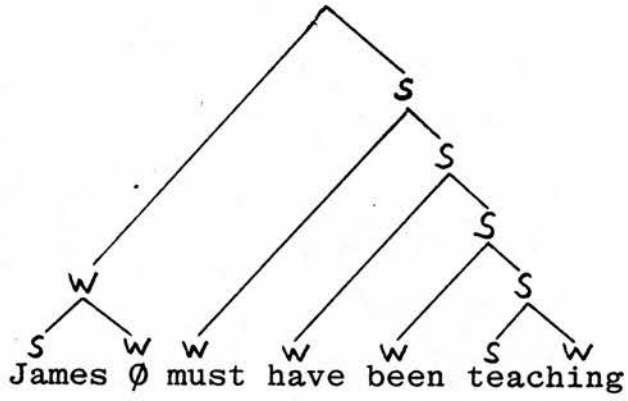

c.

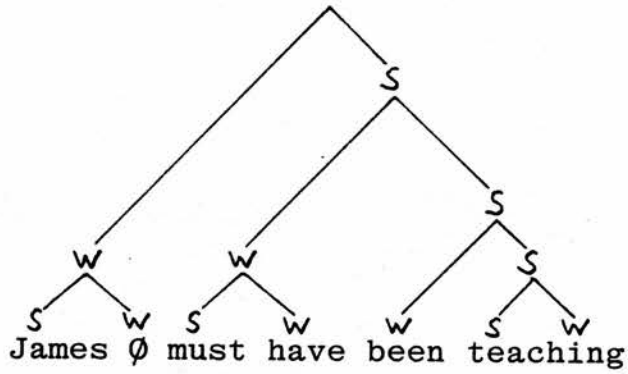

d.

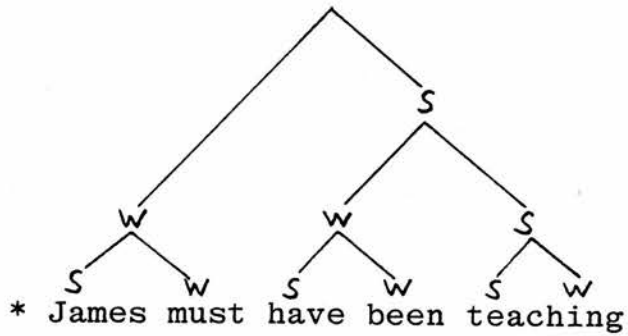

(4.69a.b.) are the two possible underlying structures. (4.69c) is derived from (4.69b) via Footing. (4.69d) ought not to be allowed: it is not a possible stressing of this sentence. But how do we rule it out? It is produced by our present model if *James must* are footed and the 'metrical VP boundary' is between *must* and *have*. If we allow Footing to apply from left to right in VP regardless of the kind of function word that it affects, then there is no way of ruling out this structure.

Right enough, our present hierarchy (4.62) allows this structure to be produced as well. But once we have recognised the need for such a hierarchy it can be adjusted in order to make the last auxiliary in a string a more likely candidate for Footing than the preceding one (if that isn't a modal). If we deny ourselves this hierarchy, however, there is no possibility of making an appropriate adjustment of the model.

This adjustment of the hierarchy would indeed seem to be a valid generalisation. But needless to say, the apparent ad hoc character of the hierarchy is at the same time its main weakness. Nevertheless I think I have shown that some sort of hierarchy has to be invoked here, at least if the one alternative discussed so far is the only one on offer.

Other alternatives have in fact been offered. It has frequently been observed that adjacent function words may contract into single recurrent linguistic units, such as *I'll* (from *I will*), *must have* (reduced to ['mʌstəv]), *mustn't* (from *must not*), *he's* (from *he is*) and so forth (Bresnan 1971, Baker 1971, Selkirk 1972, Zwicky 1970, Zwicky and Pullum 1982, and others).

Selkirk (1972), whose proposal is the most elaborate of

the ones listed and also the one that ties in most neatly with the present model, argues as follows. Nonlexical items are underlyingly stressed but become stressless if they precede their head (in syntactic terms; this accounts for the stressing of *is* in, say, *John's not as tall as Bruce is*, where *is* doesn't precede its head but a deletion site) and if they are monosyllabic.

Of these two conditions, the second one is of interest to us. The grammar contains cliticisation rules, about as ad hoc as the hierarchy I proposed above, that encliticise certain function words onto preceding ones. Encliticisation is a transformation, which changes, say, (4.70a) into (4.70b):

(4.70)

- a.  $\bar{V} [ \text{Mod} [ \text{must} ]_{\text{Mod}} \text{Aux} [ \text{have} ]_{\text{Aux}} \text{X} ] \bar{V} \Rightarrow$   
 b.  $\bar{V} [ \text{Mod} [ \text{Mod} [ \text{must} ]_{\text{Mod}} \text{have} ]_{\text{Mod}} \text{X} ] \bar{V}$

A Clitic Stress Reduction Rule then destresses the second syllable of the new modal constituent. The result is, in our terms, an  $\begin{matrix} \wedge \\ S \quad W \end{matrix}$  structure. Selkirk proposes similar rules for Modal/Aux plus *not*, Modal plus *have/be* and a variety of other combinations.

In essence, this approach is remarkably similar to the one I have been defending above. The fact that Selkirk's function words are underlyingly stressed whereas mine aren't is, of course, a rather radical difference but it is nevertheless quite immaterial here as the two models could be reconciled with each other either way. The hierarchy of this model differs from Selkirk's cliticisation rules in that it specifies only the item that is to become

S; Selkirk specifies both it and the one that becomes the clitic. I leave open until later which of the two is observationally more adequate.

One difference between the two models is rather important: Selkirk's cliticisation rules are in essence Readjustment Rules similar in character to the ones that I mentioned earlier, proposed by Langendoen (1975). All they do is shift boundaries; notice that it is not them that bring about a phonetic effect but the subsequent rule of Clitic Stress Reduction. Footing, on the other hand, is a rule of the metrical component, which has an immediate phonetic effect but leaves the syntactic bracketing untouched.

How do the two models compare, then, in the way they handle the data? Consider (4.71):

(4.71) a.

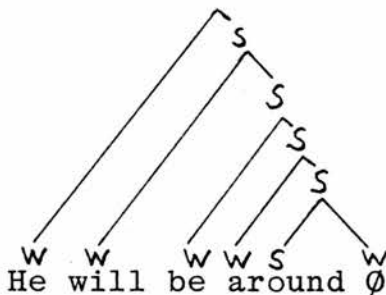

b.

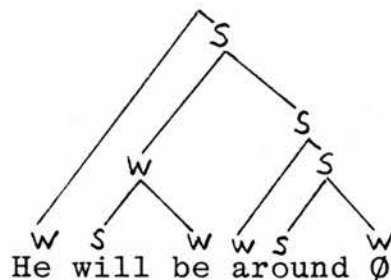

c.

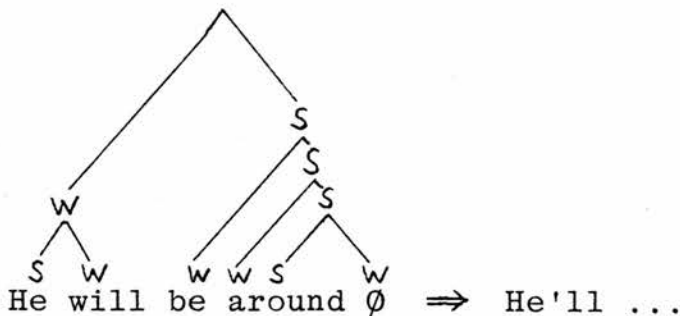

The possible scansion of this sentence exemplify both the merits and the failures of the two models. In my model, (4.71a) is the underlying structure; in Selkirk's, this structure is produced if all nonlexical monosyllables are destressed and no cliticisation rule is applied. Hierarchic Footing then produces (4.71b) as a derived structure whereas Selkirk's model, if I understand it correctly, has two options: either, *be* encliticises onto the modal (Selkirk 1972:113) - the result would be, in our terms, (4.71b) - or, the modal (she actually allows *will* to be called Aux) hangs on to the preceding pronoun - (4.71c) (Selkirk 1972:154).

Suppose we adjust our hierarchy in such a way that it is able to produce both (4.71b) and (4.71c). The problem immediately arises that, in the sentence analysed in (4.68) above, we get an ill-formed  $\begin{array}{c} \wedge \\ S \quad W \end{array}$  structure on

*he must*. The answer seems to be that *must have* tends to cliticise on the one hand in (4.68), and *he will* (4.71c) on the other.

We might either say that the hierarchic model has to take into account not only the element that becomes S but also the one that is to be its sister, or we might re-interpret Selkirk's solution in the following way: certain pairs of nonlexical items, presumably ones that frequently recur, get shifted into the lexicon as some kind of idioms. Among those would be *he will*, *must not*, *must have*, *are not*, *want to*, *have to* and all the others that Selkirk captures in her cliticisation rules. The fact that *not*-cliticisation precedes, in her model, subject-aux inversion (as in *hasn't he gone?*) is compatible with this proposal. Whenever these pairs occur, then, they are idioms or at least somehow lexicalised. As lexical items they are subject to the rules of word stress and receive initial stress; they

are subject to phonological processes of obscuration; they might as a result of those become monosyllabic (as *aren't*, *I'll*) - note that Selkirk's model does not allow monosyllabicity for these items. In the syntactic structure, they are dominated by one node which may or may not branch.

This approach would move the problem into the lexicon. The underlying metrical structure would then have a great deal of rhythmic alternation, brought about by the bisyllabic clitic idioms in the string. But does that mean that we would need no Footing of terminal nodes? Probably not. Let us return, briefly, to the structures in (4.71) above. Given that *will* in (4.71c), is cliticised onto the preceding *he* through whatever mechanism (metrical, cliticisation rule, or idiomatic), the following structures, I feel, ought to be permitted:

(4.72) a.

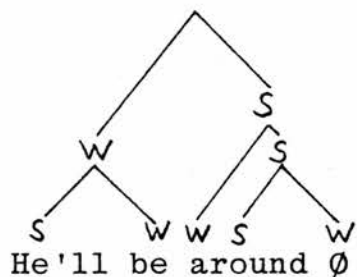

b.

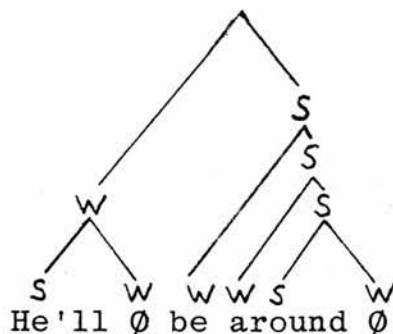

c.

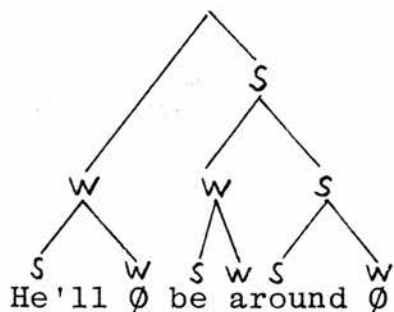

d.

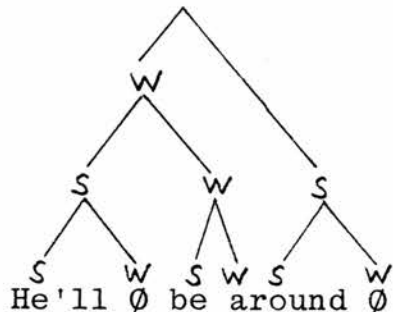

cont'd



(4.72) cont'd

e.

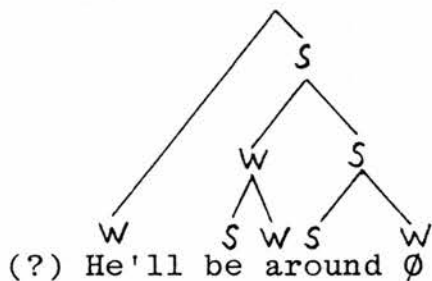

I don't suppose that the Footing operation carried out in (4.72a) can (or indeed needs to be) motivated as idiomatic cliticisation. Equally, Selkirk's model makes no provision for this kind of structure. But notice that a model where *he'll* is a lexicalised item automatically produces this structure since all lexical items have a word tree at least the size  $\begin{array}{c} \wedge \\ S \quad W \end{array}$ . Next, suppose we

don't let *be* automatically be the weak sister of lexicalised *he'll*. This is possible under our new version of the Zero Syllable Constraint (4.66). The result would be the tree (4.72b). In this tree, we can apply Footing and produce (4.72c), and, through W-Pairing, (4.72d). Both of these derived structures are, I suppose, well-formed and ought to be within the scope of our metrical model. And given this, I think that no mechanism needs to be invented that produces the rather poorly structured (4.72e). Of (4.72c.d.e), the former two seem to me more adequate, as well as being more highly structured, than the latter. Indeed, (4.72e) is not produced in a model that employs lexicalised clitics.

It seems, then, that we need an operation that produces something like (4.72c). Notice that there is no way *be a-* can with any justification be called a clitic idiom and

and that Selkirk doesn't produce this structure either. This, I would suggest, is sufficient evidence that some kind of Footing is needed even in conjunction with a model that handles certain clitics as idioms. The one conclusion that we can draw, then, is that Footing (4.63) should be among our metrical transformations of English.

As it stands, Footing is simply another case of W-Pairing (4.51): while W-Pairing applies to nonterminal nodes only, Footing applies to terminal ones. The structural descriptions of the two rules are identical. Are we in fact talking about one and the same rule?

This question leads us back to the mode in which Footing applies. W-Pairing applies wherever its structural description is met; for Footing I have proposed a hierarchy in which nonlexical items get selected for becoming strong. If we have a provision in the grammar that allows for idiomatic clitics, does that mean that Footing can do without the hierarchy in (4.62)? If this is the case then W-Pairing and Footing are the same rule, identical in mode of application as well as form. My tentative answer to this question is yes, but I'm not very certain about it. If I'm right, then the model involving idiomatic clitics as well as Footing is simpler than the one I started off with as well as descriptively more adequate. Notice that it is easier to collapse W-Pairing and Footing into one than it is to keep them apart: further conditions would have to be added to them if we wanted to avoid their collapse. As they stand, they simply are the same. Recall that I observed earlier that any grammar is likely to require at least some idiomatic clitics in order to be descriptively adequate, with or without hierarchic application of Footing. And given that the hierarchy doesn't seem able to cope on its own, it seems to make some sense to include as much as possible in the list of idiomatic

clitics and handle what is left with a, possibly non-hierarchical, rule of Footing (= W-Pairing).

This section is not conclusive, nor is it meant to be. Neither the hierarchy, nor Selkirk's approach, nor the idiom solution have been either confirmed or ruled out. All I would like to state is the belief that a solution will combine two of the three approaches that have been discussed. The third one (whichever it is) will probably prove unnecessary and each of the two that we end up using might be formally rather simple and - if this degree of optimism isn't immoral - externally motivated. Footing, for example, is rather well-motivated by the fact that we need W-Pairing anyway. And the fact that contractions like *isn't* precede subject-aux inversion and also rather 'look like' lexical items where their segmental and suprasegmental make-up is concerned lends at least some support to the idea that they might be lexicalised idioms.

What remains to be worked out, then, is an answer to the question which one(s) of the mechanisms above is/are going to be used eventually, how higher-level W-Pairing interacts with this level of metrical transformation, and, I suppose, how these rather powerful devices can be constrained (if indeed they have to be). As for this last question, some filters might be suggested which stop the grammar from admitting certain configurations. Thus, we might impose a filter which prevents a W-Pairing in (4.72b) above that produces a structure of the form



where the left-hand terminal W is a zero syllable. This, it will be remembered, violates the Zero Syllable Constraint. In general, I would think that a decision not to have automatic cliticisation across a  $]_p p[$  boundary would have to imply that no pairing operation

may work across that boundary either. This would rule out the above-mentioned structure; it also rules out (4.72d). Whether this is desirable I don't know. I suspect that it is in fact undesirable since the



structure is barred by the Zero Syllable Con-

straint anyway.

Moreover, consider (4.68) above. W-Pairing is possible in

this structure so as to produce  $\begin{array}{c} \text{W} \\ \swarrow \quad \searrow \\ \text{S} \quad \text{S} \quad \text{W} \end{array}$  for *he must have*. This, I believe, ought to be banned in English whenever (as is the case in this example) Defooting is unavoidable for further derivation. In any case, the one thing that becomes clear in this section is that it contains a number of interesting questions, most of them unanswered.

#### 4.5.3 Left-branching structures: S-Pairing and W-Pairing

There are two basic types of left-branching metrical structures: ones in which strength is assigned by the NSR, resulting in a left-to-right increase of strength, and ones in which the CSR produces a left-to-right decrease of strength. The former type, it will be remembered from section 3.2, can in morphosyntactic terms be subcategorised into embedded syntactic phrases, on the one hand, and embedded compounds with nuclear stress on the other. Thus, the following three kinds of structures have to be discussed in this section:

(4.73) a.

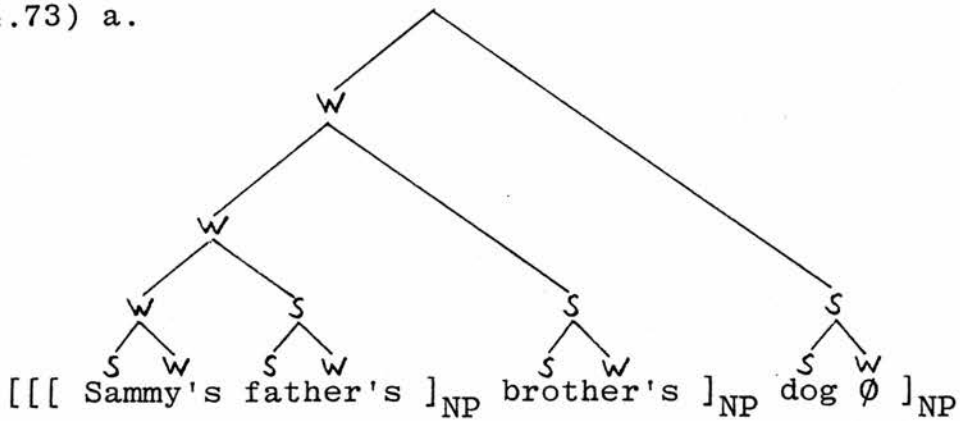

b.

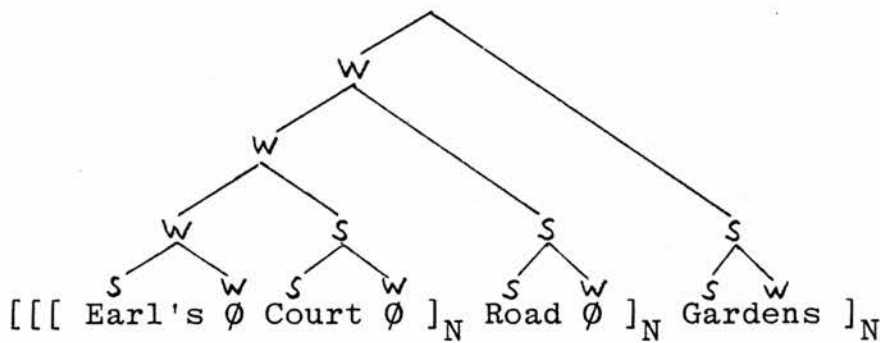

c.

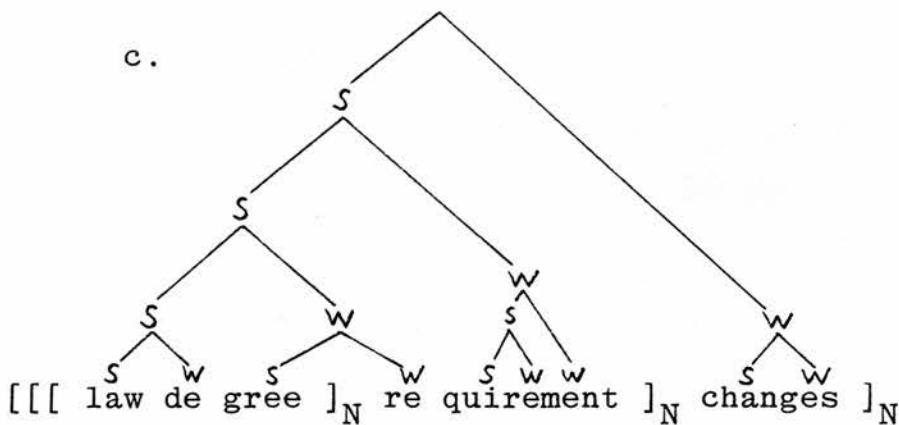

Let us deal with each of these three cases in turn.

Increasing prominence patterns like the one predicted by our model in (4.73a) are shunned in English. What we would be more likely to find is rhythmic alternation among the nodes dominating words. On the other hand, consider (4.74):

(4.74)

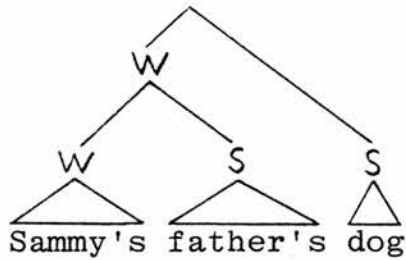

Here, I would claim, most speakers would actually produce an increasing pattern, unlike comparable structures like, say, *home-made beer* ((4.60) above), where Iambic Reversal is in operation. This difference - increasing pattern in *Sammy's father's dog* and alternation in *home-made beer* - is borne out in this model. Iambic Reversal is not available in (4.74) as it is barred from the heads of phrases. *Home-made*, on the other hand, is a compound adjective and there is nothing to stop Reversal.

Another observation has to be taken into account at this point. All the writers dealing with Readjustment Rules take as evidence in favour of such rules not only the alternation observed in prominence patterns such as (4.73a) but also - and often primarily: v. Langendoen (1975), Cooper (1980) - the occurrence of pauses or intonation breaks which are said to mark constituent boundaries. If we relaxed the 'head of phrase' constraint on Iambic Reversal and allowed this rule to produce rhythmic alternation in (4.73a), there would still be an embedded structure inside which no intonation breaks of the kind discussed here could be motivated. It makes sense to assume that intonation breaks occur in a metrical tree at ][-type metrical boundaries. Reversal in (4.73a) would produce no such boundaries.

There is yet another reason to bar Iambic Reversal from

left-branching embedded phrases, and that shows up if we consider phrases that have word-level Reversal at the same time, like this one:

(4.75)

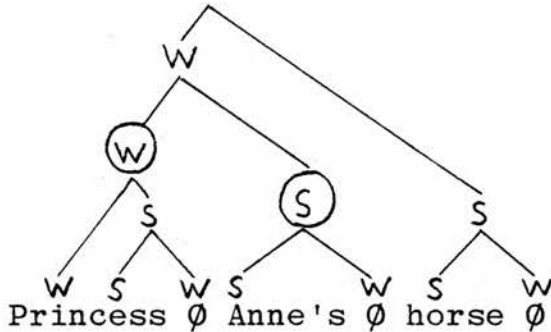

For a start, *Anne's* will usually retain its strength, just as *father's* in (4.74) does. The point is that relaxation of the 'head of phrase' constraint would not only run counter to this fact; Reversal of the circled nodes in (4.75) would also remove the environment required for the Reversal of *Princess*. In other words, if we permitted phrase-level Reversal here then we would also have to impose some - presumably cyclic - order (compare Kiparsky 1979), otherwise there would be nothing to motivate this process on word level where it undoubtedly takes place. This, I admit, is an observation rather than an argument in the present discussion and the whole issue is far from settled.

The question is what the process looks like that leaves structures like (4.74) and (4.75) unchanged but changes (4.73a) into a structure that realises rhythmic alternation as well as boundary-marking pauses. I propose the following transformation:

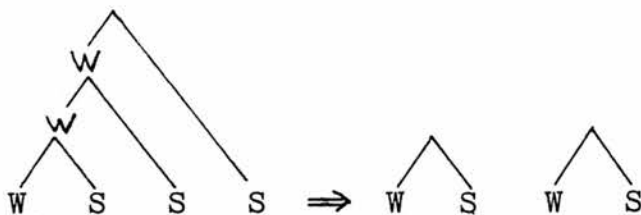
(4.76) S-Pairing

S-Pairing leaves (4.74) and (4.75) unchanged. From (4.73a) it produces the structure (4.77) below; note that this structure expresses rhythmic alternation and contains a juncture (after *father's*) that would motivate a pause:

## (4.77)

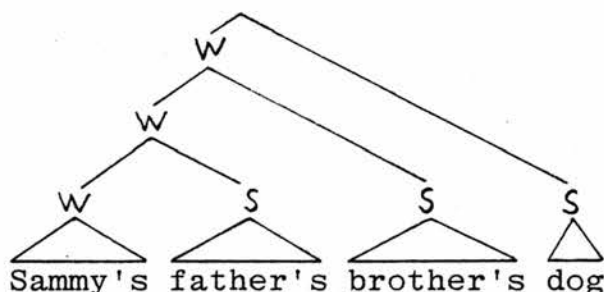

Note also that, once again, the DTE of the whole construction (*dog*) doesn't lose its strength. The same constraint has been observed in the context of previously discussed transformations.

Let us turn to the structure given in (4.73b). In metrical terms, this structure is identical with the one above it; the difference lies in the morphosyntactic bracketing. (4.73b) is a multiply embedded compound noun, with a prominence pattern governed by the NSR, and not a phrase. The question at issue is, then, whether alternation is achieved in a structure like this through Iambic Reversal



or through S-Pairing. After what has been said so far we are allowed to apply either (or indeed both).

Notice, first of all, that in *Earl's Court Road* ((4.78) below) we get Iambic Reversal of the circled nodes, rather like *home-made beer* but unlike *Sammy's father's dog*. This distribution confirms what has been said about Iambic Reversal so far. And its implications are quite interesting: we get as a result systematically different behaviour of NSR-compounds and phrases, although both have identical structures in their underlying metrical representation. The difference is brought about by the reference that Reversal makes to morphosyntactic bracketing.

(4.78)

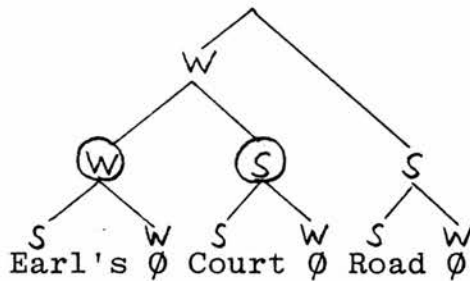

Having said that, we can now transform the structure (4.73b) into an alternating one via Iambic Reversal (as in (4.79a) below) or, alternatively, via S-Pairing (4.79b):

(4.79) a.

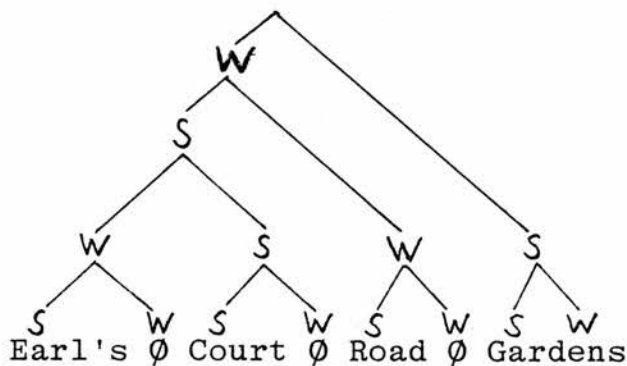

cont'd

(4.79) cont'd

b.

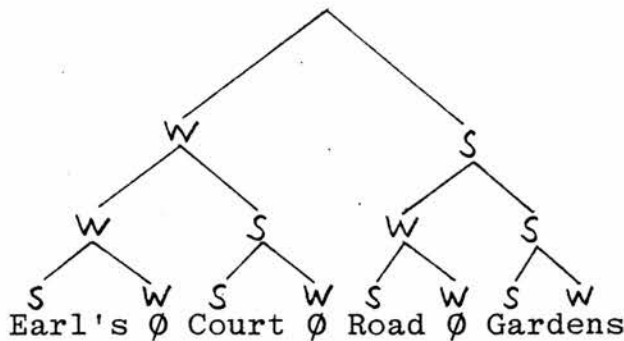

How can we make this choice, or can we indeed get both? The question is difficult to resolve and, as one would expect for prosodic phenomena that involve nonterminal nodes, evidence is hard to come by.

Nevertheless, I should at least try to give a tentative answer. Recall that S-Pairing produces, in a phrase like (4.77) above, two (alternating) blocks separated by an optional intonation break: [*Sammy's father's*] [*brother's dog*]. No breaking up of this kind seems to happen in *Earl's Court Road Gardens*. In fact, I would argue against an even optional intonation break, or pause, between *Court* and *Road*. On this basis, I would suggest that we apply Reversal here, thus favouring (4.79a), and not S-Pairing.

This forces a further decision on us. How is the choice going to be formalised in our model? Should we impose a condition on S-Pairing that restricts this transformation to phrases, or should we order the two rules with respect to each other in such a fashion that Iambic Reversal applies before S-Pairing, so that in this case the former produces a structure unsuitable for the latter? I offer no answer to this question but merely observe that there don't seem to be any instances where both rules can

actually apply to the same string, in whatever order. This, I think, rather weakens the case for extrinsic order but it is not a basis on which to make a decision.

I would think that no further flattening of the structure (4.79a) is possible. In particular, I wouldn't want to argue in favour of Defooting in this structure. Notice that precisely this is predicted by the form that I have given the Defooting rule (4.59). The structural description of the rule is not met in (4.79a) (nor, for that matter, in (4.79b)) and according to this model the string will retain its zero syllables on the surface. I think that this prediction is in fact correct and that in performance each one of the monosyllabic constituents must constitute an Abercrombian foot.

I would like to take up the main point of this section again, the claim that Iambic Reversal is applicable in 'level-stressed' compounds but not in phrases. There are some counterexamples to this claim: Reversal is common in phrases like *very good whisky*, *some more tea*, *Married Man's Allowance*, *Golden Gate Bridge* etc. Cases like this are, of course, somewhat embarrassing for this model but it seems to me that they can be accommodated if we appeal to 'lexicalisation', once again. Recall that I argued along similar lines in chapter three above. Here, I would argue that because of their idiomatic character, or because of their sheer frequency of occurrence, *very good* and *some more* get interpreted as end-stressed compound adjectives (rather like *home-made*), *Married Man's* and *Golden Gate* as compound nouns, rather like *Earl's Court*. This would make them eligible for Iambic Reversal. In whichever way this phenomenon is formalised, I think we have to capture in some way the observation that high frequency of occurrence, or idiomatic character, increases the likelihood of Iambic Reversal.

Finally, let us turn to left-branching CSR victims like (4.60) above. According to an LP-type analysis with metrical grid, in a complex compound like [[[*law degree*] *requirement*] *changes*], *law* is metrical stronger than the (metrical even) rest. Further alternation would then be solely a matter of adding extra grid elements (a common practice, it will be remembered, in LP but not in the approach adopted here).

I propose another pairing operation for cases like this, a transformation that changes the structure in (4.73c) into something like (4.80):

(4.80)

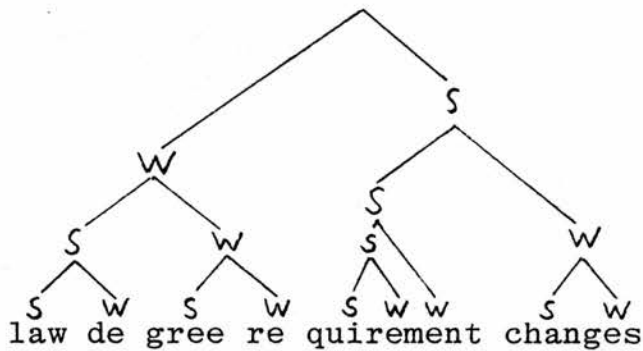

Similarly, we would get for [[[[*labour party*] *finance*] *committee*] *president*] a metrical structure transformation as in (4.81):

(4.81)

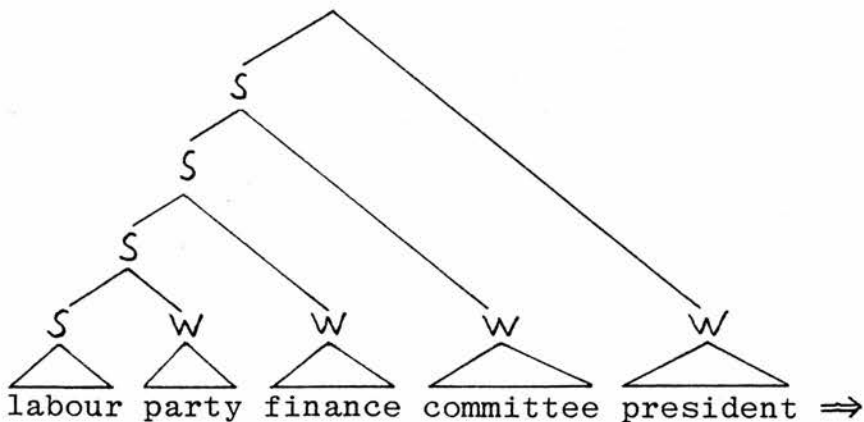

cont'd

(4.81) cont'd

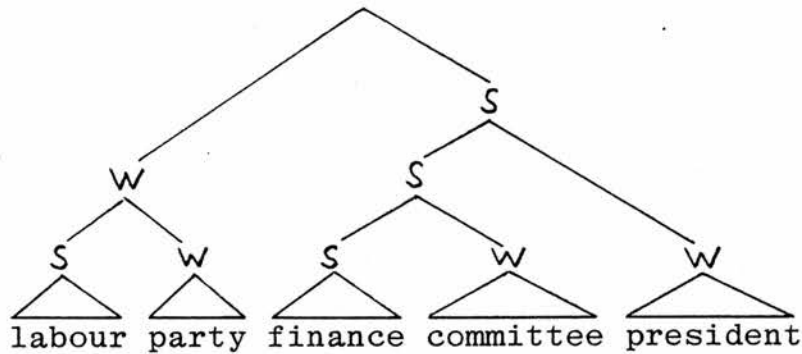

What is peculiar about this transformation is that it pairs parallel W nodes and also reverses the strength relations that hold among the higher nodes. It is rather as if, after the lexical level has been rebracketed, we get a re-application of the Compound Stress Rule. After, for example, the metrical rebracketing of  $[[[labour\ party]\ finance]\ committee]$  into  $[labour\ party]\ [finance\ committee]$ , the second of these constituents branches and will thus be strong.

This raises an interesting question. Is this effect produced by a CSR that is globally applicable throughout the derivation, or is it an idiosyncrasy that ought to be built into the metrical transformation that handles this particular set of cases? In other words, is CSR some kind of well-formedness condition that makes a right-hand node strong if it branches, wherever in the derivation this structure turns up? Or does CSR only apply once, presumably in the production of the underlying metrical structure? If the latter is the case, then the metrical transformation at work here must also carry out the task of switching the existing higher-level prominence over to the right.

Given what we know about the CSR and its sub-M equivalent, the Word Rule, I believe that the latter option is the one

to be taken, even if it misses a generalisation about compound structure. The Word Rule, it will be recalled, works only on one particular level of the derivation in the lexicon. At least in German, stressed prefixes can be

attached to existing  $\begin{array}{c} \diagup \\ S \quad W \\ \diagdown \end{array}$  structures and the result is an  $\begin{array}{c} \diagup \\ S \quad \begin{array}{c} \diagup \\ W \\ \diagdown \end{array} \\ \diagdown \end{array}$  structure, where the W dominating  $\begin{array}{c} \diagup \\ S \quad W \\ \diagdown \end{array}$  can only be accounted for if the Word Rule doesn't at that point apply any more. Clearly, the Word Rule is not a well-formedness condition. If it is to be collapsed with the Compound Rule - an important generalisation - then the Compound Rule cannot be a well-formedness condition either. I realise that I am arguing here across languages. But very tentatively, I take it that we don't allow the CSR to take on global responsibilities and express the entire change of structure in (4.80) and (4.81) in the following transformation, bearing in mind that it just might be possible to opt for the more powerful alternative if and when further evidence can be produced:

(4.82) W-Pairing (right-branching)

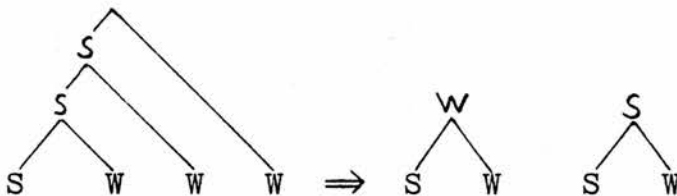

Note that this is yet another instance where two different morphological compound structures get metrically neutralised:  $[[[AB]C]D]$  and  $[AB][CD]$ . This seems to be a very common phenomenon in a variety of languages: German, English and incidentally, as Rischel (1972) points out, also Danish. He cites the case of *landbrugsstøtteordning* ('arrangement for financial support for agriculture')

and analyses it metrically as [AB][CD] although it is actually ambiguous: [[[A]B]C]D] is also a possible morphological bracketing.

There are two observations to be made here. One, that the English compounds discussed above in connection with rule (4.82) are also ambiguous; in fact, I find myself unable to come up with any examples that aren't. Two, that the Danish example has its main stress on *land*. This is in line with the Danish CSR, which always makes the left-hand one of two sister nodes strong (Rischel 1972), unlike its German and English counterparts.

These observations suggest a rather different approach to this problem. If it is the case that [[[A]B]C]D] compounds are always ambiguous and if the second possible reading is always [AB] [CD], then, it might be argued, speakers will always favour the latter metrical structure because the CSR produces for it rhythmic alternation, as in English with the main stress on C (and a subordinate one on A) and in Danish with the main stress on A (and a subordinate stress on C). This explanation would remove the necessity of having rule (4.82) as the input structures for this rule wouldn't get produced in the underlying metrical structure, in the first place.

This line of inquiry seems worth pursuing although it ought to be borne in mind that it is not likely to lead to a lot of further simplifications. Ambiguity of this kind, it seems to me, is only likely to occur with compounds whose minimal length would be [ABCD]. Neither in noncompound constructions nor in shorter compounds would I expect to come across the same kind of phenomenon.

## References

- Abercrombie, D. (1965) Syllable quantity and enclitics in English. In *Studies in phonetics and linguistics*. London: Oxford University Press.
- Abercrombie, D. (1967) *Elements of general phonetics*. Edinburgh: Edinburgh University Press.
- Abercrombie, D. (1976) 'Stress' and some other terms. *Work in Progress* 9:57-59. University of Edinburgh, Department of Linguistics.
- Allen, G.D. (1968) The place of rhythm in a theory of language. *UCLA Working Papers in Phonetics* 10:60-84.
- Allen, G.D. (1975) Speech rhythm: its relation to performance universals and articulatory timing. *Journal of Phonetics* 3:75-86.
- Allen, M.R. (1978) *Morphological investigations in English*. Unpublished Ph.D. dissertation. University of Connecticut. Storrs.
- Allen, M.R. (1980) Semantic and phonological consequences of boundaries: a morphological analysis of compounds. In Aronoff and Kean (1980).
- Anderson, J.M. and C. Ewen (1980a) Introduction: a sketch of dependency phonology. In Anderson and Ewen (1980b).
- Anderson, J.M. and C. Ewen, eds. (1980b) *Studies in dependency phonology*. Ludwigsburg: R.U.U. Strauch.
- Anderson, J.M. and C. Ewen (forthcoming) *Principles of dependency phonology*.
- Anderson, J.M. and C. Jones (1974) Three theses concerning phonological representations. *Journal of Linguistics* 10: 1-26.
- Anderson, J.M. and C. Jones (1977) *Phonological structure and the history of English*. Amsterdam: North-Holland Publishing Co.
- Aronoff, M. (1976) *Word formation in generative grammar*. Cambridge, Mass.: MIT Press.
- Aronoff, M. and M.L. Kean, eds. (1980) *Juncture: a collection of original papers*. Saratoga: Anma Libri.



- Austin, T.R. (1976) A non-cyclic analysis of German word stress. *Occasional Papers in Linguistics* 2:105-116. University of Massachusetts, Amherst.
- Baker, C.L. (1971) Stress level and auxiliary behaviour in English. *Linguistic Inquiry* 2:167-182.
- Bech, G. (1963) Zur Morphologie der deutschen Substantive. *Lingua* 12:177-189.
- Benware, W.A. (1980a) Eine Änderung im deutschen Akzentmuster: In ehrendem Gedenken an Alexander Issatschenko. *Die Sprache* 26:186-190.
- Benware, W.A. (1980b) Zum Fremwortakzent im Deutschen. *Zeitschrift für Dialektologie und Linguistik* 47: 289-312.
- Berndt, R. (1960) *Einführung in das Studium des Mittelenglischen*. Halle: VEB Max Niemeyer.
- Booij, G.E. (1977) *Dutch morphology: a study of word formation in generative grammar*. Lisse: Peter de Ridder Press.
- Booij, G.E. (1981) *Generatieve fonologie van het Nederlands*. Utrecht and Antwerpen: Het Spektrum.
- Brame, M.K. ed. (1972) *Contributions to generative phonology*. Austin: Texas University Press.
- Brekle, H. and D. Kastovsky eds. (1977) *Perspektiven der Wortbildungsforschung*. Bonn: Bouvier.
- Bresnan, J.W. (1971) Contraction and the transformational cycle in English. Ms. MIT.
- Bresnan, J.W. (1972) Stress and syntax: a reply. *Language* 48: 326-342.
- Butterworth, B. ed. (1980) *Language production, vol. 1: speech and talk*. London et al.: Academic Press.
- Carlson, L. (1981) Word stress in Finnish. Ms. MIT.
- Catford, J.C. (1977) *Fundamental problems in phonetics*. Edinburgh: Edinburgh University Press.
- Chomsky, N. (1965) *Aspects of the theory of syntax*. Cambridge, Mass.: MIT Press.
- Chomsky, N. (1970) Remarks on nominalization. In Jacobs and Rosenbaum (1970).

- Chomsky, N. and M. Halle (1968) *The sound pattern of English*. New York: Harper and Row.
- Classe, A. (1939) *The rhythm of English prose*. Oxford: Blackwell.
- Cooper, W.E. (1980) Syntactic-to-phonetic coding. In Butterworth (1980).
- Crystal, D. ed. (1982) *Linguistic controversies: essays in linguistic theory and practice in honour of F. R. Palmer*. London: Edward Arnold.
- Dogil, G. (1979) *Autosegmental account of phonological emphasis*. Edmonton: Linguistic Research Inc.
- Dogil, G. (to appear) Grammatical prerequisites to the analysis of speech style: fast/casual speech. In Gibbon and Richter (to appear).
- Dressler, W. (1972) *Allegroregeln rechtfertigen Lentoregeln*. Innsbruck: IBS.
- Dressler, W. (1973) Zum Aussagewert der Lehnwortphonologie für die Abstraktheitsdebatte. *Die Sprache* 19:125-139.
- Dressler, W. (1977) *Grundfragen der Morphophonologie*. Österreichische Akademie der Wissenschaften, Phil.-Hist. Klasse, Sitzungsberichte, Band 315. Wien.
- Dressler, W. et al. eds. (1981) *Phonologica 1980: Akten der Vierten Internationalen Phonologie-Tagung, Wien, 29. Juni-2. Juli 1980*. Innsbruck: IBS.
- Engel, U. and P. Grebe eds. (1974) *Sprachsystem und Sprachgebrauch: Festschrift für Hugo Moser zum 65. Geburtstag, Teil 1*. Düsseldorf: Schwann.
- Ewen, C. (1980) *Aspects of phonological structure, with particular reference to English and Dutch*. Unpublished Ph.D. dissertation. University of Edinburgh.
- Faiss, K. (1978) *Verdunkelte Compounds im Englischen: Ein Beitrag zur Theorie und Praxis der Wortbildung*. Tübingen: Gunter Narr.
- Faiss, K. (1981) Compound, pseudo-compound, and syntactic group especially in English. In Kunsmann and Kuhn (1981).
- Faiss, K. (1982) Compound oder Suffigierung im Deutschen und Englischen. Linguistic Agency, University of Trier. Series A. Paper No. 94.

- Fischer-Jørgensen, E. (1948) Some remarks on the function of stress with special reference to the Germanic languages. *Congr. Intern. Sc. Anthropol. and Ethnol. Comptes-Rendus*, IIIe session. Bruxelles.
- Fudge, E. (1969) Syllables. *Journal of Linguistics* 5: 253-286.
- Gibbon, D. and H. Richter eds. (to appear) *Pattern, process and function in discourse phonology*. Berlin: De Gruyter.
- Giegerich, H.J. (1978a) On the rhythmic stressing of function words: a modest proposal. *Work in Progress* 11:42-51. University of Edinburgh, Department of Linguistics.
- Giegerich, H.J. (1978b) *Phonological aspects of the rhythm of spoken English*. Unpublished M.A. dissertation. Johannes Gutenberg-Universität Mainz.
- Giegerich, H.J. (1980) On stress-timing in English phonology. *Lingua* 51:187-221.
- Giegerich, H.J. (1981a) Compound stress in German: some observations and an exercise in metrical phonology. *Work in Progress* 14:83-97. University of Edinburgh, Department of Linguistics.
- Giegerich, H.J. (1981b) On the nature and scope of metrical structure. Indiana University Linguistics Club.
- Giegerich, H.J. (1981c) Zero Syllables in metrical theory. In Dressler *et al.* (1981).
- Giegerich, H.J. (1982) Metrische Phonologie und Kompositionssakzent im Deutschen. *Papiere zur Linguistik*.
- Giegerich, H.J. (1983) On English sentence stress and the nature of metrical structure. *Journal of Linguistics* 19:1-28
- Gimson, A.C. (1980) *An introduction to the pronunciation of English*. 3rd edn. London: Edward Arnold.
- Götz, D. (1971) *Studien zu den verdunkelten Komposita im Englischen*. Nürnberg: Hans Carl.
- Gussenhoven, C.H.M. (ms.) Stress shift and the nucleus. Undated ms.
- Halle, M. and S.J. Keyser (1971) *English stress: its form, its growth, and its rule in verse*. New York: Harper and Row.

- Halliday, M.A.K. (1967) *Intonation and grammar in British English*. The Hague: Mouton.
- Hayes, B. (1981) A metrical theory of stress rules. Indiana University Linguistics Club.
- Hayes, B. (1982) Extrametricality and English stress. *Linguistic Inquiry* 13:227-276.
- Helbig, G. and J. Buscha (1979) *Deutsche Grammatik: Ein Handbuch für den Ausländerunterricht*. 5., unveränderte Aufl. Leipzig: VEB Verlag Enzyklopädie.
- Heller, K. (1966) Das Fremdwort in der deutschen Sprache der Gegenwart. *Untersuchungen im Bereich der Gebrauchssprache*. Leipzig.
- Hoekstra, T. *et al.* (1981a) Introduction. In Hoekstra *et al.* (1981b).
- Hoekstra, T. *et al.* eds. (1981b) *Lexical grammar*. Dordrecht: Foris Publications.
- Hooper, J.B. (1972) A note on inserted and deleted vowels. *Stanford Working Papers on Language Universals* 10: 141-144.
- Hooper, J.B. (1976) *An introduction to natural generative phonology*. New York *et al.* Academic Press.
- Issatschenko, A. (1974) Das 'Schwa Mobile' and 'Schwa Constans' im Deutschen. In Engel and Grebe (1974).
- Jackendoff, R. (1975) Morphological and semantic regularities in the lexicon. *Language* 51:639-671.
- Jackendoff, R. (1977)  *$\bar{X}$  syntax: a study in phrase structure*. Cambridge, Mass.: MIT Press.
- Jackendoff, R. and F. Leirdahl (1981) On the theory of grouping and meter. *Musical Quarterly* 67:479-506.
- Jacobs, J. (to appear) Neutral and nicht-neutral Satzaccent im Deutschen. In Vennemann (to appear).
- Jacobs, R.A. and Rosenbaum eds. (1970) *Readings in English transformational grammar*. Waltham: Ginn.
- Jakobson, R. and M. Halle (1956) *Fundamentals of language*. The Hague: Mouton.

- Jespersen, O. (1962) Notes on metre. In *Selected Writings of Otto Jespersen*. London: Allen and Unwin.
- Jones, D. (1964) *An outline of English phonetics*. 9th edn. repr. Cambridge: Heffer.
- Jones, D. (1977) *Everyman's English pronouncing dictionary*. Rev. and ed. by A.C. Gimson. 14th edn. London: J.M. Dent.
- Kiparsky, P. (1966) Über den deutschen Akzent. *Studia Grammatica* 7:69-98.
- Kiparsky, P. (1975) Stress, syntax, and meter. *Language* 51: 576-616.
- Kiparsky, P. (1977) The rhythmic structure of English verse. *Linguistic Inquiry* 8:189-247.
- Kiparsky, P. (1979) Metrical structure assignment is cyclic. *Linguistic Inquiry* 10:421-441
- Kiparsky, P. (1981) Remarks on the metrical structure of the syllable. In Dressler *et al.* (1981).
- Kohler, K.J. (1977) *Einführung in die Phonetik des Deutschen*. Berlin: Erich Schmidt.
- Krech, E.-M. (1968) *Sprechwissenschaftlich-phonetische Untersuchungen zum Gebrauch des Glottisschlageinsatzes in der allgemeinen deutschen Hochlautung*. Basel.
- Krech, H. *et al.* (1969) *Wörterbuch der deutschen Aussprache*. München: Hueber.
- Kunsmann, P. and O. Kuhn eds. (1981) *Weltsprache Englisch in Forschung und Lehre: Festschrift für Kurt Wächtler*. Berlin: Erich Schmidt.
- Ladefoged, P. (1975) *A course in phonetics*. New York: Harcourt Brace Jovanovich.
- Langendoen, T. (1975) Finite-state parsing of phrase-structure languages and the status of readjustment rules in grammar. *Linguistic Inquiry* 6:533-554.
- Lass, R. (1976) *English phonology and phonological theory*. Cambridge: Cambridge University Press.
- Lass, R. and J.M. Anderson (1975) *Old English phonology*. Cambridge: Cambridge University Press.
- Lees, R.B. (1963) *The grammar of English nominalizations*. The Hague: Mouton.

- Lehiste, I. (1977) Isochrony reconsidered. *Journal of Phonetics* 5:253-263.
- Liberman, M. (1975) *The intonational system of English*. Ph.D. dissertation. MIT. Cambridge, Mass. [Published New York: Garland, 1979].
- Liberman, M. and A. Prince (1977) On stress and linguistic rhythm. *Linguistic Inquiry* 8:249-336.
- Lieberman, P. (1967) *Intonation, perception, and language*. Cambridge, Mass.: MIT Press.
- Lipka, L. (1977) Lexikalisierung, Idiomatisierung und Hypostasierung als Probleme einer synchronischen Wortbildungslehre. In Brekle and Kastovsky (1977).
- Luick, K. (1964) *Historische Grammatik der englischen Sprache*. Vol. 1. Repr. Stuttgart: Tauchnitz, and Oxford: Blackwell.
- Lutstorf, H.T. (1960) *The stressing of compounds in Modern English*. Dr.phil. dissertation Universität Zürich [Published Bern: Walter Fischer, 1960].
- Marchand, H. (1969) *The categories and types of present-day English word-formation: a synchronic-diachronic approach*. 2nd, rev. edn. München: C.H. Beck.
- Mathesius, V. (1934) Zur synchronischen Analyse fremden Sprachguts. *Englische Studien* 70:21-25.
- Meinhold, G. and E. Stock (1980) *Phonologie der deutschen Gegenwartssprache*. Leipzig: VEB Bibliographisches Institut.
- Nakatani, L.H. and J.A. Shaffer (1978) Hearing 'words' without words: prosodic cues for word perception. *Journal of the Acoustical Society of America* 63: 234-245.
- Pike, K.L. (1946) *The intonation of American English*. Ann Arbor: University of Michigan Press.
- Pike, K.L. and E. Pike (1947) Immediate constituents of Mazatec syllables. *International Journal of American Linguistics* 13:78-91.
- Philipp, M. (1970) *Phonologie de l'allemand*. Paris: Presses Universitaires de France.
- Prince, A.S. (1983) Relating to the grid. *Linguistic Inquiry* 14:19-100.

- Rischel, J. (1972) Compound stress in Danish without a cycle. *Annual Report of the Institut of Phonetics University of Copenhagen* 6:211-228.
- Roach, P. (1982) On the distinction between 'stress-timed' and 'syllable-timed' languages. In Crystal (1982).
- Ross, J.R. (1972) A reanalysis of English word stress. In Brame (1972).
- Sanders, W. (1972) Hochdeutsch /ä/ - 'Ghostphonem' oder Sprachphänomen? *Zeitschrift für Dialektologie und Linguistik* 39:37-58.
- Schane, S.A. (1979) Rhythm, accent, and stress in English. *Linguistic Inquiry* 10:483-502.
- Schmerling, S.F. (1971) A stress mess. *Studies in the Linguistic Sciences* 1:52-66.
- Schmerling, S.F. (1976) *Aspects of English sentence stress*. Austin: Texas University Press.
- Selkirk, E.O. (1972) *The phrase phonology of English and French*. Ph.D. dissertation. MIT. Cambridge, Mass. [Published New York: Garland, 1980].
- Selkirk, E.O. (1980a) On prosodic structure and its relation to syntactic structure. Indiana University Linguistics Club.
- Selkirk, E.O. (1980b) The role of prosodic categories in English word stress. *Linguistic Inquiry* 11:563-605.
- Siegel, D. (1974) *Topics in English morphology*. Ph.D. dissertation, MIT. Cambridge, Mass. [Published New York: Garland, 1979].
- Stötzer, U. (1975) *Die Betonung zusammengesetzter Wörter, unter besonderer Berücksichtigung der Komposita mit fremden Konstituenten*. Unpublished Dr.phil. dissertation. Humboldt-Universität Berlin.
- Stötzer, U. (1977) Betonung der Komposita im Satz. *Deutsch als Fremdsprache* 14:152-155.
- Sweet, H. (1879) On the laws of stress in compounds, in English. *Transactions of the Philological Society: Monthly Abstracts of Proceedings*. 4-6.
- Thompson, H.S. (1980) *Stress and salience in English: theory and practice*. Palo Alto: Xerox.

- Ulbrich, H. (1972) *Instrumentalphonetisch-auditive R-Untersuchungen im Deutschen*. Berlin.
- Vennemann, T. ed. (to appear) *Silben, Segmente, Akzente: Referate zur Wort-, Satz- und Versphonologie anlässlich der vierten Jahrestagung der Deutschen Gesellschaft für Sprachwissenschaft, Köln, 2.-4. März 1982*. Tübingen: Niemeyer.
- Von Essen, O. (1979) *Allgemeine und angewandte Phonetik*. 5., neubearbeitete und erweiterte Aufl. Berlin: Akademie-Verlag.
- Wellmann, H. (1975) *Das Substantiv (= Deutsche Wortbildung: Typen und Tendenzen in der Gegenwartssprache. 2. Hauptteil)*. Düsseldorf: Schwann.
- Wollmann, A. (1971) Stress shift in level-stressed compounds and the transformational cycle. *Münchener Papiere zur Linguistik* 2:1-8.
- Wurzel, W.U. (1970a) Der Fremdwortakzent im Deutschen. *Linguistics* 56:87-108.
- Wurzel, W.U. (1970b) *Studien zur deutschen Lautstruktur (= Studia Grammatica 8)*. Berlin: Akademie-Verlag.
- Wurzel, W.U. (1980) Der deutsche Wortakzent: Fakten - Regeln - Prinzipien. Ein Beitrag zu einer natürlichen Akzenttheorie. *Zeitschrift für Germanistik* 3:299-318.
- Zwicky, A.M. (1970) Auxiliary reduction in English. *Linguistic Inquiry* 1:323-336.
- Zwicky, A.M. and G. Pullum (1982) Cliticization versus inflexion: English *n't*. Indiana University Linguistics Club.