

**Event-Related EEG Correlations
Between Physically Isolated
Participants**

Marios D. Kittenis

Presented in 2007 for the Degree of Doctor of Philosophy in Psychology
at the University of Edinburgh

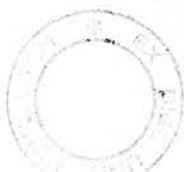

Declaration

I declare that this thesis is my own work and has not been submitted for any other degree or professional qualification.

Marios D. Kittenis

Quote

“...it’s all in the timing, you know.”

Robert L. Rorris¹

¹Personal conversation, 2004; presumably meant as a joke.

Abstract

This thesis is an attempt to evaluate findings previously reported in the research literature which have suggested the presence of event-related correlations in electrical brain activity between physically isolated participants. These studies are summarised in a literature review, where a number of methodological procedures are identified and evaluated, and the evidence presented by each study is assessed. One problem identified in this review is a lack of conceptual and methodological continuity across previous studies investigating this effect. In order to address this concern, a series of three experiments has been designed and conducted in an attempt to investigate this topic using a procedure and analytical methodology which remains largely constant across the three studies, so that their results can be comparable and cumulative. Each of these three experiments involved the randomly-timed photic stimulation of one participant, in order to test the hypothesis whether synchronous event-related changes in the EEG activity of another, physically isolated (and non-stimulated) participant could be identified. An additional question investigated is whether certain variables (such as the interpersonal relationship between participant pairs) may be related to any such EEG correlations found between participants, as has been suggested in previous studies.

In each of the first two studies, three groups of participants were recruited; participant pairs who knew each other well, randomly matched pairs of strangers, and single participants not matched with a photically stimulated partner. In both these studies significant differences have been found in measures of evoked-alpha global field power from non-stimulated subjects in related pairs, between periods of photic stimulation of their partners and randomly sampled control periods of no stimulation. Similar effects have not been found in randomly matched pairs, or in unmatched control subjects. Although these findings appeared to suggest the presence of correlations in brain activity between related participant pairs, certain temporal characteristics of the changes in EEG activity observed in non-stimulated subjects are not directly compatible with such an interpretation. In the final study, only related pairs of participants were recruited and a variation of the experimental paradigm was adopted in order to increase the overall sample size; no evidence of a similar effect has been found in this study however.

An overview of the results of the three studies is finally presented, and possible analytical and theoretical interpretations of the findings are discussed. Although the results of the first two studies were strongly suggestive of a genuine effect, the lack of replication of this effect in the final study necessitates the consideration of the overall findings as inconclusive. A critical review of the design and analytical methodology adopted in these experiments is presented and potential improvements are suggested; a review of more recent studies using similar experimental paradigms is also presented in the final chapter, and potential avenues for future research are proposed.

Acknowledgements

I would like to thank first of all my original supervisor, Robert Morris, for his encouragement to dare and ask difficult questions and for preparing me not to expect easy answers in return; although you made a break for it early, you have left me with much to think and laugh about for a very long time, and for this I am grateful. I owe much gratitude to my subsequent supervisors, Peter Caryl for his invaluable support, sound advice and patience beyond the call of duty, especially through the last stages, and to Dick Bierman, for graciously stepping in to help and for sharing more insights and good ideas than I could ever follow. The feedback of the examiners, Caroline Watt and Harald Halach, was instrumental in improving many aspects of this thesis, and their time and effort is gratefully appreciated. Many thanks are due to my past supervisors, Richard Bird and Roger Carpenter, for fostering my curiosity and teaching me to temper it with patience and persistence. Much gratitude goes to Graham Jamieson for generously sharing his time and EEG knowledge, to Jiri Wackermann for inspiring the experimental design and suggesting the main analytical measure used in these studies, and to Ian Baker, for being my EEG buddy and \LaTeX mentor, and for his solid support through the rough patches. To all the participants in the experiments, thank you for freely donating your time, enthusiasm and your heads, this work would not have been possible without your help. I am grateful for the generous support of the Bial Foundation (grant 37/00), the Denwyn Dobby scholarship, the Society of Psychical Research and the Koestler Parapsychology Unit, who have funded various stages of the research presented in this thesis, and also to the Inova Foundation and the Psychology Department of the University of Edinburgh for providing the funding for the EEG equipment used in the experiments. Many thanks and good wishes go to the extended KPU family, past and present, especially Ian Baker and Paul Stevens for their help with too many things to mention, Jo Law, Joanna Morris, Caroline Watt, Fiona Steinkamp, John Beloff, Claudia Coelho, Peter Lamont, Peter Ramakers, Stuart Wilson, James Lumsden-Cook, Niko Tiliopoulos, Richard Harrison, Mary-Jane Anderson, Daniel Hsia and Alison Easter, for their good company and their encouragement to carry on. Many thanks go to Jimmy Duncan, Alan Marshall, Bill Robertson, Mike Allerhand, Fiona Graham, Anna Sim, Karen Fleet and George Tait, for much behind-the-scenes support. To Iain Williamson, thank you for encouraging me to do this and for inspiring me to look beyond the surface of appearances; fare-well my friend, I hope we'll meet again. Many thanks go to Richard Bandler and Brian Colbert, for adding some much needed art to this science, and much respect and good wishes to Casey Hardison for making a stand for cognitive liberty. To David Luke, thank you for all the feedback and insights and your encouragement to work and play. I owe too much gratitude to mention to all my friends and family, for your love, support and tolerance through it all, especially the write up; to anyone I may have forgotten right now, many thanks and I owe you one.

Dedication

This thesis is dedicated to my parents, Dimitris and Aggeliki, for their unwavering love and support.

Contents

Declaration	i
Quote	ii
Abstract	iii
Acknowledgements	iv
Dedication	v
Contents	vi
List of Figures	ix
List of Tables	xiv
1 Introduction and literature review	1
1.1 “Is Berger’s dream coming true?”	2
1.2 Literature review	4
2 Study 1 and general methodology	17
2.1 Introduction	17
2.2 Method	18
2.2.1 Design	18
2.2.2 Participants	19
2.2.2.1 Selection of participants	19
2.2.3 Induction of internal attention states	21
2.2.3.1 Relaxation procedure	24
2.2.3.2 Drumming	25
2.2.4 Procedure	25
2.2.4.1 Related pairs	26
2.2.4.2 Unrelated pairs	27
2.2.4.3 Alone group	27
2.2.4.4 Timeline of procedure	27
2.2.5 Equipment and laboratory configuration	28
2.2.5.1 EEG system and parameters	28
2.2.5.2 Photic stimuli: materials and parameters	28
2.2.5.3 Randomised presentation of photic stimuli	30

2.2.5.4	Laboratory layout and equipment connections	30
2.3	Measures of EEG activity	32
2.3.1	Event related potentials	32
2.3.2	Event-related changes in the frequency domain	34
2.3.2.1	Induced event-related band power	34
2.3.2.2	Evoked event-related band power	35
2.3.3	Selection of EEG parameter as dependent variable	37
2.3.4	Global Field Power	40
2.3.5	Effect measure: λ -ratio	42
2.4	Results	43
2.4.1	Preliminary data processing	43
2.4.2	General results	43
2.4.3	Related Pairs	46
2.4.4	Unrelated Pairs	46
2.4.5	Alone Participants	47
2.5	Discussion	47
3	Study 2	52
3.1	Introduction	52
3.1.1	Hypotheses	54
3.2	Method	54
3.2.1	Design	55
3.2.2	Participants	55
3.2.3	Equipment and materials	55
3.2.3.1	Audio material	55
3.2.3.2	EEG system and parameters	55
3.2.3.3	Photic stimuli: materials and parameters	56
3.2.3.4	Randomisation and presentation of stimuli	57
3.2.3.5	Equipment connections and electrical isolation	58
3.2.4	Procedure	59
3.2.4.1	Related pairs	59
3.2.4.2	Unrelated pairs	59
3.2.4.3	Alone participants	59
3.2.4.4	General procedure	59
3.3	Results	60
3.3.1	Preliminary data processing	60
3.3.2	Dependent measure	60
3.3.3	Analysis of responses to direct photic stimulation	61
3.3.4	General results for all groups	64
3.3.4.1	Common photic stimuli	64
3.3.4.2	Rare photic stimuli	64
3.3.5	Results per group	66
3.3.5.1	Related pairs	66
3.3.5.2	Unrelated pairs	68
3.3.5.3	Alone participants	68

3.3.6	Differences in oscillatory activity between the three groups	69
3.3.7	Remaining questions	73
3.4	Discussion	74
3.4.1	Differences in α -rhythms between groups	74
3.4.2	Comparison of effect between common and rare events	76
3.4.3	Temporal displacement of effect	78
3.4.4	Conclusions	80
4	Study 3	82
4.1	Combined findings of Studies 1 and 2	82
4.1.1	Conclusions	85
4.2	Design of Study 3	88
4.2.1	Hypotheses	92
4.3	Method	92
4.3.1	Design	92
4.3.2	Participants	93
4.3.3	Equipment and materials	93
4.3.3.1	Audio material	93
4.3.3.2	EEG system and parameters	94
4.3.3.3	Randomisation and presentation of stimuli	94
4.4	Results	95
4.4.1	Preliminary data processing	95
4.4.2	Dependent measure	95
4.4.3	Comparison of λ -ratio measures	96
4.4.3.1	General results for all groups	97
4.4.4	Comparison of visual evoked responses	101
4.5	Discussion	104
5	General discussion	107
5.1	Overview of research findings	107
5.2	Theoretical considerations	113
5.2.1	Presentiment effect	113
5.2.2	Quantum non-locality and entanglement	114
5.2.3	Observational theories	116
5.2.4	Generalised Quantum Theory	117
5.2.5	Decision Augmentation Theory	119
5.2.6	'Classical' real-time psi	120
5.3	Review of recent literature	121
5.4	Limitations of thesis	128
5.4.1	Methodological limitations	128
5.4.2	Procedural limitations	130
5.4.3	Analytical limitations	131
5.5	Summary of findings and final suggestions	132
	References	136

List of Figures

1.1	Two early EEG tracings Berger recorded between 1928-1929, showing bursts of alpha activity from a subject resting with eyes closed; reprinted from Gloor, (1969).	4
1.2	Occipital EEG frequency spectrum (0-20Hz) for one subject acting as 'receiver', showing amplitude changes in the alpha band as a function of the frequency of photic stimulation of the 'sender', at 6 and 16Hz; "0" designates no photic stimulation; reprinted from Targ and Puthoff (1974).	9
2.1	Frequency spectrum of the drumming audio recording.	26
2.2	Emission spectrum of the white LEDs used in the experiment. A peak of blue light (≈ 465 nanometers) which is directly emitted by the GaN LED can be seen, as well as the broader spectrum emitted by the phosphor coating ($\approx 500 - 700\text{nm}$).	29
2.3	Diagram of laboratory; double wall lines signify sound-sheilded rooms.	31
2.4	Diagram of equipment and connections.	31
2.5	Average evoked potential during direct photic stimulation (solid red line) and control periods (dotted blue line) at electrode Oz. Group mean for $n = 39$ participants, with an average of 68 presented stimuli per subject. Photic stimuli were presented at $t = 0\text{ms}$ for 80ms.	33
2.6	Induced (non-phase-locked) alpha band power during direct photic stimulation (solid red line) and control periods (dotted blue line) at electrode Oz. Group mean for $n = 39$ participants, with an average of 68 presented stimuli per subject. Photic stimuli were presented at $t = 0\text{ms}$ for 80ms.	36
2.7	Evoked (phase-locked) alpha band power during direct photic stimulation (solid red line) and control periods (dotted blue line) at electrode Oz. Group mean for $n = 39$ participants, with an average of 68 presented stimuli per subject. Photic stimuli were presented at $t = 0\text{ms}$ for 80ms.	36
2.8	A 2-D plot of the topographical distribution of induced- α and evoked- α event-related activity in response to direct photic stimulation across the thirty-electrode array. Group mean for $n = 39$ participants, with an average of 68 presented stimuli per subject. Photic stimuli were presented at $t = 0\text{ms}$ for 80ms.	39
2.9	Evoked alpha band power across the thirty electrode recording sites during direct photic stimulation (solid red lines), and during control periods (dotted blue lines). Group mean for $n = 39$ participants, with an average of 68 presented stimuli per subject.	41

2.10	Global field power (GFP) calculated from the 30-channel data shown in Fig. 2.9. Activity shown is evoked alpha band power during direct photic stimulation (solid red line), and during control periods (dotted blue line). Group mean for $n = 39$ participants, with an average of 68 presented stimuli per subject. Photic stimuli were presented at $t = 0$ ms for 80ms.	41
2.11	Mean λ -ratio for non-stimulated subjects during periods of photic stimulation of their partners, and during comparison control periods of no stimulation. Error bars show \pm one standard error from the mean.	44
2.12	Mean evoked- α global field power during photic and control periods for non-stimulated participants in the Related pairs group ($n = 13$). Solid (red) line shows mean of photic stimulation epochs and dotted (blue) line shows mean of controls; on average, 93 photic and 93 control events were presented per subject.	46
2.13	Mean evoked- α global field power during photic and control periods for non-stimulated participants in the Unrelated pairs group ($n = 13$). Solid (red) line shows mean of photic stimulation epochs and dotted (blue) line shows mean of controls; on average, 93 photic and 93 control events were presented per subject.	48
2.14	Mean evoked- α global field power during photic and control periods for non-stimulated participants in the Alone participants group ($n = 13$). Solid (red) line shows mean of photic stimulation epochs and dotted (blue) line shows mean of controls; on average, 93 photic and 93 control events were presented per subject.	48
3.1	Emission spectrum of green and red LEDs used in this experiment.	57
3.2	Diagram of equipment and connections.	58
3.3	Comparison of mean ERPs at Oz in response to direct stimulation with common (green line) and rare (red line) photic stimuli for $n = 65$ participants.	61
3.4	Mean GFP (evoked- α) in response to direct photic stimulation for all $N = 65$ participants. (a) shows responses to common flashes and (b) to rare flashes; comparable control periods are shown in dotted lines. Please note the large difference in mean number of stimuli presented; an average of 105 common compared to 35 rare flashes (per subject/session).	62
3.5	Comparison of mean evoked- α GFP in response to direct stimulation with common (green line) and rare (red line) photic stimuli for $n = 65$ participants. In order to make the waveforms comparable, only one-third of epochs for common stimuli has been included; therefore both waveforms are comprised of an average of 35 stimuli per subject.	62
3.6	Common stimuli: Mean λ -ratio for non-stimulated subjects during periods of photic stimulation of their partners, and during comparison control periods of no stimulation. Error bars show \pm one standard error from the mean.	64
3.7	Rare stimuli: Mean λ -ratio for non-stimulated subjects during periods of photic stimulation of their partners, and during comparison control periods of no stimulation. Error bars show \pm one standard error from the mean.	65
3.8	Mean evoked-alpha GFP for common and rare stimuli, related pairs (non-stimulated subjects). Solid line is mean of photic periods and dotted line is mean of controls.	67

3.9 Mean evoked-alpha GFP for common and rare flashes, unrelated pairs (non-stimulated subjects). Solid line is mean of photic periods and dotted line is mean of controls. 68

3.10 Mean evoked-alpha GFP for common and rare flashes, alone participants. Solid line is mean of photic periods and dotted line is mean of controls. 69

3.11 Frequency spectrum (FFT) of the 1s pre-stimulus period for the three groups . . 70

3.12 Lower graph shows alpha oscillations in three alpha sub-bands which are out of phase in the pre-stimulus interval, synchronising in response to the stimulus. This stimulus-evoked phase-locking of alpha rhythms contributes $\approx 36 - 100\%$ of the amplitude in the P100 and N200 components of the standard ERP (upper graph); reproduced from Klimesch et al. (2000). 71

3.13 (a) Comparison of mean pre-stimulus (1s) induced (non-phase-locked) alpha power between the three groups. (b) Scatterplot of the relationship between pre-stimulus induced and post-stimulus evoked alpha power (mean GFP) for $n = 39$ directly photically stimulated subjects. Line represents best fit of linear regression. 72

3.14 Re-scaled graph of mean evoked-alpha GFP for common and rare flashes for Alone participants. Solid line is mean of photic periods and dotted line is mean of controls. 73

3.15 (a) Mean photovoltaic response to green flashes (solid line) and associated control periods (dotted line). Average number of epochs for each event was one-hundred-and-five (105). The start and end of the flash duration (0-40ms) is marked. (b) Mean photovoltaic response to red flashes (solid line) and associated control periods (dotted line). Average number of epochs for each event was thirty-five (35). The start and end of the flash duration (0-70ms) is marked. 79

4.1 Combined results of studies 1 and 2: Mean evoked- α global field power for Related pairs ($n = 26$). Solid line represents photic stimulation and dotted line control periods. 84

4.2 Combined results of studies 1 and 2: Mean evoked- α global field power for Unrelated pairs ($n = 26$). Solid line represents photic stimulation and dotted line control periods. 84

4.3 Combined results of studies 1 and 2: Mean evoked- α global field power for Alone participants ($n = 26$). Solid line represents photic stimulation and dotted line control periods. 85

4.4 Combined results of studies 1 and 2: Mean induced- α global field power for Related participants ($n = 26$). Solid red line represents photic stimulation periods and dotted blue line represents control periods. 87

4.5 Combined results of studies 1 and 2: Mean ERP (global field power) for Related participants ($n = 26$). Solid red line represents photic stimulation periods and dotted blue line represents control periods. 89

4.6	A 2-D plot of the topographical distribution of evoked- α event-related activity across the thirty-electrode array for $n = 26$ non-stimulated and $n = 26$ directly photically stimulated participants (Related pairs groups) from studies 1 and 2 (with an average of 93 and 105 presented stimuli per session, respectively in each study). Photoc stimuli were presented at $t = 0\text{ms}$; please note difference in scale between graphs.	89
4.7	Frequency spectrum of the audio recording of brown noise mixed with the sound of rainfall.	93
4.8	Combined results of studies 1 and 2: Mean evoked- α global field power for Related participants ($n = 26$). Solid line represents photic stimulation, and dotted line represents control periods. Colour index shows intervals to be used as test and control periods in Study 3.	96
4.9	Mean λ' -ratio for all subjects during periods of photic stimulation of their partners, and during comparison control periods of no stimulation. Error bars show \pm one standard error from the mean; $n = 26$ in each group.	98
4.10	Drumming group: Mean waveform of evoked- α GFP during photic stimulation of partner (red line) and control periods of no stimulation (blue dotted line). Seventy-eight events of each type (on average) presented per session at $t = 0\text{ms}$; $n = 26$	99
4.11	Brown Noise group: Mean waveform of evoked- α GFP during photic stimulation of partner (red line) and control periods of no stimulation (blue dotted line). Seventy-eight events of each type (on average) presented per session at $t = 0\text{ms}$; $n = 26$	99
4.12	Frequency spectrum (FFT) Comparison between the Drumming and Brown Noise groups (during periods of no stimulation).	100
4.13	Drumming group: Mean waveforms of evoked- α GFP during photic stimulation of each subject only ('Flash for self') and during photic stimulation of both subjects in each pair ('Flash for both'). Black line shows the mean of these two waveforms; the 50ms interval surrounding the peak amplitude of the mean waveform is marked. Seventy-eight events of each type (on average) presented per session at $t = 0\text{ms}$; $n = 26$	102
4.14	Brown Noise group: Mean waveform of evoked- α GFP during photic stimulation of each subject only ('Flash for self') and during photic stimulation of both subjects in each pair ('Flash for both'). Black line shows the mean of these two waveforms; the 50ms interval surrounding the peak amplitude of the mean waveform is marked. Seventy-eight events of each type (on average) presented per session at $t = 0\text{ms}$; $n = 26$	102
4.15	Mean peak GFP during photic stimulation of each subject only and photic stimulation of both subjects in each pair. Error bars show \pm one standard error from the mean; $n = 26$ in each group.	103
5.1	Comparison of mean frequency spectrum between studies 1+2 (related pairs, $n = 26$) and study 3 (drumming group, $n = 26$); samples taken from control periods of no stimulation.	110

5.2 Combined results of studies 1 and 2: Mean ERP (global field power) for non-stimulated participants in related pairs ($n = 26$). Solid red line represents photic stimulation epochs (for partner) and dotted blue line represents control epochs. . 112

5.3 Combined results of studies 1 and 2: Comparisons of mean evoked- α GFP during photic and control periods for each of the three groups ($n = 26$ per group, with an average of ≈ 70 epochs of each type per subject). 112

List of Tables

2.1	Mean λ -ratio and standard deviation values for photic and control conditions for each of the three groups.	44
2.2	Results of Wilcoxon signed-ranks test (two-tailed; $\alpha = .05$) for differences in mean λ values between control and photic conditions and associated effect sizes ($n = 13$ for each group).	45
3.1	Common stimuli: Mean λ -ratio and standard deviation values during photic and control periods for non-stimulated participants. $n = 13$ in each of the three groups.	65
3.2	Rare stimuli: Mean λ -ratio and standard deviation values during photic and control periods for non-stimulated participants. $n = 13$ in each of the three groups.	66
3.3	Results of Wilcoxon signed-ranks test (two-tailed) for differences in mean λ values between control and photic conditions, and estimated effect sizes ($n = 13$ for each group). Calculated for common and rare stimuli in each group, therefore significance level is adjusted for multiple tests ($\alpha = .025$).	66
4.1	Mean λ' -ratio and standard deviation values for subjects in the two groups, during photic stimulation of their partners and during comparison control periods of no stimulation. Results of Wilcoxon signed-ranks tests (two-tailed) for these comparisons and associated effect size estimates; $n = 26$ in each of the two groups.	100
4.2	Mean peak GFP and standard deviation values during photic stimulation of each subject only (Self flash), and photic stimulation of both subjects in each pair (Both flash). Results of Wilcoxon signed-ranks tests (two-tailed) for these comparisons and associated effect size estimates; $n = 26$ in each of the two groups.	103

Chapter 1

Introduction and literature review

A number of studies have appeared sporadically in the scientific research literature during the past five decades, which have reported findings suggesting the presence of correlations in measures of electrical brain activity between physically isolated pairs of human participants (e.g. Duane & Behrendt, 1965; Targ & Puthoff, 1974; Grinberg-Zylberbaum, Delafior, Attie, & Goswami, 1994; Wackermann, Seiter, Keibel, & Walach, 2003). The authors in each of these studies have interpreted their findings using a diverse variety of explanatory frameworks, although most commonly, these findings were considered to be similar in nature to certain apparently anomalous effects studied in parapsychological research, such as ostensible psi phenomena. The term *anomalous* refers to effects whose nature is not understood, and whose presence appears to be in conflict with generally accepted physical laws, or with other, well-established observations, and the term *psi* refers to “the process or processes operative when a significant correlation is found between behavioral and/or physiological events in a living organism and some other real world event [i.e. a physical, observable and quantifiable event], when according to our present knowledge of physics, no relevant information about the event could have reached the organism” (Tart, 1963, p.375). On the basis of their findings, the authors in many of these studies have speculated that there may be means of interaction or communication between individuals other than the recognised sensory and motor channels, which can still operate under conditions of physical and sensory isolation, i.e. when no known means of energy or information transfer between these individuals are available. Some of these investigators have noted that they were initially motivated to investigate this hypothesis on the basis of experiential reports of instances where illness or trauma in one pair of identical twins had appeared to affect the other, even though the twins were far apart and each was unaware of the other’s predicament (Grinberg-Zylberbaum et al., 1994); reports of such experiences are not exclusive to twins, although usually there is a familial or emotional relationship between the individuals involved (e.g. see Broughton, 1992). Such phenomena are generally considered to be the subject area of parapsychological research, which over the last century has developed a large and innovative variety of experimental paradigms and conceptual frameworks to approach this complex and often controversial topic (e.g. see Irwin, 1999).

An overview of such paradigms and their findings is beyond the scope of this thesis, which

will focus exclusively on one experimental paradigm, involving the use of electroencephalographic (EEG) measures to investigate hypothetical correlations in electrical brain activity between physically isolated pairs of human participants. As the use of EEG measures is therefore a defining feature of the subject-matter of this thesis in terms of delineating the relevant literature to be reviewed, as well as being a central aspect of the experimental methodology used in the three empirical studies reported in the following chapters, it will therefore be useful to begin our review of the background literature on this topic with a historical overview of the development of electroencephalography. This historical overview will also prove to be relevant to the topic of this thesis for additional reasons beyond the use of EEG techniques as a methodological tool, as will become obvious in the following section.

1.1 “Is Berger’s dream coming true?”

1

The early beginnings of electrophysiology can be traced to Luigi Galvani (1737-1798), Alessandro Volta (1755-1832), George Ohm (1787-1854) and Michael Faraday (1791-1867), whose work led to the understanding of electrical current and potential, and to the recognition of the electrical properties of living tissue, especially in relation to muscle activity. Another important early contribution was by Emil Du Bois-Reymond (1818-1896), who focused on the study of physiologically related electrical phenomena and constructed galvanometers with increased sensitivity for this purpose, and also developed non-polarisable clay electrodes, which proved to be instrumental for the first animal and human EEG recordings (Collura, 1993). The discovery of electrical activity in the brain is credited to Richard Caton (1842-1926), who -using Du Bois-Reymond’s electrodes- was the first to record spontaneous electrical activity from the exposed brains of monkeys and rabbits at the Royal Infirmary in Liverpool (Caton, 1875). Caton was also the first to record changes in brain electrical activity in response to sensory stimulation, and reported that “Impressions through the senses were found to influence the currents ... by stimulation of the ... retina by light” (Caton, 1877, p.62).

The development of human electroencephalography however can be traced directly to German psychiatrist Hans Berger (1873-1941), who had embarked on a mostly solitary forty-year long program of psychophysical research in the late 1890’s (Gloor, 1994). Berger had originally studied mathematics and astronomy at the University of Berlin, and in 1892 he enlisted for a year of military service in Würzburg; during this time he had a strange experience which baffled the young scientist, and prompted his search for the connections between mind and matter, between the physiology of the brain and mental processes:

“One spring morning, while mounted on horseback and pulling heavy artillery for a military training exercise, Berger’s horse suddenly reared, throwing the young man to the ground on a narrow bank just in front of the wheel of an artillery gun. The horse-drawn battery stopped at the last second, and Berger escaped certain death with no more than a bad fright. That same evening, he received a telegram from his father, inquiring about his son’s well being. Berger later learned that his

¹This was the title of Pierre Gloor’s ‘Berger Lecture’, delivered at the 13th International Congress of Electroencephalography and Clinical Neurophysiology, Vancouver, BC, Canada, September 1993. This lecture was also published as a review article (Gloor, 1994).

older sister in Coburg was overwhelmed by an ominous feeling on the morning of the accident and she had urged their father to contact young Hans, convinced that something terrible had happened to him. He had never before received a telegram from his family, and Berger struggled to understand this incredible coincidence based on principles of natural science. There seemed to be no escaping the conclusion that Berger's intense feelings of terror had assumed a physical form and reached his sister several hundred miles away—in other words, Berger and his sister had communicated by mental telepathy. Berger never forgot this experience, and it marked the starting point of a life-long career in psychophysics." (Millett, 2001, p.524)

Berger continued his studies after his return from Würzburg, although his interests now turned to medicine, and after completing his medical training he begun work at the psychiatric hospital at Jena, where he remained until his retirement and where he conducted the research which ultimately led to the development of EEG (Millett, 2001). Berger's research program was highly ambitious, and his work was beset with difficulties largely related to limitations imposed by the technology available at the time; his thinking however, although guided by surprisingly basic principles, had anticipated many of the twentieth century's breakthroughs in neuroscience. He rejected mind-body dualism which was a dominant paradigm at the time, on the basis that it violates the principle of conservation of energy, and founded his own attempt to address the mind-body problem based on this very same principle (Gloor, 1994). Berger speculated that mental activity must be depended on the transfer and transformation of energy in the brain, and that therefore it should be possible to detect changes in temperature, blood flow and electrical activity in the brain which are related to mental activity. He began his search for a physiological measure of mental processes by looking at potential metabolic correlates of mental activity, and initially focused on studying changes in cerebral blood flow in relation to various cognitive tasks and sensory stimuli; working with technical instruments which were not up to the task however, he was largely unsuccessful in these attempts. His assumptions ultimately proved to be correct however, as it is these same principles which now underly contemporary brain imaging technologies such as PET and fMRI². Berger then turned his attention to studying electrical activity in the human brain, a task somewhat more feasible given the instruments he had at his disposal, although certainly far from straightforward. Although for many years he struggled with setbacks, often involving the failure of equipment pushed beyond their capacities, he patiently persisted in improving his instruments and methodology -largely by trial and error- and this time his work eventually bore fruits. By 1927 he had begun to produce the first EEG tracings from patients with skull defects, (whose brains were more exposed and electrical potentials were therefore less obstructed by intervening bone), and with some further improvements in instrumentation, soon after was producing good quality recordings from volunteers with intact skulls (Millett, 2001). From these early recordings Berger identified two distinct types of spontaneous oscillations in electrical brain activity, one of approximately 10 cycles-per-second (10Hz), which he named *alpha* waves (see Fig. 1.1), and the other of approximately 20Hz, which he named *beta* waves.

Berger's findings were initially greeted with much scepticism, as "Many British and American workers did not have access to the German journals where Berger published his papers on

²Positron Emission Tomography and functional Magnetic Resonance Imaging

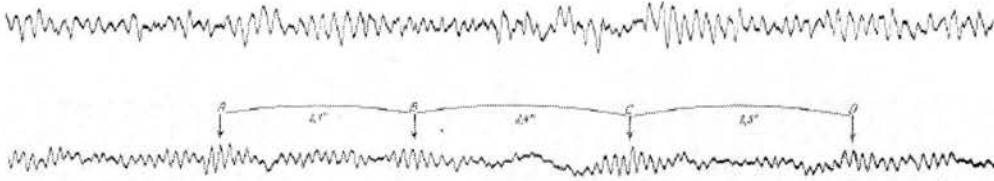

Figure 1.1: Two early EEG tracings Berger recorded between 1928-1929, showing bursts of alpha activity from a subject resting with eyes closed; reprinted from Gloor, (1969).

the human EEG in the early 1930s, and those workers who struggled through Berger's reports (no small feat, due to Berger's rambling and convoluted German prose) were convinced that the EEG was the result of some capricious electrical artifact" (Millett, 2001, p.541). His observations were eventually replicated by other researchers however, most famously by Cambridge physiologist Lord Adrian in 1934, who proposed using the term "Berger waves" as synonymous for alpha waves, giving Berger international recognition. His methods and many of the terms he coined quickly became established, and have remained primary standards in EEG research and clinical practices to this day.

EEG technology flourished during the 1940s and 1950s, and as research findings quickly led to the development of a multitude of clinical applications, electroencephalography soon became an invaluable diagnostic and monitoring tool in medicine, (especially for psychiatry, anaesthesiology and neurology), and has since also occupied a central role in psychophysiological and neuropsychological research. Berger however never lived to see the full success of his labours; after his retirement he became deeply depressed, in relation to his chronic (and worsening) heart problems, the rise of National Socialism in Germany and the start of World War II, and eventually committed suicide in 1941 (Gloor, 1969; Millett, 2001). Although Berger appeared to have begun his life-long study of the psychophysical interaction between mind and brain after becoming convinced by his strange army experience "that human thought was endowed with physical properties and could be transmitted from person to person" (Millett, 2001, p.540), he never applied the tools he had developed to study such phenomena himself. It therefore seems somehow fitting that the EEG methods which are the fruits of his achievements are now being used to study the type of phenomena which had initially inspired their development, and at the very least, such efforts can be regarded as a tribute to his life's work.

1.2 Literature review

This section presents a chronological review of experimental studies investigating the hypothesis of event-related EEG correlations between physically isolated participants. *Event-related* in this context refers to changes in parameters of EEG activity which are directly related to sensory, motor or cognitive events, such as sensory stimulation (e.g. audible tones, flashes of light, skin pressure), motor movements (e.g. button presses), or mental tasks (e.g. silent counting, internal visual imagery). A typical experimental protocol in such studies for example, would involve the sensory stimulation of one participant of a pair at randomly chosen time intervals; this stimulated participant will demonstrate event-related changes in EEG activity

in response to the stimuli, such as *evoked potentials* or an attenuation of their resting alpha rhythm, i.e. *alpha desynchronisation* (these measures are described in the following chapter, in section 2.3 on page 32). EEG activity recorded from the non-stimulated subject would then be examined for evidence of changes which are synchronous to the event-related responses of their stimulated partner. Only studies which have used measures of event-related EEG activity as the dependent variable will be included in this literature review; several studies have used measures of EEG parameters in order to search for correlates of “psi hitting” within the context of a parapsychological experiment, while using other measures as dependent variables (e.g. McDonough, Don, & Warren, 2002). These studies will not be included in this review, as they are not directly relevant to the topic of this thesis.

The first documented attempt³ to use EEG measures as a dependent variable in a psi experiment appeared in a brief report of the Research Committee of the Psychical Research (1959). This report described six exploratory sessions where EEG was recorded from a physically isolated subject, while a distant agent was exposed to either intermittent photic stimulation or “psychologically painful or distracting stimuli”, types of stimulation which would produce pronounced changes in the EEG activity of the agent (although this was not recorded). The experimenters visually examined the EEG record of non-stimulated subjects for any signs of similar changes, but reported finding “no gross evidence of the operation of psi” (p.71)

A more concerted effort was reported a few years later by Charles Tart (1963), who recorded one channel of EEG and skin resistance from eleven student volunteers; these were told that they were taking part in an experiment on subliminal perception, and were asked to indicate with a key press whenever they thought a stimulus had occurred. Tart served as the agent himself (in all sessions), and was seated in another laboratory separated from the subjects’ chamber by several intervening walls. Throughout each session Tart received electric shocks administered by an assistant at random time intervals through electrodes attached on his ankle (“Shock” condition), and reported that these shocks were raised in intensity until the agent indicated that they had reached the maximum level he could tolerate. As a comparison condition, half of the shock trials involved delivering the electric current to a resistor (“Nonshock” condition). As well as the behavioral measure of stimulus detection (i.e. key presses), Tart used measures of skin resistance, alpha, beta and delta+theta EEG power, as well as a measure of “EEG complexity” to compare control (resting) periods against Shock and Nonshock periods. He reported that behavioural responses were at chance level, and only found significant effects with the EEG complexity measure, for both the Shock-Control and for the Nonshock-Control comparisons. He interpreted the results to “generally support the hypothesis that the subjects were physiologically responding to both the Shock and Nonshock trials by some form of psi cognition”, and attributed the lack of a difference between Shock and Nonshock conditions to the instructions given to the subjects, which “did not orient them to look for any particular kind of stimulus”. Although this study was on the whole well-designed and appeared to involve sufficient precautions against sensory leakage, we consider Tart’s conclusion to be unwarranted for several reasons. For example, although a total of twelve statistical comparisons were carried out no relevant adjustment of the alpha significance level is reported, and the measure of “EEG complexity” with which the significant effects were found is somewhat poorly defined in the article. Finally, no explanation is given why Shock and Nonshock periods were not directly compared against each other; the possibility that the significant differences found between both

³To the author’s knowledge.

these conditions and control periods could suggest that electrical interference between the shock apparatus and the EEG recording may have been responsible for the observed effects, is not mentioned.

A more well-known early study by Duane and Behrendt (1965) appeared as a brief article in *Science*; working at the Department of Ophthalmology in Jefferson Medical College (Philadelphia, USA), Duane and Behrendt recruited fifteen pairs of monozygotic twins and attempted to test the hypothesis that stimulus-related changes in the EEG activity of one subject may be reflected in similar changes in the EEG activity of their (non-stimulated) sibling. They recorded EEG simultaneously from both participants in each pair of twins, and while one subject of the pair was asked “to sit quietly, remain serene, and keep their eyes open” (p.367), their sibling was instructed by the experimenters to open and close their eyes at various intervals. The amplitude of the alpha rhythm (i.e. spontaneous EEG oscillations between 8–13Hz) is known to increase when subjects close their eyes, and to decrease in response to opening the eyes; the response of the alpha rhythm to the presence or absence of visual stimulation is a robust and very reliable phenomenon (e.g. Shaw, 2003), and was in fact one of Hans Berger’s early observations (Berger, 1929). Consistent and easily identifiable event-related EEG responses can be produced by inducing such changes in the amplitude of the alpha rhythm, and this method was adopted by Duane and Behrendt. They therefore examined the EEG trace of one subject of each pair (who had his/her eyes open throughout the session), for potential increases in alpha activity coinciding with similar increases in the EEG activity of their twin sibling, whose alpha amplitude varied in response to the experimenters’ instructions to open or close their eyes. Duane and Behrendt named this phenomenon “extrasensory induction”, and defined it as “the appearance without conventional elicitation of an alpha rhythm in one twin while this is being evoked under standard conditions in the other” (p.367). They reported finding evidence of such “extrasensory induction” in two out of the fifteen pairs of twins they had tested, and also that they repeated the tests with unrelated pairs of subjects and found no instances of such induction.

Although certainly innovative and pioneering, Duane and Behrendt’s (1965) study was however far from exemplary in terms of the quality of the design and its execution, and had attracted strong criticism from within the parapsychological community. In a letter to *Science*, Charles Tart (1966) expressed his surprise at the publication of the Duane and Behrendt study in a journal that had published a number of articles critical of psi research in the past, as he believed that “the report would have been rejected on first reading by all of the four reputable parapsychological journals” (p.151). One of the main problems is the lack of information on several crucial aspects of the design and procedure; for example, Duane and Behrend give no information as to how the timing of their instructions to the subjects to open and close their eyes was chosen, which strongly suggests that this was done at the experimenters’ discretion, without the use of any formal randomisation method. They also neglect to report how many trials (i.e. instructions for eyes open/eyes closed) each session had involved, and whether the timing of these events was marked on the EEG records of the ‘senders’ and ‘receivers’ (and if so, how). Furthermore, although they present the lack of a similar effect in unrelated pairs as supporting evidence for the validity of the effect they had observed in 2 out of the 15 pairs of twins, they give no indication as to how many unrelated pairs they had tested, or how these participants were selected and matched into pairs. The most questionable aspect of their design however, is the lack of a standardised, quantitative measure of changes in the amplitude of the alpha

rhythm; they simply report that “analysis of the records was by gross inspection. The evidence sought was the presence or absence of alpha patterns [in ‘receivers’] and their correlations in tracings obtained from the subjects [the ‘senders’]” (p.367). Such entirely subjective, qualitative evaluation is clearly open to bias, especially as the authors also neglect to report whether the analysis was conducted by persons blind to the timing of the instructions given to their participants, or to the method used to decide this timing (if any such method was used). Finally, as they did not use any quantitative measures, it is therefore impossible to statistically evaluate their hypothesis, and although they do acknowledge that their results are not conclusive, they nevertheless claim that “extrasensory induction of brainwaves exists between individuals when they are completely separated” (p.367). Such a conclusion is clearly unjustified, and this study can at best be described as an exploratory pilot experiment; there were no follow-up studies however published by Duane and Behrendt, which is surprising given the potential implications of the effect they had reported, should that effect prove to be genuine and replicable. Despite its many faults however, their study was published in a high-profile journal and had therefore received considerably wide exposure; their experimental design has certainly been influential in the development of the experimental paradigms adopted in later studies, as it is clearly prototypical of many of the studies that have followed.

A pilot experiment involving only two participants was published by Silverman and Buchsbaum (1970), which appears to be the first study to have used measures of *evoked potentials* as a dependent variable⁴. This study attempted, reportedly without success, to detect evoked potentials in a non-stimulated subject while another subject was stimulated with single (i.e. not repetitive) stroboscopic flashes. This was followed by a study by Lloyd (1973), which also involved only one pair of subjects⁵; Lloyd recorded EEG from one subject of the pair, who was first presented with auditory stimuli (loud tones) in order to produce evoked potentials. After the presentation of several such stimuli, the other subject of the pair was asked to “send a telepathic signal” to the ‘receiver’ in the form of a mental image, at regular one-second intervals (prompted by timed photic flashes). Lloyd reported that the ‘telepathic stimulus’ also produced evoked potentials comparable to those obtained by the auditory tone stimulus, although there is no mention of the criteria used to judge what constitutes an evoked potential; Millar (1979a) also pointed out that the scales used on the graphs Lloyd presented were incorrect. Although involving only one subject, this study had attracted considerable attention at the time and its findings were widely referred to as the “Lloyd effect” (Millar, 1979b). John Beloff (1974, p.413) commented in this context, “what worries me about this brilliant pilot experiment is why it was not immediately followed up by a much more systematic attack that would really have clinched this remarkable discovery if that is what it is”.

John Beloff and Brian Millar subsequently conducted a replication of that study at Edinburgh University, using a sample of twenty subjects and with the addition of necessary controls and a number of improvements in the design and procedures (Millar, 1979a). Their experiment demonstrates a commendable level of methodological sophistication, and can perhaps be considered to be the first sufficiently controlled study using this paradigm. Millar presented agents with photic flashes using a stroboscope, and for control periods used trials where the strobe

⁴A detailed description of evoked potentials can be found in Chapter 2, page 32.

⁵We have been unable to obtain a copy of this article, and all information presented here has been sourced from Beloff (1974) and Millar (1979b, 1979a). According to Beloff and Millar, the name “Lloyd” is a pseudonym.

lamp was occluded by an opaque screen, thus ruling out the possibility that electrical interference or audible noise⁶ from the flashes could produce artefactual differences between test and control conditions. The timing of flashes was randomised using a “computerised RNG” (using a ‘true’ noise valve), and flash and control epochs from the EEG record of non-stimulated subjects were averaged to produce evoked activity curves. They then compared the mean power (μV^2) within the 50-450ms interval -the time window where ordinary sensory evoked potentials (EPs) appeared in stimulated subjects- between flash and control epochs using two types of analysis; a binomial test of the number of significant outcomes in 20 individual t-tests, and an overall t-test of the difference in the variance measure (between flash and control EPs) over all 20 non-stimulated subjects. Additionally they conducted a blind-judging analysis involving an attempt by a trained colleague to visually discriminate flash and control EPs. They found no significant effects in any of the three tests, and measures in all conditions were very close to mean chance expectation. A number of exploratory post-hoc analyses were then conducted (e.g. looking at possible temporal displacement effects), which also found no evidence suggestive of event-related changes in the EEG activity of non-stimulated participants. Millar concluded that no evidence of “telepathically evoked potentials was obtained” in their study, and questioned the validity of the effect reported by Lloyd (1973), colourfully adding that he has “little doubt that his results are the product of a lamentably inadequate methodology coupled with a rose-tinted oscilloscope” (Millar, 1979a, p.392).

A study conducted by Charles Rebert and Ann Turner in 1974 was published in full in *Behavioral Neuropsychiatry* (Rebert & Turner, 1974), although it is best known from a brief summary which appeared in *Nature* (Targ & Puthoff, 1974)⁷. EEG was recorded from six subjects while physically isolated agents were stimulated with trains of photic flashes (at frequencies of 6 or 16Hz) at randomly chosen intervals. Such repetitive photic stimulation typically produces an attenuation of the amplitude of the spontaneous alpha rhythm (“alpha blocking”, or alpha desynchronisation), similar to the effect of opening the eyes; another (although less consistent) effect of such stimulation is what has been called “photic driving”, which involves a shift in the dominant EEG frequency towards the frequency of photic stimulation.⁸ The experimenters therefore examined the EEG of non-stimulated subjects for such changes coinciding with the photic stimulation of the agents, and also asked non-stimulated subjects to indicate with a button press after each trial whether they thought the ‘sender’ had been presented with flashes at 6 or 16Hz, or with no flashes. They reported that overt guesses as to the type of stimulus presented to the ‘senders’ did not differ from chance expectation, and found no evidence of photic driving from any ‘receiver’ at either 6 or 16Hz. Some indication of suppression of alpha activity related to the type of stimulation of the ‘sender’ was reportedly found in one subject however, and seven additional sessions were subsequently conducted with this subject. The authors reported that average alpha power and peak alpha power on trials associated with 16Hz flashes were significantly lower compared to trials when no flashes were presented (see Figure 1.2), and this is what would be expected if this subject had been directly photically stimulated. However, as well as measures of average and peak power, three more variables

⁶Stroboscopes produce a crackling noise when flashing.

⁷Another brief summary also appears in May, Targ, and Puthoff (2002).

⁸For example, a subject resting with eyes closed may demonstrate an alpha rhythm with maximal amplitude centered at 11Hz. If this subject is photically stimulated with flashes at a frequency of 15Hz, they are likely to show an increase in EEG amplitude at that frequency, and/or their alpha rhythm may increase in frequency to approach 15Hz.

were measured and compared in this study, namely *contingent negative variation* (also known as the *readiness potential*, essentially an anticipatory response), as well as “peak position” and “synchrony”, two measures which are not defined in either article; the authors simply report that no significant effects were found for these comparisons. Therefore although a large number of statistical comparisons was conducted in this study, (probably as many as fifteen), no correction of the α significance level is reported, strongly suggesting that no such corrections were used. As reported significance levels were $p < .03$ and $p < .04$ for peak and average power respectively, even a modest adjustment of the α level to take multiple comparisons into account would most likely render these effects non-significant. Another problematic feature of this study is the exploratory variation of aspects of the protocol from one experimental session to another; in two of the seven sessions no sender was used, in one of these with the subject’s knowledge, while in the other without the subject being aware of this. The authors have made considerable efforts however to examine the possibility that their results may have been produced by system artefacts or by subtle sensory cueing of the subject, by conducting several control sessions. The results of these control sessions convincingly suggest that no such artefacts or sensory leakage can account for the observed effect; the validity of the effect itself however -in terms of statistical significance- nevertheless remains uncertain.

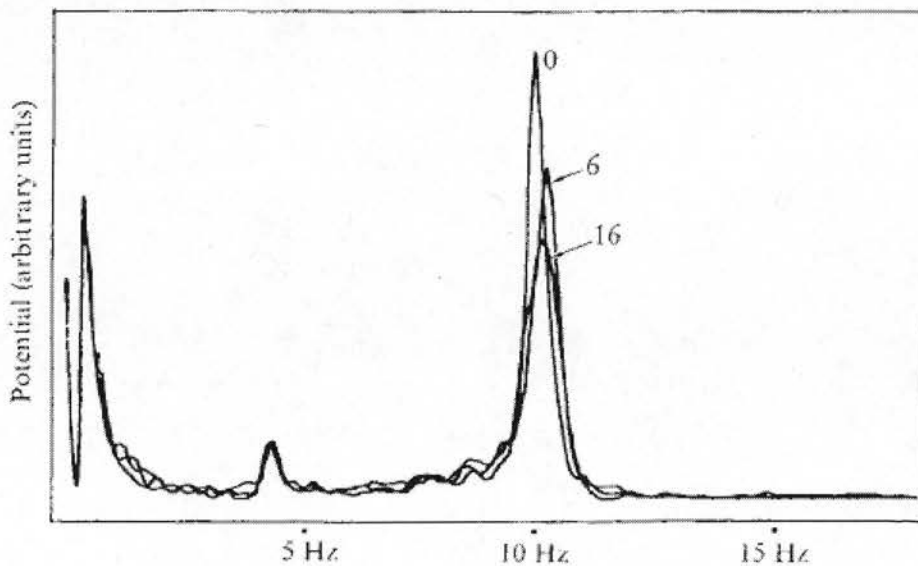

Figure 1.2: Occipital EEG frequency spectrum (0-20Hz) for one subject acting as 'receiver', showing amplitude changes in the alpha band as a function of the frequency of photic stimulation of the 'sender', at 6 and 16Hz; "0" designates no photic stimulation; reprinted from Targ and Puthoff (1974).

Two attempted replications of this study are briefly reported in May et al. (2002)⁹, both of which found significant differences in alpha power between no stimulation and 16Hz photic stimulation periods in non-stimulated 'receivers'. This difference however was in opposite directions in the two studies; i.e. a decrease in alpha power in relation to photic stimulation was

⁹Most likely conducted in the late 1970s or early 1980s, although this is not specified in the report.

found in the first study, whereas an increase was found in the second. The authors suggested that the fixed-band filter settings they had used to sample alpha activity were inappropriate, as some subjects demonstrated dominant alpha rhythms outside the filtered range, and concluded that although significant effects were found in these studies, the results are inconclusive and can only be considered as suggestive of an effect.

Between the mid-1980s and the mid-1990s a series of studies were published by Mexican neurophysiologist Jacobo Grinberg-Zylberbaum (hereafter noted as G-Z) as the principal author, investigating the question of potential psychophysiological correlations between distant participants using EEG methods (e.g. Grinberg-Zylberbaum, 1982; Grinberg-Zylberbaum et al., 1994). As several of G-Z's early studies have only been published in Spanish-language journals, it is difficult to present a complete overview of his work; this review will therefore focus primarily on two of his later papers which we consider to be representative of his work, and which have also attracted most attention from the wider scientific community. In Grinberg-Zylberbaum, Delaflor, Sanchez-Arellano, Guevara, and Perez (1992) three experiments are reported, each involving the stimulation of one subject of a pair with flashes in order to produce visual evoked potentials, and the examination of EEG activity from non-stimulated subjects for evidence of similar activity, which they termed "transferred potentials". Although their design is similar to many previous studies, G-Z's main innovation was the use of a procedure whereby participants in each pair were asked to spend some time alone together before their session, during which they were to attempt to establish "nonverbal, empathic communication in which they could feel each other's presence directly", a state which G-Z termed "direct communication". When subjects reported achieving such a state, they were taken to separate, sound proof and electromagnetically shielded chambers, and were instructed to maintain an awareness of each other throughout the session. The first experiment reported in Grinberg-Zylberbaum et al. (1992) involved five such pairs of participants, and while one subject of each pair remained in darkness, the other was "stimulated with simultaneous visual and auditory stimuli at random intervals". A control condition is also mentioned where the two subjects did not interact prior to their session, but the number of such sessions conducted is not specified. G-Z et al. visually compared averaged evoked potentials in stimulated subjects with averaged activity for the same periods in their non-stimulated partners, and calculated correlation coefficients between consecutive pairs of 32 data points from these epochs, thus obtaining "between 83 and 139 correlation values ... for each comparison of the averages of the evoked and "transferred" potentials, depending on the duration of the epochs which varied between 200 and 400ms". No explanation is given as to why the epoch length varied in this way, and although G-Z report that "only positive correlations with values greater than $r = 0.6$ were accepted as meaningful", they provide no explanation for their choice of this cut-off point. G-Z et al. present several graphical examples of identified "transferred potentials" (TPs), and report a number of high correlation values associated with these TPs. These examples are taken only from a few selected subjects however, and only for selected subsets of samples from these subjects' overall set of available EEG epochs; the correlation coefficients reported by G-Z et al. appear to have been equally selectively chosen, and refer to seemingly arbitrary time windows on the epochs, corresponding to intervals when apparent TPs were maximal. They further claim that no TPs were found in subjects who had not previously achieved "direct communication", but give no details as to how many such subjects existed. As no overall numerical or graphical results are presented for all subjects in this study, and as no formal statistical evaluation of the hypothesis has been

used, it is therefore impossible to evaluate the validity of these claims. The second experiment reported in Grinberg-Zylberbaum et al. (1992) is presented as a replication of the first study, “using a different analysis technique and ... new controls”. The same procedure as in the first experiment is followed for establishing “direct communication” between fourteen pairs of subjects, and a similar photic stimulation protocol is used. The authors calculated correlation coefficients between average evoked activity in stimulated and non-stimulated subjects, and defined the presence of a TP as involving a minimum positive value of $r = .6$. Although they suggest that by defining TPs in this way they have replaced the subjective visual identification of TPs they had used in the first experiment with a statistical procedure, they only present graphical results for one subject who apparently demonstrated TPs, and only report numerical values for associated correlation coefficients (ranging from $r = .606$ to $r = .98$) between latencies of 100 and 178ms. This interval was where the TP appeared to be most pronounced, and although presumably correlation coefficients were calculated for the entire epoch, these are not reported. No other numerical or graphical results are presented for any other subject, and G-Z et al. only vaguely report that “Similar results were obtained in 8 subjects; in other words, in about 57% of all cases”. The third reported experiment in Grinberg-Zylberbaum et al. (1992) involved four subjects, who were asked to sit together in silent darkness and to establish a state of “direct communication”. Once this was established, three of the subjects were taken to another chamber where they were collectively stimulated with photic flashes, although the authors do not specify the total number of such stimuli presented. They present a graph of two apparent TPs from the non-stimulated subject, stating that each is “an average from 256 samples”, although it is unclear whether this refers to an average of 256 epochs, or 256 consecutive data points, i.e. one epoch. The fact that the presented waveforms are of 256ms duration appears to imply the latter, which would suggest that these are two selected epochs (from an unspecified total) apparently showing TPs. Once again they report numerical correlation values only for selected segments of the epoch, where apparent TPs are more prominent. It is clear that on the whole this article is a collection of exploratory experiments lacking well-defined measures and hypotheses, where only an arbitrarily selected subset of the results is reported; therefore no conclusion can be reached as to whether the presence of “transferred potentials” has been demonstrated beyond chance expectation.

What is probably the most well-known article by G-Z was published in *Physics Essays* (Grinberg-Zylberbaum et al., 1994), and involved an experiment where EEG was recorded from both participants of seven pairs, while one participant of each pair was photically stimulated at random intervals with a total of 100 flashes. Participant pairs repeated the test in two conditions; in Condition 1 the subjects in each pair were shown to the two chambers “without having seen each other and without knowing that his/her partner was in the other chamber”¹⁰. In Condition 2 the subjects were introduced to each other “with instructions to get to know and then to feel one another in meditative silence for 20 minutes”. One hundred EEG epochs from each participant related to the moments of photic stimulation were averaged, and the resulting evoked potentials from each stimulated subject were compared to the averaged activity of their non-stimulated partner, by estimating correlation coefficient values between successive pairs of 16 data points from the two waveforms, and calculating the statistical significance or

¹⁰This appears to imply that participants in each pair did not know each other, although this is not explicitly stated in the article; no information is given as to how participants were recruited.

each correlation (although how this was calculated is not specified). The authors found no significant correlations for such comparisons in Condition 1 (when subjects did not interact prior to the session), but reported finding significant correlations in two pairs in Condition 2, which ranged between $r = .6$ and $r = .9$ during the first 132ms after photic stimulation. Although this difference between the two conditions is certainly suggestive of an effect, the authors fail to present overall results for all subject pairs and conditions, and only present graphical data and correlation values for the two pairs apparently showing “transferred potentials” in Condition 2, and for one pair in Condition 1 showing no such potentials. The authors also report conducting two control tests, both of which involved sampling 100 epochs of EEG activity from both subjects of a pair at random time intervals; in one of these control tests epochs were sampled during periods of no stimulation for either subject, and in the other control test epochs were sampled during periods when flashes were administered, but no subject was in the stimulation chamber. It is not clear in their report however, whether these control tests were conducted with each of the seven pairs of subjects, or whether they were conducted only once. The authors present only two graphical examples, one from each test, which show no TPs and very low correlation values for the comparisons between the averaged epochs; no other information is given about overall results from these tests. Although the Grinberg-Zylberbaum et al. (1994) article is probably the most detailed of G-Z’s publications with regards to methodological issues, it still does not contain enough information to evaluate their claims. As in previous reports, their discussion focuses on a few selected graphical examples of apparent “transferred potentials”, which although may be visually impressive, are not sufficiently convincing in terms of statistical validity to justify their far-reaching conclusions. May, Spottiswoode, and Faith (2001) have conducted an evaluation study where they calculated correlation values and associated significance estimates between the averages of 100 randomly sampled epochs from the EEG of resting subjects collected on different days. These were therefore unrelated samples, and no real correlations between these would be expected; May et al. however reported that such EEG data show considerable differences from truly random data. Their analysis suggested that even with completely unrelated EEG samples, there is a sizeable likelihood of finding large correlation estimates, and that such correlations demonstrate an artefactual enhancement of p values.

In summary, although the G-Z et al. studies have been widely cited in the literature as providing strong evidence for the presence of anomalous interactions between isolated human participants, on closer inspection it is clear that they offer insufficient information regarding their methodology and results to fully evaluate these claims. Although these studies are on the whole exploratory and their results cannot be considered as evidential, they have provided some suggestive findings, which are certainly worthy of further investigation using improved methodology and formally defined statistical criteria for evaluating the null hypothesis. The G-Z series of studies has nevertheless left its mark on a gradually emerging experimental paradigm, (involving investigations of event-related EEG correlations between two participants, one of whom is randomly stimulated), in primarily two ways. The first was the emphasis G-Z and colleagues have placed on the psychological state of their participants, by attempting to cultivating a shared state of empathic awareness between participant pairs; this was an influential approach and was adopted by many later studies. The second conceptual contribution of G-Z’s work to later studies involves the theoretical interpretation of their findings; in later papers, and especially in Grinberg-Zylberbaum et al. (1994), the authors present their results as evidence of non-local correlations between the brain activity of participant pairs, and they draw close

parallels between quantum entanglement as observed in subatomic particles, and the type of effects they have described as “transferred potentials“ between human participants. Although there are several problems with such an interpretation, not least the lack of a model of how quantum indeterminacy could be maintained in the warm and noisy environment of the human brain for prolonged periods, this theoretical model has proved to be a powerful metaphor that has guided many of the subsequent experimental attempts to replicate their findings.

One such attempt at a replication of the G-Z studies was conducted at the Institute of Psychiatry in London and was reported in a short research brief by Sabell, Clarke, and Fenwick (2001). The study involved an experimental group of twelve pairs of participants who knew each other well and who meditated together before the session, and a control group of twelve pairs who had not met each other before and did not interact prior to the session. One subject of each of these pairs was stimulated with 100 randomly timed auditory tones (the authors only report EEG results from non-stimulated subjects, so presumably EEG was not recorded from stimulated participants). In their analysis the authors used the averaged evoked activity in non-stimulated subjects (time-locked on photic stimulation of their partners), and compared the largest peak-to-peak amplitude in the pre-stimulus interval (-600 to 0ms) with the corresponding amplitude in the post-stimulus interval (0 to 600ms); the rationale in choosing this measure was that changes in the evoked activity of non-stimulated participants which are related to the auditory stimulation of their partners (i.e. effects similar to “transferred potentials”), would be expected to produce such pre- versus post-stimulus differences in evoked activity. The authors also conducted comparisons of such pre- versus post-stimulus differences in the frequency domain, focusing on four bands; 3-6Hz (upper delta/theta), 6-9Hz (theta/lower alpha), 9-12Hz (mid-alpha) and 12-15Hz (high alpha/beta). This is clearly a better test of the null hypothesis compared to the correlations used in the G-Z studies, as the statistical expectations of these within-subjects comparisons under the null hypothesis can be accurately predicted. The authors reported finding no significant differences between such pre-/post-stimulus periods for any of these comparisons; it is difficult to evaluate the validity of this conclusion however, as they have used a 3-factor Anova with time period (pre- versus post-stimulus), group (related pairs versus controls) and electrode positions as the factors. Such a global test could have masked significant differences in specific comparisons, for example differences between related pairs and controls in a measure of pre-/post-stimulus activity within the 6-9Hz band. Perhaps a better approach would be to convert the difference in pre- versus post-stimulus activity into a single ratio measure and use this as the dependent variable¹¹, and to perform separate statistical tests for evoked activity and for each frequency band, comparing related pairs and controls.

An article published in *Neuroscience Letters* by Wackermann et al. (2003)¹² describes an experimental attempt to investigate the type of effects reported by Grinberg-Zylberbaum et al. (1994), using a considerably improved methodology and analytical procedures. Three groups of participants were recruited in that study; one group (E_1) consisted of seven “...self-reportedly emotionally connected pairs (spouses, relatives, friends)”, and a second group (E_2) consisted of seven unrelated pairs of participants. In both these groups EEG was recorded simultaneously from both subjects of each pair, and while one subject was not stimulated in

¹¹This approach has been adopted in the three studies described in the thesis, and we are indebted to Sabell et al. (2001) for providing the inspiration for this measure.

¹²This study has also been reported elsewhere by Walach, Seiter, and Keibel (2001).

any way throughout the session, the other subject (who was located in another room), was visually stimulated at random time intervals using a checkerboard reversal pattern. Related pairs were given some time to interact with each other prior to their session, whereas unrelated pairs were unaware of each other's presence or of the real purpose of the experiment. The third group was comprised of two control sub-groups; one subgroup (K_1) consisted of three related pairs, and the other (K_2) consisted of four single participants. Related pairs in K_1 were exposed to the same procedure as related pairs in E_1 , although the screen where visual stimuli were presented was covered with an opaque shield so that the stimuli were not visible. In K_2 EEG was recorded from a single, non-stimulated subject, while visual stimuli were presented in the other (empty) room. Six channels of EEG were recorded from both stimulated and non-stimulated subjects of each pair simultaneously (and from single non-stimulated subjects in K_2), and stimulus-related epochs were averaged to produce waveforms of evoked activity. Visual evoked potentials were clearly visible in stimulated subjects, and according to the null-hypothesis no similar synchronous activity would be expected in their non-stimulated partners. In order to test this hypothesis Wackermann et al. identified the latency of maximum visual evoked activity in the stimulated subject of each pair, and sampled the voltage amplitude at the same latency in the averaged activity of their non-stimulated partners. They then used further samples from inter-stimulus periods to estimate a "reference interval" range for each non-stimulated subject within which amplitude variations would be expected, and counted the number of instances where the voltage of evoked activity from non-stimulated subjects at the critical latency (i.e. the time when their stimulated partner showed maximal evoked activity) exceeded this range. Such "outlier" counts were estimated for each group, and a considerably greater number of such outliers was found for the two experimental groups compared to the combined control groups. A statistical test (similar to the χ^2 test) indicated that overall between-group differences were significant at $p = 0.01$. The authors suggest that their results "indicate a high co-incidence of variations of the brain electrical activity in the non-stimulated subjects with brain responses of the stimulated subjects" (p.63) in both related and unrelated pairs of participants, and noted that there was no preferred direction in the effect (i.e. both unusually high and unusually low voltage values contributed to the effect), or any localisation of the effect in any particular cortical region. They commented that "the lack of directional and topographical consistency of the effect is physiologically counter-intuitive and suggestive of an erratic artefact", although they were "unable to identify any mechanism that could account for such an artefact" (p.63). This study is without doubt the most methodologically sophisticated of experiments using this type of paradigm (conducted up to this point), and as several levels of controls were used both in the execution of the experiment and in the analysis of the results, it is difficult to point out any potential sources of artefact which could account for the results. The authors conclude that "we are facing a phenomenon which is neither easy to dismiss as a methodological failure or a technical artefact nor understood as to its nature" (p.63-64), as no known biophysical mechanism can account for the observed correlations in EEG activity between isolated subjects; they speculate that a possible theoretical approach may be to generalise the notion of quantum entanglement as understood in physical systems, so that it can be applied to arbitrary systems, including biological organisms.

A number of studies investigating the same phenomenon have been published in recent years (e.g. Radin, 2004; Standish, Kozak, Johnson, & Richards, 2004; Achterberg et al., 2005; Richards, Kozak, Johnson, & Standish, 2005); these will not be reviewed in the present chapter

however, as they had been published after the first experiment reported in this thesis had been conducted, and were therefore not taken into account when designing the experimental protocol for this series of studies.¹³ These more recent studies will be reviewed in the final chapter, where their findings will be compared with the findings of the three studies reported in this thesis.

This review of studies investigating apparently anomalous event-related correlations in brain activity between isolated participant pairs has suggested that although the number of studies reporting such effects is noteworthy, several of these studies suffer from a number of methodological and analytical flaws, and/or report insufficient details to conclusively evaluate their findings. This is particularly the case with earlier studies, and although progressive improvements in the quality of experimental methodologies can be seen over time, a remaining problem is that little methodological or conceptual continuity can be found between these studies. Most studies have been carried out by different groups of investigators, with each group using considerably different (and often idiosyncratic) experimental procedures and analytical methods. Due to such methodological disparities it is exceptionally difficult to draw overall conclusions from these studies, especially as most have used small sample sizes and could therefore be vulnerable to chance artefacts. A related problem which must be acknowledged in this context, is the possibility of a disproportionate publication of studies reporting positive effects, i.e. a file-drawer effect.

In order to address these concerns, a series of three experimental studies has been designed and conducted in an attempt to investigate this topic using a standardised experimental procedure and analytical methodology, which will remain largely constant across the three studies. The design of these three experiments is to a large extent based on the studies described in this chapter, and the first of these experiments has been designed as a conceptual replication of the Wackermann et al. (2003) study. Although in the subsequent two experiments several changes in the design and experimental procedures were introduced, in order to maintain methodological continuity the same measures have been used throughout the three studies, and sufficient similarities in design have been retained so that their results can be comparable and cumulative.

Several of the studies summarised above have used theoretical models and terminology which -in the author's view- have often restricted their exploration of this topic within a limited context as allowed by their explicit or implicit assumptions. For example, the term "transferred potential" implies that the effect involves the transfer of some quantity, perhaps of energy or information; this is not necessarily the case however, and the term seems especially inappropriate when a model based on non-local correlations and quantum entanglement is proposed as the preferred explanatory hypothesis. As we are involved in an attempt to investigate a phenomenon whose precise nature is unknown and whose very existence is uncertain, we believe it is vitally important to make every effort to avoid such self-imposed limitations. In this series of studies we have therefore adopted a largely data-driven approach in our attempt to investigate this topic empirically, and have avoided the use of terminology likely to involve implicit theoretical assumptions. Therefore terms such as "senders" and "receivers" will be avoided, and the terms *stimulated* and *non-stimulated subjects* will be preferred; similarly, any observed synchronous changes in brain activity between stimulated and non-stimulated participants will be described

¹³Although a review article of studies investigating "dyadic correlations" in the EEG activity of isolated subjects by Wackermann (2004), which includes some of these newer studies, has contributed considerably in the design of our second experiment as described in Chapter 3

as *event-related correlations*, thereby avoiding terms likely to imply a causal relationship or the involvement of any specific physical mechanism. Although this terminology may at times make the description of empirical parts of this thesis appear somewhat cumbersome, we believe that this is preferable to the costs of using convenient terminology which may however restrict our conceptual scope of vision.

Chapter 2

Study 1 and general methodology

2.1 Introduction

The central aim of the first experiment is to attempt to replicate the primary findings of the studies reviewed in Chapter 1, while also attempting to address some of the methodological criticisms discussed in that chapter. The effects reported in previous studies often appeared to be small and erratic, therefore in designing our experimental protocol with the aim of replication, it was considered important to attempt to utilise factors that may potentially enhance and stabilise these effects. In the literature of experimental psi research certain variables have been suggested to correlate with improved scoring in various psi tasks (e.g. Honorton, 1977), and an attempt has been made to incorporate a selection of such potentially “psi-conducive” variables as part of our procedure. The validity of the hypothesised relationship of such variables to psi effects in most cases has not been sufficiently established, therefore the rationale for incorporating these factors into our procedure was largely utilitarian, rather than theoretical or empirical. The available evidence suggests that these variables *may* facilitate psi effects, therefore as long as they can be easily incorporated into our design without compromising its integrity, it would make practical sense to do so. The selection process of relevant variables to include in the procedure is described in detail in the Method section.

Although the core experimental paradigm used in the three studies reported in this thesis has been influenced to some extent by virtually all past studies reviewed in the previous chapter, specific mention is due to four studies from which we drew particular inspiration and ideas. The first is the study by Rebert and Turner (1974), which first drew our attention to this type of experimental paradigm and which seeded the idea to devote this PhD thesis to investigate this topic. Our initial aim was to replicate that study with a larger participant sample while improving certain aspects of its methodology, and we were also interested in developing an experimental paradigm able to address additional questions beyond the simple presence or absence of event-related EEG correlations between pairs of isolated participants. One such question concerned the potential role of the interpersonal relationship and pre-session interaction between participant pairs, an issue first addressed by Grinberg-Zylberbaum et al. (1994), who reportedly identified in their studies event-related EEG correlations between pairs of participants who had interacted prior to their session, but no such effects between pairs who had not. It was our intention to investigate this question while also improving on the design used

by Grinberg-Zylberbaum et al. (1994), which suffered from several methodological limitations. The later study by Sabell et al. (2001) has provided the inspiration for the development of the ratio measure of pre- versus post-stimulus activity which has been used as the dependent variable in this series of studies (this is described below in section 2.3.5 on page 42).

The more recent study by Wackermann et al. (2003) was published as we were working on designing an experimental protocol for our first experiment along the lines of Rebert and Turner's (1974) and Grinberg-Zylberbaum et al.'s (1994) work. The methodological paradigm developed by Wackermann et al. (2003) was a considerable improvement to all previous studies conducted on this topic, and appeared to be addressing many of the same questions that we had been planning to investigate. We therefore decided to base the design of our first study on the general framework of the Wackermann et al. (2003) study, while introducing certain modifications (e.g. in our choice of stimuli and dependent measures), so that this would constitute a conceptual rather than an exact replication study. The design of subsequent Studies 2 and 3 increasingly deviated from the original framework of the Wackermann et al. (2003) study, as changes suggested by the results of each completed experiment were incorporated into the design of the following studies.

The ultimate aim in designing the series of three experiments described in this thesis was to investigate this topic using a core methodology which would remain constant across the three studies so that their results can be comparable and cumulative, while also attempting to increasingly refine the hypotheses and methodology by introducing modifications in each new study likely to clarify some of the unresolved questions raised by the findings of each completed experiment.

2.2 Method

The primary purpose of this section is to describe the experimental methodology used in Study 1. Although certain methodological modifications were introduced in the two subsequent experiments, many core aspects of this methodology have remained unchanged throughout the three studies. Therefore in order to avoid unnecessary repetition in each of the following experimental chapters, those aspects of the methodology that have remained constant across the three studies will only be described in detail in this section. Modifications to the experimental design, stimuli and procedures introduced in the two subsequent studies will be described in detail in the Method sections of the respective experimental chapters. This section also aims to describe the development of the general experimental paradigm used in the three studies, which will hopefully serve to acquaint the reader with the rationale and choices involved in designing this paradigm.

2.2.1 Design

As our design was largely based on the Wackermann et al. (2003) study, three groups of participants were recruited in Study 1, two of which were identical to groups E_1 and E_2 in that study, as described in the previous chapter; i.e. we have recruited a group of related pairs who reported sharing an empathic relationship, and a group of randomly-matched, unrelated pairs. However, although in Wackermann et al. (2003) unrelated participants were unaware that they were paired with another participant or that they were taking part in a psi experiment, unrelated

participants in our study had full knowledge of the experimental design. Single non-stimulated participants were used as a control group, as in group K_2 in Wackermann et al. (2003). At the time of designing Study 1 we only had access to one EEG recording system, therefore EEG was recorded only from non-stimulated participants in each pair during experimental sessions. Additional EEG samples from each individual participant when they were themselves directly photically stimulated were also recorded in separate sessions, and the group-averaged responses to these stimuli were then used to guide the selection of the dependent variable and definition of the effect measure used to assess the experimental hypothesis; this process is described in detail below in section 2.3 on page 32.

As will be described in that section, we have adopted a different dependent measure and statistical procedures to the Wackermann et al. (2003) study, and therefore their participant sample size could only serve as a rough estimate of the appropriate sample size required for this study. We therefore increased the sample size by nearly a factor of two, and recruited thirteen related pairs, thirteen unrelated pairs, and thirteen single participants.¹ Randomly timed, single photic flashes were used as visual stimuli in this study, instead of the checkerboard-reversal pattern used by Wackermann et al. (2003), partly in order to introduce sufficient differences between our respective designs, and partly for technical reasons which are discussed below in section 2.2.5.2 on page 28. Finally, in Wackermann et al. (2003) a between-groups statistical comparison was used, whereas in this study only within-group statistical comparisons will be conducted, by comparing intra-individual differences in EEG activity between photic stimulation and control epochs. This approach was preferred in order to avoid possible artefacts related to individual variability in EEG activity affecting any between-groups comparisons. The statistical methods used in this study are detailed below on page 42.

2.2.2 Participants

Sixty-five participants were recruited in Study 1 ($n = 65$ in total), most of whom were unpaid volunteers, with the exception of $n = 25$ participants recruited to take part in the final additional sessions.² Thirty-six female and twenty-nine male participants took part, with a mean age of 28.7 years, ranging between 20-58 years of age. Participants were recruited for the study through flyers posted on notice boards throughout Edinburgh, and by word of mouth (e.g. through requests by the experimenter, or the recommendation of past participants). This flyer (shown in Appendix B) briefly introduced the topic of the study and requested for volunteers to take part.

2.2.2.1 Selection of participants

As part of our attempt to utilise variables considered likely to enhance potential psi effects, participants with certain individual characteristics were specifically encouraged to take part

¹Initially, thirteen related pairs, five unrelated pairs and five single participants were tested, and this part of the study has been published elsewhere (Kittenis, Caryl, & Stevens, 2004); this article can be found in Appendix A. Additional sessions with eight unrelated pairs and nine single participants were subsequently conducted in order to equalise the sample size across the three groups.

²Due to pressing time constraints (involving the imminent closure of the laboratory we were using), a small payment was offered to these volunteers in order to speed up recruitment; all other aspects of the procedure remained unchanged.

in this study. For example, the flyer advertising the study briefly mentioned that individuals with previous experience with meditation, yoga, martial arts or other mental disciplines, as well as those with artistic/creative interests and abilities would be particularly suitable participants for the study. Such individual characteristics were emphasised as desirable as past studies have suggested that these may correlate with better performance in parapsychological experiments. In some studies for example, meditators were found to score better in psychokinesis (PK) tasks than non-meditators (e.g. Matas & Pantas, 1971), while other studies have found pre-meditation to post-meditation differences in ESP tests, with improved performance in tests carried out in the post-meditation period (e.g. Schmeidler, 1970; Dukhan & Rao, 1972). Creativity has also often been associated with better performance in ESP tasks, and a substantial number of studies have provided results supportive of this relationship (e.g. Dalton, 1997; Morris, Summers, & Yim, 2003). The conclusiveness of the collective results from these studies however, is considerably limited by the inherent complexity of the creativity construct, the wide variety of measures that have been used to assess it across different studies, as well as the possibility that the relationship between creativity and psi performance is confounded by other characteristics of creative populations (Holt, Delanoy, & Roe, 2004). The same can be said for the hypothetical relationship between meditation and performance in psi tasks, and the limited number of studies that have attempted to investigate this relationship further constrains overall confidence in its validity and reliability. Regardless however of the actual presence and degree of such relationships, there are additional reasons to expect that recruiting participants with these attributes may nevertheless carry certain advantages. For example, there is evidence that both in creative populations and in participants who have practiced a mental discipline there is a greater proclivity to experience altered states of consciousness (e.g., see Holt et al., 2004), and in view of the relaxation and state induction procedures included in this study (described in section 2.2.3 on page 21), such proclivity is deemed to be a favourable characteristic.

Another individual variable worth considering in this context, is the personal beliefs and attitudes of the participants, about this experiment in particular, and more generally about the type of effects this experiment is perceived to be investigating. Since Gertrude Schmeidler (1952) first reported her observations that participants who reported belief in the possibility of ESP (whom she termed “sheep”), tended to score higher in ESP tests than those who rejected this possibility (whom she termed “goats”), several studies have reported correlations between measures of belief in psi and scores in psi tests (e.g. Palmer, 1977). What has come to be known as the *sheep-goat effect* is considered to be one of the most successfully replicated findings of experimental psi research (Irwin, 1999), although the overall effect size is quite small (Lawrence, 1993). If we assume that the ESP effects identified in these studies reflect a genuine human ability, such a correlation between task performance and personal beliefs about the likely outcome of the task is not surprising, as similar effects are often encountered in sports psychology (Hardy, Jones, & Gould, 1998). No attempt has been made to preferentially recruit “sheep” for this experiment, as however most participants were unpaid volunteers, they were primarily motivated to take part in the study out of personal interest in the topic. Therefore most participants expressed positive beliefs regarding the potential existence of ESP-like interactions, and many reported having had personal experiences of events which they interpreted as involving ESP, precognition, or other types of anomalous interactions with their environment. The personal attitudes and beliefs of research participants are also known to be malleable to a certain extent, by experimental demand characteristics and by the perceived attitudes and

beliefs of the experimenter (e.g. Rosenthal, 1966). Therefore recruiting participants with such characteristics as creative abilities and meditation experience, and suggesting that these may be favourable attributes for psi performance, involves the additional advantage of reinforcing participants' positive expectations as regards to the likely outcome of the experiment.

However, although participants with certain individual characteristics were specifically encouraged to take part in this study, no volunteers were excluded if they did not match these criteria, and all those who contacted us were readily invited to take part. Therefore participants were entirely self-selected, and only volunteers with a history of epilepsy were excluded for safety reasons.³ Pairs of volunteers sharing a close empathic relationship were specifically encouraged to participate in the study, especially if they had experienced synchronicities or other incidents relating to each other which they had interpreted as involving psi interactions. Although in recruiting related participants we had encouraged pairs in different types of relationships to take part, (e.g. lovers, friends, relatives), the majority of recruited pairs (9/13) were couples of opposite gender in long-term relationships; of the remaining pairs three involved close friends, and one was a mother-daughter pair.

Individual participants were also invited to take part, and were told that they would be paired with someone whom they do not know. Only two-thirds of these single participants were matched with a partner however, (those assigned to the Unrelated pairs group), whereas the remaining one-third were not paired with another participant (those assigned to the Alone group). The assignment of individual participants to either the Unrelated or Alone group, as well as the pairing of participants in the Unrelated group was conducted pseudo-randomly.⁴

2.2.3 Induction of internal attention states

Another experimental variable which has received considerable attention in parapsychological research, is the potential relevance of the participants' state of consciousness (or *internal attention state*) in the manifestation and detection of psi interactions.⁵ It has frequently been noted that spontaneous ostensible psi experiences often tend to occur during alterations in consciousness, such as those encountered in dreams, during meditation, or in hypnagogic and drug-induced altered states (e.g. Parker, 1975; Alvarado, 1998; Luke & Kittenis, 2005). The systematic exploration of internal states in relation to psi phenomena was initiated by Rhea White (1964), with an article where she analysed introspective reports from a number of ex-

³Visual stimulation with repetitive flashes can potentially induce seizures in individuals prone to photosensitive epilepsy (e.g. Hishikaw et al., 1967). Although the photic stimuli administered in this study were presented at randomly timed intervals and therefore did not have the periodicity normally required for inducing photosensitive seizures, it was preferable to err on the side of caution and screen out any participants with a past history of epilepsy; only one volunteer was excluded from the study for this reason.

⁴When each of the thirty-nine individual participants volunteered their name was written on a small piece of paper which was then folded and added into a cup. The experimenter also placed thirty-nine folded pieces of paper into another cup, thirteen of which carried the designation "Alone", and the other twenty-six the designation "Unrelated". The name of a volunteer was drawn blindly from the first cup, and a paper designating their assigned group was drawn blindly from the other. The names of all participants assigned to the Unrelated pairs group were subsequently placed into a third cup, and two names were blindly drawn from this at a time to randomly form participant pairs.

⁵Within the context of this thesis the terms *internal attention states* and *states of consciousness* will be considered as synonymous and will be used interchangeably.

ceptionally successful psi percipients, and concluded that mental and physical relaxation is a common factor in their strategies for entering a psi receptive state of mind. In a review of experimental ESP studies utilising relaxation and other manipulations of internal states, such as meditation, sensory deprivation and hypnotic induction, Honorton (1977) concluded that these procedures appear to enhance “psi-receptivity”, as reflected by larger effect sizes in these studies. Based on these findings, Honorton developed a model of the relationship between sensory attenuation and psi receptivity to account for this effect, and concluded:

“Psi functioning is enhanced (i.e., is more easily detected and recognised) when the receiver is in a state of sensory relaxation and is minimally influenced by ordinary perception and proprioception.” (Honorton, 1977)

Honorton conceptualised “psi” information as a weak signal, and human percipients as potential detectors of this signal. His model suggested that reducing somatosensory stimulation (and conscious mental activity) is equivalent to reducing noise in the perceptual system, which would therefore be expected to make the detection of a weak signal easier. Taking this model into account, a progressive relaxation procedure was included as part of our experimental protocol.

Honorton’s *noise-reduction* model has been influential in the development of the ganzfeld protocol, which has been widely adopted in psi research during the past three decades (see Bem & Honorton, 1994; Milton & Wiseman, 1999, for reviews). The ganzfeld procedure typically involves physically isolating participants in a sensorially shielded environment (usually a soundproof, dimly-lit room), and some form of relaxation procedure is most often used at the beginning of the session. The participant designated as the “receiver” is then be exposed to the *ganzfeld* (German for “whole field”), by listening to white noise through headphones and by wearing translucent eye shields, while diffused red light was most often used to illuminate the room. The ganzfeld procedure was designed so that the participant’s attention is directed towards internal mentation processes, a desirable feature in that paradigm, as the task required of the “receiver” is to attempt to perceive and verbalise impressions from the perceptual experience of a distant “sender”. This mentation report is then used to judge the similarity of its content to the “target” (usually an image, video clip, or actual physical location) on which the “sender” is concentrating.⁶

Although the development of the ganzfeld protocol had been, at least initially, guided by the noise-reduction model, it is important to note that the procedure does not in fact involve *sensory deprivation*, (which according to the model would be the ideal condition for the detection of a weak signal), but constant stimulation of the visual and auditory sensory systems with random noise. This stimulation with random, patternless noise, in effect starves the perceptual system of any meaningful input, thereby inducing a state of *perceptual deprivation*. Perhaps as a result of an attempt by the perceptual systems to compensate for the lack of patterned stimulation, participants in the ganzfeld often report vivid dreamlike imagery and other characteristic features of altered states of consciousness, such as mood alterations, altered body image, or a distorted sense of time. These effects of ganzfeld exposure are well known; the ganzfeld state was in fact first brought to the attention of psychological research due to reports

⁶Most commonly, four potential targets are chosen at random out of a pool of a hundred or more, and one target is then chosen randomly out of these four to be used in the session. Various forms of judging procedures have been used, although these usually involve blindly comparing the similarity of the percipient’s mentation report to each of the four potential targets.

from pilots and sailors of perceptual alterations and hallucinations when traveling for prolonged periods of time through clouds or deep fog (Zubek, 1969). Sensory deprivation is thought to have similar effects, although it is considerably more difficult to induce in the laboratory (usually requiring the use of a flotation/isolation tank), and very rarely occurs naturally.⁷ Therefore the primary effect of ganzfeld exposure appears to be the induction of an altered state of consciousness characterised by hallucinatory imagery, primarily in the visual modality (Pütz, Braeunig, & Wackermann, 2006). This imagery is subjectively very similar to that experienced in the hypnagogic/hypnopompic states encountered at the threshold between sleep and the waking state (e.g. Mavromatis, 1987).⁸ Inducing such an altered state in participants would be appropriate for experiments using the ganzfeld-ESP paradigm, not least because this procedure generates prodigious amounts of internal imagery, which then constitutes the raw data of a ganzfeld study in the form of the percipients' mentation reports.

The suitability of the ganzfeld state for the present study was tested in a series of pilot sessions ($n = 6$), in which certain variations in EEG recording and stimulus presentation parameters were also tested. In these sessions participants were exposed to variations of a ganzfeld-type perceptual deprivation procedure, involving auditory stimulation with white or brown noise, and exposure to a homogeneous, patternless visual field. What quickly became apparent in these sessions however was that many of our participants tended to drift into sleep, especially if they were not being stimulated with photic flashes during the session. In the absence of any additional stimulation, (and without the requirement for participants to verbalise their experience, as is the case in the ganzfeld-ESP protocol), the combination of a relaxation procedure and ganzfeld exposure appeared to decrease participants' arousal to the point of readily inducing sleep.⁹ In addition to its propensity to induce sleep, the primary effect of the ganzfeld state, i.e. the generation of internal visual imagery, may also be problematic in the context of the present study. Vivid visual imagery will undoubtedly affect EEG activity, especially in the visual areas, and this activity may interact in unpredictable ways with event-related responses to visual stimuli. For these reasons the ganzfeld procedure was considered inappropriate for this study; using no other sensory stimulation however after the relaxation induction was also considered to be an unfavourable option, as this was likely to induce hypo-arousal, and consequently also carried an increased risk of inducing sleep in our participants.

In searching for alternative procedures, the use of rhythmic auditory stimulation was considered as a possibility. The use of percussion in shamanic cultures for inducing altered states of consciousness is well documented (e.g. Neher, 1962; Winkelman, 1986), and rhythmic auditory stimulation with drumming has also been used experimentally in parapsychological research. In a study using a variant of the ganzfeld procedure, Symmons and Morris (1997) stimulated participants with electronically-generated drumming at beat frequencies of 4 and 7Hz, together with visual stimulation with a homogeneous field; the authors reported significant

⁷For example, reduction in vision due to peripheral eye pathology is thought to underly the visual hallucinations experienced by individuals with Charles Bonnet syndrome (Schultz & Melzack, 1991).

⁸Although recent EEG research has revealed distinct differences between the electrophysiological signatures of these states (Wackermann, Pütz, Buchi, Strauch, & Lehmann, 2002)

⁹Nearly all relaxation techniques apply various interventions to prevent subjects from falling asleep (Vaitl et al., 2005). This was a particular risk in this study, especially as non-stimulated participants will not be required to respond in any way during the test period when their partner is photically stimulated, and as they will not be photically stimulated themselves.

effects at both frequencies, and suggested that rhythmic auditory stimulation may be a useful alternative to white noise in ganzfeld ESP experiments.

A series of pilot sessions were conducted in order to test the suitability of rhythmic auditory stimulation for this study ($n = 5$), in which after the relaxation period participants listened to a recording of live drumming at a stable beat frequency (described in section 2.2.3.2). This stimulus appeared to be effective in maintaining a sufficient level of arousal to keep participants awake throughout the session, and subjective reports from the participants were also largely positive; their qualitative impression of the effects of the drumming was that it was well-suited for facilitating a state of consciousness where they could remain focused and alert throughout the session, and some commented that knowing that their partners were listening to the same drum-beat helped them maintain awareness of each other.

This section has so far documented the process of developing an experimental procedure for the induction of an appropriate state of consciousness and level of psychophysiological arousal in our participants. We have qualified what constitutes a suitable attention/arousal state in the context of this experiment on two criteria: a state that objectively maintains a low level of psychophysiological arousal which is however above the threshold of sleep onset, and also one that participants find subjectively to be suitable for the purpose of the study.¹⁰ As the combination of a relaxation procedure followed by drumming fulfills both these criteria, this was eventually adopted as part of our experimental procedure which is described in more detail below.

2.2.3.1 Relaxation procedure

A relaxation induction procedure was specifically developed for this experiment, and was recorded into audio format (the full transcript can be found in Appendix C). This procedure primarily involves a sequence of progressive relaxation instructions aiming to induce deep physical and mental relaxation, and was presented simultaneously to both participants of each pair at the start of their session. As part of our general intention to facilitate a similar state of consciousness in participant pairs, a number of more specific suggestions were also incorporated into this relaxation procedure. For example, participants were encouraged to maintain an awareness of their partner throughout the session, and were reminded that they were simultaneously listening to the same audio recording and would continue to do so until the end of the session¹¹. Participants were reminded of the purpose of the experiment in order to facilitate an intentional attitude, but were also encouraged to surrender to their experience during the session, and to relinquish any conscious effort to achieve a specific goal.

¹⁰It is assumed that the purpose of this study (at least in respect to the participants' perception of their task), is to establish some form of distant psychophysiological interaction between the isolated partners of each pair. This is admittedly a vague and possibly inaccurate assumption about what mechanism(s) may in fact underly the effects identified in previous studies. We have tentatively adopted it in this study primarily as a guiding metaphor for designing the experimental procedure, particularly in terms of how the experiment is conceptualised and presented to the participants.

¹¹The same instructions were given to Unrelated participant pairs, as well as to Alone participants not matched with a partner.

2.2.3.2 Drumming

After this relaxation procedure participants listened to an audio recording of shamanic drumming throughout the experimental part of the session (i.e. during the presentation of photic stimuli to one of the two participants). This was a recording from two drummers playing single-headed frame drums, with the drums facing each other in order to optimise natural reverberation (Rutherford & Charing, 2001). The drum rhythm was relatively constant in beat frequency throughout the session, which ranged between 1.5–2 beats-per-second (bps); as this was a recording of live drumming, some variation in beat frequency is to be expected. Due to such natural variations in beat frequency across time and between the two drummers, the two drum rhythms weave in and out of phase with each other throughout the recording, and this forms a combined rhythm which appears to be unpredictable, even though it is fairly constant in frequency. The phase interplay between the two drummers, as well as the reverberation between the two drums and small variations in pitch across beats, add additional layers of complexity to the rhythm. This particular recording was chosen, as although the rhythm has a largely constant frequency (used to maintain a stable state of consciousness for an extended period of time), the subtle complexity and unpredictability of the rhythm can also help to maintain the listeners' interest and attention, whereas a simple, periodic (i.e. fixed-frequency) rhythm could have easily induced boredom. It is also well known that periodic auditory stimulation can increase the amplitude of EEG rhythms at the beat frequency, what has sometimes been called "auditory driving" (Neher, 1961). Therefore an additional reason for not using a strictly periodic rhythm is to avoid the possibility of entraining the resting EEG of participants to the beat frequency. Such entrainment could potentially complicate the analysis of the results, as it would be likely to increase variability in the amplitude and morphology of visual evoked potentials; photic flashes delivered in phase with the positive peaks of this entrained rhythm would produce higher-amplitude EPs compared to flashes delivered in phase with negative peaks, and this would therefore increase overall variability in the amplitude of EPs to randomly presented stimuli (Intriligator & Polich, 1995). Spectral analysis of the drumming audio track (see Fig. 2.1) revealed no stable low-frequency rhythms, and identifiable peaks can only be found at ≈ 90 and 120Hz.

2.2.4 Procedure

The design and purpose of the experiment was described to participants before their session, and information regarding the design was only withheld from Alone participants, who were falsely told that they were matched with another participant whom they would meet at the end of the session. As well as test sessions, where one participant (or none, in the case of the Alone group) was photically stimulated while EEG was recorded from the other non-stimulated subject, each participant also took part in an individual session, in which they were directly photically stimulated while their own EEG was recorded. Individual sessions were sometimes conducted before, and sometimes after the test session, depending on practical considerations and the preference of the participants.

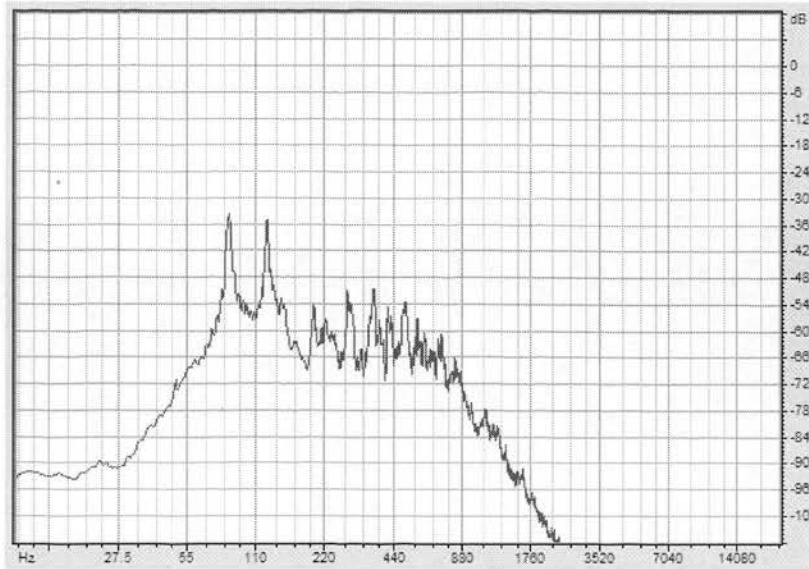

Figure 2.1: Frequency spectrum of the drumming audio recording.

2.2.4.1 Related pairs

Related pairs of participants decided amongst themselves who was to be the stimulated and who the non-stimulated subject, either by mutual choice, or pseudo-randomly (i.e. with a coin-toss) if they had no preference. They were asked to spend up to 15 minutes alone together before the session, during which time their aim would be to enhance their awareness of each other and attempt to cultivate “a shared empathic state of mind”. Some activities which could possibly help them achieve this state were suggested, such as joint meditation, synchronised breathing, physical touch, gazing into each other’s eyes, or by exchanging personal items (e.g. jewellery), but they were primarily encouraged to use whatever activity felt most appropriate for them both. They were somewhat discouraged from interacting verbally during this period, and were given the option to burn some incense while in the room together, which they could also take in their respective separate experimental rooms. This was introduced as an optional sensory stimulus, which could potentially act as a memory cue helping them maintain their awareness of each other into the experimental period; odours are often extremely potent memory cues, an observation most famously described by Marcel Proust (1934) in his “Remembrance of Things Past”.¹² A common odour in the participants’ respective rooms would also make their sensory environments more similar. Participants were given a choice between several different types of incense, and most (although not all) pairs opted to use some.

After their time alone together, Related participants went to their respective experimental rooms on their own, and did not interact with the experimenter (or anyone else), until after

¹²Contemporary neuroscience appears to support this observation, and further suggests that odours seem particularly effective in evoking the emotional elements of memories. For example, an fMRI study has indicated that the subjective experience of the emotional potency of memories correlates with specific activation in the amygdala, and this activity is greater in magnitude when memories are evoked using odours, compared to when the same memories are evoked using visual cues (Herz, Eliassen, Beland, & Souza, 2004).

the end of the session. Stimulated participants (who were not wearing an electrode cap) helped their partners connect the electrode cap they were wearing to the EEG amplifier and to put on the headphones, closed the door of their room, and then went to their own room, closed the door and put on the LED glasses and headphones. The experimenter could see when the non-stimulated participant had settled in from their EEG trace, and gave the other participant a few more minutes to settle down into their own room. The experimenter made sure both doors were securely closed and initiated the session.

2.2.4.2 Unrelated pairs

Participants other than those in the Related pairs group, (i.e. 39 of the 65 subjects), had volunteered individually to take part in the study, and were pseudo-randomly allocated to either the Unrelated or Alone groups. Two-thirds of these individual participants (i.e. $n=26$) were pseudo-randomly matched into pairs to form the Unrelated pairs group. These pairs did not know each other prior to the experiment, and did not meet each other until after the end of the session. Within pairs each participant was pseudo-randomly designated to be either the stimulated or the non-stimulated partner. The non-stimulated participant (who was to have their EEG recorded during the joint session) was asked to arrive at the laboratory earlier than their partner, in order to have the electrode cap fitted and to have their individual session recorded (involving direct photic stimulation).¹³ When the subject who was to be photically stimulated arrived at the laboratory, he/she was led to their room without having any contact (visual or otherwise) with their non-stimulated partner; at the end of the session participants were introduced to each other.

2.2.4.3 Alone group

Participants in the Alone group were not matched with a stimulated partner, although they were told that they would be paired with another participant whom they would meet after the experiment (i.e. as participants in the Unrelated group were told). Therefore these were all non-stimulated participants, and while photic flashes were delivered according to the standard procedure, in this group no participant was present in the other room to observe the flashes. After the session the experimenter gave these participants a full debrief and explained the reasons for the deception.

2.2.4.4 Timeline of procedure

At the beginning of each session the progressive relaxation instructions were played to participants; this recording lasted for approximately 11 minutes, and was followed by the drumming recording which lasted for approximately 15 minutes. Two minutes after the start of the drumming randomised photic stimulation was initiated, and lasted for an average of 11.7 minutes (the actual session length depending on the cumulative duration of the randomly chosen inter-stimulus intervals). At the end of the experimental part of the session, (after all photic stimuli

¹³For practical reasons, in the Unrelated pairs group the non-stimulated participant always had their individual session before the joint session, while the stimulated participant had their individual session afterwards (either immediately after the joint session, or they would come back another day if they preferred). In the Related pairs group this varied according to the participants' preferences and relevant practical considerations.

had been presented), the volume of the drumming gradually faded out, and participants listened to another recording of verbal instructions for ≈ 2 -3 minutes. These instructions alerted the participants to the approaching end of the session, and facilitated their gradual return to their ordinary waking state of consciousness (see Appendix C).

2.2.5 Equipment and laboratory configuration

2.2.5.1 EEG system and parameters

A portable *NuAmps* EEG system (Neuroscan, USA), was used for data acquisition and analysis. The NuAmps EEG amplifier has forty unipolar analog input channels, from which it samples simultaneously at a user-selected frequency between 125-1000Hz with 22bit A/D resolution. The full scale of its input range is ± 130 mV and its input impedance is >80 M Ω . It uses optical signal isolation for the input channels, and accepts digital TTL inputs (+5V logic) for marking the timing of events on the EEG recording, which are also electrically isolated from the participant and EEG channels. The NuAmps amplifier was connected via USB to a laptop PC running SCAN 4.3.1 (Neuroscan, USA), a software package with two primary modules, *Acquire*, which is used for data acquisition, and *Edit*, used for offline data analysis.

Thirty monopolar EEG channels were recorded at a 500Hz sampling rate from the following electrode sites: Fp1, Fp2, Fz, F3, F4, F7, F8, FCz, FC3, FC4, FT7, FT8, Cz, C3, C4, T7, T8, CPz, CP3, CP4, TP7, TP8, Pz, P3, P4, P7, P8, Oz, O1 and O2, with averaged ears used as reference. A 50Hz bandstop filter was used, and the bandpass filter range was 1-100Hz. An electrode cap (*QuikCap* by Neuroscan, USA) was used for electrode placement together with clip ear electrodes; all electrodes were sintered Ag/AgCl.

2.2.5.2 Photic stimuli: materials and parameters

A variety of sensory stimuli have been used in the studies reviewed in Chapter 1 in order to produce EEG responses in stimulated participants; these included trains of photic flashes (Rebert & Turner, 1974), electric shocks (Tart, 1963), single photic flashes (Millar, 1979a), and a checkerboard-reversal pattern (Wackermann et al., 2003). Photic flashes have generally been preferred, as there is less of a risk for sensory leakage with visual compared to auditory stimuli (although some early studies had used stroboscopes to deliver the flashes, which also produce sounds when flashing).

Randomly timed single photic flashes delivered by light-emitting diodes (LEDs) were used as photic stimuli in this study. A checkerboard reversal pattern was used as a visual stimulus in the Wackermann et al. (2003) study which we are attempting to replicate, and one reason for choosing a different visual stimulus was in order to introduce sufficient differences between our respective designs, so that the present study would constitute a conceptual rather than an exact replication of that study. Using photic flashes triggered by LEDs also carries certain technical and methodological advantages however. For example, presenting a checkerboard reversal pattern would most likely require the use of a computer monitor, and there are certain limitations in the timing accuracy with which stimuli can be presented on screen (associated with the screen refresh rate of monitors), whereas the timing of presentation of LED flashes can be controlled with far more accuracy¹⁴. Perhaps more importantly, there are issues involving

¹⁴A screen refresh rate of 75Hz for example would give a temporal resolution of ≈ 13.3 ms,

the emission of electromagnetic radiation from computer monitors which need to be taken into account, as it is crucial that the possibility of sensory leakage between participants, and electromagnetic leakage between equipment, is eliminated as much as possible. By contrast, LEDs emit virtually no electromagnetic radiation (i.e. other than light); this was tested in pilot sessions where a recording was taken using the EEG amplifier, from a closed-loop unshielded cable surrounding the LEDs while flashes were being triggered. This recording revealed no signs of electromagnetic interference associated with the flashes (in frequencies $< 500\text{Hz}$), even when several hundred flash-related epochs were averaged together. One final advantage of using LED flashes as stimuli is that these can be delivered through closed eyelids; recording EEG from participants with eyes closed is preferable, as this minimises ocular artefacts which could otherwise contaminate the recording and would need to be removed offline, with potential distortion of the signal and loss of data due to the rejection of noisy epochs.

To present photic stimuli, a pair of dark glasses fitted with eight white (clear) light-emitting diodes (LEDs) was used, made by Photosonix (USA); four phosphor-coated GaN LEDs were fixed inside each lens in a diamond-shaped arrangement. The luminance of each set of four LEDs at a distance of 1cm (\approx the distance from the eyes) was 1000Lux (Lumen/m^2)¹⁵, and the emission spectrum can be seen in Figure 2.2. Although a blue peak is evident in the spectrum, flashes from the LEDs appeared to human observers as a cool, clear white light, with no visible colour hue.

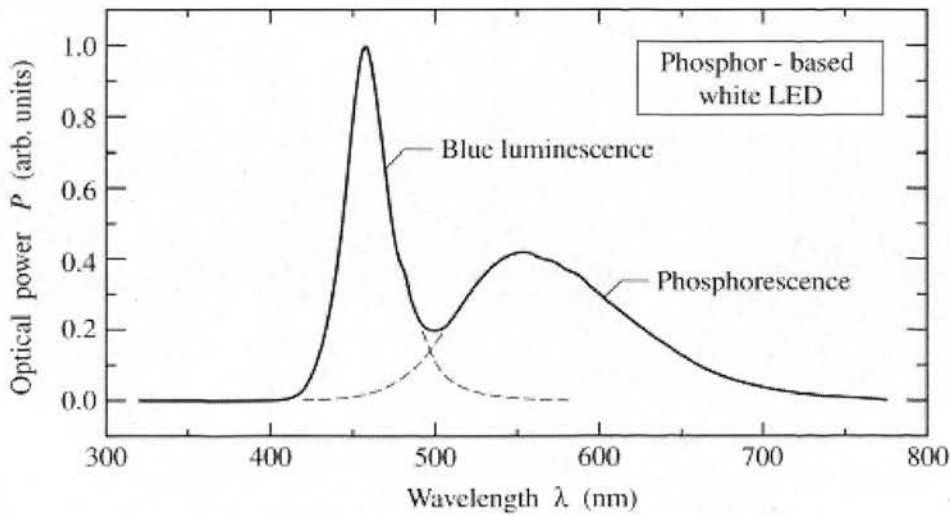

Figure 2.2: Emission spectrum of the white LEDs used in the experiment. A peak of blue light (≈ 465 nanometers) which is directly emitted by the GaN LED can be seen, as well as the broader spectrum emitted by the phosphor coating ($\approx 500 - 700\text{nm}$).

Each photic flash was presented for a duration of 80ms. LED flashes were triggered using TTL pulses (+5V logic) delivered from the parallel port of a computer running a script-driven program (*Inquisit* by Millisecond Software).

whereas presenting flashes with LEDs (using our equipment configuration; see below) would provide a timing accuracy of $< 2\text{ms}$.

¹⁵Approximately 5-10% of light reaches the retina through closed eyelids (Shneerson, 2005).

2.2.5.3 Randomised presentation of photic stimuli

Inquisit is a software package for psychological experimentation, and was specifically chosen for its ability to provide time-accurate stimulus presentation in a Windows OS environment. As Windows is not a real-time operating system, it may introduce anomalies into stimulus presentation times and response latency measurements, which can be problematic when millisecond-scale accuracy is important (as is the case with EEG recordings). Although no software package running under Windows can guarantee perfectly accurate timing, some applications can take steps that make timing anomalies very rare. Inquisit has been independently tested by researchers at the University of Ghent, Belgium, using *FASTLOG*, a program they have developed for testing the timing accuracy of PC experimentation software (De Clercq, Crombez, Buysse, & Roeyers, 2003). The relative difference between the timing data given by Inquisit and their system never exceeded 1.84ms in these tests, and in most cases was < 1 ms.

A command script was written which instructed Inquisit to control the randomised presentation of photic and control stimuli (see Appendix D for the command script used in this experiment). A pseudo-random algorithm¹⁶ (L'Ecuyer, 1994) is used by Inquisit to repetitively select with equal probability ($p = .5$) one of two events: *photic events* involve the delivery of two synchronous electric (TTL) pulses, one of which is directed to the LED glasses and triggers a photic flash, while the other is directed to the EEG recording amplifier and is used to mark the timing of each flash on the EEG record. *Control events* involve only one TTL pulse which is used to mark the EEG record (i.e. no concurrent photic flashes are presented with these events); therefore control events can be seen as random samples of EEG activity during periods when neither participant was photically stimulated.

One-hundred-and-eighty-six (186) events were presented during each test session; therefore on average, one would expect 50% of these (93) to be photic flashes, and 50% to be control events. In order to avoid possible learning and anticipatory effects events were sampled with replacement (i.e. selection probabilities were always $p = .5$ for each event type, regardless of how many times it had already been selected during each session), therefore the actual number of photic and control events presented varied between sessions. The same algorithm was used to randomise the duration of interstimulus intervals (ISIs), which ranged between 3 and 6 seconds in half-second steps, with the mean ISI being 4.5s. ISIs were also selected using replacement sampling, with equal selection probabilities ($p = .142$) for each of the seven possible ISIs. The mean duration of the stimulation period would therefore be expected to approximate 13.1 minutes, although (due to replacement sampling of ISIs) the actual duration varied from session to session. During individual sessions, (involving direct photic stimulation of each participant while their own EEG was being recorded), one-hundred-and-thirty-six (136) stimuli were presented, (on average, sixty-eight of each type), with the same range and mean of randomly chosen inter-stimulus intervals.

2.2.5.4 Laboratory layout and equipment connections

A diagram of the laboratory can be seen in Fig. 2.3, and a diagram showing the connections between equipment can be found in Fig. 2.4. The computer performing the stimulus randomisation was directly connected to the LED glasses in order to trigger photic flashes, and to the EEG amplifier in order to provide photic and control event markers to the EEG recording.

¹⁶This algorithm uses the system clock for seeding.

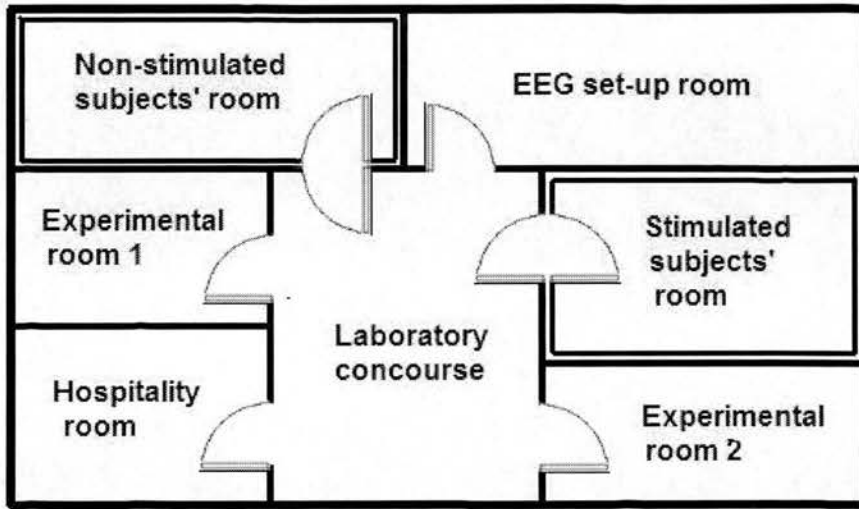

Figure 2.3: Diagram of laboratory; double wall lines signify sound-shielded rooms.

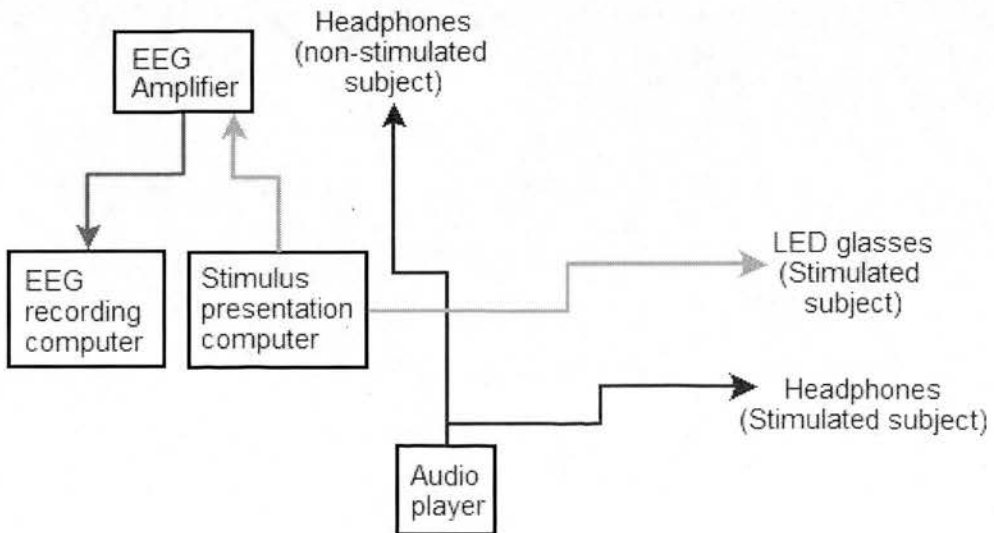

Figure 2.4: Diagram of equipment and connections.

Event marker inputs to the NuAmps EEG amplifier are electrically isolated from the participant and the EEG recording channels, protecting against contamination of the EEG record from the TTL pulses used to provide event markers, or of inadvertently cuing the participants as to the existence and timing of events. No auditory or visual cues are emitted from the amplifier which could indicate the presence of the triggers to the participants. The audio recording of the relaxation procedure and drumming was played to both participants through headphones using a shared one-way audio link (stereo).

2.3 Measures of EEG activity

This section describes the process of selecting the dependent variable to be used for the quantitative analysis of our data, and of developing the operational definition to be used for testing the experimental hypothesis. To guide this process, EEG recordings from individual sessions where participants were photically stimulated directly were analysed first, in order to identify the electrophysiological characteristics of ordinary event-related EEG responses to the photic stimuli we were using.

2.3.1 Event related potentials

The most widely used method for identifying event-related responses in EEG activity is to calculate event related potentials (ERPs) (or evoked potentials (EPs), as they are alternatively called).¹⁷ ERPs are calculated through the additive averaging of a number of epochs of EEG sampled at times when stimuli were presented. These epochs are time-locked to the moment of stimulus presentation (for example, each epoch could range between 500ms pre-stimulus and 1000ms post-stimulus, where 0ms was the moment the stimulus was presented), therefore through the point-to-point averaging of a large number of such epochs, brain electrical activity which is directly related to the stimulus is additively selected, whereas “background” oscillatory EEG activity not related to the stimulus is attenuated. Such signal processing through averaging is most often necessary to reveal the evoked potentials, as these are usually on the order of microvolts, whereas spontaneous EEG activity is usually in the order of tens of microvolts (Coles & Rugg, 1996). ERPs can be calculated as:

$$\text{ERP}_{(j)} = \frac{1}{N} \sum_{i=1}^{i=N} x_{(i,j)} \quad (2.1)$$

where N = total number of trials, and $x_{(i,j)}$ = the j^{th} sample of the i^{th} trial of the data (Kalcher & Pfurtscheller, 1995).

ERPs recorded from the scalp represent electrical fields related to the synchronous activity of large populations of neurons, although there is considerable debate at the moment regarding the precise neural mechanism(s) underlying the generation of evoked potentials.¹⁸ The mean

¹⁷We will use the terms ERPs and EPs interchangeably to refer to the same method, as described in this section.

¹⁸This issue is not directly relevant at this point, but will be discussed in the following chapter.

evoked potential at electrode Oz for $n = 39$ participants during direct photic stimulation can be seen in Figure 2.5.¹⁹

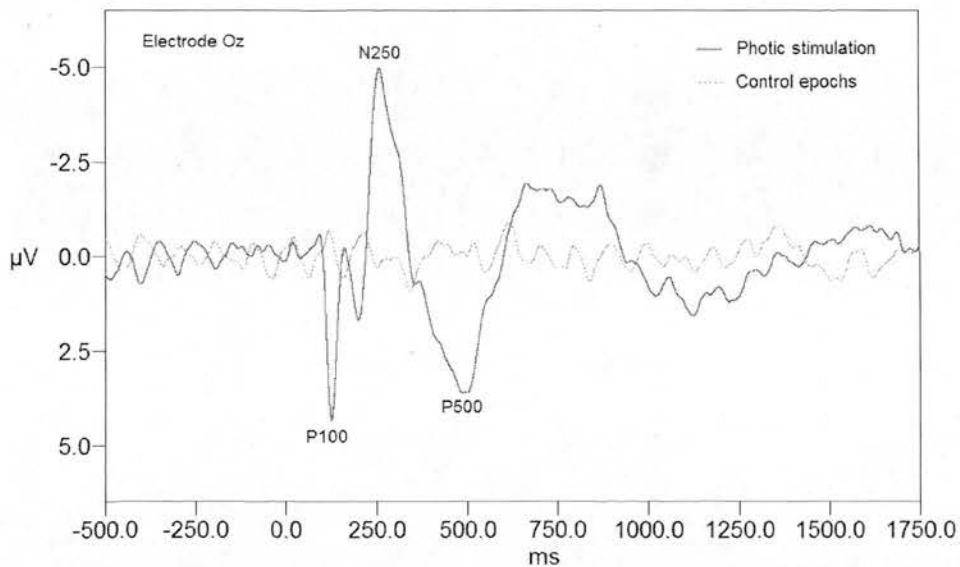

Figure 2.5: Average evoked potential during direct photic stimulation (solid red line) and control periods (dotted blue line) at electrode Oz. Group mean for $n = 39$ participants, with an average of 68 presented stimuli per subject. Photic stimuli were presented at $t = 0$ ms for 80ms.

To a large extent, ERP research into cognitive processes involves the classification of ERP components (such as the latency of prominent peak and troughs), and the comparison of such components after experimental manipulations of stimulus characteristics or task demands. It is not relevant to the aims of this study to attempt to identify all the components involved in the ERP responses to the photic stimuli we have used, but it will be useful to distinguish between two classes of components. Those whose characteristics depend on the physical properties of the stimuli have been termed *exogenous*, or sensory components, and those whose characteristics depend on factors related to the subjects and the nature of their interaction with the environment, (such as attention, expectation, or the nature of processing required by a stimulus), have been called *endogenous*, or cognitive components (Coles & Rugg, 1996). This distinction has proved to be somewhat oversimplified however, as almost all 'exogenous' components can be modified by cognitive manipulations, and many of the 'endogenous' components can be affected by aspects of the stimulus eliciting conditions. Coles and Rugg (1996) have suggested that it would be more accurate to conceive of an endogenous-exogenous dimension, which is roughly coextensive with time; therefore early ERP components that occur within the first 100ms after stimulus presentation tend to be exogenous, whereas components occurring later tend to be more endogenous. According to this distinction, the first positive deflection in Figure 2.5 which peaks at ≈ 100 ms (P100) is most likely to represent a sensory (exogenous) component, whereas

¹⁹In accordance with the conventions of ERP literature, in graphs showing ERPs the y-axis is displayed with positive values at the bottom. Subsequent graphs not showing ERPs will follow the engineering convention of displaying positive values at the top of the y-axis.

the negative deflection at 250ms (N250) and the P500 are more likely to represent cognitive (endogenous) components.

2.3.2 Event-related changes in the frequency domain

2.3.2.1 Induced event-related band power

Evoked potentials calculated as described above, only reflect event-related brain activity which is *phase-locked* to the stimulus, that is, activity with fixed-latency and fixed-polarity across epochs in respect to stimulus onset. Phase-locked activity is not the only type of event-related change found in brain dynamics however; Hans Berger (1929) was the first to observe that certain events can attenuate (or desynchronise) the ongoing oscillatory brain activity. 'Alpha-blocking' for example, is a reduction in spectral alpha power in response to a stimulus, which reflects the event-related attenuation of ongoing alpha rhythms. Such event-related changes can be said to be time-locked to the event, but they are not phase-locked, (as the alpha oscillations have no fixed-latency or fixed-polarity relationship to stimulus onset), and therefore cannot be extracted by averaging. These changes can be detected by frequency analysis, and in the case of alpha blocking, the effect is often prominent enough to be readily observable on the raw EEG trace.²⁰ Alpha desynchronisation in response to a stimulus (or action, such as opening the eyes), is probably the best known phenomenon in human electroencephalography, and it is also comparatively well understood (e.g. see Shaw, 2003). The alpha rhythm is considered to be generated by large groups of neurons firing in synchrony, and such large-scale synchronisation typically occurs when no active information processing is required of these neuronal groups; for example, a large-amplitude alpha rhythm typically appears in the parieto-occipital region when the eyes are closed. When the need to actively process information arises, such as when a stimulus is presented, these neural oscillations become desynchronised, and their summed electrical potential recorded on the scalp is thereby reduced. This desynchronisation of large-scale neural oscillations is related to the synchronisation of activity in smaller aggregates of neurons, which is the hallmark of active information processing (Walter, 1950).

Although several methods have been suggested for quantifying event-related changes in the amplitude of (non-phased-locked) oscillatory activity, the *intertrial variance* method proposed by Kalcher and Pfurtscheller (1995) has been the most widely adopted. This method first involves bandpass filtering of the epoched EEG data within the frequency band of interest, and then calculating the point-to-point intertrial variance:

$$IV_{(j)} = \frac{1}{N-1} \sum_{i=1}^{i=N} (x_{f(i,j)} - \bar{x}_{f(j)})^2 \quad (2.2)$$

where N = total number of trials, $x_{f(i,j)}$ = the j^{th} sample of the i^{th} trial of the bandpass filtered data, and $\bar{x}_{f(j)}$ = mean of data at the j^{th} sample (averaged over all bandpass filtered trials) (Kalcher & Pfurtscheller, 1995).

²⁰This was the method used in one of the first studies to look at possible event-related EEG correlations between distant subjects (Duane & Behrendt, 1965); as discussed in the previous chapter however, visual inspection of the raw EEG for alpha suppression is obviously a poor choice of dependent variable.

Due to phase differences in oscillatory activity between epochs, high-amplitude activity results in high intertrial variance values, and low-amplitude activity results in lower values; if an event therefore attenuates or enhances the amplitude of oscillatory activity at a fixed point in time across epochs, the point-to-point intertrial variance between epochs will reflect such changes with considerable sensitivity. Kalcher and Pfurtscheller (1995) have suggested using the term *induced activity* in order to discriminate this measure from evoked (i.e. phase-locked) responses.

Figure 2.6 shows the changes in induced alpha power in response to direct photic stimulation at Oz for $n = 39$ participants in Study 1 (i.e. this was calculated from the same data from which the ERP shown in Fig. 2.5 was also calculated). The waveform in Fig. 2.6 shows a typical example of the alpha desynchronisation response, where a dramatic attenuation of alpha activity follows the presentation of the photic stimulus. This response starts soon after stimulus onset, reaches a maximum at $\approx 250\text{ms}$, and returns to a pre-stimulus baseline level at $\approx 900\text{ms}$ after stimulus presentation.

The main advantage of this method over previously suggested measures for calculating event-related changes in the frequency domain, is that the intertrial variance measure only quantifies non-phase-locked activity, as the mean (which represents evoked activity) is subtracted from each trial, whereas in former methods both phase-locked and non-phase-locked activity contributed to the band power changes. The development of this method has enabled the independent calculation of event-related changes in evoked and induced activity within discrete frequency bands, and a growing number of studies have been using it to investigate a wide variety of sensory, cognitive and motor processes, looking at band-specific evoked and induced components, separately or in parallel (e.g. Pfurtscheller & Silva, 1999; Klimesch, Döppelmayr, Rohm, Pöllhuber, & Stadler, 2000). One of the first and most interesting observations in these studies, was that the same task or sensory stimulus may result in the desynchronisation of induced alpha, and at the same time, in the synchronisation of evoked alpha activity (Klimesch et al., 2000).

2.3.2.2 Evoked event-related band power

Evoked alpha activity refers to phase-locked, event-related activity within the alpha band, which is calculated through the additive averaging of the (alpha) bandpass filtered EEG epochs. These are therefore also often referred to as *alpha ERPs*, as they are calculated in the same way as evoked potentials, using however only the alpha band activity rather than the broader-spectrum EEG;²¹ evoked-alpha activity can therefore be described as the specific alpha-band component of the general ERP (Kalcher & Pfurtscheller, 1995). The evoked-alpha activity in response to direct photic stimulation was calculated as described above, with two additional steps after averaging: squaring the voltage data to obtain power values, and calculating the envelope of the resulting waveform (see Fig. 2.7).

This measure shows a steep rise in evoked- α band power immediately following stimulation with photic flashes, which reaches a peak at $\approx 228\text{ms}$, and returns to a pre-stimulus baseline level $\approx 500\text{ms}$ after stimulus presentation. When the evoked- α response to photic stimulation seen in Fig. 2.7 is compared to the induced- α response in Fig. 2.6, what has been called an

²¹EEG epochs used to calculate standard ERPs are also normally bandpass-filtered, although usually within a broader frequency range, such as between 1-30Hz.

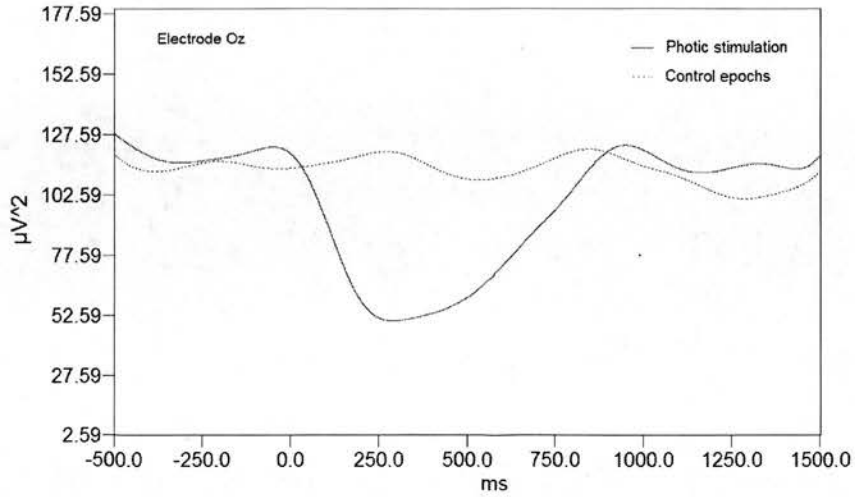

Figure 2.6: Induced (non-phase-locked) alpha band power during direct photic stimulation (solid red line) and control periods (dotted blue line) at electrode Oz. Group mean for $n = 39$ participants, with an average of 68 presented stimuli per subject. Photic stimuli were presented at $t = 0$ ms for 80ms.

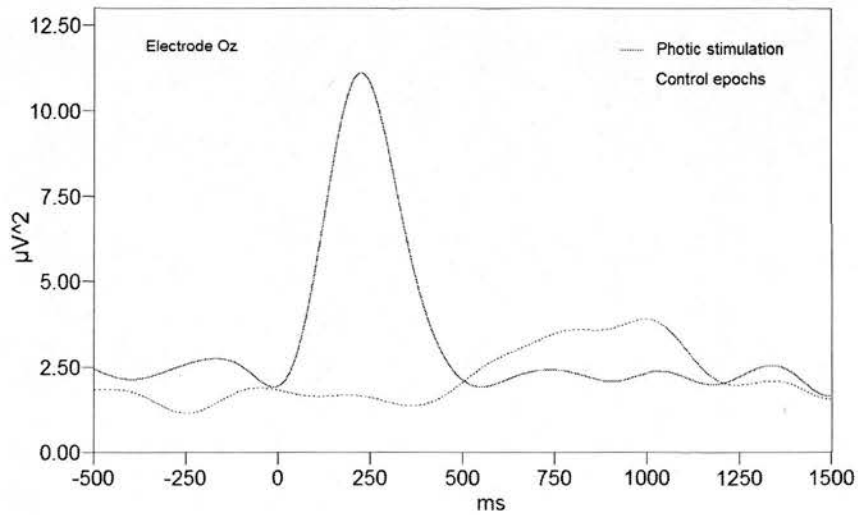

Figure 2.7: Evoked (phase-locked) alpha band power during direct photic stimulation (solid red line) and control periods (dotted blue line) at electrode Oz. Group mean for $n = 39$ participants, with an average of 68 presented stimuli per subject. Photic stimuli were presented at $t = 0$ ms for 80ms.

apparent 'paradox' (Klimesch et al., 2000) can be observed; that is, a decrease in induced- α power and a simultaneous increase in evoked- α power in response to the same stimulus. As has been mentioned earlier, the attenuation of induced- α activity is considered to reflect the desynchronisation of large-scale alpha oscillations, due to active information processing prompted by the stimulus. The increase in evoked- α activity on the other hand, has been shown to be related to a transient phase-locking of alpha sub-bands in response to the stimulus (Klimesch et al., 2000). Although this had at first appeared to be a paradox, closer observation has revealed that these responses serve functionally distinct purposes, and whereas induced- α desynchronisation is associated with cognitive information processing (with different alpha sub-bands serving different functions) (Klimesch, 1999), evoked- α synchronisation appears to be primarily involved in sensory processing, and has been shown to have a strong influence on the early components of ERPs (Basar, 1999). Therefore the distinction in the functional roles of evoked and induced alpha responses, appears to follow the exogenous-endogenous dichotomy of sensory and cognitive functions, also found in the early and later components in ERPs respectively.

2.3.3 Selection of EEG parameter as dependent variable

Three different measures of event-related changes in EEG activity commonly observed in response to photic stimulation have been described so far: event-related potentials, and event-related changes in induced-alpha and evoked-alpha activity. There are several other parameters of EEG activity which also show changes following sensory stimulation, such as induced and evoked event-related changes in the theta, delta and beta bands, as well as changes in event-related coherence. These variables have not been investigated as extensively as event-related changes in the alpha band however, and their functional significance is still relatively poorly understood. For the purposes of this study, we have therefore constrained our search for a parameter of EEG activity to be used as the dependent variable within the three measures described above; the discussion which follows details the rationale for our eventual choice of one of these measures to be used for the quantitative evaluation of the experimental hypothesis.

Previous studies investigating the possibility of event-related correlations in EEG activity between isolated participants have employed as their dependent variable either measures of alpha desynchronisation (i.e. event-related changes in induced- α activity), or the standard (i.e. broad-spectrum) evoked potentials. Changes in induced- α activity have only been used in a small number of early studies, while later studies have tended to favour measures based on evoked potentials. As can be seen in Fig. 2.5 however, the waveforms of evoked potentials are relatively complex in structure, and contain a number of components with different functional associations. This characteristic of ERPs is an advantage in cognitive psychophysiology, where experimental variables can be manipulated in order to disentangle the functional significance of the various components, which could then lead to practical and theoretical advances. Within the context of the present study however, where we are primarily concerned with the question of whether a series of sensory events can be shown to be associated with identifiable changes in EEG activity, the structural complexity of the ERP and the wealth of information contained within it may needlessly complicate our task. As can be seen in Figs. 2.6 and 2.7, the waveforms of event-related changes in induced and evoked alpha activity are structurally relatively simple, and occur within a shorter time frame; induced- α responses are completed

within 900ms post-stimulus and evoked- α responses within 500ms post-stimulus, whereas the ERP waveform does not return to a pre-stimulus baseline level until 1500ms after stimulus presentation. The structural simplicity and brief temporal evolution of induced and evoked responses is a considerable advantage within the context of this study, as this simplifies the quantification and comparison of activity during photic and control epochs. We have therefore decided to further limit our search for a suitable dependent variable in this study to evoked and induced event-related changes in alpha activity.

In a survey of the relevant literature on induced and evoked alpha activity, several factors were taken into account in considering which to adopt as our dependent variable. One difference between these two measures has already been mentioned; induced activity is largely associated with active (cognitive) information processing, whereas evoked activity is more closely related to sensory processing (Klimesch et al., 2000). We have no theoretical reasons to expect any anomalous correlations in EEG activity to manifest preferentially in one or the other of these domains, and previous studies have not addressed this issue. Such correlations have reportedly been observed using either of these measures, but the few early studies which employed measures of induced activity were, on the whole, poorly designed and lacking in adequate controls, while most of the stronger evidence for such correlations has appeared in later studies using evoked measures. Additionally, in studies using evoked measures and which have also reported the latency of the observed correlated activity (e.g. Grinberg-Zylberbaum et al., 1994), such correlations most often appeared to manifest soon after stimulus presentation; if we assume that this is indeed a stable and reliable characteristic of such anomalous correlations, this would argue in favour of using evoked- α measures, as these preferentially reflect early components of ERPs (Klimesch et al., 2000).²²

Further investigation of the characteristics of induced- α activity has provided additional reasons to consider this as a less suitable candidate for a dependent variable in this study. For example, event-related changes in induced- α activity have been shown to demonstrate much higher inter-individual variability than evoked responses, which can be attributed, at least in part, to large individual differences in ongoing alpha activity (Shaw, 2003). Such large individual differences can be observed not only in the amplitude of the resting alpha rhythm, but also in the peak frequency of the alpha rhythm across individuals. For example, whereas one individual may have a resting alpha rhythm which is maximal at 7.5Hz, another may show a rhythm with maximal power at 13.5Hz, and therefore large portions of alpha band power in these individuals will fall outside a fixed alpha frequency window of 8-13Hz. For this reason, studies investigating event-related changes in induced- α activity have increasingly tended to adjust the definition of the alpha band on a subject-specific basis, and have termed this the *individual alpha frequency* (IAF) (Doppelmayr, Klimesch, Pachinger, & Ripper, 1998). Additionally, as evidence has accumulated suggesting that certain frequency sub-bands within the extended (induced) alpha band correspond to different cognitive processes, there is a growing tendency to divide the IAF band to three smaller sub-bands (lower-1 alpha, lower-2 alpha and upper alpha), and to study these separately according to their functional relevance (Klimesch, Döpplemayr, Russegger, Pachinger, & Schwaiger, 1998).

Adopting such a strategy of determining the individual alpha band for each subject in this study, and further sub-dividing this into narrower sub-bands, would make the analysis of the results unnecessarily cumbersome, and appears to be ill-suited for the primary purpose

²²This can also be seen in our own data, by comparing the waveforms in figures 2.5 and 2.7.

of the study. It is most likely that this purpose would be better served by using a measure based on evoked- α activity, which is comparatively insensitive to individual differences in alpha rhythms, and demonstrates much lower inter-individual variability in event-related responses. An additional reason for giving preference to measures of evoked- α activity as our dependent variable, concerns differences in the topographical distribution of activity between evoked- α and induced- α event-related responses; plots of these distributions can be seen in Figure 2.8.

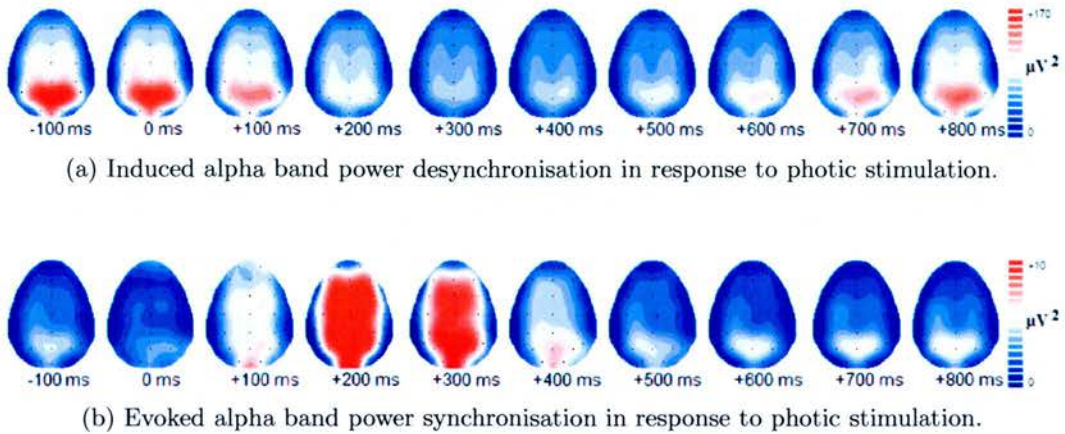

Figure 2.8: A 2-D plot of the topographical distribution of induced- α and evoked- α event-related activity in response to direct photic stimulation across the thirty-electrode array. Group mean for $n = 39$ participants, with an average of 68 presented stimuli per subject. Photic stimuli were presented at $t = 0$ ms for 80ms.

The top graph (Fig. 2.8a) shows the topographical distribution of event-related changes in induced- α activity in response to photic stimulation, across the thirty-electrode array from which we were recording. During the pre-stimulus period, activity from the ongoing (i.e. “resting”) alpha rhythm is prominently visible in the parieto-occipital area; following stimulus presentation, this induced (non-phase-locked) alpha activity is reduced and nearly disappears, and gradually returns to pre-stimulus levels after ≈ 800 ms. The bottom graph (Fig. 2.8b) shows the topographical distribution of evoked-alpha responses to photic stimulation. This shows a sharp increase in evoked (phase-locked) alpha power following stimulation, which originates in the occipital area and spreads throughout most of the cortex, returning to a pre-stimulus baseline level of activity ≈ 500 ms later. In comparing these graphs, induced- α responses to photic stimulation can be described as a desynchronisation of ongoing (i.e. “resting”) alpha oscillations which are primarily localised in posterior areas, whereas evoked- α responses (which are thought to reflect a transient phase-locking of alpha sub-bands), are more global in topographical distribution. This difference would appear to favour the use of evoked- α measures, especially as induced- α responses have been shown to have considerable inter-individual variability, not only in magnitude and latency, but also in topographical distribution (Burgess & Gruzelier, 1996). Another reason to consider the wider topographical distribution of evoked- α responses as a favourable characteristic concerns the use of a global measure of multi-channel EEG activity in this study, as is described in following section. For the reasons described above, a measure of evoked- α activity was adopted as the dependent variable to be used for the quantitative evaluation of the experimental hypothesis; a qualitative assessment of evoked

potentials and induced- α responses will also be presented in later sections for the purpose of exploratory analysis.

2.3.4 Global Field Power

Multi-channel EEG from thirty scalp electrodes was recorded in this study, therefore a number of different options are available in considering how to summarise this data and use it for quantitative analysis. A common practice in EEG/ERP literature for example, is to select a few electrodes that are of particular interest (e.g. due to past empirical findings or for theoretical reasons), or to group together electrodes from functionally or anatomically distinct cortical areas and treat these separately. Previous studies investigating potentially anomalous event-related EEG correlations have typically recorded EEG from only a small number of electrodes, (usually four to six), thus providing EEG data-sets with very low spatial resolution; as a consequence, it is not possible to reach any reliable conclusion regarding the possible cortical localisation of the effects they have observed. As we had no empirical or theoretical reasons to expect to find a localised effect in non-stimulated participants in this study, we have therefore decided to use a global measure of EEG activity, and calculated the Global Field Power (GFP) for this purpose.

The GFP corresponds to the spatial standard deviation between multiple electrodes as a function of time, and can be used to quantify the instantaneous global electrical activity across the entire spatial potential field, sampled over the scalp (Lehman & Skrandies, 1980). As the GFP shows how the strength of the entire potential field recorded across the scalp varies over time, it is often used as a global measure for identifying the latency of components in event-related potentials, independently of any specific electrode site. The GFP is calculated as:

$$\text{GFP} = \sqrt{\frac{1}{2n} \sum_{i=1}^n \sum_{j=1}^n (U_i - U_j)^2} \quad (2.3)$$

where n is the number of electrodes which measure the potentials e_i and e_j , with $i, j = 1 \dots n$; the observed potentials are $U_i = e_i - e_{\text{commonreference}}$ (Lehmann & Skrandies, 1984). The Global Field Power is reference-independent, and quantifies activity over the entire electrode array considering all electrodes equally; as such, it avoids the potentially problematic issues of multiple comparisons when several electrodes are used, or of an arbitrary selection of electrodes. It was therefore deemed to be a suitably conservative choice of EEG parameter to be used for the quantitative analysis of our data.²³

Figure 2.9 shows the distribution of evoked alpha band power in response to photic flashes across the thirty electrode sites, and Figure 2.10 shows the GFP waveform calculated from this activity. As the GFP shows how the strength of the entire potential field recorded from the 30-electrode array varies over time, it can therefore serve as a single-channel metric of global EEG activity, and can be used to determine the temporal characteristics of event-related responses. Identifying such temporal characteristics of responses to direct photic stimulation is a crucial step in defining a measure of EEG activity with which to test the hypothesis of event-related EEG correlations in non-stimulated participants, and this is described in the following section.

²³We are grateful to Dietrich Lehmann and Jiri Wackermann for suggesting the use of this measure.

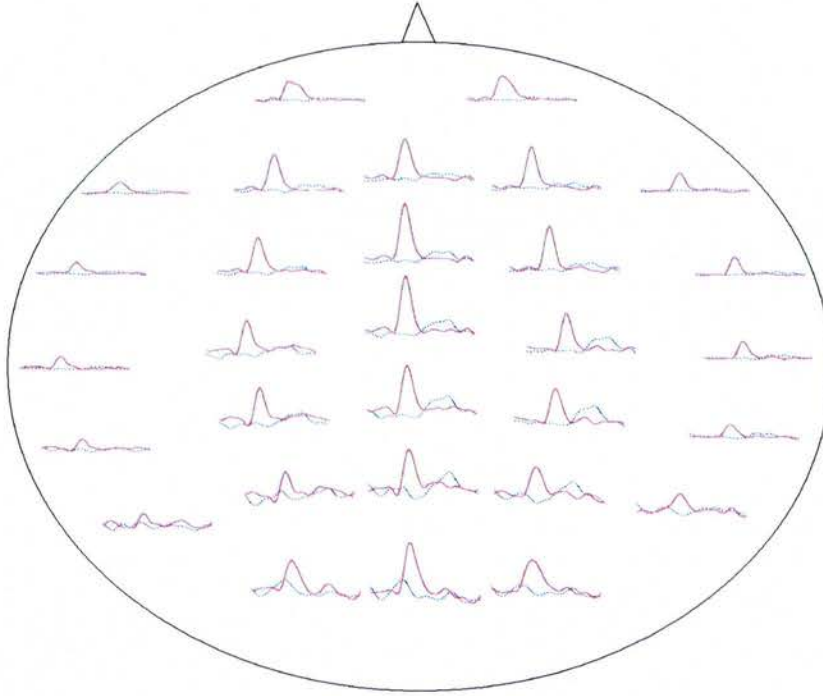

Figure 2.9: Evoked alpha band power across the thirty electrode recording sites during direct photic stimulation (solid red lines), and during control periods (dotted blue lines). Group mean for $n = 39$ participants, with an average of 68 presented stimuli per subject.

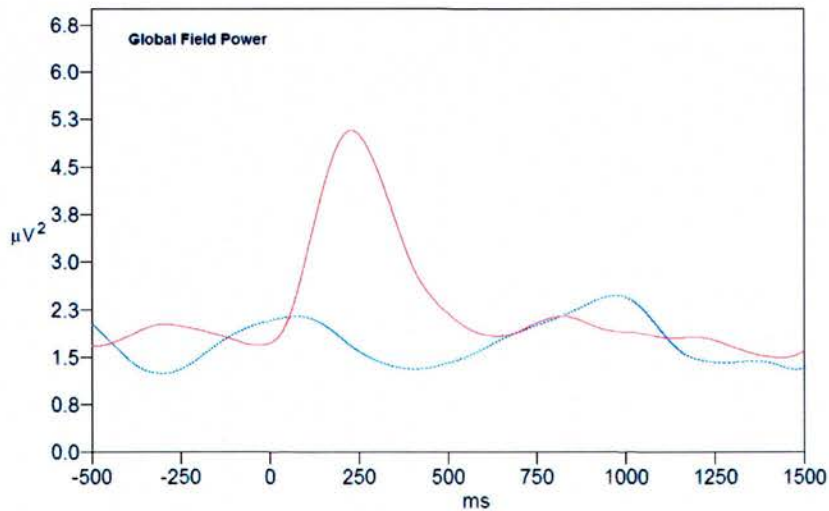

Figure 2.10: Global field power (GFP) calculated from the 30-channel data shown in Fig. 2.9. Activity shown is evoked alpha band power during direct photic stimulation (solid red line), and during control periods (dotted blue line). Group mean for $n = 39$ participants, with an average of 68 presented stimuli per subject. Photic stimuli were presented at $t = 0$ ms for 80ms.

2.3.5 Effect measure: λ -ratio

In our effort to operationalise and formally test the hypothesis of event-related correlations in EEG activity between isolated participants, we have attempted to avoid any assumptions regarding the nature of potential mechanisms that may mediate such correlations. Once stripped of all theoretical assumptions, (such as speculations about information transfer, non-local correlations, etc.), the fundamental question addressed by all previous studies on this topic is whether event-related changes in the electrical brain activity of a sensorially stimulated subject correlate with synchronous changes in the electrical brain activity of another, physically isolated (and non-stimulated) subject. Reformulating the question in this way allows us to describe the experimental design as follows: EEG activity is recorded from a human participant, while a sensory event occurs repeatedly at random time intervals and is observed by another participant. Our task is to establish whether after several presentations of this event, the EEG recording from the non-stimulated participant shows evidence of changes in brain activity which are correlated with these events.

As the timing of presentation of these stimulus events is known with precision, and comparable control periods are available which have been randomly selected using the same algorithm and prior probabilities as have been used to randomise the presentation of photic stimuli, we can therefore compare EEG activity in non-stimulated participants during these periods to determine whether any consistent differences appear across subjects. Based on observations of ordinary responses to direct stimulation with photic flashes described above (see Figure 2.10), we can define the time window of interest in the EEG activity of non-stimulated participants to be the one-second interval centered upon the moment of photic stimulation of their partners. As evoked-alpha event-related responses in stimulated participants take place within the 500ms post-stimulus interval, it would be reasonable to expect any potential responses in non-stimulated subjects to also appear within this time window. We can therefore define our test period to be the 500ms interval after stimulus presentation, and use the 500ms pre-stimulus period as a comparison reference interval, and a log-ratio measure λ of post-/pre-stimulus power can be calculated using the formula:²⁴

$$\lambda = \log_{10} \frac{\sum_{t=0}^{500} \alpha \text{GFP}_t}{\sum_{t=-500}^0 \alpha \text{GFP}_t} \quad (2.4)$$

where the numerator is the sum of evoked- α global field power within the 0 to 500ms post-stimulus interval, and the denominator is the sum of evoked- α GFP within the -500 to 0ms pre-stimulus interval. According to this measure, a lack of difference between pre-stimulus and post-stimulus power would result in a λ value close to zero, whereas higher alpha-power in the post-stimulus interval would return positive values, and higher alpha-power in the pre-stimulus interval would result in negative values. For example, the log-ratio of such a comparison for the average response to direct photic stimulation seen in Fig. 2.10 would be: $\lambda_{\text{photic}} = \log_{10} \frac{872.2}{461.1} = .347$, whereas the ratio for the comparable control period would be: $\lambda_{\text{control}} = \log_{10} \frac{420.3}{401.7} = .019$.

Therefore by comparing the λ -ratio between test and control periods, the hypothesis of

²⁴We are grateful to Jiri Wackermann for suggesting the use of this log-ratio measure.

signal detection²⁵ by non-stimulated subjects can be formally tested, as specific statistical predictions can be made about the expected ratios under the null hypothesis.²⁶ As non-stimulated participants were never exposed to any photic stimuli themselves, their ‘photic’ epochs simply correspond to the (randomly selected) times when their isolated partners were photically stimulated. Similarly, ‘control’ epochs for non-stimulated subjects are effectively random samples taken during periods when their partners were not stimulated. The timing and order of photic and control events was randomised using the same algorithm and selection probabilities, so that at any given point in time throughout the session, each event was equally likely to occur. Therefore for non-stimulated participants, ‘photic’ and control epochs effectively constitute two sets of (statistically equivalent) random samples taken from their continuous EEG record, and as such, no difference between these would be expected. The null and experimental hypotheses can therefore be formally defined as:

$$H_0 : \lambda_{\text{photic}} \simeq \lambda_{\text{control}}$$

$$H_1 : \lambda_{\text{photic}} \neq \lambda_{\text{control}}$$

with the criterion for $\lambda_{\text{photic}} \neq \lambda_{\text{control}}$ being a statistically significant difference between λ_{photic} and λ_{control} ; a non-directional hypothesis was chosen as in the Wackermann et al. (2003) study differences were found in both directions. A separate comparison will be performed for each of the three groups, and based on the findings of the Wackermann et al. (2003) study, we would expect to find a significant difference between λ_{photic} and λ_{control} in the Related and the Unrelated groups, and no such difference in the Alone group.

2.4 Results

2.4.1 Preliminary data processing

The raw EEG data from all 65 participants was band-pass filtered offline within 1–30Hz with 24db/octave roll-off. EEG records were visually inspected and bad channels were marked and removed. Ocular artefacts were minimal as participants had their eyes closed throughout the session, therefore no ocular artefact correction method was used. Three-second epochs time-locked upon event markers were sampled from the continuous EEG records (–1s to +2s, with event at $t = 0$). Epochs were baseline corrected and those containing amplitudes $> 100\mu\text{V}$ were automatically rejected; epochs were also visually inspected and those containing additional smaller artefacts (e.g. from eye movements or muscle activity) were manually rejected. Manual artifact rejection was conducted blindly as to whether epochs related to photic or control events.

2.4.2 General results

Figure 2.11 shows the mean λ -ratios for non-stimulated subjects in the three groups, comparing photic stimulation and control periods. In the Related pairs group, the mean λ value is higher

²⁵Defined as changes in EEG activity temporally correlated with the stimulation of an isolated partner.

²⁶This λ -ratio measure is based on the (logarithmic decibel scale) signal-to-noise ratio measure.

during periods of photic stimulation compared to control periods, and this is also the highest positive mean λ value across the three groups (indicating relatively higher evoked- α global field power during the post-stimulus period). A higher mean λ value for photic relative to control periods can also be seen in the Unrelated pairs group, although in this case the difference is entirely due to an unusually low λ value for control periods, as the λ ratio for photic periods in this groups is close to the expected value of zero. For the Single participants group, mean λ values for both photic and controls periods are similar, and are close to the value of $\lambda = 0$ expected under the null hypothesis. Numerical values for means and standard deviations of λ -ratio values for all groups and conditions can be found in Table 2.1.

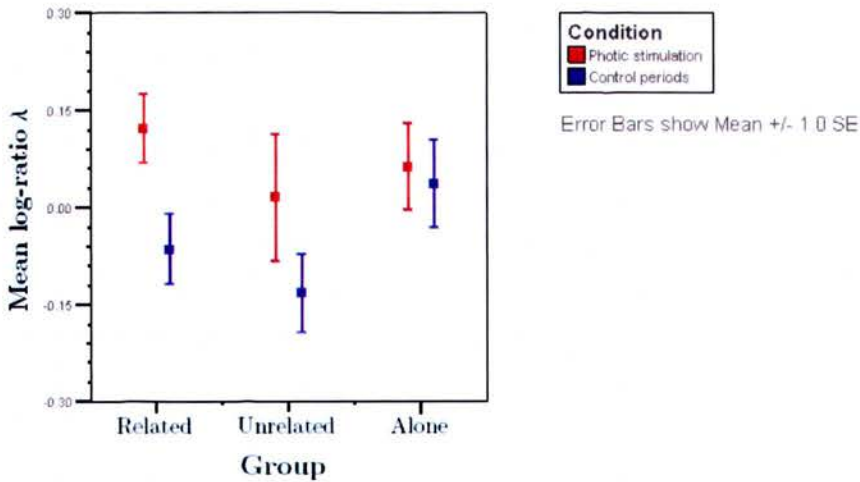

Figure 2.11: Mean λ -ratio for non-stimulated subjects during periods of photic stimulation of their partners, and during comparison control periods of no stimulation. Error bars show \pm one standard error from the mean.

Table 2.1: Mean λ -ratio and standard deviation values for photic and control conditions for each of the three groups.

	<i>Related</i>		<i>Unrelated</i>		<i>Alone</i>	
	Photic	Control	Photic	Control	Photic	Control
Mean λ	.121	-.064	.015	-.132	.062	.037
Standard Deviation	.190	.196	.349	.216	.241	.243
Standardised λ ($\bar{\lambda}/SD$)	.636	-.326	.043	-.611	.257	.152

Although log-ratio data are often assumed to satisfy parametric assumptions, a preliminary examination of our data revealed that these were not normally distributed. Therefore the non-parametric Wilcoxon signed-ranks test was used to statistically evaluate the differences in λ values between photic and control periods in each group; the results of this test can be found in Table 2.2. A significant difference in mean λ -ratio values between photic and control periods

was found for the Related pairs group ($p = .023$; two-tailed), while differences in the other two groups were non-significant. Associated effect size estimates can also be found in Table 2.2.

Table 2.2: Results of Wilcoxon signed-ranks test (two-tailed; $\alpha = .05$) for differences in mean λ values between control and photic conditions and associated effect sizes ($n = 13$ for each group).

	<i>Related</i>	<i>Unrelated</i>	<i>Alone</i>
Wilcoxon p	.023	.173	.861
Wilcoxon z	-2.271	-1.363	-.175
Effect size r	.433	.245	.051

The significant difference between λ_{photic} and $\lambda_{control}$ in the Related pairs group appears to support the experimental hypothesis, and the estimated effect size of $r = .43$ for this difference is relatively high. The direction of this effect also indicates greater evoked- α activity in non-stimulated participants during periods of photic stimulation of the partners, compared to control periods of no stimulation. The small sample size in this study must be taken into consideration however when evaluating these results, and it is also important to note that the mean value of $\lambda = .121$ seen for photic periods in this group, is not the most extreme deviation from the value of $\lambda = 0$ expected under the null hypothesis. Control periods in the Unrelated pairs group show a mean value of $\lambda = -.132$ which is more extreme, although in the opposite direction (i.e. indicating relatively higher evoked- α GFP in the pre-stimulus period). This latter deviation cannot reasonably be attributed to a correlation in event-related EEG activity between Unrelated participants, as it occurs during control periods of no stimulation; it could however be seen to suggest, that deviations of such magnitude in λ -ratio values due to random variation may not be uncommon in the means of groups of this size, which would question the validity of rejecting the null hypothesis based solely on the significant effect found for the Related pairs group. If we take a measure of variance in λ values into account however, the Related pairs group has the lowest standard deviation values of the three groups, while the standard deviation values in the Unrelated pairs group are unusually high. When λ values are standardised by dividing mean λ by standard deviation therefore, the highest value is found during photic periods in the Related pairs group; standardised λ values for the three groups can be found in Table 2.1.

Taking these points into consideration, although a significant difference in λ values has been identified in the Related pairs group, it would be difficult to reach a definite conclusion regarding the hypothesis of event-related correlations in EEG activity between isolated participants based on comparisons of λ -ratio values alone. The λ -ratio has been adopted in order to provide a quantitative measure for the statistical evaluation of the experimental hypothesis, but as it simply quantifies post-stimulus versus pre-stimulus differences in evoked- α global field power, it provides very limited information as to the morphology and temporal characteristics of the underlying EEG activity. It would therefore be useful at this point to examine the mean waveforms of evoked- α global field power for each group.

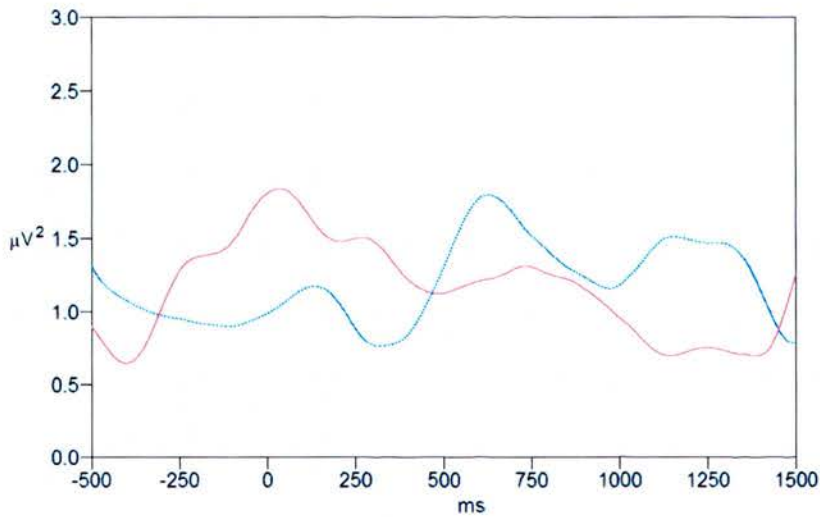

Figure 2.12: Mean evoked- α global field power during photic and control periods for non-stimulated participants in the Related pairs group ($n = 13$). Solid (red) line shows mean of photic stimulation epochs and dotted (blue) line shows mean of controls; on average, 93 photic and 93 control events were presented per subject.

2.4.3 Related Pairs

Figure 2.12 shows the average waveforms of mean evoked- α global field power during photic and control periods, for the thirteen non-stimulated participants in the Related pairs group. A relative rise in mean evoked- α GFP can be seen during photic stimulation periods, although there is no clearly formed event-related response waveform as can be seen during the same periods in stimulated subjects (Fig. 2.10). In addition, a rise in mean evoked- α GFP of nearly the same magnitude can also be seen during control periods, and although this peaks at ≈ 600 ms (which is outside the -500 to $+500$ ms window of interest), a deviation of such magnitude at any point during control periods may be seen to suggest that such fluctuations in mean evoked- α GFP for randomly-sampled epochs in a group of this size may not be uncommon, which would challenge an interpretation of the significant effect found in this group using the λ -ratio comparisons as evidence for event-related EEG correlations between isolated participants. Such an interpretation is also somewhat incompatible with the observation that although event-related activity in photically stimulated subjects is maximal at ≈ 250 ms after stimulus presentation, the rise in evoked- α GFP seen in non-stimulated participants during photic stimulation periods peaks at ≈ 50 ms. Finally, the observed deviation in evoked- α GFP seen during photic periods in non-stimulated participants appears to begin during the pre-stimulus period, i.e. before the presentation of photic stimuli to their partners, a characteristic which is also problematic to an interpretation of the effect as a correlation in EEG activity between isolated participant pairs.

2.4.4 Unrelated Pairs

The mean evoked- α GFP waveforms for non-stimulated participants in the Unrelated pairs group (Figure 2.13), reveal that although evoked- α activity during photic periods (red line)

reaches its highest level during the 500ms post-stimulus interval, the morphology of the waveform does not indicate a clearly formed event-related response, and the difference in magnitude of activity within the 500ms post-stimulus interval compared to the rest of the epoch is quite small, something which is also reflected in the small $\lambda = .015$ value for photic periods in this group.

The activity underlying the large negative $\lambda = -.132$ value found during control periods in this group, can be identified by examining the mean evoked- α GFP waveform (blue dotted line); a relatively large deviation in mean GFP can be seen in the pre-stimulus period, which is also larger in magnitude at the peak latency (≈ -240 ms) than the deviation seen during photic stimulation periods.

These observations support the non-significant result of the comparison of λ -ratios in photic and control periods for this group, and further confirm that no evidence can be found for anomalous event-related correlations between pairs of unrelated isolated participants.

2.4.5 Alone Participants

Estimated λ -ratios for Alone participants in both photic and control periods were very close to the expected value of zero (Table 2.1), and the mean evoked- α GFP waveforms for both photic and control periods are relatively flat, showing no prominent deviations from baseline, and never exceed $1\mu\text{V}^2$ in magnitude (Fig. 2.14). This is what would be expected from the means of epochs randomly sampled from non-stimulated subjects, and it is somewhat reassuring, as it suggests that no systematic sources of error, such as electromagnetic leakage from the triggering of photic flashes or the setting of event markers, were affecting the EEG recordings from non-stimulated participants.

2.5 Discussion

In this study a statistically significant difference between λ_{photic} and λ_{control} has been found in the Related pairs group, with a higher mean λ -ratio observed during photic compared to control periods in non-stimulated subjects, whereas no significant differences between such periods have been found in the other two groups. Although this appears to support the experimental hypothesis and to suggest the presence of an anomalous correlation in event-related activity between related pairs of participants, closer inspection of the results has led to several observations which may challenge such an interpretation. For example, the temporal characteristics of the observed rise in mean evoked- α GFP during photic periods for non-stimulated subjects in the Related pairs group (Fig. 2.12), are not aligned with the temporal characteristics of responses to direct photic stimulation in their partners; the activity in non-stimulated subjects reaches a peak much earlier than would be expected if this activity was correlated with the event-related responses of directly stimulated participants. Furthermore, the observed rise in evoked- α activity in non-stimulated subjects appears to precede the presentation of photic stimuli to their partners; this characteristic is clearly problematic if it is assumed that such activity reflects event-related responses in non-stimulated participants, or event-related EEG correlations between stimulated and non-stimulated participants. As the timing of photic events was randomised, conventional anticipatory activity (especially in non-stimulated participants)

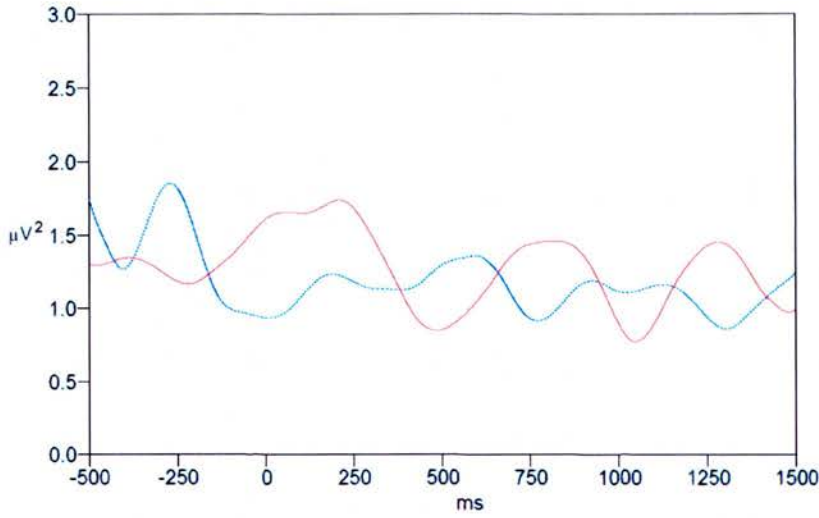

Figure 2.13: Mean evoked- α global field power during photic and control periods for non-stimulated participants in the Unrelated pairs group ($n = 13$). Solid (red) line shows mean of photic stimulation epochs and dotted (blue) line shows mean of controls; on average, 93 photic and 93 control events were presented per subject.

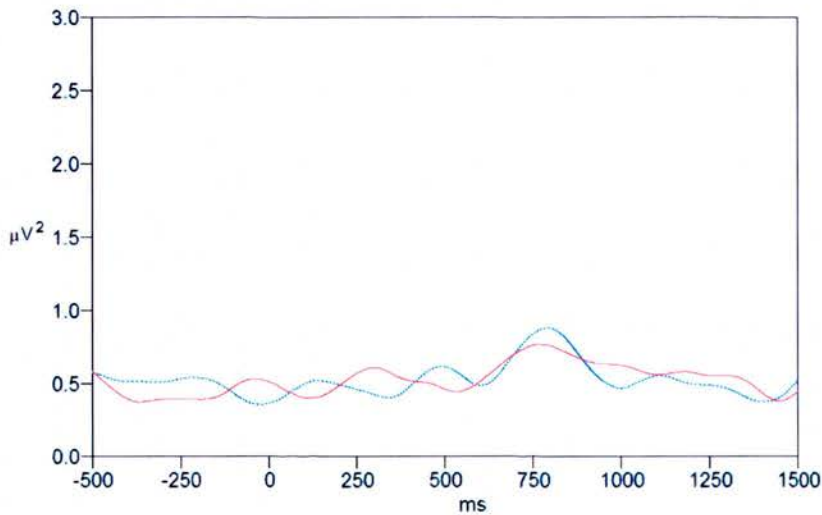

Figure 2.14: Mean evoked- α global field power during photic and control periods for non-stimulated participants in the Alone participants group ($n = 13$). Solid (red) line shows mean of photic stimulation epochs and dotted (blue) line shows mean of controls; on average, 93 photic and 93 control events were presented per subject.

cannot account for this effect; such observed pre-stimulus activity cannot be readily accommodated within causal or non-local correlational explanatory models, and may therefore represent an additional anomaly in need of further investigation. Although similar anomalous anticipatory responses have been reported in a number of experimental studies (e.g. Bierman & Radin, 1997), such responses preceded the actual sensory stimulation of the subjects involved; observations of anticipatory responses in non-stimulated participants which are correlated with the sensory stimulation of distant participants have not, to our knowledge, been reported before in the literature. Taking into account the small sample size of this study, it would therefore be premature to interpret the observed pre-stimulus activity as evidence of a temporal anomaly; it would perhaps be more appropriate at this stage to consider the unusual temporal characteristics of the observed activity as a challenge to the experimental hypothesis of event-related EEG correlations between isolated participants.

Another problematic observation concerns deviations in mean evoked- α GFP in the waveforms of activity during control periods (for non-stimulated participants in the Related and Unrelated groups; Figs. 2.12 and 2.13); these are of comparable magnitude to the deviation seen during photic periods in the Related pairs group, which is responsible for the significant effect identified in this group. This observation appears to suggest that fluctuations of this magnitude in the average waveforms of evoked- α GFP from randomly sampled epochs may not be unusual, at least in the averages of groups of this size ($n = 13$). This may appear to suggest that fluctuations of such magnitude due to chance variation may not be uncommon, it is important to note however that group-average waveforms such as these can be disproportionately affected by extreme deviations in the waveforms of a small number of unrepresentative individuals. In contrast, the use of the non-parametric Wilcoxon test for comparing differences in λ -ratios between photic and control periods, ensures that extreme scores in a few subjects will not affect the overall outcome of the test. The mean λ_{photic} in Related pairs was significantly higher than the mean $\lambda_{control}$ according to this test, and it was also the most extreme *positive* value across the three groups (Related $\lambda_{photic} = .121$). Although a more extreme (although negative) mean λ -ratio value has been found in control periods for the Unrelated pairs group (Unrelated $\lambda_{control} = -.132$), when mean λ values are divided by the standard deviation for each group, the most extreme standardised λ value is found during photic periods for the Related pairs group (see Table 2.1).

Several of the previous studies investigating potential EEG correlations between isolated participants have reported observing “transferred potentials” (TPs), i.e. ERP-like waveforms in the averages of epochs taken from the EEG activity of non-stimulated participants, which coincided with the photic stimulation of their isolated partners, and which were similar in morphology to the VEPs of these stimulated subjects (Grinberg-Zylberbaum et al., 1994). In most reported examples of such TPs, the similarity in evoked activity between stimulated and non-stimulated participants occurred soon after stimulus presentation (within the first 200ms post-stimulus), which was one of the reasons for our choice of evoked- α measures in this study, as evoked- α activity is known to preferentially reflect the early components of ERPs (Klimesch et al., 2000). Although we have found no clear evidence of such “transferred potentials” in the group-mean waveforms of evoked- α GFP for any of the three groups in this study, a moderate rise in evoked- α GFP has been observed in the Related pairs group during photic stimulation periods. It is worth noting that the reported TPs in previous studies have always involved comparisons of individual averages (i.e. comparing evoked activity between stimulated and

non-stimulated participants within each pair), whereas in this study we have compared group averages of such activity. This method was chosen in order to avoid some of the problematic aspects of the methodology used in previous studies, as identified in Chapter 1; many of the reported instances of TPs involved the selective reporting of suggestive examples, and most often the reporting of overall quantitative results was absent or incomplete. As can be seen in the group-mean waveforms of evoked- α GFP in non-stimulated participants in the Results section, relatively large (and presumably random) fluctuations in evoked- α activity can be found during control periods, even in group averages from thirteen participants; it is only to be expected that random fluctuations of even greater magnitude would be observed in individual mean waveforms, and the risk of misinterpreting these as TPs, when they occasionally happen to occur within a chosen interval of interest, would be considerable. For this reason we have chosen not to compare individual averages, and to only compare group means of evoked- α activity; perhaps this would be seen to render our results incomparable with the results reported by Grinberg-Zylberbaum et al. (1994), but we do not consider this to be a valid objection. Should activity suggestive of TPs be present in the means of some individuals at a frequency of occurrence which is above what would be expected by chance, this activity would also be reflected in the overall group averages, even if it is “dampened down” somewhat by individuals who have not demonstrated TPs. It is possible that this is responsible for the relative rise in activity seen during photic periods in the mean evoked- α GFP waveform for Related pairs (Fig. 2.12).

In conclusion, the significant difference between λ_{photic} and $\lambda_{control}$ found for non-stimulated participants in the Related pairs group must be interpreted in conjunction with other relevant observations of descriptive aspects of the data, as discussed above. This significant effect and the observation that the largest standardised λ value is found during photic periods in the Related pairs group, appear to support the experimental hypothesis. However, the temporal characteristics of the observed changes in mean evoked- α GFP in this group (see figure 2.12) are not entirely compatible with an interpretation of the effect as evidence of event-related correlations between isolated pairs of participants. We therefore recommend treating the significant effect identified in the Related pairs groups with caution at this point, and consider it as suggestive but not evidential of an anomalous interaction between isolated participants. To further clarify this issue, additional tests will need to be conducted in order to increase the cumulative sample size and decrease the uncertainty regarding the contribution of chance variation; this function will be served by the two subsequent studies reported in this thesis.

The lack of a significant difference between mean λ_{photic} and $\lambda_{control}$ values in the Unrelated pairs group supports the null hypothesis, and appears to contradict the findings of Wackermann et al. (2003) who found similar effects for Related and Unrelated pairs. It is possible that differences in experimental design, procedure, or analysis methods may be responsible for this difference; for example, unrelated participants in the Wackermann et al. (2003) study were unaware that they were paired with another participant, or that they were taking part in a psi experiment, whereas unrelated participants in our study had full knowledge of the purpose and design of the experiment. We had chosen to fully inform unrelated participants in this way, so that the only difference between Related and Unrelated groups would be the presence of an interpersonal relationship and pre-session interaction (or lack of such) between participant pairs. However, the lack of an effect for Unrelated participants in this study should

be considered as a tentative conclusion pending further testing, for the same reasons that the apparent effect in the Related pairs group is treated with reservation. The lack of an effect in the Alone participants group, and the lack of notable fluctuations in the average waveforms of evoked- α GFP for this group in particular, supports the null hypothesis as predicted, and is reassuring as it suggests that our measures were not contaminated by electromagnetic leakage or other sources of error.



Chapter 3

Study 2

3.1 Introduction

In a review of studies investigating potential correlations in event-related EEG activity between physically separated participants, Wackermann (2004) identified the main problems in research concerning such correlations as being the “lack of a solid theoretical background, and still insufficient knowledge about the phenomenon in question”. One conclusion of that review was that a phenomenon has been identified in several studies which is not easy to attribute to a methodological or technical artefact, but whose nature is not currently understood. Wackermann suggested that the goal of future research should be first to “find a minimal set of conditions rendering the investigated effect stable, reproducible and quantifiable”; we consider our attempt in this study to replicate the effect found in Study 1 to be aimed at achieving this goal. Study 2 also aims to serve as an extension of the first study, in the sense that the experimental design will be sufficiently similar in order to enable the results of the two studies to be combined. This will provide a cumulative dataset with a larger overall sample size, which will hopefully help to resolve the uncertainties regarding the validity of the effect identified in Study 1.

The significant effect identified in Study 1 appeared to suggest the presence of a correlation in event-related EEG activity between isolated participants in the Related pairs group; however, closer inspection of descriptive aspects of the data has provided reasons to consider the results as inconclusive. Although non-stimulated participants in the Related pairs group had demonstrated activity during periods of photic stimulation of their distant partners which was significantly higher in mean λ -ratio compared to activity during control periods of no stimulation, a more extreme deviation in mean λ -ratio has also been observed during control periods in the Unrelated pairs group (although in the opposite direction). This was interpreted as an indication that random variation may have been involved in the significant effect observed for Related pairs, which challenges the interpretation of the effect as evidence of event-related correlations between participant pairs. A similar effect was not found for Unrelated pairs, and although relatively large fluctuations in activity were present in the mean waveforms of evoked- α GFP in this group, these appeared during both photic and control periods. Single participants without a stimulated partner (Alone group) showed no significant difference in activity between photic and control periods, and their group-mean waveforms of evoked- α GFP in both periods

were characterised by a notable lack of prominent fluctuations, a finding which suggests the absence of any methodological or technical artefact affecting the results.

In designing Study 2 our principal aim was to attempt to replicate the effect found for Related pairs in Study 1, and by providing additional data which can be cumulatively combined with the results of the first study, to reduce variance and thereby enable a more confident evaluation of the experimental hypothesis. The design of Study 1 was based on an earlier study which had identified a similar effect using a different type of visual stimuli (i.e. a checkerboard reversal pattern), different measures of EEG parameters and different statistical methods (see Wackermann et al., 2003). Both Study 1 and the Wackermann et al. (2003) study have found an effect for Related pairs, and no effect for Alone participants; unlike our findings in Study 1 however, Wackermann et al. (2003) found an effect of similar magnitude for both Related and Unrelated pairs of participants. As Experiment 2 is intended to be a replication of these two previous studies, we will therefore retain the same group design (involving Related, Unrelated and Alone participants) in an attempt to resolve these contradictory findings concerning the presence of an effect for Unrelated pairs.

Wackermann (2004) suggests that following the reliable replication of this effect, the next goal would be to vary conditions systematically in order to study the dependence of the magnitude of the effect on experimental variables. In order to address this second goal, we have included variations in the physical parameters of the photic stimuli to be used in Study 2. In considering which parameters of the stimuli to vary, we were primarily guided by an interest in producing visual evoked potentials (VEPs) in stimulated participants of clearly differentiable magnitudes. Measures of EEG activity in non-stimulated subjects during epochs associated with these two types of stimuli could then be compared, in order to test the hypothesis that the stimuli producing the stronger responses in stimulated subjects, would also be associated with larger effects in non-stimulated subjects.

After considering various possible variations in stimuli parameters able to produce such differentiable responses, an *oddball*-type paradigm was eventually chosen for this purpose. In the oddball paradigm two stimuli are presented in a random sequence with one presented only infrequently relative to the other. The infrequently presented (oddball) stimulus typically produces larger evoked potentials compared to the common stimulus, as well as a prominent P300 component (e.g. Barry et al., 2004). The oddball paradigm usually involves a two-target discrimination task, where subjects are required to respond to the target (oddball) stimuli (e.g. by pressing a key, or by mental counting), while ignoring the common (standard) stimuli. This *active oddball* paradigm is best suited for producing a reliable P300 component, which has numerous uses as an index of cognitive competence and mental dys/function (e.g. Polich, Ladish, & Bloom, 1990). Such a paradigm however, places obvious attentional, cognitive and behavioural task demands on the subjects, and introducing such additional demands in Study 2 would be undesirable, as ideally the methodology should be kept as similar as possible to Study 1, in order to allow the comparison and combination of their results. A less-frequently used variation of the oddball paradigm, involves no active discrimination task, i.e. subjects are simply required to attend to all stimuli without responding in any way. This *passive oddball* paradigm is more similar to the procedure used in Study 1, and will be preferred here for this reason. Both passive and active oddball tasks produce larger-amplitude EPs for rare compared to common stimuli, although this amplitude is somewhat smaller in passive compared to active tasks (Mertens & Polich, 1997). The P300 component produced in passive oddball tasks also

appears to be more variable and more prone to habituation than that seen in active tasks (e.g. Mertens & Polich, 1997), but as our interest in adopting an oddball paradigm in Study 2 is for the sole purpose of producing EPs of two differentiable amplitudes (between common and rare/oddball stimuli), the presence of a reliable P300 component is not relevant to our design.

White (clear) flashes had been used in Study 1, therefore one possible modification of that procedure along the lines of an oddball-type paradigm, would involve using flashes of different colours, with one colour of flashes presented less frequently relative to the other. This is similar to the use of tones of different frequencies in auditory oddball tasks, which is a very commonly used procedure in ERP studies. After exploring various options through a series of pilot sessions, a passive oddball paradigm was eventually adopted in Study 2, involving the presentation of green and red photic flashes at a 3:1 ratio respectively. A detailed description of this paradigm, of the physical parameters of the chosen stimuli, and of the pilot sessions which led to their selection can be found in the Method and Discussion sections. A further addition to the methodology of Study 2 was the use of two EEG recording units, in order to record EEG simultaneously from stimulated and non-stimulated participants.

3.1.1 Hypotheses

Based on the results of Study 1, our hypotheses for Study 2 are as follows:

1. For non-stimulated participants in the Related pairs group, we expect to find evidence of event-related changes in evoked-alpha activity during periods of photic stimulation of their distant partners (i.e. we expect to find a statistically significant difference between λ_{photic} and $\lambda_{control}$).
2. Although no significant effect was found for Unrelated pairs in Study 1, a previous study by Wackermann et al. (2003) has reported significant effects of a similar magnitude for both Related and Unrelated pairs. Therefore precise predictions regarding this group cannot be made at this point, and the null hypothesis of no difference between λ_{photic} and $\lambda_{control}$ will be tested in an attempt to clarify the contradictory findings between these studies.
3. We expect to find no difference in event-related EEG activity between photic and control epochs for non-stimulated participants in the Alone group (i.e. $\lambda_{photic} \simeq \lambda_{control}$).
4. An oddball stimulation paradigm is used in this study, where evoked responses to less-frequently presented stimuli are known to be characterised by larger amplitudes, compared to responses to more-frequently presented stimuli. If an effect similar to the one found in Study 1 is also found in this study, (i.e. a difference between photic and control periods in the event-related EEG activity of non-stimulated participants), we would also expect this effect to be larger in relation to rare compared to common stimuli.

3.2 Method

Although the experimental design of Study 2 is largely based on the design of Study 1, certain changes to the methodology have been introduced, primarily involving the addition of the oddball paradigm. These changes will be described in detail in this section, where certain

elementary aspects of the methodology that have remained unchanged between the two studies will also be summarised. In the interest of avoiding unnecessary repetition, the summary of such common methodology will be brief, therefore concerning elements of the methodology for which no information is explicitly given in this section, the reader should refer to the previous chapter.

3.2.1 Design

EEG was recorded simultaneously from two physically isolated participants, while one of the two was stimulated with randomly timed (single) photic flashes. These flashes were presented interspersed with randomly timed control events (involving no stimulation), and event-related band power measures were used to compare photic stimulation and control epochs. The null hypothesis predicts no difference between such epochs for the non-stimulated subject of each pair. Green and red flashes were presented at a 3:1 ratio respectively, as part of a passive oddball stimulation paradigm. Three groups of participants were recruited, involving related pairs, unrelated pairs, and single subjects.

3.2.2 Participants

Sixty-five unpaid volunteers were recruited through fliers posted on notice boards and distributed throughout Edinburgh, as well as by word of mouth. Twenty-six participants had volunteered as (thirteen) pairs, reportedly sharing an empathic relationship (as close friends, relatives or partners); these participants constituted the Related pairs group. Thirty-nine individual volunteers were pseudo-randomly assigned into either the Unrelated pairs group, (where they were pseudo-randomly matched into thirteen pairs), or the Alone group (where they were not matched with another subject). Thirty-one female and thirty-four male participants took part, with a mean age of 30.4 years, ranging between 19 and 56 years of age.

3.2.3 Equipment and materials

3.2.3.1 Audio material

The same audio recording of a progressive relaxation procedure was used as in Study 1 (see Appendix C for the transcript), which included suggestions to the participants to maintain an awareness of each other throughout the session. This was followed by the recording of shamanic drumming (1.5–2 beats-per-second) also used in Experiment 1 (Rutherford & Charing, 2001). The aim of this procedure was to induce deep relaxation, and to simultaneously facilitate a similar, non-ordinary state of consciousness in both participants. The audio recording was played to both participants using a shared one-way audio link.

3.2.3.2 EEG system and parameters

Two independent EEG recording units were used for data acquisition in this study, in order to enable simultaneous recording of EEG from the stimulated and non-stimulated participants in each pair. Each unit consists of a 40 channel NuAmps EEG amplifier (Neuroscan, USA) and a (Windows XP) PC laptop running the data acquisition software (Scan 4.3.1). The NuAmp

amplifier unit used for recording EEG from non-stimulated participants was situated in Experimental room 1, and was powered (via the laptop) by a medical-grade isolated power supply. The unit used for recording EEG from stimulated participants was situated in Experimental room 2, and was powered by the laptop battery (see Figure 2.3 for room diagram). The use of a common mains power source for both EEG units was avoided, in order to guard against any possible spurious correlations between the two recordings due to shared contamination from mains-related noise. Thirty monopolar channels were recorded from each participant with a 500Hz sampling rate from the following electrode sites: Fp1, Fp2, Fz, F3, F4, F7, F8, FCz, FC3, FC4, FT7, FT8, Cz, C3, C4, T7, T8, CPz, CP3, CP4, TP7, TP8, Pz, P3, P4, P7, P8, Oz, O1 and O2, with averaged ears used as reference. Data was bandpass-filtered online within 1–100Hz, with an additional 50Hz bandstop (notch) filter (24db/octave roll-off was used on all filters). An electrode cap (Neuroscan, USA) with sintered Ag/AgCl electrodes was used for electrode placement.

3.2.3.3 Photic stimuli: materials and parameters

In this experiment we have adopted a variation of the oddball stimulation paradigm, which involves presenting subjects with two sensory stimuli in a random sequence, so that one is presented only infrequently relative to the other; the less frequently presented stimulus typically evokes larger electrocortical responses compared to the more frequently presented one. We have adopted this paradigm in order to explore the nature of the effect found in Study 1, which had suggested the presence of a correlation in event-related EEG activity between physically isolated participants. As no currently known physical mechanism can account for such correlations, exploring the psychophysiological parameters of the effect can be helpful in clarifying the nature of the underlying processes that may be involved, and as Wackermann (2004) has suggested, one way to approach this would be by varying the physical parameters of the stimuli used. By including in the experimental design variations known to produce differential responses in ERP amplitude in stimulated subjects, we can test whether the magnitude of the effect seen in non-stimulated subjects is related to the magnitude of stimulus-evoked responses in their stimulated partners. One study has reported correlational evidence supporting such a relationship (Radin, 2003); in that study only one type of stimulus was used however, and a correlation was found between the amplitude of activity in non-stimulated subjects and natural variations of ERP amplitude in stimulated subjects.

In Study 1 we had used white (clear) photic flashes as stimuli, and as a modification of this procedure into an oddball stimulation paradigm, green and red photic flashes will be used in Study 2. During pilot testing $n = 6$ subjects were presented with equal numbers of green and red flashes, at an equal luminance of 1000Lux (Lumen/m²). These tests revealed that evoked responses to these two colours of flashes were only minimally different, and large differences in responses between subjects further obscured any consistent patterns sometimes seen within individuals. It was certainly clear that when presented at an equal frequency, neither colour of flashes consistently produced larger-amplitude evoked responses. In further pilots tests the relative presentation frequency of the two types of flashes was manipulated, and we established that by presenting green and red flashes in a 3:1 ratio respectively, consistently larger-amplitude evoked potentials are produced in response to the less-common (red) flashes. In attempting to further accentuate the difference in the magnitude of responses to the two stimuli, we also

varied the duration of the flashes and established that presenting the common (green) stimuli for 40ms and the rare (red) stimuli for 70ms further increased the amplitude of evoked responses to the rare stimuli, and also had the subjective effect of making these stimuli appear brighter. As our intention was to use two types of stimuli producing evoked responses of clearly distinct magnitudes, this difference in duration of stimulus presentation was adopted as part of our protocol.

A pair of dark glasses fitted with eight coloured LEDs was used to present photic stimuli (Photosonix USA), with four LEDs (two green and two red) fixed inside each lens in a diamond-shaped arrangement. The luminance of each pair of (same colour) LEDs at a distance of 1cm (approximately the distance from the eyes) was 1000Lux (for both green and red LEDs). Peak emission wavelength was 660nm for the red and 565nm for the green LEDs (see Fig. 3.1), and the duration of flashes was 70ms for the red and 40ms for the green stimuli.

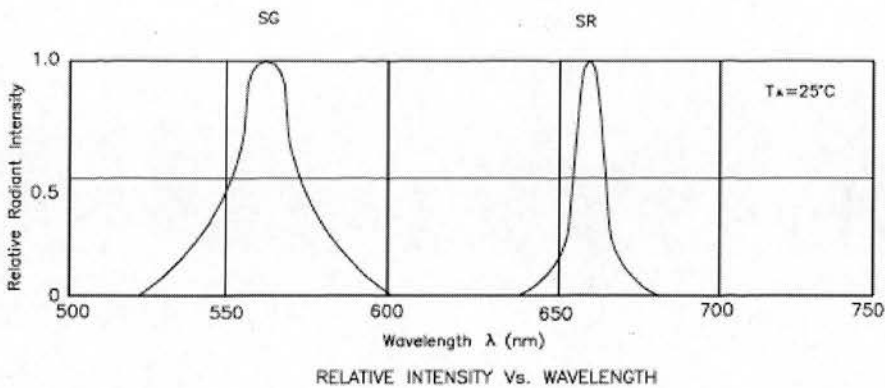

Figure 3.1: Emission spectrum of green and red LEDs used in this experiment.

3.2.3.4 Randomisation and presentation of stimuli

LED flashes were triggered using TTL pulses (+5V logic) from the parallel port of a computer running a script-driven program (*Inquisit* by Millisecond Software, USA), which controlled the randomised presentation of the two types of photic stimuli, (i.e. green and red flashes), at a 3:1 ratio respectively; separate synchronous TTL pulses were used to mark the timing of these photic events on the continuous EEG record of both recording EEG units (see Appendix D for the *Inquisit* script used in this experiment). Control events consisted of EEG event markers only, i.e. without associated flashes presented; control markers for common and rare events were also selected at a 3:1 ratio respectively, in order to provide comparable numbers of control epochs for each type of photic stimulus. Two hundred and eighty (280) events were presented during each session, and on average, half of these (140) would be expected to be photic flashes and the other half to be control events. Given the 3:1 ratio one would expect an average of 105 green and 35 red flashes per session, although the actual number presented varied, as a pseudo-random algorithm repetitively sampled with replacement one of the four types of events. The same algorithm (L'Ecuyer, 1994) was also used to randomise the duration of interstimulus intervals (ISI), which ranged between 3 and 5.5 seconds in half-second steps, with the mean ISI

being 4.25s.¹

3.2.3.5 Equipment connections and electrical isolation

The computer controlling the presentation of photic stimuli was connected directly to the stimulated participants' LED glasses, as in Study 1. Unlike Study 1 however, in Study 2 we were recording EEG simultaneously from both participants in each pair, and the issue of possible electrical leakage between the two EEG units, however remote, was a major concern to us for obvious reasons. It was therefore decided to ensure that the two EEG units did not share the same (mains) power source, and for this reason one unit was powered by battery. As in this equipment configuration (see Figure 3.2) the stimulus randomisation computer must be connected to both EEG units in order to send synchronised event marker signals, another potential source of leakage between the two EEG units would be via the stimulus presentation computer. In order to eliminate this possibility, it was decided to ensure that the delivery of event markers (signaling the timing of stimulus and control events) to the two EEG units was conducted via optical isolation.

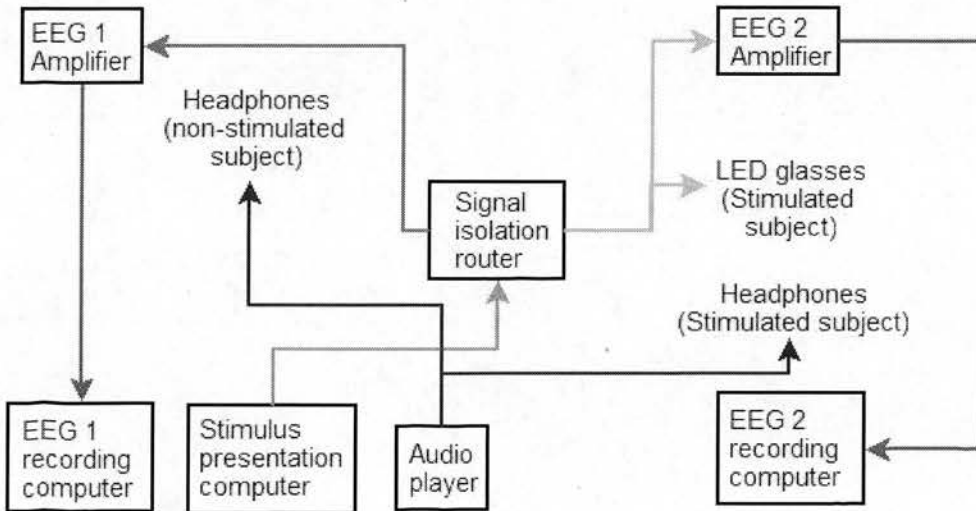

Figure 3.2: Diagram of equipment and connections.

A purpose-built optical isolation signal router was constructed (see Appendix E for the circuit diagram), which uses a series of eight independent photovoltaic relays (*PVA33* by International Rectifier). The timing of photic and control events is signaled to the EEG amplifiers using TTL (+5V logic) pulses, which trigger the appropriate photo-relays (depending on the event type); relays triggered by TTL pulses connect the appropriate serial port pin of each EEG amplifier unit to the earth ground of the same unit. Therefore beyond this optical isolation stage, signals for event markers to the EEG amplifiers were electrically passive; i.e. no electrical current was used to convey event marker signals, and no electrical connection existed between each unit and the stimulus presentation computer. Optical isolation also ensured the absence

¹This mean ISI of 4.25s refers to the presentation of *both* photic and control events, and as these were presented at an equal frequency, the mean ISI between photic flashes (i.e. the mean ISI as perceived by stimulated participants) was therefore 6.4s.

of any form of electrical link between the two participants and/or their respective recording EEG units, therefore each participant and EEG unit was electrically isolated from the other, as well as from the stimulus-generating PC. No auditory or visual cues are emitted from the recording amplifiers during the signaling of event markers, and the amplifiers' EEG channels are themselves optically isolated from the subjects.

3.2.4 Procedure

3.2.4.1 Related pairs

Related pairs of participants decided amongst themselves who was to be the photically stimulated subject, either by choice or pseudo-randomly. They were asked to spend 10-15 minutes alone together before their session, during which time they were asked to try to "enhance their awareness of each other" (the same instructions were given as in study 1). If the participants requested advice on how to do this, the experimenter suggested various possible activities such as joint meditation, synchronised breathing and/or the exchange of personal items, and participants were encouraged to do whatever felt most appropriate for them both.

3.2.4.2 Unrelated pairs

Unrelated pairs did not know each other prior to the experiment, and only met after the session was completed. The experimenter pseudo-randomly matched individual participants into pairs, and pseudo-randomly assigned them to the roles of stimulated and non-stimulated partner. They were each told that a participant whom they don't know is in the other room, and were asked to try and stay aware of this person throughout the session; i.e. they were given the same instructions as Related pairs, excluding the pre-session interaction.

3.2.4.3 Alone participants

Alone participants were told that they *may* be paired with another participant whom they do not know, and that the probability of this happening is 2:3. This strategy was preferred to outright deception, and participants were told to assume that they *are* paired with someone, as this was ultimately more likely.² All participants in the Alone group served as non-stimulated subjects, and the procedure followed was the same as for the other groups, i.e. the audio recording was played to both rooms, and the flashes were delivered as normal in the other (empty) room.

3.2.4.4 General procedure

The design and purpose of the experiment was explained to all participants before their session, and if they expressed a desire to, (and if time allowed), they were shown the results of Study 1. In general the experimenter attempted to give them positive expectations as to the outcome, while also explaining that this is still exploratory work, and that the presence of an effect has not been established beyond doubt. They were asked to keep the aim of the experiment in mind

²This was true when they had first volunteered, as through random group allocation 2/3 of all single volunteers were assigned to the Unrelated group (and randomly matched into pairs), while the other 1/3 were assigned to the Alone group.

throughout the session, but were also discouraged from making a conscious effort to “perform well” in any way.

The progressive relaxation recording was played at the beginning of each session, which lasted for approximately 11 minutes and was followed by the drumming recording which lasted until the end of the photic stimulation period. Three minutes after the start of the drumming randomised photic stimulation was initiated, which lasted for an average of 19.8 minutes, the actual duration in each session depending on the cumulative duration of the randomly chosen inter-stimulus intervals. After the end of photic stimulation the drumming volume faded out, and the final instructions were played preparing the participants for the end of the session (see Appendix C for the script of the relaxation procedure and verbal instructions).

All non-stimulated participants also had an individual session where their EEG was recorded while they were directly stimulated with photic flashes themselves, in order to have a record of their own ordinary psychophysiological responses to the stimuli. This session was sometimes conducted before and sometimes after the joint session, depending on the participants’ preferences and other practical considerations.

3.3 Results

3.3.1 Preliminary data processing

The raw EEG data from all 65 participants was band-pass filtered offline within 1–30Hz with 24db/octave roll-off. EEG records were visually inspected and bad channels were marked and removed. These missing channels were replaced by channels reconstructed from intact neighbouring channels via linear interpolation; no individual EEG record had more than four such reconstructed channels. Ocular artefacts were minimal as participants had their eyes closed throughout the session, therefore no ocular artefact correction method was used.

Three-second epochs time-locked upon event markers were sampled from the continuous EEG records (−1s to +2s, with event at $t = 0$). Epochs were baseline corrected and those containing amplitudes $> 100\mu\text{V}$ were automatically rejected. Epochs were also visually inspected and those containing additional smaller artefacts (e.g. from eye movements or muscle activity) were manually rejected; such manual artifact rejection was conducted blind as to whether epochs related to photic or control events.

3.3.2 Dependent measure

The envelope of evoked (i.e. phase-locked) event-related power within the alpha band was used as a measure of responses to photic stimulation, as in Study 1. The raw EEG of all event-related epochs was first band-pass filtered around the central frequency band of interest (8–13Hz), and epochs were averaged point-by-point (as in evoked potentials). The amplitude values of the resulting average waveform were then squared in order to obtain power measures (μV^2), and the envelope of this waveform was calculated.

As we had recorded EEG from thirty scalp electrodes, the Global Field Power (GFP) was calculated as a measure of global EEG activity (see Equation 2.3). The GFP corresponds to the spatial standard deviation between multiple electrodes as a function of time, and is used to quantify the global electrical activity across the spatial potential field sampled over the

scalp (Lehman & Skrandies, 1980). The GFP quantifies activity over the entire electrode array considering all electrodes equally, and it is reference-independent.

3.3.3 Analysis of responses to direct photic stimulation

EEG data from all photically stimulated participants (including participants who were not stimulated during the experimental sessions) was analysed first, in order to identify the electrophysiological characteristics of ordinary responses to the photic stimuli we were using. Figure 3.3 shows mean ERPs for common (green) and rare (red) photic stimuli for all participants ($n = 65$). It is clear from this comparison that rare stimuli produce responses of a higher amplitude at all ERP components (marked in Fig. 3.3), compared to common stimuli, as would be expected in an oddball stimulation paradigm.

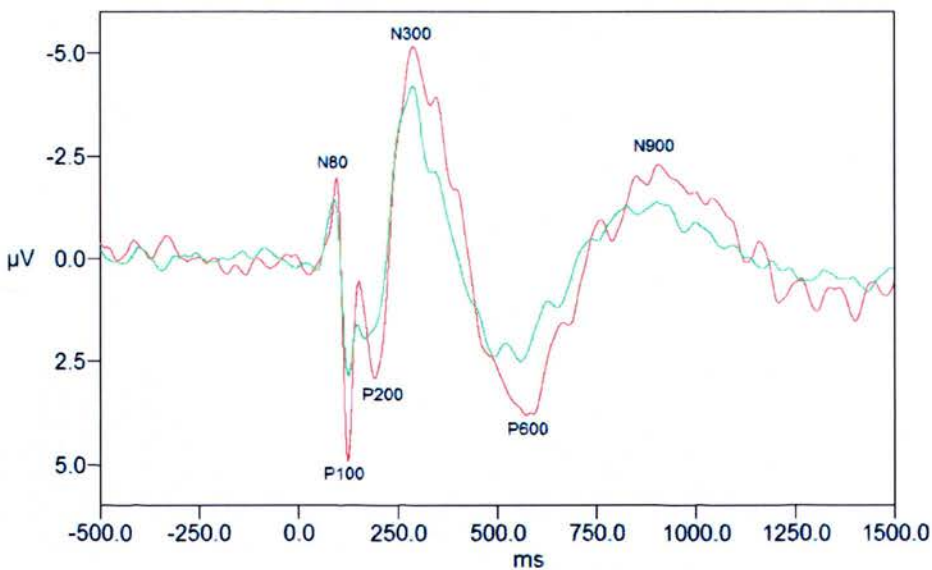

Figure 3.3: Comparison of mean ERPs at Oz in response to direct stimulation with common (green line) and rare (red line) photic stimuli for $n = 65$ participants.

The mean evoked- α GFP for all participants ($n = 65$) during direct photic stimulation can be seen in Figure 3.4. As expected, these responses are characterized by higher amplitudes associated with rare (red) compared to common (green) flashes, although the large difference in the mean number of trials for each type of stimulus (35 for rare and 105 for common stimuli) makes the direct comparison of these waveforms somewhat difficult. Average waveforms of evoked- α activity are sensitive to the number of epochs they are comprised of, as ongoing (i.e. non-phase-locked) oscillatory activity will increasingly cancel out during the averaging of event-related epochs, in direct proportion to the number of epochs which are averaged. Average waveforms from a smaller number of epochs will therefore retain a greater amount of this background activity, and this is responsible for the higher baseline seen in the waveform for rare compared to common stimuli in Fig. 3.4.

Figure 3.5 adjusts for this difference by using only one-third of the epochs for common stimuli; both these waveforms are comprised of the same number of epochs (35 on average) and

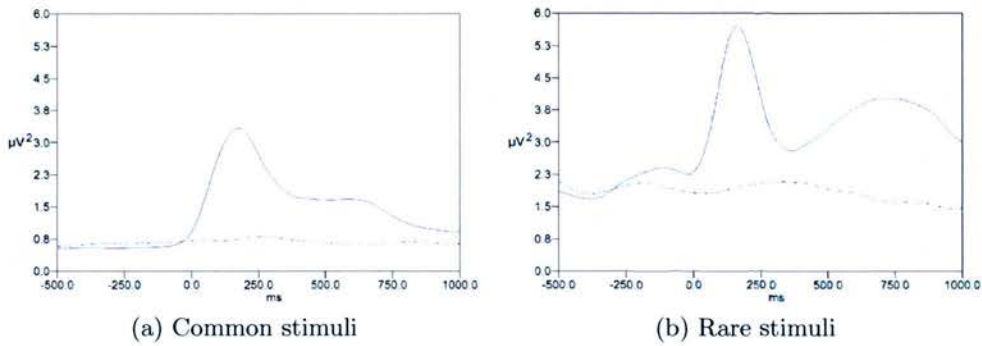

Figure 3.4: Mean GFP (evoked- α) in response to direct photic stimulation for all $N = 65$ participants. (a) shows responses to common flashes and (b) to rare flashes; comparable control periods are shown in dotted lines. Please note the large difference in mean number of stimuli presented; an average of 105 common compared to 35 rare flashes (per subject/session).

are therefore directly comparable. It is clear from this graph that rare photic flashes produce evoked- α responses with a considerably higher amplitude, and responses to rare stimuli also demonstrate a late component ($\approx 500 - 1000\text{ms}$), which is not present in responses to common stimuli; this is most likely to represent cognitive processing related to the oddball status of the rare stimuli.

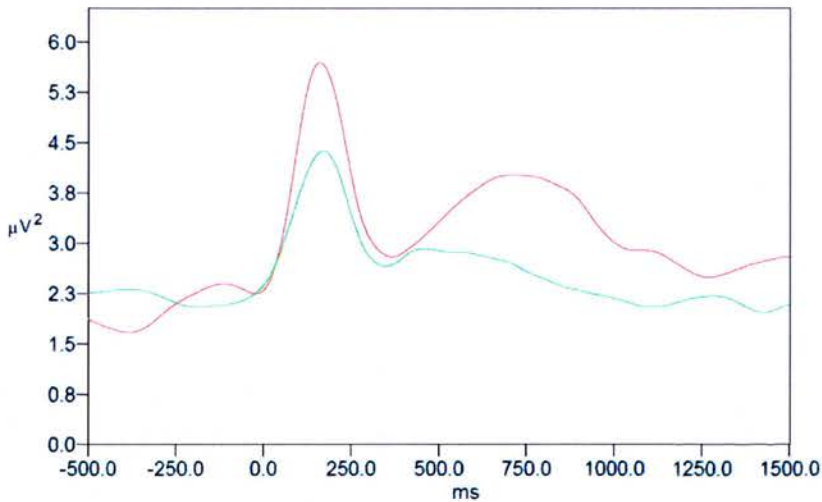

Figure 3.5: Comparison of mean evoked- α GFP in response to direct stimulation with common (green line) and rare (red line) photic stimuli for $n = 65$ participants. In order to make the waveforms comparable, only one-third of epochs for common stimuli has been included; therefore both waveforms are comprised of an average of 35 stimuli per subject.

The difference in activity between photic stimulation (solid lines) and control (dotted lines) periods is clearly visible in Fig. 3.4, and a comparison of activity during these periods in the EEG of non-stimulated participants will be used to investigate potentially anomalous correlations with the EEG activity of their stimulated partners. In Study 1 we had defined

the time window of interest in the EEG activity of non-stimulated participants to be the one-second interval centered upon the time of photic stimulation of their partners, as responses in stimulated participants appear primarily within the 500ms post-stimulus interval, and it would be reasonable to expect any potential responses in non-stimulated subjects to also appear within this time window. We therefore defined our test period to be the 500ms interval after stimulus presentation, and used the 500ms pre-stimulus interval as a comparison reference period. As in Study 1, we have calculated a log-ratio measure of post-/pre-stimulus power using the formula:

$$\lambda = \log_{10} \frac{\sum_{t=0}^{500} \alpha \text{GFP}_t}{\sum_{t=-500}^0 \alpha \text{GFP}_t} \quad (3.1)$$

where the numerator is the sum of evoked- α GFP within the 0 to 500ms post-stimulus interval, and the denominator is the sum of evoked- α GFP within the -500 to 0ms pre-stimulus interval. According to this measure, no difference between pre-stimulus and post-stimulus power would result in a λ value close to zero, whereas positive values would indicate higher alpha-power in the post-stimulus interval, and negative values would indicate higher alpha-power in the pre-stimulus interval. For example, the log-ratio of such a comparison for the average response to direct photic stimulation (common flashes) seen in Fig. 3.4a would be: $\lambda_{\text{photic}} = \log_{10} \frac{2.22}{0.56} = .598$, whereas the ratio for the comparable control period would be: $\lambda_{\text{control}} = \log_{10} \frac{0.73}{0.64} = .057$. Therefore by comparing this ratio λ between test and control periods, the hypothesis of event-related changes in the EEG activity of non-stimulated subjects can be formally tested, as specific statistical predictions can be made about the expected ratios under the null hypothesis.

As non-stimulated participants were never exposed to any photic stimuli themselves, their 'photic' epochs correspond to the (randomly selected) times when their isolated partners were photically stimulated. Similarly, 'control' epochs for non-stimulated subjects are effectively random samples taken during periods when their partners were not stimulated. The timing and order of photic and control events was randomised using the same algorithm and selection probabilities, so that at any given point in time throughout the session, each event was equally likely to occur. Therefore for non-stimulated participants, test and control epochs effectively constitute two sets of (statistically equivalent) random samples taken from their continuous EEG activity, and as such, no difference between these would be expected. The null and experimental hypotheses can therefore be formally defined as:

$$\begin{aligned} H_0 &: \lambda_{\text{photic}} \simeq \lambda_{\text{control}} \\ H_1 &: \lambda_{\text{photic}} \neq \lambda_{\text{control}} \end{aligned}$$

with the criterion for $\lambda_{\text{photic}} \neq \lambda_{\text{control}}$ being a statistically significant difference between λ_{photic} and λ_{control} at $p < .025$ using a two-tailed non-parametric Wilcoxon signed-ranks test.³

³As two comparisons are conducted for each group (one for each type of stimuli), the α value is adjusted accordingly for multiple testing.

3.3.4 General results for all groups

3.3.4.1 Common photic stimuli

Figure 3.6 shows the mean estimated λ -ratio for non-stimulated subjects in the three groups, contrasting periods of presentation of common photic stimuli (to their partners) with comparable control periods. A large difference in mean λ values can be seen between photic and control periods for the Related pairs group, which is due to a large negative λ value in photic periods, indicating comparatively high evoked- α activity in the pre-stimulus interval, whereas the mean λ -ratio in the corresponding control periods is close to the expected λ value of zero. No comparable differences between photic and control periods in mean λ values can be seen in the other two groups, where estimated ratios are close to the value of $\lambda = 0$ expected under the null hypothesis. Numerical values for the mean λ -ratios in these comparisons, as well as associated values for the standard deviation, can be found in Table 3.1. It is worth noting that the lowest estimated standard deviation across all groups can be seen in the Related pairs group during photic periods, which suggests that the large (negative) mean λ -ratio value for this group is not due to extreme scores from a few atypical participants.

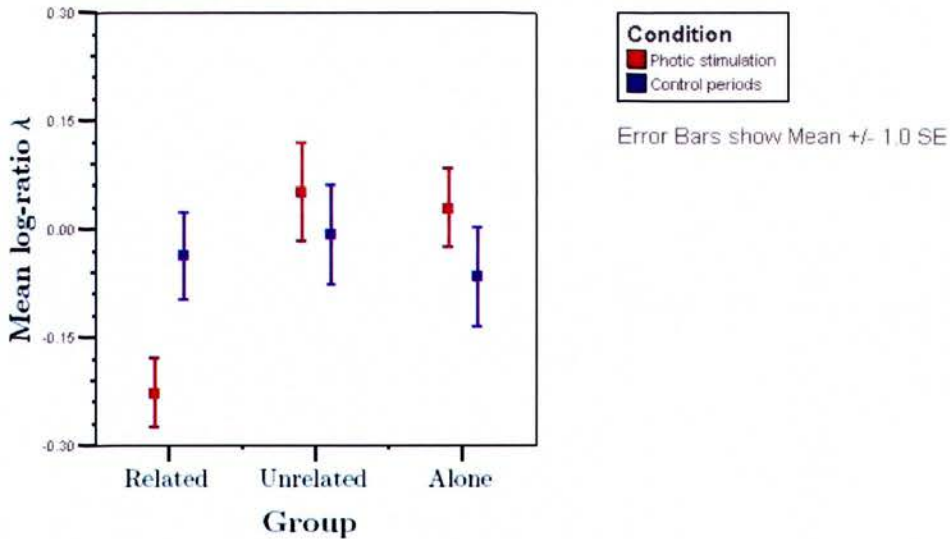

Figure 3.6: **Common stimuli:** Mean λ -ratio for non-stimulated subjects during periods of photic stimulation of their partners, and during comparison control periods of no stimulation. Error bars show \pm one standard error from the mean.

3.3.4.2 Rare photic stimuli

For rare photic stimuli no major difference can be seen in mean λ values between photic and control periods for any of the groups, although moderate positive λ values for photic periods can be seen in the Unrelated and Alone groups (see Figure 3.7 and Table 3.2). It must be emphasized however, that only an average of thirty-five rare stimuli had been presented during

Table 3.1: **Common stimuli:** Mean λ -ratio and standard deviation values during photic and control periods for non-stimulated participants. $n = 13$ in each of the three groups.

	<i>Related</i>		<i>Unrelated</i>		<i>Alone</i>	
	Photic	Control	Photic	Control	Photic	Control
Mean λ	-.228	-.035	.049	-.008	.029	-.066
Stand. dev. (λ)	.172	.218	.243	.248	.195	.245

each session, compared to an average of 105 presented common stimuli. Therefore the individual mean evoked- α GFP waveforms for rare events are likely to involve higher levels of variance, as they result from the averaging of a smaller number of epochs. This within-subject variance is not reflected in the standard deviation of λ -ratio values (see Table 3.2), or the standard error estimates shown in Fig. 3.7, as these variance measures only assess between-subject variance in λ -ratio values. This should be taken into account when comparing results for common and rare events; λ -ratio estimates and group-mean evoked- α GFP waveforms for rare events are likely to be less reliable than the equivalent measures for common events, as rare events involve a smaller number of epochs.

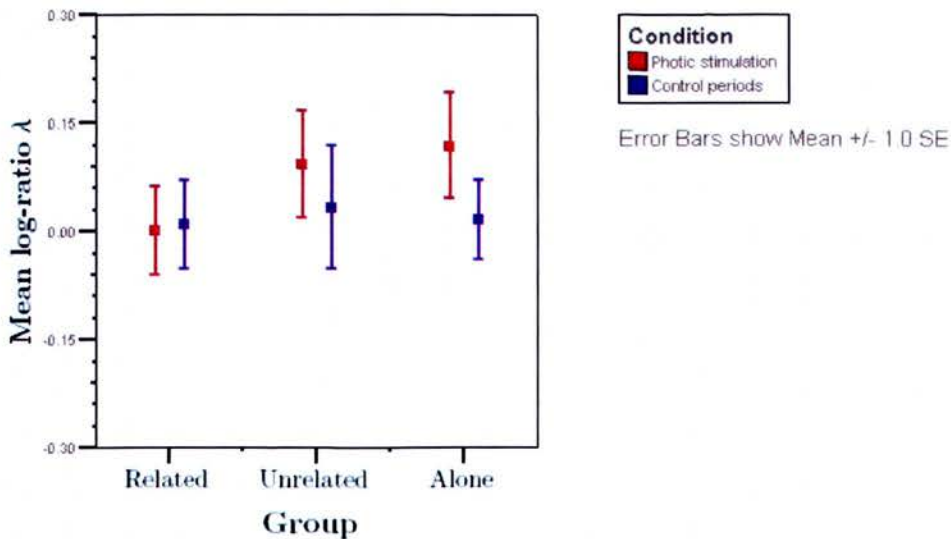

Figure 3.7: **Rare stimuli:** Mean λ -ratio for non-stimulated subjects during periods of photic stimulation of their partners, and during comparison control periods of no stimulation. Error bars show \pm one standard error from the mean.

A non-parametric Wilcoxon signed-ranks test was used to evaluate differences in mean λ values between photic and control periods for the comparisons above; the results of this test and associated effect size estimates for these comparisons can be found in Table 3.3. A significant difference in mean λ -ratio values between photic and control periods was found for common stimuli in the Related pairs group ($p = .007$; $\alpha = .025$), whereas differences in the other two

Table 3.2: **Rare stimuli:** Mean λ -ratio and standard deviation values during photic and control periods for non-stimulated participants. $n = 13$ in each of the three groups.

	<i>Related</i>		<i>Unrelated</i>		<i>Alone</i>	
	Photic	Control	Photic	Control	Photic	Control
Mean λ	.002	.011	.094	.033	.119	.016
Stand. dev. (λ)	.221	.221	.267	.308	.260	.197

groups were non-significant. Differences in mean λ -ratio values between photic and control periods for rare stimuli were non-significant for all groups. The estimated effect size for the Related pairs group (common events) is relatively large ($r = -.43$) and is of the same magnitude as the estimated effect size for the same group in Study 1, although in the *opposite* direction. The mean λ -ratio for photic periods is significantly smaller than the λ -ratio for control periods in Study 2, whereas the opposite was true in Study 1; the reasons for this difference will be clarified in the following section.

Table 3.3: Results of Wilcoxon signed-ranks test (two-tailed) for differences in mean λ values between control and photic conditions, and estimated effect sizes ($n = 13$ for each group). Calculated for common and rare stimuli in each group, therefore significance level is adjusted for multiple tests ($\alpha = .025$).

	<i>Related</i>		<i>Unrelated</i>		<i>Alone</i>	
	Common	Rare	Common	Rare	Common	Rare
Wilcoxon p	.007	.917	.701	.861	.221	.221
Wilcoxon z	-2.691	-.105	-.384	-.175	-1.223	-1.223
Effect size r	-.43	-.01	.11	.10	.20	.21

3.3.5 Results per group

Graphs of mean evoked- α activity for each group and type of stimulus can be found in Figures 3.8–3.10. As in each individual session 105 common and 35 rare events were presented on average, the group mean waveforms for rare events result from the averaging of a smaller number of epochs; these are subsequently more noisy and show a higher baseline compared to the waveforms for common events. Therefore waveforms for common and rare events are not directly comparable, and only comparisons between photic and control periods for each group and type of stimulus are legitimate in this context.⁴

3.3.5.1 Related pairs

For common stimuli in the Related pairs group (Fig. 3.8a), a rise in evoked- α activity can be seen during photic periods between -250ms and +150ms, whereas in control periods α activity appears to be stable throughout the epoch. This post/pre-stimulus difference in activity during

⁴Note that common and rare event graphs are plotted on a different y-axis scale for this reason.

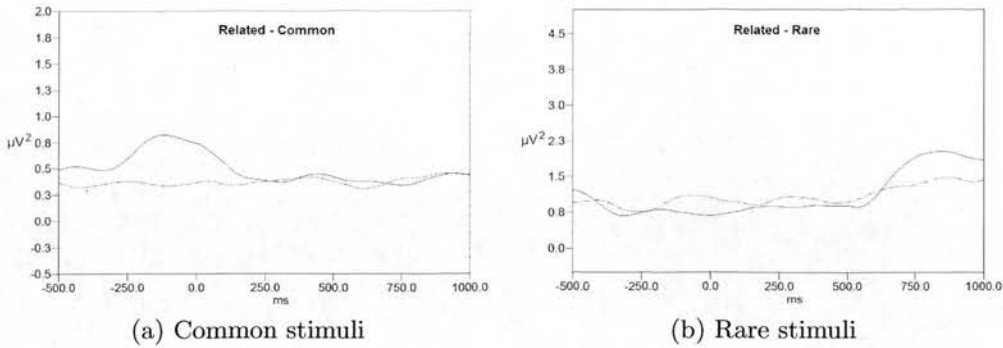

Figure 3.8: Mean evoked-alpha GFP for common and rare stimuli, related pairs (non-stimulated subjects). Solid line is mean of photic periods and dotted line is mean of controls.

common photic events is reflected in the large negative λ value for this group (see Fig. 3.6). For rare stimuli (Fig. 3.8b) activity in control and photic periods is similar and shows no deviations from baseline (some increase in amplitude can be seen around +750ms, but this is outside the period of interest; see also comments above regarding relative noise in averages for rare events).

It has already been established that the difference in λ -ratio between photic and control periods (for common events) in this group is statistically significant. The shape of the evoked- α GFP waveform (Fig. 3.8a) for photic periods seems to suggest the presence of an evoked potential field, with perhaps large inter-individual variability in magnitude and latency of responses accounting for the apparently slow rise and fall, and the flat peak of the average waveform (relative to evoked responses to direct photic stimulation; see Fig. 3.4). This activity in non-stimulated subjects however, is clearly not temporally aligned with the ordinary evoked activity seen in responses to direct photic stimulation (see Fig. 3.4), as it appears to begin ≈ 250 ms *before* stimulus presentation, and nearly returns to baseline by the time stimulated subjects are showing the first signs of their responses. This characteristic is incompatible with a hypothesis of synchronous non-local correlations in EEG activity between isolated participants, which has been the most common interpretation of the effect identified in previous studies using this type of experimental paradigm (e.g. Grinberg-Zylberbaum et al., 1994; Wackermann et al., 2003). It is however similar to the effect observed in Study 1, where deviations in evoked- α activity in non-stimulated participants also appeared to begin before the photic stimulation of their partners ($t \approx -150$ ms), and reached a peak approximately 34ms post-stimulus. In the present experiment the observed mean deviation appears to start even earlier, and peaks well before the actual presentation of photic stimuli.

Although in both studies there are clear and significant differences in λ -ratios between photic and control periods for Related pairs, and deviations from baseline suggestive of evoked responses can be seen in the mean waveforms of evoked- α activity for this group, the temporal locus of activity in non-stimulated participants does not accurately correspond to the timing of evoked activity in their stimulated partners. For this reason, although there are good statistical grounds in both studies for rejecting the null hypothesis, an interpretation of these effects as evidence of distant correlations between the brain activities of stimulated and non-stimulated participants is considerably problematic. One possibility would be to interpret these observations as suggestive of a temporal anomaly, along the lines of a precognitive or presentiment

effect. Without any theoretical justification or further supporting evidence however, we consider such an interpretation to be premature and unjustified at this point.

If the unusual EEG activity seen in non-stimulated participants during the photic stimulation of their partners with common stimuli is considered to suggest a correlation between the brain activities of participant pairs, one would also expect non-stimulated participants to show similar activity during the stimulation of their partners with rare flashes. Furthermore, one would expect such activity in non-stimulated subjects to be of a greater magnitude to the one seen in relation to common flashes, as rare stimuli produce responses of greater magnitude in stimulated subjects themselves. The absence of a similar effect for rare stimuli is an additional reason for interpreting these results with caution, and will be further addressed in the discussion.

3.3.5.2 Unrelated pairs

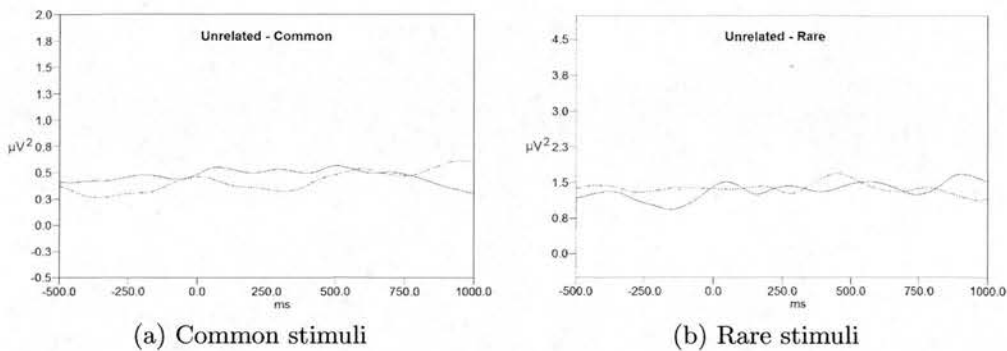

Figure 3.9: Mean evoked-alpha GFP for common and rare flashes, unrelated pairs (non-stimulated subjects). Solid line is mean of photic periods and dotted line is mean of controls.

For the Unrelated pairs group (Fig. 3.9), mean evoked- α activity is similar during photic and control periods, for both common and rare events. All waveforms are similar and relatively flat, as one would normally expect from the averages of randomly sampled epochs from the EEG of non-stimulated participants. These results fully support the null hypothesis, and can also be seen to suggest that no methodological or other artefacts were affecting our results.

3.3.5.3 Alone participants

In contrast to the Unrelated pairs group, mean evoked- α waveforms for the Alone group (Fig. 3.10) show relatively large fluctuations during both photic and control periods, for both common and rare events. The fact that these large fluctuations had relatively little effect on the mean calculated λ values for this group (as seen in Figures 3.6 and 3.7), is largely due to the fact that the λ ratio quantifies differences in post-/pre-stimulus activity for each individual participant, and if these differences are not consistent across subjects (particularly in regard to direction), they will tend to cancel out when averaged. The similarity in fluctuations between photic and control waveforms is somewhat reassuring, as it indicates no overall difference in activity between these periods. The magnitude of the fluctuations however, some of which are larger

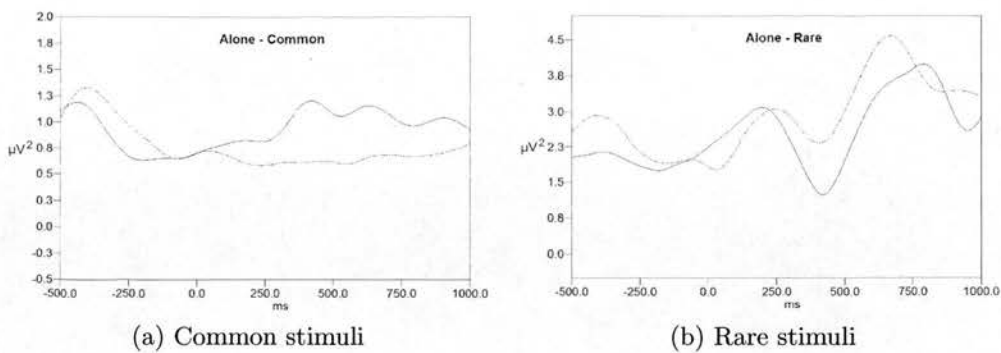

Figure 3.10: Mean evoked-alpha GFP for common and rare flashes, alone participants. Solid line is mean of photic periods and dotted line is mean of controls.

than the deviation responsible for the significant effect in the Related Pairs group, can be seen to be a reason for concern. If these fluctuations are simply considered to be random in the case of the Alone group, the same argument could be made for the fluctuation responsible for the significant effect found for the Related Pairs group.

3.3.6 Differences in oscillatory activity between the three groups

Subsequent investigation has revealed that the frequency spectrum of background EEG activity differed considerably between the three groups, with the Alone group showing much higher overall power in the alpha band than the other two groups (see Figure 3.11). Frequency-based measures of the ongoing (i.e. 'background') EEG activity have been traditionally considered to reflect neural processes which are largely independent from the averaged stimulus-evoked potentials. Evoked potentials are normally much smaller in amplitude than the ongoing EEG activity, and can usually only be revealed after multiple epochs which are time-locked upon repeated presentations of a stimulus are averaged together (i.e. the standard ERP method). This point-to-point averaging across multiple epochs cancels out ongoing EEG oscillations having no fixed time relationship to the stimulus (i.e. non-phase-locked activity), whereas stimulus-evoked activity with fixed latency and fixed polarity in relation to the stimulus (phase-locked activity) is additively enhanced. This process resembles the gradual extraction of signal from noise, and perhaps somewhat seduced by this analogy, most ERP research to date has generally regarded 'background' EEG oscillations as being largely irrelevant to the study of evoked potentials.

This view has dominated the literature until quite recently, even though a number of studies have been reporting strong positive correlations between the amplitude of pre-stimulus EEG rhythms and the amplitude of stimulus-evoked potentials for some time (Rodin, Grisell, Gudobba, & Zachary, 1965; Sayers & Beagly, 1974). It is now well established that both the amplitude and the phase of EEG rhythms at the moment of stimulus presentation are strongly involved in shaping the magnitude and morphology of stimulus-evoked potentials (Jansen & Brandt, 1991; Brandt, Jansen, & Carbonari, 1991; Li, Yao, Liu, & Zhao, 2005), and that individual differences in overall EEG power (especially in the theta and alpha bands) are an

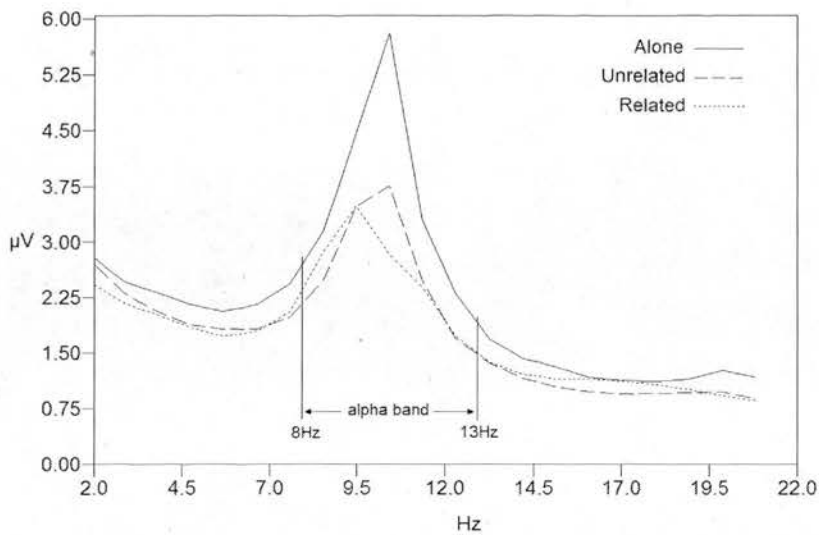

Figure 3.11: Frequency spectrum (FFT) of the 1s pre-stimulus period for the three groups

important source of variability for ERP components such as the P300 (Intriligator & Polich, 1995). Based on these findings, a growing number of studies have suggested that evoked potentials are (at least partly) the result of a reorganisation in the phase relationships of ongoing EEG oscillations (Brandt, 1997; Makeig et al., 2002; Penny, Kiebel, Kilner, & Rugg, 2002).

This 'phase-resetting' hypothesis has received good experimental support; figure 3.12 shows an example of this process, where the amplitude of early components of the ERP (P100 and N200; upper graph) is shown to be related to the stimulus-evoked phase-locking of ongoing alpha oscillations (bottom graph); (Klimesch et al., 2000). The alternative (i.e. more 'traditional') view, suggests that the stimulus evokes a discrete neural response with fixed-latency and fixed-polarity in each trial. As the evidence so far appears to partially support both theories, and neither theory alone seems able to account for all aspects of ERPs, it is likely that both mechanisms may be involved the generation of evoked potentials (Shah et al., 2004).

The relevance of these findings to the interpretation of our results will become more obvious by referring to figure 3.13. Figure 3.13a shows the difference in spectral alpha power between the three groups for the one-second pre-stimulus period, where the mean induced α power in the Alone group is clearly much higher than in the other two groups, which share very similar levels of pre-stimulus α activity; this suggests that Alone participants have 'resting' alpha rhythms of considerably higher amplitude compared to participants in the other two groups. Figure 3.13b demonstrates the strong positive correlation between such pre-stimulus alpha rhythms (i.e. induced α activity) and post-stimulus evoked (phase-locked) α power.

When considered together, these two observations can account for the difference between the average evoked α -GFP waveforms for the Alone group (figure 3.10) and the waveforms for the other two groups (figures 3.8 and 3.9). As participants in the Alone group have been shown to have ongoing α -rhythms of much higher amplitude than the other groups, one would also expect their evoked- α activity (i.e. α -rhythms which are phase-locked to the event markers) to also demonstrate higher amplitudes. This would be the case even with random event markers not associated with any sensory or other event, due to the chance phase alignments between

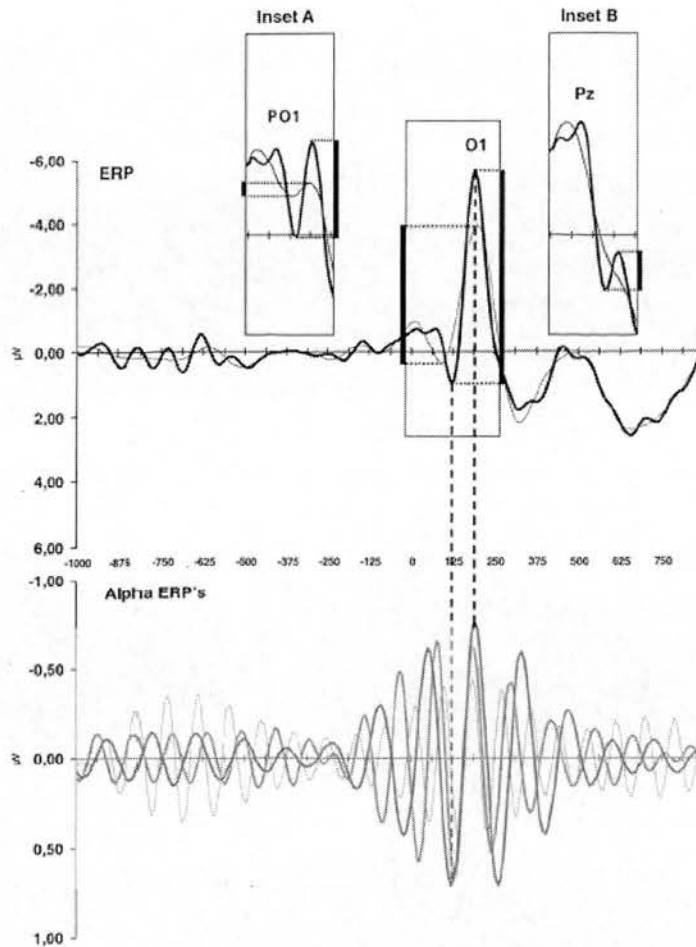

Figure 3.12: Lower graph shows alpha oscillations in three alpha sub-bands which are out of phase in the pre-stimulus interval, synchronising in response to the stimulus. This stimulus-evoked phase-locking of alpha rhythms contributes $\approx 36 - 100\%$ of the amplitude in the P100 and N200 components of the standard ERP (upper graph); reproduced from Klimesch et al. (2000).

waveforms in a finite number of averaged epochs. The potential for large chance fluctuations in averaged waveforms will be higher with a small number of epochs (as can be seen in the averages of rare compared to common events), as well as with epochs containing large-amplitude waveforms (as can be seen in the Alone group averages).⁵ Therefore although the fluctuations in evoked- α activity seen in figure 3.10 may appear large compared to the waveforms for the other two groups, the large difference in pre-stimulus α rhythms between the Alone group and the other two groups suggests that such between-group comparisons are not valid and are likely to be misleading. The Related and Unrelated groups are more readily comparable however, as the amplitude of their resting pre-stimulus α -rhythms is nearly equivalent.

One way to constitute the average evoked- α waveform graph for the Alone group compa-

⁵Averaging a very large number of epochs sampled using such random markers would tend to produce a flat line, regardless of the amplitude of ongoing rhythms, as any chance phase alignments would eventually cancel each other out.

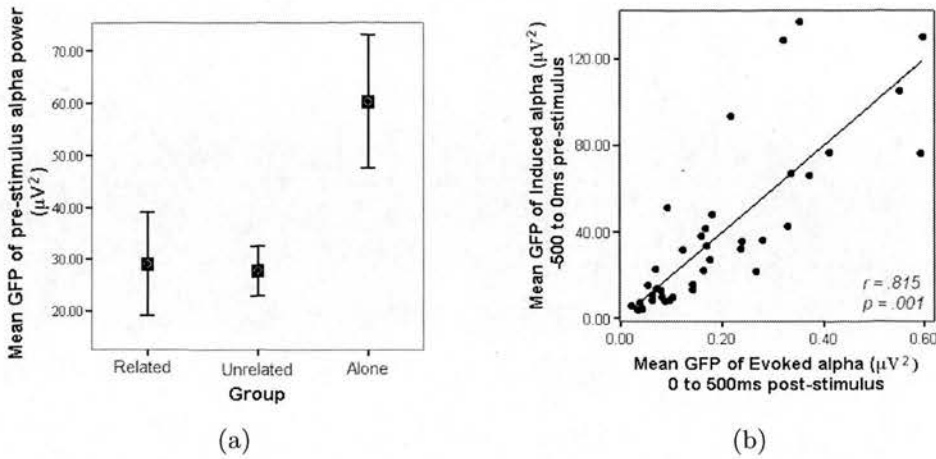

Figure 3.13: (a) Comparison of mean pre-stimulus (1s) induced (non-phase-locked) alpha power between the three groups. (b) Scatterplot of the relationship between pre-stimulus induced and post-stimulus evoked alpha power (mean GFP) for $n = 39$ directly photically stimulated subjects. Line represents best fit of linear regression.

rable (at least visually) to those of the other groups, would be to adjust the scale of the graph in proportion to the pre-stimulus difference in induced α -power between the groups, while also taking into account the observed magnitude of the relationship of pre-stimulus induced α -power and post-stimulus evoked- α power. Such a re-scaled graph can be found in figure 3.14.⁶

The evoked α -GFP waveforms for the Alone group in this re-scaled graph appear far more comparable to those of the Related and Unrelated groups. Although there are still relatively large fluctuations in power, especially for rare events, these fluctuations appear in the GFP waveforms of both the photic and control epochs, showing no consistent difference between them. Although the waveforms of photic and control epochs for common events appear to deviate after $\approx +250$ ms, the statistical comparison of the respective λ values did not approach significance ($p = .221$). It is important to remember that the GFP graphs represent group averages of evoked α activity, and as such they may be disproportionately affected by high values in one, or a few, atypical individuals. By contrast, the Wilcoxon comparisons of λ -ratios evaluate the consistency of differences between photic and control epochs across individuals, and only in the Related pairs group (and only for common stimuli), was this difference large and consistent enough to be statistically significant.

⁶The ratio of pre-stimulus α -power for the Related and Unrelated groups (averaged together) to that of the Alone group is $1/2.07$. As the correlation of pre-stimulus induced α -power and post-stimulus evoked α -power is $r = .815$, the required scaling ratio was calculated as $S_r = 2.07 * 0.815 = 1.687$. Figure 3.14 is the product of the graphs in figure 3.10 with the y-axis values multiplied by S_r . Please note that such re-scaling is only a rough approximation, and there is evidence that the relationship between the amplitude of pre-stimulus α and the amplitude of post-stimulus evoked potentials may not be best described by a linear relationship (as we have assumed by using the linear regression coefficient), but rather by a cubic curve (Li et al., 2005).

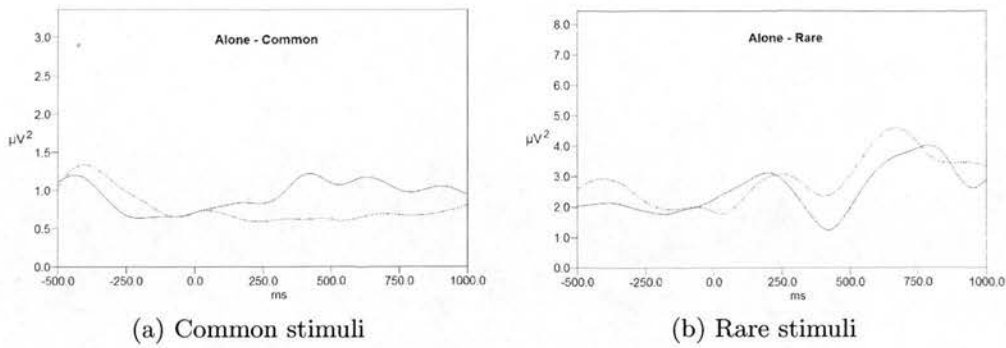

Figure 3.14: Re-scaled graph of mean evoked-alpha GFP for common and rare flashes for Alone participants. Solid line is mean of photic periods and dotted line is mean of controls.

3.3.7 Remaining questions

Despite the significant effect identified in the Related pairs group, and the partial resolution of the question regarding the large evoked- α fluctuations found in the Alone participants group, several issues raised by the results of this study remain unresolved; these are listed below, and will be examined in more detail in the Discussion.

1. Participants in the Alone group demonstrated EEG activity characterised by resting α -rhythms of much higher-amplitude compared to participants in the other two groups. As this characteristic has affected the evoked- α GFP measure which was used as our dependent variable, it is important to investigate possible reasons for this difference in α -rhythms between these groups.
2. A significant effect was only found for the Related pairs group, and only in relation to common stimuli. Finding an effect for related and not for unrelated pairs is perhaps not surprising, and this would be in agreement with the results of Study 1. If we assume this effect to reflect a genuine event-related correlation between the brain activity of participant pairs however, then we would also expect to find an effect, (possibly of an even larger magnitude), in relation to rare stimuli, as such stimuli typically evoke stronger responses in directly stimulated subjects compared to common stimuli. The lack of an effect for rare stimuli would therefore appear to challenge an interpretation of the significant effect identified for common stimuli as indicative of event-related correlations between the EEG activity of participant pairs.
3. The observed deviation in evoked- α activity seen in non-stimulated subjects occurs primarily during the pre-stimulus interval, i.e. *before* their partners are photically stimulated (see figure 3.8a). The temporal locus of the effect is therefore problematic for an interpretation of the effect as evidence of event-related correlations between the brain activities of participant pairs.

3.4 Discussion

3.4.1 Differences in α -rhythms between groups

The Alone group was found to have resting α -rhythms of dramatically higher amplitude compared to the other two groups, and as this characteristic was shown to have affected our measure of evoked- α activity, we will now discuss possible reasons for this difference between groups.

It is well known that α -rhythms vary considerably across individuals, both in amplitude as well as in dominant frequency (Shaw, 2003), and with a relatively small sample size as was used in this study, it is possible that the Alone group simply contained more subjects with naturally high-amplitude α -rhythms than the other two groups. The Related pairs group was self-selected, and could well have been different in many respects to the other two groups. Single participants were pseudo-randomly allocated to either the Unrelated or Alone groups, but with small samples, such randomisation cannot be guaranteed to be effective. Another possible explanation involves potential psychological effects of the different instructions given to the three groups.

Related pairs had come to the laboratory together and were generally highly motivated to participate in the task and to perform well. Unrelated pairs did not know each other, and did not meet before the session; they were explicitly told however that they were matched with another volunteer, whom they would meet at the end of the session. In contrast, Alone participants were only told the probabilities of being matched with a partner (2:3), and were asked to assume that they were indeed matched with another participant, as this was ultimately more likely. This was true when they first volunteered, as all single volunteers were randomly assigned either to the Unrelated or to the Alone group; two-thirds of these volunteers were assigned to the Unrelated group and then randomly matched into pairs. However, by the time they had arrived at the laboratory for their session, Alone participants obviously already belonged to the one-third of volunteers who were not matched with a partner; the only reason we had decided to give them probabilistic information (which was only actually true at some point in the past), was to avoid using outright deception. Although this procedure introduced an additional, and ultimately unwanted, difference between the Alone and Unrelated groups, it was chosen based on the comments of Alone participants in Study 1, many of whom had objected to being falsely told that they were matched with another person). In designing the procedure for Study 2, we chose to respect these objections in order to maintain a relationship of trust between the experimenter and the participants, although this might have been a less than ideal arrangement in terms of experimental design. When questioned after the experiment however, most Alone participants said that they had assumed they were not matched with another person, as the vague probabilistic information the experimenter had given them seemed somewhat "suspicious" within the context of a psychology experiment.⁷ This (ultimately correct) assumption, that they were alone and that there was no other person in the other laboratory room, may well have affected the way Alone participants responded to the experimental procedure. It seems quite

⁷A few participants in the Unrelated group also reported they had assumed (erroneously in their case) that they were not matched with a partner. Unfortunately, no complete formal records were kept of the numbers of participants in each of the Unrelated and Alone groups who had reported this. The informal session notes of the experimenter suggest that < 3 participants in the Unrelated group had assumed they were alone, compared to > 9 participants in the Alone group.

likely that under such an assumption, they would no longer be as motivated as the other two groups to engage with the task, as they considered themselves to be part of the control group. As a result, Alone participants may have been less alert and less attentive throughout the session, and if so, this would have affected the amplitude of their ongoing α -rhythms. Hans Berger had recognised early on in his investigations that an individual's state of arousal correlates to a large extent with the amplitude of their alpha rhythms (Gloor, 1994). A prominent α -rhythm is now commonly considered as an indication of relaxation and cortical inactivity, and this relationship is sufficiently robust that intra-individual changes in α -power have often been used as a physiological metric of arousal (Lindsey, 1960). Berger had also noted an inverse relationship of alpha amplitude with attention, with alpha amplitude decreasing when attention is focused and consciously directed, a finding subsequently confirmed by many others (Shaw, 2003).⁸

The high-amplitude α -rhythms observed in Alone participants, could therefore be a physiological concomitant of decreased motivation, wavering attention, and a lack of engagement with the experimental task. In the partially sensory-deprived environment of this experiment, which required subjects to sit in a reclining chair in a dimly-lit, sound-attenuated room, whilst listening to a relaxation induction procedure and low-frequency monotonous drumming, a lack of motivation and engagement with the task would most probably lead to inattentiveness and lowered arousal. Such an interpretation is only speculative however; we cannot conclude that Alone participants were in a low-arousal state simply because they demonstrated high-amplitude α -rhythms, as potentially large inter-individual differences in alpha amplitude considerably limit the validity of any between-groups comparisons. To empirically test this hypothesis, one would need a separate measure of arousal which is physiologically independent from alpha activity. An index of electrodermal activity would perhaps be ideal, but this was not measured in this experiment.

A potential improvement on the design of this experiment could have avoided this problem. An alternative to using a group of Unrelated pairs and a group of unmatched Alone participants as we have done in Study 2, would be to use two groups both consisting of randomly matched pairs of unrelated subjects. The only difference between these would be that in one of the groups no photic stimuli would be presented to "stimulated" participants. In order for such a group to still serve as an effective control (e.g. for the possibility of electrical leakage between equipment), it would be necessary to deliver photic stimuli to the LED glasses as normal, while somehow preventing the "stimulated" participants in this group from seeing these flashes (e.g. by covering the LEDs with an opaque material). There are obvious practical difficulties in implementing such a design, but it would perhaps be the only way to effectively compare groups with and without a stimulated participant, while avoiding potentially confounding variables such as we have encountered in Study 2. In a design where randomly matched pairs are used for both groups, whether the "stimulated" participant in a particular pair will actually be presented with photic stimuli or not, can be randomly decided after all interpersonal interactions with the non-stimulated participant have been completed.

⁸This inverse relationship of alpha amplitude to arousal only holds true in the waking state. Looking at a wider window on the continuum of arousal, alpha amplitude appears to follow an inverted-U curve, with the highest α -amplitude associated with relaxed wakefulness in the middle, and decreasing α -amplitude both when the subject becomes more aroused, as well as with the onset of sleep (Lindsey, 1960).

3.4.2 Comparison of effect between common and rare events

Contrary to our predictions, the effect identified in the Related pairs group was only observed in relation to common photic stimuli. This characteristic is to a large extent, physiologically counterintuitive, as ordinary responses to direct photic stimulation in an oddball paradigm are typically characterised by evoked potentials of a larger amplitude in relation to rare compared to common stimuli. An oddball paradigm had been adopted in this study to produce differential responses in stimulated subjects, in order to test whether the magnitude of the effect seen in non-stimulated subjects may be related to the magnitude of evoked responses in their stimulated partners. The lack of an effect for rare stimuli in the Related pairs group does not support this hypothesis, and may also be considered to question the validity of the effect observed for common stimuli.

It is important to take into account however, that measures of evoked- α activity are sensitive to the number of epochs that the average waveforms are calculated from. Evoked- α measures quantify phase-locked event-related activity, whereby non-phase-locked (i.e. induced) background oscillations are removed through the additive averaging of a number of event-related epochs; through such averaging evoked activity is additively enhanced, whereas induced activity is subtracted. Removing all such background oscillatory activity however would require the averaging of a very large number of epochs, and in most cases some amount of induced activity would be present in the average evoked- α waveforms. The amount of this residual induced activity is directly proportional to the number of epochs used in the averaging, and for this reason, mean evoked- α waveforms from a smaller number of epochs demonstrate a higher baseline compared to mean evoked- α waveforms from a larger number of epochs. This characteristic is responsible for the difference seen in the baseline evoked- α activity between the waveforms for common and rare events in this study (e.g. see Fig. 3.8), and may also be responsible for the apparent lack of an effect for rare stimuli. As the amplitude of background oscillatory activity is in the order of tens of microvolts, whereas the amplitude of evoked responses is normally in the order of microvolts, it is essential to use a sufficiently large number of event-related epochs in order to extract the waveforms of stimulus-evoked activity from the background EEG 'noise'. This is especially important where small-amplitude responses are expected, as is likely to be the case in this study. Therefore it is possible that the apparent lack of an effect for rare stimuli may be due to an insufficient number of available event-related epochs. Due to the requirements of the oddball paradigm, only one-third as many rare events were presented relative to common events (35 compared to 105 respectively), and this number of samples may be insufficient to discriminate event-related evoked responses from background oscillatory activity through additive averaging. Although this was a risk we had considered at the time of designing the experimental protocol, increasing the number of rare events presented per session would also require increasing the number of common events proportionally by a factor of three; this would have extended the session duration beyond what we expected to be comfortable for the participants, and had therefore decided against it.

The lack of an effect for rare stimuli may also be related to the physical and psychological properties of the stimuli used in this study. Green photic flashes were always used as the more frequently presented (common) stimuli, based on the comments of participants in the pilot sessions, who had reported that red flashes felt more "stimulating", and suggested that this may

due to the connotations of red colour, i.e. due to its common use in traffic light signals, and its semantic associations with danger. This subjective effect was reported even when red flashes were presented at the same frequency and for the same duration as green flashes, and although evoked responses to the two type of flashes were not markedly different in such a case. As part of our attempt to maximise the difference in the magnitude of evoked responses to the two types of stimuli, we had decided to use the red flashes as the rare, longer-lasting (and subjectively brighter) stimulus, which also had semantic (and perhaps also conditioned) associations with arousal and alertness. In contrast, as green flashes were more common they were expected to be perceived as less interesting and less arousing, and perhaps to also involve a relatively greater degree of habituation throughout the session. In terms of experimental design however, it would have been preferable to counterbalance the use of the two colours of flashes (as common and rare stimuli) across subjects. Although directly stimulated participants did show larger evoked responses to rare stimuli as expected, having used only red flashes as rare stimuli further complicates the interpretation of the lack of an effect for rare flashes in non-stimulated subjects. As a result, we cannot discriminate the potential contribution of the frequency of presentation, the duration and of the colour of the flashes itself, in the differential effect found between common (green) and rare (red) flashes in non-stimulated subjects. Our working hypothesis was that any effect found for non-stimulated subjects would be likely to show similar psychophysiological characteristics to the event-related EEG responses of their stimulated partners; this may not be a valid assumption however, and past research has presented contradictory findings in this respect (e.g. Grinberg-Zylberbaum et al., 1994; Wackermann et al., 2003). It could be the case for example, that the differences in psychophysical and psychological properties between the two stimuli used in this study, may be relevant to the potential for event-related EEG correlations to manifest between separated subjects. As the physical, physiological and psychological mechanisms through which these correlations may function are unknown, expecting a direct correspondence of electrocortical activity between stimulated and non-stimulated participants was only an exploratory hypothesis, adopted due to the lack of a theoretical framework able to generate more sophisticated predictions.

Although a conclusive explanation for the lack of an effect for rare stimuli cannot be identified due to the limitations discussed above, several suggestions can be made to guide future research intending to clarify this issue. We would still encourage the use of stimuli producing differential physiological responses in stimulated subjects, in order to investigate possible correlated activity with differential signatures in their non-stimulated partners. We would also however advise the use of stimuli as similar as possible (if not identical) in physical properties, in order to avoid the difficulties in interpreting any differential findings, as we have encountered in this study. In this respect, we would also advise against using an oddball-type paradigm in the future, as this would normally necessitate the use of stimuli with different physical properties. By requiring the use of a different frequency of presentation for each stimulus, another consequence of using an oddball paradigm is that fewer epochs associated with rare events are subsequently available for analysis, which inevitably reduces the signal-to-noise ratio in averaged waveforms for rare events. A suggestion by Wackermann (2004), to separately stimulate the left and right visual fields (with identical visual stimuli) would avoid all the disadvantages of the stimuli used in this study, and would also produce evoked responses with distinct psychophysiological signatures (in stimulated subjects).

3.4.3 Temporal displacement of effect

The significant difference between photic and control epochs found for non-stimulated subjects in the Related pairs group, may be interpreted to suggest a correlation in event-related brain activity between the physically isolated partners. However, the temporal characteristics of the observed increase in evoked- α power in non-stimulated participants are not conducive to such an interpretation, as this activity largely precedes the photic stimulation (and associated brain responses) of their partners (Fig. 3.8). The effect found in Study 1 followed a somewhat similar pattern, in that evoked- α activity in non-stimulated participants appeared to rise above a baseline level before the presentation of the stimuli (Fig. 2.12). In Study 1 however, this activity reached a peak at approximately +36ms post-stimulus, whereas in Study 2 peak amplitude is reached as early as -150ms pre-stimulus.

In investigating this unexpected temporal displacement, the first hypothesis to consider is the possibility of an artefact, such as timing errors in the delivery of the electrical trigger pulses used to mark the timing of photic stimuli on the EEG records of participants. No similar temporal discrepancies can be seen in the averages from directly stimulated subjects however (see Fig. 3.4), which rules out the possibility that such errors have been introduced by the computer responsible for stimulus randomisation and presentation. This computer generated TTL pulses (+5V logic) which were used to trigger photic flashes to stimulated subjects, as well as to deliver synchronous event markers to the recording EEG amplifiers of both stimulated and non-stimulated subjects. With each flash presented (using one TTL pulse), another synchronous TTL pulse was used to mark the timing of photic events on the EEG records of both subjects in each pair; therefore timing errors introduced at this stage should equally affect both stimulated and non-stimulated subjects, and this is quite clearly not the case.

It is still possible that timing errors could have been introduced in the recordings of non-stimulated subjects only however, during the later stage of optical isolation of event marker signals. As has been described in the Method section, we have used a series of photovoltaic relays to signal the timing of event markers to the two EEG amplifiers, in order to ensure electrical isolation, both between the stimulus presentation computer and the two EEG amplifiers (and subjects), but also between the two subjects (and respective EEG amplifiers) themselves (see circuit diagram in Appendix E). Eight independent optical relays were used (four for each subject), in order to separately signal event markers for each of the four events presented (i.e. common flash, rare flash, common control and rare control). As it was the same physical relay therefore that always handled signals indicating common flash events for the EEG record of non-stimulated subjects (relay *U8* in circuit diagram, Appendix E), it is therefore possible that a fault in this component could have introduced timing errors in the averages of EEG activity recorded from these subjects. For example, a slow relay could introduce delays in the placing of event markers intended to signal the timing of photic flashes, and if this delay was sufficiently long, a VEP response could falsely appear to occur before the photic event that had generated it. Such a problem could therefore be responsible for the temporal discrepancy seen in our results.

In order to test this hypothesis, a system test was conducted using a photodiode (*BPW21* by Osram Opto-Semiconductors) with a fast response time (mean rise/fall time 1.5 μ s), and a spectral sensitivity approximating that of the human visual system. This photodiode was connected as an open circuit to the EEG amplifier (i.e. as a photovoltaic cell), and was attached to the LED glasses, so that photic flashes would trigger a photovoltaic response in the diode

which would register on the EEG recording as voltage increase. A trial was conducted with 280 events presented randomly over a period of ≈ 20 min, according to the standard experimental procedure for Study 2 described in the Method section. The photovoltaic response to the flashes was recorded using the EEG amplifier which was normally used to record brain activity from non-stimulated participants, and associated event markers were delivered using TTL pulses through the signal isolation device, according to the usual experimental protocol. This test can provide a precise indication of the actual timing of photic flashes in relation to event markers, as any timing discrepancies between these events would easily become apparent.

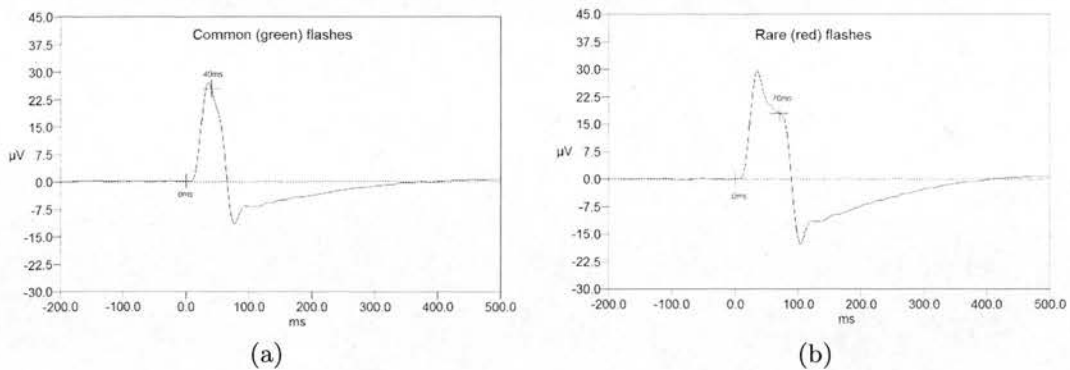

Figure 3.15: (a) Mean photovoltaic response to green flashes (solid line) and associated control periods (dotted line). Average number of epochs for each event was one-hundred-and-five (105). The start and end of the flash duration (0-40ms) is marked. (b) Mean photovoltaic response to red flashes (solid line) and associated control periods (dotted line). Average number of epochs for each event was thirty-five (35). The start and end of the flash duration (0-70ms) is marked.

Figure 3.15 shows the results of this system test for green (Fig. 3.15a) and red (Fig. 3.15b) flashes. No major temporal divergence can be seen between the event markers ($t = 0$ on the graph) and the photovoltaic response to the flashes, other than a small positive delay in response time (≈ 8 ms), which is similar for green and red flashes. Further inspection of individual epochs revealed no observable variation in this delay across epochs.⁹

These results appear to verify the accuracy of synchronisation between the placing of event markers and the presentation of photic stimuli. The small delay between the timing of event markers and photovoltaic responses to flashes (≈ 8 ms) is in the opposite direction to the discrepancy seen in the EEG records of non-stimulated subjects, and cannot account for the temporal characteristics of their results¹⁰. It seems therefore unlikely that a technical artefact is responsible for the temporal discrepancy seen in these results, and alternative hypotheses will need to be considered.

⁹As the sampling rate was 500Hz, the temporal resolution of the EEG recording was 2ms, therefore such variations in latency could be occurring < 2 ms without being observable. Variations at such small time scale would of course be irrelevant in this context.

¹⁰Activity in non-stimulated subjects appears to begin ≈ -250 ms pre-stimulus, therefore, (assuming the activity is genuinely related to the distant photic stimuli), a delay of $\approx 250 + 8$ ms in setting the event marker would be needed to produce the temporal difference seen in our results

3.4.4 Conclusions

As we have found no technical or methodological artefact which can adequately account for the effects found in Studies 1 and 2, there appear to be two main possible interpretations of these findings at this point.

The first possible interpretation is to consider the effect found for Related pairs in Studies 1 and 2 as due to chance fluctuations in evoked- α activity. Although in both studies a significant difference in λ -ratio estimates, (a measure of pro-/pre-stimulus evoked- α activity), has been found between photic and control epochs for non-stimulated subjects in Related pairs, it is clear from the average of control periods (from both stimulated and non-stimulated subjects) that chance fluctuations of this magnitude occasionally do appear in the average evoked- α waveforms for samples of this size. The fact that such fluctuations in the average waveforms from Related pairs happened to occur within our time window of interest (i.e. -500 to +500ms) rather than at other times during the epoch, may be nothing more than a chance occurrence, and the temporal inconsistency of the observed effect between Studies 1 and 2 would appear to support this interpretation.

The other possible interpretation is to consider the observed effect as evidence of distant correlations in event-related brain activity between physically isolated participants. The fact that significant differences between photic and control periods were found only for Related pairs in both studies, and that the fluctuations in evoked- α activity responsible for these significant differences manifested during photic stimulation periods and not during control periods, would appear to support this interpretation. However, due to the temporal discrepancy seen in both studies between the observed brain activity in non-stimulated participants and the timing of photic stimulation of their partners, this hypothesis can apparently only be sustained by invoking an additional anomaly, i.e. the presence of a retrocausal or precognitive effect. Such effects have been sporadically reported in the literature, usually involving observations of physiological activity which precedes the presentation of randomised stimuli, and which cannot be explained as anticipatory responses (e.g. see Bierman & Radin, 1997). In the case of Studies 1 and 2 however, no stimuli had been presented to the participants demonstrating this apparently precognitive effect, and the participants who were directly photically stimulated do not show any similar activity preceding the presentation of photic stimuli. This presents us with something of a conundrum; even if one tentatively assumes that it is possible to respond to stimuli precognitively, to propose that non-stimulated participants may respond precognitively to stimuli presented to others, when these other stimulated participants show no such precognitive responses themselves, would most likely be stretching the limits of plausibility. It would perhaps make evolutionary sense for pairs of humans who share an emotional, empathic bond, (and therefore have a mutual interest in each others' survival), to make use of any precognitive abilities available to perceive potential dangers pertaining to themselves as well as to each other. But in order not to overwhelm the organism with torrents of irrelevant information, (as could potentially be obtained through such channels, if no spatial or temporal restrictions apply), such abilities must be weak and normally dormant, only manifesting perhaps on the rare occasions where the organism's survival is at stake. It would therefore seem to be exceedingly unlikely for such abilities to manifest as abundantly as they appear to be in our results, if these results are interpreted as evidence of such interactions.

The relatively small sample size in each study is largely responsible for limiting our ability to interpret these results with more certainty. With a larger sample size, chance fluctuations in

evoked- α activity in individual waveforms would cancel each other out when group averages are calculated, whereas with only thirteen (Related) subjects in each study, it is possible that large-amplitude chance fluctuations in a few individuals may still have affected the group average. It would therefore be useful at this point to combine the results of Studies 1 and 2 in order to calculate average waveforms for each group and condition across the two studies. This will provide a sample size of $n = 26$ for each of the three groups, and will allow general conclusions to be drawn from these averages with a greater degree of confidence. As the findings from the combined results of Studies 1 and 2 have consequently influenced the design of Study 3, these will be reported in the introduction to the following chapter.

Chapter 4

Study 3

4.1 Combined findings of Studies 1 and 2

Studies 1 and 2 were designed to be sufficiently similar, so that their results can be cumulatively combined; this will be presented in this section, and the overall results will be used to guide the design of Study 3. Studies 1 and 2 each consisted of three groups (Related pairs, Unrelated pairs and Alone participants), with thirteen non-stimulated participants in each group. Although in Study 1 EEG was only recorded from non-stimulated participants during the test sessions, whereas Study 2 involved simultaneous EEG recordings from both participants in each pair, this is not relevant to the combined analysis, as only data from non-stimulated participants will be used. Although in both studies photic stimulation epochs were compared with randomly sampled control periods, the primary difference between the two studies involved the presentation of two types of photic stimuli in Study 2 (green and red flashes), whereas in Study 1 only one type of flashes (white) had been presented.

Although it would be possible to include epochs related to both green and red flashes from Study 2 in this cross-study average, on closer inspection this option appeared to carry several disadvantages. The main difficulty concerns the fact that Study 2 involved an oddball stimulation paradigm, where rare (red) photic stimuli have a lower frequency of presentation compared to common (green) photic stimuli, and produce evoked responses with distinctly different amplitude, latency and morphological characteristics. Due to their infrequent presentation, rare stimuli are perceived as 'oddballs' (i.e. different, unusual), and involve additional cognitive processing compared to common stimuli, as can be seen by the additional late components in evoked- α responses to these stimuli (see Fig. 3.5, page 62).

Photic stimuli in Study 1 and the common photic stimuli in Study 2 share a similar frequency of presentation, i.e. on average, one flash was presented every 4.5s in Study 1, and one flash every 6s for common flashes in Study 2, whereas rare photic flashes in Study 2 were presented every 13.5s on average, therefore both were expected to be perceived as 'common' stimuli (even though common stimuli in study 2 were of shorter duration compared to stimuli in study 1, i.e. 40ms Vs 80ms respectively).¹ Another issue related to the frequency of stimulus

¹This similarity in presentation frequency is reflected in a morphological similarity in the average waveforms of evoked- α responses to direct photic stimulation with these stimuli (for Study 1 see Fig. 2.10 on page 41, and for Study 2 see Fig. 3.4 on page 62)

presentation, is the cumulative number of photic stimuli presented in each session. Study 1 involved an average presentation of 93 flashes during each session, whereas in Study 2 an average 105 common flashes and an average of 35 rare flashes were presented in each session. Therefore the total number of epochs per session in each study is unequal by a considerable margin (93 versus 140, in studies 1 and 2 respectively), if both common and rare stimuli are used from study 2. If however only common flashes are included from Study 2, the number of epochs in each study will be more comparable.

As the photic stimuli used in Study 1 are more similar in duration and frequency of presentation to the common photic stimuli used in Study 2, and these also share a comparable cumulative number of presentations during each session, it was decided to only include common events from Study 2 in the cross-study average. The absence of an obvious effect for rare stimuli in Study 2 may also be seen as a reason not to include this data, although this could be objected to as an arbitrary rejection of data not favourable to the experimental hypothesis. However, combining the results of Studies 1 and 2 is conducted as an exploratory post-hoc analysis, and not for the purpose of hypothesis testing. It may be that for unknown reasons, rare stimuli failed to evoke responses in non-stimulated participants whereas common stimuli succeeded; this possibility would advise against reducing the signal-to-noise ratio by including rare events in the average of the two studies.

Figure 4.1 shows the average waveform of evoked- α global field power for Related pairs in studies 1 and 2, for $n = 26$ non-stimulated subjects. A rise in evoked- α activity can be seen in the mean waveform for photic epochs, which appears to begin ≈ -250 ms pre-stimulus and reaches a maximum at -15 ms, i.e. immediately preceding stimulus presentation. The rise and fall of this activity appears to be nearly symmetrical in time, centered approximately at the moment of stimulus presentation, and the peak of activity at this latency also shows the highest evoked- α GFP value observed throughout the three groups ($1.19\mu V^2$). Evoked- α activity observed during photic periods in this group is of a clearly higher magnitude to activity during control periods, and its morphology is highly suggestive of an event-related response. However, its temporal characteristics are incompatible with such an interpretation; this issue will be further discussed in the following section.

Figure 4.2 shows the average waveform of evoked- α global field power for Unrelated pairs in studies 1 and 2, for $n = 26$ non-stimulated subjects. A small rise in mean evoked- α activity can be seen during the post-stimulus interval in photic stimulation periods, which reaches a maximum at $+210$ ms. Although the peak at this latency shows the highest GFP value throughout both photic and control periods in this group ($1.07\mu V^2$), fluctuations of only a slightly smaller magnitude can be seen throughout the control period, which suggests that the deviation seen during photic periods is very likely to be due to similar chance fluctuations.

Figure 4.3 shows the average waveform of evoked- α global field power for Alone participants in studies 1 and 2, for $n = 26$ non-stimulated subjects. The waveforms for both photic and control periods in this group show relatively minor fluctuations which never exceed $0.95\mu V^2$, and which are not suggestive of event-related activity. This is somewhat reassuring, as it suggests that the deviation seen in the average waveform for Related pairs is unlikely to be due to a methodological or technical artefact.

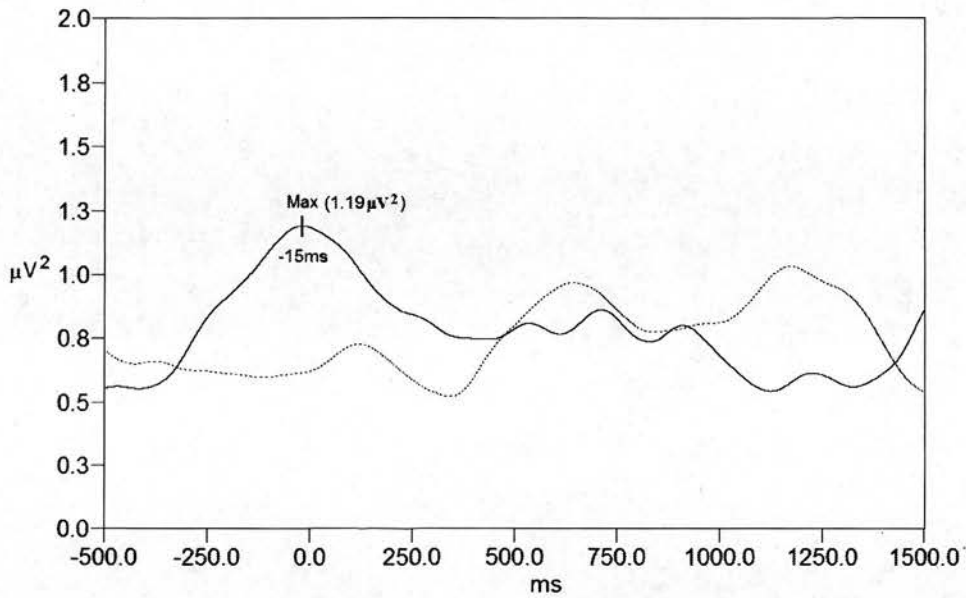

Figure 4.1: Combined results of studies 1 and 2: Mean evoked- α global field power for Related pairs ($n = 26$). Solid line represents photic stimulation and dotted line control periods.

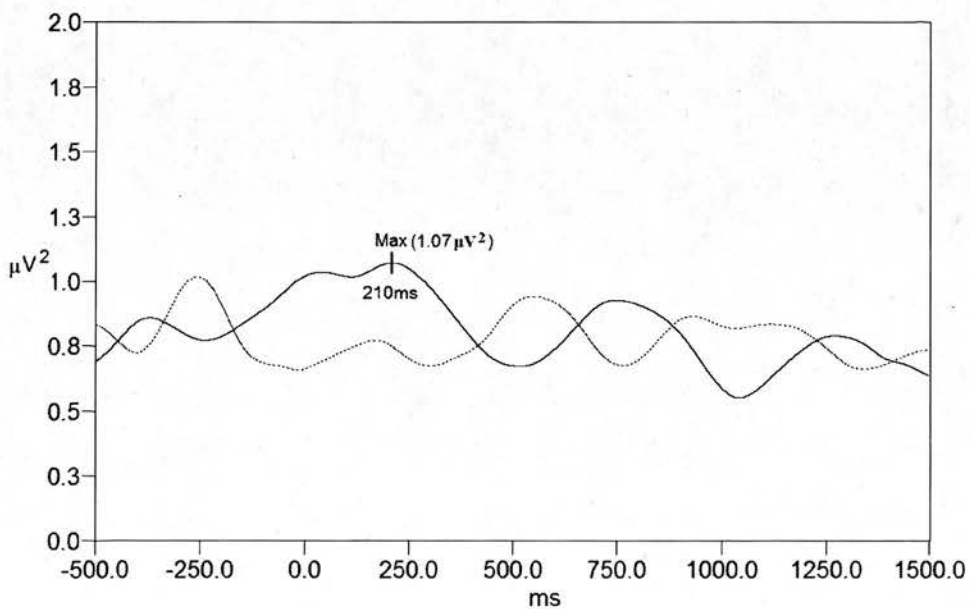

Figure 4.2: Combined results of studies 1 and 2: Mean evoked- α global field power for Unrelated pairs ($n = 26$). Solid line represents photic stimulation and dotted line control periods.

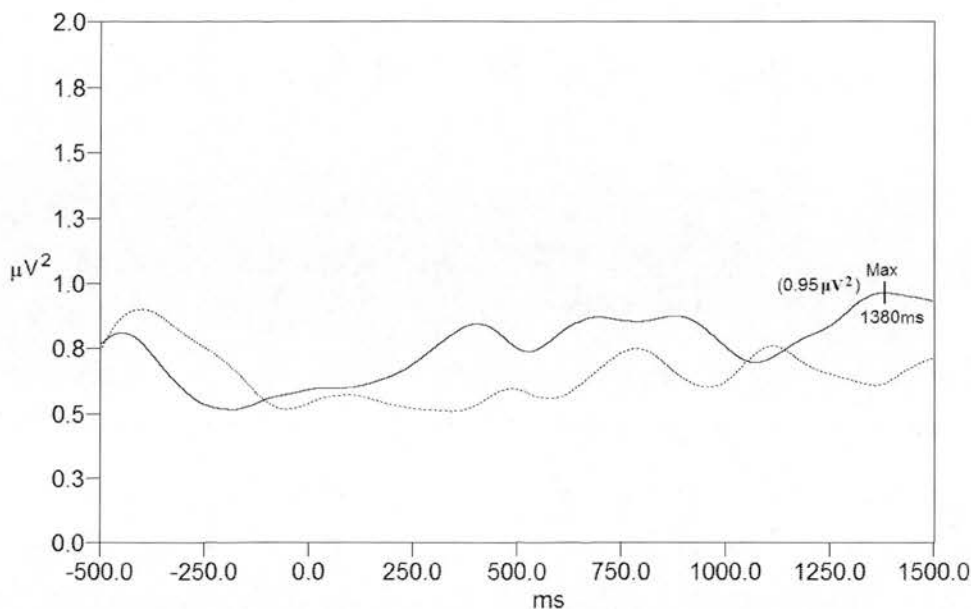

Figure 4.3: Combined results of studies 1 and 2: Mean evoked- α global field power for Alone participants ($n = 26$). Solid line represents photic stimulation and dotted line control periods.

4.1.1 Conclusions

The average evoked- α waveforms for the combined results of studies 1 and 2 have revealed changes in evoked- α activity in non-stimulated participants in the Related pairs group, which appear to be related to the photic stimulation of their physically isolated partners. This is in agreement with the results of the statistical tests conducted in each of the two studies, which had identified significant differences in evoked- α activity between photic and control periods for this group. The main difficulty in interpreting these results concerns the temporal characteristics of the observed effect; as the activity observed in non-stimulated participants (on average) precedes the event-related activity of their photically stimulated partners, and also precedes the presentation of the stimuli themselves, such temporal characteristics do not appear to be directly compatible with an interpretation of the effect as involving event-related correlations between the EEG activity of participants pairs.

It would however be constructive at this point, to briefly suspend any concerns regarding the interpretation of these unusual temporal characteristics, in order to examine the cumulative results of the two studies from a purely data-driven perspective. The results of studies 1 and 2 have independently suggested the presence of a rise in evoked- α activity in non-stimulated participants in Related pairs, during epochs when their partners were photically stimulated, and revealed no similar changes in activity during control periods of no stimulation. The mean evoked- α waveform for this group in Study 1 (see Fig. 2.12 on page 46) indicates that this activity took place primarily between -150 and +250ms, and peaked just after stimulus presentation ($\approx +36$ ms); the mean waveform for the same group in Study 2 (see Fig. 3.8 on 67) indicates that the rise in activity took place largely between -250ms and +150ms, with the peak of activity at ≈ -150 ms. The findings of these two studies when seen separately and in combination, appear to suggest that the observed rise in evoked- α activity has a variable latency

across individual participants, with an average maximum amplitude centered approximately at the time of stimulus presentation. Visual inspection of mean evoked- α waveforms for individual participants appeared to confirm this hypothesis; although several subjects showed only minor and seemingly random fluctuations in activity, some subjects demonstrated activity strongly suggestive of event-related responses. The latency of such activity was highly variable across subjects, although it appeared to 'gravitate' towards $t = 0$ ms, as is also suggested by the combined average waveform for the two studies seen in Fig. 4.1 above.

In order to clarify the nature of this effect, it may be useful to recapitulate the underlying physiological EEG processes which are reflected in the evoked- α activity measures used in these studies. As has been described in the previous chapters, measures of evoked- α activity quantify EEG changes (within the alpha band) which are phase-locked to the moment of stimulus presentation. The presentation of a stimulus forces a re-organisation in the phase relationships of ongoing oscillatory EEG rhythms, and alpha rhythms which are out of phase with each other (in the pre-stimulus interval), have been shown to become synchronised (in the post-stimulus interval) in response to the stimulus, and to contribute in the formation of evoked potentials (e.g. Klimesch et al. (2000); see Fig. 3.12 on page 71). This mechanism of phase synchronisation of ongoing (i.e. "background") alpha rhythms is the process largely underlying the rise in evoked- α activity seen in response to direct photic stimulation (e.g. see Fig. 2.7 on page 36), and is also likely to be involved in the effect found in the evoked- α activity of non-stimulated participants. In the case of non-stimulated participants however, the observed changes in evoked- α activity appear to precede the presentation of photic stimuli and the evoked responses of their photically stimulated partners; in order to produce the average evoked- α waveform seen in Fig. 4.1 (page 84), the phase relationships of ongoing alpha oscillations in non-stimulated participants would appear to briefly synchronise as the moment of stimulus presentation approaches.

Although this effect can be described as "event-related", in the sense that evoked- α activity appears to change in relation to the presentation of photic stimuli, this relationship between evoked- α activity (in non-stimulated participants) and the presentation of photic stimuli (to their partners), appears to be correlational rather than causal; what necessitates the inference of a correlational relationship is the variable latency of the effect across participants, which sometimes follows and sometimes precedes the presentation of the stimuli. These characteristics cannot be accommodated within a causal-deterministic biophysical framework, and they would also seem to be at odds with quantum mechanical interpretations, as models of quantum-entanglement between the brain activity of participant pairs proposed in previous studies (e.g. Grinberg-Zylberbaum et al., 1994; Wackermann et al., 2003) would predict synchronous changes in brain activity between participants. Nevertheless, the change in mean evoked- α activity seen in non-stimulated participants in Related pairs across the two studies (Fig. 4.1 on page 84), appears to be centered at the moment of photic stimulation of their partners. As the timing of stimulus presentation was randomised, and as non-stimulated participants were also blind to the presentation of photic flashes, this activity cannot be ascribed to ordinary anticipatory responses, as often seen when stimuli are presented periodically. The fact that this activity precedes the presentation of photic stimuli would also appear to rule out the possibility of electromagnetic leakage (e.g. from LED flashes) affecting the results.

As has been described in Chapter 3, direct stimulation with photic flashes produces both evoked (phase-locked) and induced (non-phase-locked) responses (e.g. see Fig. 2.6 on page 36).

In contrast to evoked responses to photic stimulation, induced responses involve a desynchronisation of ongoing alpha rhythms, i.e. the alpha-blocking effect. It would therefore be useful to examine whether the effect found in non-stimulated participants also appears to involve changes in induced alpha activity; figure 4.4 shows a graph of the average non-phase-locked alpha activity for $n = 26$ non-stimulated participants in the Related pairs groups from studies 1 and 2. As can be seen in that graph, induced- α activity shows no signs of event-related changes, and activity during photic and control periods is similar. The effect found for non-stimulated participants therefore does not demonstrate the changes in induced oscillatory EEG activity normally found in responses to direct photic stimulation, and appears to be limited to changes in evoked (phase-locked) activity.

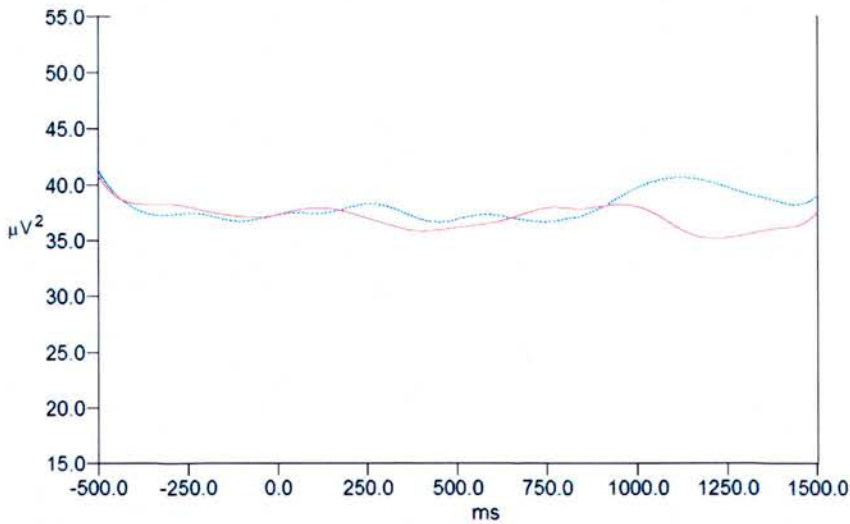

Figure 4.4: Combined results of studies 1 and 2: Mean induced- α global field power for Related participants ($n = 26$). Solid red line represents photic stimulation periods and dotted blue line represents control periods.

The measure of evoked- α activity used as dependent variable in studies 1 and 2, specifically quantifies evoked activity within the alpha band (8-13Hz); as direct photic stimulation produces evoked responses in a broad frequency range however, (i.e. the standard ERP; see Fig. 2.5 on page 33), it would be useful to investigate whether such changes can also be found in non-stimulated participants. Figure 4.5 shows the broad-frequency (1-30Hz) ERP for $n = 26$ non-stimulated participants in the Related pairs groups from studies 1 and 2. Although there is no indication in this graph of a clearly formed evoked potential as found in responses to direct photic stimulation, the ERP waveforms of photic and control periods appear to deviate from each other between approximately -250 and +250ms, and an identifiable peak in activity can be seen during photic periods at ≈ -4 ms, i.e. immediately preceding the presentation of photic stimuli. Although this difference between photic and control waveforms in the broad-frequency ERP is clearly smaller than the difference found using the evoked- α measure, it may nevertheless suggest that the effect, although shown to be limited to changes in evoked activity, may not be limited exclusively to evoked changes within the alpha band. However, subsequent examination of evoked activity separately in the delta (1-4Hz), theta (4-8Hz), and beta (13-30Hz) bands, have revealed no evidence suggestive of event-related activity, and no differences

between photic and control periods in non-stimulated participants. Therefore the deviation between photic and control periods seen in the broad-frequency evoked potential (Fig. 4.5) can be attributed primarily to changes in evoked activity within the alpha band (8-13Hz).

The global field power measure used so far in the combined study analysis, quantifies the evolution of the entire potential field recorded over the scalp from the thirty-electrode array (see Eq. 2.3); as the GFP consists of a single-channel measure of global EEG activity, it does not provide any information as to the spatial distribution of this activity over the scalp. It will be useful however to examine the spatial distribution of evoked- α activity in stimulated and non-stimulated participants; this can be seen in Figure 4.6. The top graph (Fig. 4.6a) shows the spatial distribution of responses from photically stimulated participants (Related pairs, studies 1 and 2); as expected, this shows a rapid increase in evoked- α activity in response to photic stimulation, which starts in the occipital area and spreads throughout most of the cortex. The bottom graph (Fig. 4.6b) shows the spatial distribution of evoked- α activity in non-stimulated participants during the same time interval. In agreement with the average cross-study GFP waveform presented and discussed above (Fig. 4.1), evoked- α activity appears to increase before stimulus presentation, and reaches a maximum approximately at $t = 0$ ms. This activity in non-stimulated participants appears to be considerably more localised compared to the evoked- α responses seen in their partners, and is primarily focused in the parieto-occipital area.

In summary, the analysis of the combined data from studies 1 and 2 has largely confirmed the findings of each individual study, namely that changes in evoked- α activity in non-stimulated participants which appear to be related to the photic stimulation of their physically isolated partners, can only be found for participants in the Related pairs group. However, the unusual temporal characteristics of the observed activity do not fully support an interpretation of the effect as involving correlations in event related brain activity between participant pairs. Further examination of the combined data has revealed that unlike stimulated participants, non-stimulated subjects do not show any changes in induced activity, and neither do they show any changes in evoked activity in frequency bands other than alpha. These characteristics, along with the observation that the observed changes in evoked- α activity in non-stimulated participants are far more localised than event-related changes in their photically stimulated partners, suggest that direct parallels between the brain activity of stimulated and non-stimulated subjects cannot easily be drawn. Although the combined dataset from studies 1 and 2 has enabled a more thorough examination of the characteristics of the observed effect, the relatively small magnitude of the difference in activity between photic and control periods, and the (still) relatively small sample size in the two studies, continue to limit the conclusiveness of our interpretation of the results. The purpose of the third and final study is to further investigate the effect identified in the first two studies, while increasing the sample size and introducing modification in the experimental methodology likely to avoid some of the problems and clarify some of the questions encountered in the previous studies.

4.2 Design of Study 3

The effect found in studies 1 and 2 involves changes in the EEG activity of non-stimulated participants, which appear to be related to the photic stimulation of their partners. Unlike event-related responses to direct photic stimulation, this effect has been shown not to involve event-related changes in induced activity, or any changes in evoked activity in frequency bands

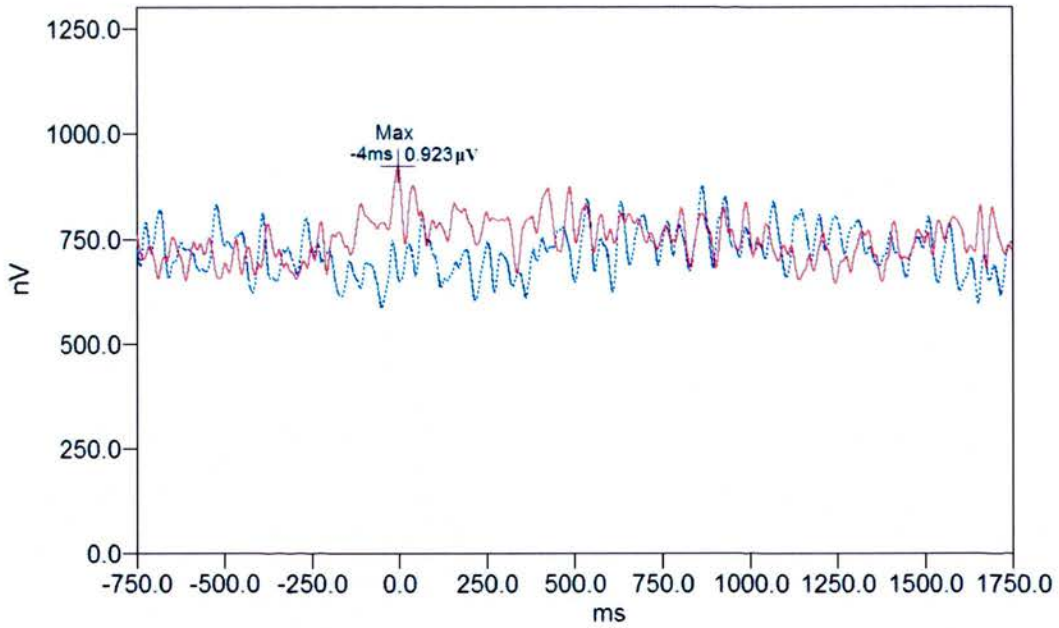
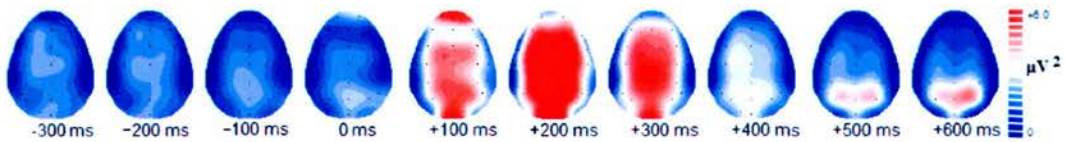
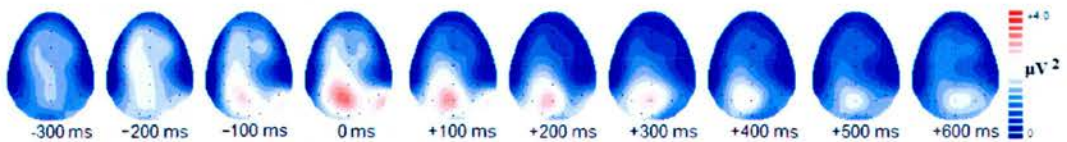

Figure 4.5: Combined results of studies 1 and 2: Mean ERP (global field power) for Related participants ($n = 26$). Solid red line represents photic stimulation periods and dotted blue line represents control periods.



(a) Mean evoked alpha band power for stimulated participants ($n = 26$).



(b) Mean evoked alpha band power for non-stimulated participants ($n = 26$).

Figure 4.6: A 2-D plot of the topographical distribution of evoked- α event-related activity across the thirty-electrode array for $n = 26$ non-stimulated and $n = 26$ directly photically stimulated participants (Related pairs groups) from studies 1 and 2 (with an average of 93 and 105 presented stimuli per session, respectively in each study). Photic stimuli were presented at $t = 0$ ms; please note difference in scale between graphs.

other than alpha. Therefore the measure of evoked- α activity adopted as the dependent variable in studies 1 and 2 appears to be well-suited for investigating this effect, and will also be used in Study 3. As the effect has only been observed in Related pairs in both studies conducted so far, only related pairs will be recruited in Study 3 in an attempt to study this effect in more detail.

In the average waveform of the combined data from studies 1 and 2, (for non-stimulated participants in the Related pairs group; see Fig. 4.1), the observed activity appears to begin (on average) approximately -250ms before stimulus presentation, and is roughly symmetrical pre-/post-stimulus. It is therefore important to note, that as the measure of event-related activity used for the statistical evaluation of the experimental hypothesis in studies 1 and 2 (i.e. the λ -ratio; see Eq. 2.4) quantifies the relative difference in activity between the pre- and post-stimulus intervals, this would return a value close to zero for the mean combined waveform of the two studies. Although in both studies 1 and 2 significant differences in mean λ -ratio estimates have been found between photic and control periods, and the effect size for this difference was of equal magnitude, the direction of the difference was reversed between the two studies. The combined analysis of the results of both studies has suggested that large between-subject variability in the latency of the effect was responsible for this difference between studies, and that the average effect across the $n = 26$ subjects is centered approximately at $t = 0$ ms. This would suggest that the λ -ratio measure as used in studies 1 and 2 is not suitable for quantifying this effect, therefore a modified formula based on the combined results of the first two studies will be used in Study 3; this will be described in detail in the Method section.

In the experimental procedure used in studies 1 and 2, participants listened to a recording of continuous drumming during their experimental session, intended to induce a similar state of consciousness in participant pairs. As discussed in the General Methodology section in Chapter 2 (page 17), based on the findings of past research there were reasons to expect that such a shared altered state may help in facilitating the emergence of event-related correlations in brain activity between stimulated and non-stimulated subjects. Although an effect has been found in these studies which may be interpreted to suggest the presence of such correlations, it is not possible to examine whether the drumming procedure was related to the effect in any way, as this was the only type of auditory stimulus used. An additional issue which must be raised in relation to the drumming procedure, is the question of possible auditory evoked potentials being produced in non-stimulated participants in response to the drumming. This has been addressed briefly in Chapter 2, where it was demonstrated that the drumming rhythm has no stable low-frequency periodic elements, and is therefore unlikely to produce “auditory driving”, i.e. an increase in the amplitude of the resting EEG at the same frequency as the drumming (see Fig. 2.1 on page 26). However, auditory EPs to individual drumbeats are still to be expected, and although these are likely to be fairly randomly timed, they may still produce fluctuations in evoked activity in non-stimulated participants, beyond the level of what one would expect in the EEG activity of resting subjects. Some of these auditory EP fluctuations could then be included in the samples of photic and control epochs from non-stimulated subjects, and may eventually affect the resulting average waveforms of evoked- α activity used as the dependent variable. Although such fluctuations are unrelated to the timing of photic and control events, and would therefore be expected to cancel out when averaged, this may only happen in practice when a very large number of epochs is used. There is no reason to expect fluctuations in evoked- α activity from auditory EPs to affect photic and control periods differentially, but such fluctuations could

make spurious differences between photic and control periods more likely. For these reasons, in Study 3 drumming will be compared with a different type of auditory stimulation which has no periodic structure and no discrete sounds which could produce auditory EPs; auditory stimulation based on brown noise was used for this purpose, and this will be described in more detail in the Method section.

The main limitation of studies 1 and 2 was their relatively small sample size, and the combined analysis of their results has made it clear that this needs to be increased even further in order to verify the validity and clarify the nature of the observed effect. However, as experimental sessions in these studies were considerably time-consuming (usually lasting between 1.5-3 hours), and participant recruitment was therefore difficult, Study 3 has been designed with the aim of maximising the amount of data which can be collected, without the need to recruit a larger number of participants. The modification proposed is to photically stimulate both participants in each pair, at different (randomised) time intervals; therefore while the procedure can largely remain the same, both participants in each pair will serve as stimulated and as non-stimulated subjects, thereby doubling the available sample size. For example, in a pair of participants A and B, participant A will be photically stimulated at random time intervals, and participant B will be stimulated at different randomly selected intervals. The same measure can be used as in studies 1 and 2, i.e. evoked- α activity in subject A will be compared between periods when subject B was photically stimulated and periods when neither subject was stimulated, and evoked- α activity in subject B will be compared between periods when subject A was photically stimulated and periods when neither subject of the pair was stimulated.

By slightly modifying this design further, it would also be possible to investigate an additional comparison, which was not possible in the two previous studies. In the design described above, both participants in each pair will be directly photically stimulated at different times during their session; if these subjects are also photically stimulated simultaneously at some other (also randomly determined) time intervals, it would be possible to compare, for example, the visual evoked responses of subject A when only A is photically stimulated, to the visual evoked responses of subject A when both subjects A and B are photically stimulated (and vice versa). According to the experimental hypothesis adopted in studies 1 and 2, changes in the EEG activity of a non-stimulated participant which are correlated to event-related changes in the EEG activity of a distant randomly stimulated partner, would be considered as indicative of distant correlations in brain activity between participant pairs. Such distant EEG correlations may also be expected to manifest as changes in the amplitude of a subject's visual evoked responses which are dependent on whether their partner is also visually stimulated at the same time. This can provide an additional comparison for testing the hypothesis of event-related correlations in brain activity between participant pairs, which may also carry several advantages to the method used so far in the previous two studies. For example, a persistent problem in studies 1 and 2 was the uncertainty regarding whether chance fluctuations in evoked- α activity may be involved in the observed effects. This problem was related to the fact that the comparisons used to evaluate the experimental hypothesis in these studies involved measures of EEG activity from periods of no stimulation; i.e. EEG samples from 'photic' and 'control' periods in non-stimulated participants essentially consisted of random samples from their resting EEG activity, as these participants were never photically stimulated themselves. This is an unusual procedure in EEG studies, and there is a distinct lack of standardised methods for performing

this type of comparison. It is the lack of such methods which necessitated the development of the λ -ratio measure used in this series of studies, and although this measure is used consistently across the three studies described in this thesis, it can still only be considered as an exploratory method which has not been sufficiently evaluated. It would therefore be beneficial to supplement this with a standardised method which is in general use in EEG/ERP research, such as the comparison of evoked responses to two types of stimuli. In the case of the comparison proposed in this study however, there is actually only one type of photic stimulus, as all photic flashes are physically identical; the only difference is that (on average) half of the photic stimuli presented to each subject will coincide with the simultaneous photic stimulation of their partner, whereas the other half of the stimuli presented will only involve photic stimulation of that one subject.

4.2.1 Hypotheses

Based on the combined results of studies 1 and 2, our hypotheses for Study 3 are as follows:

1. We expect to find changes in evoked-alpha activity in non-stimulated participants during periods of photic stimulation of their physically isolated partners. As these changes identified in the two previous studies appeared to be maximal between -250 and +250ms, the λ -ratio measure will be modified to consider this period as the test interval of interest.
2. We expect the amplitude of visual evoked- α responses in photically stimulated participants to vary depending on the presence or absence of simultaneous photic stimulation for their physically isolated partners.
3. Participant pairs will be randomly assigned to one of two groups; one group will be exposed to auditory stimulation with drumming during the experimental session (as in studies 1 and 2), whereas the other group will be exposed to auditory stimulation with brown noise. We expect to find no difference in effects (as defined above) between these two groups.

4.3 Method

4.3.1 Design

EEG was recorded simultaneously from two physically isolated participants, while both participants were stimulated with randomly timed (white) photic flashes. Flashes were presented independently to each participant (only), as well as simultaneously to both, in a randomised sequence and with an equal frequency of presentation; these flashes were presented interspersed with randomly timed control events involving no stimulation for either participant. For each participant, event-related band power measures were used to compare activity during periods when (only) their partner was photically stimulated, to control epochs when neither subject was stimulated (as in the two previous studies, although with a modified λ -ratio formula; see relevant section below). Additionally, the peak amplitude of visual evoked- α responses of each participant was compared between periods of photic stimulation of themselves only, and periods of photic stimulation of both participants in each pair. Only related pairs of participants were recruited in this study, and each pair was randomly assigned to one of two groups. In one group

participants listened to a recording of shamanic drumming throughout the session (*Drumming* group), while in the other group participants listened to a recording of brown noise (*Brown Noise* group); the experimental procedure was otherwise identical for both groups.

4.3.2 Participants

Fifty-two unpaid volunteers were recruited through fliers posted on notice boards and distributed throughout Edinburgh, as well as by word of mouth. Only related pairs of participants were recruited in this study, i.e. pairs reportedly sharing an empathic relationship, as close friends, relatives or partners. Each participant pair was pseudo-randomly assigned to either the Drumming or Brown Noise group. Twenty-seven male and twenty-five female participants took part in this study, with a mean age of 33.4 years, ranging between 18 and 64 years of age.

4.3.3 Equipment and materials

4.3.3.1 Audio material

The same audio recording of a progressive relaxation procedure was used as in studies 1 and 2 (see Appendix C for the transcript), which also included suggestions to the participants to maintain an awareness of each other throughout the session. For participant pairs in the Drumming group, this was followed by a recording of shamanic drumming (1.5–2 beats-per-second) as used in studies 1 and 2 (Rutherford & Charing, 2001), whereas for participant pairs in the Brown Noise group this was followed by a recording of brown noise mixed with the sound of rainfall.

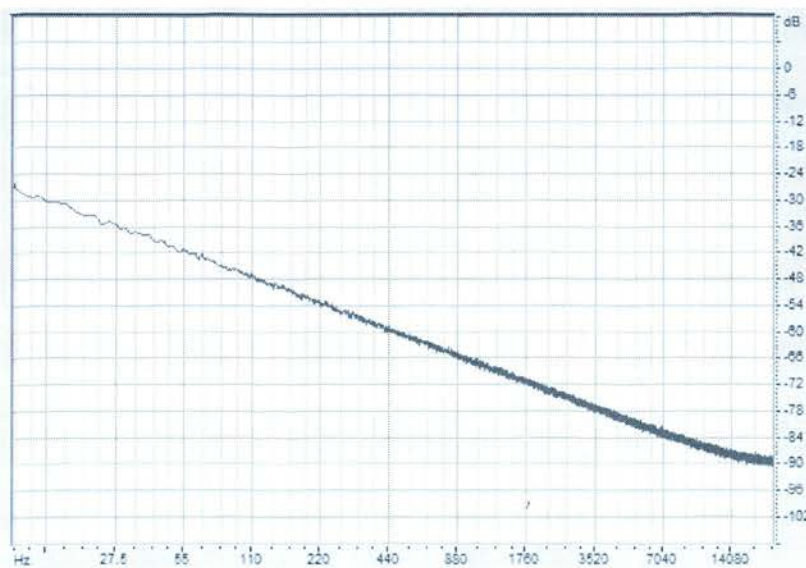

Figure 4.7: Frequency spectrum of the audio recording of brown noise mixed with the sound of rainfall.

Auditory stimulation with drumming involves rhythmic beats known to produce auditory evoked potentials, therefore in order to provide a contrasting alternative, a recording of brown

noise mixed with the sound of rainfall was chosen; this auditory stimulus has no rhythmic elements and contains no discrete sounds which could produce auditory evoked potentials. Brown noise is derived from white (i.e. random) noise by filtering out the high frequencies, and was chosen as the auditory stimulus as it was considered to be more pleasant compared to white noise. This was mixed with a recording of the sound of rainfall in order to make the auditory stimulus more interesting for participants; the frequency spectrum of this mixed recording can be seen in Figure 4.7, which demonstrates that the characteristics of brown noise dominate the recording.

The aim of this procedure was to induce deep relaxation, and to simultaneously facilitate a similar, non-ordinary state of consciousness in each pair of participants (in both groups). The audio recording was played to both participants using a shared one-way audio link.

4.3.3.2 EEG system and parameters

Continuous EEG was recorded simultaneously from both participants of each pair using two independent EEG recording units. Each unit consists of a 40 channel NuAmps EEG amplifier (Neuroscan, USA) and a (Windows XP) PC laptop running the data acquisition software (Scan 4.3.1). The EEG equipment placement and configuration was as in Study 2; the optical isolation signal router was also used in this study to relay the timing of photic and control events from the stimuli presentation computer to the EEG amplifiers, in order to eliminate the possibility of electrical leakage between the two EEG recording units (see Figure 3.2 for equipment connections diagram). Thirty monopolar channels were recorded from each participant with a 500Hz sampling rate from the following electrode sites: Fp1, Fp2, Fz, F3, F4, F7, F8, FCz, FC3, FC4, FT7, FT8, Cz, C3, C4, T7, T8, CPz, CP3, CP4, TP7, TP8, Pz, P3, P4, P7, P8, Oz, O1 and O2, with averaged ears used as reference. Data was bandpass-filtered online within 1–100Hz, with an additional 50Hz bandstop (notch) filter (24db/octave roll-off was used on all filters). An electrode cap (Neuroscan, USA) with sintered Ag/AgCl electrodes was used for electrode placement.

4.3.3.3 Randomisation and presentation of stimuli

As discussed in the previous chapter, the oddball stimulation paradigm used in Study 2 proved to be problematic for several reasons, therefore in Study 3 we will revert to the stimulation paradigm used in Study 1, and present only white (clear) photic flashes. Two pairs of dark glasses each fitted with eight white LEDs were used to present photic stimuli (Photosonix, USA); four phosphor-coated GaN LEDs are fixed inside each lens in a diamond-shaped arrangement. The luminance of each set of four LEDs at a distance of 1cm (\approx the distance from the eyes) was 1000Lux (Lumen/m²); the emission spectrum can be seen in Figure 2.2.

LED flashes (of 55ms duration) were triggered using TTL pulses (+5V logic) delivered from the parallel port of a computer running a script-driven program (*Inquisit* by Millisecond Software, USA), which controlled the randomised presentation of the three types of photic stimuli, (i.e. flash for subject A only; flash for B only; flash for both), and control events (i.e. no flash for either subject). Each of these four events was randomly selected (replacement sampling) with equal probabilities using *Inquisit*'s inbuilt pseudo-random algorithm (L'Ecuyer, 1994). Three-hundred and thirteen (313) events were presented during each session; therefore on average, approximately seventy-eight (78) events of each type would be expected in each

session (although the actual number varied due to replacement sampling). The same algorithm was also used to randomise the duration of interstimulus intervals (ISIs), which ranged between 4–7 seconds in half-second steps, with the mean ISI being 5.5s.² Separate synchronous TTL pulses were used to mark the timing of photic and control events on the continuous EEG record of both recording EEG units (see Appendix D for the Inquisit script used in this experiment); control events consisted of EEG event markers only, i.e. without associated flashes presented.

4.4 Results

4.4.1 Preliminary data processing

The raw EEG data from all 52 participants was band-pass filtered offline within 1–30Hz with 24db/octave roll-off. EEG records were visually inspected and bad channels were marked and removed. These missing channels were reconstructed from intact neighbouring channels via linear interpolation; no individual EEG record had more than four such reconstructed channels. As both subjects in each pair were photically stimulated in this study, we would expect ocular artefacts related to eye movements in response to flashes to contaminate the EEG recordings (unlike studies 1 and 2, where non-stimulated subjects showed virtually no such artefacts). Ocular artefacts were corrected using the ocular movement reduction algorithm in Scan-Edit v.4.3 (Neuroscan, USA). Three-second epochs time-locked on event markers were sampled from the continuous EEG records (–1s to +2s, with event at $t = 0$). Epochs were baseline corrected and those containing amplitudes $> 100\mu\text{V}$ were automatically rejected. Epochs were also visually inspected and those containing additional smaller artefacts (e.g. from eye movements or muscle activity) were manually rejected; such manual artifact rejection was conducted blind as to whether epochs related to photic or control events.

4.4.2 Dependent measure

The envelope of evoked (i.e. phase-locked) event-related power within the alpha band was used as a measure of responses to photic stimulation, as in studies 1 and 2. The raw EEG of all event-related epochs was first band-pass filtered around the central frequency band of interest (8–13Hz), and epochs were averaged point-by-point (as in evoked potentials). The amplitude values of the resulting average waveform were then squared in order to obtain power measures (μV^2), and the envelope of this waveform was calculated.

As we had recorded EEG from thirty scalp electrodes, the Global Field Power (GFP) was calculated as a measure of global EEG activity (see equation 2.3). The GFP corresponds to the spatial standard deviation between multiple electrodes as a function of time, and is used to quantify the global electrical activity across the spatial potential field sampled over the scalp (Lehman & Skrandies, 1980); the GFP quantifies activity over the entire electrode array, considering all electrodes equally.

²This mean ISI of 5.5s refers to the presentation of *both* photic and control events; the mean ISI between photic flashes (i.e. the mean ISI as perceived by participants) was therefore 6.8s.

4.4.3 Comparison of λ -ratio measures

Although both subjects in each pair were photically stimulated in this study, it is still possible to conduct the same comparison as in studies 1 and 2; i.e. measures of evoked- α activity from the EEG of each participant can be compared between periods when (only) their partner was photically stimulated, and periods when neither subject was stimulated. The same method using the λ -ratio measure can be employed in this study, although this will be slightly modified in order to take into account the findings from the combined analysis of studies 1 and 2.

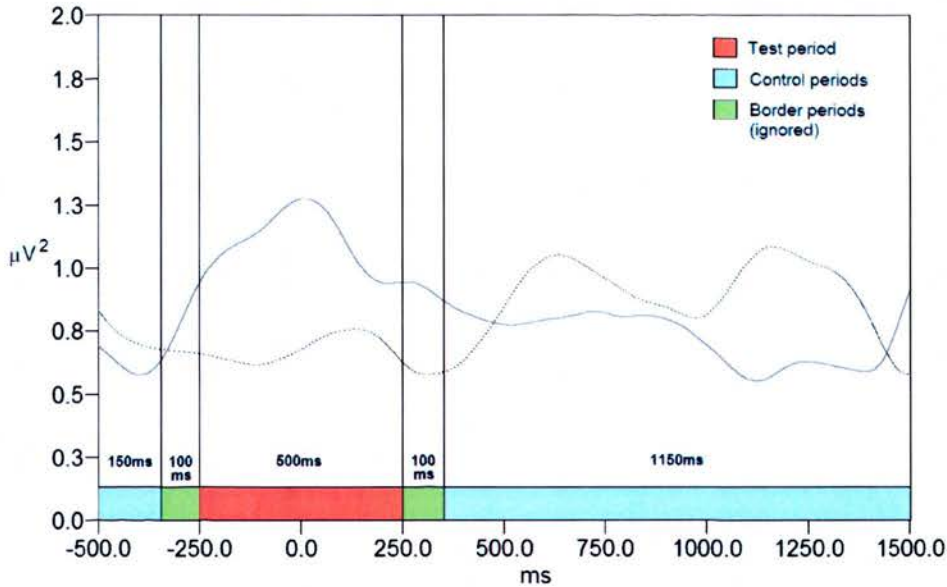

Figure 4.8: **Combined results of studies 1 and 2:** Mean evoked- α global field power for Related participants ($n = 26$). Solid line represents photic stimulation, and dotted line represents control periods. Colour index shows intervals to be used as test and control periods in Study 3.

The changes in evoked- α activity in non-stimulated subjects identified in the combined study results, appeared to be maximal between -250 and +250ms; therefore if these changes represent genuine event-related activity, we would expect to find similar changes during the same interval in Study 3. Although the choice of this interval may appear to imply that a hypothesis involving a temporal anomaly is being adopted in Study 3, the decision to focus on the -250 to 250ms interval is entirely data-driven, based on the empirical findings from the cumulative results of studies 1 and 2, which have suggested that changes in evoked- α activity in non-stimulated subjects during epochs involving the photic stimulation of their partners are more likely to appear within that interval (see Figure 4.8). Any interpretations regarding the temporal characteristics of these effects will be postponed until the analysis of the results of Study 3 is completed, when a large enough body of data will be available to evaluate the nature of these characteristics with more confidence. As different test and control intervals will be used in this study (as shown in Fig. 4.8), the λ -ratio measure to be used in Study 3 will be modified accordingly:

$$\lambda' = \log_{10} \frac{\frac{1}{500} \sum_{t=-250}^{250} \alpha \text{GFP}_t}{\frac{1}{1300} \left(\sum_{t=-500}^{-350} \alpha \text{GFP}_t + \sum_{t=350}^{1500} \alpha \text{GFP}_t \right)} \quad (4.1)$$

where the numerator is the sum of evoked- α global field power within the -250 to 250ms test interval of interest, and the denominator is the sum of evoked- α GFP within two other intervals to be used as comparison control periods; the interval between -500 to -350ms, and the interval between 350 and 1500ms (see Figure 4.8). As test and control periods are of unequal length, the sum of evoked- α activity in the numerator and denominator are divided by the respective length of these periods in milliseconds (i.e. 500ms for test periods and 1300ms for control periods). Two 100ms intervals which border the test and control periods will be excluded from the analysis.

Therefore this modified λ' measure is designed to quantify the relative difference in evoked- α GFP between the -250 to 250ms interval and the rest of the epoch. As in studies 1 and 2, the null hypothesis to be tested is the expectation that there will be no difference between λ'_{photic} (involving epochs when only the other subject was stimulated) and $\lambda'_{\text{control}}$ (involving epochs when neither subject of each pair was stimulated). Therefore the data used in this comparison in Study 3 are equivalent to data from non-stimulated participants in studies 1 and 2, i.e. photic and control epochs effectively constitute two sets of (statistically equivalent) random samples taken from their continuous EEG activity at times when they were not themselves photically stimulated. As such, no difference between these epochs would be expected, and the null and experimental hypotheses can therefore be defined as:

$$\begin{aligned} H_0 : \lambda'_{\text{photic}} &\simeq \lambda'_{\text{control}} \\ H_1 : \lambda'_{\text{photic}} &\neq \lambda'_{\text{control}} \end{aligned}$$

with the criterion for $\lambda'_{\text{photic}} \neq \lambda'_{\text{control}}$ being a statistical difference between λ'_{photic} and $\lambda'_{\text{control}}$ with $p < .025$, using a two-tailed non-parametric Wilcoxon signed-ranks test. As an additional statistical comparison will be conducted in this study, (i.e. comparing the magnitude of evoked- α responses to direct photic stimulation relative to the synchronous stimulation of another participant), the alpha significance level is adjusted accordingly for multiple comparisons.

4.4.3.1 General results for all groups

Figure 4.9 shows the mean λ' -ratio for subjects in the two groups during photic stimulation of their partners (only), and during comparison control periods of no stimulation for either participant of each pair. Participants in the Drumming group show mean λ' values very close to zero, for both photic and control periods, which suggests that differences in evoked- α activity between the test interval of interest (-250 to 250ms) and the rest of the epoch were minimal. The mean λ' values for participants in the Brown Noise group are slightly larger in magnitude (although negative), but the mean of photic and control periods is nearly identical.

Table 4.1 shows numerical values for means and variance estimates for these comparisons; mean λ' -ratio values are very close to zero for both groups and conditions, as would be expected if no event-related changes in α activity (similar to those identified in the combined results of

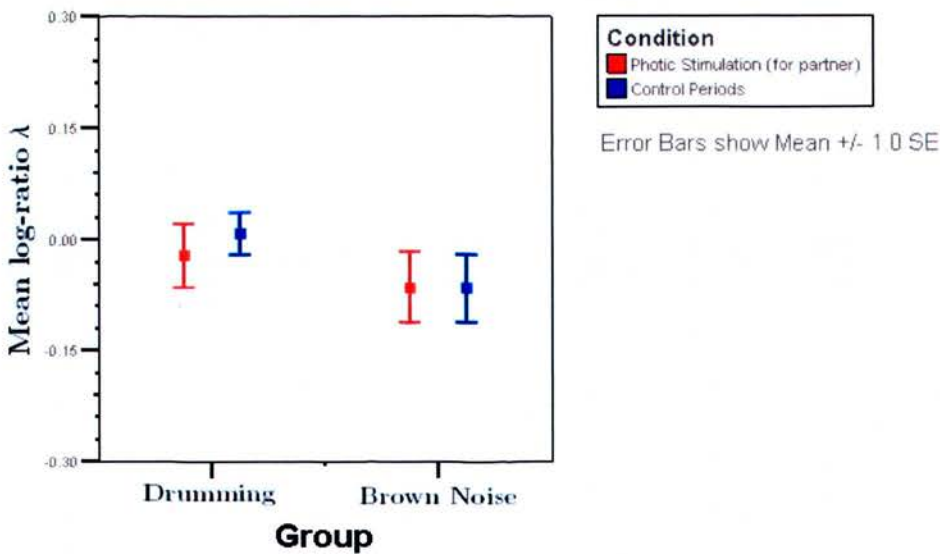

Figure 4.9: Mean λ -ratio for all subjects during periods of photic stimulation of their partners, and during comparison control periods of no stimulation. Error bars show \pm one standard error from the mean; $n = 26$ in each group.

studies 1 and 2) were present in this study. The results of the statistical comparisons of photic and control periods using the Wilcoxon signed-ranks test, strongly support the null hypothesis for both the Drumming ($p = .638, n = 26$) and the Brown Noise group ($p = .99, n = 26$). Estimated standard deviation values are comparable to those found in studies 1 and 2.

The mean waveforms of evoked- α GFP for participants in the Drumming group can be seen in Figure 4.10. It is clear that there are no notable deviations from baseline within the -250 to 250ms interval of interest, and although some rise in activity can be seen later in the epoch for both photic and control periods, these fluctuations are small and never exceed $1\mu V^2$. This is generally what would be expected from the group average of evoked- α GFP from randomly sampled epochs during periods of no stimulation, and it is therefore supportive of the null hypothesis.

The mean waveforms of evoked- α GFP for participants in the Brown Noise group can be seen in Figure 4.11. Although an unusually low level of evoked- α activity can be seen within the -250 to 250ms interval of interest during control periods, the mean waveforms in this group for both photic and control periods are characterised by large fluctuations throughout the epoch, reaching relatively extreme values in the early and late parts of the epoch. Although in agreement with the non-significant results of the Wilcoxon test, no meaningful differences between photic and control periods can be identified, the magnitude of the observed fluctuations is unexpected under the null hypothesis. As the mean waveforms for the Drumming group do not show fluctuations of a similar magnitude, it would be useful to identify why these may have appeared in the Brown Noise group. Similar large fluctuations in evoked- α activity have also been observed in Study 2, in the group mean waveforms of participants in the Alone group. In that study such fluctuations were shown to be related to large-amplitude ongoing (i.e. “background”) alpha-rhythms; it would therefore be reasonable to suspect that a similar

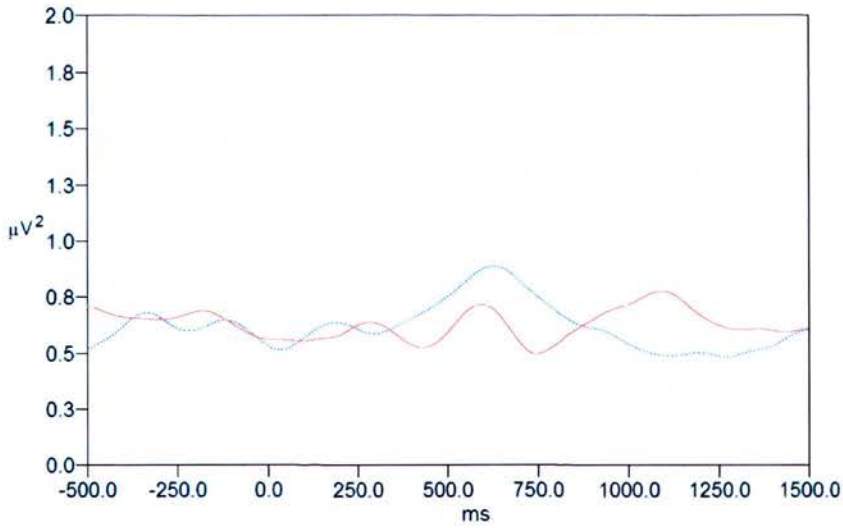

Figure 4.10: **Drumming group:** Mean waveform of evoked- α GFP during photic stimulation of partner (red line) and control periods of no stimulation (blue dotted line). Seventy-eight events of each type (on average) presented per session at $t = 0ms$; $n = 26$.

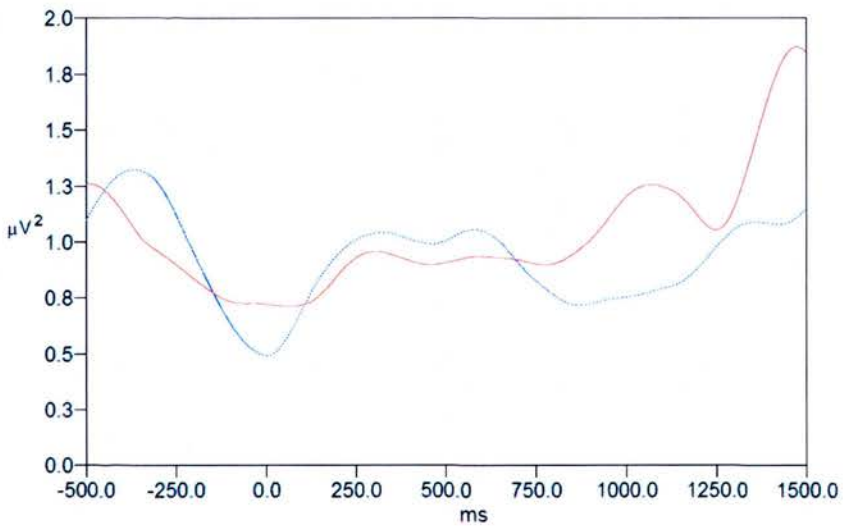

Figure 4.11: **Brown Noise group:** Mean waveform of evoked- α GFP during photic stimulation of partner (red line) and control periods of no stimulation (blue dotted line). Seventy-eight events of each type (on average) presented per session at $t = 0ms$; $n = 26$.

Table 4.1: Mean λ -ratio and standard deviation values for subjects in the two groups, during photic stimulation of their partners and during comparison control periods of no stimulation. Results of Wilcoxon signed-ranks tests (two-tailed) for these comparisons and associated effect size estimates; $n = 26$ in each of the two groups.

	<i>Drumming</i>		<i>Brown Noise</i>	
	Photic	Control	Photic	Control
Mean λ	-.021	.007	-.064	-.066
Stand. dev. (λ)	.217	.143	.245	.238
Wilcoxon p	.638		.99	
Wilcoxon z	-.47		-.013	
Effect size r	-.075		.004	

process may be involved in this study.

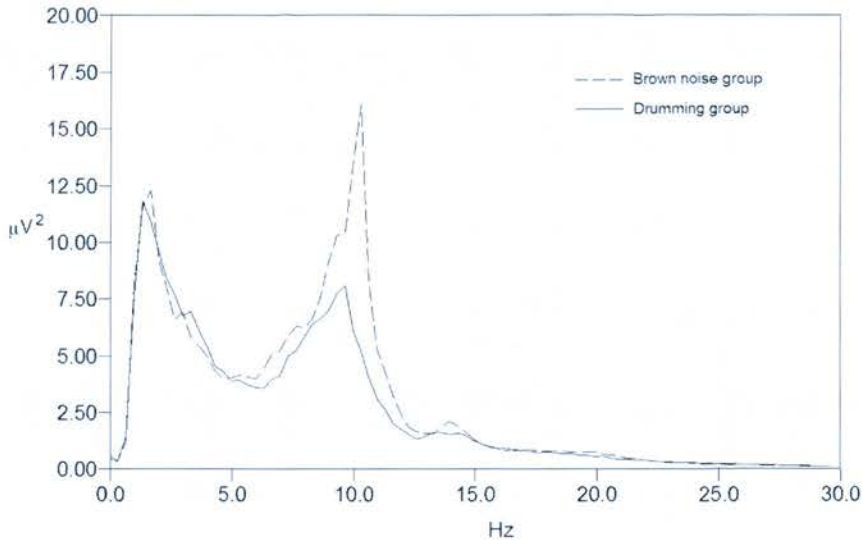

Figure 4.12: Frequency spectrum (FFT) Comparison between the Drumming and Brown Noise groups (during periods of no stimulation).

Figure 4.12 shows the frequency spectrum for the Drumming and Brown Noise groups; it is clear from this comparison that alpha activity (8–13Hz) in the Brown Noise group is of a much higher amplitude compared to alpha activity in the Drumming group. As has been discussed in Study 2, the amplitude of ongoing (i.e. induced) alpha rhythms has been shown to be positively correlated to the amplitude of evoked- α activity; therefore the large fluctuations in evoked- α activity observed in the Brown Noise group are most likely the result of high-amplitude resting alpha rhythms in this group.³ We can only speculate as to the reasons for the observed high-amplitude α -rhythms in the Brown Noise group, but this is likely to be related to the differences in experimental procedure between the two groups, i.e. the difference in type of

³The reader is referred to the Results and Discussion sections of Study 2 for a more in-depth treatment of this topic.

auditory stimulation. As mentioned in Study 2, the amplitude of an individual's resting alpha rhythms is known to be related to their level of psychophysiological arousal (e.g. Lindsey, 1960), and it would not be surprising if auditory stimulation with brown noise induced a lower level of arousal in participants, compared to auditory stimulation with drumming. Although brown noise was mixed with a recording of rainfall sounds in order to make it more interesting to participants, it is easy to see retrospectively why this combination could have induced a low arousal state in participants, at least in comparison to participants listening to the drumming recording.

4.4.4 Comparison of visual evoked responses

The second comparison to be performed in this study involves the amplitude of visual evoked- α responses to direct photic stimulation. The peak amplitude of each participant's visual evoked responses when only they alone were photically stimulated, will be compared to their visual evoked responses when both they and their partner were photically stimulated simultaneously; no difference between these responses would normally be expected, as participant pairs are physically isolated from each other and unaware of the timing of each other's stimulation, and as all photic flashes are physically identical. If such differences are found consistently across subjects however, this would be seen to support the hypothesis of correlations in event-related brain activity between participant pairs.

In order to conduct these comparisons, the mean waveforms of evoked- α responses to photic flashes for each group must first be examined, in order to determine the interval of interest to be used in the comparison. Figure 4.13 shows the mean evoked- α GFP waveforms for the Drumming group, during photic stimulation of each subject only (Self-flash) and during photic stimulation of both subjects in each pair (Both-flash). In order to determine the interval of interest, the mean waveform of the two waveforms to be compared is first calculated (shown as black line in Fig. 4.13). The latency of the peak of this mean waveform is then identified (162ms in this case), and the 50ms interval surrounding this peak is defined as the interval of interest (marked in Fig. 4.13). The mean evoked- α GFP for each subject within this interval (137-187ms in this case), will then be compared between Self-flash and Both-flash periods.

The same procedure has been followed to determine the interval of interest for the Brown Noise group; Figure 4.14 shows the mean evoked- α GFP waveforms for Self-flash and Both-flash periods, as well as the mean of the two (black line). The peak latency of the mean waveform is 229ms in this group, and the 50ms interval surrounding this is 204-254ms; the mean evoked- α GFP within this interval will therefore be compared between Self-flash and Both-flash periods for each subject.

Figure 4.15 shows the mean peak GFP during the intervals defined above for participants in the two groups; it is clear that mean peak GFP is very similar during Self-flash and Both-flash periods, for both the Drumming and the Brown Noise groups. This is in agreement with the mean evoked- α GFP waveforms shown above, (Figs. 4.13 and 4.14), which also show minimal differences between Self-flash and Both-flash periods.

Numerical values for mean peak GFP and standard deviation estimates can be found in Table 4.2, which also shows the results of the Wilcoxon signed-ranks test for these comparisons. These test results fully support the null hypothesis of no difference in peak evoked- α activity between Self-flash and Both-flash conditions.

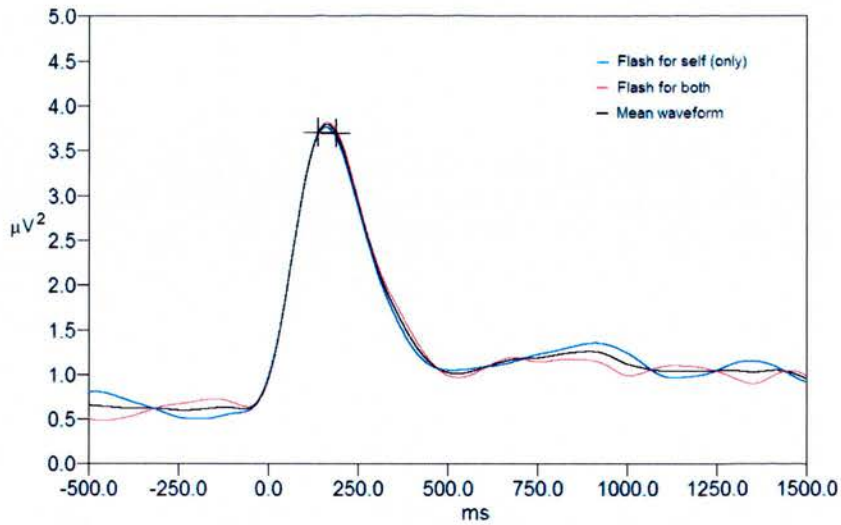

Figure 4.13: **Drumming group**: Mean waveforms of evoked- α GFP during photic stimulation of each subject only ('Flash for self') and during photic stimulation of both subjects in each pair ('Flash for both'). Black line shows the mean of these two waveforms; the 50ms interval surrounding the peak amplitude of the mean waveform is marked. Seventy-eight events of each type (on average) presented per session at $t = 0ms$; $n = 26$.

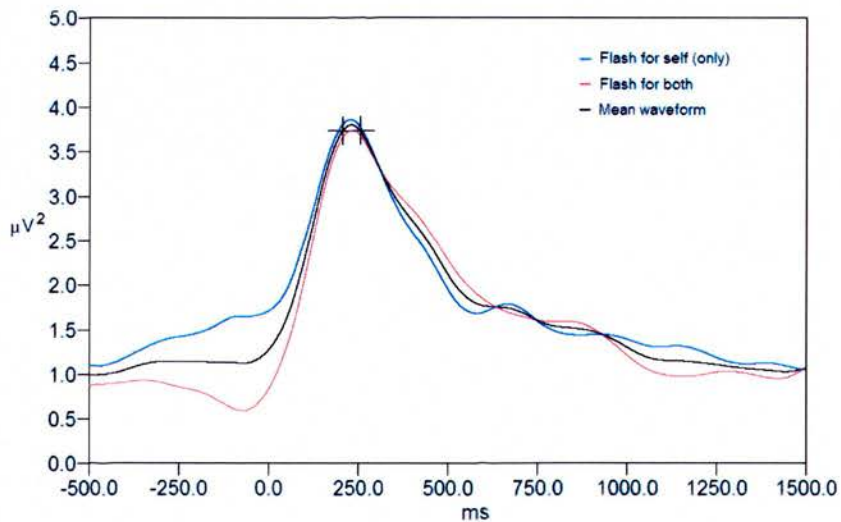

Figure 4.14: **Brown Noise group**: Mean waveform of evoked- α GFP during photic stimulation of each subject only ('Flash for self') and during photic stimulation of both subjects in each pair ('Flash for both'). Black line shows the mean of these two waveforms; the 50ms interval surrounding the peak amplitude of the mean waveform is marked. Seventy-eight events of each type (on average) presented per session at $t = 0ms$; $n = 26$.

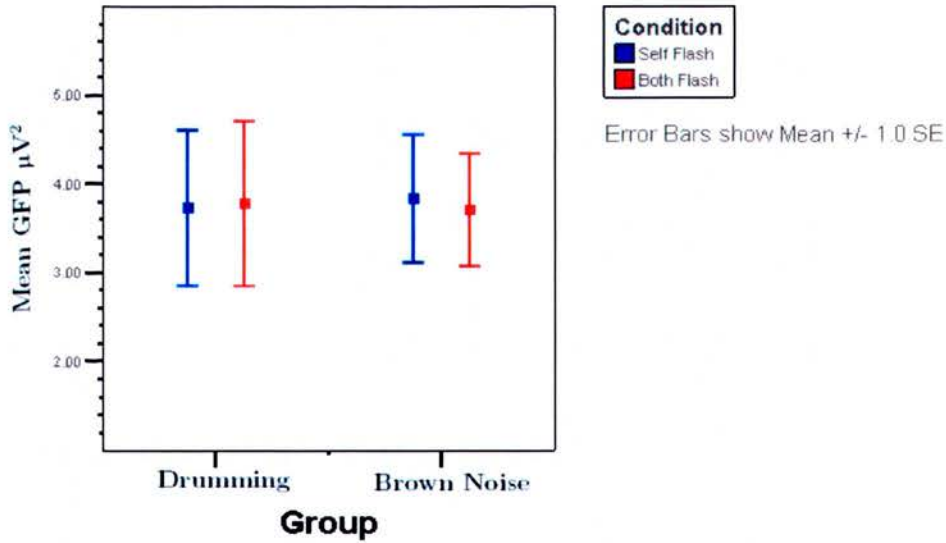

Figure 4.15: Mean peak GFP during photic stimulation of each subject only and photic stimulation of both subjects in each pair. Error bars show \pm one standard error from the mean; $n = 26$ in each group.

Table 4.2: Mean peak GFP and standard deviation values during photic stimulation of each subject only (Self flash), and photic stimulation of both subjects in each pair (Both flash). Results of Wilcoxon signed-ranks tests (two-tailed) for these comparisons and associated effect size estimates; $n = 26$ in each of the two groups.

	<i>Drumming</i>		<i>Brown Noise</i>	
	Self flash	Both flash	Self flash	Both flash
Mean peak GFP (μV^2)	3.73	3.78	3.83	3.72
Std. Dev. (μV^2)	4.48	4.72	3.68	3.21
Wilcoxon p		.79		.809
Wilcoxon z		-.267		-.241
Effect size r		-.005		.016

In examining the mean evoked- α GFP waveforms for these comparisons, perhaps the only noteworthy difference between Self-flash and Both-flash periods can be seen in the Brown Noise group (Fig. 4.14) during the pre-stimulus interval (-500 to 0ms). However, as has been briefly discussed above in relation to the large fluctuations in evoked- α activity seen in this group during periods of no direct photic stimulation (see Fig. 4.11), the frequency spectrum of background EEG activity for the Brown Noise group is characterised by unusually large amplitude alpha rhythms (see Fig. 4.12). As the amplitude of these rhythms is known to be correlated to the amplitude of evoked- α activity, the seemingly large difference in evoked- α GFP between Self-flash and Both-flash waveforms in the pre-stimulus period in Fig. 4.14 is most likely to be artefactual, and can be attributed to the large-amplitude oscillatory activity in the alpha band identified in this group.

4.5 Discussion

Study 3 was designed after an examination of the combined results of studies 1 and 2, with the aim of using their findings to develop an experimental paradigm specific to studying the effect identified in those two studies, while also addressing some possible methodological problems. For example, only related pairs of participants were recruited in Study 3, as significant effects in studies 1 and 2 were only found for this group, and the oddball stimulation paradigm used in Study 2 was abandoned, as it was found to be problematic in many respects, in favour of using only one type of photic stimulus. Additionally, in order to address the possibility that auditory evoked potentials may have affected the measure of evoked- α activity in studies 1 and 2, in Study 3 auditory stimulation with drumming was contrasted with stimulation with brown noise, which does not produce auditory EPs.

The effect identified in studies 1 and 2 involved differences in the evoked- α activity of non-stimulated subjects, between periods when their partner was photically stimulated and periods when neither participant of the pair was stimulated, and this was an aspect of the design which has remained largely unchanged in Study 3. In order to maximise the available sample size however, which was a factor limiting the conclusiveness of the results of the first two studies, each participant in Study 3 has served both as stimulated and as non-stimulated subject, a change in the design which doubles the available sample size. Additionally, the λ -ratio measure used in the first two studies was modified in Study 3 to consider as the test interval of interest the period between -250 to 250ms, as based on the combined results of the first two studies, changes in evoked- α activity in non-stimulated subjects were maximal within this interval. The results of this comparison in Study 3 were non-significant however, and λ' -ratio values for photic stimulation periods (for partner) and control periods (no stimulation for either) were similar, in both the Drumming and the Brown Noise groups. Furthermore, λ -ratio values for both groups and conditions were close to $\lambda = 0$, which suggests minimal differences in evoked- α activity between the -250 to 250ms interval of interest and the rest of the epoch, a finding which can also be confirmed visually by examining the group-mean waveforms of photic and control periods for the two groups (see Figs. 4.10 and 4.11). Therefore the effect found in studies 1 and 2 has not been replicated in Study 3, and as the sample size of each of the two groups in this study was as large ($n = 26$) as the combined sample size of studies 1 and 2 (for related pairs), this presents the possibility that the effect found in the first two studies may have been a chance artefact due to normal fluctuations in evoked- α activity. Such an interpretation would

be supported by the temporal displacement of the effect observed between studies 1 and 2, which is inconsistent with what would be expected in ordinary event-related responses. The modified λ' -ratio measure used in Study 3 was developed to take into account the possibility of an inherent variability in the latency of the effect, but this has not been successful in identifying a similar effect as found in studies 1 and 2.

In evaluating the lack of an effect in a replication study however, it is necessary to take into account differences in the experimental design and procedures between studies, which may have affected the chances of replication. The primary difference between the first two studies and Study 3 in this respect, is that both subjects in each pair were photically stimulated in the final study, whereas participants in the first two studies had clearly designated roles as either stimulated or non-stimulated subjects. Stimulated and non-stimulated participants in the first two studies were essentially adopting the respective roles of “sender” and “receiver”,⁴ and it is quite likely that they have perceived their task differently to participants in the third study, who were asked to take both roles interchangeably (and also simultaneously, when both were photically stimulated at the same time). Regardless of any speculative differences in the participants’ perception of their task however, these differences in experimental procedure between the first two studies and the third would have undoubtedly affected the participants’ psychological and psychophysiological state. Non-stimulated participants in the first two studies were simply asked to sit back and listen to the relaxation procedure and drumming recording, while keeping their partners in mind; in contrast, participants in the third study were given the same instructions, but they were also photically stimulated throughout the session (every 6.8s, on average). Such photic stimulation would be expected to increase their overall level of psychophysiological arousal during the session, and could also have affected their internal attention state, by drawing their focus more towards the external environment. According to Honorton’s (1977) noise reduction model, which postulates that “psi functioning is enhanced ... when the receiver is in a state of sensory relaxation and is minimally influenced by ordinary perception and proprioception”, sensory stimulation, higher somatic arousal and a more externally directed focus of attention would be detrimental to psi interactions between participant pairs. Whether this could have contributed to the lack of an effect in Study 3 will be further discussed in the following chapter.

The second hypothesis addressed in Study 3 involved comparisons in the amplitude of visual evoked- α potentials of each subject, during photic stimulation of that subject only (Self-flash), and during photic stimulation of both subjects in each pair (Both-flash). The expectation was that if event-related correlations in brain activity are responsible for the changes in evoked- α measures identified in non-stimulated participants in studies 1 and 2, then such correlations may also be involved in modulating a subject’s evoked- α responses to direct photic stimulation, in relation to the presence or absence of synchronous photic stimulation for their partner. This comparison was adopted in Study 3 as it provides an additional method for testing the hypothesis of event-related correlations in brain activity between participant pairs, which would also involve the use of methodology which is well-established in ERP/EEG research. The results of this comparison proved to be non-significant however, and the amplitude of visual evoked- α potentials during Self-flash and Both-flash periods was virtually identical, in both the Drumming and the Brown Noise groups (see Fig. 4.15 on page 103). These findings are in

⁴Although the terms “sender” and “receiver” were avoided by the experimenter, both in the writing of this thesis as well as during the running of experiments.

agreement with the non-significant results found in the comparisons of λ_{photic} and $\lambda_{control}$, and further support the conclusion that no evidence of event-related correlations in brain activity between participant pairs could be found in Study 3.

Although only related pairs of participants were recruited in Study 3, these pairs were randomly assigned to one of two groups; in one group participants listened to the same drumming recording throughout the session as used in studies 1 and 2, whereas the second group listened to a recording of brown noise. This manipulation was adopted in order to investigate the possibility that auditory evoked potentials produced in response to the drumming may have affected the measure of evoked- α activity used as dependent variable. Such auditory evoked potentials could have produced fluctuations in evoked- α activity in non-stimulated participants, thereby increasing the likelihood of finding spurious changes in averaged evoked- α measures resembling event-related activity. As no effects have been found in Study 3 for either of the two groups, it is somewhat difficult to evaluate the possibility that the effects identified in the first two studies may have been related to such auditory potentials. However, in examining the mean waveforms of evoked- α activity from the Drumming and Brown Noise groups in the present study (Figs. 4.10 on page 99 and 4.11 on page 99), it is clear that whereas mean evoked- α activity was stable throughout the epoch in the waveforms of the Drumming group, evoked- α activity in the Brown Noise group was characterised by unusually large fluctuations. This finding was therefore the opposite of what would be expected if auditory evoked potentials had been producing fluctuations in evoked- α activity. Subsequent investigation of the frequency spectrum for the two groups (see Fig. 4.12 on page 100), has revealed that participants in the Brown Noise group had resting alpha rhythms of considerably higher amplitude compared to participants in the Drumming group, and this difference is most likely responsible for the large fluctuations in mean evoked- α activity in the Brown Noise group. In conclusion, the results of the comparison of auditory stimulation with drumming and brown noise in Study 3 do not support the hypothesis that auditory evoked potentials may have been responsible for the effects identified in the first two studies. However, as evidence for similar effects has not been found in Study 3, the validity of the effects observed in studies 1 and 2 is brought into question; this question will now be addressed in more depth in the final chapter.

Chapter 5

General discussion

5.1 Overview of research findings

The three experiments presented in this thesis have investigated the hypothesised presence of correlations in event-related brain activity between physically isolated pairs of participants, as has been suggested by the findings of previous studies (see Chapter 1, section 1.2 on page 4 for a review). The results of the first two experiments appeared to support the presence of such correlations between related participant pairs (i.e. pairs in a self-reported empathic relationship), as significant differences in measures of brain activity (evoked- α Global Field Power) from non-stimulated subjects were found between periods of photic stimulation of their partner and control periods of no stimulation (Study 1: $z = -2.27$, $p = .023$, $n = 13$; Study 2: $z = -2.55$, $p = .011$, $n = 13$). Similar effects have not been found in unrelated (i.e. randomly matched) pairs of participants, or in control sessions with single, non-paired subjects (i.e. where photic flashes were administered but no other subject was present to observe these), which suggests that the methodological and analytical procedures used in these experiments were free from systematic sources of error. The temporal characteristics of the observed deviations in the brain activity of non-stimulated subjects in related pairs varied between the two studies however, and this activity did not accurately coincide with the latency of mean evoked responses in their stimulated partners. In study 1 the activity observed in non-stimulated participants (group mean) reached a peak before the average maximum of evoked responses in their partners (see Fig. 2.12 on page 46), whereas in study 2 this activity preceded the actual presentation of photic stimuli (see Fig. 3.8 on page 67); this temporal inconsistency of the effect appears somewhat incompatible with an interpretation of the effect as reflecting correlations in brain activity between participant pairs. One methodological difference between these first two studies was the addition of an oddball stimulation protocol in study 2, whereby two types of photic stimuli of different colour and duration were randomly presented in a 3:1 ratio, which typically produces evoked potentials of larger amplitude in response to the less frequently presented stimulus. Based on the hypothesis that the investigated effect involves event-related correlations in EEG activity between isolated participant pairs, it was predicted that such experimental manipulation of the amplitude of evoked responses in stimulated subjects would correlate with the magnitude of observed effects in their non-stimulated partners. Contrary to this hypothesis however, a significant difference between photic and control periods (for non-stimulated subjects

in related pairs) was only found in relation to common (i.e. frequently presented) photic stimuli ($z = -2.69$, $p = .007$), whereas differences between epochs associated with rare stimuli and control periods were non-significant ($z = -.105$, $p = .91$). When the results from related pairs in studies 1 and 2 are combined (including rare epochs from study 2), a Stouffer $z = 3.41$ with associated probabilities $p = .0006$ is obtained (cumulative $n = 26$).

A number of methodological modifications were introduced in the third and final study in an attempt to investigate the identified effect in greater detail, and to further exclude potential sources of artefacts. A largely data-driven approach was adopted in choosing these modifications, based on the combined findings of studies 1 and 2. As the effects identified in these two studies were only observed between related participants, twenty-six related pairs were recruited in study 3; in order to further increase the available sample size, the experimental design was modified so that both participants in each pair were photically stimulated throughout each session, thereby alternately serving as stimulated and as non-stimulated subjects (increasing the available sample size by a factor of two; i.e. total $n = 52$). Additionally, as the average deviation in EEG activity in non-stimulated participants across the first two studies was observed between -250ms pre-stimulus and 250ms post-stimulus, this period was adopted as the test interval of interest in study 3, and the dependent variable measure was modified accordingly (see section 4.4.3 on page 96).

One potential source of artefacts not considered in the first two studies, is the possibility that the auditory stimulation of participants with drumming may have produced auditory evoked potentials in their EEG activity. Although the timing of any such auditory EPs in non-stimulated subjects would be independent from the randomised photic stimulation of their partners, such potentials may have produced large fluctuations in evoked- α activity, which in turn may introduce spurious differences between test and control epochs in studies with a small sample size. The twenty-six participant pairs in the final study were therefore randomly allocated into one of two groups; participants in one group were exposed to drumming during the session (as in the first two studies), whereas participants in the other group listened to a recording of brown noise. Greater fluctuations in evoked- α activity were found in participants exposed to brown noise however, which suggests that auditory evoked potentials are unlikely to be responsible for the effects found in studies 1 and 2.

An effect similar to the one seen in the first two studies has not been found in the final study, and differences between photic and control epochs in non-stimulated participants were non-significant in both the drumming ($z = -.47$, $p = .63$, $n = 26$) and the brown noise groups ($z = -.01$, $p = .99$, $n = 26$). An additional methodological modification in study 3 involved the simultaneous photic stimulation of both participants in each pair at random time intervals during each session; this has enabled the comparison of actual visual evoked potentials from each subject between epochs when only themselves were photically stimulated, and epochs when their partner was also simultaneously stimulated. We had speculated that if the effect found in studies 1 and 2 was due to correlations in brain activity between participant pairs, differences in the peak amplitude of evoked potentials between epochs when only one, and epochs when both participants were stimulated would be expected. No such differences were found however for either the drumming ($z = -.26$, $p = .79$, $n = 26$) or the brown noise groups ($z = -.24$, $p = .81$, $n = 26$).

Therefore the effect found in studies 1 and 2 has not been replicated in the final study, and the combined Stouffer z for all three studies (comparison of photic and control epochs for

non-stimulated subjects in related pairs) is $z = 1.83$ with a non-significant $p = .067$ (when both the drumming and brown noise groups from study 3 are included; cumulative $n = 78$). It can be argued that the brown noise group was sufficiently different methodologically to justify considering this separately; in such a case, if only the drumming group from study 3 is included the combined Stouffer z for the three studies is $z = 2.35$ with a significant $p = .019$ (cumulative $n = 52$). No matter how well justified however, any such post hoc data selection can only be considered to have limited validity and does not negate the fact that an effect was only found in the first two studies, each only involving a relatively small sample size ($n = 13$ non-stimulated participants in related pairs), whereas the final study with an $n = 26$ did not show a similar effect. This may suggest that the differences between photic and control periods found in the first two studies were due to chance fluctuations in evoked- α activity, whereas the lack of a similar effect in study 3 represents a regression towards mean chance expectation when a larger sample size is used.

Alternative interpretations for the inconsistent findings between studies must also be considered however; for example, the experimental procedure used in studies 1 and 2 was nearly identical (as it involved the photic stimulation of only one participant in each pair), whereas in study 3 both participants in each pair were photically stimulated throughout each session. In order to explore possible explanations for the lack of replication of the effect in the final study, it may therefore be instructive to consider studies 1 and 2 in combination and study 3 separately. As in study 3 both subjects in each pair were photically themselves stimulated during each experimental session, they would therefore be expected to be in a state of higher psychophysiological arousal compared to non-stimulated subjects in studies 1 and 2, who simply relaxed listening to drumming throughout the session; photic stimulation would also be expected to direct the participants' focus of attention towards their external environment. Both these characteristics (higher somatic arousal and externally directed attention) are considered detrimental to psi performance according to Honorton's (1977) noise reduction model, and may have contributed to the lack of an effect in study 3. As discussed in previous chapters, one EEG correlate of psychophysiological arousal is the amplitude of spontaneous alpha rhythms; it is therefore possible to investigate whether participants in study 3 demonstrate higher levels of arousal compared to participants in studies 1 and 2, by comparing the amplitude of their resting alpha rhythms during control (i.e. non-stimulation) periods. A comparison of the frequency spectrum during these periods between studies 1+2 and study 3 can be found in Figure 5.1; this shows that the resting alpha rhythms (8-13Hz) of subjects (non-stimulated in related pairs) in studies 1+2 (Fig. 5.1a) are of considerably higher amplitude compared to the resting alpha rhythms of subjects in study 3 (drumming group) (Fig. 5.1b). As subjects in all three studies were not stimulated during these control intervals (and were all resting listening to drumming), the only difference between studies 1+2 and study 3 is that in the latter these participants were themselves photically stimulated at other intervals during the session, whereas subjects in studies 1+2 were not stimulated at any time throughout their session. It is therefore likely that the observed difference in the amplitude of resting alpha rhythms between these groups can be attributed to the intermittent photic stimulation of participants in study 3, and the lower-amplitude alpha activity seen in these subjects can be considered to reflect increased psychophysiological arousal throughout the session.

This difference in the subjects' resting alpha rhythms and levels of somatic arousal between studies 1+2 and study 3 may therefore be responsible for the difference in observed

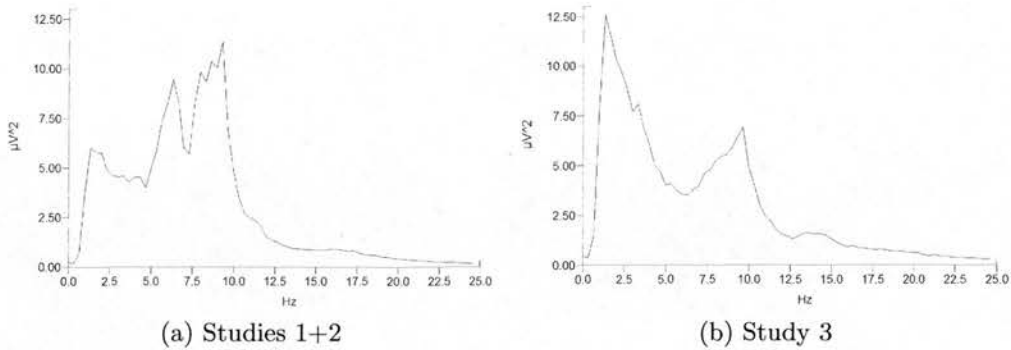

Figure 5.1: Comparison of mean frequency spectrum between studies 1+2 (related pairs, $n = 26$) and study 3 (drumming group, $n = 26$); samples taken from control periods of no stimulation.

effects between these studies; even if this hypothesis is accepted however, there are two possible interpretations of the overall results from the three studies. One interpretation would be to consider the effect found in studies 1 and 2 as a genuine anomaly (possibly suggesting some form of correlation in event-related brain activity between the isolated partners), and to attribute the lack of a similar effect in study 3 to changes in the experimental procedure which were responsible for inducing higher psychophysiological arousal (and higher-amplitude resting alpha rhythms) in these participants. However, as has been seen in study 2 in the case of the single-subjects' group (see section 3.3.6 on page 69), and in study 3 in the case of the brown noise group (see section 4.4.3.1 on page 97), large-amplitude resting alpha rhythms can introduce 'noise' fluctuations in measures of average evoked- α activity. As the observed effect in studies 1 and 2 involved changes in measures of evoked- α activity, an alternative interpretation would therefore be to consider this effect as due chance fluctuations related to large-amplitude spontaneous alpha rhythms; the lack of a similar effect in study 3 would in turn be attributed to the lower-amplitude alpha rhythms of subjects in this study not contributing to such fluctuations, and also to the larger sample size used in this study helping to reduce such chance fluctuations in the average results. Another characteristic of the effect found in the first two studies which may be considered to be suggestive of chance fluctuations, is the variation in the temporal location of the observed changes in evoked- α activity between studies 1 and 2. As has been described above, the maximum average deviation in evoked- α activity observed in non-stimulated subjects in study 1 appeared subsequent to the photic stimulation of their partners (and roughly coincided in latency with their visual evoked responses), although in study 2 the observed activity immediately preceded the presentation of photic stimuli. Finally, the failure of the oddball stimulation protocol adopted in study 2 to elicit an effect in epochs associated with rare stimuli, also does not appear to support an interpretation of the effect found in the first two studies as indicative of event-related brain correlations between participant pairs.

Considering the above observations, it is not possible to reach a definitive conclusion regarding the presence of such correlations between isolated participants based solely on the results of these three studies. It may be possible to clarify this question to some extent by conducting additional analyses on this data, as it will also be constructive to take into account the findings of other studies addressing the same question, a number of which have been published

after the research presented in this thesis had been conducted. A review of relevant recent studies and suggestions for potential additional analyses will be presented in following sections in this chapter.

Although it is therefore necessary to consider the overall findings of the three studies presented in this thesis as inconclusive, it seems nevertheless difficult to avoid the impression that the results of the first two studies seem strongly suggestive of a genuine anomaly. Large deviations in evoked- α activity in studies 1 and 2 were observed in non-stimulated subjects in related pairs only during periods of photic stimulation and not during control periods, while there was also a lack of similar effects in the unrelated and alone groups in these two studies (although differences between groups have not been evaluated statistically as yet; see section 5.4 below for discussion). Additionally, the evoked- α activity seen in non-stimulated subjects in the combined average of the first two studies appeared to reach a maximum almost precisely at the moment when their partners were photically stimulated (see Fig. 4.1 on page 84), an effect which is not found during comparable control periods, and which subsequent tests have been unable to dismiss as a technical artefact (see Results sections of Chapters 2 and 3). It should also be noted that a difference in brain activity between photic stimulation and control periods can not only be found in the evoked- α measure used as the dependent variable in the analysis, but it can also be seen in the ERP averages of these epochs (see Fig. 5.2). Although measures of evoked- α activity were shown to be vulnerable to noise from large-amplitude spontaneous alpha-rhythms (see Chapter 3, section 3.3.6 on page 69), ERP averages are known to be far more robust to such artefacts as they quantify activity from a wider frequency spectrum (1-30Hz in this case) (e.g. Shaw, 2003).

The presence of this deviation between photic and control periods in the ERP averages therefore does not appear to support the hypothesis that chance fluctuations in alpha activity were responsible for the observed effect. This hypothesis is also challenged by comparing the average evoked- α activity in studies 1+2 during photic and control periods for each of the three participant groups, as can be seen in Figure 5.3. The largest mean deviation is found in the related pairs groups during photic periods (reaching a peak approximately at the time when their partner was stimulated), whereas no deviation of similar magnitude can be seen in any of the other waveforms. Each of these waveforms represents the mean evoked- α GFP of $n = 26$ subjects from an average of ≈ 70 epochs per subject, and as these epochs were effectively random samples from the continuous EEG of non-stimulated subjects, their mean would be expected to tend towards zero. Although chance deviations from this mean would naturally be expected in a finite sample size, there should be no systematic difference between 'photic' and 'control' periods (as these participants were not photically stimulated themselves at any time), nor should there be any differences between groups. The observation that the largest fluctuation is found in the related pairs group, and that this fluctuation also coincides in time with the presentation of photic stimuli is therefore both unexpected and highly suggestive (as is perhaps the observation that the second largest deviation is found in the unrelated pairs group during photic epochs). Therefore dismissing these findings as chance fluctuations in alpha activity seems to be an unsatisfactory explanation; this is particularly so as the related and unrelated groups have been shown to have overall considerably lower-amplitude resting alpha rhythms relative to the single-subjects group (see Fig. 3.11 on page 70).

In such situations of uncertainty regarding the correct interpretation of experimental results, John Beloff's advice was to seek "to do justice to the evidence while, at the same time,

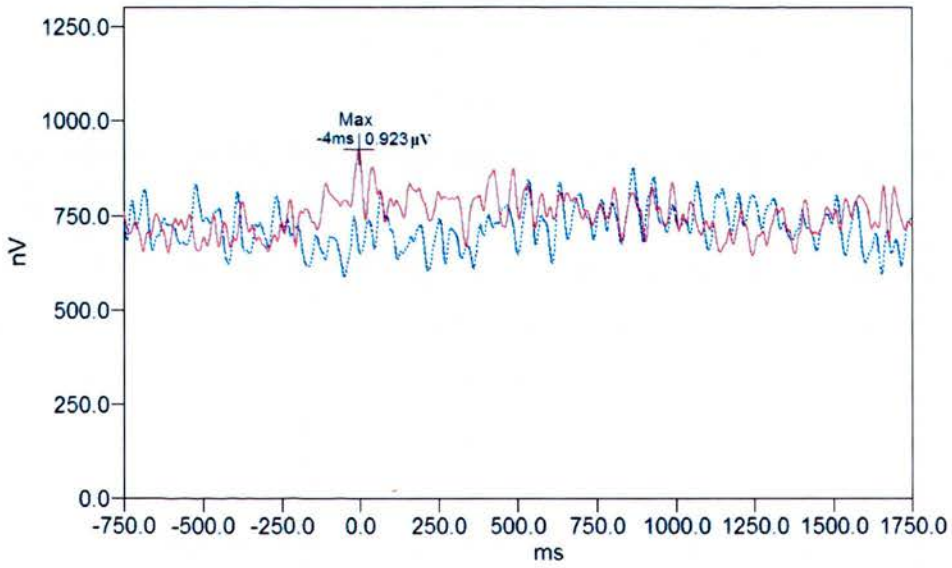

Figure 5.2: Combined results of studies 1 and 2: Mean ERP (global field power) for non-stimulated participants in related pairs ($n = 26$). Solid red line represents photic stimulation epochs (for partner) and dotted blue line represents control epochs.

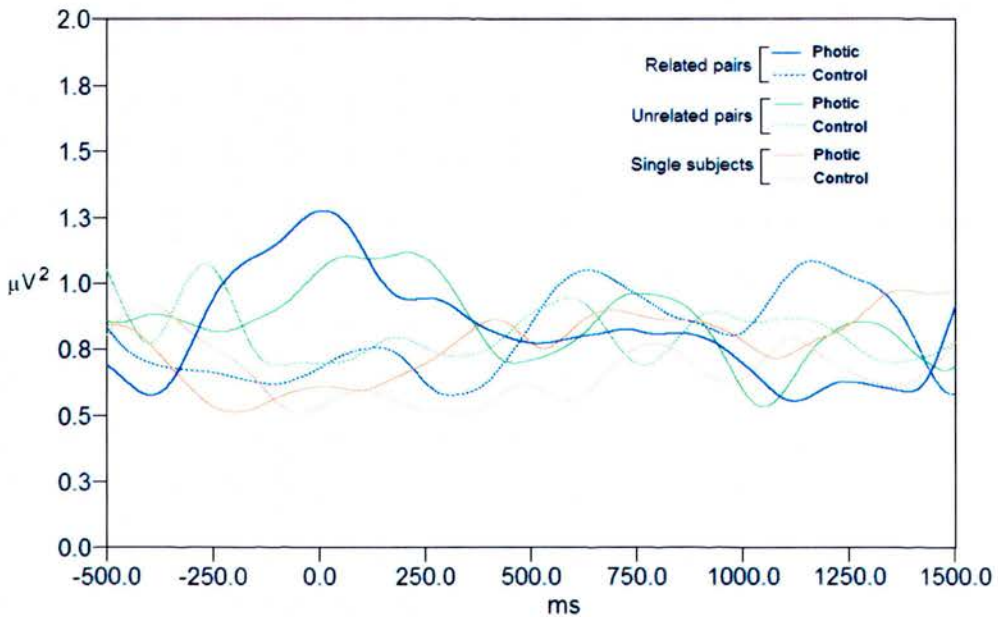

Figure 5.3: Combined results of studies 1 and 2: Comparisons of mean evoked- α GFP during photic and control periods for each of the three groups ($n = 26$ per group, with an average of ≈ 70 epochs of each type per subject).

seeking to do the least violence to our reason and our general knowledge” (Beloff, 1990, p.13). In the following section we will attempt to follow this premise, by tentatively considering the possibility that the effects found in the first two studies may represent a genuine anomaly (i.e. an effect not due to artefact or chance), and will discuss possible theoretical interpretations of such an effect.

5.2 Theoretical considerations

5.2.1 Presentiment effect

The observation that the average deviation in the brain activity of non-stimulated participants in the combined results of studies 1 and 2 tends to reach a maximum amplitude nearly exactly at the same time as stimuli are presented to their distant partners, and that the magnitude of this deviation is not reached at any other time during control periods (or in any other group other than related pairs), is arguably what is most suggestive of an anomalous effect. This observation however also appears to be incompatible with an interpretation of the effect as involving event-related correlations in brain activity between participant pairs, unless a hypothesis involving an additional temporal anomaly is invoked. Such temporal anomalies have been reported in the research literature, most notably in observations of differential anticipatory physiological activity to randomly presented emotionally valent or neutral stimuli, i.e. in what has been called the *presentiment effect* (e.g. Bierman & Radin, 1997). Although these findings appear to be in conflict with ordinary notions of causality (where causes precede effects by definition), as well as with our own everyday experience of a unidirectional linear causal sequence of events unfolding from past to future¹, time-reversed or retrocausal phenomena are generally not precluded by most currently established physical laws which are essentially time-symmetric (with the notable exception of the second law of thermodynamics), and several models have been proposed attempting to integrate such temporal anomalies within the framework of existing physical theories (e.g. see Sheehan, 2006).

The findings of presentiment studies however appear to demonstrate anomalous anticipatory physiological activity in subjects who are subsequently stimulated themselves, whereas what has been found in studies 1 and 2 is physiological activity in one participant which appears to precede the presentation of stimuli to another, distant participant. An ability to respond in advance to emotionally relevant future stimuli would have considerable survival value in certain situations (e.g. predator-prey interactions), and would therefore carry obvious evolutionary advantages for any biological organism able to make use of it². By extension of this argument, in socially complex animals like humans who form strong, life-long empathic bonds (and therefore have a mutual interest in each other’s survival and well-being), we may expect to see a transference of the presentiment effect to a non-stimulated but emotionally bonded partner;

¹Although experiences during altered states of consciousness have been reported where the linear causal sequence of events was perceived to unfold in a reversed temporal order (e.g. Luke & Kittenis, 2005)

²It should be emphasised however that an argument of evolutionary utility does not amount to supportive evidence for presentiment effects, nor is it an explanation of how these effects may operate; it simply points out that if such trans-temporal phenomena are physically possible, biological organisms would benefit by employing them as part of their sensorimotor abilities.

the observation that an effect was found only between related pairs of participants in studies 1 and 2 would be consistent with this speculation. Directly stimulated subjects in these pairs however show no similar anomalous anticipatory activity when they themselves are stimulated; therefore suggesting the presence of a presentiment effect in non-stimulated subjects when no similar effect can be seen in their stimulated partners would be stretching the limits of plausibility, especially as the stimuli used in these experiments had little (if any) emotional significance for either participant in each pair.

5.2.2 Quantum non-locality and entanglement

As has been stated in the Abstract and the Introduction of this thesis (see Chapter 1, page 16), during the design and execution of these studies it was our intention to avoid any assumptions as to the physical and physiological mechanisms likely to be involved in the studied phenomena, and to adopt a descriptive terminology as devoid of theoretical presuppositions as possible. The very title of this thesis however, (which is a commonly adopted description of this research topic in several other studies, e.g. Radin, 2004), may implicitly suggest theoretical interpretations of the studied phenomena postulating non-local correlations as found in entangled quantum-mechanical (Q-M) systems, and it should be acknowledged that a hypothesis involving such non-local (EPR-like) correlations was favored as a tentative explanatory model by the author, as is also the case in most recent studies using this experimental paradigm. Although nonlocal correlations between entangled particles have been predicted by Q-M formalisms from the early stages in the theory's evolution, their existence was initially greeted with much scepticism as it appeared to violate classical locality principles, and their apparently paradoxical implications were considered to indicate fundamental limitations in the theory's ability to fully describe physical reality (Einstein, Podolsky, & Rosen, 1935). Such non-local correlations have eventually been demonstrated experimentally however (e.g. Aspect, Grangier, & Roger, 1982), and are now routinely produced in a variety of physical systems using several different experimental arrangements, which has also stimulated research efforts to utilise their properties in practical applications (e.g. quantum cryptography and computing).

These experimental verifications of non-local correlations in entangled systems have so far involved demonstrations of *spatial nonlocality*, i.e. synchronous, non-causal correlations between entangled particles separated by spatial distance. Quantum theory makes no predictions regarding the possibility of *temporal nonlocality*, as unlike spatial coordinates, time is not normally treated as an observable in quantum mechanics but serves as an external parameter in the dynamical evolution of a system³. Therefore although non-local correlations as found in Q-M may serve as a model for synchronous correlations in brain activity between distant participants (as suggested in most previous studies using this paradigm), these cannot account for the apparently trans-temporal anomaly observed in studies 1 and 2. Although recent experimental verifications of Wheeler's delayed-choice Gedanken experiment (see Jacques et al., 2007) do appear to suggest that properties *resembling* temporal nonlocality can be seen in quantum-entangled systems, these findings do not necessarily imply that trans-temporal or retrocausal mechanisms are at work; they simply re-affirm the premise that quantum systems remain in an indeterminate probabilistic ('superposed') state until their properties are measured

³In contrast to relativity theory, where space-time is considered as a four-dimensional continuum.

(or observed), at which point they assume one definite value (an ‘eigenstate’).

The terms “measurement” and “observation” are often used interchangeably to refer to the act of obtaining information about the properties of a quantum-mechanical entity, which is generally considered to disturb the system and trigger its transition from an indeterminate to a definite state (state vector or wavefunction ‘collapse’). There is a profound lack of consensus amongst physicists however, as to what exactly constitutes a measurement or observation and whether these terms can be considered to be equivalent (or even relevant at all); this largely depends on which of the many interpretations of quantum mechanics one chooses to adopt, with different interpretations taking widely varying views on the matter. For example, some interpretations propose that it is the choice and arrangement of measuring instruments and their interaction with the quantum system which is responsible for eliminating quantum indeterminacy, while others suggest that collapse happens randomly irrespective of measurement (“objective collapse”), and some interpretations propose that wavefunction collapse -in the sense of a transition from a composite of probabilities to an actual state- may not be taking place at all (e.g. the “many-worlds” hypothesis) (see e.g. Baggot, 2003, for an introduction). The most widely adopted “Copenhagen” interpretation of quantum theory (often considered as the “standard” interpretation of Q-M) assigns a special status to measurement as being intimately involved in the collapse process, but does not define what constitutes a measurement and avoids speculations as to the nature of the collapse process by adopting a somewhat agnostic view. It postulates that the wave function can only be considered to represent the state of the observer’s knowledge about the system, with the collapse of the wave function reflecting a change in this knowledge from a probabilistic to a definite state; therefore according to this view, quantum theory only describes what we can know about the world, as it cannot describe the physical world independently of an observer.⁴

Although an extensive discussion of quantum mechanics and its various interpretations is beyond the scope of this thesis, as well as the expertise of the author, the “measurement problem” in quantum theory is unavoidably relevant if a model based on quantum-mechanical principles is to be used as an explanatory framework for the anomalies seen in studies 1 and 2 (or for the anomalies found in psi research in general). One additional interpretation which needs to be mentioned in this respect, suggests that it is the observation of a quantum system by a conscious observer which triggers the wavefunction collapse.⁵ Although this is not one of the most widely adopted interpretations of Q-M, it can account for the experimental findings equally well and seems to the author to be no less plausible than any of the alternatives; objections against it often seem to rest on a reluctance to accept an active role for consciousness in physical processes, which is perhaps not surprising given the predominance of epiphenomenal views of consciousness in contemporary physics. By admitting consciousness as a potentially relevant variable in physical quantum processes however, this interpretation also offers the possibility to

⁴The difficulty in discerning whether the propositions of quantum theory refer to ontological properties of the physical world or whether they have ‘only’ epistemic value, can be seen in J. A. Wheeler’s discussion of the delayed-choice phenomena which he described as showing “...a strange inversion of the normal order of time. We, now,... [by choosing which observable of a particle to measure] ...have an unavoidable effect on what we have a right to say about the already past history [of that particle]. The dependence of what is observed upon the choice of experimental arrangement (...) conflicts with the view that the universe exists ‘out there’ independent of all acts of observation” (Wheeler, 1984, p.184).

⁵First proposed by John von Neumann and later expounded by Wigner (1967) and others.

account (or at least allow) for such consciousness-related anomalies as identified in psi research, whilst avoiding the need to postulate violations of existing physical laws.

5.2.3 Observational theories

Since the 1974 conference on *Quantum Physics and Parapsychology*, several models attempting to accommodate psi phenomena within the theoretical framework of quantum mechanics have been proposed (e.g. Walker, 1975; H. Schmidt, 1975). Often collectively referred to as *observational theories*, these models usually adopt an interpretation of Q-M which considers the observer as being responsible for collapsing the state vector. An additional postulate in most of these models is that the observer may also influence the probabilities of the outcome of the collapse, an assumption which is not part of standard quantum theory where this outcome is considered to be stochastically determined (i.e. non-deterministically random). These models were originally proposed to account for anomalous deviations in the output of (quantum) random number generators (RNGs) observed in the context of ‘micro-psychokinesis’ experiments. These experiments involve giving feedback to subjects regarding the output of RNGs, while they are also instructed to attempt to intentionally influence this output; correlations have often been found between participant intention and RNG behaviour, which appear to be anomalous unless a hypothesis involving consciousness affecting Q-M state vector collapse probabilities is considered (e.g. H. Schmidt, 1982).

It may be useful at this point to re-conceptualised the design of our studies as a ‘biological-PK’ experiment, i.e. as one involving an intentional agent (the photically stimulated participant) and a dynamically fluctuating target process (i.e. the EEG activity of their non-stimulated partner). As participants were fully aware of the aim of the study, stimulated subjects have often reported attempting such an intentional influence on their partner at the times when they were exposed to the flashes, and although they were not instructed to do this by the experimenter, neither were they discouraged from doing so if they stated such an intention before the session. Although measures of electrical brain activity are clearly different in physical and statistical properties to RNG output, the spontaneous EEG signal is known to have 1/f-like spectral power characteristics resembling white noise (Freeman, 2004), which suggests that it can be considered (at least partly) as a deterministic pseudo-random signal; periodic dynamics in the resting EEG (such as alpha rhythms) are strongly present, but continuous complex shifts in the phase, amplitude and locus of these rhythms (even in the absence of external stimulation) ensure that only transient periodicity is maintained. Therefore although (unlike RNG output) short-term periodic activity is common in the spontaneous EEG, the long-term statistical trend would be expected to be pseudo-random.⁶ The general assumption that the brain is a strictly classical-deterministic system is also increasingly being questioned with several authors suggesting the potential involvement of quantum-mechanical processes in neural function (e.g. Jibu & Yasue, 1995), which also raises the possibility that elements of non-deterministically random (i.e. quantum-stochastic) activity may also be present in the EEG signal. If this is the case,

⁶This may not be true when the EEG is “driven” or “entrained” by externally presented periodic stimuli (e.g. repetitive sounds or flashes). Although in our studies auditory stimulation with drumming was used, the spectral characteristics of this audio recording do not show any stable long-term periodicity in frequencies below 55Hz, and the EEG signal was high-pass filtered to frequencies below 30Hz (see Chapter 2, section 2.2.3.2 and Fig. 2.1 on page 25).

observational models of micro-PK effects may also be applicable in EEG experiments such as ours.

Such a re-conceptualisation of our studies as ‘bio-PK’ experiments may be able to account for the apparent temporal anomalies found in our results, if so-called “retroactive-PK” phenomena are considered. Experiments involving the same micro-PK protocol as described above have been conducted using pre-recorded (but unobserved) RNG data, and have often reported similar findings as when real-time RNG feedback was used (e.g. H. Schmidt, 1976); although this may be interpreted as indicating a retro-causal process, a hypothesis involving quantum indeterminacy persisting until the point of observation seems a more plausible alternative⁷. One implication of these findings is that observation may affect the results of a study long after the experiment has been conducted and the data has been collected; this may be particularly relevant for PK research using quantum-mechanical RNGs, where the possibility of experimenter-observation effects has frequently been pointed out (e.g. Bierman, 2001). This may also be relevant for our studies if we conceptualise the experiments as bio-PK tasks, as our (non-stimulated) subjects were not given feedback and the (first) observation occurred when the EEG data was analysed by the author. If quantum indeterminacy is assumed to persist for prolonged periods of time on a macroscopic level and is also present in EEG signals, an effect of experimenter observation may be able to account for the peculiar temporal characteristics observed in the results of the first two studies. In such a case, observing the maximum evoked- α deviation in the average of these two studies \approx at $t = 0$ would be considerably more meaningful, as (primarily due to the pre-/post-stimulus comparison adopted in the analysis) this was ultimately the point in time which had most attracted the experimenter’s attention. A common objection to Q-M models of psi phenomena is that quantum entanglement between elements as large, warm and complex as living organisms (or even neurons) has not been demonstrated experimentally, and may be difficult to justify theoretically; however, entanglement between macroscopic objects (e.g. gas-clouds and multi-atom ‘Bucky-ball’ carbon molecules) has now been demonstrated at room temperatures (Collins, Gisin, Linden, Massar, & Popescu, 2002), which questions the limits within which quantum entanglement phenomena are usually assumed to operate.

5.2.4 Generalised Quantum Theory

Another approach utilising quantum theory to formulate a model of psi phenomena has been proposed originally under the name of *Weak Quantum Theory* (Atmanspacher, Römer, & Walach, 2002), and more recently as *Generalised Quantum Theory* (GQT) by Lucadou, Römer, and Walach (2007).⁸ GQT proposes a relaxation of the conditions normally restricting the application of quantum theory to physical-material systems, so that quantum-mechanical concepts such as complementarity and entanglement can be applied to arbitrary domains, including biological and non-physical (e.g. psychological and philosophical) research topics. In generalised quantum theory Lucadou et al. (2007) conceptualise psi anomalies (such as telepathy, psychokinesis and precognition) as belonging to a wider class of synchronistic phenomena, whose

⁷As is also suggested by the delayed-choice ‘quantum eraser’ experiment first proposed by Scully and Drühl (1982), where the determination of particle-like or wave-like behaviour of a photon can be delayed until after the registration (but not the observation) of its entangled twin (see Kim, Yu, Kulik, Shih, & Scully, 2000, for an experimental demonstration of this effect).

⁸Of which Lucadou’s (1987) *Model of Pragmatic Information* is a clear antecedent.

operation can be attributed to non-local entanglement correlations between the sub-elements of a so-called “organisationally closed” system; however, GQT does not postulate that such synchronistic phenomena arise directly from physical quantum mechanisms, and therefore does not assume a strong physical reductionism (as most observational theories do). One of the central axioms of GQT directly derived from physical quantum theory (where it is a known property of entangled systems), is that entanglement correlations cannot be used to transmit meaningful signals (i.e. information) or to exert controllable causal influences.⁹ When applied to synchronistic phenomena this “no signal transfer” rule leads to several interesting predictions, many of which seem consistent with certain common findings in psi research. One of these is the often noted “decline effect”, i.e. the notorious tendency for positive results in original psi experiments to decline in effect size or disappear altogether in subsequent replications. The predicted consequences of this rule may therefore be related to what has been described as the “elusiveness of psi” (e.g. Beloff, 1990), that is, the tendency of these phenomena to disappear when one tries to isolate them with more precision or to uncover the mechanisms involved; the effects may appear somewhere else in the data where they are not expected, as found for example in apparent “displacement effects” such as significant below-chance scoring in psi tasks. Such “elusiveness” of these phenomena would be expected in entanglement correlations postulated by GQT, as reliably reproducible psi effects could potentially be used for supraluminal signal transfer.

It may be useful at this point to discuss the relevance of these predictions of GQT to our own findings; the lack of replicability of the effect across the three studies would be expected according to this model, and especially so in study 3 where we had attempted to maximise the effect size by only recruiting related pairs, and to pinpoint the effect by focusing our analysis window on the time period between -250 to $+250$ ms (i.e. when the effect appeared most prominent in studies 1 and 2). The inconsistency in the temporal location of the observed phenomenon between studies 1 and 2 may also be considered to reflect a displacement effect; as has been described in the first section of this chapter, significant differences between photic and control periods in the log-ratio measure of post-stimulus versus pre-stimulus evoked- α power were found in both the first and second studies (with more extreme values observed in photic periods and values in control periods close to chance expectation). This difference however was in opposite directions in each study, with the deviation in evoked- α activity occurring primarily during the post-stimulus period in study 1, and primarily during the pre-stimulus period in study 2. It is interesting to note in this respect, that the effect size in these first two studies was of equal value but of opposing signs, i.e. $r = .43$ in study 1 and $r = -.43$ in study 2. (see Fig. 2.12 on page 46, and Fig. 3.8 on page 67). The prohibition against signal transmission postulated by GQT may also explain two other unusual characteristics of our results which seem incompatible with any known psychophysiological processes; the first is the failure to obtain effects with ‘rare’ stimuli when the oddball stimulation paradigm was used in study 2. This paradigm was adopted in an attempt to elicit EEG activity of differential magnitude in non-stimulated subjects, by stimulating their partners with two different types of stimuli; if this had been successful however, it would have been possible to use such differential stimulation of “senders” to transmit encoded signals to “receivers”, in the form of morse or

⁹The authors note that this property cannot be derived from other axioms in GQT (like it is in standard quantum theory), but suggest that “it is strongly expected to be true and it may be wise to postulate it as an additional axiom” (Lucadou et al., 2007, p.55-56).

binary code signals for example. Another physiologically counterintuitive feature of our results which has only briefly been mentioned so far (see Chapter 4, section 4.1 on page 82), is the observation that changes in the brain activity of non-stimulated subjects (correlated with the photic stimulation of their partners) were only found in measures of evoked- α (phase-locked) activity, and not in measures of induced- α (non-phase-locked) activity (see Fig. 4.1 on page 84 and Fig. 4.4 on 87). Spontaneous alpha activity is highly responsive to visual stimulation, as can be seen in the well known alpha desynchronisation effect (i.e. the induced- α response; see Fig. 2.6 on page 36), an effect which is reliable and robust enough to be visible in single (i.e. raw EEG) epochs. In contrast, event-related changes in evoked- α activity are of a much lower amplitude, and usually can only be observed after the additive averaging of a number of epochs, as in ERPs (see Chapter 2, section 2.3.2 on page 34 for details regarding the calculation of these measures). Therefore as the induced- α response can be measured on an epoch-by-epoch basis (i.e. using the raw EEG signal), it would be possible to encode a signal in such responses by using for example the length of the inter-stimulus interval to differentiate between the two values of a binary code¹⁰, whereas the fact that evoked- α responses can only be measured after the additive averaging of several epochs would make such encoding impossible. One problem with these predictions of GQT is that decline and displacement effects can also be considered to be consistent with the null hypothesis, i.e. that the inability to replicate initially significant effects may simply indicate that those effects were due to chance error, with an increasing number of follow-up studies showing a regression towards the mean. Although Lucadou et al. (2007) offer suggestions for potentially overcoming this problem, in this author's view these need to be further formalised before they can be implemented experimentally.

5.2.5 Decision Augmentation Theory

The *Decision Augmentation Theory* (DAT) proposed by May, Utts, and Spottiswoode (1995) suggests that psi phenomena arise entirely out of experimenter effects operating at the level of ordinary decision processes. The model postulates that information obtained precognitively by experimenters may influence their decisions (e.g. in choices of experimental design and analysis methods), so that results are obtained which are consistent with the experimenters' intentions and expectations. The DAT does not propose a physical mechanism which may underlie the process of "anomalous cognition" through which experimenters are considered to obtain the advantageous information, but provides a model which reduces all psi effects to a precognitive decision bias; it is therefore described by the authors as a *phenomenological* model which simply attempts to order and structure the raw observations of experiments, as opposed to what they call *fundamental* models, which attempt to provide a physical explanation (such as most of the observational models described above). Such a decision bias towards volitional outcomes as described by DAT may be more relevant to experiments involving randomly generated targets, particularly where the experimenter chooses the starting time and/or length of the trial, as is often the case with PK studies. This was also the case in our studies, where the starting time of each trial and of the associated stimulus randomisation process (but not the trial length) was initiated by the experimenter through a button press. May et al. (1995) point out that

¹⁰For example, a binary signal could be encoded according to the following rule: single alpha-desynchronisation responses separated by an interval of two or more seconds would count as "0", and pairs of responses separated by a one-second interval would count as "1".

effects mediated through such a process would be more likely when a number of short-length trials are involved in an experiment, which would provide more opportunity for experimenter decision-bias to come into play; in our studies however each experimental session involved only one trial, and therefore one decision by the experimenter of when to start the trial and the randomisation process. Although the randomisation of stimuli was deterministically defined by a pseudo-random algorithm seeded by the system clock (which would make it prone to DAT-like effect), we consider the possibility that one decision per session could bias our results to the extent seen in studies 1 and 2 through a DAT-like process as highly unlikely. This hypothesis is testable however, and future studies can investigate it by comparing for example sessions involving only one experimenter-initiated trial, against sessions involving several such trials. Perhaps the most important contribution of DAT however is in drawing attention to the potential role of experimenter intention in psi experiments, an issue which is often surprisingly overlooked.

5.2.6 ‘Classical’ real-time psi

Most of the discussion of possible theoretical interpretations of the effects found in the first two studies has so far focused on models derived from quantum mechanics, mainly for the reason that if the effects are accepted as non-artefactual, it is difficult to conceive of a classical mechanism which can accommodate the apparently pre-cognitive effects seen in Fig. 5.2 (page 112). Although the temporal characteristics of the effect appear to place it at odds with an interpretation involving classical signal-like mechanisms, the question addressed by the experiments presented in this thesis was essentially founded on the working hypothesis that we may possess perceptual capabilities beyond those currently established; if we allow for this possibility without assuming potential limits to such abilities, then at least one alternative interpretation becomes available which does not preclude classical mechanisms.

A pseudo-random algorithm seeded by the system clock (L’Ecuyer, 1994) was used for randomising the timing and sequence of photic and control events, and therefore the randomisation process can be considered to be essentially deterministic¹¹. This randomisation was carried out by the script-driven software running this algorithm (*Inquisit* by Millisecond Software), *at the start* of each experimental session; i.e. this program would first formulate a randomised list of the sequence of events (and associated inter-stimulus intervals) to be presented in each session, which it then proceeded to execute. This process was invisible to the experimenter, who was in fact unaware at the time that the randomisation process was being carried out at the start of each session, and was under the impression that the randomisation was conducted in real-time¹². This difference would normally be inconsequential for practically any other psychological or psychophysiological experiment; in this case however, as the timing of stimuli to be presented was determined at the start of each experimental session and this informa-

¹¹Unless one allows for the possibility that electronic noise in the computer’s components could introduce quantum-stochastic randomness in clock-time irregularities.

¹²The documentation provided with *Inquisit* implied that the default setting for the software was to run the randomisation algorithm in real-time. After all three of the experiments were conducted, the author contacted the manufacturers to ask for the exact specifications of the algorithm used by the software, and during this correspondence they clarified that the default setting is to run the randomisation at the start of each experimental session (although real-time randomisation is also possible as an option).

tion was stored in the computer's memory, it was therefore potentially available to subjects before the stimuli were presented, at least in principle. This leaves open the possibility that non-stimulated participants may have gained access to this information through some form of real-time psi perception, which could then account for their apparently pre-cognitive anticipatory responses. Contemplating this possibility does require some stretch of the imagination, as it would imply the operation of a "super-psi" faculty which seems exceedingly implausible to the author. In order to fully exclude such a possibility however, future experiments should (as a minimum) adopt real-time randomisation when pseudo-random algorithms are used, or ideally use 'true'-RNGs for stimulus randomisation.

Whether such a possibility seems more or less implausible than previously mentioned hypotheses involving non-local correlations between participant pairs, pre-cognitive DAT experimenter effects, quantum-collapse observer effects or any other theoretical interpretation, depends to a large extent on the reader's theoretical preferences and a priori assumptions; if one is particularly uncomfortable with contemplating macroscopic violations of spatial and temporal locality for example, then such a super-psi mechanism may be more acceptable than any of the alternatives. Perhaps the least uncomfortable of all possible interpretations discussed above however, is to consider the findings of studies 1 and 2 as being due to chance error; as the final study has shown no evidence of a similar effect, and the cumulative results of all three experiments are non-significant, this possibility cannot be ruled out without further investigation. A number of studies investigating this topic have been published after the series of experiments described in this thesis was initiated, which have not been included in the literature review presented in Chapter 1; the following section presents a review of these studies (conducted after 2004), which may be useful in evaluating the current state of the evidence for these effects, and may also help in clarifying their nature.

5.3 Review of recent literature

Four of the five studies to be reviewed in this section have been published in the *Journal of Alternative and Complementary Medicine*, something which perhaps indicates that the investigation of ostensible distant psychophysiological interactions is not only of pure theoretical interest, but may be relevant for the understanding of potentially health-promoting practices involving no physical or sensory contact between practitioners and recipients, such as 'distant healing' or prayer for example. In the first of these studies reported by Standish et al. (2004), thirty related pairs of participants with prior meditation experience were recruited, and subjects in each pair were assigned to "sender - receiver" roles; two sessions were conducted with each pair, with the roles reversed in the second session (thereby providing an $n = 60$ "receivers"). Participants in each pair were seated in separate rooms and first listened to relaxation instructions, which included suggestions to maintain an awareness of each other. EEG was simultaneously recorded from both subjects (O1+O2 referenced to Cz), and the "sender" was then exposed to a sequence of conditions where a checkerboard pattern presented on screen would be either static or reversing ('flicker' condition; rate of reversal 1Hz), while the "receiver" was constantly presented with a static checkerboard pattern throughout the session. Each session involved two flicker (F) and two static (S) periods (each of 64s duration) presented in the sequence F-S-F-S, thereby obtaining 128 flicker and 128 static one-second event-related epochs from each subject. For data analysis a time window within each "receiver's" epochs was selected, centered upon

the maximum P100 latency of their stimulated partner's averaged EP responses (usually 80-180ms), and a within-subject measure of 'hits' was defined as outliers (in the amplitude of raw epochs) from a Monte-Carlo distribution created from random-latency epochs sampled from control (static) periods. Statistical analysis involved a Runs test of non-random sequence of hits, with $\alpha < .01$ set as the significance criterion; five of the sixty subjects showed significant p values at this level during the flicker periods, whereas no subject showed similar effects during the static periods. By combining z values from all subjects using the Stouffer method, the authors reported an overall significant effect at $p = .005$ for the flicker condition compared to a non-significant $p = .64$ for the static condition. A follow-up experiment (reported in the same paper) with four of the five pairs who produced significant effects in the first study was conducted, with one of these pairs showing a replication of the effect. The design of this study is a considerable improvement to most previously published studies investigating such effects (reviewed in chapter 1), although there are certain limitations which must to be pointed out. For example, the choice of the Runs test seems somewhat unjustified, and the authors offer no explanation as to why they would expect a lack of randomness in the sequence of 'hits' to be a more relevant statistical test for their hypothesis, rather than a direct comparison of the cumulative number of outliers in flicker versus static conditions. Additionally, the lack of randomisation in the presentation order of flicker and static conditions is particularly problematic, something which the authors of the study also acknowledge. Certain changes in EEG activity would be expected to occur simply as a function of time; for example, alpha rhythms tend to increase in amplitude as a subject becomes more relaxed, and there is a tendency for movement artefacts in EEG recordings to occur at the beginning of a session as the subject "settles in". As the fixed sequence of conditions used in this study was F-S-F-S in all sessions, flicker periods were generally presented earlier in the session than static periods, which would make any comparison of EEG measures between these periods vulnerable to such artefacts. This is particularly a risk if no artefact removal procedures are followed, and the use of such procedures is not mentioned in the paper; the information provided implies that all recorded epochs were used, which would suggest that no artefact rejection procedures were applied. Although it should be acknowledged that the use of a Runs test rather than a direct 'number of hits' comparison may protect to some extent from such problems (it is not stated in the paper whether the test was chosen for this reason), adequate randomisation of the order and timing of conditions is crucial in this type of studies, and should be an indispensable part of their methodology.

A follow-up experiment using the one participant pair who had demonstrated a replication of the effect in the above study has been reported by Richards et al. (2005), where both EEG and fMRI measures were used (in separate sessions) and some improvements in the methodology were included. As in the previous study, checkerboard reversal and static stimuli were alternately presented to the "sender", although in this experiment the duration of these periods was varied (presumably randomly, although this is not explicitly stated). Four EEG and four fMRI sessions were conducted, two of each with one subject acting as the "sender", and two where the roles were reversed. In the EEG sessions a measure of alpha power was adopted (rather than the amplitude measure used in the previous study), and a similar Monte-Carlo randomisation technique was used to compare alpha power values between flicker and static periods in EEG epochs from "receivers"; both subjects showed significantly lower alpha power in flicker versus static periods in one of the two sessions they had each acted as "receivers". In

the fMRI sessions one subject showed brain activation correlated with their partner's stimulus-on ('flicker') periods in both sessions in which they had acted as "receivers", whereas the other subject showed similar activation in one of the two sessions when the roles were reversed; this activation was significantly different from stimulus-off periods in the left occipital region in one participant, and in the right occipital region in the other participant. The results of this study are certainly suggestive of a meaningful effect, as both alpha-suppression and occipital activation would normally be expected in directly visually stimulated participants, and the apparent success of this particular pair of participants in replicating the effect is also encouraging. The issue of adequate randomisation of stimulus conditions does not appear to have been fully addressed however, and as the authors themselves acknowledge, no strong conclusions can be drawn from a study with such a small sample size. Their effort to replicate previously identified effects using selected pairs and fMRI measures is commendable however, and certainly merits further study on a larger scale with additional improvements in methodology.

A paper published in the same issue of the *Journal of Alternative and Complementary Medicine* by Achterberg et al. (2005) reports such an attempt, although this experiment was designed within a somewhat different conceptual context. Eleven participant pairs were recruited, with each pair consisting of a healing practitioner and a person whom they knew well and felt emotionally connected to. The experimental procedure involved periods of "distant intentionality" (DI), during which the healers were asked to attempt to establish an intentional (mental/emotional) connection with their distant partners; standardised instructions on what this might involve and how to achieve it were not provided, and each healer adopted methods related to their own personal practices. During comparable control periods the healers were instructed to direct their attention away from their partner. The recipients of DI were physically isolated within the fMRI scanner and were simply instructed to relax as much as possible; they were aware of the purpose of the experiment and that their partner would be attempting DI during the session, but were not aware of the order of DI "on" and "off" periods. A randomised sequence of six "on" (+) and six "off" (-) periods of 2-minute duration was used in each session, with the same sequence used in all sessions (as follows: - + + - + - - + + - + -). Significant differences in the average brain activity of recipients ($n = 10$; data from one pair could not be used) coinciding with DI intervals were reported to be found in several brain regions, reflecting higher levels of metabolic activity in recipients during DI "on" versus "off" periods (it is not explicitly stated in the paper whether any differences involving higher activation levels during "off" periods were found in other brain regions). There appears to be some lack of detail regarding the statistical procedures used in the study, although this impression may simply reflect this author's relative lack of familiarity with fMRI analysis techniques. On the whole the study appears to have been reasonably well designed, with the primary limitation being the use of a fixed-order sequence of on-off periods in all sessions; although the authors state that the sequence used was randomly determined, using the same order of conditions in all experimental sessions is clearly not the optimal methodological choice. The authors acknowledge this limitation in their discussion, and further point out that as the sequence of conditions was known to three people other than the healer (technician, nurse and experimenter), it is difficult to draw conclusions as to whether the effects are due to DI interactions between participant pairs, as potential DI interactions between the investigators and the recipient cannot be excluded. Additionally, although the sequence of conditions was not known to the recipients prior to their session, a more sceptical reviewer could point out the possibility that recipients in

later sessions may have found out this information from previous participants. The importance of adequate randomisation of conditions is once again emphasized, and given the considerable efforts expended in conducting these studies, it is difficult to justify a lack of attention to this issue which would require a comparatively minimal effort to resolve.

Another study published in the *Journal of Alternative and Complementary Medicine* by Radin (2004)¹³ reports an experiment involving thirteen related pairs of participants. One-channel EEG (Cz) and EDA activity were recorded from both subjects in each pair, who mutually decided themselves the assignment of “sender” (S) and “receiver” (R) roles. Prior to each session participant pairs were asked to exchange a personal item with each other and to maintain a “feeling of connectedness” throughout the experiment. The “receiver” was asked to relax for ≈ 30 minutes, during which period the “sender” was occasionally presented with a live video image of their partner for randomly varying intervals of 17-25s duration, interspersed by randomised inter-stimulus intervals of 5-25s duration (a pseudo-random algorithm seeded by the system clock was used). The two EEG systems were running on independent power supplies (batteries), and event markers to these systems were optically isolated. For the analysis, EEG epochs of 10s duration centered upon stimulus transition moments (video image onset and offset, ± 5 seconds) were acquired; sample-points within each epoch (1250 samples per epoch) were normalised, and those with values beyond ± 3 standard deviations were excluded from the analysis as potential artefacts (manual inspection of epochs for smaller artefacts was not conducted, reportedly with the intention to avoid any subjective assessment of the data). An ‘ensemble variance’ measure (i.e. variance at each sample point across epochs) was calculated for all subjects (separately for Ss and Rs), and a Pearson correlation between these S-R variance arrays was estimated. A ‘bootstrap’ method was used to determine the statistical likelihood of these correlations, by repeatedly sampling (with replacement) from the Rs’ epochs by randomly time-shifting the starting point of these ‘surrogate’ epochs; the S-R correlation was calculated again using these time-shifted surrogate R epochs, and the process was repeated 10,000 times. As the null hypothesis predicts that there should be no difference between the original time-synchronised S-R correlation and the surrogate time-shifted S-R correlations, the probability of obtaining the original S-R correlation value by chance was estimated, and was reported to be $p = .0005$ for all thirteen participants combined. A secondary hypothesis investigated in this study was whether a relationship could be found in the magnitude of EEG measures between S-R pairs; larger values in R peak variance were reported to be found in relation to larger amplitude ERPs in Ss, which appears to suggest such a relationship. The author interprets this finding as suggesting that “the S-R relationship is causally modulated by S’s response to the stimulus” (p.318), a conclusion which we find to be unjustified; as the magnitude of the Ss’ responses was not experimentally varied, only a correlational relationship can be inferred. The overall results of this study do seem to suggest an anomalous correlation in EEG activity between S-R participant pairs however, and the methodology used is of a considerably higher quality than found in most previous studies; the adopted statistical techniques are also robust and seem well-suited for studying this type of effects. Two objections must be raised however in relation to the chosen treatment of EEG data in this study. Although the formalised and automated exclusion of extreme outlier sample-points does eliminate potential subjective bias as the author rightly points out, this method offers little reassurance however that smaller artefacts were not being

¹³Also published in the Parapsychological Association’s 46th annual convention proceedings; (Radin, 2003).

included in the final dataset. The adopted practice of removing individual outlier sample-points from raw EEG epochs (whilst retaining the rest of the epochs which contained these outliers), may further increase the likelihood of retaining smaller artefacts; such an approach is highly unconventional compared to standard EEG/ERP practices, where artefact-containing epochs are either entirely rejected, or otherwise corrected and retained if the source of the artefacts is known and can be measured (e.g. as when eye-movement artefacts are corrected using the signal from simultaneously recorded electro-oculogram). The second objection relates to the method used to randomly sample surrogate epochs by randomly time-shifting the start point of these samples; as these surrogate epochs were sampled from within the original epochs (which were of 10s duration), a surrogate epoch starting for example at $t = 3\text{s}$ would consist of the final 7s of the original epoch, with the first 3s of the original epoch attached at the end (to create a 10s-long surrogate epoch). This method of “cut and loop” of continuous EEG segments is unlikely to provide epochs resembling genuine EEG signals, as a discontinuity would be introduced at the point of re-assembly of the two segments, something which is likely to appear as artefactual sudden shifts in the amplitude and phase of the signal. Such ‘discontinuous’ epochs may produce artificially suppressed correlations with genuine (i.e. continuous) EEG epochs, which would question the validity of comparisons of the original S-R correlation with the surrogate S-R correlations. This is not a fatal flaw in the study however, and can easily be remedied by repeating the same analysis using randomly sampled continuous epochs from the raw (i.e. non-epoched) EEG signal instead. Despite these potential analytical flaws, the findings of this experiment remain strongly suggestive of a genuinely anomalous effect; this is also supported by a visual inspection the average waveforms of normalised ensemble variances for S and R participants, where the maximum peak (within the entire epoch-length) for Rs closely coincides with the maximum peak corresponding to their partners’ visual evoked-responses (see Radin, 2004, Fig. 3 on page 320). One remaining question regarding this study, is that although EDA was also reported to have been recorded during the experiments, no relevant results are provided for this measure.

Wackermann, Muradas, and Pütz (2004) have reported an attempted replication of their previous study, on which much of the design of the experiments reported in this thesis has been based (see Wackermann et al., 2003, reviewed in chapter 1 of this thesis). Sixteen pairs of related participants were recruited, with participants in each pair seated in separate shielded rooms while 19-channel EEG was recorded simultaneously from both, using two separate EEG systems. One member of each pair (B) was resting with eyes open in a dark room, while their partner (A) was intermittently stimulated with a checkerboard-reversal pattern (1s duration, reversal rate 4Hz); these stimulation periods were interspersed with inter-stimulus periods of randomly varying duration (1.6-7.6s) during which the monitor was blank. Each session consisted of two parts (applied in counter-balanced order), in one of which the monitor was covered with an opaque shield (‘covered’ condition), while in the other the monitor was visible (‘uncovered’ condition), and in each of these conditions 168 stimuli were presented. An ‘effective voltage’ measure of the average EEG was calculated for B subjects at latencies (t^*) when the effective voltage of their corresponding stimulated partners reached a maximum in the ‘uncovered’ condition (i.e. corresponding to A subjects’ visual EPs). A within-subject ratio measure Q was estimated for B subjects by dividing their effective voltage during stimulation epochs ($V_{eff}^B(t^*)$) by the median of effective voltages calculated for 1000 epochs randomly sampled from inter-stimulus periods (V_{ref}^B); such Q ratios were calculated individually for each

condition, subject and electrode site. Similar ‘control’ ratios (here noted as Q' for easier distinction) were calculated by using the effective voltage values of epochs randomly sampled from inter-stimulus periods as the numerator (i.e. these were also divided by V_{ref}^B). The rank of ‘test’ Q values within the cumulative distribution of ‘control’ Q' values was established, and an aggregate rank score for all subjects was transformed to normalised Z -values. Such Z -values were calculated independently for ‘covered’ and ‘uncovered’ conditions, and a comparison of normalised differences between these values was conducted for each electrode site. The null hypothesis would predict no difference between these values, whereas a hypothesis involving event-related correlated brain activity between participants would predict higher Z -values in the ‘uncovered’ condition. The results however revealed predominantly negative values in the ‘uncovered’ condition, and predominantly positive Z -values in the ‘covered’ condition; significant differences between these were found in the left parieto-occipital region and the right frontal region, reflecting lower EEG power in ‘covered’ versus ‘uncovered’ conditions in non-stimulated participants. The authors acknowledge that this is a somewhat confusing and counter-intuitive finding, which “cannot be accounted by any simple stimulus-response mechanism responsible for biophysical correlations of brain states” (p.467). Although they speculate that higher brain activation in the ‘covered’ condition may be interpreted as reflecting an ESP-like response of B subjects to the physical stimuli (rather than to the visual stimulation of their partners)¹⁴, they also point out that this hypothesis cannot easily account for the unusually low levels of EEG activity found in non-stimulated subjects during the ‘uncovered’ condition. The authors point out that an alternative interpretation may involve taking into account possible experimenter (real-time psi) effects, especially as the experimenters were aware of the occurrence of visual stimuli during each experimental session (although the timing of presentation of these stimuli was randomly varied between sessions); it is not explicitly clarified in the article at which point stimulus randomisation took place, but seems implied that this was conducted in real-time. The possibilities of experimenter effects operating at the stage of data observation, or of DAT-like effects are not mentioned in the article, although these interpretations would also fit the obtained effects, possibly equally well as a hypothesis of real-time experimenter-psi effects. Although we can certainly sympathise with the authors’ expressed concern that they find such interpretations to be “more disturbing than compelling” (p.467), on the whole we find these to be equally so; the findings themselves however are certainly compelling enough to encourage further investigation, regardless of any potentially unsettling implications. If experimenter effects are shown to be genuinely involved, this would force us to consider the potential role of experimenter intentions or expectations (which is perhaps what the authors find to be most disturbing), and such considerations may be crucial for understanding the phenomena at hand. A planned replication study is reported in this paper, in which experimenters will be blind to stimulus presentation conditions, and stimulus parameters will be varied to modulate the stimulated participants’ responses in order to test for correlated variations in activity in non-stimulated subjects¹⁵. As our methodological paradigm was largely based on the experiment reported by Wackermann et al. (2003) (see review in Chapter 1, section 1.2 on page

¹⁴This observation appears to share some similarities with the effect found in studies 1 and 2 in this thesis, where the average maximal EEG activity in non-stimulated participants was found to coincide with the moment of stimulus presentation, rather than with the moment of the stimulated subjects’ maximal evoked responses.

¹⁵This study has not yet been published to this author’s knowledge.

4), the two published studies by this research group (i.e. Wackermann et al., 2003, 2004) are the most comparable to our own, both in their methods and in their findings. Although in studies 1 and 2 we have only found a significant effect for related participant pairs, whereas Wackermann et al. (2003) have reported significant effects in both related and unrelated pairs, a theoretical interpretation of these effects based on the Generalised Quantum Theory may be able to account for this discrepancy¹⁶. Walach et al. (2001) have commented that the fact that unrelated pairs in the Wackermann et al. (2003) study were blind to the presence of their “partner” (as well as to the real purpose of the experiment) would have contributed to stronger entanglement between participants according to GQT, whereas the lack of such a blind (as was the case with our unrelated pairs), would diminish entanglement effects. They do not explain however why in such a case entanglement effects would be more likely to be expected in related pairs (who were clearly aware of each other’s presence), if, as they suggest, “the entanglement element would not derive so much from the subjective feeling of being connected, as from the formal fact of the experimental set-up” (Walach et al., 2001, p.322); further clarification of the notion of entanglement within the context of GQT seems to be required (although this is provided to some extent in Lucadou et al. (2007)). Finally, parallels can be seen between the unexpected characteristics of the effects identified in their replications study (i.e. deviations in activity during the stimulus-off condition) (see Wackermann et al., 2004, reviewed above), and the also unexpected characteristics of the effect identified in our study 2 (i.e. deviations in activity during the pre-stimulus period); both of these observations may be seen to suggest some form of displacement or “evasion” effect, which manifests in different ways in each of these studies.

The review of studies using this experimental paradigm published before 2004 (presented in Chapter 1; see section 1.2 on page 4), as well as the review of more recent studies presented in this section clearly show a steady improvement in their adopted methodological and analytical procedures, and their results as a whole suggest the presence of a phenomenon which appears highly unlikely to be artefactual or due to chance error. At the current stage of our knowledge this phenomenon can only be described as an anomaly, as it cannot be readily attributed to any established and understood physical or physiological mechanism, and cannot easily be accommodated within generally accepted theoretical models. Certain aspects of the observed characteristics of this phenomenon also appear to be inconsistent with its most common interpretation, i.e. as an effect involving event-related correlations in brain activity between physically isolated participants (a hypothesis adopted by most of the later studies, including our own). This may indicate that such an apparently empirical description of the effect may in fact carry implicit assumptions which are contradicted by the findings¹⁷, or alternatively, that additional variables which have not been fully considered may be involved in the manifestation of this effect. One such variable mentioned in some studies is the potential involvement of experimenter effects, which may include experimenter-specific patterns of social interaction with

¹⁶Although as can be seen in Fig. 5.3 on page 112, the average evoked- α activity waveforms of studies 1+2 appear to suggest the presence of a smaller effect in unrelated pairs in these two studies, which is however non-significant.

¹⁷For example, the term “physically isolated” is generally used to refer to spatial separation between participants which precludes ordinary (i.e. classical-local) sensory interactions. Temporal locality is most often implicitly assumed, and potential violations of this assumption are rarely considered (even though the apparent time-independence of psi phenomena has frequently been noted in parapsychological research).

participants, “experimenter-psi” effects (involving real-time psi interactions with participants), DAT-like precognitive decision biases, and/or quantum-observational effects; the consideration of such additional variables also leaves open the question of whether there is a unitary effect involved, or a composite of effects of different origins.

The notable inconsistency between experiments in the observed characteristics of the identified effect, especially between experiments involving nearly identical procedures and conducted by the same investigators (such as our own three studies and those reported in Wackermann et al., 2003 and 2004), can alternatively be interpreted as suggesting that the effects identified are likely to indicate chance artefacts. The apparent “elusiveness” of such phenomena is a common finding in psi research, and certain theoretical models have been proposed which postulate that such elusiveness (and lack of replicability) may be itself an intrinsic part of the phenomena involved (e.g. Bierman, 2001; Lucadou et al., 2007). Perhaps the most promising research avenue available to clarify this issue is the use of meta-analytical methods to evaluate the cumulative findings of these studies. This has not yet been attempted for studies using this type of experimental paradigm (to the author’s knowledge), although such meta-analytical methods have proved useful in evaluating the evidence for other anomalies identified in psi research, such as the ganzfeld findings (see Bem & Honorton, 1994; Milton & Wiseman, 1999, for reviews) and micro-PK effects (e.g. Bosch, Steinkamp, & Boller, 2006), as well as in other areas where small effects are expected and the validity of the investigated phenomena is uncertain (e.g. Cucherat, Haugh, Gooch, & Boissel, 2000). We would very much encourage such attempts to evaluate the overall findings of studies using this experimental paradigm, and we hope that the research literature review presented in this thesis may be helpful to researchers interested in pursuing this goal. A meta-analytical evaluation of these studies will also be helpful in assessing the extent to which selective publication bias (i.e. a “file-drawer” effect) may be involved in artificially inflating the number of published studies reporting positive results, an issue which is rarely acknowledged in published reviews of this research literature (e.g. Charman, 2006). For example, although early publications in high-profile journals like *Science* and *Nature* (e.g. Duane & Behrendt, 1965; Targ & Puthoff, 1974) would normally be expected to stimulate a number of replication attempts, there is a distinct lack of published follow-up studies in the literature for nearly twenty years (i.e. until the series of studies reported by Grinberg-Zylberbaum et al., e.g. 1992).

5.4 Limitations of thesis

The final section of this chapter presents a critical evaluation of the experiments conducted as part of this thesis, and potential improvements in methodology are suggested. Research approaches available for addressing the many questions raised or left unanswered by the results of these studies are finally suggested, in the hope that they may be useful to researchers interested in further investigating this topic.

5.4.1 Methodological limitations

One limitation of this research project as a whole which should first be pointed out, is that although our original stated intention was to conduct a series of three studies with a largely consistent methodology aiming to facilitate the comparison and combination of their respective

results, several procedural and methodological changes were introduced in each of the two later studies, some of which have eventually complicated the interpretation of the collective results and have limited the clarity of our overall conclusions. Some of these changes were clearly beneficial and reflected methodological improvements, such as the use of simultaneous EEG recordings from both participants of each pair in the second and third studies, and the use of ocular artefact correction techniques in the final study. Some of these methodological changes however appear in retrospect to have been somewhat poorly chosen, usually due to a lack of sufficient consideration of potentially relevant theoretical issues. One such example is the introduction of the oddball stimulation paradigm in the second study; although the rationale behind the choice to adopt this paradigm was justified within a classical physiological theoretical framework¹⁸, as has been discussed in section 5.2.4 (page 117) above, certain quantum-mechanical models (such as GQT) would predict that this paradigm would be ineffective (due to the postulated prohibition of causal signal transmission between non-locally correlated entities). Although the use of the oddball paradigm was the only methodological difference between the first and second studies, a considerable number of changes had been introduced in the third study, which has created considerable difficulties in interpreting the differential findings between this final study and the findings of studies 1 and 2 (see Chapter 4 for details, and the first section of this chapter for an overview). The lack of methodological consistency across experiments was one of the limitations of previous studies we had identified in our review (see final section in Chapter 1), and although one of the aims of this research project was to address this concern, we have only partially achieved this goal. We would therefore strongly encourage future studies investigating this topic to further emphasise consistency of experimental design in replication studies, and to carefully consider potential implications of introducing methodological changes in follow-up experiments.

Another methodological criticism can be directed to our decision to include a number of additional sessions in the dataset of study 1, which were conducted subsequently to the completion of studies 2 and 3 (the reader is reminded that study 1 had originally involved thirteen related pairs, five unrelated pairs and five single participants; the results from this original dataset have been published elsewhere (see Kittenis et al., 2004, which can be found in Appendix A). The additional sessions were conducted in order to equalise the sample size of each participant group within study 1, and to equalise the overall sample sizes of studies 1 and 2, so that easier comparisons could be made between participant groups and between the two studies. Although the experimental procedure followed in the additional sessions was identical to the original procedure of study 1, subjects recruited for the later sessions were paid a nominal fee in order to speed up recruitment¹⁹, whereas the original sessions were conducted with unpaid volunteers (as were all sessions in the other two studies). Although offering payment may have resulted in the recruitment of subjects with different individual characteristics in these later sessions, we consider the benefits of increasing the sample size of study 1 as likely to outweigh the potential risk of such individual differences having an impact on the results; ideally however, study 1 should have been designed to have an equal sample size across groups from the outset.

¹⁸The intention was to experimentally vary the magnitude of visual evoked responses in stimulated subjects, in order to test whether this manipulation would produce differential activity in non-stimulated participants (i.e. whether the magnitude of event-related brain activity between participant pairs would co-vary).

¹⁹This was necessary due to pressing time constraints related to the imminent closure of the laboratory we were using.

Finally, the method adopted in these studies for randomising the sequence and timing of photic stimuli was not the optimal choice available, as has been discussed in section 5.2.6 above. If a pseudo-random algorithm is to be used in future studies, stimulus randomisation should be conducted in real time (rather than at the start of each experimental session as was conducted in this study), and it may be useful to compare such pseudo-random procedures with the use of non-deterministic randomisation mechanisms (e.g. electronic noise RNGs).

5.4.2 Procedural limitations

A procedure aiming to induce psychophysiological relaxation and a mild alteration in the participants' state of consciousness has been used in these studies; this first involved a progressive relaxation induction presented using recorded verbal instructions, followed by the stimulation of participants with an audio recording of shamanic drumming for ≈ 30 minutes (see chapter 2 for details, section 2.2.3.2 on page 25). The relaxation induction and drumming were presented simultaneously to both participants in each pair (via headphones), with the intention of inducing a similar state of consciousness in these subjects. The extent to which this procedure has been effective in inducing relaxation and an altered conscious state, and whether this may have been relevant to the observed effects has not yet been addressed. It was expected that different participants would respond to this procedure to varying degrees, as certain individual variables related to suggestibility are well known to correlate with the magnitude and quality of responses to relaxation and hypnotic induction procedures²⁰, as well as to procedures aiming to induce alterations in consciousness (e.g. Pekala, 1991). As *absorption* is one such individual variable known to correlate highly with hypnotic susceptibility and the propensity for experiencing alterations in conscious states, the *Modified Tellegen Absorption Scale* (MTAS) was administered to participants prior to each session (Jamieson, 1986). In order to assess the magnitude and certain qualitative aspects of the participants' experiential responses to this procedure, the *Phenomenology of Consciousness Inventory* (PCI) was administered at the end of each session (Pekala, 1991). Due to time limitations we have been unable to fully analyse these questionnaires in order to include their results in this thesis, although this analysis will be attempted and the results will hopefully be presented in future publications. Informally, participants have reported to the experimenter a wide variety of subjective experiences in response to the relaxation induction and drumming procedure, ranging from states minimally different to their ordinary waking consciousness, to quite profound alterations in consciousness both in intensity and in qualitative content, most often resembling (phenomenologically and electrophysiologically) hypnagogic states (Mavromatis, 1987), or those induced through sensory/perceptual deprivation (e.g. see Wackermann et al., 2002); in yet some other participants, the relaxation procedure appeared to simply induced sleep. As a fairly large database (overall $N = 182$) of such phenomenological experiences (as quantified by the PCI) has been collected in the course of these studies, along with concurrently recorded 30-channel EEG, it would certainly be worthwhile to pursue an investigation of potential correlations between PCI variables and EEG measures, as well as an investigation of potential correlations between MTAS and PCI variables (such as absorption, hypnotic susceptibility and the degree of consciousness alterations), and EEG variables related to the ostensibly anomalous activity observed in related

²⁰The relaxation induction procedure used in these studies was structured along the lines of a standard hypnotic induction script; see Appendix C for details.

non-stimulated subjects in studies 1 and 2. As well as exploring the generally poorly understood relationship of these individual and phenomenological (i.e. ‘trait’ and ‘state’) variables between themselves and electrophysiological EEG activity, such an investigation may also be of value in testing the frequently hypothesised relationship between such variables and psi performance (e.g. Alvarado, 1998).

A final limitation of our experimental procedure which must also be acknowledged, is the somewhat arbitrary approach adopted in recruiting participants for these studies. Although most participants were self-selected volunteers who responded to flyers advertising the studies, the experimenter sometimes approached specific participant pairs (amongst his friends and acquaintances) whom he personally considered to show potentially “psi-conductive” characteristics (see Appendix B); the studies were also selectively advertised in places deemed likely to attract the attention of such participants (e.g. yoga and meditation centres; see the Introduction and Method sections of Chapter 2 for more details). A more consistent approach involving either random sampling or formally defined criteria for subject selection would be advised for future studies.

5.4.3 Analytical limitations

One aspect of our chosen analytical procedure which may not have been fully justified, is our decision to focus on evoked- α activity as the dependent variable in our studies. As this EEG measure has not been used in any of the previous studies addressing this research question, it is unconventional in this respect and some clarification of our reasons for choosing it may be required; it would therefore be worthwhile to summarise here the reasons which lead to the eventual choice of the evoked- α measure as the dependent variable in these studies (a more lengthy discussion comparing the three EEG measures initially considered, i.e. ERPs, evoked- α and induced- α activity is presented in Chapter 2, section 2.3 on page 32). As photic stimuli were presented in these studies and alpha activity is known to be highly responsive to visual stimulation (e.g. Shaw, 2003), activity in the alpha band was therefore of particular interest, and we had decided to focus primarily on measures of evoked- α and induced- α activity as potential candidates for our dependent measure²¹. As mentioned in Chapter 2, evoked- α responses to visual stimulation show less inter-individual variation in latency, amplitude and morphology compared to induced- α responses, which is clearly an advantage when the same epoch window is to be compared across all subjects (i.e. using an induced- α measure would have necessitated establishing subject-specific epoch intervals of interest). The final decision to adopt the evoked- α measure was taken after a pilot study with two related pairs was conducted, which showed an apparent effect (in one of the two pairs) only for the evoked- α and not for the induced- α measure. Although this was admittedly a very small pilot study and the value of basing methodological choices on its results may therefore be questionable, we had decided against conducting additional pilot session due to time concerns²². Once the evoked- α measure was adopted as the dependent variable however it has been used consistently across the three studies; retrospectively it has proved to be a better choice in identifying an effect compared

²¹This decision was also partly due to the author’s personal interest in studying these relatively novel EEG measures in greater depth.

²²The start of this series of experiments was delayed by nearly two years after it was originally planned, partly due to considerable delays in the delivery of the EEG equipment.

to the induced- α measure (see comparison of these two measures in Chapter 4, section 4.1 on page 82), which also seems to support the findings of the pilot experiments. As discussed earlier in this chapter, there are possible theoretical reasons why this may be so, related to the impossibility of using averaged evoked measures to encode causal signals in nonlocally correlated quantum-entangled systems (see section 5.2.4 on page 117).

The analytical procedure adopted in these studies has involved statistical tests of overall group effects, rather than tests of subject-specific effects; an implicit assumption of such a procedure is that the studied effects are expected to be widely distributed across the population. Whether this is truly the case however, or whether the effects can only be found in a few (e.g. perhaps particularly “gifted”) subject pairs is an open question, as the empirical evidence available is insufficient to allow drawing a firm conclusion²³. Most of the studies reviewed in this thesis using similar experimental paradigms have adopted the latter approach; although on the whole we consider both possibilities to be equally likely, we had chosen an analytical procedure investigating group effects primarily for practical reasons. Within-subject comparisons would normally require a number of single-epoch measures of activity from each subject, and as we had decided to use a measure of evoked activity (which is by definition an average of multiple epochs), such epoch-specific measures were therefore not available. The possibility of using permutation analysis to test for within-subject effects is an alternative we had not considered at the time, although this would perhaps be an ideal analytical methodology as it is equally applicable for testing within-subject as well as overall group effects.

Non-parametric statistical techniques (i.e the Wilcoxon signed-ranks test) were used as they do not involve assumptions regarding the underlying distribution of our data (which is unknown); as a rank test, the Wilcoxon is also insensitive to extreme individual scores (i.e ‘outliers’), which could have otherwise artificially distorted the results. Non-parametric techniques in general are robust in dealing with non-normally distributed datasets (although they are less flexible and unable to consider multi-factorial designs), and they are also more conservative and therefore less powerful than parametric alternatives; given the controversial nature of the subject-matter however, it was considered preferable to use conservative statistics. The lack of formal statistical comparisons for between-group effects (i.e between Related, Unrelated and Alone groups in studies 1 and 2) is admittedly a serious omission which needs to be rectified; given the above suggestions however regarding the possible use of permutation analysis, it seems preferable to also address this question using this type of technique.

5.5 Summary of findings and final suggestions

In view of the above considerations, we recommend that the original hypothesis (i.e. of within-group differences in evoked- α activity between photic and control periods in non-stimulated subjects) is re-evaluated using permutation analysis, and that individual (i.e. within-subject) effects, as well as comparisons between the three groups involved in studies 1 and 2 (i.e. related, unrelated pairs and single-subjects), should also be examined using this technique; this is an approach we are planning to adopt for future publications of this research project. Permutation statistics are also well-suited for investigating potential observer effects by using a “split-half”

²³A discussion of the “democratic psi” versus the “psychic stars” hypotheses in relation to this experimental paradigm can be found in Millar (1979a).

analysis for example, where the experimental data is randomly split between two investigators who analyse their 'share' of the data independently using the same procedures.²⁴ Differences between the respective results of these investigators may indicate the operation of quantum-observational effects, and the statistical likelihood of such differences being due to chance can be accurately estimated by calculating the distribution of results for all possible split-half combinations, and comparing the obtained results against this distribution. As experimenters can subsequently also re-analyse each other's 'share' of the data to confirm their respective results, this can also be used to test the reliability of the methods used to analyse the data, and to check for potential experimenter-specific errors in the process of data analysis. The potential role of observer effects in studies using this paradigm should be formally addressed and investigated in future research, as it may be crucial for understanding the nature of the phenomena involved.

As has been discussed earlier in this chapter, the collective findings of the three studies presented in this thesis can only be considered as inconclusive at this point (pending further analysis); although the results of the first two studies were highly suggestive of a genuine effect, the observed characteristics of this effect were only partially consistent with a hypothesis of anomalous correlations in brain activity between isolated participants. It is also somewhat difficult to draw overall conclusions from other studies using similar experimental paradigms (as reviewed above and in Chapter 1), primarily due to the diversity of their adopted methodological and analytical procedures. In many of these studies an effect has been identified which at the present time can only be described as an anomaly, although considerable similarities in their findings suggest it is a genuine phenomenon which is unlikely to be an artefact. A meta-analysis of these reviewed studies²⁵ would be particularly useful for establishing the presence of this phenomenon with more confidence, as well as for further clarifying its nature.

In this respect, we would encourage more communication between the different research groups investigating this topic, so that some commonality in experimental methods can be adopted which would facilitate future meta-analyses. Further coordination between independent research groups may also be helpful in improving the quality of future studies, as a set of guidelines can be agreed upon to guide the design of further experiments. Such coordinated efforts between independent research groups may also be conducive to addressing theoretical questions; as discussed in section 5.2 above, a number of different theoretical interpretations are applicable to the findings of our own research and those of the reviewed studies. Although most of these interpretations can be tested experimentally, concerted efforts by independent research groups will be much more effective in achieving this goal, as for example different groups could adopt (through mutual agreement) specific variations in their experimental designs in order to collectively test a variety of different theory-driven hypotheses.

Further cooperation between research teams may also involve the pooling of their raw EEG data into a shared and openly accessible database, which would enable investigators to confirm each others' results using their preferred methods of analysis. Although the diversity of analytical methods used in the studies reviewed in this thesis has been identified as a limitation in drawing overall conclusions from their findings, this diversity of analytical approaches may

²⁴Such a split-half analysis was conducted by the author and Dick Bierman for the results of study 3; small differences found between our respective results were non-significant using conventional statistics, although these should also be evaluated using permutation methods.

²⁵As well as more recent studies which have now been completed but not yet published, e.g. Hinterberger, Studer, Jäger, and Walach (in press)

also prove to be beneficial; if the raw data from these studies is made openly accessible, different investigators could apply their own methods of expertise to evaluate each other's results and to further investigate the nature of the identified phenomena. An additional advantage of such an 'open-access' database, would be that the results can also be evaluated by independent investigators who have not been involved in conducting the experiments, something which would discourage the uninformed sceptical dismissal of the findings.

It is worth noting that the majority of studies using event-related EEG paradigms to investigate this topic have been designed within the conceptual framework of ordinary sensory psychophysiology, even though many have postulated quantum-entanglement effects as an explanatory hypothesis. It seems increasingly clear however that the observed phenomena cannot be accounted for through simple extensions of ordinary psychophysiological mechanisms, and a thorough re-evaluation of assumptions implicit in our adopted terminology, experimental designs and methods of analysis seems to be required at this point. Although we believe that this can be achieved to some extent by emphasising the experimental investigation of theory-driven questions and through greater coordination between independent research projects, it may also be necessary to consider the implications of these phenomena in a context larger than the laboratory setting in order to make progress in understanding their nature.

The interest of journals devoted to alternative and complementary medicine in these experiments has already been pointed out in the literature review section above (5.3), which highlights the potential relevance of these effects in understanding other apparently anomalous phenomena such as 'distant healing'. Other areas of psi research which are highly relevant in this context involve experimental paradigms such as *Direct Mental Interactions with Living Systems* (DMILS) (e.g. Watt, Ravenscroft, & McDermott, 1999), where behavioural or physiological measures are obtained from one participant while another isolated subject attempts to intentionally influence these measures at randomly designated intervals, as well as *remote staring* experiments (e.g. S. Schmidt, Schneider, Utts, & Walach, 2004). There is considerable overlap both conceptually and methodologically between remote staring, DMILS studies and the ones reviewed in this thesis, and an attempt to integrate their findings may prove to be particularly fruitful; we might also have much to learn however from comparing the differences in conceptual approaches and terminologies used in these paradigms. For example, the notion of *intentional influence* is regarded to be of central importance in DMILS studies, whereas in most event-related EEG correlation studies this is usually only given peripheral attention, if it is considered at all.²⁶

A more thorough investigation of the potential relevance of intention in the operation of these phenomena appears to be warranted, and as the difficulty of discriminating possible experimenter and participant effects in psi research has already been pointed out, this investigation will require giving equal consideration to experimenter as well as participant intentional variables. Such an investigation will be valuable regardless of whether these phenomena are shown to be genuinely anomalous, or whether they can eventually be accounted for as artefactual. If the latter is found to be the case, the intentions (and associated beliefs and expectations) of experimenters and participants will most likely be involved in introducing such artefacts, possibly through currently unknown (or known but underestimated) psychological bias mechanisms. As there is no reason to expect these mechanisms to operate exclusively in parapsychological re-

²⁶Although one recent study has combined elements of these paradigms by incorporating "distant intentionality" as an experimental variable in their procedure (Achterberg et al., 2005).

search, such a conclusion may have far-reaching implications for virtually every discipline using experimental methods as its primary investigatory tool. If on the other hand we are ultimately unable to attribute the observed phenomena to any sources of error, the potential implications of their existence and operation are likely to be far more extensive. As long as they continue to elude our attempts to replicate them reliably, it seems wiser to keep both possibilities on the scales and let the weight of accumulating evidence decide the final balance. The simple accumulation of proof-oriented evidence however can only establish the presence (or absence) of anomalies, and thereby indicate potential gaps in our perception and comprehension of the world; efforts to formulate legitimate theoretical models able to accommodate these phenomena within the wider body of scientific knowledge are also fundamental, if our aim is not only to catalogue a set of anomalies, but ultimately to transform such a testimony of our ignorance into actual understanding.

References

- Achterberg, J., Cooke, K., Richards, T., Standish, L. J., Kozak, L., & Lake, M. D. (2005). Evidence for correlations between distant intentionality and brain function in recipients: A functional magnetic resonance imaging analysis. *Journal of Alternative and Complementary Medicine, 11*(6), 965-971.
- Alvarado, C. S. (1998). ESP and altered states of consciousness: an overview of conceptual and research trends. *The Journal of Parapsychology, 62*, 27-63.
- Aspect, A., Grangier, P., & Roger, G. (1982). Experimental realization of Einstein-Podolski-Rosen-Bohm Gedankenexperiment: A new violation of Bell's inequalities. *Physical Review Letters, 49*(2), 91-94.
- Atmanspacher, H., Römer, H., & Walach, H. (2002). Weak quantum theory: Complementarity and entanglement in physics and beyond. *Foundations of Physics, 32*(3), 379-406.
- Baggot, J. (2003). *Beyond measure: Modern physics, philosophy and the meaning of quantum theory*. Oxford University Press.
- Barry, R. J., Rushby, J. A., Johnstone, S. J., Clarke, A. R., Croft, R. J., & Lawrence, C. A. (2004, November). Event-related potentials in the auditory oddball as a function of EEG alpha phase at stimulus onset. *Clinical Neurophysiology, 115*(11), 2593-2601.
- Basar, E. (1999). Integrative brain function, neurophysiology and cognitive processes. In (chap. Brain function and oscillation). Springer, Berlin.
- Beloff, J. (1974). ESP: The search for a psychophysiological index. *Journal of the Society for Psychical Research, 47*(761), 403-420.
- Beloff, J. (1990). *The relentless question*. McFarland.
- Bem, D. J., & Honorton, C. (1994). Does psi exist? Replicable evidence for an anomalous process of information transfer. *Psychological Bulletin, 115*, 4-18.
- Berger, H. (1929). Über das elektrenkephalogramm des menschen (On the human electroencephalogram). *Archiven für Psychiatrie und Nervenkrankheiten, 87*, 527-570.

- Bierman, D. J. (2001). The physical nature of consciousness. In P. v. Loocke (Ed.), (p. 269-292). Benjamins Publ., New York.
- Bierman, D. J., & Radin, D. I. (1997). Anomalous anticipatory response on randomized future conditions. *Perceptual and Motor Skills*, *84*(2), 689-690.
- Bosch, H., Steinkamp, F., & Boller, E. (2006). Examining psychokinesis: The interaction of human intention with Random Number Generators—A meta-analysis. *Psychological Bulletin*, *132*(4), 497-523.
- Brandt, M. (1997). Visual and auditory evoked phase resetting of the alpha EEG. *International Journal of Psychophysiology*, *26*, 285-298.
- Brandt, M., Jansen, B., & Carbonari, J. (1991). Pre-stimulus spectral EEG patterns and the visual evoked response. *Electroencephalography and Clinical Neurophysiology*, *80*, 16-20.
- Broughton, R. S. (1992). *Parapsychology: The controversial science*. New York: Ballantine Books.
- Burgess, A. P., & Gruzelier, J. H. (1996). The reliability of event-related desynchronisation: a generalisability study analysis. *International Journal of Psychophysiology*, *23*, 163-169.
- Caton, R. (1875). The electric currents of the brain. *British Medical Journal*, *2*(2), 278.
- Caton, R. (1877). Interim report on investigation of the electric currents of the brain. *British Medical Journal*, *1*((Suppl)), 62.
- Charman, R. (2006). Has direct brain to brain communication been demonstrated by electroencephalographic monitoring of paired or group subjects? *Journal of the Society for Psychical Research*, *70*, 6-29.
- Coles, M. G. H., & Rugg, M. D. (1996). Electrophysiology of mind. In M. D. Rugg & M. G. H. Coles (Eds.), (p. 2-26). Oxford University Press.
- Collins, D., Gisin, N., Linden, N., Massar, S., & Popescu, S. (2002). Bell inequalities for arbitrarily high-dimensional systems. *Physical Review Letters*, *88*.
- Collura, T. F. (1993). History and evolution of electroencephalographic instruments and techniques. *Journal of Clinical Neurophysiology*, *10*(4), 476-504.
- Cucherat, M., Haugh, M. C., Gooch, M., & Boissel, J. P. (2000). Evidence of clinical efficacy of homeopathy. *European Journal of Clinical Pharmacology*, *56*(1), 27-33.
- Dalton, K. (1997). Exploring the links: Creativity and psi in the Ganzfeld. In *The parapsychological association 40th annual convention: Proceedings of*

- presented papers (p. 119-134).
- De Clercq, A., Crombez, G., Buysse, A., & Roeyers, H. (2003). A simple and sensitive method to measure timing accuracy. *Behavior Research Methods, Instruments and Computers*, *35*, 109-115. University of Ghent.
- Doppelmayr, M., Klimesch, W., Pachinger, T., & Ripper, B. (1998). Individual differences in brain dynamics: important implications for the calculation of event-related power. *Biological Cybernetics*, *79*, 49-57.
- Duane, T. D., & Behrendt, T. (1965). Extrasensory electroencephalographic induction between identical twins. *Science*, *150*, 367.
- Dukhan, H., & Rao, K. R. (1972). Meditation and ESP scoring. In W. G. Roll, R. L. Morris, & J. D. Morris (Eds.), *Research in parapsychology* (p. 148-151). Metuchen, N.J.: Scarecrow Press.
- Einstein, A., Podolsky, B., & Rosen, N. (1935). Can quantum-mechanical description of physical reality be considered complete? *Physical Review*, *47*, 777-780.
- Freeman, W. (2004). Origin, structure, and role of background EEG activity. *Clinical Neurophysiology*, *115*(9), 2089-2107.
- Gloor, P. (1969). Hans Berger on the electroencephalogram of man. *Electroencephalography and Clinical Neurophysiology, Supplement 28*, 350.
- Gloor, P. (1994). Berger lecture. Is Berger's dream coming true? *Electroencephalography and Clinical Neurophysiology*, *90*(4), 253-266.
- Grinberg-Zylberbaum, J. (1982). Psychophysiological correlates of communication, gravitation and unity: The synergetic theory. *Psychoenergetics*, *4*, 227-256.
- Grinberg-Zylberbaum, J., Delaflor, M., Attie, L., & Goswami, A. (1994). The Einstein-Podolsky-Rosen paradox in the brain: the transferred potential. *Physics Essays*, *7*(4), 422-428.
- Grinberg-Zylberbaum, J., Delaflor, M., Sanchez-Arellano, M. E., Guevara, M. A., & Perez, M. (1992). Human communication and the electrophysiological activity of the brain. *Subtle Energies*, *3*(3), 25-42.
- Hardy, L., Jones, G., & Gould, D. (1998). *Understanding psychological preparation for sport*. Wiley.
- Herz, R. S., Eliassen, J., Beland, S., & Souza, T. (2004). Neuroimaging evidence for the emotional potency of odor-evoked memory. *Neuropsychologia*, *42*(3), 371-378.
- Hinterberger, T., Studer, P., Jäger, M., & Walach, H. (in press). Event-related correlations between brain electrical activities of separated

- human participants. *International Journal of Neuroscience*.
- Hishikaw, Y., Yamamoto, J., Furuya, E., Yamada, Y., Miyazaki, K., & Kaneko, Z. (1967). Photosensitive epilepsy: Relationships between visual evoked responses and epileptiform discharges induced by intermittent photic stimulation. *Electroencephalography and Clinical Neurophysiology*, *23*(4), 320-334.
- Holt, N. J., Delanoy, D. L., & Roe, C. A. (2004). Creativity, subjective paranormal experiences and altered states of consciousness. In *The parapsychological association 47th annual convention: Proceedings of presented papers* (p. 433-436).
- Honorton, C. (1977). Handbook of parapsychology. In B. Wolman (Ed.), *Handbook of parapsychology* (p. 435-472). New York: Van Nostrand Reinhold.
- Intriligator, J., & Polich, J. (1995). On the relationship between EEG and ERP variability. *International Journal of Psychophysiology*, *20*, 59-74.
- Irwin, H. J. (1999). *Introduction to parapsychology* (3rd ed.). McFarland. (North Carolina)
- Jacques, V., Wu, E., Grosshans, F., Treussart, F., Grangier, P., Aspect, A., et al. (2007). Experimental realization of Wheeler's delayed-choice GedankenExperiment. *Science*, *315*, 966.
- Jamieson, G. A. (1986). *The structure and meaning of absorption*. Masters dissertation, University of Queensland, Australia.
- Jansen, B., & Brandt, M. (1991). The effect of phase of prestimulus alpha activity on the averaged visual evoked response. *Electroencephalography and Clinical Neurophysiology*, *80*, 241-250.
- Jibu, M., & Yasue, K. (1995). *Quantum brain dynamics and consciousness* (Vol. 3). Amsterdam: John Benjamins Publ.
- Kalcher, J., & Pfurtscheller, G. (1995). Discrimination between phase-locked and non-phase-locked event-related eeg activity. *Electroencephalography and Clinical Neurophysiology*, *94*, 381-384.
- Kim, Y.-H., Yu, R., Kulik, S. P., Shih, Y., & Scully, M. O. (2000). Delayed "choice" quantum eraser. *Physical Review Letters*, *84*, 1-5.
- Kittenis, M., Caryl, P. G., & Stevens, P. (2004). Distant psychophysiological interaction effects between related and unrelated participants. In S. Schmidt (Ed.), *The parapsychological association 47th annual convention: Proceedings of presented papers* (p. 67-76). Vienna.
- Klimesch, W. (1999). EEG alpha and theta oscillations reflect cognitive and memory performance: a review and analysis. *Brain Research Review*, *29*,

- 169-195.
- Klimesch, W., Döppelmayr, M., Rohm, D., Pöllhuber, D., & Stadler, W. (2000). Simultaneous desynchronisation and synchronisation of different alpha responses in the human electroencephalograph: a neglected paradox? *Neuroscience Letters*, *284*, 97-100.
- Klimesch, W., Döppelmayr, M., Russegger, H., Pachinger, T., & Schwaiger, J. (1998). Induced alpha band power changes in the human EEG and attention. *Neuroscience Letters*, *244*, 73-76.
- Lawrence, T. R. (1993). Gathering the sheep and the goats...: A meta-analysis of forced-choice sheep-goat ESP studies, 1947-1993. In *The parapsychological association 36th annual convention: Proceedings of presented papers* (p. 75-86). (Toronto, Canada)
- L'Ecuyer, P. (1994). Uniform random number generation. *Annals of Operations Research*, *53*(1), 77-120.
- Lehman, D., & Skrandies, W. (1980). Reference-free identification of components of checkerboard-evoked multichannel potential fields. *Electroencephalography and Clinical Neurophysiology*, *48*, 609-621.
- Lehmann, D., & Skrandies, W. (1984). Spatial analysis of evoked potentials in man - a review. *Progress in Neurobiology*, *23*, 227-250.
- Li, L., Yao, D., Liu, T., & Zhao, L. (2005, Aug). A study of the phase resetting from pre-stimulus to post-stimulus alpha wave. In *Institute of electrical and electronics engineers* (p. 3656-3659). (27th annual international conference proceedings)
- Lindsey, D. (1960). Attention, consciousness, sleep and wakefulness. In J. Field, H. Magoun, & V. Hall (Eds.), *American handbook of physiology. section 1, neurophysiology* (Vol. 3, p. 1553-1593). Washington D.C.: American Physiological Society.
- Lloyd, D. H. (1973). Objective events on the brain correlating with psychic phenomena. *New Horizons*, *1*, 69-75.
- Lucadou, W. v. (1987). The model of pragmatic information (MPI). In *Proceedings of presented papers, 30th annual parapsychological association convention*. Edinburgh.
- Lucadou, W. v., Römer, H., & Walach, H. (2007). Synchronistic phenomena as entanglement correlations in generalised quantum theory. *Journal of Consciousness Studies*, *14* (4), 50-74.
- Luke, D. P., & Kittenis, M. (2005). A preliminary survey of paranormal experiences with psychoactive drugs. *Journal of Parapsychology*, *69*,

- 305-327.
- Makeig, S., Westerfield, M., Jung, T. P., Enghoff, S., Townsend, J., Courchesne, E., et al. (2002). Dynamic brain sources of visual evoked responses. *Science*, *295*, 690-694.
- Matas, F., & Pantas, L. (1971). A PK experiment comparing meditating versus nonmeditating subjects. In *Proceedings of the parapsychological association* (Vol. 8, p. 12-13).
- Mavromatis, A. (1987). *Hypnagogia: The unique state of consciousness between wakefulness and sleep*. Routledge.
- May, E. C., Spottiswoode, S. J. P., & Faith, L. V. (2001). A methodological issue in the study of correlation between psychophysiological variables. In C. Alvarado (Ed.), *The parapsychological association 44th annual convention: Proceedings of presented papers*. New York.
- May, E. C., Targ, R., & Puthoff, H. E. (2002). Mind at large. In C. T. Tart, H. E. Puthoff, & R. Targ (Eds.), (p. 112-122). Charlottesville, VA: Hampton Roads.
- May, E. C., Utts, J. M., & Spottiswoode, J. P. (1995). Decision augmentation theory: Towards a model of anomalous mental phenomena. *The Journal of Parapsychology*, *59*, 195-220.
- McDonough, B., Don, N., & Warren, C. (2002). Differential event-related potentials to targets and decoys in a guessing task. *Journal of scientific exploration*, *16*(2), 187-206.
- Mertens, R., & Polich, J. (1997, November). P300 from a single-stimulus paradigm: passive versus active tasks and stimulus modality. *Evoked Potentials-Electroencephalography and Clinical Neurophysiology*, *104*(6), 488-497.
- Millar, B. (1979a). The "Lloyd effect". *European Journal of Parapsychology*, *2*(4), 381-394.
- Millar, B. (1979b). Physiological detectors of psi. *European Journal of Parapsychology*, *2*(4), 456-478.
- Millett, D. (2001). Hans Berger: From psychic energy to EEG. *Perspective in Biology and Medicine*, *44*:4, 522-542.
- Milton, J., & Wiseman, R. (1999). Does psi exist? Lack of replication of an anomalous process of information transfer. *Psychological Bulletin*, *125*, 387.
- Morris, R., Summers, J., & Yim, S. (2003). Evidence for anomalous information transfer with a creative population. In *Proceedings of presented papers of*

- the parapsychological association 46th annual convention* (p. 116-131).
- Neher, A. (1961). Auditory driving observed with scalp electrodes in normal subjects. *Electroencephalography and Clinical Neurophysiology*, *13*, 449-451.
- Neher, A. (1962). A physiological explanation of unusual behavior in ceremonies involving drums. *Human Biology*, *34*:2, 151-160.
- Palmer, J. (1977). Handbook of parapsychology. In B. Wolman (Ed.), (p. 175-201). New York: Van Nostrand Reinhold.
- Parker, A. (1975). *Mind states: ESP and altered states of consciousness*. Taplinger.
- Pekala, R. J. (1991). *Quantifying consciousness: An empirical approach*. New York: Plenum Press.
- Penny, W. D., Kiebel, S. J., Kilner, J. M., & Rugg, M. D. (2002). Event-related brain dynamics. *Trends in Neurosciences*, *25*(8), 387-389.
- Pfurtscheller, G., & Silva, F. H. Lopes da. (1999). Event-related EEG/EMG synchronization and desynchronization: basic principles. *Clinical Neurophysiology*, *110*, 1842-1857.
- Polich, J., Ladish, C., & Bloom, F. E. (1990). P300 assesment of early Alzheimers disease. *Electroencephalography and Clinical Neurophysiology*, *77*(3), 179-189.
- Proust, M. (1934). *Remembrance of things past*. Random House.
- Psychical Research, R. C. American Society for. (1959). Report of the Research Committee for 1958. *Journal of the American Society for Psychical Research*, *53*(2), 69-71.
- Pütz, P., Braeunig, M., & Wackermann, J. (2006, August). EEG correlates of multimodal ganzfeld induced hallucinatory imagery. *International Journal of Psychophysiology*, *61*(2), 167-178.
- Radin, D. I. (2003). Thinking outside the box: EEG correlations between isolated human subjects. In *Proceedings of the 46th parapsychology association convention* (p. 1784-1799). New York: The Parapsychology Association.
- Radin, D. I. (2004). Event-related electroencephalographic correlations between isolated human subjects. *The Journal of Alternative and Complementary Medicine*, *10*(2), 315-323.
- Rebert, C. S., & Turner, A. (1974). EEG spectrum analysis techniques applied to the problem of psi phenomena. *Behavioral Neuropsychiatry*, *6*, 18-24.
- Richards, T. L., Kozak, L., Johnson, C., & Standish, L. J. (2005). Replicable functional magnetic resonance imaging evidence of correlated brain signals

- between physically and sensory isolated subjects. *Journal of Alternative and Complementary Medicine*, 11(6), 955-963.
- Rodin, E., Grisell, J., Gudobba, R., & Zachary, G. (1965). Relationships of background EEG rhythms to photic evoked responses. *Electroencephalography and Clinical Neurophysiology*, 19, 301-304.
- Rosenthal, R. (1966). *Experimenter effects in behavioral research*. New York: Appleton-Century-Crofts.
- Rutherford, L., & Charing, H. (2001). *Drumming for the shamanic journey*. Eagle's Wing. Eagle's Wing, London. (Audio CD)
- Sabell, A., Clarke, C., & Fenwick, P. (2001). Inter-subject EEG correlations at a distance: The transferred potential. In C. Alvarado (Ed.), *Proceedings of the 44th parapsychology association convention* (p. 419-422). New York: The Parapsychological Association.
- Sayers, B., & Beagly, H. (1974). Objective evaluation of auditory evoked EEG responses. *Nature*, 251, 608-609.
- Schmeidler, G. R. (1952). Personal values and ESP scores. *Journal of Abnormal and Social Psychology*, 47, 757-761.
- Schmeidler, G. R. (1970). High ESP scores after a swami's brief instruction in meditation and breathing. *Journal of the American Society for Psychological Research*, 64, 100-103.
- Schmidt, H. (1975). Quantum physics and parapsychology. In L. Oteri (Ed.), (p. 205-222). Parapsychology Foundation, New York.
- Schmidt, H. (1976). PK effects with pre-recorded targets. *Journal of the American Society for Psychological Research*, 70, 267-291.
- Schmidt, H. (1982). Collapse of the state vector and psychokinetic effect. *Foundations of Physics*, 12, 565-581.
- Schmidt, S., Schneider, R., Utts, J., & Walach, H. (2004). Distant intentionality and the feeling of being stared at: Two meta-analyses. *British Journal of Psychology*, 95, 235-247.
- Schultz, G., & Melzack, R. (1991). The Charles Bonnet syndrome: 'phantom visual images'. *Perception*, 20(6), 809-825.
- Scully, M. O., & Drühl, K. (1982). Quantum eraser: A proposed photon correlation experiment concerning observation and 'delayed choice' in quantum mechanics. *Physics Review A*, 25, 2208.
- Shah, A. S., Bressler, S. L., Knuth, K. H., Ding, M., Mehta, A. D., Ulbert, I., et al. (2004). Neural dynamics and the fundamental mechanisms of event-related brain potentials. *Cerebral Cortex*, 14(5), 476-483.

- Shaw, J. (2003). *The brain's alpha rhythms and the mind*. Amsterdam: Elsevier.
- Sheehan, D. P. (Ed.). (2006, June). *Frontiers of time: Retrocausation-experiment and theory*. AIP, New York.
- Shneerson, J. M. (2005). *Sleep medicine: A guide to sleep and its disorders*. Blackwell.
- Silverman, J., & Buchsbaum, M. (1970). Psi favorable states of consciousness. In R. Cavanna (Ed.), (p. 143-169). N.Y.: Parapsychology Foundation.
- Standish, L., Kozak, L., Johnson, L., & Richards, T. (2004). Electroencephalographic evidence of correlated event-related signals between the brains of spatially and sensory isolated human subjects. *The Journal of Alternative and Complementary Medicine*, 10(2), 307-314.
- Symmons, C., & Morris, R. L. (1997). Drumming at 7hz and automated ganzfeld performance. In *The parapsychological association 40th annual convention: Proceedings of presented papers* (p. 441-453).
- Targ, R., & Puthoff, H. (1974). Information transmission under conditions of sensory shielding. *Nature*, 252(5476), 602-607.
- Tart, C. T. (1963). Physiological correlates of psi cognition. *International Journal of Parapsychology*, 5(4), 375-386.
- Tart, C. T. (1966). More on extrasensory induction of brain waves. *Science*, 151, 28.
- Vaitl, D., Birbaumer, N., Gruzelier, J., Jamieson, G. A., Kotchoubey, B., Kubler, A., et al. (2005). Psychobiology of altered states of consciousness. *Psychological Bulletin*, 131(1), 98-127.
- Wackermann, J. (2004). Dyadic correlations between brain functional states: Present facts and future perspectives. *Mind and Matter*, 2(1), 105-122.
- Wackermann, J., Muradas, J. R. N., & Pütz, P. (2004). Event-related correlations between brain electrical activities of separated human subjects: Preliminary results of a replication study. In *Proceedings of the 47th parapsychological association convention* (p. 465-468).
- Wackermann, J., Pütz, P., Buchi, S., Strauch, I., & Lehmann, D. (2002, November). Brain electrical activity and subjective experience during altered states of consciousness: ganzfeld and hypnagogic states. *International Journal of Psychophysiology*, 46(2), 123-146.
- Wackermann, J., Seiter, C., Keibel, H., & Walach, H. (2003). Correlations between brain electrical activities of two spatially separated human subjects. *Neuroscience Letters*, 336, 60-64.
- Walach, H., Seiter, C., & Keibel, H. (2001). Transferred potentials fact or

- artifact? Results of a pilot study. In R. A. Chez (Ed.), *Proceedings: Bridging worlds and fillings gaps in the science of healing*. Corona del Mar, CA: Samueli Institute.
- Walker, E. H. (1975). Quantum physics and parapsychology. In L. Oteri (Ed.), (p. 1-53). Parapsychology Foundation, New York.
- Walter, W. G. (1950). Electroencephalography. In D. Hill & G. Par (Eds.), (chap. Normal rhythms - their development, distribution and significance). MacMillan, New York.
- Watt, C., Ravenscroft, J., & McDermott, Z. (1999). Exploring the limits of direct mental influence: Two studies comparing "blocking" and "co-operating" strategies. *Journal of Scientific Exploration*, 13(3), 515-535.
- Wheeler, J. A. (1984). Quantum theory and measurement. In J. A. Wheeler & W. H. Zurek (Eds.), (p. 182-213). Princeton University Press.
- White, R. A. (1964). A comparison of old and new methods of response to targets in ESP experiments. *Journal of the American Society of Psychical Research*, 58, 21-56.
- Wigner, E. P. (1967). *Symmetries and reflections*. MIT Press, Cambridge MA.
- Winkelman, M. (1986). Trance states: A theoretical model and cross-cultural analysis. *Ethos*, 14:2, 174-203.
- Zubek, J. P. (1969). *Sensory deprivation: 15 years of research*. London: Appleton Century Crofts.

Appendix A

This article describes study 1 and presents the results of data collected until August 2004; additional sessions were later conducted as presented in Chapter 2 of this thesis; see Chapter 5 (section 1) for a discussion.

Presented at the 47th Annual Convention of the Parapsychological Association (Vienna) and published as:

Kittenis, M., Caryl, P. G., and Stevens, P. (2004). Distant psychophysiological interaction effects between related and unrelated participants. In Schmidt, S., editor, *The Parapsychological Association 47th Annual Convention: Proceedings of Presented Papers*. Vienna.

Distant psychophysiological interaction effects between related and unrelated participants.

Marios Kittenis¹, Peter G. Caryl², & Paul Stevens¹

¹ Koestler Parapsychology Unit, University of Edinburgh

² Psychology Department, University of Edinburgh

ABSTRACT

The aim of this study is to investigate possible remote psychophysiological interactions between sensorially isolated participants, using EEG measures and a photic stimulation procedure. It is an attempt to conceptually replicate past findings suggesting the presence of such interactions, and to clarify the role, (if any), of an existing emotional relationship and pre-session interaction between participant pairs.

Forty-one unpaid volunteers were assigned to one of three groups. One of these consisted of thirteen related pairs of participants who reported sharing an empathic relationship, another of five unrelated pairs (i.e. randomly matched strangers), and the last of five single participants. Related pairs spent some time alone together before testing, whereas unrelated pairs did not know each other and did not meet until after the session; single participants were told they would be paired with someone they didn't know, but were not matched with anyone. Pairs of participants simultaneously listened to a recording of a progressive relaxation procedure including suggestions aimed to induce a hypnagogic-like state, which was followed by 15 minutes of continuous drumming; this procedure was intended to induce a similar alteration of consciousness in both participants. During the drumming period the EEG of one person of the pair ("receiver") was recorded while the other ("sender") was occasionally stimulated with randomly timed single photic flashes. For the single participants group the same procedure was followed but there was no "sender" to observe the flashes.

EEG epochs that were time-locked on photic stimulation of the "senders" were taken from the continuous EEG record of the "receivers". Similar randomly sampled epochs were taken from periods of no stimulation to serve as controls. According to the null hypothesis no difference would be expected between these samples, as sensory stimulation of the "receivers" was homogenous throughout the experimental period. Event-related evoked alpha power measures revealed a tendency for samples from "remote" photic stimulation periods to show larger deviations from pre-stimulus baseline than control samples; these deviations were in the same direction as normal responses to direct photic stimulation. This difference between "remote" photic stimulation and control periods was found to be significant for the related pairs group at $p < 0.023$ (Wilcoxon signed-ranks test, two-tailed; $N=13$). Deviations of similar direction and magnitude were found in unrelated pairs ($p < 0.007$ when combined with related group, $N=18$), while recordings from single participants (when no other person was stimulated) showed no such effect. Further patterns identified in the results and possible interpretations are discussed.

INTRODUCTION

An increasing number of parapsychological experiments make use of physiological measures as dependent variables, rather than the more traditional psychological/behavioural measures. This choice relies on the fairly reasonable assumption that perception of any psi-mediated information will inevitably result in measurable changes in physiological parameters at some stage of the perceptual process, as is the case with ordinary perception. An additional motive for using such measures is the possibility that directly measuring physiological parameters may be advantageous in detecting subtle non-normal perceptual responses, which are perhaps not sufficiently salient to rise above the threshold of conscious awareness. For psi experiments using psychophysiological recordings that directly measure parameters of brain activity, such as the EEG and fMRI, an extra potential advantage is that such measures could help in identifying some of the underlying neural mechanisms that may be involved in possible psi processes. Of particular relevance to the present study is research using visual stimulation of one participant while measuring the EEG of another non-stimulated subject.

In one of the first studies to use such methodology, "senders" were stimulated with repetitive photic flashes at frequencies of 6 and 16Hz. Seven pairs were tested, and while in only one of these the "receiver" showed alpha power blocking when the "sender" was stimulated, this pair was tested further and a repeatable effect was observed (Targ & Puthoff, 1974). In a subsequent study, pairs of subjects meditated together and were then taken to separate Faraday cages. One person of each pair was stimulated with trains of 100 flashes at random time intervals, while EEG was recorded from both. The stimulated subjects demonstrated visual evoked potentials as expected, which significantly correlated with the EEG activity of the non-stimulated subjects, which were said to demonstrate "transferred potentials" (Grinberg-Zylberbaum, Delaflor, Attie, & Goswami, 1994). Apparently this was not the case for the control condition, in which the subjects in each pair did not interact prior to the experiment. A subsequent attempt at a replication of this study by (Sabell, Clarke, & Fenwick, 2001) however, failed to find an effect. A more recent study using a similar experimental design but different stimuli and analysis methods, has reported significant deviations from baseline in non-stimulated participants when another was visually stimulated, but found no differences in effects between related and unrelated pairs and nothing resembling a "transferred potential" (Wackermann, Seiter, Keibel, & Walach, 2003). A conceptual replication by (Radin, 2003) further suggested that subjects were responding to another person being stimulated and not to the distant stimuli themselves, as the magnitude of responses across flashes appeared to co-vary between "senders" and "receivers". Such interactions can perhaps more correctly be described as correlations rather than "remote responses", especially as it is not yet clear whether they exhibit the same physiological characteristics as responses to direct stimulation.

This project is intended to be a conceptual replication of these previous studies, an attempt to further explore the nature of these effects, and an attempt to clarify the issue of whether interpersonal relationship and prior interaction between participant pairs is a variable affecting the observed effect.

METHOD

Design:

EEG was recorded from one spatially isolated participant while another was stimulated with randomly timed single photic flashes. These were presented interspersed with randomly timed control events, and event-related band power measures were used to compare stimulation and control epochs. Our participant pool consisted of three groups, involving empathically related pairs, unrelated pairs, and single subjects. The null hypothesis predicts no differences between such epochs for the unstimulated person of the pair, and no differences between groups. Individual sessions, where each participant was directly photically stimulated while their own EEG was recorded, were also conducted in order to investigate the normal physiological responses to such stimuli.

Participants:

Forty-one unpaid volunteers took part in the study, divided into three groups; thirteen related pairs i.e. pairs of volunteers who reported sharing an empathic relationship (close friends, relatives or lovers), five unrelated pairs (i.e. ten individual volunteers who didn't know each other were randomly matched into pairs), and five single subjects (individual volunteers were not matched with another, although they were told they would be, i.e. there was no "sender"). There were 23 female and 18 male participants, with a mean age of 28.7, ranging between 20 to 58 years of age.

Audio materials:

An audio recording was used to alter the conscious state of our participants, which included a progressive relaxation procedure and suggestions for entering a hypnagogic-like state, followed by a recording of continuous drumming with an inter-beat frequency ranging between 4-5Hz (recording of live drumming). The aim of this procedure was to facilitate deep relaxation, to induce a non-ordinary conscious state simultaneously in both participants, and to help participants maintain an awareness of each other, while also giving them suggestions for avoiding any effort to succeed in the task and for suspending any positive or negative expectations they may have.

System implementation:

A 40 channel NuAmps EEG system (Neuroscan, USA), was used for data acquisition and analysis. Thirty-two monopolar EEG channels (including references) were recorded at a frequency of 500Hz from the following electrode sites: Fp1, Fp2, Fz, F3, F4, F7, F8, FCz, FC3, FC4, FT7, FT8, Cz, C3, C4, T7, T8, CPz, CP3, CP4, TP7, TP8, Pz, P3, P4, P7, P8, Oz, O1, O2, A1 and A2 (reference was averaged ears, i.e. $(A1+A2)/2$). A 50Hz bandstop filter was used, and the bandpass filter range was 1-100Hz. An electrode cap was used for electrode placement together with clip ear electrodes; all electrodes were sintered Ag/AgCl.

To present photic stimuli we used a pair of dark glasses fitted with eight white (clear) LEDs, (four over each eye). Photic flashes were triggered using TTL pulses from the parallel port of a PC running a

script-driven program (Inquisit by Millisecond Software), which controlled the randomised presentation of two types of stimuli, one of which would trigger a flash and simultaneously register an event marker on the EEG trace, while the other (control event) would only set an event marker on the EEG trace with no associated flash presented. Inquisit used a pseudo-random algorithm to sample with replacement one of the two stimuli, and one of eight possible inter-stimulus delays of 1-8 seconds (i.e. mean IS interval was 4.5s). One hundred and eighty-six stimuli were presented during each joint session; on average half of these (93) would be single photic flashes and half would be control event markers on the EEG trace. Individual sessions (direct photic stimulation) consisted of 68 stimuli of each type, with the same range of randomly chosen inter-stimulus intervals.

The audio recording was played to both participants using a shared one-way audio link. The computer controlling stimulus randomisation was connected to the "sender's" LED glasses and to the EEG amplifier in the "receiver's" room and used synchronised TTL pulses to trigger flashes and set event markers on the EEG record, marking the timing of photic flashes and control periods. TTL inputs to the EEG amplifier are electrically isolated from the participant and the amplifier, protecting against contamination of the EEG record from the electrical signals used to provide event markers, and of cueing the participants to the existence or timing of these signals. No auditory or visual cues were emitted from the amplifier that could indicate the presence of the triggers to the "receivers".

Procedure:

In individual sessions each participant was directly photically stimulated while his or her own EEG was recorded. In "remote" sessions, the EEG of one participant was recorded while the other (or no one in the case of the "no partner" group) was photically stimulated.

Related pairs of participants decided themselves who was to be the "sender" and who the "receiver", either by choice or randomly. They could spend 10-15 minutes alone together before the session, doing anything they thought might help them enhance their awareness of each other. Some possibilities were suggested, such as joint meditation, synchronised breathing, exchanging personal items (e.g. jewellery), but they were encouraged to do whatever felt most appropriate for them both. They were discouraged from using verbal interaction during this period, and they were given the option to burn some incense while in the room together, of which they could each take some in their respective separate experimental rooms. This was thought to be likely to help them maintain their awareness of each other into the experimental period, as odours are especially effective as memory cues and are particularly effective in evoking the emotional elements of memories¹. A common odour in participants' respective rooms would also make their sensory environments more similar. Participants were given a choice between different types of incense, and most pairs (but not all) opted to use some. After spending time alone together, participants went to their respective experimental rooms and did not interact with the experimenter again, (or anyone else), until the end of the session.

¹ Evidence from fMRI studies indicates that the subjective experience of the emotional potency of odour-evoked memories is correlated with specific activation in the amygdala, which is greater in magnitude than that seen when the same memories are evoked using visual cues (Herz, Eliassen, Beland, & Souza, 2004).

Unrelated pairs did not know each other prior to the experiment and only met after the session had finished. Therefore the experimenter chose randomly who was to be the "sender" and who the "receiver".

The five single participants who were not matched with a "sender" were told that they would be paired with someone they didn't know, and that they would meet them after the experiment (i.e. the same as what the unrelated pairs were told). Therefore they were all "receivers", and while the photic stimulation procedure was carried out as described above, there was no "sender" in the other room to observe the flashes. After the session the experimenter gave these participants a full debrief and explained the reasons for the deception.

At the beginning of each session the progressive relaxation instructions were played to the participants; this recording lasted for approximately 11 minutes and was followed by the drumming, which lasted for approximately 15 minutes. Two minutes after the drumming had started randomised photic stimulation was initiated, which lasted for an average of 11.7 minutes (the actual session length depending on the cumulative duration of the randomly chosen inter-stimulus intervals).

RESULTS

The raw EEG data from all $N = 41$ participants was treated with a 1-30Hz band-pass filter and visually inspected for artefacts. Channels that were consistently noisy or which lost electrode contact during recording were marked and excluded from further analysis. The entire EEG records of two participants had to be excluded from analysis due to faulty recording (loose reference electrode). One of these was a "sender" during direct photic stimulation, and the other a "receiver" (from the "alone" group), during remote photic stimulation.

Three-second long epochs were taken from the continuous EEG records, centred upon stimulus presentations times (and random control markers) ranging from -1 to +2 seconds. According to the stimulus randomisation protocol we had used, the shortest possible interstimulus interval was 1s; therefore we could not use all of the 3s epochs, as some would contain more than one stimulus event and/or overlapping responses to stimuli. We therefore excluded from our analysis all events appearing after inter-stimulus intervals of less than 3s. Epochs were baseline corrected and those containing amplitudes $>100\mu\text{V}$ were automatically rejected; epochs were also visually inspected and those found containing additional artefacts from eye movements or muscle activity were manually rejected. This manual artefact rejection was conducted blind as to whether epochs contained photic or control events. After such rejections, the number of epochs of each type available for analysis for each person and channel averaged at 55 for direct photic stimulation sessions and 70 for "remote" stimulation sessions. (The average number of stimulus events originally presented was 68 and 93 respectively).

The EEG data from direct photic stimulation sessions was analysed first in order to investigate the electrophysiological characteristics of normal responses to the photic stimuli we were using, and thus provide a template with which to guide the analysis of data from "remote" sessions.

Results of direct photic stimulation sessions:

Event-Related Band Power measures (ERBP) were used, where the raw EEG of all event-related epochs is band-pass filtered around a central frequency band of interest. We have chosen to focus on the alpha band (8-13Hz), as power in this band is well known to be affected by photic stimulation, e.g.(Kawaguchi, Jijiwa, & Watanabe, 1993). We have used a measure of evoked (phase-locked) activity, as initial analysis demonstrated that evoked responses to photic stimulation are better defined and simpler to describe than induced (non phase-locked) responses. In evoked ERBP, the amplitude values within each epoch are squared in order to obtain power measures (μV^2), and a number of epochs that are time-locked to the stimulus are averaged point-by-point (as in Event Related Potentials). Evoked alpha ERBP measures can therefore effectively be described as the alpha-band component of the general ERP.

The Global Field Power (GFP) was calculated for each participant from the 30 original electrode channels as a measure of global EEG activity. The GFP is defined as the standard deviation across multiple channels as a function of time, and is used to quantify the instantaneous global activity across the spatial potential field sampled over the scalp (Lehmann & Skrandies, 1980). An example of the GFP of the evoked alpha response to photic stimulation can be seen in Fig. 1, showing a rapid increase in alpha power which starts almost immediately after stimulus presentation ($T=0ms$), peaks at 224ms and returns to baseline near 500ms after stimulus presentation.

Figure 1: Evoked alpha response to direct photic stimulation; averaged Global Field Power for 30 channels and $N=39$ Ss.

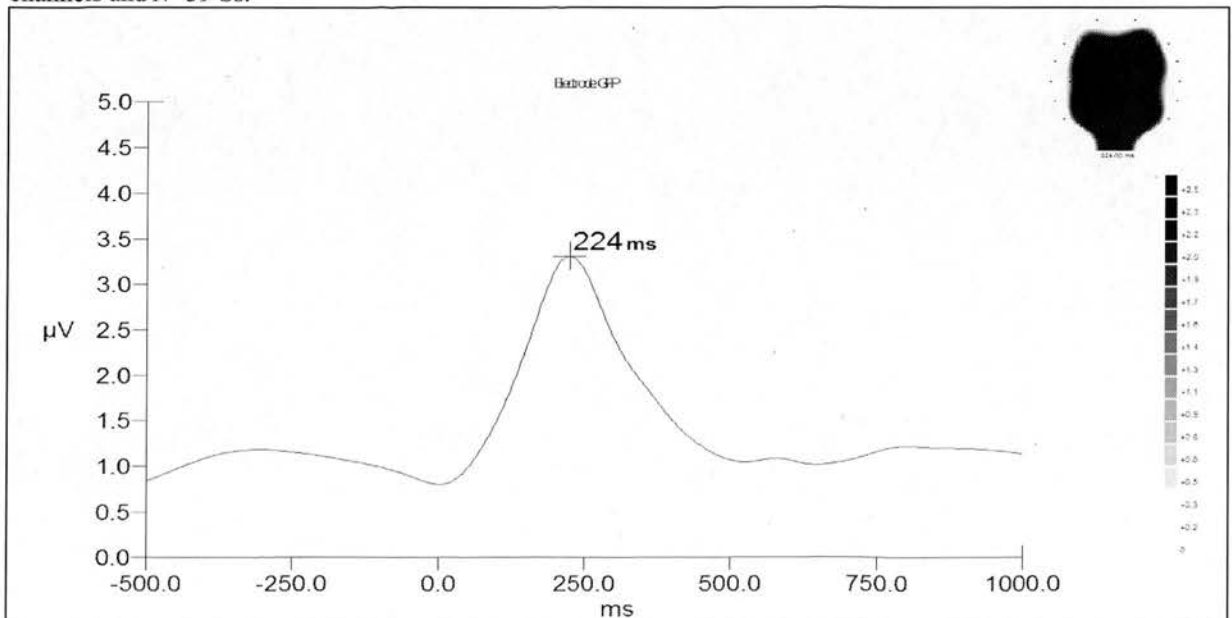

We can define a period of interest within remote stimulation epochs based on the averaged responses of all participants to direct photic stimulation, on the assumption that if “receivers” are responding to photic stimulation of the “senders”, their responses will have similar temporal characteristics. We therefore defined our test interval to be the range of 0 to 500ms after stimulus presentation, as responses to direct stimulation reach a maximum and return to baseline within this

interval. As a comparison reference period we used the pre-stimulus interval of -500 to 0ms. We can

calculate a ratio measure of post- to pre-stimulus power using the formula: $10 \cdot \log \frac{W_{post}}{W_{pre}}$

where W_{post} is the mean α -power in the 0 to 500ms post-stimulus interval and W_{pre} is the mean α -power in the -500 to 0ms pre-stimulus interval. Therefore if there is no difference between pre-stimulus and post-stimulus power the log-ratio value would be 0, whereas positive values would indicate a higher mean α -power in the post-stimulus interval, and negative values would indicate a higher mean α -power in the pre-stimulus interval. For example, the log-ratio of such a comparison for the response to direct photic stimulation seen in Fig.1 would be: $10 \cdot \log (1.90 / 1.03) = 2.6$.

Results of “remote” photic stimulation sessions

As we would expect no systematic difference in α -power between pre- and post-stimulus intervals in the EEG of the “receivers”, for the simple reason that they are not being stimulated themselves, we could in theory simply compare the above log-ratio of evoked α -power measures from epochs time-locked on photic stimulation of the “senders”, against the expected value under the null hypothesis, i.e. 0. As we do not know however the exact statistical properties of the EEG signal, such theoretical assumption may not be justified, and a safer route would be to compare the log-ratio from periods of photic stimulation of the “senders”, against the same ratio from control periods of no stimulation. The null hypothesis would also predict no difference between such periods for the unstimulated “receivers”. Figure 2 shows the mean estimated log-ratios of these intervals for the three groups and two conditions.

Figure 2: Mean log-ratios of post/pre-stimulus α -power (GFP) per group and condition.

Error bars show +/-1 standard error from the mean.

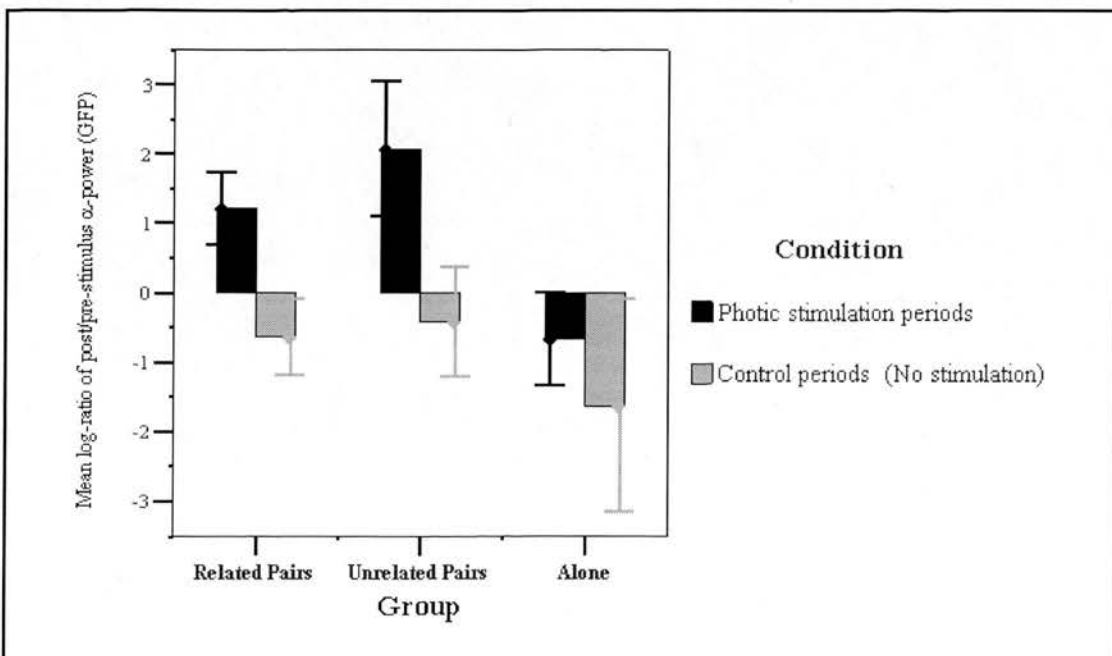

A trend can easily be identified for positive ratios to be observed during epochs of photic stimulation of these participants' partners, in both related and unrelated pairs, indicating higher alpha power in post-stimulus intervals compared to the pre-stimulus baseline. In contrast, control periods from these groups show a small negative trend. No such difference can be seen in participants who were not matched with a partner (no one seeing the flashes); the log-ratios in this group are negative in both photic and control periods, indicating higher alpha power in the pre-stimulus interval. The deviation from baseline in photic periods appears larger for unrelated pairs, but due to the small number of participants in this ($N=5$) and the "alone" group ($N=4$), we can make such comparisons only tentatively and with much caution.

These differences are highly comparable with recent findings in other studies, which have identified a similar pattern of effects between groups similar to these. Wackermann et al., (2003) found deviations from baseline activity in the EEG of non-stimulated subjects, coinciding with periods when their partner was visually stimulated. Groups of related and unrelated pairs showed responses of similar magnitude, while a group of participants having no partner, and another with pairs where the "sender" could not see the stimuli, did not show any such responses. It is important to note that as in that study different visual stimuli (checkerboard pattern reversal) and different EEG analysis methods were used to ours, the agreement between them is therefore only of a qualitative nature.

Table 1: Overall mean log-ratios of post/pre-stimulus α -power and standard deviations for each of the three groups and two conditions.

	Group	Mean	Std. Deviation	N
"Remote" photic stimulation periods	Related	1.22	1.9	13
	Unrelated	2.07	2.17	5
	Alone	-.65	1.33	4
	Total	1.07	2.01	22
Control periods (no stimulation)	Related	-.64	1.96	13
	Unrelated	-.41	1.76	5
	Alone	-1.62	3.07	4
	Total	-.77	2.08	22

To test the statistical significance of the observed difference we used a Wilcoxon matched-pairs signed-ranks test, which is distribution-free and does not rely on parametric assumptions. As can be seen in table 2 below, the difference in the related pairs group between photic and control epochs is significant at $p < 0.023$ ($N = 13$; two-tailed). Conducting the test on groups as small as the unrelated pairs ($N = 5$) and unpaired participants ($N = 4$) is not likely to be reliable and will not be attempted. We could however combine the results from related and unrelated pairs, in which case we find a $p < 0.007$ ($N = 18$; two-tailed). The overall difference between photic and control epochs for all three groups combined is also significant at $p < 0.007$ ($N = 22$; two-tailed).

To estimate the effect sizes associated with these differences we calculated the values of the effect-size correlation r using the following formula:

$$r = d / \sqrt{d^2 + 4} \quad \text{where} \quad d = \frac{\bar{X}_1 - \bar{X}_2}{\sqrt{(\sigma_1^2 + \sigma_2^2) / 2}}$$

Table 2 shows the calculated effect sizes and p values for each group and combination of groups. Effect sizes of $r > 0.3$ are considered to be large; for example the $r = 0.43$ seen in the related group indicates that the mean of the photic condition stands at the 84th percentile of the control condition. Such effect sizes are comparable to some of the largest found in DMILS studies, where for example, the average effect size for 19 such experiments was found to be $r = 0.25$ (Schlitz & Braud, 1997).

Table 2: Estimated effect sizes and p values for differences in evoked alpha power changes between control and photic conditions; calculated for all groups separately and in combinations.

	Related Pairs ($N=13$)	Unrelated Pairs ($N=5$)	“No sender” group ($N=4$)	Related & Unrelated Pairs ($N=18$)	All three groups combined ($N=22$)
Wilcoxon Signed - Ranks Test	$p < 0.023$ (2-tailed)	N/A	N/A	$p < 0.007$ (2-tailed)	$p < 0.007$ (2-tailed)
Effect size r	$r = .43$	$r = .55$	$r = -.1$	$r = .47$	$r = .41$

It will be useful at this point to look at the temporal and spatial characteristics of the averaged waveform of alpha-ERBP from the “remote” stimulation periods. Figure 3 shows the average Global Field Power for the two groups that appeared to show an effect, i.e. the related and unrelated pairs ($N=18$).

Figure 3: Mean Global Field Power of alpha-ERBP during “remote” photic stimulation for related and unrelated “receivers” combined ($N=18$).

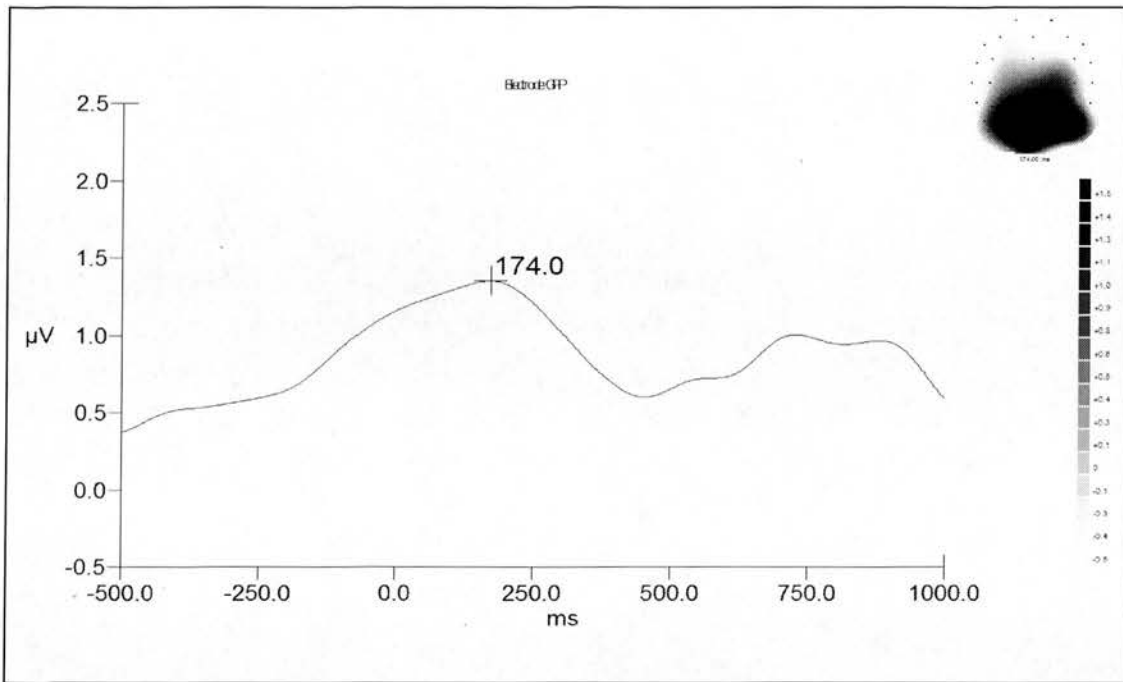

This shows a relatively slow rise in phase-locked alpha power which peaks at 174ms post-stimulus; this “response” however also appears to begin to rise at least -150ms before stimulus presentation. Such a feature is obviously highly problematic if we attempt to interpret the effect as a physiological response to a remote stimulus, as this would violate the generally accepted assumption of linear temporal causality, according to which responses must follow stimuli and not vice versa. The spatial distribution of the effect however (see Fig.4) indicates a parietal/occipital locus for the observed deviation, which would be expected for the alpha component of a visual evoked response. Therefore unlike its problematic temporal characteristics, the posterior localisation of the effect is somewhat consistent with a physiological interpretation. The spatial/temporal evolution of the “remote response” can also be seen in Fig.4 and can be compared to the normal response to direct photic stimulation.

Figure 4: Spatial distribution of evoked alpha-power during direct photic stimulation ($N=39$) and during “remote” photic stimulation (related & unrelated pairs, $N=18$). Photic flashes were presented at $T=0$ for 80ms.

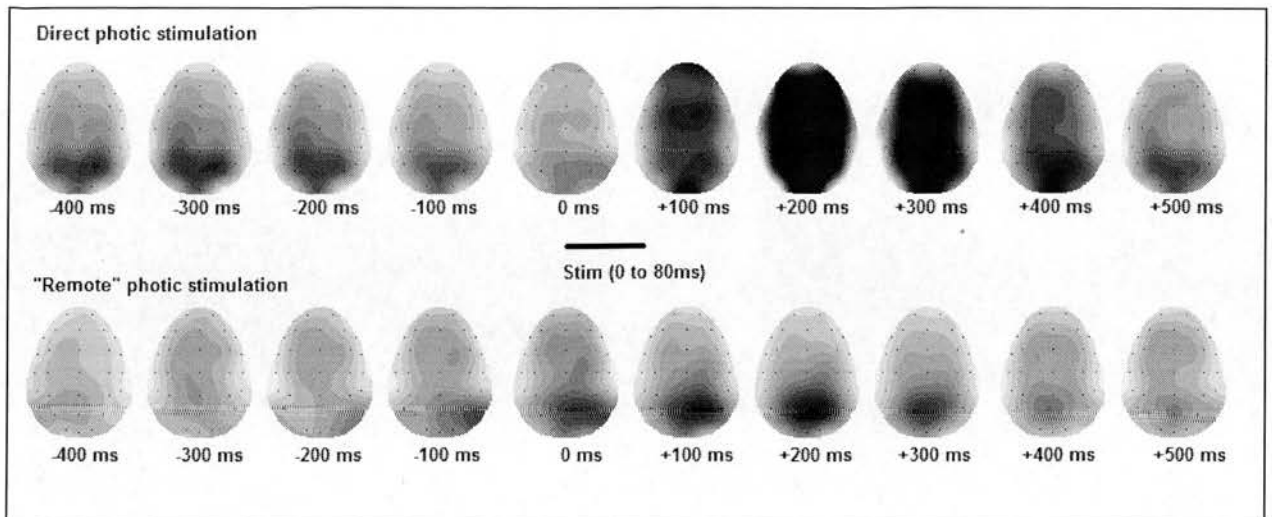

We are now in the process of analysing the results from the questionnaires administered to our participants, i.e. the *Modified Tellegen Absorption Scale* (Jamieson, 1986), the *Phenomenology of Consciousness Inventory* (Pekala, 1991), and a general participant information form, to further explore individual variables that may be related to performance in this experiment. Particular attention will be paid to the reported subjective consciousness alterations (in the PCI), and whether their intensity and quality, as well as correlations between the experiences of participants in each pair, relates in any way to task performance.

DISCUSSION

The results show apparent changes in α -power in the EEG of non-stimulated participants, when other physically isolated participants are photically stimulated, which are in the same direction as that observed when participants are themselves stimulated, i.e. phase-locked α -power increases during the post-stimulus period. As sensory stimulation for the unstimulated "receivers" is homogenous throughout the experimental period, the significant difference between "remote" photic stimulation epochs and control epochs in log-ratios of post-/pre-stimulus α -power, suggests the presence of an anomalous effect during the "remote" photic stimulation periods. The lack of such a difference in the group of "receivers" who were not paired with a "sender", further suggests that this effect is dependent on sensory stimulation of another participant, and cannot be attributed to a general methodological flaw, or to direct anomalous perception of the remote stimuli. The parietal/occipital locus of the effect is consistent with what would be expected from the alpha component of a visual evoked response, and further suggests the presence of a "remote response".

The time-evolution of the observed effect however, is somewhat problematic and raises additional questions. The fact that "remote responses" appear to start at around -150ms pre-stimulus, and to peak 50ms before the "senders'" response to direct stimulation does, suggests one of two

possibilities; perhaps the observed effect is not a genuine response to the remote events, as it is not accurately time-locked on these events, but is instead a fluctuation in α -power caused by unknown factors. If however the observed deviation from baseline represents a genuine anomalous response to the remote events, then this would seem to indicate the presence of a temporal as well as a spatial anomaly. As this was not a hypothesis we had considered before the analysis of the results, we can only present this possibility as a question to be explored further in future research. The lack of a “pre-stimulus” element in responses to direct photic stimulation however, raises the question of why should such an anomaly only be present in “remote responses”. The temporal asynchrony between direct and “remote responses” (assuming the latter are genuine), would seem to suggest that what we observe is not an ordinary stimulus-response effect. The physiologically counterintuitive features of the “remote responses” prompt us to suggest that perhaps it is better not to describe these anomalous effects as responses at all, but as “non-local biological interactions” (without implying the involvement of a quantum-mechanical process), or as “remote psychophysiological correlations”.

The main limitation of this study was the small number of participants in the “unrelated” and “alone” groups, which made direct statistical comparisons between groups, as well as statistical tests within these two groups impossible to conduct. The related pairs group was the focus of the experiment, and the other two groups were added as exploratory elements within the study. As such they can only be useful for making qualitative comparisons between the groups. We are now planning a larger study with a similar design but with equal numbers of participants in each group, to enable formal statistical comparisons to be made. We are also planning to make use of an “oddball” stimulation paradigm, which could further clarify the physiological characteristics of any anomalous effects found.

Acknowledgements:

This project was supported by the Bial Foundation with grant no. 37/00. The EEG equipment was purchased with the help of a grant from Inova.

REFERENCES

- Grinberg-Zylberbaum, J., Delaflor, M., Attie, L., & Goswami, A. (1994). The Einstein-Podolsky-Rosen paradox in the brain: The transferred potential. *Physics Essays*, 7(4), 442-448.
- Herz, R. S., Eliassen, J., Beland, S., & Souza, T. (2004). Neuroimaging evidence for the emotional potency of odor-evoked memory. *Neuropsychologia*, 42(3), 371-378.
- Jamieson, G. A. (1986). *The structure and meaning of absorption*. Unpublished Masters dissertation, University of Queensland, Australia.
- Kawaguchi, T., Jijiwa, H., & Watanabe, S. (1993). The dynamics of phase-relationships of Alpha waves during photic driving. *Electroencephalography and Clinical Neurophysiology*, 87(3), 88-96.

- Lehmann, D., & Skrandies, W. (1980). Reference-free identification of components of checkerboard-evoked multichannel potential fields. *Electroencephalography and Clinical Neurophysiology*, 48, 609-621.
- Pekala, R. J. (1991). *Quantifying Consciousness: An empirical approach*. New York: Plenum Press.
- Radin, D. I. (2003). Thinking outside the box: EEG correlations between isolated human subjects. *Proceedings of the Parapsychological Association*, 46, 184-199.
- Sabell, A., Clarke, C., & Fenwick, P. (2001). *Inter-subject EEG correlations at a distance - the transferred potential*. Paper presented at the Proceedings of the 44th Annual Convention of the Parapsychological Association, New York.
- Schlitz, M., & Braud, W. (1997). Distant intentionality and Healing: assessing the evidence. *Alternative Therapies*, 3(6), 62-73.
- Targ, R., & Puthoff, H. (1974). Information transmission under conditions of sensory shielding. *Nature*, 252, 602-607.
- Wackermann, J., Seiter, C., Keibel, H., & Walach, H. (2003). Correlations between brain electrical activities of two spatially separated human subjects. *Neuroscience Letters*, 336, 60-64.

Appendix B

Sample of the flyer used for participant recruitment.

Would you like to take part in research into empathy and ESP?

We are now doing research exploring the possibility that people who share an emotional connection are sometimes able to communicate and interact with each other from a distance without using any of the commonly recognised senses, an ability that has sometimes been called 'telepathy' or 'ESP'.

Such communication is often experienced in the form of hunches and gut feelings about the other person that turn out to be accurate, or in the form of synchronicities and seemingly odd coincidences, such as calling each other on the phone at the same time, or mentioning something that they have been thinking about.

Recent experiments seem to suggest that this kind of remote interaction might not be so rare after all, and could possibly be happening regularly on an unconscious level but that we only become consciously aware of it occasionally. In this study we are using EEG (brainwave) recordings to see if such communication is registered on a physiological level.

We are now looking for volunteers to take part in this study, so if you find the topic interesting and would like to participate, or if you simply want to know more about it please get in touch.

We are primarily looking for pairs of people who share a close empathic connection, regardless of the type of the relationship; what is important is that you share a sense of mutual understanding and empathic awareness of each other. Ideally you might have had the kind of experiences mentioned above, or feel that you sometimes communicate or interact in ways that you cannot explain. People with experience in yoga, meditation, martial arts or any other mental discipline (including any activity that requires concentration, like juggling or playing a musical instrument), and people with creative/artistic abilities are especially welcome, but anyone can take part as long as you are not suffering from any type of epilepsy. We are also looking for individual volunteers (you will be paired with someone you don't know). If you are considering taking part please get in touch and we'll let you know more about it. This research is based in the Koestler Parapsychology Unit at the University of Edinburgh.

You can call me at: (0131) 65 11 684 (please leave a message and I'll call you back), or email: marios@moebius.psy.ed.ac.uk

Many Thanks!

Appendix C

Script of relaxation procedure:

(Numbers between sentences signify pause in seconds; ellipsis (...) signifies brief pause.)

Before we start, you will first listen to a relaxation exercise, to help you get rid of all physical and mental tension. 3s

Take some time to settle in and make yourselves comfortable in your chairs. 5s

Once you're settled, begin to become aware of your breathing... breathe slowly in and out starting from low down your belly, and take deep, full breaths, using your diaphragm to breath and fill your lungs... (you can check this by placing your hand over your belly button and as you breathe, it should rise and fall)

Take a few deep, long breaths... and feel the relief as you breath out... notice how your body relaxes as you do... Take a couple more deep breaths...8s, and when you are ready, just allow your eyelids to close... 3s

Now, as you breath gently and slowly let the muscles around your eyes relax... feel the muscles move and soften and as they do, relax... let go... let them settle comfortably, feel the softness spreading, moving gently across your face, relaxing and soothing as it spreads gently outwards... over your temples... and your cheeks...

Feel the muscles around your nose beginning to soften, and let the relaxation flow down your face, relaxing your upper lip... lower lip... cheeks..., and your tongue, can relax. Feel it spread through your jaw..., let the relaxation spread down your throat..., relaxing the muscles of swallowing... and the muscles of speaking...

5s

Now bring your attention to your forehead, and feel it becoming smooth... letting go of your frown lines, and even your smile lines, just as much as you can let go.

Feel the softening spread gently from your forehead, up through your hair and over you scalp, relieving any sense of tension... Some feeling of tightness might remain, but the more you relax the more comfortable you feel ... This soft sensation is now flowing down the back of your head and neck, relaxing all the muscles that are used to hold your head... you will keep just enough tension to hold your head upright, resting against the pillow... there's a feeling of release as you let go,... a feeling of peace and calm... Muscles you are not normally aware of

are relaxing, and loosening, and softening, your head no longer needs to use all those muscles, it is safely, and gently letting go... it is heavier and is resting, it seems soft and comfortable. Notice how good it feels, as your mouth, cheeks, eyes, forehead, and scalp become completely, and thoroughly relaxed... 3s

You may notice, that as each part of your body relaxes, this dilates the blood vessels and more blood is flowing to the different organs, both internal ones as well as the muscles on the surface. As more blood is available, your muscles relax even more, giving a pleasant sensation of warmth spreading throughout your body... 3s

As your head feels fully relaxed, now, allow the feeling to flow down into your shoulders, releasing all the tension in that area... let it spread all through the shoulders now, and out and down along your upper arms, ...throughout your elbows and down into your wrists and hands, a warm ripple spreading right to the tips of your fingers.

Feel now the warmth move from your shoulders and neck down your spine, right down to the tailbone, ...relaxing all the muscles in your back... both sides feeling freer and more comfortable, your muscles in your back relaxing, un-knotting, warming..., your joints enjoying the freedom and the release.... Feel now the muscles holding your ribs, ...they too are softening, relaxing, moving rhythmically with your breathing in... and out... 2s

This deep feeling of relaxation is all through your torso, just let everything drift away, all thoughts gone now.... your mind as well as your bodies is feeling relaxed..., your Self is relaxing..., just as much as is right for you. 2s

With each slow, deep breath you take, allow yourselves to drift deeper, and deeper, into a very pleasant state of warmth and comfort... each breath out releases, letting go of unnecessary thoughts, let them all float away.

As you breathe you feel the relaxation wash down through your hips, ... and pelvis... the muscles you use for sitting are relaxing, allowing you to settle in more comfortably in your chairs... and the warm feeling now spreads down through your thighs., knees and calves...all through your legs and on down to your feet..., through your ankles..., and right to your toes. Feel the little movements as your muscles release and adjust... and then settle..., just allow them to let go. Each time you allow your body to relax, so it becomes easier, as it becomes easier you relax even more, more deeply, enjoying the sensation of release... Your whole bodies feel quiet now, heavy, comfortable, and relaxed. Your breathing is calm and regular, taking care of itself.... with each breath imagine yourselves, falling deeper, and deeper into complete relaxation... 3s

Let yourselves relax still more. A feeling of well-being gradually comes over you... give way to the feeling, as it is so pleasant... just let yourself go.

Lets count backwards from ten now, to help you go even deeper, still. With each count, feel yourselves go deeper, and deeper into a profoundly relaxed and pleasant state, of warmth and comfort.

10... 2s

9... 2s

8... 2s

7... 2s

6... 2s

5... 2s

4... 2s

3... 2s

2... 2s

1... 6s

As you enjoy this deeply relaxed state, scan your body with this calm awareness... notice any areas of tension and let them release...

Let this pleasant sensation move and fill your bodies throughout... as it spreads and moves gently relaxing all areas still having some tension... 2s

Letting go even more, just as much as is right for you. Even in this deeply relaxed state, you are able to maintain a clear awareness of each other, as you both breathe at this rate..., as your hearts... beat at this rate..., feeling so comfortable and relaxed... and at the same time, calmly focused and aware, finding a state that is right and pleasant for you both....

Final Instructions...

In a while, you will both listen to some drumming for about ten to fifteen minutes... this will help you remain comfortably relaxed and keep your Mind clear from any thoughts while still being clearly aware of each other. You don't need to try to do anything during this period, just simply relax and enjoy the session. Keep your attention focused on the drumming and each other, and if any thoughts come to mind, just allow them to come and go on their own, without trying to push them away, or paying much attention to them... and if your mind wanders, just gently bring it back to the sound of the drumming, that you're both hear...

(Drumming period, 15-20 minutes)

Coming back:

Now... is time to start coming back soon to your ordinary consciousness, still feeling fully relaxed, and also alert, and refreshed. In a few moments I am going to begin to count from one, up to ten, ...and as I do, your awareness will gradually and gently return to its most pleasant ordinary state, feeling rested and refreshed... you might want to breathe more deeply for a while... in your own time. 5s

Coming back comfortably and easily, and keeping all you need from this experience...

One... still being aware of each other in the other room

Two... becoming aware of the sensation of your legs touching the chair or the floor

Three...

Four... becoming more aware of the weight of your body on the chair

Five...

Six... becoming more aware of the room you are in now

Seven...

Eight... Becoming more aware of your surroundings, the background sounds, smells and light

Nine... becoming much more focused now, clear, alert and calm

Ten... feeling alert and awake, and whenever you are ready, just let your eyes open

You might like to stretch now for a while, and take a couple of deep breaths, and whenever you are ready, take off the glasses and headphones, and I will come and help you both in a moment.

Appendix D

D.1: Inquisit script for Experiment 1:

```
<picture NAton> / position = (50, 80)
/ items = ("NAton.jpg")
/ numitems = 1
</picture> </text>

<port single> <instruct>
/ port = lpt1 / nextkey = ("s")
/ subport = data / font = ("Arial", -13, 400, 0, 34)
/ numitems = 1 </instruct>
/ items = ("11000001")
</port> <page ready>
Press the "s" key to start the trial
</page>

<port singledud> <page end>
/ port = lpt1 This trial run has finished
/ subport = data </page>
/ numitems = 1
/ items = ("00000010")
</port> <trial start>
/ stimulustimes = [0 = null; 56 = start,
NAton; 111 = null;]
/ responsemode = noresponse
/ trialduration = 3000
</trial>

<port null> <trial end>
/ port = lpt1 / stimulustimes = [0 = null; 56 = end; 88
/ subport = data = null;]
/ numitems = 1 / responsemode = noresponse
/ items = ("00000000") / trialduration = 3000
</port> </trial>

<port start> <trial phot3>
/ port = lpt1 / pretrialpause = 3000
/ subport = data / stimulustimes = [0 = single, NAton; 80 =
/ numitems = 1 null;]
/ items = ("00001000") / responsemode = noresponse
</port> / posttrialpause = 0
</trial>

<port end> <trial phot4>
/ port = lpt1 / pretrialpause = 4000
/ subport = data / stimulustimes = [0 = single, NAton; 80 =
/ numitems = 1 null;]
/ items = ("00001000") / responsemode = noresponse
</port> / posttrialpause = 0

<text runningreminder>
/ numitems = 1
/ items = ("running experiment")
/ txbgcolor = (210, 0, 11)
/ font = ("Courier", -16, 700, 0, 49)
```

```
</trial>
```

```
<trial phot5>  
/ pretrialpause = 5000  
/ stimulustimes = [0 = single, NAton; 80 =  
null;]  
/ responsemode = noresponse  
/ posttrialpause = 0  
</trial>
```

```
<trial phot6>  
/ pretrialpause = 6000  
/ stimulustimes = [0 = single, NAton; 80 =  
null;]  
/ responsemode = noresponse  
/ posttrialpause = 0  
</trial>
```

```
<trial dphot3>  
/ pretrialpause = 3000  
/ stimulustimes = [0 = singledud; 80 =  
null;]  
/ responsemode = noresponse  
/ posttrialpause = 0  
</trial>
```

```
<trial dphot4>  
/ pretrialpause = 4000  
/ stimulustimes = [0 = singledud; 80 =  
null;]  
/ responsemode = noresponse  
/ posttrialpause = 0  
</trial>
```

```
<trial dphot5>  
/ pretrialpause = 5000  
/ stimulustimes = [0 = singledud; 80 =  
null;]  
/ responsemode = noresponse  
/ posttrialpause = 0  
</trial>
```

```
<trial dphot6>  
/ pretrialpause = 6000  
/ stimulustimes = [0 = singledud; 80 =  
null;]  
/ responsemode = noresponse  
/ posttrialpause = 0  
</trial>
```

```
<block expstart>  
/ screencolor = (100, 100, 200)  
/ preinstructions = (ready)  
/ bgstim = (runningreminder)  
/ trials = [1 = start;]  
</block>
```

```
<block expend>  
/ screencolor = (11, 0, 130)  
/ trials = [1 = end;]  
</block>
```

```
<block run1>  
/ screencolor = (165, 0, 190)  
/ trials = [1-16 = replace (phot3, phot4,  
phot5, phot6, dphot3, dphot4, dphot5,  
dphot6)]  
</block>
```

```
<expt>  
/ blocks = [1 = expstart; 2 = run1; 3 =  
expend;]  
</expt>
```

NAton.jpg:

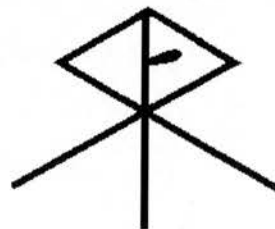

D.2: Inquisit script for Experiment 2:

```
<picture NAton>
/ items = ("NAton.jpg")
/ numitems = 1
</picture>

<port single>
/ port = lpt1
/ subport = data
/ numitems = 1
/ items = ("11001000")
</port>

<port singleodd>
/ port = lpt1
/ subport = data
/ numitems = 1
/ items = ("10100001")
</port>

<port singledud>
/ port = lpt1
/ subport = data
/ numitems = 1
/ items = ("00000100")
</port>

<port oddud>
/ port = lpt1
/ subport = data
/ numitems = 1
/ items = ("00000010")
</port>

<port null>
/ port = lpt1
/ subport = data
/ numitems = 1
/ items = ("00000000")
</port>

<port start>
/ port = lpt1
/ subport = data
/ numitems = 1
/ items = ("00000000")
</port>

<port end>
/ port = lpt1

/ subport = data
/ numitems = 1
/ items = ("00000000")
</port>

<text runningreminder>
/ numitems = 1
/ items = ("running experiment")
/ txbgcolor = (210, 0, 11)
/ font = ("Courier", -16, 700, 0, 49)
/ position = (50, 80)
</text>

<instruct>
/ nextkey = ("s")
/ font = ("Arial", -13, 400, 0, 34)
</instruct>

<page ready>
Press the "s" key to start the trial
</page>

<page end>
This trial run has finished
</page>

<trial start>
/ stimulustimes = [0 = null; 56 = start,
NAton; 111 = null;]
/ responsemode = noresponse
/ posttrialpause = 5000
</trial>

<trial end>
/ pretrialpause = 6000
/ stimulustimes = [0 = null; 56 = end; 88
= null;]
/ responsemode = noresponse
</trial>

<trial phot1>
/ pretrialpause = 3000
/ stimulustimes = [0 = single, NAton; 40 =
null;]
/ responsemode = noresponse
/ posttrialpause = 0
</trial>
```

```
<trial phot2>
/ pretrialpause = 3500
/ stimulustimes = [0 = single, NAton; 40 =
null;]
/ responsemode = noresponse
/ posttrialpause = 0
</trial>
```

```
<trial phot3>
/ pretrialpause = 4000
/ stimulustimes = [0 = single, NAton; 40 =
null;]
/ responsemode = noresponse
/ posttrialpause = 0
</trial>
```

```
<trial phot4>
/ pretrialpause = 4500
/ stimulustimes = [0 = single, NAton; 40 =
null;]
/ responsemode = noresponse
/ posttrialpause = 0
</trial>
```

```
<trial phot5>
/ pretrialpause = 5000
/ stimulustimes = [0 = single, NAton; 40 =
null;]
/ responsemode = noresponse
/ posttrialpause = 0
</trial>
```

```
<trial phot6>
/ pretrialpause = 5500
/ stimulustimes = [0 = single, NAton; 40 =
null;]
/ responsemode = noresponse
/ posttrialpause = 0
</trial>
```

```
<trial dphot1>
/ pretrialpause = 3000
/ stimulustimes = [0 = singledud; 40 =
null;]
/ responsemode = noresponse
/ posttrialpause = 0
</trial>
```

```
<trial dphot2>
/ pretrialpause = 3500
/ stimulustimes = [0 = singledud; 40 =
null;]
```

```
/ responsemode = noresponse
/ posttrialpause = 0
</trial>
```

```
<trial dphot3>
/ pretrialpause = 4000
/ stimulustimes = [0 = singledud; 40 =
null;]
/ responsemode = noresponse
/ posttrialpause = 0
</trial>
```

```
<trial dphot4>
/ pretrialpause = 4500
/ stimulustimes = [0 = singledud; 40 =
null;]
/ responsemode = noresponse
/ posttrialpause = 0
</trial>
```

```
<trial dphot5>
/ pretrialpause = 5000
/ stimulustimes = [0 = singledud; 40 =
null;]
/ responsemode = noresponse
/ posttrialpause = 0
</trial>
```

```
<trial dphot6>
/ pretrialpause = 5500
/ stimulustimes = [0 = singledud; 40 =
null;]
/ responsemode = noresponse
/ posttrialpause = 0
</trial>
```

```
<trial oddphot1>
/ pretrialpause = 3500
/ stimulustimes = [0 = singleodd, NAton;
70 = null;]
/ responsemode = noresponse
/ posttrialpause = 0
</trial>
```

```
<trial oddphot2>
/ pretrialpause = 5000
/ stimulustimes = [0 = singleodd, NAton;
70 = null;]
/ responsemode = noresponse
/ posttrialpause = 0
</trial>
```

```
<trial doddphot1>
/ pretrialpause = 3500
/ stimulustimes = [0 = oddud; 70 = null;]
/ responsemode = noresponse
/ posttrialpause = 0
</trial>
```

```
<trial doddphot2>
/ pretrialpause = 5000
/ stimulustimes = [0 = oddud; 70 = null;]
/ responsemode = noresponse
/ posttrialpause = 0
</trial>
```

```
<block expstart>
/ screencolor = (100, 100, 200)
/ preinstructions = (ready)
/ bgstim = (runningreminder)
/ trials = [1 = start;]
</block>
```

```
<block expend>
/ screencolor = (11, 0, 130)
/ trials = [1 = end;]
</block>
```

```
<block run1>
/ screencolor = (165, 0, 190)
```

```
/ trials = [1-28 = replace (phot1, phot2,
phot3, phot4, phot5, phot6, dphot1,
dphot2, dphot3, dphot4, dphot5, dphot6,
oddphot1, oddphot2, doddphot1,
doddphot2)]
</block>
```

```
<expt>
/ blocks = [1 = expstart; 2 = run1; 3 =
expend;]
</expt>
```

NAton.jpg:

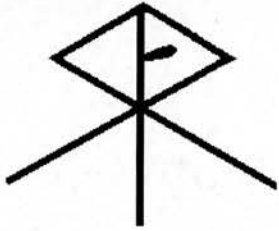

D.3: Inquisit script for Experiment 3:

```
<picture NAton>
/ items = ("NAton.jpg")
/ numitems = 1
</picture>

<picture Enigma>
/ items = ("Enigma780.gif")
/ numitems = 1
</picture>

<port singleA>
/ port = lpt1
/ subport = data
/ numitems = 1
/ items = ("01000001")
</port>

<port singleB>
/ port = lpt1
/ subport = data
/ numitems = 1
/ items = ("00100010")
</port>

<port double>
/ port = lpt1
/ subport = data
/ numitems = 1
/ items = ("01101000")
</port>

<port dud>
/ port = lpt1
/ subport = data
/ numitems = 1
/ items = ("00000100")
</port>

<port null>
/ port = lpt1
/ subport = data
/ numitems = 1
/ items = ("00000000")
</port>

<port end>
/ port = lpt1
/ subport = data
/ numitems = 1

/ items = ("00000000")
</port>

<text runningreminder>
/ numitems = 1
/ items = ("running experiment")
/ txbgcolor = (210, 0, 11)
/ font = ("Courier", -16, 700, 0, 49)
/ position = (50, 80)
</text>

<instruct>
/ nextkey = ("s")
/ font = ("Arial", -13, 400, 0, 34)
</instruct>

<page ready>
Press the "s" key to start the trial
</page>

<page end>
This trial run has finished
</page>

<trial start>
/ pretrialpause = 93
/ stimulustimes = [0 = null; 56 = NAton;
80 = Enigma; 111 = null;]
/ responsemode = noresponse
/ posttrialpause = 131
</trial>

<trial end>
/ pretrialpause = 696
/ stimulustimes = [88 = end;]
/ responsemode = noresponse
</trial>

<trial photA1>
/ pretrialpause = 4000
/ stimulustimes = [0 = null; 31 = NAton;
56 = singleA,Enigma; 111 = null;]
/ responsemode = noresponse
/ posttrialpause = 0
</trial>

<trial photA2>
/ pretrialpause = 4500
```



```
/ stimulustimes = [0 = null; 31 = NAton;  
56 = singleA,Enigma; 111 = null;]  
/ responsemode = noresponse  
/ posttrialpause = 0  
</trial>
```

```
<trial photA3>  
/ pretrialpause = 5000  
/ stimulustimes = [0 = null; 31 = NAton;  
56 = singleA,Enigma; 111 = null;]  
/ responsemode = noresponse  
/ posttrialpause = 0  
</trial>
```

```
<trial photA4>  
/ pretrialpause = 5500  
/ stimulustimes = [0 = null; 31 = NAton;  
56 = singleA,Enigma; 111 = null;]  
/ responsemode = noresponse  
/ posttrialpause = 0  
</trial>
```

```
<trial photA5>  
/ pretrialpause = 6000  
/ stimulustimes = [0 = null; 31 = NAton;  
56 = singleA,Enigma; 111 = null;]  
/ responsemode = noresponse  
/ posttrialpause = 0  
</trial>
```

```
<trial photA6>  
/ pretrialpause = 6500  
/ stimulustimes = [0 = null; 31 = NAton;  
56 = singleA,Enigma; 111 = null;]  
/ responsemode = noresponse  
/ posttrialpause = 0  
</trial>
```

```
<trial photA7>  
/ pretrialpause = 7000  
/ stimulustimes = [0 = null; 31 = NAton;  
56 = singleA,Enigma; 111 = null;]  
/ responsemode = noresponse  
/ posttrialpause = 0  
</trial>
```

```
<trial photB1>  
/ pretrialpause = 4000  
/ stimulustimes = [0 = null; 31 = NAton;  
56 = singleB,Enigma; 111 = null;]  
/ responsemode = noresponse  
/ posttrialpause = 0
```

```
</trial>
```

```
<trial photB2>  
/ pretrialpause = 4500  
/ stimulustimes = [0 = null; 31 = NAton;  
56 = singleB,Enigma; 111 = null;]  
/ responsemode = noresponse  
/ posttrialpause = 0  
</trial>
```

```
<trial photB3>  
/ pretrialpause = 5000  
/ stimulustimes = [0 = null; 31 = NAton;  
56 = singleB,Enigma; 111 = null;]  
/ responsemode = noresponse  
/ posttrialpause = 0  
</trial>
```

```
<trial photB4>  
/ pretrialpause = 5500  
/ stimulustimes = [0 = null; 31 = NAton;  
56 = singleB,Enigma; 111 = null;]  
/ responsemode = noresponse  
/ posttrialpause = 0  
</trial>
```

```
<trial photB5>  
/ pretrialpause = 6000  
/ stimulustimes = [0 = null; 31 = NAton;  
56 = singleB,Enigma; 111 = null;]  
/ responsemode = noresponse  
/ posttrialpause = 0  
</trial>
```

```
<trial photB6>  
/ pretrialpause = 6500  
/ stimulustimes = [0 = null; 31 = NAton;  
56 = singleB,Enigma; 111 = null;]  
/ responsemode = noresponse  
/ posttrialpause = 0  
</trial>
```

```
<trial photB7>  
/ pretrialpause = 7000  
/ stimulustimes = [0 = null; 31 = NAton;  
56 = singleB,Enigma; 111 = null;]  
/ responsemode = noresponse  
/ posttrialpause = 0  
</trial>
```

```
<trial photD1>  
/ pretrialpause = 4000
```

```

/ stimulustimes = [0 = null; 31 = NAton;
56 = double,Enigma; 111 = null;]
/ responsemode = noresponse
/ posttrialpause = 0
</trial>

<trial photD2>
/ pretrialpause = 4500
/ stimulustimes = [0 = null; 31 = NAton;
56 = double,Enigma; 111 = null;]
/ responsemode = noresponse
/ posttrialpause = 0
</trial>

<trial photD3>
/ pretrialpause = 5000
/ stimulustimes = [0 = null; 31 = NAton;
56 = double,Enigma; 111 = null;]
/ responsemode = noresponse
/ posttrialpause = 0
</trial>

<trial photD4>
/ pretrialpause = 5500
/ stimulustimes = [0 = null; 31 = NAton;
56 = double,Enigma; 111 = null;]
/ responsemode = noresponse
/ posttrialpause = 0
</trial>

<trial photD5>
/ pretrialpause = 6000
/ stimulustimes = [0 = null; 31 = NAton;
56 = double,Enigma; 111 = null;]
/ responsemode = noresponse
/ posttrialpause = 0
</trial>

<trial photD6>
/ pretrialpause = 6500
/ stimulustimes = [0 = null; 31 = NAton;
56 = double,Enigma; 111 = null;]
/ responsemode = noresponse
/ posttrialpause = 0
</trial>

<trial photD7>
/ pretrialpause = 7000
/ stimulustimes = [0 = null; 31 = NAton;
56 = double,Enigma; 111 = null;]
/ responsemode = noresponse
/ posttrialpause = 0
</trial>

<trial dphot1>
/ pretrialpause = 4000
/ stimulustimes = [0 = dud; 100 = null;]
/ responsemode = noresponse
/ posttrialpause = 0
</trial>

<trial dphot2>
/ pretrialpause = 4500
/ stimulustimes = [0 = dud; 100 = null;]
/ responsemode = noresponse
/ posttrialpause = 0
</trial>

<trial dphot3>
/ pretrialpause = 5000
/ stimulustimes = [0 = dud; 100 = null;]
/ responsemode = noresponse
/ posttrialpause = 0
</trial>

<trial dphot4>
/ pretrialpause = 5500
/ stimulustimes = [0 = dud; 100 = null;]
/ responsemode = noresponse
/ posttrialpause = 0
</trial>

<trial dphot5>
/ pretrialpause = 6000
/ stimulustimes = [0 = dud; 100 = null;]
/ responsemode = noresponse
/ posttrialpause = 0
</trial>

<trial dphot6>
/ pretrialpause = 6500
/ stimulustimes = [0 = dud; 100 = null;]
/ responsemode = noresponse
/ posttrialpause = 0
</trial>

<trial dphot7>
/ pretrialpause = 7000
/ stimulustimes = [0 = dud; 100 = null;]
/ responsemode = noresponse
/ posttrialpause = 0
</trial>

```

```
<block expstart>
/ screencolor = (100, 100, 200)
/ preinstructions = (ready)
/ bgstim = (runningreminder)
/ trials = [1 = start;]
</block>
```

```
<block expend>
/ screencolor = (11, 0, 130)
/ trials = [1 = end;]
</block>
```

```
<block run1>
/ screencolor = (165, 0, 190)
/ trials = [1-313 = replace (photA1,
photA2, photA3, photA4, photA5, photA6,
photA7, photB1, photB2, photB3, photB4,
photB5, photB6, photB7, photD1, photD2,
photD3, photD4, photD5, photD6,
photD7, dphot1, dphot2, dphot3, dphot4,
dphot5, dphot6, dphot7)]
</block>
```

```
<expt>
/ blocks = [1 = expstart; 2 = run1; 3 =
expend;]
</expt>
```

NAton.jpg:

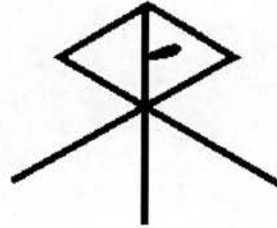

Enigma780.gif:

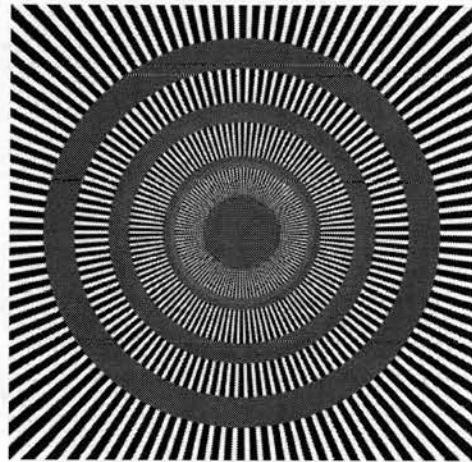

Appendix E

Circuit diagram for optical isolation signal router

