

**The Vitamin C content of underground storage organs.  
Control by import and turnover.**

**Malcolm S. Bain**

**A thesis presented in fulfilment of the requirements of the  
degree of Doctor of Philosophy.  
The University of Edinburgh 2005**



## **Acknowledgements**

I would like to thank Professor Steve Fry for his help, advice, patience and enthusiasm during the completion of this body of wrk throughout the past 4 years.

I would like to thank the BBSRC for funding the studentship.

Thank you to my superb family and group of friends, who were always there when I needed them.

Most of all, thank you Hanna, you make everything wonderful.

## Abbreviations

AgNO <sub>3</sub>	Silver nitrate
Asc	Ascorbate
DCPIP	Dichlorophenolindolphenol
DTT	Dithiothreitol
BuOH:HOAc:H <sub>2</sub> O	Butanol/acetic acid/water (12:3:5, v/v/v)
DHA	Dehydroascorbate
DKG	Diketoglutonate
GalA	Galacturonic acid
GalO	Galactonic acid
GalOL	Galactonolactone
HCl	Hydrochloric acid
HPLC	High pressure liquid chromatography
HPO <sub>3</sub>	Metaphosphoric acid
H <sub>2</sub> O	Water
H <sub>2</sub> O <sub>2</sub>	Hydrogen peroxide
H <sub>2</sub> SO <sub>3</sub>	Suphurous acid
HSO <sub>3</sub> <sup>-</sup>	Bisulphite
NaOH	Sodium Hydroxide
NaBH <sub>4</sub>	Sodium borohydridre
MPE	Mercaptoethanol
<i>m</i> -Tar	<i>meso</i> -Tartrate
OG	Orange G
SE	Standard error
SO <sub>3</sub> <sup>2-</sup>	Sulphite
Tar	Tartrate
TFA	Trifluoroacetic acid
ThrO	Threonate

## **ABSTRACT**

The vitamin, L-ascorbate is an essential component of human nutrition and is readily available in fruits and vegetables. L-Ascorbate is reported as present in plant cell walls and thought to inhibit oxidative coupling and lignification of the wall, while it may also promote expansion. L-Ascorbate is also an important antioxidant in both plants and animals, reacting with oxidative radicals present in the environment and produced by biochemical reactions within cells. L-Galactonolactone has been shown to be the direct precursor to L-ascorbate; however, information regarding L-ascorbate degradation is limited to only a few plant species and within limited organ types.

Ascorbate is the precursor for the synthesis of several well-documented metabolic products including L-tartrate, L-threonate and oxalate. However, studies into the conversion of L-ascorbate to these compounds has only ever taken place within excised immature fruit or leaves. It was of interest to trace the metabolic fate of L-ascorbate within an intact plant, including the possible transport of L-ascorbate throughout the plant and also its metabolism within a storage organ.

Endogenous ascorbate concentrations remained unaffected following exposure of excised radish hypocotyls to various forms of stress that included aerobic, anaerobic, light, dark, 254 and 366 nm ultraviolet and contact with 33 mM sodium nitroprusside. Exposure of intact radish plants to a high-oxygen atmosphere produced significant drops in the ascorbate concentrations of the hypocotyl tissue.

Irrigation of the roots of radish plants with 50 mM sodium ascorbate did not affect hypocotyl ascorbate concentrations. Exposing radish plants to (50 mM) sodium ascorbate

by watering through laterally trimmed roots and vacuum infiltration failed to increase endogenous ascorbate concentrations.

Excised radish leaves fed 0.1 M L-galactonolactone showed a clear increase in L-ascorbate concentrations. Hypocotyls bathed in 0.1 M L-galactonolactone showed no increase in L-ascorbate concentrations. Radish plants fed L-galactonolactone through an incision in a leaf petiole showed a clear increase in L-ascorbate concentrations in the fed leaf as well as neighbouring leaves; however, no increase in ascorbate concentrations was seen in the hypocotyl.

Hypocotyl disks bathed in de-gassed water for 24 hours showed production of L-ascorbate after being fed L-galactonolactone as well as clear uptake of L-[6-<sup>3</sup>H]galactonolactone with a  $K_m$  of 0.96 nM. mM ?

A hypocotyl disk fed 17 MBq of L-[6-<sup>3</sup>H]galactonolactone produced cellular radiolabelled ascorbate as well as several other unknown metabolic products. The hypocotyl bathing solution contained several unknown products released by the cells into the extracellular fluid. Compounds were detected by electrophoretic fluorography at pH 6.5 and by chromatographic fluorography BuOH:HOAc:H<sub>2</sub>O (12:3:5). Unknown compounds were detected by this method while tartrate, threonate and oxalate, metabolites of ascorbate metabolism were not detected.

# Contents

**Title Page**

**Declaration**

**Dedication**

**Acknowledgements**

**Abbreviations**

**Contents**

**Abstract**

<b>1 Introduction</b>	1
1.1 The history of Vitamin C	1
1.1.1 Ascorbate as an antioxidant	2
1.1.2 Ascorbate and cell expansion	6
1.2 Ascorbate synthesis	8
1.3.1 The products of ascorbate catabolism	16
1.3.2 Ascorbate and tartrate	17
1.3.3 Ascorbate and oxalate	27
1.4 The transport of ascorbate and its regeneration	28
1.4.1 Intracellular ascorbate transport	28
1.4.2 Intercellular ascorbate transport	28
1.5 The radish plant	31
1.5.1 General morphology	31
1.5.1.1 The root	32
1.5.1.2 The hypocotyl	32
1.5.1.3 The shoot	33
1.5.2 Development of the seedling	33
1.5.3 Hypocotyl development	35
1.5.3.1 Vascular transition	36
1.5.3.2 Secondary and tertiary thickening of the primary root	38
1.6 Aims of project	39

<b>2 Materials and methods</b>	<b>40</b>
2.1 Radish growth conditions	40
2.1.1 Cultivar selection	40
2.1.2 Growth conditions for routine use	40
2.1.3 Bought hypocotyls	41
2.2 Experimentally decreasing endogenous ascorbate	41
2.2.1 Ascorbate breakdown in radish swollen hypocotyls	41
2.2.2 Exposure to water and heavy metals	41
2.2.3 Atmospheric tests	42
2.2.4 Sodium nitroprusside	42
2.2.5 Effect of ultraviolet	43
2.2.6 Effect of a high oxygen atmosphere	43
2.2.7 Irrigation with exogenous ascorbate	43
2.3 Experimentally increasing endogenous ascorbate	44
2.3.1 Xylene cyanol uptake	44
2.4 Ascorbate quantification	45
2.4.1 Measurement of endogenous ascorbate	45
2.5 Detection of markers and metabolites	46
2.5.1 Preperation of markers for electrophoresis and chromatography	46
2.5.2 Detection of markers by staining with silver nitrate	46
2.5.3 detection of markers by staining with bromophenol blue	47
2.5.4 Quantification of radioactivity by scintillation counting	48
2.6 Seperation of gaactonolactone metabolites	48
2.6.1 High-voltage paper electrophoresis at pH 6.5	48
2.6.2 High-voltage paper electrophoresis at pH 3.5	49
2.6.3 Paper chromatography	49
— 2.6.4 Ion exchange chromatography	50
2.6.5 Metabolite elution from paper	51
2.6.6 Purification of D-[6- <sup>14</sup> C]galacturonic acid	52
2.6.7 Conversion of D-[6- <sup>14</sup> C]galacturonic acid to L-[1- <sup>14</sup> C]galactonic acid	52
2.6.8 Conversion of L-[1- <sup>14</sup> C]galactonic acid to L-[1- <sup>14</sup> C]galactonolactone	53
2.6.9 One-pot conversion of D-[6- <sup>14</sup> C]galacturonic acid to L-[1- <sup>14</sup> C]galactonolactone	53

2.6.10 Autoradiography	54
2.6.11 Fluorography	54
2.6.12 Materials	54
<b>3 Method development influencing hypocotyl ascorbate content</b>	<b>55</b>
3.1 Experimentally lowering levels of ascorbate within the hypocotyls	55
3.2 Solute uptake directly into the hypocotyls and via the root system	63
3.3 The effect of exogenous ascorbate on ascorbate content of plants	70
<b>4 Uptake of L-ascorbate and L-galactonolactone by radish leaves and the intact plant</b>	<b>76</b>
<b>5 Uptake of metabolites by excised hypocotyl disks</b>	<b>86</b>
5.1 Uptake of L-[1- <sup>14</sup> C]galactonolactone by hypocotyls disks	86
5.2 Uptake of L-[6- <sup>3</sup> H]galactonolactone by underground storage organs	93
5.3 Uptake of radiolabelled sugars by underground storage organ disks	96
5.4 Uptake of L-[6- <sup>3</sup> H]galactonolactone by radish hypocotyls disks following overnight washing	99
<b>6 Conversion of D-[6-<sup>14</sup>C]galacturonic acid to L-[1-<sup>14</sup>C]galactonolactone</b>	<b>109</b>
6.1.1 Purification of D-[6- <sup>14</sup> C]galacturonic acid	109
6.1.2 Conversion of D-[6- <sup>14</sup> C]galacturonic acid to L-[1- <sup>14</sup> C]galactonic acid	111
6.1.3 Conversion of L-[1- <sup>14</sup> C]galactonic acid to L-[1- <sup>14</sup> C]galactonolactone	113
6.1.4 Single pot conversion of D-[6- <sup>14</sup> C]galacturonic acid to L-[1- <sup>14</sup> C]galactonolactone	118
6.2 Detecting possible secreted metabolites	119
6.2.1 Separation of possible ascorbate turnover products by ion exchange chromatography and electrophoresis	124
6.3 Metabolism of exogenous L-[6- <sup>3</sup> H]galactonolactone	136
<b>7 Discussion</b>	<b>152</b>
<b>8 References</b>	<b>161</b>



# **1 INTRODUCTION**

## **1.1 THE HISTORY OF VITAMIN C**

L-Ascorbate, vitamin C, is the simplest of all the vitamins (Fig. 1). Ascorbate was among the first vitamins to be purified and characterised. It is manufactured in all metabolically active tissues of land plants. Animals that have the ability to oxidise L-gulono-1,4-lactone can synthesise ascorbic acid. Animals lacking this ability include certain insects, fish, birds and mammals, including all primates. These animals rely on dietary sources of vitamin C for survival. Deficiency in ascorbate results in scurvy, affecting many sailors throughout the middle ages, often leading to death. Fresh fruit and vegetables were recommended to long-voyage sailors to combat scurvy; however, at this time the benefit from fruit and vegetables was strongly contested (Davies *et al.*, 1991; Carpenter, 1986). During this period of history it was suggested that the consumption of various juices and fruits was effective in the prevention or treatment of the disease. James Lind, a surgeon on the H.M.S. Salisbury between 1746 and 1747, went on to identify oranges and lemons to be an effective treatment for scurvy although he remained sceptical of the preventative role of many fresh fruit and vegetables (Carpenter, 1986). It took until 1795 before the British Navy was persuaded to carry lemon juice aboard ships, solving the problem of scurvy amongst British Navy sailors. By the mid 19<sup>th</sup> century scurvy had begun to be recognised as a deficiency disease (Carpenter, 1986), and in the early part of the 20<sup>th</sup> century, the role of fresh fruit and vegetables' role in the prevention of scurvy was being studied. In 1907 results of research into the cause of scurvy in guinea pigs was published by Holst and Frölich. During the first world war the Lister Institute suggested the

beneficial properties of milk and fruit juice in the protection against scurvy. In 1919, Drummond described the anti-scorbutic effect as water-soluble C. In the late 1920's Szent-Györgi, identified a reducing factor extracted from adrenal cortex (Burns, 1967). He believed the reducing agent was a hormone with the nature of a sugar. He identified its molecular formula as  $C_6H_8O_6$  and named the compound "hexuronic acid", while in the same year he extracted large amounts of "hexuronic acid" for elucidation of its structure and properties (Burns, 1967; Hirst *et al.*, 1933). In 1933, Reichstein *et al.* identified a method for synthesis of "hexuronic acid" and Haworth *et al.* (1934) suggested a structure for Szent-Györgi's "hexuronic acid". They also confirmed this structure by development of various synthetic routes of production, leading to the naming of this compound as vitamin C.

### **1.1.1 ASCORBATE AS AN ANTIOXIDANT**

Aerobic metabolism, the interaction of light with pigments and environmental pollutants all expose plants to several reactive oxygen species. These include superoxide, hydrogen peroxide, hydroxyl radicals and singlet oxygen. Some of these reactive oxygen species can readily oxidise proteins, unsaturated fatty acids and DNA, causing damage to cell function. Ascorbate and glutathione are the major small molecule antioxidants within the plant cell. Leaf cells have 2–5 mM ascorbate and less than 1 mM glutathione (Noctor and Foyer, 1998). The significance of a lower concentration of glutathione remains unclear. However, the oxidised free radical of ascorbate, monodehydroascorbate, is much less reactive and therefore much less damaging within the cell than radicals derived from

glutathione (Sturgeon *et al.*, 1998). With an ever-growing world population, and increased industrialisation in Eastern Europe, Asia and South America, there has been a steady increase in the levels of oxidative pollutants produced within the earth's atmosphere (Barnes *et al.* 1999). O<sub>2</sub> is essential for survival. However, it is also responsible for several reactive oxygen species including the superoxide ion (O<sub>2</sub><sup>•-</sup>), the hydroxyl radical (•OH) and ozone (O<sub>3</sub>), all of which are extremely reactive and cytotoxic (Scandalios, 1993). Cellular O<sub>2</sub> concentrations are highest in plants of all aerobic organisms, with concentrations in mammalian mitochondria, 0.1 μM, much lower than the 250 μM generated in leaf cells during photosynthesis (Scandalios, 1993). Ozone (O<sub>3</sub>) has been steadily on the increase throughout the last century and is now one of the most prevalent photochemically produced air pollutants in the northern hemisphere (Volz and Kley, 1988; Marengo *et al.*, 1994). Ozone enters the leaf through open stomata and then dissolves in the mesophyll cell's apoplastic fluid (Kersteins and Lenzian, 1989). In aqueous solution ozone decomposes and then forms the hydroxyl radical. The damage caused by ozone can cause major alterations to membrane function (Pauls and Thompson, 1981), as well as in components of the cytosol (Heath, 1980). To avoid damage to cellular function the plant has antioxidants within the apoplast to detoxify reactive species.

Apoplastic ascorbate has been postulated to provide the first line of defence against reactive oxygen species, including sulphur dioxide (SO<sub>2</sub>) and ozone (Smirnoff, 1996; Turscanyi *et al.* 2000, Barnes *et al.* 2000). Barnes *et al.* (1999) also provide evidence suggesting that plants may increase their resistance to air pollution over generations,

while Simontacchi *et al.* (1995) provided evidence that plants increase levels of antioxidants in direct response to oxidative stress.

Other anti-oxidant systems within the cell such as MDHA reductase and glutathione also function to remove reactive oxygen species and other free radicals, protecting the cell. Ascorbate is a highly reactive anti-oxidant present in the apoplast (Sanchez *et al.* 1997, Hove *et al.*, 2001, Luwe *et al.* 1993). Ascorbate reacts with ozone and with its breakdown product, the hydroxyl radical, removing them from the apoplastic solution. Ascorbate has been shown to play an important role in level of resistance to ozone (Zheng *et al.* 2000, Lyons *et al.* 1999). Plants with increased leaf ascorbate have increased resistance to ozone (Maddison *et al.* 2002). In 1996, Conklin *et al.* showed that an *Arabidopsis* mutant (*soz 1*) had increased sensitivity to ozone, sulphur dioxide and ultraviolet B irradiation because it accumulated only 30% of the ascorbate levels of an *Arabidopsis* wild type.

The rapid increase in ozone due to industries within western countries has been mirrored by SO<sub>2</sub> production in eastern countries and South America. Sulphur dioxide is produced by the burning of fossil fuels, and enters leaves through open stomata. It dissolves in apoplastic fluid and forms sulphurous acid (H<sub>2</sub>SO<sub>3</sub>), which is neutralised to form sulphite (SO<sub>3</sub><sup>2-</sup>) and bisulphite (HSO<sub>3</sub><sup>-</sup>) (Takahama *et al.* 1992). The presence of these compounds leads to increased formation of superoxide within the apoplast (Asada and Kiso, 1973; Asada *et al.* 1974). These compounds can be oxidised to sulphate (SO<sub>4</sub><sup>2-</sup>) by apoplastic peroxidases (Takahama, 1992). Sulphate and / or bisulphite produces sulphite radicals, which in the absence of ascorbate are able to generate uncontrolled radical reactions (Takahama *et al.* 1992). However, apoplastic peroxidases use ascorbate as a co-factor to remove these compounds (Takahama *et al.* 1992) along with superoxide

dismutases which convert superoxide to  $O_2$  and hydrogen peroxide (Tanaka and Sugahara, 1980) reducing cytotoxic effects. Cytoplasmic and chloroplastic ascorbate may provide defence against naturally-produced reactive oxygen species. Ascorbate (Fig. 1) reacts with the reactive oxygen species to produce monodehydroascorbate (Fig. 1). Monodehydroascorbate then disproportionates to form dehydroascorbate (Fig. 1) and ascorbate.

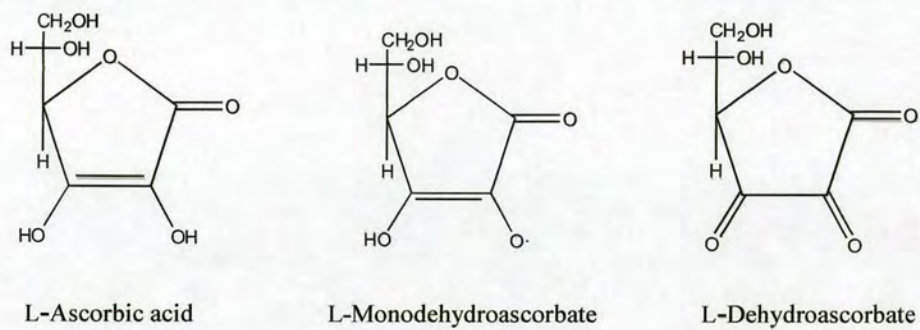

**Fig. 1.1 The oxidation products of ascorbate**

Dehydroascorbate is unstable at physiological pH levels. To maintain the ascorbate pool the plant reduces monodehydroascorbate and dehydroascorbate using three enzymes in the ascorbate–glutathione cycle: monodehydroascorbate reductase, glutathione-dependent dehydroascorbate reductase and glutathione reductase (Smirnoff, 1995; Noctor and Foyer, 1998; Asada 1999).

### 1.1.2 ASCORBATE AND CELL EXPANSION

It is proposed that the products of ascorbate oxidation, monodehydroascorbate and dehydroascorbate, influence cell expansion (Smirnoff, 1996). Application of ascorbate plus dehydroascorbate, a mixture which produces traces of monodehydroascorbate, has been shown to stimulate cell expansion in onion roots (Hidalgo *et al.*, 1989; Gonzalez-Reyes, 1994; Gonzalez-Reyes, 1995). Whether this is proof of monodehydroascorbate action on root growth is debatable. Expansion is claimed to occur as a result of increased cytosol-to-apoplast transmembrane electron transport using apoplastic monodehydroascorbate as electron acceptor *via* the cytochrome *b* system (Smirnoff, 2000). Lin and Varner (1990) identified ascorbate oxidase in high concentrations at sites of rapid cell expansion e.g. fruit epidermis. Esaka *et al.*, (1992) supported this by identifying ascorbate oxidase in areas of meristematic activity, e.g. root tips and also expanding cucurbit fruits. Ascorbate oxidase is also very low in embryonic axes of pea seedlings during early germination. However, a marked increase in ascorbate oxidase activity has been noted just preceding initiation of embryonic axis growth (Esaka *et al.*, 1992). This suggests that cell growth may be promoted by ascorbate oxidase or its reaction products. No evidence exists identifying whether ascorbate oxidase is present in order to break down ascorbate at the site of expansion, or for production of monodehydroascorbate, the enzyme product. Neither does any evidence exist that cell wall expansion is actually due to ascorbate oxidase presence. It may be a consequence rather than cause of cell expansion in plants.

Lin and Varner (1991) propose dehydroascorbate is formed to: (a) prevent wall protein covalent cross-linking by modification of lysine side chains; (b) prevent electrovalent interactions between wall proteins and pectin by modifying the positively charged lysine and arginine residues that would normally interact with negatively charged polygalacturonate; (c) remove of calcium from the calcium-pectin complex in the cell wall by calcium-oxalate formation causing a less rigid wall and accommodating cell wall loosening.

Cordoba-Pedregosa *et al.* (1996) suggested that ascorbate inhibits wall peroxidase action through direct scavenging of hydrogen peroxide. The inhibition of peroxidase action would reduce peroxidative cross-linking of wall polymers, keeping the cell wall relatively extensible. In contrast, Fry (1998) proposed that apoplastic ascorbate may function to generate hydroxyl radicals. These are generated by hydrogen peroxide reacting with traces of reduced transition metals within the cell wall. The apoplastic ascorbate mediates reduction of dioxygen and  $\text{Cu}^{2+}$  (Eqns. 1, 2 &3).

Eqn.

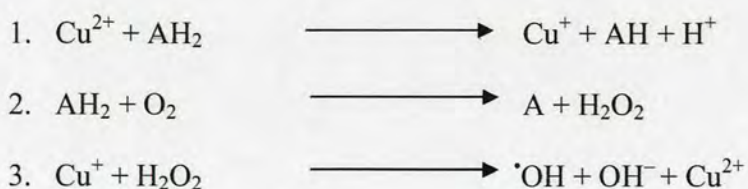

The hydroxyl radicals produced would be capable of causing scission of cell wall polysaccharides. This has been shown to occur *in vitro* (Fry, 1998). Fry *et al.* (2001) also provide evidence for *in vivo* polysaccharide scission. Evidence identifies  $\cdot\text{OH}$ - attacked

polysaccharides that may be a result of a process involved in the softening of pear (*Pyrus communis*) fruit.

## **1.2 ASCORBATE SYNTHESIS**

Ascorbate is produced in plants throughout their lives within various tissues, in some cases to very high levels; as in the case of rose hip which contains approximately 1000 mg/ascorbat/g fresh weight (Davies *et al.*, 1991). There has been a great deal of discussion over the possible pathways of ascorbate synthesis. Horowitz *et al.* (1952) found that rats anaesthetised with the xenobiotic chlorotone, and then fed D-[1-<sup>14</sup>C]glucose excreted urinary ascorbate labelled at carbon 6. Further labelling by Horowitz and King (1953), Loewus *et al.* (1960) and Burns (1967) using D-[6-<sup>14</sup>C]- and D-[2-<sup>14</sup>C]glucose led to the identification of the pathway of ascorbate synthesis in albino rats. From 1954 until the present day, no pathway for ascorbate synthesis in plants has been conclusively proven. Isherwood *et al.* (1954) proposed an analogous pathway to that of Horowitz and King (1953) for biosynthesis of ascorbate in higher plants (Fig. 2). Isherwood *et al.* (1956) tested this scheme using D-[1-<sup>14</sup>C]-, D-[2-<sup>14</sup>C]- and D-[6-<sup>14</sup>C]glucose administered to detached strawberries: <sup>14</sup>C was recovered predominantly from carbons 1, 2 and 6 of ascorbic acid respectively. This is clear evidence for conversion of glucose to ascorbate with retention of the six-carbon chain without inversion or fragmentation. This disproves the pathway shown in Fig. 2 as the sole possible pathway since inversion takes place. Further studies using D-[1-<sup>14</sup>C]glucose administered to other species including geranium apices (*Pelargonium crispum* L.) and



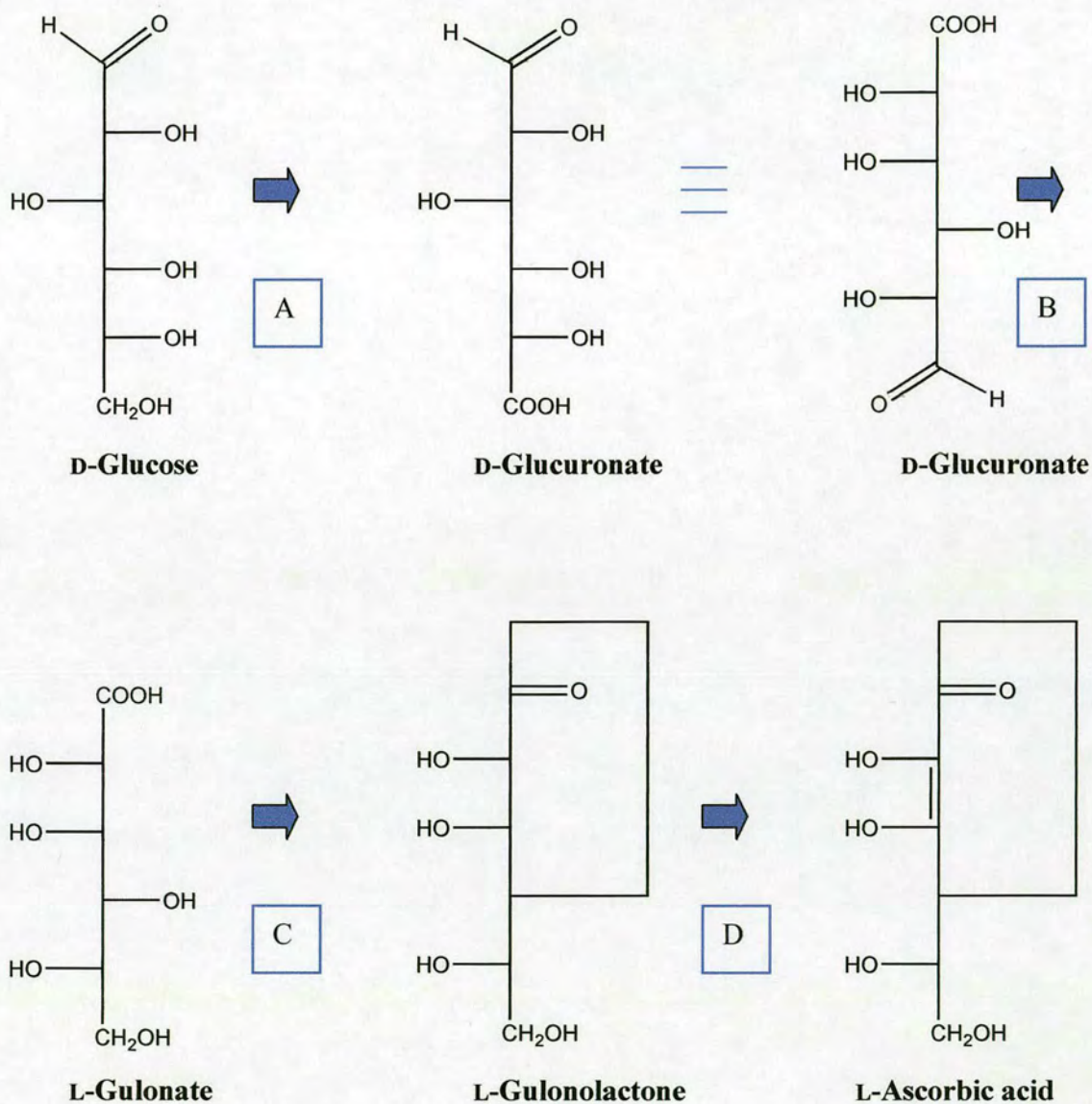

**Fig. 1.2 Scheme proposed by Burns (1967) for biosynthesis of ascorbate in albino rat.**

**A**, Oxidation at C6; **B**, reduction at C1; **C**, C1 to C4 lactonisation; **D**, oxidation at either C2 or C3

Virginia creeper leaves (*Parthenocissus quinquefolia* L.) confirmed that no inversion or fragmentation of glucose takes place in the production of ascorbate. The use of radioisotopic tracers, until 1998, had failed to identify a sequence of reactions for ascorbate synthesis in higher plants. However, four chemical events were known to have to occur in the non-inversion conversion of D-glucose to L-ascorbate.

- Oxidation of carbon 1
- Oxidation at either carbon 2 or carbon 3
- Epimerisation at carbon 5
- Lactonisation between carbons 1 and 4

Loewus and Kelly (1961) provided evidence for epimerisation at C5 of D-glucose during conversion to L-ascorbate using the radioisotope D-[6-<sup>14</sup>C]glucose. Loewus and Kelly also carried out work with strawberry (*Fragaria*) feeding strawberry fruit D-[6-<sup>14</sup>C]glucosone (D-*arabino*-[6-<sup>14</sup>C]hexos-2-ulose), which proved a more effective precursor than D-[6-<sup>14</sup>C]glucose in labelling L-ascorbate. They found that 90 to 98% of <sup>14</sup>C present in L-ascorbate was in position 6 of the carbon chain when D-[6-<sup>14</sup>C]glucosone was fed to strawberry.

Loewus *et al.* (1990) went on to propose a non-inversion pathway for L-ascorbate biosynthesis (Fig. 3) involving: oxidation of D-glucose at C2, epimerisation at C5 and lactonisation at C1 and C4.

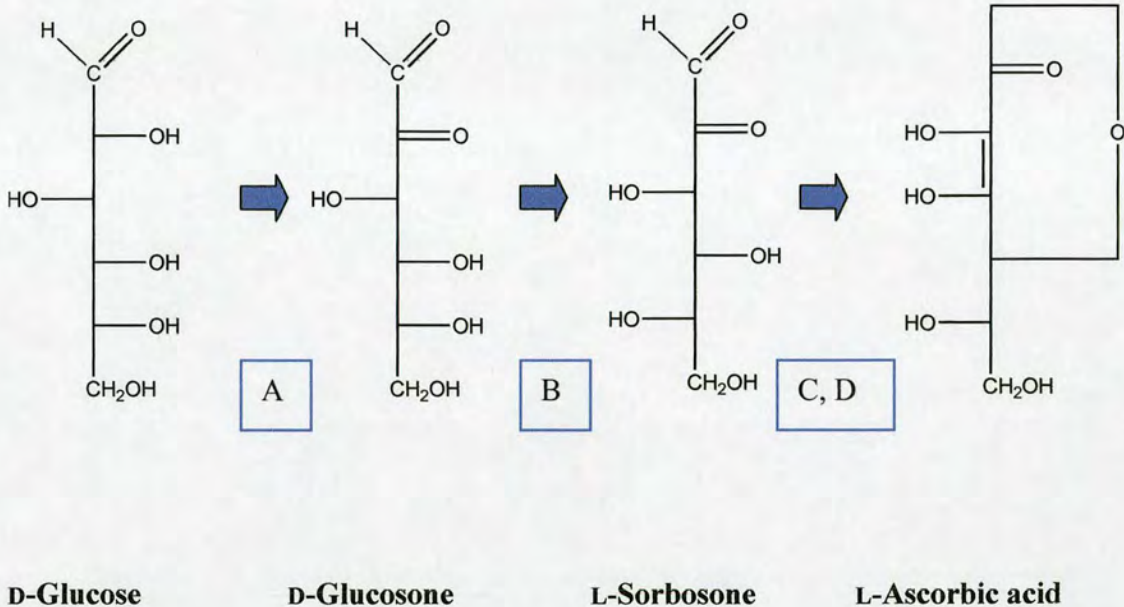

**Fig. 1.3 Non-inversion scheme proposed by Loewus *et al.* (1990).**

**A**, Oxidation at C2; **B**, epimerisation at C5; **C**, oxidation at C1; **D**, lactonisation

This involved the intermediate D-glucosone which had been previously been detected in red algae and several species of macrofungi, although it has never been detected in higher plants. Loewus *et al.* (1990) assumed the presence of D-glucosone, and then assumed that D to L epimerisation at C5 occurred after oxidation of carbon 2. This would lead to L-sorbosone (*L-xylo-hexos-2-ulose*). L-Sorbosone is then proposed to be oxidised by an NADP-dependent dehydrogenase that has been reported in bean and spinach leaf (Saito *et al.*, 1990), producing L-ascorbate by the removal of hydrogen from C1. An observation to

note from Isherwood *et al.* (1954) is that exogenously supplied L-galactono-1,4-lactone readily converts to L-ascorbate in plants, and this has been repeatedly confirmed (Baig *et al.*, 1970; Leung and Loewus, 1985) yet Loewus *et al.* (1990) proposed a pathway in which D-glucosone (detected in algae, but not in plants) is an intermediate while galactono-1,4-lactone is not. The failure to detect endogenous L-galactono-1,4-lactone (Wheeler *et al.* 1998) in plants could be as a result of its rapid conversion to ascorbate. If L-galactono-1,4-lactone is the natural precursor of L-ascorbate, then an enzyme for L-galactono-1,4-lactone synthesis must exist. Wheeler *et al.* (1998) proposed a pathway that involved L-galactono-1,4-lactone (Fig. 4). They identified the novel enzyme L-galactose:NADP<sup>+</sup> oxidoreductase in higher plants, which converts L-galactose to L-galactono-1,4-lactone *in vitro*. The authors suggested that the enzyme produces L-galactono-1,5-lactone, an unstable product that naturally re-arranges to the more stable L-galactono-1,4-lactone; however, there is no evidence to support this. L-Galactose can exist either in the pyranose (6 membered ring) ~ 94% or furanose (5 membered ring) ~ 6% (Loewus, 1999), and Wheeler *et al.*, (1998) have simply chosen the more prevalent of the two, which would yield L-galactono-1,5-lactone. The other critical area of study, in their pathway, was the proposed production of L-galactose 1-phosphate from GDP-L-galactose, leading to the formation of L-galactose. Wheeler *et al.* (1998) found GDP-mannose-3,5-epimerase activity in extracts of pea embryonic axes, as well as in ammonium sulphate precipitates of *Arabidopsis thaliana* leaves. Using GDP-D-[U-<sup>14</sup>C]mannose as substrate, Wheeler *et al.* (1998) identified L-galactose and one or more acidic compounds which produced L-galactose after hydrolysis. They proposed that L-galactose was formed as a result of specific hydrolytic activities acting on GDP-L-

galactose then L-galactose 1-phosphate to form L-galactose, since very little free mannose was released from GDP-D-[U-<sup>14</sup>C]mannose by the same enzyme preparation. When the experiment was repeated on pea extracts with cytochrome *c*, radioactive L-ascorbate was identified. Although these results are not conclusive, they put forward a strong argument for one possible pathway for the synthesis of ascorbate in plants (Fig. 4).

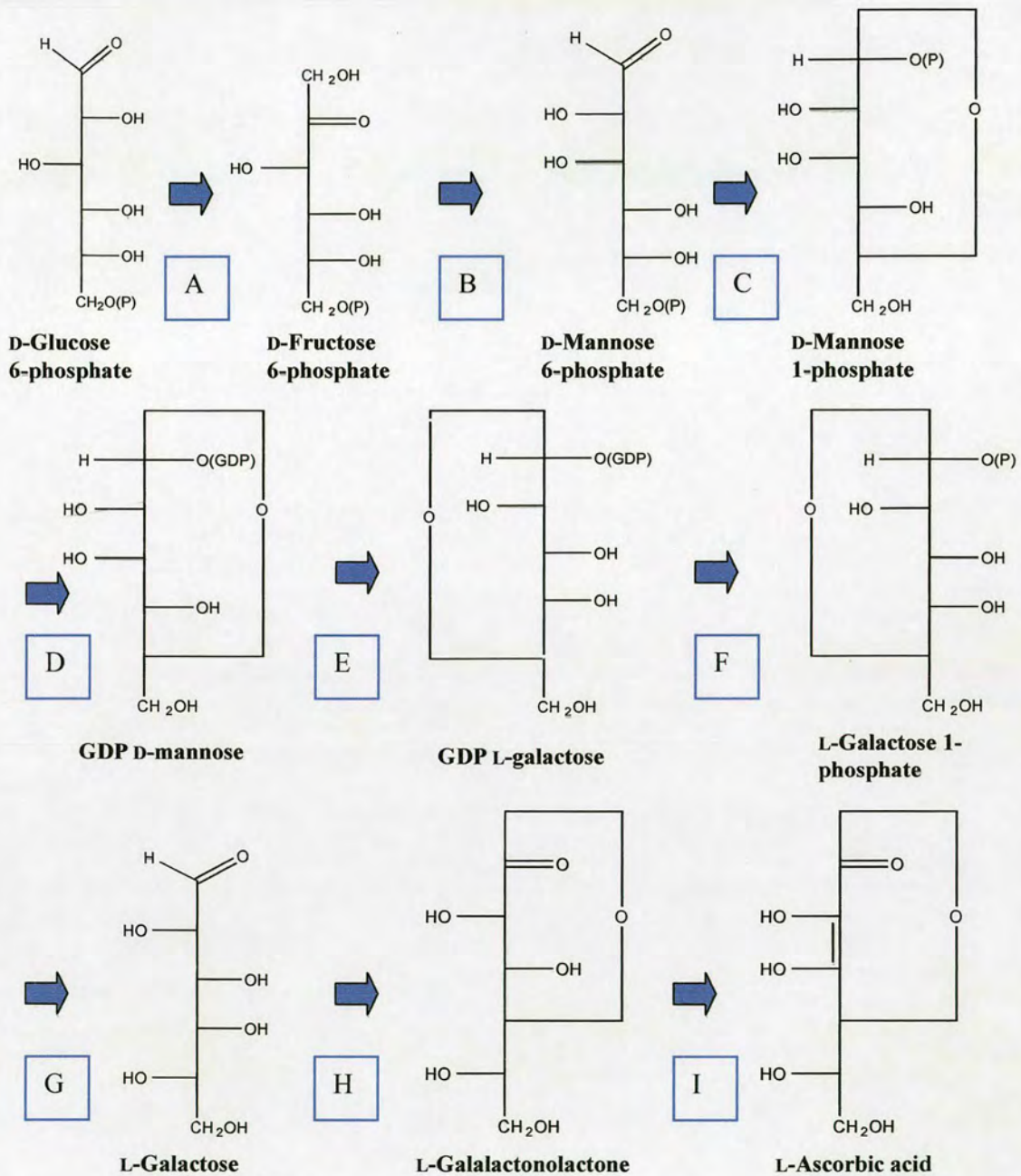

**Fig. 1.4 L-Ascorbate biosynthesis in plants as proposed by Wheeler *et al.* (1998)**

**A,** Isomerisation by phosphoglucose isomerase; **B,** isomerisation by phosphomannose isomerase; **C,** isomerisation by phosphomannose mutase; **D,** transfer reaction by GDP-mannose pyrophosphorylase; **E,** epimerisation; **F,** hydrolysis at C1; **G,** hydrolysis at C1; **H,** oxidation at C1; **I,** oxidation at C2 and C3

### **1.3.1 THE PRODUCTS OF ASCORBATE CATABOLISM**

To date, the identification of plant-related functional roles involving intact L-ascorbate has largely focused on its redox properties, and has received a great deal of attention (Halliwell, 1996; Smirnoff and Pallanca, 1996; Noctor and Foyer, 1998; Smirnoff, 1996). These and most other studies have put considerable focus on ascorbate's roles in photosynthesis (Miyake and Asada, 1992; Neubauer and Yamamoto, 1992; Smirnoff, 1996), plant stress (Miyake and Asada, 1992; Takahama *et al.*, 1992; Luwe *et al.*, 1993; Polle *et al.*, 1995), cell division (Smirnoff, 1996), cell wall expansion and polysaccharide scission (Esaka *et al.*, 1988; Smirnoff, 1996; Fry, 1998; Fry, 2001). Less work has gone into the breakdown of L-ascorbate by cleavage of the carbon skeleton. Identification of methods of plant ascorbate cleavage within the cell may allow down-regulation of such processes. This may lead to an increase in ascorbate content within tissues, affording better protection against pollutants and their damaging effects as well as increased nutritional benefits.

### 1.3.2 ASCORBATE AND TARTRATE

Ascorbate is also an intermediate. During turnover, ascorbate's major end products are L-tartrate (Fig. 5), L-threonate, oxalate, CO<sub>2</sub> and products obtained by recycling through triose phosphates and hexose phosphates (Loewus, 1999).

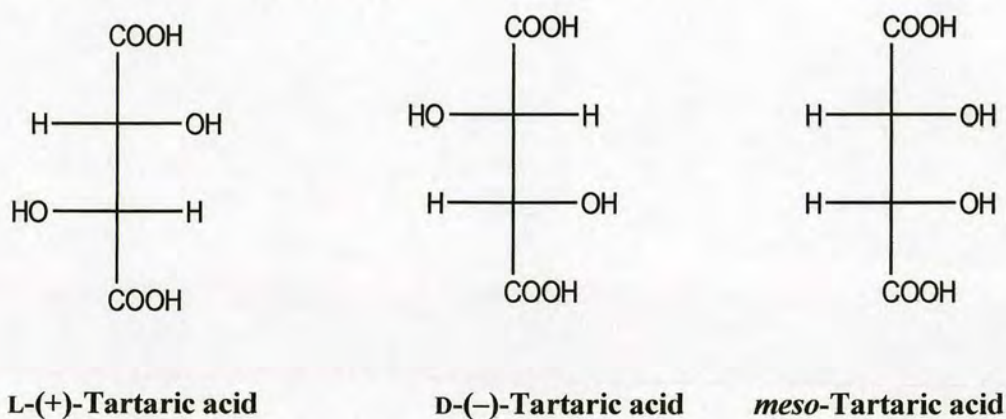

**Fig. 1.5 Isomers of tartaric acid**

As ascorbate and tartrate are commonly found to occur together in plants, Hough and Jones (1958) proposed that L-ascorbate could be a precursor for L-tartrate through cleavage of the C2–C3 bond and subsequent oxidation of the C<sub>4</sub> fragment. They tested their hypothesis using L-[6-<sup>14</sup>C]ascorbate fed to detached grape leaf (a tartrate accumulator). However, Hough and Jones found that 85% of the <sup>14</sup>C was incorporated into glucose, fructose, sucrose, unidentified higher oligosaccharides and polysaccharides after 24 hours of metabolism. This suggested that carbon 6 of L-ascorbate was not involved in tartrate synthesis. Loewus and Stafford (1958) released data showing that 90% of the <sup>14</sup>C from L-[6-<sup>14</sup>C]ascorbate administered to grape leaf, following metabolism for 25 hours, finished up in C1, C3, C4 and C6 of glucose with almost equal labelling



between these four atoms. Loewus and Stafford suggested that if L-[6-<sup>14</sup>C]ascorbate entered the triose phosphate pool, it would be converted to L-[5-<sup>14</sup>C]pentose, then to D-[1-<sup>14</sup>C]pentose by inversion of the carbon chain. Pentose phosphate metabolism would then lead to [1,3-<sup>14</sup>C]hexose phosphates. Following equilibration with triose phosphate metabolism in the leaf, [1,3-<sup>14</sup>C]hexose phosphates would form D-glucose labelled in the reported positions. However, Loewus and Stafford do not support this hypothesis with any evidence.

Saito and Kasai (1969) used immature grape berries to examine ascorbate catabolism. Administering L-[1-<sup>14</sup>C]ascorbate, they found 72% of <sup>14</sup>C in the soluble fraction as tartaric acid, with <sup>14</sup>C predominantly in the C1 carboxyl group after 24 hours. The <sup>14</sup>C detected in C2 and C3 of tartaric acid can be explained as being due to slight recycling of L-[1-<sup>14</sup>C]ascorbate through the pentose and hexose phosphate pathways. This paper points towards a pathway where L-ascorbate is cleaved at the C4–C5 bond, with the 4-carbon fragment going on to produce L-tartrate (Wagner *et al.*, 1975; Fig. 5), while the C<sub>2</sub> fragment is recycled, most likely through the sugar-phosphate pathways. Stafford (1961) performed quantitative analysis of the Geraniaceae as a method of taxonomic characterisation. Within this family, a variety of species within *Geranium*, *Erodium* and *Pelargonium* were examined. Stafford grouped all *Geranium* and *Erodium* into group C, non-accumulators. *Pelargonium* consisted of mostly group A, high accumulators of tartaric acid (greater than 0.1 μmol / g fresh weight), although several were in group B, low accumulators (less than 0.1 μmol / g fresh weight), and group C, non-accumulators of tartaric acid. *Pelargonium crispum*, a geraniaceous plant, is an identified tartrate accumulator, group A, (Stafford, 1961). Wagner and Loewus (1973) carried out

experiments similar to those of Saito and Kasai (1969) using *Pelargonium crispum* leaves fed L-[1-<sup>14</sup>C]ascorbate and L-[6-<sup>14</sup>C]ascorbate. They found that only the latter, L-[6-<sup>14</sup>C]ascorbate, labelled L-tartrate, and did so exclusively in the C4 carboxyl carbon of L-tartaric acid. L-[1-<sup>14</sup>C]Ascorbate labelled oxalate. These results suggested a contrasting pathway to that identified in grapes. They suggest that in *Pelargonium* L-ascorbate is cleaved at the C2–C3 bond, leading to formation of L-tartrate, while the 2-carbon fragment forms oxalic acid, as opposed to being recycled as in the grape pathway (Fig. 6). To study these pathways in more detail Williams and Loewus (1978) and Williams *et al.* (1979) fed L-[6-<sup>14</sup>C]galactono-1,4-lactone to *Pelargonium crispum* leaves. They found that labelled ascorbate had 90% of its <sup>14</sup>C in carbon 6 while 96% of the <sup>14</sup>C detected in tartaric acid was present in the C1 or C4 carboxyl group. These experiments did not distinguish between C1 or C4 labelling of L-tartrate carboxyl groups. When L-[U-<sup>14</sup>C]galactono-1,4-lactone was fed to *Pelargonium* the specific radioactivities of tartrate and oxalate were found to be identical, showing that following C4–C5 cleavage the products go on to form tartrate and oxalate, without carbon recycling as in the case of the Vitaceae pathway. Results obtained using L-[4-<sup>14</sup>C]ascorbate, L-[4-<sup>3</sup>H]ascorbate and L-[U-<sup>14</sup>C]ascorbate in *Pelargonium* and members of the Vitaceae, agreed with the C2–C3 cleavage in *Pelargonium* and C4–C5 cleavage in Vitaceae (Williams and Loewus, 1978; Saito and Loewus, 1979).

Studying the biosynthetic pathway of tartrate biosynthesis has resulted in the elucidation of three different pathways. The first occurs in grape and other vitaceous plants (Saito and Kasai, 1969, 1982, 1984; Malipiero *et al.*, 1987; Fig. 6). Saito and Kasai (1982) provided good evidence for this pathway. Grape slices (1 mm thick) were placed in a

glass cylinder on top of filter paper moistened with 0.1 ml 0.3 M potassium phosphate buffer, pH 5.5. [1-<sup>14</sup>C]Ascorbic acid solution (1 μCi/10 μl) was applied to the tissue surface. The cylinder was sealed and pressure reduced to 6 mm Hg for 30 sec and grape slices vacuum-infiltrated into the fruit and tested for intermediates after 5 hours of metabolism. Saito and Kasai identified <sup>14</sup>C in three ascorbate catabolic products: *L-xyl*o-hex-2-ulosonate, *L*-idonate and *L-xyl*o-hex-5-ulosonate, after which incorporation of <sup>14</sup>C into tartaric acid took place. They also carried out an inhibition experiment using iodoacetic acid. They used the same conditions as the initial experiment but the buffer solution used also contained 10<sup>-3</sup> M iodoacetic acid. In each experiment they found that the incorporation of <sup>14</sup>C into tartrate completely stopped, and the amount of <sup>14</sup>C that had been incorporated into tartrate in their control experiment was found to be divided among *L-xyl*o-hex-2-ulosonate, *L*-idonate and *L-xyl*o-hex-5-ulosonate. The work of Saito and Kasai (1982) provide a plausible route that these three intermediates could take from ascorbate to tartrate (Fig. 6). Saito and Kasai (1984) provide experimental evidence to support the order of these three intermediates in the pathway to tartrate (Fig. 6). They fed grape tissues dehydro-*L*-[1-<sup>14</sup>C]ascorbate, *L-xyl*o-hex-2-ulosonate, *L*-idonate and *L-xyl*o-hex-5-ulosonate. They found high levels of <sup>14</sup>C incorporation into tartrate very similar to that of the previous ascorbate experiment (Saito and Kasai, 1982) suggesting C1–C4 go on to form tartrate. When they fed grape tissues *L-xyl*o-hex-5-ulosonate, the <sup>14</sup>C was incorporated into sugars and insoluble residues in a similar manner to *L*-[6-<sup>14</sup>C]ascorbate (Saito and Kasai, 1982), suggesting that the C5–C6 fragment is recycled in the carbon pool.

The second pathway (Fig. 7) is thought to occur throughout many plant families, and is considered more important by some (Loewus, 1999), since this pathway generates high levels of oxalate, while producing tartrate in far lower quantities (Wagner and Loewus, 1973; Nuss and Loewus, 1978; Williams and Loewus, 1978; Williams *et al.*, 1979; Helsper and Loewus, 1982; Saito and Loewus, 1992). Wagner and Loewus (1973) fed L-[1-<sup>14</sup>C]ascorbate and L-[1-<sup>14</sup>C]galactono-1,4-lactone to *Pelargonium crispum*. After 72 hours of metabolism, 15.4 and 32.3% respectively of the <sup>14</sup>C was detected in tartrate. Less than 0.5% of the <sup>14</sup>C taken up by the foliated tips was found in oxalic acid. Application of L-[6-<sup>14</sup>C]ascorbate to *Pelargonium crispum* foliated tips produced 12.1% oxalate and only 0.4% tartrate after 72 hours of metabolism, supporting Fig. 7.

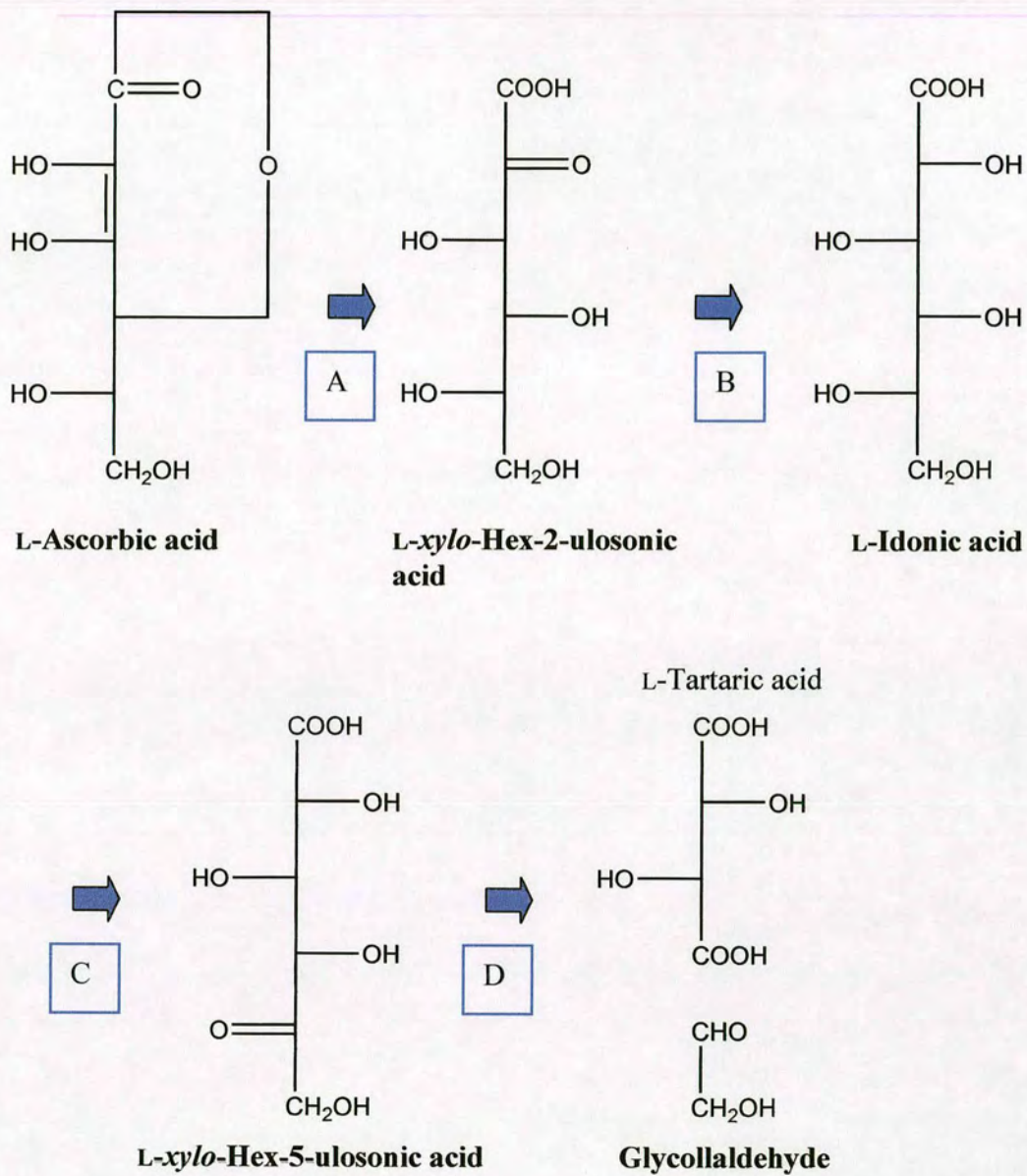

**Fig. 1.6 C4–C5 cleavage of L-ascorbate to form tartrate in vitaceous plants (Saito and Kasai, 1982; 1984).**

**A**, Oxidation; **B**, reduction at C<sub>2</sub>; **C**, oxidation at C<sub>5</sub> and cleavage at C<sub>4</sub>–C<sub>5</sub>; **D**, reduction of C<sub>2</sub> fragment.

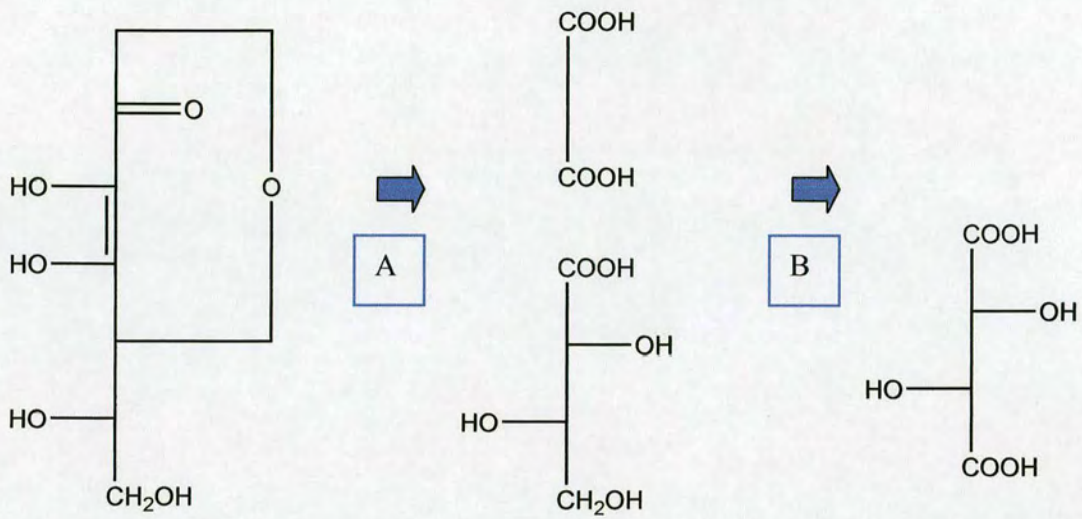

**L-ascorbic acid**

**oxalic acid + L-threonic acid**

**L-tartaric acid**

**Fig. 1.7 C2–C3 cleavage of L-ascorbate to form oxalate and tartrate in geraniaceous plants (Helsper and Loewus, 1982).**

**A, Hydrolysis and cleavage at C2–C3; B, oxidation at C4**

The third pathway in the synthesis of tartrate does not involve ascorbate. *myo*-Inositol is converted to D-gluconate and on to tartrate (Loewus *et al.*, 1962; Fig. 8). This pathway exists in leguminous plants, and does not appear consistently within a species (Saito and Loewus, 1989a). In tests of 32 cultivars of *Phaseolus vulgaris* L., Saito and Loewus (1989a) found only seven cultivars that accumulated significant levels of tartrate. They compared these against seven of the remaining 25 non-accumulating cultivars (Saito and Loewus, 1989b). The seven accumulator cultivars showed increased tartrate levels when D-glucuronate was administered, while D-xylo-hex-5-ulosonate, a proposed tartrate precursor (Saito and Kasai, 1982), was found to increase tartrate in the seven tartrate accumulators as well as seven tartrate non-accumulators. Labelling studies indicate that C4–C5 carbon chain cleavage takes place (Saito and Loewus, 1989a; Saito and Loewus 1989b; Saito, 1994).

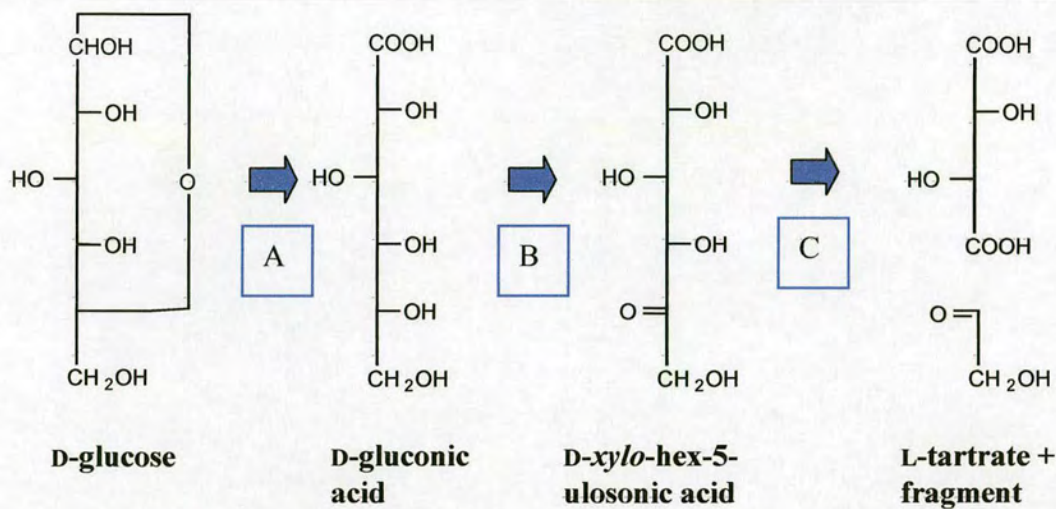

**Fig. 1.8 C4–C5 cleavage of D-gluconate to form L-tartrate in leguminous plants.**

A, Delactonisation; B, oxidation at C5; C, C4–C5 cleavage



### 1.3.3 ASCORBATE AND OXALATE

Through studies of the biosynthetic link between ascorbate and tartrate in *Pelargonium crispum* (Wagner and Loewus 1973), oxalic acid was identified as the C<sub>2</sub> fragment derived from carbons 1 and 2 of ascorbate. This led to further studies in the oxalate-accumulating plants *Amaranthus*, *Begonia*, *Beta*, *Chenopodium*, *Halogeton*, *Lemna*, *Nicotainia*, *Oxalis*, *Rheum*, *Rumex*, *Spinacia* and *Triticum* (Loewus, 1999), since ascorbate could be a major carbon source for oxalate biosynthesis. Yang and Loewus (1975) found that feeding the oxalate-accumulating plants *Spinacia oleracea*, *Oxalis stricta* and *Oxalis oregano* L-[1-<sup>14</sup>C]ascorbate led to the production of labelled oxalate. Nuss and Loewus (1977) found similar results, varying from 22 to 50% conversion of 1-<sup>14</sup>C from ascorbate to oxalate in oxalate-accumulating plants, while non-oxalate accumulators converted between 2 and 19% of 1-<sup>14</sup>C from ascorbate to oxalate. This led to interest in the metabolic fate of the C<sub>4</sub> fragment. To explore this Williams and Loewus (1978) developed a procedure to label ascorbate specifically in order to follow the fate of individual atoms in the molecule. Helsper and Loewus (1982) fed *Rumex* leaves with L-[U-<sup>14</sup>C]ascorbate for 24 hours, which gave a distribution of <sup>14</sup>C: 14% in threonate, 1% in tartrate, 11% in oxalate, 49% in other compounds, 14% in insoluble residue and 11% in CO<sub>2</sub>. From these results they proposed threonate as an intermediate between ascorbate and oxalate as shown in Fig. 7.

## **1.4 THE TRANSPORT OF ASCORBATE AND ITS REGENERATION**

### **1.4.1 INTRACELLULAR ASCORBATE TRANSPORT**

Ascorbate is thought to be synthesised on the outer face of the inner membrane of the mitochondria (Siendones et al., 1999; Horemans *et al.*, 2000). Once synthesised it must translocate to other cell compartments e.g. into chloroplasts. Since ascorbate is a negatively charged molecule at cytosolic pH levels, and the electroneutral dehydroascorbate molecule is also insufficiently lipophilic to cross the plant's lipid membranes by diffusion, then presumably transport mechanisms for ascorbate, regulating transport into and out of particular cell compartments, must exist.

### **1.4.2 INTERCELLULAR ASCORBATE TRANSPORT**

Evidence exists showing that ascorbate is moved through plants. Kluge (1970) found ascorbate present in phloem exudates. More recently, Franceschi and Tarlyn (2002) provided evidence of ascorbate transport, suggesting an accumulation of ascorbate in sink tissues from source leaf phloem. With emerging evidence of ascorbate involvement in growth and development by as yet unproven mechanisms (Alcain and Buronm 1994; Arrigoni, 1994; Cordoba and Gonzalez-Reyes, De Gara and Tommasi, 1994; Navas and Gomes-Diaz, 1995, 1994; Fry, 1998; Davey *et al.*, 2000; Horemans *et al.*, 2000; Fry *et*

*al.*, 2002; Dumville and Fry, 2003) clear evidence as to whether plants transport ascorbate to sink tissues is important. Franceschi and Tarlyn (2002) indicated that ascorbate transporters were present in the phloem. They applied [<sup>14</sup>C]ascorbic acid to mature, source leaves of *Arabidopsis*, *Impatiens walleriana* and *Medicago sativa*, and demonstrated that [<sup>14</sup>C]ascorbic acid accumulated in the phloem. They also identified that [<sup>14</sup>C]ascorbic acid was transported to shoot and root tips of young *M. sativa*, and to young floral buds (sink tissue) of mature *M. sativa*, but not to mature (source tissue) organs. HPLC of phloem sap showed that it was ascorbic acid that was transported and not L-galactonolactone. The authors demonstrated that L-galactonolactone elevated ascorbic acid levels in phloem in proportion to the quantity added. They also demonstrated that L-ascorbic acid was transported and not L-galactonolactone, and that an increase in ascorbic acid took place within sink tissues. These results suggest demands for ascorbate within non or partly photosynthetic tissues are met by translocation from source tissues, although non-photosynthetic rose cell cultures are known to produce ascorbic acid.

The facilitated movement of ascorbate across plant plasma membrane was identified by Mozafar and Oertli (1992). They provided evidence for uptake of ascorbate by soybean roots and leaves and the re-translocation of absorbed ascorbate into newly formed tissue. Horemans *et al.* (1996, 1997, 1998) have since studied transport mechanisms by using purified *Phaseolus vulgaris* plasma membrane vesicles, identifying the possibility that ascorbate is transported out of and into the cell by facilitated diffusion. In the case of chloroplasts, Beck (1983) provides evidence that there is negligible free diffusion involved in the uptake process. Plasma membranes do not follow this model. Horemans

*et al.* (1996) suggest a biphasic model for uptake of ascorbate by plasma membrane vesicles. Their results suggest that the plant has the ability to initiate two mechanisms for ascorbate uptake, one for low concentrations of ascorbate, and one in response to high concentrations of ascorbate present outside the plasma membrane. They used heat to denature enzymes in the plasma membrane that may be responsible for ascorbate transport and showed that transport of ascorbate across the plasma membrane is in some way protein-assisted. Horemans *et al.* (1998) have studied the transport of ascorbate in its different redox states. *Phaseolus vulgaris* plasma membranes (Horemans *et al.*, 1996) and *Nicotiana tabacum* protoplasts (Horemans *et al.*, 1998) showed a clear preference for the uptake of dehydroascorbate over ascorbate. Rautenkranz *et al.* (1994) have also suggested that transport of dehydroascorbate and that of ascorbate take place competitively.

The actual mechanism behind ascorbate transport across plant membranes of any sort has not yet been elucidated. Ingebretsen and Normann (1982) report ascorbate movement through the outer mitochondrial membrane by diffusion. However, external concentrations of ascorbate were 6 mM, high concentrations in relation to the plasma membrane, and as a result the ascorbate may pass through by diffusion. Horemans *et al.* (1996, 1998) proposed that facilitated diffusion (a carrier-mediated transport of solutes in the direction of high concentrations to low concentrations) is responsible for dehydroascorbate movement across plasma membranes. Rautenkranz *et al.* (1994), Horemans *et al.* (1998) and Hassidim *et al.* (1987) report contrasting results to this, identifying, in metabolically active protoplasts, the driving force as a proton electrochemical gradient.

## **1.5 THE RADISH PLANT**

The mustard family, Cruciferae, includes the radish, *Raphanus sativus* L., as well as several other widely cultivated crucifers: cabbage, *Brassica oleracea*, var *capitata* L.; turnip, *Brassica rapa* L.; rape, *Brassica napus* L.; and cauliflower, *Brassica oleracea* L.; var. *botrytis*. These are predominantly herbaceous with a pungent watery juice, simple alternate leaves that are variously lobed and dissected, and flowers that are regular, perfect, and cruciform. The fruit represents a pod-like structure known as a silique (Hayward, 1967).

### **1.5.1 GENERAL MORPHOLOGY**

The Radish is extensively cultivated as a crop and grows as a true biennial in northern climates. Winter varieties are the most commonly planted and grown in greenhouses, reaching marketable size in 20 to 40 days. Summer radishes are grown outdoors, requiring 42–56 days to mature, and tend to be larger than early types, remaining succulent and tender for a short time only. The winter varieties require several months to mature, have a compact, firm flesh, and can be stored for several months (Hayward, 1967).

### **1.5.1.1 The root**

The root and hypocotyl constitute the succulent portion of the plant which is generally eaten in the fresh state. The hypocotyl may be spherical, bluntly cylindrical, or conical and elongated. The hypocotyl varies greatly in colour from white to cream, pink, red and mottled pink and red as well as grey and black.

Development of the root system is of an entirely different character in the round or turnip-shaped varieties from that of the half-long or long types. Half-long have a spherical top half similar to that of turnip-shape, while the lower half is elongated into the soil (Weaver and Bruner, 1927). The turnip-shaped hypocotyl has a rapidly growing taproot which, when mature, penetrates the soil to a depth of 60 to 90 cm. The absorbing area of the root lies in the upper 5 to 20 cm of surface soil. The half-long and long varieties have tap roots that extend to 1.4 to 1.6 metres in depth with lateral roots extending outward to a maximum of 1 metre in surface soil (Hayward, 1967).

### **1.5.1.2 The hypocotyl**

The upper portion of the succulent hypocotyl is practically devoid of lateral roots, consisting of a thickened hypocotyl that varies throughout maturity by reorganisation of its vascular tissue (Hayward, 1967). Some nutrient reserves are found in the hypocotyl in the form of glucose and fructose. Certain Chinese cultivars may contain high levels of starch compared to other cultivars. Radish plants grown at high temperatures under long-day conditions have been found to produce starch grains in the parenchyma (Hayward, 1967). The hypocotyl does not contain any great quantity of specific nutrients.

### **1.5.1.3 The shoot**

The stem develops in two phases. During the first 4 to 6 weeks after germination a rosette of leaves develops from a short crown stem. The second period, following this vegetative period, has a crown stem flower stalk forming (Hayward, 1967). The simple, petiolate leaves are variable in shape, the smaller upper ones being more or less oblong while the lower ones are deeply lyrate-pinnatifid (Hayward, 1967).

### **1.5.2 DEVELOPMENT OF THE SEEDLING**

Germination of the Cherry Bell cultivar is rapid with lateral root formation on the upper 2 cm of the taproot within four days (Fig. 1.5.1). The taproot pushes through the seed coat near the micropyle and elongates rapidly, becoming hooked at its upper limits. In the early stages of development, elongation of the hypocotyl and root proceeds much more quickly than that of the epicotyl (Hayward, 1967). The growth and straightening of the hypocotyl lifts the cotyledons above ground, and they expand forming the seedling's first photosynthetic organs (Fig. 1.5.1). After approximately nine days the first true leaves and secondary lateral roots appear.

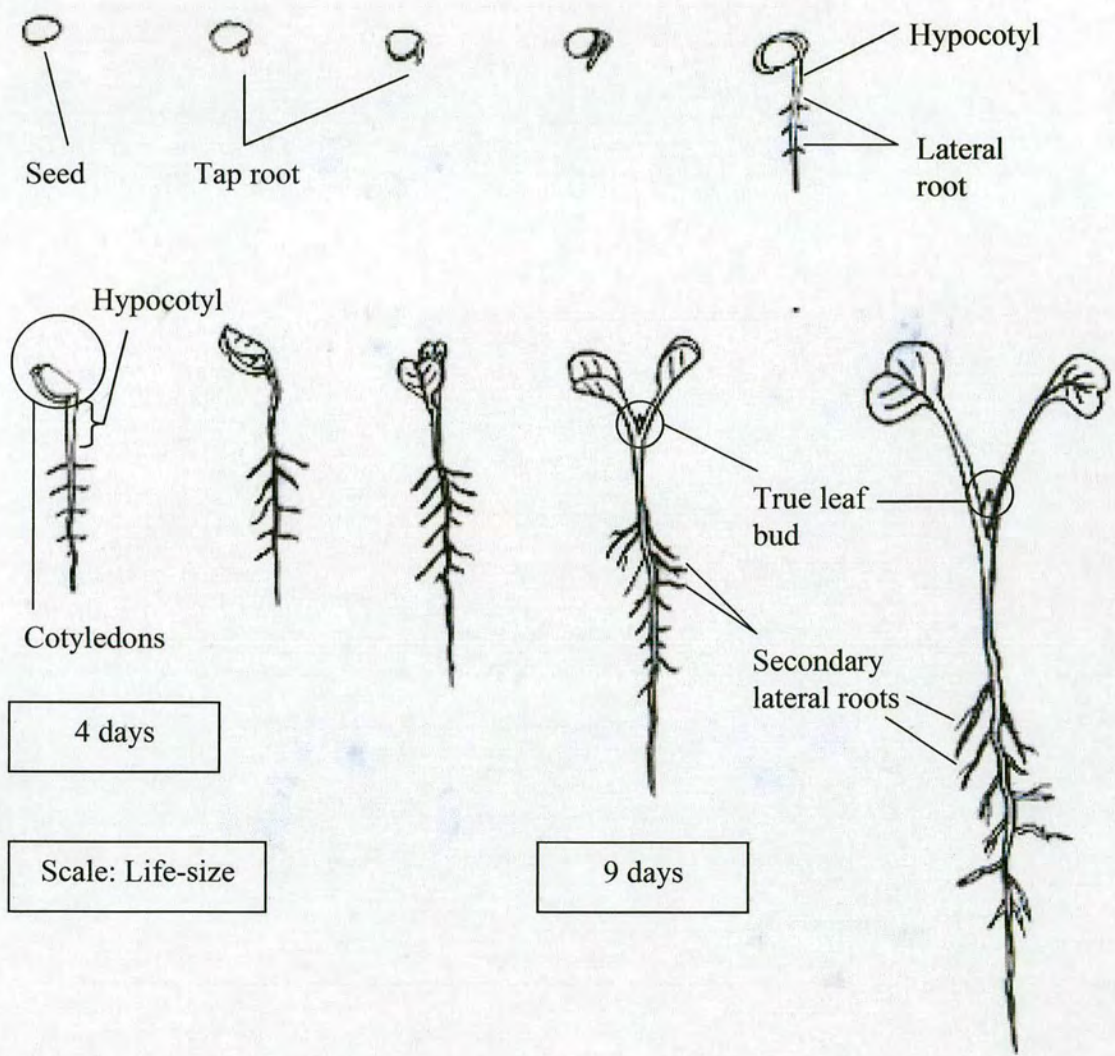

Fig. 1.5.1 Stages in development of seedling, variety Red Globe (Hayward, 1938)



### **1.5.3 HYPOCOTYL DEVELOPMENT**

Approximately seven days following germination the hypocotyl elongates rapidly in the Cherry Bell cultivar owing to continual division and enlargement of the cells. There is little structural difference between the middle and lower hypocotyl, but the lower portion of the latter resembles the primary root except that the epidermal cells produce no root hairs and their outer walls are slightly cutinised. The point at which these differences appear, defining the middle and lower hypocotyl, is termed the collet (Hayward, 1967).

#### **1.5.3.1 Vascular transition**

The phloem consists of sieve tubes, companion cells and some parenchyma, while the xylem is made up of large reticulate vessels. As the root and hypocotyl thicken, they tend to become oval in transection (Fig. 1.5.2 A). It is in the upper hypocotyl that the change from hypocotyl structure to stem occurs. The formation of central pith separates the differentiating primary xylem into two distinct units. The primary phloem cells group and extend circumferentially to form two crescent-shaped sectors at the lower level (Fig. 1.5.2 B), while at mid and upper-hypocotyl these form two groups, one on either side of the xylem units (Fig. 1.5.2 C, D). The metaxylem differentiates in a lateral direction in relation to the (protoxylem) points rather than in a centripetal one. This results in the formation of two wedges of scalariform and reticulate metaxylem extending from each protoxylem strand, while the central region of the axis consists of undifferentiated pith parenchyma. Each xylem unit and the two groups of adjacent phloem make up a cotyledonary trace (Fig. 2 B, C) (Hayward, 1967; Grassley, 1932).

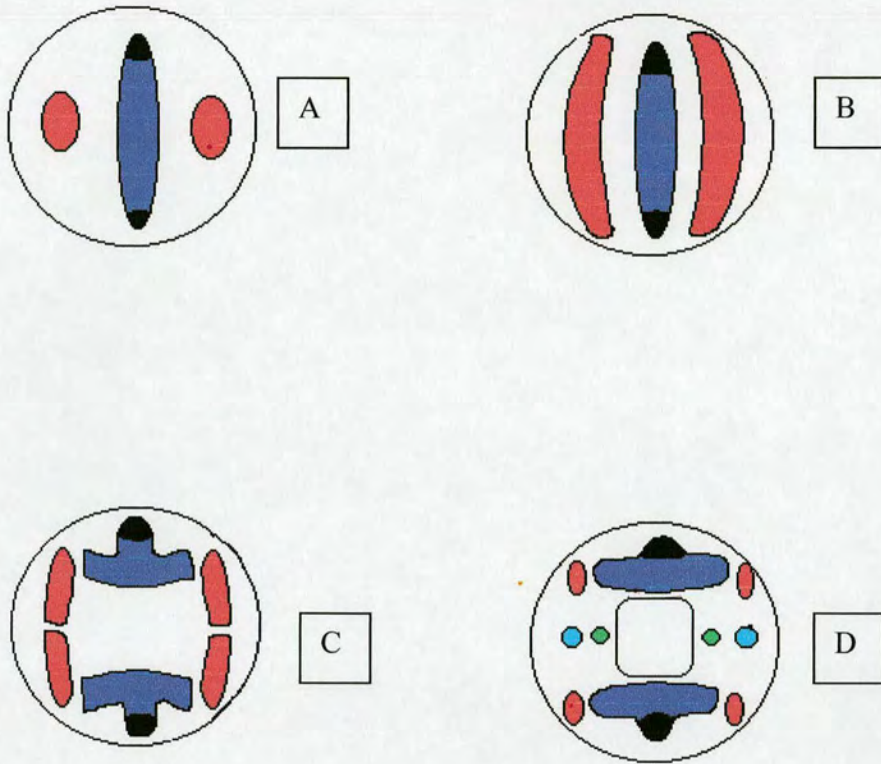

**Fig. 1.5.2 Diagram showing stages in Vascular transition (Grassley and Frances, 1932)**

A, root level; B, lower hypocotyl; C, middle hypocotyl; D, upper hypocotyl.

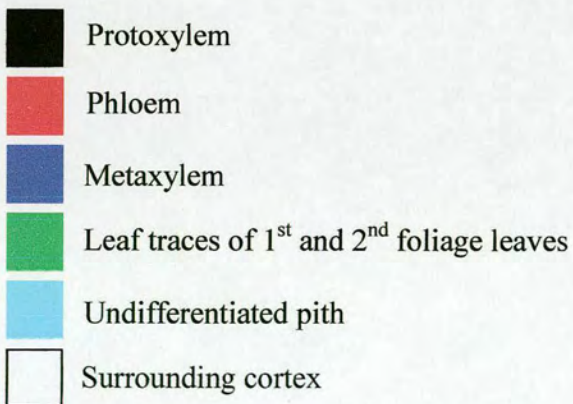

### **1.5.3.2 Secondary and tertiary thickening of primary root and hypocotyl**

The onset of secondary thickening (when the hypocotyl and upper portion of the root begin to enlarge) occurs around the time that the first foliage leaves appear at this time the hypocotyl and upper portion of the root begin to broaden. This secondary thickening results from growth of the stelar portion of the axis since the cortical and epidermal cells do not divide or enlarge to any great extent after the primary tissue of the stele is completely differentiated. As a result, there is a rupturing of the cortex and epidermis, forming two longitudinal splits in the transitional region of the hypocotyl extending down towards the root. The split lies in a vertical plane separating the two cotyledons; then as enlargement continues, these extend almost to the cotyledonary node (Hayward, 1967). There is almost no elongation of the hypocotyl following maturation of the primary tissue.

At the onset of secondary thickening, differentiation of primary xylem cells is effectively completed. The cambium arises in the parenchyma lying between the metaxylem and the primary phloem (Fig. 1.5.2). The activity begins in this zone, and as growth continues, there is lateral extension of the cambium. The secondary phloem consists of sieve tubes, companion cells and some parenchyma, while the secondary xylem is made up of large reticulate vessels surrounded by parenchyma. As the hypocotyl and root continue to thicken, they may become oval in transection. As the axis of the hypocotyl increases in diameter, flaky plates of cork cells are continually shed and replaced by new phellem (Hayward 1967).

The secondary xylem vessels are arranged in approximately radial rows that are separated by parenchyma. Continued growth and division of the parenchyma causes the secondary

xylem vessels to be separated radially. The cells vary in length from double to five or six times the breadth. The end walls of the xylem vessel elements are sloping and are resorbed as the vessel develops. The increase in fleshiness of the hypocotyl is due to tertiary thickening and can be extensive. Division of the secondary xylem parenchyma takes place, supplementing the function of the primary cambium. The secondary and tertiary thickening of the hypocotyl occurs in the same way as that of the root, except that the root does not have central pith.

## **1.6 AIMS OF PROJECT**

The aim of the work described in this thesis was to elucidate a method of feeding radioactive L-galactonolactone (the immediate precursor of ascorbate) to an intact plant and to a plant storage organ, followed by identification of L-ascorbate's metabolic products. Previous studies had looked at ascorbate turnover in excised immature fruit and leaves. The metabolism of ascorbate has been described in animals and plant cells of excised plant leaves, immature fruit and cell cultures. L-Galactonolactone metabolism has never previously been studied in an intact plant or storage organ. Identification of a method that would maintain an intact plant, while allowing the study of ascorbate metabolism, would provide original insights into the fate of ascorbate as part of a plant that is still influenced by all organs. This may lead to evidence as to whether or not ascorbate is transported throughout the plant and whether it may be involved in cell

expansion or important in the role of storage organs or sink tissues. Identification of a method to study the biochemical fate of ascorbate within a hypocotyl would provide information regarding ascorbate and a storage organ for the first time. It was considered that a storage organ may act as a reservoir for ascorbate as and when it is required by the rest of the plant or that it may act as a store for excess ascorbate and release it back to the rest of the plant as and when required. It was also considered that the hypocotyl might metabolise ascorbate by a different degradative pathway from that of the rest of the plant. It is for these reasons that the work within this thesis was undertaken.

## **2 MATERIALS AND METHODS**

### **2.1 RADISH GROWTH CONDITIONS**

#### **2.1.1 Cultivar selection**

Eight *Raphanus sativus* cultivars (Sparkler, Cyros F1, French Breakfast, Prinz Rotin, Cherry Bell, Hailstone, White Icicle and Pink Beauty, all supplied by Kings Seeds, Essex) were tested for consistent germination and maximum growth of hypocotyls. John Innes compost, No. 1, from Scottish Gardener, Larkhall, Lanark and neutral pH peat soil containing 200 L peat, 50 L sand and grit, 750 g limestone and 1200 g Vitex Superbase fertiliser, manufactured and provided by the University's garden staff.

#### **2.1.2 Growth conditions for routine use**

Cyros F1 radish seeds were germinated under wet paper towels at room temperature for two days. Individual seedlings were planted in individual pots (6 × 6 × 10 cm) containing "John Innes compost, No. 1". Seedlings were watered Monday to Friday with distilled water, in a growth room at 22°C with 16-hour days. This was continued for 5 weeks, after which the plants were mature enough for experimentation.

### 2.1.3 Bought hypocotyls

Excised hypocotyls were purchased from Sainsbury's, Cameron Toll, Edinburgh. Hypocotyls were approximately 2 cm in diameter. The hypocotyl skin surface was pink (possibly due to anthocyanin removal from the skin during harvesting and washing). Hypocotyls were imported from Spain or Romania.

## **2.2 EXPERIMENTALLY DECREASING ENDOGENOUS ASCORBATE**

### 2.2.1 Ascorbate breakdown in radish swollen hypocotyls

To monitor breakdown of [ $^{14}\text{C}$ ]ascorbate it is desirable to define conditions under which ascorbate is undergoing net breakdown within the swollen hypocotyls. Bought swollen hypocotyls were therefore exposed to several conditions to examine if they led to a decline of ascorbate concentrations.

### 2.2.2 Exposure to water and heavy metals

Approximately fifty bought radishes were stored in 35-cm-diameter basins containing approximately a 1-cm-depth of water or 50  $\mu\text{M}$  copper sulphate solution and covered in aluminium foil to reduce light. The hypocotyls were stored at room temperature. At each time-point five hypocotyls were assayed for ascorbate content.

### 2.2.3 Atmospheric tests

Bought excised radish hypocotyls were exposed to aerobic conditions by storing individual hypocotyls in 60-ml Sterilin pots (polycarbonate beakers) with the lids placed loosely on top. Individual hypocotyls were exposed to anaerobic conditions by storage in Sterilin pots with the lids firmly screwed shut. Individual hypocotyls were exposed to gases rich in ethylene by placing individual hypocotyls in Sterilin pots with the lids screwed tightly shut in the presence of one 1-cm<sup>3</sup> ripening apple fruit piece. Hypocotyls were stored at room temperature under normal laboratory lighting or in the dark at room temperature. Treatments were duplicated. At each time-point two radishes from each condition were assayed for ascorbate content.

### 2.2.4 Sodium nitroprusside

Potted radish plants were watered with approximately 50 ml of 100 mM sodium nitroprusside each day after they reached an age of 5 weeks. Controls were watered with approximately 50 ml of de-ionised water. All hypocotyls were kept at approximately 20°C during the experiment, with 16-hour days. Similar sized and shaped hypocotyls were selected for ascorbate quantification. At each time-point six radish hypocotyls were assayed for ascorbate content.

### 2.2.5 Effect of ultraviolet



Bought excised radish hypocotyls were exposed to 254-nm or 366-nm ultraviolet light (MINERALIGHT<sup>®</sup> LAMP MULTIBAND UV-2541366, NM, Upland, CA 91786, U.S.A.) placed for 0–3 days at a distance of approximately 30 cm from the hypocotyl at room temperature. Otherwise the hypocotyls were in complete darkness. At each time-point five hypocotyls were assayed for ascorbate content.

#### 2.2.6 Effect of a high-oxygen atmosphere

Radish plants were placed in two 40 × 60 × 40 cm airtight boxes under normal laboratory lighting. One box had a flow of pure oxygen passed in at approximately 10 litres per hour; the control box was exposed to a flow of air. Five hypocotyl samples were taken each day and tested for ascorbate content.

#### 2.2.7 Irrigation with exogenous ascorbate

This experiment aimed initially to elevate levels of ascorbate, leading to greater turnover of ascorbate as concentrations returned to original levels allowing study of ascorbate metabolites. Individual radish plants in pots containing approximately 150 ml of soil were irrigated with 50 ml of 50 mM sodium ascorbate, after 5 weeks of growth, at times 0, 3, 6, 9 and 12 hours consecutively. The plants were kept under laboratory lighting at room temperature throughout the experiment. At each time-point five radish hypocotyls were assayed for ascorbate content.

## **2.3 EXPERIMENTALLY INCREASING ENDOGENOUS**

### **ASCORBATE**

#### **2.3.1 Xylene cyanol uptake**

Xylene cyanol, which has a strong blue colour and is highly charged, was used to study how radish tissues may be infiltrated with an exogenous hydrophilic solute such as ascorbate. Several conditions were tested to identify the most effective method of supplying xylene cyanol for uptake via the roots into the hypocotyl apoplast. One method of increasing ascorbate uptake by the plant is damaging the root system by heating or trimming, reducing the plant's ability to screen out soil water solutes, as seen in the xylene cyanol experiments. Increased uptake of an ascorbate precursor (L-galctono-1,4-lactone) will also allow for the study of ascorbate's fate within an intact radish plant. Lateral roots were trimmed from 5-week-old whole plants and the remaining root system (but not the hypocotyl) was placed in 0.2% xylene cyanol. Other plants had their root systems placed in boiling water for ten seconds, or frozen in liquid nitrogen for ten seconds, and then thawed, and then the roots (but not the hypocotyls) were placed in 0.2% xylene cyanol. Hypocotyls were examined by slicing into strips to study xylene cyanol distribution. Vacuum-infiltration was a fourth method tested for enhancing the uptake of xylene cyanol, and therefore probably also of ascorbate. Excised swollen hypocotyls were submerged in 0.2% xylene cyanol and vacuum-infiltrated. This was most effective when the vacuum, between 40 and 100 mm Hg, was broken and re-started every 5 min for approximately 20 min.

## **2.4 ASCORBATE QUANTIFICATION**

### **2.4.1 Measurement of endogenous ascorbate**

Colorimetric titration methods for measuring ascorbate concentrations use the redox properties of ascorbate. 2,6-Dichlorophenolindophenol (DCPIP) is pink in acid solution and is decolourised rapidly by ascorbic acid. This colour change can be measured spectrophotometrically. A dilution series of ascorbic acid in metaphosphoric acid (5% w/v  $\text{HPO}_3$ ) was titrated with DCPIP to prepare a standard curve.

Hypocotyls (approximately 4 g fresh weight) were homogenised with a mortar and pestle for 90 seconds with an equal volume of 10% (w/v)  $\text{HPO}_3$  and a pinch of sand. The volume of the homogenate was made up to 40 ml with 5%  $\text{HPO}_3$ . This homogenate was mixed in a beaker containing a magnetic stirrer for 45 minutes at 23°C and centrifuged at 4000 rpm for 5 minutes. A portion (0.3 ml) of the supernatant was added to a cuvette containing 1.0 ml of 5%  $\text{HPO}_3$  and the  $A_{519}$  was measured to account for anthocyanin colour. Directly following this a suitable volume of 0.01% DCPIP (usually 1.0 ml), was selected so as not to be decolourised completely by the ascorbate extracted from the radish tissue, was added and mixed; 10 seconds later the  $A_{519}$  was again measured. The initial absorbance of the 1.3 ml of diluted extract, multiplied by 13 / 23, was subtracted from the absorbance measured after addition of DCPIP. This was a straightforward method, capable of quantifying ascorbic acid at concentrations of 10  $\mu\text{M}$  or above.

## **2.5 DETECTION OF MARKERS AND METABOLITES**

### **2.5.1 Preparation of markers for electrophoresis and chromatography**

Marker solutions were prepared to 1% (w/v) concentration in de-ionised water. Ascorbic acid, diketogulonic acid and dehydroascorbic were stored at  $-20^{\circ}\text{C}$ . All other markers were stored at  $4^{\circ}\text{C}$  in the presence of 0.5% chlorobutanol. Mixtures of markers were prepared with each individual marker at either 0.5% or 0.33%.

### **2.5.2 Detection of markers by staining with silver nitrate**

A series of three solutions was used to stain compounds such as ascorbic acid, and most of its potential breakdown products (Trevelyan et al. 1950). Chromatograms or electrophoretograms were dipped once through a solution of silver nitrate (5 mM  $\text{AgNO}_3$  in acetone with water added drop-wise until the precipitate dissolved) and allowed to dry for 15 minutes. The papers were then twice dipped through sodium hydroxide (NaOH 0.125 mM in 96% ethanol) with 15 minutes' drying following each dip. Papers were then drawn steadily through an aqueous solution of sodium thiosulphate ( $\text{Na}_2\text{S}_2\text{O}_3$  10% w/v) and immediately transferred to a basin of running tap-water and washed for at least 1 hour.

### 2.5.3 Detection of markers by staining with bromophenol blue

Bromophenol blue changes from yellow at pH 2.8 to violet at pH 4.5. It was used to detect ascorbic acid, oxalic acid and other organic acids after electrophoresis (Jork et al. 1990; Fry 1988). Bromophenol blue (40 mg) was dissolved in NaOH (10 mM, 100 ml). The paper was dipped at least three times through a solution of methanol (25%) in diethyl ether (75%) with 15 minutes' drying following each dip to remove any residual acetic or formic acid. The paper was then gently and evenly sprayed with bromophenol blue. Any yellow spots appearing on the blue background were marked with a soft pencil.

### 2.5.4 Quantification of radioactivity by scintillation counting

Scintillation counting was performed on a Beckman LS 6500 multi-purpose scintillation counter. 'OptiPhase Hisafe 3' (Fisher Chemicals) scintillation fluid (10 volumes) was added to aqueous radioactive samples. Radiolabelled compounds separated by electrophoresis or chromatography were located by autoradiography. The area of the paper corresponding to each radiolabelled compound was cut out and radioactivity quantified by scintillation counting in 'OptiScint Hisafe' scintillation fluid (2 ml).

## **2.6 SEPARATION OF GALACTONOLACTONE METABOLITES**

### 2.6.1 High-voltage paper electrophoresis at pH 6.5

Paper electrophoresis at pH 6.5 was used to separate charged molecules on the basis of their charge to mass ratio. This method was used to suggest the presence of either radiolabelled ascorbate and / or galactonic acid although they are difficult to distinguish as they run at similar speeds. Samples were dried on to Whatman 3 MM or Whatman No.1 paper along an origin drawn 9 cm from the cathode end of the paper. External markers were loaded at a spacing of 1.0 to 2.0 cm, centre-to-centre, along the origin. Orange G (approximately 50 µg) was loaded in the gaps between markers and / or as an internal marker and used to monitor the progress of electrophoresis visually as well as to identify any irregularities during the running of the electrophoretogram. The paper was laid on a sheet of glass with the origin raised between two glass rods and heavily wetted with buffer (acetic acid:pyridine:water (1:33:300 v/v/v), pH 6.5). The origin was wetted last. The paper was suspended in a large chromatography tank filled with toluene. The end of the paper closest to the origin was held in a trough containing approximately 250 ml of buffer and a platinum cathode. The bottom end of the paper dipped into another layer of the same buffer containing the platinum anode. The toluene was water-cooled to below 30°C during running.

Running time and voltage varied greatly depending on what was studied and the atmospheric temperature. [<sup>14</sup>C]Oxalate forms a radioactive streak during electrophoresis. This is likely to be due to formation of radiolabelled calcium oxalate from traces of Ca<sup>2+</sup> in the paper. Formation of the radioactive streak was minimised, but not entirely prevented, by the addition of EDTA (to 5 mM) to the running buffer.

### 2.6.2 High-voltage paper electrophoresis at pH 3.5

Paper electrophoresis at pH 3.5 was carried out by the same method as at pH 6.5. Electrophoresis at pH 3.5 was used to separate galacturonic acid, galactonic acid and galactonolactone as they run at different speeds. The paper was prepared in the same way as for pH 6.5 electrophoresis. The paper was wetted with half-strength running buffer (acetic acid:pyridine:water (10:1:189 v/v/v), pH 3.5 full strength ratio). The paper was suspended in a large chromatography tank filled with white spirit. The end of the paper closest to the origin was held in a trough containing approximately 250 ml of full strength buffer and a platinum cathode. The paper was then treated by the same method as pH 6.5 electrophoresis. Running times were around 30 minutes at 3 kV although time and voltage varied with temperature.

### 2.6.3 Paper chromatography

Paper chromatography is one of the oldest chromatographic methods. It is a cheap and effective method, its main advantage being good resolution of ascorbate and dehydroascorbate from many other ascorbate-related metabolites. Paper chromatography also allows good sensitivity when staining with silver nitrate: e.g. 0.1 µg of arabinose can be detected (Fry 1988). The stationary phase is a sheet of paper (Whatman No. 1), usually 46 × 57 cm. All samples were loaded 9 cm from the short edge of the paper. The far end of the paper was serrated to ensure solvent dripped off the paper evenly if it reached the

end. In descending chromatography the paper was hung from a glass trough containing the solvent butanol:acetic acid:water (12:3:5 v/v/v) in an airtight, glass chromatography tank (Panglas Shandon 500 Chromatank). The solvent then descended by capillary action for 20 h. Compounds move at particular speeds relative to the solvent front ( $R_F$ ), allowing effective separation of L-[1- $^{14}$ C]ascorbate from other radiolabelled molecules. A series of markers including ascorbate, dehydroascorbate, diketogulonate, other organic acids and glucose were also loaded on to the paper. After chromatography the paper was hung in the fume hood to dry.

#### 2.6.4 Ion-exchange chromatography

The cation-exchange resin used was Dowex 50W X 2 50-100 in the  $H^+$  form (Bio Rad, Richmond, California, USA). This was treated so that pyridinium became the counter-ion as the pyridine eluted is volatile and can be easily removed by drying. The Dowex resin was washed twice with 0.5 M HCl to remove impurities, twice with de-ionised  $H_2O$ , twice with two washes of pyridine/formic acid/ $H_2O$ , 1:1:18, and finally with running buffer [10 mM pyridine (formate $^-$ ), pH 5.0]. All washes were for at least 2 h. Columns of bed volume 5 ml were then set up in PolyPrep columns (empty 10-ml columns containing a filter at the base to hold resin while allowing eluate to come off).

The radish extract (approximately 1 ml), normally containing radioactive metabolites, was loaded onto the Dowex 50 (Py $^+$ ) column. A further 10 ml of 10 mM pyridine (formate $^-$ ) running buffer, pH 5.0, was washed through the column to elute neutral and



acidic compounds. The total volume of eluate was collected and the pH adjusted to 5.0 with pyridine.

→ The anion-exchange resin used was Dowex 1 X 4-200 (strongly basic) in the  $\text{Cl}^-$  form. This was treated so that formate became the counter-ion as the formic acid eluted, is volatile and can be easily removed by drying. The Dowex resin was washed twice with 0.5 M NaOH to remove impurities, twice with 0.5 M formic acid, twice with 2 M sodium formate and finally with running buffer 10 mM formate ( $\text{Py}^+$ , pH 5.0). All washes were for at least 2 hours. PolyPrep columns were then set up as for Dowex 50.

The sample was loaded onto the column and the eluate collected in two 5.5-ml fractions, after which 0.01 M formate ( $\text{Py}^+$ , pH 5.0), 0.1 to 0.3 M formic acid at 0.05 M increments, 4.0 M formic acid and 4.0 M trifluoroacetic acid were loaded onto the column as a manual step gradient. At each increment, 10 ml of eluant was loaded onto the column, and two 5-ml fractions of eluate were collected.

Fractions were stored in 2-ml Sarstedt tubes containing 10  $\mu\text{l}$  of 1.76% ascorbic acid (non-radioactive) and 1.54% dithiothreitol.

#### 2.6.5 Metabolite elution from paper

The area of paper containing a compound of interest was cut out and rolled tightly into a syringe barrel. The syringe barrel was placed in a tube and 200  $\mu\text{l}$  of de-ionised water was pipetted over the paper. The tube and syringe barrel were then centrifuged for approximately five minutes at approximately 4000 rpm. A further 100  $\mu\text{l}$  was pipetted

onto the paper and centrifuged again under identical conditions. This was repeated four times, and the eluate collected for future experiments.

#### 2.6.6 Purification of D-[6-<sup>14</sup>C]galacturonic acid.

To separate [6-<sup>14</sup>C]galacturonic acid from any impurities, 1 ml of stock [6-<sup>14</sup>C]galacturonic was loaded onto Whatman No. 1 as a 20-cm streak formed from 10- $\mu$ l spots at 1-cm intervals. This was electrophoresed at pH 3.5, 3 kV for 30 min. Radioactive acids were detected by autoradiography and external markers were stained with silver nitrate. The pure [6-<sup>14</sup>C]galacturonic acid was removed from the Whatman No. 1 paper as described in 2.6.5. This was repeated several times with similar results.

#### 2.6.7 Conversion of D-[6-<sup>14</sup>C]galacturonic acid to L-[1-<sup>14</sup>C]galactonic acid.

[6-<sup>14</sup>C]Galacturonic acid was added to an appropriate volume of 0.2 M NaBH<sub>4</sub> in 1 M NH<sub>3</sub> such that, for every mol of [<sup>14</sup>C]galacturonic acid used, at least one mol of NaBH<sub>4</sub> was present, and incubated at room temperature for 5 hours. Remaining unreacted NaBH<sub>4</sub> was broken down with a calculated amount of acetic acid based on the amount of NH<sub>3</sub> used. The solution was thoroughly mixed to avoid formation of an interface.

A time-course using 50,000 cpm of [6-<sup>14</sup>C]galacturonic acid was set up to identify the time required for as much galacturonic acid to be converted to galactonic acid as was possible. At each time point, 5  $\mu$ l was removed and the reaction stopped with 2  $\mu$ l of 1.7

M acetic acid. Non-radioactive internal markers (10  $\mu$ l 0.5% galacturonic acid and 10  $\mu$ l 0.5% galactonic) acid were added to each sample.

#### 2.6.8 Conversion of L-[1-<sup>14</sup>C]galactonic acid to L-[1-<sup>14</sup>C]galactonolactone

Various acids and time scales were tested to identify the most effective method of converting galactonic acid to galactonolactone. A 0.5% solution of D-galactonic acid was exposed to different acid conditions and 20  $\mu$ l loaded onto 3 MM paper at intervals. Paper electrophoresis (pH 3.5) was carried out at 3 kV for 30 minutes. Silver nitrate staining was used to identify compounds of interest.

#### 2.6.9 One-pot conversion of D-[6-<sup>14</sup>C]galacturonic acid to L-[1-<sup>14</sup>C]galactonolactone

Conversion of galacturonic acid stock to galactonolactone was done as one preparation. Galacturonic acid (2 ml) was dried by SpeedVac and re-dissolved in 400  $\mu$ l of de-ionised water. One hundred  $\mu$ l of 0.2 M NaBH<sub>4</sub> in 1 M NH<sub>3</sub> was added and the mixture was incubated at laboratory temperature for 5 hours. The reaction was stopped with 12  $\mu$ l of 17 M acetic acid. The total volume was dried down by SpeedVac, re-dissolved in 2 ml 4 M TFA and incubated for 7 days in darkness at laboratory temperature. The sample was loaded as a 20-cm streak onto Whatmann 3 MM paper and electrophoresed at pH 3.5 for 75 minutes. After autoradiography the galactonolactone streak was removed as described in X and the eluate stored at -20°C.



#### 2.6.10 Autoradiography

The chromatogram or electrophoretogram was cut to the cassette size (a maximum of 30 × 40 cm). The paper was held in place by masking tape and three corners of the paper were marked with spots of radioactive ink. X-ray film was placed on top of the paper (Cronex X-ray film, 30 × 40 cm; Sterling Diagnostic Imaging, Inc., Newark, DE 19714, U.S.A.). The spots of ink were later used to line up the X-ray film and the chromatogram. After the required time of storage to achieve adequate exposure of the film to the radioactive compounds, it was developed. Markers were stained and used to identify unknown compounds. Certain compounds were verified by precise co-chromatography (internal markers) of radioactive and non-radioactive material.

#### 2.6.11 Fluorography

This method allows  $^3\text{H}$  to be detected with X-ray film. The chromatogram or electrophoretogram was treated as for autoradiography except the paper was dipped through 7% PPO in diethyl ether three times and allowed to dry after each dip before exposure to X-ray film.

#### 2.6.12 Materials

All chemicals including radiolabels were supplied by Sigma–Aldrich Chemical Company unless otherwise specified.

### **3. METHOD DEVELOPMENT INFLUENCING HYPOCOTYL ASCORBATE**

#### **CONTENT**

#### **3.1 EXPERIMENTALLY LOWERING LEVELS OF ASCORBATE WITHIN THE HYPOCOTYL**

Radish cultivar, Cyros F1, was selected for studying ascorbate content, import and turnover. Cyros F1 was found to be the most consistent cultivar in terms of germination, survival and size of hypocotyl.

Exposure of plants to stress conditions was hypothesized to produce active oxygen species that may lead to ascorbate turnover. The following experiments looked at this hypothesis and the possible decrease in ascorbate content within the plant due to turnover.

Tests of the effect of aerobic, anaerobic, light and dark conditions, and the presence of an ethylene-rich atmosphere (Fig. 3.1 and 3.2) showed no change of ascorbate content within the hypocotyls. The nitric oxide-releasing agent sodium nitroprusside (Fig. 3.3) (Maccarrone *et al.* 1995) had no effect on the ascorbate content of the hypocotyls.

Ultraviolet was hypothesized to produce oxidative radicals within the cells of the hypocotyls leading to turnover of ascorbate as it reacted with these active oxygen species. Ultraviolet exposure of healthy plants at wavelengths 254 nm and 366 nm for 3 days caused no change in ascorbate levels within the attached hypocotyl (Fig. 3.4). Ultraviolet exposure of excised hypocotyls for 3 days appeared to cause a reduction in ascorbate by approximately 10% at 254 nm and 20% at 366 nm (Fig. 3.5). However, the statistical

analysis ( $P > 0.05$  for each wavelength) shows we do not reject the null hypothesis and conclude that the difference is not statistically significant difference between the control and 254 nm or 366 nm. This may have been due to the high variability in ascorbate measurements of the 366 nm and 254 nm exposed hypocotyls. Both treatments resulted in the hypocotyls visibly shrivelling and drying within 24 hours of exposure, and continued to do so after exposure to ultraviolet had stopped. The decrease in ascorbate levels was most probably due to cell death as the hypocotyls softened and dried out rapidly, not specific degradation of ascorbate by oxidising radicals produced by the ultraviolet light.

Exposure of radish plants to a high-oxygen atmosphere was hypothesized to cause ascorbate turnover due to the increased levels of active oxygen species present in the plants' immediate atmosphere. A high-oxygen atmosphere caused a statistically significant 30% decrease ( $P < 0.05$ ) in ascorbate concentration within the hypocotyl, while no change in ascorbate level was measured in hypocotyls when plants were grown in atmospheric air (Fig. 3.6). This result suggests that ascorbate breakdown can be promoted by high concentrations of  $O_2$ . This effect could be used to study the products of ascorbate turnover, although this would require unnatural growth conditions, which may produce misleading results that would not occur under normal growth conditions.

It was of interest to feed radish plants sodium ascorbate to see if uptake was possible. If uptake took place then ascorbate metabolism under specific conditions could be studied using radiolabelled ascorbate. Plants fed sodium ascorbate through the root system (Fig. 3.7) showed no consistent increase in internal levels of ascorbate within the hypocotyl throughout the period of observation. This result suggests either rapid turnover of ascorbate within the plant, or that the plant does not allow uptake of ascorbate through

the root system (perhaps because of the presence of the Casparian strip in the endodermis). Experiments were replicated twice except; Fig. 3.3, three replicates, Fig. 3.12, four replicates.

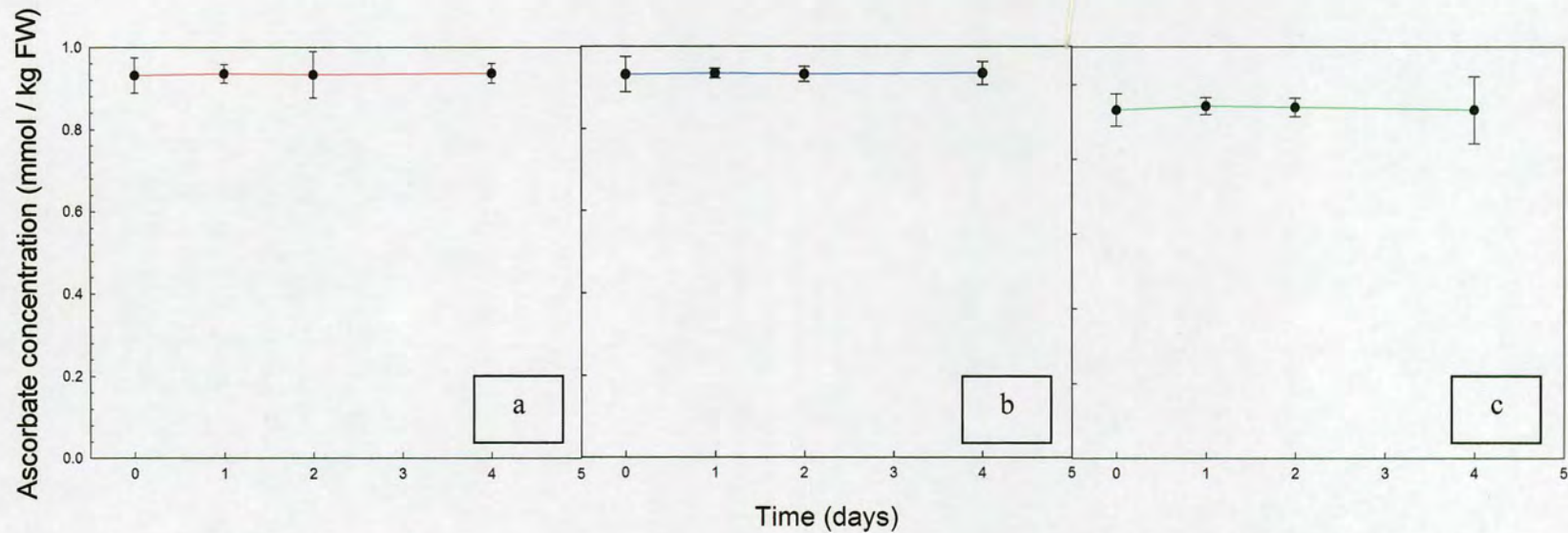

**Fig. 3.1. Ascorbate concentration in excised radish hypocotyls exposed to different atmospheric conditions in darkness.**

Sixty bought excised radish hypocotyls were exposed to constant conditions. Each radish was placed in an individual Sterilin pot and incubated in total darkness for the entirety of the experiment. The lid was either lightly placed on to the pot (a), or screwed on tightly (b). In the ethylene test (c) the lid was screwed on tightly after a 1-cm<sup>3</sup> piece of apple flesh had been placed inside the pot. At each time-point five hypocotyls were randomly selected from each of the three tests and assayed for ascorbate content. The graphs show means  $\pm$  SE.



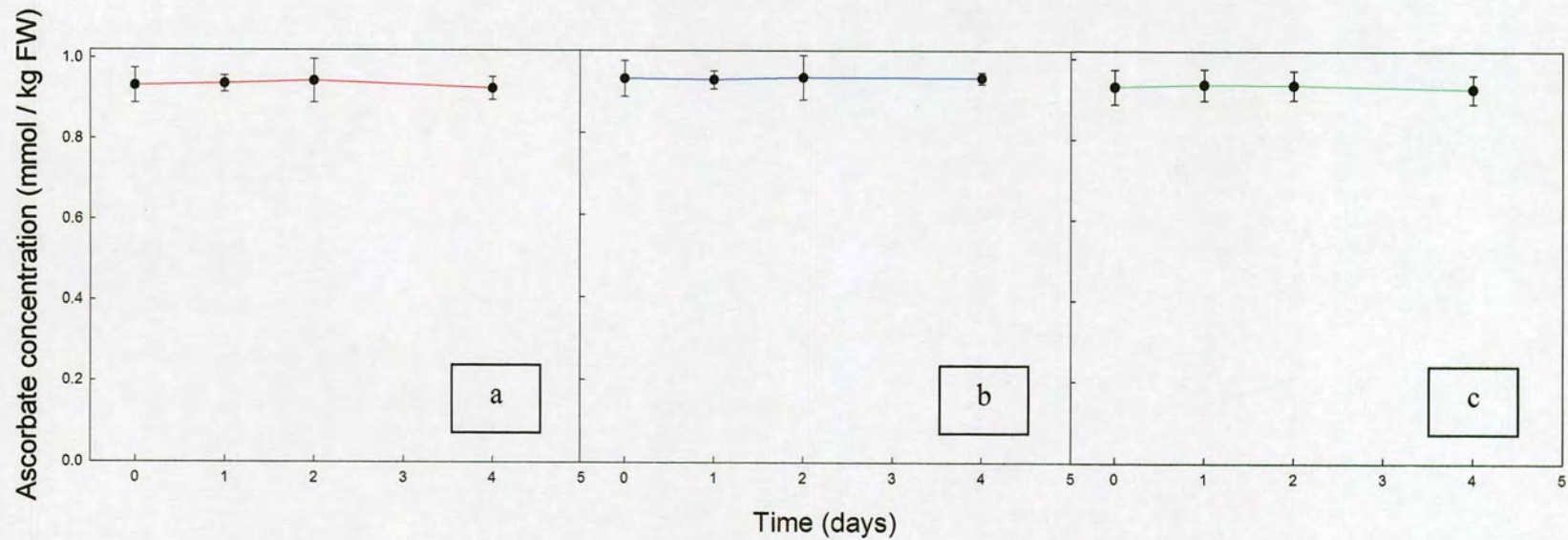

**Fig. 3.2. Ascorbate concentration in excised radish hypocotyls exposed to different atmospheric conditions in light.**

Hypocotyls were stored in Sterilin pots under constant (24-hour) laboratory lighting conditions. The graphs show means  $\pm$  SE. Other details as in Fig. 1.

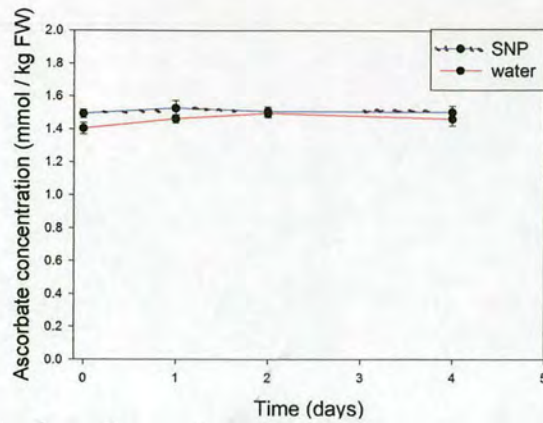

**Fig. 3.3. The effect of sodium nitroprusside on ascorbate concentrations in hypocotyls of intact radish plants.**

Radish plants were grown from seed for 5 weeks. After 5 weeks they were watered for 0–4 days with 50 ml per day of 33 mM sodium nitroprusside, which should release NO (Maccaroni *et al.*, 1995) and may affect the ascorbate redox status. At each time point five plants were randomly selected and their hypocotyls assayed for ascorbate content. The graph shows means  $\pm$  SE.

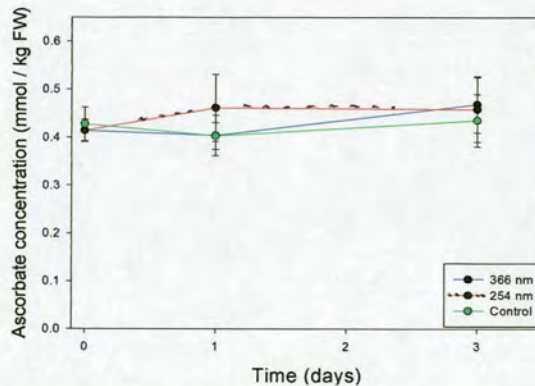

**Fig. 3.4. The effect of ultraviolet radiation on ascorbate concentrations in hypocotyls of intact radish plants.**

Potted radish plants (with the hypocotyl above the soil surface) grown for 5 weeks were placed under an ultraviolet lamp at 254 nm or 366 nm exposing the plant foliage and hypocotyl to ultraviolet from a distance of 30 cm for 24 hours. Otherwise the plants were in complete darkness. Six hypocotyls were randomly selected at each time point and assayed for ascorbate content. The graph shows means  $\pm$  SE.

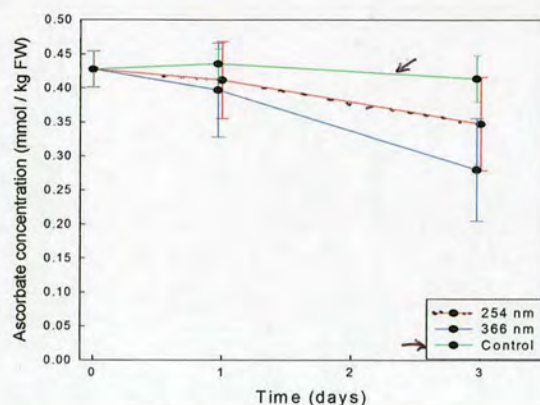

**Fig. 3.5. The effect of ultraviolet light on ascorbate concentrations of excised hypocotyls.**

Bought excised radish hypocotyls were exposed to 254 or 366 nm ultraviolet light from a lamp at a distance of 30 cm for 24 hours. Otherwise the hypocotyls were in complete darkness. At each time point five hypocotyls were assayed for ascorbate content. The graph shows means  $\pm$  SE.

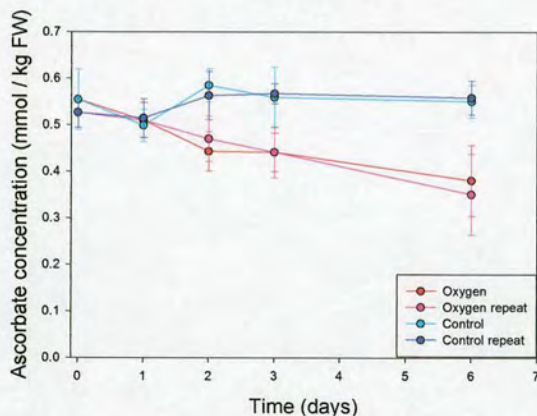

**Fig. 3.6. The ascorbate concentration in the hypocotyls of radish plants exposed to a high-oxygen atmosphere.**

After 5 weeks of growth radish plants were placed under new conditions for 0–6 days. Plants were exposed to either normal atmospheric air (Control) or a high-oxygen atmosphere (Oxygen). The test and control plants were grown at the same time in identical boxes, under the same light. At each time point five plants were randomly selected and their hypocotyls were assayed for their ascorbate content. The graph shows means  $\pm$  SE. The whole test was repeated on a different occasion with similar results (repeat).

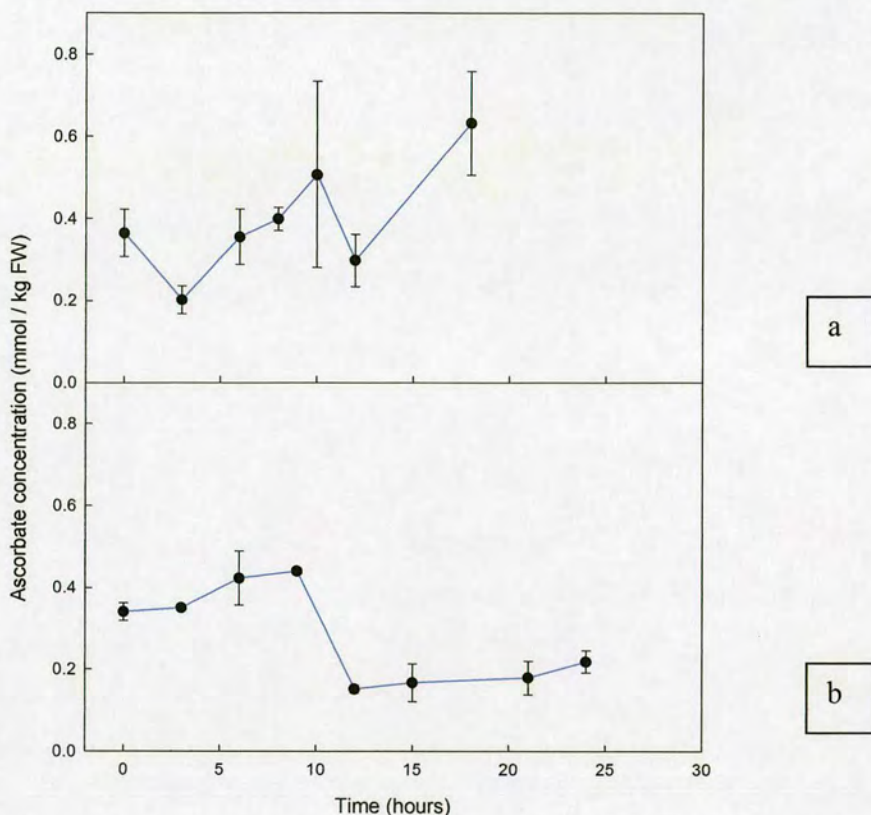

**Fig. 3.7. The effect of feeding 50 mM sodium ascorbate to intact radish plants through the root system.**

Radish plants were grown from seed in soil for 5 weeks and then fed 50 ml of 50 mM sodium ascorbate (pH 4) per plant pot. Additions per plant pot of 50 ml were made every 3 hours until 12 hours. After 12 hours the roots remained in any residual solution. The experiment was conducted under constant illumination. Plants were randomly selected and their hypocotyls were assayed for ascorbate content (a). The results of a repeat experiment are shown in (b). The graphs show means  $\pm$  SE.

### **3.2 SOLUTE UPTAKE DIRECTLY INTO THE HYPOCOTYL AND VIA THE ROOT SYSTEM**

Plants had their roots treated, and excised hypocotyls were treated, in several different ways as a study of possible methods by which solutes e.g. radioactive galactonolactone could be fed to the hypocotyls allowing the study of ascorbate metabolism. Xylene cyanol allowed visual evidence of how a hydrophilic solute such as galactonolactone might be transported throughout the plant. Stained hypocotyl tissue by xylene cyanol allowed visual identification of transport throughout the plant, and the charged nature of xylene cyanol avoided uptake across the lipid membrane into cellular organelles.

Plants that had had their roots frozen in liquid nitrogen showed very poor uptake of xylene cyanol into the hypocotyls within 24 h (Fig. 3.8), suggesting that the frozen / thawed roots maintained some capability to screen what passed into the xylem. However, plants that had had their roots trimmed and the remaining root system placed in xylene cyanol solution showed uptake of xylene cyanol into the hypocotyl over time (Fig. 3.9). Plants that had had their roots boiled for varying time periods and then placed in xylene cyanol solution also showed uptake of xylene cyanol into the hypocotyl (Fig. 3.10).

Vacuum infiltration enabled good penetration of xylene cyanol into hypocotyl tissue (Fig. 3.11). The hypocotyl was submerged in xylene cyanol solution, and a vacuum applied. The vacuum pulled air out of the hypocotyls and then, upon release of the vacuum, xylene cyanol would move into spaces from which air had been removed.

The damaging of plant roots could lead to the possible release of metabolites from dead cells that may lead to misleading results in experiments. Their release may lead to

reaction with radioactive metabolites fed to, and formed within the plant during an experiment. A further problem with any method of root uptake was that uptake was slow, making it very difficult to accurately study initial metabolites in ascorbate metabolism. Experiments identified that uptake was slow by root systems that had been trimmed (Fig. 3.9). This may have been due to the root systems sealing cut root ends following trimming. The boiled and frozen root systems also had slow uptake. This method of root treatment was expected to allow good uptake of xylene cyanol since root cells were dead and therefore the membranes porous. It was not clear why uptake was poor. Following uptake by the root systems xylene cyanol can be seen (Fig. 3.8, 3.9 and 3.10) primarily in the xylem moving through the outer tissues of the hypocotyl into the leaves. Very little movement into the central tissue of the hypocotyl took place. Therefore, this may not promote galactonolactone movement into hypocotyl tissue but simply carry galactonolactone through the hypocotyl into the leaves. Conversion of galactonolactone to ascorbate within the plant is assumed to be fast and the study of initial ascorbate metabolites would be difficult and possibly misleading due to a mixture of old and new ascorbate metabolites being present after the time required to allow uptake into the plant. This would be due to galactonolactone molecules taken up throughout the 24 hours being at different stages of metabolism upon analysis, therefore giving a wide variety of products within ascorbate metabolism. Galactonolactone is converted to ascorbate by mitochondria (Ingebretsen and Normann, 1982). However, vacuum infiltration does not specify the organelle of the cell where galactonolactone will reach. As a result galactonolactone and its metabolic products would be exposed to enzymes, oxidising and reducing agents that would not normally come into contact with ascorbate in a normal

hypocotyl. While ascorbate would only be produced in the mitochondria, galactonolactone may be broken down to other compounds within the rest of the cell and lead to confusing results upon analysis of cellular contents if the assumption were made that all radioactive compounds were a result of ascorbate metabolism. In addition, experiments would require large volumes of radioactive solution to submerge the hypocotyls and as a result the radioactivity would have to be diluted heavily in order to achieve this high volume.

These methods have too many drawbacks and flaws to provide an attractive method that would provide conclusive data to study ascorbate metabolism within either the hypocotyls or an intact plant.

Other methods were tested. (1) Injection of xylene cyanol could have proved useful. This would have allowed accurate positioning of galactonolactone directly into the central tissue of the hypocotyl. This method was unsuccessful because injecting any more than approximately 0.1 ml into the hypocotyl resulted in xylene cyanol coming back out of where the needle entered the hypocotyl (data not shown). (2) Hypocotyls with all roots and leaves removed had the excised root end placed in a Petri dish containing xylene cyanol solution. A vacuum line was attached to the top wound from where the stem had been removed and xylene cyanol was sucked through. However, although xylene cyanol was moved through the hypocotyl, movement was very rapid primarily through the xylem and almost no evidence of xylene cyanol passing through the tissue remained in the hypocotyl due to lack of staining. (3) Hypocotyls with roots and leaves removed had the root or stem end placed in a Petri dish containing xylene cyanol solution. The cut end left open to the atmosphere was covered with Vaseline. Warm air from a hair dryer was

passed over the hypocotyl in an attempt to promote absorption of xylene cyanol throughout the hypocotyl rather than only through the xylem. Uptake was effectively nil, with only slight staining of the tissue taking place close to where the cut end had been placed in xylene cyanol solution.



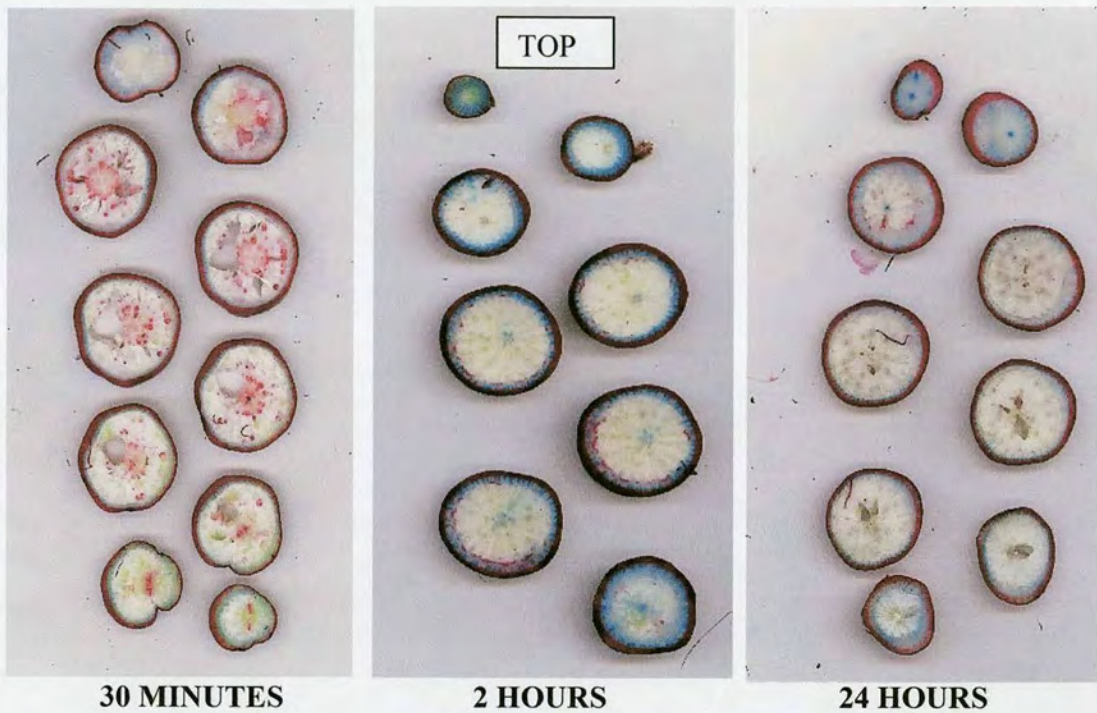

**Fig. 3.8. The effect of freezing root systems on uptake of xylene cyanol by potted radish plants.**

Roots were frozen in liquid nitrogen for 10 seconds to remove the plants' ability to screen out uptake of hydrophilic molecules. Roots were allowed to thaw and placed in 0.01% xylene cyanol solution. After 30 minutes, 2 and 24 hours, individual hypocotyls were removed, washed free of any external xylene cyanol, sliced horizontally from the stem "TOP" down through the hypocotyl toward the root and scanned. The red colour in the radish flesh is natural anthocyanin; the blue coloration is xylene cyanol.

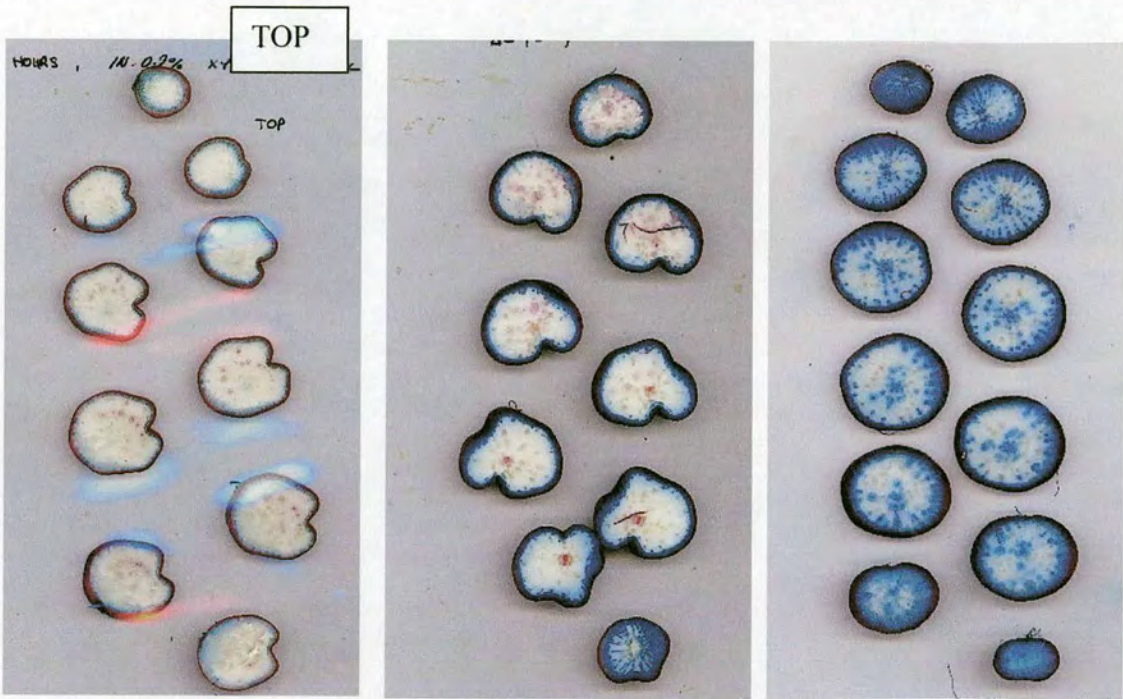

**Fig. 3.9. The effect of trimming lateral roots on xylene cyanol uptake by potted radish plants.**

Lateral root ends were trimmed by approximately 3 cm and the remaining root system was placed in 0.2% xylene cyanol. After 3, 24 and 48 hours, individual hypocotyls were removed, washed free of any external xylene cyanol, sliced as in Fig. 8 and scanned.

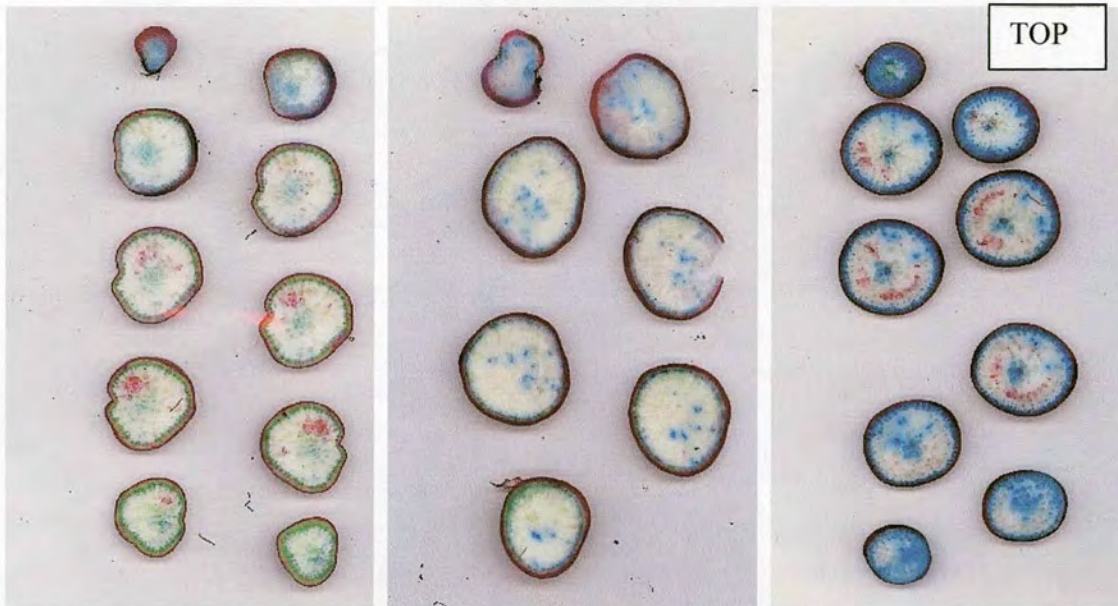

30 MINUTES

2 HOURS

24 HOURS

**Fig. 3.10. The uptake of xylene cyanol by potted radish plants after their root systems were placed in boiling water.**

Roots were placed in water at 100°C for 10 seconds to remove the plants' ability to screen out uptake of hydrophilic molecules including xylene cyanol. The root system was placed in 0.2 % xylene cyanol. After 30 minutes, 2 and 24 hours, individual hypocotyls were removed, washed free of any external xylene cyanol, sliced as in Fig. 8 and scanned.

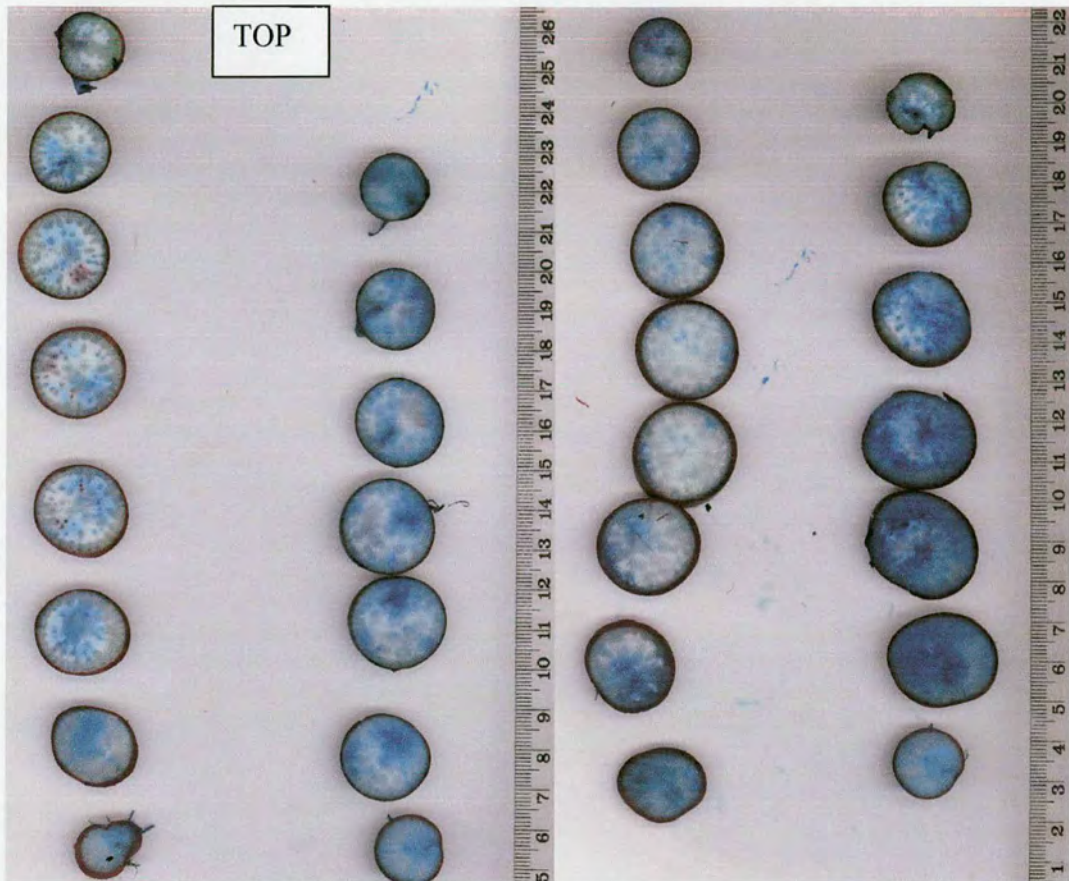

**10 MINUTES INTERRUPTED**

**20 MINUTES INTERRUPTED**

**Fig. 3.11. The effect of vacuum infiltration on xylene cyanol penetration into excised radish hypocotyls.**

Radish hypocotyls were vacuum infiltrated with 0.2% xylene cyanol at approximately 100 mm Hg for increasing periods of time. At approximately 5-minute intervals the vacuum seal was broken, returned to atmospheric pressure, and re-sealed. Individual hypocotyls were removed, washed free of any external xylene cyanol, sliced as in Fig. 8 and scanned. The experimental time was measured from when the vacuum reached 100 mm Hg.

### **3.3 THE EFFECT OF EXOGENOUS ASCORBATE ON ASCORBATE CONTENT OF PLANTS**

Plants were tested by different methods to study their uptake of ascorbate, to identify an effective method of elevating internal ascorbate, thus facilitating analysis of plant ascorbate metabolites. Intact plants were fed sodium ascorbate via their roots and their leaves and hypocotyls were then studied to test the possibility that ascorbate was simply carried straight through the hypocotyl and into the leaves by the transpiration stream. Plants fed sodium ascorbate via the intact root system showed no increase in internal levels of ascorbate within the hypocotyl or leaves throughout the period of observation (Fig. 3.12). While no increase in ascorbate was measured, this may be a result of rapid degradation of ascorbate as it enters the plant. We know from xylene cyanol experiments that uptake is visible to a small degree and therefore takes place within 24 hours; therefore the lack of change in ascorbate levels must mean that ascorbate is rapidly converted into new metabolites. It may be that the root's Casparian strip stops ascorbate moving into the xylem. While the Casparian strip cannot completely stop entrance of xylene cyanol it may be able to do so for ascorbate. The xylene cyanol experiments show little movement from the xylem into the hypocotyl tissue, suggesting that ascorbate metabolism most likely occurs within the xylem.

Plants that had had their lateral roots trimmed and the remaining root system placed in a sodium ascorbate solution also showed no increase of ascorbate over time in either the leaves or the hypocotyl (Fig. 3.13). However, we know that uptake of xylene cyanol into the hypocotyl takes place (Fig. 3.9) and therefore uptake of sodium ascorbate probably

also takes place. This points to the conclusion that degradation of ascorbate is taking place. Degradation could take place either in the plant itself, or within the soil. Ascorbate content of the soil was tested 48 hours after adding the sodium ascorbate solution and was found to have more than three quarters of the original ascorbate concentration added (results not shown). Results suggest that ascorbate catabolism would have to take place in the plant.

Intact plants were submerged in a solution of sodium ascorbate and exposed to vacuum. Again, no change in ascorbate was measured in either the leaves or the hypocotyl (Fig 3.14). We know that hypocotyls are vacuum infiltrated well by xylene cyanol (Fig. 3.11) and would have expected vacuum infiltration of sodium ascorbate to be effective. The results suggest very rapid metabolism of ascorbate within the plant.

Fig. 3.13 and 3.14 support the hypothesis that ascorbate degradation is taking place as the ascorbate moves into and through the plant. This means that ascorbate metabolism can be studied simply by feeding ascorbate; however, it must be acknowledged that this type of ascorbate metabolism may not necessarily be identical to that taking place with endogenous ascorbate. In order to study 'natural' metabolism a precursor can be used that will only be turned over to ascorbate in the appropriate organelles (mitochondria) of the plant cell.

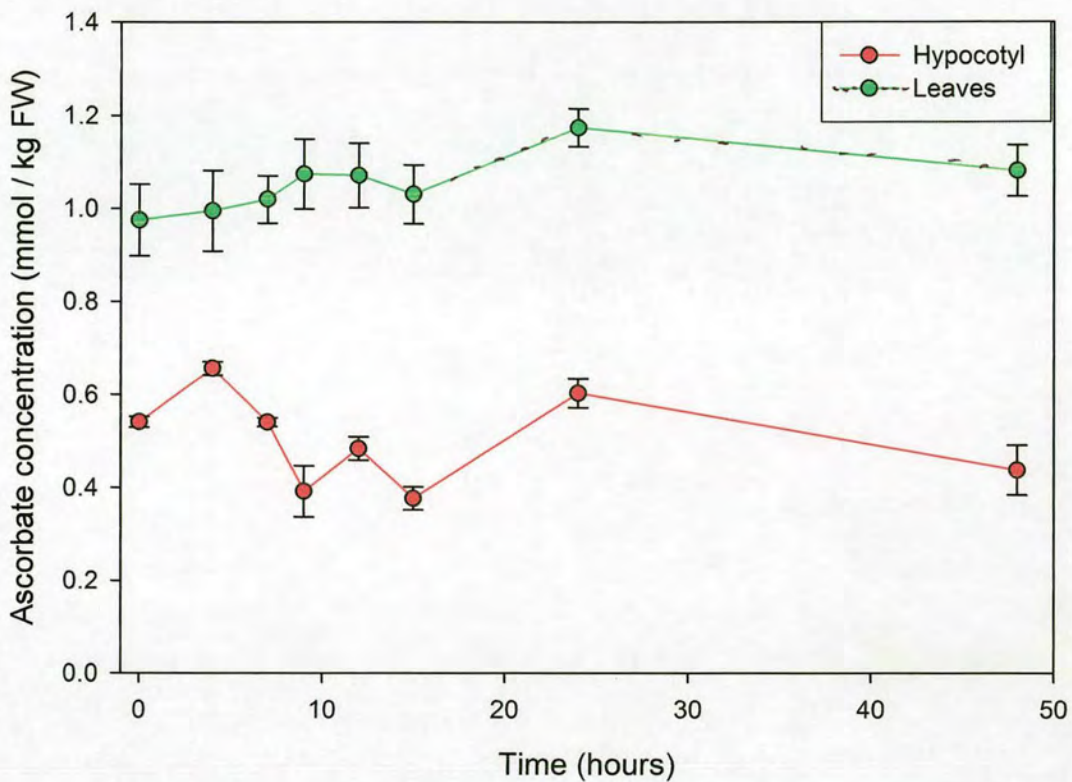

**Fig. 3.12 The effect of root-fed ascorbate on the ascorbate content of hypocotyls and leaves.**

Radish plants were grown from seed for 5 weeks and then fed 50 ml of 50 mM sodium ascorbate (pH 4) per plant pot. Further additions were made at 3, 6 and 9 hours of 50 ml per pot at each time point. After 9 hours the roots were left in any residual solution. At time intervals whole plants were removed, washed free of any external ascorbate and the ascorbate content of the leaves and hypocotyl measured separately using 0.01% DCPIP (A). The graphs show means  $\pm$  SE.

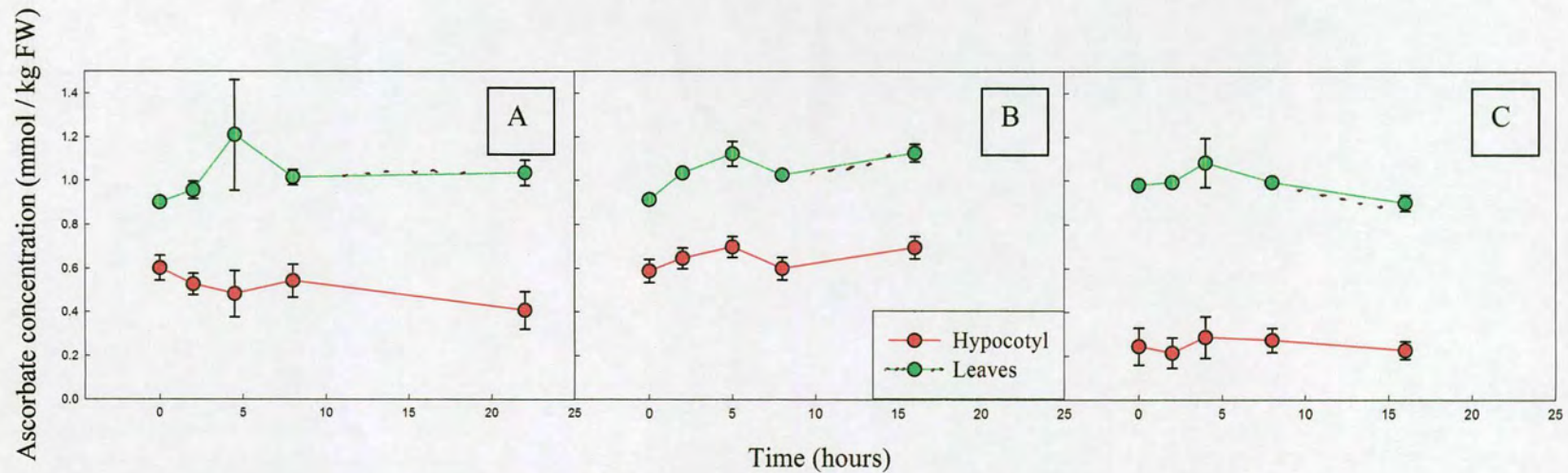

**Fig. 3.13** The effect of root-fed ascorbate on the ascorbate content of hypocotyls and leaves in plants with lateral roots trimmed.

Lateral root ends were trimmed and the remaining root system was placed in 50 mM sodium ascorbate (pH 4) for the duration of the experiment. Ascorbate content was measured as in Fig. 12. The graphs show means  $\pm$  SE. The results of repeat experiments are shown in (B) and (C).



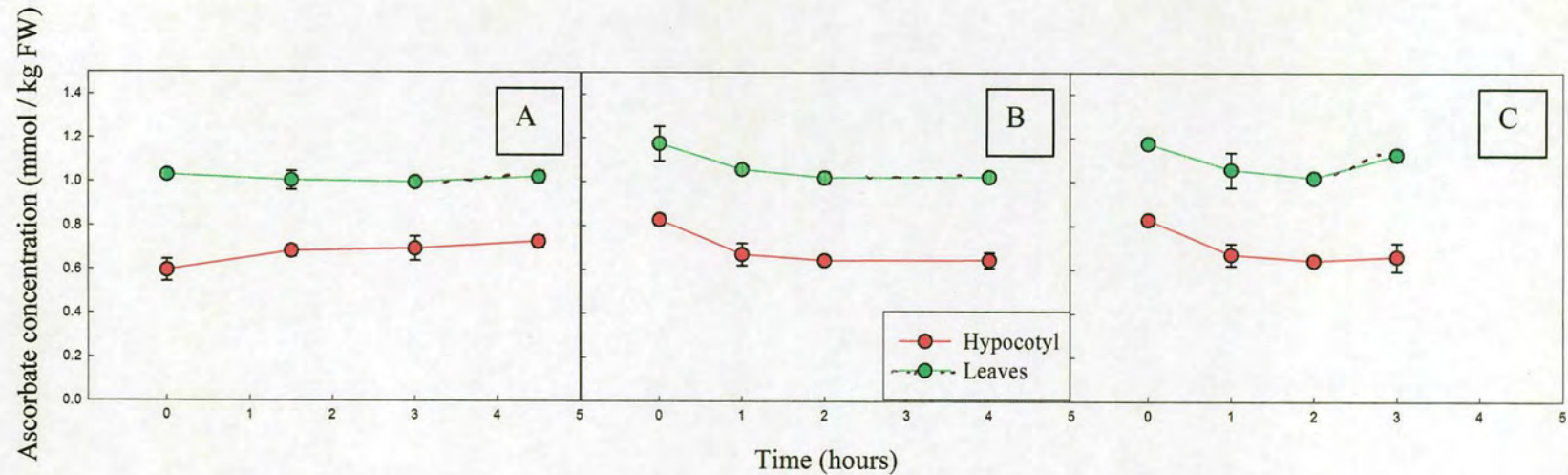

**Fig. 3.14 The effect of vacuum infiltration of sodium ascorbate on ascorbate content of hypocotyls and leaves in plants.**

Whole plants were vacuum infiltrated in approximately 0.5 L of 50 mM sodium ascorbate (pH 4) at approximately 11 mm Hg for 20 minutes. At 10 minutes the vacuum seal was broken, allowed a return to normal pressure, and re-sealed. Ascorbate content was measured as in Fig. 12. The “zero-time” sample was immediately before the first infiltration. The experimental time was measured from when the vacuum reached 100 m Hg (A). The graphs show means  $\pm$  SE. The results of repeat experiments are shown in (B) and (C).

#### **4. UPTAKE OF L-ASCORBATE AND L-GALACTONOLACTONE BY RADISH LEAVES AND THE INTACT**

To study the fate of L-ascorbate within the intact plant, leaves and hypocotyl, it was firstly desirable to ensure that radish tissues gave similar metabolic results to other species studied by Loewus and Stafford (1958). The following sets of experiments were designed to study conversion of L-galactonolactone to L-ascorbate within the leaf, hypocotyl and intact plant.

Excised leaves continually fed L-galactonolactone through the cut petiole showed a clear increase in L-ascorbate levels in comparison to leaves fed water (Fig. 4.1). This suggests that uptake of L-galactonolactone due to transpiration and conversion of L-galactonolactone to L-ascorbate is also taking place, presumably in leaf cell mitochondria. The variation in L-ascorbate content between repeat experiments (Fig. 4.1 A and B) is most probably due to the plants not having been grown at the same time.

Excised leaves fed L-galactonolactone through the cut petiole for 2 hours and then fed water for the remainder of the experiment also showed a clear increase in L-ascorbate levels in comparison to leaves fed water (Fig. 4.2). This experiment is very similar to that of Fig. 1. However, in Fig. 1 L-ascorbate levels increased by approximately 0.5 mmol / kg FW while in Fig. 2, L-ascorbate levels increased by 0.8 mmol / kg FW in (B) and 1.0 mmol / kg FW in (A). It is not clear why this should occur. A possible reason for this result is that 0.1 M L-galactonolactone fed continuously to radish leaf cells is toxic and causes breakdown of cell metabolism and results in reduced conversion of L-galactonolactone to L-ascorbate.

Bathing the isolated hypocotyl in L-galactonolactone did not affect L-ascorbate concentration (Fig. 4.3). An increase in ascorbate concentration was expected since it was supposed that L-galactonolactone would partly penetrate the hypocotyl at the cut ends and would then be converted to L-ascorbate, producing a measurable change. The lack of increase in L-ascorbate could be for several reasons. The hypocotyl is regarded as a storage organ, and therefore it may be possible that the hypocotyl cells do not have the capability to convert L-galactonolactone to L-ascorbate, but only to store it after production and transport from the leaves. However, in experiments detailed in 5.10 to 5.12 hypocotyl tissue was shown to have the capability to convert L-galactonolactone to L-ascorbate. Another possible reason is that the hypocotyl is too dense and penetration of the tissue by L-galactonolactone is negligible. The hypocotyl may have intercellular fluids that contain enzymes that convert L-galactonolactone to galactonate, and therefore L-galactonolactone was never able to reach the cells. However, experiment 5.10 to 5.12 showed an increase in L-ascorbate by feeding hypocotyl tissue L-galactonolactone.

To feed an almost intact radish plant L-galactonolactone, an incision was cut into the petiole through which uptake by the transpiration stream was possible (Fig. 4.4).

A radish plant fed L-galactonolactone in this way showed an increase in L-ascorbate content in the leaf directly fed L-galactonolactone, as well as in the neighbouring leaves, while no increase within the hypocotyl took place (Fig. 4.5). The result suggests that L-galactonolactone is readily converted to L-ascorbate within the leaves. The result also suggests that either L-galactonolactone or L-ascorbate is transported between the leaves, while it is not transported to the hypocotyl. It could also be that L-galactonolactone is transported to the hypocotyl and not converted to L-ascorbate, or that L-ascorbate is

transported to the hypocotyl but rapidly broken down upon reaching the hypocotyl. However, experiment 5.16 showed an increase in L-ascorbate by feeding hypocotyl tissue L-galactonolactone.

Radish plants fed L-galactonolactone (Fig. 4.6) were initially the same as in Fig. 4.5 and gave similar results. A rapid increase in L-ascorbate content was seen in the leaf directly fed L-galactonolactone. A slower increase was seen in leaves neighbouring the fed leaf. After 30 hours in those plants that were changed from being fed L-galactonolactone to water, we can see a drop in L-ascorbate content of leaves neighbouring the fed leaf. This would suggest that these leaves do not store L-galactonolactone or L-ascorbate, but convert or use them respectively, as they become available. The directly fed leaf has the same amount of L-ascorbate as the leaf that was fed water after 30 hours. This would suggest that the fed leaf has stored either L-ascorbate or L-galactonolactone. However, it is more likely that the leaf is flooded with L-galactonolactone and transport of L-galactonolactone from the directly fed leaf is slow, and as a result a build-up within this leaf occurs.

In a related experiment radish plants were fed L-galactonolactone through the petiole for 15 hours after which the wound was closed (Fig. 4.7). The L-ascorbate content of the fed leaf did not drop even after 50 hours, although greater variation in L-ascorbate content existed at 50 hours. The L-ascorbate content of the neighbouring leaves had increased by 16 hours but then dropped to the L-ascorbate content of control plants fed water. This would suggest that a certain amount of storage of either L-ascorbate or L-galactonolactone occurred. The L-ascorbate content of the hypocotyl again did not vary between the plants fed L-galactonolactone and the plants fed water.

The evidence thus suggests that the transport of L-galactonolactone and/or L-ascorbate takes place between different leaves but not between leaves and the hypocotyl. Experiments were replicated once except; Fig. 4.6, five replicates, Fig. 4.3, four replicates

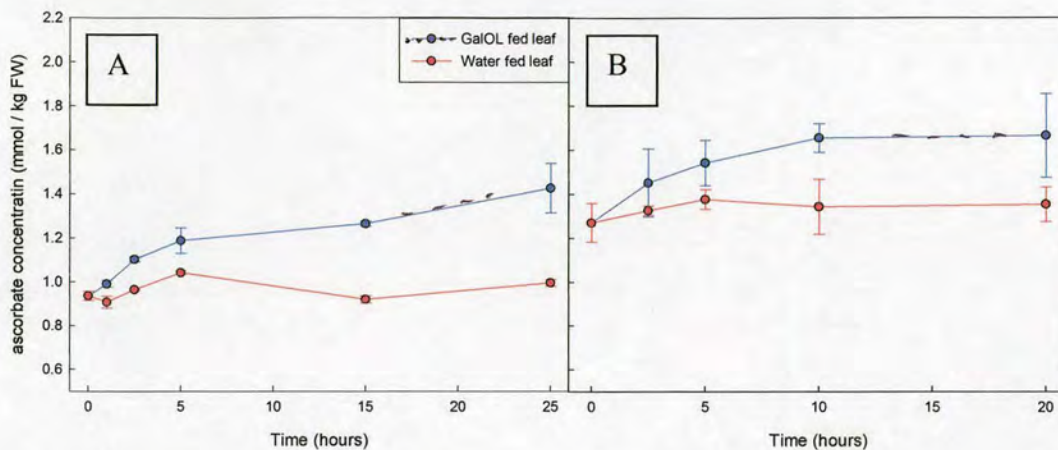

**Fig. 4.1** The effect of feeding L-galactonolactone continually on the ascorbate concentration of excised leaves.

Radish plants were grown from seed for 5 weeks. After 5 weeks the plant was placed under water and the leaves cut mid-way along the petiole and then placed straight into a continuous supply of 0.1 M L-galactonolactone. At each time point five leaves were randomly selected and assayed for ascorbate content. The results of a repeat experiment are shown in (B). The graphs show means  $\pm$  SE.

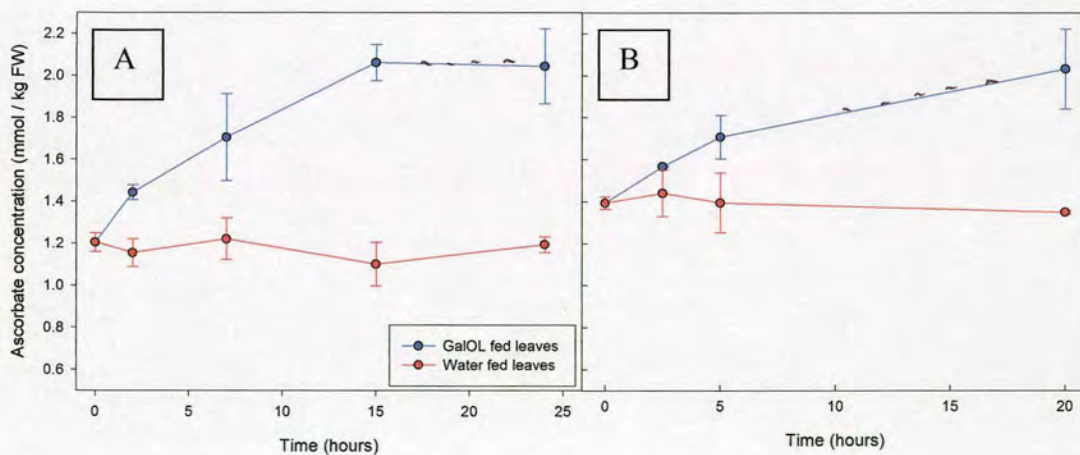

**Fig. 4.2** The effect of feeding L-galactonolactone for 2 hours on the ascorbate concentration of excised leaves.

Leaves were obtained as in Fig. 1. After 2 hours in 0.1 M L-galactonolactone the leaves were removed and placed into a continuous supply of de-ionised water. Other details as in Fig. 1.

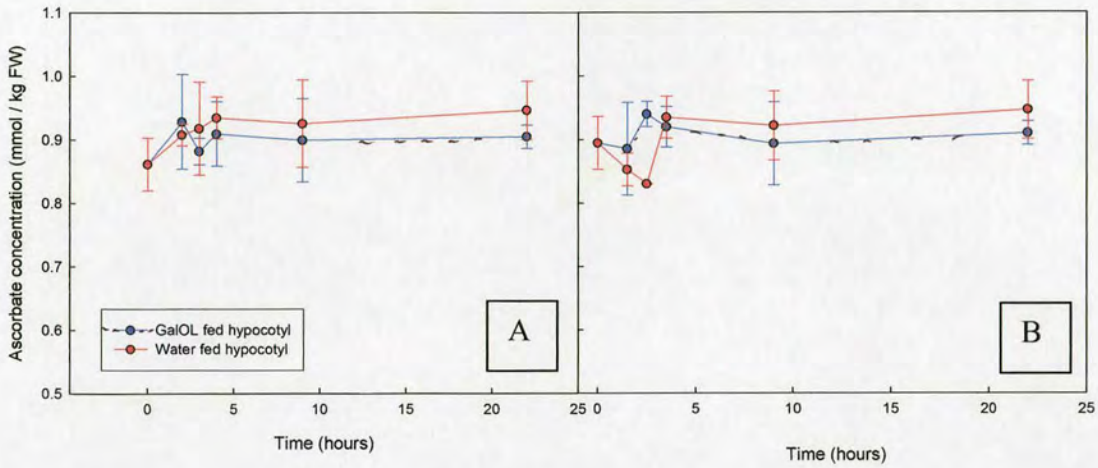

**Fig. 4.3 The effect of feeding L-galactonolactone continually on the ascorbate concentration of excised hypocotyls.**

Radish plants were grown from seed. After 5 weeks the plant was removed from its pot and placed under water, and the hypocotyl was cut from the root and leaves and then partly submerged in approximately 250 ml of 0.1 M L-galactonolactone in a 5 L container. The hypocotyls were rolled around within the container bathed in the solution on a rotating shaker. At each time point five hypocotyls were randomly selected and assayed for ascorbate content. The results of a repeat experiment are shown in (B). The graphs show means  $\pm$  SE.

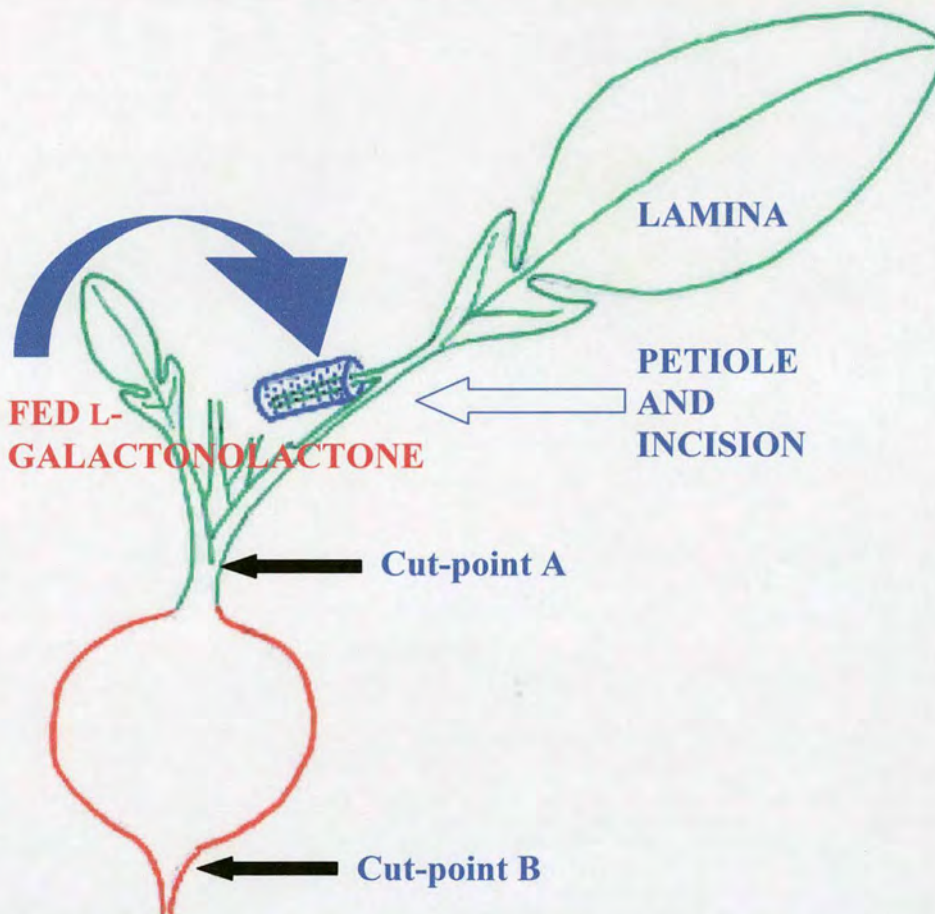

**Fig. 4.4 Diagram of a radish plant, and how L-galactonolactone was fed through the petiole**

The radish plant remained in its soil and pot. After 5 weeks one leaf was placed under water and an incision was mid-way along the petiole, and then increased in size by cutting up the length of the petiole for approximately 2 cm creating a flap. This was attached to a 1-ml Eppendorf tube containing either 0.1 M L-galactonolactone or water. The L-galactonolactone or water was drawn into the leaf over time by the transpiration stream. Plants fed L-galactonolactone or water were kept separate. Leaves were removed from the hypocotyl for ascorbate quantification by cutting them individually from the plant at point A. The hypocotyl was removed from the remaining root for ascorbate quantification by cutting at point B.



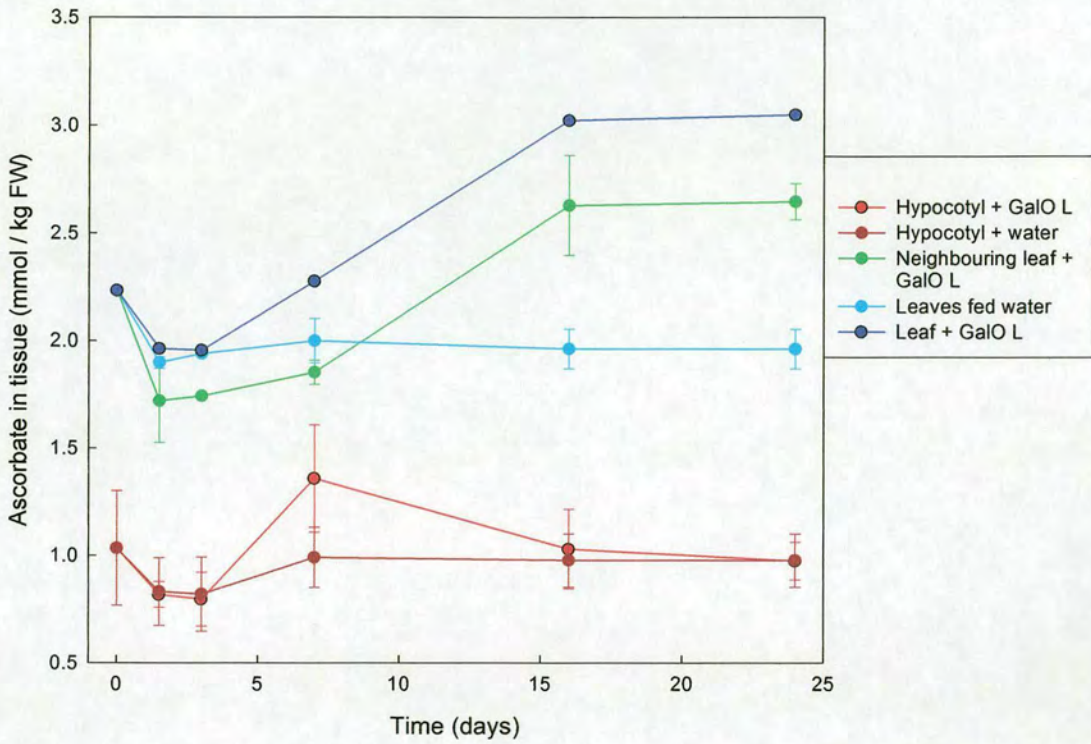

**Fig. 4.5 The effect of feeding L-galactonolactone through a partially cut petiole on the ascorbate concentration of a radish plant.**

Radish plants were grown from seed. At each time point three plants were randomly selected from plants fed L-galactonolactone and plants fed water and assayed for the ascorbate content of different organs. The leaves directly fed L-galactonolactone of all 3 plants were pooled and tested as one sample. Other details as in Fig. 4

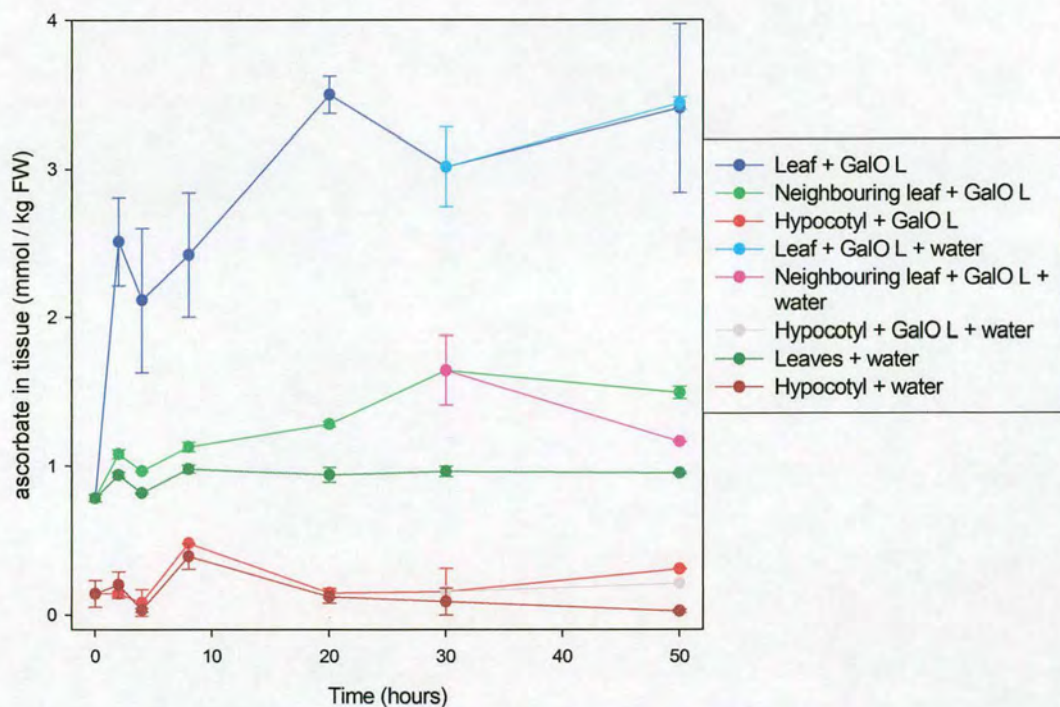

**Fig. 4.6 The effect of feeding L-galactonolactone followed by water at 30 h through a partially cut petiole on the ascorbate concentration of an radish plant.**

Radish plants were prepared and assayed for ascorbate as in Fig. 4. At 30 hours several plants were randomly selected and their source of L-galactonolactone was replaced with water for the remainder of the experiment. Plants fed water before 30 h were tested for ascorbate content separately from plants fed L-galactonolactone to allow comparison. The leaf directly fed water had its ascorbate content measured with the neighbouring leaves. The graph shows means  $\pm$  SE.

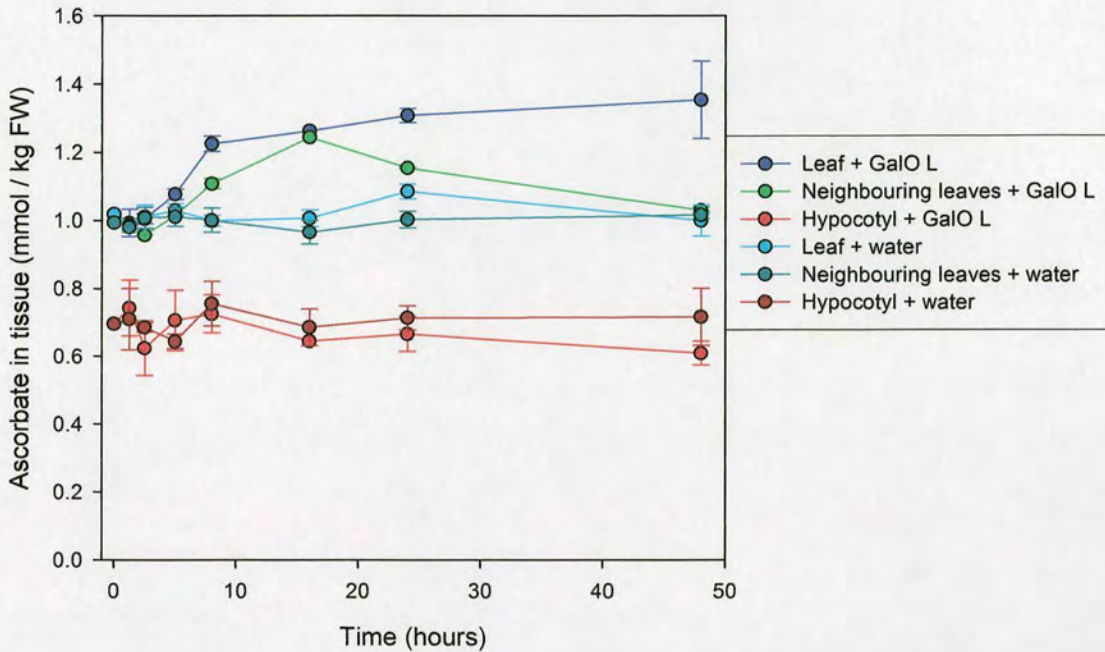

**Fig. 4.7 The effect of feeding L-galactonolactone through a cut petiole for 15 h on the ascorbate concentration of a radish plant.**

Radish plants were prepared and assayed for ascorbate as in Fig. 4. At 15 h, plants that had been fed L-galactonolactone had this source of L-galactonolactone replaced with water for the remainder of the experiment. Plants fed water before 15 h were tested for ascorbate content separately from plants fed L-galactonolactone to allow comparison. The graph shows means  $\pm$  SE.

## **5 UPTAKE OF METABOLITS BY EXCISED HYPOCOTYL DISKS**

### **5.1 UPTAKE OF L-[1-<sup>14</sup>C]GALACTONOLACTONE BY HYPOCOTYL DISKS**

Previous work has been carried out to study the fate of L-ascorbate primarily within leaves (Loewus and Stafford, 1958) and immature plants (Saito and Kasai, 1969). The following set of experiments was designed to enable the study of L-ascorbate metabolism in a plant storage organ: the edible radish hypocotyl. To study the fate of L-ascorbate within radish hypocotyl tissue I identified a method that would allow the effective uptake of the L-ascorbate precursor L-galactonolactone. All experiments used disks taken from the white central tissue or the outer tissue of the hypocotyl (Fig. 5.1). Initial uptake experiments used ten disks per Petri dish (Fig. 5.2). Fig. 5.3 shows uptake of L-[1-<sup>14</sup>C]galactonolactone and [<sup>3</sup>H]isoprimeveritol when dishes were placed on a shaker ensuring the disks were bathed in water containing the radioactive substances. [<sup>3</sup>H]isoprimeveritol was added to the bathing solution because it is unable to cross into the cell owing to its large molecular size. This allows comparison between a control (isoprimeveritol), which is not expected to be taken up, and the test compound (galactonolactone). Aliquots of the solution were removed at each time point and assayed by scintillation counting. Hypocotyl disks did not take up either the [<sup>3</sup>H]isoprimeveritol or the [<sup>14</sup>C]galactonolactone during the time course.

The lack of uptake of L-[1-<sup>14</sup>C]galactonolactone could be due to impurities that had not been removed during manufacture of galactonolactone and its isolation. To test this type of explanation, an *Arabidopsis* cell culture was fed a sample of [<sup>14</sup>C]galactonolactone and

[<sup>3</sup>H]isoprimeveritol. The cell culture was gently shaken in a Petri dish. At time intervals samples were removed and assayed for both isotopes. The *Arabidopsis* cell culture showed a clear uptake of almost all L-[1-<sup>14</sup>C]galactonolactone within the first 50 min while the [<sup>3</sup>H]isoprimeveritol as expected remained in the bathing solution (Fig. 5.4). Uptake of [<sup>3</sup>H]galactonolactone is clearly possible. This identified that the problem with uptake was in some way due to the radish disks and not the L-[1-<sup>14</sup>C]galactonolactone.

De-ionised water would not provide any nutrients that may be necessary for the survival of the radish disks during the uptake of L-[1-<sup>14</sup>C]galactonolactone. To compensate for this, succinate buffer and nutrient solutions (Fig. 5.5 (a–g)) were supplied to the radish disks during the feeding of L-[1-<sup>14</sup>C]galactonolactone and [<sup>3</sup>H]isoprimeveritol. With disks bathed in solutions containing K, Ca and Glc (Fig. 5.5 a), or Suc (Fig. 5.5 b), variable radioactive counts were measured throughout their time-course; however, the variability was consistent for both <sup>14</sup>C and <sup>3</sup>H suggesting that the variation was in sample volume measured, and therefore due to experimental error. No net uptake of either radioactive metabolite was measured in media containing K, Ca and Glc (Fig. 5.5 a) or Suc (Fig. 5.5 b) or K, Ca, Glc and Suc (Fig. 5.5 f). The effect of K, Ca or K, Ca or Suc showed no uptake of radioactive counts throughout the time-course. The solutions containing mixtures of K, Ca, Glc or Suc did not affect uptake of either radioactive metabolite. Glucose and/or sucrose were proposed to help cell survival but these metabolites also did not affect cell uptake of galactonolactone (Fig. 5.5 a, b, d, f). Neither glucose nor sucrose was added in the experiment reported in Fig. 5.5 c to see if they possibly acted as competitors to the uptake of galactonolactone. No uptake of galactonolactone occurred showing that the problem with uptake of galactonolactone was not due to competition.

The various cations and sugars had no effect on the hypocotyl disks' ability to take up galactonolactone. It had been thought that these solutes might help promote uptake of galactonolactone. However, they did not, suggesting that the problem with uptake may be due to something other than the nutrient level within the bathing solution. Experiments were replicated three times except; Fig. 5.3, twice, Fig 5.4, once, Fig. 5.5, once, Fig. 5.8, twice, Fig. 5.16, four times.

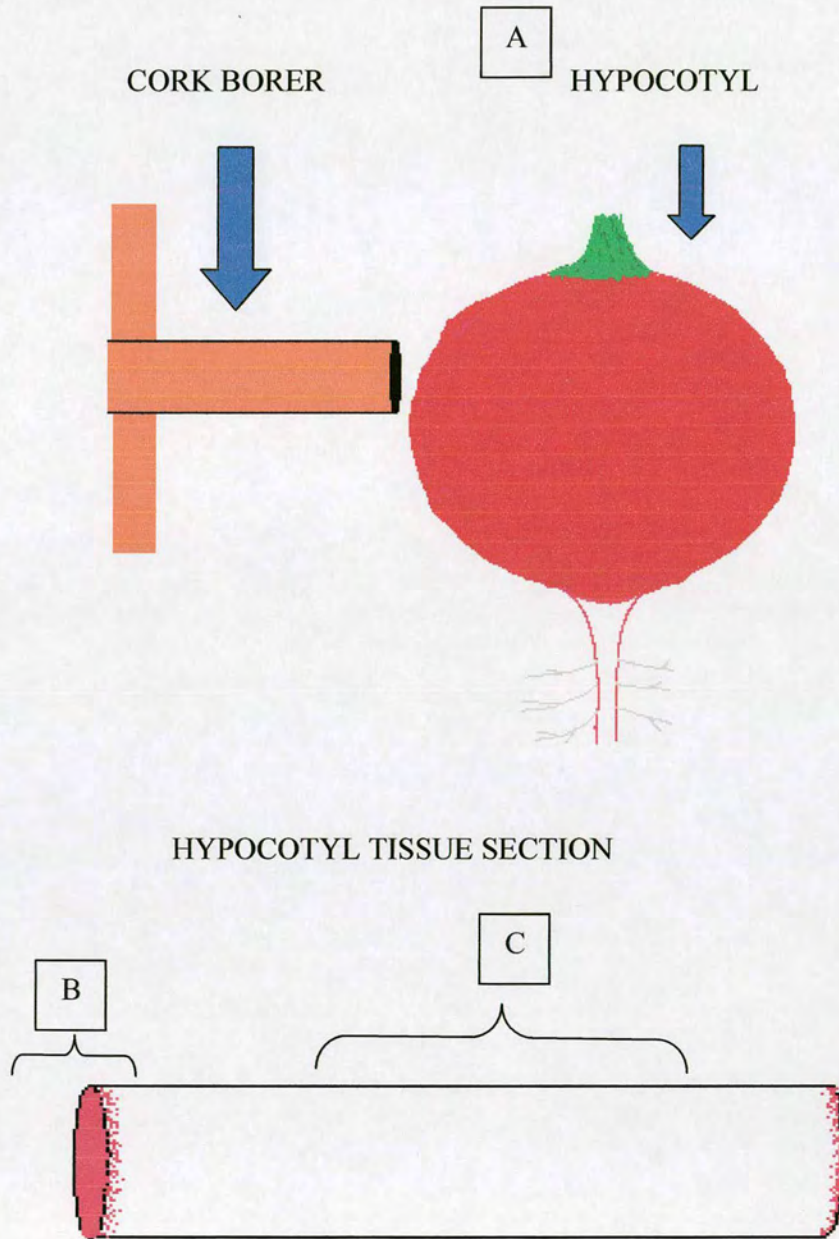

**Fig. 5.1 Hypocotyl tissue core removal and disk selection**

A transverse plug cut from the hypocotyl by a cork borer (A) was removed and disks cut from either the outer tissue (B) or the inner tissue (C) were used for uptake experiments.

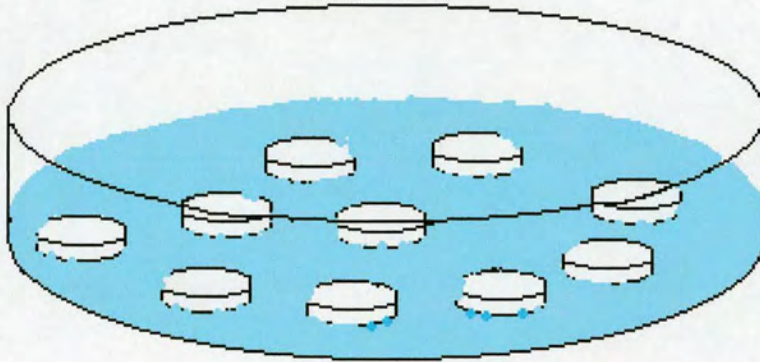

**Fig. 5.2 Hypocotyl disks bathed in solution within a Petri dish**

Disks cut from the central tissue of the hypocotyl were placed in a Petri dish and bathed in 10 ml of solution by gently rotating the Petri dish.

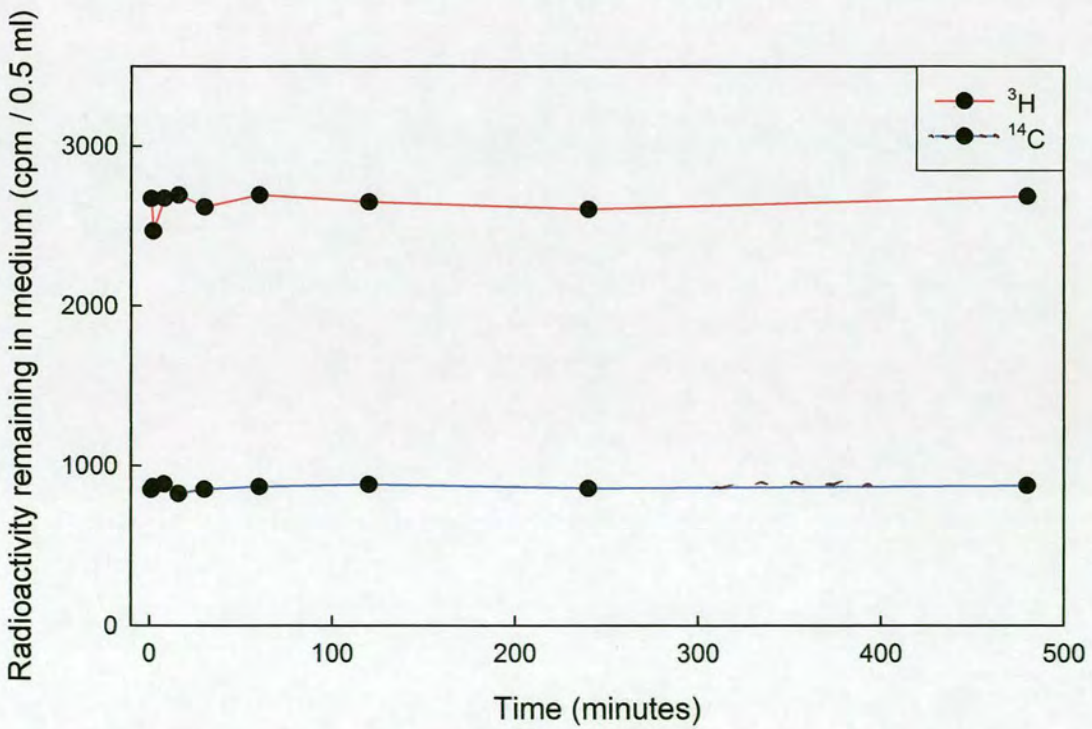



**Fig. 5.3 Uptake of L-[1-<sup>14</sup>C]galactonolactone and [<sup>3</sup>H]isoprimeveritol by hypocotyl disks in water.**

Ten "C" disks (Fig. 5.1) were bathed in a Petri dish containing 10 ml of de-ionised water, shaken gently and incubated at room temperature in daylight.

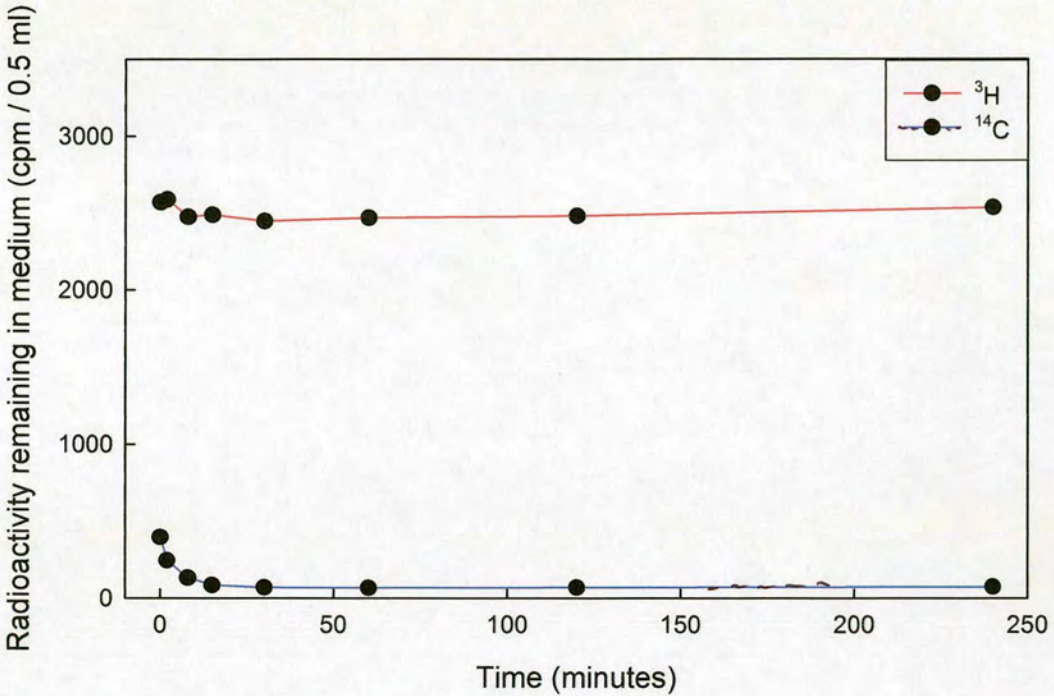

**Fig. 5.4 Uptake of L-[1-<sup>14</sup>C]galactonolactone and [<sup>3</sup>H]isoprimeveritol by *Arabidopsis* cell culture.**

*Arabidopsis* cell culture (10 ml) was placed in a Petri dish, shaken gently and incubated at room temperature.

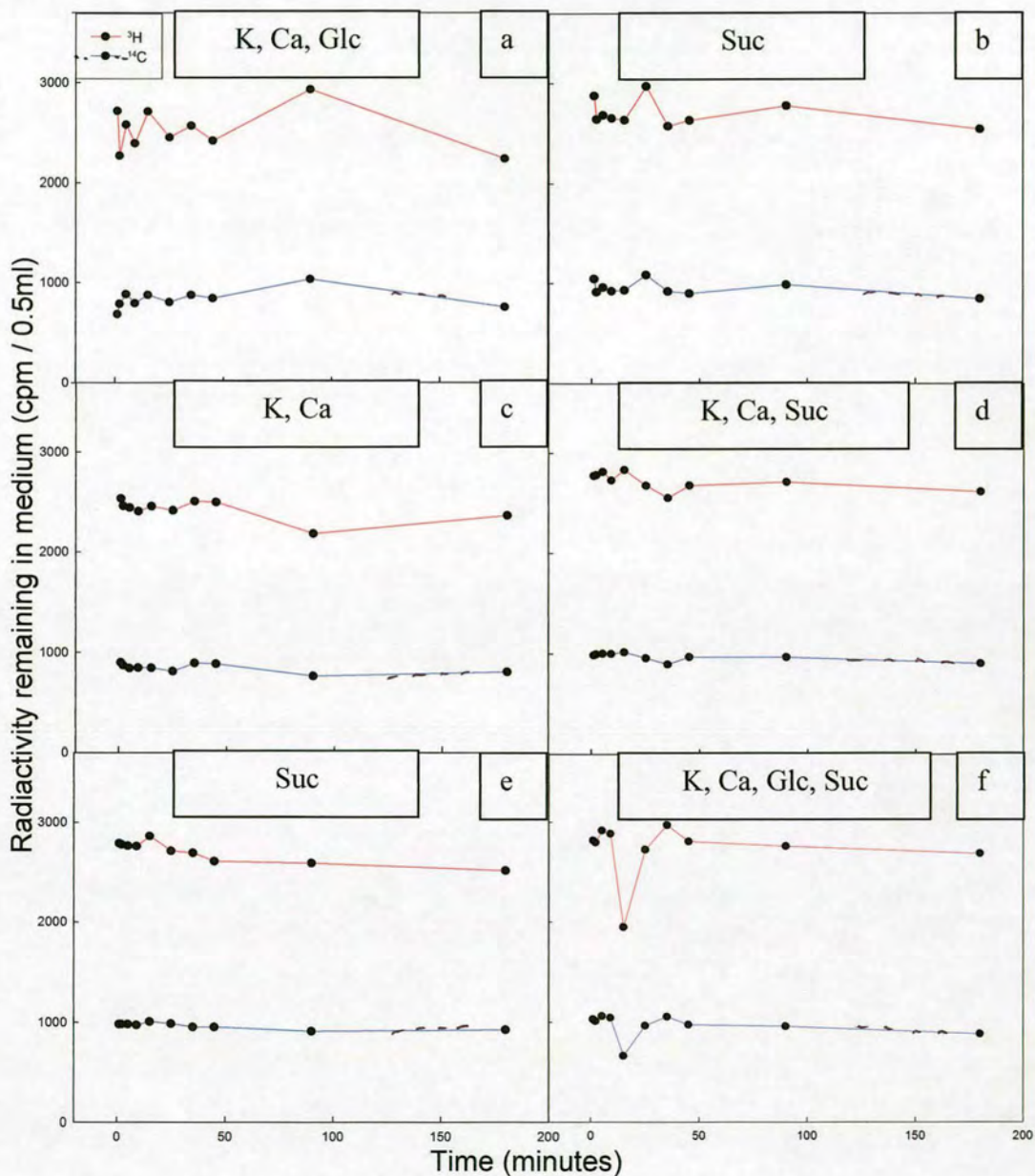

**Fig. 5.5 Uptake of L-[1-<sup>14</sup>C]galactonolactone and [<sup>3</sup>H]isoprimeveritol by hypocotyl disks bathed in different media**

Uptake at room temperature by ten "C" disks (Fig. 5.1) bathed in a Petri dish containing 10 ml of 20 mM succinate (pH 5) supplemented with (a) 20 mM KCl, 20 mM CaCl<sub>2</sub>, and 0.2% glucose; (b) 0.2% sucrose; (c) 20 mM KCl and 20 mM CaCl<sub>2</sub>; (d) 20 mM KCl, 20 mM CaCl<sub>2</sub> and 0.2% sucrose; (e) 0.2% sucrose; (f) 20 mM KCl, 20 mM CaCl<sub>2</sub>, 0.2% glucose and 0.2% sucrose.

## 5.2 UPTAKE OF L-[6-<sup>3</sup>H]GALACTONOLACTONE BY UNDERGROUND STORAGE ORGANS

Previous experiments by Stuart and Varner (1980) involved the study of metabolites within edible underground storage organs, using carrot tissue for experimentation. As there was no obvious uptake of radiolabelled galactonolactone by radish disks (Fig. 5.3 and 5.5), similar experiments were carried out using disks of underground storage organs, carrot, radish, potato and turnip. The disks were washed in running tap water overnight. The experiment failed to show uptake of L-[1-<sup>14</sup>C]galactonolactone by any disks (Fig. 5.6). The slight dip in <sup>14</sup>C was mirrored by that in <sup>3</sup>H. Any disappearance of [<sup>14</sup>C]galactonolactone caused by carrot, radish, potato or turnip disks was most probably a result of the disk acting as a sponge. Radioactive molecules would move into the disks' apoplastic volume and therefore be diluted in more than the original 10 ml of bathing solution. Results suggest that no uptake of galactonolactone by the protoplasts of the disk cells takes place.

Disks were also fed L-[6-<sup>3</sup>H]galactonolactone (Fig. 5.7). Again, neither radish disks nor other types of vegetable showed uptake of radioactivity.

In conclusion washing storage organ disks in running tap water before testing for [<sup>3</sup>H]galactonolactone uptake failed to produce uptake of either metabolite used.

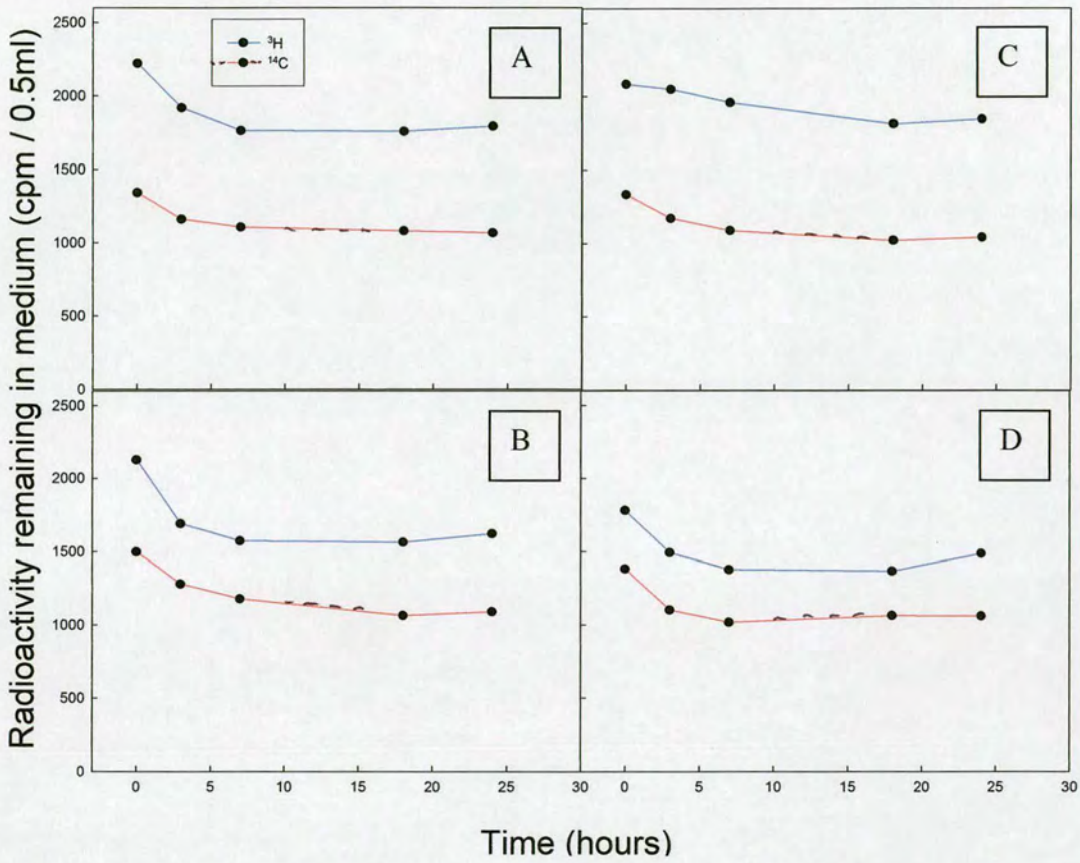

**Fig. 5.6 Uptake of  $[^{14}\text{C}]$ galactonolactone and  $[^3\text{H}]$ isoprimeveritol by vegetable disks.**

Uptake of L-[1- $^{14}\text{C}$ ]galactonolactone and  $[^3\text{H}]$ isoprimeveritol by ten "C" disks (Fig. 1) of (A) carrot root, (B) radish hypocotyl, (C) turnip hypocotyl, (D) potato tuber bathed in a Petri dish containing 10 ml of water at room temperature.

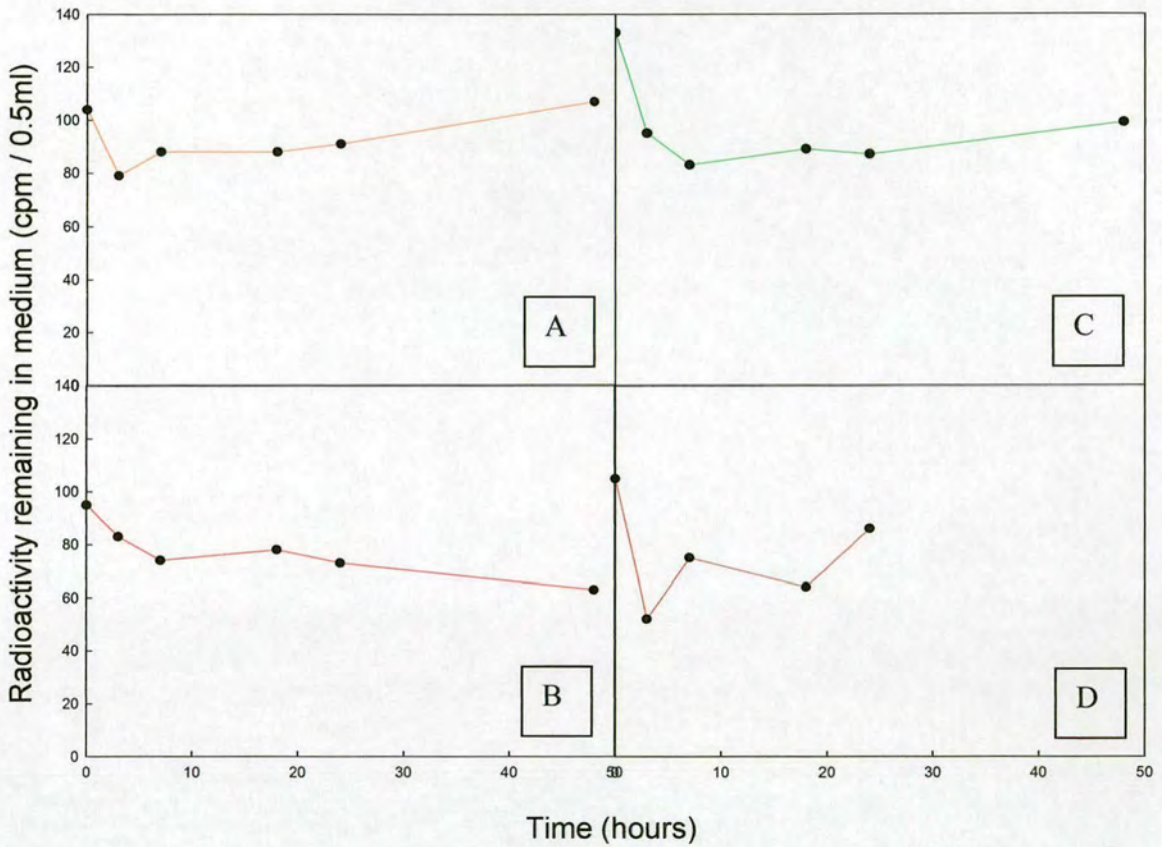

**Fig. 5.7 Uptake of [<sup>3</sup>H]galactonolactone by vegetable disks.**

Four vegetable types were tested for uptake of [<sup>6-3</sup>H]galactonolactone by ten "C" disks (Fig. 1) of (A) carrot root, (B) radish hypocotyl, (C) turnip hypocotyl, (D) potato tuber, bathed in 10 ml of de-ionised water at room temperature.

### **5.3 UPTAKE OF RADIOLABELLED SUGARS BY UNDERGROUND STORAGE**

#### **ORGAN DISKS**

To see if the problem with uptake was due to contaminants in the radiochemical, L-galactonolactone, disks were fed [6-<sup>14</sup>C]glucose and [U-<sup>14</sup>C]sucrose to see if vegetable cells would take up these radiochemicals (Fig. 5.8). Glucose and sucrose were chosen since they are important plant metabolites capable of being taken up and utilised by many diverse plant tissues.

Radish, carrot, potato and turnip were tested for their uptake of [6-<sup>14</sup>C]glucose (Fig. 5.8). Sustained glucose uptake was seen only in carrot root disks, although there was also uptake of [<sup>3</sup>H]isoprimeveritol. This was unexpected since isoprimeveritol is not taken up by any other plant tissues tested (Fry, personal communication). The result may be due to microbial contamination. The lack of uptake seen in radish hypocotyl disks, turnip hypocotyl disks and potato tuber disks was unexpected since glucose transporters would be expected in the plasma membrane and glucose is an important cell metabolite.

Radish, carrot, potato and turnip were also tested for their uptake of [<sup>14</sup>C]sucrose (Fig. 5.9). No uptake of sucrose was seen by any of the vegetables. This was also unexpected since sucrose is important in plant metabolism.

No uptake of sucrose or glucose took place under these conditions. These results pose the problem that if the disks will not take up either glucose or sucrose they are unlikely to take up more minor metabolites such as galactonolactone. However, if this is the case, clearly it is not just a problem with galactonolactone, but a problem with the disks regarding how they are prepared or treated during the experiment, which can be rectified.

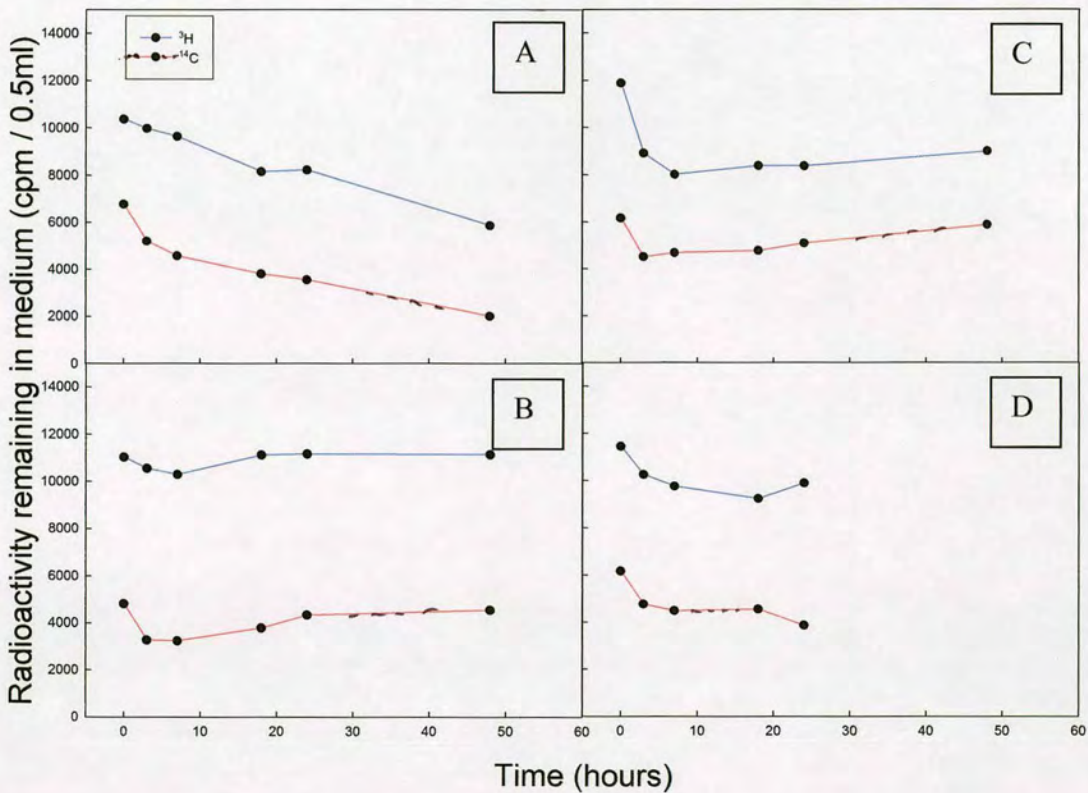

**Fig. 5.8 Uptake of  $[^{14}\text{C}]$ glucose and  $[^3\text{H}]$ isoprimeveritol by vegetable disks.**

Radish plants were grown from seed for 5 weeks. "C" disks (Fig. 5.1) were cut from the and placed in running tap water for 24 hours. Uptake of  $[^{14}\text{C}]$ glucose and  $[^3\text{H}]$ isoprimeveritol was studied using ten disks of carrot root (A), radish hypocotyl (B), turnip hypocotyl (C), and potato tuber (D), bathed in 10 ml of de-ionised water at room temperature. Potato disk measurements were stopped early because of the presence of contaminant organisms that may have produced false results.

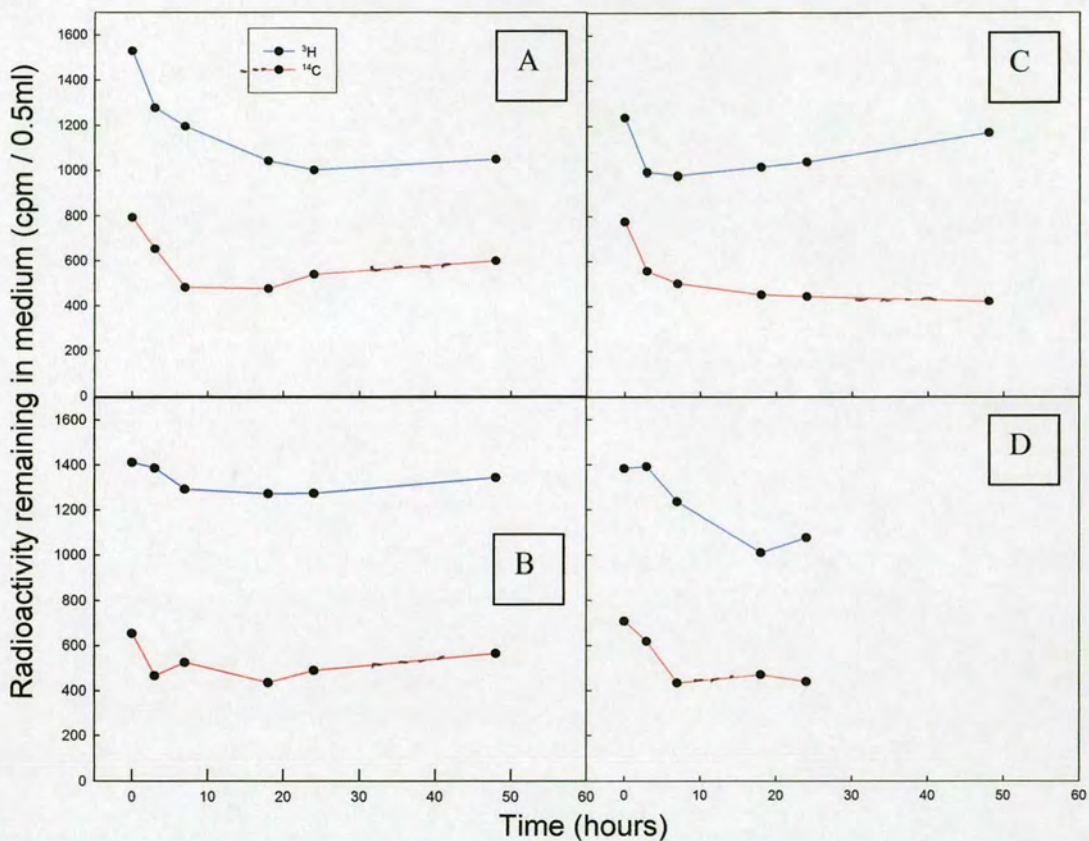

**Fig. 5.9 Uptake of  $[^{14}\text{C}]$ sucrose and  $[^3\text{H}]$ isoprimeveritol by vegetable disks**

Uptake of  $[^{14}\text{C}]$ sucrose and  $[^3\text{H}]$ isoprimeveritol by ten "C" disks (Fig. 5.1) of carrot root (A), radish hypocotyl (B), turnip hypocotyl (C), and potato tuber (D), bathed in 10 ml of de-ionised water at room temperature. Other details as in Fig. 5.8.



#### **5.4 UPTAKE OF L-[6-<sup>3</sup>H]GALACTONOLACTONE BY RADISH HYPOCOTYL DISKS FOLLOWING OVERNIGHT WASHING**

Failure to discover conditions under which hypocotyl disks would take up galactonolactone led to testing another method where tap water was allowed to de-gas before hypocotyl disks were washed in the water. The disks were also tested in varying concentrations of galactonolactone to discover the concentrations causing saturation of the galactonolactone uptake system.

Tap water was stood in a container overnight and allowed to de-gas. Hypocotyl disks were placed in the de-gassed water, which was then gently stirred overnight. The disks were then bathed in solutions containing varying concentrations of non-radioactive galactonolactone as well as 2  $\mu\text{M}$  L-[1-<sup>14</sup>C]galactonolactone and [<sup>3</sup>H]isoprimeveritol. These experiments allowed identification of clear and effective uptake of L-galactonolactone, how rapidly the uptake took place, and the approximate concentration that saturated the uptake system.

Hypocotyl disks cut from white flesh (Fig. 5.1 "C") and tested under laboratory lighting (Fig. 5.10) showed clear uptake in the presence of 10  $\mu\text{M}$  non-radioactive galactonolactone (Fig. 5.10 B). No uptake of L-[1-<sup>14</sup>C]galactonolactone under similar conditions from a solution containing 1 mM non-radioactive galactonolactone was seen (Fig. 5.10 A). Uptake is thus possible under these conditions if the total concentration of galactonolactone is kept low.

Hypocotyl disks cut from the outer tissue (Fig. 5.1 "B") of the hypocotyl and tested under laboratory lighting in a solution containing 1 mM non-radioactive galactonolactone

showed slight uptake of L-[1-<sup>14</sup>C]galactonolactone (Fig. 5.11 A). Clear uptake of L-[1-<sup>14</sup>C]galactonolactone was seen in a similar experiment when the disks were bathed in a solution containing 10  $\mu$ M galactonolactone (Fig. 5.11 B). Uptake was possible under both concentrations, unlike with disks from inner hypocotyl tissue (Fig. 5.10). Uptake of the L-[1-<sup>14</sup>C]galactonolactone was more rapid at 10  $\mu$ M in the experiment using outer tissue.

Disks cut from the white flesh of the hypocotyl and tested in darkness for uptake showed slight uptake of L-[1-<sup>14</sup>C]galactonolactone in the presence of 100  $\mu$ M (Fig. 5.12 C) and clear uptake in a solution containing 10  $\mu$ M (Fig. 5.12 D) non-radioactive L-galactonolactone. Negligible uptake of L-[1-<sup>14</sup>C]galactonolactone was seen in the presence of 1 or 10 mM L-galactonolactone (Fig. 5.12 A or B). Lighting conditions thus appeared to have no effect on uptake of L-[1-<sup>14</sup>C]galactonolactone. Concentrations of 100  $\mu$ M and lower of non-radioactive galactonolactone allowed uptake of L-[1-<sup>14</sup>C]galactonolactone. A Michaelis–Menton plot (Fig. 5.13) and a Lineweaver–Burk plot (Fig. 5.14) was used to calculate a  $K_m$  of 0.96 nM for disk uptake of L-[1-<sup>14</sup>C]galactonolactone.

Hypocotyl disks cut from the outer tissues of the hypocotyl and tested in darkness for uptake showed no uptake of L-[1-<sup>14</sup>C]galactonolactone in the presence of 1 mM galactonolactone (Fig. 5.15 A), unlike under laboratory lighting (Fig 5.11 A). Clear uptake was seen under the same conditions at 10  $\mu$ M galactonolactone (Fig. 5.15 B). Uptake appears to be possible at low (10  $\mu$ M) concentrations. Uptake L-[1-<sup>14</sup>C]galactonolactone of was more rapid at 10  $\mu$ M in disks from outer radish tissue than in those from central hypocotyl tissue or under conditions of darkness.

Pre-soaking hypocotyl disks in de-gassed tap-water allowed uptake of galactonolactone unlike simply bathing disks in water during uptake (Fig. 5.3), bathing disks in various nutrient solutions during uptake (Fig. 5.5) or washing disks in non-degassed tap water overnight before testing for uptake. Disks from outer hypocotyl tissue in laboratory lighting had higher uptake of galactonolactone than under all other conditions.

To test whether the method of pre-soaking disks, known to result in uptake of galactonolactone, led to ascorbate production, radish disks cut from white hypocotyl tissue (Type "C", Fig. 5.1) were bathed in 0.1 M L-galactonolactone. Disks were removed at time points and tested for ascorbate content. Results showed that net ascorbate production took place only when disks were bathed in L-galactonolactone, indicating that galactonolactone was being converted to ascorbate (Fig. 5.16).

The success of this method allows the study of galactonolactone uptake and presumably its metabolism within hypocotyl tissue as may normally occur. This method will allow studies to progress into ascorbate metabolism.

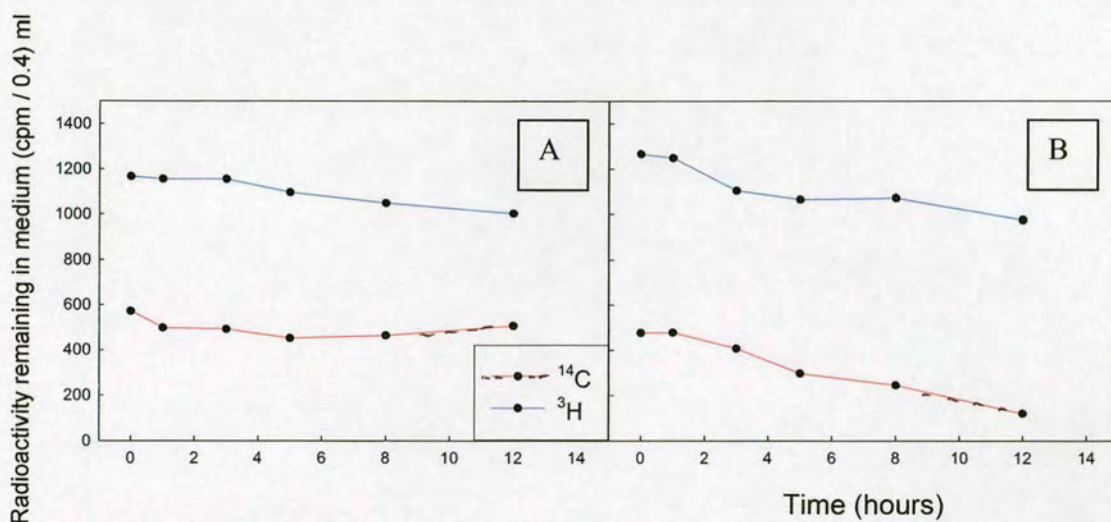

**Fig. 5.10 Uptake of L-[1-<sup>14</sup>C]galactonolactone and [<sup>3</sup>H]isoprimeveritol by disks without hypocotyl skin in laboratory light.**

Multiple disks "C" (Fig. 5.1) were added to 1 L de-gassed tap water. The container was covered with a layer of muslin and the water was gently stirred for 24 hours with a magnetic stirrer. Disks that sank in the water after stirring had stopped were selected for experiments. Uptake of L-[1-<sup>14</sup>C]galactonolactone (2 μM) and [<sup>3</sup>H]isoprimeveritol was tested by bathing 10 disks in 10 ml de-ionised water in a Petri dish containing: (A) 1 mM L-galactonolactone or (B) 10 μM L-galactonolactone at room temperature under laboratory light.

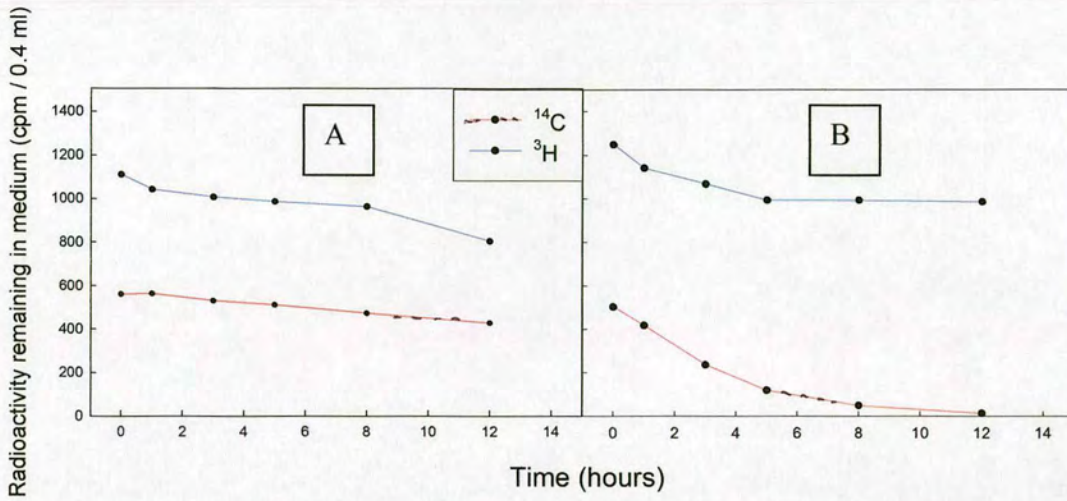

**Fig. 5.11 Uptake of L-[1-<sup>14</sup>C]galactonolactone and [<sup>3</sup>H]isoprimeveritol by disks with hypocotyl skin in day light.**

Multiple type "B" disks (Fig. 5.1) were cut. The outer tissue was removed from the hypocotyl and the first 3 mm of the hypocotyl surface that included both outer red and underlying white tissue was used. All other details as in Fig. 5.10.

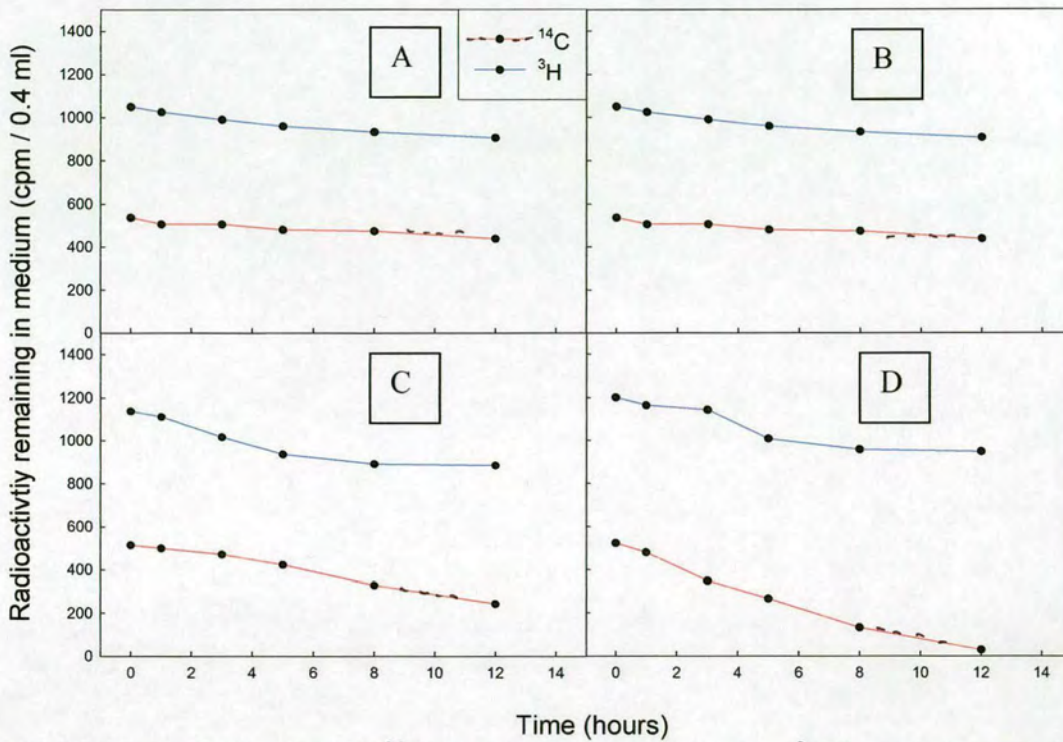

**Fig. 5.12 Uptake of L-[1- $^{14}\text{C}$ ]galactonolactone and [ $^3\text{H}$ ]isoprimeveritol by hypocotyl disks from internal tissue in constant darkness.**

Uptake by type "C" disks (Fig. 5.1) was tested under constant darkness with each Petri dish containing (A) 10 mM galactonolactone, (B) 1 mM galactonolactone, (C) 100  $\mu\text{M}$  galactonolactone, (D) 10  $\mu\text{M}$  galactonolactone. All other details as in Fig. 5.10.

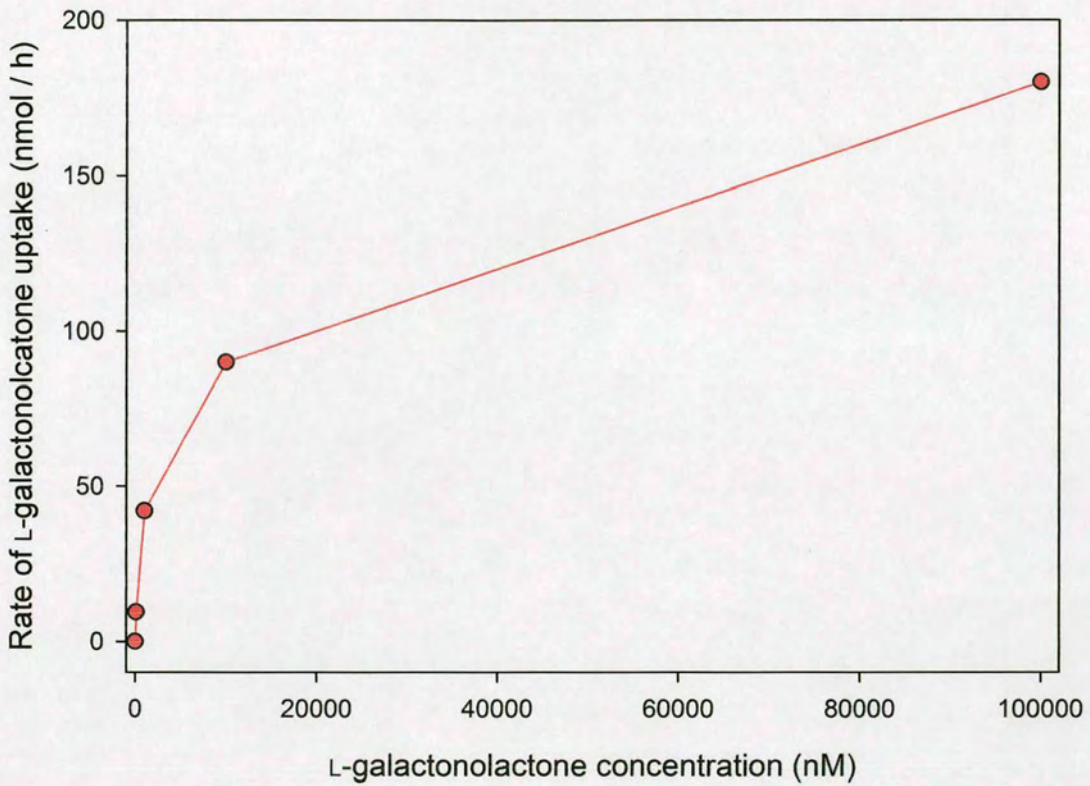

**Fig. 5.13 Rate of uptake of L-[1-<sup>14</sup>C]galactonolactone by hypocotyl disks from internal tissue in constant darkness.**

Rate of uptake by type "C" disks (Fig. 5.1) under increasing concentrations of L-galactonolactone (Fig. 5.12).

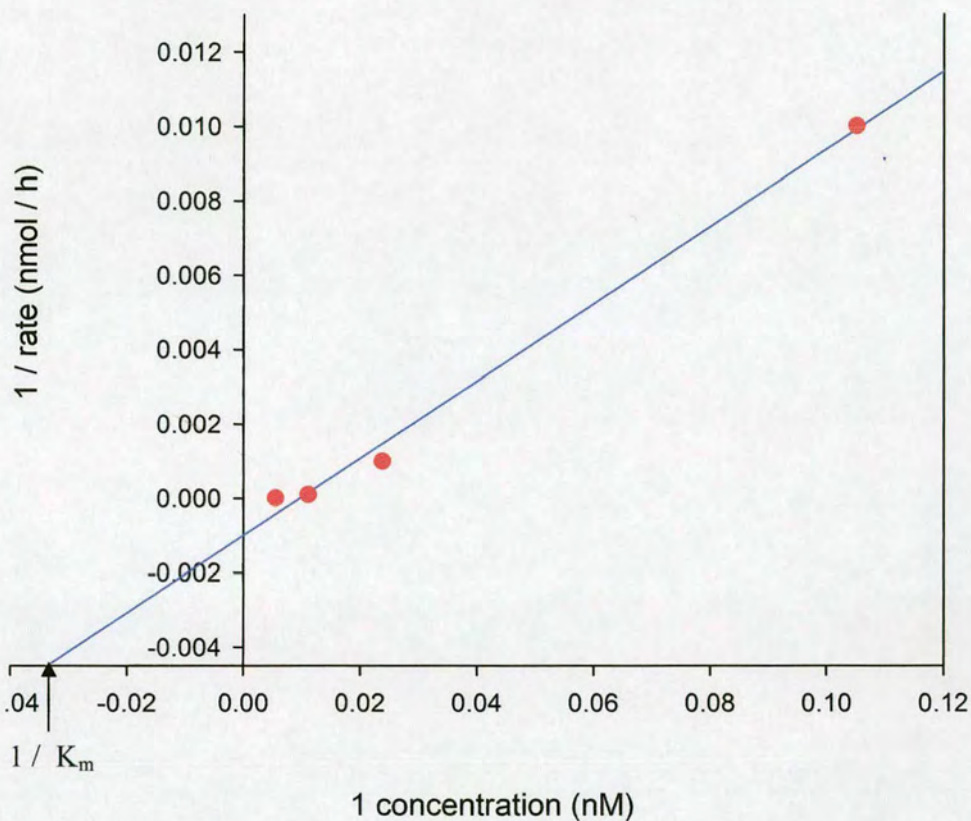

**Fig. 5.14** Lineweaver–Burke plot of rate of uptake of L-[1-<sup>14</sup>C]galactonolactone by hypocotyl disks from internal tissue in constant darkness.

Rate of uptake of type “C” disks (Fig. 5.1) under increasing concentrations of L-[1-<sup>14</sup>C]galactonolactone (Fig. 5.12). The line of the graph gave a value of  $-0.034$  for  $1 / k_m$ .



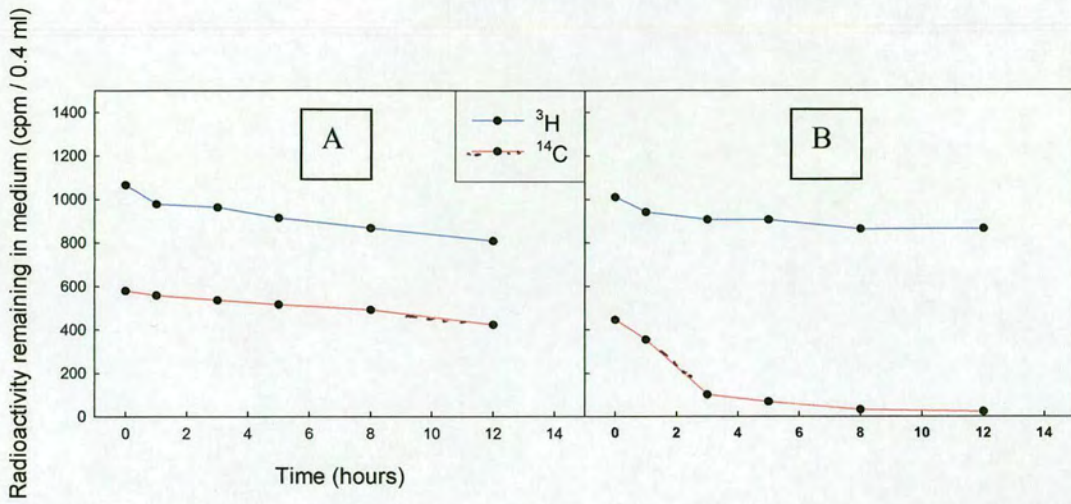

**Fig. 5.15 Uptake of L-1-[<sup>14</sup>C]galactonolactone and [<sup>3</sup>H]isoprimeveritol by disks with outer hypocotyl tissue in constant darkness.**

Type "B" disks were cut from outer hypocotyl tissue and tested for uptake in darkness. All other details as in Fig. 5.10.

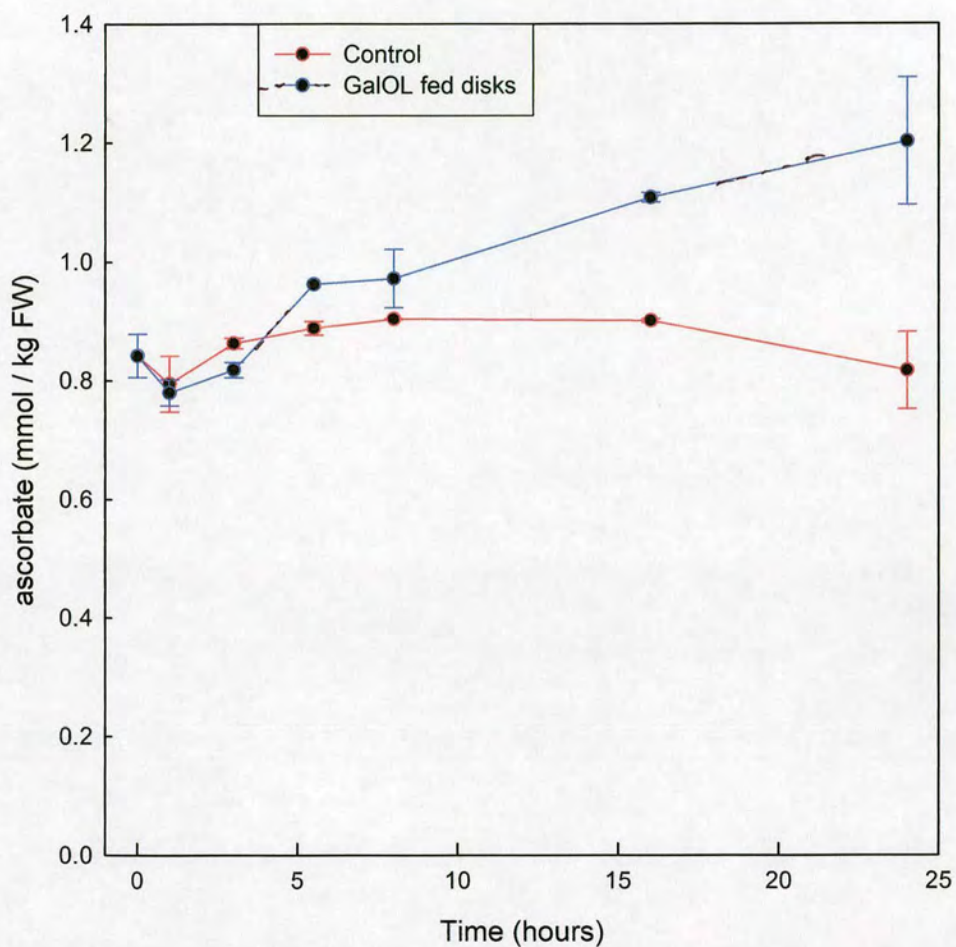

**Fig. 5.16 Net ascorbate production of disks bathed in L-galactonolactone**

Type "C" disks (Fig. 5.1) were tested. Net production of ascorbate was tested by bathing 25 disks in 25 ml of 0.1 M L-galactonolactone under laboratory lighting. At each time-point three hypocotyl disks were randomly selected from the container and assayed for ascorbate content.

## **6 CONVERSION OF L-[6-<sup>14</sup>C]GALACTURONIC ACID TO L-[1-<sup>14</sup>C]GALACTONOLACTONE**

The aim of these experiments was to create a pure stock of [1-<sup>14</sup>C]galactonolactone

### **6.1.1 PURIFICATION OF D-[6-<sup>14</sup>C]GALACTURONIC ACID**

Paper electrophoresis (pH 3.5) was used to separate 500 µl of D-[6-<sup>14</sup>C]galacturonic acid from impurities (Fig. 1). Radioactive D-[6-<sup>14</sup>C]galacturonic was detected by autoradiography and the electrophoretogram's external markers. Clear separation of [6-<sup>14</sup>C]galacturonic acid from other radioactive compounds was achieved.

A second purification by paper electrophoresis (pH 3.5) of impure [6-<sup>14</sup>C]galacturonic acid was used to ensure the method was repeatable. The [6-<sup>14</sup>C]galacturonic acid was separated from other radioactive compounds as in Fig. 1. No further steps were taken to purify the samples of [6-<sup>14</sup>C]galacturonic acid.

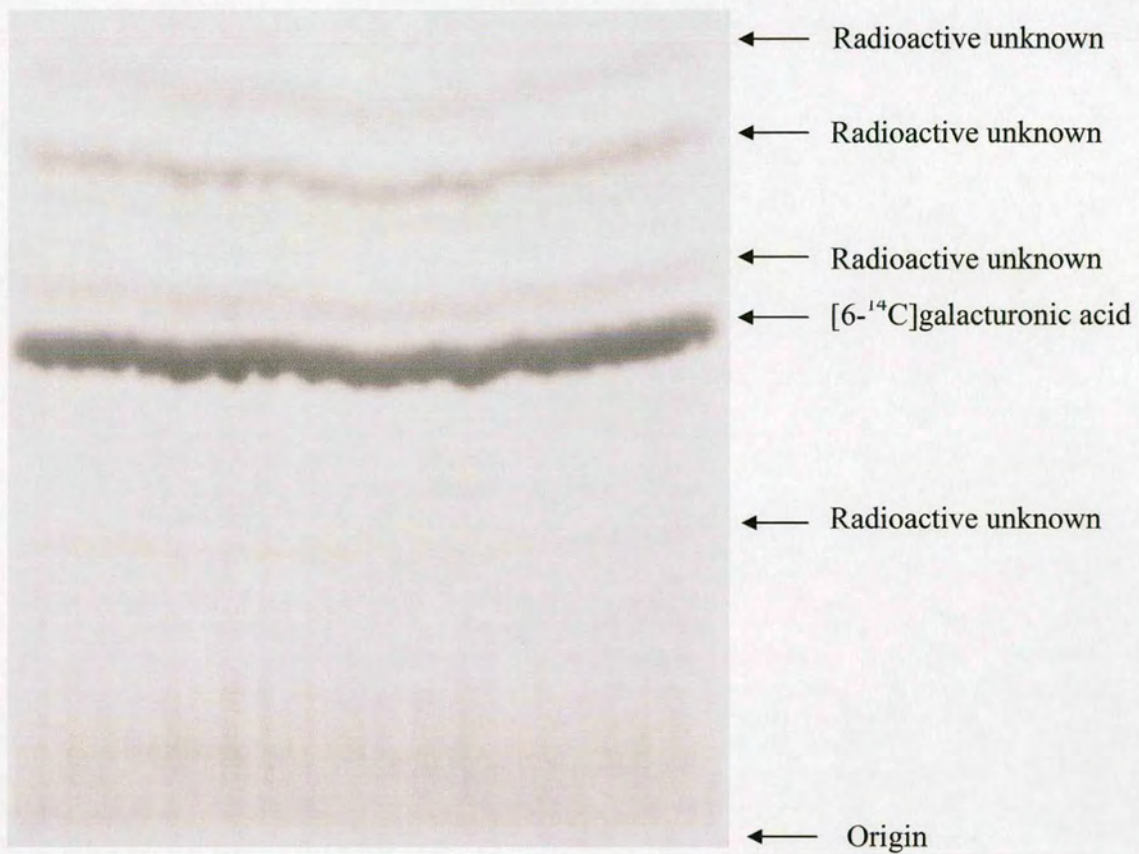

**Fig. 6.1 Purification of D-[6-<sup>14</sup>C]galacturonic acid**

Autoradiogram of paper electrophoretogram (pH 3.5, 3 kV, for 30 minutes) of impure [6-<sup>14</sup>C]galacturonic acid. D-[6-<sup>14</sup>C]galacturonic acid (83 MBq) was loaded on Whatman No.1 as a 20-cm streak.

### 6.1.2 CONVERSION OF L-[6-<sup>14</sup>C]GALACTURONIC ACID TO L-[1-<sup>14</sup>C]GALACTONIC ACID

D-[6-<sup>14</sup>C]Galacturonic acid was converted to [1-<sup>14</sup>C]galactonic acid with 0.2 M NaBH<sub>4</sub> in NH<sub>3</sub> (at least 1 mol of NaBH<sub>4</sub> per mol of galacturonic acid) at room temperature for 5 hours. The reaction was stopped by addition of acetic acid to destroy any NaBH<sub>4</sub>

In preliminary work a time course was set up using a small amount of [6-<sup>14</sup>C]galacturonic acid. The products were separated using paper electrophoresis at pH 3.5. Fig. 6.3 shows a steady conversion of [6-<sup>14</sup>C]galacturonic acid to [1-<sup>14</sup>C]galactonic acid with maximum conversion at 300 min. Therefore for routine use [6-<sup>14</sup>C]galacturonic acid was incubated with 0.2 M NaBH<sub>4</sub> in NH<sub>3</sub> for 300 mins.

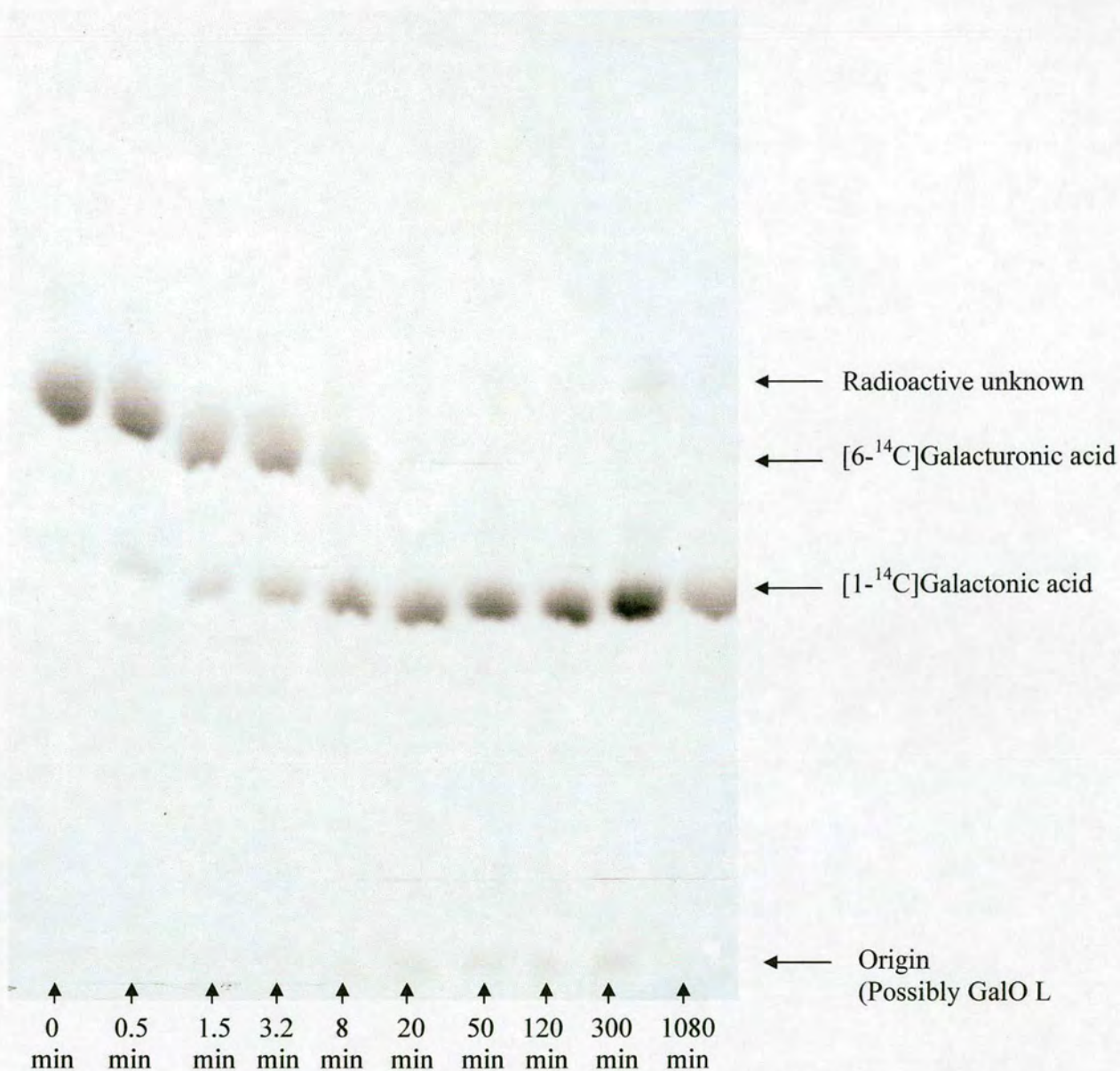
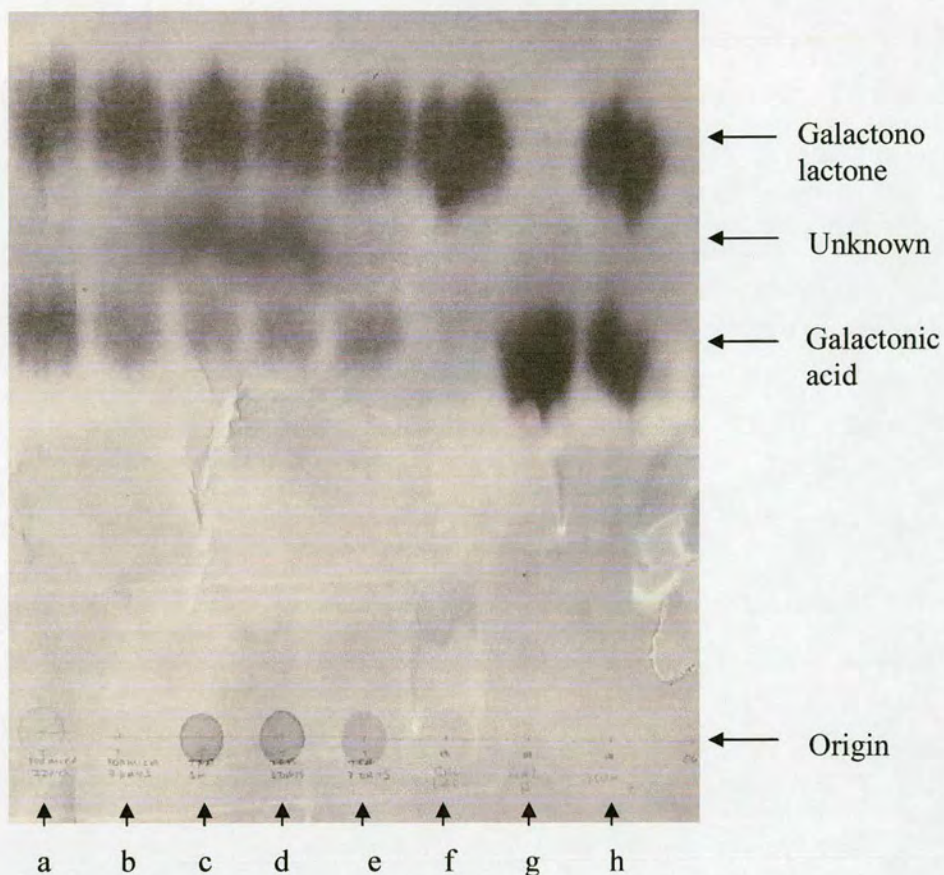

**Fig. 6.2 Conversion of D-[6-<sup>14</sup>C]Galacturonic acid to L-[1-<sup>14</sup>C]galactonic acid**

Autoradiogram of paper electrophoretogram (pH 3.5, 3 kV for 36 mins) of [6-<sup>14</sup>C]galacturonic acid, [1-<sup>14</sup>C]galactonic acid and [1-<sup>14</sup>C]galactonolactone. A 1 ml sample of 0.2 M NaBH<sub>4</sub> in NH<sub>3</sub> containing 1.6 MBq of D-[6-<sup>14</sup>C]Galacturonic acid was mixed with 95 μl samples removed at time points and mixed with 17 M AcOH. Samples were dried by SpeedVac, re-dissolved in 10 μl of H<sub>2</sub>O and loaded onto Whatman 3 MM paper.

### 6.13 CONVERSION OF L-[1-<sup>14</sup>C]GALACTONIC ACID TO L-[1-<sup>14</sup>C]GALACTONOLACTONE

Various acids and time scales were used tested to identify the most effective method of converting galactonic acid to galactonolactone (Fig. 6.4-6.7). Solutions of D-galactonic acid (l-galactonic acid can not be purchased, D and L isomers behave identically under these experimental conditions) were exposed to different acid conditions and conversion of the acid to the lactone was distinguished by paper electrophoresis. Results show equally good conversion to galactonolactone at 3 hours, 3 dyas and 7 days; however, and intermediate that was produced at 3 hours and 3 days disappeared at 7 days and this incubation time was chosen for that reason (Fig. 6.4).



**Fig. 6.3 Conversion of galactonic acid to galactonolactone by formic acid and TFA**

Galactonic acid (1%) was dissolved in 1 M formic acid and incubated at room temperature for 3 days (d) and 7 days (e). Galactonolactone marker (f), galactonic acid marker (g) and a mixture of both (h). A sample of 20  $\mu$ l was loaded onto Whatman 3 MM paper and compounds were separated by Bu.AcOH.H<sub>2</sub>O (12:3:5) for 16 hours. The compounds were stained with silver nitrate.



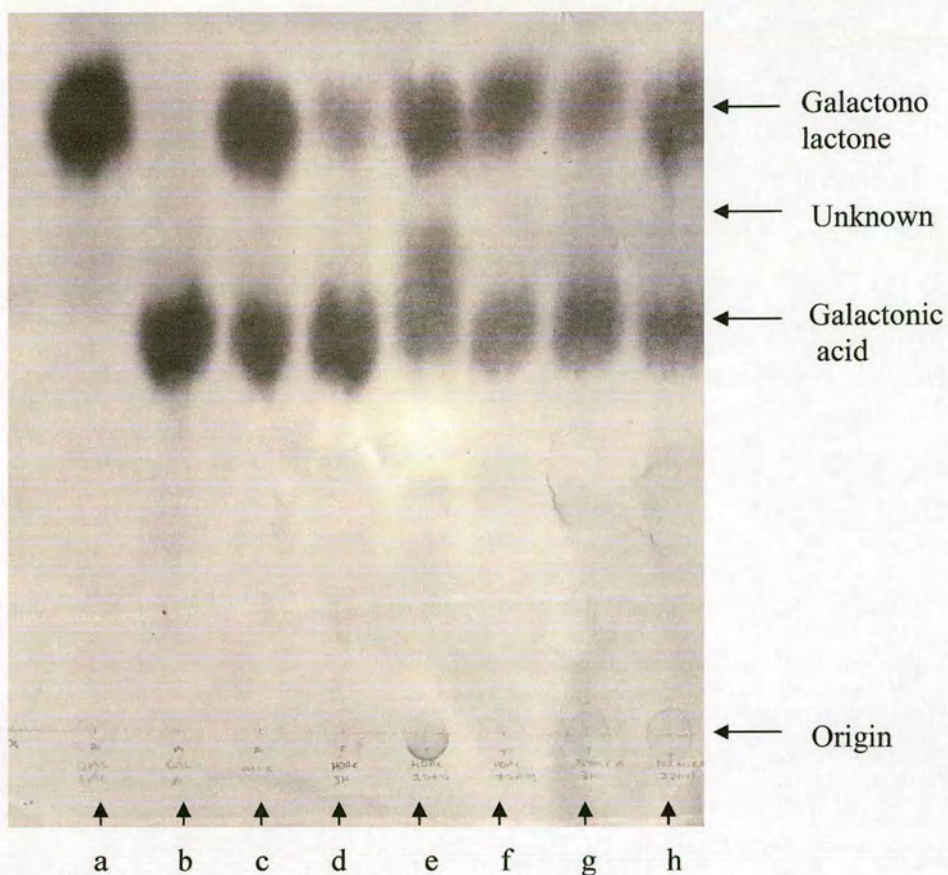

**Fig. 6.4 Conversion of galactonic acid to galactonolactone by acetic acid and formic acid**

Galactonolactone marker (a), galactonic acid marker (b) and a mixture of both (c). Galactonic acid (1%) was treated and incubated at room temperature with 1 M acetic acid for 3 hours (d), 3 days (e) and 7 days (f). Galactonic acid (1%) treated and incubated at room temperature with 1 M formic acid for 3 hours (g) and 3 days (h). Samples were treated and loaded as in Fig. 3.

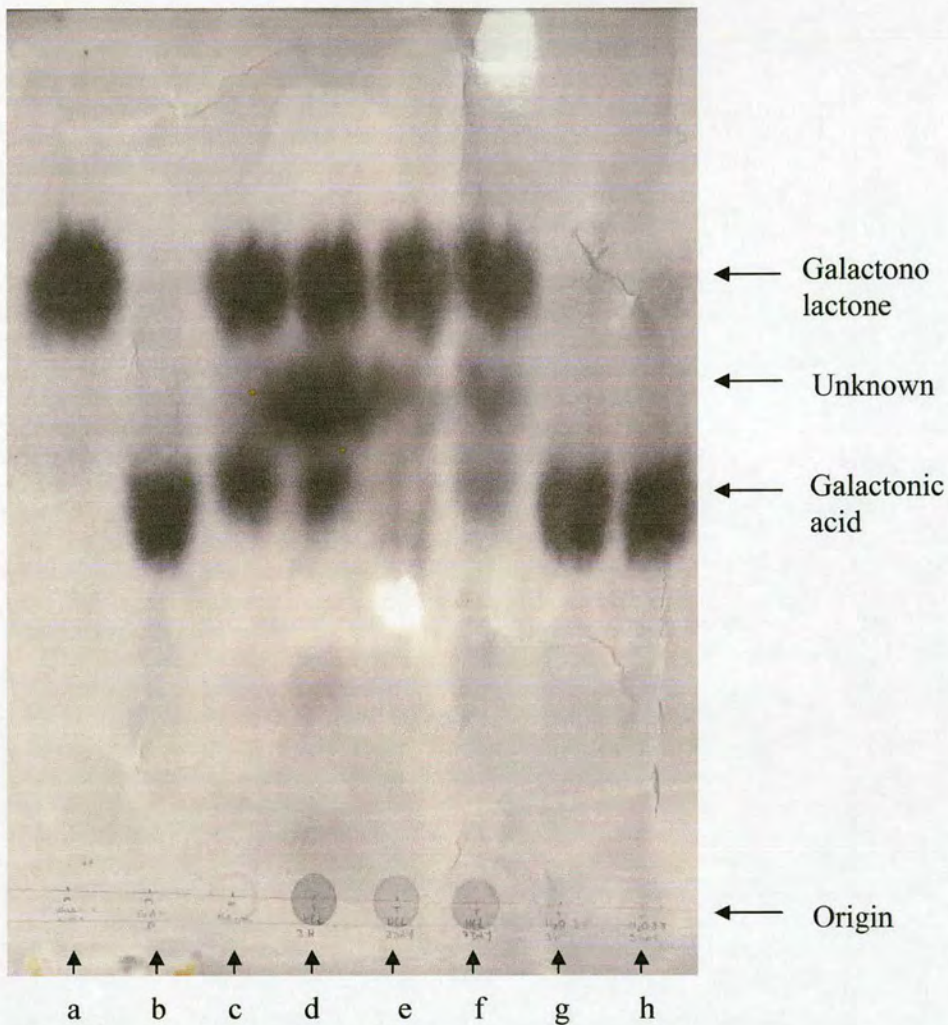

**Fig. 6.5 Conversion of galactonic acid to galactonolactone by HCl and at pH**

**3.5**

Galactonolactone marker (a), galactonic acid marker (b) and a mixture of both (c). Galactonic acid (1%) treated and incubated at room temperature with 1 M HCl for 3 hours (d), 3 days (e) and 7 days (f). Galactonic acid (1%) treated and incubated at room temperature with 10 ml, pH 3.5 H<sub>2</sub>O (NaOH) for 3 hours (g) and 3 days (h). Samples were treated and loaded as in Fig. 3.

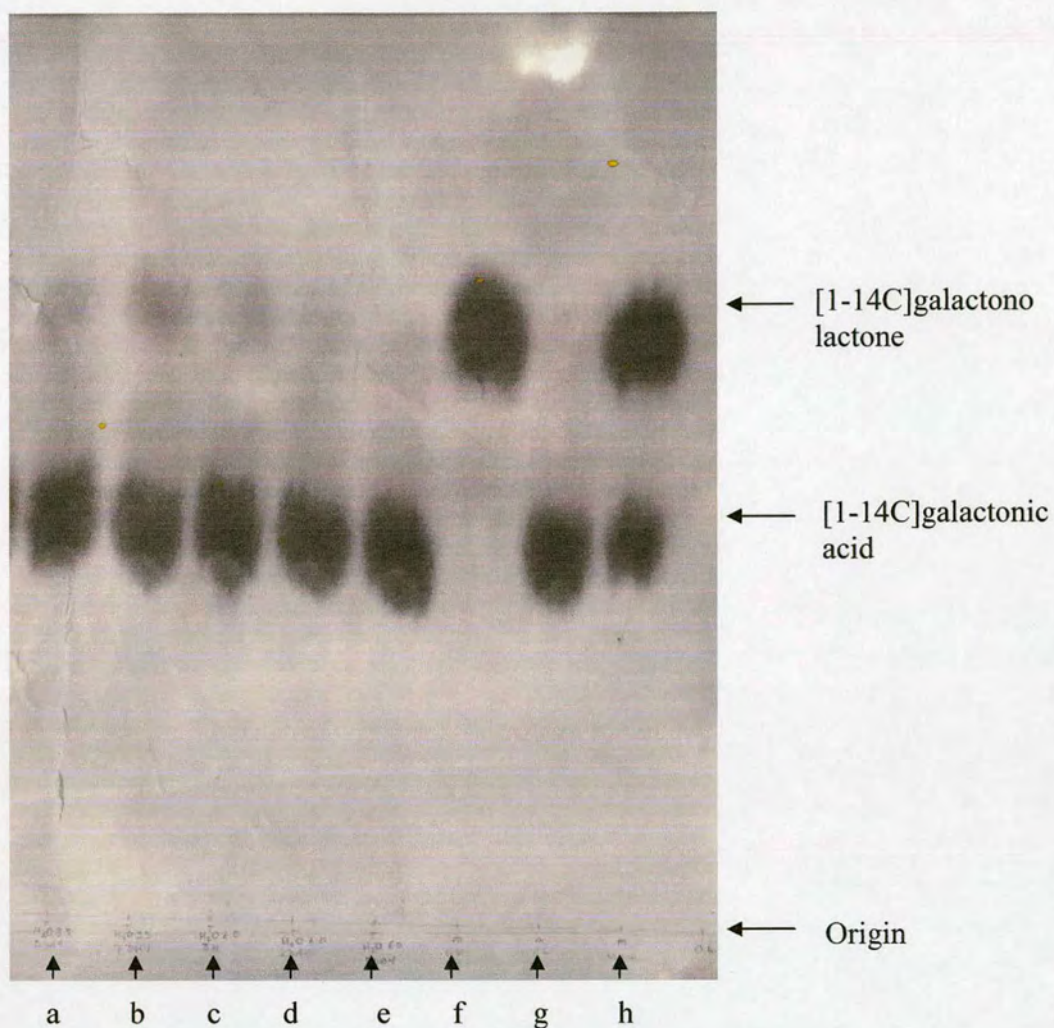
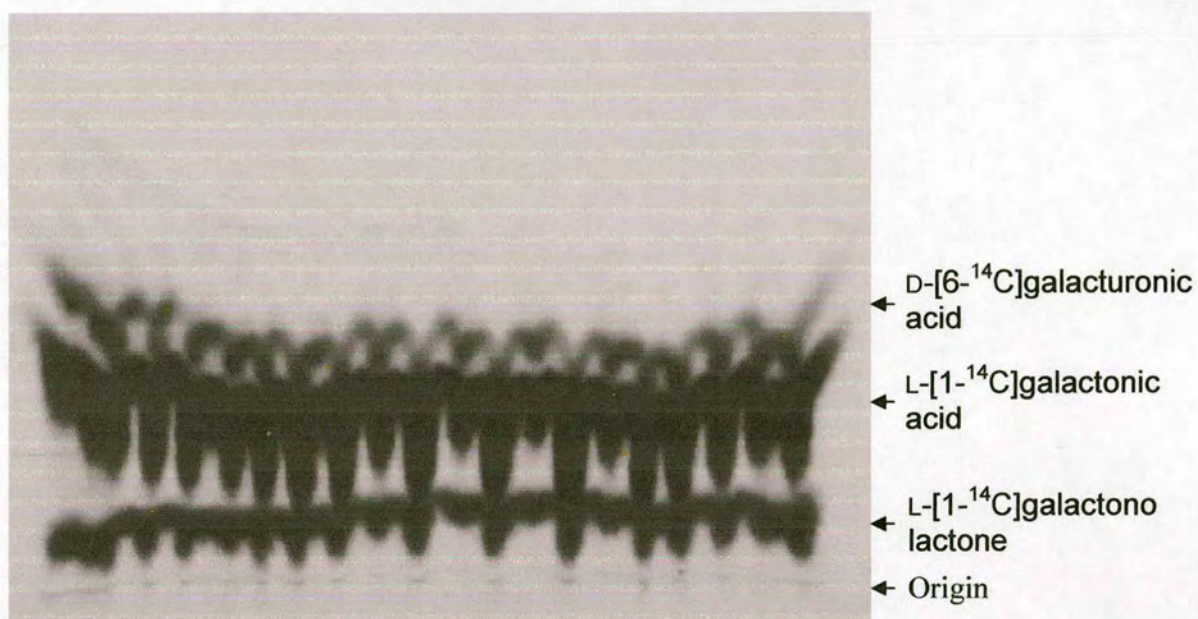

**Fig. 6.6 Conversion of galactonic acid to galactonolactone at pH 3.5 and 6.0**

Galactonic acid (1%) treated with 10 ml, pH 3.5 H<sub>2</sub>O (NaOH) for 3 days (a) and 7 days (b). Galactonic acid (1%) treated with 10 ml, pH 6.0 H<sub>2</sub>O (HCl), for 3 hours (c), 3 days (d) and 7 days (e). Galactonolactone marker (f), galactonic acid marker (g) and a mixture of both (h). Samples were loaded and treated as in Fig. 3.

#### **6.1.4 SINGLE-POT CONVERSION OF D-[6-<sup>14</sup>C]GALACTURONIC ACID TO L-[1-<sup>14</sup>C]GALACTONOLACTONE**

Conversion of a larger amount of D-[6-<sup>14</sup>C]galacturonic acid to L-[1-<sup>14</sup>C]galactonolactone was done as a one-pot preparation (Fig. 6.8). D-[6-<sup>14</sup>C]galacturonic acid was dried by SpeedVac and re-dissolved in deionised water. This was mixed with NaBH<sub>4</sub> in NH<sub>3</sub> for 5 hours and the reaction stopped with acetic acid. This mixture was dried down in the SpeedVac, re-dissolved in TFA, incubated for 7 days and then resolved by electrophoresis at pH 3.5. After autoradiography the L-[1-<sup>14</sup>C]galactonolactone streak was removed and stored at -20 °C.

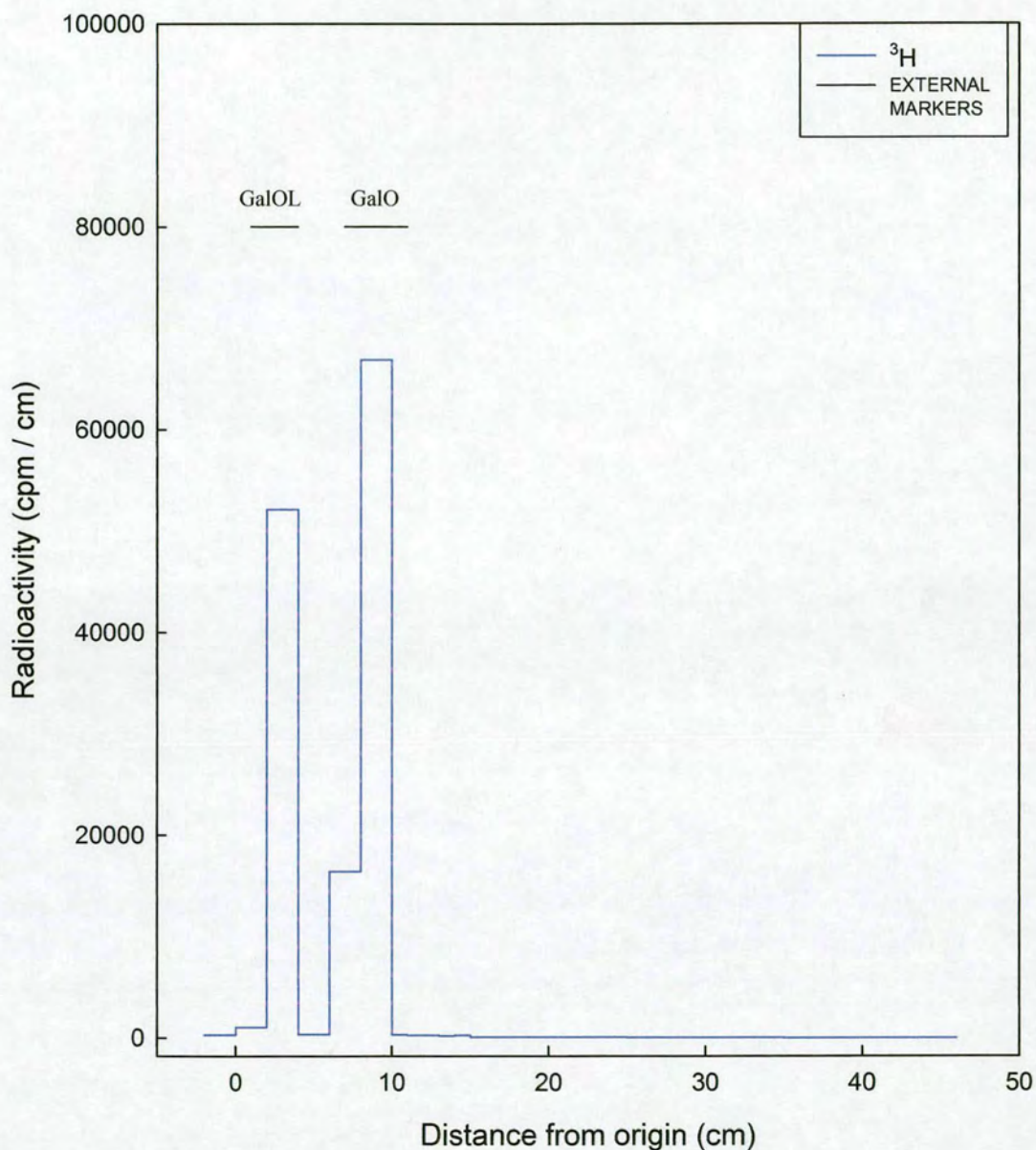

**Fig. 6.7 Conversion of D-[6-<sup>14</sup>C]galacturonic acid to L-[1-<sup>14</sup>C]galactonolactone**

SpeedVac dried D-[6-<sup>14</sup>C]Galacturonic acid (50 MBq) was converted to L-[1-<sup>14</sup>C]galactonic acid with 15 ml 0.2 M NaBH<sub>4</sub> in NH<sub>3</sub> at room temperature. The reaction was stopped using 17 μl 4 M acetic acid. The dried sample was re-dissolved in 1 ml of 4 M TFA to convert L-[1-<sup>14</sup>C]galactonic acid to L-[1-<sup>14</sup>C]galactonolactone. The sample was loaded onto Whatman 3 MM paper and compounds separated by paper electrophoresis at pH 3.5, 3 kV for 65 mins which allowed the L-[1-<sup>14</sup>C]galactonolactone section to be cut out and eluted.

## **6.2 DETECTING POSSIBLE SECRETED METABOLITES**

Radiolabelled compounds may break down to several new products while in storage. To avoid confusion between radiolabelled starting materials, their breakdown products following storage, and radiolabelled compounds produced due to metabolism by plant tissue, electrophoretic and chromatographic maps of radiochemicals used in different experiments were constructed. Radioactive samples of interest were separated by paper electrophoresis and measured by scintillation counting. Starting materials were intended to be a mixture of only galactonolactone and galactonic acid (Fig. 6.1). However, in Fig. 6.2, 6.3 and 6.4 a contaminant can be seen after the first two known peaks of radioactivity. This must be considered when studying results of *in-vivo* radiolabelling experiments. Experiments to study possible contaminants were duplicated twice.



**Fig. 6.2.1 Electrophoresis of a “pure” sample of L-[6-<sup>3</sup>H]galactonic acid.**

A graph of radioactive distribution of L-[6-<sup>3</sup>H]galactonic acid breakdown products separated by electrophoresis (pH 6.5, 3 kV, for 20 minutes) and measured by scintillation counting .

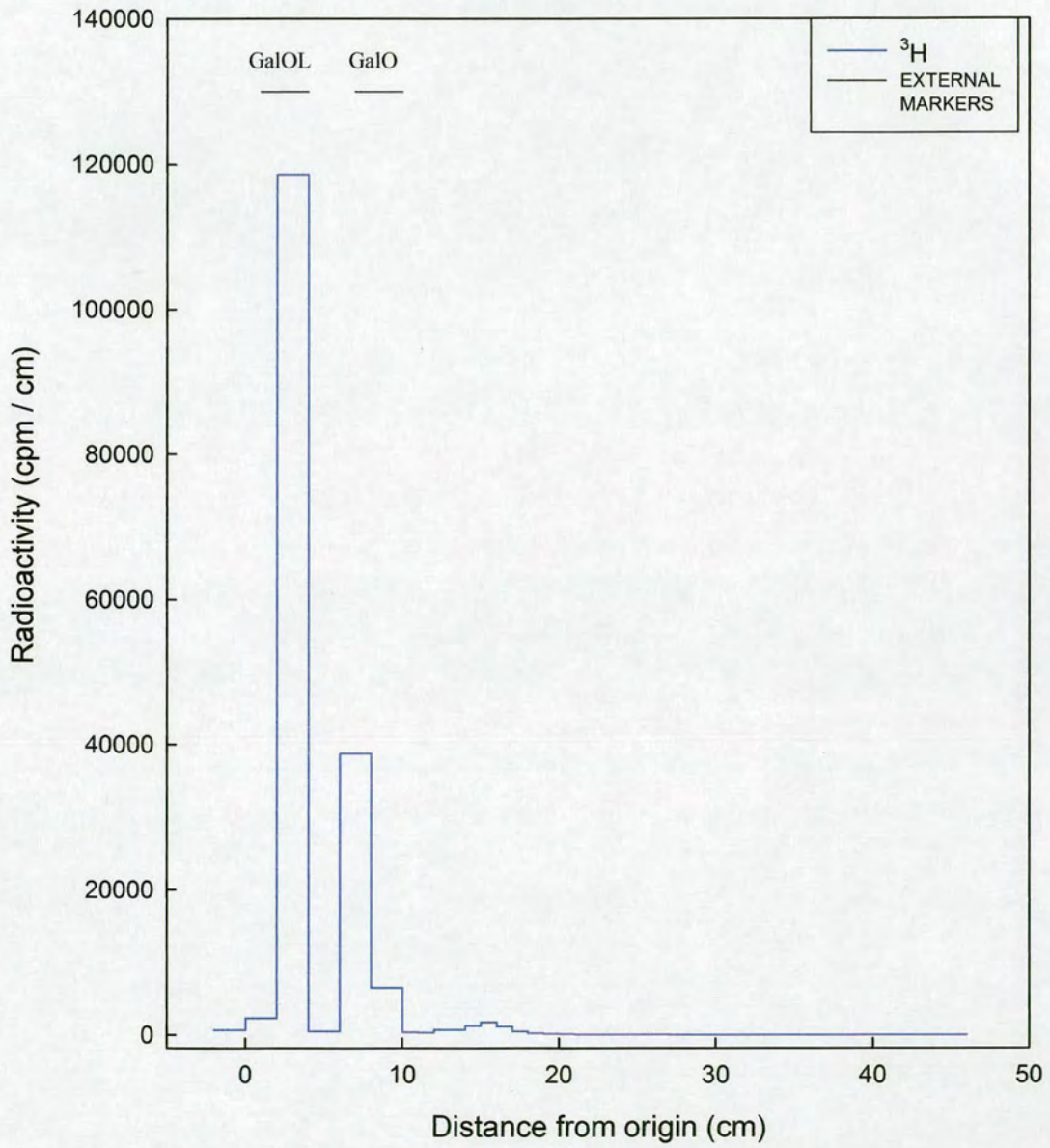

**Fig. 6.2.2** Electrophoresis of a “pure” sample of L-[6-<sup>3</sup>H]galactonolactone. For details see Fig. 6.2.1.



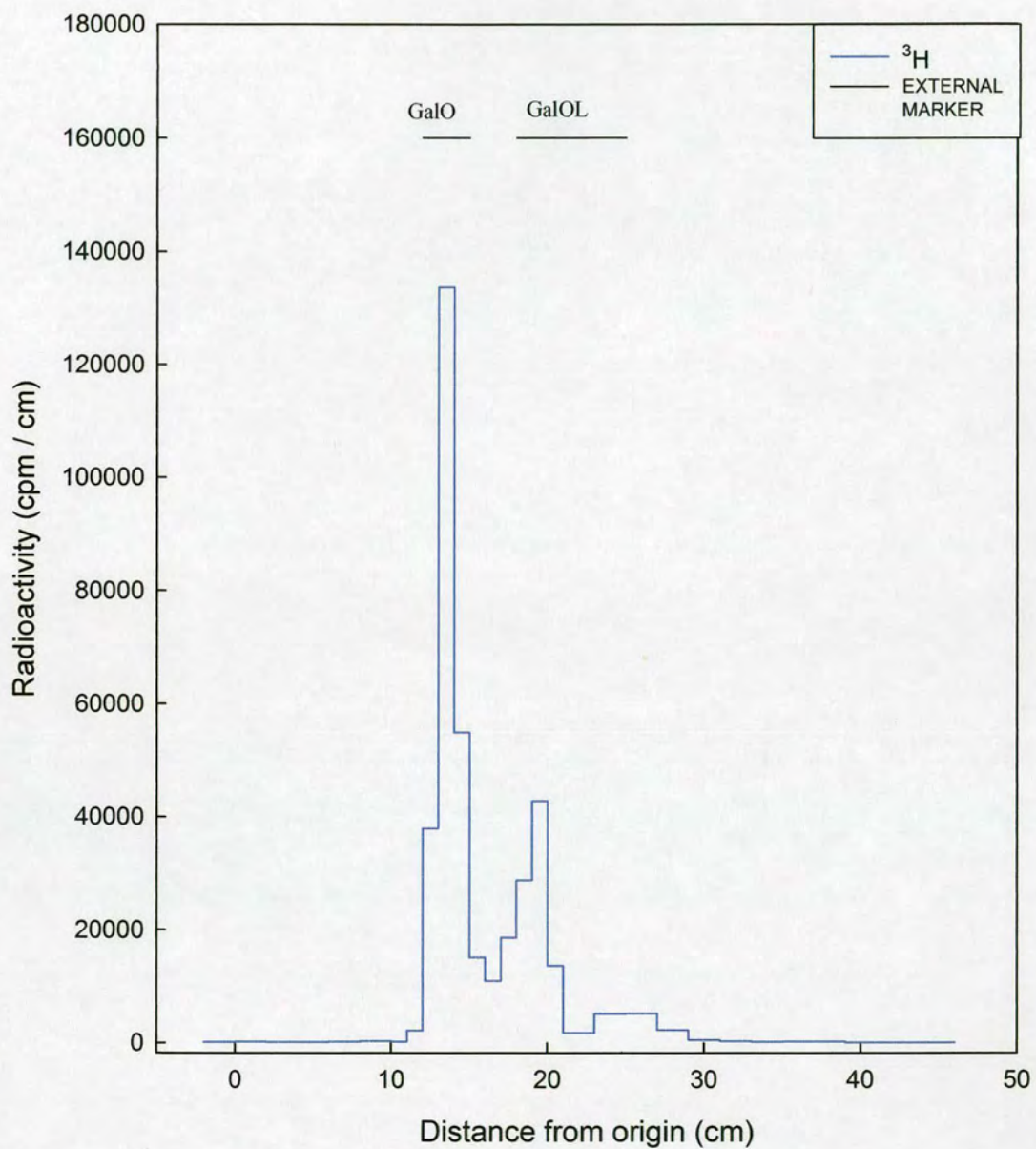

**Fig. 6.2.3 Paper chromatogram a “pure” sample of L-[6- $^3\text{H}$ ]galactonic acid**

L-[6- $^3\text{H}$ ]galactonic acid metabolites separated by chromatography (BuOH:HOAc:H<sub>2</sub>O, 12:3:5, for 18 hours). Other details as in Fig. 6.2.1

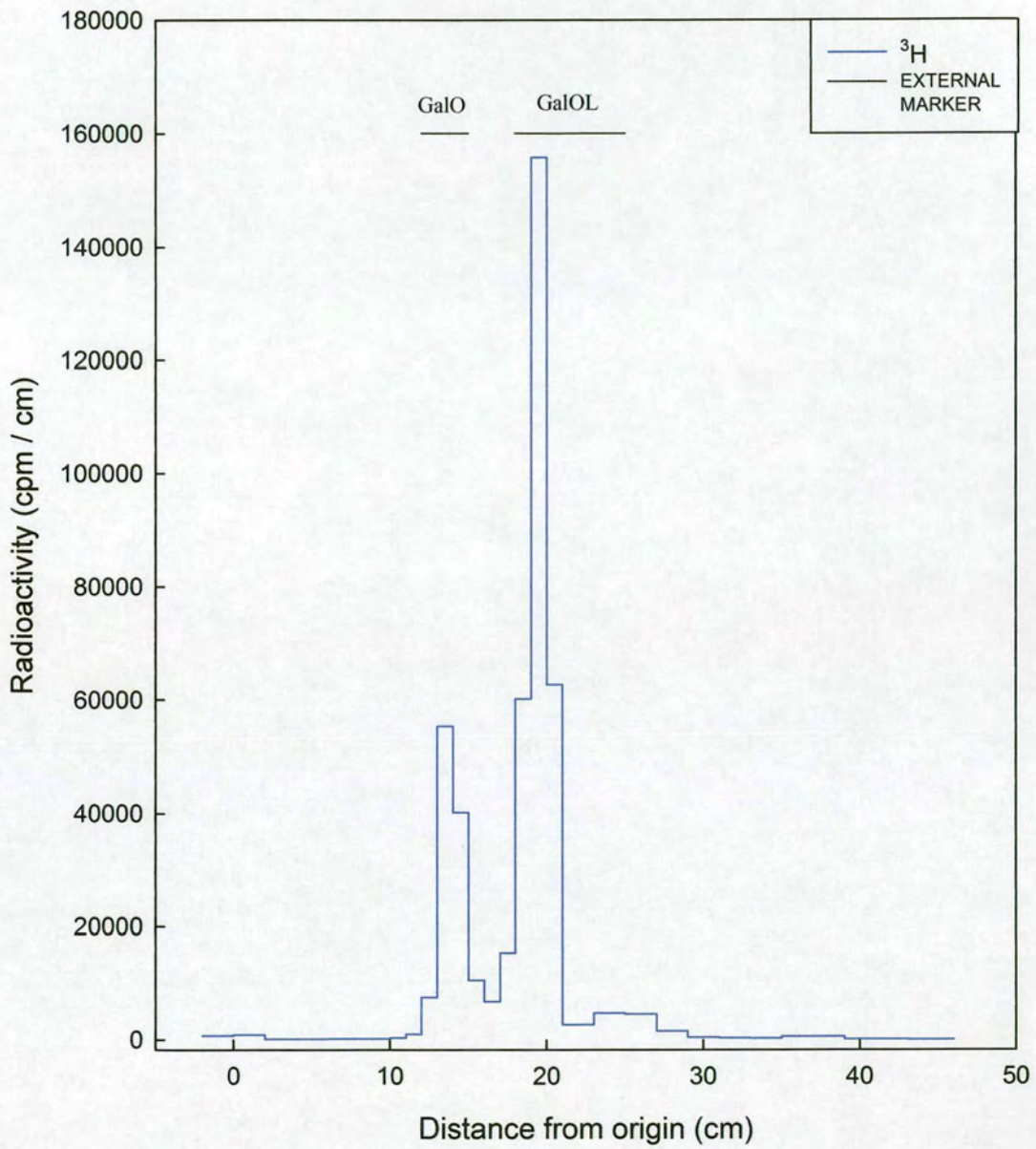

**Fig. 6.2.4 Chromatography of a “pure” sample of L-[6-<sup>3</sup>H]galactonolactone.**

For details see Fig. 6.2.3

### **6.2.1 SEPARATION OF POSSIBLE ASCORBATE TURNOVER PRODUCTS BY ION EXCHANGE CHROMATOGRAPHY AND PAPER ELECTROPHORESIS**

After feeding the ascorbate precursor, L-[6-<sup>3</sup>H]galactonolactone to a radish plant or particular tissue, cells have the capability to convert this to L-ascorbate and most likely several other down-stream compounds. Experiments were carried out to identify a method that would allow separation followed by identification of possible ascorbate turnover products. In order to identify possible ascorbate turnover metabolites a marker solution containing a variety of possible ascorbate metabolites was used. The sample was passed through a Dowex 50 (H<sup>+</sup>) column. The eluate was collected and then loaded onto a Dowex 1 (OH<sup>-</sup>) column. Bound compounds were washed off the column with an acid gradient. Fractionated samples were collected and any compounds present were separated by either pH 3.5 or pH 6.5 paper electrophoresis. Silver nitrate staining was used to detect sugars.

A mixture of possible ascorbate turnover compounds (Fig. 6.5) was eluted with poor separation. Several compounds were eluted initially, but because of the method used it was unclear which compounds these were. Galacturonic acid, galactonic acid and threonic acid did not separate under these conditions. Tartaric acid was undetectable by this method because it was at too low a concentration to visibly stain. This could have been because the compound did not bind to the column and washed out with at the start of the gradient with neutral compounds. However, it should have been detectable by electrophoresis, suggesting it was not removed from the column by the acid gradient.

A different method of washing the Dowex beads was used to see if this would improve binding to the column and resultant separation of compounds (Fig. 6.6). A different acid gradient was also used to see if separation between compounds would improve as well as allow identification of points at which compounds were released. The electrophoretic process was allowed to proceed for a longer time. However, although individual compounds resolved from each other more effectively due to the extended time, compounds loaded onto the column were not clearly visible, due either to the washing process used for the beads, or the step gradient. Only tartaric acid eluted, which was unexpected since tartaric acid (a dicarboxylic acid) would be expected to bind firmly to the Dowex 1 (OH<sup>-</sup>) column.

Quick and accurate identification of points of elution from the column of compounds within the mixture was possible by spot tests (Fig. 6.7 and 6.8). Compounds could easily be detected by silver staining (Fig. 6.7), while acids were detected by bromophenol blue spraying (Fig. 6.8). This allowed identification of acid concentrations that were not effective at removing metabolites.

Improved resolution of the metabolite mixture was achieved by using a step gradient to concentrate released metabolites into a smaller volume than would occur in a continuous gradient, and to help identify at which points particular molecules were eluted from the column (Fig. 6.9). The electrophoretogram clearly shows that neutral products, presumably including glucose, DHA and galactonolactone, were removed at the beginning of the gradient as these would not be expected to bind to the column. Galacturonic acid was released over a long period after 0.1 M formic acid. It was not clear why it is not washed from the column within one or two fractions. In a similar

position, galactonic acid was removed effectively within two fractions. Towards the end of the 0.15 M formic acid fraction what appears to be a neutral product was released. This may be ascorbate oxidised to DHA or galactonic acid lactonised to galactonolactone, and released from the column. This method failed to release either threonic acid or tartaric acid (Fig. 6.9).

To help with identification of different metabolites it was decided to run fractions by pH 6.5 electrophoresis. A longer initial wash was used by diluting the sample further to avoid possibly initially overloading the column, that may have been stopping binding of compounds. To help remove threonic acid and tartaric acid from the column the 0.4 M formic acid was replaced with 4 M formic acid. These changes failed to improve identification or resolution of metabolites (Fig. 6.10).

To improve identification and resolution results from the column a different elution was used for both types of bead. L-Ascorbate was added to the eluate from the Dowex 50 ( $H^+$ ) column to protect any ascorbate that had come through the first elution step removing positively charged molecules. Some of the added ascorbate was sacrificed instead of the radiolabelled ascorbate as would happen in a labelling experiment (Fig. 6.11). Release of neutral products occurred rapidly, and while neutral products were seen in later fractions they were greatly reduced, and were more likely to be oxidised ascorbate and / or galacturonic acid than neutral products. Release of ascorbate was seen from the initial eluate to 0.3 M formic acid fractions. Ascorbate was clearly present in this experiment most likely due to added ascorbate at the first eluate stage, suggesting that in previous experiments ascorbate was broken down and therefore cold ascorbate would be essential to protect labelled ascorbate. Boxes A and B (Fig. 6.11) show faint staining of a

compound that relates to the marker threonic acid. This suggested the changes made in the bead washing method was improving binding and concise release of this bound compound. However, this was not observed in the case of ascorbate and would need to be improved.

To identify a technique that could be used to protect ascorbate from oxidation throughout an experiment, three antioxidants were mixed with radioactive ascorbate, dried and re-dissolved in water, then electrophoresed (Fig. 6.12). A mixture of dithiothreitol and non-radioactive ascorbate limited L-[1-<sup>14</sup>C]ascorbate to produce only one unknown breakdown product. This addition would be used for future experiments to protect any labelled ascorbate from artifactual breakdown.

A refined elution method was used to improve separation by addition of ascorbate and DTT to the starting mixture and by the use of TFA to remove remaining bound compounds from the column (Fig. 6.13). Clear separation of all metabolites [L-ascorbate, DHA, GalOL, GalO , L-tartrate, threonate] was achieved. Ascorbate and galactonic acid ran to similar positions by electrophoresis. However, DCPIP can be used to identify where ascorbate is present by DCPIP decolourisation. Threonate and ascorbate were removed over a wide range of acidic concentrations with the majority removed predominantly in three fractions. Ascorbate also appeared to produce DHA, which remained at the origin (0.1 – 0.15 M formic acid). This may be unavoidable due to the redox nature of ascorbate. Tartaric acid was removed concisely with 2 and 4 M formic acid. TFA removed small amounts of neutral compounds. What these were is not clear.

A method has been developed to separate specific ascorbate metabolites. The overall method allows identification of these products.

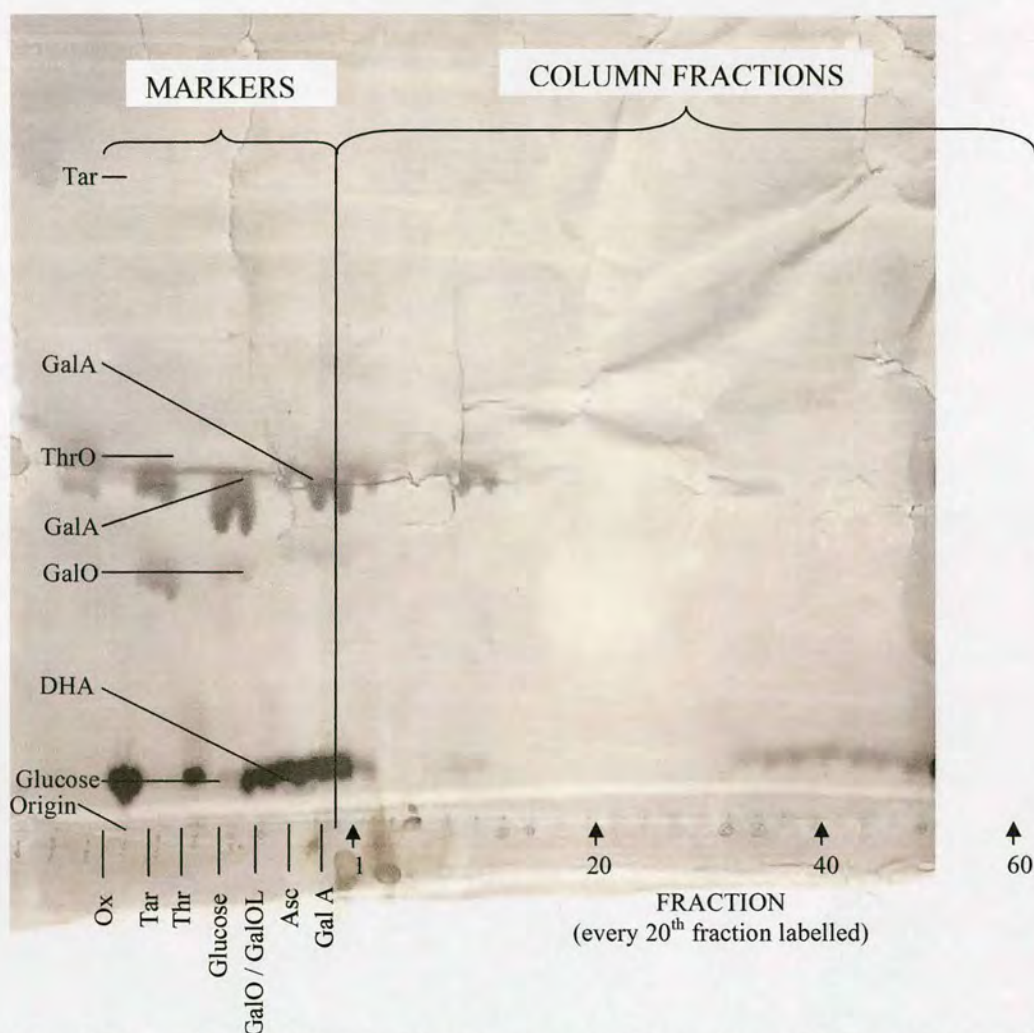

**Fig. 6.2.5 pH 3.5 Electrophoretogram of marker mixture released by a continuous acid gradient of H<sub>2</sub>O to 4 M formic acid from a Dowex 1 column**

Marker mixture [0.1%: glucose; Asc (ascorbate); GalOL (galactonolactone); GalO (galactonate); ThrO (threonate); Tar (tartrate)] was loaded as a 5-ml sample onto the Dowex 50 (H<sup>+</sup>) and the eluate collected. \*The eluate was loaded onto Dowex 1 (formate<sup>-</sup>)\* and washed through with a 2-step acid gradient of 100 ml of 0.1 M formic acid into 50 ml H<sub>2</sub>O, followed by 20 ml 4 M formic acid into 20 ml 1 M formic acid. Fractions had samples removed (20- $\mu$ l), pooled with one other fraction, dried by SpeedVac, re-dissolved in 20  $\mu$ l of H<sub>2</sub>O and loaded as a single spot onto Whatman 3 MM paper (10 spots represent 20 fractions). Fractions were electrophoresed (pH 3.5, 3 kV, for 40 minutes) and detected with silver nitrate.

\*Dowex 50<sup>+</sup> column gel had previously been washed in 0.5 M HCl, 0.5 M NaOH and 20 mM Na formate (pH 3.5). Dowex 1 had been washed in 0.5 M NaOH, 0.5 M formic acid, 2 M NaOH and water. Gels were washed for at least 1 hour in 200 ml of each solution separately.

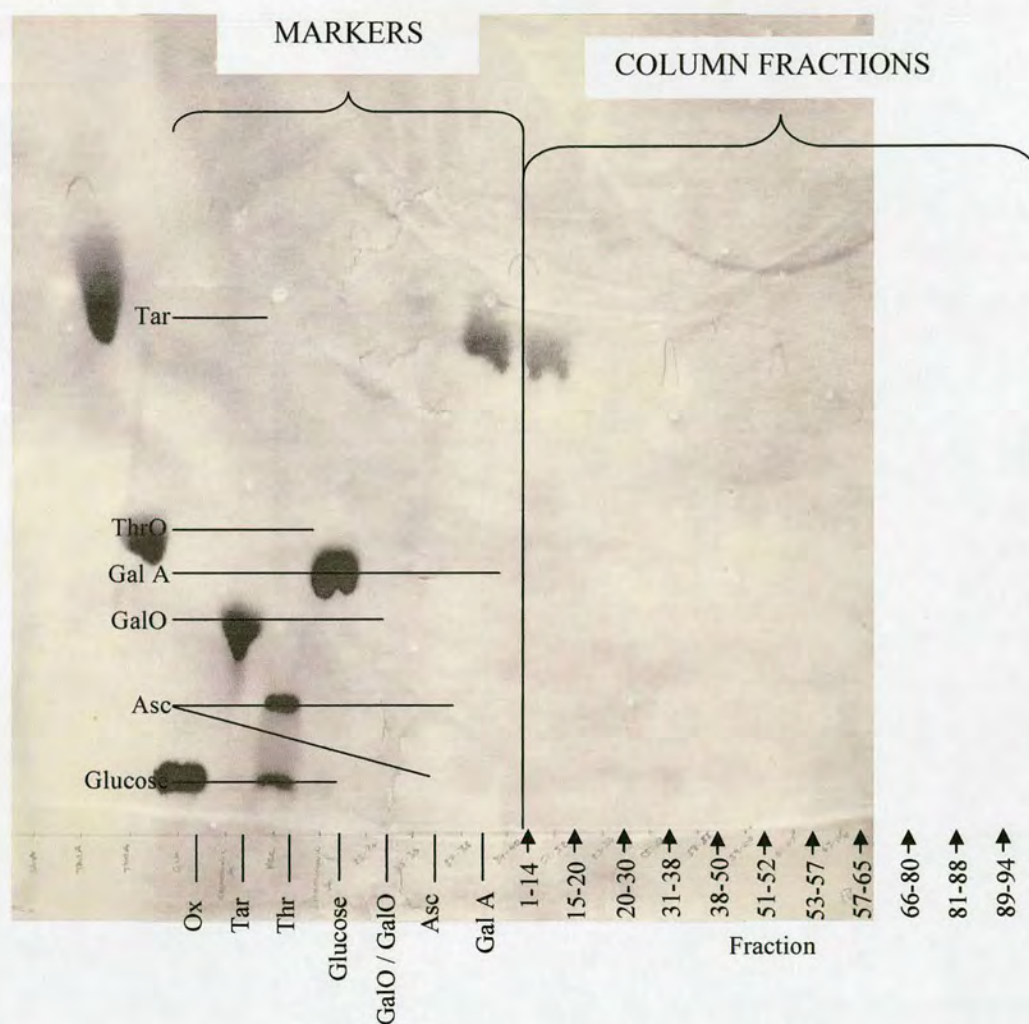
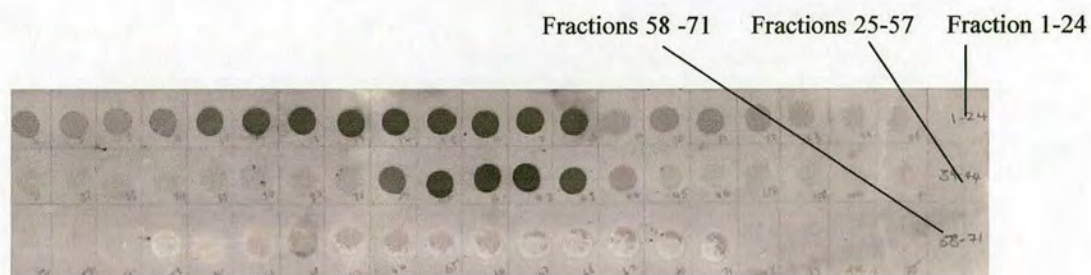

**Fig. 6.2.6 pH 3.5 Electrophoretogram of marker mixture released by a 4-step acid gradient of 10 mM pyridinium formate to 4 M TFA from Dowex 1**

Marker mixture [0.1 %: Asc (ascorbate); GalO (galactonate); ThrO (threonate); Tar (tartrate)] was loaded as a 5-ml sample onto Dowex 50 (H<sup>+</sup>) and the eluate collected. \*The eluate was loaded onto Dowex 1 (formate<sup>-</sup>)\* and washed through with a 4-step acid gradient; 50 ml 10 mM pyridinium formate into 100 ml 0.1 M formic acid; 20 ml 0.1 M formic acid into 20 ml 4 M formic acid; 20 ml 4 M formic acid into 20 ml 8 M formic acid; 20 ml H<sub>2</sub>O into 20 ml 4 M TFA. Other details as in Fig. 6.2.5.

\*Dowex 50<sup>+</sup> was washed in 200 ml of 0.5 M NaOH, then 0.5 M HCl and finally pyridine:formic acid:water, 1:1:18. Dowex 1 was washed as in Fig .5 but running buffer wash was 0.05 M pyridinium formate (pH 5.0).





**Fig. 6.2.7 Strip test of marker mixture released from a Dowex 1 (formate<sup>-</sup>) column and stained with silver nitrate**

Marker mixture [0.1 %: Asc (ascorbate); GalO (galactonate); ThrO (threonate); Tar (tartrate)]. Each fraction had 2 droplets removed, and placed on Whatman No. 1 paper. The droplets were allowed to dry and then stained with silver nitrate. Other details as in Fig. 6.2.5.

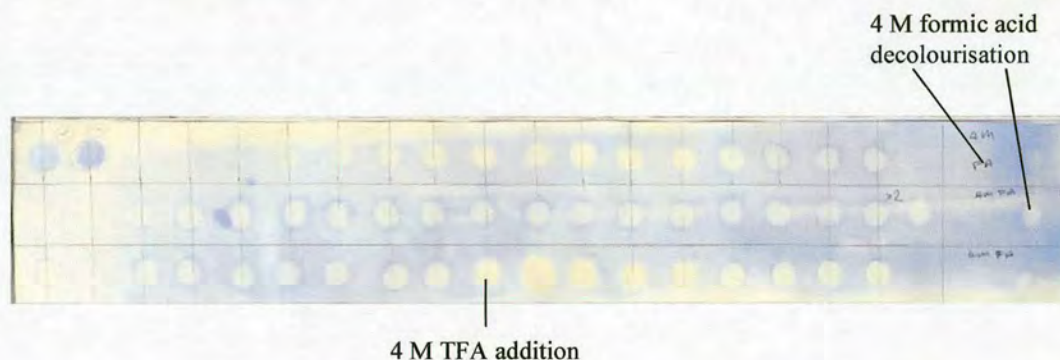

**Fig. 6.2.8 Strip test of marker mixture released from a Dowex 1 (formate<sup>-</sup>) column and stained with bromophenol blue**

The droplets were allowed to dry and the paper was then stained by spraying with 0.01 M bromophenol blue. No or little decolourisation of bromophenol blue is caused by 4 M formic acid; therefore, decolourisation is caused by another acid. Clear decolourisation is caused upon addition of the eluant 4 M TFA. Other details as described in Fig. 6.2.7

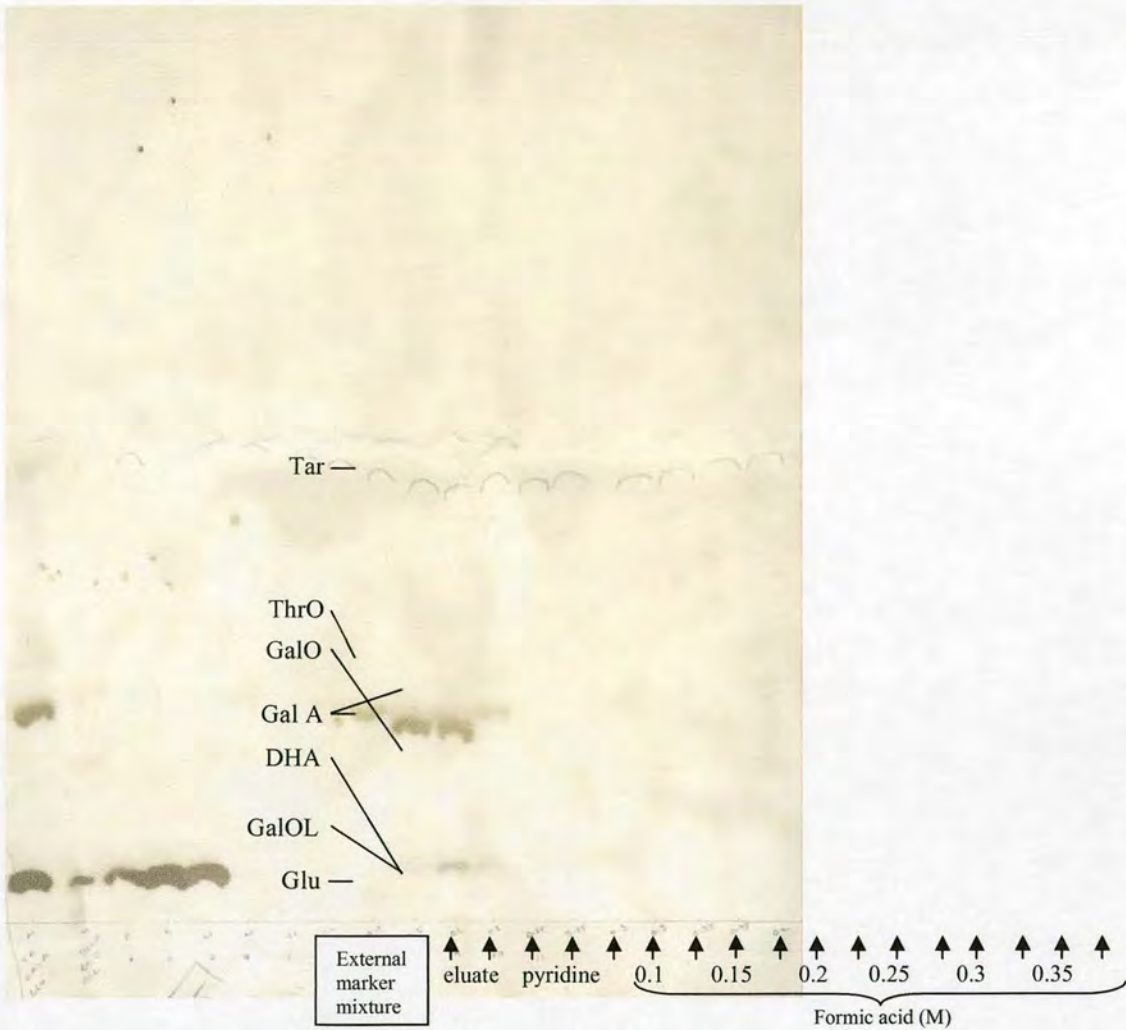

**Fig. 6.2.9 pH 3.5 electrophoretogram of marker mixture released by an acid step gradient from a Dowex 1 column**

Marker mixture of [0.1%: Asc (ascorbate); GalOL (galactonolactone); GalO (galactonate); ThrO (threonate); Tar (tartrate)] was loaded as a 5 ml H<sub>2</sub>O sample onto Dowex 50 (H<sup>+</sup>) and washed through with a further 5 ml of H<sub>2</sub>O, collecting the eluate\*. The eluate was loaded onto Dowex 1 (formate<sup>-</sup>). Fractions were collected as 5-ml samples. An acid step gradient was used to wash samples through Dowex 1 (formate<sup>-</sup>). The eluate was followed by; 10 ml, 10 mM pyridinium formate (pH 5.0); 10 ml, 0.1 M formic acid; 10 ml, 0.15 M formic acid; 10 ml, 0.2 M formic acid; 10 ml, 0.25 M formic acid; 10 ml, 0.3 M formic acid; 10 ml, 0.35 M formic acid; 0.4 M formic acid. 1 ml of each fraction was collected. SpeedVac was used to dry the 1-ml samples, dried samples were re-dissolved in 20  $\mu$ l H<sub>2</sub>O and loaded onto the paper. Fractions were electrophoresed (pH 3.5, 3 kV, for 65 minutes) of fractions eluted with an acid step gradient from Dowex 1.

\*Dowex 50 and Dowex 1 were washed as in Fig. 6.2.6.

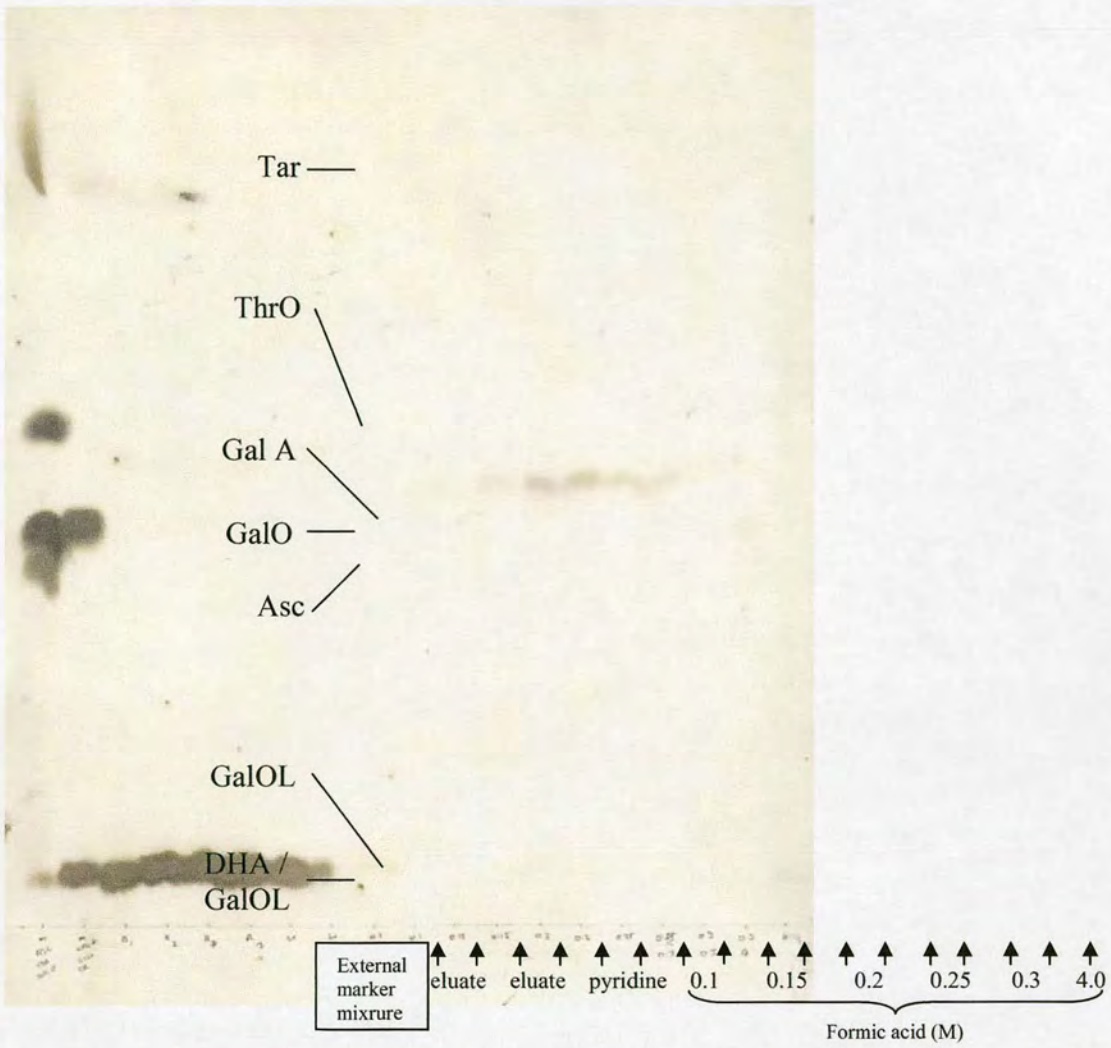

**Fig. 6.2.10 pH 6.5 Electrophoretogram of marker mixture released by an acid step gradient up to 4 M formic acid from a Dowex 1 column**

Marker mixture [0.1%: Asc (ascorbate); GalOL (galactonolactone); GalO (galactonate); ThrO (threonate); Tar (tartrate)] was dissolved in 20 ml of H<sub>2</sub>O. The final acid step had 0.4 M formic acid replaced with 4 M formic acid. Fractions eluted by the acid step gradient from Dowex 1 (formate<sup>-</sup>) were detected by paper electrophoresis (pH 6.5, 3 kV, for 20 minutes). Dowex 50 (H<sup>+</sup>) and Dowex 1 (formate<sup>-</sup>) were washed as in Fig. 6.2.6. Other details as in Fig 6.2.9.

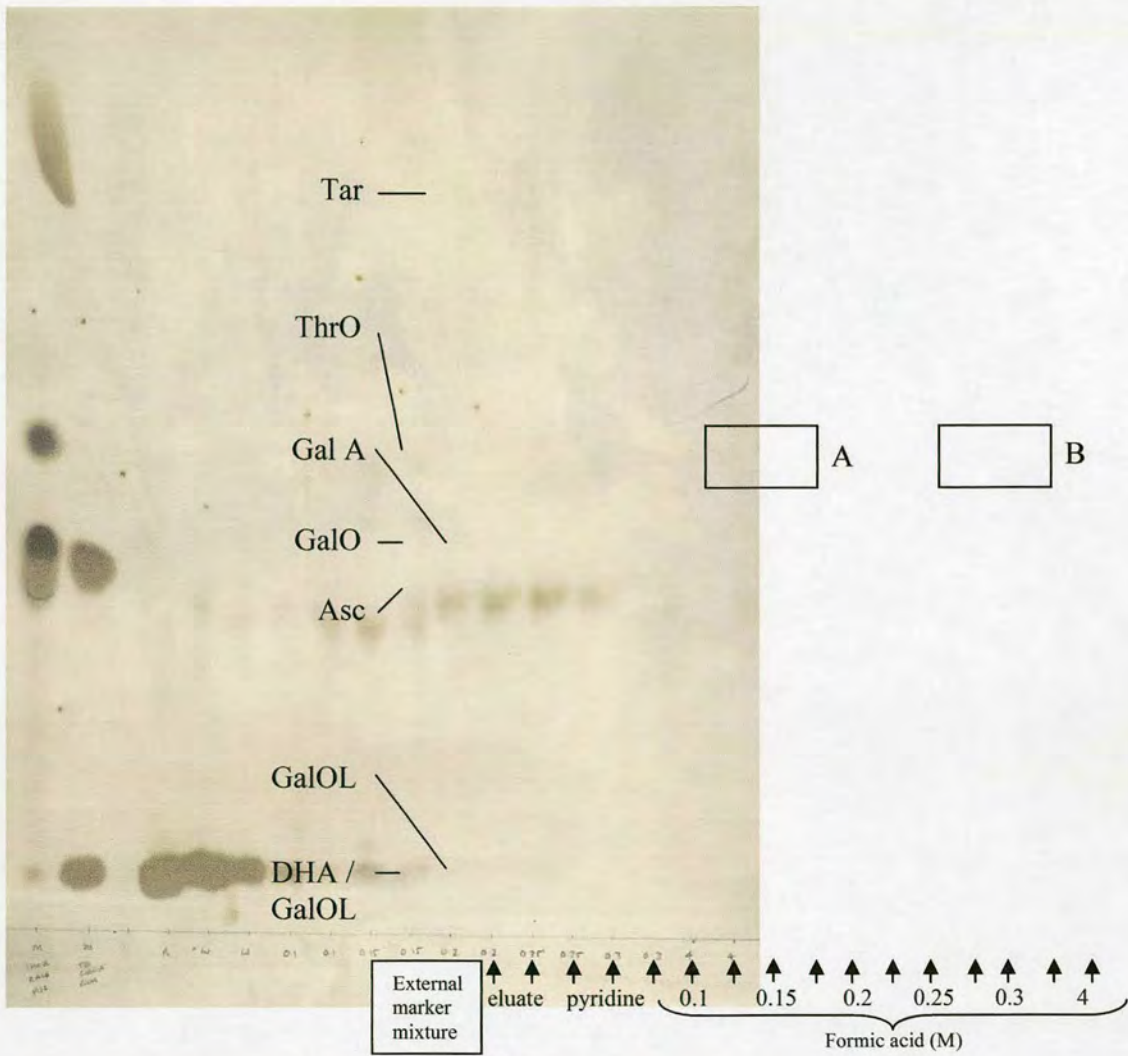

**Fig. 6.2.11 pH 6.5 electrophoretogram of marker mixture released by an acid step gradient from a Dowex 1 column with added L-ascorbate**

Marker mixture [0.1 %: Asc (ascorbate); GalOL (galactonolactone); GalO (galactonate); ThrO (threonate); Tar (tartrate)] dissolved in 10 ml of H<sub>2</sub>O. 0.1 M L-ascorbate was added to the 10 ml of Dowex 50 (H<sup>+</sup>) eluate before loading onto the Dowex 1 (formate<sup>-</sup>). The final acid step had 0.4 M formic acid replaced with 4 M formic acid. Markers were detected by paper electrophoresis (pH 6.5, 3 kV, for 24 minutes). Other details as in Fig. 6.2.9.

Dowex 50 (H<sup>+</sup>) was washed twice for at least 2 hours at each stage; NaOH (0.5 M); HCl; Pyridine: formic acid: H<sub>2</sub>O, 1: 1: 18. Dowex 1 (formate<sup>-</sup>) was washed twice for at least 2 hours at each stage; NaOH (0.5 M); formic acid (0.5 M); sodium formate (2 M); pyridinium formate (10 mM, pH 5.0).

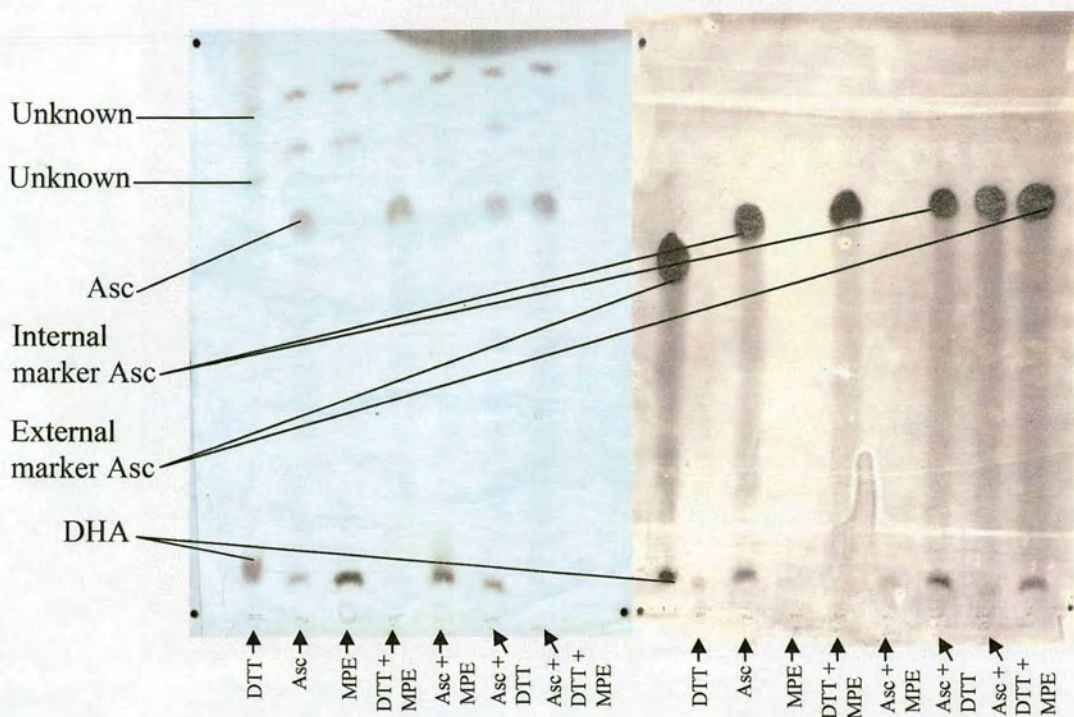

**Fig. 6.2.12 Autoradiogram of pH 6.5 electrophoretogram of L-[1-<sup>14</sup>C]ascorbate dissolved with other antioxidants**

Radioactive ascorbate [0.42 MBq per sample] was mixed with 10 mM DTT (dithiothreitol), Asc (ascorbate) and/or MPE (mercaptoethanol) as indicated and left to stand in open air for 30 min, dried by SpeedVac, re-dissolved in 20  $\mu$ l H<sub>2</sub>O and loaded onto Whatman 3 MM paper. Samples were separated by electrophoresis (pH 6.5, 3 kV, 55 min) and detected by autoradiography. The markers were then stained with silver nitrate (right-hand panel).

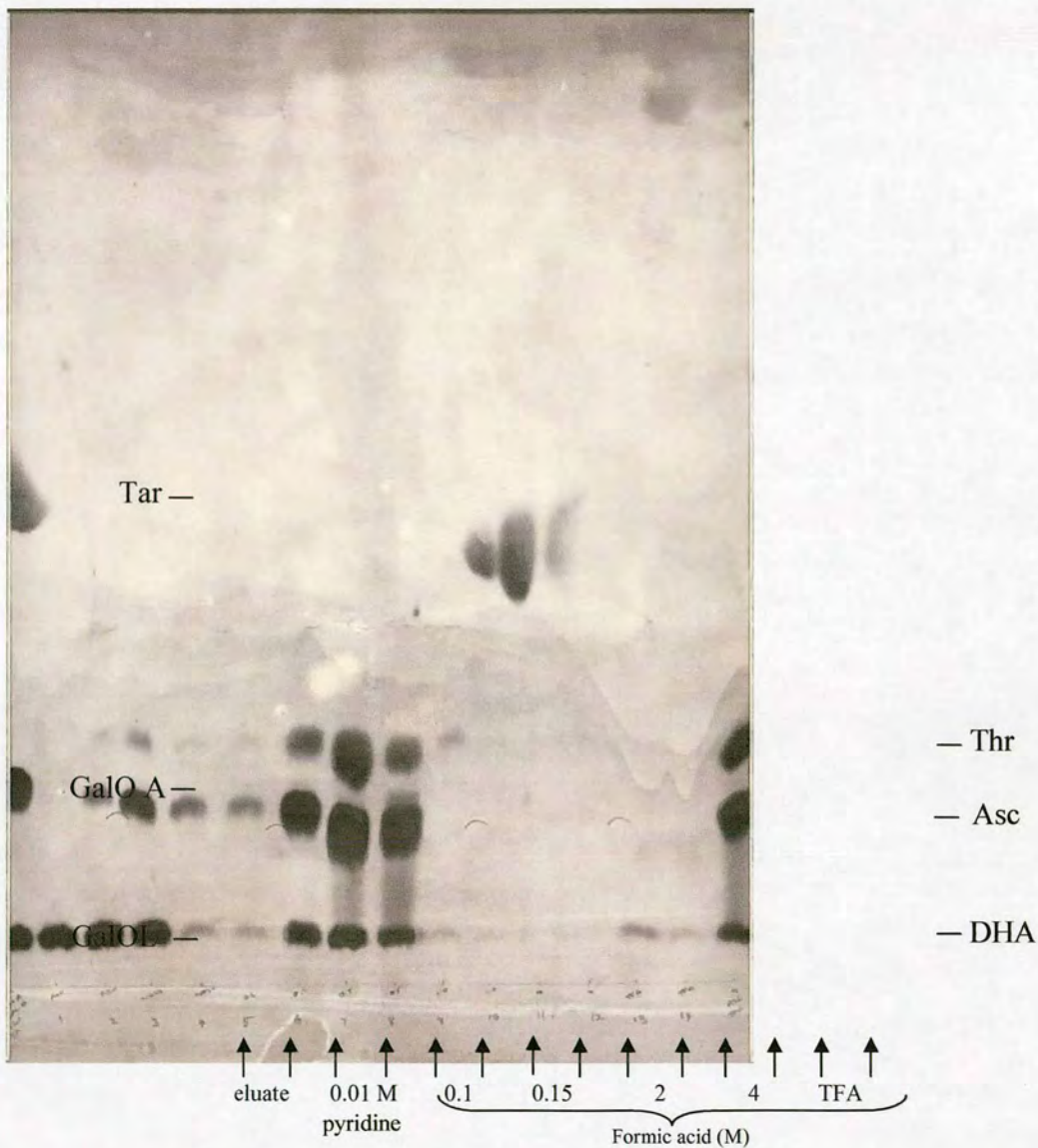

**Fig. 6.2.13 pH 6.5 electrophoretogram of marker mixture released by an acid step gradient from a Dowex 1 column with added L-ascorbate and DTT**

Paper electrophoretogram (pH 6.5, 3 kV, for 20 minutes) of fractions eluted with an acid step gradient from Dowex 1 (formate<sup>-</sup>). The marker mixture was dissolved in 10 ml 10 mM pyridine (formate<sup>-</sup>, pH 5.0) with 0.1 M L-ascorbate and 0.1 M DTT and loaded onto the column. The eluate pH was adjusted to 5 with NaOH and loaded onto Dowex 1 (formate<sup>-</sup>). The new eluate was collected in 5-ml fractions; and following this, washes were applied of 10 ml each of 10 mM pyridine (formate<sup>-</sup>, pH 5.0); 0.1 M formic acid; 0.15 M formic acid; 2 M formic acid; 4 M formic acid; 4 M TFA. Other details as in Fig. 6.2.9.

### **6.3 Metabolism of exogenous L-[6-<sup>3</sup>H]galactonolactone by radish disks**

The hypothesis of this experiment was that a radish disk would take up L-[6-<sup>3</sup>H]galactonolactone, converting it to L-[6-<sup>3</sup>H]ascorbate. A single radish disk was bathed in a solution of L-[6-<sup>3</sup>H]galactonolactone in de-ionised water. After 8 hours the disk was removed and any <sup>3</sup>H-metabolites were extracted from hypocotyl tissue and fractionated by ion-exchange chromatography. This experiment was carried out once due to the quantity of radioactivity required; however, four replicate pilot studies using 1 MBq L-[6-<sup>3</sup>H]galactonolactone were carried out to validity.

Radioactivity was eluted as at least two peaks (Fig. 6.3.1): the initial four fractions contained radioactive compounds that had not bound to the column, most likely neutral compounds, while the formic acid gradient was expected to elute negatively charged molecules. Fractions containing the internal marker non-radioactive ascorbate were identified using DCPIP decolourisation, which agreed with the second radioactive peak (Fig. 1). However, the radioactive products in this peak could potentially be several different compounds.

The range of these <sup>14</sup>C-compounds was tested by paper chromatography and paper electrophoresis followed by fluorography. Possible [<sup>3</sup>H]ascorbate spots were identified by co-chromatography with non-radioactive ascorbate (Fig. 6.3.2) and co-electrophoresis with non-radioactive ascorbate (Fig. 6.3.3). Fig. 6.3.1 shows a radioactive peak where ascorbate is present while Fig. 6.3.2 a and 6.3.3 a show radioactive spots where non-radioactive ascorbate was detected by DCPIP decolourisation (Fig. 6.3.2 b and Fig. 6.3.3 b). Fig. 6.3.1 shows very little radioactivity released from the column after the ascorbate

peak. This is the area where threonic acid, *meso*-tartaric acid or tartaric acid, ascorbate breakdown products, would be released. Fig. 6.3.2 b and 6.3.3 b show no presence of these three compounds. This result does not mean these compounds are not present, but that they are not detectable. The results suggest that a major metabolite was [<sup>3</sup>H]ascorbate. The results also suggest that several unidentified products of L-[6-<sup>3</sup>H]galactonolactone were synthesised.

Acid gradients removed the majority of radiolabelled ascorbate with maximum elution in fraction 8 and decreasing levels of radioactivity in later fractions (Fig. 6.3.2 and 6.3.3). Identification of other <sup>3</sup>H-metabolites from the disk was not possible with the markers tested. L-[6-<sup>3</sup>H]Galactonolactone products were tested against “aged Asc” (L-[<sup>14</sup>C]ascorbate exposed to atmospheric air for 48 hours) to see if any radioactive spots were comparable; no radioactive spots within the “aged Asc” or bathing solution were found to be in the other. These results support the hypothesis that [<sup>3</sup>H]galactonolactone was metabolised by the disk, producing [<sup>3</sup>H]ascorbate, identified by three separate methods (Fig. 6.3.1–6.3.3). Results show release of putative [<sup>3</sup>H]ascorbate (Fig. 6.3.2a), elution of galactonolactone in fractions 1–4 as it passes through the column without binding with any other uncharged molecules (Fig. 6.3.1), as well as several unknown metabolites (Fig. 6.3.2 a) in fractions eluted with 0.1 M formic acid to 0.2 M formic acid. The hypocotyl disk bathing solution was chromatographed to look for possible radioactive metabolites released by the disk following uptake of galactonolactone. The fluorogram (Fig. 6.3.4) shows no presence of [<sup>3</sup>H]ascorbate in the bathing solution indicating minimal release of [<sup>3</sup>H]ascorbate from the hypocotyl disk cells into the medium. The fluorogram does show spots likely to be [<sup>3</sup>H]galactonolactone and



[<sup>3</sup>H]galactonic acid, the latter as a result of the lactone ring being hydrolysed. Several other metabolites can be seen by fluorography. Fig. 6.3.5 shows four <sup>3</sup>H-compounds from hypocotyl bathing solution (Unknowns W, X, Y and Z). These were not identified with any of the markers available, but were eluted from the paper and saponified in an attempt to identify their nature (Fig. 6.3.6). Saponification failed to help identify these compounds nature.

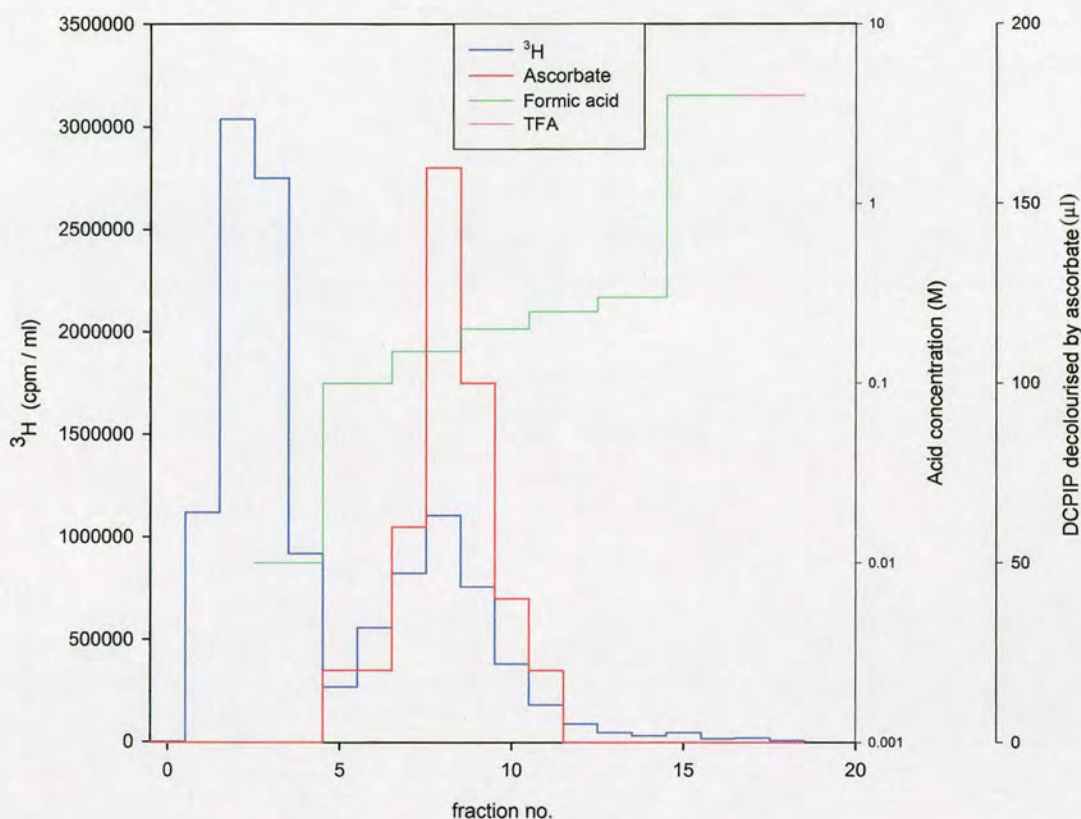

**Fig. 6.3.1 Metabolites of [ $^3\text{H}$ ]galactonolactone within hypocotyl disks, released from a Dowex 1 column by an acid gradient.**

A radish disk (prepared as in Fig. 5.1) was bathed in 1 ml of de-ionised water containing 17 MBq of L-[6- $^3\text{H}$ ]galactonolactone for 8 hours. Excess liquid was then blotted from the disk, which was homogenised in 1 ml of 10% formic acid containing 1.54% ascorbic acid. The extract was passed through a Dowex 50 (pyridinium<sup>+</sup>) column and the new eluate loaded onto Dowex 1 (formate<sup>-</sup>). Bound compounds were eluted from the Dowex 1 column using a buffer (formate 0.01 M, pH 5) followed by a formic acid (0.1 M – 4 M) step gradient and 4 M trifluoroacetic acid.  $^3\text{H}$  was measured in the eluate. Carrier ascorbate was measured in a small sample of each fraction by decolourisation of DCPIP.

Fig. 6.3.2

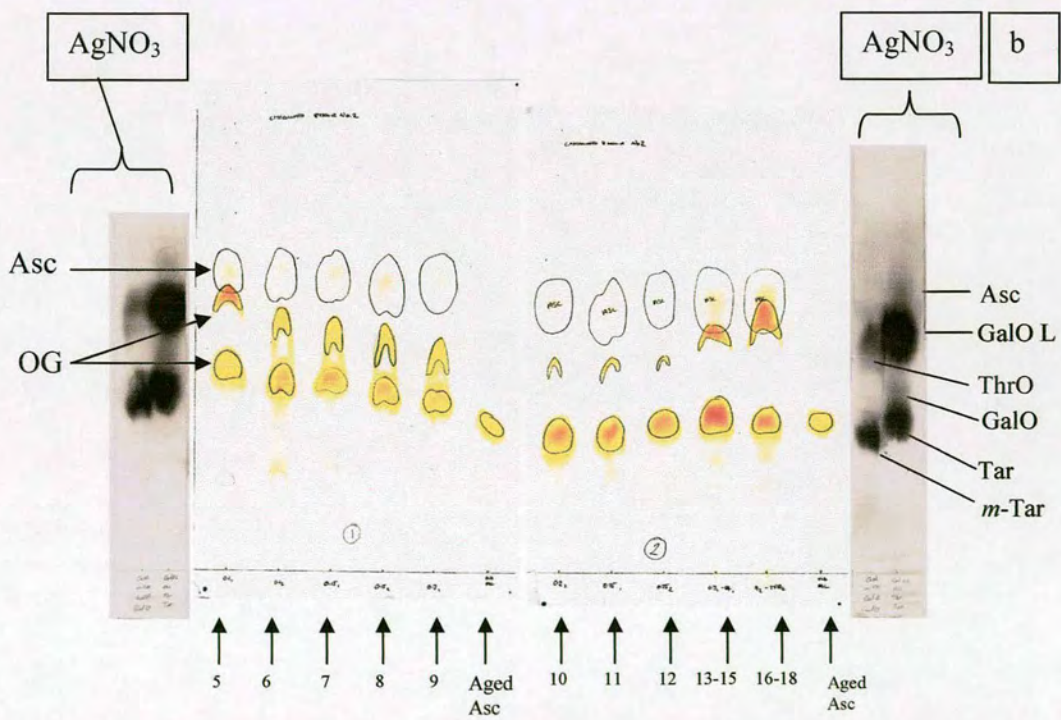
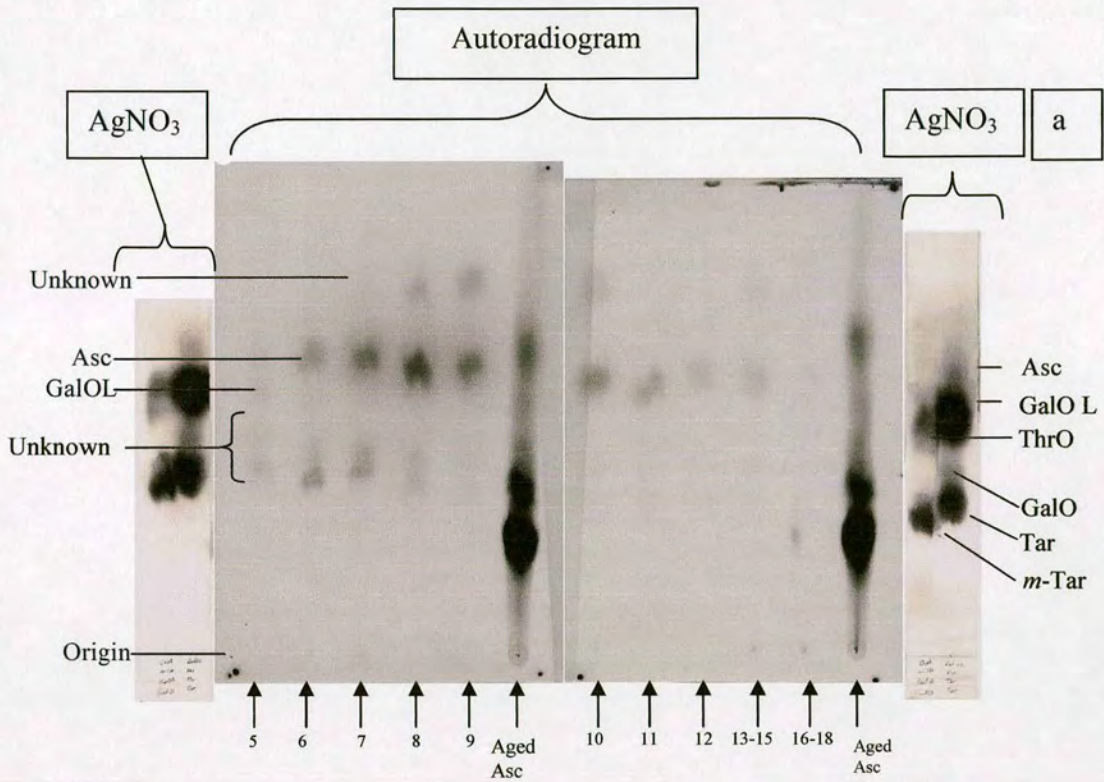

**Fig. 6.3.2 Chromatography of  $^3\text{H}$ -metabolites produced by a radish disk bathed in [ $^3\text{H}$ ]galactonolactone**

(a) Fluorogram of paper chromatogram (BuOH:HOAc:H<sub>2</sub>O, 12:3:5, for 18 hours) of fractions eluted from a Dowex 1 (formate<sup>-</sup>) column (see Fig. 1). Fractions 5–16 represent the fractions removed by formic acid from the column and fractions 17 and 18 were removed by 4 M trifluoroacetic acid (TFA). “Aged Asc” was [ $^{14}\text{C}$ ]ascorbate exposed to laboratory air for 48 hours to generate its characteristic breakdown products (Green, 2003).

(b) Internal markers for the chromatogram shown in Fig. 6.3.2a. The paper chromatogram was sprayed with DCPIP. Results show white-circled areas where DCPIP was decolourised because of the presence of internal marker ascorbate on the paper. Orange G (OG) was present as a reference marker.

Silver-stained markers were ascorbate (Asc), *meso*-tartrate (*m*-Tar), L-tartrate (Tar), oxalate, L-threonate (ThrO), D-galactonate (GalO), and L-galactonolactone (GalO L).

Fig. 6.3.3

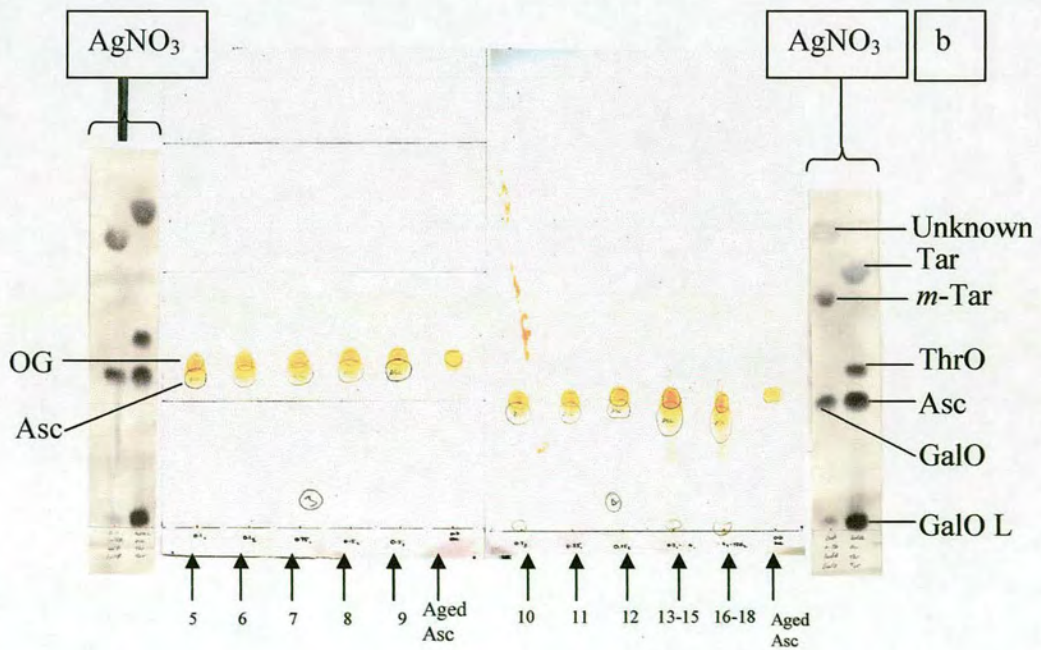
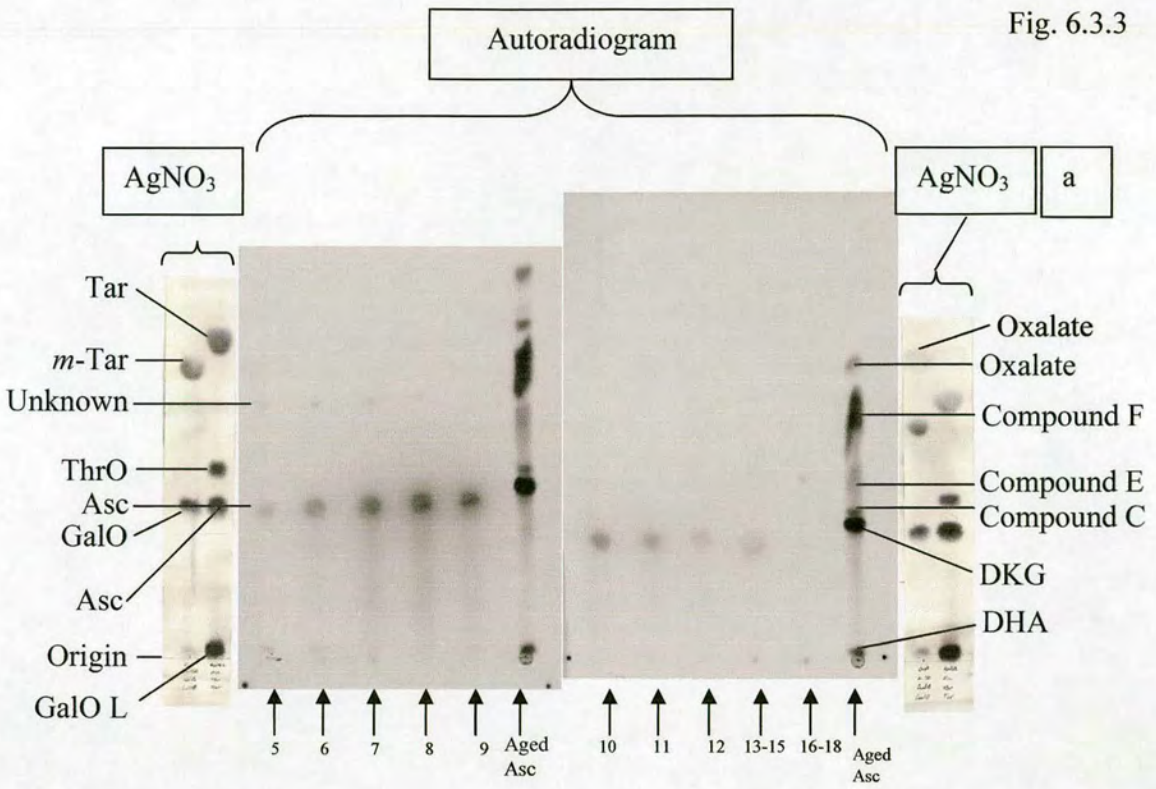
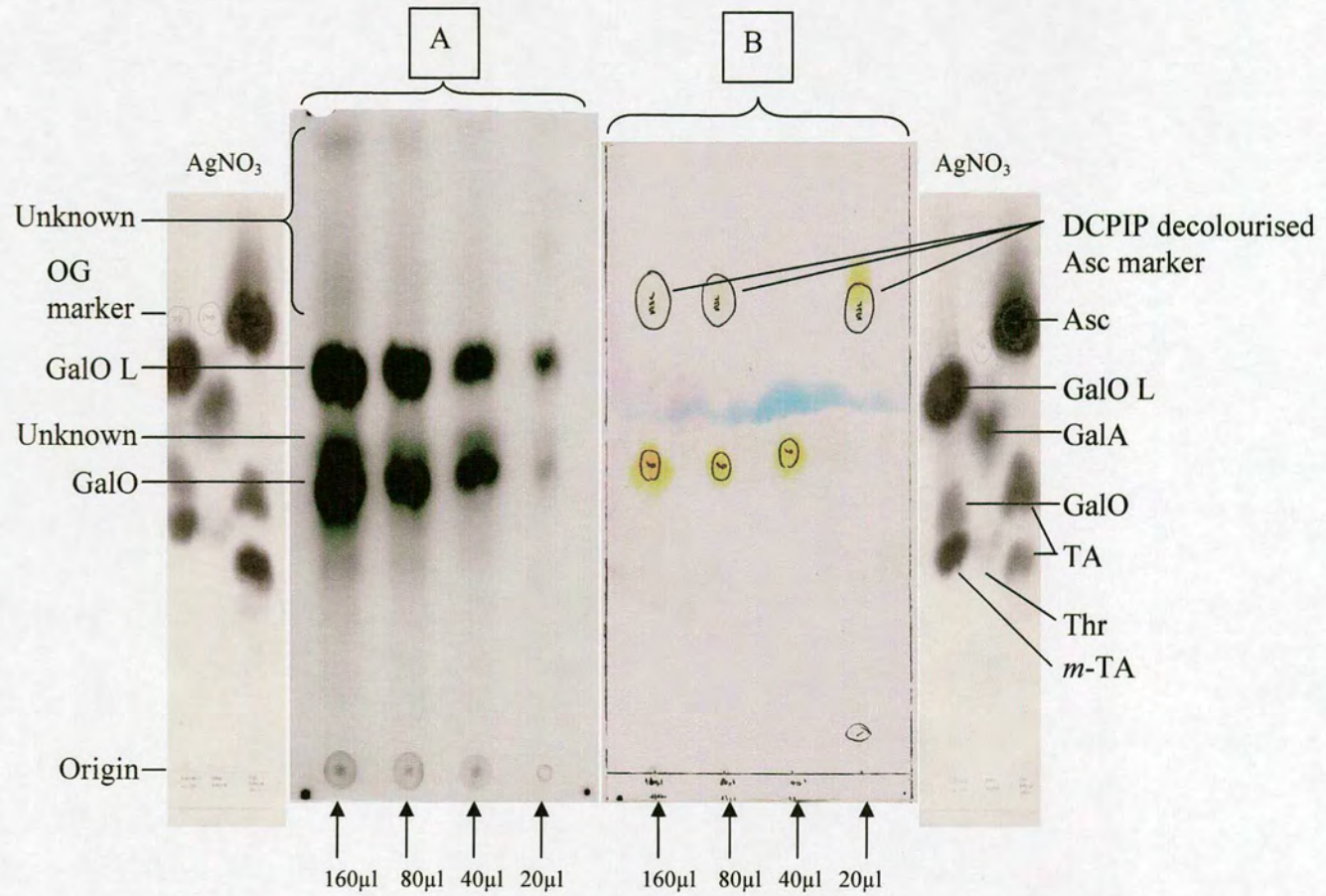

**Fig. 6.3.3 Electrophoresis of  $^3\text{H}$ -metabolites produced by a radish disk bathed in [ $^3\text{H}$ ]galactonolactone.**

(a) Fluorogram of paper electrophoretogram (pH 6.5, 3 kV, for 20 minutes) of fractions eluted from a Dowex 1 (formate<sup>-</sup>) column. Fractions represented as described in Fig 6.3.2.

(b) Internal markers of the electrophoretogram shown in Fig. 6.3.3a. The paper electrophoretogram and markers were treated as in Fig. 2.

Fig. 6.3.4

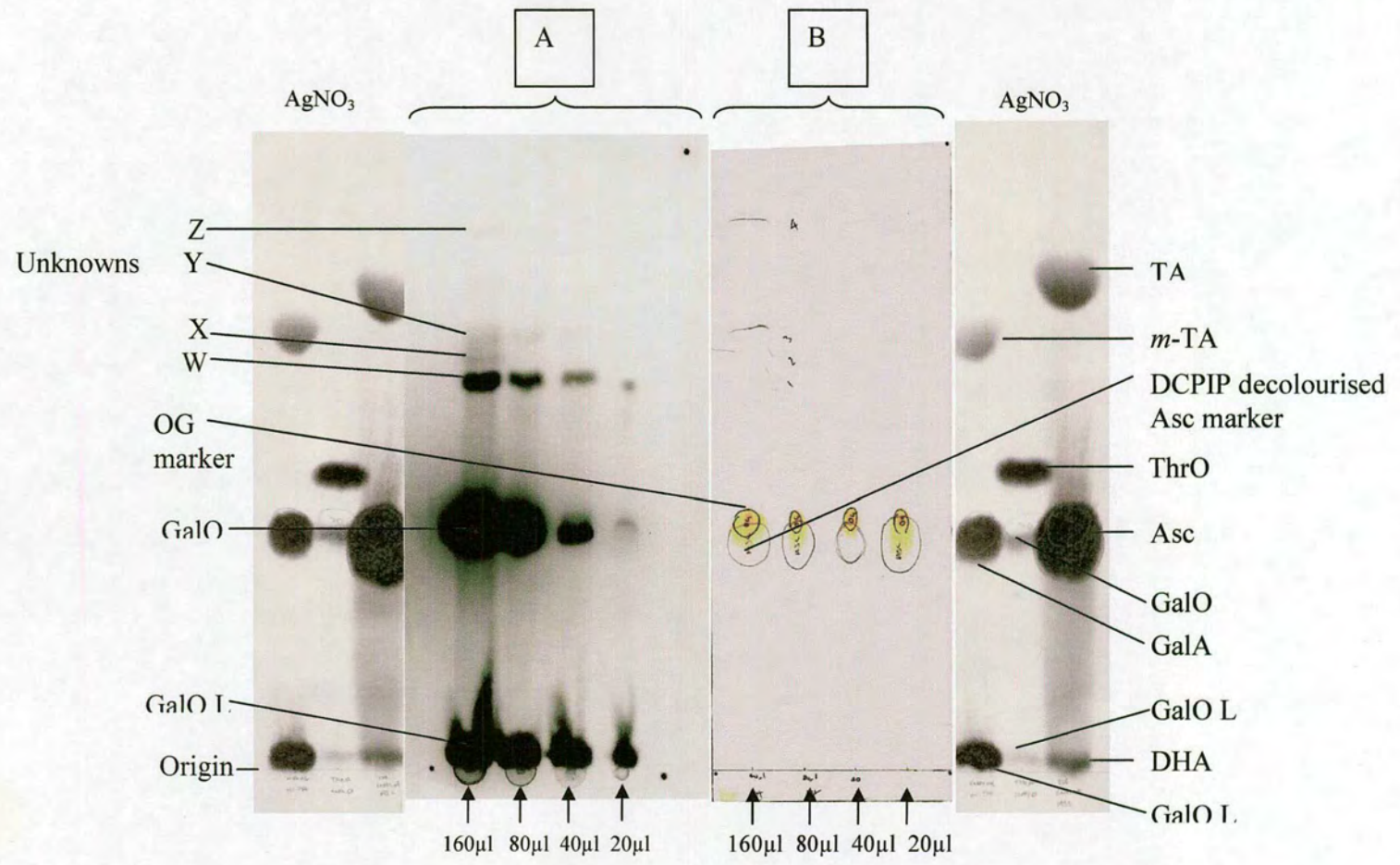

**Fig. 6.3.4 Chromatogram and fluorogram of bathing solution containing radish disk released metabolites**

(A) Fluorogram of paper chromatogram (BuOH:HOAc:H<sub>2</sub>O, 12:3:5, for 18 hours) of different volumes of bathing solution. The chromatogram (B) shows where internal marker ascorbate (Asc) runs, indicated by DCPIP decolourisation. The fluorogram (A) shows <sup>3</sup>H compounds. Silver-stained markers (AgNO<sub>3</sub>) were ascorbate (Asc), *meso*-tartrate (*m*-Tar), L-tartrate (Tar), L-threonate (ThrO), D-galactonate (GalO) and L-galactonolactone (GalO L).



Fig. 6.3.5



**Fig. 6.3.5 Electrophoretogram and fluorogram of bathing solution containing radish disk released metabolites**

The electrophoretogram (B) (pH 6.5, 3 kV, for 20 min) of different volumes of bathing solution shows where internal marker ascorbate (Asc) runs indicated by DCPIP decolourisation. The fluorogram (A) shows  $^3\text{H}$ -compounds. Silver stained ( $\text{AgNO}_3$ ) markers as in Fig. 6.3.4.

Fig. 6.3.6

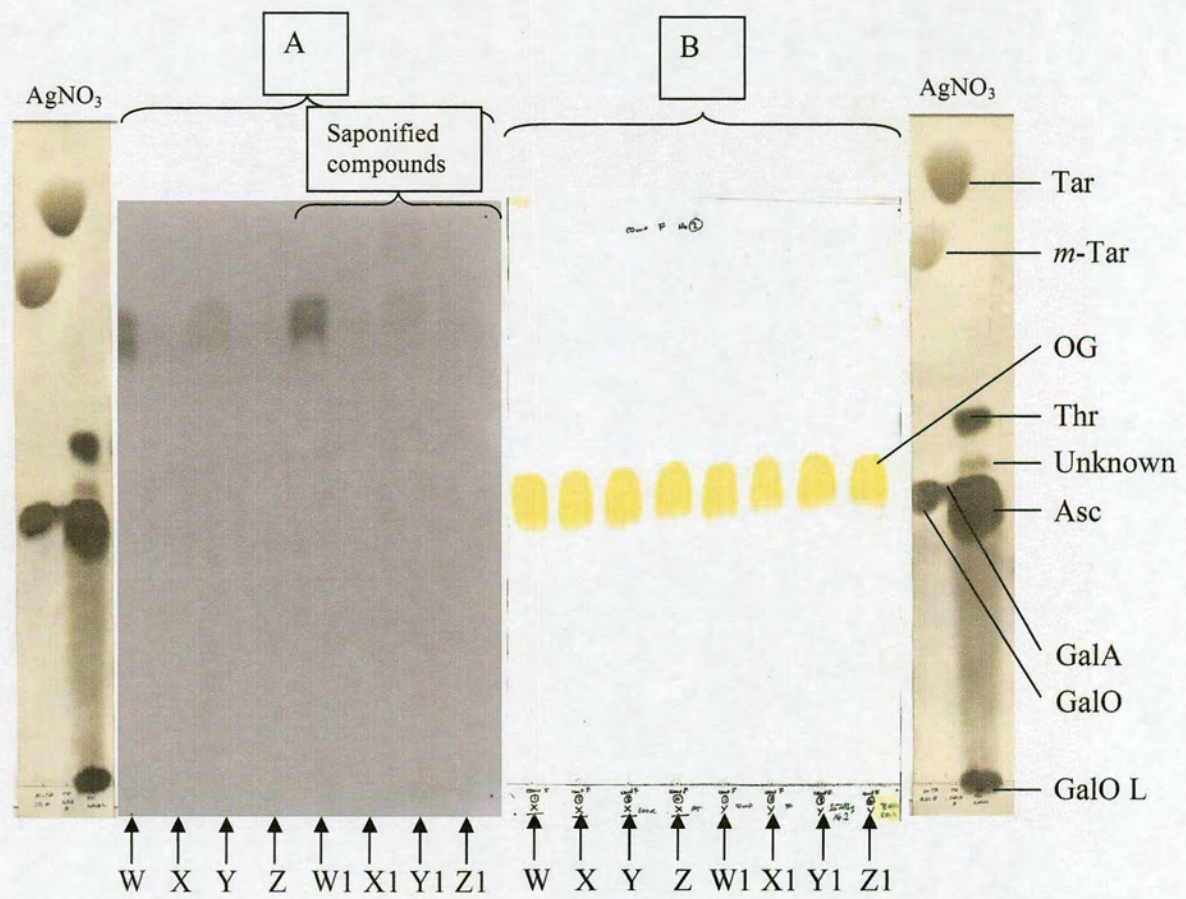

**Fig. 6.3.6 Electrophoretogram and fluorogram of isolated compounds from a radish disk bathing solution**

The electrophoretogram (B) (pH 6.5, 3 kV, for 20 min) shows internal marker orange G (OG). The fluorogram (A) shows  $^3\text{H}$ -compounds isolated from radish bathing solution (W, X, Y and Z) and the same compounds saponified (W1, X1, Y1 and Z1). To saponify samples, each was eluted from the electrophoretogram (see Fig. 5) with 400  $\mu\text{l}$   $\text{H}_2\text{O}$ . Samples were dried by SpeedVac and re-dissolved in 20  $\mu\text{l}$   $\text{H}_2\text{O}$ . Each sample was divided into 10- $\mu\text{l}$  volumes. W, X, Y and Z were treated with 105  $\mu\text{l}$  of 1 M NaOH containing 5  $\mu\text{l}$  17.5 M HOAc. W1, X1, Y1 and Z1 were treated with 100  $\mu\text{l}$  of 1 M NaOH, left at room temperature for 10 min and then mixed with 5  $\mu\text{l}$  17.5 M HOAc (Fig 5). Each sample was mixed with 5  $\mu\text{l}$  1 % OG. Silver stained ( $\text{AgNO}_3$ ) markers as in Fig. 6.3.4.

## 7 DISCUSSION

Ascorbate is found in all plants and in virtually every cell compartment of the cell (Conklin, 2001; Loewus, 1999; Smirnov, 1996; Loewus and Loewus, 1987; Arrigoni and DeTullio, 2000; Francashi and Tarlyn, 2002; Noctor and Foyer, 1998; Smirnov and Wheeler, 2000; Davey *et al.*, 2000; Horemans *et al.*, 2000; Smirnov *et al.*, 2001).

Ascorbate has been linked to having several roles within the plant cell. There is an increasing amount of evidence that ascorbate is involved in the growth and development of plants, although the mechanisms by which this takes place remain unclear (Arrigoni, 1994; Alcain and Buron, 1994; Cordoba and Gonzalez-Reyes, 1994; De Gara and Tommasi, 1999). When ascorbate levels have been manipulated by experimentation results suggest ascorbate affects cell cycle and/or cell division (Francashi and Tarlyn, 2002), cell elongation (Kato and Esaka, 1999; Hidalgo *et al.*, 1991). Mutant and transgenic plants with reduced endogenous ascorbate show reduced shoot growth rates (Veljovic-Jovanovic *et al.*, 2001) and reduced cell growth and cell division (Tabata, *et al.*, 2001). Ascorbate also functions as a biochemical antioxidant, with its roles in redox processes during photosynthesis and defence against oxidative stresses (Smirnov, 2000; Noctor and Foyer, 1998; Davey *et al.*, 2000; Horemans *et al.*, 2000). The wide variety of possible roles within the plant of ascorbate makes it an interesting area of study.

In order to study the fate of ascorbate under conditions that would naturally occur within a plant it is necessary to ensure that any ascorbate synthesised as a result of external influence, for experimentation, is synthesised within the normal cell compartments and as a result treated by the plant cells in a way that occurs naturally within nature. For this

reason plants were fed L-galactonolactone, the direct precursor during synthesis to ascorbate within plants (Wheeler and Smirnoff, 1998). The data presented provides information on methods for the uptake of L-galactonolactone and its conversion to ascorbate, as well as analysis of ascorbate and its' related compounds. The identification of these methods of study and analysis add valuable information relevant to the study of the mechanism and action of ascorbate within plants.

While L-ascorbate is a universal constituent of all green plants poverty means deficiencies are still common place in developing countries. L-Ascorbate may also have a role in cardiovascular disease and certain cancers (Davey *et al.*, 2000). In relative dietary contributions of a food, it is not only the nutrient levels, but the quantity of consumption of a food that is important. Potatoes are the most highly consumed vegetable in Europe (except in Italy) (Davey *et al.*, 2000). Thus potatoes with between 30 mg (100g)<sup>-1</sup> and 10mg (100)<sup>-1</sup> of L-ascorbate are the major source of L-ascorbate in the European diet. In order to choose a storage organ that could be used as a model for the potato it had to be manageable to work with and relatively fast growing. Radish plants were used for these studies to identify what role the hypocotyl played within the plant in relation to ascorbate transport and metabolism. The choice of the radish meant that any data gathered could be considered relevant to what takes place within a tuber of the potato plant. This in turn may prove useful in improving the potato tuber for dietary benefits.

A rational explanation of L-ascorbate biosynthesis in higher plants was hindered for many years due to the incompatible findings that required retention of the carbon chain sequence of D-glucose, a role for hexose phosphate, an epimerisation step and the fact

that L-galactono-1,4-lactone was the most effective substrate for the final oxidation step. Then in 1998, Wheeler and Smirnoff provided a plausible pathway that accommodated all the unsettled issues (Fig 1.4) Wheeler studied ascorbate synthesis using barley leaf slices, *Arabidopsis thaliana* leaves and embryonic axes of germinating pea seedlings.

Tartrate biosynthesis study has been carried out by Hough and Jones (1956) using detached grape leaves, by Saito and Kasai (1969) in immature grape berry slices and by Stafford (1961) in detached *Pelargonium crispum* leaves.

Oxalate biosynthesis was studied by Yang and Loewus (1975) and Nuss and Loewus (1978) using several different oxalate accumulating plant seedlings and detached leaves.

Until recently with the work Franceschi and Tarlyn (2002), no work had been carried out studying the feeding of an intact plant with L-galactonolactone, and no work has been carried out on feeding an intact plant L-galactonolactone and then studying ascorbate metabolites or ascorbate transport to the plant storage organ.

Feeding intact radish plants L-galactonolactone was studied because no such experiments have been carried out in plants with storage organs. An increase in the leaves fed L-galactonolactone and their neighbouring leaves was observed suggesting transport of either ascorbate or L-galactonolactone; however, recent work carried out by Franceschi and Tarlyn (2002) suggests that it is ascorbate and not L-galactonolactone that is transported. Surprisingly, no increase in ascorbate was measured within the hypocotyl. This may be due to the vascular structure of the plant restricting ascorbates transport to the hypocotyl, or it may be that ascorbate is rapidly turned over if increased beyond a specific level within the hypocotyl. Franceschi and Tarlyn (2002) showed that it is L-ascorbate that is transported by the plant and not L-galactonolactone, which would

suggest that the plant either controls access of L-ascorbate to the hypocotyl due to its vascular structure or that the hypocotyl tissue rapidly breaks down L-ascorbate. Further experiments with hypocotyl disks led to an increase in endogenous levels of L-ascorbate when fed L-galactonolactone suggesting that in the intact plant, transported L-ascorbate is rapidly broken down in the hypocotyls tissue and that the hypocotyl cells synthesises its own L-ascorbate independently of the plant foliage.

Franceschi and Tarlyn (2002) showed that L-ascorbate is transported to sink tissues of the plant including root tips, shoots and floral organs where rapid growth is occurring. This could agree with my findings as a possible explanation for rapid turnover of L-ascorbate within the hypocotyl is that it is used within the hypocotyls for organ wall expansion partly by non-enzymic polysaccharide scission. This has been shown *in vivo* by Fry (1998) and studied in ripening in pear fruit (Fry *et al.*, 2001). To study this further, intact plants would be fed radiolabelled L-galactonolactone and L-ascorbate to establish which metabolite is transported from the leaf to other parts of the plant. Plants would be analysed to establish if radioactive metabolites are present in the hypocotyl, and therefore if physiology or breakdown of ascorbate is responsible for the lack of change in ascorbate content of the hypocotyl. It would be useful to study the growth of the hypocotyls to establish if growth is enhanced by the presence of increased L-ascorbate exogenously supplied in comparison to natural levels.

Underground storage organs had a tissue plug cut from central tissue and disks were cut from either external “skin” tissue or from central white tissue and used for L-[1-<sup>14</sup>C]galactonolactone uptake studies. Tap water was allowed to de-gas before hypocotyl



disks were washed in the water was tested. Clear uptake of L-[1-<sup>14</sup>C]galactonolactone took place with a  $K_m$  of 0.96 nmol under these conditions, and would allow small-scale study of L-[1-<sup>14</sup>C]galactonolactone metabolism in storage organ flesh for the first time. A further study also identified this method as allowing hypocotyl tissue to increase its ascorbate levels showing that hypocotyl tissue has the ability to convert L-galactonolactone to L-ascorbate. This is the first time data has been shown to identify that fact that a storage organ has the capability to synthesise its own source of L-ascorbate.

A note of interest that could be followed up from this experiment was that tissue containing the outer layer of the hypocotyl took up L-galactonolactone more rapidly than central tissue. This may occur for two reasons. Firstly, the radish skin would act as the first barrier against oxidative radicals, and secondly, this area may require a greater level of L-ascorbate for cell wall expansion in comparison to central hypocotyls tissue and could be studied as described by Fry (2001)

To identify the products of L-[6-<sup>3</sup>H]galactonolactone metabolism it was necessary to design a method that would allow specific L-[6-<sup>3</sup>H]galactonolactone related molecule identification. A large amount of study has gone into the identification of ascorbate turnover products (Loewus, 1999) and the identification method was designed with these in mind. Washes were designed to maximise the binding capacity of Dowex 50 ( $H^+$ ) to remove all positively charged molecules as positively charged compounds were of no interest to this study. Dowex 1 ( $formate^-$ ) was washed in such a way as to release compounds at specific acid concentrations to allow removal of bound negative compounds within small volumes. This allowed radioactive compounds washed off the

Dowex 1 (formate<sup>-</sup>) to be highly concentrated in specific fractions and therefore easily identifiable and easily distinguishable from one another. By using paper electrophoresis it was possible to separate compounds accurately.

To study the possible production of L-[6-<sup>3</sup>H]ascorbate a single radish disk was fed L-[6-<sup>3</sup>H]galactonolactone. Clear identification of ascorbate synthesis was seen within the hypocotyl tissue as large quantities of L-[6-<sup>3</sup>H]ascorbate were seen, identified by both electrophoretic fluorography and chromatographic fluorography. Several other radiolabelled compounds were seen to be present within the cell extract; however, these did not agree with any of the ascorbate turnover markers that had been used, suggesting that there are metabolites prior to the more commonly discussed tartrate, threonate and oxalate within ascorbate turnover; or, that the turnover of ascorbate within the radish hypocotyl is different to that reported in plant leaves and fruit (Loewus, 1999). Results identified the presence of several unknown radiolabelled metabolites present in the bathing solution as well. Further study would go into the identification of these compounds.

Our present insight into the biochemical processes involved with ascorbate is still very crude. However, the development of methods that allow us to study ascorbate and its metabolic products as well as identification of how ascorbate is utilised within the plant is essential if we are to progress our knowledge and understanding of its roles. The study of ascorbate is important because knowledge of its role and that of its turnover products within the plant still remains vague. Ascorbate is proposed to be involved in cell growth and development, cell cycle and/or cell division; however, the mechanism by which these areas are affected by ascorbate is still unclear. The data presented provides methods for

the study of ascorbate metabolism within a living plant and accurate methods for identification of ascorbates fate.

To follow on from this work, radiolabelling experiments would be used to identify if any compounds are transported into the hypocotyl following uptake of radiolabelled galactonolactone into the leaf, and if so, what compounds these are. Immature and mature radish plants would be fed radiolabelled galactonolactone to study the possible transport of ascorbate to sink tissues, which would include immature leaves and immature hypocotyls. Further analysis of hypocotyl disk cellular extract would be carried out to identify radiolabelled compounds other than ascorbate as well as identification of compounds released from cells into the bathing solution.

## 7 DISCUSSION

Ascorbate is found in all plants and in virtually every cell compartment of the cell (Conklin, 2001; Loewus, 1999; Smirnov, 1996; Loewus and Loewus, 1987; Arrigoni and DeTullio, 2000; Francashi and Tarlyn, 2002; Noctor and Foyer, 1998; Smirnov and Wheeler, 2000; Davey *et al.*, 2000; Horemans *et al.*, 2000; Smirnov *et al.*, 2001).

Ascorbate has been linked to having several roles within the plant cell. There is an increasing amount of evidence that ascorbate is involved in the growth and development of plants, although the mechanisms by which this takes place remain unclear (Arrigoni, 1994; Alcain and Buron, 1994; Cordoba and Gonzalez-Reyes, 1994; De Gara and Tommasi, 1999). When ascorbate levels have been manipulated by experimentation results suggest ascorbate affects cell cycle and/or cell division (Francashi and Tarlyn, 2002), cell elongation (Kato and Esaka, 1999; Hidalgo *et al.*, 1991). Mutant and transgenic plants with reduced endogenous ascorbate show reduced shoot growth rates (Veljovic-Jovanovic *et al.*, 2001) and reduced cell growth and cell division (Tabata, *et al.*, 2001). Ascorbate also functions as a biochemical antioxidant, with its roles in redox processes during photosynthesis and defence against oxidative stresses (Smirnov, 2000; Noctor and Foyer, 1998; Davey *et al.*, 2000; Horemans *et al.*, 2000). The wide variety of possible roles within the plant of ascorbate makes it an interesting area of study.

In order to study the fate of ascorbate under conditions that would naturally occur within a plant it is necessary to ensure that any ascorbate synthesised as a result of external influence, for experimentation, is synthesised within the normal cell compartments and as a result treated by the plant cells in a way that occurs naturally within nature. For this

## REFERENCES

Alcain, F. J., Buron, M. I., Effect of ascorbate on cell growth and differentiation. *Journal of Bioenergetics and Biomembranes*. 26, 393–398, 1994

Arrigoni, O. Ascorbate system in plant development. *Journal of Bioenergetics and Biomembranes*. 26, 407–419, 1994

Arrigoni O., De Tullio M.C. The role of ascorbic acid in cell metabolism: between gene-directed functions and unpredictable chemical reactions. *Journal of Plant Physiology*. 157, 481–488, 2000

Asada, K., The water-water-cycle in chloroplasts: scavenging of active oxygen and dissipation of excess photons. *Annual Review of Plant Physiology and Plant Molecular Biology*. 50, 601–639, 1999

Asada K., Kiso K. initiation of aerobic oxidation of sulphite by illuminated spinach chloroplasts. *European Journal of Biochemistry*. 33, 253–257, 1973

Asada K., Kiso K., Yoshikawa K. Univalent reduction of molecular oxygen by spinach chloroplasts on illumination. *Journal of Biological Chemistry*. 249, 2175–2181, 1974

Baig, M.M.A., Kelly, S., Loewus, F.A. L-Ascorbic acid biosynthesis in higher plants from L-gulonono-1,4-lactone and L-galactono-1,4-lactone. *Plant Physiology*. 46, 277–280, 1970

Barnes, J., Bender, J., Lyons, T., Borland, A., Natural and man made selection for air pollution resistance. *Journal of Experimental Botany*, 50, 1423–1435, 1999

Beck, E., Barkert, A., Hofmann, M., Uptake of L-ascorbate by intact spinach chloroplasts. *Plant Physiology*. 73, 41–45, 1983

Burns, J.J., Ascorbic acid. In: D.M. Greenberg (ed.) , *Metabolic Pathways, Vol. 1* p.394, New York: Academic Press. (3rd Ed.) 1967

Carpenter, M., Carnes, P., Willard, E., Dietary-lipid and Vitamin E interaction in blood platelet function. *FASEB* 45, 236 1986

Conklin P. L., Williams E. H., Last R. L. Environmental stress sensitivity of an ascorbic acid-deficient *Arabidopsis* mutant. *Proceedings of the National Academy of Science of the USA*. 93, 9970–9974, 1996

Cordoba-Pedregosa, M.D., Gonzalez-Reyes, J.A., Canadillas, M.D., Navas, P., Cordoba, F., Role of apoplastic and cell-wall peroxidases in the stimulation of root elongation by ascorbate. *Plant Physiology*. 112, 1119–1125, 1996

Davies, M.B., Austin, J., Partridge, P.A., *Vitamin C: Its chemistry and biochemistry*. 1991, Royal Society of Chemistry Paperbacks.

Davey M. W., Van Monatgu M., Sanmatin M., Kanellis A., Smirnoff N., Benzie I. J. J., Strain J. J., Favell D., Fletcher J. Plant L-ascorbic acid: chemistry, function, metabolism, bioavailability and effects of processing. *Journal of the Science of Food and Agriculture*, 80, 825–860, 2000

De Gara, L., Tommasi, F. Ascorbate redox enzymes: a network of reactions involved in plant development. *Recent Developments in Phytochemistry*. 3, 1–15, 1999

Esaka, M., Fujisawa, K., Goto, M., Kisa, Y., Regulation of ascorbate oxidase by auxin and copper. *Plant Physiology*. 100, 231–237, 1992

Esaka, M., Imagi, J., Suzuki, K., Kubota, K., Formation of ascorbate oxidase in cultured pumpkin cells. *Plant and Cell Physiology*. 29, 231–235, 1988

Franceschi, V., Tarlyn, N., l-Ascorbic acid is accumulated in source leaf phloem and transported to sink tissues in plants. *Plant Physiology*, 130, 649–656, 2002

Fry, S.C., Oxidative scission of plant cell wall polysaccharides by ascorbate-induced hydroxyl radicals. *Biochemical Journal*. 332, 507–515, 1998

Fry, S.C., Dumvill, J.C., Miller, J.G., Fingerprinting of polysaccharides attacked by hydroxyl radicals *in vitro* and in the cell walls of ripening pear fruit. *Biochemical Journal*. 357, 729–737, 2001

Gonzalez-Reyes, J.A., Hidalgo, A., Caler, J.A. Palos, R., Navas, P., Nutrient uptake changes in ascorbate free radical-stimulated roots. *Plant Physiology*. 104, 271–276, 1994

Gonzalez-Reyes, J.A., Alcain, F.J., Caler, J.A., Serrano, A., Cordoba, F., Navas, P., Stimulation of onion root elongation by ascorbate and ascorbate free radical in *Allium cepa* L. *Protoplasma*. 184, 31–35, 1995

Grassley, A. The anatomy of the primary body of *Raphanus sativus*, L. Thesis. University of Chicago, 1932

Halliwell, B., Vitamin C: antioxidant or pro-oxidant *in vitro*? *Free Radical Research*. 25, 439–454, 1996

Heath R L. Initial events in injury to plants by air pollutants. *Annual Review of Plant Physiology* 31 395–431. 1980



Herbert, R. W., Hirst, E.L., Percival, E.G.V., Reynolds, R.J.W., Smith, F., The constitution of ascorbic acid. *Journal of the Chemical Society*. Part 2, 1270–1290, 1933

Hayward, E. H. *The structure of economic plants*. New York: The Macmillan Company. p. 283 (2nd Ed), 1967

Helsper, J.P., Loewus, F.A., Metabolism of L-threonic acid in *Rumex × acutus*. L and *Pelargonium crispum* (L.) L'Her. *Plant Physiology*. 69, 465–468 1982

Hidalgo, A., Gonzalez-Reyes, J.A., Navas, P., Ascorbate free radical enhances vasculourisation in onion root meristems. *Plant, Cell and Environment*. 12, 455–460, 1989

Horemans, N., Asard, H., Caubergs, R.J., Transport of ascorbate into plasma membrane vesicles of *Phaseolus vulgaris* L. *Protoplasma*. 194, 177–185, 1996

Horemans, N., Asard, H., Caubergs, R.J., The ascorbate carrier of higher plants plasma membranes preferentially translocates the fully oxidised (dehydroascorbate) molecule. *Plant Physiology*. 114, 1247–1253, 1997

Horemans, N., Asard, H., Caubergs, R.J., Carrier mediated uptake of dehydroascorbate into higher plant plasma membrane vesicles show trans-stimulation. *FEBS Letters*. 421, 41–44, 1998

Horemans, N., Potters, G., Asard, H., Caubergs, R.J., Transport of ascorbate into protoplasts of *Nicotiana tabacum* bright yellow 2 cell line. *Protoplasma*. 205, 114–121, 1998

Horowitz, H.H., Doerschuk, A.P., King, C.G., The origin of L-ascorbic acid in the albino rat. *Journal of Biological Chemistry*. 199, 193–198, 1952

Horowitz, H.H., King, C.G., The conversion of glucose-6-<sup>14</sup>C to ascorbic acid in the albino rat. *Journal of Biological Chemistry*. 200, 125–128, 1953

Hough, L., Jones, J.K.N., The biosynthesis of the monosacharides. *Advances in Carbohydrate Chemistry*. 11, 185–262, 1956

Hove L. W. A., Bossen M. E., San Gabino B. G., Sgreva C. The ability of apoplastic components to protect poplar leaves against ambient ozone concentrations: a quantitative approach. *Environmental Pollution* 114, 371–382, 2001

Ingebretsen, O.L., and Normann, P.T., Transport of ascorbate into guinea pig liver mitochondria. *Biochimica et Biophysica Acta*. 684, 21–26, 1982

Isherwood, F.A., Chen, Y.T., Mapson, L.W., Synthesis of ascorbic acid in plants and animals. *Biochemical Journal*. 56, 1–15, 1954

Kersteins G., Lenzian K. J. interaction between ozone and plant cuticles I. Ozone deposition and permeability. *New Phytologist* 112, 13–19, 1989

Leung, C.T., Loewus, F.A., Ascorbic acid in pollen: conversion of L-galactono-1,4-lactone to L-ascorbic acid in *Lilium longiflorum*. *Plant Science*. 39, 45–48, 1985

Loewus, F.A., Biosynthesis and metabolism of ascorbic acid in plants and analogs of ascorbic acid in fungi. *Phytochemistry*. 52, 193–210, 1999

Loewus, F.A., Kelly, S., Identity of L-ascorbic acid formed from D-glucose by the strawberry (*Fragaria*). *Nature*. 191, 1059–1061, 1961

Loewus F.A., Loewus M. W. Biosynthesis and metabolism of ascorbic acid in plants. *Critical Reviews in Plant Science*. 5, 101–119, 1987

Loewus, F.A., Stafford, H.A., Observations on the incorporation of  $^{14}\text{C}$  into tartaric acid and the labelling pattern of D-glucose from an excised grape leaf administered L-ascorbic acid-6- $^{14}\text{C}$ . *Plant Physiology*. 33, 155–156, 1958

Loewus, F.A., Jang, R., Seegmiller, C.G., The conversion of  $^{14}\text{C}$ -labelled sugars to L-ascorbic acid in ripening strawberries. *Journal of Biological Chemistry*. 222, 649–664, 1956

Loewus, F.A., Kelly, S., Hiatt, H.H., Ascorbic acid synthesis from D-glucose-2- $^{14}\text{C}$  in the liver of the intact rat. *The Journal of Biological Chemistry*. 235, 937–939, 1960

Loewus, F.A., Kelly, S., Neufeld, E.F., Metabolism of *myo*-inositol in plants: conversion to pectin, hemicellulose, D-xylose and sugar acids. *Proceedings of the National Academy of Sciences of the U.S.A.* 48, 421–423, 1962

Loewus, M.W., Bedgar, D.L., Saito, K., Loewus, F.A., Conversion of L-sorbosone to L-ascorbic acid by a NADP-dependent dehydrogenase in bean and spinach leaf. *Plant Physiology*. 94, 1492–1495, 1990

Luwe, M.W.F., Takahama, U., Heber, U., Role of ascorbate in detoxifying ozone in the apoplast of spinach (*Spinacia oleracea* L.) leaves. *Plant Physiology*. 101, 969–976, 1993

Lyons T., Ollerenshaw J. H., Barnes J. D. Impacts of ozone on *Plantago major*: apoplastic and symplastic anti-oxidant status. *New Phytologist* 141, 253–263, 1999

Maccarrone, M., Corasaniti, T., Guerrieri, P., Nistico, G., Agro, A., Nitric oxide-donor compounds inhibit lipoxygenase activity. *Biochemical and Biophysical Research Communications*. 219, 128–133, 1995

Maddison J., Lyons T., Plöchl M., Barnes J.D. Hydroponically cultivated radish fed l-galactono-1,4-lactone exhibit increased tolerance to ozone. *Planta*. 214, 383–391, 2002

Malipiero, U., Kuffner, H.P., Rast, D.M., Ascorbic to tartaric acid conversion in grape vines. *Journal of Plant Physiology*. 129, 33–40, 1987

Marencano, A., Gouget, H., Nedelec, P., Evidence of a long-term increase in tropospheric ozone from pic du midi data series – consequences – positive radiative forcing. *Journal of geophysics research and atmosphere*. 99, 16617–16632, 1994

Miyake, C., Asada, K., Thylakoid-bound ascorbate peroxidase in spinach chloroplasts and photo reduction of its primary oxidation product monodehydroascorbate radicals in thylakoids. *Plant and Cell Physiology*. 33, 541–553, 1992

Mozafar, A., Oertli, J.J., Vitamin C (ascorbic acid): uptake and metabolism by soybean. *Journal of Plant Physiology*, 141, 316–321, 1993

- Navas, P., Gomes-Diaz, P. Ascorbate free radical and its role in growth control, *Protoplasma*. 184, 8–13, 1995
- Neubauer, C., Yamamoto, H.A., Mehler peroxidase reaction mediates zeaxanthin formation and zeaxanthin related fluorescence quenching in intact chloroplasts. *Plant Physiology*. 99, 1354–1361, 1992
- Noctor, G., Foyer, C.H., Ascorbate and glutathione: keeping active oxygen under control. *Annual Review of Plant Physiology and Plant Molecular Biology*. 49, 249–279, 1998
- Nuss, R.F., Loewus, F.A., Further studies in oxalic acid biosynthesis in oxalate accumulating plants. *Plant Physiology*. 61, 590–592, 1978
- Pallanca, J.E., Smirnoff, N. Ascorbic acid metabolism in pea seedlings. A comparison of D-glucosone, L-sorbosone and L-galactono-1,4-lactone as ascorbate precursors. *Plant Physiology*. 120, 453–461, 1999
- Pauls K. P., Thompson J. E. Effects of *in vitro* treatment with ozone on the physical and chemical properties of membrane. *Plant Physiology* 53, 255–262, 1981
- Polle, A., Weiser, G., Havranek, W.M., Quantification of ozone influx and apoplastic ascorbate content in the needles of Norway spruce trees (*Picea abies* L.) at high altitude. *Plant, Cell and Environment*. 18, 681–688, 1995

Rautenkranz, A.A.F., Li, L., Machler, F., Martinoia, E., Oertli, J.J., Transport of ascorbic and dehydroascorbic acids across protoplast and vacuole membranes isolated from barley (*Hordeum vulgare* L. cv Gerbel) leaves. *Plant Physiology*. 106, 187–193, 1994

Reichstein, T., Grossner, A., Oppenauer, R., Synthesis of D- and L-ascorbic acids (vitamin C). *Nature*. 132, 280, 1933

Saito, K., Kasai, Z., Tartaric acid biosynthesis from L-ascorbic acid-1-<sup>14</sup>C in grape berries. *Phytochemistry*. 52, 651–654, 1973

Saito, K., Kasai, Z., Conversion of L-ascorbic acid to L-idonic acid, L-idono- $\gamma$ -lactone and 2-keto-L-idonic acid in slices of immature grapes. *Plant and Cell Physiology*. 23, 499–507, 1982

Saito, K., Kasai, Z., Synthesis of L-tartaric acid from L-ascorbic acid via 5-keto-D-gluconic acid in grapes. *Plant Physiology*. 76, 170–174, 1984

Saito, K., Loewus, F.A., Occurrence of L-(–)-tartaric acid and its formation from D-gluconate or D-xylo-5-hexulosonate in bean leaf (*Phaseolus vulgaris* L.) *Plant Science*. 62, 175–180, 1989a

Saito, K., Loewus, F.A., Formation of L-(–)-tartaric acid in leaves of the bean, *Phaseolus vulgaris* L.: radioisotopic studies with putative pre-cursors. *Plant and Cell Physiology*. 30, 629–636, 1989b

Saito, J., Nick, J.A., Loewus, F.A., D-Glucosone and L-sorbosone, putative intermediates of L-ascorbic acid biosynthesis in detached bean and spinach leaves. *Plant Physiology*. 94, 1496–1500, 1990

Saito, K., Loewus, F.A., D-Glucosone and L-sorbosone, putative intermediates of l-ascorbic acid biosynthesis in detached bean and spinach leaves. *Plant Physiology*. 94, 1496–1500, 1992

Saito, K., Specific transfer of  $^3\text{H}$  from D-[3- $^3\text{H}$ ]gluconic acid into L-tartaric acid in vitaceous plants. *Phytochemistry*. 37, 1017–1022, 1994

Sanchez M., Queijeiro E., Revilla G., Zarra I. Changes in ascorbic acid levels in the apoplastic fluid during growth of pine hypocotyls. Effect on peroxidase activities associated with cell walls. *Physiologia Plantarum* 101, 815–820, 1997

Scandalios, J., Oxygen stress and superoxide ndismutases. *Plany Physiology*, 101, 7–12, 1993



Simontacchi, M., Andrés, C., Puntarola, S. Oxygen-dependant increase of antioxidants in soybean embryonic axes. *International Journal of Biochemical Cell Biology*. 27, 1221–1229, 1995

Smirnoff, N., The function and metabolism of ascorbic acid in plants. *Annals of Botany*. 78, 661–669, 1996

Smirnoff, N., Antioxidant systems and plants response to the environment. In: *Environment and Plant Metabolism: Flexibility and Acclimation* pp. 217–243. Ed. Bios Scientific Publishers, Oxford. 1995

Smirnoff, N., Pallanca, J.E., Ascorbate metabolism in relation to oxidative stress. *Biochemical Society Transactions*. 24, 472–478, 1996

Smirnoff, N., Conklin, P. L., Loewus, F. A., Biosynthesis of ascorbic acid in plants: a renaissance. *Annual Review of Plant Physiology and Plant Molecular Biology*. 52, 437–448, 2001

Smirnoff, N., Wheeler, G.L., Ascorbic acid in plants: Biosynthesis and function. *Critical Reviews in Plant Sciences*. 19, 267–290, 2000

Stafford, H.A., Distribution of tartaric acid in the leaves of certain angiosperms. *American Journal of Botany*. 46, 347–352, 1959

Stafford, H.A., Distribution of tartaric acid in Geraniaceae. *American Journal of Botany*. 48, 669–701, 1961

Sturgeon, B.E., Sipe, H.J., Barr, D.P., Corbett, J.T., Martinez, J. G., Mason, R.P., The fate of the oxidising radical in the presence of glutathione and ascorbate—implications for the radical sink hypothesis. *Journal of Biological Chemistry*. 273, 30116–30121, 1998

Tabata, K., Oba, K., Suzuki, K., Esaja, M. Generation and properties of ascorbic acid-deficient transgenic tobacco cells expressing antisense RNA for L-galactono-1,4-lactone dehydrogenase. *Plant Journal*. 27, 139–148, 2001

Takahama U., Oniki T. Regulation of peroxidase dependant oxidation of phenolics in the apoplast with IAA-enhanced elongation of epicotyls from *Vigna angularis*. *Plant and Cell Physiology*. 35, 257–266, 1992

Takahama, U., Veligovic-Iovanovic, S., Heber, U., Effects of the air pollutant SO<sub>2</sub> on leaves. *Plant Physiology*. 92, 601–607, 1992

Tanaka K., Sugahara K. Roles of superoxide dismutase in defence against SO<sub>2</sub> toxicity and an increase in superoxide dismutase activity with SO<sub>2</sub> fumigation. *Plant and Cell Physiology*. 21 601–611, 1980

Turscányi, E., Lyons, T., Matthias, P., Barnes, J. Does ascorbate in the mesophyll cell walls form the first line of defence against ozone? Testing the concept using broad bean (*Vicia faba L.*). *Journal of experimental Botany*. 51, 901–910, 2000

Veljovic-Jovanovic, S. D., Pignocchi, C., Noctor, G., Foyer, C. H. Low ascorbic acid in vtc-1 mutant of *Arabidopsis* is associated with decreased growth and intracellular redistribution of the antioxidant system. *Plant Physiology*. 127, 426–435, 2001

Volz, A., Kley, D., Evaluation of the Montsouris series of ozone measurements made in the nineteenth century. *Nature*, 332, 240–242, 1988

Wagner, G., Loewus, F.A. The biosynthesis of (+)-tartaric acid in *Pelargonium crispum*. *Plant Physiology*. 52, 651–654, 1973

Wagner, G., Yang, J.C., Loewus, F.A., Stereoisomeric characterisation of tartaric acid produced during L-ascorbic acid metabolism in plants. *Plant Physiology*. 55, 1071–1073, 1975

Weaver, J. E., Bruner, W. E. *Root development of vegetable crops*. McGraw-Hill Book Company. 1927

Wheeler, G.L., Jones, M.A., Smirnoff, N., The biosynthetic pathway of vitamin C in higher plants. *Nature*. 393, 365–369, 1998

Williams, M., Loewus, F.A., Biosynthesis of (+)-tartaric acid from L-[4-<sup>14</sup>C]ascorbic acid in grape and geranium. *Plant Physiology*. 61, 672–674, 1978

Williams, M., Saito, K., Loewus, F.A., Ascorbic acid metabolism in geranium and grape. *Phytochemistry*. 8, 2177–2182, 1969

Yang, J.C., Loewus, F.A., Metabolic conversion of L-ascorbic acid to oxalic acid in oxalate accumulating plants. *Plant Physiology*. 56, 283–285, 1975

Zheng Y., Lyons T., Ollerenshaw J. H., Barnes J. D. Ascorbate in the leaf apoplast is a factor mediating ozone resistance in *Plantago major*. *Plant Physiology and Biochemistry* 38, 403–411, 2000

