

CUTANEOUS SENSORY MECHANISMS IN THE SPINAL CORD

Thesis

by

ALAN GEOFFREY BROWN

submitted for the Degree of

Ph. D.

in the Faculty of Veterinary Medicine, University of
Edinburgh.

October 1968



CONTENTS

ACKNOWLEDGEMENTS.....	page 111.
SUMMARY.....	iv.
SECTION I: THE PREVIOUS LITERATURE.....	1.
CUTANEOUS RECEPTORS AND THEIR AFFERENT NERVE FIBRES....	2.
THE FLEXOR REFLEX AFFERENTS.....	16.
DORSAL ROOT FIBRE ENTRY INTO THE SPINAL CORD.....	18.
THE DORSAL COLUMNS.....	20.
THE SPINOCERVICAL TRACT.....	23.
THE VENTRAL SPINAL CORD.....	32.
THE CONTROL OF THE INPUT IN CUTANEOUS SENSORY SYSTEMS.	35.
SECTION II: CUTANEOUS AFFERENT FIBRE COLLATERALS IN	
THE DORSAL COLUMNS.....	43.
INTRODUCTION.....	44.
METHODS.....	44.
RESULTS.....	47.
DISCUSSION.....	58.
SECTION III: THE SPINOCERVICAL TRACT: TYPES OF UNIT	
AND THEIR STIMULUS-RESPONSE PROPERTIES.....	64.
INTRODUCTION.....	65.
METHODS.....	65.
RESULTS.....	70.
DISCUSSION.....	87.

SECTION IV: MODALITY CODING IN THE SPINOCERVICAL TRACT...	92.
INTRODUCTION	93.
METHODS	93.
RESULTS	94.
DISCUSSION	103.
SECTION V: CONTROL OF THE SPINOCERVICAL TRACT IN	
DECEREBRATE PREPARATIONS.....	106.
INTRODUCTION	107.
METHODS	107.
RESULTS	108.
DISCUSSION	112.
SECTION VI : GENERAL DISCUSSION.....	115.
SECTION VII : REFERENCES.....	123.

ACKNOWLEDGEMENTS

I am indebted to Professor A. IGGO, my supervisor, for stimulating my interest in cutaneous sensory physiology and for his continued encouragement and assistance. Dr. D. N. FRANZ participated in some of the experiments of SECTIONS III and IV. I thank him for his practical help and for many stimulating discussions. Technical assistance was provided by Mrs. J. PILDITCH, and Messrs. B. CAMERON, R. CLARK, R. HUME and C. WARWICK, whom I thank. Finally I thank my wife, JUDITH, for her encouragement and support, and particularly for compiling the reference list.

Part of the apparatus used was provided by a Royal Society Grant-in-Aid of Scientific Investigations.

Note: Some of the results presented in this thesis have been published in full or in part (BROWN 1968a,b,c).

SUMMARY

SECTION I: THE PREVIOUS LITERATURE. The literature relevant to the subject of the thesis is reviewed. The review is limited to reports on cutaneous receptors, their afferent nerve fibres and those spinal cord mechanisms which are of general importance for sensory mechanisms. For the most part, the literature reviewed is of experiments on cats, the species used most for neurophysiological experiments. The importance of adequate stimulation of identified receptors is stressed.

SECTION II: CUTANEOUS AFFERENT FIBRE COLLATERALS IN THE DORSAL COLUMNS. Microelectrode recordings were made from cutaneous afferent fibre collaterals, in the lumbar dorsal column, which were antidromically excited from C 2. The types of cutaneous afferent unit having axon collaterals which ascend the dorsal columns to the dorsal column nuclei were identified. All dorsal column collaterals had slower conduction velocities than corresponding peripheral axons and the degree of slowing was determined by the class of unit. The differential slowing was confirmed by recording compound action potentials from various parts of dorsal column - peripheral nerve pathways.

SECTION III: THE SPINOCERVICAL TRACT: TYPES OF UNIT AND THEIR STIMULUS-RESPONSE PROPERTIES. Microelectrode recordings were made from axons of the spinocervical tract, in anaesthetized, unanaesthetized decerebrate and unanaesthetized spinal cats. The properties of the units depended on the type of preparation used. Differences between decerebrate and spinal cats were assumed to be due to a descending neuronal system active in the decerebrate animal. The stimulus-response relationship to hair movement was described by a Power function, for those units sensitive to hair movement. All spinocervical tract units responded to high skin temperatures (above about 40°C) with an increased frequency of discharge. Several types of primary cutaneous afferent unit which excite the spinocervical tract were identified.

SECTION IV: MODALITY CODING IN THE SPINOCERVICAL TRACT.

Examination of individual spinocervical tract cell discharges evoked by different forms of natural stimulation revealed differences characteristic for the stimulus type. It was concluded that the modality of a stimulus, as well as its intensity, can be coded in the discharge of a single spinocervical tract cell.

SECTION V: CONTROL OF THE SPINOCERVICAL TRACT IN DECEREBRATE

PREPARATIONS. By means of a reversible cold block of the spinal cord, individual spinocervical tract units were examined in the decerebrate and in the spinal state, and the actions of the descending neuronal system were studied. The equivalence of unit types in the two preparations was established. The descending system acts to ~~selectively~~ inhibit certain of the excitatory inputs to individual spinocervical tract cells, while at the same time it prevents many inhibitory actions on the cells.

SECTION VI: GENERAL DISCUSSION. The properties of the two ascending pathways studied are compared. Some problems raised by the present work, and the possible functions of the spinocervical system, are discussed.

SECTION I

THE PREVIOUS LITERATURE

CUTANEOUS RECEPTORS AND THEIR AFFERENT NERVE FIBRES

The first clear statements that there is some sort of 'specificity' of sensory nerves, and that activity in these nerves always gives rise to the same sensation no matter how the activity is brought about, were made by BELL (1811, 1837) and MULLER (1842). For the cutaneous senses this idea was developed by VON FREY (1894a,b, 1895, 1896). The classical theory, of VON FREY, allots a particular cutaneous receptor to each of the four main modalities of cutaneous sensation (touch, cold, warmth and pain). This theory has been challenged from time to time by several groups of workers on different grounds.

HEAD and his collaborators (HEAD and SHERREN 1905; HEAD, RIVERS and SHERREN 1905; RIVERS and HEAD 1908), on the basis of the sensory changes produced by peripheral nerve injuries, proposed that there are two systems of peripheral sensory mechanism, one subserving generalized, diffuse sensations (protopathic system) and the other subserving specific, localized sensations (epicritic system). The experiments of HEAD and his group have been repeated by several workers (TROTTER and DAVIES 1909; BORING 1916; SCHAFER 1927) and the results have not been confirmed. Although very severely criticized (WALSHE 1942) the ideas of HEAD are still current (ROSE and MOUNTCASTLE 1959; BISHOP 1960a,b).

A more severe attack on classical theory came from WEDDELL's laboratory. In contradiction of his earlier work (WOOLLARD, WEDDELL and HARPMAN 1940) it was stated that in hairy skin there are only hair follicle receptors and free nerve endings and that in the cornea only free nerve endings, although reports of all modalities of sensation can be elicited from these areas. In several hairless skin areas different encapsulated endings could not be classified into different types and specific endings could not be related to specific modalities of sensation (SINCLAIR, WEDDELL and ZANDER 1952; HAGEN, KNOCHE, SINCLAIR and WEDDELL 1953; LELE, WEDDELL and WILLIAMS 1954; SINCLAIR 1955). Later, LELE and WEDDELL (1959) described receptors in the cat's cornea that respond only to mechanical stimulation, and MILLER and WEDDELL (1966) and MILLER (1967) described similar receptors in rabbit ear skin. The views of this group of workers have changed and are now much closer to classical theory in its modern form, that is, that there are some functionally specific receptors (WEDDELL 1967). The work of this group was important in that it showed that receptor morphology is variable, that functional specificity need not depend on gross morphological characteristics and, perhaps most important of all, stimulated a considerable amount of electrophysiological research.

Most of the results of electrophysiological experiments

supports the concept of functionally specific receptors in the skin. WALL (1960a,b), however, denies the presence of specific receptors innervated by myelinated axons in the cat. He claims that these axons 'are arranged in a monotonic continuum with threshold and diameter varying together'. The receptors innervated by the smaller myelinated axons are supposed to have higher mechanical thresholds and slower rates of adaptation than those innervated by the larger axons. WALL's results, although in disagreement with nearly all other workers, have had a considerable influence and have been used (MELZACK and WALL 1965) to formulate a hypothesis of the control of cutaneous afferent fibre input to the spinal cord. This will be discussed below.

For a definitive answer to the question, 'Are there specific receptors in the skin?' recordings must be made from the peripheral axons during natural stimulation of their receptors. The development of 'single unit' techniques by ADRIAN and his collaborators was a landmark in the history of neurophysiology. ADRIAN (1926) and ADRIAN and ZOTTERMAN (1926a,b) showed that the all-or-none law applied to sensory nerve fibres and that the information is transmitted as a frequency code. Sensitive mechanoreceptor units could be driven at their highest frequencies by non-harmful stimuli (air-jets) and it was assumed that there are special receptors that respond to harmful (painful) stimuli (ADRIAN, CATTELL and

HOAGLAND 1931). Support for this contention was obtained by ADRIAN (1931^{a,b}) and ZOTTERMAN (1936, 1939) who showed that activity could be evoked in very small axons by stimuli that were painful to man. Furthermore, ADRIAN and UMRATH (1929) showed that mechanoreceptors (Pacinian corpuscles) were not excited by thermal stimuli. Since these early experiments much work has been done using well-controlled stimulating conditions and it is now possible to describe the properties of many cutaneous receptors and their afferent fibres.

Primary afferent units with myelinated (A) axons

A primary afferent unit is defined as a single afferent neurone together with the receptors which it innervates (IGGO 1966; 'sensory unit' of TOWER 1940). Receptors may be classified physiologically as rapidly- or slowly-adapting (responding only during a changing stimulus or, in addition, during a maintained stimulus respectively). Alternatively receptors may be classified on the basis of the energy form to which they are most sensitive, e.g. as mechanoreceptors, thermoreceptors etc. To date, all units with myelinated axons from the skin of the trunk and limbs of subprimate mammalian species have been mechanoreceptive. (Some sensitive thermoreceptors in primate species and on the face of subprimate forms are innervated by small myelinated axons, IGGO 1964, 1968).

Hair follicle afferent units. There has been a tendency in the past to regard all hair follicle receptors (except those of the vibrissae) as a single group of rapidly-adapting receptors (ADRIAN and ZOTTERMAN 1926; ADRIAN 1931; MARUHASHI, MIZUGUCHI and TASAKI 1952; WEDDELL and PALLIE 1955; WEDDELL, TAYLOR and WILLIAMS 1955; WEDDELL 1960, 1961; WALL 1960a,b). ZOTTERMAN (1939), however, pointed out that both large and small action potentials could be evoked in fine branches of the cat's saphenous nerve by stroking the fur. He concluded that smaller axons innervated receptors with a higher sensitivity than those innervated by larger axons. This conclusion was confirmed by HUNT and McINTYRE (1960c).

Recently BROWN and IGGO (1967), by combining direct microscopical observation of the hairs with carefully controlled movement of individual hairs, have established that there are three types of hair follicle afferent unit from the hindlimbs of cats and rabbits. Type D units are excited by movement of down hairs (and possibly also guard hairs) and have axons with conduction velocities in the A delta range. Type G units are excited by movement of guard hairs and include units with the highest mechanical threshold of all hair follicle units. Type T units are excited by movement of the tylotrichs of STRAILE (1958, 1960, 1961), which are the longest hairs of the coat. Each axon of Type T units innervates only a few (2-7) hairs and in the cat the

axons of these units have significantly higher conduction velocities than any other type of unit in the saphenous nerve. (For details of all types of afferent unit described see Tables 1 and 2).

BROWN and IGGO (1967) have shown that the stimulus-response relationship of hair follicle units to hair movement is accurately described by a power law ($R = k \cdot S^n$; STEVENS 1957, where R is the frequency of the evoked response, S the velocity of hair displacement and k a constant of proportionality). The hair follicle receptors function as detectors of the velocity of hair movement.

In addition to their mechanical sensitivity, Type D units also respond to sudden rapid cooling of the skin of the receptive field. In response to cooling by 10°C in 2 seconds they give a discharge of impulses at frequencies of 10-20 a second which lasts for 3-4 seconds. When driven mechanically these units can respond with a discharge at several hundred impulses a second and therefore the frequency of the maximal response to cooling is less than 10 per cent. of that to hair movement. The significance of the response to cooling is not known but would not be expected to be great because of the disparity in the responses to the two kinds of stimulation. Type G and T units never gave more than 1 or 2 impulses to cooling at these rates.

Three types of slowly-adapting hair follicle units have been described; those of the vibrissae (FITZGERALD 1940), the tactile hairs on the cat's forelimb (NILSSON and SKOGLUND 1965) and the tactile hairs on the face (IGGO 1968). They all appear to behave in a similar way, the frequency of discharge depending on the position of the hair. These units have not, however, been studied as carefully as the other hair follicle units and no information is available on the conduction velocities of their axons or their stimulus-response relationships.

Slowly-adapting units with receptors in hairy skin. Following CHAMBERS and IGGO (1967) and BROWN and IGGO (1967) the two types of slowly-adapting units from the hairy skin of cats and rabbits will be called Types I and II.

Recordings from Type I units have been made by several workers (FRANKENHAEUSER 1949; MARUHASHI, MIZUGUCHI and TASAKI 1950; HUNT and McINTYRE 1960b; WITT and HENSEL 1959). Only FRANKENHAEUSER noted a morphologically distinct end-organ at the sensitive spot. The relation between the structure and function was noted by IGGO (1963). The receptors of Type I units are the cutaneous touch corpuscles (Haarscheiben of PINKUS 1902, 1904). Their discharge characteristics have been described by IGGO (1963, 1966) and also by TAPPER (1964a,b, 1965). WERNER

and MOUNTCASTLE (1964) described the stimulus-response properties of units that they claimed were of this type, but 43 per cent. of their units had a spontaneous discharge. Type I units do not have a spontaneous discharge. This is a characteristic of Type II units (CHAMBERS and IGGO 1967) and WERNER and MOUNTCASTLE confused the two types.

Each Type I unit has 1-5 touch corpuscles (IGGO 1968). The mechanical thresholds of these units are 2-10 mg weight (IGGO 1963). The adapted discharge to maintained displacement is irregular and its frequency is temperature dependent (HUNT and McINTYRE 1960b; WITT and HENSEL 1959; IGGO 1963). These units are also excited by cooling the skin several °C in 1-2 seconds (WITT and HENSEL 1959; IGGO 1963) but the response to cooling is markedly less than that to mechanical displacement. This has led some authors to conclude that the temperature effect is of little significance (MOUNTCASTLE 1966). Until this problem is examined in the central nervous system, however, the significance of the effects of cooling will remain unsettled.

The differentiation between Type I and Type II slowly-adapting units was clearly made by WITT and HENSEL (1959). IGGO (1966) and CHAMBERS and IGGO (1967) also recognized the two types. The characteristics of Type II

units are; each has a single sensitive spot in the skin, is excited by stretching the skin, has a regular discharge in the absence of intentional mechanical stimulation and a very regular adapted discharge to maintained displacement of the receptor. The end-organ is a lightly encapsulated structure in the dermis (CHAMBERS and IGGO 1967). Type II units are similar to Type I in their temperature sensitivity.

Nociceptive units. Recently BURGESS and PERL (1967) have described units, with receptors in the hairy skin of the cat, which respond to potentially and actually harmful mechanical stimuli, in particular to squeezing the skin with toothed forceps. These units do not respond to heating the skin above 50°C or cooling below 20°C or to acid and bradykinin applied to abraded skin. They have axons conducting in the A delta range and are the first nociceptive units with myelinated axons to be adequately described. It is possible that some of the nociceptive units described by MARUHASHI et al. (1950) were of this type.

Units with receptors in the foot pads. In the foot pads (plantar cushion and toe pads) there seem to be two well-defined types of receptors. Rapidly-adapting, highly sensitive receptors have been studied by GRAY and

his collaborators (ARMETT and HUNSPERGER 1961; FULLER and GRAY 1966). Slowly-adapting mechanoreceptive units were described by ADRIAN and ZOTTERMAN (1926b) and by MARUHASHI et al. (1950). It is not ^{known} whether these two types of unit are the only ones with myelinated axons *having* ~~and~~ their receptors in the pads.

Other units with myelinated axons. A slowly-adapting receptor responding to claw movement has been predicted by GORDON and JUKES (1964) in a study of cells in the dorsal column nuclei. These have not been studied at the primary afferent unit level.

Pacinian corpuscles in subcutaneous tissue may be excited by movement of the overlying skin (HUNT and McINTYRE 1960a; HUNT 1961). They should be considered in any experimental situation where they might be excited.

Primary afferent units with non-myelinated (C) axons

Units with C fibres have been resistant to single unit analysis, because of their small size and arrangement within the Schwann cells (GASSER 1955). By means of an antidromic blocking method DOUGLAS and RITCHIE (1957)

and DOUGLAS, RITCHIE and STRAUB (1960) demonstrated that some C fibres innervated receptors that respond to light tactile stimulation and some to temperature changes at the skin. This work did not, however, provide any information about single units and their receptors.

Single unit recordings from cutaneous C fibres have been made by IGGO. The majority of cutaneous C fibres innervate sensitive mechanoreceptors, including hair follicle receptors (IGGO 1960). The most sensitive have mechanical thresholds of 25 mg, the least, 5 g. They are slowly-adapting and there is an approximately linear relationship between the amount of skin indentation and the frequency of the adapted discharge (IGGO and KORNHUBER 1968). Repeated application of the mechanical stimulus at intervals of less than 3 minutes reduces the response in these units (IGGO and KORNHUBER 1968). There are some units with C fibres that respond to heating the skin above about 48°C and others that respond to cooling below about 17°C (IGGO 1959). These two types of unit also respond to mechanical stimulation and require at least 3 g weight to excite them. This sensitivity to mechanical stimulation is not constant but is increased after repeated heating or cooling. In subprimate species the sensitive thermoreceptors of the

trunk and limbs are innervated by non-myelinated fibres (HENSEL, IGGO and WITT 1960; IRIUCHIJIMA and ZOTTERMAN 1960). Some are excited by cooling and a fall in temperature of as little as 0.2°C will excite the most sensitive units. Others are excited by warming the skin as little as 0.3°C . The sensitive thermoreceptor units have a constant discharge at steady skin temperatures within a certain range, and the frequency of the discharge is a function of skin temperature. Neither of these types of unit is excited by mechanical stimulation of the skin.

It can be seen that many of the receptors innervated by C fibres respond to only one form of energy, e.g. the sensitive thermoreceptors and the sensitive mechanoreceptors. Others, such as the 'heat' and 'cold' receptors also respond to strong mechanical stimulation. Very few units that respond to all types of harmful stimuli have been described (IRIUCHIJIMA and ZOTTERMAN 1960 described one such unit). It seems that at the receptor level at least, pain, or for the receptor the ability to respond to harmful stimuli, should be regarded as a set of submodalities.

Conclusions

It is now possible to identify several kinds of primary afferent unit. Of particular importance is the fact that many of these can be recognized during an electrophysiological experiment on the central nervous system. In TABLES 1 and 2 details are presented of those units which have been adequately described in the literature to allow this identification. There are still some areas where more work is needed, e.g. the receptors of the pads and claws and those innervated by non-myelinated axons. In particular it is premature to conclude that all types of units with C fibres have been described.

It may be concluded that most cutaneous receptors are particularly sensitive to only one form of physical energy. That is, there is a high degree of specificity. There is also some morphological specificity, e.g. the touch corpuscle, the Type II ending and the Pacinian corpuscle. Perhaps, when the electronmicroscope is used in conjunction with electrophysiological experiments, structural features at the cellular level will be correlated with functional characteristics.

The views of WEDDELL and WALL that there are no

TABLE 1

Identified primary afferent units with myelinated axons and receptors in the skin of the trunk and limbs of the cat

UNIT	LOCATION OF RECEPTOR	ADEQUATE STIMULI	AXONAL C. V. m/sec	REFERENCE
Type D hair follicle	Down hair follicles	Movement of down hairs	15 - 24	BROWN & IGGO (1967)
Type G hair follicle	Guard hair follicles	Movement of guard hairs	18 - 93	BROWN & IGGO (1967)
Type T hair follicle	Tylotrich follicles	Movement of tylotriches	44 - 72	BROWN & IGGO (1967)
Tactile hair follicle	Carpal tactile hair follicles	Movement of tactile hairs	A	NILSSON & SKOGLUND (1965)
Type I slowly adapting	Touch corpuscles	Displacement of touch corpuscles	33 - 95	IGGO (1963) BROWN & IGGO (1967)
Type II slowly adapting	Intradermal ending	Displacement of ending	20 - 100	CHAMBERS & IGGO (1967) BROWN & IGGO (1967)
Myelinated nociceptive	Skin	More than 3 g wt.	6 - 36	BURGESS & PERL (1967)
Pad rapidly adapting	(? Pacinian corpuscles)	Movement of pad	46 - 85	ARMETT & HUNSPERGER (1961)
Pad slowly adapting	?	Pressure on pad	A	ADRIAN & ZOTTERMAN (1926b)
Interosseus	Pacinian corpuscles	Vibration	54 - 90	HUNT & McINTYRE (1960c)

TABLE 2

Identified primary afferent units with unmyelinated axons and receptors in the skin of the trunk and limbs of the cat

UNIT	LOCATION OF RECEPTOR	ADEQUATE STIMULI	AXONAL C. V. m/sec	REFERENCE
Hair follicle	Hair follicles ? type	Hair movement	0.55 - 1.25	IGGO (1960)
Mechanoreceptive	Skin	50 mg - 10 g	0.55 - 1.25	IGGO (1959) (1960)
Heat	Skin	44 - 48°C or more	0.5 - 1.7	IGGO (1959 a, b)
Cold	Skin	17 - 10°C or less	0.5 - 1.7	IGGO (1959 a, b)
Cool	Skin	Cooling a few tenths of a °C	C	HENSEL, IGGO & WITT (1960)
Warm	Skin	Warming a few tenths of a °C	C	HENSEL, IGGO & WITT (1960)

specific receptors in hairy skin do not agree with the experimental results. As mentioned in the introduction to this section, however, WEDDELL (1967) has retracted these views in many respects. The 'gate theory' of MELZACK and WALL (1965) on the control of input to the spinal cord, depends in part on small axons from the skin being continuously active. This is not so, except for axons of the thermoreceptors which play no part in the theory. The other basis of the theory, that activity in C fibres hyperpolarizes the presynaptic terminals of A fibres therefore facilitating synaptic transmission from the A fibres, has been directly refuted (ZIMMERMAN 1968; FRANZ and IGGO 1968).

Since units with non-myelinated axons contain a range of receptors responding to all kinds of stimuli it is perhaps tempting to consider them as forming the basis of HEAD's protopathic system, with the units having myelinated axons forming the epicritic system, as ROSE and MOUNTCASTLE (1959) and BISHOP (1960a,b) have done. The sensitive thermoreceptors would presumably fit into the epicritic system. Until more is known about the central projections and the reflex and sensory functions of the different types of primary afferent unit, it is premature to try to fit them into any system such as HEAD's. At present a modern interpretation of the classical theory

fits the experimental facts better than any other. That is, there are functionally specific receptors.

THE FLEXOR REFLEX AFFERENTS

Within the last decade the concept of the flexor reflex afferents has been built into a complex system of neuronal organization to explain the results from a large amount of experimental work. The flexor reflex afferents were originally defined (ECCLES and LUNDBERG 1959) as the Group II and III muscle afferent fibres, high threshold joint afferent fibres and cutaneous afferent fibres, since electrical stimulation of these nerves usually leads to the appropriate synaptic actions on motoneurons involved in the flexor reflex. It is now common practice to refer all actions evoked by electrical stimulation of these nerve fibres to the 'flexor reflex afferents', even though the action may be on ascending spinal pathways (HOLMQVIST, LUNDBERG and OSCARRSON 1960; CARPENTER, ENGBERG and LUNDBERG 1965) or interneurons of uncertain function (JANKOWSKA, JUKES, LUND and LUNDBERG 1967).

The concept has, however, been extremely useful in explaining the actions produced by electrical

stimulation of peripheral nerves on primary afferent axons, interneurons and motoneurons at the segmental level (LUNDBERG 1964). The actions demonstrated by electrical stimulation must also be demonstrated by adequate stimulation of the receptors before any particular afferent unit is assigned to this system. None of the work on the flexor reflex afferents has used natural stimulation of any one type of receptor, and the stimuli used, such as pinch and pressure, are capable of exciting most of the mechanoreceptors present. Indeed there is evidence that not all cutaneous afferent units belong to this system. HOLMQUIST and LUNDBERG (1962) observed in decerebrate cats that pressure and pinch of the skin had varied effects on the monosynaptic test reflex from afferent fibres of flexor muscles. CARPENTER, ENGBERG, FUNKENSTEIN and LUNDBERG (1963) noted that dorsal root potentials (DRP's) recorded at the lumbo-sacral level in response to electrical stimulation of hindlimb cutaneous nerves were more complex than those elicited from muscle and joint nerves. In spinal cats cutaneous nerve volleys elicited DRP's with two components. The first, from axons with low electrical threshold, had a shorter central latency and more restricted distribution along the cord than the second, from higher threshold fibres. In decerebrate cats this second component, unlike the first, was not

present, and it was considered to be the only component elicited from the flexor reflex afferents. Observations such as these demonstrate the underlying weaknesses of the flexor reflex afferent concept. The assignment of any particular type of cutaneous afferent unit to the flexor reflex afferents should await the results of experiments in which natural stimulation of identified receptors leads to central actions underlying flexor reflexes.

DORSAL ROOT FIBRE ENTRY INTO THE SPINAL CORD

RANSON (1913, 1914a,b) using silver staining methods showed that in the dorsal rootlets the non-myelinated fibres lie at the periphery and the myelinated ones centrally, a finding confirmed by SZENTAGOTHAÏ (1964). Later, RANSON and BILLINGSLEY (1916) and RANSON and CLARK (1959) stated that the C fibres lie in the lateral division of the rootlet. The earlier version seems to be the correct one. The C fibres were said to form the tract of LISSAUER and, after running longitudinally for a few segments, to terminate in the substantia gelatinosa Rolandi. These conclusions were supported by PEARSON (1952). The tract of LISSAUER, at the tip of the dorsal horn, also receives fibres from the

substantia gelatinosa (CAJAL 1952; EARLE 1952; SZENTAGOTHAI 1964).

Electron microscopy has recently permitted a more detailed investigation of the termination of dorsal root fibres in the dorsal horn. RALSTON (1965, 1968a,b) has shown that after dorsal root section there are very few signs of degenerating synaptic knobs in laminae II and III of the dorsal horn. (Lamination of the dorsal horn was described by REXED (1952, 1954) and lamina II corresponds ^{with} to the substantia gelatinosa, but see below). Degenerating knobs are common in deeper parts of the dorsal horn, that is in laminae III, IV, V and VI, where the myelinated axons terminate. The failure to find degenerating non-myelinated axons in laminae I and II may be due to the difficulties of identifying them or to the rapid removal of degenerating nerve fragments (RALSTON 1968b). However, SPRAGUE and HA (1964) using the NAUTA method for demonstrating preterminal degeneration state that ~~their~~ material supports the findings of RANSON (1913, 1914a,b), EARLE (1952) and SZENTAGOTHAI (1964). That is, the small fibres of the dorsal root enter the medial half of LISSAUER's tract and send collateral axons to the dorsal horn (laminae II and III), where they terminate.

It can be seen that there is not a unified agreement on the termination of dorsal root fibres in the dorsal part of the grey matter of the spinal cord. The site of termination of the non-myelinated fibres remains enigmatic. Part of the difficulty stems from different authors defining the substantia gelatinosa in different ways. Thus SZENTAGOTHAI includes laminae II and III in the substantia, whereas RALSTON only includes lamina II. It would seem from the work of SZENTAGOTHAI and of RALSTON that lamina II is for the most part a proprio-spinal system, and that lamina III receives an input from large dorsal root fibres which enter it from the ventral side. The function of the substantia gelatinosa is unknown. WALL (1962) believes that it is responsible for producing presynaptic inhibition of primary afferent fibres from the skin, but according to ECCLES, SCHMIDT and WILLIS (1963) the cells presumed to be responsible for this action are deeper in the cord (more than 2 mm from the cord dorsum).

THE DORSAL COLUMNS

Most of the dorsal column fibres are collateral axons of the dorsal root fibres. Only 25 per cent., however, of the myelinated dorsal root fibres which enter

the cord at lumbar levels, in the cat, reach the dorsal column nuclei (GLEES and SOLER 1951). Group I muscle afferent fibres do not reach the dorsal column nuclei from the hindlimb (LLOYD and McINTYRE 1950), but the figures of GLEES and SOLER indicate that most of the myelinated cutaneous afferent fibres probably do not reach the nuclei either. The dorsal column fibres ascend in an orderly manner with those from more caudal levels medial to those from more rostral levels (FERRARO and BARRERA 1935, 1936; FOERSTER 1936; WALKER and WEAVER 1942; GLEES, LIVINGSTONE and SOLER 1951; YAMAMOTO, SUGIHARA and KURU 1956; WERNER and HITSEL 1967). It is not known whether all dorsal column fibres from the hindlimb are axon collaterals of dorsal root fibres, and therefore primary. Recently, UDDENBERG (1968a) has produced electrophysiological evidence for the presence of post-synaptic units in the cervical dorsal columns, which respond to mechanical stimulation of the skin and subcutaneous tissues of the forelimb. The dorsal columns are not, therefore, composed exclusively of afferent fibre collaterals.

Electrophysiological experiments on the dorsal columns (BARRON and MATTHEWS 1935; YAMAMOTO, SUGIHARA and KURU 1956; UDDENBERG 1968a,b) and the dorsal column nuclei (KUHN 1949; JOHNSON 1952; GORDON and PAINE 1960;

KRUGER, SIMINOFF and WITLOVSKY 1961; PERL, WHITLOCK and GENTRY 1962; McCOMAS 1963; GORDON and JUKES 1964) WINTER 1965) have shown that the following types of cutaneous stimulation excite cells of this system; movement of hairs, joints and claws and movement and pressure on the skin and footpads. This work has not shown in detail which primary afferent units project through this system. It is not known whether all three types of hair follicle unit and both types of slowly-adapting unit in hairy skin have axons which pass to the dorsal column nuclei. Indeed there is evidence that the axon collaterals of the A delta fibres do not (WALL 1960b; TAUB and BISHOP 1965). It follows that the axons of the insensitive mechanoreceptors (BURGESS and PERL 1967) and the Type D hair follicle units (BROWN and IGGO 1967), which have A delta fibres, do not project to the dorsal column nuclei.

As the collaterals ascend the dorsal column they undergo a reduction in diameter, and therefore in conduction velocity. For the fastest axons this reduction has been estimated, from compound action potentials, as 25-62 per cent. of the peripheral nerve velocity (GASSER and GRAHAM 1933; LLOYD and McINTYRE 1950; COLLINS and RANDT 1956; WALL 1960b). UDDENBERG (1968b) has compared the conduction velocities of continuous single

axons in the cervical dorsal column and in peripheral nerves of the forelimb. There was a reduction for hair follicle units of about 33 per cent. and for 'touch' units of about 36 per cent.. There is no published evidence, however, that would allow estimates to be made of the reduction in conduction velocity of the collateral axons of the various types of primary afferent unit that can not be recognized. It is not known whether the reduction is similar for all types of unit or differs according to unit type.

UDELBERG (1962a) has suggested that there is a modality segregation of dorsal column axons at the cervical level. Hair follicle units are superficial, slowly-adapting units are deep and Group I muscle afferent units (which pass into the dorsal columns from forelimb nerves, OSBARRSON and ROSEN 1953; OCCARRSON 1955) in between. These results for the cervical dorsal column of the cat have not been confirmed for the lumbar dorsal column of the squirrel monkey (LERNER and HITSCHL 1967).

THE SPINOCERVICAL TRACT

Recent work has shown that, in addition to the dorsal column-medial lemniscal and spinothalamic pathways

from the skin to the thalamus and somatosensory areas of the cerebral cortex, there is a third pathway in many mammalian species. This is the pathway described by MORIN (1955). The spinocervical tract is the spinal part of this pathway (VAN BEUSEKOM 1955). It arises in the dorsal horn of the spinal cord in laminae IV and V of REXED (ECCLES, ECCLES and LUNDBERG 1960; WALL 1960, 1967; ELTZ 1963), ascends in the most medial part of the ipsilateral dorsolateral funiculus (LUNDBERG and OSCARSSON 1964, TAUB and BELLONI 1965) and terminates in the lateral cervical nucleus (REXED and STROUF 1952; BRODAL and REXED 1953; MORIN 1955; LUNDBERG 1964; TORROVIN 1966). The axons of the cells of the lateral cervical nucleus cross over to the contralateral side at the level of the junction of medulla and spinal cord to join the medial lemniscus, and terminate in the ventrobasal nuclear complex of the thalamus (MORIN 1955; MORIN and VATALINO 1955; CATALANO and MARCHE 1957; BURCH 1964; CORONH and JULIA 1963; LAIBER, NORMANIL and M. BUSTRO 1965; HORROBIN 1966). The pathway ultimately projects to the contralateral somatosensory cortical areas S I and S II and to the ipsilateral area S II (ANDERSON 1962; MORSELL and VOCIHOVE 1962; MORSELL and OLIO 1966).

MORIN (1955) originally suggested that the lateral

cervical nucleus receives its afferents as collateral axons of the dorsal spinocerebellar tract. This has been restated recently (MORIN, KITAI, PORTNOV and DEMIRIJAN 1963), but it is doubtful if the dorsal spinocerebellar tract has connexions with the lateral cervical nucleus. BRODAL and REXED (1953) have shown preterminal degeneration in the nucleus after lesions of the ipsilateral dorsolateral funiculus as low as S 3, which is lower than CLARKE's column, the origin of the dorsal spinocerebellar tract (REXED 1954). ANDERSSON (1962) has shown that no short latency evoked potential can be recorded from S II after section of the dorsal columns and spinocervical tract but with the dorsal spinocerebellar tract intact. More conclusively, MORROBIN (1966) has shown that there is no activation of cells of the lateral cervical nucleus on stimulation of the anterior cerebellum, which would be expected if dorsal spinocerebellar tract fibres give collateral axons to the nucleus.

A dorsal spino-olivary tract described by GRUNDFEST and CARTER (1954), DI BIAGIO and GRUNDFEST (1954, 1956) and KRIEGER and GRUNDFEST (1956) may be the same as the spinocervical tract. This spino-olivary tract has a **relay** in the lateral cervical nucleus (DI BIAGIO and GRUNDFEST 1956). It has been shown, both anatomically (VAN BEUSEKOM

1955) and physiologically (DI BIAGIO and GRUNDFEST 1956; HORROBIN 1966) that there is a projection from the nucleus to the inferior olive. HORROBIN (1966) has suggested that the afferent fibres to the inferior olive arise as collateral axons of the fibres travelling to the thalamus.

The lateral cervical nucleus (and presumably, therefore, the spinocervical tract) has been shown to be present in cat (REXED and STROM 1952), dog, sheep, seal and whale (REXED 1958), raccoon (HA, KITAI and MORIN 1965) and the Japanese and Owl monkeys (MIZUNO, NAKANO, IMAIZUMI and OKAMOTO 1967). A preliminary report (HA and MORIN 1964) notes its presence in the Elephant shrew and Tree shrew, lemur, and several species of monkey. A well-defined nucleus is not present in mouse, rat, guinea-pig or man (REXED 1958) or rabbit (MIZUNO 1966; A. G. BROWN and A. W. W. JENKINS, unpublished observations, 1966). The presence of a spinocervical system may be correlated with the absence of a direct spinothalamic pathway and vice versa (see below).

Electrophysiology of the spinocervical tract and the lateral cervical nucleus

Only one published study has described results obtained unequivocally from the spinocervical tract (TAUB and BISHOP 1965). In this work recordings were made from axons in the dorsolateral funiculus of the lumbar spinal cord which were excited antidromically from C 3 and which were either not excited from levels rostral to the lateral cervical nucleus or, if excited, had a much reduced conduction velocity between the two sets of stimulating electrodes compared with the velocity between cervical and lumbar levels. It may be assumed, however, that the majority of units responding to cutaneous stimulation and located in the most medial part of the dorsolateral funiculus (particularly at levels below L 4) are axons of this tract. More difficulties of identification are presented by recording from cells in the dorsal horn. Only 43 per cent. of units recorded in lamina IV and 19 per cent. in lamina V had axons that passed into the ipsilateral dorsolateral funiculus (FETZ 1968). Thus only some 30 per cent. of units in laminae IV and V are candidates for cells of the spinocervical tract. Some of the contradictions in the literature may be due to different workers recording from different neuronal systems. For example,

a group of cells in the dorsal horn excited by mechanical stimulation of the foot pads (studied by GRAY and his co-workers; ARMETT, GRAY and PALMER 1961; ARMETT, GRAY, HUNSPERGER and LAL 1962; FULLER and GRAY 1966) do not project through this system (see below). In the following account results are only presented if the recorded units were probably spinocervical tract axons or cells.

The characteristics of spinocervical tract units seem to depend on the animal preparation used. Even within a single type of preparation there are discrepancies in the results. In decerebrate cats LUNDBERG and OSCARRSON (1961) described two types of unit whereas TAUB (1964) described only one type. In spinal preparations WALL (1960a) described a single type, but more recently MENDELL and WALL (1965), MENDELL (1966) and WALL (1967) showed that there are at least two types of unit. All authors agree that spinocervical tract units are excited by mechanical stimulation of the skin, usually by hair movement and sometimes by heavy pressure on the skin.

Published reports of the thermal sensitivity of spinocervical tract units are conflicting. WALL (1960a) described units that responded to warming the skin with infrared irradiation, from 27°C to about 31°C, with an

increased frequency of discharge. TAUB (1964) stated that all units in his sample responded with an increased frequency of discharge to cooling the skin (by means of an ethyl chloride spray), and with a decreased frequency of discharge to warming the skin. BURGESS (1965) showed that units recorded from the dorsolateral funiculus responded with an increase in frequency to both warming the skin to temperatures above 43°C and to cooling the skin with an ethyl chloride spray.

The use of an ethyl chloride spray as a cold stimulus may produce confusing results. The initial mechanical stimulation produced by the spray is well-known. There is, in addition, a longer lasting mechanical stimulation that is not so well recognized. If the hairs are observed under a dissecting microscope they can be seen to move as the ethyl chloride vapourises and releases them. This is most marked for the smallest hairs, the down hairs, and a discharge of impulses lasting 20-30 seconds may be recorded in axons of down hair follicle (Type D) afferent units after spraying ethyl chloride onto the receptive field (A. G. BROWN, unpublished observations). This response is additional to the effects of rapid cooling on the down hair receptors (BROWN and IGGO 1967). Any responses recorded after ethyl chloride application should be interpreted with

caution. They do not necessarily indicate activity from thermoreceptors.

Spinocervical tract units also receive inhibitory inputs from the skin. WALL (1960a) showed that inhibition could be produced by heavy pressure on the foot and perineal region. TAUB (1964) demonstrated inhibition to light touch as well as heavy pressure and that the inhibitory receptive field of a single unit was often multiple. Neither worker was able to find inhibition of the 'surround' type. At the level of the lateral cervical nucleus and the somatosensory cortical receiving area S II there is a similar lack of surround inhibition (ANDERSSON 1962; GORDON and JUKES 1963; OSWALDO-CRUZ and KIDD 1964; HORROBIN 1966). The absence of surround inhibition seems to be a characteristic of this system and is in contrast to the dorsal-column-medial lemniscal system (GORDON and PAINE 1960; PERL, WHITLOCK and GENTRY 1962).

Studies on the lateral cervical nucleus in several species (GORDON and JUKES 1963; OSWALDO-CRUZ and KIDD 1964; HA, KITAI and MORIN 1965; KITAI, HA and MORIN 1965; HORROBIN 1966) have confirmed that this system is concerned with information from mechanoreceptors. Receptive fields are either small, with the units sensitive to

hair movement or 'light touch', or large, with the units responding to more severe mechanical stimulation. These studies, however, have not elucidated which particular receptors project onto the system or how the information from the receptors is handled.

KENNARD (1954) has shown that behavioural responses to noxious stimuli can be reduced by section of the dorso-lateral funiculus but not after ventral quadrant section. This suggests that the spinocervical tract may be involved in transmitting information about noxious stimuli, in the cat. NORRSELL (1966) has shown, in the dog, that lesions which section the spinocervical tract produce transient impairment of conditioned reflexes to light tactile stimuli (puffs of air). Section of the dorsal columns produced no such impairment. Section of both spinocervical and dorsal column pathways led to marked impairment of the reflexes. NORRSELL concludes that the spinocervical tract is the main spinal pathway of the conditioned reflexes.

THE VENTRAL SPINAL CORD

The spinothalamic tracts are the classical pathways in the ventral spinal cord that are concerned with cutaneous sensory mechanisms. Two tracts are described on each side, the ventral or anterior and the lateral spinothalamic tracts. Direct spinothalamic connexions have been demonstrated in man and some other primate species (EDINGER 1889; MOTT 1895; COLLIER and BUZZARD 1903; GOLDSTEIN 1910; WALKER 1940; WEAVER and WALKER 1941; BOWSHER 1961). The spinothalamic tract arises from large cells of the dorsal horn, crosses the spinal cord in the anterior commissure and ascends in the ventral column. As the fibres ascend those from lower segments are pushed laterally by those from higher segments. The termination of the tract, according to BOWSHER (1961), who used the NAUTA and GLEES methods for demonstrating preterminal and terminal degeneration, is in N. ventralis posterolateralis, N. parafasciculans and N. centralis lateralis of the thalamus. The spinothalamic system is supposed to subserve touch, itch, pain and temperature sensations (FOESTER and GAGEL 1932; KROLL 1930; WALKER 1942; DRAKE and MCKENZIE 1953).

The general agreement that exists on the presence of a spinothalamic tract in primate species is not carried over to subprimate species. In rabbit MARCHI degeneration studies have indicated the presence of a spinothalamic tract (WALLENBERG 1896; 1900; KOHNSTAMM 1900). Furthermore a tract in the ventral spinal cord of rabbit, with monosynaptic connections from contralateral cutaneous nerves, has been described (MAGNI and OSCARSSON 1962). There has been no evidence yet, however, that the tract described by MAGNI and OSCARSSON terminates in the thalamus. In cat the situation has been complicated by the presence of the spinocervical-lemniscal pathway, described relatively recently (MORIN 1955).

Experiments on cats in which the dorsal columns were sectioned and evoked responses were recorded from the thalamus (GAZE and GORDON 1955; WHITLOCK and PERL 1959; PERL and WHITLOCK 1961) do not necessarily indicate that the activity ascended in the ventral spinal cord, since the spinocervical tract ascends in the dorsolateral funiculus. The spinocervical-lemniscal system terminates in N. ventralis lateralis of the thalamus (LANDGREN, NORDWALL and WENGSTROM 1965) and this partly invalidates the finding of preterminal degeneration in thalamic nuclei after lesions that section axons from the lateral cervical nucleus (GETZ 1952; ANDERSON and BERRY 1959) as a demonstration of a spinothalamic tract in cat. After cord

section at T 1 degeneration has been observed in N. ventralis posterolateralis (ANDERSON and BERRY 1959). Also, after cord transection at C 1 and T 1 preterminal degeneration was present in thalamic nuclei other than N. ventralis posterolateralis (GETZ 1952; ANDERSON and BERRY 1959).

It appears that there may be a direct spinothalamic component in the cat which consists of small axons, since no tract can be demonstrated by the MARCHI method (MORIN and THOMAS 1955) or the HAGGQVIST method (VAN BEUSEKOM 1955). The spinothalamic projection in the cat is, however, more likely to be polysynaptic. This is the view of VAN BEUSEKOM who states that all ascending fibres in the ventral spinal cord (except those of the ventral spinocerebellar tract) terminate in the lateral reticular nucleus or the ventrolateral reticular substance of the medulla.

Large fibred tracts in the cat's ventral spinal cord, the contralateral and the bilateral flexor reflex tracts (LUNDBERG and OSCARRSON 1962), receive polysynaptic excitation from cutaneous afferent fibres. They have been shown to project to the inferior olive and the lateral reticular nucleus respectively (GRANT and OSCARRSON 1966; GRANT, OSCARRSON and ROSEN 1967).

Whether there is any projection from these latter structures to the thalamus is not known, but VAN BEUSEKOM (1955) assumes such a projection from the lateral reticular nucleus. These tracts may be part of a pathway from cutaneous receptors to the thalamus.

THE CONTROL OF THE INPUT IN CUTANEOUS SENSORY SYSTEMS

It has become apparent that the input from sense organs to the nervous system, and the flow of information through the system, is subject to controls at various levels (LIVINGSTONE 1959; LUNDBERG 1964b). This development is one of the more important contributions made in recent years, not only to the physiology of cutaneous sensory mechanisms but to neurophysiology in general.

In cutaneous afferent systems the first point at which control is exerted is on the terminals of the primary afferent fibres at their first synapses in the spinal cord. At present there is no evidence for control at the receptor level by efferent axons, as there is for the muscle spindle (reviewed by GRANIT 1955). The properties of the so-called accessory fibres, usually non-myelinated, which run with the afferent axon to the end-organ, have not been established.

Control at the primary afferent fibre

Activity in cutaneous afferent fibres is subject to presynaptic inhibition from activity in other afferent fibres. Signs of presynaptic inhibition on primary afferent fibres are the cord dorsum potential (P wave, GASSER and GRAHAM 1933), the dorsal root potential (DRP, BARRON and MATTHEWS 1938) and an increase in the excitability of the terminals of the dorsal root fibres (WALL 1958). Direct evidence of the depolarizing action responsible for presynaptic inhibition can be obtained by recording from inside the presynaptic fibre near its termination (ECCLES, MAGNI and WILLIS 1962).

Depolarization of the presynaptic fibre leads to a reduction in size of the presynaptic action potential. Since the size of the potential is thought to control the amount of transmitter released at the nerve terminals (LILEY 1956) this depolarization leads to a reduction in the efficacy of synaptic transmission. At present, presynaptic inhibitory action is detected by recording DRP's, testing changes in the excitability of presynaptic terminals or by directly recording the primary afferent depolarization. To record the latter, however, the axon has to be large enough to allow intracellular micro-electrode recording and therefore the site of recording

is restricted to the larger axons and to some distance from the nerve terminals. The only direct observations in mammalian spinal cord of a reduction in post-synaptic excitatory potentials, due to presynaptic inhibition, are by FRANK and FUORTES (1957) and ECCLES, ECCLES and MAGNI (1961) who showed that monosynaptic EPSP's set up in motoneurons by activity in Group I muscle afferent fibres could be reduced in size by activity in other muscle afferent fibres.

There has, to date, been no direct evidence as to which of the terminals of cutaneous fibres are subject to presynaptic inhibitory action. Most of the work on presynaptic inhibition has been done using electrical stimulation of peripheral nerve. These techniques have shown that cutaneous axons receive most of their presynaptic inhibition from other cutaneous axons, and some from Group II and III and extensor Ib muscle afferent fibres (ECCLES, KOSTYUK and SCHMIDT 1962b; ECCLES, SCHMIDT and WILLIS 1963; ECCLES, HOLMOVIST and VOORHOEVE 1964).

Experiments involving electrical stimulation of peripheral nerve show that there is presynaptic inhibition produced by this method of stimulation but give no indication of its organization in terms of receptor types. That there may be some organization is apparent

from the work of CARPENTER, ENGBERG, FUNKENSTEIN and LUNDBERG (1963) who showed that DRP's evoked by activity in low threshold cutaneous axons have two components, which are differentially controlled by a supraspinal system. For an adequate demonstration of the functional importance of presynaptic inhibitory mechanisms, natural stimulation of cutaneous receptors should be used. A start in this direction has been made by SCHMIDT, SENGES and ZIMMERMAN (1967) who showed that the terminals of axons of rapidly-adapting pad receptors, hair follicle receptors (presumably those with large axons) and touch corpuscles were all depolarized by mechanical stimulation of the skin or the pad. The amount of depolarization depended on the amplitude of mechanical displacement and on its nearness to the receptive field of the fibre under study. In further studies JANIG, SCHMIDT and ZIMMERMAN (1968) have shown that there is some organization of the presynaptic inhibition to primary afferent fibres. The slowly-adapting units preferentially inhibit other slowly-adapting units and the rapidly-adapting ones also preferentially inhibit their own types.

Presynaptic inhibition at the primary afferent fibre is also produced by activity in several neuronal systems which arise in the brain and descend through the spinal cord. Signs of presynaptic inhibition of cutaneous

axons are produced by electrical stimulation of the sensori-motor cortex (S I and S II) both ipsi- and contralaterally. One pathway concerned is the cortico-spinal tract (CARPENTER, LUNDBERG and NORRSELL 1963; ANDERSEN, ECCLES and SEARS 1964). In cats with transected pyramids, stimulation of the sensorimotor cortex also produces primary afferent depolarization. The pathways concerned are said to be, in part, cortico-reticulo-spinal and cortico-rubrospinal (HONGO and JANKOWSKA 1967).

Primary afferent depolarization has also been produced by electrical stimulation of the brain-stem and the cerebellum. The pathways responsible have been tentatively identified as the medial longitudinal fasciculus and the reticulospinal tract (CARPENTER, ENGBERG and LUNDBERG 1966).

While the above experiments have demonstrated the existence of descending pathways for the production of presynaptic inhibition they have not elucidated the importance of the pathways or the mechanism. There is no information available on which of the cutaneous afferent fibres receive the depolarization or which synaptic systems are inhibited in this way. ECCLES (1963, 1964) has proposed that presynaptic inhibition at the primary afferent fibre level functions as a

general negative feedback on the flow of sensory information into the central nervous system. This proposal appears to have only limited usefulness and the more specific nature of primary afferent depolarization from other primary afferent fibres observed by JANIG, SCHMIDT and ZIMMERMAN (1968) may well be found in the primary afferent depolarization produced by the descending systems.

The terminals of the dorsal column collateral axons also receive primary afferent depolarization from other dorsal column collaterals (ANDERSEN, ECCLES, SCHMIDT and YOKOTA 1964a,b), from the corticospinal tract (MAGNI, MELZACK, MORUZZI and SMITH 1959; TOWE and JABBUR 1961; CHAMBERS, LIU and McCOUCH 1963; LEVITT, CARRERAS, LIU and CHAMBERS 1964; ANDERSEN, ECCLES, SCHMIDT and YOKOTA 1964b; WINTER 1965) and from the midbrain reticular formation (CHAMBERS, LIU and McCOUCH 1963). As with the primary afferent fibres at the segmental level, it is not known whether there is any specificity in the distribution of presynaptic inhibition at the dorsal column nuclei.

Control of transmission through the spinocervical system

There is a little evidence to suggest that primary afferent depolarization evoked from cutaneous axons inhibits transmission of information through the spinocervical tract (ECCLES, KOSTYUK and SCHMIDT 1962). Direct evidence of control of transmission through this system relates to control from supraspinal systems. TAUB (1964) demonstrated that both spontaneous and evoked discharges in spinocervical tract units could be inhibited by electrical stimulation of cerebellar nuclei, the mesencephalic tegmentum and a central pontobulbar region. WALL (1967) has shown that there is a descending inhibitory system, active in the decerebrate cat, which inhibits both spontaneous and evoked discharges of cells in lamina IV of the dorsal horn. WALL could observe no effect on these cells upon stimulating the pyramidal tract, nor could LUNDBERG, NORRSELL and VOORHOEVE (1963) on stimulation of the sensorimotor cortex. Recently, however, FETZ (1968) has demonstrated that stimulation of the pyramidal tract at stimulus strengths which produce a just visible twitch of hindlimb muscles, may produce either inhibition or excitation of cells in lamina IV of the dorsal horn. It appears, therefore, that spinocervical tract cells may be under the control of several descending neuronal systems, including

the corticospinal tracts and other tracts taking origin
in the mid- and hindbrain.

SECTION II

CUTANEOUS AFFERENT FIBRE COLLATERALS IN THE DORSAL COLUMNS

INTRODUCTION

In SECTION I the properties of cutaneous primary afferent units have been described (see TABLES 1 and 2). The experiments of the present SECTION were performed to ascertain which of these units have axon collaterals that ascend the dorsal column to the dorsal column nuclei. The conduction velocities of the dorsal column axons were measured and compared with their known velocities in peripheral nerve.

METHODS

The experiments were performed on 15 cats, 2.0-3.4 kg in weight, anaesthetized with either pentobarbitone sodium, 35 mg/kg intraperitoneally, or chloralose, 70 mg/kg intravenously in 0.9% NaCl. The chloralose was given after induction of anaesthesia with ethyl chloride and ether. Anaesthesia was maintained during an experiment by pentobarbitone sodium, 12-15 mg i.v. as required.

After tracheal and venous cannulations, the spinal cord was exposed by laminectomies at C 1-3 and L 2-4. The dorsal columns were sectioned transversely at mid C 1 and dissected from the spinal cord down to mid C 3. The cat was then fixed rigidly to a frame by a head-holder, a clamp on the body of the first lumbar vertebra and pins on the iliac crests. The exposed regions of the spinal cord were covered with warm liquid paraffin after opening the dura. The rectal temperature of the animal was maintained between 36-39°C by a thermostatically controlled electric blanket placed on the ventral body surface.

Microelectrode studies. Recordings were made from single fibres in the lumbar dorsal columns of 10 cats with either glass micropipette electrodes filled with 3M KCl, tip resistance 6-15 MΩ, or with tungsten microelectrodes (HUBEL 1957). Recorded potentials were led to a Bak Unity Gain Electrometer, to a Tektronix 122 Preamplifier and displayed on a Tektronix 502 Oscilloscope.

When a single unit was isolated the dorsal columns at C 2 were stimulated electrically through a pair of silver-wire electrodes with 0.2 msec. square-wave shocks. The time taken for the antidromic impulse to travel from cervical to lumbar levels was read directly from the

oscilloscope. The conduction distance was measured at the end of each experiment. In this way the conduction velocities of the dorsal column axons could be calculated. Since the axons were shown by this method to run to the second cervical segment, it was assumed that they projected to the dorsal column nuclei.

The coat of the tail and the hindlimb ipsilateral to the recording site was clipped. The receptive fields of the units were examined under a binocular operating microscope. Single hairs on the skin were moved with watchmakers' forceps, glass probes, or, to gain greater precision, with the piezoelectric electromechanical transducer described by BROWN and IGGO (1967).

Compound action potential studies. The spinal cords of 5 cats were prepared as for the single unit studies. In addition, the medial plantar nerve, the sural nerve and the superficial peroneal nerve were exposed (in the foot, the popliteal fossa and the distal third of the leg respectively). The nerves were cut peripherally and the proximal ends dissected free and placed on pairs of silver-wire electrodes for recording or stimulating. A pair of stimulating electrodes was placed on the dorsal columns at C 2 and recording (monopolar) or stimulating (bipolar) electrodes on the dorsal column at L 2. Evoked

potentials were recorded from; 1. The lumbar dorsal column and the cutaneous nerves in response to stimulation of the cervical dorsal column; 2. The lumbar dorsal column after stimulation of the cutaneous nerves; 3. The cutaneous nerves after stimulation of the dorsal column at L 2. Electrical stimuli were delivered at frequencies greater than 20 a second to prevent setting up dorsal root reflexes (WALL 1960b). Recorded potentials were led to a Tektronix 122 Preamplifier and displayed on a Tektronix 502 Oscilloscope. Superimposed traces were recorded photographically.

RESULTS

Microelectrode studies

Recordings were made from those dorsal column axons, at the lumbar level, which were antidromically excited from the dorsal columns at C 2. Criteria for antidromic excitation were; there was a one-to-one relationship between stimulus and response at rates of up to several hundred a second, only one action potential was elicited by each stimulus and the response had a constant latency. Since the axons were excited from C 2, it was assumed that they projected onto the dorsal column nuclei.

This control was necessary since only 25 per cent. of the dorsal root fibres which enter the lumbar dorsal columns reach the dorsal column nuclei (GLEES and SOLER 1951). This criterion was satisfied by 132 units, all of which responded to mechanical stimulation of the skin or subcutaneous tissues.

Units were classified according to the features of their receptive fields, the adequate stimulus and the type of discharge evoked by mechanical stimulation. Units excited by movement of the joints were not examined closely and are not included in the present account.

The conduction velocities of the axons in the dorsal column (from C 2 to L 3-4) ranged from 14 to 84 m/sec (FIG. 1). The extremes of this range agree with those calculated from the compound action potential studies described below. The microelectrode, presumably, recorded from axons throughout the diameter range present in the dorsal columns.

Rapidly-adapting units

One hundred and eight of the 132 units responded only during movement of the skin or hairs and not during

FIGURE 1.

Histogram of the conduction velocities of the total sample of dorsal column axons. The velocities were calculated from conduction times measured from C 2 to L 3-4.

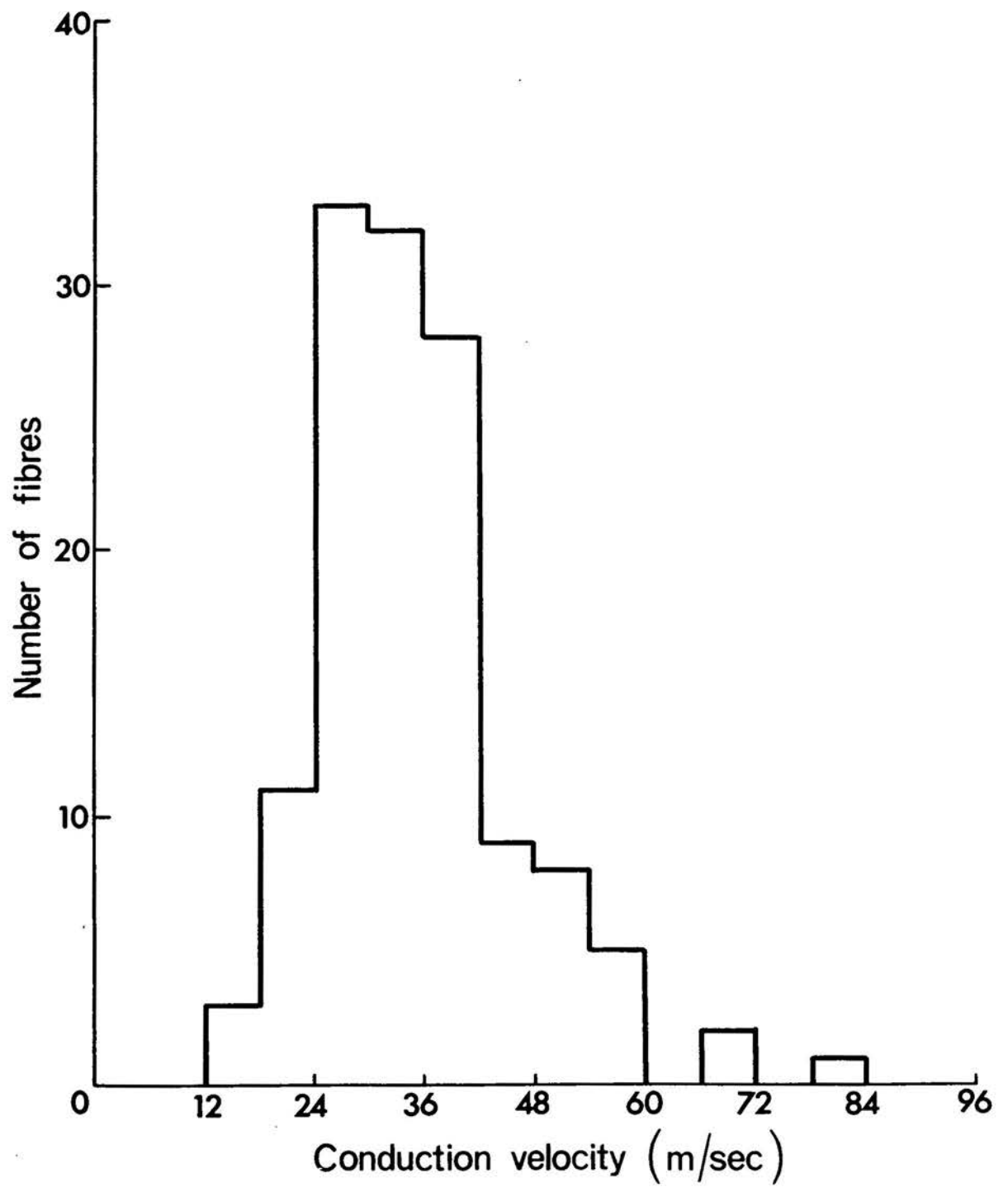

maintained displacement. They were, therefore, rapidly-adapting. Most (90) were excited by movement of either guard hairs or tylotrichs (Type G or Type T units as classified by BROWN and IGGO 1967).

Type G hair follicle units. These accounted for 48 (36.4%) of the total sample. The conduction velocities of their axons in the dorsal column were 14-50 m/sec (34.0 ± 1.32 , mean \pm S.E., FIG 2). The areas of their receptive fields ranged from about 0.5 cm^2 on the toes to as much as 64 cm^2 on the lateral abdomen. The more proximal fields on the hindlimb were larger than the distal fields, and on the toes the fields were very small (FIG. 3A). These data on receptive field sizes of Type G units extend the results of BROWN and IGGO (1967) which showed, that in the area of distribution of the saphenous nerve, there was no obvious tendency for field size to be correlated with the position of the fields.

Type T hair follicle units. Forty-two Type T units were identified (31.8% of the total sample). The conduction velocities of their axons in the dorsal column were 24-57 m/sec (31.5 ± 2.32 , mean \pm S.E., FIG 2). There was no significant difference between the conduction velocities of axons of Type G and Type T units in the dorsal columns. This contrasts with the saphenous nerve

FIGURE 2.

Histograms of the conduction velocities of dorsal
column axons according to afferent unit type.

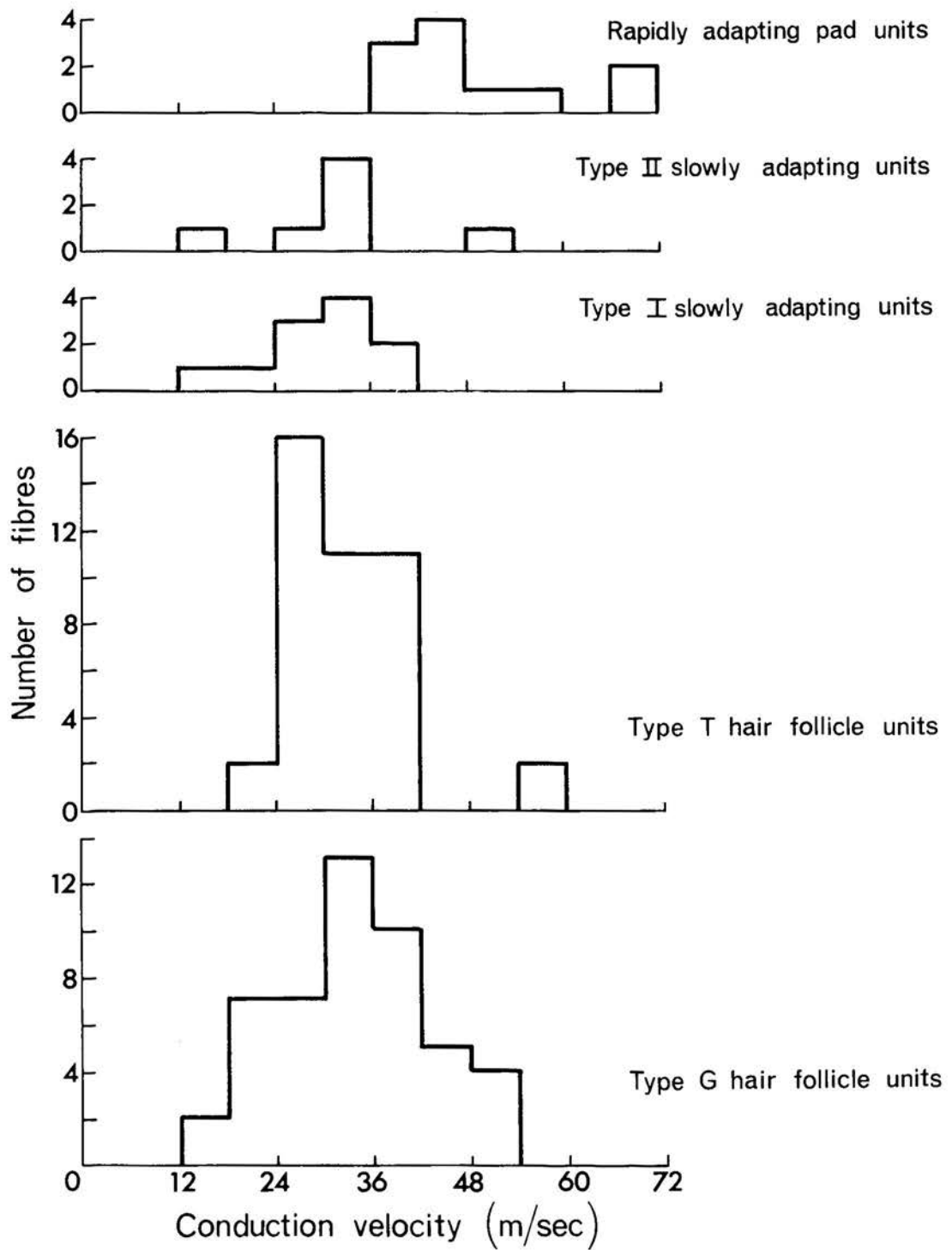

where axons of Type T units have significantly higher conduction velocities than axons of any other type of unit (BROWN and IGGO 1967).

As with Type G units, the receptive fields of Type T units were smaller on the toes and distal parts of the hindlimb and larger on the more proximal parts (FIG. 3B). This again contrasts with the results of BROWN and IGGO (1967) in which, in the more limited area of skin studied (the area of distribution of the saphenous nerve) there was no tendency for distal fields to be smaller than proximal ones.

Rapidly-adapting pad units. Eleven units (8.3%) were observed in which a response could be evoked by movement of the horny skin of a pad. These responses were rapidly-adapting and the units were extremely sensitive to pad movement. Care was necessary in assigning units to this group as many of the hair follicle units with fields between the pads could be excited by movement of an adjacent pad, if this also moved the hairs. The 11 pad units described here were not excited by movement of hairs near the pad.

The axons of the pad units had conduction velocities in the dorsal column of 39-67 m/sec (49.4 ± 2.94 , mean \pm S.E.,

FIGURE 3.

Receptive fields of hair follicle afferent units on
the posterior aspect of the hindlimb. A) Type G
hair follicle units; B) Type T hair follicle units.

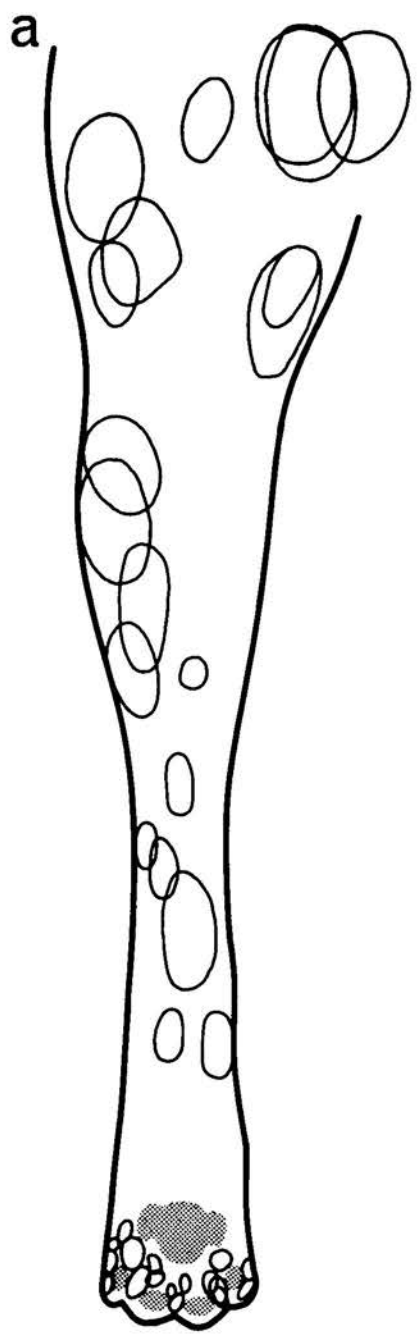

50mm

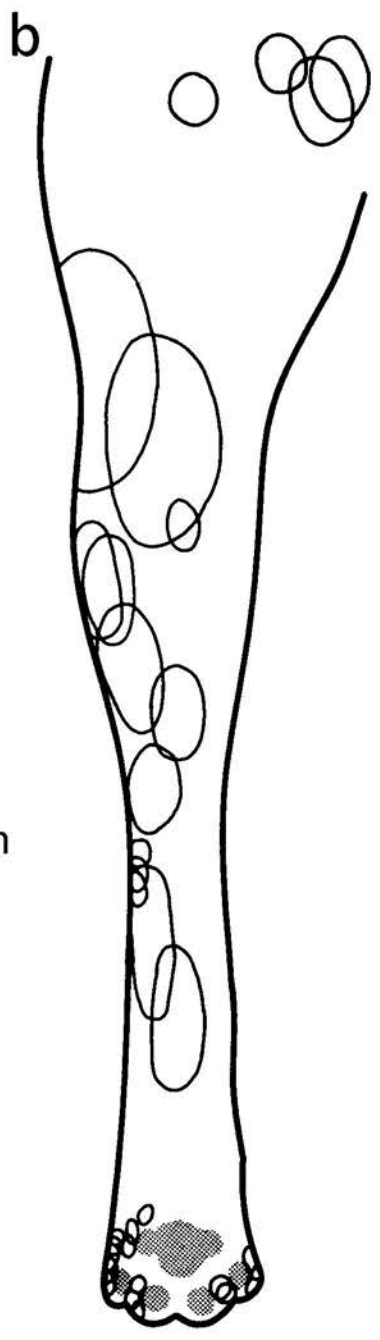

FIG. 2), which were significantly higher than those of any other group of axons in the dorsal columns ($P < 0.001$, t test). The receptive fields were restricted to part of a pad in 10 units, but in one covered the medial two pads and the medial half of the central pad.

Other rapidly-adapting units. Seven other rapidly-adapting units were observed. They were not excited by hair or pad movement. Two required heavy pressure on the skin to evoke a response and had receptive fields on the foot and the ventral surface of the root of the tail. Their dorsal column conduction velocities were 32 and 29 m/sec respectively. Another unit was excited by touching a spot-like area of skin just above the ankle and had a conduction velocity of 50 m/sec. One had a subcutaneous receptive field on the foot (25 m/sec). Two units were sensitive to movement of a claw and had a particularly sensitive spot-like receptive field at the base of a claw. In these respects they were similar to the claw units of GORDON and JUKES (1964). They differed, however, in that they were rapidly-adapting. Their conduction velocities were 39 and 52 m/sec. The remaining unit was sensitive to tapping the foot and could be made to discharge one or two action potentials by tapping the frame which supported the animal. No cutaneous receptive field could be found for this unit. The axon had a



conduction velocity of 60 m/sec.

Slowly-adapting units

Twenty-two of the 132 units adapted slowly to a maintained displacement of their receptive fields. All but 4 of these were of the two types of slowly-adapting unit described by CHAMBERS and IGGO (1967).

Type I slowly-adapting units. The axons of these units innervate cutaneous touch corpuscles. Eleven units (8.3%) were of this type. The axons had dorsal column conduction velocities of 18-40 m/sec (30.4 ± 1.96 , mean \pm S.E., FIG 2). Only 3 of these units had receptive fields on the thigh or leg. Most had their fields either on the tail or on the foot.

Type II slowly-adapting units. The axons of these units innervate an intradermal end-organ (CHAMBERS and IGGO 1967). They often have a very regular discharge in the absence of intentional mechanical stimulation and are excited by stretching the skin, and therefore by moving the limb. Great care was necessary in the present experiments to distinguish them from the joint units, which may also have a regular discharge, are excited by moving the limb

and have axons in the dorsal columns. The 7 units (5.3%) classified as Type II all satisfied the following criteria; each unit had 1. A single spot-like receptive field extremely sensitive to displacement, with the end-organ localized in the skin, since the position of the receptive-spot moved when the skin was moved; 2. No touch corpuscle at the sensitive spot; 3. Was excited by localized stretching of the skin and had a regular discharge in the absence of intentional mechanical stimulation; 4. Was excited by sudden rapid cooling, e.g. by an ethyl chloride spray. These criteria, taken together, enabled slowly-adapting Type II units to be distinguished from all other slowly-adapting mechanoreceptive units in hairy skin and from the units activated by joint movement. The conduction velocities of the dorsal column fibres of these units were 12-50 m/sec (32.0 ± 3.37 , mean \pm S.E., FIG. 2).

Other slowly-adapting units. Four other units with slowly-adapting discharges to maintained displacement of their receptive fields were observed. One had its receptive field on the tail and responded to squeezing the skin, one responded to heavy pressure on the leg just above the ankle, one responded to movement of the lateral claw and one to pressure on a pad. The axons had dorsal column conduction velocities of 25, 84, 27

and 28 m/sec respectively.

Anomalous units

Two units, antidromically excited from C 2, were recorded from the lumbar dorsal column, and they had receptive fields difficult to classify. The fields seemed to be both cutaneous and subcutaneous, and the response to pressure was slowly-adapting. When the receptive field was stimulated electrically, by a pair of steel-needle electrodes, they did not follow rates of stimulation higher than about 100 a second, and at low rates of stimulation gave more than one impulse, of varying latencies, to a single stimulus. Their dorsal column conduction velocities were 24 and 32 m/sec. These units may have been postsynaptic, i.e. the axons recorded in the dorsal column may not have been collateral axons of dorsal root fibres.

Depths of the units in the dorsal column

No systematic measurements were made of the depths at which the units were recorded. It was noted, however, that in single microelectrode insertions hair follicle

units tended to lie superficially and joint units deeply. Usually, the electrode was not lowered further when joint units became preponderant (greater than 1.5mm). Hair follicle units were the most numerous of all units in the superficial 1 mm of the column, but were also present at depths greater than 2 mm. Most of the Type I slowly-adapting units were found in the superficial 300 microns, whereas Type II units were deeper than 300 microns and usually at 300-700 microns. The depths were read off the micromanipulator.

Compound action potential studies

The single unit studies described above establish that there is a differential slowing of the conduction velocities of the axons as they ascend the dorsal column. The degree of slowing depends on unit type. The conduction velocities in the dorsal column and in peripheral nerve are compared in TABLE 3. Axons of the rapidly-adapting pad receptors (which probably include Pacinian corpuscles) slowed very much less (25.2%) than those of any other class of unit (47.7-61.5%). Since axons of the pad receptors are contained in the medial plantar nerve and not in the sural or superficial peroneal nerves, the compound action potentials recorded from various parts of the three

TABLE 3

Comparison of dorsal column units with those of peripheral nerve

Type of unit	Mean axonal conduction velocity in dorsal column m/sec	Mean axonal conduction velocity in peripheral nerve m/sec*	% slowing*	Proportions of units** (%)	
				Dorsal column	Peripheral nerve
Type G hair follicle	34.0	65.2	47.7	44.5	53.3
Type T hair follicle	31.5	81.6	61.5	38.9	6.4
Type I slowly-adapting	30.4	68.6	55.7	10.2	29.1
Type II slowly-adapting	32.0	64.3	50.2	6.5	11.1
Pad rapidly adapting	49.4	66.0	25.2	-	-

* The values of the mean peripheral nerve conduction velocities for Types G, T, I and II units are based on those of BROWN & IGGO (1967) for the saphenous nerve and for the pad units on ARMETT & HUNSPERGER (1961). The figures of BROWN & IGGO were derived from conduction times measured over 40-60 mm of nerve. In the above Table 20% has been added to BROWN & IGGO's figures to bring them into line with those of HUNT & McINTYRE (1960b) which were measured from the popliteal fossa to the dorsal roots (sural nerve).

** The proportions of units in peripheral nerve are taken from BROWN & IGGO (1967) and have been calculated as the proportion in the A alpha-gamma fibre group. The dorsal column proportions are calculated from the limited population consisting of Types G, T, I and II units.

peripheral nerve - cervical dorsal column pathways were examined for any differences. The results of a typical experiment are shown in TABLE 4.

The conduction velocities of the dorsal column fibres between C 2 and L 2, determined from the compound action potentials, were 15-70 m/sec. This compares with velocities of 12-84 m/sec for the single units recorded with microelectrodes. The microelectrode sample may, therefore, be taken as representative of the fibres contained in the dorsal column. The absence from the sample of fibres conducting below 12 m/sec was presumably due to the scarcity of such fibres ascending the dorsal columns.

When the cervical dorsal column was stimulated, threshold responses recorded at L 2 and the medial plantar nerve appeared at the same intensity of stimulation (FIG 4A). The threshold responses in the other nerves (sural and superficial peroneal) required higher intensities of stimulation (1.13-1.53 times the threshold intensity) and the dorsal column response recorded at L 2 was correspondingly larger (FIG. 4B,C). The fastest dorsal column fibres were, therefore, axon collaterals of fibres of the medial plantar nerve, probably those which innervate the rapidly-adapting pad receptors.

TABLE 4

The results of a typical compound action potential experiment

Stimulation site	Recording site	Latency of response (msec)		% change in latency
		Threshold	Maximum	
Dorsal columns at C2	Dorsal column at L2	3.0	3.0	0
	MP	9.3	7.7	17.2
	SP	8.00	7.7	4.1
	SU	8.0	7.3	8.4
Dorsal column at L2	MP	5.3	4.7	12.5
	SP	4.0	4.0	0
	SU	3.3	3.3	0
MP	Dorsal column at L2	4.7	4.7	0
SP		4.0	4.0	0
SU		3.3	3.3	0

MP = medial plantar nerve

SP = superficial peroneal nerve

SU = sural nerve

FIGURE 4.

Threshold responses to electrical stimulation of the dorsal columns at C 2. Each pair of records shows responses to electrical stimulation of the dorsal columns at C 2 recorded from the dorsal column at L 2 (upper trace) and from peripheral nerve (lower trace), at stimulus strengths just sufficient to evoke the peripheral nerve responses. A) Medial plantar nerve, B) Superficial peroneal nerve, C) Sural nerve. The medial plantar response and the dorsal column response appear at the same intensity of stimulation. At threshold for the superficial peroneal and sural nerve responses the dorsal column responses are above threshold. The arrows indicate the threshold responses. Each record is formed by the superposition of several faint traces. The amplification is the same for all records.

A



B



C



10 msec

The threshold response in the medial plantar nerve, evoked by electrical stimulation of the dorsal column at C 2, had a longer latency than that of less sensitive C 2 collaterals. That is, the latency of the initial part of the maximal response in the medial plantar nerve was shorter than that of the threshold response (FIG. 5A,B). In the different experiments this shortening of the latency was 11-26.5 per cent.. This effect was absent or less conspicuous in the other nerves (superficial peroneal 0-4.1%, sural 0-8.4%, except for one experiment when the degree of shortening of the sural response was 13.8% and in the same experiment the latency change for the medial plantar nerve was also high, 26%). That the change in latency was due to activity in different axons was established by stimulating at C 2 with two shocks, the first just above threshold and the second strong enough to evoke the shorter latency components and with a variable delay. There was no interaction between the threshold and the shorter latency components. Thus the fibres with the lowest electrical threshold, and therefore the largest diameters at C 2 (the axons of the rapidly-adapting pad mechanoreceptors) did not have the shortest latency from C 2 to the periphery.

A similar result was obtained when the dorsal column

FIGURE 5.

Compound action potentials recorded from peripheral nerves in response to stimulation of the dorsal columns at C 2. Each column of records shows the growth of the compound action potential recorded from peripheral nerve from threshold to maximal response. A,B) Medial plantar nerve, C,D) Superficial peroneal nerve, E,F) Sural nerve. The arrows indicate the position of the stimulus artefacts and the dashed lines the position of the response of minimal latency at each strength of stimulation. The point at which the threshold response appeared has been continued downwards as a dashed line.

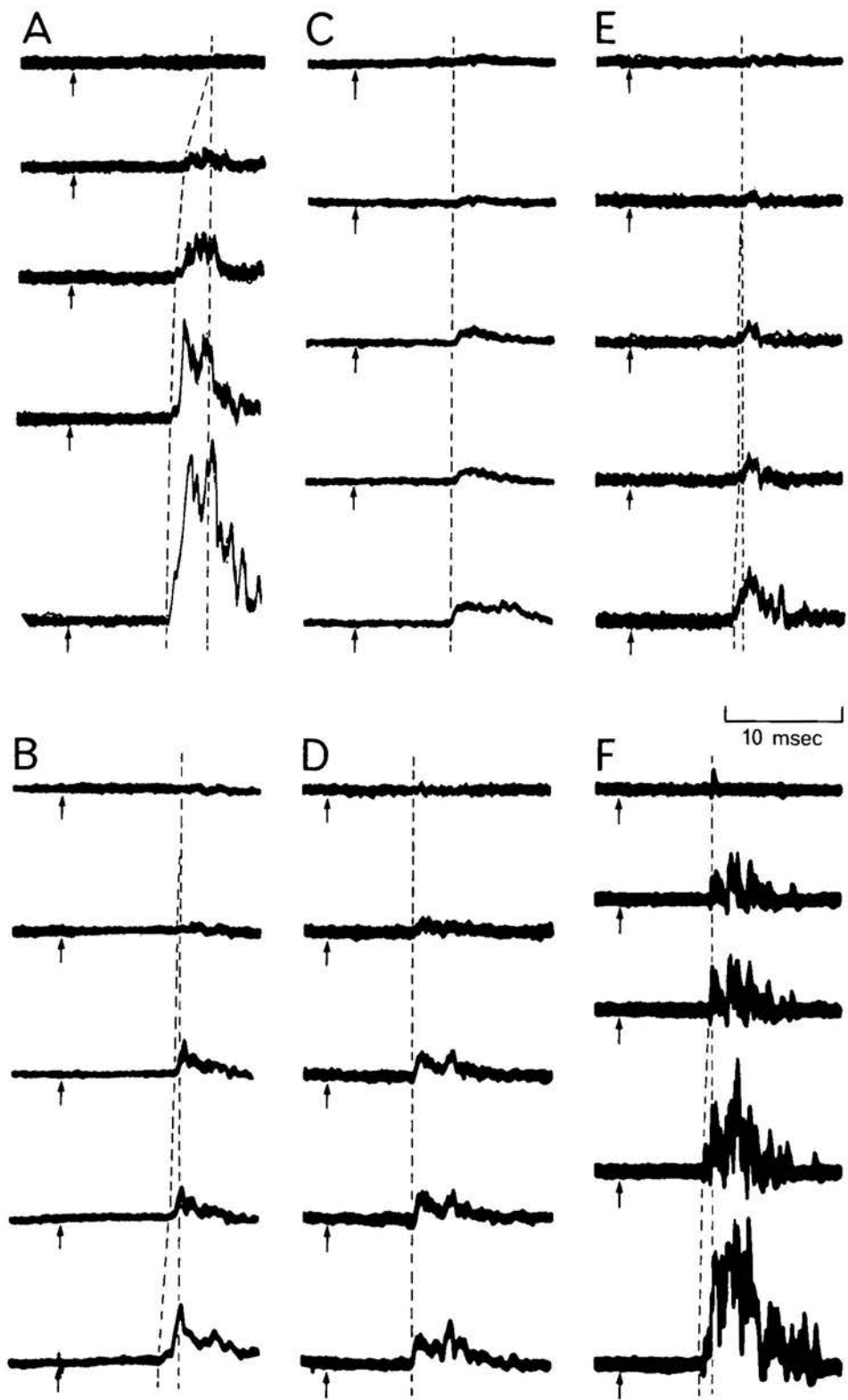

at L 2 was stimulated electrically and the response recorded at the peripheral nerves. That is, there was a shortening of the latency of the response in the medial plantar nerve as the strength of stimulation was increased. For the other nerves there was no shortening of latency (TABLE 3). When the peripheral nerves were stimulated and the response recorded from the dorsal column at L 2, the threshold responses all had the shortest latency. These results indicate that the axons of the rapidly-adapting pad mechanoreceptors are the largest axon collaterals in the dorsal column at L 2 and C 2, but are not the largest axons in the medial plantar nerve in the foot.

DISCUSSION

These results establish that axons of the following types of cutaneous afferent unit have collaterals that ascend the dorsal columns to the dorsal column nuclei; hair follicle units Types G and T, slowly-adapting units Types I and II, rapidly- and slowly-adapting pad mechanoreceptor units. A few other kinds of unit were found and included 4 which required heavy pressure or squeezing to evoke a discharge. The dorsal columns may, therefore, carry information from insensitive mechanoreceptors.

They may be those units described by MARUHASHI et al. (1952) and BURGESS and PERL (1967) which respond to similar stimuli and which have axons in the A beta-gamma range. Cells in the dorsal column nuclei which respond to similar sorts of stimuli have been described by GORDON and JUKES (1964). The possibility that post-synaptic neurones, with receptive fields on the hind-limb, have axons that ascend the dorsal column needs further investigation.

The conduction velocities of the axons in the dorsal column were measured. It was hoped that axons ~~that axons~~ that might have been missed by the microelectrode at high cervical levels, due to thinning of the axons near their termination, would be picked up at lumbar levels. Axons with overall dorsal column conduction velocities down to 12 m/sec were examined. Since the compound action potential studies indicated that the slowest fibres in the dorsal columns have conduction velocities of the order of 15 m/sec, the microelectrode successfully sampled the smaller fibres in the dorsal column. The absence of responses from both Type D hair follicle units and the nociceptors innervated by A delta fibres from units sampled in the dorsal column cannot be attributed to a technical limitation of the methods and establishes that A delta fibres do not send collaterals to the dorsal

column nuclei. This confirms the conclusions of WALL (1960b) and TAUB and BISHOP (1965) that A delta fibres do not have collaterals in the dorsal column. However, axons with peripheral nerve conduction velocities in the A delta range have been recorded from the dorsal column at L 1 (R. F. SCHMIDT, personal communication). The A delta fibres may, therefore, enter the dorsal column but ascend only for a few segments.

The degree of slowing of the conduction velocities of axon collaterals as they ascend the dorsal column (GASSER and GRAHAM 1933; LLOYD and McINTYRE 1950; COLLINS and RANDT 1956; UDDENBERG 1968b) and therefore the degree of thinning of the axons was not the same for all classes of units. The axons of the rapidly-adapting pad mechanoreceptors showed least reduction in conduction velocity (25.2%) and the Type T hair follicle units the most (61.5%). This is shown in TABLE 3 where the conduction velocities in peripheral nerve and dorsal column are compared. TABLE 3 also shows that relatively fewer Type I slowly-adapting units and relatively more Type T hair follicle units are present in the dorsal column than in the saphenous nerve. The scarcity of Type I units in the dorsal column suggests that axons of most of the Type I units do not project into the dorsal column to the dorsal column nuclei. The greater repre-

sentation of Type T units in the dorsal column suggests an important role for them in this pathway.

SCHMIDT et al. (1967) have shown that the rapidly-adapting pad receptor units are the most powerful mechanoreceptor units for producing primary afferent depolarization of mechanoreceptor afferent terminals, and that the dorsal column fibres with the lowest electrical threshold produce most of the depolarization that can be produced in these fibres. The present results show that axons of the rapidly-adapting pad receptors have the lowest electrical threshold in the dorsal column. That is, the primary afferent depolarization produced by electrical stimulation of the dorsal columns is produced largely by activity in axons of the pad receptor units.

The present results also clear up some confusion in the literature concerning the cutaneous afferent fibre input to the spino-cervical tract. Most workers agree that the largest cutaneous afferent fibres project onto the spino-cervical tract (REXED and BRODAL 1952; MORIN 1955; MARK and STEINER 1958; LUNDBERG and OSCARRSON 1961; TAUB 1964). However, TAUB and BISHOP (1965) state that the largest fibres of the sural nerve and the largest axons in the dorsal column do not excite spino-

cervical tract cells. It is now established that the largest axons in the sural nerve do not give rise to the largest axon collaterals in the dorsal column. The latter are collaterals of the axons of the pad units which are not present in the sural nerve. Type T units, which have the largest axons in cutaneous nerves from hairy skin (BROWN and IGGO 1967; see TABLE 3) have strong excitatory connections with the spinocervical tract (see SECTION III), but axons of the rapidly-adapting pad receptors, which have the fastest dorsal column axons, do not have excitatory connections with the tract (LUNDBERG and OSCARRSON 1961; TAUB 1964; OSWALDO-CRUZ and KIDD 1964; see SECTION III). Thus TAUB and BISHOP's observations that the fastest dorsal column axons do not project onto the spinocervical tract are clarified, but their observation that the fastest sural nerve fibres do not have substantial excitatory connections with the tract remains unexplained.

In a recent study of dorsal column fibres that respond to electrical stimulation of forelimb nerves, UDDENBERG (1968b) has shown that hair follicle units are situated superficially in the column, slowly-adapting units deep and Group I muscle afferent units in between. This separation of units, well-marked at the cervical level, is not so obvious at lumbar levels. In the lumbar

dorsal column the hair follicle units were superficial and the Type II slowly-adapting units slightly deeper. However, hair follicle units far outnumbered all other types in the superficial 1 mm of the cord. Units excited by movement of joints were predominant in the deep parts of the column. These results for the cat lumbar dorsal column differ from those of WERNER and WHITSEL (1967) for the lumbar dorsal column of the squirrel monkey where there is no organization of the ascending fibres on the basis of unit type. In the cat lumbar dorsal column, however, WERNER and WHITSEL have confirmed that the joint units are prominent in the deep parts (G. WERNER, personal communication 1968).

SECTION III

THE SPINOCERVICAL TRACT: TYPES OF UNIT AND THEIR STIMULUS-
RESPONSE PROPERTIES

INTRODUCTION

The literature pertaining to the spinocervical tract was reviewed in SECTION I, where the contradictory nature of that literature was emphasized. The experiments to be reported in the present SECTION were performed to see if it were possible to recognize which primary cutaneous afferent units project onto this system and to try to resolve the contradictions. The experiments were designed, as far as possible, to avoid any unnatural stimulation of receptors, e.g. the skin of the hindlimbs was left intact, and to ascertain if there were any differences in the type of inputs to different spinocervical tract cells. Controlled natural stimulation of the skin and subcutaneous tissues was used and the response properties of spinocervical tract cells were determined in different types of animal preparation.

METHODS

Three types of animal preparation were used for these experiments. 1. Cats anaesthetized with chloralose,

70 mg/kg in 0.9 per cent. NaCl intravenously, after induction of anaesthesia with ethyl chloride and ether. Anaesthesia was maintained with intravenous injections of chloralose, 20-40 mg, as required. (6 cats).

2. Cats decerebrated by section of the brain-stem in the plane of the bony tentorium and removal of the forebrain. The decerebration was done under ether anaesthesia during temporary occlusion of the carotid and vertebral arteries. (3 cats) 3. Cats made spinal by section of the spinal cord at the level of the atlanto-occipital junction and then decerebrated, under ether anaesthesia. (6 cats). In the decerebrate and decerebrate-spinal cats the ether was discontinued after decerebration. This was 2-3 hours before recording was begun and most of the ether would have been 'blown off' by respiration.

Laminectomies were performed at C 1-3 and L 2-4. The dorsal columns were sectioned at caudal C 3. The spinal and decerebrate cats were immobilized by intravenous injections of gallamine triethiodide (20 mg initially and then 8-12 mg as required) and artificially respired. Their carotid arterial blood pressures were recorded by a mercury manometer and maintained, if necessary, by intravenous injections of a solution of dextrans (a mixture of equal volumes of 4% dextrans of molecular weight 40,000 and 6% dextrans of molecular

weight 110,000, both in 0.9% NaCl). In the early experiments dextrans were given if the blood pressure fell below 70 mm Hg, and in the later ones if it fell below 80 mm Hg. Fixation of the animal and maintenance of its body temperature were as detailed in SECTION II.

Electrophysiological recording methods. Recordings were made from axons at and near the surface of the medial part of the dorsolateral funiculus in the lumbar spinal cord. Either glass micropipette electrodes filled with 3M KCl, tip resistance 6-15 M Ω , or tungsten microelectrodes (HUBEL 1957) were used. The tungsten electrodes were found to be more satisfactory in that they held single units longer (up to 3 hours), were more successful in recording from axons conducting at less than 30 m/sec, and a single electrode could be used for several experiments. Tungsten electrodes with resistances of the order of 5 M Ω were most successful in recording from axons. Recorded axonal action potentials ranged from about 200 μ V to about 20 mV in amplitude. Potentials were amplified and displayed as described in SECTION II.

Identification of spinocervical tract axons. Pairs of silver-wire stimulating electrodes were placed on the dorsolateral funiculus at C 1 and C 3. As the recording

microelectrode was lowered into the lumbar cord, 0.2 msec square-wave shocks were delivered through the electrodes at C 3 until an antidromic action potential was recorded. Shocks were then delivered through the C 1 electrodes and the antidromic response, if present, was recorded. Units were assigned to the spinocervical tract if there was no response from C 1 or, if there was a response, if the conduction velocity of the axons between C 1 and C 3 was 50 per cent. or less than that from C 3 to the lumbar recording site. Most axons could be excited from C 1 at higher strengths of stimulation than at C 3. The conduction velocities between C 1 and C 3 were usually 20-40 per cent. of the values from C 3 to the lumbar cord. Similar means of identification have been used by TAUB and BISHOP (1965). Conduction distances were measured at the end of each experiment.

Mechanical stimulation of hairs and skin. The coat of the tail and the hindlimb ipsilateral to the recording site was clipped. Receptive fields of spinocervical tract units were located by stroking the skin with glass probes and were then examined under a binocular operating microscope to ascertain whether movement of any particular type of hair or cutaneous touch corpuscles were adequate stimuli for a unit. Single hairs or small

groups of hairs, and the skin, were moved with watch-makers' forceps, fine probes or with the piezoelectric transducer described by BROWN and IGGO (1967). Movement of this transducer faithfully followed an electrical waveform, applied at the fixed end, down to rise times of 10 msec. In the present series of experiments no rise times less than 20 msec were used. The amplitude of movement of lengths of the piezoelectric material (lead zirconate titanate, PZT, Brush Clevite Ltd.), produced by applying 135 V across the fixed end from a Tektronix Sawtooth Generator, was measured by casting a focussed shadow of the stimulator onto a photoelectric cell and comparing the output of the cell with that produced by known movements of the shadow. The length of piezoelectric strip used was measured at the end of each experiment.

Pressure on the skin was produced by probes rigidly held in micromanipulators, or with the thermode described below. More severe mechanical stimulation was produced by squeezing the skin with artery forceps.

Thermal stimulation. The temperature of the receptive fields of spinocervical tract units was changed with the thermode shown in FIG. 6. It consisted of a thermoelectric microtome stage cooler (De La Rue Frigistor, Ltd.),

FIGURE 6.

Thermoelectric thermode. A) Cross section (left) and view from the face (right). B) Temperature changes recorded by the thermistor on the thermode face, in contact with the skin.

A

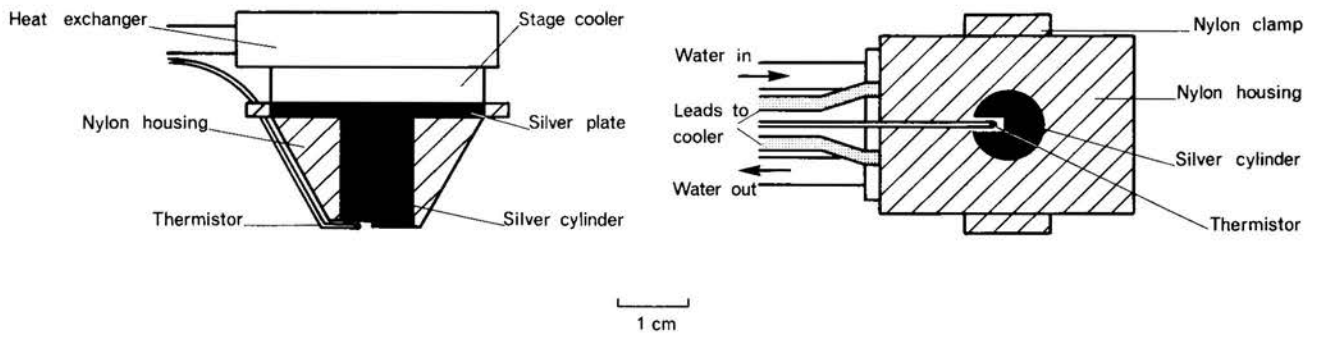

B

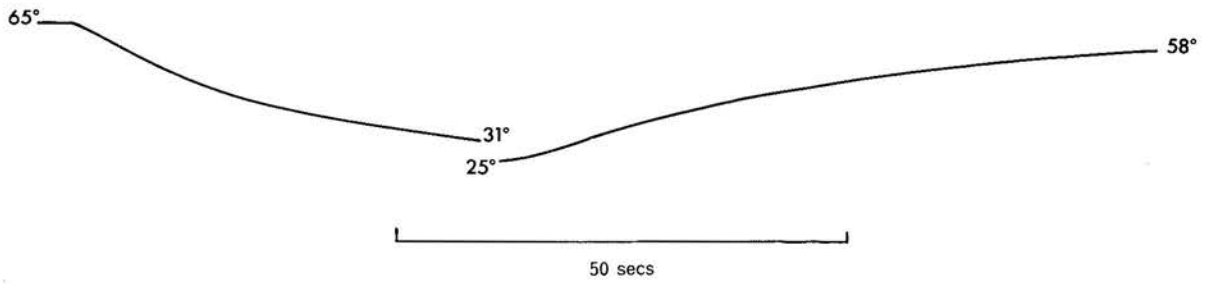

30 x 20 mm, to one surface of which a solid silver head was clamped. The head was thermally insulated from the air by a nylon housing which surrounded the sides of the head. A thermistor bead was mounted on the head by epoxyresin (Araldite, CIBA), and measured the temperature at the skin-thermode interface. The thermistor formed one arm of a Wheatstone bridge circuit and the DC voltage output from the bridge was amplified and displayed on one beam of the oscilloscope.

Hot water at about 70°C was circulated over the back face of the stage and allowed the working range of the thermode to be $0-65^{\circ}\text{C}$. The temperature of the skin surface could be held indefinitely at any temperature within this range with an accuracy of 0.1°C by controlling the size and direction of the DC current through the cooler. Changes in the intensity of the DC current shifted the temperature of the thermode along an exponential path at an initial rate of up to about $1^{\circ}\text{C}/\text{sec}$. (FIG 6B).

RESULTS

There were marked differences between the response properties of spinocervical tract units in spinal cats,

on the one hand, and in decerebrate and anaesthetized cats, on the other. Units in spinal cats were much more responsive, to both excitatory and inhibitory stimuli, than units in the other preparations.

All the excitatory receptive fields of the 257 units examined were on the ipsilateral hindlimb or the tail. When on the tail they were usually on the ipsilateral side. None of the units examined was excited by movement of the horny skin of the foot-pads, the claws or cutaneous touch corpuscles.

Tests for the presence of inhibition were made against the spontaneous discharge in most units, but also against the evoked activity in some of each type. Inhibition, when present, was usually produced by squeezing or pressing onto the skin. Less frequently, it was produced by brushing the hair. When hair movement was an effective inhibitory stimulus, movement of many hairs was required and it was not possible to ascertain if movement of any particular type of hair produced the inhibition.

Types of units in the spinocervical tractSpinal cats

Three types of unit were distinguished in spinal cats, on the basis of their responses to mechanical stimuli. They were, in general, similar to the units described by WALL (1960a, 1967) and MENDELL (1966). The three types were excited by, 1. hair movement, 2. hair movement and pressure on the skin, 3. heavy pressure or pinch of the skin and/or subcutaneous tissues. They all had a spontaneous discharge in the absence of intentional stimulation of the excitatory receptive field (see SECTION IV).

Units excited by hair movement alone (21 units). These responded to hair movement with a rapidly-adapting discharge of impulses (superimposed on the spontaneous activity). Maintained displacement of the skin, or squeezing the skin, led to no increase in frequency of the discharge above the spontaneous value, once the response due to hair movement was over.

The excitatory receptive fields were small on the distal limb, particularly on the toes where they were as small as 3 x 2 mm and similar in size to the

fields of primary hair follicle afferent units. On the proximal limb the fields were larger and often covered most of the posterior and lateral aspects of the thigh and leg, indicating considerable convergence of primary afferent fibres onto a single spino-cervical tract cell. Excitatory receptive fields of these units are shown in FIG. 7A drawn to scale.

The excitatory fields were examined under an operating microscope and individual hairs moved with the electromechanical transducer to see if movement of any particular type of hair was effective in exciting these units. Movement of all three types of hair (down hairs, guard hairs and tylotrichs) was an effective stimulus. The excitatory fields included most, if not all, of the hairs within the perimeter of the receptive field.

Fourteen units were examined for inhibitory receptive fields to mechanical stimulation of both hindlimbs and the tail. Inhibition was demonstrable in only 5 of the 14, 4 being inhibited by squeezing the contralateral ankle and 1 by squeezing the ipsilateral third and fourth toes (FIG. 8A). No inhibition was produced by hair movement alone. These results contrast with those for the other two types of unit in spinal cats

FIGURE 7.

Excitatory receptive fields of spinocervical tract
units in spinal cats. A) Fields of units excited by
hair movement only. B) Fields of units excited by
hair movement and skin pressure.

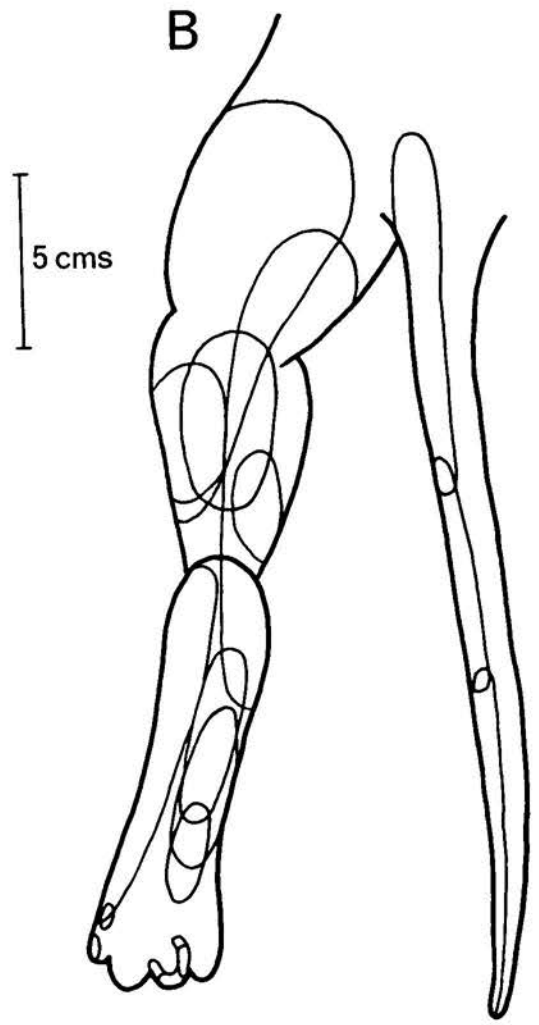
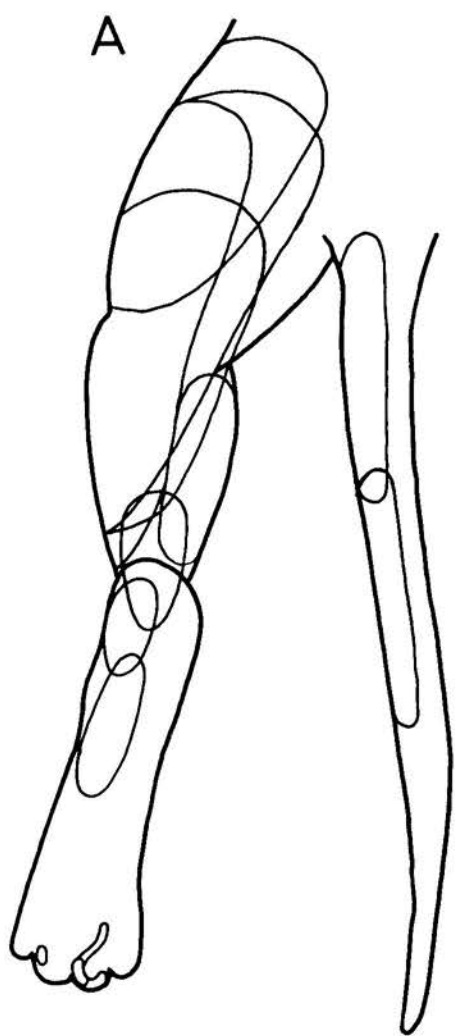

FIGURE 8.

Receptive fields (excitatory and inhibitory) of individual spinocervical tract units in spinal cats.

A) Units excited by hair movement only. B) Units excited by hair movement and skin pressure. C) Units excited by pressure and pinch.

Key - Excitatory fields: black.

Inhibitory fields: clear - hair movement.

dotted - moderate pressure.

cross-hatched - pinch.

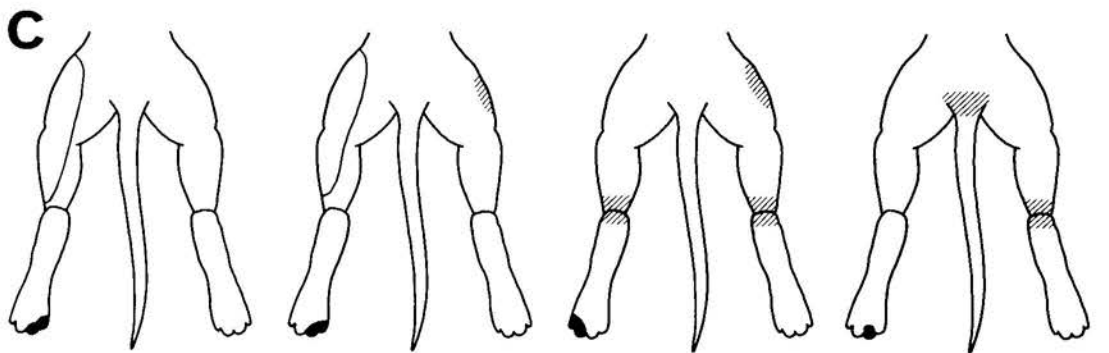
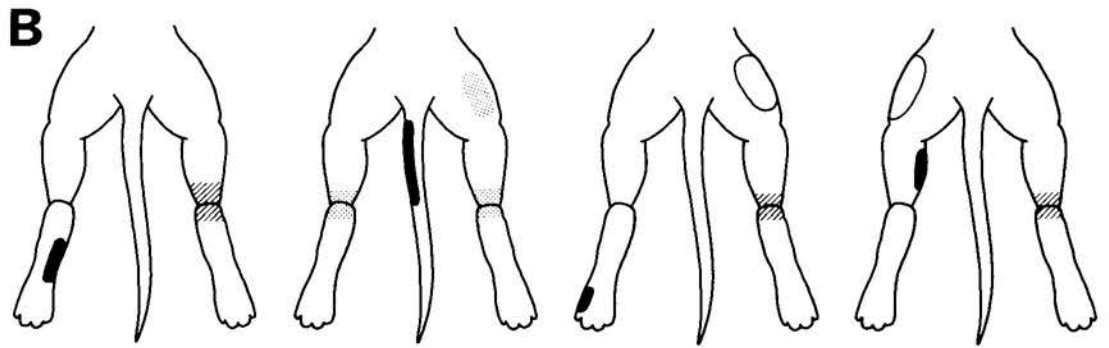
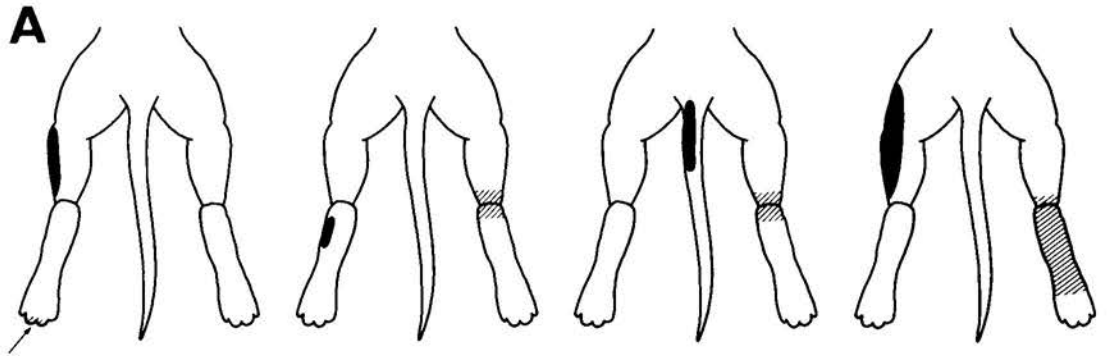

10 cms

where inhibition was common and with ^amore complex organization.

Units excited by both hair movement and pressure on the skin. (33 units). A rapidly-adapting discharge was evoked in these units by hair movement. This was similar to the response in the units excited by hair movement alone. In contrast to the latter, these units were also excited by maintained displacement of the skin of the excitatory receptive field, and the response was greater when the skin of the field was squeezed with artery forceps. The increased discharge lasted as long as the pressure or squeeze was applied (followed for up to one hour).

The excitatory fields, like those of units excited by hair movement alone, were larger on the proximal than on the distal parts of the limb. They were, however, larger than fields of the 'hair only' units (FIG. 7B), indicating a greater degree of convergence from the primary afferent fibres.

Movement of all three types of hairs led to a discharge in these units. When a probe, rigidly held in a micromanipulator, was pressed onto a touch corpuscle in the field there was no greater response than was produced by a similar stimulus applied to the skin

between corpuscles. WALL (1967) has stated that pressing onto a touch corpuscle leads to a discharge of impulses in these units and this point was carefully checked. These units were no more sensitive to displacement of a corpuscle than they were to movement of adjacent skin. It is concluded that nerve fibres innervating touch corpuscles do not excite spinocervical tract cells of this type. Furthermore, there were no points in the excitatory receptive field which had a greater sensitivity than adjacent points, although the fields were usually more sensitive near their centres. If axons of the intradermal ending (CHAMBERS and IGGO 1967) excite these cells, it would be expected that there would be spots of heightened sensitivity in the fields. Although these units could be excited by stretching the skin, as can the intradermal ending, this stimulus will also excite mechanoreceptors innervated by C fibres, (IGGO 1960). It is concluded that activity in nerve fibres which innervate intradermal endings do not excite these spinocervical tract units.

Nineteen of 22 units examined could be inhibited by mechanical stimulation. The most common (16/19) means of producing inhibition was by squeezing the contralateral ankle. A single unit often had more than one inhibitory field and inhibition was sometimes

produced by different forms of mechanical stimulation of the same or different fields, e.g. hair movement, pressure or squeeze. The inhibitory fields of 4 units are shown in FIG. 8B. Inhibition of these units was, therefore, more common than of units excited by hair movement alone and there was also a greater complexity in the peripheral organization of the inhibition. Inhibitory fields were usually situated on the contralateral limb. When on the ipsilateral limb they were separated from the excitatory fields by a region of skin, which, when stimulated, did not affect the unit. Inhibition of the 'surround' type was not observed.

Units excited by heavy pressure and pinch of the skin and/or subcutaneous tissues (15 units). These units contrasted with the other units in spinal cats in that hair movement alone was insufficient to evoke a response. They required heavy pressure and/or pinch to excite them and responded with a slowly-adapting discharge. Most (11/15) had their excitatory receptive fields on one or more toes of the ipsilateral foot, two were on the ipsilateral ankle, one on the ipsilateral leg and one on the tail. There was a marked after-discharge in these units, following excitatory stimuli, which lasted for up to 30 sec. after the stimulus was removed.

Inhibitory fields were found in 7 of 8 units tested (FIG. 8C). The peripheral organization of inhibition in these units was similar to that for the units excited by hair movement and skin pressure.

Anaesthetized and decerebrate cats

In contrast to spinal cats where 3 types of spinocervical tract unit were found, 5 types were observed in anaesthetized and decerebrate cats. The general principles of the organization of the receptive fields were similar in the two types of preparation and they will be described together. The types were excited by; 1. Movement of guard hairs; 2. Movement of tylotrichs; 3. Movement of down hairs, guard hairs and tylotrichs; 4. Pressure and pinch of the skin and subcutaneous tissues. The fifth type could not be influenced by mechanical stimulation of the hindlimbs or tail.

Units excited by movement of guard hairs (17 units).

These units were excited by movement of the guard hairs and not by movement of the down hairs or tylotrichs. Excitatory fields were small on the distal limb and often as small as the fields of primary guard hair follicle units (SECTION II). On the proximal limb the fields were large indicating considerable convergence

of primary units onto a single spinocervical tract cell. Excitatory fields are shown in FIG. 9A. Pressure on the excitatory field often led to an increase in the frequency, over and above that of the spontaneous discharge, in these units.

When the excitatory fields were examined under an operating microscope, and the hairs and skin moved with the mechanical stimulator, the fields were observed to be 'spotty' with the excitable spots at the position of the guard hairs and their follicles. Movement of skin between guard hair follicles did not elicit a response in these units, when the movement was produced by the mechanical stimulator. Movement of individual guard hairs usually only evoked 1 or 2 impulses, and then only when the movement was rapid (FIG. 14A). Inhibition was not demonstrated in these units but only 2 were adequately tested.

Units excited by movement of tylotrichs (24 units).

These responded to movement of tylotrichs but not to movement of down or guard hairs. When a probe was moved across the receptive fields of these units, the fields were observed to be 'spotty' with the sensitive spots at the site of tylotrichs and their follicles. This was particularly noticeable on the thigh and leg

FIGURE 9.

Excitatory receptive fields of spinocervical tract
units in anaesthetized and decerebrate cats. A) Units
excited by guard hair movement. B) Units excited by
tylotrich movement. C,D) Units excited by movement of
all the hairs (C anaesthetized, D decerebrate).

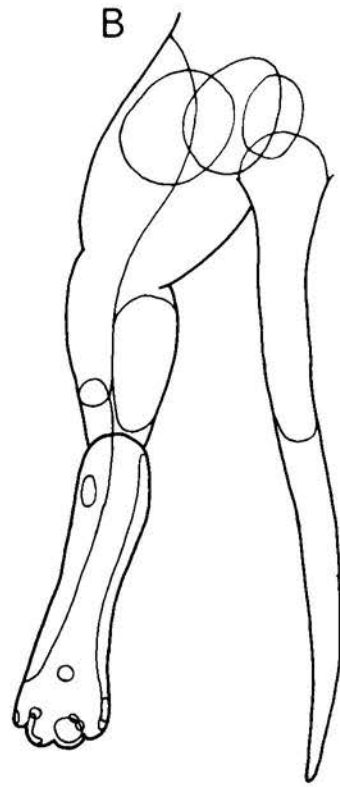
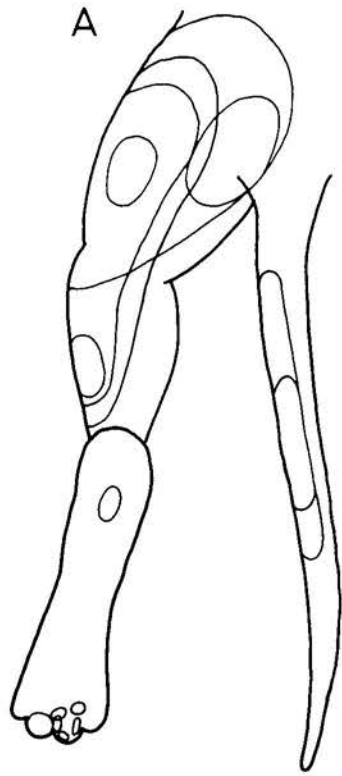

5 cms

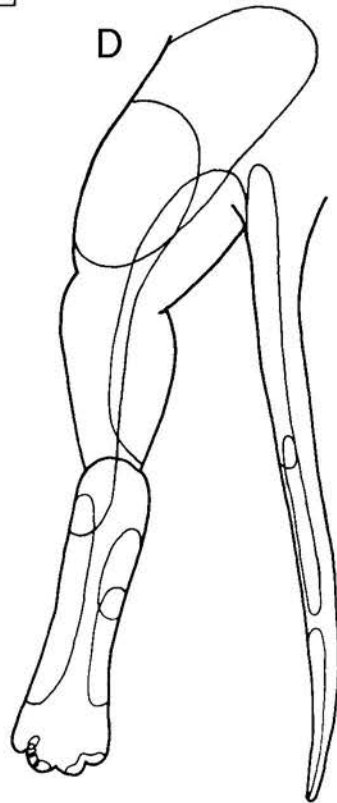
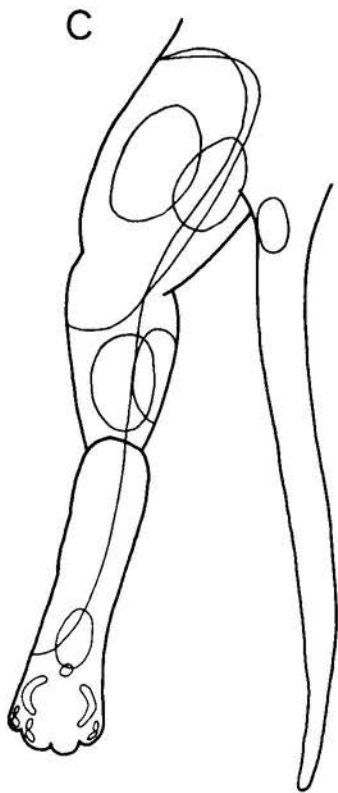

where the tylotrichs are further apart than on the foot and toes. Pressing or pinching the skin never led to a slowly-adapting discharge in these units. Excitatory fields (FIG. 9B) were small on the toes and large on the thigh and leg. Four units were examined for inhibitory fields. One, excited by moving 6 tylotrichs proximal to the central pad, could be inhibited by squeezing the central pad and also by brushing the hairs ipsilateral to the root of the tail. Inhibitory fields could not be found for the other three units.

Units excited by movement of all types of hair (56 units).

These responded with a rapidly-adapting discharge of impulses during movement of all three types of hairs, and often with a slowly-adapting discharge during maintained skin displacement. The receptive fields were not 'spotty' like the previous two types, but some units had regions of greater sensitivity within the excitatory field. The fields were small on the toes but large on the thigh and leg where they included the largest fields of any spinocervical tract unit recorded. Some fields covered most of the posterior surfaces of the thigh, leg and foot (FIG. 9C,D).

Of 13 units examined, 11 had inhibitory receptive fields. Inhibition was commonly (9/11) produced by

squeezing the contralateral ankle. Inhibitory fields were often multiple and both ipsilateral and contralateral to the excitatory field, with adequate stimuli for inhibition being hair movement, moderate and heavy pressure and pinching (FIG. 10A,B). The organization of inhibition to these units was similar to that to units in spinal cats excited by hair movement and skin pressure.

Unit excited by pressure and pinch of the skin and subcutaneous tissue. Only 1 unit of this type was observed but it has been included in a class of its own because of the similar type of unit in spinal cats. This unit was excited by squeezing the second and third toes and was inhibited by squeezing the contralateral ankle.

Units which could not be influenced from the periphery. Eleven units, identified as spinocervical tract units (see Methods), were recorded which could not be influenced by mechanical stimulation of the hindlimbs, tail or lateral abdomen. They had no spontaneous activity. This type of unit was not observed in spinal cats and since the proportion of high threshold units in decerebrate and anaesthetized animals was low, these units may have been inhibited high threshold units.

FIGURE 10.

Receptive fields (excitatory and inhibitory) of individual spinocervical tract units in anaesthetized and decerebrate cats. The units were all excited by movement of all the hairs. A) Anaesthetized. B) Decerebrate.

Key - Excitatory fields: black.

Inhibitory fields: clear - hair movement.

cross-hatched - pinch.

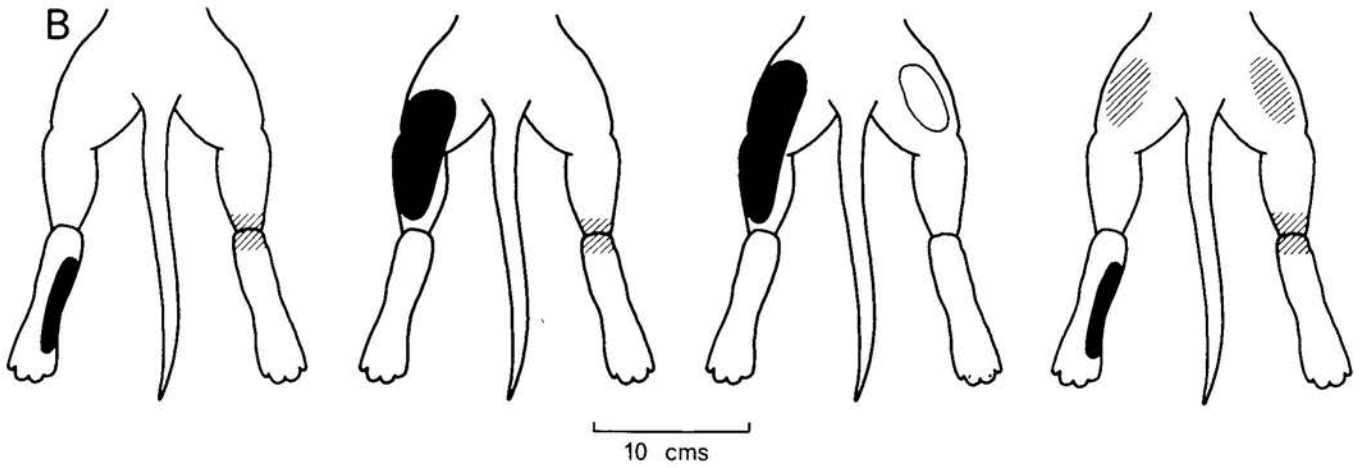
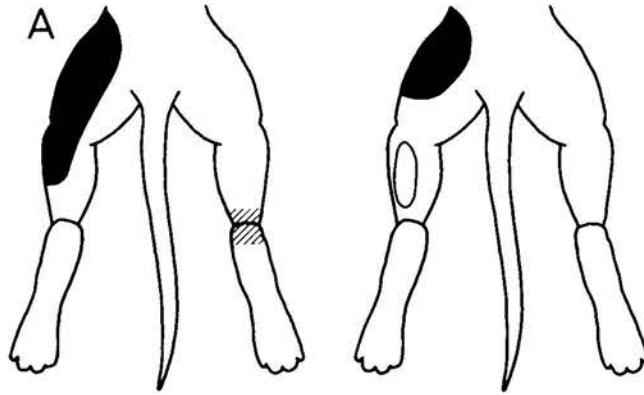

Conduction velocities of spinocervical tract axons

The conduction velocities of 257 spinocervical tract axons were measured from C 3 to the lumbar recording site. The measured values (FIG. 11) indicate the velocities of the axons over most of their length. They ranged from 17 to 103 m/sec, with a unimodal distribution and a mean of 59.5 m/sec. The histograms in FIGS. 12 and 13 show the breakdown of the total sample into types according to the different preparations.

The conduction velocities of units excited by movement of guard hairs (decerebrate and anaesthetized cats) were significantly lower ($P < 0.001$, t test) than those of any other type of unit. In the spinal cats a low velocity group of axons was contained in the class of units excited by hair movement and skin pressure and suggests that they belong to the same spinocervical tract cells (see SECTION V).

FIGURE 11.

Histogram of the conduction velocities of the total sample of spinocervical tract axons. The velocities were calculated from the conduction times between C 3 and L 2-4.

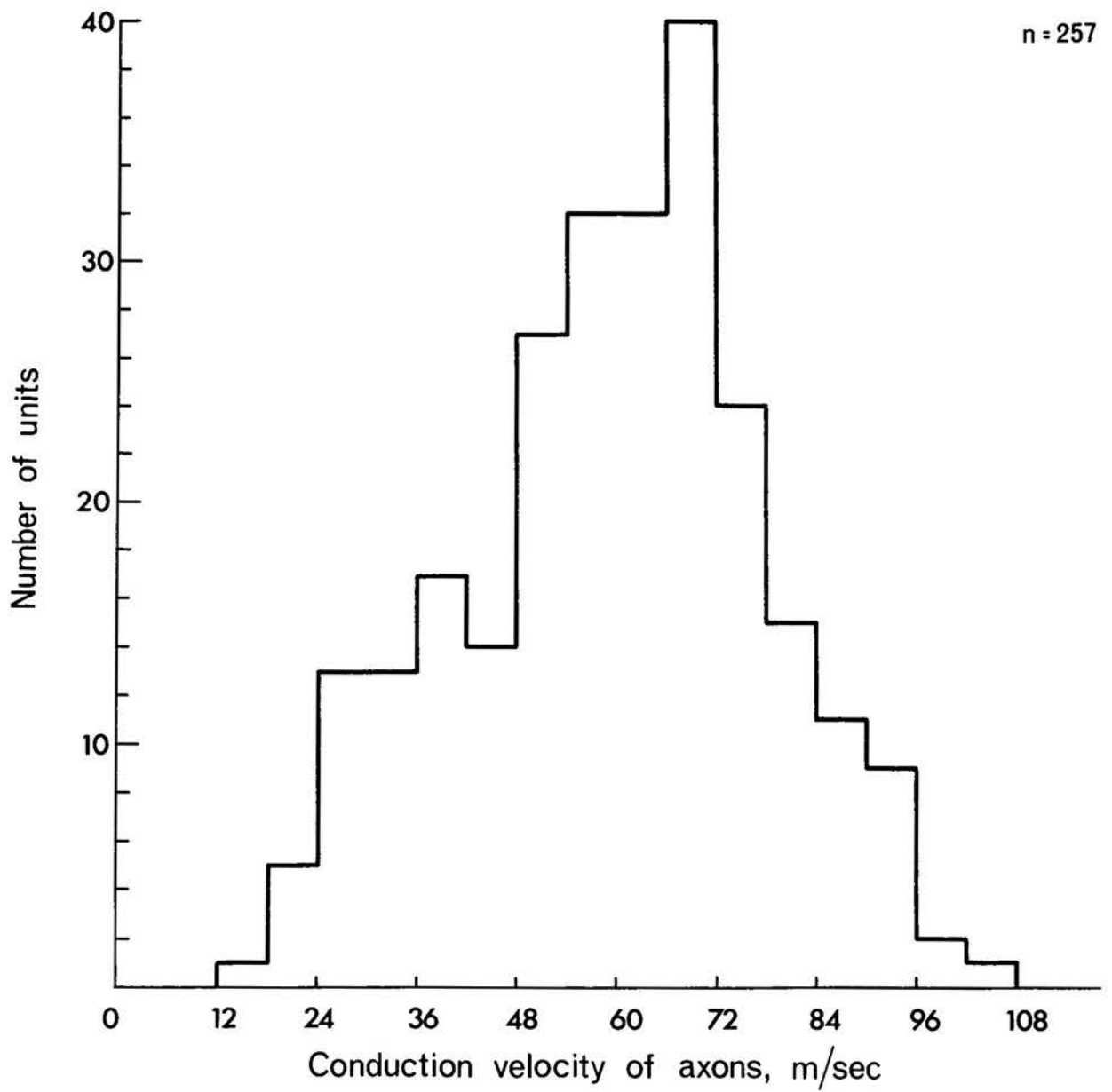

FIGURE 12.

Histograms of the conduction velocities of spinocervical tract axons in spinal cats according to unit type. The composite diagram (bottom) includes 21 units excited by hair movement which were not classified into 'hair only' or 'hair and pressure' types.

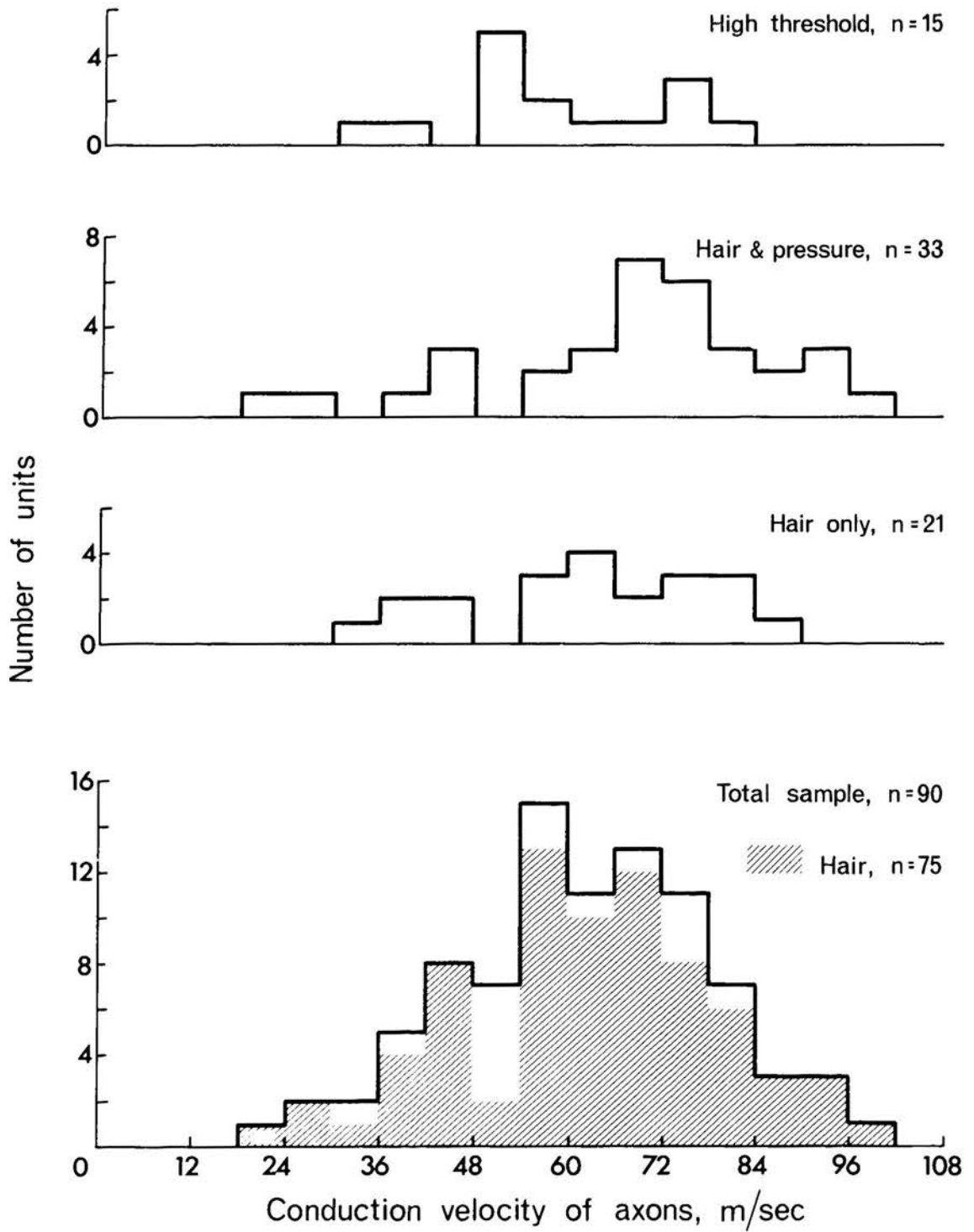
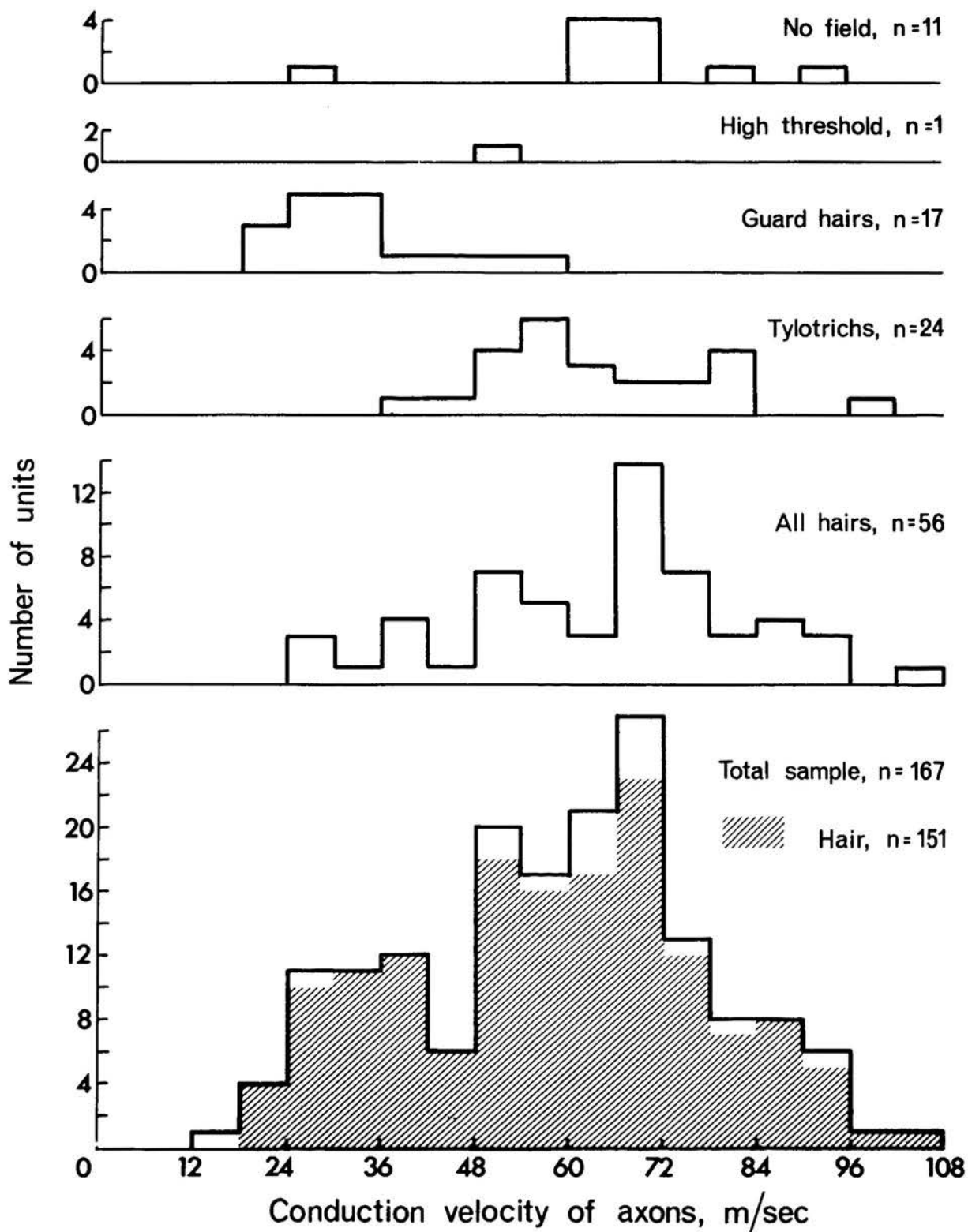

FIGURE 13.

Histograms of the conduction velocities of spino-cervical tract axons in anaesthetized and decerebrate cats according to unit type. The composite histogram (bottom) includes 54 units excited by hair movement which were not classified according to hair type. This figure also includes 4 units in the total sample which were not included in the histograms of unit types because their characteristics could not be accurately defined.



Response of spinocervical tract units to hair movement

The stimulus-response properties of units excited by hair movement were examined. Movement of single hairs, or groups of up to 6 hairs, was produced by the mechanical stimulator, under direct microscopical observation. Units excited by movement of guard hairs only (decerebrate and anaesthetized cats) never responded with more than 1 or 2 impulses when single or small groups of hairs were moved, and then only when the movement was rapid (see FIG. 14A). They were the least sensitive of the units excited by hair movement. This type of behaviour is similar to that of many primary Type G hair follicle afferent units (BROWN and IGGO 1967) and presumably reflects that primary unit activity. All other types of spinocervical tract unit excited by hair movement responded with either 1 or 2 impulses, like the guard hair units, or with a train of up to 12 impulses during movement of the hair at constant velocities down to $0.13 \mu/\text{msec}$ (FIG. 14B).

When a single hair, or a group of hairs, was moved repeatedly at the same displacement velocity, the frequencies of the evoked trains of impulses were similar, particularly at the higher velocities (FIG. 15). Responses

FIGURE 14.

The two types of response of spinocervical tract units to hair movement. A) Only 1 or 2 impulses produced by rapid hair movement (at the 'off' of the stimulus).
B) Trains of impulses produced by different constant rates of hair movement in a single unit.

A

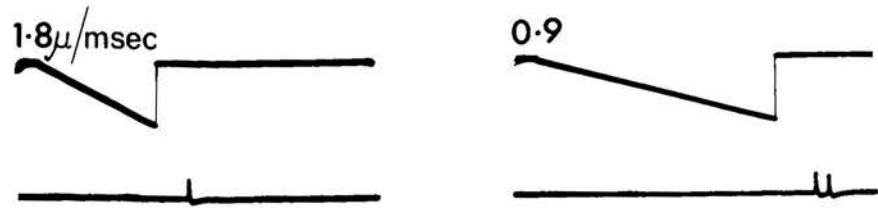

B

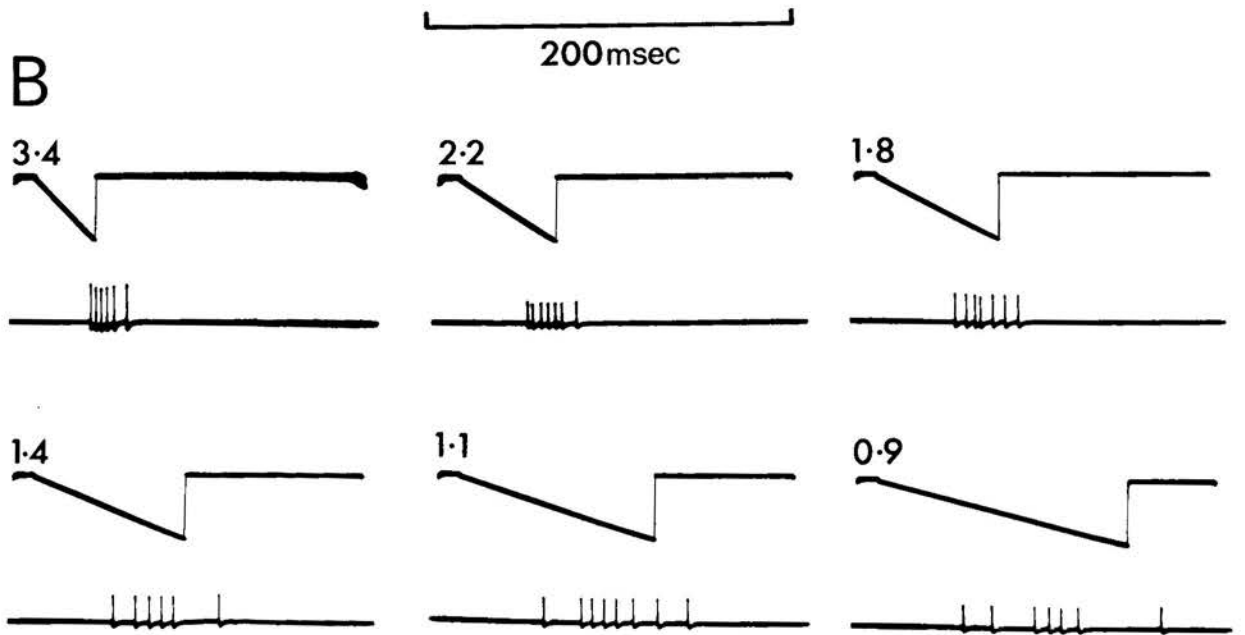

were less constant in spinal animals, particularly at the lower velocities and in units with a high frequency spontaneous discharge. The pattern of discharges for any one displacement velocity were also similar except at the low velocities (FIG. 15).

The relationship between velocity of hair movement and frequency of the evoked response was determined. When the mean frequency of the response (calculated from at least 5 consecutive responses) was plotted against the displacement velocity, on logarithmic coordinates, there was a good fit to a straight line (FIG. 16B,C,D). Thus the displacement-frequency relation for spinocervical tract units satisfies a power function $R = k.S^n$ (STEVENS 1957), where R is the response, S the intensity of the stimulus and k a constant of proportionality. The slopes of the lines in FIG. 16 are the exponents of the power function (n). The values for 11 units ranged from 0.89 to 1.46 (1.09 ± 0.01 , mean \pm S.E.) with most about 1.0. This contrasts with the exponents for primary hair follicle afferent units which range from 0.50 to 0.89 (0.67 ± 0.03 ; BROWN and IGGO 1967, see FIG. 16A) and indicates greater sensitivity in the spinocervical system. The difference between the means of the exponents in spinocervical and primary units is highly significant ($P < 0.001$, t test).

FIGURE 15.

Consistency of the response of a spinocervical tract unit (decerebrate cat) to the same stimulus. Each column shows the consecutive responses of a unit to the same rate of displacement of a group of hairs in the receptive field. The rate of displacement (μ /msec) is shown at the top of each column. The evoked responses are superimposed on the spontaneous activity of the unit. This unit was excited by movement of all three types of hairs.

3·0

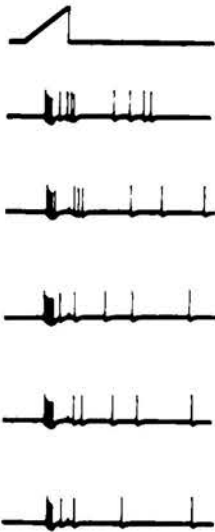

0·9

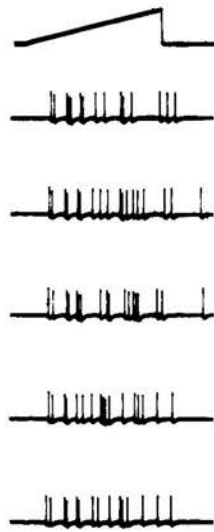

0·45

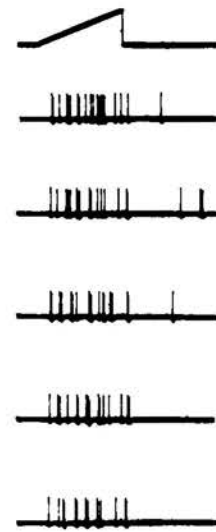

0·29

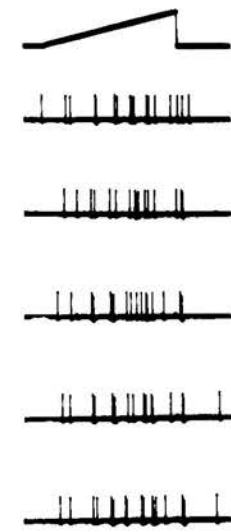

0·12

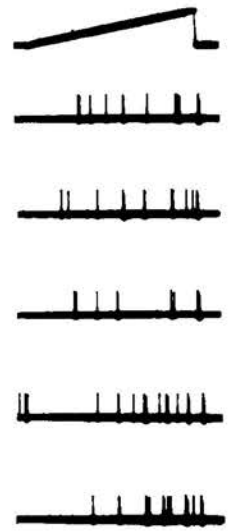
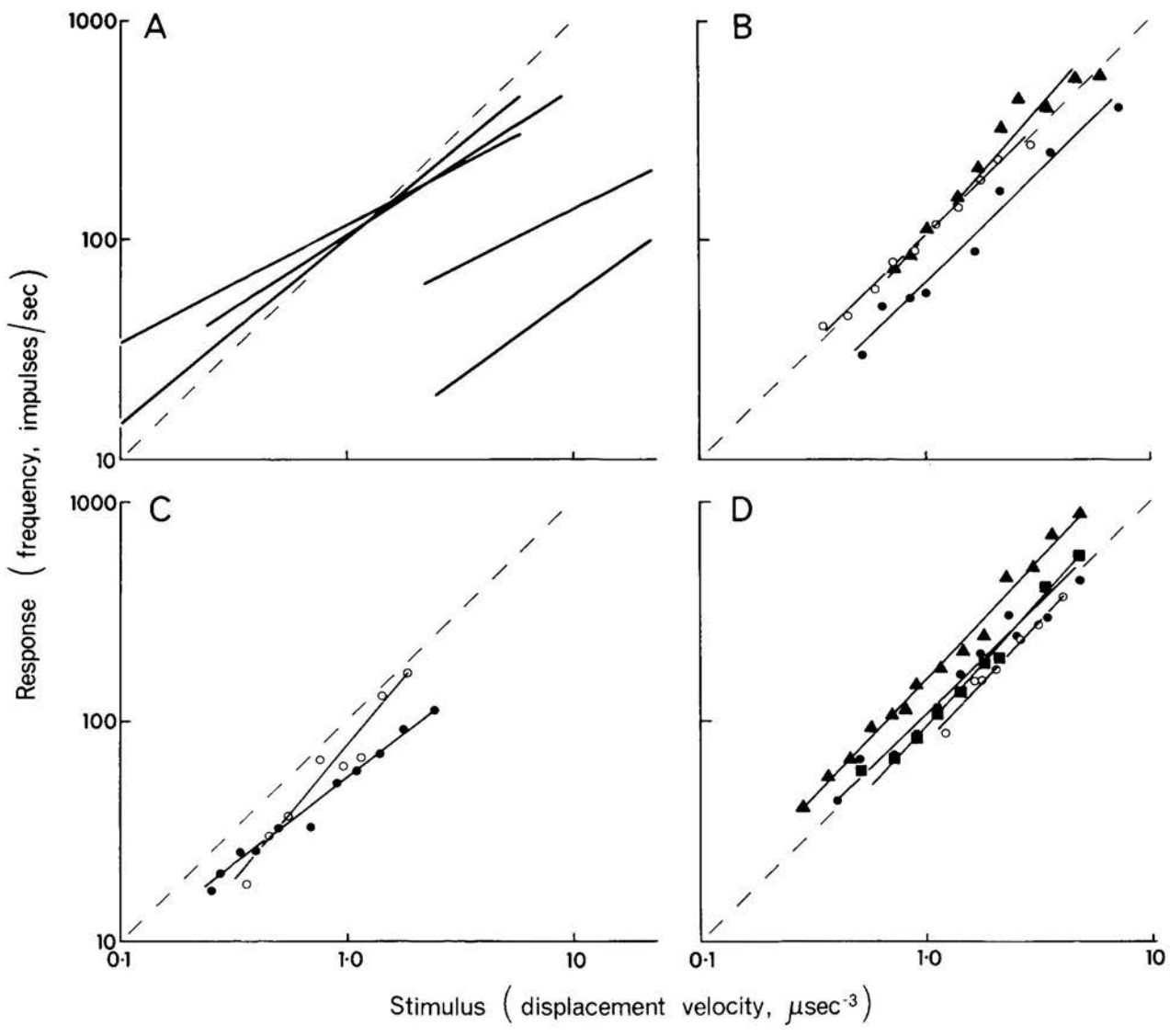

FIGURE 16.

Stimulus-response relationships to hair movement in spinocervical tract cells. Each point is the mean of at least 5 consecutive responses to similar stimuli in the same unit. A) Primary hair follicle afferent units, taken from the paper of BROWN and IGGO (1967) for comparison with the spinocervical tract units. B) Spinocervical tract units in spinal cats. C) Spinocervical tract units in anaesthetized (o) and decerebrate (●) cats excited by movement of tylotrichs. D) Spinocervical tract units in anaesthetized (o) and decerebrate (●) cats excited by movement of all three types of hairs. The dashed reference line in each figure has a slope of unity.



Thermal sensitivity of spinocervical tract units

The temperature sensitivity of spinocervical tract units was examined using the thermode described in Methods. This thermode, held rigidly in a micromanipulator, was placed on the skin. Thus although there was mechanical stimulation due to the pressure exerted by the thermode this stimulation was constant.

Spinocervical tract units in all three types of preparation responded to high skin temperatures (over 40°C) with an increased frequency of discharge. The two types of unit, in spinal cats, which were excited by hair movement had the greatest response; units in decerebrate and anaesthetized cats excited by movement of guard hairs or tylotrichs had the least response. The maximal response occurred at $50\text{--}65^{\circ}\text{C}$ in different units and could be as high as 40 impulses a second and 4 times the frequency of the discharge at neutral skin temperatures (FIGS. 17, 18). These responses were repeatable for any one unit if the skin temperature was raised and lowered several times (3 or 4). The high temperatures did not, therefore, destroy the receptors responsible for this response. The graphs of FIG. 18 show the frequencies plotted against skin temperatures for different types of

FIGURE 17.

Responses of a spinocervical tract unit to different static skin temperatures at the receptive field. The numbers at the left of each tracing indicate the thermistor temperature and the mean frequency of the discharge of the unit. The ^{straight} upper trace in each record is the DC voltage output from the thermistor bridge circuit.

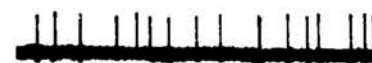
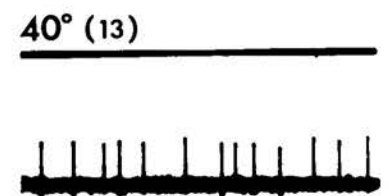
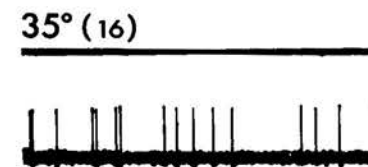
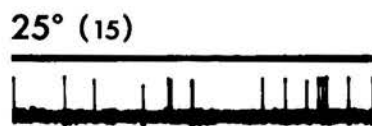
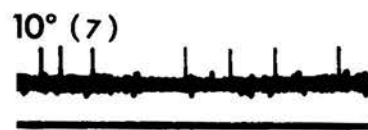
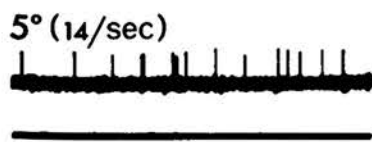

1 sec

FIGURE 18.

Graphs of the responses of spinocervical tract units to thermal stimulation of the receptive fields. Each point is the mean frequency calculated from records of 1-10 sec. duration. A) Spinal cats; units responding to hair movement (○△□), units responding to hair movement and skin pressure (●▲). B) Decerebrate (○△□) and anaesthetized (●▲) cats, units responding to movement of all three types of hairs. C) Anaesthetized cats, units responding to movement of guard hairs. D) Decerebrate (○) and anaesthetized (●) cats, units responding to movement of tylotrichs.

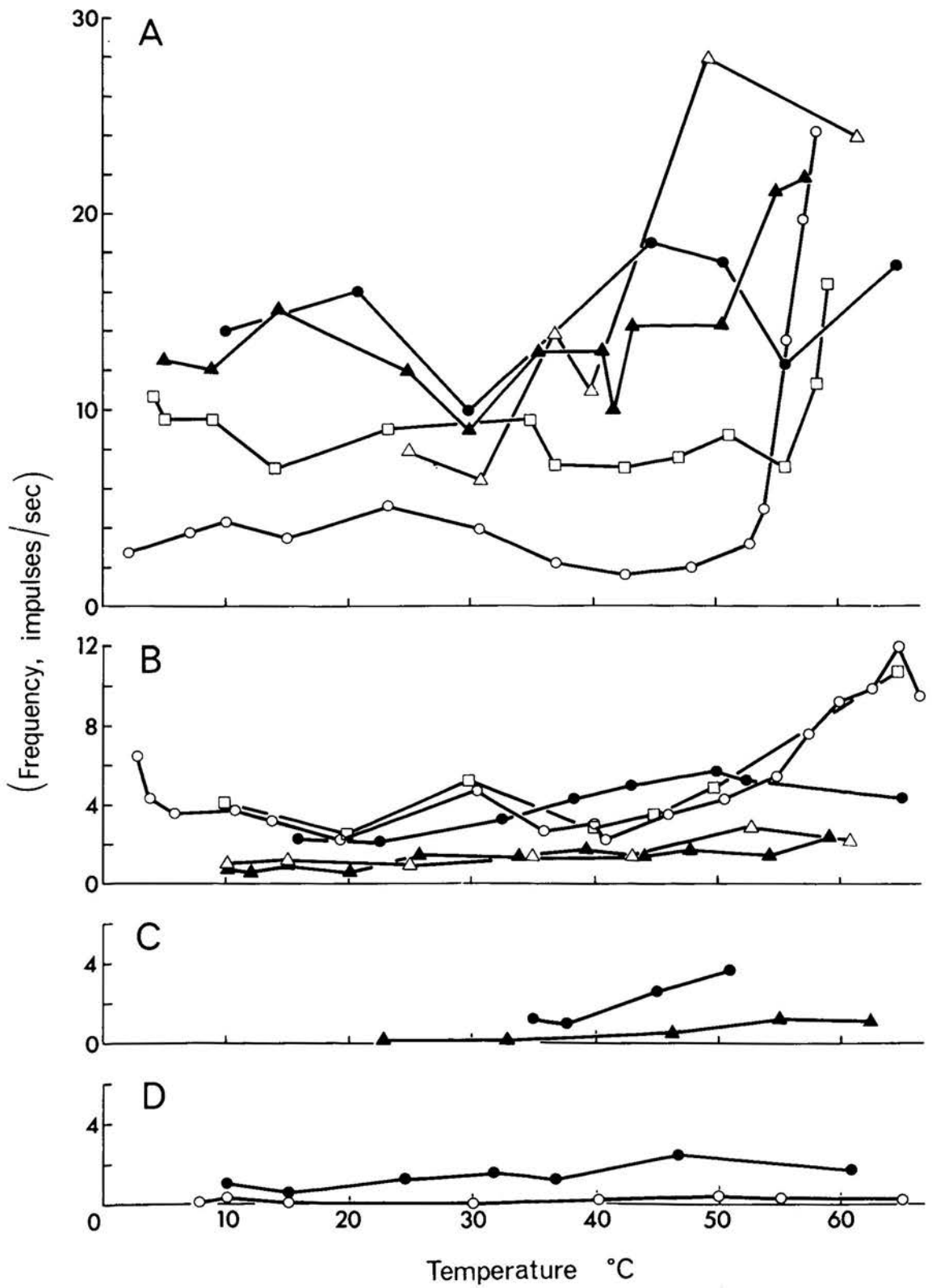

units in different preparations. Those units which were excited mechanically by pressure and pinch usually had their receptive fields on the toes. In this situation there was difficulty in obtaining good thermal contact with the thermode, and responses to high thermode temperatures were correspondingly small. When the excitatory fields of these units were heated by an electric light bulb placed close to the skin, a response was elicited which was similar to that seen in the other types of unit.

In some units there was also an increase in the frequency of discharge at low skin temperatures (FIG. 18). This, when present, was always much less than the response to high temperatures. The increase in frequency began at skin temperatures of 15-25°C and the maximal response occurred at 4-18°C.

The dynamic temperature sensitivity of spinocervical tract units was examined. When the temperature of the excitatory fields was changed, both warming and cooling, at rates of about 1°C/sec the mean frequencies of the discharges at any particular temperature were similar to those at the corresponding static temperatures. There was no obvious effect of warming or cooling the skin of the receptive fields at these rates.

Skin temperatures of 45°C and over are known to excite 'heat' receptors innervated by C fibres (IGGO 1959). The effect of such temperatures on other receptors was studied by recording from strands dissected from the saphenous nerve in an anaesthetized cat. At temperatures above 45°C activity was only recorded from C fibres, and receptors innervated by A fibres could not be excited. In particular, the slowly-adapting responses of touch corpuscles and the intradermal ending failed at skin temperatures above 45°C . At low skin temperatures (less than 20°C) there was little activity from touch corpuscles or the intradermal ending. The only fibres active at frequencies of 5 a second or more at these temperatures were C fibres. The responses of spino-cervical tract units to high and low skin temperatures were, therefore, probably due to activity in axons innervating the 'heat' and 'cold' receptors of IGGO (1959).

DISCUSSION

The present results establish that there are several types of unit in the spino-cervical tract and that the types vary depending on the animal preparation used. In unanaesthetized spinal cats there were three

and the results are in general agreement with those of WALL (1960a, 1967) and MENDELL (1966) with regard to the mechanical sensitivity of the units, since these authors have shown that some spinocervical tract units are excited by hair movement only and some by hair movement and skin pressure. The high threshold units reported in the present work may have been included in the latter group by WALL and MENDELL. In unanaesthetized decerebrate and in anaesthetized cats five types of unit were found and not only one (TAUB 1964) or two (LUNDBERG and OSCARRSON 1961).

The differences between spinal cats and decerebrate cats suggest (in agreement with WALL 1967) that there is a descending neuronal system, active in the decerebrate animal, which inhibits certain of the excitatory inputs to spinocervical tract cells. In the decerebrate animal the spinocervical tract is a much more specific system than in the spinal animal, due to the activity of this control system. The similarity between the results for decerebrate and anaesthetized cats suggests that either this, or other (e.g. the pyramidal tract, FETZ 1968), descending inhibitory system is active in the anaesthetized animal or that the anaesthetic depresses the same systems that are depressed by the descending activity.

There was a logarithmic relation between the stimulus (velocity of displacement) and the response (frequency of discharge) for those units in the spino-cervical tract sensitive to hair movement. That is, the relationship was described by a power function (STEVENS 1957). The exponents of the function ($R = k.S^n$) were 0.89-1.46 and differ from those of primary hair follicle afferent units (0.50-0.89, BROWN and IGGO 1967). The larger exponents in the spinocervical system indicate that there is an increase in sensitivity in transmission through ^{the} spinocervical system. Some of this increase may occur peripherally, due to the innervation of single hairs by more than one afferent fibre (BROWN and IGGO 1967) and to the overlapping of receptive fields of primary afferent units, with receptors of different thresholds, that converge onto a single spinocervical tract cell. Some of the increase may occur at the tract cell itself. The spinocervical tract is a further example of an afferent system where STEVENS' Power Law is applicable.

Some of the contradictions in the literature concerning the effects of thermal stimulation on spino-cervical tract cells are now resolved. It is clearly established, in agreement with BURGESS (1965), that these units are excited by high skin temperatures

(greater than about 40°C). In addition, some units are excited by temperatures of 25°C and below. Reports of the action of ethyl chloride and similar agents acting as cold stimuli must be interpreted with caution (see pp 29-30). The receptors of the down hair follicles are excited by sudden rapid cooling (BROWN and IGGO 1967) and also by the long-lasting mechanical effect of the evaporation (sublimation) of ethyl chloride. Those spinocervical tract units that respond to down hair movement show well-marked responses to ethyl chloride spray, but such responses may be due to the effect of cooling or mechanical stimulation of down hair receptors. In the present experiments there was no response in these units to cooling at rates of $1^{\circ}\text{C}/\text{sec}$, but these rates may be too low to excite.

It is now possible to identify some of the types of primary afferent units that excite spinocervical tract cells. Hair follicle units Types D, G and T have excitatory connections with many spinocervical tract cells. The other types of unit with sensitive mechanoreceptors and large myelinated axons, i.e. Types I and II slowly-adapting units, pad and claw units, do not excite the tract, since movement of touch corpuscles, pads and claws never excited spinocervical tract cells and there were no sensitive spot-like areas in the receptive fields that

would correspond ^{with} ~~to~~ the intradermal endings. The response of spinocervical tract units to high skin temperatures is probably from the 'heat' receptors since these are the only units active at such temperatures. For those units that respond to low temperatures the receptors are probably ~~the~~ 'cold' receptors since there is no activity in the majority of A fibres at these temperatures. There are several candidates for the role of receptors activated by heavy pressure and pinch. They may be either the nociceptors innervated by A delta fibres and/or the nociceptors innervated by C fibres. Furthermore, it is not possible on the basis of the present results to form any conclusion as to whether the hair follicle receptors innervated by C fibres excite the spinocervical tract. Further work is needed to clarify the position regarding mechanoreceptive nociceptors and hair follicle receptors innervated by C fibres.

SECTION IV

MODALITY CODING IN THE SPINOCERVICAL TRACT

INTRODUCTION

The results of SECTION III show that a single spinocervical tract cell may be excited by hair movement, skin pressure and both high and low skin temperatures. This SECTION is concerned with whether or not there are any differences in the discharges produced in single spinocervical tract cells by different types of stimuli.

METHODS

The experiments were those of SECTION III and an additional experiment on a spinal cat. Some of the results obtained from animals used in SECTION V have been included.

The discharges of spinocervical tract units were recorded on film. The film was projected through a photographic enlarger and interspike intervals were measured to the nearest 5 msec.

RESULTSSpontaneous discharges

A spontaneous discharge may be defined as a discharge of impulses occurring in the absence of intentional stimulation of the excitatory receptive field. Spontaneous discharges in spinocervical tract units depend on the presence and depth of anaesthesia, on the type of animal preparation used and on activity in dorsal root fibres (TAUB 1964; WALL 1967). The spontaneous activity does not, therefore, arise de novo in the cell, but is due to synaptic activity and probably reflects the excitability of the cell.

All spinocervical tract units in spinal cats had a spontaneous discharge. In decerebrate animals, with the exception of units with no receptive field, all units but one had a spontaneous discharge. In cats anaesthetized with chloralose the majority of units had a spontaneous discharge at frequencies less than 5 a second.

In spinal cats the frequency of the spontaneous discharge, measured over at least 10 sec, depended on

the type of unit; units excited by hair movement, $5.13 \pm 0.47/\text{sec}$ (mean \pm S.E., $n = 14$), units excited by hair movement and skin pressure, $6.73 \pm 0.49/\text{sec}$ ($n = 26$), units excited by pressure and pinch $11.07 \pm 1.07/\text{sec}$ ($n = 10$). The frequency of discharge of units excited by pressure and pinch was significantly higher than that of the others (P less than 0.025 and 0.01 respectively, t test). The mean rate of spontaneous discharge for all spinocervical tract units was greater in spinal cats than in decerebrate cats, mainly due to activity in units excited by pressure and pinch, which were silent in decerebrate animals (see SECTION V). For all types of units excited by hair movement, however, there were significantly different rates between spinal and decerebrate cats (spinal $6.15 \pm 1.83/\text{sec}$, $n = 40$; decerebrate $3.49 \pm 1.47/\text{sec}$, $n = 14$; P less than 0.005, t test).

Visual examination of records revealed that the spontaneous discharge was irregular and characteristically consisted of groups of 2 to 5 impulses separated by varying periods of silence (up to about 10 sec for units with the lowest frequencies) or by a number of single impulses. Impulse interval histograms (first-order) showed that the discharge was not described by the Poisson distribution, since the histograms all decayed at rates longer than the Poisson type and had a 'right-

hand tail' (FIG. 19). This deviation from a Poisson distribution is emphasized in the semi-logarithmic plots in FIG. 19 and was supported by the relation between the mean and standard deviation of the intervals. For 18 of 23 units the mean interval was shorter than the standard deviation. For a Poisson distribution they are the same and for a gamma distribution (Poisson distribution with a dead time) the standard deviation is less than the mean (GOLDBERG, ADRIAN and SMITH 1964).

Joint interval histograms provided a more detailed examination of the spontaneous discharges. This test, introduced by RODIECK, KIANG and GERSTEIN (1962) allows the detection of an ordered pattern of intervals. The abscissa represents the duration of the first of a pair of intervals and the ordinate the second of the pair, when each interval in a train of impulses is paired with the succeeding one. Joint interval histograms of the spontaneous discharges of 3 units are shown in FIG. 19. The features common to all units examined (23) was the strong tendency for short intervals (10 msec or less) to follow short intervals, as shown by the accumulation of points near the origins of the graphs. In most units there was a tendency for short and long intervals to alternate, as shown by the high density of points near to both axes.

FIGURE 19.

Spontaneous activity in spinocervical tract units.

Each set of graphs consists of data from the same unit. The units are identified at the top of each set; each column shows a) the impulse interval histogram, b) the impulse interval histogram plotted semi-logarithmically to emphasise the non-Poisson-like distributions, c) joint interval histograms of the duration of the second of a pair of intervals (T_2) plotted against the first of the pair (T_1). The accumulation of points near to the origin and the two axes in each joint interval histogram is characteristic for spinocervical tract units.

UNIT 68-9-10 SPINAL HAIR & PRESSURE

a)

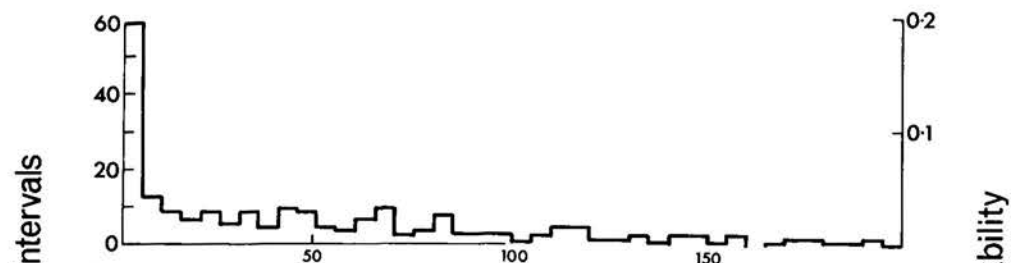

b)

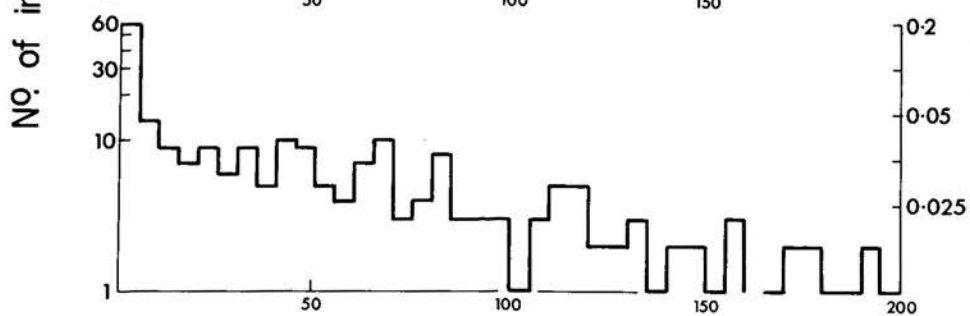

c)

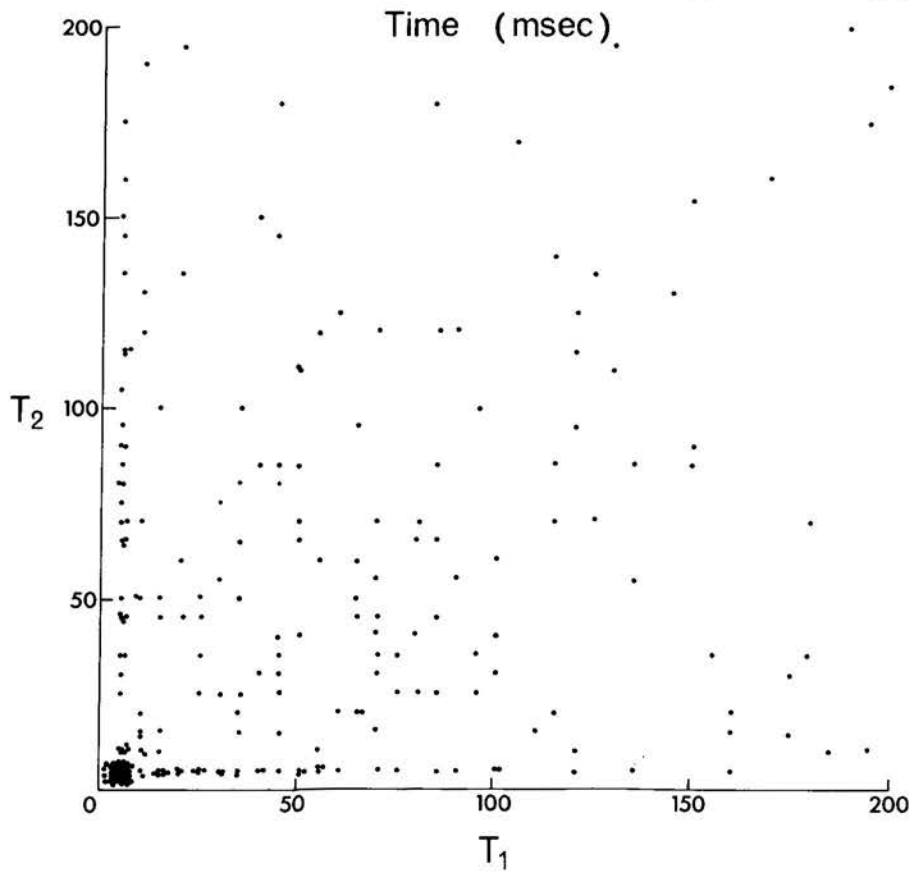

UNIT 68-7-5 DECEREBRATE DGT

a)

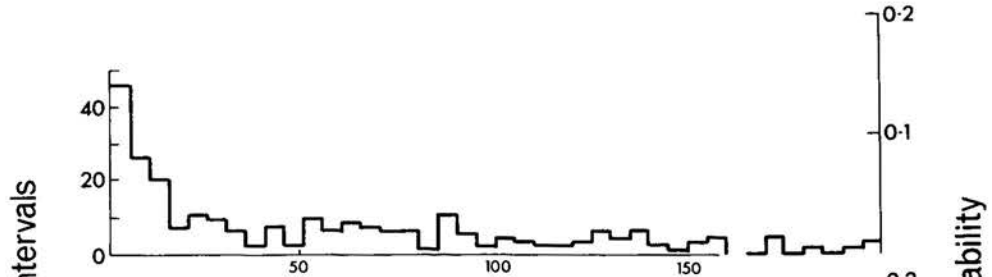

b)

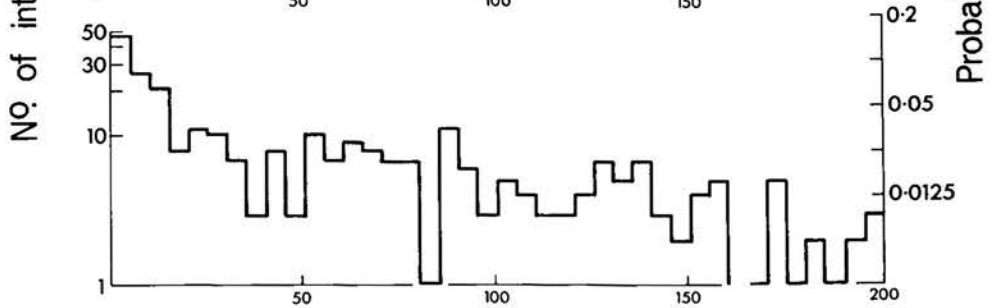

c)

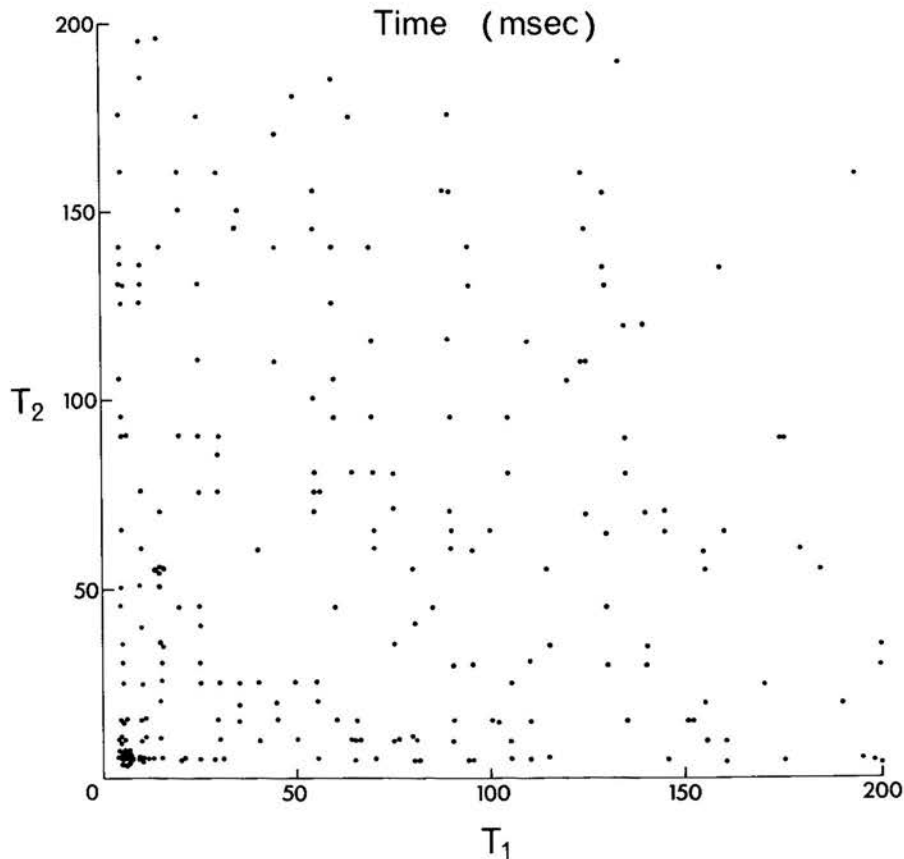

UNIT 67-16-2 SPINAL HIGH THRESHOLD

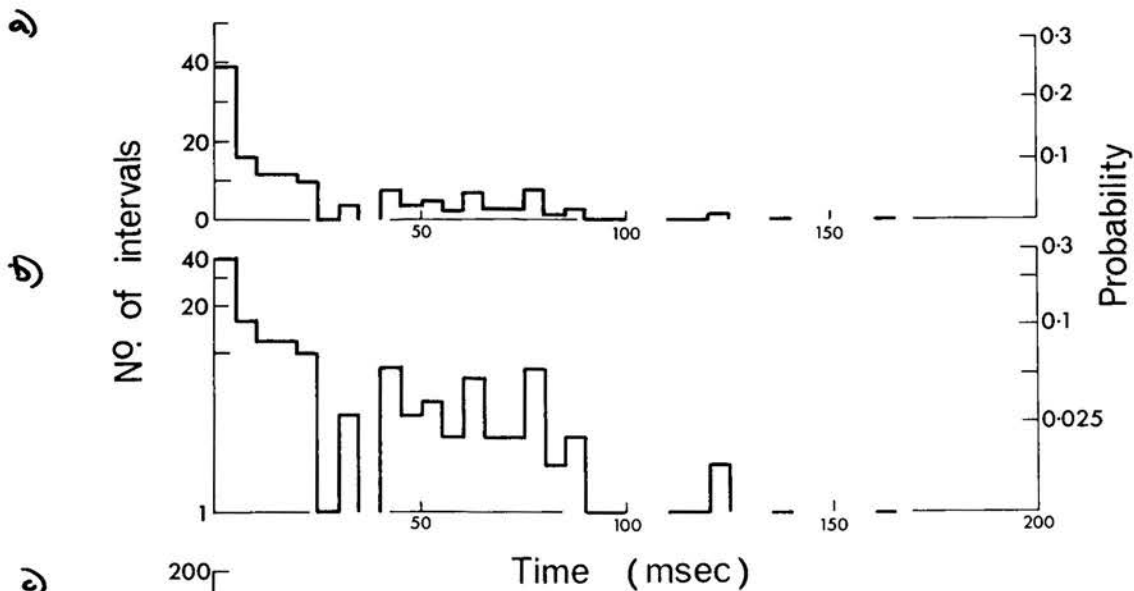

For a more detailed analysis of the spontaneous discharge it would be necessary to use more sophisticated tests, such as the determination of serial correlation coefficients (GOLDBERG, ADRIAN and SMITH 1964) and to examine longer periods of activity. The qualitative results described here will suffice for purposes of comparison with the characteristics of the evoked discharges.

Responses to skin pressure and squeeze

Not all spinocervical tract units respond to pressing or squeezing the skin of the excitatory receptive field (see SECTION III). The discharges of units that do respond to these stimuli were examined, and for the 21 units the results were similar. There was little change in the overall character of the discharge compared with the spontaneous discharge. The only changes were a decrease in the value of the mean impulse interval, corresponding to the increase in the frequency of the discharge, but at the same time, a lower probability for the occurrence of very short intervals (10 msec or less). However the probability of the occurrence of short intervals was still greater than of any other. These effects are illustrated in FIG. 20, where the spontaneous activity and the activity evoked by squeezing

FIGURE 20.

Responses of spinocervical tract units to squeezing the skin. Each pair of impulse interval histograms shows A) the spontaneous activity and B) the activity evoked by squeezing the skin with artery forceps, for a single unit.

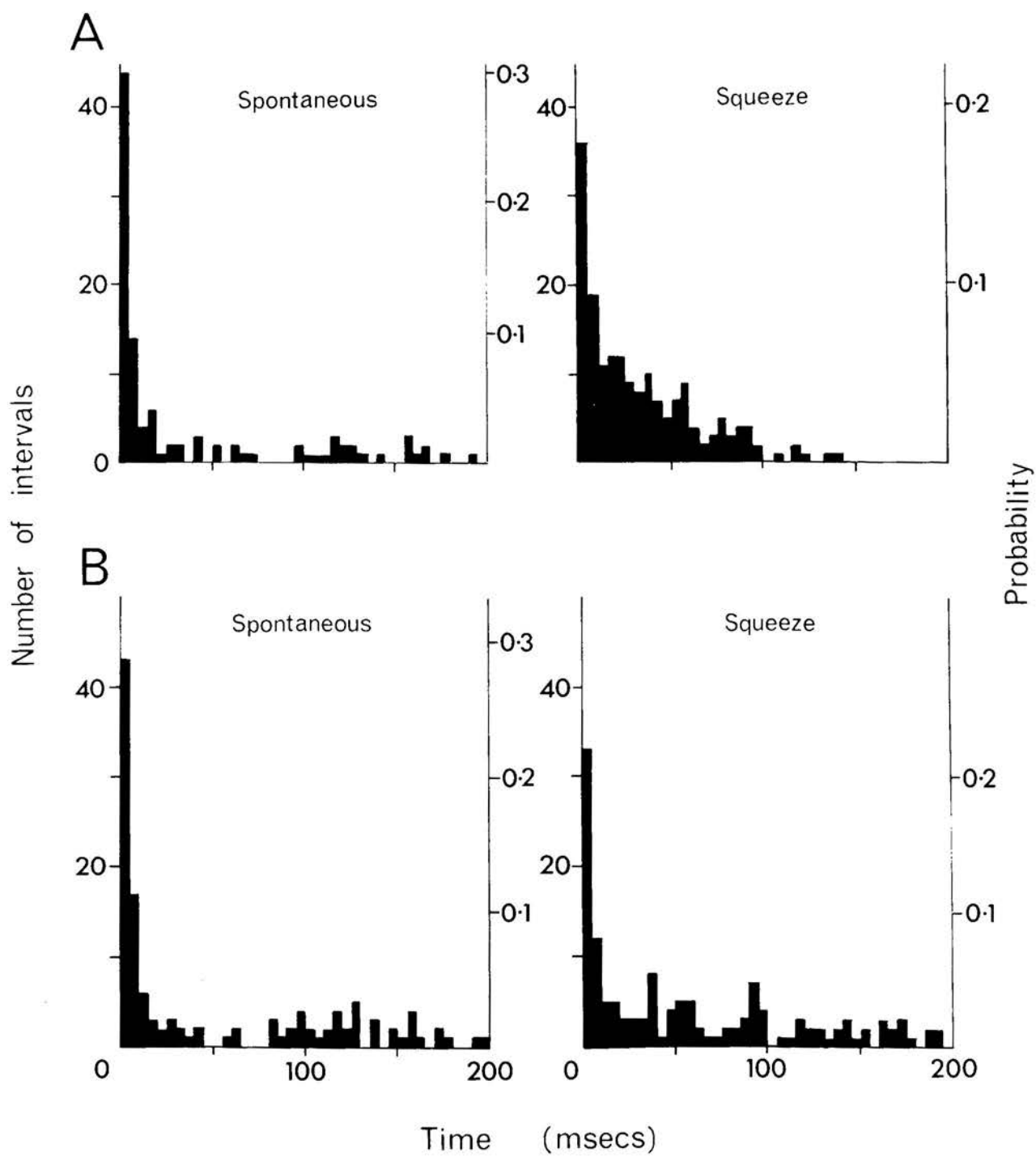

the skin with artery forceps are compared by means of interval histograms.

Responses to thermal stimulation of the skin

The characteristics of the discharges evoked in some units by heating the skin above about 40°C were markedly different from those of the spontaneous discharges and the discharges evoked by pressure and pinch. These units were those, in spinal cats, excited by hair movement and skin pressure, and those, in decerebrate cats, excited by movement of all the hairs. Units, in spinal cats, excited by pressure and pinch were not examined, and units, in decerebrate cats, excited by movement of guard hairs or tylotrichs did not give sufficiently well-marked responses for analysis.

As the skin temperature was raised to levels that led to an increase in the frequency of discharge, the response changed from an irregular discharge with a preponderance of short intervals to a fairly regular discharge with very few short intervals. This can be seen in the records of FIG. 17 (SECTION III) at the higher temperatures. When the results were plotted as impulse-interval histograms there were striking differences

in the shapes of the histograms at different skin temperatures (FIG. 21A,B). As the skin temperature was raised the mean and modal values for the impulse intervals approached each other, and over a narrow range of temperatures they were very close (FIG. 21A,B). The increased regularity of the discharge at high skin temperatures was also reflected in the changes of the coefficients of variation of the intervals. This is shown in FIG. 22 (filled symbols, solid lines) where the coefficient of variation is plotted against skin temperature. As the temperature was raised through the threshold for eliciting a change in frequency of the discharges, the coefficients of variation fell to reach minimum values in the temperature range where the mean and modal values were closest. Then, as the temperature was raised further, the coefficients increased, corresponding with a greater preponderance of short intervals in the discharge. If the skin temperature was raised to these high values 3 or 4 times, the responses recorded from a single unit were similar each time (see FIG. 23). It is concluded that the receptors responsible for the response ('heat' receptors) were not damaged by the high skin temperatures.

For the unit illustrated in FIG. 23, discharges

FIGURE 21.

Responses of spinocervical tract units to thermal stimulation. The units are identified at the top of each set of interval histograms. The numbers on the extreme right (preceded by a + sign) indicate the number of intervals greater than 200 msec. The temperatures ($^{\circ}\text{C}$) are indicated towards the right of the histograms. It can be seen that the units excited by hair movement and skin pressure in spinal (A) and decerebrate (B) cats have histograms characterized by similar mean and modal values at high skin temperatures, with very few short intervals (less than 10 msec) at the high temperatures compared with the temperatures below 40°C . The units excited by hair movement only in spinal cats (C,D) have histograms with a great preponderance of short intervals at all temperatures.

A. Spinocervical tract, spinal cat 67-24-9 Hair & pressure

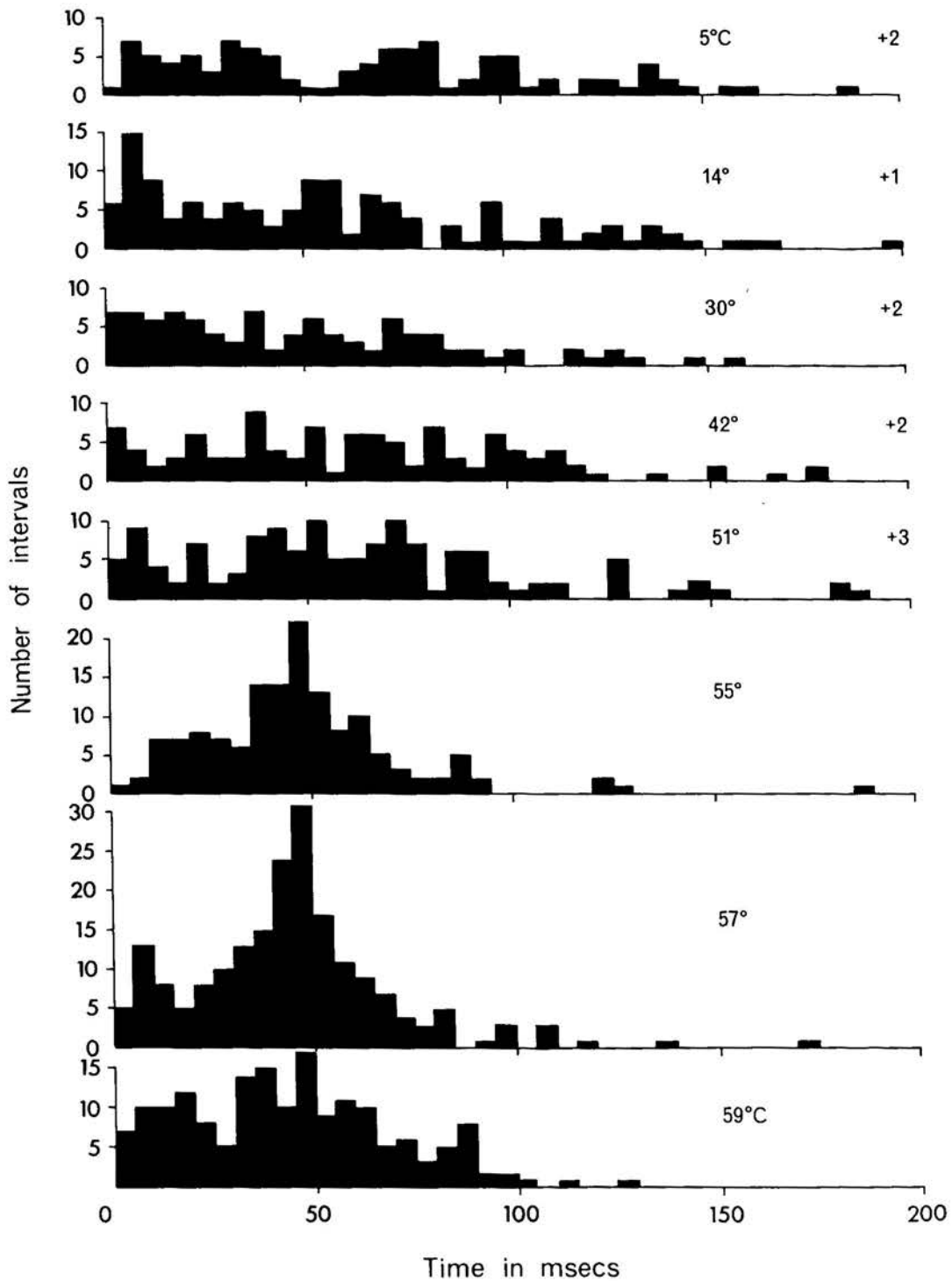

B. Spinocervical tract, decerebrate cat 67-25-22 DGT

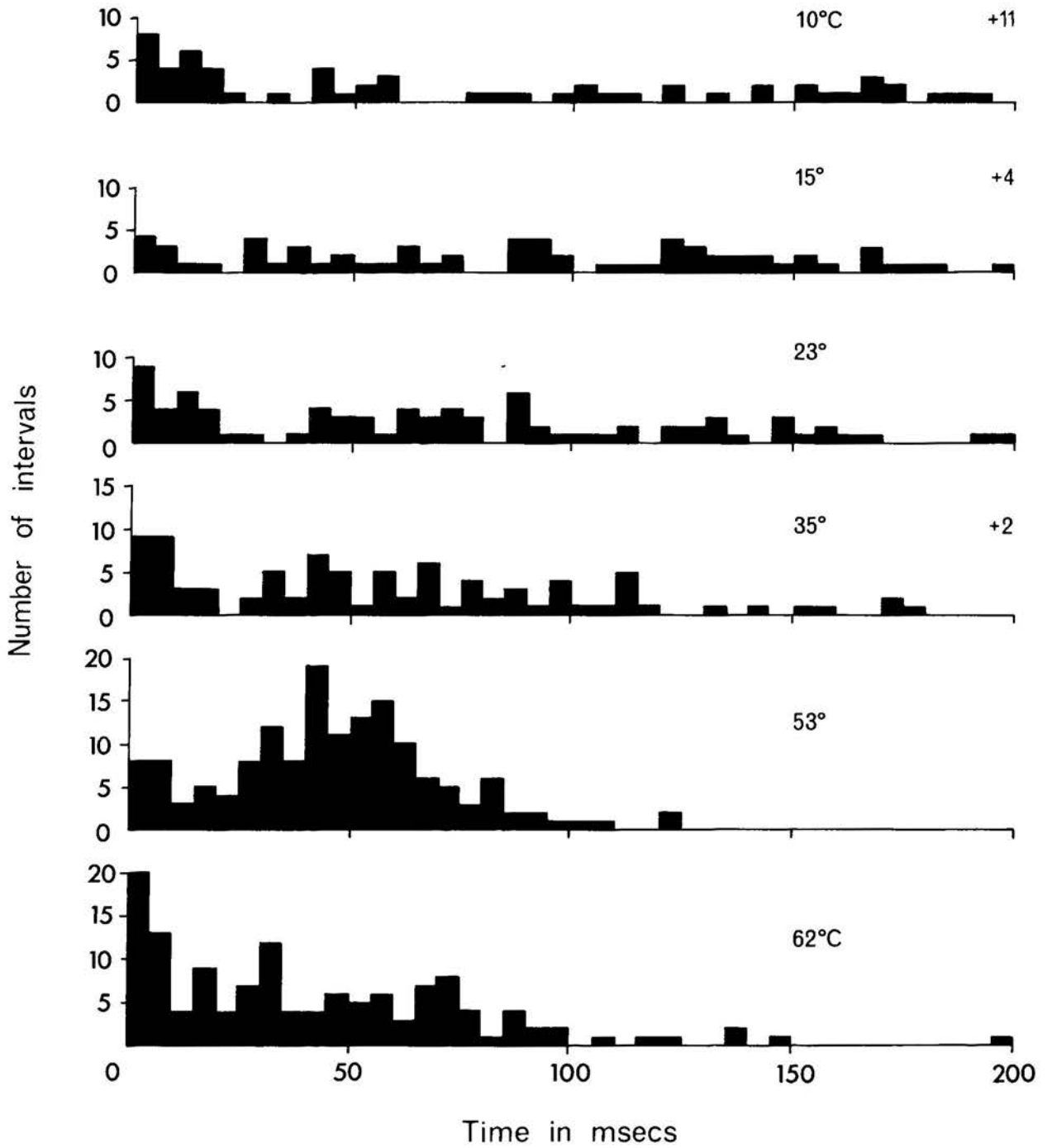

C. Spinocervical tract, spinal cat 67-24-11 Hair only

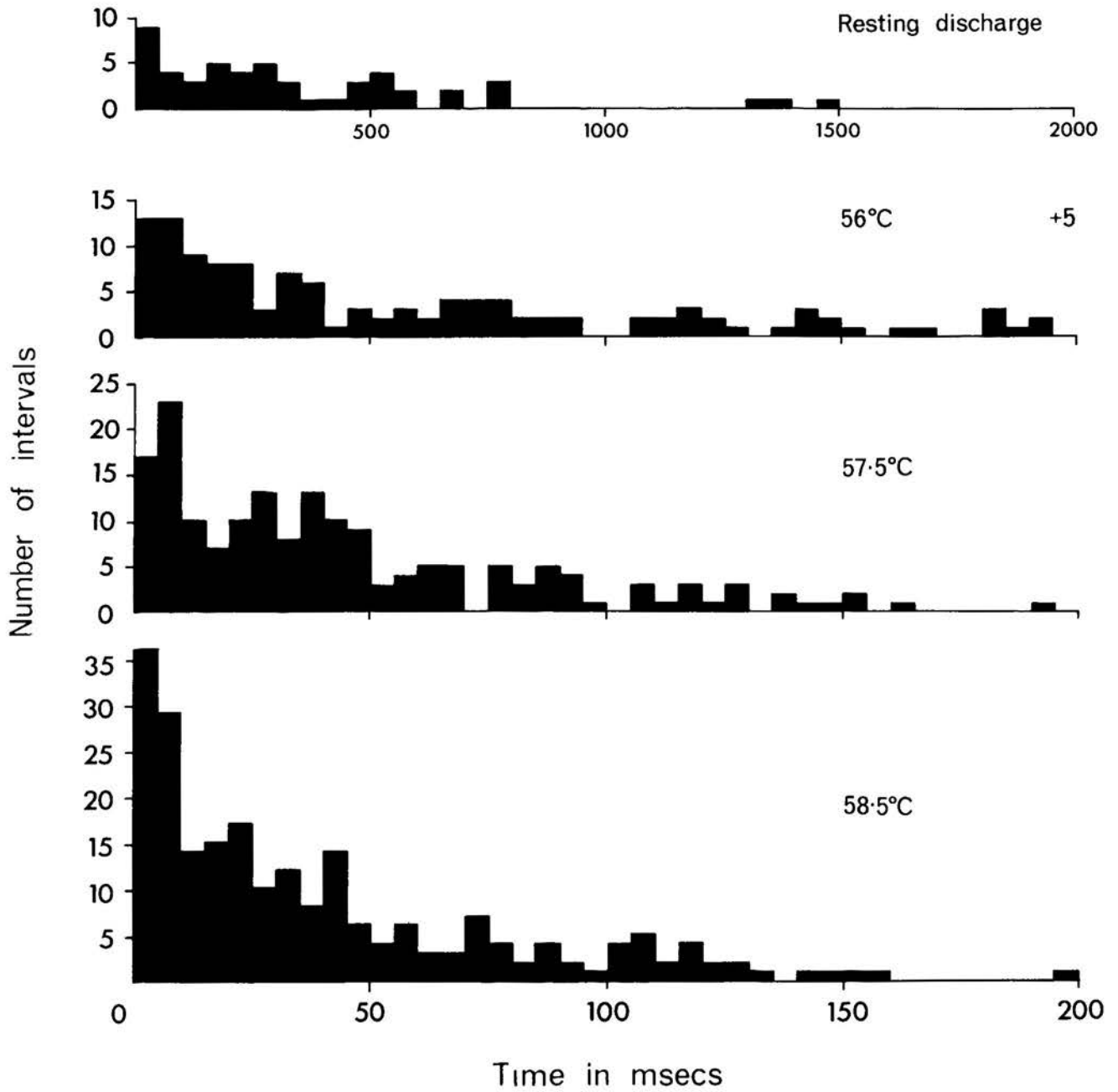

D. Spinocervical tract, spinal cat 67-24-12 Hair only

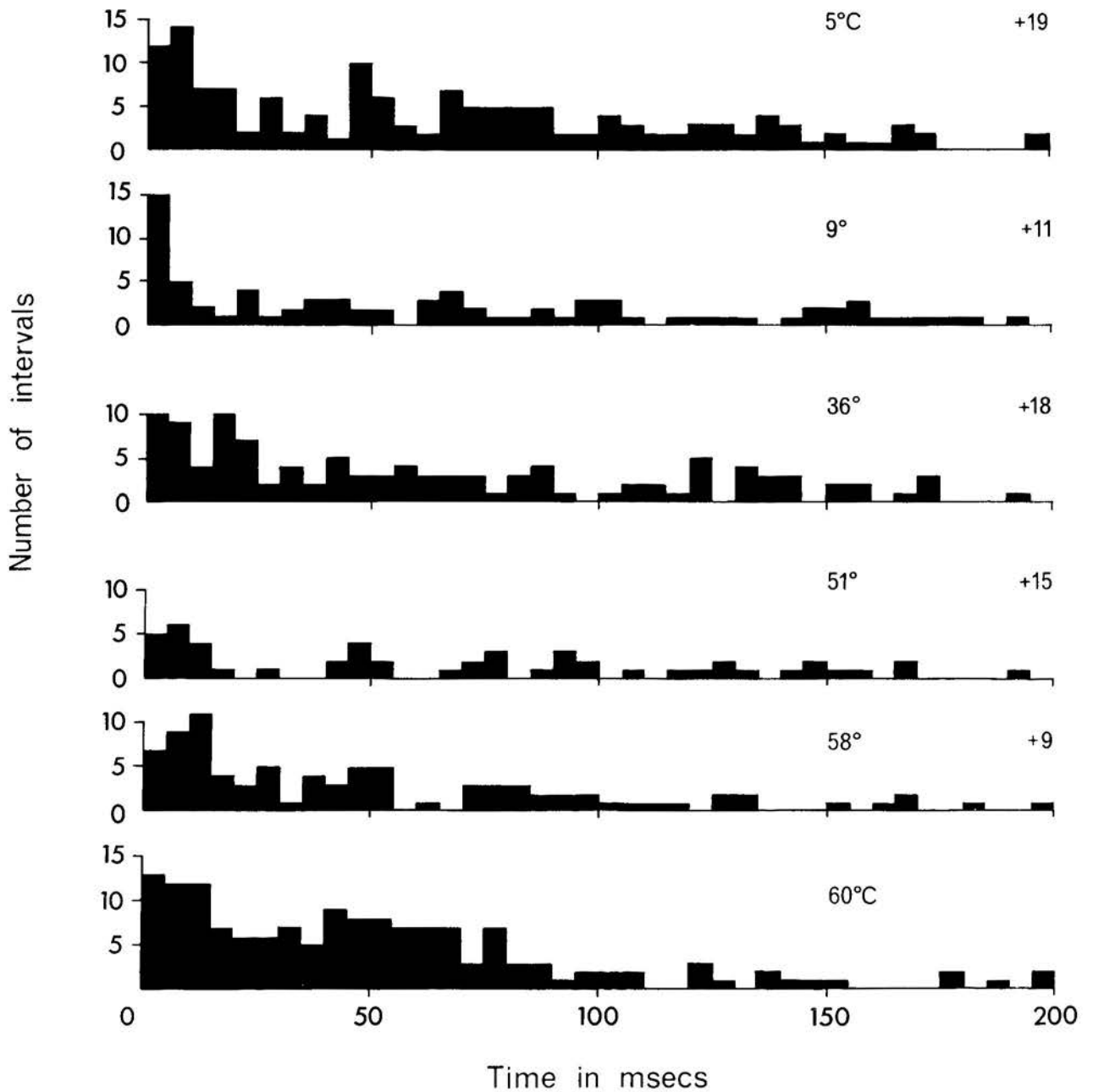
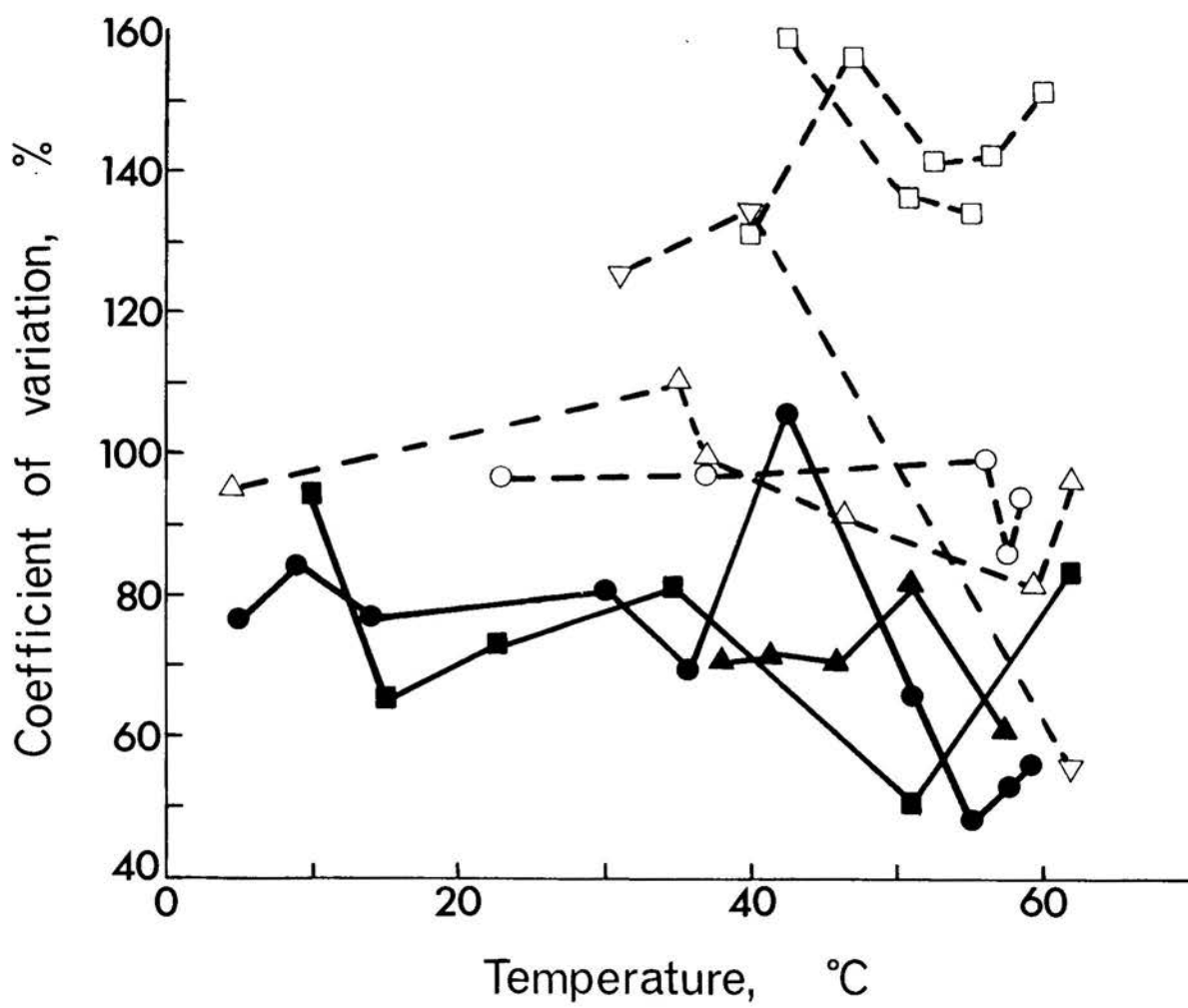

FIGURE 22.

The changes in the coefficient of variation of the impulse intervals of spinocervical tract unit discharges at different skin temperatures. Units excited by hair movement only, spinal cats, - open symbols and dashed lines. Units excited by hair movement and skin pressure, spinal cats, - filled symbols and continuous lines.



were recorded at 16 static skin temperatures, between 2° and 61°C, and the higher temperatures were repeated. This unit was unusual in that it showed very little change in the mean frequency of the discharge throughout this temperature range (FIG. 23Q). The pattern of the discharge changed, however, as shown by the interval histograms (FIG. 23A-P) and the graph of coefficient of variation of the intervals against skin temperature (FIG. 23R). The discharge became most regular at skin temperatures of about 45-48°C. The repeatability of the results shows that heating the skin to about 61°C for some 15 seconds did not greatly affect the response properties of this unit.

Units, in spinal cats, which responded to hair movement and not to skin pressure, were more varied in their responses to high skin temperatures. There was little change in the characteristics of the discharge in 4 of 5 units examined in spite of changes in the frequency of the discharge (see FIG. 18A). The discharge remained irregular with a preponderance of short intervals, at all skin temperatures (FIG. 21C,D). Corresponding to this maintained irregularity, the coefficients of variation of the impulse intervals showed little change, although they did show some decrease at the higher temperatures (FIG. 22, open symbols and dashed lines). In one of the

FIGURE 23.

Responses of a single unit to different skin temperatures.

A-P) Impulse interval histograms at the stated skin temperatures. The results were obtained in the order A to P. Q) Graph of the mean frequency of discharge against skin temperature. R) Graph of the coefficient of variation of the impulse intervals against skin temperature. In Q and R the arrows indicate the order in which the results were obtained.

Although there is little change in the mean frequency of discharge at the different skin temperatures there are marked changes in the character of the discharge as indicated by the changes in the coefficients of variation and the interval histograms. The effects were repeatable as can be seen from the figure.

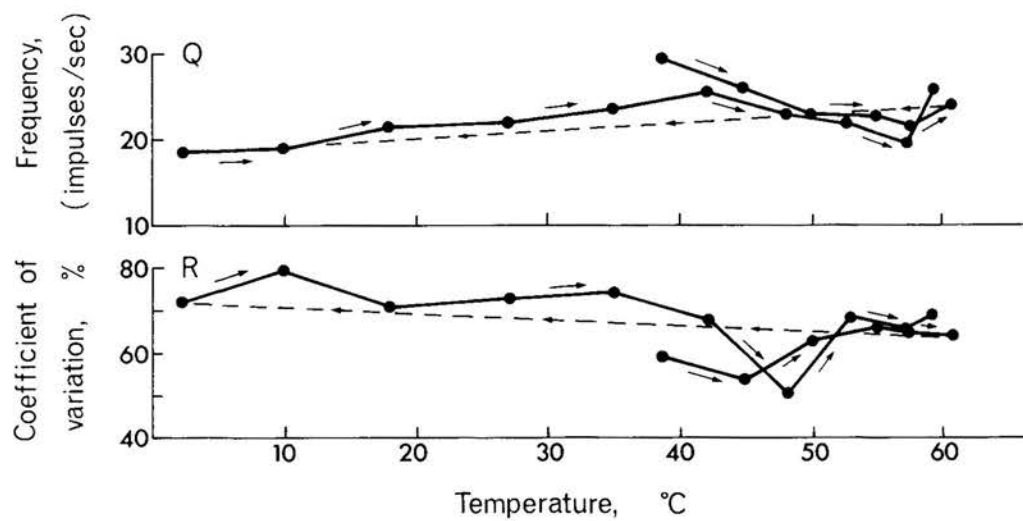
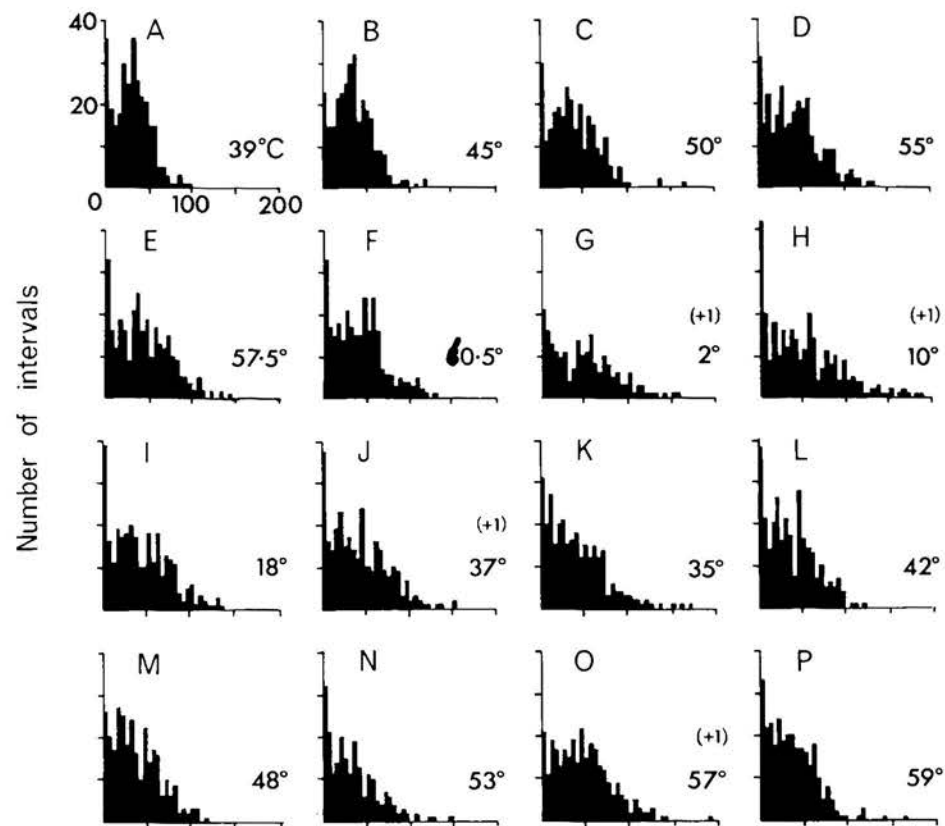

five units of this type there was a change in the discharge at high skin temperatures similar to that seen in units excited by hair movement and skin pressure (FIG. 22--~~4~~--).

The differences between the two types of discharges were not reflected in differences in the mean frequencies of discharge. At similar frequencies of discharge, at high skin temperatures, there were significant differences between the coefficients of variation of the impulse intervals for units with the different types of discharge (9 units, P less than 0.025, t test).

Responses to hair movement

In SECTION III it was shown that there was a power law relation between the mean frequency of discharge during hair movement and the rate of hair movement, for units responding to movement of one or a few hairs with a train of impulses. This discharge is, however, superimposed on the spontaneous discharge of the neurone and the question arises as to whether the response to hair movement can be differentiated from this background activity. It is not sufficient to consider only the mean rate of the spontaneous discharge and to subtract

this from the mean frequency of the evoked response, since the duration of hair movement in these experiments was from 25 to 300 msec and the mean frequency of the spontaneous discharge is no guide to the frequency of the spontaneous discharge sampled over such short periods.

The experiments were not specifically designed to test whether the response to hair movement could be differentiated from the spontaneous activity, but in several units for which the response to hair movement was tested, the spontaneous discharge had been recorded prior to mechanical stimulation. It was thus possible to compare, in retrospect, the resting and evoked discharges.

The characteristic response to hair movement was a train of 3 to about 20 impulses within the period of movement (25-300 msec), which can be seen in FIGS. 14 and 15. Examination of the spontaneous discharges revealed that there ^{were} few periods of spontaneous activity where the requisite number of impulses occurred in a sufficiently short time interval to simulate an evoked discharge. This suggests that the evoked discharge could be differentiated from the spontaneous activity. A quantitative assessment was made by counting the number of impulses occurring in 25 msec periods during

hair movements lasting 25, 50, 100 and 200 msec and the mean and variance calculated. Similar calculations were done for 25 msec periods of spontaneous activity and the sets of data were compared for any significant differences. Results for 4 units are presented in TABLE 5. The frequency of the evoked discharge was always significantly higher than the frequency of the spontaneous activity, when compared in this way.

DISCUSSION

Relatively simple tests have revealed that there are marked differences between the discharges of spino-cervical tract cells, when the discharges are evoked by different kinds of stimuli. The spino-cervical tract is capable of coding stimulus properties in terms of the characteristics of the discharge of a single unit.

Hair movement appears to be coded as a brief, high frequency discharge. This discharge is evoked on a background of spontaneous activity, but movement of even a few hairs will excite a number of spino-cervical tract neurones almost simultaneously and thus increase the possibilities for discriminating the evoked discharge

TABLE 5

Comparison of the spontaneous discharges on spinocervical tract units with
the discharges evoked by hair movement

UNIT	ACTIVITY (Spontaneous or hair move- ment (μ /msec)	No. of 25 msec periods	Mean No. of impulses in a period	VARIANCE	P (t test)
Hairs only (spinal)	Spontaneous	120	0.47	0.78	
	4.8	5	3.20	0.16	< 0.001
	2.4	5	4.20	0.16	< 0.001
	1.2	10	2.10	0.89	< 0.001
	0.6	10	1.40	0.44	< 0.005
Hairs only (spinal)	Spontaneous	60	0.38	0.30	
	2.4	4	4.75	0.69	< 0.001
	1.2	15	1.87	1.44	< 0.001
	0.6	28	1.25	1.55	< 0.001
All hairs (decerebrate)	Spontaneous	40	0.82	0.94	
	4.8	5	2.80	0.16	< 0.001
	2.4	10	1.50	0.05	< 0.025
	1.2	15	2.26	0.49	< 0.001
	0.6	35	1.83	1.33	< 0.001
All hairs (decerebrate)	Spontaneous	26	0.27	0.27	
	4.8	6	3.83	0.51	< 0.001
	2.4	6	6.33	0.26	< 0.001
	1.2	18	2.16	0.33	< 0.001
	0.6	36	1.44	1.65	< 0.001

against this spontaneous activity.

Units which do not respond to skin pressure seem to code the input from 'heat' receptors as an increase in the mean frequency of discharge with little change in its regularity. Units which respond to both pressure and heat have discharges, to the two kinds of stimuli, which differ from one another. The effect of pressure alone is to lead to an irregular discharge of higher mean frequency than the spontaneous discharge. As the skin temperature rises above about 40°C the discharge becomes much more regular. The causes of the change in the output of these units are unknown, but at least two changes occur in their input during skin heating; 1) a reduction in activity in axons of the slowly-adapting mechanoreceptors, with cessation of activity at temperatures above about 45°C , (In the present experiments these receptors would be activated by the pressure of the thermode), and 2) an increase in the activity in axons of the 'heat' receptors at skin temperatures above about 40°C . The changes in the pattern of the discharges at high skin temperatures are not necessarily due to, and are not necessarily accompanied by, an increase in the frequency of the discharge (see FIG. 23). This suggests that a change in the character of the input is more important than an overall increase in input frequency.

At skin temperatures above 45°C activity in peripheral cutaneous nerve fibres is limited almost exclusively to those of the 'heat' receptors. This activity excites two types of spino-cervical tract cells, responding either to hair movement or to hair movement and skin pressure. The inputs to the two types of tract cells are presumably very similar, if not the same, but the outputs differ greatly. The properties of the systems between input and output (e.g. position, number and size of synaptic terminals and the properties of the post-synaptic cell) therefore contribute to the characteristics of the discharges.

Whatever the causes of the differences in output of spino-cervical tract neurones, the differences imply that the spino-cervical tract has the potential to code stimulus type as well as stimulus intensity. In 1928 ADRIAN stated, "....it would make for economy if one and the same nerve fibre could be used to signal non-painful stimulation by a brief discharge and a painful sensation by a much longer one." The spino-cervical tract seems to show such economy.

SECTION V

CONTROL OF THE SPINOCERVICAL TRACT IN DECEREBRATE PREPARATIONS

INTRODUCTION

It was suggested in SECTION III that the differences between spinocervical tract units in unanaesthetized decerebrate and unanaesthetized spinal cats were due to the activity of a descending neuronal system. The experiments of the present SECTION were performed to compare the properties of individual spinocervical tract units recorded in both the decerebrate and spinal state and to examine the effects of the operation of the descending system.

METHODS

The experiments were performed on 7 decerebrate cats. The aim was to record from a spinocervical tract axon in both the decerebrate and spinal state. In order to convert from the decerebrate to the spinal state, a reversible cold block of the spinal cord was used. This was achieved by a thermoelectric thermode, similar to the one used for skin stimulation, but with a modified head which fitted around the dorsal half to two thirds of the cord (FIG. 24). The thermode was placed on the

exposed spinal cord at T 11 - L 1. The dorsal roots under the thermode were cut close to the cord to aid apposition of the thermode and cord. When the temperature of the thermode was lowered to about 0-3°C the antidromic response of spinocervical tract axons to stimulating the dorsolateral funiculus at C 3 was blocked. The dorsal columns were left intact in these experiments and stimulation of the dorsolateral funiculus at C 3 with supramaximal shocks elicited an orthodromic response in spinocervical tract units through the dorsal column axon collaterals. This orthodromic response was blocked at about the same time as the antidromic one. No other controls of the adequacy of the spinal cord block were carried out, but when the anti- and orthodromic responses were blocked the spinocervical tract units behaved as if the spinal cord were sectioned.

RESULTS

Twenty units were successfully examined in both the decerebrate and spinal states. In addition, a further 12 units were examined in one or other of the states. The properties of the 32 units were in agreement with those presented in SECTION III and some of the results from the 12 units examined in either the decerebrate

FIGURE 24.

Thermoelectric thermode used for reversible spinal cord block. A) View from the ~~side~~. B) View from the face.

A

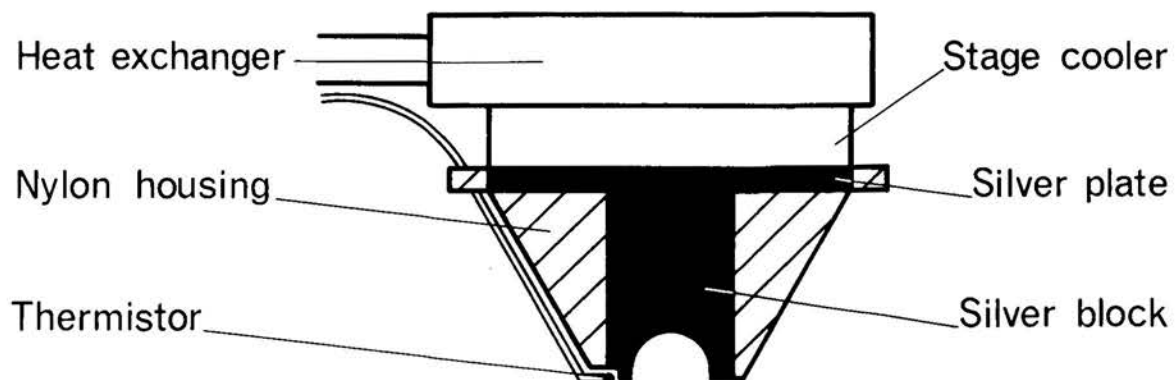

B

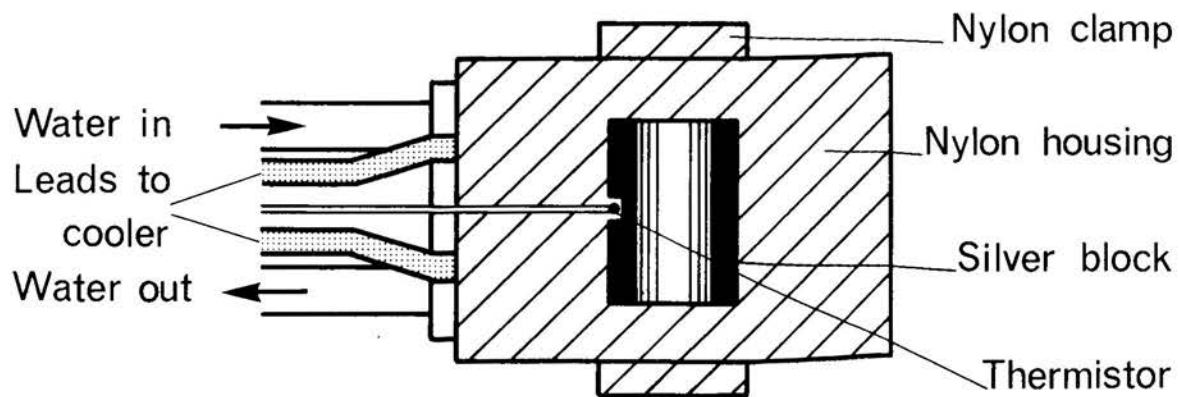

1 cm

or the spinal state have been included in SECTION IV.

Receptive fields of the units

The receptive field properties of the units were the same as described previously. That is there were three types of units in spinal cats and four types in decerebrate cats. When the preparation was converted from the decerebrate to the spinal state, or vice versa, the properties of the receptive fields changed. TABLE 6 presents the results for the 20 units examined in both states. For 4 of these units the preparation was converted from decerebrate to spinal and back to decerebrate again and the units remained true to type. Units excited only by movement of tylotrichs in decerebrate cats became excited by hair movement alone in spinal cats. Units excited either by movement of guard hairs or all the hairs in decerebrate cats became excited by hair movement and skin pressure in spinal cats. That is, the units excited by hair movement and skin pressure in spinal cats contained 2 subgroups. The units excited by movement of guard hairs only, in decerebrate cats, had low conduction velocities (18-24 m/sec) and this confirms the assumption made previously that the group in spinal cats with low conduction velocities contains

TABLE 6

Equivalence of spinocervical tract units in decerebrate and spinal preparations

Number of units	Type in decerebrate cat	Type in spinal cat
2	Excited by movement of tylotrichs only.	Excited by movement of all the hairs, not by pressure.
3	Excited by movement of guard hairs only. (2/3 also excited by pressure).	Excited by movement of all the hairs and by pressure.
14	Excited by movement of all the hairs (7/14 also excited by pressure).	Excited by movement of all the hairs and by pressure.
1	No excitatory receptive field.	Excited by pressure and pinch.

these units. Only one unit with no receptive field or spontaneous discharge in the decerebrate state was held long enough to change the preparation to the spinal state. This unit converted to the type excited by pressure and pinch of the skin and subcutaneous tissues.

Although the properties of the excitatory receptive fields of spinocervical tract units changed with the change from one state to the other, the overall size of the fields remained the same in the two states. This is in agreement with the results of WALL (1967) for cells in lamina IV of the dorsal horn.

Inhibitory fields of units changed markedly when the preparation was converted from decerebrate to spinal or vice versa. Units with no inhibitory receptive fields in the decerebrate state often had them in the spinal state (FIG. 25). When units in the decerebrate state had inhibitory fields they were more difficult to inhibit than the same units in the spinal state. This is shown in FIG. 26, where the effects of squeezing the inhibitory field (the contralateral ankle) of units in the decerebrate and spinal preparation are compared.

FIGURE 25.

Receptive fields of individual spinocervical tract
units in both the decerebrate and spinal state.

A) Decerebrate, B) Spinal.

Key: Excitatory fields - black.

Inhibitory fields - dotted - moderate pressure.

cross-hatched - pinch.

A

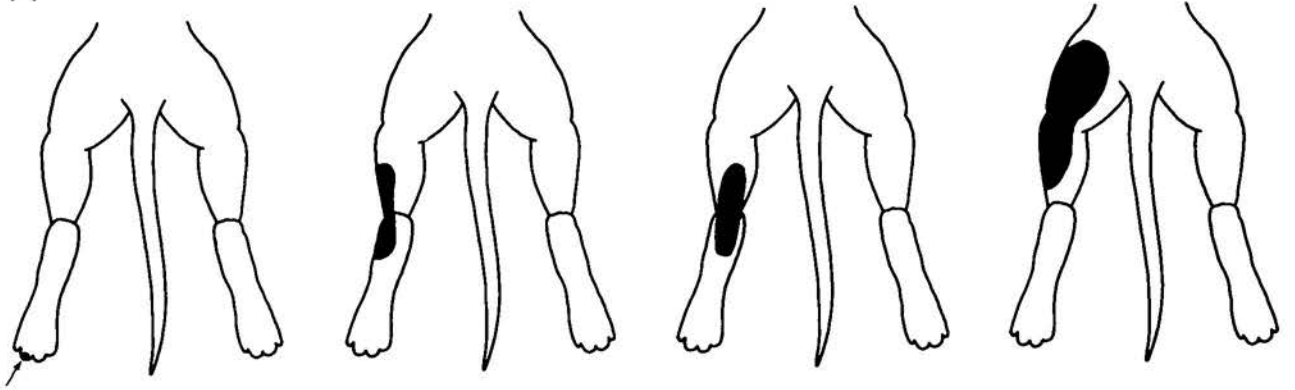

B

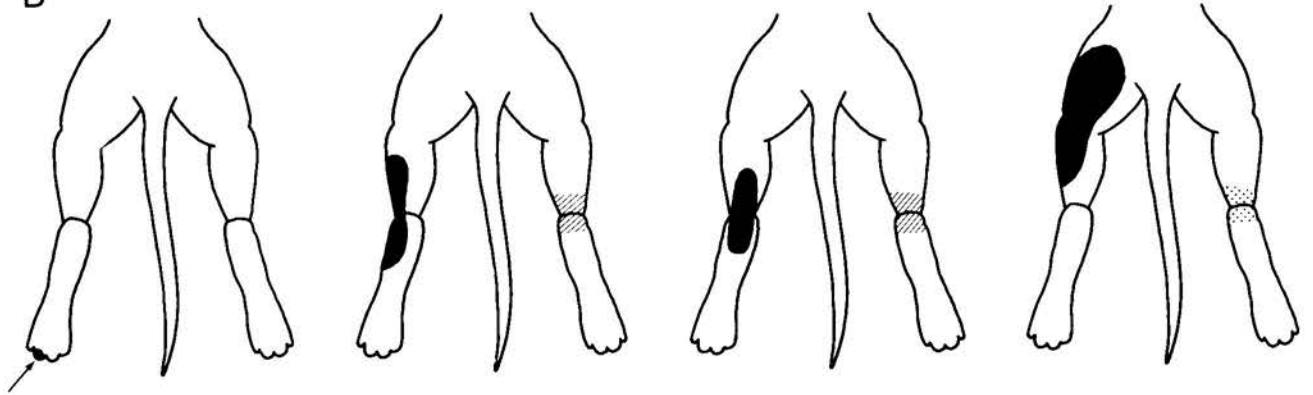
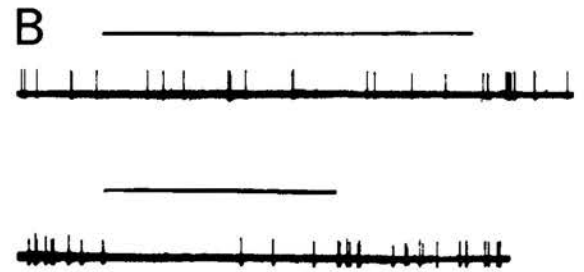
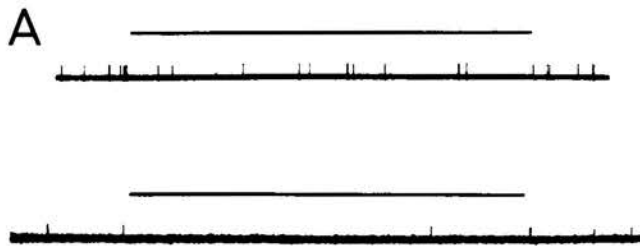

FIGURE 26.

Release of inhibition to spinocervical tract units
on conversion from the decerebrate to the spinal state.

Each pair of records shows the effect on the spontaneous activity of squeezing the contralateral ankle in ^(upper traces) A) the decerebrate and ^(lower traces) B) the spinal preparation. The bar over each record indicates the approximate duration of squeezing.



1 sec

Responses to mechanical stimulation

The observations made on units in either the spinal or decerebrate cats (SECTION III) were confirmed. The responses to pressure on the skin were much easier to evoke and were more pronounced in the spinal state than in the decerebrate state. In the decerebrate state units that responded to movement of guard hairs or all the hairs responded little, and sometimes not at all, to pressure and even pinch of the skin of the receptive field. When the preparation was converted to the spinal state these units responded to skin pressure with a well-marked increase in frequency of the discharge (FIG. 27, TABLE 6).

Responses to hair movement were more variable but supported the results of SECTION III, which showed that there were no consistent differences between the stimulus-response relations of units in decerebrate and spinal cats. The 2 units illustrated in FIG. 28 both had higher frequencies of discharge and responses composed of a greater number of impulses at any given rate of hair movement in the spinal state. For 3 other units 2 showed no consistent change in the responses and 1 had the greater response in the decerebrate state. These 5 units were all of the same type. They were

FIGURE 27.

Response of a unit to pinch in both the decerebrate and the spinal state. Responses were evoked by squeezing the skin with artery forceps. A) Decerebrate, B) spinal.



1 sec

FIGURE 28.

Stimulus-response relationships of spinocervical tract units to hair movement in both the decerebrate and spinal state. Open symbols - decerebrate; closed symbols - spinal.

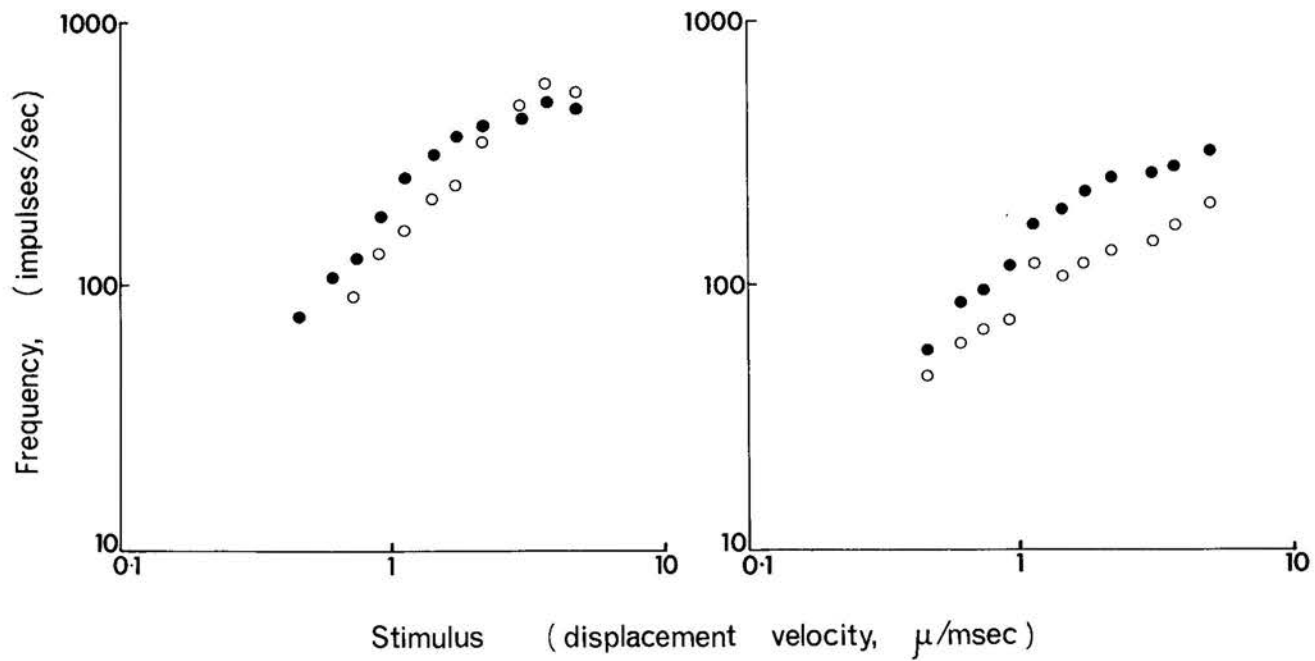

excited by movement of all the hairs in the decerebrate state and by hair movement and skin pressure in the spinal state. A much larger sample of units, including all types, would be needed to determine if there are any significant differences between the responses in the two preparations.

Responses to thermal stimulation

The results of heating the receptive fields of units in both the decerebrate and spinal states confirmed the results of SECTION III. In the spinal state, heating the skin led to a relatively greater increase in frequency of discharge than in the decerebrate state, as shown in FIG. 29. The response in the spinal state was greater even though the frequency of the spontaneous discharge tended to be higher in the spinal state.

DISCUSSION

These experiments have confirmed that there are consistent differences between spinocervical tract units in decerebrate and in spinal cats. The differences

FIGURE 29.

Responses of spino-cervical tract units to thermal stimulation of the receptive fields, in both the decerebrate and spinal states. Open symbols - decerebrate; closed symbols - spinal. The units are identified at the upper ^{top}~~right~~ corner of the figure.

- | <u>Decerebrate</u> | | <u>Spinal</u> | |
|--------------------|----------------|---------------|-----------------|
| ○ | DGT | ● | Hair & pressure |
| □ | T | ■ | Hair |
| △ | DGT & pressure | ▲ | Hair & pressure |

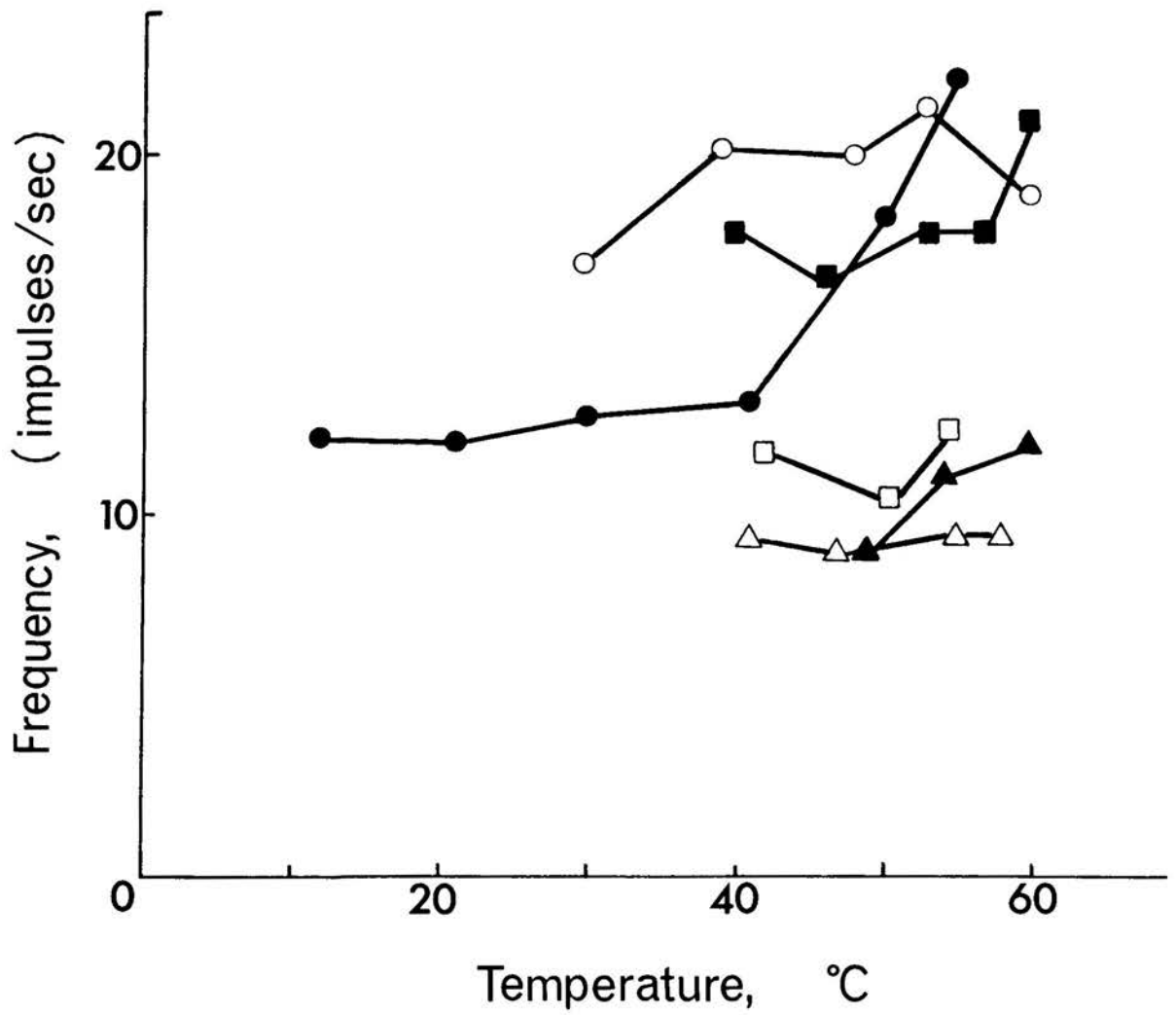

are apparently a result of the activity of a descending neuronal system which is active in the decerebrate cat and not in the spinal cat. At first ^{site} ~~site~~ the actions of this system may seem to be a general inhibition of input from receptors innervated by the smaller axons (the flexor reflex afferents?). Closer examination of the results, however, shows a more specific action. In the decerebrate animal the spinocervical tract is particularly well-adapted to transmitting information about hair movement. Some units respond to movement of guard hairs, some to movement of tylotrichs and some to movement of all the hairs. The units responding only to guard hair movement require considerable spatial summation of the input to fire more than a few impulses and are suited to transmitting information about hair movement over a large area. Units excited by movement of all the hairs are very sensitive to harmful skin temperatures, but this stimulation is more efficacious in the spinal state. In the spinal state there are responses to a much wider range of stimuli together with the unmasking of a type of unit that seems to be completely inhibited in the decerebrate state, that is, the type excited only by pressure and pinch.

The descending system prevents many inhibitory actions on spinocervical tract cells. This effect does

not seem to fit in with the actions on the excitatory effects, which makes the spinocervical tract more selective. If, in addition to their projection to the lateral cervical nucleus, spinocervical tract cells project to other cells in the spinal cord at the segmental level, as suggested by WALL (1967), then some meaning may be attached to the effects of the descending system on the inhibitory inputs. The release of inhibition in the spinal state may underly important segmental reflexes, e.g. inhibition of a flexor reflex by a contralateral flexor reflex. However, until more is known of the segmental connections of spinocervical tract cells and the actions of other descending systems such as the corticospinal tract (FETZ 1968) it is premature to speculate on the function of the inhibitory inputs to the spinocervical tract.

SECTION VI

GENERAL DISCUSSION

The experiments reported in this THESIS establish that, by careful control of the stimulating conditions, it is possible to examine the responses of central neurones to excitation of individual types of cutaneous receptors. Previous work has either considered only a few types of receptors (e.g. WERNER and MOUNTCASTLE 1968) or has used crude stimuli that excite many different types at the same time, e.g. brushing the hairs and skin with hand-held probes, ethyl chloride spray. The present advance is mainly due to a combination of direct microscopical examination of the receptive fields with visual control of stimulus placement, and the use of well-controlled natural stimulation techniques. The fact that some of the cutaneous receptors have a high degree of stimulus specificity (e.g. the thermoreceptors, 'heat' and 'cold' receptors, guard hair and tylotrich follicle receptors, Pacinian corpuscles) further aids such investigations.

Those cutaneous afferent units that project to the dorsal column-medial lemniscal and the spinocervical-lemniscal systems have now been identified by these methods. The summary diagram of FIG. 30 illustrates the excitatory inputs to the two systems from identified primary afferent units and the unidentified units with a high mechanical threshold. The dorsal columns are

FIGURE 30.

Summary diagram of the cutaneous afferent unit inputs
to the dorsal column and spinocervical systems.

Key: PC.....Pacinian corpuscle units (inter-
osseous membranes).
PAD RA.....Rapidly-adapting units from the
foot pads.
PAD SA.....Slowly-adapting units from the
foot pads.
CLAW.....Units sensitive to claw movement.
SA I.....Slowly-adapting Type I units.
SA II.....Slowly-adapting Type II units.
HThMMy.....High threshold mechanoreceptive
units with myelinated axons, (A alpha-gamma).
HF T.....Hair follicle units Type T.
HF G.....Hair follicle units Type G.
HF D.....Hair follicle units Type D.
HEAT.....Heat units.
COLD.....Cold units
PRESSURE.....Mechanoreceptive units with ? C fibres.
PINCH.....Mechanoreceptive units with high
thresholds and A delta and/or C fibres.

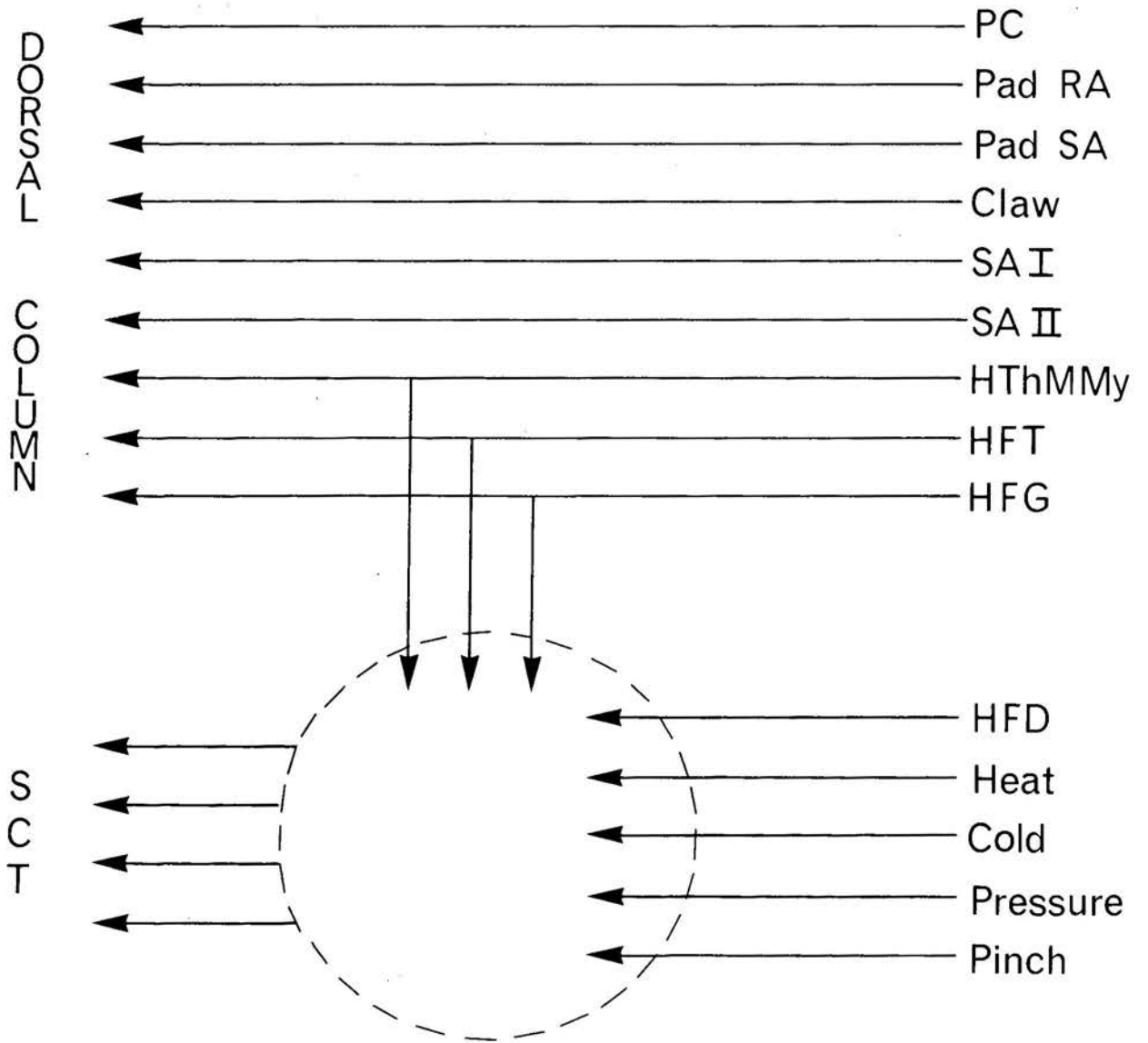

concerned almost exclusively with information from sensitive mechanoreceptors. There are a few axon collaterals of insensitive mechanoreceptors in the dorsal columns, a conclusion also reached by GORDON and JUKES (1964). The spino-cervical tract transmits information from the hair follicle receptors but is also concerned with harmful stimuli such as pinch and heat. The spino-cervical system, in contrast to the dorsal columns, does not convey information from touch corpuscles, intradermal endings or receptors of the pads and claws. The two ascending systems complement one another and between them carry information from all the known types of cutaneous receptors with the exception of the sensitive thermoreceptors.

The conduction velocities of axons in the two ascending systems differ considerably (see FIGS. 1 & 11). The spino-cervical tract contains faster conducting axons than the dorsal columns, but there are many differences between the rates of transmission of information from different receptor types along axons of the two systems. Thus the fastest dorsal column fibres are axon collaterals of the rapidly-adapting pad receptors which do not excite spino-cervical tract cells. The cutaneous receptors with the fastest pathway to the cervical spinal cord are undoubtedly those of the tylo-trich follicles, which

have the fastest peripheral axons (BROWN and IGGO 1967) and which excite spinocervical tract cells with the highest conduction velocities. In general, the hair follicle unit input through the dorsal columns is slowed down (about 50-60%) whereas transmission through the spinocervical tract is slowed very little, and for the input from Type D hair follicle units is speeded up considerably, even after taking into account the time for synaptic transmission. One possibly important function of the spinocervical-lemniscal system is to speed up the rate of transmission of information from hair follicle receptors to the somatosensory cortex. Whether this rapid conduction serves to alert the animal in preparation for pain perception and subsequent activation of descending systems as suggested by TAUB (1964) remains to be seen.

One surprising observation in the present work was that very few Type I slowly-adapting units (touch corpuscle units) project to these two main ascending pathways. The functions of the Type I units are enigmatic. Information from touch corpuscles may be utilized at the segmental level or by other ascending systems, such as the spinocerebellar tracts or the ventral flexor reflex tracts. For a study of the functions of Type I units the rabbit may be a more useful experimental

animal than the cat in spite of the differences in anatomy of the spinal cords of the two species. In rabbit all axons with conduction velocities in cutaneous nerve greater than 54 m/sec are axons of Type I units (saphenous nerve, BROWN and IGGO 1967). This is one situation where electrical stimulation of cutaneous nerves could be used to excite a single type of cutaneous afferent unit selectively.

Individual spinocervical tract cells are capable of coding both the intensity and modality of a cutaneous stimulus. The discharge evoked by heating the skin of the receptive field is quite different to that evoked, in the same unit, by squeezing the skin of the field. This is the first time such modality coding has been described in central neurones of a cutaneous system. The differences in the discharges may occur in spite of little change in mean frequency of discharge. This suggests that frequency, or mean impulse interval, may be of little importance to the nervous system, as suggested by BURNS (1968). The internal structure of a neuronal discharge may be as important, if not more important, than the number of impulses in a given time period.

The observations on modality coding in the spinocervical tract raise the possibility that the lateral

cervical nucleus might be able to sort out the information rather than just relay it relatively unchanged. This raises the problem of the function of the lateral cervical nucleus. The spinocervical tract contains axons with high conduction velocities and the interpolation of a synapse at the lateral cervical nucleus leads to a delay in the conduction of information. A re-examination of the lateral cervical nucleus is necessary, to see if the separation of unit types, present in the spinocervical tract, is maintained and if the stimulus-response relations alter in transmission through the nucleus. If the lateral cervical nucleus can sort out the information coded in the spinocervical tract then it would be possible to account for the presence of the nucleus, which is puzzling.

A further unsolved problem of the spinocervical system is that of the organization of its inhibitory receptive fields. This is not of the 'surround' type which is supposed to aid stimulus localization by increasing the contrast effects. It has been suggested (HONGO, JANKOWSKA and LUNDBERG 1966) that small inhibitory fields closely related to excitatory fields might be part of a system for detection of the direction of movement of a mechanical stimulus across the skin. In the present experiments inhibitory fields were usually on the contra-

lateral limb and when on the ipsilateral limb they were not adjacent to the excitatory fields. A few small inhibitory fields close to excitatory fields were found, in confirmation of TAUB (1964), but in only 2 of 305 units examined were there any signs of any possible directional sensitivity displayed by the evoked discharge. HONGO et al. (1966) were recording intracellularly from spino-cervical tract cells and inhibition was observed as post-synaptic inhibitory potentials. This is a more sensitive approach than recording from axons, but is not necessarily more useful for understanding the function of the spino-cervical system. Furthermore, it is not known whether the inhibition of evoked and spontaneous discharges of spino-cervical tract units in the present experiments was produced by pre- or post-synaptic mechanisms.

KENNARD (1954) has produced behavioural evidence which suggests that a system ascending in the dorso-lateral funiculus of cat is concerned with nociceptive reflexes. The present results have provided electrophysiological evidence to support this suggestion. Spino-cervical tract cells may be excited by strong mechanical stimulation and heating of the skin. The spino-cervical tract is not only concerned with such information, however, and when the descending control system is in operation, is well-suited to carry information

about hair movement. The spinocervical tract has been shown to be important (NORRSELL 1966) for behavioural responses conditioned by hair movement. In this THESIS it is suggested that the spinocervical tract speeds up information transmission from the hair follicle receptors, faithfully transmits information about the rate of hair movement, carries information from hair follicle receptors, high threshold mechanoreceptors and 'heat' receptors in the discharges of a single cell and may have important functions at the segmental level. It is obvious, however, that knowledge of the functions of the spinocervical tract is still at a superficial level.

It is concluded that the techniques used in the present work (i.e. careful stimulation of identified receptors) ^{have} ~~has~~ a useful role to play in the study of cutaneous sensory mechanisms. Although the methods are more tedious than those used previously, such as mechanical stimulation with hand-held probes, spraying with ethyl chloride etc., it is submitted that they have a greater potential for leading to an understanding of the mechanisms which ultimately lead to perception.

SECTION VII

REFERENCES

- ADRIAN, E. D. (1926) The impulses produced by sensory nerve endings. Part I. *J. Physiol.* 61 49-72.
- ADRIAN, E. D. (1928) The basis of sensation. The action of the sense organs. Christophers, London. 122pp.
- ADRIAN, E. D. (1931) The messages in sensory nerve fibres and their interpretation. *Proc. Roy. Soc. Ser. B* 109 1-18.
- ADRIAN, E. D., CATTELL, McK. & HOAGLAND, H. (1931) Sensory discharges in single cutaneous nerve fibres. *J. Physiol.* 72 377-404.
- ADRIAN, E. D. & UMRATH, K. (1929) The impulse discharge from the Pacinian corpuscle. *J. Physiol.* 68 139-154.
- ADRIAN, E. D. & ZOTTERMAN, Y. (1926a) The impulses produced by sensory nerve endings. Part 2 *J. Physiol.* 61 151-171.
- ADRIAN, E. D. & ZOTTERMAN, Y. (1926b) The impulses produced by sensory nerve endings. Part 3. *J. Physiol.* 61 465-483.
- ANDERSEN, P., ECCLES, J. C., SCHMIDT, R. F. & YOKOTA, T. (1964a) Slow potential waves produced in the cuneate nucleus by cutaneous nerve volleys and by cortical stimulation. *J. Neurophysiol.* 27 78-91.
- ANDERSEN, P., ECCLES, J. C., SCHMIDT, R. F. & YOKOTA, T. (1964b) Depolarization of presynaptic fibers in the cuneate nucleus. *J. Neurophysiol.* 27 92-106.
- ANDERSEN, P., ECCLES, J. C. & SEARS, T. A. (1964) Cortically evoked depolarization of primary sensory afferent fibers in the spinal cord. *J. Neurophysiol.* 27 63-77.

- ANDERSON, F. D. & BERRY, C. M. (1959) Degeneration studies of long ascending fiber systems in the cat's brain stem. *J. comp. Neurol.* 111 195-231.
- ANDERSSON, S. A. (1962) Projection of different spinal pathways to the second somatosensory area in the cat. *Acta physiol. scand.* 56 Suppl. 194.
- ARMETT, C. J., & GRAY, J. A. B., HUNSPERGER, R. W. & LAL, S. (1962) The transmission of information in primary receptor neurones and second order neurones of a **phasic** system. *J. Physiol.* 164 395-421.
- ARMETT, Christine J., GRAY, J. A. B. & PALMER, J. F. (1961) A group of neurones in the dorsal horn with cutaneous mechanoreceptors. *J. Physiol.* 156 611-622.
- ARMETT, C. J. & HUNSPERGER, R. W. (1961) Excitation of receptors in the pad of the cat by single and double mechanical pulses. *J. Physiol.* 158 15-38.
- BARRON, D. H. & MATTHEWS, B. H. C. (1935) Intermittent conduction in the spinal cord. *J. Physiol.* 85 73-103.
- BARRON, D. H. & MATTHEWS, B. H. C. (1938) The interpretation of potential changes in the spinal cord. *J. Physiol.* 92 276-321.
- BELL, C. (1811) Idea of a new anatomy of the brain submitted for the observation of his friends. London.
- BELL, C. (1837) The hand. London.
- BEUSEKOM, G. T. van (1955) Fibre analysis of the anterior and lateral funiculi of the cord in the cat. Doctoral Thesis Univ. Leiden.

- BISHOP, G. H. (1960a) The relation of nerve fiber size to modality of sensation. In 'Advances in Biology of Skin, Vol. 1. Cutaneous Sensation' Montagna, W. ed. Pergamon Press New York pp 88-98.
- BISHOP, G. H. (1960b) The central paths of the afferent impulses from skin which arouse sensation. In 'Advances in Biology of Skin, Vol. 1. Cutaneous Sensation.' Montagna, W. ed. pp 99-111.
- BORING, E. G. (1916) Cutaneous sensation after nerve division. *Quart. J. exp. Physiol.* 10 1-95.
- BOWSHER, D. (1961) The termination of secondary somatosensory neurones within the thalamus of *M. mulatta*. An experimental degeneration study. *J. comp. Neurol.* 117 213-228.
- BRODAL, A. & REXED, B. (1953) Spinal afferents to the lateral cervical nucleus in the cat. An experimental study. *J. comp. Neurol.* 98 179-213.
- BROWN, A. G. (1968a) Cutaneous afferent fibre collaterals in the dorsal columns of the cat. *Exper. Brain Res.* 5 293-305.
- BROWN, A. G. (1968b) Dorsal column cutaneous afferent fibre collaterals. *Proc. XXIV Int. Congr. Physiol. Sci.* p 62.
- BROWN, A. G. (1968c) Single unit activity in the spino-cervical tract of the cat. *J. Physiol.* (in the press).
- BROWN, A. G. & IGGO, A. (1967) A quantitative study of cutaneous receptors and afferent fibres in the cat and rabbit. *J. Physiol.* 193 707-733.

- BURGESS, P. R. (1965) A study of the transmission of sensory information in the cat spinal cord.
Ph. D. Thesis Rockefeller Inst. New York.
- BURGESS, P. R. & PERL, E. R. (1967) Myelinated afferent fibres responding specifically to noxious stimulation of the skin. *J. Physiol.* 190 541-562.
- BURNS, B. DELISLE (1968) The uncertain nervous system. Edward Arnold, London 194pp.
- BUSCH, H. F. M. (1961) An anatomical analysis of the white matter in the brain stem of the cat. Doctoral Thesis Univ. Leiden.
- CAJAL, S. RAMON Y. (1952) *Histologie du systeme nerveux de l'homme et des vertebres*. Vol. I. Consejo superior de investigaciones cientificas, Madrid.
- CARPENTER, D., ENGBERG, I., FUNKENSTEIN, H. & LUNDBERG, A. (1963) Decerebrate control of reflexes to primary afferents. *Acta physiol. scand.* 59 424-437.
- CARPENTER, D., ENGBERG, I. & LUNDBERG, A. (1965) Differential supraspinal control of inhibitory and excitatory actions from the FRA to ascending spinal pathways. *Acta physiol. scand.* 63 103-110.
- CARPENTER, D., ENGBERG, I. & LUNDBERG, A. (1966) Primary afferent depolarization evoked from the brain stem and the cerebellum. *Arch. ital. Biol.* 104 73-85.
- CARPENTER, D., LUNDBERG, A. & NORRSELL, U. (1963) Primary afferent depolarization evoked from the sensorimotor cortex. *Acta physiol. scand.* 59 126-142.

- CATALANO, J. V. & LAMARCHE, G. (1957) Central pathway for cutaneous impulses in the cat. *Amer. J. Physiol.* 189 141-144.
- CHAMBERS, Margaret R. & IGGO, A. (1967) Slowly-adapting cutaneous mechanoreceptors. *J. Physiol.* 192 26-27P.
- CHAMBERS, W. W., LIU, C. N. & MCCOUCH, G. P. (1963) Inhibition of the dorsal column nuclei. *Exper. Neurol.* 7 13-23.
- COLLIER, J. & BUZZARD, E. F. (1903) The degeneration resulting from lesions of posterior nerve roots and from transverse lesions of the spinal cord in man. *Brain* 26 559-591.
- COLLINS, W. F. & RANDT, C. T. (1956) An electrophysiological study of small myelinated axons in anterolateral column in cat. *J. Neurophysiol.* 19 438-445.
- DI BIAGIO, F. & GRUNDFEST, H. (1954) Afferent relations of inferior olivary nucleus. II Site of relay from hind limb afferents into dorsal spino-olivary tract in cat. *J. Neurophysiol.* 18 299-304.
- DI BIAGIO, F. & GRUNDFEST, H. (1956) Afferent relations of inferior olivary nucleus. IV Lateral cervical nucleus as site of final relay to inferior olive in cat. *J. Neurophysiol.* 19 10-20.
- DOUGLAS, W. W. & RITCHIE, J. M. (1957) Non-myelinated fibres in the saphenous nerve which signal touch. *J. Physiol.* 130 385-399.

- DOUGLAS, W. W., RITCHIE, J. M. & STRAUB, R. W. (1960)
The role of non-myelinated fibres in signalling cooling of the skin. *J. Physiol.* 150 266-283.
- DRAKE, C. G. & MCKENZIE, K. G. (1953) Mesencephalic tractotomy for pain. *J. Neurosurg.* 10 457-462.
- EARLE, K. M. (1952) The tract of Lissauer and its possible relation to the pain pathway. *J. comp. Neurol.* 96 93-113.
- ECCLES, J. C. (1963) Presynaptic and postsynaptic inhibitory actions in the spinal cord. In 'Brain Mechanisms' Moruzzi, G. ed. Elsevier Publ. Co. Amsterdam.
- ECCLES, J. C. (1964) The physiology of synapses. Springer-Verlag, Berlin-Göttingen-Heidelberg. 316pp.
- ECCLES, J. C., ECCLES, R. M. & LUNDBERG, A. (1960)
Types of neurones in and around the intermediate nucleus of the lumbosacral cord. *J. Physiol.* 154 89-114.
- ECCLES, J. C., ECCLES, R. M. & MAGNI, F. (1961) Central inhibitory action attributable to presynaptic depolarization produced by muscle afferent volleys. *J. Physiol.* 159 147-166.
- ECCLES, J. C., KOSTYUK, P. G. & SCHMIDT, R. F. (1962a)
Central pathways responsible for depolarization of primary afferent fibres. *J. Physiol.* 161 237-257.
- ECCLES, J. C., KOSTYUK, P. G. & SCHMIDT, R. F. (1962b)
Presynaptic inhibition of the central actions of flexor reflex afferents. *J. Physiol.* 161 258-281.

- ECCLES, J. C., MAGNI, F. & WILLIS, W. D. (1962)
 Depolarization of central terminals of Group I afferent
 fibres from muscle. *J. Physiol.* 160 62-93.
- ECCLES, J. C., SCHMIDT, R. F. & WILLIS, W. D. (1963)
 Depolarization of the central terminals of cutaneous
 afferent fibres. *J. Neurophysiol.* 26 646-661.
- ECCLES, R. M., HOLMQVIST, B. & VOORHOEVE, P. E. (1964)
 Presynaptic inhibition from contralateral cutaneous
 afferent fibres. *Acta physiol. scand.* 62 464-473.
- ECCLES, R. M. & LUNDBERG, A. (1959) Synaptic actions
 in motoneurons by afferents which may evoke the
 flexion reflex. *Arch. ital. Biol.* 97 199-221.
- EDINGER, L. (1889) Vergleichend-entwicklungsgeschichtliche
 und anatomische Studien im Bereiche des Centralnerven-
 systems: II Über die Fortsetzung der hinteren
 Rückenmarkswurzeln zum Gehirn. *Anat. Anz.* 4 121-128.
- FERRARO, A. & BARRERA, S. E. (1935) Posterior column
 fibers and their termination in *Macacus rhesus*.
J. comp. Neurol. 62 507
- FERRARO, A. & BARRERA, S. E. (1936) Lamination of the
 medial lemniscus in *Macacus rhesus*. *J. comp. Neurol.*
64 313-324.
- FETZ, E. E. (1968) Pyramidal tract effects on inter-
 neurons in the cat lumbar dorsal horn. *J. Neurophysiol.*
31 69-80.

- FITZGERALD, O. (1940) Discharges from the sensory organs of the cat's vibrissae and the modification in their activity by ions. *J. Physiol.* 98 163-178.
- FOERSTER, O. (1936) In 'Handbuch der Neurologie' Vol. 5 Bumke, O. and Foerster, O. ed. Springer, Berlin. 639pp.
- FOERSTER, O. & GAGEL, O. (1932) Die Vorderseitenstrang-durchschneidung beim Menschen. *Zeitschr. ges Neurol. Psychiat.* 138 1-92.
- FRANK, K. & FUORTES, M. G. F. (1957) Presynaptic and postsynaptic inhibition of monosynaptic reflexes. *Fed. Proc.* 16 39-40.
- FRANKENHAEUSER, B. (1949) Impulses from a cutaneous receptor with slow adaptation and low mechanical threshold. *Acta physiol. scand.* 18 68-74.
- FRANZ, D. N. & IGGO, A. (1968) Dorsal root potentials and ventral root reflexes evoked by nonmyelinated fibers. *Science* (in the press).
- FREY, M. von (1894a) Beiträge zur Physiologie des Schmerzsinnns. I. *Ber. sachs. Gesellsch. Wiss.* 46 185-196.
- FREY, M. von (1894b) Beiträge zur Physiologie des Schmerzsinnns. II. *Ber. sachs. Gesellsch. Wiss.* 46 283-296.
- FREY, M. von (1895) Beiträge zur Sinnesphysiologie der Haut. III. *Ber. sachs. Gesellsch. Wiss.* 47 166-184.
- FREY, M. von (1896) Untersuchungen über die Sinnesfunktionen der menschlichen Haut. I Druckempfindung und Schmerz. *Abh. Kgl. sächs. Gesellsch. Wiss.* 40 175

- FULLER, D. R. G. & GRAY, J. A. B. (1966) The relation between mechanical displacements applied to a cat's pad and the resultant impulse patterns. *J. Physiol.* 182 465-483.
- GASSER, H. S. (1955) Properties of dorsal root unmyelinated fibers on the two sides of the ganglion. *J. gen. Physiol.* 38 709-728.
- GASSER, H. S. & GRAHAM, H. T. (1933) Potentials produced in the spinal cord by stimulation of dorsal roots. *Amer. J. Physiol.* 103 303-320.
- GAZE, R. M. & GORDON, G. (1955) Some observations on the central pathways for cutaneous impulses in the cat. *Quart. J. exp. Physiol.* 40 187-194.
- GETZ, B. (1952) The termination of spinothalamic fibres in the cat as studied by the method of terminal degeneration. *Acta Anat.* 16 271-290.
- GLEES, P., LIVINGSTON, R. B. & SOLER, J. (1951) Der intraspinaler Verlauf und die Endigungen der sensorischen Wurzeln in den Nucleus Gracilis und Cuneatus. *Archiv. f. Psychiat. Zeitschr. Neurol.* 187 190-204.
- GLEES, P. & SOLER, J. (1951) Fibre content of the posterior column and synaptic connections of nucleus gracilis. *Zeitschr. Zellforsch.* 36 381-400.
- GOLDBERG, J. M., ADRIAN, H. O. & SMITH, F. D. (1964) Response of neurons of the superior olivary complex of the cat to acoustic stimuli of long duration. *J. Neurophysiol.* 27 706-749.

- GOLDSTEIN, K. (1910) *Über die aufsteigende Degeneration nach Querschnittsunterbrechung des Rückenmarkes (Tractus spino-cerebellaris posterior, Tractus spino-olivaris, Tractus spino-thalamicus)*. *Neurol. Centralbl.* 29 898-911.
- GORDON, G. & JUKES, M. G. M. (1963) *An investigation of cells in the lateral cervical nucleus of the cat which respond to stimulation of the skin*. *J. Physiol.* 169 28-29P.
- GORDON, G. & JUKES, M. G. M. (1964) *Dual organization of the exteroceptive components of the cat's gracile nuclei*. *J. Physiol.* 173 263-290.
- GORDON, G. & PAINE, C. H. (1960) *Functional organization in nucleus gracilis of cat*. *J. Physiol.* 153 331-349.
- GRANIT, R. (1955) *Receptors and sensory perception*. Yale Univ. Press, New Haven, London. 369pp.
- GRANT, G., OSCARSSON, O. & ROSEN, I. (1966) *Functional organization of the spinoreticulocerebellar path with identification of its spinal component*. *Exper. Brain Res.* 1 306-319.
- GRUNDFEST, H. & CARTER, W. (1954) *Afferent relations of inferior olivary nucleus. I Electrophysiological demonstration of dorsal spino-olivary tract in cat*. *J. Neurophysiol.* 17 72-91.
- HA, H., KITAI, S. T. & MORIN, F. (1965) *The lateral cervical nucleus of the raccoon*. *Exper. Neurol.* 11 441-450.
- HA, H. & MORIN, F. (1964) *Comparative anatomical observations of the cervical nucleus, N. cervicalis lateralis*. *Anat. Rec.* 148 374-375.

- HAGEN, E., KNOCHE, H., SINCLAIR, D.C.C. & WEDDELL, G.
 (1953) The role of specialized nerve terminals in cutaneous sensibility. Proc. Roy. Soc. Ser.B141 279-287.
- HEAD, H., RIVERS, W. H. R. & SHERREN, J. (1905) The afferent nervous system from a new aspect. Brain 28 99-115.
- HEAD, H. & SHERREN, J. (1905) The consequences of injury to the peripheral nerves in man. Brain 28 116-337.
- HENSEL, H., IGGO, A. & WITT, Ingrid. (1960) A quantitative study of sensitive cutaneous thermoreceptors with C afferent fibres. J. Physiol. 153 113-126.
- HOLMQVIST, B. & LUNDBERG, A. (1962) Differential supraspinal control of synaptic actions evoked by volleys in the flexion reflex afferents in alpha motoneurons. Acta physiol. scand. 54 Suppl. 186.
- HOLMQVIST, B., LUNDBERG, A. & OSCARSSON, O. (1960) Supraspinal inhibitory control of transmission to three ascending spinal pathways influenced by the flexor reflex afferents. Arch. ital. Biol. 98 60-80.
- HONGO, T. & JANKOWSKA, E. (1967) Effects from the sensorimotor cortex on the spinal cord in cats with transected pyramids. Exper. Brain Res. 3 117-134.
- HONGO, T., JANKOWSKA, E. & LUNDBERG, A. (1965) Postsynaptic inhibition evoked from primary afferents in spinal interneurons. Experientia 21 465-466.

- HONGO, T., JANKOWSKA, E. & LUNDBERG, A. (1966) Convergence of excitatory and inhibitory action on interneurons in the lumbosacral cord. *Exper. Brain Res.* 1 338-358.
- HORROBIN, D. F. (1966) The lateral cervical nucleus of the cat; an electrophysiological study. *Quart. J. exper. Physiol.* 51 351-371.
- HUBEL, D. H. (1957) Tungsten microelectrode for recording from single units. *Science* 125 549-550.
- HUNT, C. C. (1961) On the nature of vibration receptors in the hind limb of the cat. *J. Physiol.* 155 175-186.
- HUNT, C. C. & McINTYRE, A. K. (1960a) Characteristics of responses from receptors from the flexor longus digitorum muscle and the adjoining interosseous region of the cat. *J. Physiol.* 153 74-87.
- HUNT, C. C. & McINTYRE, A. K. (1960b) Properties of cutaneous touch receptors in cat. *J. Physiol.* 153 88-98.
- HUNT, C. C. & McINTYRE, A. K. (1960c) An analysis of fibre diameter and receptor characteristics of myelinated cutaneous afferent fibres in cat. *J. Physiol.* 153 99-112.
- IGGO, A. (1959) Cutaneous heat and cold receptors with slowly conducting (C) afferent fibres. *Quart. J. exper. Physiol.* 44 362-370.
- IGGO, A. (1960) Cutaneous mechanoreceptors with afferent C fibres. *J. Physiol.* 152 337-353.
- IGGO, A. (1963) New specific sensory structure in hairy skin. *Acta Neurolog.* 24 175-180.

- IGGO, A. (1966) Cutaneous receptors with a high sensitivity to mechanical displacement. In CIBA Foundation Symposium, 'Touch, heat and pain.' de Reuck, E. V. S. & Knight, Julie eds. pp 237-256. Chambers, London.
- IGGO, A. (1968) Electrophysiological and histological studies of cutaneous mechanoreceptors. In 'The skin senses.' Kenshalo, D. N. ed. Thomas, Springfield, Ill. pp 84-112.
- IGGO, A. & KORN^NHUBER, H. H. (1968) A quantitative analysis of non-myelinated cutaneous mechanoreceptors. J. Physiol. (in the press).
- IRIUCHIJIMA, J. & ZOTTERMAN, Y. (1960) The specificity of afferent cutaneous C fibres in mammals. Acta physiol. scand. 49 267-278.
- JANIG, W., SCHMIDT, R. F. & ZIMMERMAN, M. (1968) Two specific feedback pathways to the central afferent terminals of phasic and tonic mechanoreceptors. Exper. Brain Res. 6 116-129.
- JOHNSON, F. H. (1952) Microelectrode studies on the cuneate and gracile nuclei of the cat. Amer. J. Physiol. 171 737.
- JANKOWSKA, E., JUKES, M. G. M., LUND, S. & LUNDBERG, A. (1967) The effect of DOPA on the spinal cord 6. Half-centre organization of interneurons transmitting effects from the flexor reflex afferents. Acta physiol. scand. 70 389-402.

- KENNARD, M. A. (1954) The course of ascending fibers in the spinal cord of the cat essential to the recognition of painful stimuli. *J. comp. Neurol.* 100 511-524.
- KITAI, S. T., HA, H. & MORIN, F. (1965) Lateral cervical nucleus of the dog: anatomical and microelectrode studies. *Amer. J. Physiol.* 209 307-311.
- KOHNSTAMM, O. (1900) Ueber die gekreuzt-aufsteigende Spinalbalm und ihre Beziehung zum Gowerischen Strang. *Neurol. Centralbl.* 19 242-249.
- KOLMODIN, G. M. & SKOGLUND, C. R. (1960) Analysis of spinal interneurons activated by tactile and nociceptive stimulation. *Acta physiol. scand.* 50 337-355.
- KRIEGER, H. & GRUNDFEST, H. (1956) Afferent relations of inferior olivary nucleus III Electrophysiological demonstration of a second relay in dorsal spino-olivary pathway in cat. *J. Neurophysiol.* 19 1-9.
- KROLL, F. W. (1930) Schwellenuntersuchungen bei Läsionen der afferenten Leitungsbahnen. *Ztschr. ges. Neurol. Psychiat.* 128 751-776.
- KRUGER, L., SIMINOFF, R. & WITLOVSKY, P. (1961) Single unit analysis of dorsal column nuclei and spinal nucleus of trigeminal in cat. *J. Neurophysiol.* 24 333-349.
- KUHN, R. A. (1949) Topographical pattern of cutaneous sensibility in the dorsal column nuclei of the cat. *Trans. Amer. Neurol. Ass.* 227-230.

- LANDGREN, S., NORDWALL, A. & WENGSTROM, C. (1965) The location of the thalamic relay in the spino-cervical-lemniscal pathway. *Acta physiol. scand.* 65 164-175.
- LELE, P. P. & WEDDELL, G. (1959) Sensory nerves of the cornea and cutaneous sensibility. *Exp. Neurol.* 1 334-359.
- LELE, P. P., WEDDELL, G. & WILLIAMS, C. M. (1954) The relationship between heat transfer, skin temperature and cutaneous sensibility. *J. Physiol.* 126 206-234.
- LEVITT, M., CARRERAS, M., LIU, C. N. & CHAMBERS, W. W. (1964) Pyramidal and extrapyramidal modulation of somatosensory activity in gracile and cuneate nuclei. *Arch. ital. Biol.* 102 197-227.
- LILEY, A. W. (1956) The effects of presynaptic polarization on the spontaneous activity at the mammalian neuromuscular junction. *J. Physiol.* 134 427-443.
- LIVINGSTON, R. B. (1959) Central control of receptors and sensory transmission systems. In 'Handbook of Physiology, Section 1, Vol. I. Field, J. & Magoun, H. W. eds. Amer. Physiol. Soc. Washington, D. C. pp 741-760.
- LLOYD, D. P. C. & McINTYRE, A. K. (1950) Dorsal column ~~conduction of Group I muscle afferent impulses and their~~ relay through Clarke's column. *J. Neurophysiol.* 13 39-54.
- LUNDBERG, A. (1964) Ascending spinal hindlimb pathways in the cat. In 'Progress in Brain Research Vol. 12. Eccles, J. C. & Schade, J. P. eds. Elsevier, Amsterdam pp 135-163,

- LUNDBERG, A., NORSELL, U. & VOORHOEVE, P. (1963)
Effects from the sensorimotor cortex on ascending
spinal pathways. *Acta physiol. scand.* 59 462-473.
- LUNDBERG, A. & OSCARSSON, O. (1961) Three ascending
pathways in the dorsal part of the lateral funiculus.
Acta physiol. scand. 51 1-16.
- LUNDBERG, A. & OSCARSSON, O. (1962) **Two ascending spinal pathways**
in the ventral part of the cord. *Acta physiol. scand.*
54 270-286.
- LUNDBERG, A. & VYKLYCKY, L. (1966) Inhibition of trans-
mission to primary afferents by electrical stimulation
of the brain stem. *Arch. ital. Biol.* 104 86-97.
- MAGNI, F. & OSCARSSON, O. (1962) Principal organization
of coarse-fibred ascending spinal tracts in phalanger,
rabbit and cat. *Acta physiol. scand.* 54 53-64.
- MARK, R. F. & STEINER, J. (1958) Cortical projection of
impulses in myelinated cutaneous afferent nerve fibres
of the cat. *J. Physiol.* 142 544-562.
- MARUHASHI, J., MIZUGUCHI, K. & TASAKI, I. (1952) Action
currents in single afferent nerve fibres elicited by
stimulation of the skin of the toad and cat. *J. Physiol.*
117 129-151.
- McCOMAS, A. J. (1963) Responses of the rat dorsal column
system to mechanical stimulation of the hind-paw.
J. Physiol. 166 435-448.

- MAGNI, F., MELZACK, R., MORUZZI, G. & SMITH, C. R. (1959)
Direct pyramidal influences on the dorsal column nuclei.
Arch. ital. Biol. 97 357-377.
- MENDELL, L. M. (1966) Physiological properties of unmyelinated fiber projections to the spinal cord. Exp. Neurol. 16 316-332.
- MENDELL, L. M. & WALL, P. D. (1965) Responses of single dorsal cord cells to peripheral cutaneous unmyelinated fibres. Nature 206 97-99.
- MELZACK, R. & WALL, P. D. (1965) Pain mechanisms: A new theory. Science 150 971-979.
- MILLER, S. (1967) Excitation of mechanoreceptor units in the skin of the rabbit ear. Arch. ital. Biol. 105 290-314.
- MILLER, S. & WEDDELL, G. (1966) Mechanoreceptors in rabbit ear skin innervated by myelinated nerve fibres. J. Physiol. 187 291-305.
- MIZUNO, N. (1966) An experimental study of the spino-olivary fibers in the rabbit and cat. J. comp. Neurol. 127 267-292.
- MIZUNO, N., NAKANO, K., IMAIZUMI, M. & OKAMOTO, M. (1967) The lateral cervical nucleus of the Japanese monkey (*Macaca fuscata*). J. comp. Neurol. 129 375-381.
- MORIN, F. (1955) A new spinal pathway for cutaneous impulses. Amer. J. Physiol. 183 245-252.

- MORIN, F. & CATALANO, J. V. (1955) Central connections of a cervical nucleus (nucleus cervicalis lateralis of the cat). *J. comp. Neurol.* 103 17-32.
- MORIN, F., KITAI, S. T., PORTNOV, H. & DEMIRIJAN, C. (1963) Afferent projections to the lateral cervical nucleus: a microelectrode study. *Amer. J. Physiol.* 204 667-672.
- MORIN, F. & THOMAS, L. M. (1955) Spinothalamic fibers and tactile pathways in the cat. *Anat. Rec.* 121 344.
- MOTT, F. W. (1895) Experimental enquiry upon the afferent tracts of the central nervous system of the monkey. *Brain* 18 1-20.
- MOUNTCASTLE, V. B. (1966) In discussion of paper by A. Iggo in CIBA Foundation Symposium 'Touch, heat and pain' de Reuck, A. V. S. & Knight, Julie eds. Chambers, London. p 257.
- MULLER, J. (1842) *Elements of physiology*. Vol. 2. London pp1059.
- NILSSON, B. Y. & SKOGLUND, C. R. (1965) The tactile hairs on the cat's foreleg. *Acta physiol. scand.* 65 364-369.
- NORRSELL, U. (1966) The spinal afferent pathways of conditioned reflexes to cutaneous stimuli in the dog. *Exper. Brain Res.* 2 269-282.
- NORRSELL, U. & VOORHOEVE, P. (1962) Tactile pathways from the hindlimb to the cerebral cortex in cat. *Acta physiol. scand.* 54 9-17.

- NORRSELL, U. & WOLPOW, E. R. (1966) An evoked potential study of different pathways from the hindlimb to the somatosensory areas in the cat. *Acta physiol. scand.* 66 19-33.
- ^C
OSCARSSON, O. (1965) The projection of Group I muscle afferents to the cat cerebral cortex. In Nobel Symposium I Muscular afferents and motor control. Granit, R. ed. pp 307-316. John Wiley & Sons, London.
- OSCARSSON, O. & ROSEN, I. (1963) Projection to cerebral cortex of large muscle-spindle afferents in forelimb nerves of the cat. *J. Physiol.* 169 924-945.
- OSWALDO-CRUZ, E. & KIDD, C. (1964) Functional properties of neurons in the lateral cervical nucleus of the cat. *J. Neurophysiol.* 27 1-14.
- PINKUS, F. (1902) Über einen bisher unbekanntem Nebenapparat am Haarsystem des Menschen: Haarscheiben. *Dermat. Zeitschr.* 2 465-469.
- PINKUS, F. (1904) Über Hautsinnesorgane neben den menschlichen Haar (Haarscheiben) und ihre vergleichend anatomische Bedeutung. *Arch. f. Mikrosk. Anat.* 65 121-179.
- PEARSON, A. A. (1952) Role of gelatinous substance of spinal cord in conduction of pain. *Arch. Neurol. Psychiat.* 68 515-529.
- PERL, E. R. & WHITLOCK, D. G. (1961) Somatic stimuli exciting spinothalamic projections to thalamic neurons in cat and monkey. *Exper. Neurol.* 3 256-296.

- PERL, E. R., WHITLOCK, D. G. & GENTRY, J. R. (1962)
Cutaneous projections to second-order neurones of the dorsal column system. *J. Neurophysiol.* 25 335-358.
- RALSTON, III, H. J. (1965) The organization of the substantia gelatinosa Rolandi in the cat lumbosacral spinal cord. *Z. Zellforsch.* 67 1-23.
- RALSTON, III, H. J. (1968a) The fine structure of neurons in the dorsal horn of the cat spinal cord. *J. comp. Neurol.* 132 275-301.
- RALSTON, III, H. J. (1968b) Dorsal root projections to dorsal horn neurons in the cat spinal cord. *J. comp. Neurol.* 132 303-329.
- RANSON, S. W. (1913) The course within the spinal cord of the nonmedullated fibres of the dorsal roots: A study of Lissauer's tract in the cat. *J. comp. Neurol.* 23 259-281.
- RANSON, S. W. (1914a) The tract of Lissauer and the substantia gelatinosa Rolandi. *Amer. J. Anat.* 16 97-126.
- RANSON, S. W. (1914b) An experimental study of Lissauer's tract and the dorsal roots. *J. comp. Neurol.* 24 531-545.
- RANSON, S. W. & BILLINGSLEY, P. R. (1916) The conduction of painful afferent impulses in the spinal nerves. *Amer. J. Physiol.* 40 571-589.
- RANSON, S. W. & CLARK, S. L. (1959) The anatomy of the nervous system: its development and function. 10th. editn. Saunders, London. pp622.

- REXED, B. (1952) The cytoarchitectonic organization of the spinal cord of the cat. *J. comp. Neurol.* 96 415-495.
- REXED, B. (1954) A cytoarchitectonic atlas of the spinal cord in the cat. *J. comp. Neurol.* 100 297-379.
- REXED, B. (1958) personal communication in *Handbuch der Mikroskopischen Anatomie des Menschen IV/8 Das Kleinhirn.* Jansen, J. & Brodal, A. p 241. Springer-Verlag, Berlin-Göttingen-Heidelberg.
- REXED, B. & BRODAL, A. (1951) The nucleus cervicalis lateralis. A spino-cerebellar relay nucleus. *J. Neurophysiol.* 14 399-407.
- REXED, B. & STROM, G. (1952) Afferent nervous connections of the lateral cervical nucleus. *Acta physiol. scand.* 25 219-229.
- RIVERS, W. H. R. & HEAD, H. (1908) A human experiment in nerve division. *Brain.* 31 323-450.
- RODIECK, R. W., KIANG, N. Y-S., & GERSTEIN, G. L. (1962) Some quantitative methods for the study of spontaneous activity of single neurons. *Biophys. J.* 2 351-368.
- ROSE, J. E. & MOUNTCASTLE, V. B. (1959) Touch and kinesthesia In *Handbook of Physiology Section 1 Vol. I* Field, J & Magoun, H. W. eds. Amer. Physiol. Soc. Washington D.C. pp387-429.
- SCHAFFER, E. S. (1927) Recovery after severance of cutaneous nerves. *Brain* 50 538-547.
- SCHMIDT, R. F., SENEGES, J. & ZIMMERMAN, M. (1967) Presynaptic depolarization of cutaneous mechanoreceptor afferents after mechanical skin stimulation. *Exper. Brain Res.* 3 234-247.

- SINCLAIR, D. C. (1955) Cutaneous sensation and the doctrine of specific energy. *Brain* 78 584-614.
- SINCLAIR, D. C., WEDDELL, G. & ZANDER, E. (1952) The relationship of cutaneous sensibility to neurohistology in the human pinna. *J. Anat.* 86 402-411.
- SPRAGUE, J. M. & HA, H. (1964) The terminal fields of dorsal root fibers in the lumbosacral spinal cord of the cat, and the dendritic organization of the motor nuclei. In *Progress in Brain Research Vol. 11. Organization of the Spinal Cord*. Eccles, J. C. & Schade, J. P. eds. Elsevier, Amsterdam. pp 120-152.
- STEVENS, S. S. (1957) On the psychophysical law. *Psychol. Rev.* 64 153-181.
- STRAILE, W. E. (1958) Atypical guard hair follicles in the skin of the rabbit. *Nature* 181 1604-1605.
- STRAILE, W. E. (1960) Sensory hair follicles in mammalian skin: the tylotrich follicle. *Amer. J. Anat.* 106 133-148.
- STRAILE, W. E. (1961) The morphology of tylotrich follicles in the skin of the rabbit. *Amer. J. Anat.* 109 1-13.
- SZENTAGOTHAI, J. (1964) Neuronal and synaptic arrangement in the substantia gelatinosa Rolandi. *J. comp. Neurol.* 122 219-241.
- TAPPER, D. N. (1964a) Cutaneous slowly adapting mechanoreceptors in the cat. *Science* 143 53-54.
- TAPPER, D. N. (1964b) Input-output relationships of a skin tactile sensory unit of the cat. *Trans. N. Y. Acad. Sci.* 26 697-701.

- TAPPER, D. N. (1965) Stimulus-response relationships in the cutaneous slowly adapting mechanoreceptor in hairy skin of the cat. *Exper. Neurol.* 13 364-385.
- TAUB, A. (1964) Local, segmental and supraspinal interaction with a dorsolateral spinal cutaneous afferent system. *Exper. Neurol.* 10 357-374.
- TAUB, A. & BISHOP, P. O. (1965) The spinocervical tract: Dorsal column linkage, conduction velocity, primary afferent spectrum. *Exper. Neurol.* 13 1-21.
- TOWE, A. L. & JABBUR, S. J. (1961) Cortical inhibition in neurons in dorsal column nuclei of cat. *J. Neurophysiol.* 24 488-498.
- TOWER, S. S. (1940) Unit for sensory reception in cornea. *J. Neurophysiol.* 3 486-500.
- TROUTER, W. B. & DAVIES, H. M. (1913) The peculiarities of sensibility found in cutaneous area supplied by regenerating nerves. *J. Psychol. Neurol.* 20 102-150.
- UDDENBERG, N. (1968a) Differential organization in dorsal funiculi of fibres originating from different receptors. *Exper. Brain Res.* 4 367-376.
- UDDENBERG, N. (1968b) Functional organization of long, second-order afferents in the dorsal funiculi. *Exper. Brain Res.* 4 377-382.
- WALKER, A. E. (1940) The spinothalamic tract in man. *Arch. Neurol. Psychiat.* 43 284-298.

- WALKER, A. E. (1942) Somatotopic localization of spinothalamic and secondary trigeminal tracts in mesencephalon. Arch. Neurol. Psychiat. 48 884-889.
- WALKER, A. E. & WEAVER, T. A. (1942) The topical organization and termination of the fibres of the posterior columns in *M. mulatta*. J. comp. Neurol. 76 145
- WALL, P. D. (1958) Excitability changes in afferent fibre terminations and their relation to slow potentials. J. Physiol. 142 1-21.
- WALL, P. D. (1960a) Cord cells responding to touch, damage and temperature of skin. J. Neurophysiol. 23 197-210.
- WALL, P. D. (1960b) Two transmission systems for the skin sensations. In Sensory Communication, Rosenblith, W. A. ed. Wiley, New York. pp 475-496.
- WALL, P. D. (1962) The origin of a spinal cord slow potential. J. Physiol. 164 508-524.
- WALL, P. D. (1967) The laminar organization of dorsal horn and effects of descending impulses. J. Physiol. 188 403-424.
- WALLENBERG, A. (1896) Die sekundäre Bahn des sensiblen Trigeminus. Anat. Anz. 12 95-110.
- WALLENBERG, A. (1900) Secundäre sensible Bahnen im Gehirnstamm des Kaninchens. Anat. Anz. 18 81-105.
- WALSHE, F. M. R. (1942) The anatomy and physiology of cutaneous sensation: a critical review. Brain 65 48-112.

- WEAVER, T. A. & WALKER, A. E. (1941) Topical arrangement within the spinothalamic tract of the monkey. Arch. Neurol. Psychiat. 46 877-883.
- WEDDELL, G. (1960) Studies related to the mechanism of common sensibility. In Cutaneous Innervation, Montagna, W. ed. Pergamon Press, New York pp 112-160.
- WEDDELL, G. (1961) Observations on the anatomy of pain sensibility. In UFAW Symposium, The Assessment of Pain in Man and Animals, Keele, C. A. & Smith, R. eds. Livingstone, London. pp 47-59.
- WEDDELL, G. (1966) In Touch, Heat and Pain, CIBA Foundation Symposium, de Reuck, A. V. S. & Knight, Julie eds. Churchill, London. p 389.
- WEDDELL, G. & PALLIE, W. (1955) Studies on the innervation of skin. II The number, size and distribution of hairs, hair follicles and orifices from which the hairs emerge in the rabbit ear. J. Anat. 89 175-188.
- WEDDELL, G., TAYLOR, D. A. & WILLIAMS, C. M. (1955) Studies on the innervation of skin III The patterned arrangement of the spinal sensory nerves to the rabbit ear. J. Anat. 89 317-342.
- WERNER, G. & MOUNTCASTLE, V. B. (1965) Neural activity in mechanoreceptive cutaneous afferents: Stimulus-response relations, Weber functions and information transmission. J. Neurophysiol. 28 359-397.

- WERNER, G. & MOUNTCASTLE, V. B. (1968) Quantitative relations between mechanical stimuli to the skin and neural responses evoked by them. In *The Skin Senses* Kenshalo, D. N. ed. Thomas, Springfield, Illinois. pp 112-138.
- WERNER, G. & WHITSEL, B. L. (1967) The topology of dermatomal projection in the medial lemniscal system. *J. Physiol.* 192 123-144.
- WHITLOCK, D. G. & PERL, E. R. (1959) Afferent projections through ventrolateral funiculi to thalamus of cat. *J. Neurophysiol.* 22 133-148.
- WINTER, D. L. (1965) N. gracilis of cat. Functional organization and corticofugal effects. *J. Neurophysiol.* 28 48-70.
- WITT, I. & HENSEL, H. (1959) Afferente Impulse aus der Extremitäterhaut der Katze bei thermische und mechanischer Reizung. *Pflügers Arch. ges. Physiol.* 268 582-596.
- WOOLLARD, H. H., WEDDELL, G. & HARPMAN, J. A. (1940) Observations on the neurohistological basis of cutaneous pain. *J. Anat.* 74 413-441.
- YAMAMOTO, S., SUGIHARA, S. & KURU, M. (1956) Microelectrode studies on sensory afferents in the posterior funiculus of cat. *Jap. J. Physiol.* 6 68-85.
- ZOTTERMAN, Y. (1936) Specific action potentials in the lingual nerve. *Skand. Arch. physiol.* 75 105-120.
- ZOTTERMAN, Y. (1939) Touch, pain and tickling: An electrophysiological investigation on cutaneous sensory nerves. *J. Physiol.* 95 1-28.

ZIMMERMAN, M. (1968) Dorsal root potentials after C-fiber stimulation. *Science* 160 896-898.