

THE STRUCTURAL BEHAVIOUR OF MASONRY INFILL PANELS
IN FRAMED STRUCTURES

A Thesis submitted for the Degree of

Doctor of Philosophy

of the

UNIVERSITY OF EDINBURGH

by

MOHAMMED RAOUF ABDUL-KADIR, B.Sc., C.E.

Department of Civil Engineering and Building Science

April, 1974.

CONTENTS

	<u>Page No:</u>
CONTENTS	i
ACKNOWLEDGEMENTS	v
PRINCIPAL NOTATIONS	vi
ABSTRACT	viii
CONVERSION FACTORS	x
CHAPTER 1 INTRODUCTION	1
1.1 General	1
CHAPTER 2 MASONRY INFILLED FRAMES	7
2.1 Review of Previous Work	7
2.2 Summary and Scope of the Work	18
CHAPTER 3 BEHAVIOUR OF ONE-STOREY BRICKWORK INFILLED FRAMES	21
3.1 Introduction	21
3.2 Materials	22
3.2.1 Bricks	22
3.2.2 Sand	22
3.2.3 Cement	22
3.2.4 Mortar	22
3.2.5 Steel	22
3.3 Method of Construction	22
3.3.1 Frame	22
3.3.2 Brickwork panels	23
3.4 Testing Arrangement and Loading Method	23
3.5 Tests Results	24
3.6 Square and Rectangular Panels	24
3.7/	

	<u>Page No:</u>	
3.7	Infilled Frames with Gap at the Top of the Panel	26
3.8	Walls Built with Modified Mortar	27
3.9	Discussion of Results	28
3.9.1	Load-Deflection Curves	28
3.9.2	Modes of Failure	29
3.9.3	The Influence of Frame Stiffness	32
3.9.4	The Influence of $\frac{h}{l}$ ratio	34
3.9.5	Joint Rigidity	34
3.9.6	Lack of Fit	35
3.9.7	Modified Mortar	36
3.10	Conclusions	37
CHAPTER 4	ANALYSIS OF ONE-STOREY INFILLED FRAMES	40
4.1	Introduction	40
4A	AN APPROXIMATE METHOD TO DETERMINE THE STRENGTH AND STIFFNESS OF MASONRY INFILLED FRAMES WITHOUT OPENING	42
4.2	Equivalent Diagonal Strut	42
4.3	Length of Contact	44
4.4	The Effective Width of the Diagonal Strut	46
4.5	Lateral Stiffness	47
4.6	Lateral Strength	49
4.6.1	Cracking Strength	50
4.6.2	Crushing Strength	52
4B	ANALYSIS OF INFILLED FRAMES BY THE FINITE ELEMENTS METHOD	57
4.7	The Finite Elements Method	57
4.8	Assumptions and Analysis Procedure	59
4.9	Member Forces	61
4.10/		

	<u>Page No:</u>
4.10	Stress Distribution Inside the Panel 62
4C	RESULTS AND CONCLUSIONS 64
4.11	Comparison of Results 64
4.11.1	Cracking Strength 64
4.11.2	Ultimate Strength 65
4.11.3	Lateral Stiffness 67
4.11.4	Member Forces 71
4.12	Conclusions 73
CHAPTER 5	BRICKWORK INFILLED FRAMES CONTAINING OPENING 75
5.1	Introduction 75
5.2	Materials, Construction and Experimental Method 76
5.3	Size of Opening 77
5.4	Results 78
5.5	Panel Behaviour and Modes of Failure 78
5.6	Discussion and Effect of Openings 80
5.7	An Approximate Method to Determine the Stiffness of Infilled Frames containing Opening 82
5.7.1	Equivalent Frame 82
5.7.2	Semi-composite lateral Stiffness 83
5.8	Comparison of Results 85
5.9	Conclusions 87
CHAPTER 6	MULTISTOREY INFILLED FRAMES 89
6.1	Introduction 89
6.2	Materials, Construction and Testing Details 90
6.3	Results 91
6.4	Discussion of Results 91
6.4.1	Multi-storey Panels 91
6.4.2./	

	<u>Page No:</u>
6.4.2 Two-bay Single-storey Panels	93
6.5 An Approximate Method for Determining the Deflection of Multi-storey Infilled frames	93
6.6 Comparison of Results	97
6.7 Conclusions	99
CHAPTER 7 GENERAL CONCLUSIONS AND SUGGESTIONS	100
7.1 General Conclusions	100
7.2 Suggestions and Comments	102
REFERENCES	104
APPENDIX A: BRICK, MORTAR AND BRICKWORK PROPERTIES (1:3 MORTAR)	112
APPENDIX B: BRICKWORK PROPERTIES BUILT WITH MODIFIED MORTAR	114
APPENDIX C:	117

ACKNOWLEDGEMENTS

I wish to thank Professor A.W. Hendry for giving me the opportunity to undertake this research under his personal supervision, and Dr S.R. Davies for his great help throughout the study.

I would also like to thank my colleagues in the Department for their helpful discussions, the technical staff of the workshop and the photographic unit for their assistance.

Thanks are also due to the University of Sulaymania for awarding the scholarship and the Gulbenkian Foundation for their financial support during the study.

My thanks go also to my friend Taha for his encouragement, and to Mrs J. Bogie for her careful typing of the manuscript.

PRINCIPLE NOTATIONS

a_h, a_l	cross-section area of column and beam of the bounding frame, respectively.
a_{wh}, a_{wl}	cross-section area of column and beam of the equivalent frame (wall containing opening), respectively.
d	length of the diagonal.
E, E_w	modulus of elasticity of frame and wall respectively.
e	column deformation or elongation.
f	coefficient of internal friction.
f_w	ultimate compressive strength of brickwork.
$f_1, f_2, f_3, \dots, f_n$	axial forces in the columns.
h, l	height and length of frame (centre lines), respectively.
h_w, l_w	height and length of wall, respectively.
h'_w, l'_w	height and length of the equivalent frame (wall containing opening) respectively.
I_h, I_l	second moment of area of column and beam of the frame, respectively.
J_h, J_l	second moment of area of column and beam of the equivalent frame (wall with opening), respectively.
K, S	lateral stiffness .
P	lateral load.
P_{cr}, P_{ult}	cracking and ultimate load, respectively.
R	diagonal load carried by the wall.
T	shear strength of brickwork.
t	wall thickness.
U	strain energy.
u	shear bond strength of brickwork.
$w/$	

w	effective width.	
α_1, α_h	length of contact with the beam and the column, respectively.	
θ	diagonal angle.	
σ	compressive stress.	
δ, Δ	deflection.	
ϵ_c	strain of brickwork at failure.	
ϕ	Angle of rotation of rigid floor.	
ψ	$= \frac{C}{A + B + C}$	
λ_h, λ_l	$= \sqrt[4]{\frac{E t \sin 2\theta}{4EI_h h w}} \quad , \quad \sqrt[4]{\frac{E t \sin 2\theta}{4EI_l l w}}$	respectively.

ABSTRACT

Masonry walls in frame buildings are generally considered as non-structural elements and their contribution in resisting lateral loads has therefore been neglected in the design of frame type structures. However, recent experiments as well as practical buildings have shown that the stiffness and strength of a frame are greatly increased by the presence of an infill, due to the high in-plane stiffness of masonry infills and the composite action of the frame and the infill.

In this investigation the detailed behaviour of brickwork infilled frames with and without opening has been described and discussed in the light of a large number of small-scale experiments. The experiments have been carried out mainly on single storey panels. It has been shown that the strength and stiffness of the panels are influenced by many factors, such as, frame stiffness, $h : l$ proportion, the presence of adjacent infills, frame joints rigidity, gaps at the interface, and the bond strength of the mortar used in construction. Two modes of failure have generally been observed; shear cracks along the brick-mortar interface and crushing of the brickwork near the loaded corner defining the ultimate carrying capacity of the panel.

The complex behaviour of masonry infilled frames and the wide variation in experimental results discourage the analysis of such a system by refined theoretical methods. In this investigation emphasis is given to simple approximate approaches. On the basis of an equivalent diagonal strut, the panels have been analysed for stiffness prediction. Approximate methods are also given to predict the lateral strengths at cracking and at ultimate. In all cases results compare satisfactorily/

satisfactorily with the experimental values. For panels containing opening the infill has been replaced by an equivalent frame acting diagonally along the corners.

On the basis of a single storey-stiffness, a simple method for analysis of multi-storey infilled frames has been presented; the axial deformation of the frame members has been taken into account.

The analytical study has been extended to the application of finite element method for analysis of single storey panels; good results may be obtained provided that appropriate boundary conditions are assumed.

CONVERSION FACTORS

	<u>Imperial Units</u>	<u>SI Units</u>
Length	1 ft	0.3048 m
	1 in	25.4 mm
Area	1 in ²	645.2 mm ²
	1 ft ²	0.0929 m ²
Second Moment of Area	1 in ⁴	0.4162x10 ⁻⁶ m ⁴
Mass	1 lb	0.4536 Kg
Force	1 lbf	4.448 N
	1 ton f	9.964 KN
Pressure	1 lbf/in ²	6.895 KN/m ²
Moment of Force	1 lbf in	0.1130 Nm

CHAPTER 1INTRODUCTION1.1 GENERAL

In the design of tall buildings, adequate lateral stiffness is required to resist loads which may arise due to wind, earthquake and blast effects. In frame-type structures, lateral stiffness may be achieved by rigidity of the joints, bracing members or by cantilever shear walls acting in conjunction with the frame. Braced construction or the use of shear walls to prevent sway instability would produce a very satisfactory structural system. The use of rigidly-jointed frames may not produce the most economic structure, although their adoption is due to other factors.

The plastic theory is widely used to design framed structures. However, the application of simple plastic theory to the design of tall buildings exposes the severe limitation of that theory. Two of the basic assumptions are: (a) that deflections are small, and (b) that instability of the frames as a whole or of individual members does not occur. There is no danger of instability of individual column lengths. This is because of the heavy sections used at lower storeys. However, instability of the frame as a whole is a more serious problem.

Wood⁽⁶²⁾ has made extensive studies of the deterioration of frame stability owing to the formation of plastic hinges, and has demonstrated the dramatic fall in critical loads that can be expected. This deterioration of stability places a severe limitation on the extent to which plastic theory may be used for design. Referring to the composite action induced by infilled panels in framed structures, Wood /

Wood concluded that: "As a temporary measure composite action should be capable of bridging the variable gap that exists between the actual collapse loads of elasto-plastic multi-storey bare frames, involving frame instability to some extent, and the collapse loads predicted by simple plastic theories, for only small propping forces are necessary to counteract instability".

In many frame-type structures, walls and partitions are made of precast concrete or masonry units which are often considered to be nonstructural elements. They contribute remarkably to the lateral stiffness and strength of the structure, their contribution has not been taken into account and their effect has been over-looked.

The interaction of infill materials with the structural frame has a most important effect on the structural behaviour. This effect has been clearly demonstrated in many examples of actual buildings. The Empire State Building is a rigidly-jointed structure. After the completion of the building, during a severe wind storm, diagonal cracks appeared in the masonry of a number of partitions, and cracks were observed between the masonry and the frame. The period of vibration of this building has been measured under winds up to 100 m.p.h., working back from this period of oscillation, it has been possible to determine the real stiffness of the whole structure. When compared with the stiffness of the bare frame obtained by model analysis, the effect of the walls and cladding were found to increase the stiffness to four and a half times that of the frame alone⁽⁴¹⁾.

In detailed studies of a traditional pre-world war two San-francisco office building, it was found that the non-structural elements such as fire-proofing, masonry walls and stairs have a great/

great deal to do with the dynamic properties of the building⁽⁵⁾. Studying the structural dynamics behaviour of buildings, Blume⁽⁶⁾ has concluded that the strength and rigidity of traditional type buildings with non-calculated filler walls and partitions are many times those of the frames which were intended to provide the structural resistance.

When designing a structure to resist lateral loads due to wind and earthquakes, it is expected to carry loads beyond the working loads and with a great strain-energy capacity. It is well known that a structural steel frame, particularly where of a rigid frame-type construction, fails with a considerable strain-energy capacity with all the characteristic benefits of ductility. A brick wall of the same size, failure occurs with a pronounced brittle crack with no stored-up energy, the direct effect, however, of a much greater stiffness. A composite panel, steel frame with brick infilling preserves both the ductility of the steel frame and the extra stiffness of the brick wall whilst giving a collapse load considerably higher than the sum of the separate components load, coupled with remarkable increase of strain-energy.

Infilled panels may not only increase the stiffness and the damping of a structure and hence shorten its fundamental period of vibration, but may alter the mode of response of the structure and the resulting distribution of forces among the different frame elements. When the effect of infilled panels is included in an analysis, it is necessary also to consider the behaviour of the structure when some or all of the panels are destroyed. Damage due to earthquakes must be fully repaired, for they can be cumulative from one earthquake to the next, regardless of the length of intervening time, plastering/

plastering and painting cracked walls are not considered as a structural repair.

Infilled panels may also be subjected to vertical loads due to earthquake or relative vertical deflection in the structure, for earthquakes have vertical movement as well as horizontal, and in tall reinforced concrete buildings relative vertical movement between exterior and interior columns may occur^{due} to: thermal expansion and contraction of exterior columns, different axial load stresses in columns leading to different elastic and creep deformations of the members, and differential settlements of the foundations for the columns.

In recent years, masonry cladding on framed structures which has been built-in tightly between horizontal members of the frame, especially reinforced concrete frames, have suffered cracking and disruption⁽¹¹⁾, which have been attributed to a combination of structural deformation of the frame due to shrinkage, elastic and creep movements, and differential thermal movements of the masonry material and moisture expansion in case of brickwork. These differential movements of the structural components will impose considerable forces on the panels. Buckling action could take place if these forces were coupled with eccentricity. Infilled panels if considered as a structural component of the building, should be designed not only to resist the lateral forces, but also those which may arise from the possible causes of differential movements, otherwise properly designed movement joints will be required⁽¹⁰⁾. Special shear connectors to allow for both movements and lateral load transmission may provide a reasonable solution for the problem.

Apart from racking action of masonry walls in stiffening frames against/

against lateral sway, the composite action may take other forms:

In a deep composite beam where a masonry load bearing wall is built on a beam which spans between supports, composite action between the wall and the beam significantly affects the distribution of load transmitted through the wall to the beam. The composite action approximates to that of a tied arch, the arch forming in the wall with the beam acting as a tie. In composite design making use of arching in the brickwork leads to a considerable reduction in bending moment in the beam⁽⁶⁴⁾.

Deep wall beams if surrounded by members on all sides would carry further more vertical loading.

Masonry walls are liable to be subjected to transverse loading, i.e. perpendicular to the wall plane such as: gas explosion and wind loading, cracking may occur for even small lateral loads. However, in infilled frames, wall resistance is greatly increased due to the stiffening effect of the bounding frame. The wall resists greater load by acting as a flat dome.

Infilled panels may be considered as a structural element in the design of vierendeel girders filled with masonry acting as a composite system.

Many other forms of composite action can be found in practice which have not been considered, and their contributions are not taken into account. It must be realised that the full effectiveness of composite action in resisting any kind of loading will depend on the extent to which the frame members and joints are adequate to confine the wall within, frame failure prior to panel failure must be avoided.

This investigation considers the behaviour of masonry infilled frames/

frames under lateral loading only. In the last two decades, considerable attention has been given to the study of infilled frames and their response to lateral loading. Investigation was led by Polyakov in Russia. Benjamin and Williams at Stanford University (U.S.A.) made an extensive study on the behaviour of shear-walls and infilled frames. In Britain, Wood, Holmes and Smith investigated the behaviour of infilled frames, later followed by others. (A detailed review of these investigations is given in Chapter 2).

The earlier approaches to the problem have varied widely, because of the different assumptions being made, the prediction of the behaviour, stiffness and strength of infilled frames have also varied widely, all these and the inadequacy of information about the behaviour and response of such systems have restricted the possibility of designing infills as a lateral bracing component in tall steel or reinforced concrete framed structures. Recent investigators have produced better correlation with each other, but still the engineers face uncertainty about the design of infilled frames because of the numerous factors affecting their behaviour and strength. All these may lead the engineer to design the frame ignoring the infill in order to be on the safe side, or he may prefer to employ a homogeneous shear wall, about which he has more information, and last of all there is the fear that after a few years, the infill may be removed or perforated for some reason.

CHAPTER 2MASONRY INFILLED FRAMES2.1 REVIEW OF PREVIOUS WORK

In this chapter, a review of previous experimental and theoretical work on infilled frames is described.

In 1948, at the Central Research Institute for Industrial Structures (Moscow), Polyakov started the first experimental and theoretical investigation into the behaviour of infilled frames subjected to racking load. Details of the investigation have been published in several papers (35 to 38). Large scale experiments on brickwork infilled pin-jointed frames with and without openings were conducted. A study of shear and tensile strength of brickwork was part of the programme. An approximate analysis based on theory of elasticity method was used to determine the infill stresses. The lateral racking load was predicted by equating the maximum theoretical shearing stress in the infill to the corresponding strength of the infill material. Empirical formulae were introduced to predict the strength of infills with and without openings. His formulae included the effect of variation in h/l ratio of the panel, but variation in frame stiffness was not taken into account. The mode of failure in Polyakov's tests was cracking of the brick-mortar joint along the compression diagonal. Separation of the infill from the frame, except at the compression corners was observed; this separation led Polyakov to propose replacing the infill by an equivalent strut acting along the diagonal. Because of the pin-jointed frames used in his experiments, the frame itself is not capable of supporting any lateral load, the full composite action will not be achieved, and also causes a high stress concentration inside the panel at the compression corners.

In/

In some of his experiments the infill was reinforced, these tests showed that horizontal joint reinforcement did not affect the infill strength, but vertical reinforcement may increase shear bond which in turn would increase the strength of the infill.

In 1953, Thomas⁽⁵⁷⁾ presented a paper on the strength of brickwork. His study included some racking tests on encased steel frames infilled with brickwork and other building blocks. It was shown that the maximum racking load sustained with 4½ inches brick infilling was over twice that which could be supported by the encased steel frame alone. More details of these tests were given by Wood⁽⁶²⁾ in 1958, and an empirical interaction formula was suggested for use in the design of tall frame buildings⁽⁶³⁾. The composite strength of an infilled frame is given directly in terms of the separate strengths of the frame and infill:

$$C = \left[1 + \frac{2}{\frac{W}{F} + \frac{F}{W}} \right] (W + F).$$

In 1955, Whitney, Anderson and Cohen presented a paper⁽⁶¹⁾, which was based on research initiated in 1949 by the United States Department of the Army, at the Massachusetts Institute of Technology to determine the deformation and strength of infilled frames with regard to their atomic blast resistance. The lateral stiffness and strength of infilled frames were predicted by an approximate method based upon simple bending and shear deflections and stresses. The integration between the frame and infill was assumed, thus the columns act as a flange of vertical cantilever beam, in which the infill is the web. The stiffness is given by:

$$\frac{r_o}{X} = \frac{E_w}{\frac{2Kh(1-\mu)}{A_w} + \frac{h^3}{3I}}$$

where/

where

- r_o : lateral load.
- X : elastic deflection.
- E_w : Modulus of elasticity of wall material in tension and compression.
- K : shape factor.
- μ : Poisson's ratio for wall material.
- A_w : Cross sectional area of the wall only.
- I : moment of inertia of the transformed section of the bent plus the wall in terms of the wall material.
- h : height of the frame.

The same formula was proposed for masonry filler walls. However, because of the separation which occurs between the frame and the infill, integration between the two elements cannot be assumed, and the formula is not applicable to masonry infilled frames. They also suggested a method which could include the effect of vertical loading, and empirical formulae were proposed to predict the ultimate lateral strength of infill frames. Their paper included no experimental results to verify the proposed formulae.

From 1951, the research was continued by Benjamin and Williams at Stanford University, California. The results were published in four papers in 1957, 1958 and 1960^(1, 2, 3, 4). Large scale and model infilled frames were tested. In their paper⁽³⁾, reinforced concrete and steel frames with brickwork infilling were studied. Panels of different length to height ratio, bricksize, frame size and variable steel and concrete area were tested. Boundary cracks were first observed at very low load, separating the masonry panel from the frame except at the loaded corner and at the junction of the foundation and compression column. Ultimate load was defined by a sudden crack along the/

the compression diagonal. The length to height ratio was found to have an important influence on the ultimate strength and rigidity of the panel. It was concluded that the variation in column steel and concrete area did not influence the rigidity in the uncracked range, and that the frame had no important influence as long as it was strong enough to produce failure in the wall panel. This conclusion has not been reached by other investigators^(28,49), neither was it reached by the author. Their conclusions included also, that brick size is unimportant.

Considerable theoretical studies of the possible stresses in brick wall panels were carried out, but they concluded that a simpler strength of materials method would give the same accuracy in results. The following formula was proposed for the deflection of the structure, only shear deformation is considered:

$$\delta = \frac{1.2b}{atG} \quad \text{where} \quad \begin{array}{l} b = \text{height} \\ a = \text{length} \\ t = \text{thickness} \end{array} \quad G = \text{shearing modulus.}$$

Their study included tests on crossed brick couplets as a measure of bond strength. The load was applied under varying but known conditions of combined stresses; from these tests the following equation was derived to predict the ultimate strength of infilled frames:

$$P = \frac{220Cat \frac{a}{b}}{1.5 \frac{a}{b} - 1.1C} \quad \text{where} \quad \begin{array}{l} C = \text{Workmanship factor} \\ a = \text{length} \\ b = \text{height} \end{array}$$

with an upper limit of $P_{\max} = 670Cat$.

Their formulae neglect the stiffness and contribution of the frame. In their paper⁽¹⁾, Benjamin and Williams were concerned with reinforced concrete frames with plain and reinforced concrete infilling. Several modes of failure were observed: Failure by tension in the windward column/

column, shear failure at the base of the leeward column, cracking around the boundary of the infill, and cracking along, and parallel to, the compression diagonal of the infill. A full integration between the wall and the columns was assumed, and formulae based on a simple strength of materials method were proposed to determine the stiffness and strength of the structure. Their predictions are similar to those of Whitney et al. However, they stated that errors of 50% or more could be expected.

Holmes⁽¹⁷⁾ shared Polyakov's suggestion that the infill acts as a diagonal strut, and he assumed the equivalent strut to be of the same thickness and modulus of elasticity as the infill, with a width equal to one-third of the diagonal length of the infill; the stiffness was then found by an elastic analysis of the resulting structure. Assuming the infill to fail when the average diagonal strain over the effective width $\frac{d}{3}$ has reached a value equal to the failing strain of the infill material, the following formulae were presented by Holmes for the strength and deflection of infilled frames:

$$H = \frac{24EIe_w d}{h^3 \left(1 + \frac{I}{I_w} \cot \alpha\right) \cos \alpha} + Af_w \cos \alpha$$

$$\text{and } \delta_H = e_w d \cos \alpha$$

where f_w = comp. strength of infilling material.

$$A = \text{cross-sectional area of equivalent strut} = t \frac{d}{3}$$

e_w = strain in infilling at instant of failure.

h, d = height, diagonal of rectangular steel frame.

t = thickness of the wall infilling.

EI = flexural rigidity of members of steel frame.

H = horizontal shear force at failure.

His/

His assumptions were criticized by Smith and others⁽¹⁹⁾, however, his simple approach has been welcomed. Further small scale tests with concrete infilling were carried out by Holmes⁽¹⁸⁾, to determine the behaviour of single storey infilled frames under horizontal and/or vertical loading. A semi-empirical method to predict the deformation and strength of the infill was proposed. The tests results showed that the specimen with the vertical loading showed a diagonal tension crack at a higher lateral load, but failed in diagonal compression at a lower load than the specimen under lateral loading only. His study included the behaviour of two storey infilled frames; a few tests with brick and concrete infillings were presented, and a method for predicting their behaviour was proposed, based on his previously used concept of the diagonal strut.

Smith^(48, 49) based his investigation into the behaviour of infilled frames on the same principle, i.e. diagonal strut. The effective width of the equivalent strut was not assumed constant, but related to the length of contact, which in turn depends on the relative stiffness between the infill and the frame. The values of the effective width were determined theoretically: the infill loaded diagonally by an assumed interaction force over the length of contact determined for different frame stiffness, thus taking into account the change of frame rigidity. The total strain along the diagonal was determined by finite difference solution of the biharmonic equations, from which the equivalent width was derived for different frame-infill proportions. The experimental values for the effective width fell below the theoretical values, therefore the experimental values were used for analysis of the frames. It was found that a difference in frame stiffness will result in a different equivalent/

equivalent width, and in turn results in different infill stiffness. The theoretical method derived for diagonal loading was adapted to laterally loaded infilled frames; the lateral stiffness to be found by analysing the equivalent pin-jointed frame in which the infills would be replaced by equivalent diagonal struts. Tests were carried out on model steel frames infilled with mortar. The tests showed separation between the frame and the infill, and the interaction between them was concentrated around the loaded corners. The first crack appeared along the loaded diagonal extending from the centre of the infill towards the corners; collapse occurred by compression failure at the loaded corners of the infill. However, he concluded that, depending on the frame-infill relative stiffness, cracking along the loaded diagonal could precede the compression failure. His investigation extended to the behaviour of one and two storey infilled frames with rectangular infills (50, 51). He found that the effective width is also influenced by the length to height proportion of the infill and the height on the structure at which the stiffness is to be predicted. He concluded, moreover, that the lateral load to produce a compression failure of the infill is dependent on the relative stiffness of the column to the infill, and independent of the length/height proportion of the infill and the beam stiffness. The load to cause the compression failure of the infill was given by:

$$H_c = \alpha t f'_c \quad \text{where } \alpha = \text{length of contact with the column.}$$

The same method was proposed in a joint paper (Carter and Smith)⁽⁸⁾ for analysis of masonry infilled frames subjected to lateral load. Design curves for predicting shear and diagonal tension failures were presented; based on a series of theoretical stress analysis for panels of different length/

length to height proportions, with arbitrary diagonal loads acting over different length of contact. They⁽⁵²⁾ extended the proposed method to take into account the effect of variation in modulus of elasticity of the infill due to the variation of diagonal load acting on the infill.

Satchanski⁽⁴²⁾ analysed the infilled frame using the method of theory of elasticity, by replacing the interaction forces between the frame and the infill by thirty redundant reactions, thus forming thirty simultaneous equations and solving these equations for the compatibility of displacements of the frame and infill. The principle tensile stress at the centre of the infill was derived, and used for predicting the lateral strength of the structure. The theoretical values for the cracking load were 20 - 30% lower than his tests values, the tests were carried out on model and large scale reinforced concrete frames with brickwork and concrete infillings, with and without openings. Satchanski's analysis also is based on the continuous bond at the interface between the frame and the infill.

Liauw⁽²⁴⁾ conducted some tests on infilled frames using elastic materials and photoelastic technique. He analysed the structure in the elastic range using Airy's stress function expressed in the form of a Fourier series, and proceeded to the derivation of the stresses and deformation in the infill and the frame. He assumed the infill is bonded to the frame. The experiments showed a non-linear stress distribution at, and adjacent to, the interface of frame and infill, and that the stiffer frame carries larger portions of the shearing load than the more flexible frame. In another paper⁽²⁵⁾, Liauw presented an approximate method of analysis of infilled frames with or without openings. It was based/

based on the concept of equivalent frame; in which parts of the infill were assumed to act integrally with the frame members forming composite section; deformation was then found by analysing the equivalent frame by the established structural analyses. Experiments were carried out on two elastic models. He concluded that the results showed good agreement with the proposed method, when the opening area is more than 50% of the full infill area. The method presented is simple and could be applied to multi-storey buildings, however it is unreal to assume that the frame members and the wall will form a composite section because of the separation which may occur between the infill and the panel.

Analysis of infilled frames by the finite element method was first presented by Karamanski⁽²¹⁾. The method was based on the assumptions: that the frame carries axial forces only, the tie between the frame and the infill is not broken, and that the system is fixed at the base. The first assumption could be accepted since because of the small deflection of the structure, the immediate reaction of the frame is due to axial forces, but his second assumption does not represent the actual behaviour of non-integral infilled frames. However, his application of finite element method is a great contribution in theoretical analysis of infilled frames, and some modifications are required in order to be made more realistic.

A more accurate analysis of infilled frames by the finite element method was presented by Mallick and Severn⁽²⁹⁾. The method included the slip and separation between the frame and the infill, as well as the stress distribution at the contact length, as an integral part of the solution using an iterative scheme. However, the axial forces in the frame members were not included. They carried out model tests on steel/

steel frames with Kaffir-D plaster infilling. The experimental results were in good agreement with the theoretical values for square infilled frames but not so good for rectangular frames. Further investigations were carried out by Mallick and Garg⁽³¹⁾ to find out the effect of different opening positions on strength and stiffness of infilled frames, and the behaviour of frames with and without shear connectors. Only square panels with square openings having dimensions equal to $\frac{1}{4}l$, were tested. Steel frames with high alumina cement infilling were used. They concluded that opening at either end of the loading corners reduces the stiffness 85 - 90% compared with solid panels, central openings decreases the stiffness and strength about 25 - 50%, and that shear connectors showed greater stiffness up to the first crack, however the spacing of shear connectors did not effect the behaviour of infilled frames appreciably. Mallick and Severn studied also the dynamic behaviour of infilled frames⁽³⁰⁾.

The effect of vertical loading on columns of infilled frames is described by Simms⁽⁴⁶⁾. Tests on two full-scale reinforced concrete frames with infill panels of no-fines concrete were carried out. In one of the tests, the column members of the frame were subsequently prestressed in an attempt to produce the compressive stress due to working loads in lower storey frames of a multi-storey structure. The amount of prestressing was up to 75% of the permissible working stress of the concrete. The tests showed that the prestressed column specimen showed greater stiffness and strength than the other specimen.

A series of tests on model frames with infills of $\frac{1}{6}$ scale model brickwork and micro-concrete, has been reported by Mainstone⁽²⁷⁾, a few full-scale tests were also included. Some of these tests were previously published/

published in several papers^(19,26,28). A number of frames were made of very stiff members in order to simulate the restraints exerted on a panel by adjacent infills of a multi-storey, multi-bay system. Wide variation of experimental results was observed in these tests, even between nominally identical specimens. A study of infilled frame behaviour was carried out on the basis of effective width of an equivalent diagonal strut, and only a simple method based on that same principle was recommended for design purposes⁽²⁸⁾.

A paper by Mihai et al⁽³²⁾ describes tests carried out on model walls under horizontal loading. The behaviour of masonry walls with, and without, bounding reinforced concrete frames, door openings, and lintels of different sizes was reported.

A large number of tests on unframed masonry walls under racking load have been carried out and discussed by many investigators in recent years, but as these are not very relevant to the subject under review, only references are given^(12,13,34,40,43,45,47).

More recently Smolira⁽⁵⁶⁾ has published a paper describing an approximate method of the analysis of infilled shear walls (infilled frames). The principle of equivalent diagonal bracing has been adopted, his analytical formulation is based on the force-displacement method. Separate analysis taking into account the effect of possible gaps at the interface between the frame and panel has been shown. In this case the analysis is made in two stages: first the frame alone is taken into account, and the amount of lateral loads required to close the gaps between the frame and the panel are calculated, then in the second stage the diagonal force taken by the panel is considered. Numerical examples have been shown to illustrate the method. The effect of contact pressure at the interface/

interface is also discussed and it is shown that it can be included in the analysis. The value of the effective area of the panel as a diagonal bracing member can affect any analysis based on the diagonal bracing principle; this value has been assumed constant in Smolira's analysis without explanation as to how it was obtained. The axial and shearing deformations also are not included in this analysis.

2.2 SUMMARY AND SCOPE OF THE WORK

So far, the experimental investigations which have been carried out on infilled frames are few in number and they are mostly on infill materials other than brickwork. Considering the importance of such material as infill, which is widely used in everyday practice as partitions or external walls in framed structures, more information and experimental results are needed. Detailed behaviour of such panels under lateral loading must be well known, including their behaviour and response at various stages of loading especially at failure, upon which design consideration for large deflections, such as earthquake motions, may be based.

Other factors which may also affect their behaviour and strength are: different material properties composing the system, panel height to length ratio, openings, frame members stiffness and their joints, workmanship, vertical loading, adjacent infilled panels, loading causing torsion, and lack of fit between frame and panel which is unavoidable because of the thermal and moisture expansion of panel material and many other factors which generally affect the strength of masonry and the frame. Although most of these factors can not be formulated theoretically, the behaviour of infilled frames under these conditions must be revealed before any standard design method can be put forward for design purposes.

The/

The experiments carried out in this investigation are an attempt to provide some more information concerning some of these factors. This work is mostly concentrated on idealized single storey brickwork infilled frames with different height to length proportion for different frame stiffnesses, with, or without opening. Since this type of structure is mainly considered as a lateral bracing system in multi-storey frames, a few experiments have also been carried out on two, three and four storey brickwork infilled frames. In order to obtain satisfactory results for a composite system such as brickwork, a large number of experiments is essential, large scale tests are material and time consuming. On account of these limitations and the satisfactory use of model-brickwork in investigating brickwall behaviour⁽³³⁾, the tests were carried out on small scale panels.

Various methods to predict the lateral stiffness and strength of infilled frames have been proposed. Some investigators assume integration between the frame and panel, and formulae based on this assumption have been suggested. Clearly this assumption is not valid for masonry infilled frames where separation at the interfaces is to be expected. Other investigators have adopted the principle of an equivalent diagonal strut which allows for separation: the effective width of the strut has been either assumed or based on the experimental values. Results from this type of analysis depend mainly on the value of the effective width. Sophisticated mathematical analyses have shown results not much better than the approximate ones and have therefore been abandoned by most investigators.

In this present investigation, methods of predicting lateral stiffness and strength have been studied and modified in order to be applied generally./

generally. A study of the application of finite elements method has also been carried out. A simple method of analysis of multi-storey infilled frames which is based on simple calculation is also included.

CHAPTER 3BEHAVIOUR OF ONE-STOREY BRICKWORK INFILLED FRAMES3.1 INTRODUCTION

A masonry infilled frame is a very complex composite structure, its behaviour is affected by many variables. In order to study the behaviour of the structure for all the variables included, a large and extensive, as well as expensive, number of experiments are required. In order to minimize the variables and at the same time not ignoring the important parameters which are found in practice generally, only the most influential factors have been studied by the Author. However, because of the statistical nature of the brickwork composite, several identical experiments have been carried out for each variable. A wide variation in experimental results has been observed. The walls were constructed using one-third model bricks, the scale of the structure however has not been scaled down to one-third. The scale factor involved in experiments has been found to be unimportant⁽³⁾, moreover, the structure can be considered and analysed as a small structure by itself; therefore an appropriate scale was taken so that many difficulties arising from the testing procedure could be avoided and some saving in materials could be made. The back to back principle was adopted for testing which was found to be very practical and easy.

In this chapter the behaviour of square and rectangular brickwork infilled frames as well as their modes of failure have been described and discussed; some other factors are also included, such as, the effect of gap between the frame and the panel at the top, the rigidity of the frame joints, and the effect of high bond strength mortar on the behaviour of masonry infilled frames. Results are shown in either tabular/

tabular or graphical form and conclusions are given.

3.2 MATERIALS

3.2.1 Bricks

One-third scale model bricks were used for the construction of the walls. The bricks were from three different batches with an average crushing strength of 4228 psi, the details of the strength of the bricks are given in Appendix A.

3.2.2 Sand

Fine Leighton-Bazzard sand was used for the mortar for all the walls. The grading curve is shown in Fig. (3.1).

3.2.3 Cement

Rapid hardening Portland cement "Ferrocrete" was used for all the walls tested.

3.2.4 Mortar

1 : 3 cement and sand by weight, with an average crushing strength of 2262 psi, was used for the construction of the walls, except for panels WR1, WR2, WR3 and WR4 where modified mortar with additive "Revinex" was used (App. B). Water-cement ratio was found by trial and error to obtain a mortar with good workability for construction.

3.2.5 Steel

Mild-steel rectangular cross-section was used for all the frames. Cross-sections of 1.5 inches width with varying thickness ranging between $\frac{1}{2}$ to 1 inch were used.

3.3 METHOD OF CONSTRUCTION

3.3.1 Frame

The frames were constructed in a duplicate form on the back to back principle Fig. (3.2), this arrangement simulates a pair of rigid frames/

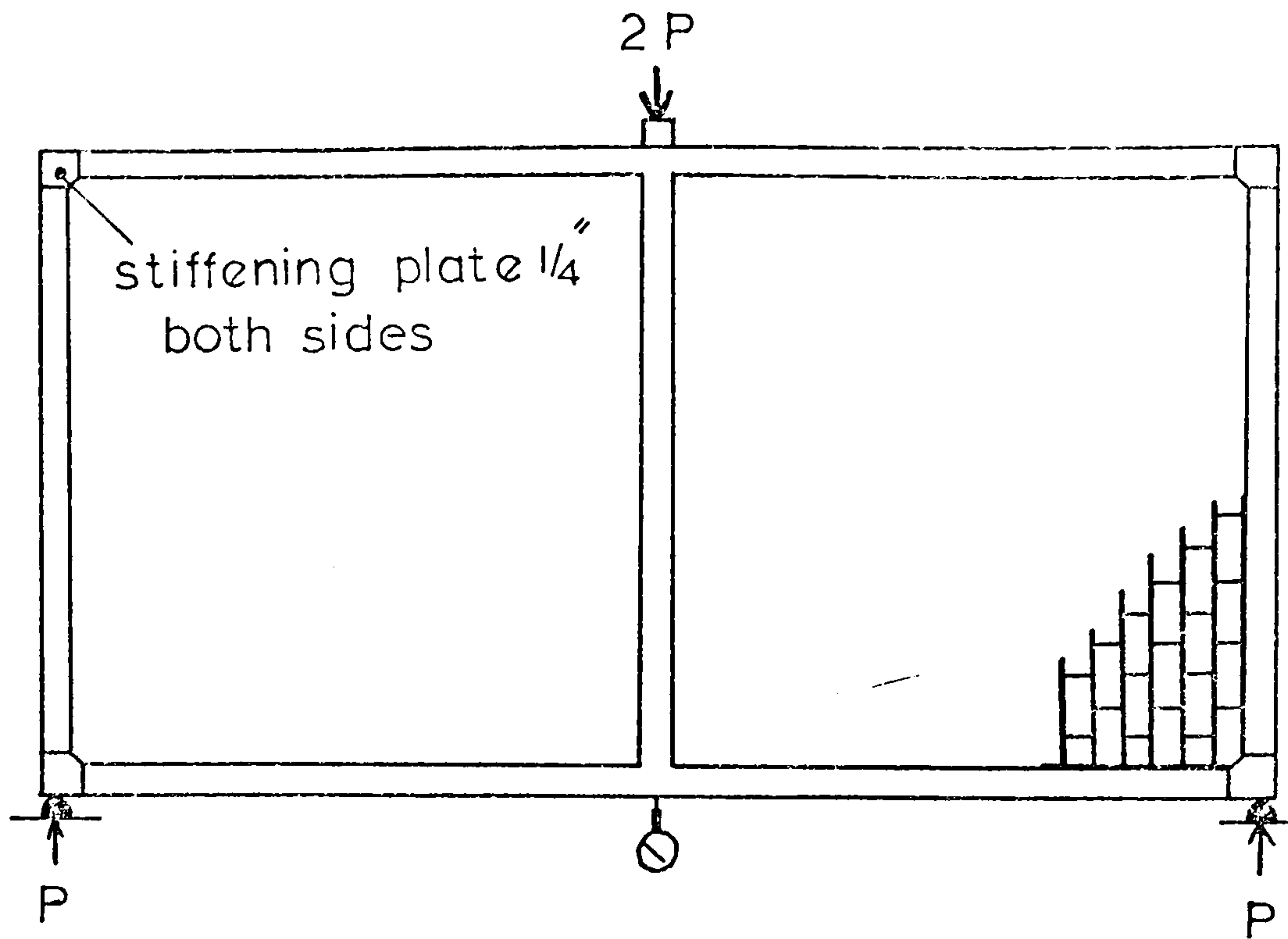

Fig.(3.2) Testing method.

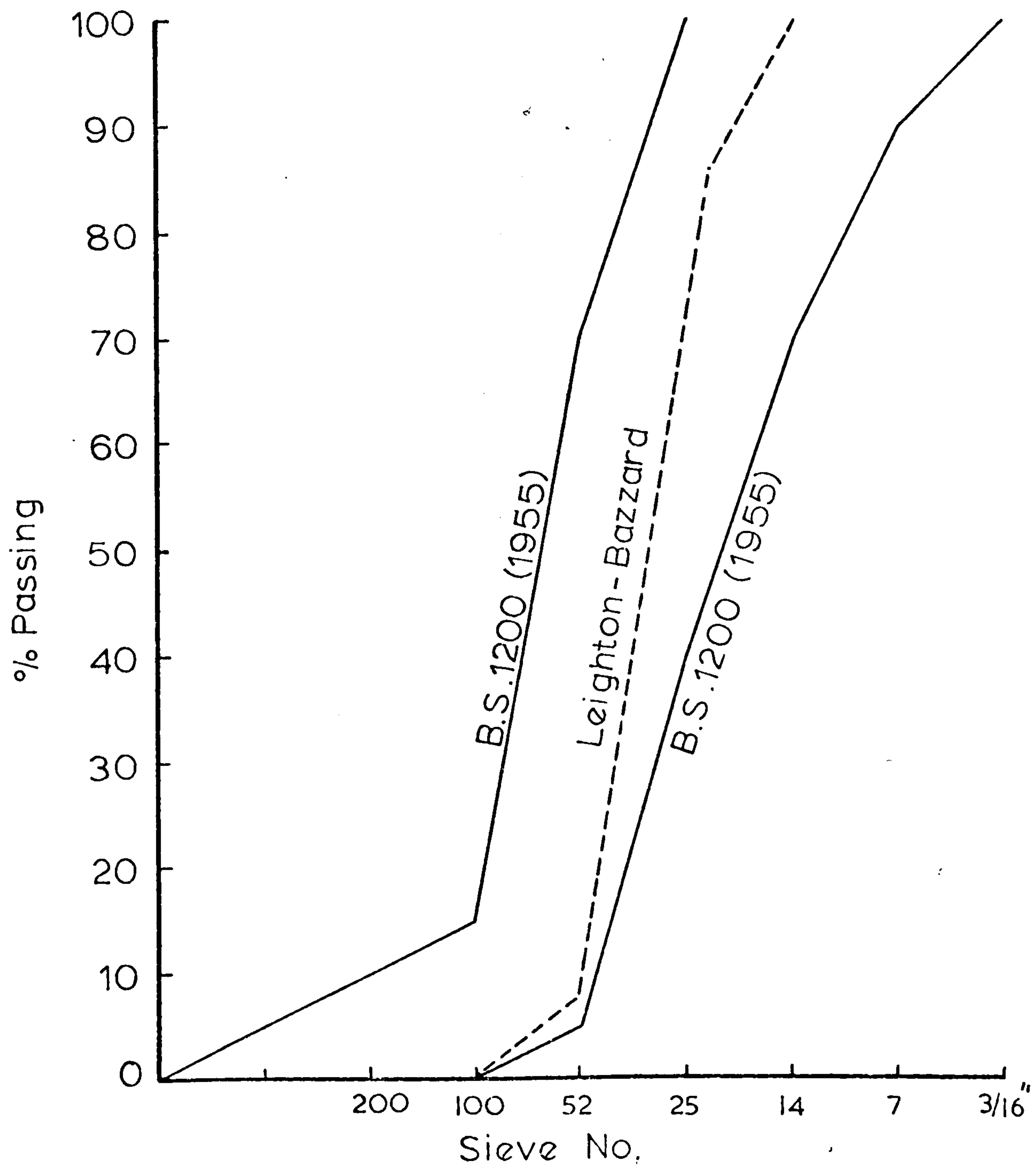

Fig.(3.1) Leighton-Bazzard sand grading curve.

frames with central beam providing a rigid base for the frames. The columns were made continuous and the beams were welded between them with double V-butt welds on all sides. In order to provide the full bending strength of the members, plates of $\frac{1}{4}$ inch thickness were welded to the joints on both sides. After each test, the frame was checked for any plastic deformation. In the absence of permanent deformations, and for economic reasons due to the great number of tests involved in the programme, each frame was re-used only once.

3.3.2 Brickwork panels

The frame was fixed vertically with a flat wood board behind to keep the wall in plane during the construction. The wood board was marked with horizontal lines to provide a guide line for the joint thickness and brick. The bricks were immersed in water for 30 - 45 minutes before construction. The brick wall was built in a normal way. Great attention was given to the joints between the frame and the brickwork, especially the top joint between the wall and the beam, to ensure a good fit so that no gap was left in between. After completion, the walls were covered with a polythene sheet, and were left for at least two weeks before testing.

3.4 TESTING ARRANGEMENT AND LOADING METHOD

The duplicate form of the frames provides a simple method for testing model infilled frames. This method has been found to be very satisfactory by many investigators.^(2,29,48) The frame was tested as a beam, simply supported at its ends, carrying a central point load in which the load on each panel is equal to the half of the applied load. The infilled frames were tested under the Avery machine, half circle section bars were put at the end supports directly under the centre line of the top beam. A rectangular cross-section bar was put at the loading/

loading point in the centre of the middle beam. A 0.0001 inch dial gauge was put at the bottom directly under the line of the applied load. Load was applied at constant rate, and deflection was taken at pre-determined load intervals. The load was kept constant during the deflection readings.

3.5 TESTS RESULTS

Dimensions and properties of the panels tested, load at the first shear crack, load at the compression failure of the brickwork, and the stiffness of the panels, are shown in Table (3.1).

The average lengths of contact measured along columns and beams are shown in Table (3.2). The load-deflection curves of the panels are shown in Figs. (3.3) to (3.8). Figs. (3.10) to (3.15) show the variation of the cracking strength, ultimate carrying capacity and the stiffness, due to the variation in frame stiffness for square, rectangular $\frac{l}{h} = 1.6$ and $\frac{l}{h} = 2.0$, panels. The curves are expressed in terms of dimensionless parameters $\lambda_h h$ or $\lambda_l l$ ($\frac{P_{cr}}{u l t}$ vs. $\lambda_l l$, $\frac{P_{ult}}{f h t}$ vs. $\lambda_h h$ and $\frac{P}{\Delta}$ vs. $\lambda_h h$). The smaller the value of λ , the stiffer the frame relative to the infill. In Figs. (3.10) to (3.15), the results are shown in graphical form, a smooth curve has been drawn passing through the average values. Later these values are compared with the theoretical values in the corresponding chapters.

The behaviour of the panels under lateral loading is described in sections 3.6, 3.7 and 3.8. Discussions are given in section 3.9.

3.6 SQUARE AND RECTANGULAR PANELS

The tests carried out on model brickwork infilled frames with different height to length ratio and frame stiffness under lateral loading are described below: At the initial stage of loading, separation of the frame from the infill occurred, however, it was too difficult to observe/

Test No.		Infill h _w x l _w (inches)	frame members (inches)	cracking load (ton)	ultimate load (ton)	lateral stiffness (ton/inch)	Notes
WF11	WS1	15.75	0.50	1.375	3.875	37	
WF12		x	x	1.00	3.50	45.5	
WF22		15.75	1.50	0.50	3.625	46	
WF36				0.50	3.65	59	
WF5	WS2			0.50	2.50	28 +	Joint failure
WF6				0.43	2.00	31 +	
WF9		15.75	0.75	1.065	3.65	45	
WF21		x	x	0.625	4.10	78	
WF34		15.75	1.50	1.25	3.73	58	
WF37				1.10	4.125	50	
WF38				0.50	4.10	44	
WF33	WS3			0.80	4.67	45 +	Joint failure
WF7		15.75	1.0	1.375	7.50	72	
WF23		x	x	1.30	6.88	74	
WF10		15.75	1.50	1.00	7.50	60	
WF40				1.20	5.90	64	
WF31	WF1	15.75	0.50	0.925	3.25	59	
WF32		x	x	0.80	3.07	54	
WF39		25.25	1.50	1.40	3.95	52	
WF41				0.85	3.75	43	
WF13	WT2	15.75	0.75	1.375	5.25	65	
WF14		x	x	1.00	4.50	63	
WF24		25.25	1.50	1.30	5.175	53	
WF27				1.43	6.20	91	
WF19	WT3	15.75	1.0	1.075	7.50	80	
WF20		x	x	1.125	7.40	91	
WF26		25.25	1.50	1.60	8.05	100	
WF29				1.27	7.85	88	
WF35	WL1	15.75	0.50	0.45	2.95	50 +	Joint failure (at ult.)
WF42		x	x	1.025	3.70	46	
WF43		31.50	1.50	1.28	4.00	70	
WF15	WL2	15.75	0.75	0.925	6.45	55	
WF16		x	x	1.125	6.40	90	
WF30		31.50	1.50	1.20	6.675	68	
WF44				1.50	5.40	72	
WF18	WL3	15.75	1.0	1.125	8.375	91	
WF25		x	x	1.50	8.85	93	
WF28		31.50	1.50	1.27	8.475	96	
WR1	WRS	15.75 x	0.50x	2.65	5.35	125	Built with mod.mort.
WR3		15.75	1.50	2.80	5.75	133	
WR2	WRT	15.75 x	0.75x	3.15	7.20	185	Built with mod.mort.
WR4		25.25	1.50	2.80	7.90	215	
WG1	WG	15.75 x	0.75x	0.40	4.47	17	With gap at top.
WG2		15.75	1.50	0.40	3.80	22	

Table (3.1). One storey brickwork infilled frame tests.

Table (3.2). Length of contact.

Panel	h:l	frame inches	$\lambda_h h$	α_h (col) (inches)	$\lambda_1 l$	α_1 (beam) (inches)
WS1		$\frac{1}{2} \times 1\frac{1}{2}$	7.07	4.66	7.182	6.53
WS2	1:1	$\frac{3}{4} \times 1\frac{1}{2}$	5.256	5.18	5.38	9.00
WS3		$1 \times 1\frac{1}{2}$	4.269	6.41	4.40	10.25
WT1		$\frac{1}{2} \times 1\frac{1}{2}$	6.88	5.62	9.836	9.85
WT2	1:	$\frac{3}{4} \times 1\frac{1}{2}$	5.116	5.72	7.332	12.50
WT3	1.6	$1 \times 1\frac{1}{2}$	4.155	6.50	5.96	15.0
WL1		$\frac{1}{2} \times 1\frac{1}{2}$	6.685	5.00	11.24	10.50
WL2	1:2	$\frac{3}{4} \times 1\frac{1}{2}$	4.97	5.50	8.359	11.00
WL3		$1 \times 1\frac{1}{2}$	4.037	6.23	6.789	16.40

Table (3.3). Some comparisons from Table (3.1).

Panel Properties			Cracking load (ton)	Ultimate load (ton)	lateral stiffness (ton/inch)	Remarks
h:l	frame	No				
1:1	$\frac{3}{4} \times 1\frac{1}{2}$	WS2	1.05	4.02	55.5	Normal*
1:1	$\frac{3}{4} \times 1\frac{1}{2}$	WG	0.40	4.10	20.0	Gap at top
1:1	$\frac{3}{4} \times 1\frac{1}{2}$	WSJ	0.47	2.25	29.0	Weak joints
1:1	$\frac{1}{2} \times 1\frac{1}{2}$	WS1	0.90	3.66	47.0	Normal*
1:1	$\frac{1}{2} \times 1\frac{1}{2}$	WRS	2.72	5.55	129.0	with mod.mort.
1:	$\frac{3}{4} \times 1\frac{1}{2}$	WT2	1.27	5.28	68.0	Normal*
1.6	$\frac{3}{4} \times 1\frac{1}{2}$	WRT	2.97	7.55	200.0	with mod.mort.
1:2	$\frac{1}{2} \times 1\frac{1}{2}$	WL1	1.14	3.85	55.3	Normal*
1:2	$\frac{1}{2} \times 1\frac{1}{2}$	WLJ	0.45	2.95	50.0	Joint failure

* Normal: panels built with 1:3 mortar, joints are fixed properly.

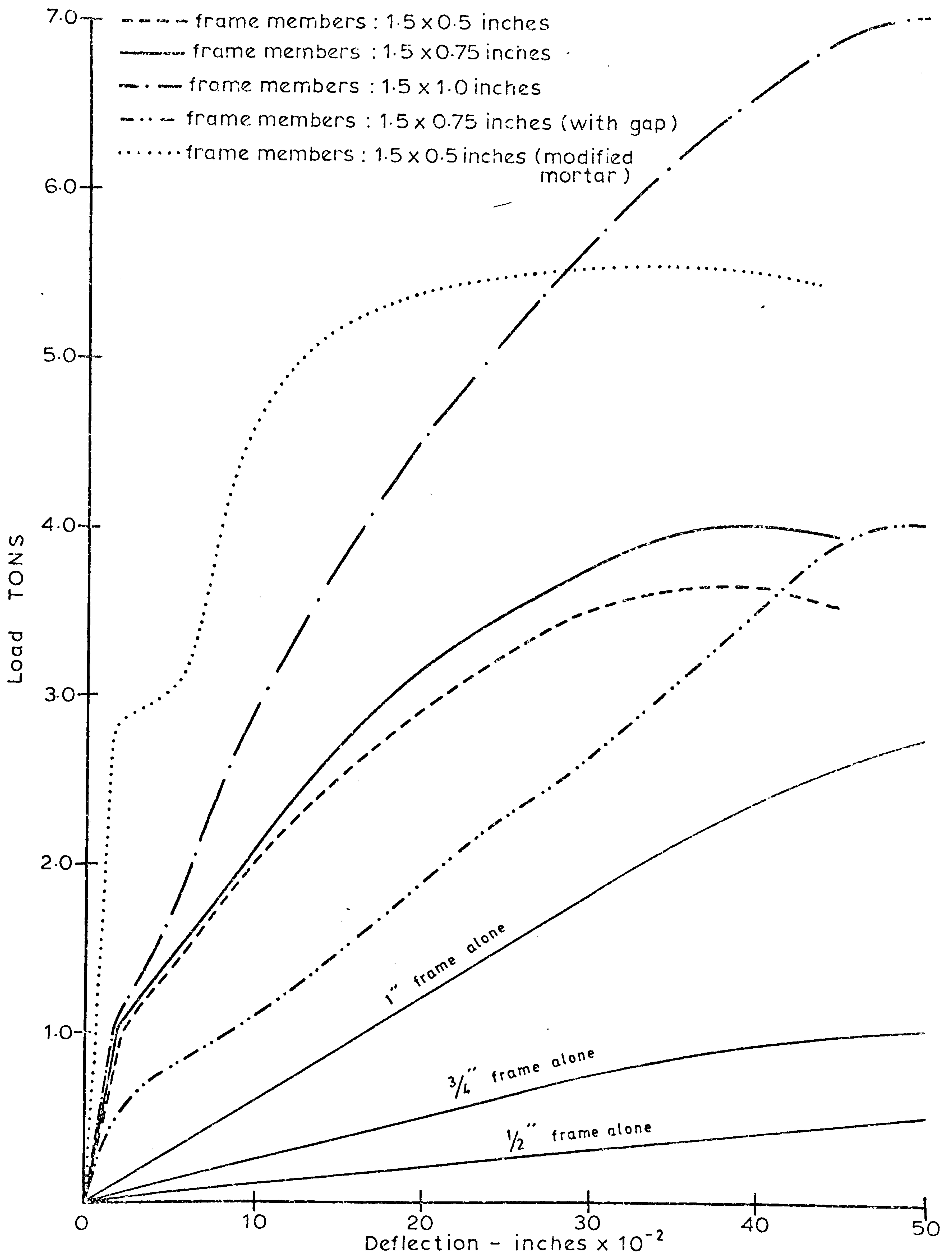

Fig.(3.3) Load-deflection curves (square panels)



Fig.(3.4) Load-deflection curves (rect. panels $h/l:1/1.6$)



Fig.(3.5) Load-deflection curves (rect. panels $h/l : 1/2$)

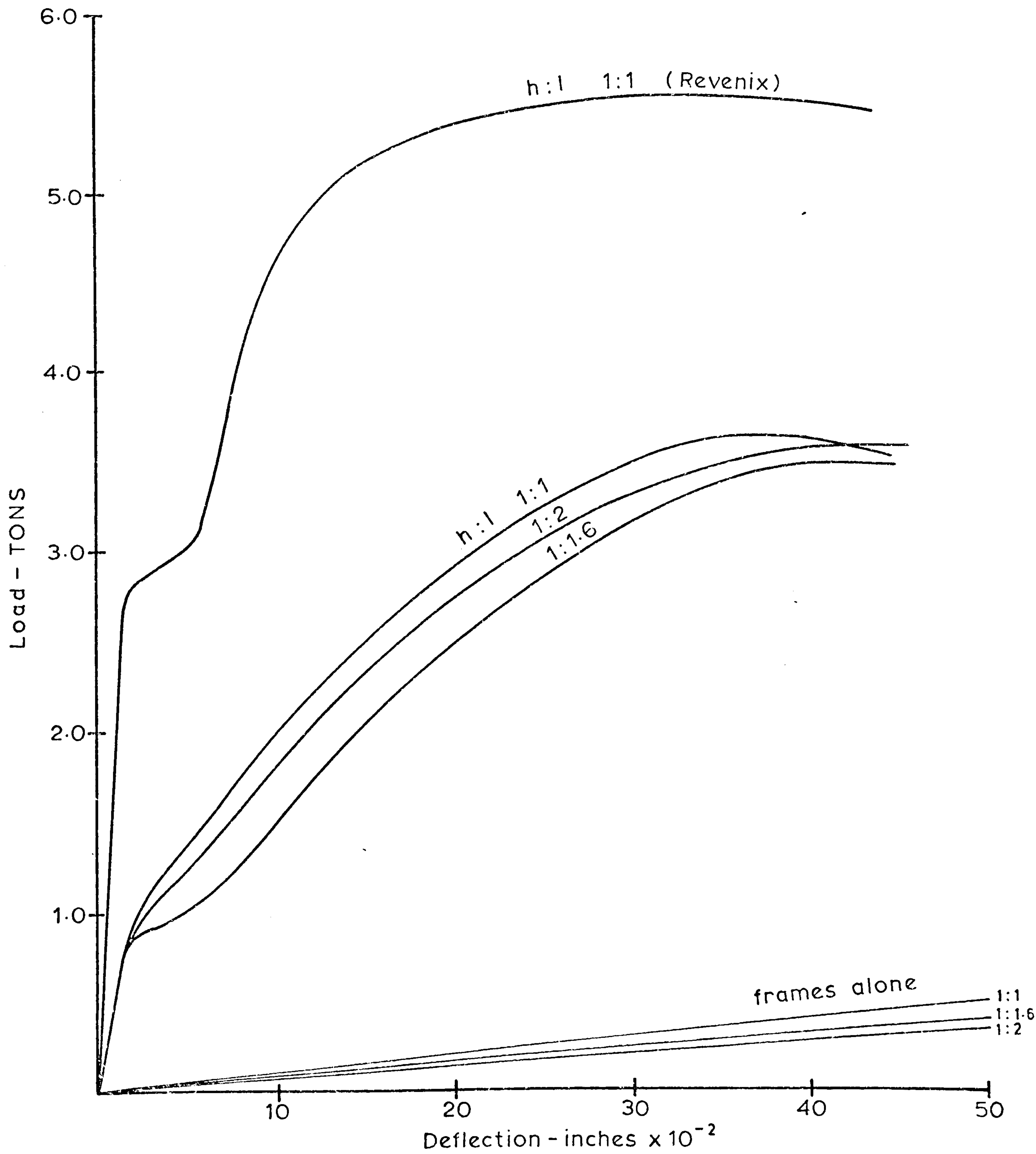

Fig.(3.6) Load- deflection curves (frame:0.5 in.)



Fig.(3.7) Load - deflection curves (frame: 0.75 in.)



Fig (3.8) Load-deflection curves (frame:1.0 in.)

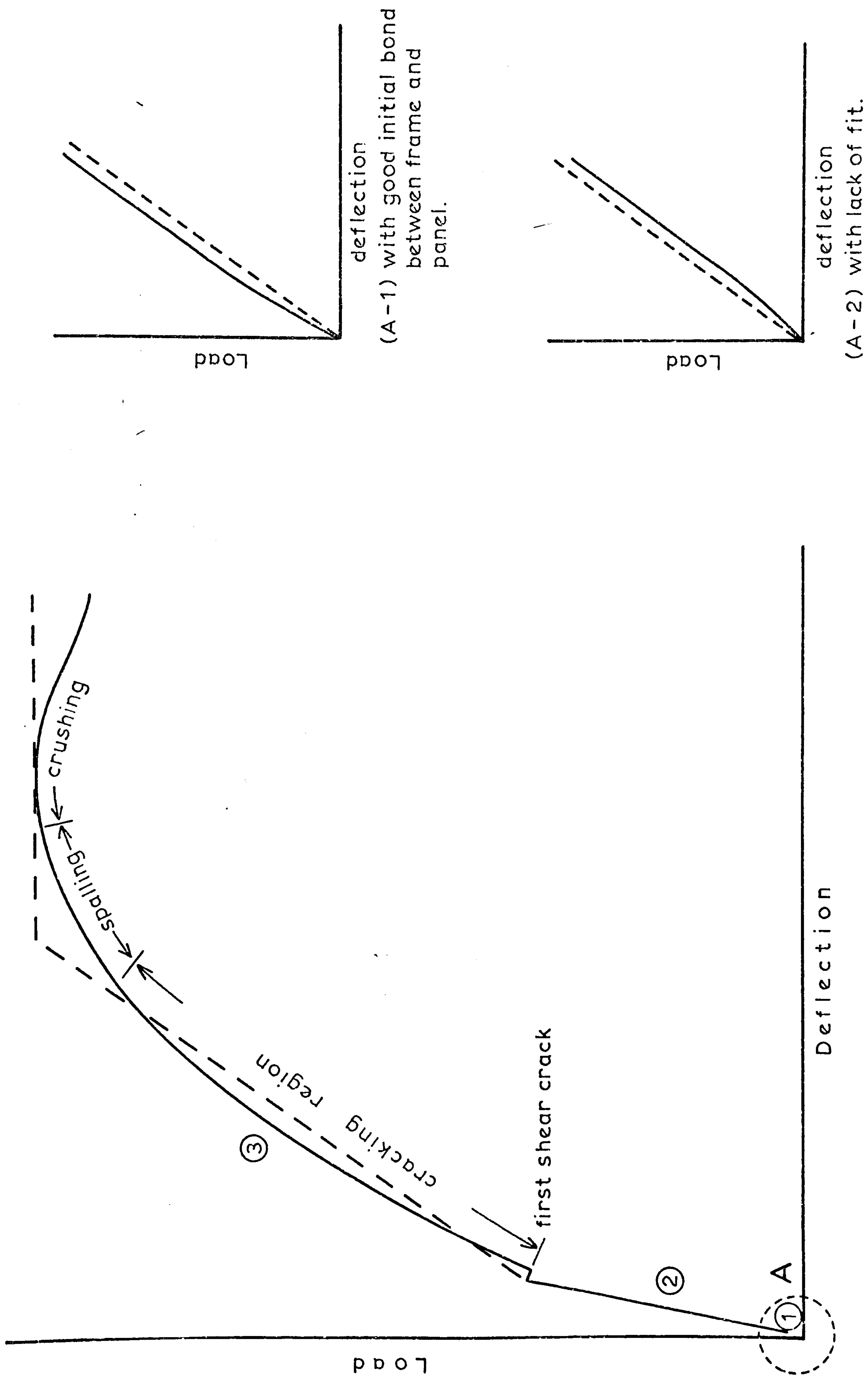
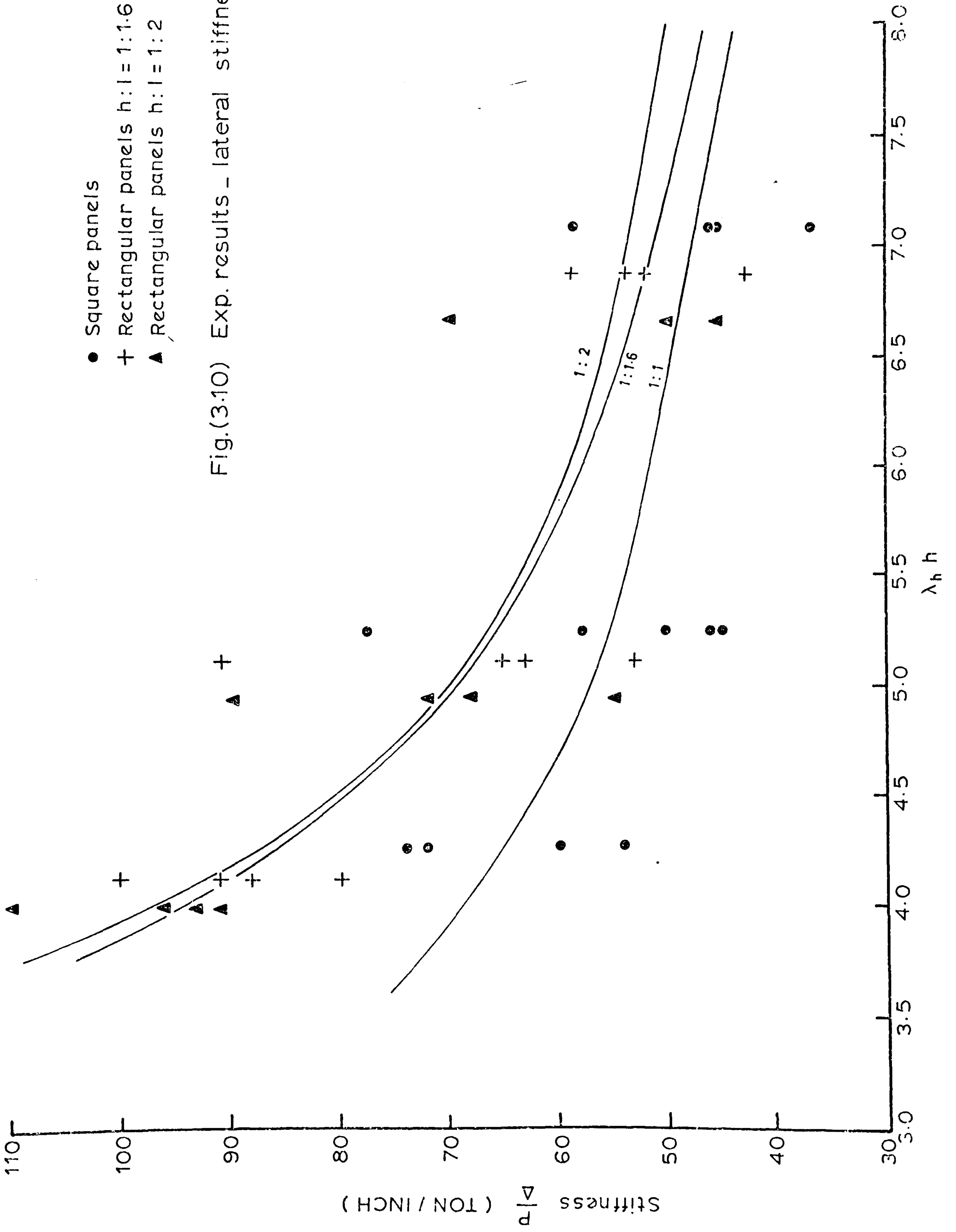

Fig.(3.9) Typical load-deflection curve.



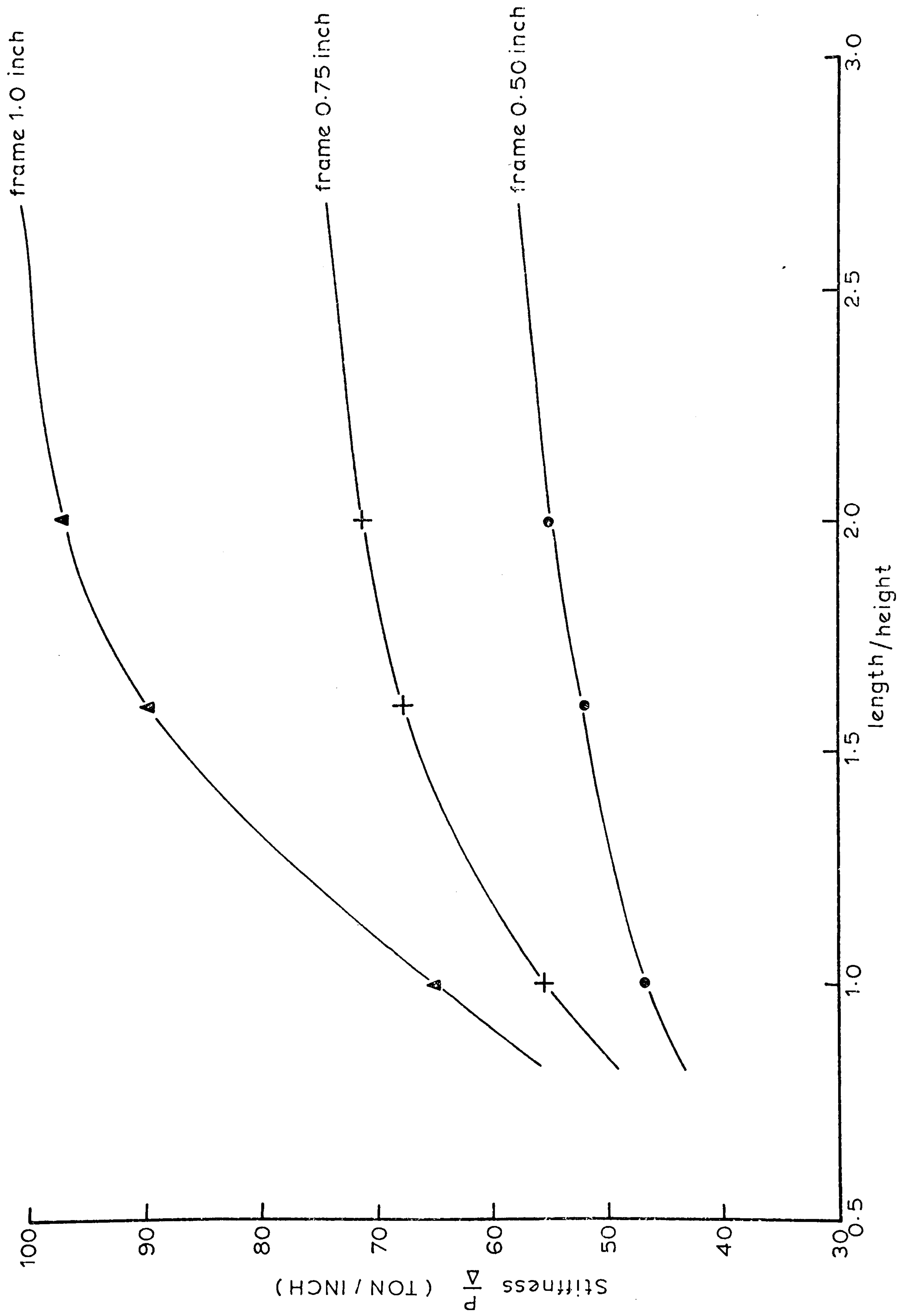
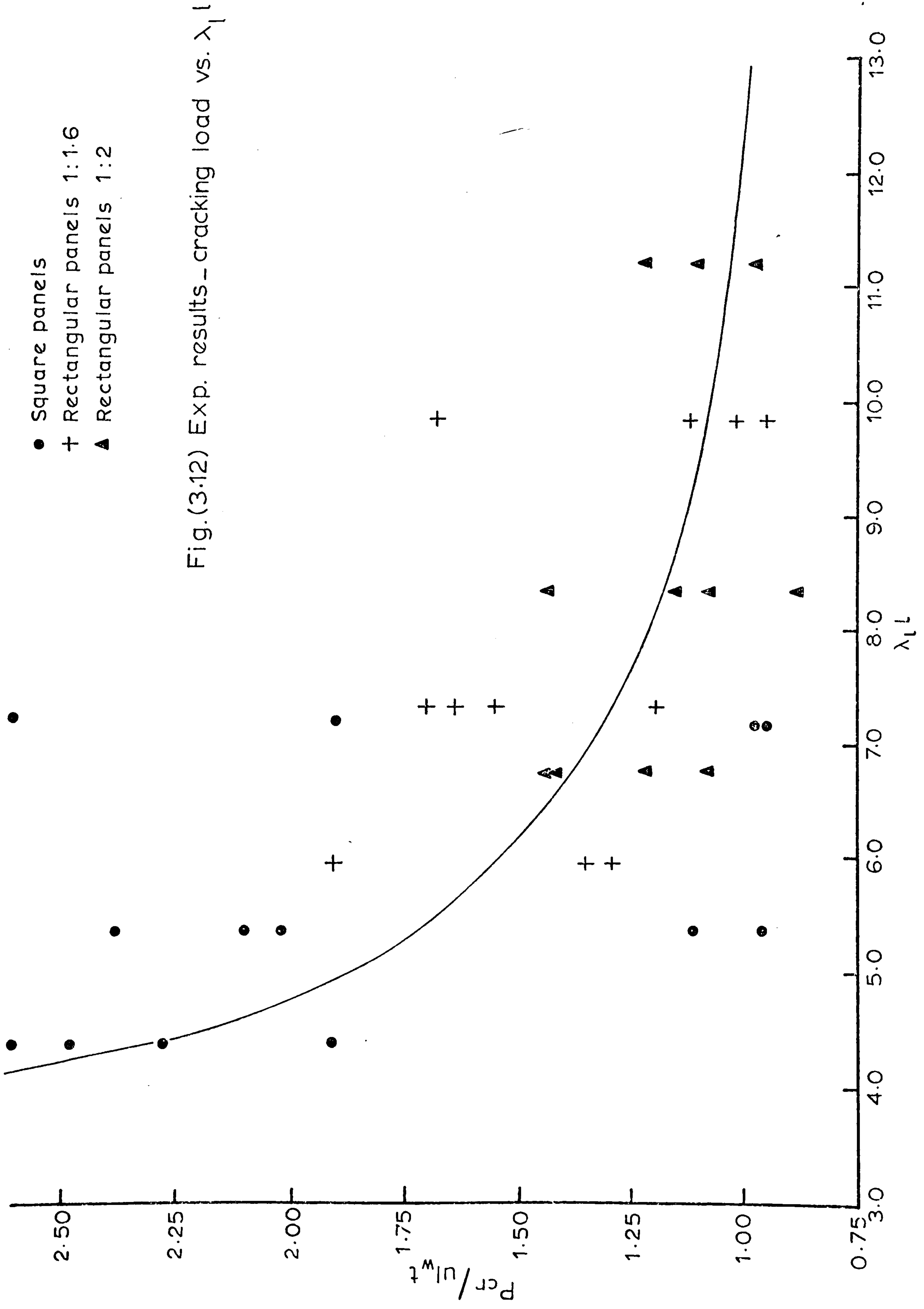

Fig.(3.11) Variation in stiffness with l/h for different frame thicknesses.



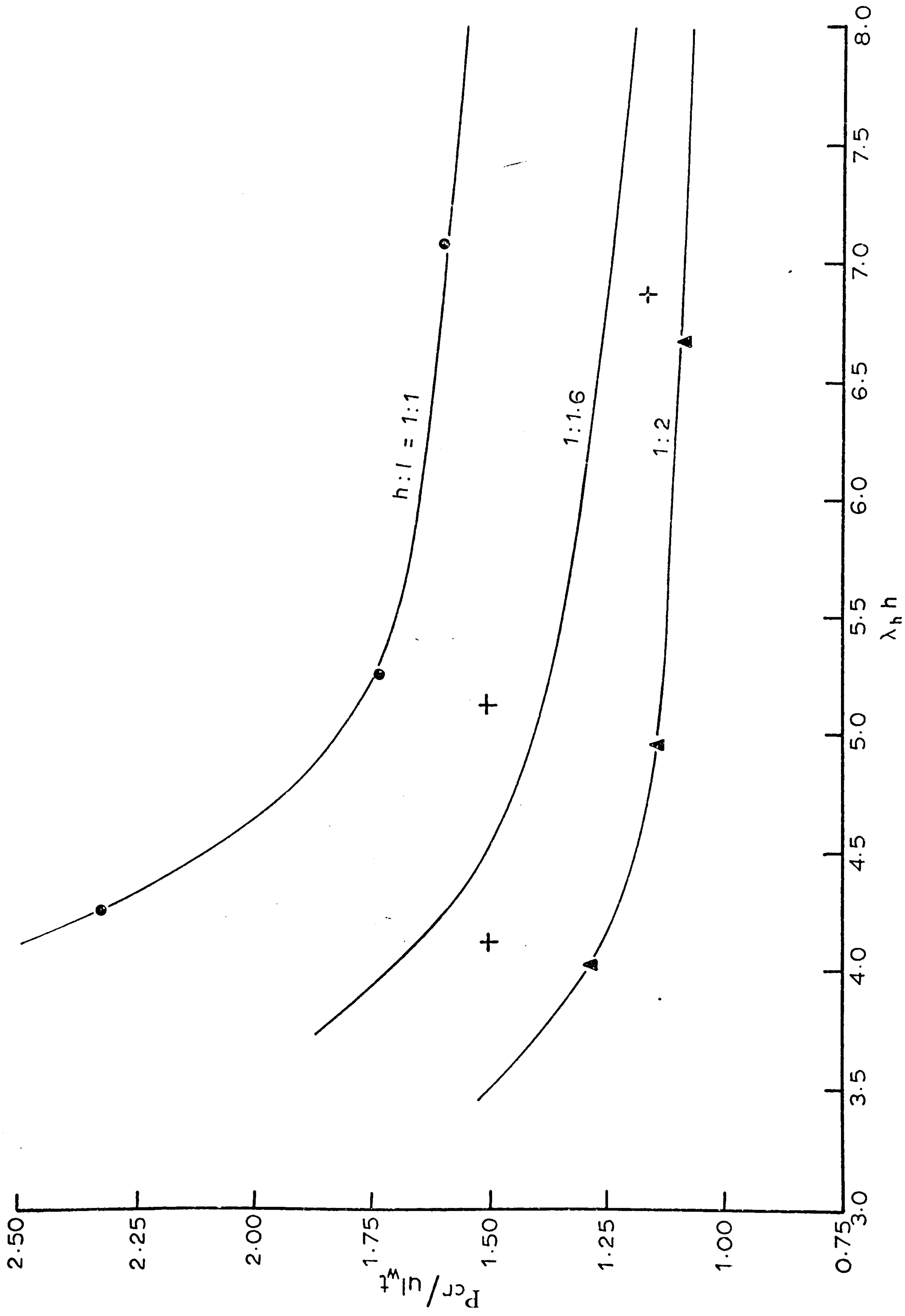

Fig. (3.13) Cracking load - mean values vs. $\lambda_h h$



Fig.(3.14) Exp. results - ultimate load

- Square panels
- + Rectangular panels 1:1.6
- ▲ Rectangular panels 1:2

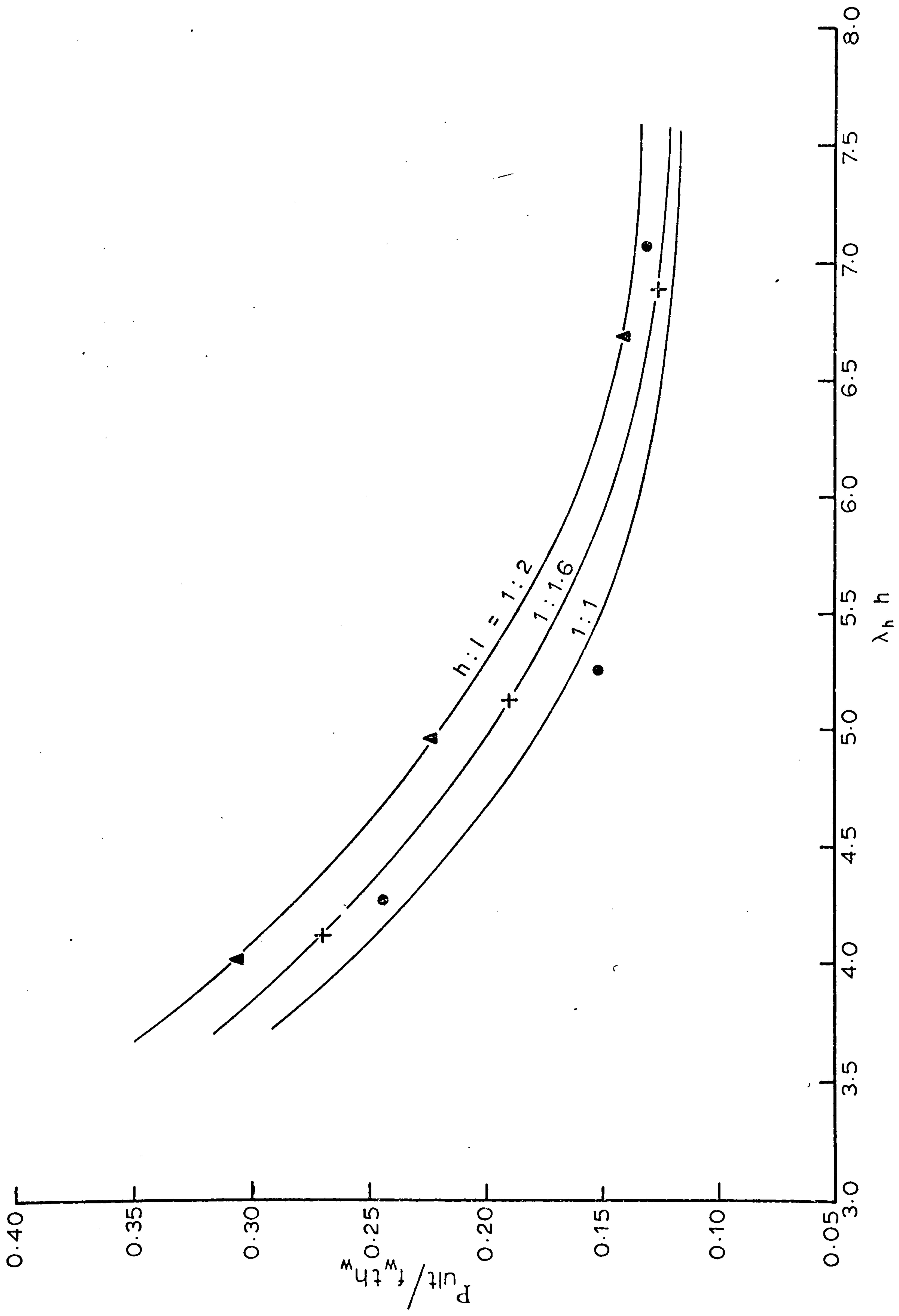

Fig.(3-15) Ultimate load - mean values

observe in some of the tests, especially with the more stiff frames. The separation was more clear in tests with flexible frame and rectangular panels. Gaps along the column were easier to observe.

Separation occurred at load of about 10-20% of the load to cause the first shear crack inside the panel. In some tests with rectangular panels hair cracks at the top of the panel were observed before the application of load. These small cracks caused an early separation of the frame from the infill. Sliding of the panel along the frame members was clearly observed in some tests. After the separation the panel remained in contact with the frame at the loaded corners only, over the length of contact which varied according to the stiffness of the frame and the panel proportions, Table (3.2). The length of contact for stiff frames was more than that for flexible frames; this was also noticed in panels with higher l/h ratio. Most of the load was then transmitted to the infill through the length of contact, which remained fairly constant until the first shear crack appeared. The first shear crack was usually at the interface between the brick and the mortar joint, a continuous crack starting from the windward column near the top junction and stepping downward towards the leeward column near the bottom junction, Plates (1, 2, 3). In some of the tests however, a straight shear crack at the centre or near the top beam was observed. Cracks in the rectangular panels were mostly horizontal at the centre and stepping near the columns, a few tests showed first crack at the unloaded corners and at less than the average cracking load. A few small vertical cracks near the top of the wall were observed in rectangular panels with flexible frames. Diagonal cracks passing through the brick and mortar were not observed, except in a few of the square panels with very stiff frames where the crack tended to/

A



C frame 0.5

B



D frame 0.5

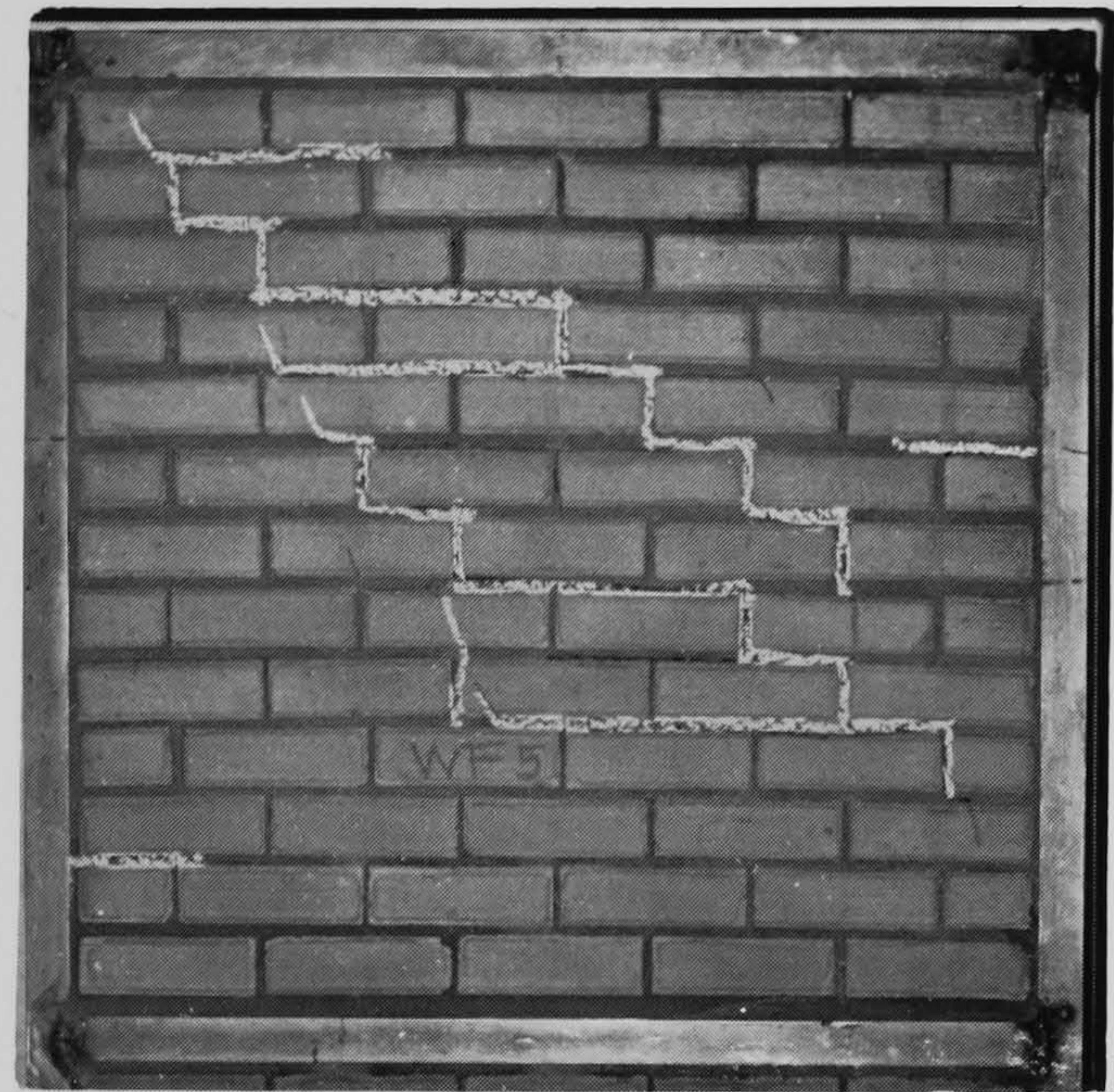

E frame 0.75



F frame 0.75



frame 1.0

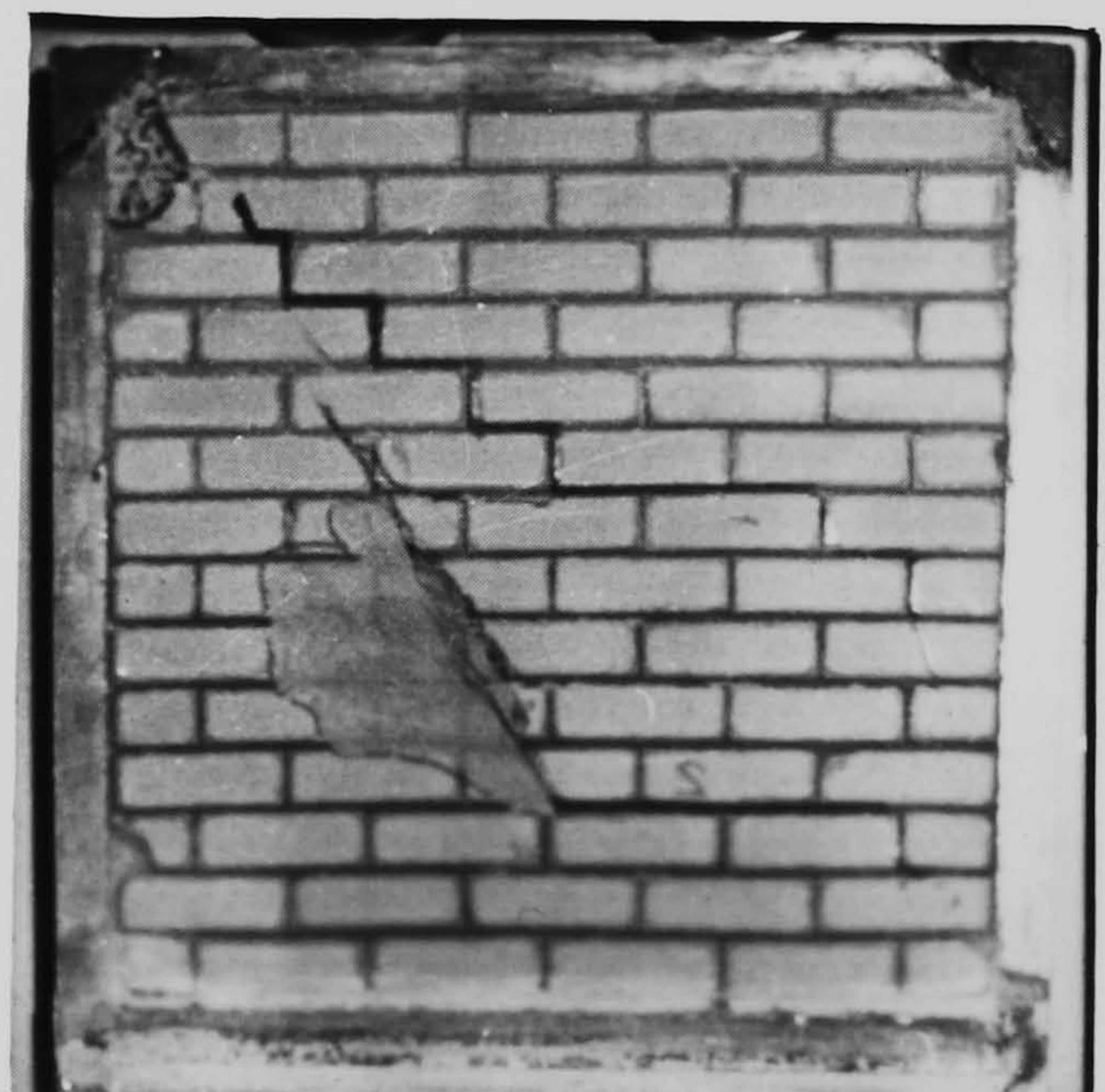

frame 1.0

PLATE I MODES OF FAILURE, SQ.

A

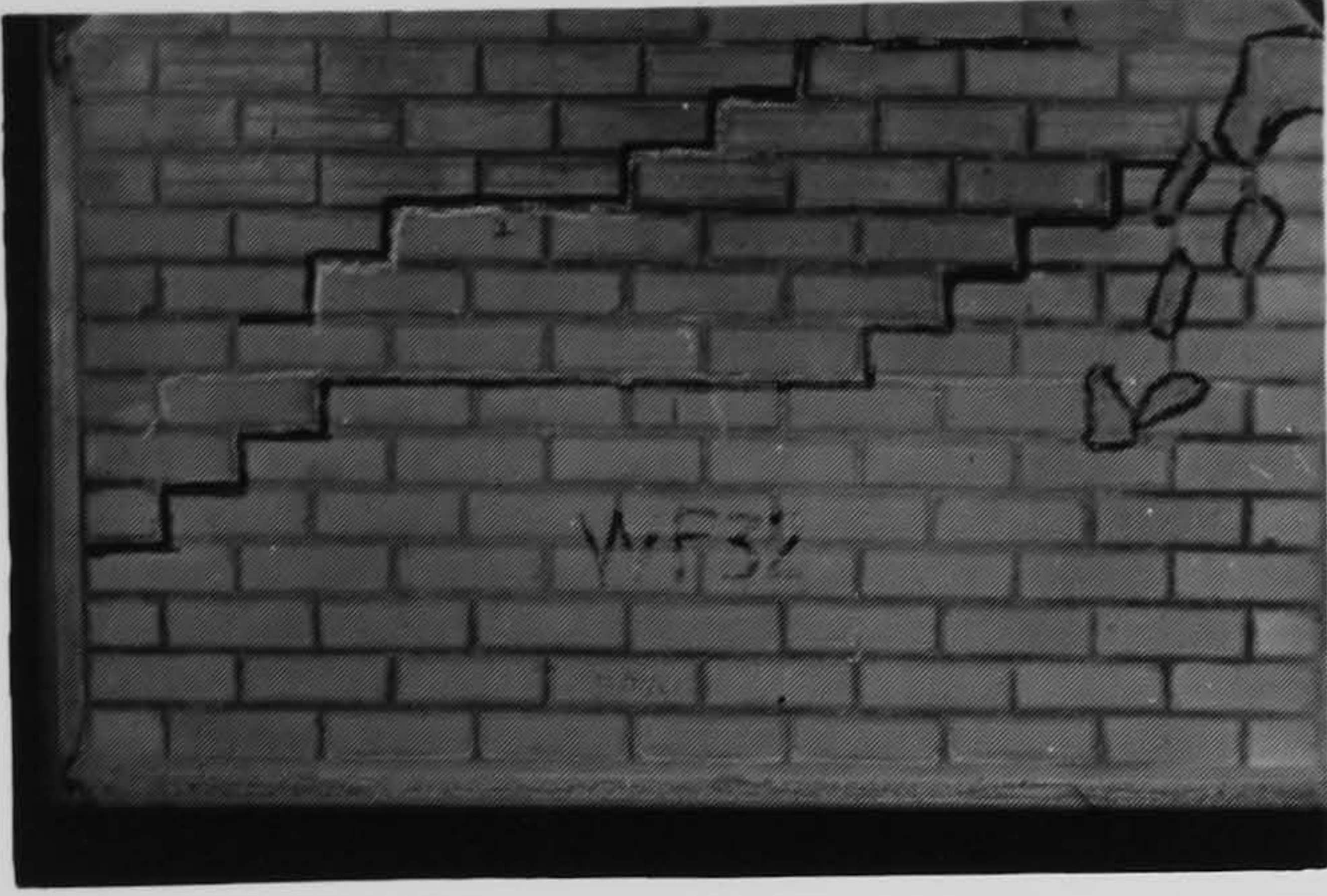

B



rect. 1:1.6 frame 0.5

C



D

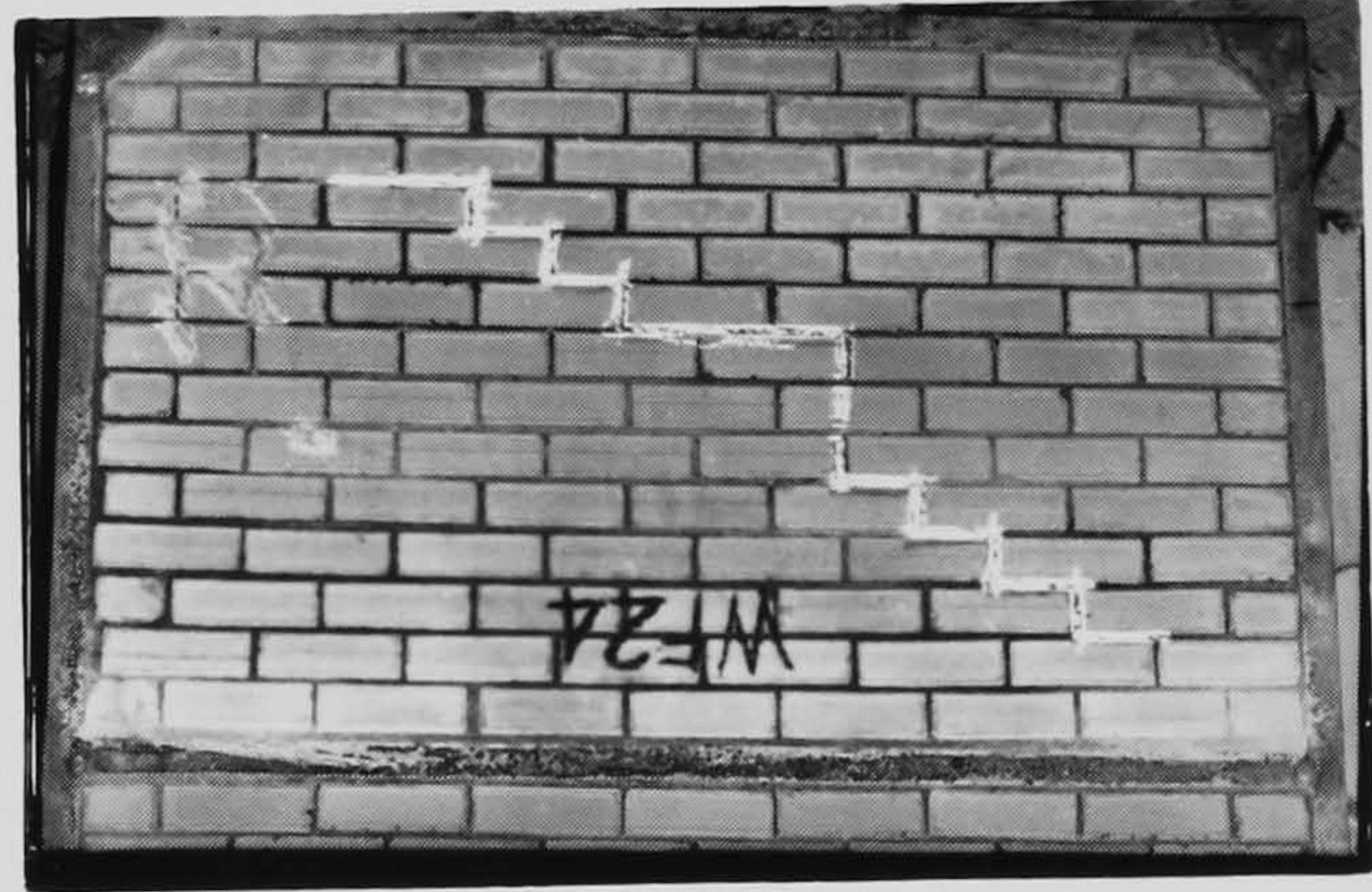

rect 1:1.6 frame 0.75

E



F

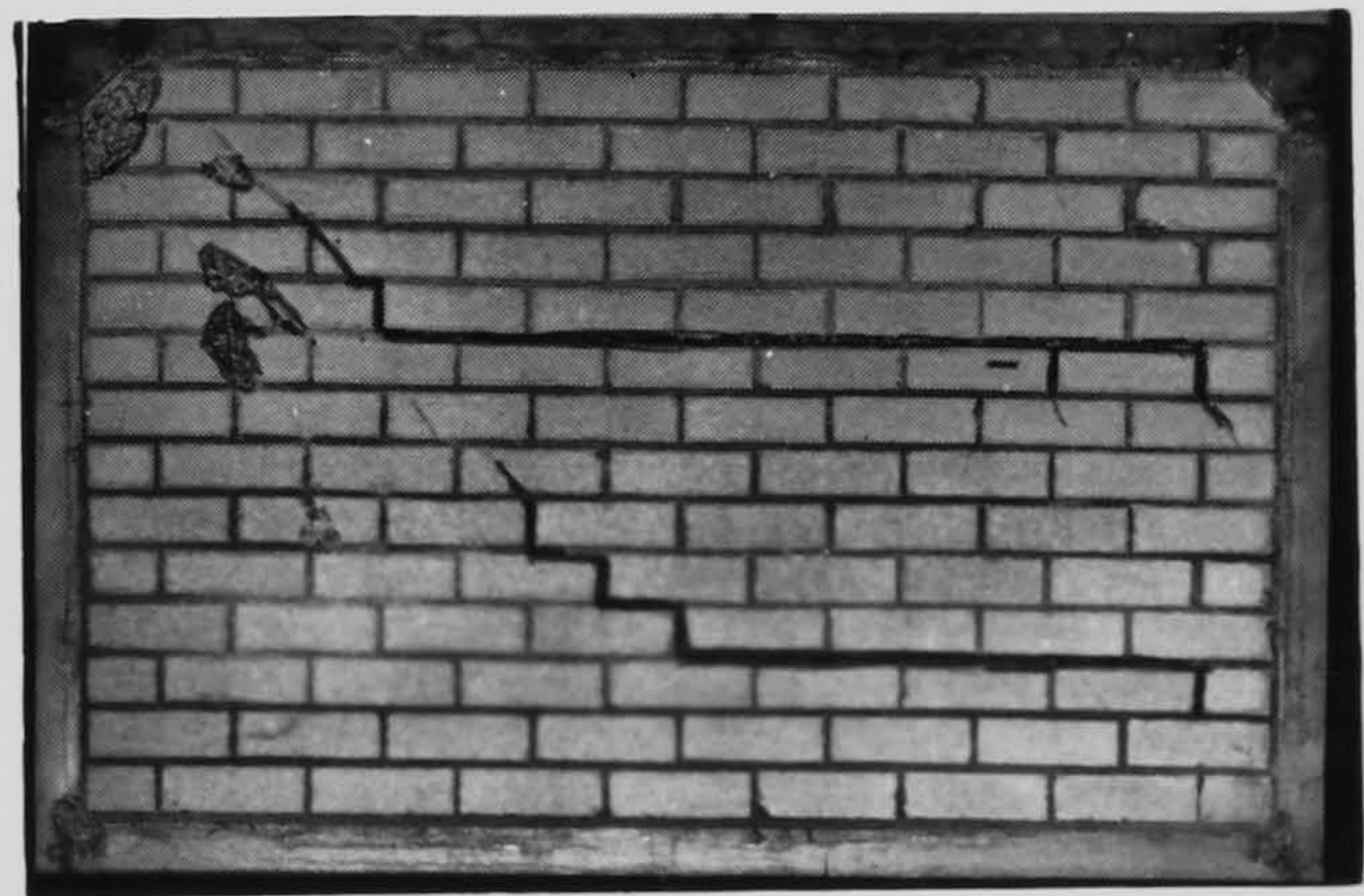

rect 1:1.6 frame 1.0

A



B

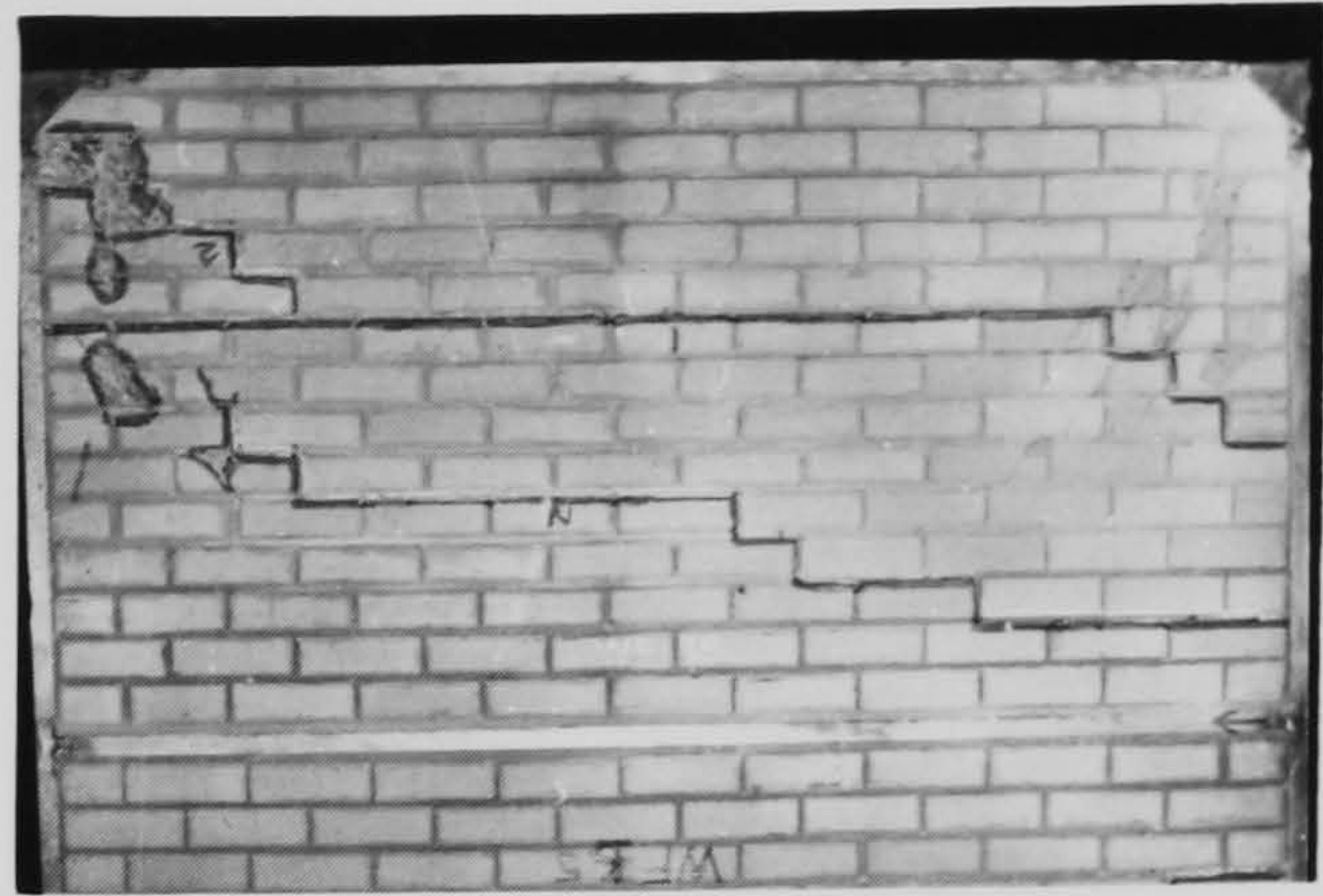

rect. 1:2 frame 0.5

C



D



rect. 1:2 frame 0.75

E



F

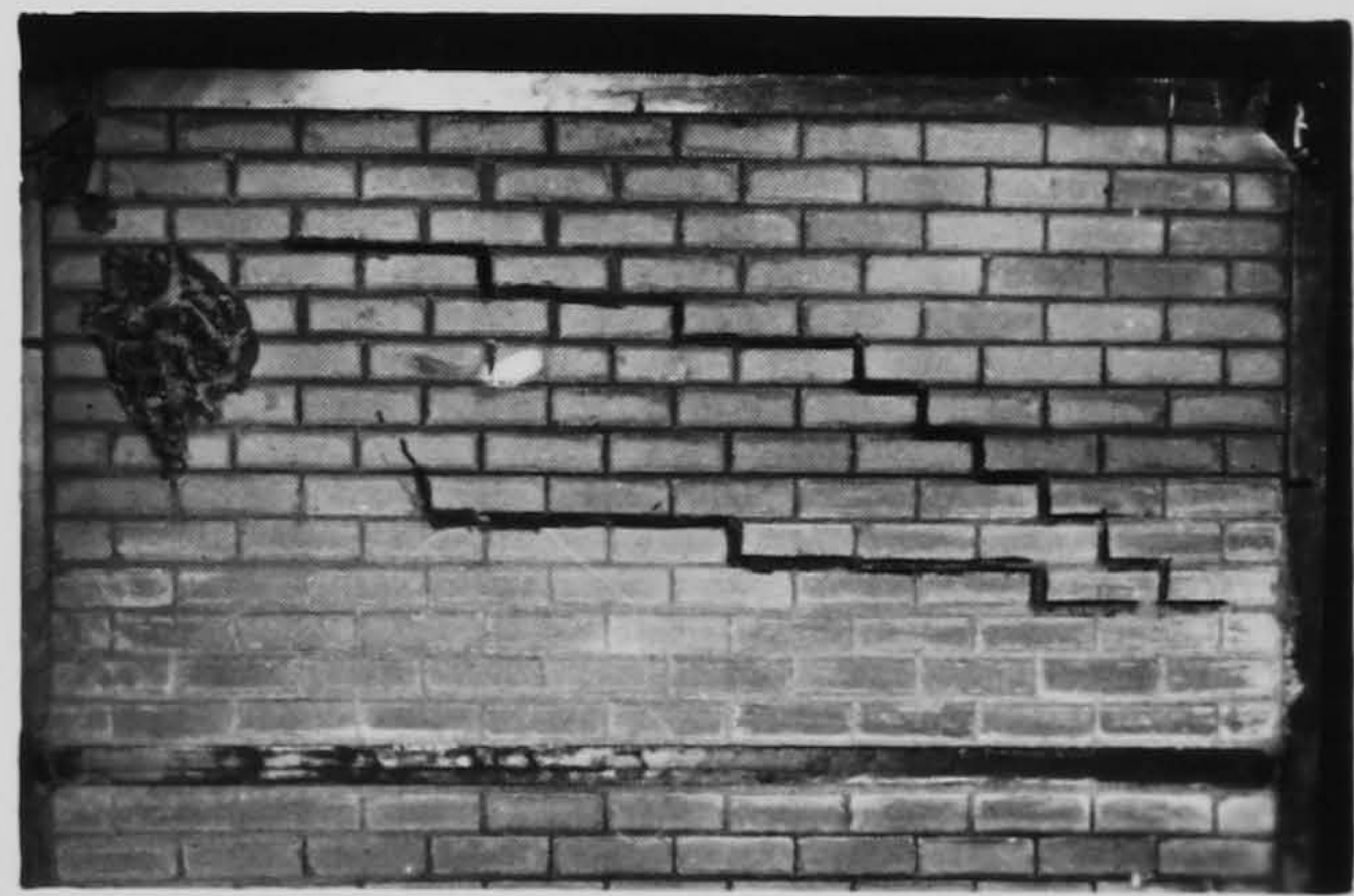

rect. 1:2 frame 1.0

to pass through some of the bricks as well as the mortar; some tests showed diagonal cracks after the appearance of initial shear cracks. After the first crack, the panel was no longer in contact with the frame over the pre-crack contact length only; the position of the crack had modified the interaction length. The first crack was sudden, a drop off in load of about 10-15% of the cracking load and a rapid increase in the deflection were observed. A wide variation in the cracking load was obtained, even for identical repeated tests.

As the load increased, the panel regained the strength, and more cracks then appeared inside the panel mostly parallel to the first shear crack.

At higher loads, cracks began to pass through both bricks and mortar, away from the panel centre and propagated near the loaded corners. These cracks were not very sudden and the stiffness decreased gradually. At a load of about 85-95% of the ultimate load, the brickwork began to spall near the loaded corners at the places where more cracks had propagated. For relatively flexible frame the spalling increased towards the corners, however, for stiffer frames the spalling spread out toward the centre of the panel away from the loaded corners. In most cases this was followed by crushing of the brickwork at the loaded corners and the deflection increased rapidly without a significant increase in the load. This stage defined the ultimate carrying capacity of the infilled frame, however, the infill frame was still capable of sustaining 80-90% of the ultimate load. In identical tests, variation in results for ultimate load was less than those for cracking load.

3.7 INFILLED FRAMES WITH GAP AT THE TOP OF THE PANEL

Two square panels WG1 and WG2 with members of $\frac{3}{4}$ x $1\frac{1}{2}$ inches cross-section/

cross-section were tested. A small gap of $\frac{1}{16}$ inch was left between the frame and the wall at the top.

The two tests showed no clear separation between the frame and the panel along the columns, and showed a high stiffness under a small load only, the first shear crack then appeared with no sudden drop back of load or sudden increase in deflection. In the two tests the first shear crack occurred at a very low load, the crack appeared at the top courses of the wall near the gap, Plate (4). As the load increased more cracks appeared and sliding of the wall along the frame members continued, eventually fitting the wall into the frame compression corners; after this stage the panel behaved as a normal cracked infilled frame with no gap but the cracks were wider. With the increase of load more cracks appeared inside the panel, finally the brickwork started to spall out near the loaded corners followed by compression failure of the brickwork at the corner. The ultimate load was found to be the same as in the corresponding panels with no gap. However, due to the early cracking of the panel and the subsequent cracks which followed, no sudden increase in deflection was observed during the appearance of cracks.

3.8 WALLS BUILT WITH MODIFIED MORTAR

Two square panels WR1 and WR3, and two rectangular panels WR2 and WR4 were tested, the brickwork was built with modified mortar (Appendix B). Due to the good bond strength of the mortar, the wall was in good contact and a good fit in the frame, no separation occurred during the loading, except for panel WR2 where a clear gap between the wall and the frame was observed, which was indicated by a sudden drop off of the load, and soon the panel regained the same stiffness as before. The first crack occurred at a very high load, a diagonal tensile/

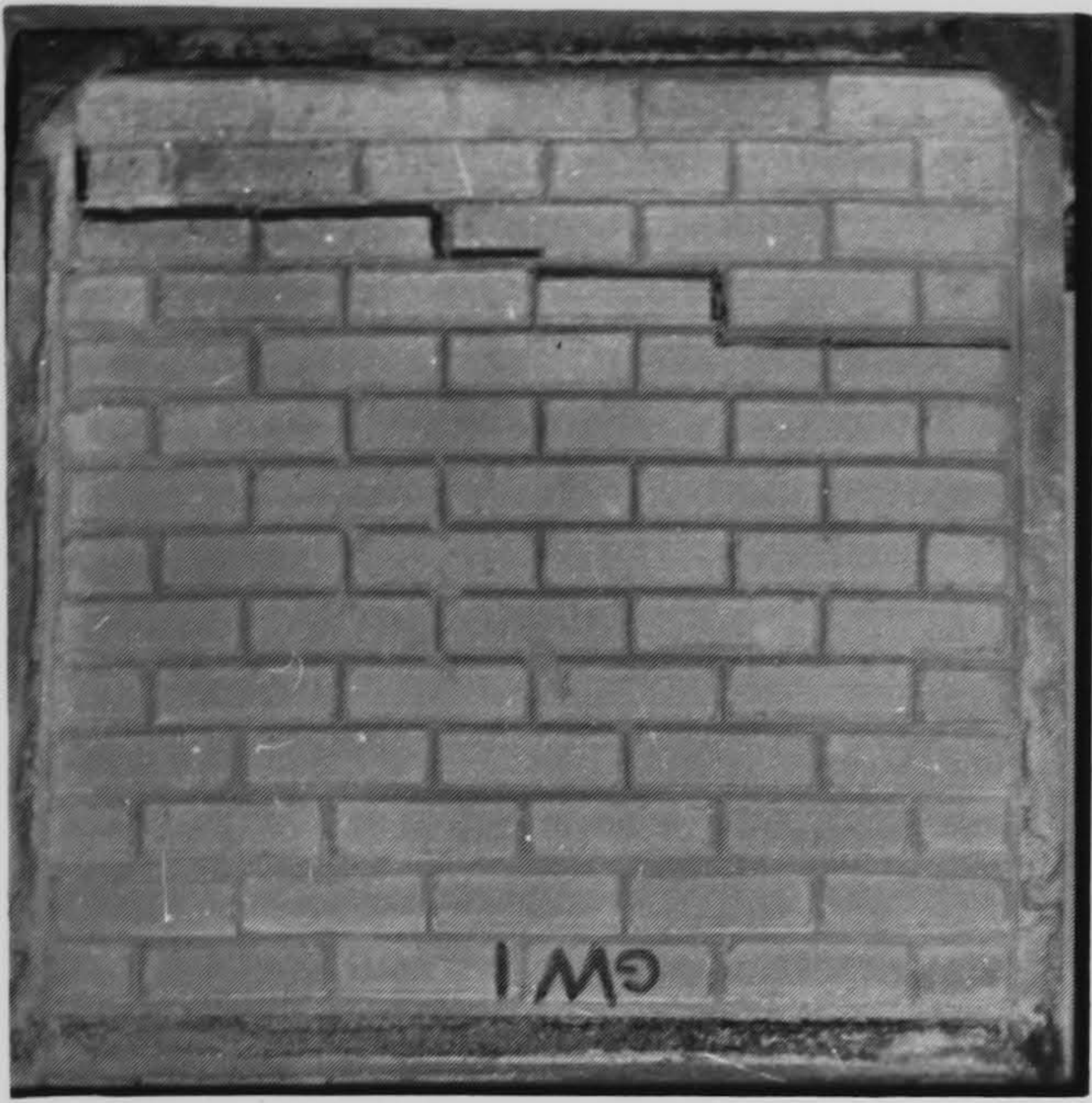

WGI



WG 2



WRI

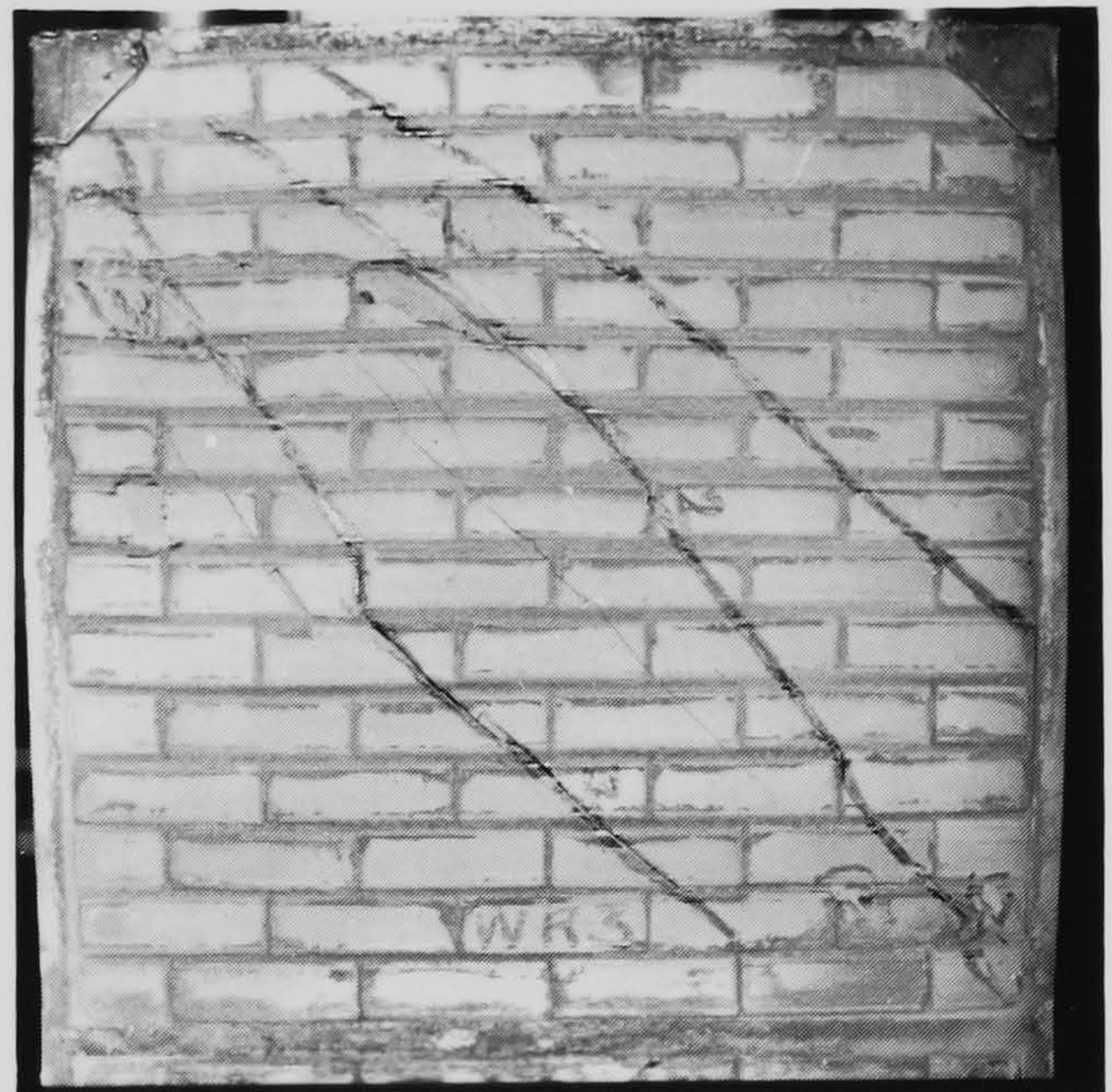

WR 3

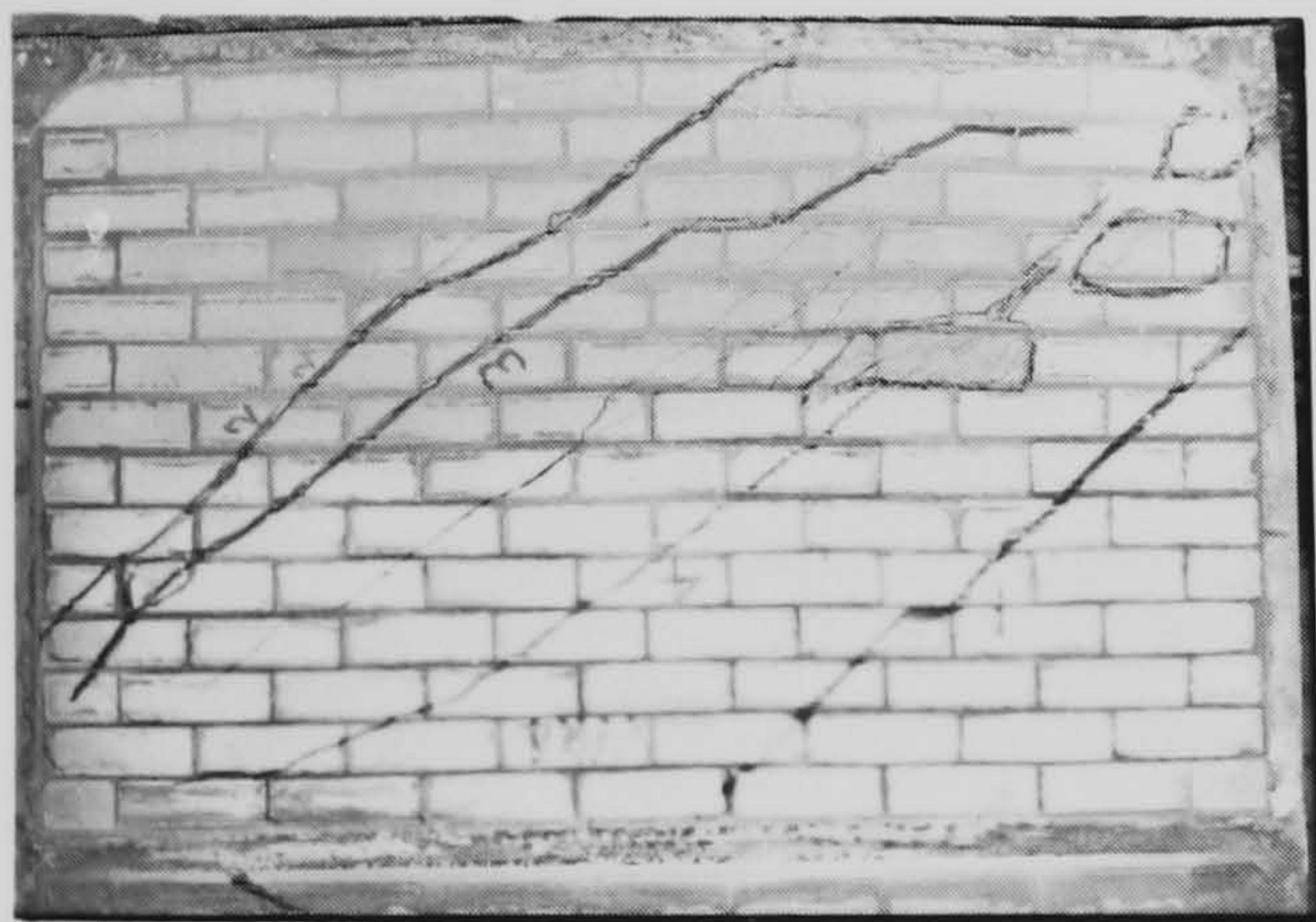

WR4



WR 2

PLATE 4 MODES OF FAILURE

tensile crack, Plate (4), almost at the centre of the panel passing through both bricks and mortar. The crack was very sudden and was accompanied by a drop in load and a large increase in deflection. Panel WR2 showed a straight shear crack near the centre of the wall at a load less than the load carried by WR4. At higher load more diagonal cracks appeared beside, and parallel to, the first diagonal crack. After a series of cracks the stiffness of the panel decreased rapidly and was followed directly by spalling of the brickwork at, and near to, both of the compression corners. The ultimate load was defined by the compression failure of the brickwork near the corners. Both the ultimate and the cracking loads, as well as the stiffness, were higher than those for the corresponding walls built with the 1 : 3 mortar.

3.9 DISCUSSION OF RESULTS

3.9.1 Load - Deflection curves

The load vs. deflection curve of an infilled frame may be represented by three stages. A typical load deflection curve is shown in Fig. (3.9). The first stage is unpredictable, depending mostly on the lack of fit of the panel with the frame and the bond at the interface between the frame members and the panel. A good fitting and a strong bond at the interface would lead to a high initial stiffness until the bond breaks at the interface, and the wall separates from the frame except at the compression corners. On the contrary, a lack of fit and a weak bond at the interface will result in a low initial stiffness. The second stage is linear although not elastic. When the wall and frame have fitted together at the compression corners they act compositely. The frame transmits the major portion of the load to the wall/

wall through the contact interface. Under such conditions, the infill will be under a combined stress and acts as a diagonal bracing member under compression. The frame deforms in a manner far different from the original frame without infill under lateral load. At this stage, the slope of the load - deflection curve will remain fairly constant until the first shear crack appears, the load will then drop off with a rapid increase in deflection. At this point the third stage starts, the panel begins to regain stiffness, this stage is non-linear but may be approximated by a straight line. More cracks develop during the loading accompanied by a small drop in load with each crack. The third stage is followed by the appearance of spalling of the infill material at the compression corners and in the panel, which progressively results in the compression failure and consequently defines the ultimate carrying capacity of the infilled frame; this stage is represented by the horizontal line in the load-deflection curve. The behaviour and modes of failure of masonry infilled frames is discussed in detail in Section 3.9.2.

3.9.2 Modes of failure

The first crack generally appears along the boundary at the interface between the loaded column and the panel, and between the foundation beam and the wall, followed by cracks at the interface of the wall and top beam, and at the leeward column. These cracks are due to the difference in deformation shape of the two elements, the wall and the frame, and due also to the tensile forces which are induced along the boundary at the interfaces. The bond between the frame and wall is not strong enough to resist the tensile forces, so if cracks do not appear between the frame and wall, they may occur at the topmost course of the wall because of the weak bond between the mortar and the brick. Indeed, /

Indeed, if the bond is maintained, both elements will act together as an integral composite and a much higher stiffness will be obtained, this was clearly demonstrated by the tests carried out on the infilled panels with high bond strength mortar, Section 3.9.7. After the appearance of the boundary cracks the panel slides along the members fitting into the compression corners, separating the wall from the frame except at both corners under the load, where the wall remains in contact with the frame members at which forces are transmitted from the frame to the panel. Due to the interface forces the deformation shape of the frame is by no means the same as the deformation of a frame alone under lateral loading. Boundary cracks occur at different load magnitudes, usually at the first stages of loading and considerably below the first shear crack load. Separation could be easily measured at the column but difficult at the top beam. In rectangular panels there is a clearer separation due to the relatively flexible frame relative to the panel. In some tests the gap was very difficult to measure at both interfaces, column and beam.

Initial cracks at the top of the panel which were observed in some tests before applying the load are due to shrinkage of the wall which causes an early separation along the interfaces, and makes the length of contact easier to measure.

The first crack inside the panel is sudden, stepping downward at the interface between the brick and mortar joints and along the compression diagonal. Variation in position and extension of the cracks may be expected, because of any weakness in the panel due to defects in workmanship, non-homogeneity of the infill material, or because of a weak bond at any course of the wall. The same reasons apply to the wide variation observed in experimental results of the cracking load.

The/

The first crack is due to the shear bond failure between the bricks and mortar at the joint interface, as a typical shear failure in masonry shear-wall structures under lateral load with low pre-compression. After the appearance of the first shear crack, the usefulness of the wall is doubtful for practical purposes.

As the load increased, the cracked wall slides along the cracked joint, Fig. (3.16), thus changing the length of contact, bearing again on the column members of the frame. A redistribution of forces at the interface will occur. More cracks appear gradually as load increases. At this stage the resistance of the panel will be mostly due to friction and wedging action inside the panel, which result from the fact that the frame prevents the disintegration of the cracked panel. This redistribution of forces and disintegration exert extra reactions on the frame members, modifying the frame deformation shape furthermore, and increase the strength of the frame.

In a few rectangular panels with flexible frames, vertical cracks at the top were observed; this is due to the deformation of the frame as shown in Fig. (3.17) and possible tensile stresses induced at the unloaded corners.

The friction and wedging action cause the cracks to pass through bricks as well as the mortar, usually at the ends of the existing cracks near the compression corners. More cracks would propagate at these places Fig. (3.18), which results in the second mode of failure: the compression failure, this appears as spalling out of the brickwork near the loaded corners, spreading out towards the centre of the panel or to the corners, depending on the relative stiffness of the frame and the infill and the rigidity of the joint. Crushing appears at places not necessarily under maximum compressive stresses but at places/

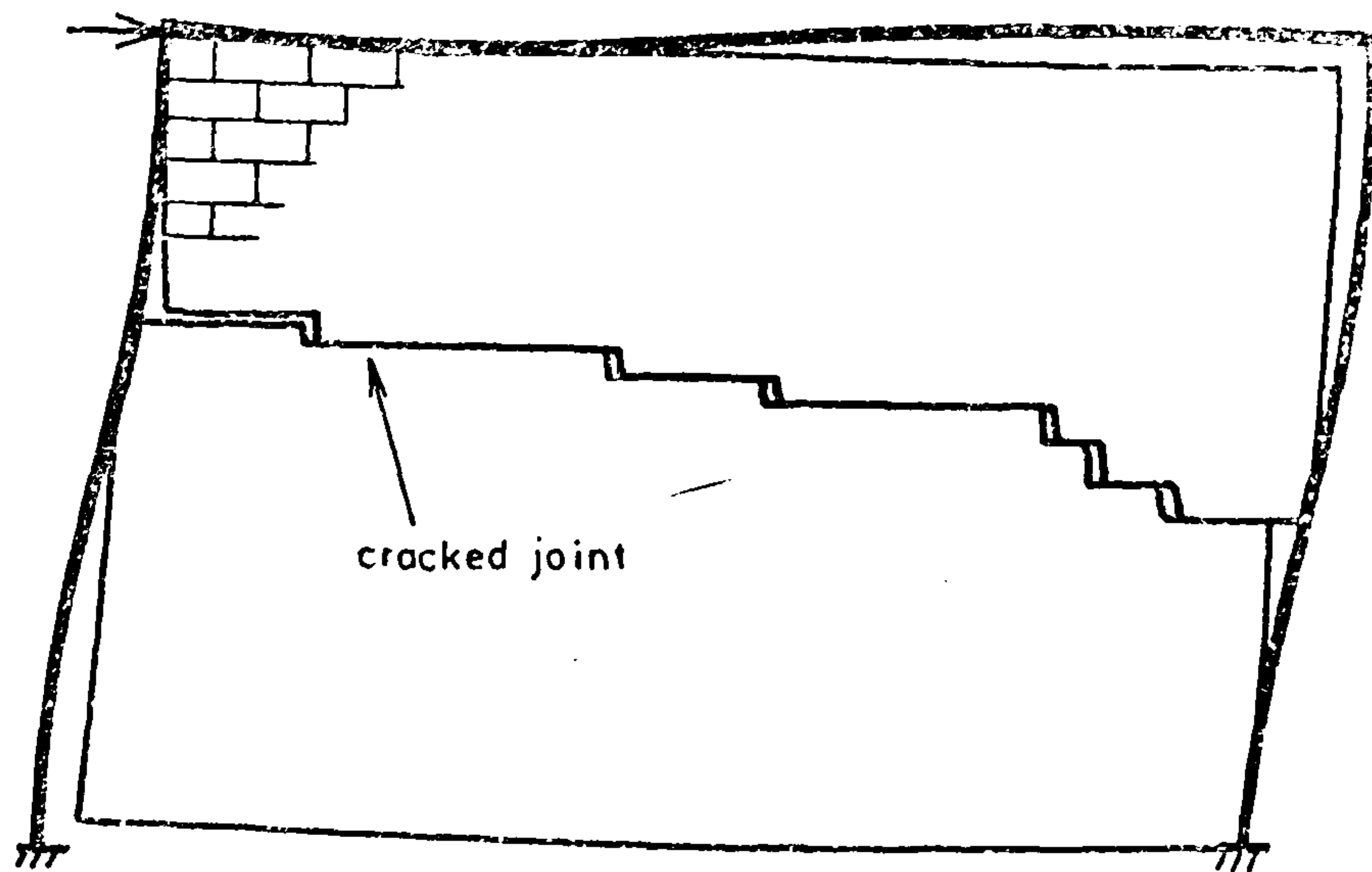

Fig.(3.16) Wall sliding along the cracked joint.

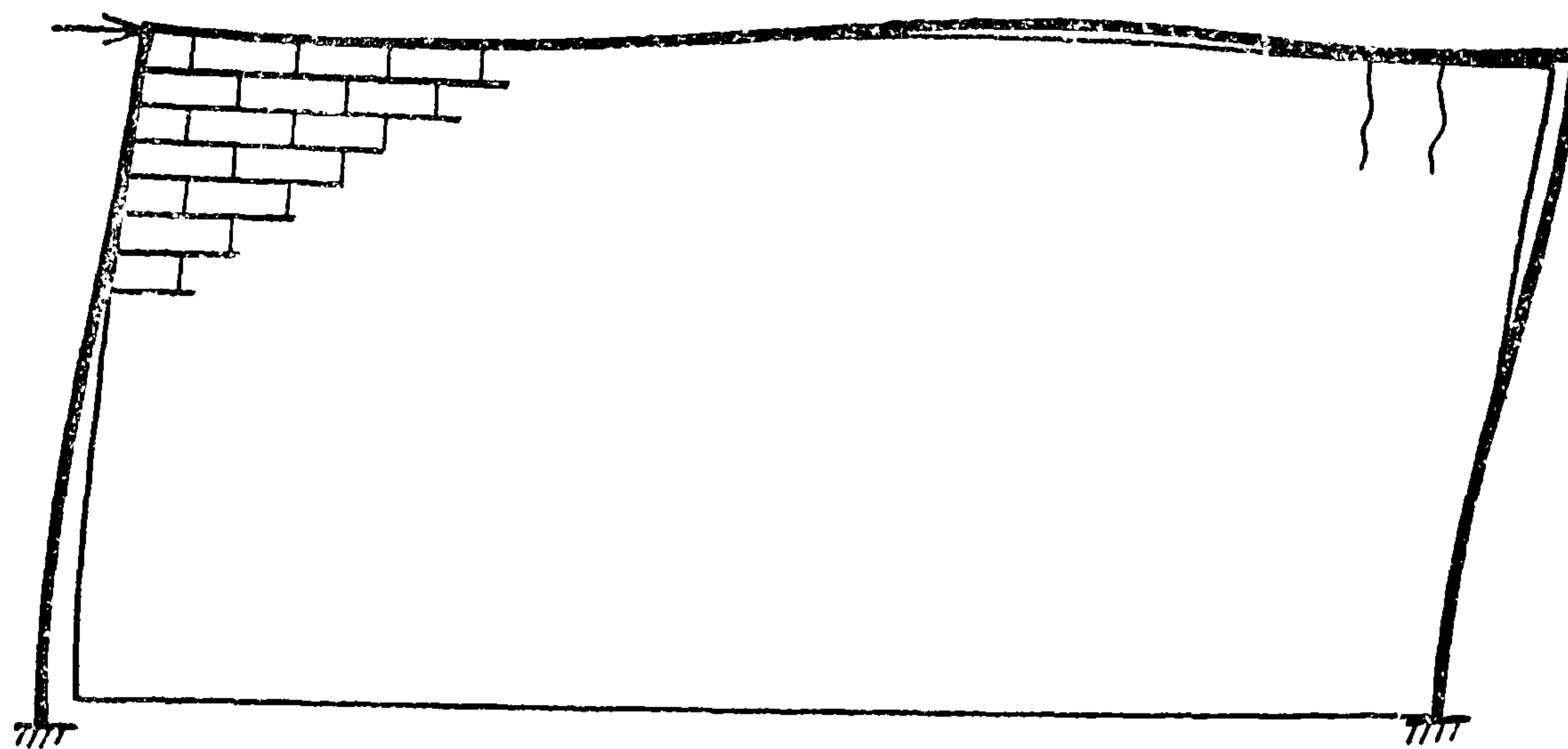

Fig.(3.17) Vertical cracks at the un-loaded corner.

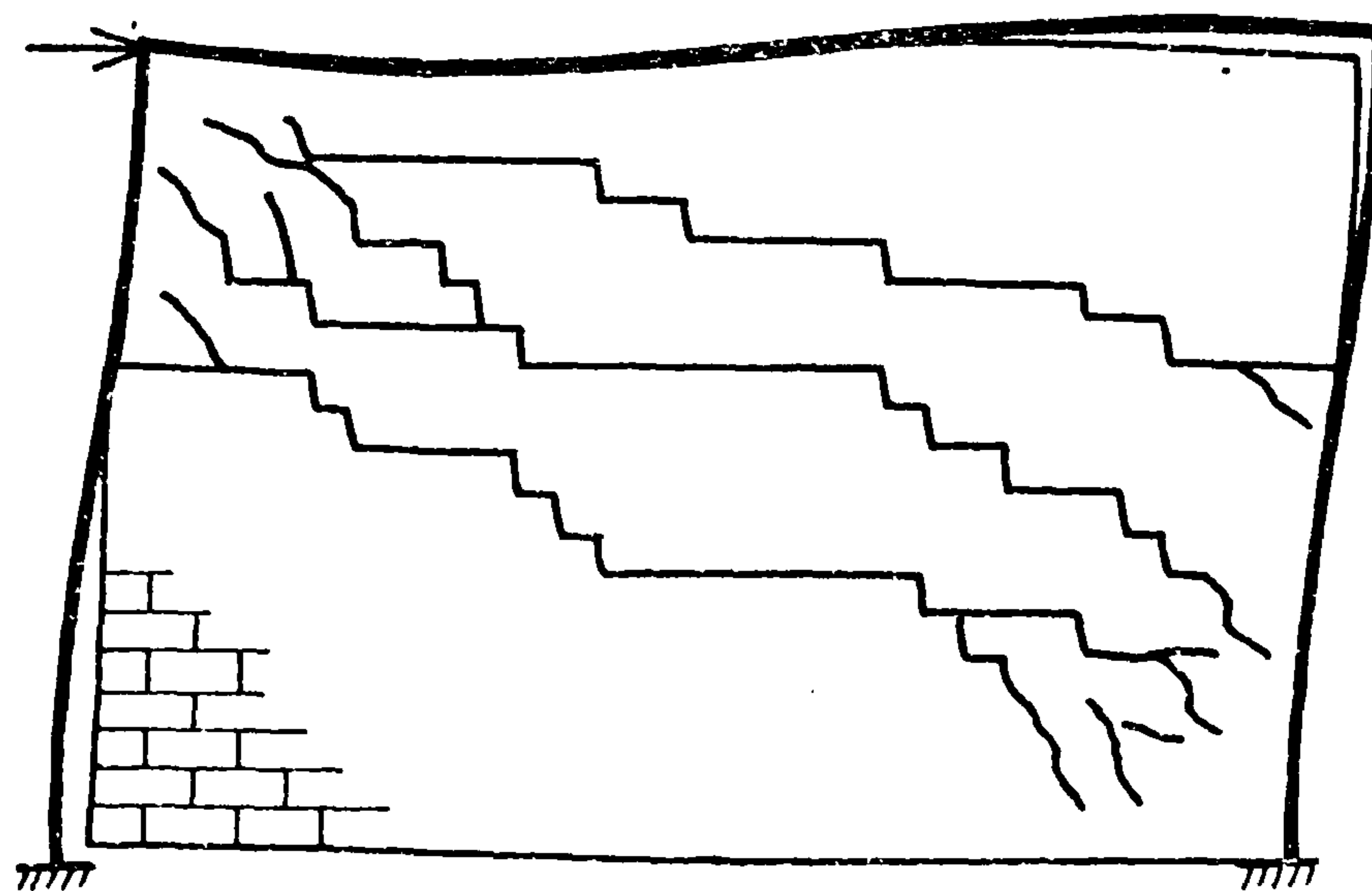

Fig.(3.18) Propagation of cracks.

places where propagation of cracks are developing. As more crushing appears, the panel becomes incapable of sustaining more load, the deflection increases while the load remains fairly constant. This stage is considered as the ultimate carrying capacity of the infilled frame structure.

Diagonal tensile cracks passing equally through both mortar and bricks are unlikely to occur in brickwork infilled panels built with ordinary mortar. It has been shown⁽⁴⁵⁾ that diagonal tensile cracks may occur in brickwork shear walls, depending on the value of the normal pre-compressive force applied. The occurrence of diagonal tensile cracks also depends on the bond strength between bricks and mortar⁽²⁰⁾: in the tests carried out with normal 1 : 3 mortar, the bond strength was weak and the frames did not provide sufficient normal forces, diagonal tensile cracks were therefore unlikely to appear.

3.9.3 The influence of frame stiffness

The lateral resistance of a brickwall panel built without a bounding frame and without pre-compression is very low. The failure is due to overturning of the entire wall at the base due to tension bond failure⁽³⁾, sliding along the base or any other plane with weak bond. However, the resistance will increase considerably if any sliding, overturning restraint or any precompression is provided. The increase depends on the amount and the way these restraints and precompression are applied. In infilled frames, where the wall is confined inside a reinforced concrete or steel frame, overturning restraint and precompression will be provided by the bounding frame. The windward column will behave as a tie in tension preventing the overturning of the wall, at the same time it transmits the major part of the lateral load to the wall over the length of contact. On the other/

other hand the beam member of the frame exerts normal and shear forces on the wall over a certain length of contact. Shear connectors will prevent the wall from sliding and increases its stiffness⁽³¹⁾.

The stiffness and the strength of the infill depend on the stress distribution at the interface between the frame and the infill, and on the length of contact between the infill and both the beam and the column of the frame. The tests showed different length of contact for different frame stiffnesses, this behaviour has also been observed by others⁽⁴⁹⁾. The stiffer frames showed greater length of contact than the flexible frames, which resulted in an increase in strength and stiffness of the infilled frames. The increase in the stiffness and the ultimate strength is more than the increase which could be attributed to the increase of the frame stiffness alone, Figs. (3.10, 3.11, 3.14 and 3.15). This clearly demonstrates the composite action of infilled frames.

However, the contribution of the frame in increasing the carrying capacity of the panel at the first crack is less pronounced, Figs. (3.12 and 3.13). The panel cracks under very small deflection, variation in frame stiffness will not result in great increases in the cracking load of an infilled frame, except for very stiff, strong frames, which are unlikely to be found in practical buildings. The mode of failure of infill panel at the ultimate load also depends on the stiffness of the frame. The tests showed that in panels with stiffer frames, the spalling of bricks developed away from the corners and spread out towards the centre of the panel and over a greater area inside the panel. However, in panels with relatively flexible frames, the failure increased towards the loading corner.

3.9.4 The influence of h/l ratio

A brickwork panel under lateral load and low precompression normally fails by shear along the mortar-brick joints. The cracking load therefore depends on, among other factors, the length and thickness of the panel as well as the shear bond strength. An increase in the length of the panel will produce increase in the cracking load. In infilled frames, as discussed earlier, the precompression is provided by the beam and is dependent on the stiffness of the frame; in rectangular panels, the frame is relatively flexible compared with the rigid panel, the amount of normal forces on the top of the panel will therefore be relatively low. The amount of increase in the cracking load, which could be expected due to the increase in panel area in infilled frames is not the same amount which can be attributed to the increase in panel area in normal shear wall with precompression over the whole length of the wall. Figs. (3.12 and 3.13) show the increase in infill frame strength due to difference in $\frac{l}{h}$ ratios. However, a great increase in stiffness can be seen in Fig. (3.11) due to the increase of $\frac{l}{h}$ ratio, especially for panels with more stiff frames, the increase is less for flexible frames. The tests showed that the increase in stiffness and strength is not significant when $\frac{l}{h}$ is greater than 1.6.

3.9.5 Joint rigidity

The contribution of the frame to increase the strength and stiffness of infilled frames is by confining the panel inside its boundary. Composite action will take place whether the frame members are pin-jointed or rigidly jointed. Tests carried out by Polyakov⁽³⁵⁾ on pin-jointed brickwork infilled frames have shown this. However, in pin-jointed/

pin-jointed frames because they are incapable of resisting any lateral load themselves, a full composite action between the frame and the wall would not be obtained. For the full composite action to take place, the frame members should be fully rigidly connected and capable of developing full bending moments at the joints, to enable the beam and the columns to transmit the major portion of the load to the panel along the interface; any weakness or opening of the joints during the loading may result in reduction in the stiffness and the strength of the structure. A few tests were carried out on square infilled frames where the joints were welded on all sides, but no stiffening plates were provided. These tests showed cracking at a considerably low load and the stiffness as well as the ultimate load decreased accordingly, Table (3.3). These reductions in strength and stiffness were due to the early opening of the joint at the loaded corner, as the load increase more cracks appeared and the joint widened more, the crushing of the brick was not reached. The failure was due to the joint failure and the total opening of the loaded corner-joint.

3.9.6. Lack of fit

Tests WG1 and WG2 were carried out on square infilled frames, a small gap, $\frac{1}{16}$ " wide was left at the top of the panel between the brickwork and the beam member. This situation may arise in practice due to shrinkage and settlement of the infill material and due to defects in workmanship. Because of this lack of fit the behaviour of the infilled frame will be modified. The load is transmitted to the infill by normal and shear forces only at the column interface, due to the presence of the gap at the top no restraint is provided by the beam, the lateral load to cause the first crack would be low. After cracking/

cracking there is a tendency for the infill to slip along the column interface and rotate until it bears on all frame members at the loaded corners. However, if the bond between the infill and the frame at the column interface is negligible, the slip and rotation could precede the appearance of the first crack inside the panel. The infill frame in this case will suffer a great deflection until the gap is filled and composite action takes place, the panel may then maintain a higher stiffness and cracking load. In the tests carried out the slipping did not occur first. The results of these tests are shown in Tables (3.1) and (3.3). The ultimate load was nearly the same as in the normal panels (with no gap), but due to the early cracking of the panel the stiffness was remarkably low.

3.9.7 Modified mortar

As described earlier, the strength and the stiffness of an infilled frame depends on the degree of fit of the panel within the frame and the way the forces are transmitted from the frame to the infill. It has been well established that the lateral strength of a masonry wall depends on the shear strength of the brickwork, which in turn depends on the bond and friction between the mortar and the bricks. A great increase in strength of brickwork could be achieved by increasing the bond strength of the mortar^(20,60). In walls WR1, WR2, WR3 and WR4 tested, the mortar used was 1 : 3 : 40% Revinex (detail in Appendix B). The mortar has a high tensile strength (600 psi) and a significant bond strength, higher than the tensile strength of the bricks used. The tests showed very high stiffness and strength due to the high bond strength induced inside the panel as well as between the frame and the panel. This modifies the transmission of loads from the frame to the infill/

infill and most if not all of the boundary would be in contact with the frame. The structure would act as a composite wall and possesses greater stiffness. The panels behave more as a homogeneous, isotropic material, their behaviour is similar to the behaviour of a reinforced concrete frame with concrete infilling built integrally. The crack is governed by the maximum tensile principle stress inside the panel.

The straight line crack which was observed in test WR2, must have been due to a weakness in the brick mortar joint at the time of construction. The first mode of failure appeared as a straight diagonal tensile crack at the centre of the panel. This type of failure has been observed in frames infilled with more elastic materials such as concrete and mortar^(49, 9).

The diagonal tensile crack occurs when the maximum tensile stress at the centre of the panel exceeds the tensile strength of the panel material, in the case of brick masonry, the weakest tensile strength of the two materials, i.e. brick or mortar⁽⁷⁾.

The ultimate load also increases due to the fact that the load transmitted from the frame to the panel is over almost the whole length of the frame members, no stress concentration is induced near the loaded corners. Test results are shown in Tables (3.1) and (3.3) and compared with their corresponding infilled frames built with ordinary 1 : 3 mortar.

3.10 CONCLUSIONS

As a result of this investigation, the following conclusions have been reached :

1./

1. At the early stages of loading, the behaviour of an infilled frame is unpredictable depending upon the lack of fit and bond between the frame and infill.
2. At the initial stage of loading, separation occurs between frame and infill along all, or some, of the members, except at the compression corners where the frame remains in contact with the infill over a certain length.
3. The length of contact along the members depends on the relative stiffness of the frame and the infill. It increases with an increase in the frame stiffness.
4. After the separation, the infill acts as a strut in compression along the loaded diagonal, at this stage the behaviour of the structure is approximately linear up to the appearance of the first crack.
5. A brickwork infilled panel exhibits two types of failure:
 - (a) Shear or diagonal tensile failure depending upon the bond strength between the bricks and mortar as well as the bond between the panel and frame. Shear failure is indicated by the appearance of cracks at the interface between mortar and bricks in a step-wise manner. Diagonal tensile cracks appear at, or near, the middle of the panel along the compression diagonal passing through both mortar and bricks. The first crack is sudden, cracks do not define the failure of the structure, however its stiffness is greatly reduced.
 - (b) Compression failure: which defines the ultimate carrying/

carrying capacity of the structure is indicated by progressive spalling of the brickwork at, or near, the compression corners depending upon the stiffness of the frame and its joints. After the compression failure the structure is capable of sustaining 80 - 90% of the ultimate load.

6. Keeping all factors affecting the strength of brickwork constant, the stiffness and strength of a brickwork infilled frame are influenced by :
 - (a) $\frac{h}{l}$ ratio of the panel.
 - (b) The stiffness of the frame members.
7. Lack of fit between frame and panel decreases the cracking strength and stiffness remarkably; however, the ultimate load is not greatly affected.
8. Weakness in the strength and rigidity of the frame joints may result in a great reduction in strength and stiffness of an infilled frame, the frame may fail at the joints before the ultimate load is reached.
9. By increasing the bond strength between bricks and mortar, panel and frame, the stiffness and strength of the composite structure is significantly increased.

CHAPTER 4ANALYSIS OF ONE-STOREY INFILLED FRAMES4.1 INTRODUCTION

It has been realized that the stiffness and strength of a frame is greatly increased by infilling the frame with masonry or concrete panels, which act compositly with the frame under lateral loading. The behaviour of infilled frames has been studied by many investigators experimentally and theoretically. The analysis of such frames can be divided into three groups:

1. A simple approach based on the simple strength of material method (2, 61) .
2. An approximate approach based on analogous frame method. (17, 25, 48, 56)
3. A more accurate approach based on theory of elasticity method and finite element method. (21, 24, 29, 42)

The accuracy of results obtained from these approaches depends on the assumptions made by the investigators. The first approach assumes total integration between the infill and the frame, then analyses the resulting structure as a vertical deep beam. This approach could be applied to reinforced concrete frames with concrete infilling built integrally, but is not applicable to frames which are not integral with the infill, as in the case of masonry in reinforced concrete or steel frames where separation between the frame and the infill occurs. This simple approach analysis overestimates the stiffness of the structure.

The second approach is based on the concept of replacing the infill by an equivalent diagonal strut; separation is also taken into account.

Fair/

Fair accuracy has been obtained by this approach, the results mostly depend on the assumed or estimated values of the effective width of the equivalent diagonal strut. This method could easily be applied to multistorey buildings, however, it is incapable of treating infilled frames with openings.

In the third approach, the structure is solved as a plane-stress problem in the elastic range. The problem is made more difficult by the existence of an interface between the frame and the infill. Different authors have used different approaches to solve the interface problem. Sachanski, Todor and Liaw assumed continuous bond between the infill and the frame. Mallic used the finite element method, the separation and slip along the interface were included as an integral part of the solution. The third approach although refined and sophisticated, gave results not more accurate than the second one. It must be noted that these more exact methods necessarily require the use of a computer even for a simple infilled frame and their application to multistorey infilled structures is very limited.

The method described in Part (A) of this chapter is based on the second approach: the concept of equivalent diagonal strut. The effective width of the strut is estimated for varying frame stiffnesses and different panel proportions. Strain energy method is used to analyse the equivalent structure. The results of the analysis are compared with the experimental results. A good agreement has been obtained. Simple methods to predict the cracking and ultimate load resistance of masonry infilled frames are also described.

Analysis of one-storey infilled frames by the method of finite elements is described in Part (B) of this chapter. In Part (C) results of both analyses are compared with the experimental results and discussed and conclusions are drawn.

4.A AN APPROXIMATE METHOD TO DETERMINE THE STRENGTH AND STIFFNESS OF MASONRY INFILLED FRAMES WITHOUT OPENINGS

4.2 EQUIVALENT DIAGONAL STRUT

This analogy first suggested by Polyakov⁽³⁵⁾, was later adapted by Holmes⁽¹⁷⁾, Smith⁽⁴⁸⁾ and Mainstone⁽²⁷⁾. The actual behaviour of an infill frame is very complex. The statistical nature of the panel material and the complex boundary condition make predicting the behaviour of infilled frames more difficult and results are grossly approximate.

The method based on an equivalent strut has been suggested to simulate the behaviour of infilled frames more closely. However, the real behaviour is more complex than that of a simple pinned-jointed diagonal strut. At the initial stage of loading, if the infill and the frame fit perfectly together, and there is some bond strength between the two, a continuous transmission of normal and shear forces will take place along the boundary. Tensile forces will be induced at the unloaded corners which later causes the separation of the frame from the infill, thus the forces are transmitted only along a certain length of contact and are concentrated at the loaded corners; the infill can then be assumed as equivalent to an inclined strut having the same thickness and modulus of elasticity as the panel material, with uniformly stressed effective width less than the total diagonal width. Unlike the concentrated reaction of a true diagonal strut, the panel will induce some change in the mode of deformation of the frame. Before the appearance of the first crack, this change in the mode of deformation has a little effect on the increase of the overall composite stiffness. However, after the simultaneous appearance of more cracks as the load increases, the initial behaviour of the infill will/

will be modified by creating two or more lateral struts in place of the original one. Most of the load carried by the infill will be due to the wedging, friction and arching action. A remarkable change in the frame deformation will result from the redistribution of the interface reactions. The frame will be carrying a greater percentage of the load than at the pre-cracking stage of the loading. In fact, the principle of a diagonal strut is no longer valid. The panel material is no longer elastic nor does it act as a single unit, thus any estimation of the stiffness of an infill frame at this stage will be grossly approximate, giving the order of deflection only, hence the behaviour of the structure cannot be predicted.

The present adapted method is based on the principle of an equivalent pin-jointed diagonal strut, but the estimation is only applied to the pre-cracking stage. The following assumptions are made:

1. Infill material is isotropic and homogeneous.
2. The infill is a close fit within the frame.
3. The infill is not bonded to the frame.
4. The frame joints are rigidly connected.

In fact a masonry panel is neither isotropic nor homogenous although most if not all the analyses of masonry structures are based on this assumption. In order to simplify an analysis this assumption is essential and errors from this cause are mostly compensated by others. In case of any lack of fit of the infill inside the frame, the initial deflection due to this lack of fit is neglected and the stiffness estimated corresponds to that after a complete fit has been reached at the loaded corners, provided that the first crack does not precede this condition.

The/

The bond between the frame and the infill is assumed to be negligible, so that the separation is allowed. The members are rigidly connected and no opening of the joints is allowed under the loads imposed by the infill.

Provided that "lack of fit" does not exist and the joints do not open during the loading, the stiffness and strength of a single storey infilled frame depend on the following main factors:

1. The physical properties of the materials.
2. The $\frac{h}{l}$ ratio of the panel.
3. The stiffness of the frame members.

Therefore any stiffness and strength predictions of an infilled frame should take these factors into account. The following sections describe the analysis procedure.

4.3 LENGTH OF CONTACT

It has been shown that after the separation; the frame remains in contact with the infill over a certain length at which the major part of the load is transmitted by the frame to the infill. The extent of this length of contact depends on the stiffness and properties of both the infill and the frame. The following non-dimensional parameters have been adopted to express the relative stiffness of the infill to the flexural stiffness of the columns and beams:

$$\lambda_h h = h \sqrt[4]{\frac{E_w t \sin 2\theta}{4EI_h h_w}}$$

$$\lambda_l l = l \sqrt[4]{\frac{E_w t \sin 2\theta}{4EI_l l_w}}$$

The parameter $\lambda_h h$ was first adopted by Smith⁽⁴⁹⁾. The terms λ_h and λ_l are similar to the parameter whose reciprocal is known as the characteristic/

characteristic length in the general solution of the equation governing the analogous behaviour of a beam on elastic foundation⁽¹⁶⁾:

$$EI \frac{d^4 y}{dx^4} = -ky \quad \text{where } k = \text{elastic modulus.}$$

The general solution is :

$$y = e^{\lambda x} (A \cos \lambda x + B \sin \lambda x) + e^{-\lambda x} (C \cos \lambda x + D \sin \lambda x)$$

$$\lambda = \sqrt[4]{\frac{k}{4EI}}$$

A, B, C and D are constants dependent on the loading and end conditions.

The length of contact between the infill and the column and between the beam and the infill can be found, if the behaviour of an infill frame is assumed to be analogous to real beam on elastic foundation. However, there are some variations between the two: the infill provides a limited depth of foundation, and the frame members have direct forces and restraints at the joints.

Considering a free beam on elastic foundation under a central concentrated load Fig. (4.1). The effective length is defined by the points where the deflection of the beam is zero, the general solution of the beam will satisfy this condition when $\lambda l = \pi, 3\pi, 5\pi, \dots$ ()

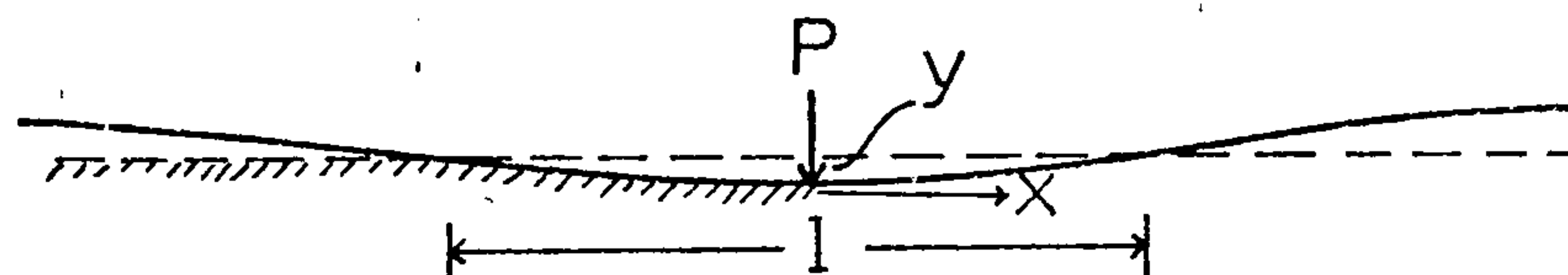

Fig. (4.1)

In infilled frames the column under the lateral load could be represented by half of the beam shown in Fig. (4.1), therefore $\alpha_h = \frac{\pi}{2\lambda_h}$, this relation was first adopted by Smith⁽⁴⁹⁾.

In the same way the beam member of an infilled frame could be represented as a beam on elastic foundation under a moment acting at one of its ends, Fig. (4.2). This moment is exerted due to the rigidity/

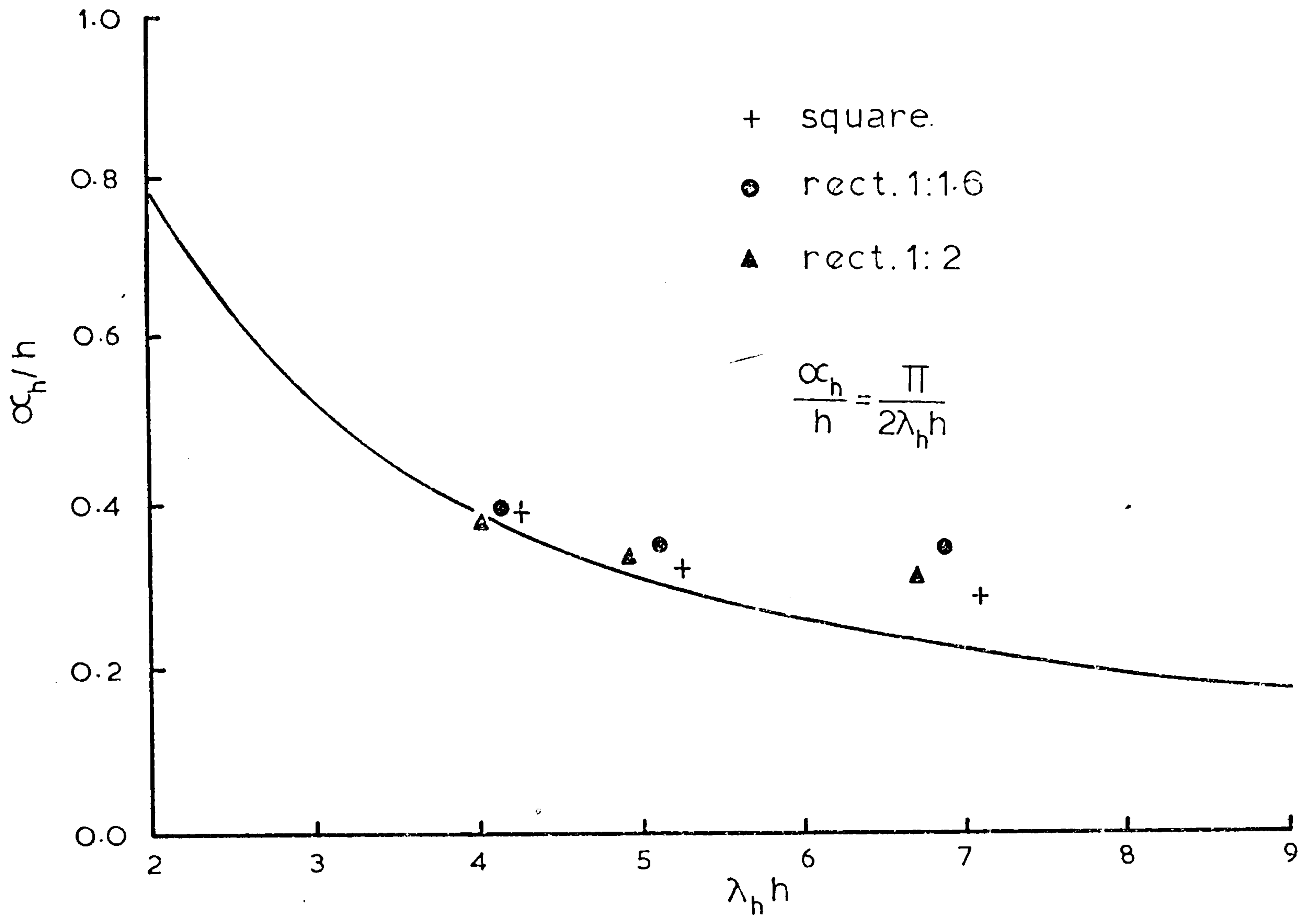

Fig.(4.3) α_h as function of $\lambda_h h$

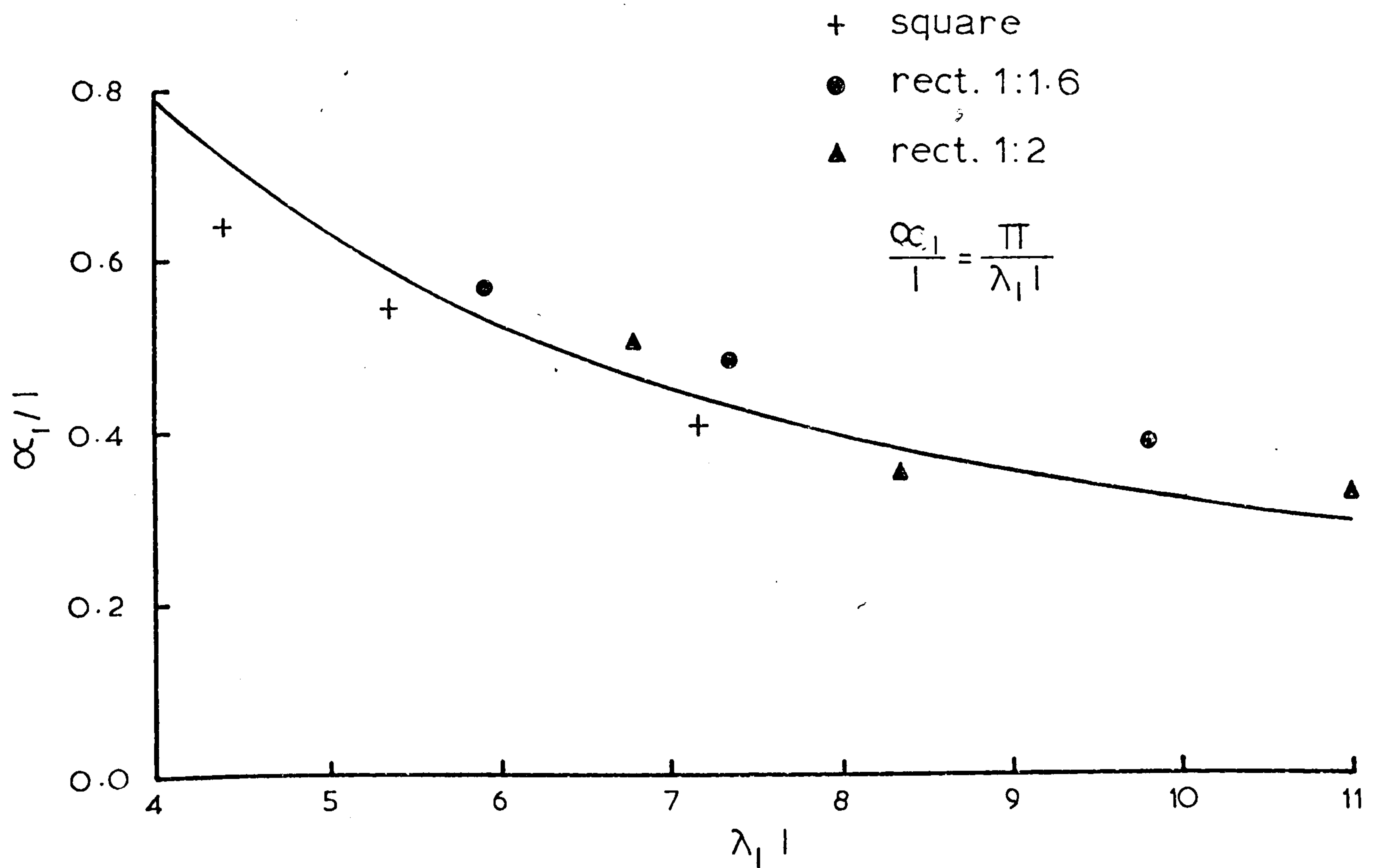

Fig.(4.4) α_l as function of $\lambda_l l$

rigidity of the joint at the loaded corner. In Fig. (4.2) the deflection is zero when $\lambda x = \pi, 2\pi, 3\pi$, etc. therefore the length of contact along the beam $\alpha_1 = \frac{\pi}{\lambda_1}$.

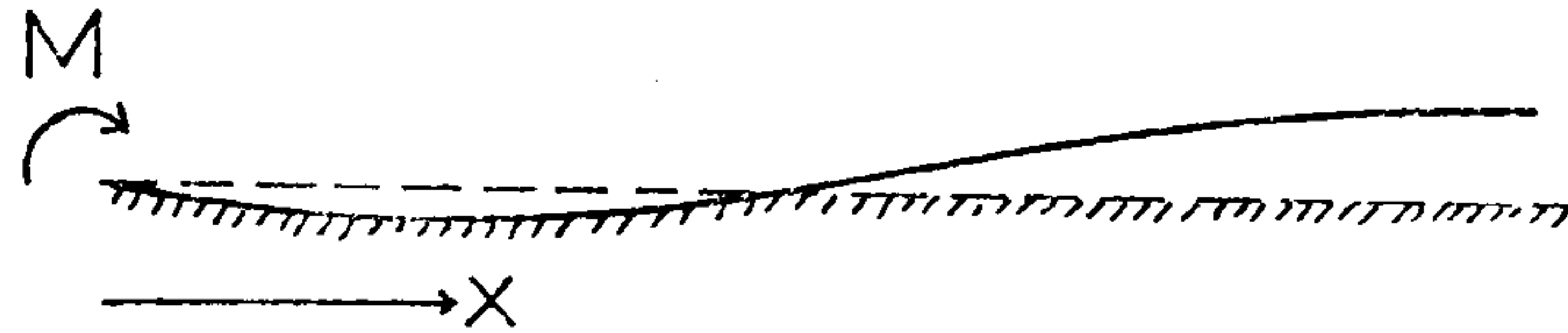

Fig. (4.2)

According to Hetenyi: when $\lambda l > \pi$ the beam could be considered as a long beam, therefore the loading conditions at the far end of the member will have a negligible effect at the other end of the member. In most practical cases, $\lambda_h h$ and $\lambda_1 l$ are always greater than π , small values of $\lambda_h h$ and $\lambda_1 l$ represent very strong and stiff frames relative to the infill.

The measured lengths of contact along the column and the beam are compared with the adopted curves in Figs. (4.3) and (4.4).

4.4 THE EFFECTIVE WIDTH OF THE DIAGONAL STRUT

Experimental results showed the stiffness of an infilled frame, and the contact lengths depend on the stiffness of the frame and the panel properties. The increase in lateral stiffness caused by increasing the frame stiffness is much greater than could be attributed to the additional stiffness of the frame alone. The increase is mostly due to the variation in panel resistance which is caused by the variation of contact lengths at which the forces are transmitted, and hence variation in length of contact results in varying effective width of the assumed diagonal strut.

The stresses inside the panel vary along the compression diagonal from minimum at the centre to maximum near the loaded corners. Along the unloaded diagonal the variation is from zero at the corners to maximum/



Fig.(4.6) Effective width as function of $\lambda_h h$

maximum at the centre of the panel. Assuming that the compressive stresses vary linearly from zero at the points of separation with the column, and with the beam, to maximum along the compression diagonal (Fig. 4.5) i.e. (W) is under a triangular stress distribution, therefore the diagonal strut will be under a uniform compressive stress over the width $w = \frac{1}{2}W$.

$$\therefore \text{the effective width } w = \frac{1}{2} \sqrt{\alpha_1^2 + \alpha_h^2}$$

$$w = \frac{1}{2} \sqrt{\left(\frac{\pi}{\lambda_1}\right)^2 + \left(\frac{\pi}{2\lambda_h}\right)^2}$$

$$= \frac{\pi}{2} \sqrt{\left(\frac{1}{\lambda_1}\right)^2 + \left(\frac{1}{2\lambda_h}\right)^2}$$

in terms of λ_1 and λ_h .

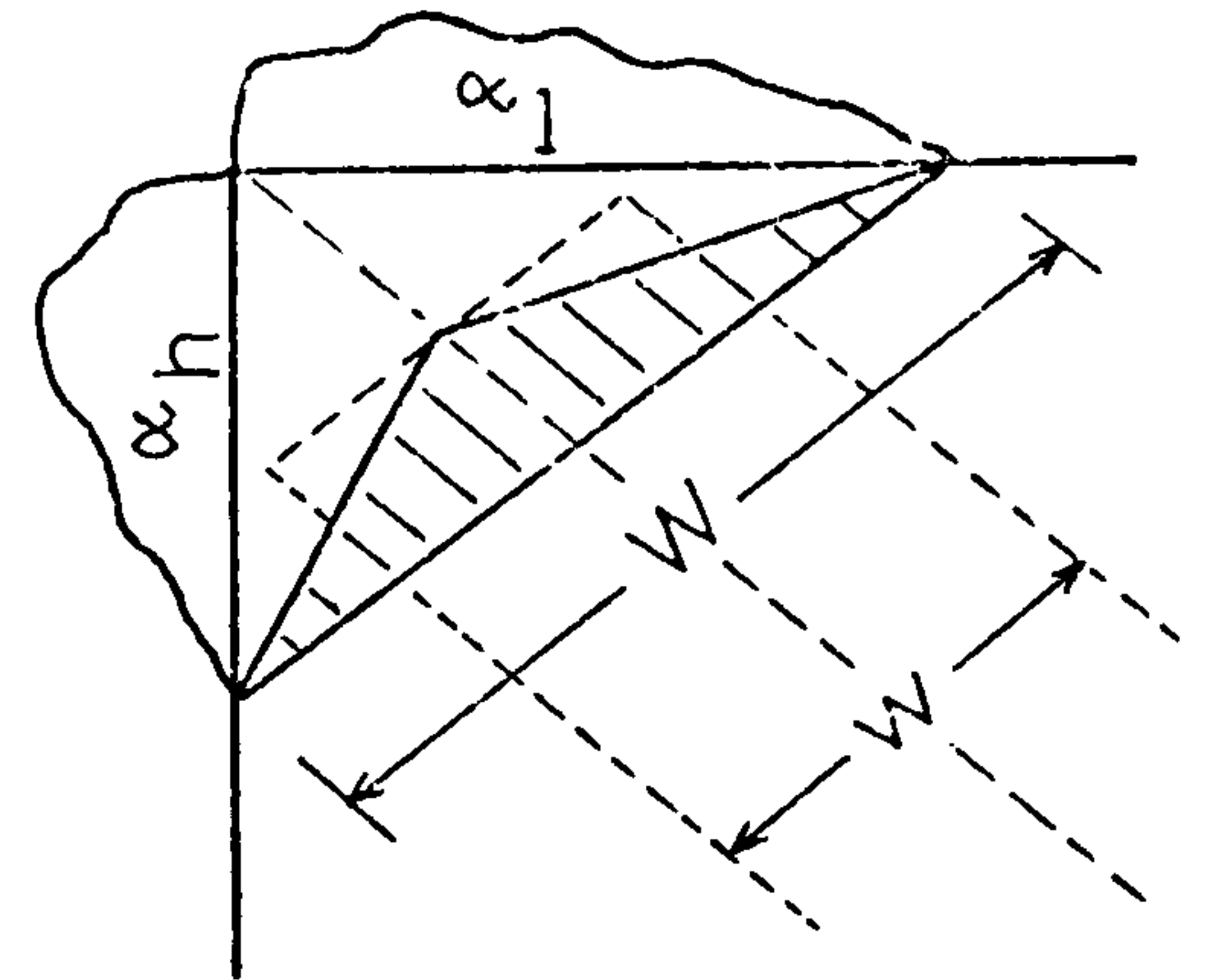

Fig. (4.5)

The equivalent strut is assumed to have the same properties and thickness as the infill material. The effective width 'w' as function of $\lambda_h h$ is shown in Fig. (4.6) for the infilled frames tested.

4.5 LATERAL STIFFNESS

After determining values of the effective width of the diagonal strut, the equivalent structure Fig. (4.7) can now be analysed to determine its lateral stiffness. The diagonal strut is assumed to be pin-jointed at the corners and under a uniform compressive stress over the effective width 'w'. The reactions exerted by the infill upon the frame at interfaces along the lengths of contact, and the consequent change in mode of frame deformation are neglected. Up to the first crack, the lateral deflection is very small relative to that of an open frame subjected to same loading conditions, the primary response of the frame is of direct forces in the members, especially in the windward column, therefore this effect may be neglected at this stage.

Using/

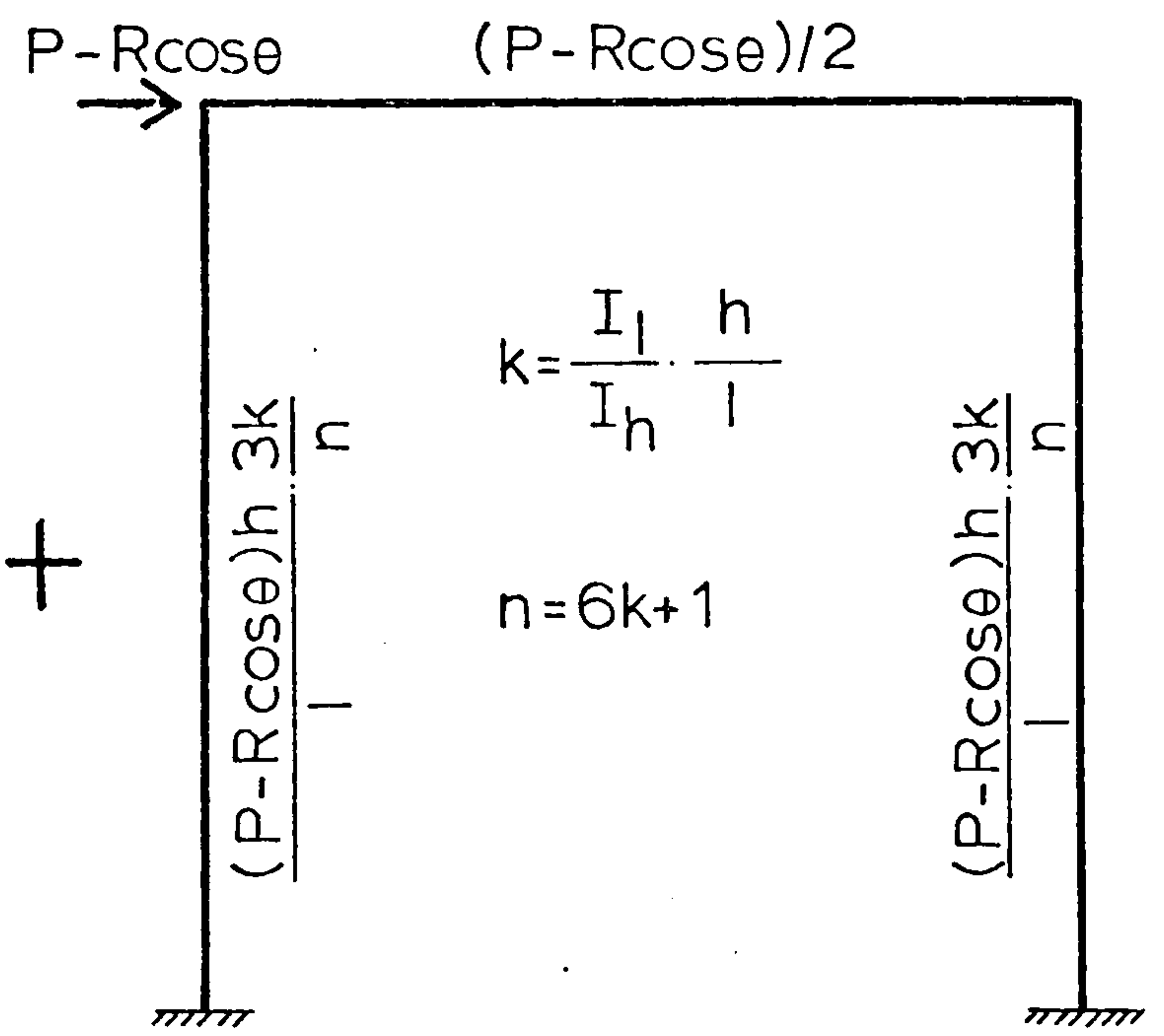
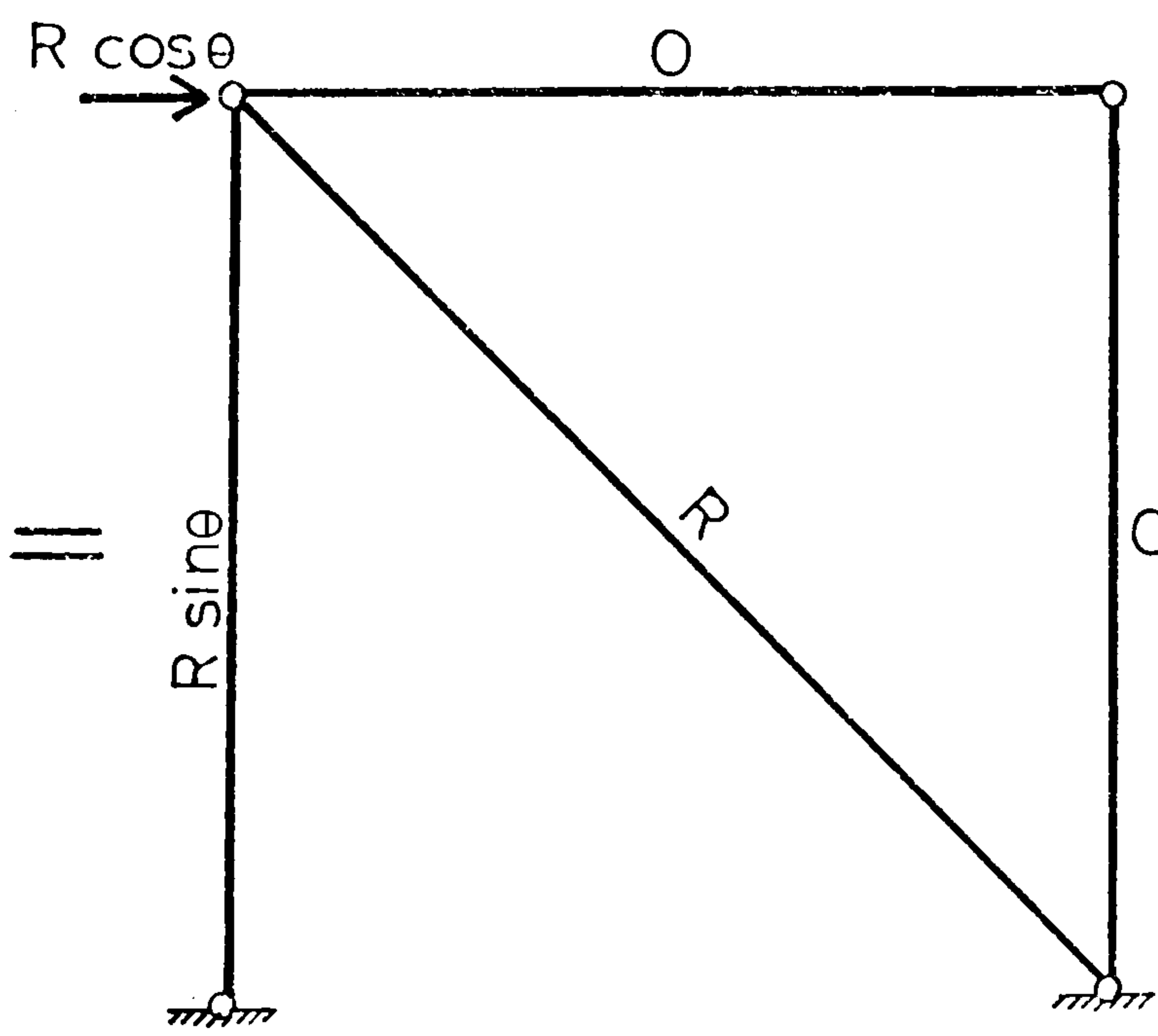
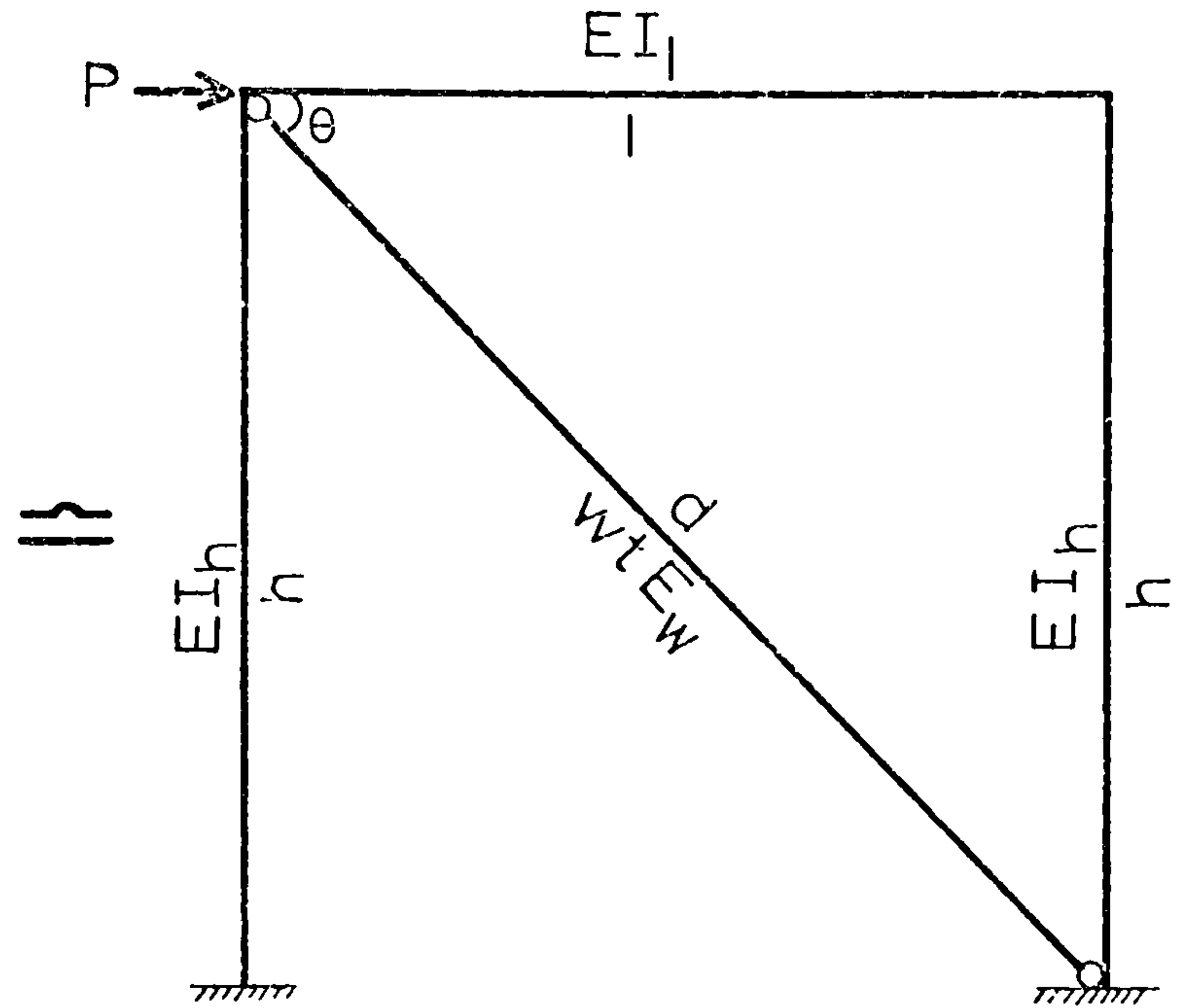
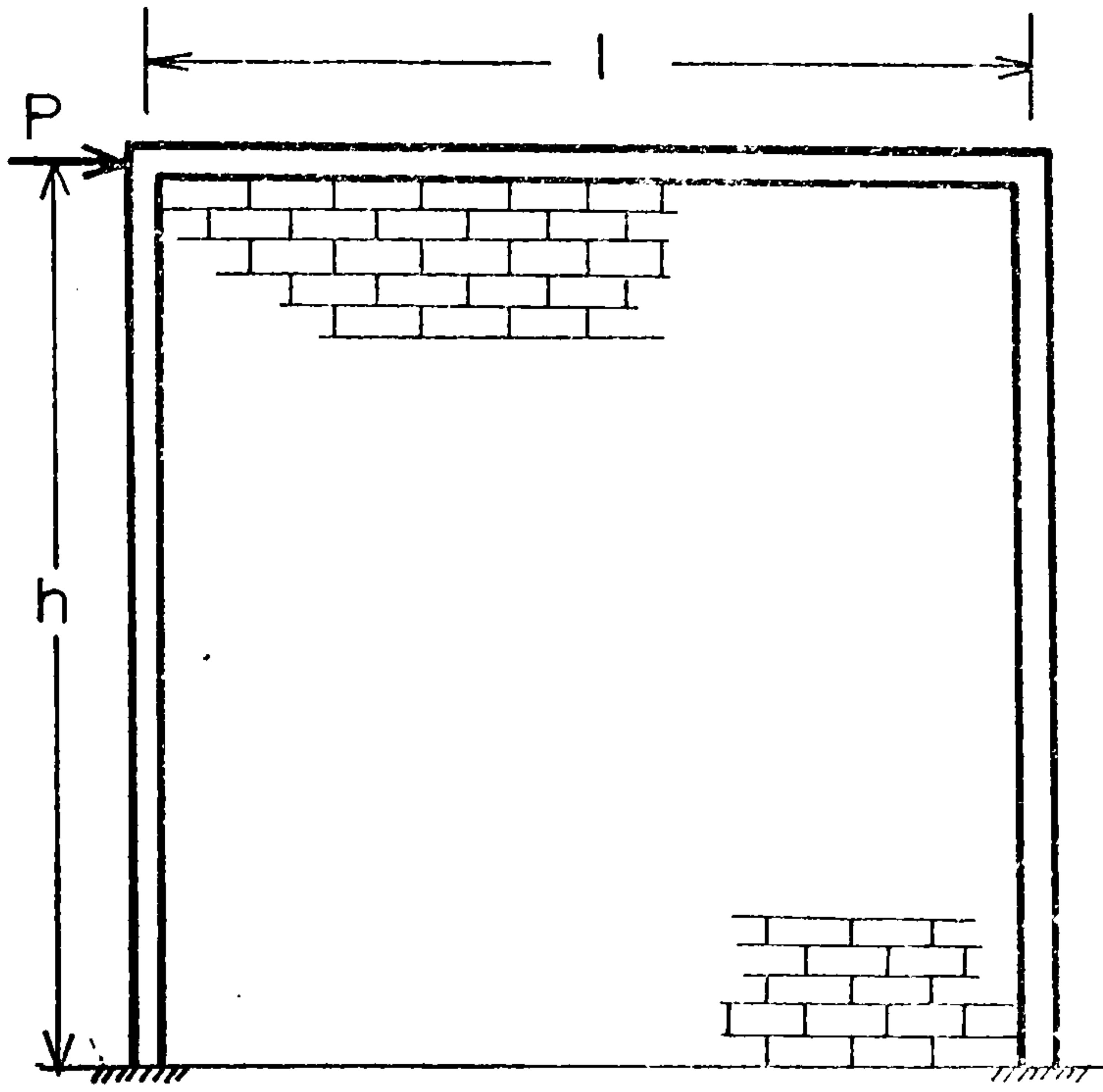

Fig.(4.7) Equivalent frame

Using the method of strain energy, taking into consideration the strain energy of the equivalent strut in compression, the windward column in tension and the total frame in bending. The lateral stiffness is found as follows:

$$\text{Strain energy of the strut in compression: } U_w = \frac{R^2 d}{2E w t}$$

$$\text{Strain energy of the column in tension: } U_c = \frac{R^2 \sin^2 \theta h}{2a_c E}$$

$$\text{Strain energy of the frame in bending } U_f = \frac{(P-R \cos \theta)^2 h^3}{24E I_h} \left[\frac{3I_1 h + 2I_h l}{6I_1 h + I_h l} \right]$$

$$\text{Total strain energy: } U_T = U_w + U_c + U_f$$

$$\text{Castigliano's theorem } \frac{\partial U_T}{\partial R} = 0 ; \text{ After substitution:}$$

$$R = \frac{C}{\cos \theta (A+B+C)} P \quad (4.5.1)$$

$$\text{where } A = \frac{\tan^2 \theta h}{a_c E} \quad B = \frac{d}{E w t \cos^2 \theta} \quad C = \frac{h^3}{12E I_h} \left[\frac{3I_1 h + 2I_h l}{6I_1 h + I_h l} \right]$$

Substitute (R) in the equation of the total strain energy, then :

$$\frac{\partial U_T}{\partial P} = \Delta \quad \text{Castigliano's theorem}$$

$$\therefore \text{ lateral stiffness } \frac{P}{\Delta} = \frac{A + B + C}{C(A + B)} \quad (4.5.2)$$

The strain energy in the other members due to direct forces could be included and added to (U_T) , eq. (4.5.2) becomes :

$$\frac{P}{\Delta} = \frac{A + B + C + D}{(C + D)(A + B)} \quad (4.5.3)$$

$$\text{where } D = \left[\frac{2h^3}{a_c E l} \left(\frac{3I_1 h}{6I_1 h + I_h l} \right)^2 + \frac{1}{4a_1 E} \right]$$

However, /

However, the contribution is too small and may be neglected.

The estimated values of lateral stiffness correspond to the stiffness of the structure obtained after the initial deflection is allowed due to any lack of fit that may exist.

4.6 LATERAL STRENGTH

Generally an infilled frame may fail in several modes. The lateral strength will be governed by the weakest mode of failure of the infill and the frame. The frame may fail by shear failure of the columns and beam, their connections and the tensile failure of the windward column, Fig. (4.8A). Some of these modes of failure have been experienced in test carried out by Benjamin and Williams⁽¹⁾. These possible modes of failure could be checked approximately by analysing the forces in the equivalent pin-jointed structure, then comparing the forces with the respective strengths of each member. Ordinary masonry infillings possess two types of failure, see Fig. (4.8B):

- a) Shear cracking at the interface between the bricks and mortar.
- b) Crushing near the loaded corner.

In brickwork infilled panel the first mode of failure always proceeds the second. It appears as a crack stepping downward along the diagonal; the location and extension of the crack are mainly dependent on the workmanship and bond strength at the joints. Crushing of the brickwork appears as a spalling of bricks close to the loaded corner for relatively low frame stiffness, and crushing over more area inside the panel for stiffer frames.

Diagonal cracks may occur in brickwork walls mainly depending on the amount of precompression applied at the top, and shear strength of the brickwork. As described earlier, in infilled frames with normal brickwork/

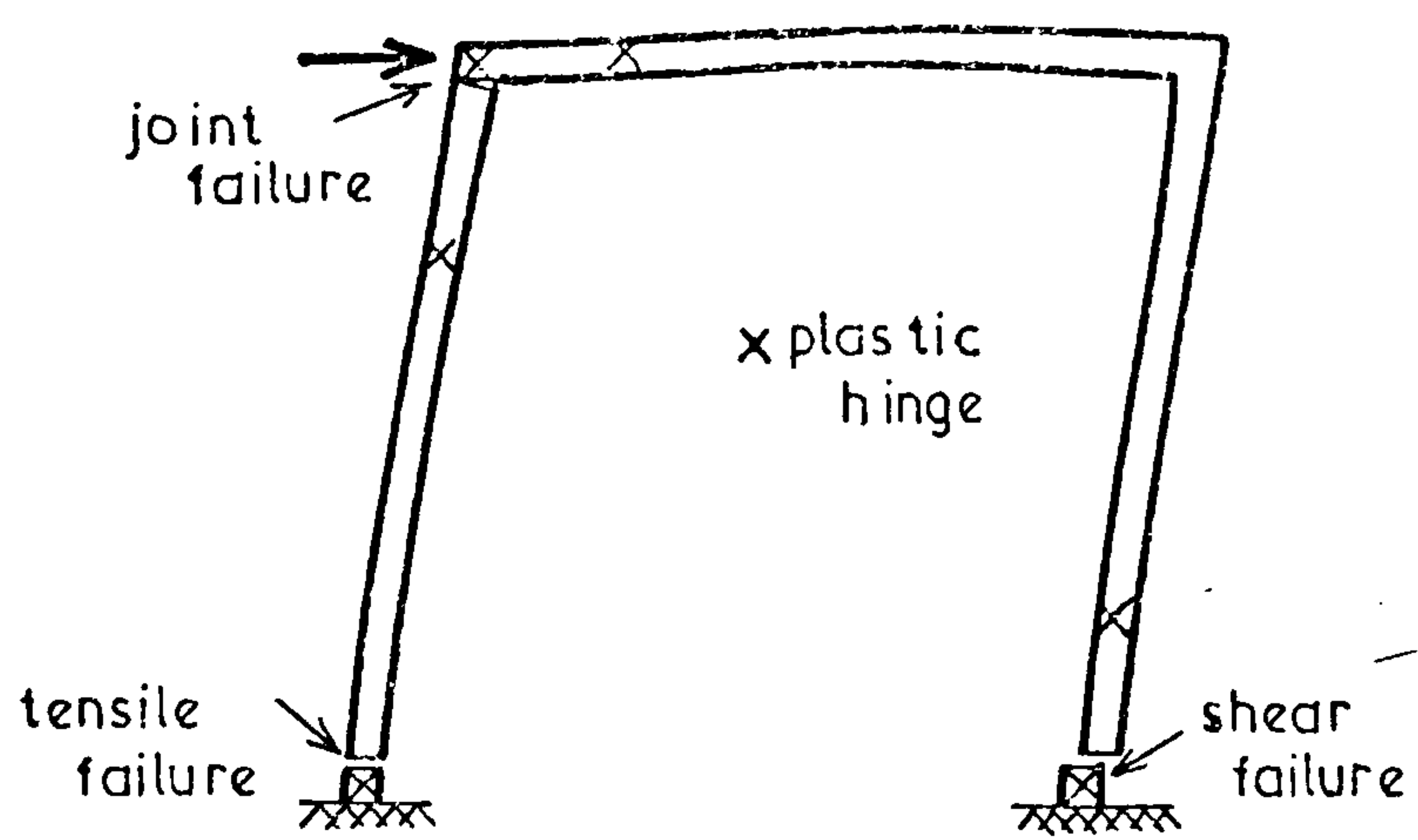

Fig.(4.8A)

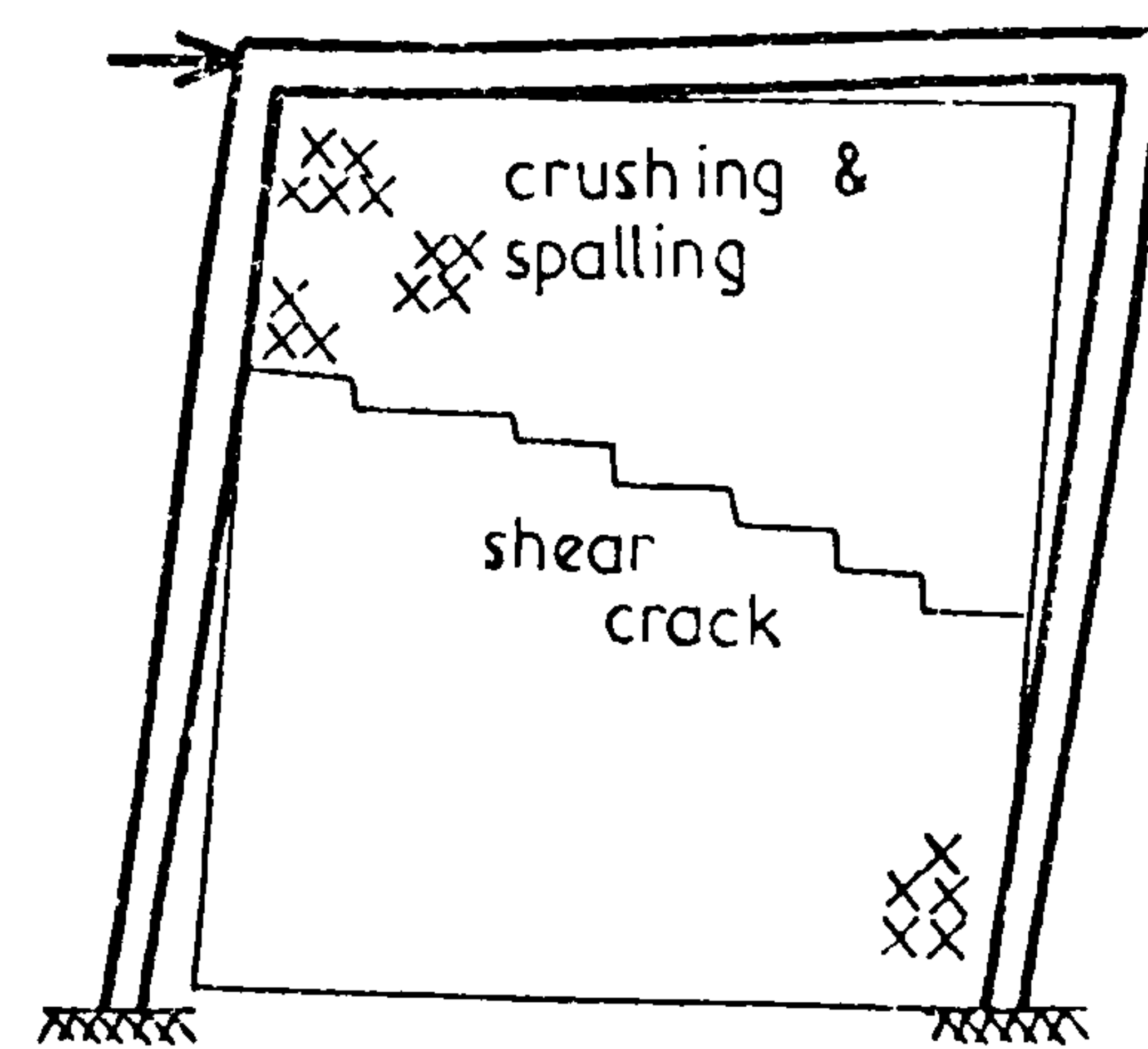

Fig.(4.8B)

Fig.(4.8) Modes of failure in masonry infilled frame

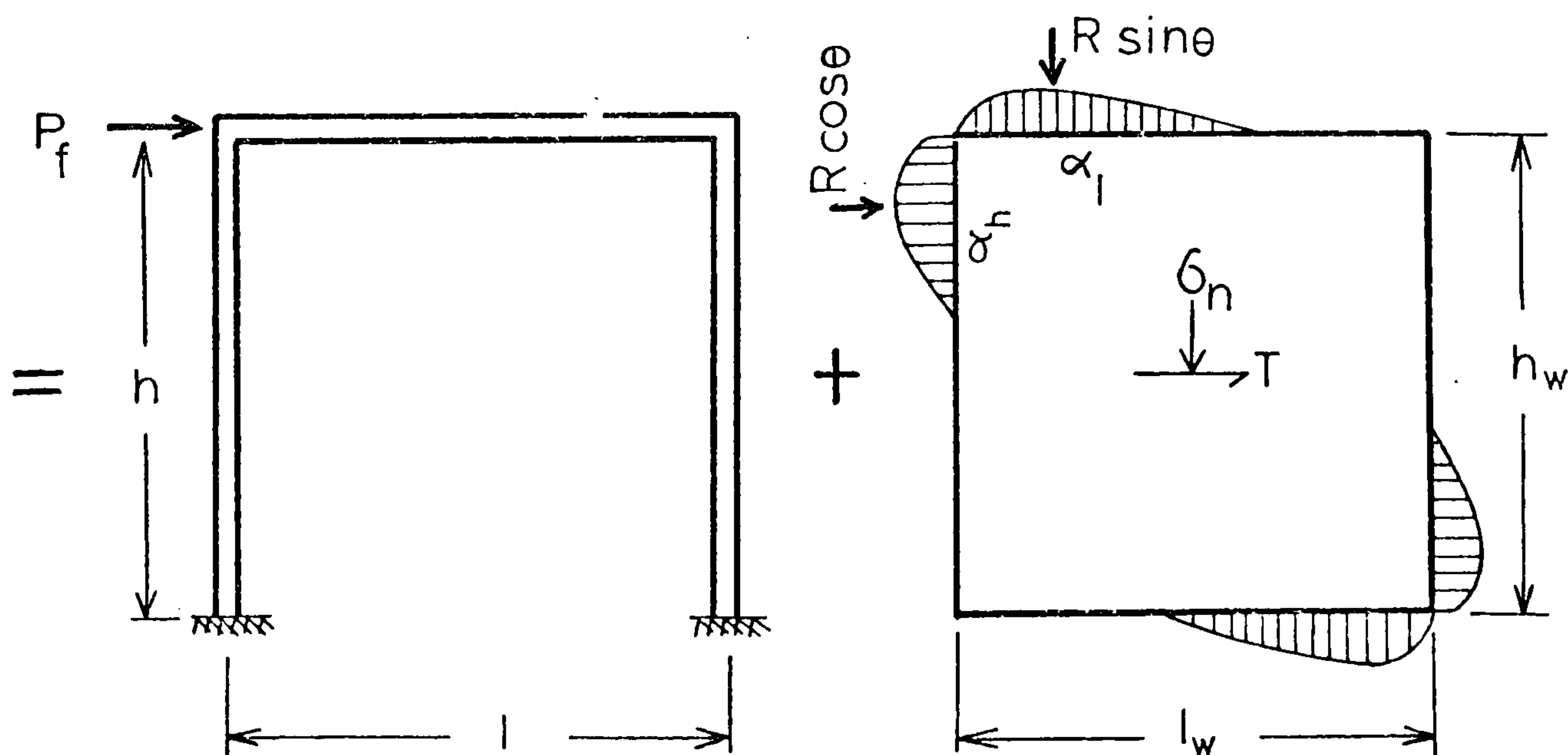
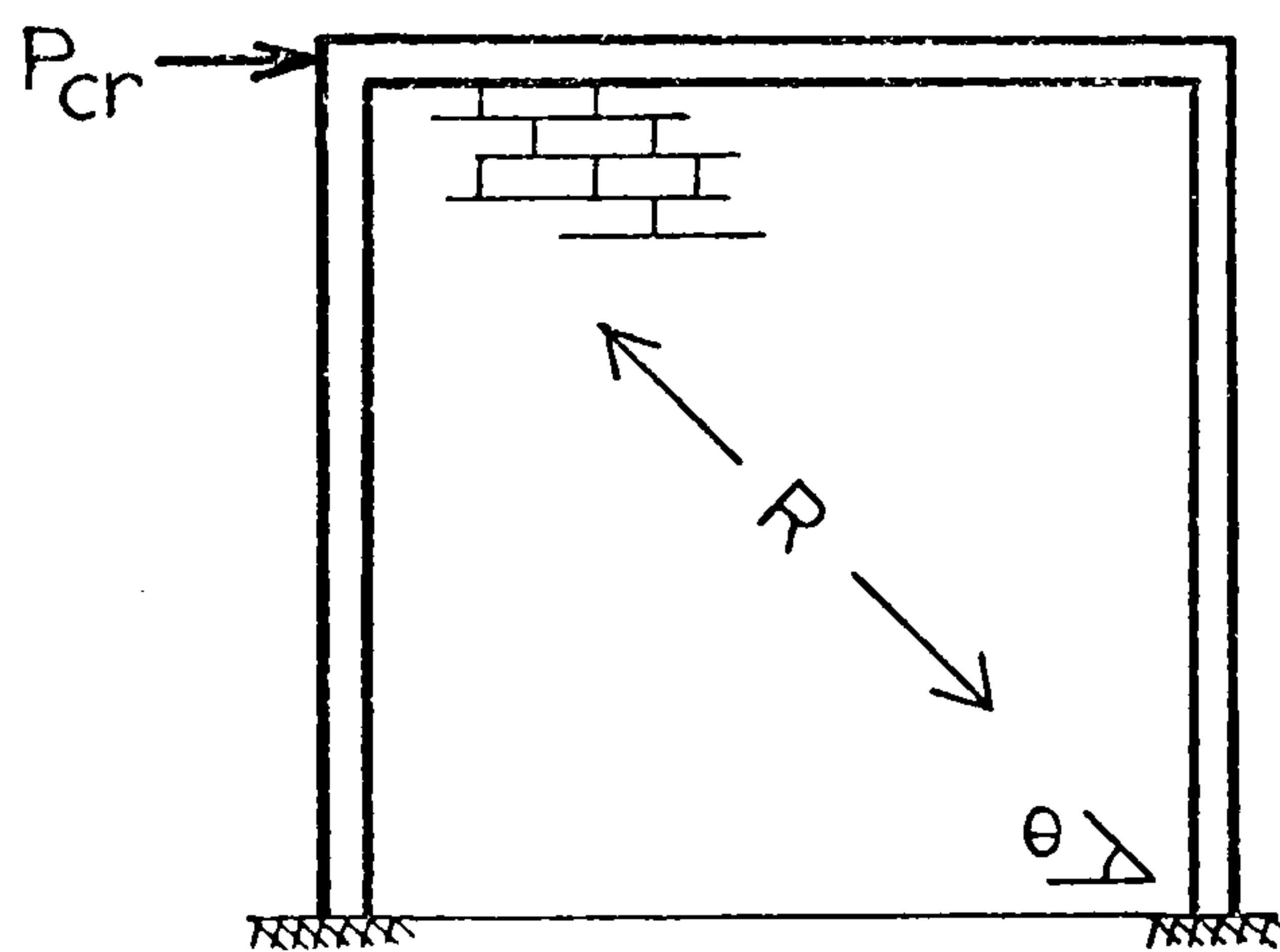

Fig.(4.9) Approximation of masonry infilled frame at cracking load

brickwork and without external vertical load, this type of failure is unlikely to occur, unless a very special mortar is used to increase the bond and shear strength of the brickwork (Section 3.8). Diagonal tensile cracking is characteristic to panels of more homogeneous materials such as mortar and concrete^(9,1,49).

The shear cracking of an infilled frame does not define complete failure of the panel because of the restraining influence of the frame, it is possible to increase the load to produce eventually a compressive failure of the infill. As the compression failure is reached, the structure is still capable of sustaining most of the load provided the frame has not failed in the manner described above, or because of the appearance of plastic hinges. However, the panel will become useless from the practical point of view, even the appearance of the initial cracks would not be acceptable. For the tests carried out throughout this investigation, the frames were designed strong enough to provide that the failure always occurs in the infill panel.

The strength of each mode of failure is described separately in Sections 4.6.1 and 4.6.2.

4.6.1 Cracking strength

The brick and mortar composite unit is a highly variable and complex material. The strength of a masonry unit is affected by many factors among them workmanship⁽¹⁵⁾. A wide variation in experimental results even for similar loading conditions has been experienced by many researchers. Accurate mathematical studies has been studied to predict the lateral strength of infilled frames, the results were not encouraging, very simple approaches were preferred and suggested^(1,17).

The author agrees that a very simple, practical formula including all/

all varying parameters is justified. Benjamin and Williams⁽³⁾, and Polyakov⁽³⁵⁾ gave similar empirical formulae to predict the lateral strength of an infilled frame; based on the couplet formula. Their formulae are only applicable to the type of bricks and mortar used in their investigation and the influence of the bounding frame has been completely neglected. It has been clearly shown that the strength of an infilled frame depends on the stiffness of frame members and panel properties; therefore any formula for predicting the strength or stiffness should include these factors.

The first mode of failure clearly indicates a shear failure along the interface between the bricks and mortar, the same mode of failure has been observed in shear wall structures without bounding frame under lateral and compressive forces⁽⁴⁵⁾. The following relationship for shear strength of brickwork has been widely used:

$$T = u + f\sigma_n \quad (4.6.1.1)$$

where T = shear strength of the brickwork.

u = shear bond strength of the brickwork.

σ_n = normal compressive stress.

f = coefficient of internal friction.

Stresses at the centre of the panel may be approximately computed assuming uniform distribution of stresses in the equivalent frame shown in Fig. (4.9) :

Average shear stress at centre

$$\text{of the panel} \quad : T = \frac{R_{cr} \cos\theta}{l_w t} \quad (4.6.1.2)$$

Average normal stress at centre

$$\text{of the panel} \quad : \sigma = \frac{R_{cr} \sin\theta \cdot \alpha_1}{l_w t} \frac{1}{l_w} \quad (4.6.1.3) *$$

Substituting/

* see page 117 [APP. C]





Fig.(4.10) $\frac{P_{\text{wall}}}{P_{\text{total}}}$ as function of $\lambda_h h$

$$\% \frac{P_{\text{wall}}}{P_{\text{total}}} = \eta$$

Substituting equations (4.6.1.2) and (4.6.1.3) in equation (4.6.1.1).

Diagonal load to cause shear crack inside the panel = R_{cr}

$$R_{cr} = \frac{ul_w t}{\cos\theta(1-f \tan\theta \frac{\alpha l}{l_w})} \quad , \text{ since } \frac{\alpha l}{l_w} = \frac{\pi}{\lambda_1 \frac{l}{w}}$$

$$\text{Therefore } R_{cr} = \frac{ul_w t}{\cos\theta(1-f \tan\theta \frac{\pi}{\lambda_1 \frac{l}{w}})}$$

$$\text{and } P_w = R_{cr} \cos \theta = \frac{ul_w t}{(1-f \tan\theta \frac{\pi}{\lambda_1 \frac{l}{w}})} \quad (4.6.1.4)$$

In which (P_w) is the load carried by the panel alone as a composite wall.

On the elastic basis the load carried by the frame can be included directly from section 4.5, equation (4.5.1) :

$$R = \frac{\psi}{\cos\theta} P \quad \text{where } \psi = \frac{C}{A+B+C}$$

$$\text{from which, at cracking: } P_w = \psi P_{cr} \quad (4.6.1.5)$$

$$\text{and } P_f = (1-\psi) P_{cr}$$

$$\therefore P_{cr} = \frac{ul_w t}{\psi(1-f \tan\theta \frac{\pi}{\lambda_1 \frac{l}{w}})} \quad (4.6.1.6)$$

$$\psi = \frac{P_w}{P_{cr} \text{ (total)}} \quad \% \text{ is shown in Fig. (4.10) as a function of } \lambda_1 h.$$

4.6.2 Crushing strength

Provided the frame (members and joints) is strong enough so that no frame failure would occur prior to failure of the panel; the ultimate lateral carrying capacity of a brickwork infilled frame is defined by crushing of the panel material near and at the compression corners

Fig./

Fig. (4.8B). Theoretically, in elastic materials failure occurs at places where the maximum compressive strength of the material has been exceeded, these are the compression corners at which stress concentration has developed. In a non-homogeneous composite material like brickwork, this basic criterion is altered due to the successive cracking of the panel. The crushing may appear anywhere between the loaded corners and the middle of the panel, crack propagation being more likely to cause spalling of the brickwork. Indeed the first sign of crushing appeared at such places and extended towards the loaded corner, or spread over areas away from the corner depending on the stiffness of the members. Crushing at the upper corner always precedes crushing at the opposite corner, this is due to the rigid rotation of the loaded joint, in most of the tests carried out, crushing at the latter did not even appear.

Prior to crushing the panel is in a disintegrated state, its resistance to lateral load is due to friction, wedging and arching action inside the frame. The composite strength at this stage is influenced by all the factors described above, any prediction of the lateral strength will be grossly approximate, mathematical analysis based on theory of elasticity cannot be applied. Approximate prediction may be derived based on assumptions which may not represent the actual behaviour of the structure.

In this section an attempt has been made to predict the ultimate carrying capacity of infilled frames. The method is very approximate and several assumptions have been made :

It has been taken that the ultimate lateral load of the composite structure is the sum of the load carried by each component, i.e.:

$$P_{ult} = P_{wu} + P_f \quad (4.6.2.1)$$

Where P_{wu} is the ultimate load carried by the panel alone as a composite component.

P_f is the lateral load carried by the frame alone at a deflection equal to the lateral deflection of the wall at the ultimate load.

$P_f = P_{fe}$ (elastic) or P_{fp} (plastic) whichever smaller.

It is assumed that the crushed region extends over the effective width of the equivalent diagonal strut (w),

therefore;

The crushed length along the column = $w \cos\theta$

It is further assumed that the normal stress varies linearly from maximum at the corner

to zero along the length $w \cos\theta$, Fig. (4.11).

Fig. (4.11)

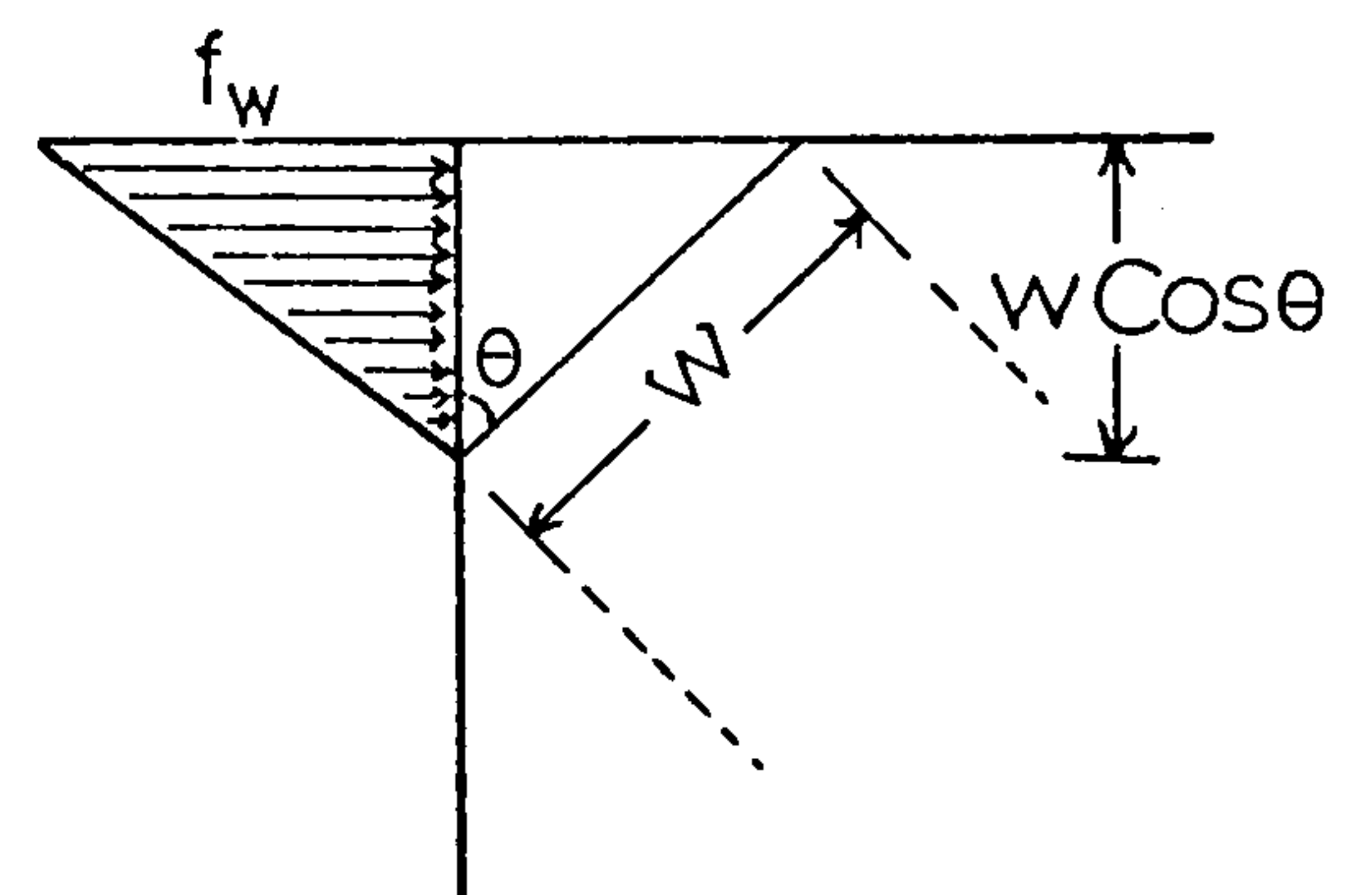

∴ The ultimate load carried by the wall, $P_{wu} = \frac{1}{2} f_w t w \cos\theta$ (4.6.2.2)

Where f_w = the ultimate compressive strength of the brickwork.

In eq. (4.6.2.1), the value of P_f represents the lateral load carried by the frame alone, not as a composite component, i.e.: neglects the effect of the interface reactions, which was also neglected when estimating P_{cr} . However, at the ultimate load where deflection is large, this effect is more important. The frame will carry a great portion of the load due to redistribution of the interface reactions and disintegration of the panel, which in turn changes the deformation shape of the frame and increases its carrying capacity. It may create plastic hinges along the beam and the columns rather than the joints which are assumed in the calculation of P_{fp} . However, this effect may be neglected, the results would be conservative which is desirable in the practical/

practical point of view, and may compensate for any error in over-estimating the value of P_{wu} .

In order to determine P_{fe} , the wall lateral deflection at failure is required. Deflection at the crushing stage is very large. After cracking, most of the lateral deflection is due to sliding of the brick layers along the cracked joints. Accurate prediction may not be possible, a value could only be obtained based on approximate assumptions. Before cracking, strain along the compression diagonal varies from maximum at the corners to a minimum value at the centre of the panel. At failure, strain at the compression corners is equal to the failure strain of the panel material. However, if it is assumed that at failure the strain along the whole diagonal is equal to the failure strain; an approximate diagonal deformation could be estimated. The strain variation along the diagonal, which is neglected, may compensate for the additional deflection caused by sliding along the cracked joints.

Tests have shown that the modulus of elasticity decreases as compressive stress increases⁽⁴⁴⁾. The following relationship has been derived from the results of tests carried out by the author on brickwork walls under axial compression (Appendix A).

$$E_w = 0.75 \times 10^{-6} - 125 \sigma \quad (4.6.2.3)$$

From eq (4.6.2.3) value of the modulus of elasticity at failure (E_{wu})

is estimated by substituting $\sigma = f_w$, then, the strain at failure

$$\epsilon_c = \frac{f_w}{E_{wu}} \quad . \quad \text{The value of } \epsilon_c \text{ can be also obtained from the experimental stress-strain diagram of the brickwork under compression.}$$

$$\text{Diagonal deformation } \Delta_w = \epsilon_c d_w$$

$$\text{Frame lateral deflection } (\delta_f) = \text{Wall lateral deflection } \delta_w = \frac{\Delta_w}{\cos \theta}$$

For/

For a laterally loaded bare frame : $\delta_f = \frac{Ph^3}{12EI_c} \left[\frac{3I_1 h + 2I_c l}{6I_1 h + I_h l} \right]$

The elastic load carried by the frame at $\delta_f =$

$$P_{fe} = \delta_f \frac{12EI_c}{h^3} \left[\frac{6I_1 h + I_h l}{3I_1 h + 2I_h l} \right] \quad (4.6.2.4)$$

Therefore eq (4.6.2.1) becomes:

$$P_{ult} = \frac{1}{2} f_w t_w \cos\theta + \delta_f \frac{12EI_c}{h^3} \left[\frac{6I_1 h + I_h l}{3I_1 h + 2I_h l} \right] \quad (4.6.2.5)$$

The plastic load carried by the frame under the assumption that the plastic hinges develop at the joints :

$$P_{fp} = \frac{4M_p}{l} \quad (4.6.2.6)$$

Because of the interaction forces and the disposition of the plastic hinges, P_{fp} is much higher than values obtained from eq (4.6.2.6). Since no plastic hinges occurred in the frames tested, therefore only P_{fe} is estimated in eq. (4.6.2.1), and compared with experimental results.

4.B ANALYSIS OF INFILLED FRAMES BY THE FINITE ELEMENTS METHOD

4.7 THE FINITE ELEMENTS METHOD

The finite element method has proved itself as a powerful method for analysing complex structures such as non-frame-type structures. The method is extremely valuable in being capable of analysing plates or rigid bodies which may be not only irregular in shape but in which the physical properties may vary from one part to another.

The structure is idealized as an assemblage of a number of geometrically shaped discrete elements whose individual stiffness properties can be estimated. These elements are assumed to be connected at the nodal points (corners) only. The relation between the internal displacements of each element and its nodal displacement is specified. This is done by using a displacement function to specify the pattern in which the element is to deform. The displacement function should satisfy internal compatibility within the element, and should also maintain compatibility of displacements between adjacent elements at the nodes and along the boundaries. On the basis of this displacement function, the element stiffness matrix, which relates the element nodal forces to the element nodal displacements, as well as the element stress and the element strain matrices for each element are derived. The element stiffness matrices are used to build up the overall stiffness matrix for the whole structure, then nodal displacements and support reactions are determined. Having found the nodal displacements, the element stress and the element strain matrices can be used to determine the stresses and strains for each element. The finite element method has been described in detail in reference (65).

The accuracy of the method depends on the shape and size of the elements/

elements, and how close the behaviour of the actual structure is represented by the idealized structure. This in turn depends on the behaviour of the elements, which form the idealized structure. In order to maintain accuracy, a large number of elements is required resulting in an increase in the number of unknowns and a corresponding increase in computer time.

Recently the finite element method has been applied to masonry shear wall structures⁽²²⁾. A masonry wall can be represented by a two-dimensional system, stresses parallel to the height and length of the wall have constant values along any line perpendicular to the face.

The main difficulty facing any detailed analysis of a masonry system is its non-homogeneity resulting from the difference in properties of the brick and mortar. The finite element method provides for the analysis of non-homogenous materials such as brickwork by dividing the bricks and mortar into separate elements. However, this requires an enormous number of elements which could be beyond the capacity of the existing computers, and makes its application unpractical.

Detailed theoretical stress analysis of brickwalls using finite element method by Smith and Rahman^(53,54) have shown that any analysis based on the assumption of a homogeneous material may lead to a substantial underestimation of the maximum stresses.

Karamanski⁽²¹⁾ was the first to apply the finite element method to the analysis of infilled frames. He assumed continuous bond between frame and panel, the frame was assumed to be flexible carrying only direct forces. Later Mallick and Severn⁽²⁹⁾ included the separation in/
in/

in the analysis whilst the axial deformation in the frame was neglected. Due to the nature of their analysis; the procedure needed to be repeated several times which required a great amount of computing time even for a small number of elements.

The following sections describe the application of finite element method to infilled frames. Separation and slip between the frame and panel as well as shear, axial and bending deformation of the frame have been included. The procedure has been simplified in order that results could be obtained directly. The STRUDL⁽⁵⁵⁾ Programme for finite element method at E.R.C.C.* in a 370/155 machine has been used. The C.P.U. time for 64 elements and 38 members was approximately 60 seconds.

4.8 ASSUMPTIONS AND ANALYSIS PROCEDURE

The infill material is assumed to be homogenous. There is no bond between the frame and panel, therefore, slip and separation between the frame and infill is allowed. The structure is idealized as shown in Fig. (4.12). The panel is divided into rectangular elements, and the frame into members. The version 2 of ICES/360 STRUDL II⁽⁵⁵⁾ has been used which permits the combination of member and element types regardless of the number and type of their nodal unknowns. The panel is analysed as a two dimensional linear plane-stress problem. The rectangular 'PSR' type element with four nodal points at the corners has been used. It has two unknowns U_1, U_2 per nodal. The element stiffness matrix is computed based on the displacement function:

$$U_1/$$

* E.R.C.C. : Edinburgh Regional Computing Centre.

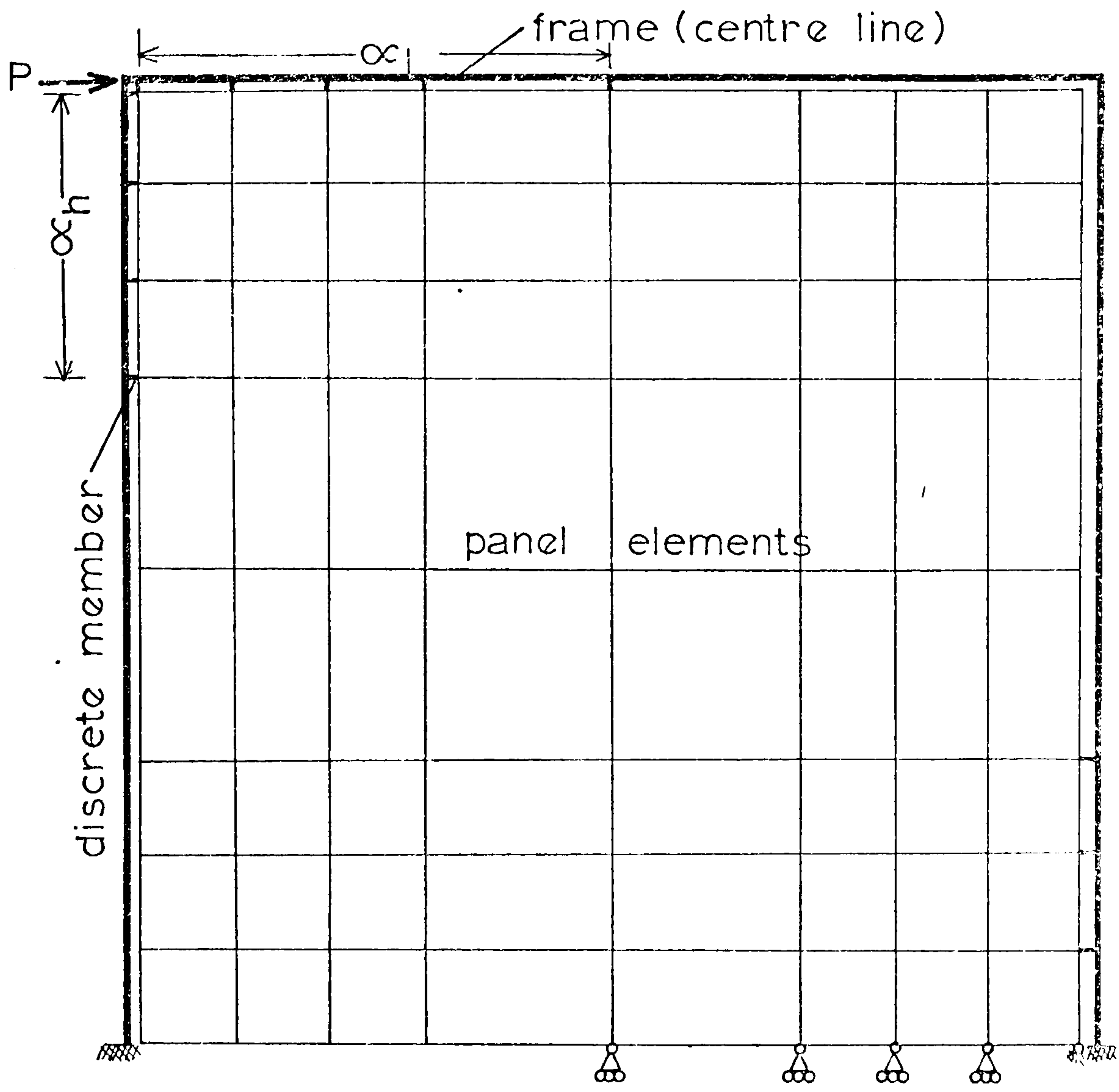

Fig.(4.12) Infilled frame idealization

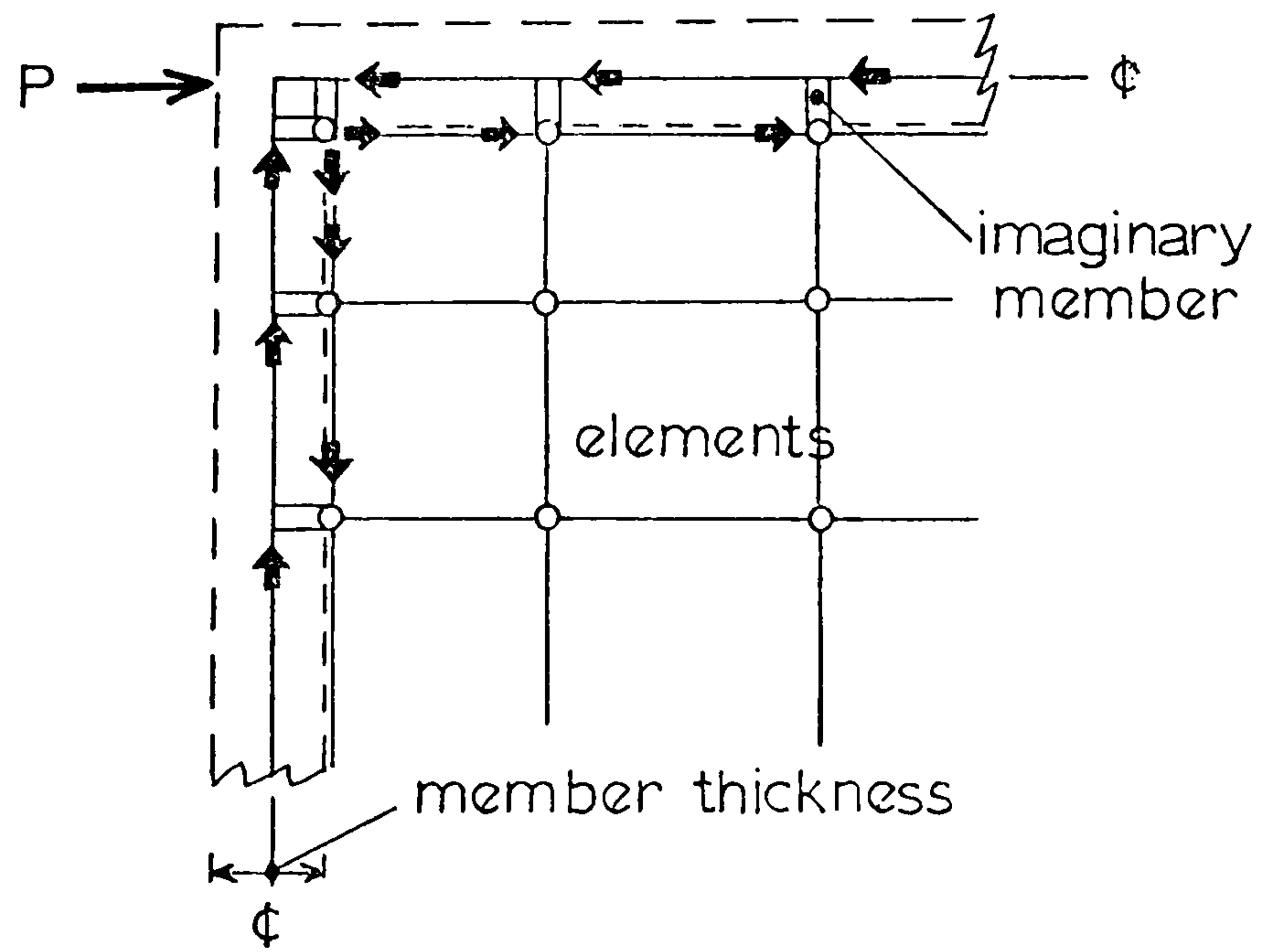

Fig.(4.13) Friction forces at the interface

$$U_1 = \alpha_1 + \alpha_2 x + \alpha_3 y + \alpha_4 xy$$

$$U_2 = \alpha_5 + \alpha_6 x + \alpha_7 y + \alpha_8 xy$$

The function produces a quadratic displacement field over the element, but a linear displacement variation along the edges. The loading should be applied at the nodal points. The frame is analysed as a plane frame type.

In order to take the separation between the frame and the panel into account, the frame is assumed to be in contact with the panel along the lengths α_1 , α_h (Sec. 4.3) only, therefore other joints at the boundary which are not connected would have separate displacements in both vertical and horizontal directions. Also in order to allow slip to occur between the frame and panel at the contact points, it is required to permit these points to have separate vertical displacements along the columns, and separate horizontal displacements along the beam. As a free joint it is not possible to release the joint in a direction, therefore, it was assumed that along the contact interfaces the frame is connected to the panel through finite small members with a length equal to the half of the frame member thickness; then as a member its end could be released in any direction required. Moreover, in this manner the centre lines of the frame members and the actual length and height of the panel can be preserved. The axial forces in these discrete members represent the normal forces transmitted from the frame to the panel through the connected points.

Since no bond between the frame and panel is assumed, there is no shear force transmission along the interface. Shear forces due to the friction between the two components can be introduced in the analysis in/

in two steps: first analyse the structure as described above, second, introduce friction forces at the contact points equal to the coefficient of friction (between steel and brickwork) multiplied by the normal forces transmitted to the panel, and re-analyse the structure.

The friction forces should be applied to both the panel and the frame in opposite directions as shown in Fig. (4.13). When friction forces were introduced in the analysis, the stiffness of the structure increased about 10 - 25% for flexible and stiff frames respectively. Only results including friction forces are compared with the experimental results in Part (4C).

The frame is fixed at the base, and all the members are rigidly connected. The panel is fixed along the length α_1 at the base and released in the horizontal direction except at the compression corner point. The lateral load is applied at the frame joint. The results of the analysis include: joints displacement, member forces and deformation, elements strain, stresses, principle strains and principle stresses at the baricentre of the element.

The structures were also analysed neglecting all interaction forces (normal and friction), the frame and panel are connected only at the two loaded corners. Results are discussed in Section (4.11).

4.9 MEMBER FORCES

Bending moments, shear and axial forces in the members are obtained from the analysis described in section (4.8). The distribution and amount of loads transmitted from the frame to the panel are also directly obtained from the analysis, which are the axial forces in the connecting members. No bending moment will be introduced in these members, since their ends have been released in the direction perpendicular/

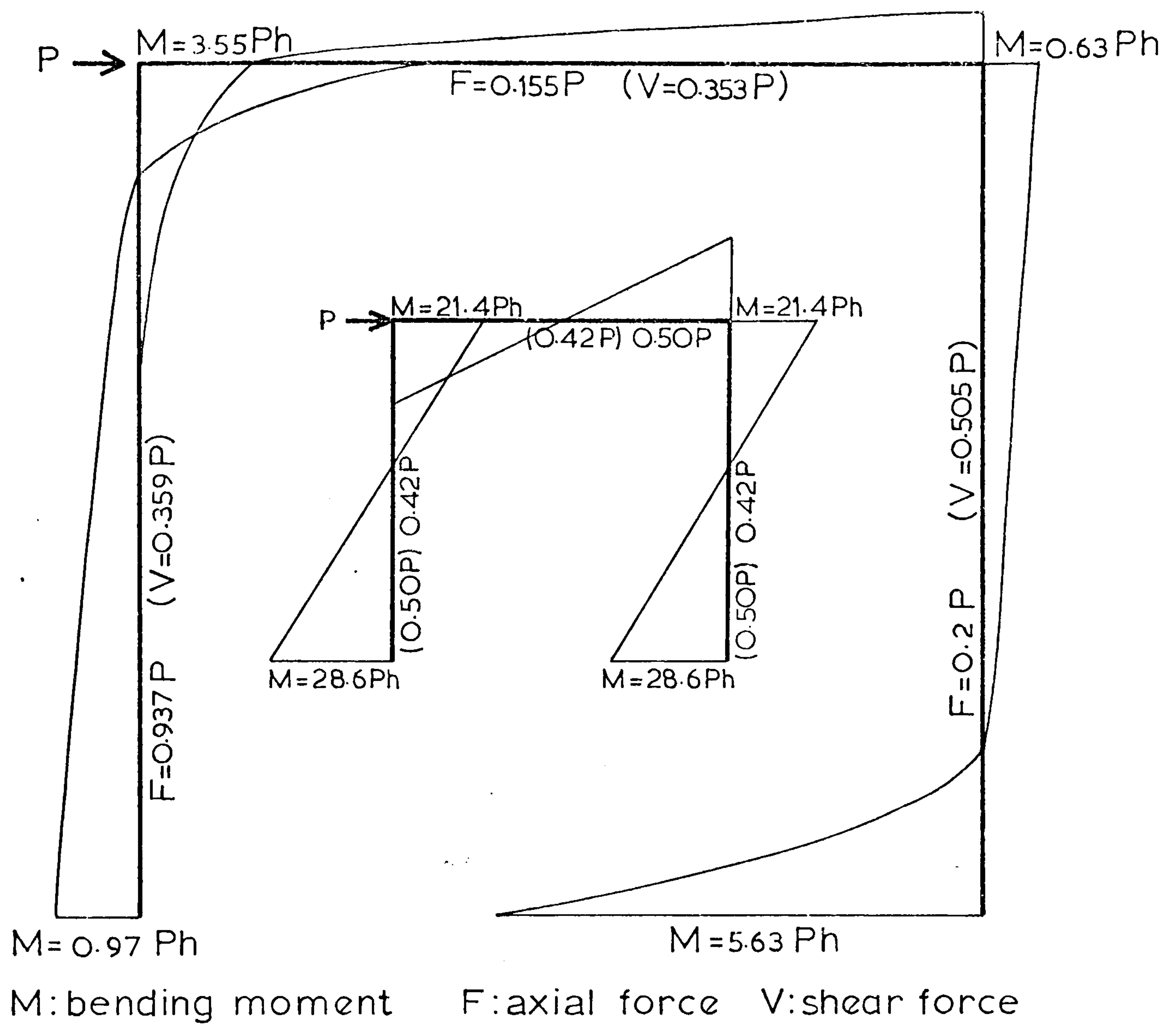

Fig.(4.14) Typical bare & infilled frame forces (WS2)

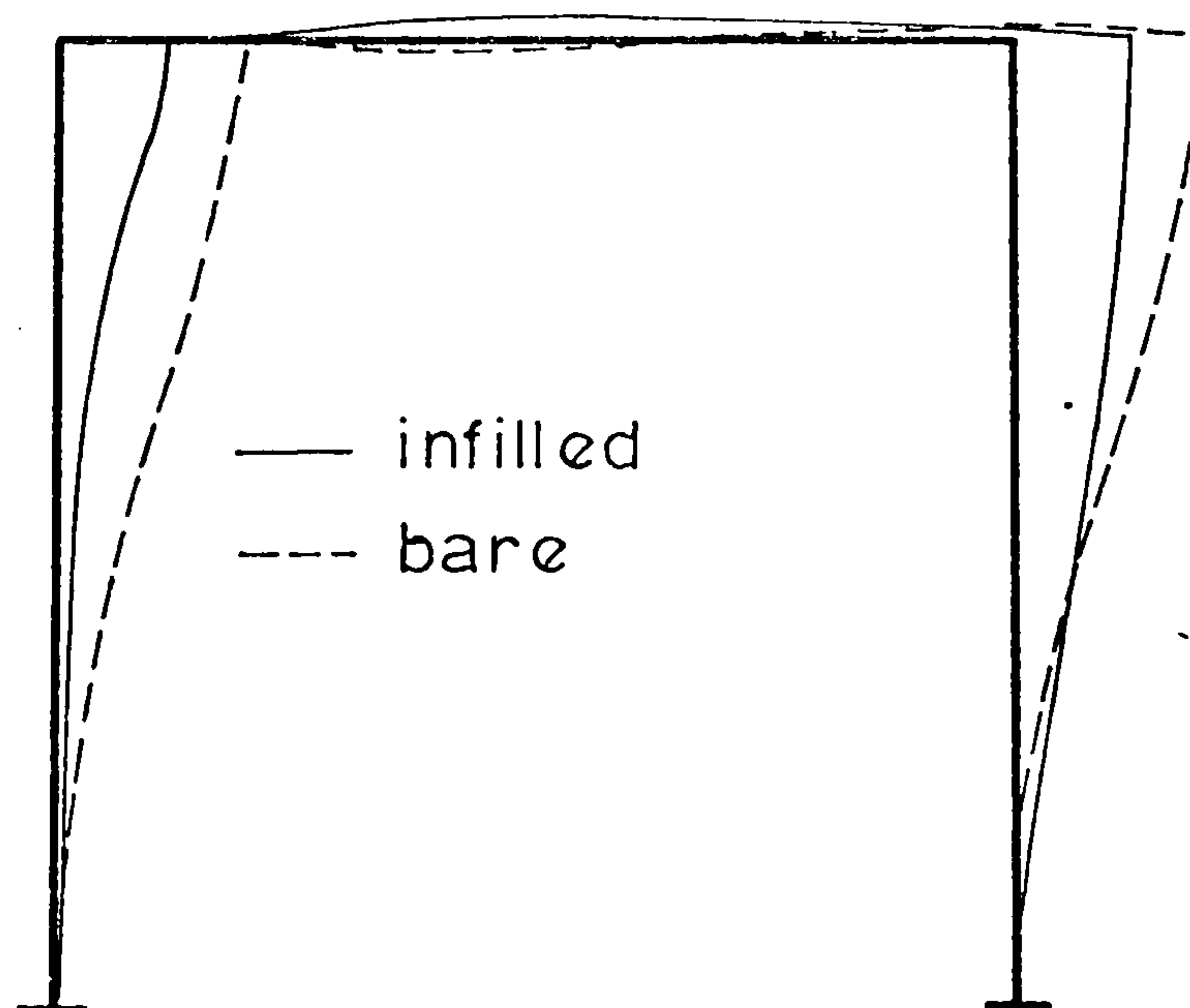

Fig.(4.15) Deflection shape of bare & infilled frame

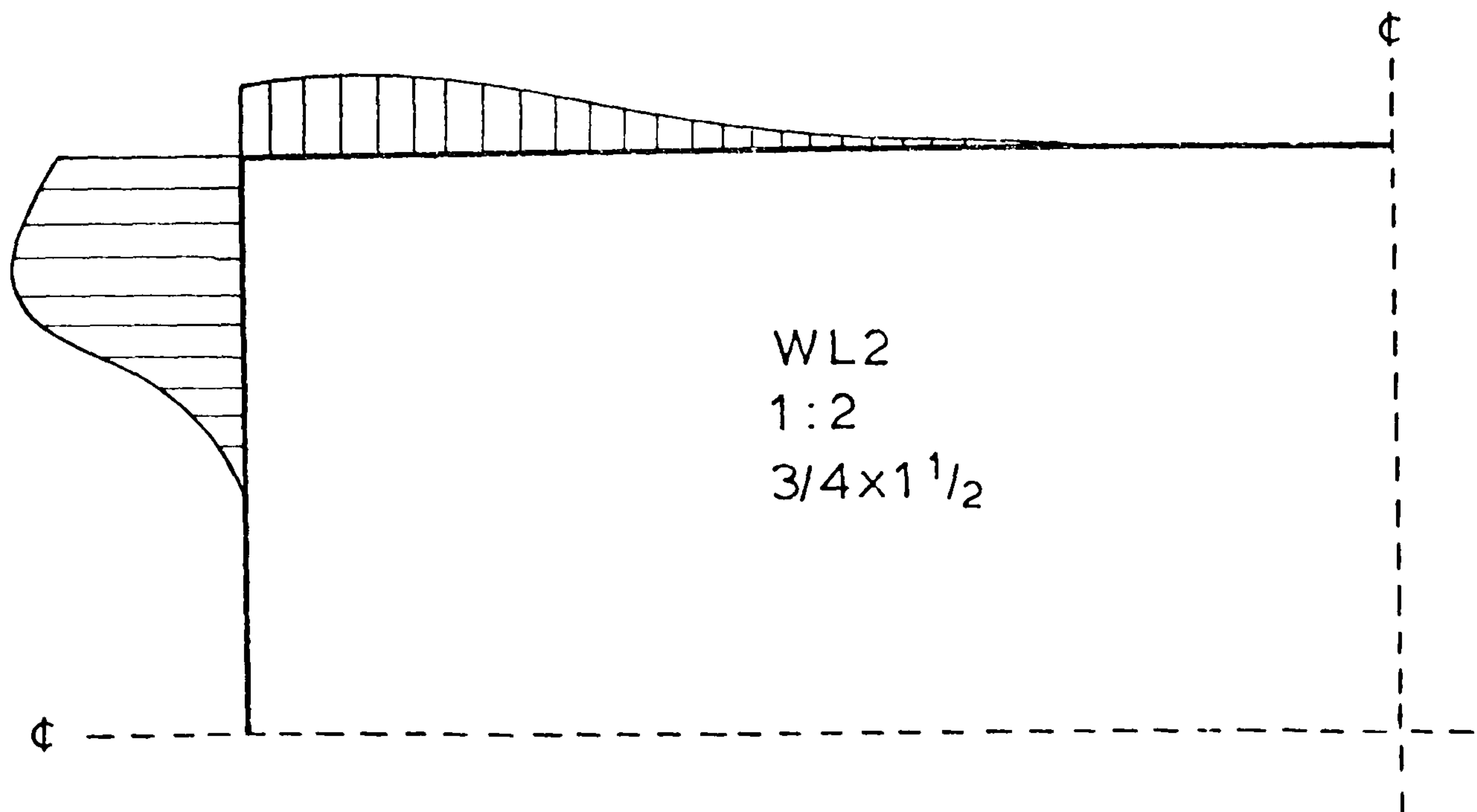
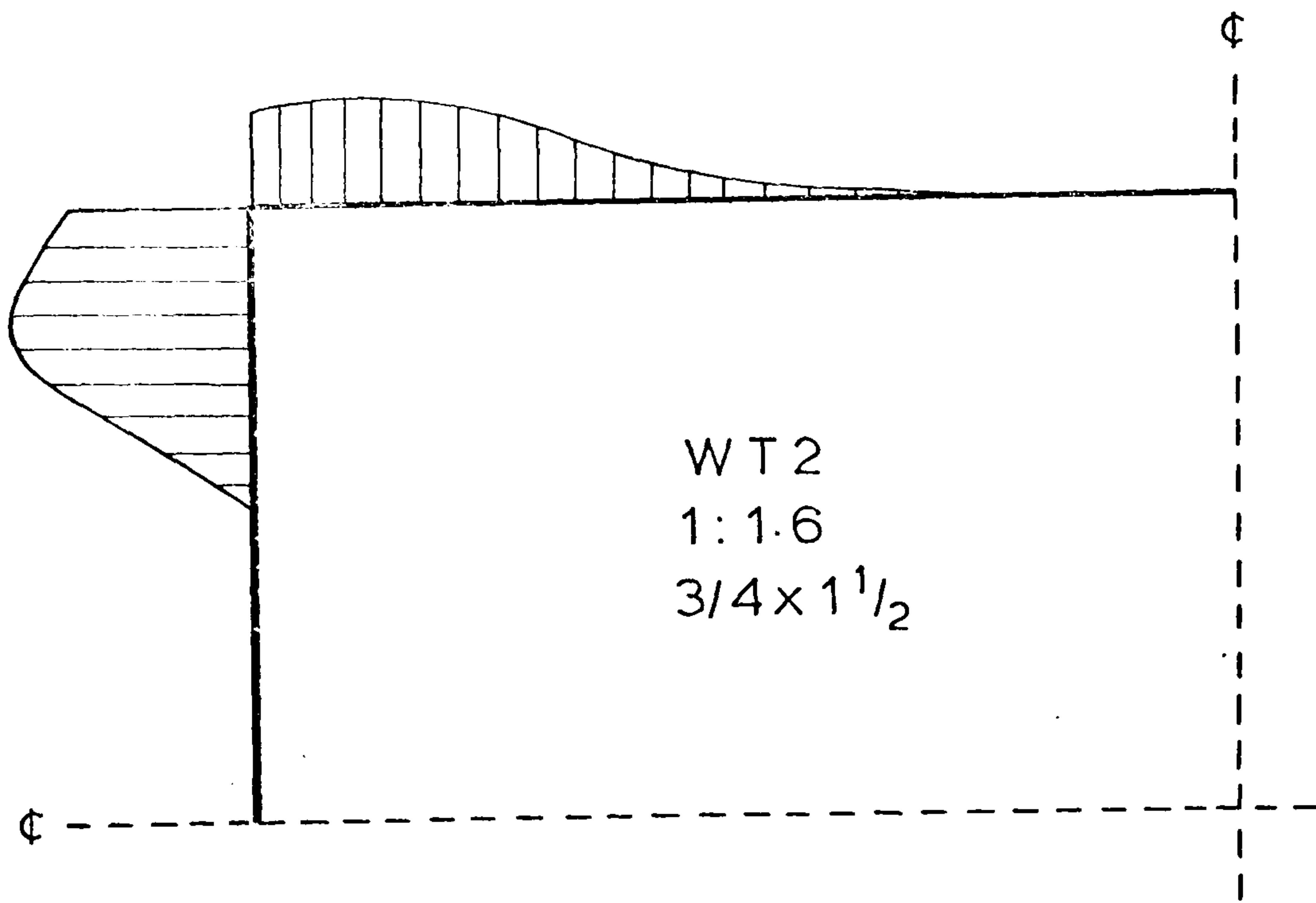
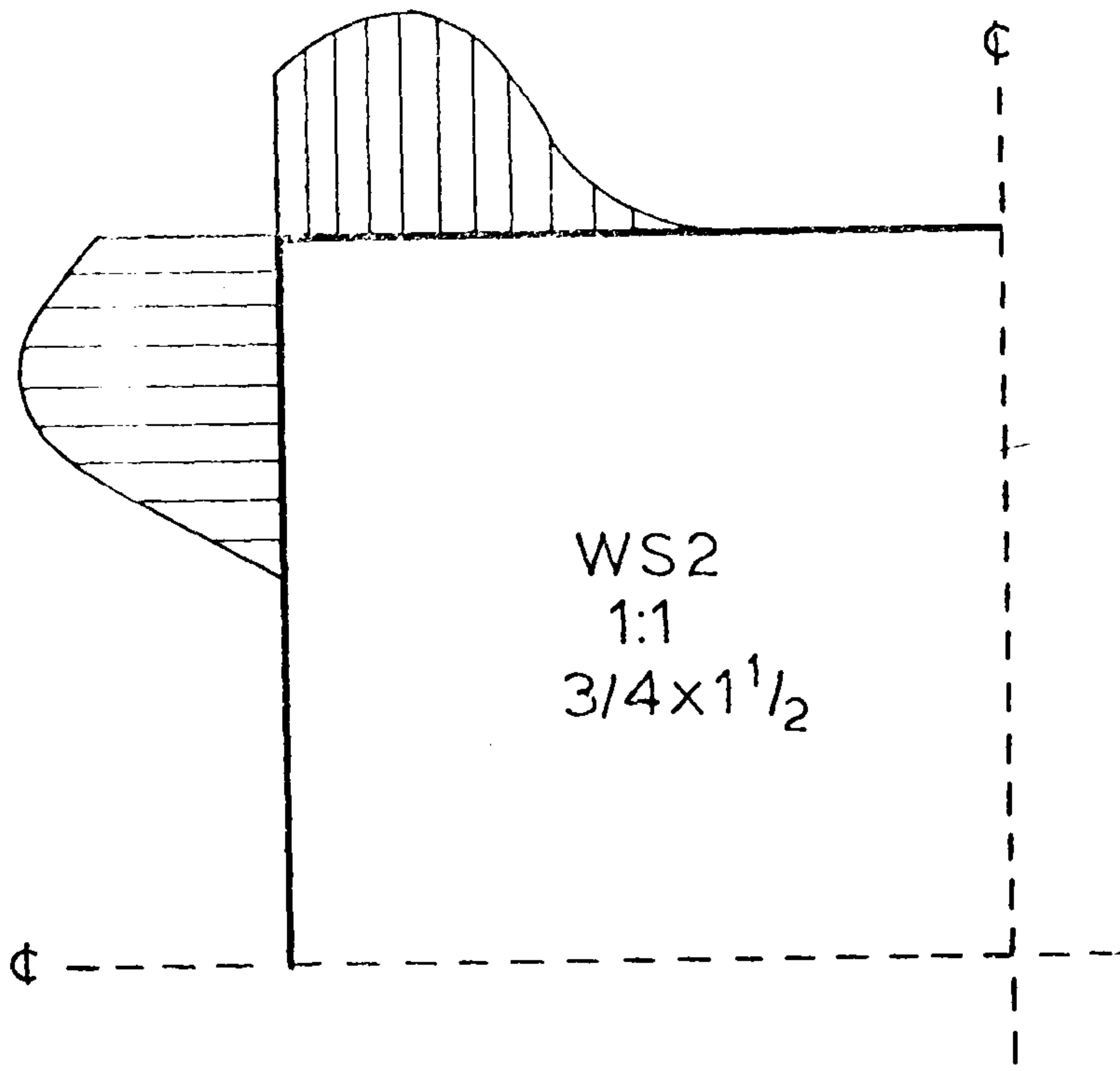

Fig.(4.16) Stress distribution at interfaces

perpendicular to their axis.

In order to obtain more accurate force distribution at the interfaces, a great number of connecting members will be required, in turn greater number of panel elements is needed since the frame can be connected to the panel only at the nodal points. Figure (4.14) shows a typical bending moment diagram for an infilled frame, shear and axial forces, and forces in the bare frame are also shown. Figure (4.15) shows the deflection shape of both frames. Interaction stress distribution for panels WS2, WT2 and WL2 are shown in Fig.(4.16).

Bending moments are remarkably reduced due to the presence of the infill. The interaction reactions on the frame members have modified the deformation shape and bending moment diagram of the frame. The points of zero bending moment have been shifted from the centre of the members towards the joints. However, the axial force in the windward column is increased. Shear and axial forces in the beam and leeward column are reduced considerably. In flexible frames the bending moments are reduced and the axial forces become dominant. Some of the results are shown and discussed in Section (4.11).

4.10 STRESS DISTRIBUTION INSIDE THE PANEL

The maximum principle tensile stress occurs at the centre of the panel, and the maximum principle compressive stress at the two compression corners. Normal and shear stress distribution are non-linear and highly concentrated at the loaded corners.

Normal and tangential stress distribution at different sections along the length and height of the panel are shown in Fig. (4.17) to Fig. (4.21), for square panels and rectangular panels with different height/

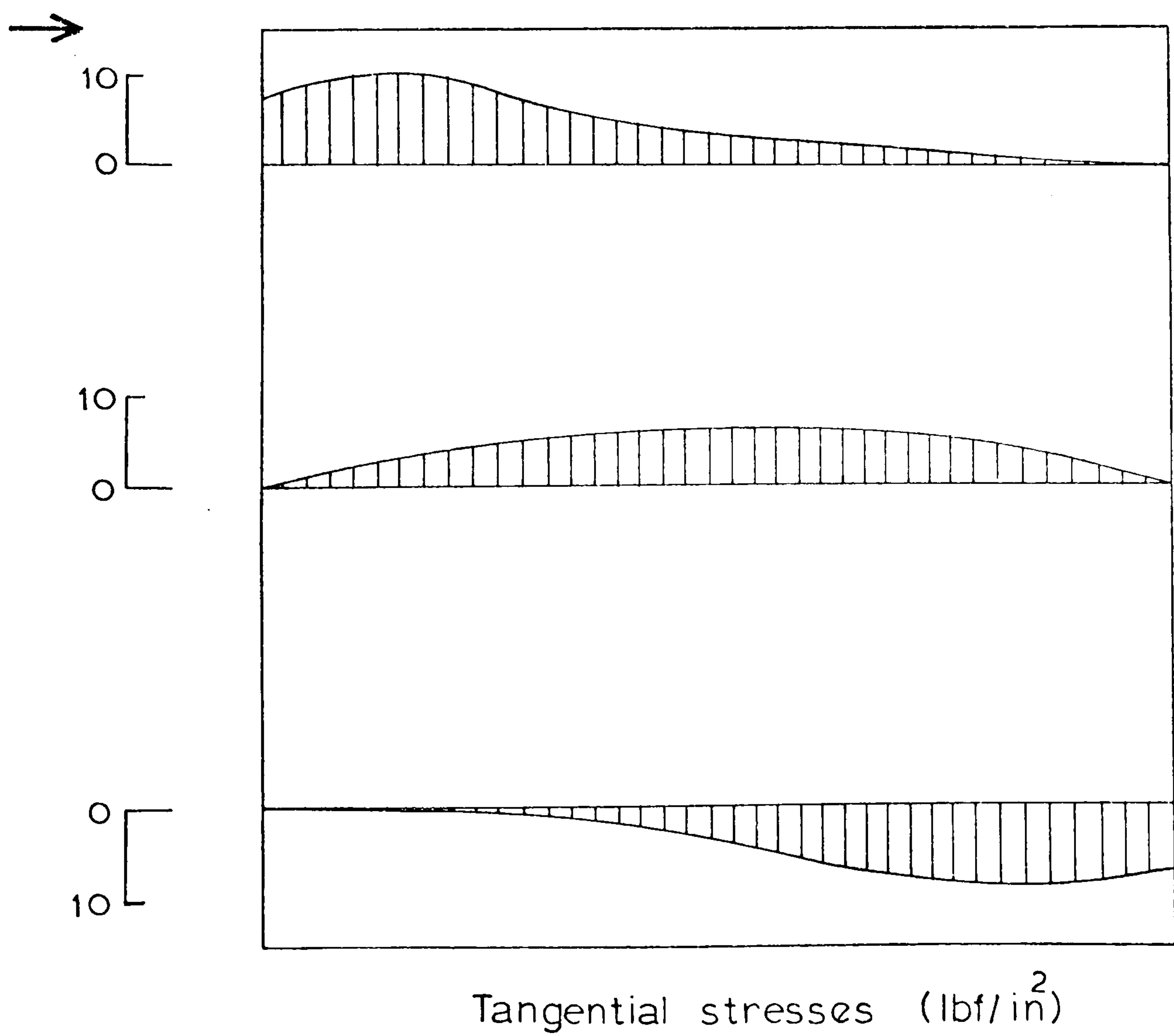
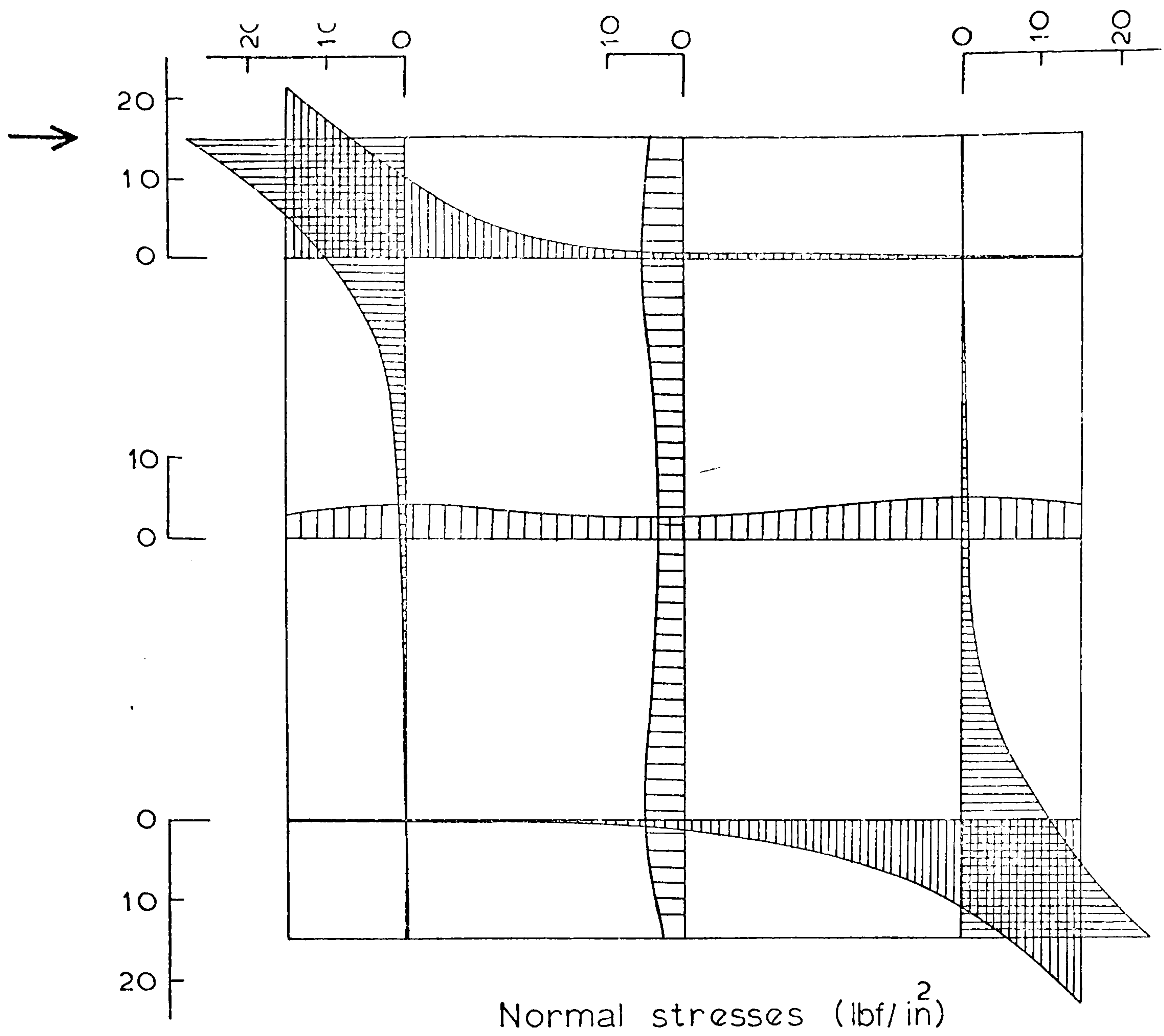

Fig.(4.17) Stress distribution, square (0.75 in)

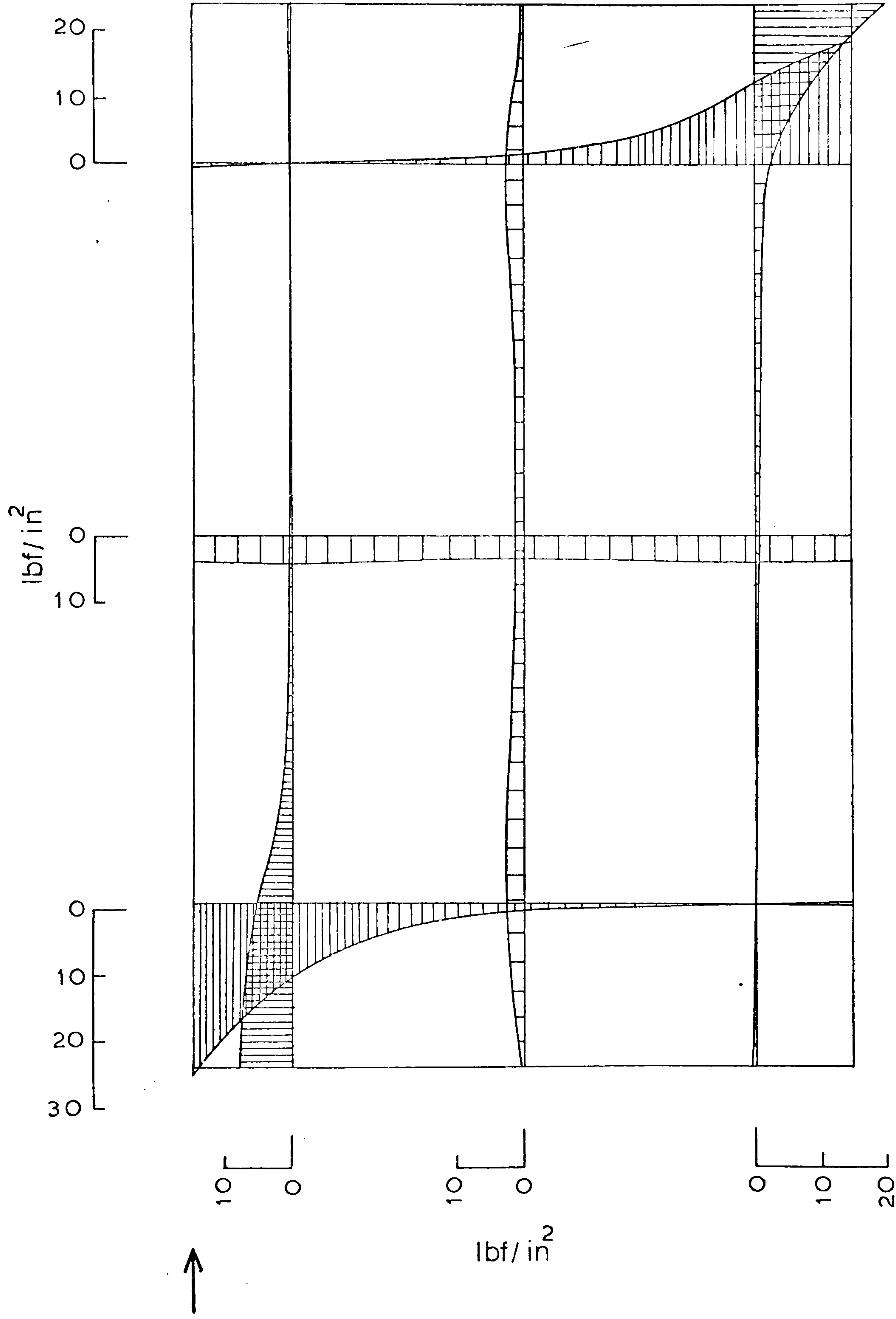

Fig.(4.18) Normal stress distribution , rect.1:16 (0.75in)

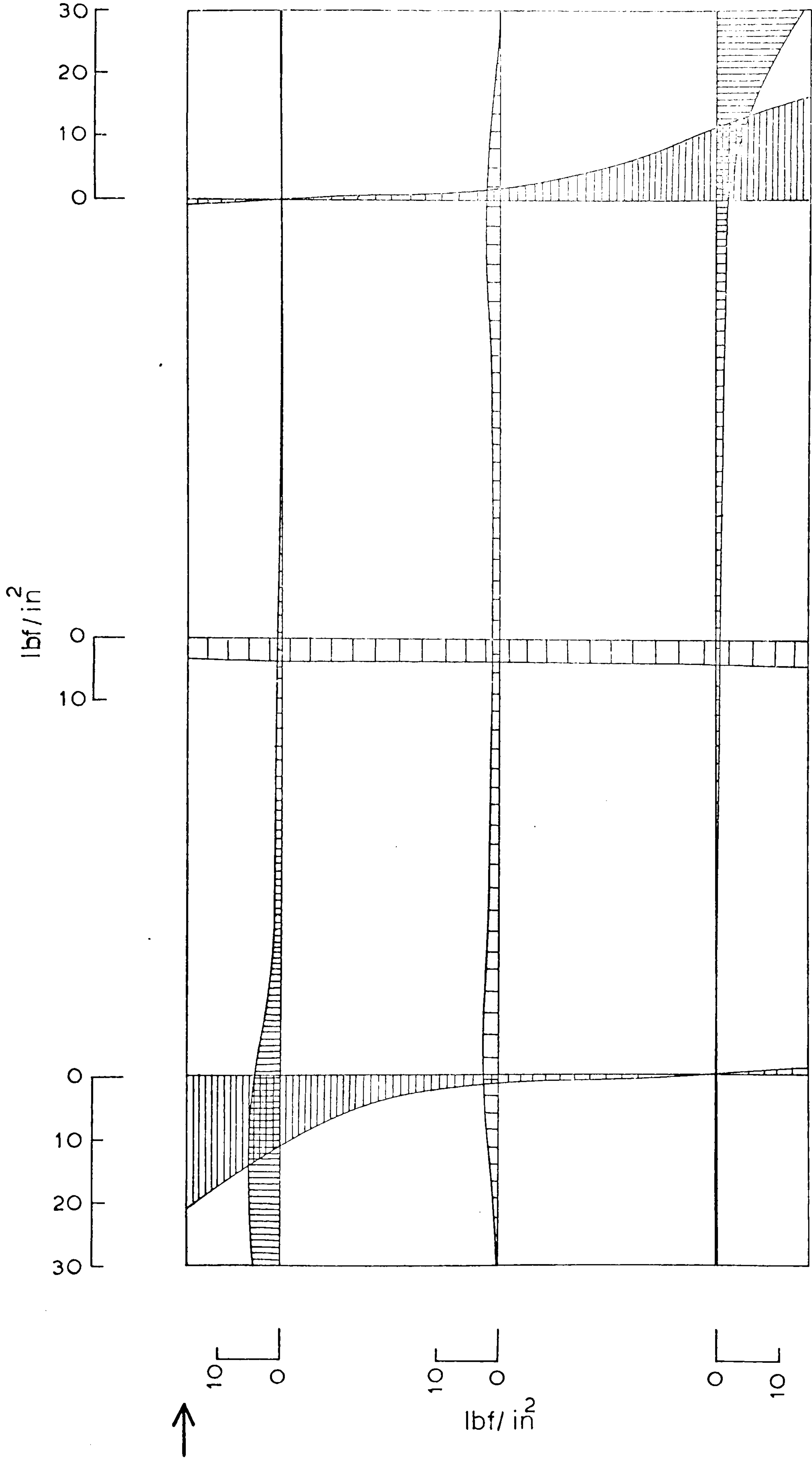

Fig.(4.19) Normal stress distribution, rect.1:2 (0.75 in)

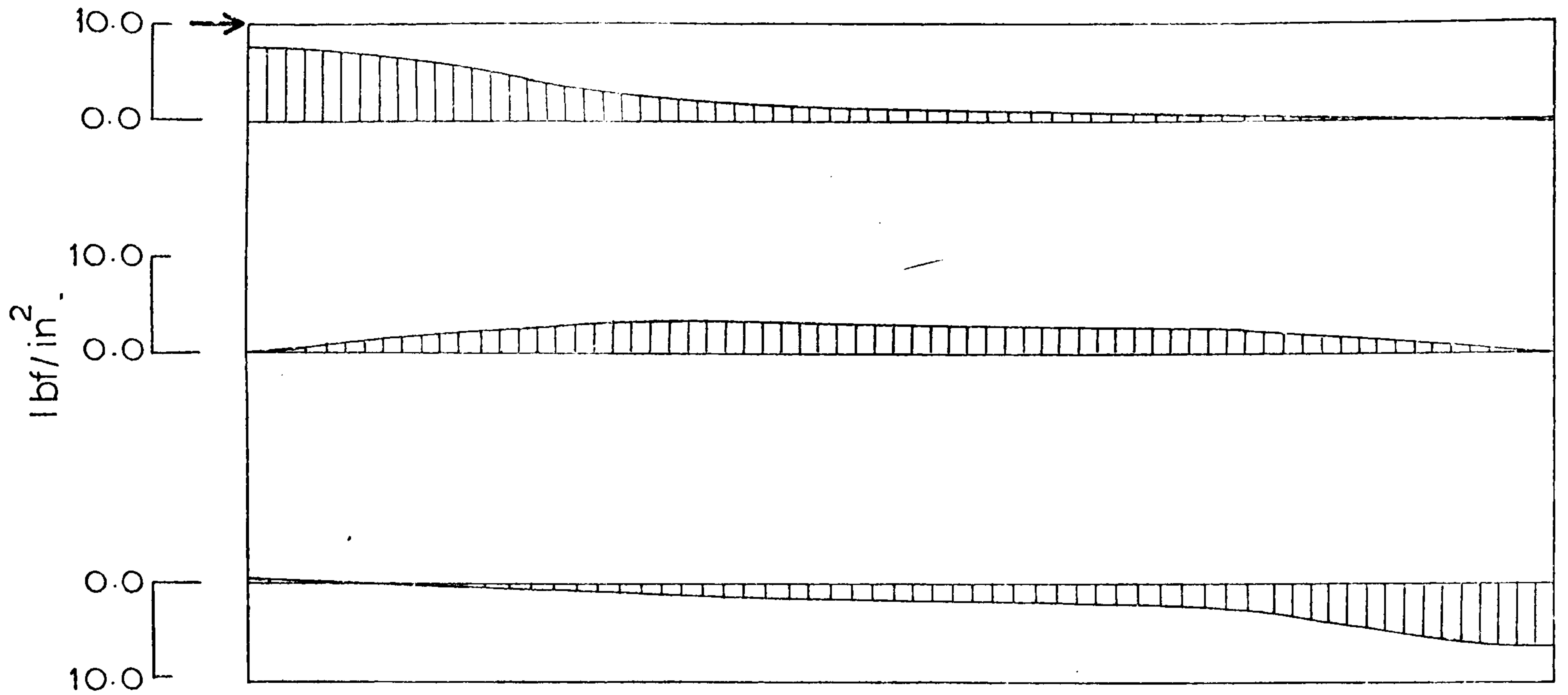

Fig.(4.20) Tangential stress distribution
rect.1:2 (0.75 in)

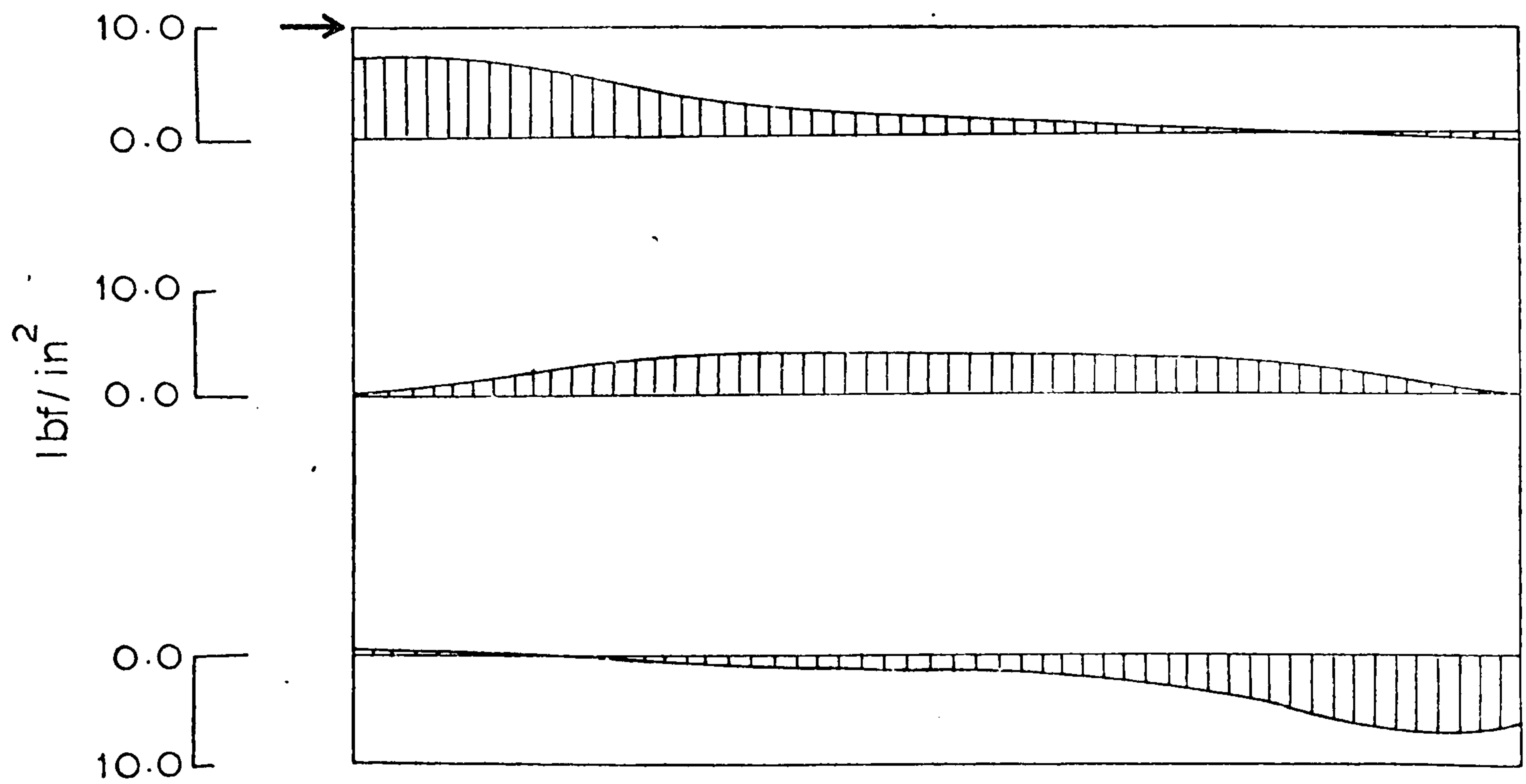

Fig.(4.21) Tangential stress distribution
rect.1:1.6 (0.75 in)

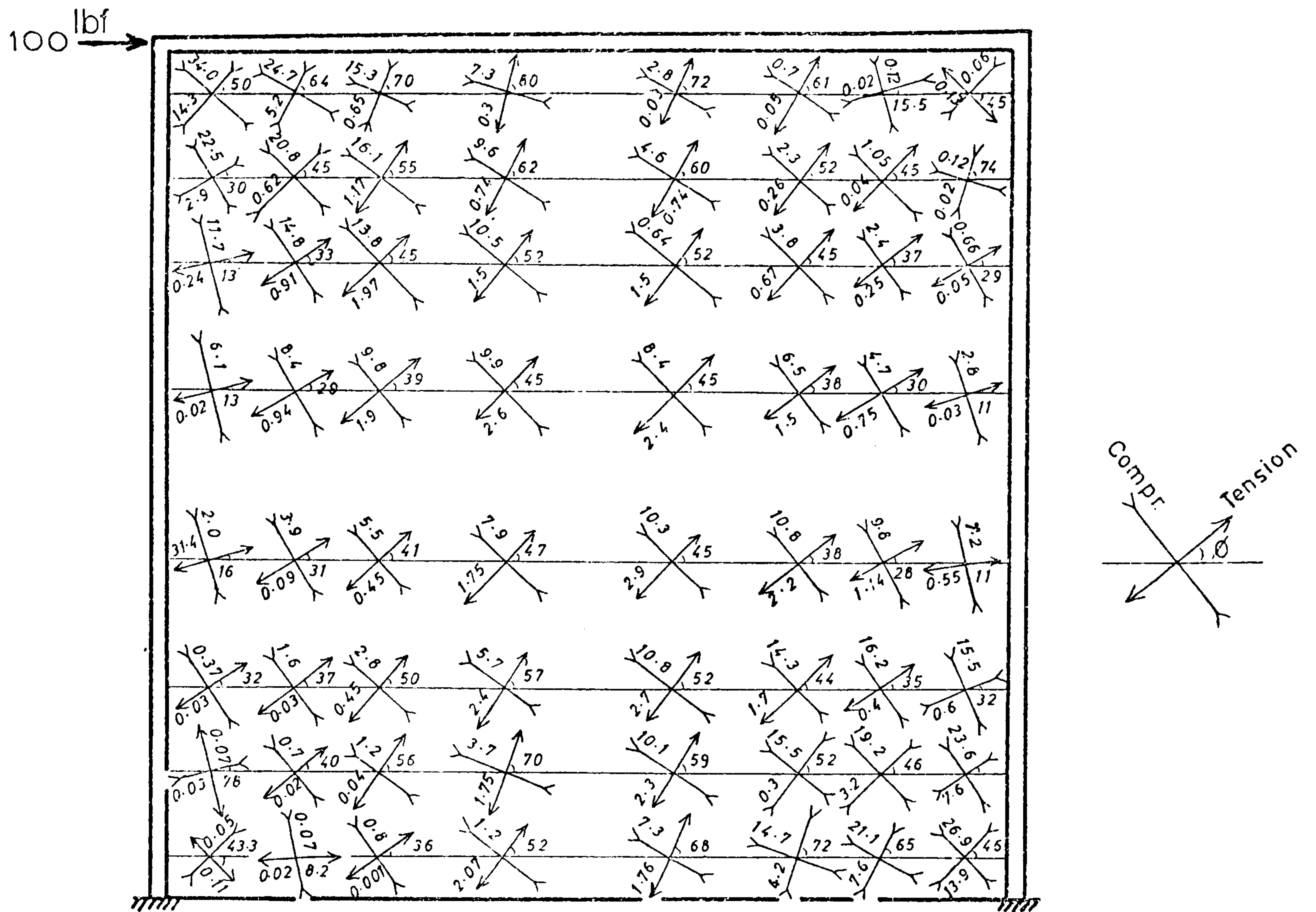

Fig. (4.22) Principle stresses (WS2)

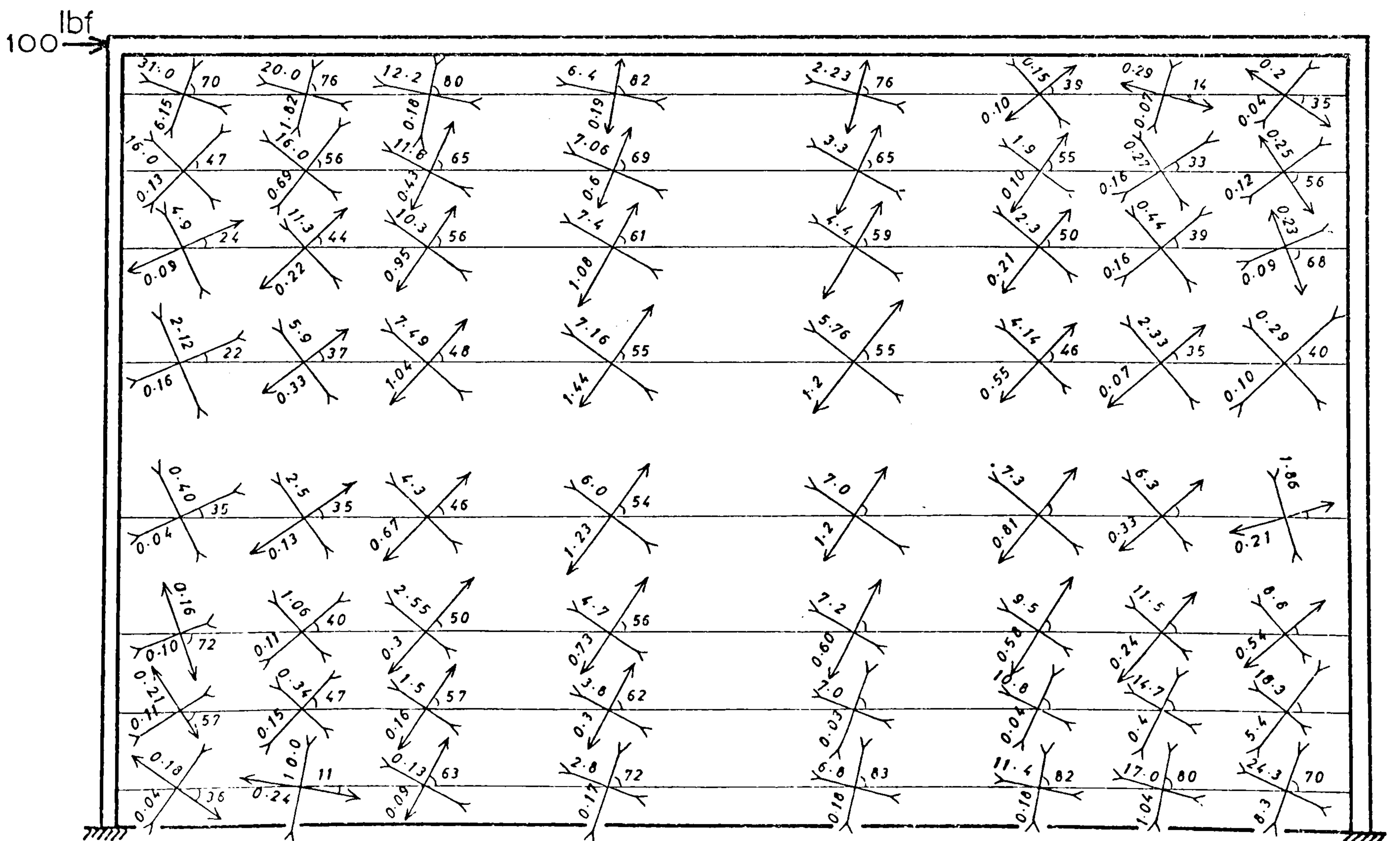

Fig. (4.23) Principle stresses (WT2)

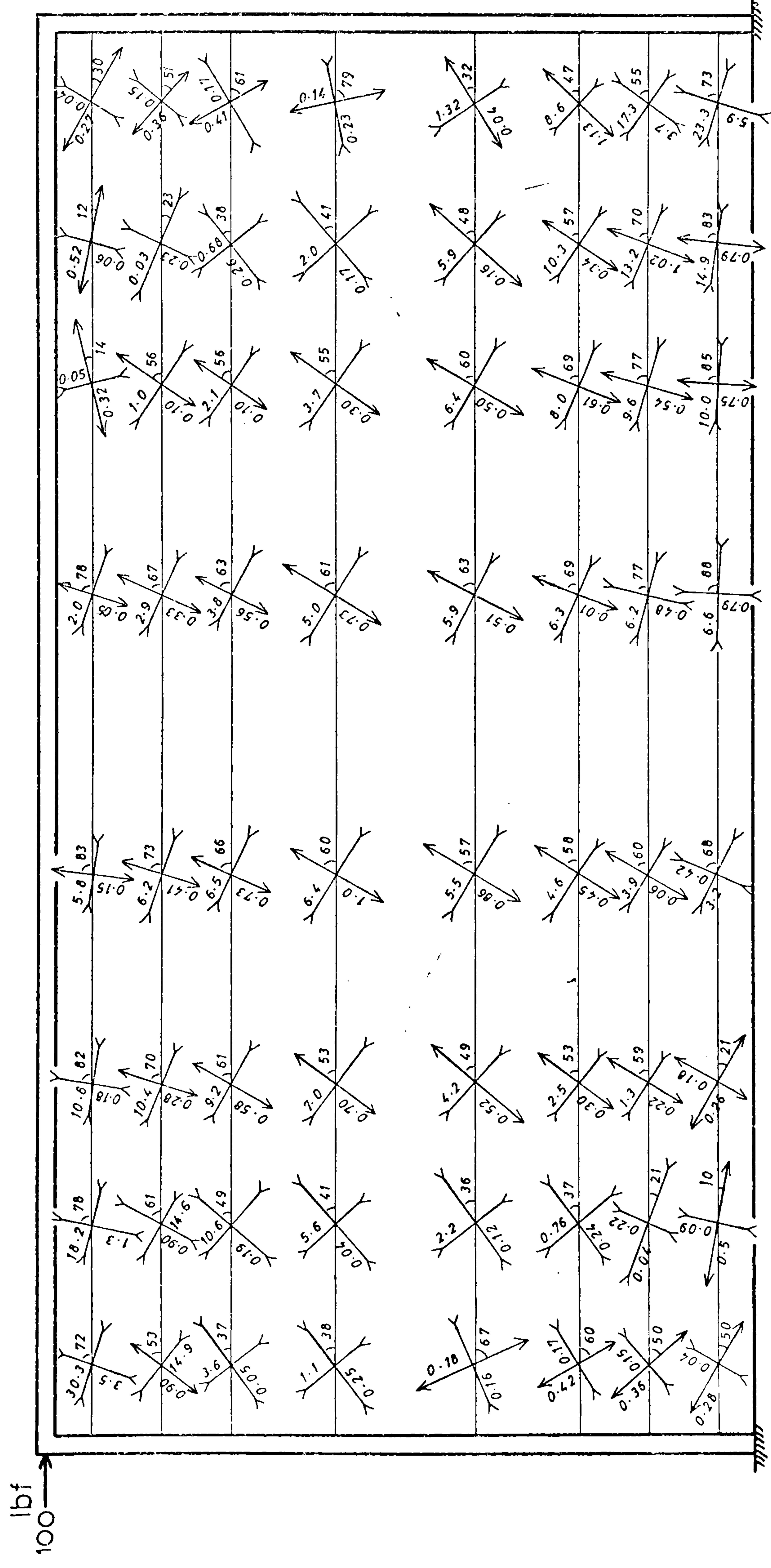

Fig.(4.24) Principle stresses (WL2)

height : length proportion, in all cases the frame members thickness is 0.75 inch (WS2, WT2 and WL2). The stresses shown are due to a 100.0 lbf applied laterally at the top left-hand corner of the infilled frame. The principle tensile stresses and the principle compressive stresses and their direction are shown in Figs. (4.22) to (4.24).

For panels with constant height : length ratio, variation in frame stiffness affects not only the length of contact, but force distribution at the interface between the frame and panel also, and in turn affects the stress distribution inside the panel. With stiff frames the principle stresses inside the panel are reduced resulting in greater stiffness and carrying capacity by the panel.

As $l : h$ ratio increased, the normal and tangential stresses along the centre line of the panel are decreased, more appreciably the normal stresses. This in turn decreases the shearing resistance induced by normal stresses ($f\sigma_n$), thus reducing the gross shear strength of the panel. This supports the discussion given in section (3.9). In rectangular panels, tensile stresses are induced at the unloaded corners, which may cause cracks at these corners.

Stress distributions for panels with different frame stiffness are similar to those shown in Figs. (4.22, 4.23 and 4.24) but with different values.

4.C RESULTS AND CONCLUSIONS

All results are shown in tabular or graphical forms in terms of dimensionless parameters. The mean values of experimental results are taken from Chapter 3, and shown with their appropriate curves. Results are compared and discussed. Results are also compared with other's work. Suggested design curves are presented, and finally conclusions are given.

4.11 COMPARISON OF RESULTS

4.11.1 Cracking strength

All results are shown in Figs. (4.25) to (4.27). The curves are the theoretical values estimated from equation (4.6.1.4)(cracking strength of the brickwork panel alone as a composite panel), and eq. (4.6.1.6)(total strength of brickwork infilled frame). Mean values of the experimental results are also shown. Results are shown in terms of the dimensionless parameters $\frac{P_{cr}}{u l t}$ and $\lambda_1 l$ [shear bond: $u = 50$ psi. Appendix (A). Coefficient of friction: $f = 0.74^{(45)}$].

The experimental results are 1 - 8% above, or below the theoretical curves, except for the rectangular infilled frames with $\lambda_1 l = 7.33$ (frame thickness = 0.75 inch), where the experimental value is 16% higher than the predicted value, and which is even higher than the test value for the panel with $\lambda_1 l = 5.96$ (stiffer frames).

The agreement between the experimental and theoretical values is very good regarding the simplicity of the prediction and the statistical nature of brickwork in such a highly composite system.

The cracking strength of brickwork infilled panel depends on the relative stiffness of the frame and the panel, and mainly on the shear/

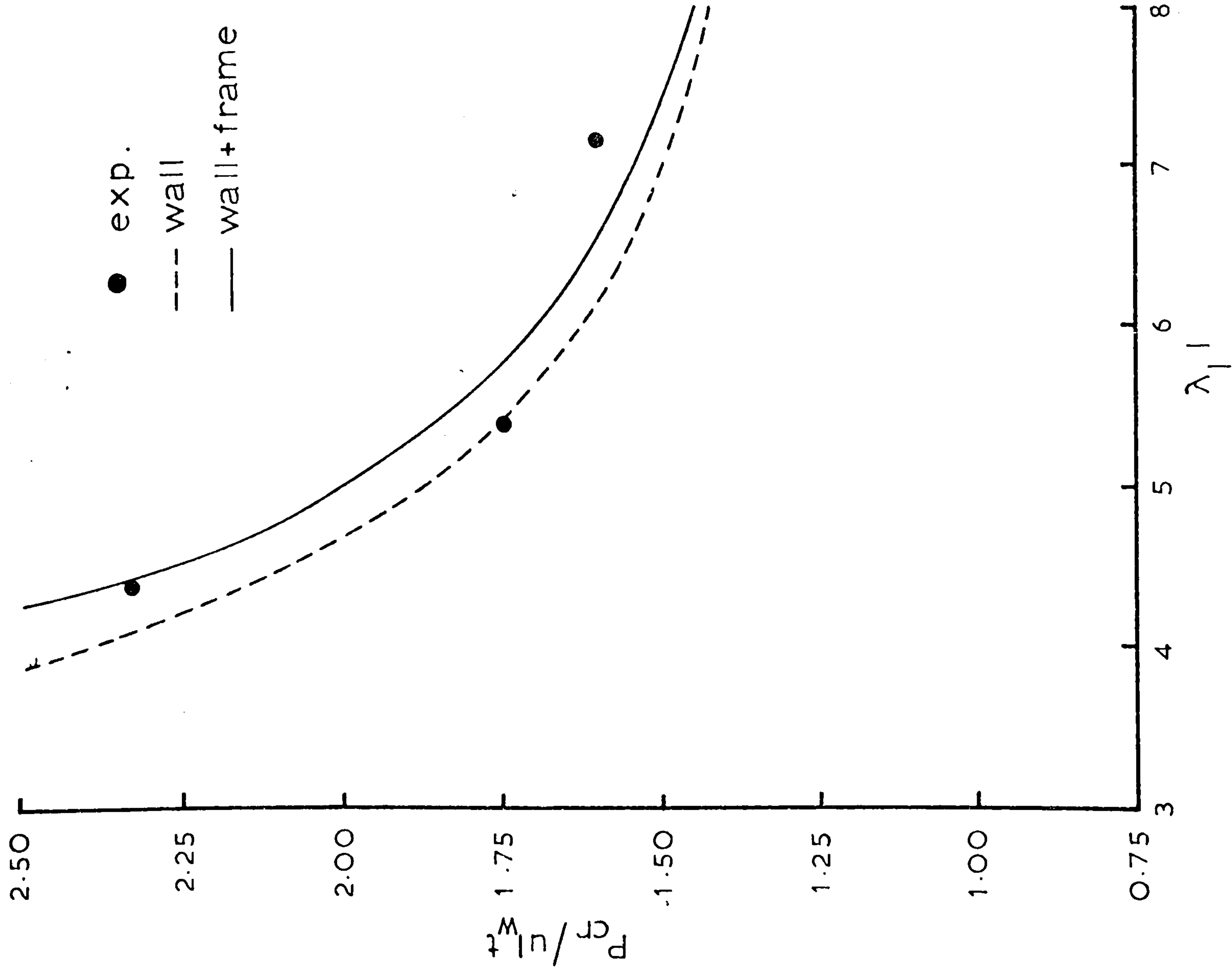

Fig. (4.25) Crack strength as function of λ_1 (sq.)

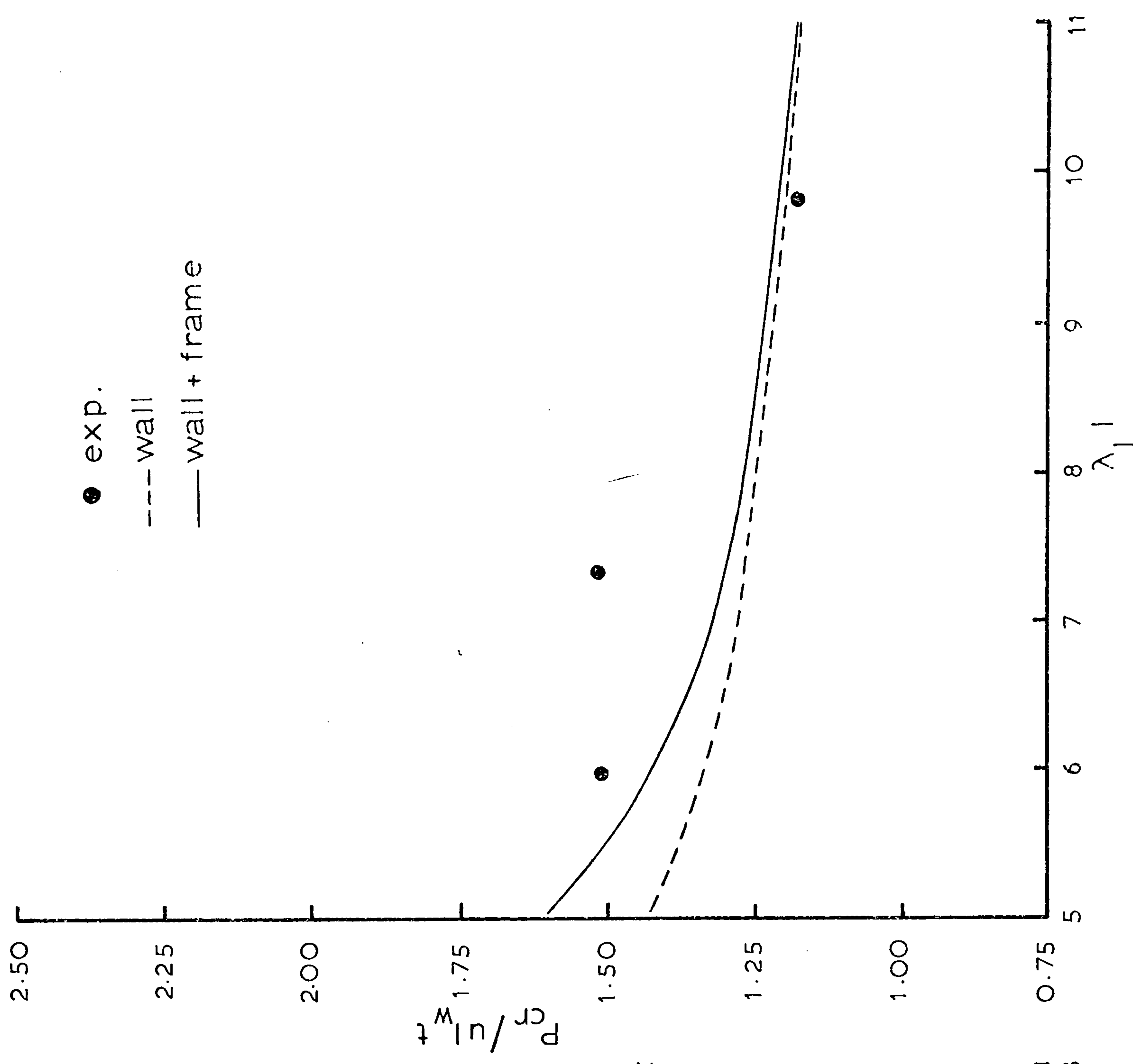

Fig. (4.26) Crack strength as function of λ_1 (rect. 1:1.6)

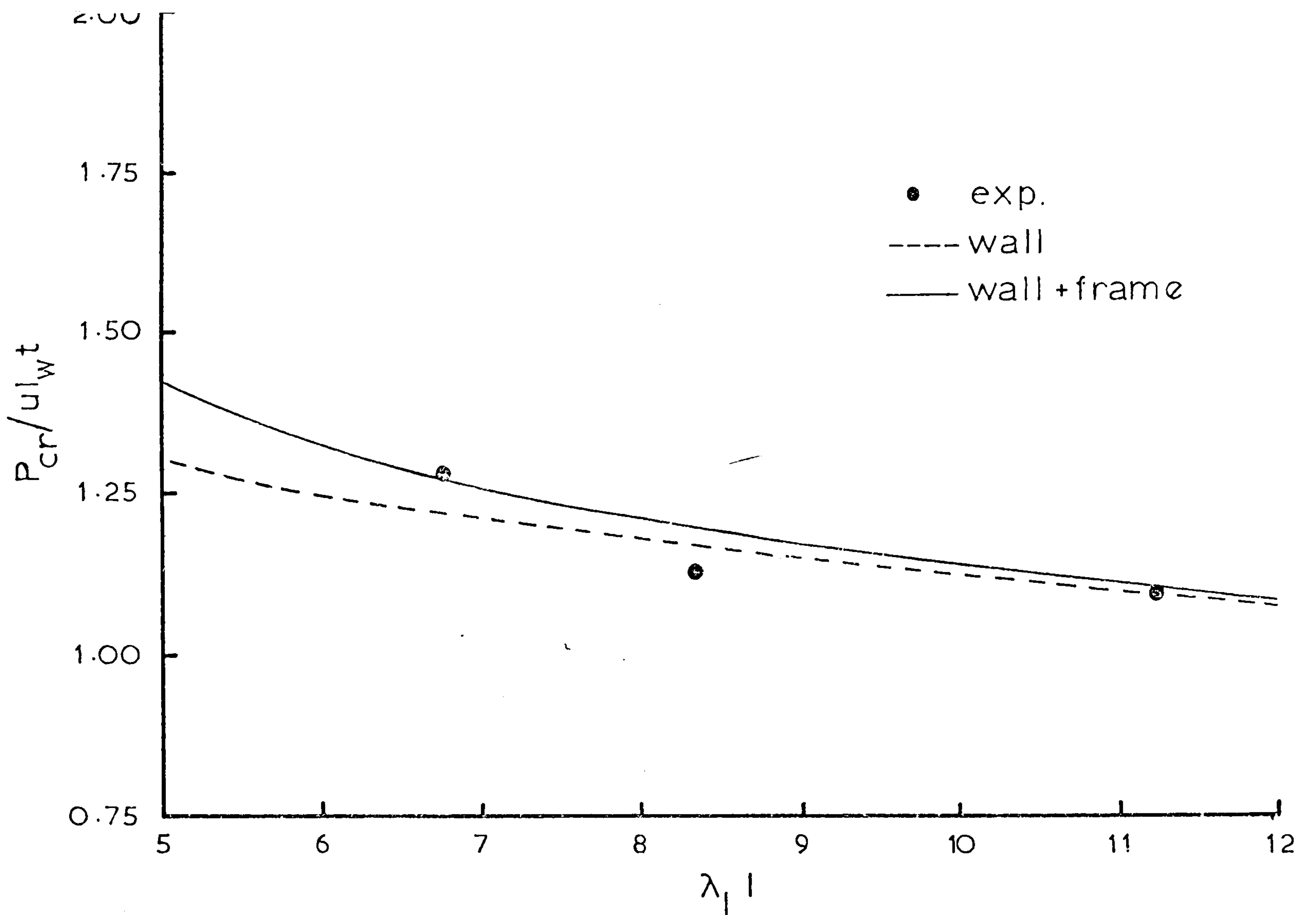

Fig.(4.27) Crack strength as function of $\lambda_1 l$ (rect. 1:2)

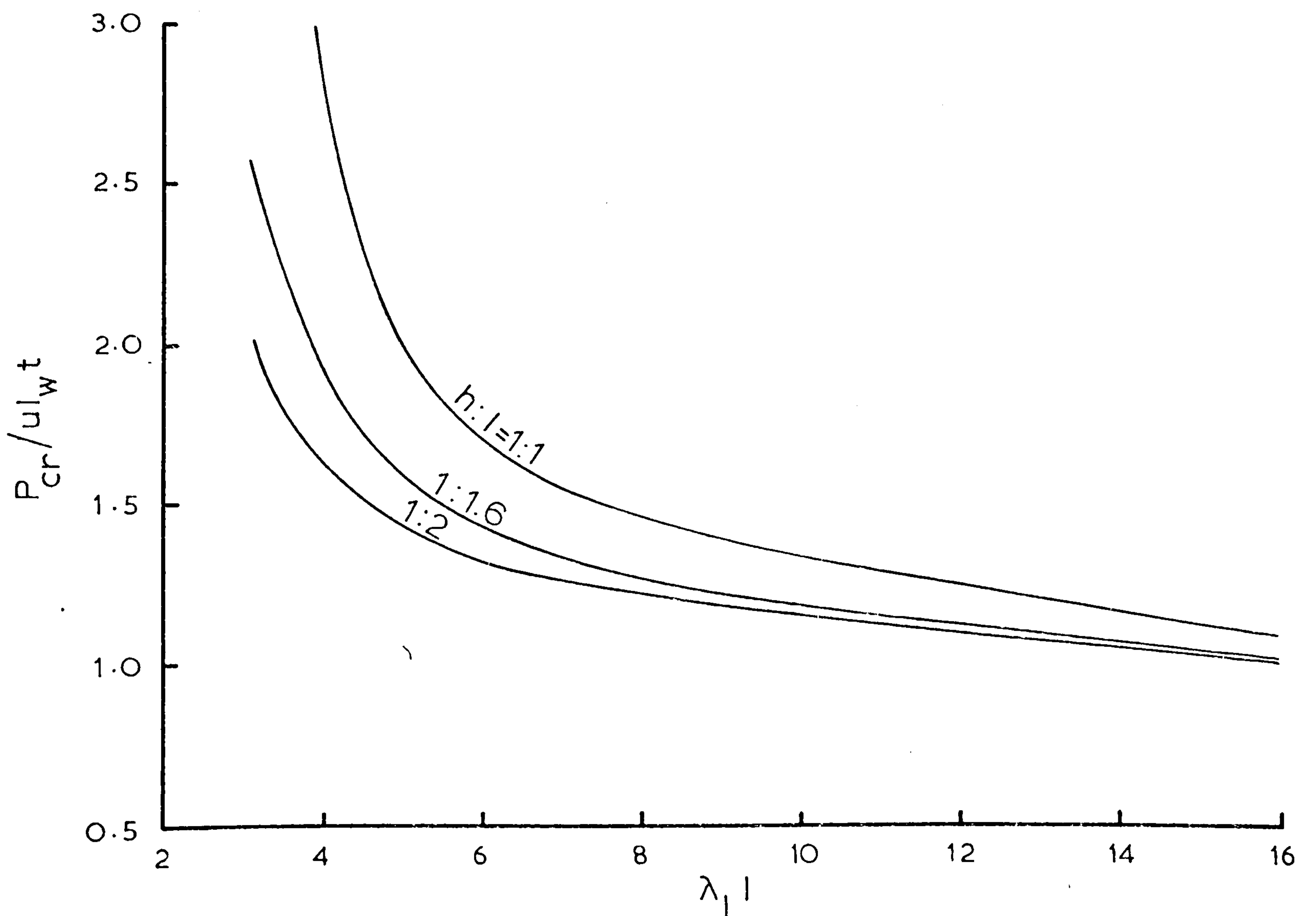

Fig. (4.28) Crack strength of wall alone as function of $\lambda_1 l$

Table (41). Comparison of experimental and predicted cracking strengths (Previous Work).

No.	Test No. Original	Panel h x l (inches)	Panel Material	Panel thick. (inches)	Frame (wxt) (inches)	Crack load (Ton)	
						Exp.	Pred.
1	2	96 x 96	Brick	4-3/16	None	13.0	10.1
2	3	96 x 96	Brick	8-3/4	None	28.0	21.5
3	5	96 x 180	Brick	4-3/16	None	15.0	17.6
4	10	96 x 96	(hollow)	6*	None	14.1	14.4
5	11	96 x 96	(block)	6*	None	13.0	14.4
6	12,13	96 x 96	()	6*	None	15.5	14.4
7	14	96 x 96	perf. br.	4-1/8	None	23.0	22.4
8	1	96 x 48	solid br.	4-3/16	None	11.1	10.35
9	4	96 x 96	solid br.	2-5/8	None	11.9	9.5
10	B.W.1→5	30.9 x 45.4	st. brick	2.5	4.4x4.4	8.4	7.0
11	B.W.6	67.5 x 99	st. brick	5.5	9 x 9	30.1	34.3
12	B.W.7	67.5 x 99	st. brick	5.5	9 x 9	34.0	34.3
13	B.W.8	90 x 132	st. brick	8.0	12 x 12	56.7	65.7
14	4-a-1	20 x 28	st. brick	2.25	5 x 4	5.8	7.5
15	4-a-2	20 x 40	st. brick	2.25	5 x 4	6.7	7.95
16	4-a-4	20 x 40	1/4 size br	2.25	5 x 4	8.48	7.95
17	4-a-3	20 x 62	st. brick	2.25	5 x 4	11.6	11.3
18	3-b2-2	33.5 x 58	st. brick	3.75	7.5x 5	17.86	17.63
19	3-b2-2a	33.5 x 58	st. brick	3.75	7.5x 5	16.1	17.63
20	3b-2-3	33.5 x 58	st. brick	3.75	12 x 5	19.6	18.9
21	3b-2-3a	33.5 x 58	st. brick	3.75	12 x 5	16.1	18.9

* Mortar area 4 inches.

Notes

1. Tests (1 to 9): carried out by Simms⁽⁴⁷⁾.
2. Other test: carried out by Benjamin and Williams⁽³⁾.
3. In Benjamin and Williams' tests, the frame is reinforced concrete.
4. In Benjamin and Williams' tests, values of (f) and (u) are taken from their paper, based on an average shear stress, and the workmanship factor is also included.
5. Benjamin and Williams' results are taken from the graphs, they represent the load at the first crack. Results are converted from Kips to Tons. (K = 1000 lbf).
6. For Simms' tests, values of (f = 0.70) and (u = 50 psi) have been assumed for solid bricks, (f = 0.3) for perforated bricks, (f = 0.7) and (u = 75 psi) for the block wall tests.
7. An equivalent value of $\lambda_1 = 20$ has been assumed for Simms' tests, and the values represent the wall load only.

shear bond strength of the brickwork which depends in turn largely on the workmanship and suction rate of the bricks at time of laying⁽⁴⁴⁾ and independent of the mortar and brick strengths. These factors and others affecting the shear strength of brickwork could not be accurately controlled in practice, even under laboratory conditions. Variation in experimental results is therefore inevitable and an approximate method is appropriate, although errors of as much as 40% with respect to some of the individual tests have been obtained.

The three theoretical curves are drawn in Fig. (4.28). These curves may be used for practical design purposes, provided that values of the parameters involved are known or estimated from experiments. Curves for panels of other height : length proportion could be easily drawn from equation (4.6.1.4).

The method is checked against some of the published experimental results for brickwork panels (load causing the first crack) from other investigators^(3,47). The comparison is shown in Table (4.1). Appropriate values of the parameters involved are either assumed, or taken from the investigators published values. The predicted values compare satisfactorily with the experimental values.

4.11.2 Ultimate strength

Experimental values and theoretical curves are shown in Figs. (4.29, 4.30 and 4.31). The curves (1), (2) and (3) represent the ultimate lateral load carried by the panel as a composite wall (eq. 4.6.2.2), the ultimate load carried by the infilled frame based on the estimated values of deflection (eq. 4.6.2.5), and the ultimate load carried by the infilled frame based on the measured deflection at ultimate/



Fig.(4.29) Ultimate strength as function of $\lambda_h h$ (square)



Fig.(4.30) Ultimate strength as function of $\lambda_h h$ (rect. 1:1.6)



Fig.(4.31) Ultimate strength as function of $\lambda_h h$ (rect.1:2)

Fig(4.32) Ultimate strength of wall alone
as function of $\lambda_h h$



Table (4.2) Comparison of experimental and predicted ultimate strengths of the brickwork infilled frames.

Test series	l/h	Frame Section (in)	Predicted (Tons)			Experiment (Tons)	Notes
			Smith*	Holmes ⁺	Author [⊕]		
WS1	1	0.5 x 1.50	6.18	6.72	2.81	3.66	See below.
WS2	1	0.75 x 1.50	8.39	7.06	4.38	3.94	
WS3	1	1.0 x 1.50	10.40	7.62	6.97	6.70	
WT1	1.6	0.5 x 1.50	6.35	10.56	3.68	3.51	
WT2	1.6	0.75 x 1.50	8.63	10.90	5.54	5.28	
WT3	1.6	1.0 x 1.50	10.68	11.47	7.95	7.70	
WL1	2	0.5 x 1.5	6.54	13.10	4.08	3.60	
WL2	2	0.75 x 1.5	8.87	13.44	6.21	6.23	
WL3	2	1.0 x 1.5	11.03	14.00	8.69	8.57	

* Estimated from $H_{ult} = \alpha t f'_c$, Smith⁽⁵⁰⁾, $\alpha_h = \frac{\pi}{2\lambda_h h}$.

+ Estimated from:

$$H_{ult} = \frac{24EI_c e'd}{h^3 (1 + \frac{I_c}{I_b} \cot\alpha) \cos\alpha} + t \frac{d}{3} f_c \cos\alpha \text{ (Holmes)}^{(17)}$$

Notations are Holmes' (see Chapter 2).

According to Holmes f_c = compressive strength of brickwork in the direction of the diagonal, therefore f_c is taken as 0.7 x Ultimate compressive strength of brickwork.

⊕ Based on the measured values of maximum deflection eq.(4.6.2.5).
Smith's predicted values represent the load carried by the wall alone, if the frame load is to be added, results are higher.

ultimate load (eq. 4.6.2.5). Results are expressed in terms of the dimensionless parameters $\frac{P_{ult}}{f_h t}$ and $\lambda_h h$.

The experimental values compare satisfactorily with curve (3), all test values fall 0 - 11% below the predicted values, except for the square panels with $\lambda_h h = 7.07$ (flexible frame) where the test value is 23% higher than the predicted one. Curve (2), based on the estimated value of maximum deflection which is estimated from the strain at failure of the panel material along the compression diagonal, also gives a good prediction of the experimental values. The discrepancies are within 2 - 15%. Comparison between the three curves show that: for high $\lambda_h h$ values (flexible frames) the amount of load carried by the frame alone is not considerable, this could be also noted for the cracking load predicted curves.

As described earlier in section (4.6.2), the method is based on many approximate assumptions, among them: a crushed region taken as equal to the effective width of the equivalent diagonal strut. Because of the non-homogeneity of the panel material, spalling was dislocated, in some cases appeared at the centre of the panel, but generally concentrated near the corners. A definite crushed region is very difficult to state. However, the results were comparable to the experimental ones, therefore was adopted for its simplicity.

Other investigators also have assumed different crushed regions in their prediction of ultimate load. Smith⁽⁵²⁾ defines the crushed region by α_h (length of contact along the column), and Holmes⁽¹⁷⁾ assumes the crushed region to be one-third of the diagonal length. The experimental values are compared with the predicted values from Holmes⁽¹⁷⁾ and Smith's⁽⁵²⁾ equations, Table (4.2).

It/

It can be seen that their prediction over-estimates the ultimate strength of the infilled frames. It is believed that: equation (4.6.2.2), curve (1), also over-estimates the strength of the panel at failure as a composite wall, however, since when the load carried by the frame alone is estimated, the interaction forces between the frame and the panel, which increases the strength of the bare frame considerably, are neglected, it appears that the frame under-estimation has compensated for the panel over-estimation, and the total strength is reasonable.

The method could be applied to both brickwork and concrete infill panels. The theoretical curves for strength of the panel as a composite wall only are shown in Fig. (4.32), and may be used for design purposes. The load carried by the frame also could be added provided the panel material strain at failure is known, i.e. similar curves to (2) could be obtained. Results are conservative which is preferable for practical design.

4.11.3 Lateral stiffness

Experimental and theoretical results are shown in Table (4.3) and in Figs. (4.33, 4.34 and 4.35) in a graphical form. Column (5) in Table (4.3) represents the values obtained from the approximate method (equivalent diagonal strut eq. (4.5.2)). Column (6) are the values obtained from the finite element analysis including the interaction forces both normal and friction forces (0.3 has been assumed for the coefficient of friction between mortar and steel). Column (7) gives the values obtained from the finite element analysis neglecting the interaction forces, i.e. the panel is only connected at the two compression corners. Curve (3) is the theoretical values based/

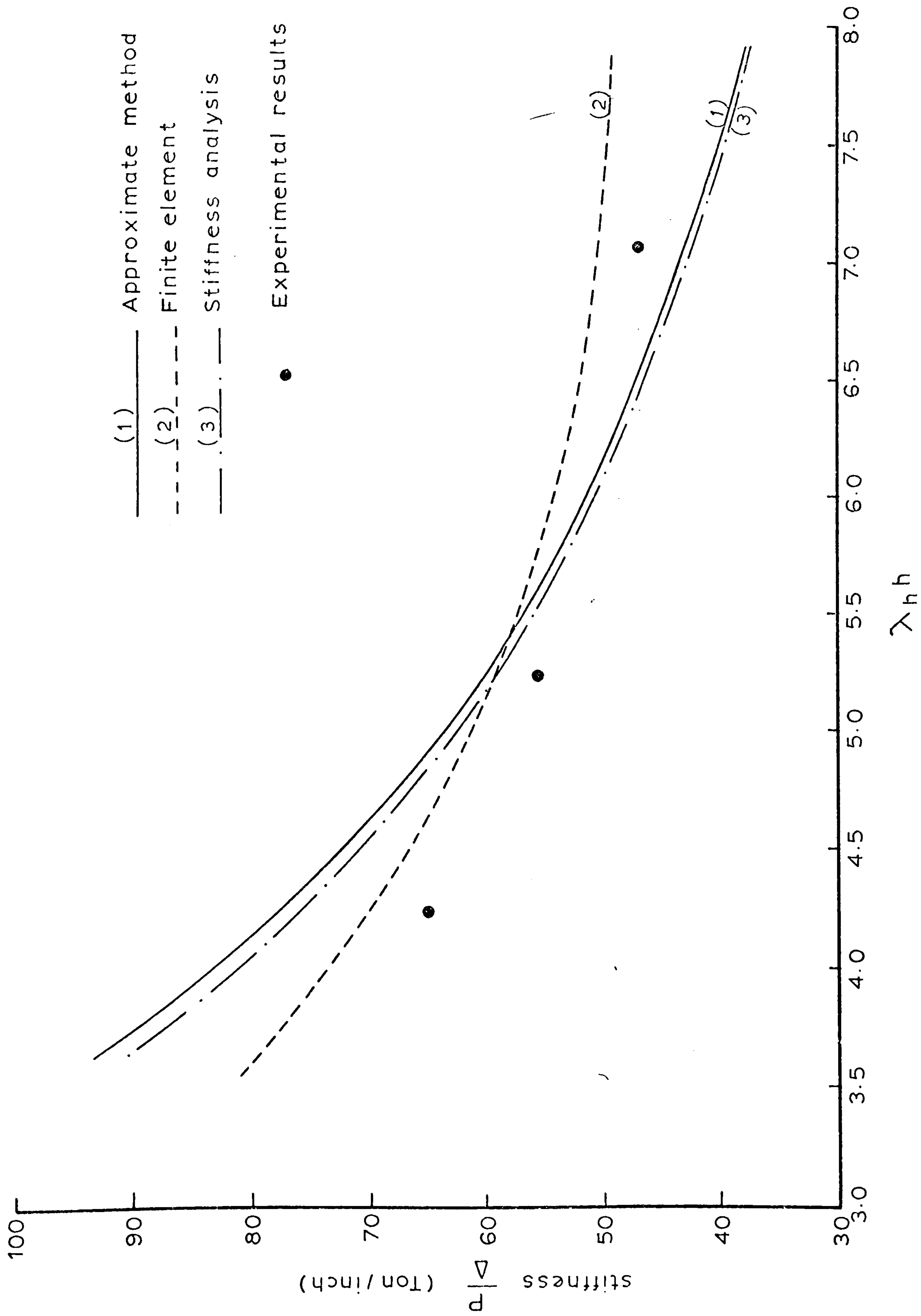

Fig.(4.33) Lateral stiffness (square)



Fig.(4.34) Lateral stiffness (rect. 1:1.6)

- (1) ——— Approximate method
- (2) - - - - Finite element
- (3) - · - · Stiffness analysis
- Experimental results



Fig.(4.35) Lateral stiffness (rect.1:2)

Table (4.3). Comparison of the experimental and theoretical lateral stiffnesses.

Test series	h:l	$\lambda \frac{h}{h}$	Experiment. (T/in)	Theoretical T/inch (author's)			Predicted by		
				Approx	F.E.+ Inter	F.E. hinge	Smith (1)*	Smith (1)*	B.&W. (2)*
WS1	1:1	7.07	47	43	50.5	48.5	48	65	193
WS2	1:1	5.256	55.5	60	59	51.5	57	75	193
WS3	1:1	4.269	65	78	70	55.5	63	81	193
WT1	1:1.6	6.88	52	53.7	56	55	46	89	310
WT2	1:1.6	5.116	68	74.5	69	66	51	99	310
WT3	1:1.6	4.155	90	95.5	81	70	57	112	310
WL1	1:2	6.685	55.3	54.5	60	58	44	87	387
WL2	1:2	4.97	71.2	76	76.5	67	48	98	387
WL3	1:2	4.037	97.5	97.3	99	76.5	55	108	387

* Notes:

(1) Smith's predicted values are estimated on the basis of an equivalent pin-jointed frame⁽⁵⁰⁾. In column (9) the values of (w) "effective width" are obtained from his analytical curves. "w" for column (8) is obtained from the modified curves according to experiments.

(2) Benjamin and Williams' results are estimated from $\delta = \frac{1.2 \text{ bv}}{\text{atG}}$ ⁽³⁾ which has been recommended for reinforced concrete frames with brickwork infilling.

based on the equivalent diagonal strut as in (1), but obtained from the stiffness analysis using the STRUDL Program for structural analysis at Edinburgh Regional Computing Centre, which includes the axial deformation for all of the frame members, term D in eq. (4.5.3) as well as rotation and shear deformation in the frame. The curve is co-linear with Curve (1), and 2 - 4% below the values obtained from eq. (4.5.2). Results are very comparable, therefore for a single-storey infilled frame, the approximate method directly estimated from eq. (4.5.2) is suggested. In the following discussion, only curves (1) and (2) are considered.

The approximate method shows good agreement with the experimental values, the method generally over-estimates the stiffness of the system slightly. The comparison is very good for rectangular panels, and not so good for square panels, especially for very stiff frames.

The estimated values of the stiffness mainly depend on the value of the effective width of the diagonal strut, which is derived from the adopted curves for length of contact at the boundaries, therefore errors in estimating the length of contact will result in different values of effective width, and in turn a different overall stiffness.

The great difference between the approximate method and experimental values for the square panels with $\lambda_h h = 4.25$, could be mainly attributed to the estimated value of length of contact along the beam $\alpha_1 = \frac{\pi}{\lambda_1 l}$. For a stiff and short beam, conditions at one end affect the forces and deflections at the other end, such as moment restraints exerted by the leeward column, thus in turn different α_1 value would be obtained. However, for rectangular panels the beam is relatively long/

long compared to its stiffness, this effect is almost negligible.

Other factors which could affect the stiffness are: (a) the assumed triangular compressive stress distribution along the diagonal; this is an approximate representation of the actual stress distribution although the maximum compressive stress over this area obtained from the finite element analysis shows close agreement with the assumed shape of stress distribution; (b) The strain energy due to bending in the frame in eq. (4.5.2), neglects the interaction forces which increase the frame stiffness. If added, the overall stiffness would be increased even more. However, as described earlier, up to the first crack (the linear portion of load-deflection curve) the deflection is very small, therefore this effect is neglected.

The finite element analysis, method (1) gives better results for square infilled frames, but the results are less good for rectangular panels. For a particular panel, variation up to 20% may result from this analysis by changing the boundary conditions at the interface.

As described in section (4.8), the analysis was first carried out with no friction forces at the interfaces, for some of the panels the assumed length of contact (obtained from $\alpha_h = \frac{\pi}{2\lambda_h h}$, $\alpha_l = \frac{\pi}{\lambda_l l}$) needed to be modified slightly because tensile forces were induced in the connecting members. In the second stage, friction forces were introduced, the stiffness increased from 10% for flexible frames to about 25% for stiffer frames (only results from second stage are shown in Table (4.3) and Figs. (4.33, 4.34 and 4.35)).

The analysis was also carried out neglecting all interaction forces at the boundary. The panel was connected to the frame only at/

at the two loaded corners as a diagonal bracing system. These values are shown in Table (4.3) column (7). This analysis is similar to the approximate method, but the interaction forces in this case are neglected for both the panel and the frame. Results from this analysis are below the values from analysis (1).

It is interesting to note that for a particular panel with constant height to length ratio, variation in frame stiffness gave only the additional stiffness due to the increased frame stiffness, unlike the other methods and the experimental results. This clearly demonstrates the importance of including interaction forces on the panel, and the composite behaviour of an infilled frame.

The idealization of the system section (4.8) for analysis is an approximate one, but enables the analysis to be carried out more rapidly than was presented by Mallick and Severn⁽²⁹⁾, and the interaction forces are determined directly, better distribution of these forces could be obtained if a smaller element size is taken.

The interaction forces could also be obtained from the approximate method by assuming an interaction force distribution shape over the length of contact with the column and the beam in which in each case its area is equal to the horizontal and vertical components of the diagonal load carried by the panel, respectively. Average tangential and normal stresses inside the panel could also be estimated from section (4.6.1), but the finite element analysis gives better stress distribution in these respects. Unless the inside behaviour of the panel is required, the approximate method for analysis is recommended.

These methods could be applied to frames infilled with masonry or/

or plain concrete. The approximate method may underestimate the stiffness of reinforced concrete infilled frames, because of the better bond between the panel and concrete, the initial stiffness could be very high, and the panel may crack before a complete separation occurs at the boundaries. This behaviour also occurred in some of the experiments carried out in this investigation which resulted in a higher stiffness value. However, unless proper shear connectors are used, the analysis is recommended to be carried out assuming no bond at the interfaces.

It is difficult to verify these methods with the experimental work of other workers on brickwork infilled frames since it is not clear whether the published values of stiffness are the initial or the mean up to the first crack, or taken from the linear part of the load-deflection curves. The author's experimental results are compared with other's predicted values in Table (4.3). As discussed in section (4.1), the simple "strength of materials" method overestimates the stiffness. The equivalent diagonal strut methods give reasonable results if proper value of the effective width of the diagonal strut is taken.

4.11.4 Member forces

Member forces (bending moments, axial forces and shear forces) are estimated from the three methods (approximate, finite element with no interaction forces and finite element with interaction forces), and compared with the bare frame forces. Results for frames with 0.75 inch thickness and different height to length ratios are shown in Table (4.4). Table (4.5) shows the results for square panel for different frame stiffnesses.

Bending/

Table (4.4). Comparison between frame forces estimated by different methods, for panels WS2, WT2 and WL2.

Prop- erties	Analys. type	Bending moment x Ph x 10 ⁻² at				Axial force x P			Max. Shear Forces x P		
		A	B	C	D	1	2	3	1	2	3
$\frac{l}{h} = 1$ ($\frac{3}{4} \times 1.5$) (WS2)	Bare frame	28.60	21.40	21.40	28.60	0.421	0.50	0.421	0.50	0.421	0.50
	F.E. (1)	0.97	3.55	0.63	5.63	0.937	0.155	0.20	0.359	0.353	0.505
	F.E. (2)	1.49	1.09	As (B)	As (A)	0.951	0.025	0.021	0.025	0.021	As (1)
	Equiv. strut	1.27	0.935	As (B)	As (A)	0.975	0.0218	0.0182	0.0218	0.0182	As (1)
$\frac{l}{h} = 1.6$ $\frac{3}{4} \times 1\frac{1}{2}$ (WT2)	Bare frame	30.30	19.70	As (B)	As (A)	0.244	0.50	As (1)	0.50	0.244	As (1)
	F.E. (1)	0.598	3.248	0.482	5.49	0.64	0.077	0.198	0.33	0.185	0.527
	F.E. (2)	1.08	0.70	As (B)	As (A)	0.608	0.017	0.0086	0.017	0.0086	As (1)
	Equiv. strut	0.992	0.638	As (B)	As (A)	0.622	0.016	0.0071	0.016	0.0071	As (1)
$\frac{l}{h} = 2$ $\frac{3}{4} \times 1\frac{1}{2}$ (WL2)	Bare frame	31.25	18.75	As (B)	As (A)	0.1875	0.50	As (1)	0.50	0.1875	As (1)
	F.E. (1)	0.617	3.06	0.472	5.41	0.53	0.059	0.197	0.305	0.138	0.529
	F.E. (2)	1.015	0.607	As (B)	As (A)	0.491	0.0158	0.0061	0.0158	0.0061	As (1)
	Equiv. strut	0.93	0.55	As (B)	As (A)	0.501	0.0146	0.0055	0.0146	0.0055	As (1)

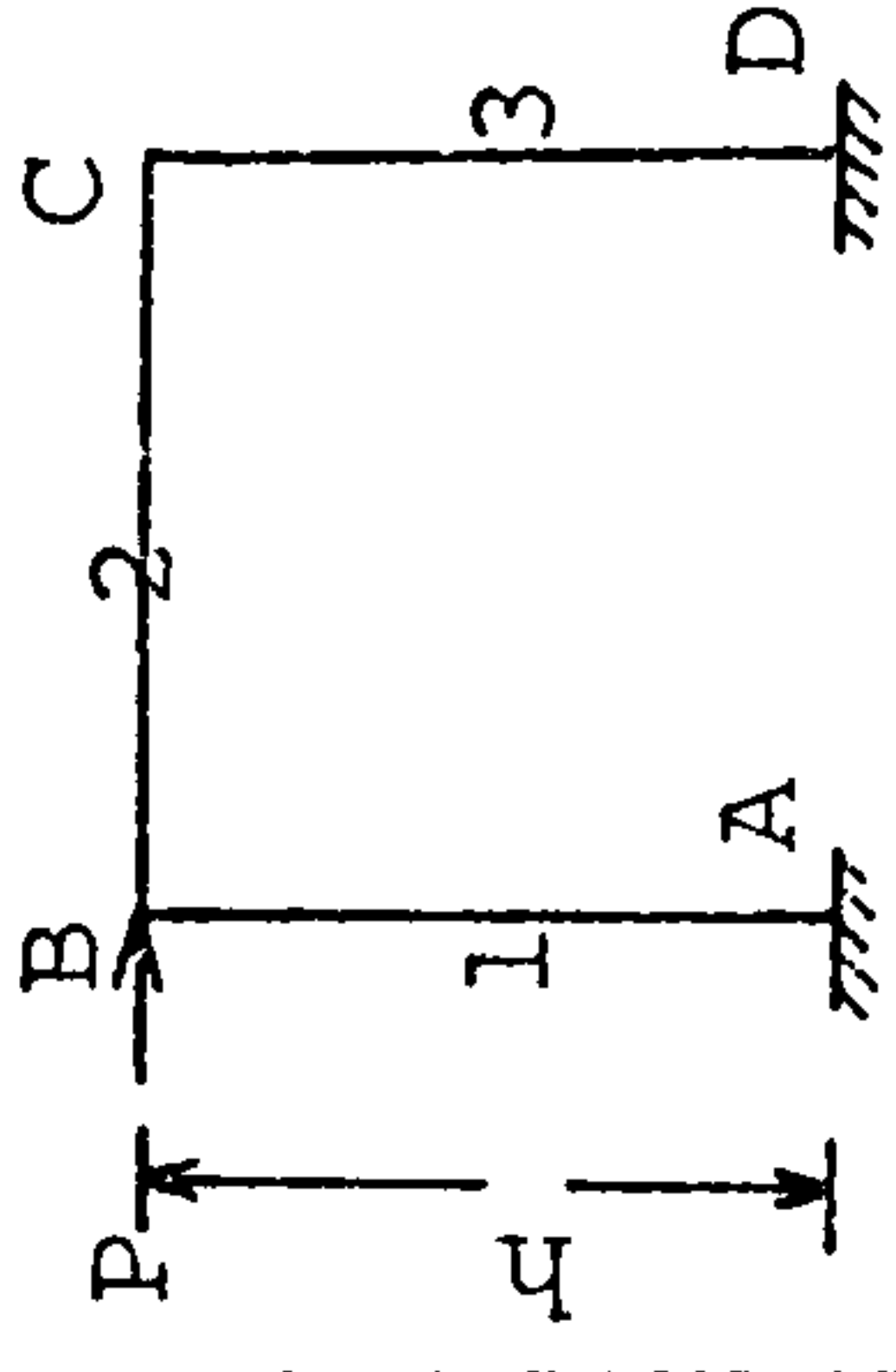
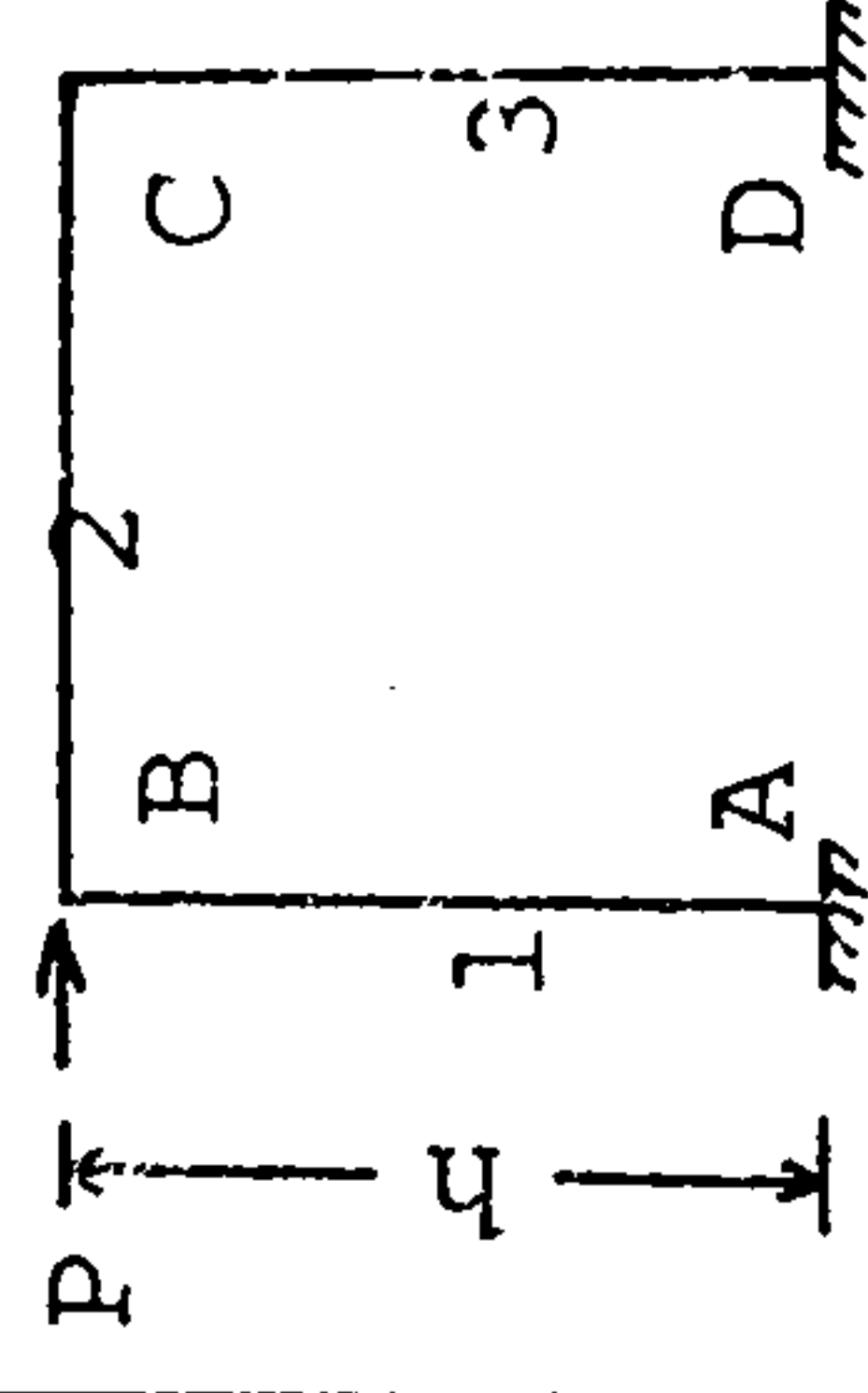

Table (4.5). Comparison between frame forces estimated by different methods for square panels with different frame stiffnesses.

Prop- erties	Analys. type	Bending moment x Ph x 10 ⁻² at				Axial force x P			Max. shear force x P		
		A	B	C	D	1	2	3	1	2	3
(WS1) frame section 0.5x1.5	Bare frame	28.6	21.4	21.4	28.6	0.421	0.050	0.421	0.050	0.421	0.50
	F.E. (1)	0.36	2.046	0.19	3.402	0.923	0.098	0.152	0.257	0.25	0.385
	F.E. (2)	0.483	0.353	As (B)	As (A)	0.964	0.0082	0.0069	0.0082	0.0069	As (1)
	Equiv. strut	0.568	0.40	As (B)	As (A)	0.988	0.0095	0.0078	0.0095	0.0078	As (1)
(WS2) frame section 0.75 x 1.5	Bare frame	28.60	21.40	As (B)	As (A)	0.421	0.50	As (1)	0.50	0.421	As (1)
	F.E. (1)	0.97	3.55	0.63	5.63	0.937	0.155	0.20	0.359	0.353	0.505
	F.E. (2)	1.49	1.09	As (B)	As (A)	0.951	0.025	0.0021	0.025	0.021	As (1)
	Equiv. strut	1.27	0.935	As (B)	As (A)	0.975	0.0218	0.0182	0.0218	0.0182	As (1)
(WS3) frame section 1.0 x 1.5	Bare frame	28.6	21.4	As (B)	As (B)	0.421	0.50	As (1)	0.50	0.421	As (1)
	F.E. (1)	1.858	4.955	1.694	7.91	0.842	0.183	0.241	0.422	0.38	0.563
	F.E. (2)	3.145	2.33	As (B)	As (A)	0.921	0.0528	0.0448	0.0529	0.0448	As (1)
	Equiv. strut	2.265	1.653	As (B)	As (A)	0.956	0.0379	0.0321	0.038	0.0321	As (1)



Bending moments compared with those of a bare frame are drastically reduced by all the methods. Results from the approximate method and the finite element (2) are very close, but because of the interaction forces, bending moments at the loaded joints obtained from the finite element (1) are considerably higher than the other two method values. This indeed represents the behaviour of the infilled frames more closely.

Axial forces in all cases are reduced at the leeward column, but greatly increased at the windward column which indicates the amount of the upward forces exerted by the panel.

Shear forces are greatly reduced by the approximate and finite element (2) method. However, in method (1), also because of the interaction forces, a great shear force has been induced at the junction of the leeward column with the base, which is comparable to the bare frame shear force. Indeed these explain the failure occurred by tensile forces in the windward column and shear forces at the base of the leeward column in Benjamin and Williams' tests⁽¹⁾, where the frames were of reinforced concrete not strong enough to produce failure in the panel. For design purposes these modes of failure must not be over-looked. Careful consideration must be taken.

For an infilled frame with constant $h : l$ ratio, Table (4.5), the stiffer frame shows higher shear forces and bending moments but less maximum axial force than the flexible frame. This supports the theoretical curves for lateral strength in which this is clearly indicated.

4.12 CONCLUSIONS

As a result of this theoretical investigation, the following conclusions may be drawn :

1. The stiffness of an infilled frame panel may be approximately predicted assuming the infill acts as an equivalent diagonal strut in which its effective area is related to the stiffness of the frame and the properties of the panel, then analysing the system by established structural analysis methods.
2. The finite element method may be used to predict the lateral stiffness of an infilled frame, provided that proper boundary conditions at the interface between the frame and panel are considered.
3. The load causing the first crack in a masonry infilled frame may be approximately predicted on the basis of an average shear and normal stress, as described in section (4.6.1).
4. The ultimate load carried by an infilled frame (load to cause crushing inside the panel) may be predicted approximately on the basis of the sum of loads carried by the frame and the panel as a composite system.
5. Before cracking of the panel, the frame carries a small portion of the total lateral load, after cracking and at ultimate, a higher percentage of the load is carried by the frame.

6. In an infilled frame when compared with a bare frame, bending moments are significantly reduced with maximum value at the loaded joints, axial force is increased in the windward column, and higher shear forces may be expected. These factors must be considered in the design of an infilled frame structure in order to avoid frame failure.
7. Stress variation inside the panel is non-linear and highly concentrated at the compression corners. Maximum tensile stress occurs at the centre of the panel, and maximum compressive stress at the loaded corner.

CHAPTER 5BRICKWORK INFILLED FRAMES CONTAINING OPENING5.1 INTRODUCTION

Masonry panels in framed structures, internal and external walls provide considerable resistance to lateral forces. These walls normally contain openings for doors, corridors and windows. Very large opening areas may exist at the lower levels of multi-storey buildings. Openings in masonry walls will eventually cause reduction in stiffness and strength of the structure. Reduction in ultimate load of 30% and 40% has been reported by Holmes⁽¹⁷⁾ in tests carried out on full scale frames with brickwork infillings having a central opening.

Coull's⁽⁹⁾ tests on mortar infilled panel containing square opening with dimension of $\frac{1}{3}$ of the infill length, showed a reduction of about 60 - 70% and 45% in stiffness and strength respectively. Sachanski's⁽⁴²⁾ tests on model bricks showed more than 50% reduction in the carrying capacity of the panels. Benjamin and William's⁽²⁾ tests showed the same amount of reduction in ultimate strength.

In actual structures, openings vary in size and location for different purposes. Mallick and Garg⁽³¹⁾ studied the effect of different opening positions on the lateral stiffness and ultimate load of infilled frames. Model frames with mortar infilling were tested, the openings had the same size for all the different locations. A reduction of 75% in lateral strength and 85 - 90% in lateral stiffness were observed with panels provided with opening at either end of the loaded diagonal, panels with central opening showed stiffness and strength of about 25 - 50% of those of solid panels. Door openings were recommended to be located in the centre of the lower half of the panel/

panel, and the window opening in the midheight of the left or right half of the panel near to the vertical edge of the panel.

At and near the edges of the openings, local stress concentration may be induced, proper reinforcements may be provided in such locations. Tests on reinforced concrete shear walls containing openings were carried out by Benjamin and Williams⁽²⁾, it was concluded that long diagonal well anchored corner bars significantly increase both strength and rigidity of a wall containing openings once cracking begins. A few tests by Coull⁽⁹⁾, showed the effect of nominal reinforcement around the openings was negligible considering first cracking load and strength.

All these tests show that, although the stiffness and strength of an infill panel are significantly reduced by the presence of openings, nevertheless the panel contributes to a certain extent in increasing the carrying capacity of a bare frame, and in reducing undesirable deflection due to lateral forces.

Tests described in this chapter were carried out on square and rectangular brickwork infilled frames with central opening of different sizes, a few tests were carried out on panels with door opening at the lower middle of the panel. The behaviour of such panels are investigated, and an approximate method to predict the lateral stiffness of infill frames with opening is also presented, the method is based on an equivalent frame approach.

5.2 MATERIALS, CONSTRUCTION AND EXPERIMENTAL METHOD

One third scale model bricks with an average compressive strength of (4228 psi), and 1 : 3 Cement : Sand mortar (by weight) with an average compressive strength of (2262 psi), were used for construction of all the panels tested. Mild steel frames were used, the joints were/

were welded and plate stiffeners were added. The walls were built in the same way as the solid panels described earlier in Chapter (3). Wood frames to the size of the openings were fixed to the back board. No lintels were provided for the openings, the wood frame supported the brick courses above the opening during the construction, and was kept in position during the curing period. Great care was taken during transferring the walls to the loading machine. The infilled frames were tested under the Avery machine, the same way as described earlier for solid panels.

5.3 SIZE OF OPENING

According to architectural requirements, the location and size of opening could vary for practical purposes, however, the most common position of window opening is at the centre of the panel, corridor and door openings are at the lower middle part of the panel. Since the lateral load due to earthquake motion or wind forces can act from either side of the panel, it is not recommended to locate the openings at the diagonal corners of the wall, for the diagonal bracing of the wall will be no longer fully operative, resulting in a great reduction in stiffness and strength of the panel.

Only openings at locations more widely used in practice are included in this investigation. Panels with central openings, and door openings at the lower middle of the panel, were tested. They included three different opening areas. The panels were square and rectangular with $\frac{h}{l}$ ratio of 1 : 1.6. The frame members stiffness was kept constant for all the tests, so that the only variable being the size of the openings. The exact location and dimensions of the openings were mostly governed by the brick courses and dimensions. Details of all the panels tested are given in Table (5.1).

5.4/

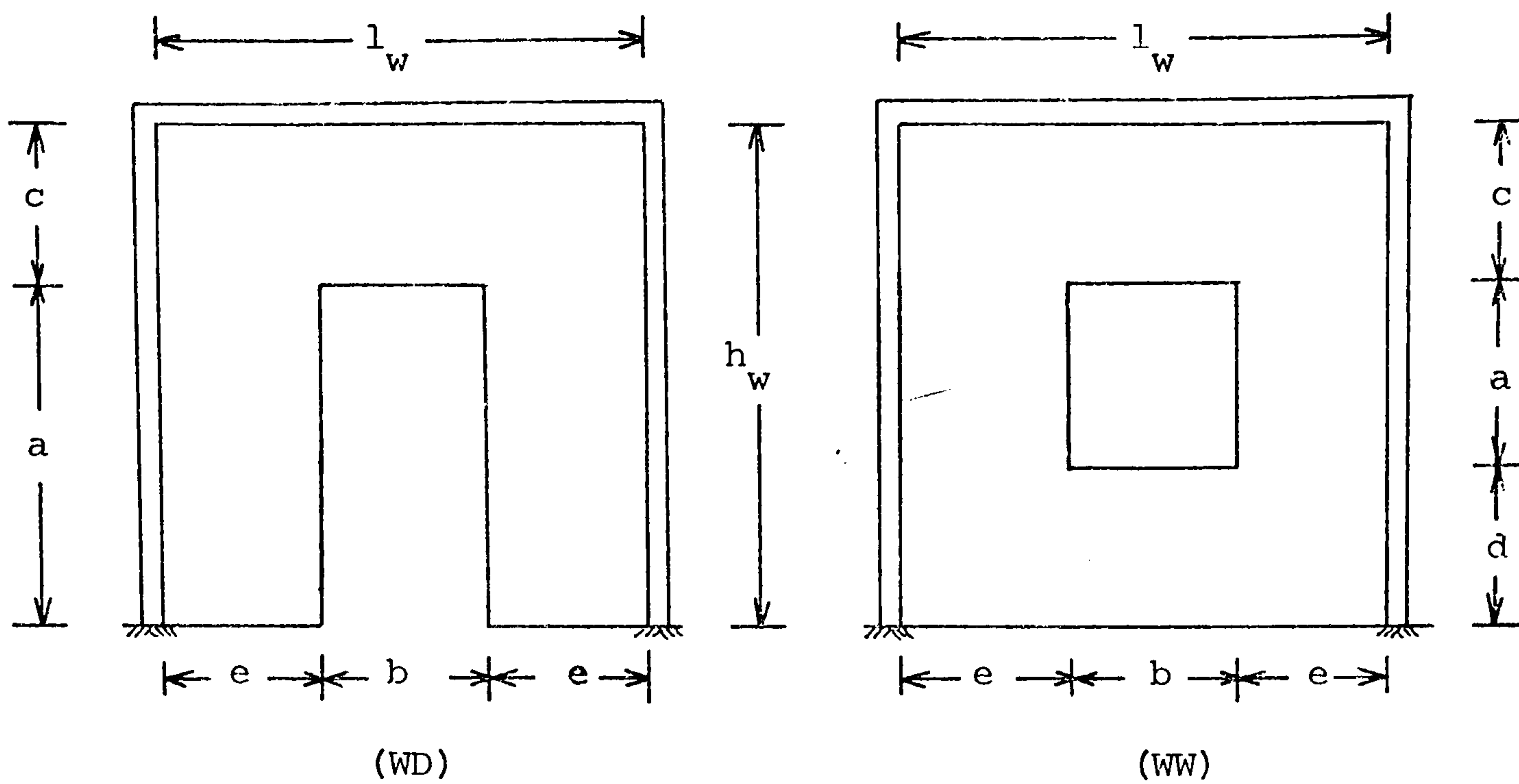

Test No.	All dimensions are in inches						$\frac{A_{open}}{A_{full}} \%$
	$h_w \times l_w$	a	b	c	d	e	
WW5	15.75 x 15.75	3.375	3.126	6.625	5.75	6.312	4.25
WW6		3.375	3.126	6.625	5.75	6.312	4.25
WW1		6.75	6.25	4.50	4.50	4.75	17.0
WW3		6.75	6.25	4.50	4.50	4.75	17.0
WW2		11.25	9.50	2.25	2.25	3.125	43.0
WW4		11.25	9.50	2.25	2.25	3.125	43.0
WWA	15.75 x 25.25	4.50	6.50	5.50	5.75	9.375	7.35
WWA1		4.50	6.50	5.50	5.75	9.375	7.35
WWB		6.875	9.45	4.437	4.437	7.90	16.33
WWB1		6.875	9.45	4.437	4.437	7.90	16.33
WWC		9.00	15.75	3.375	3.375	4.75	35.6
WWC1		9.00	15.75	3.375	3.375	4.75	35.6
WD1	15.75 x 15.75	11.25	6.25	4.50	-	4.75	28.34
WD2	15.75 x 15.75	11.25	6.25	4.50	-	4.75	28.34

All frame members are 1.50 x 0.75 inches.

Table (5.1). Dimensions of the panels containing opening.

5.4 RESULTS

During the loading various measurements were taken, the lateral deflection at the centre of the beam member, the first crack load and the load at failure of the panel. The type and mode of failure were observed. Figs. (5.1) and (5.2) show the load deflection relationship for the panels tested. The cracking and failure loads are shown in Table (5.2). Mean values of lateral stiffness before cracking and after cracking are also shown in Table (5.2).

5.5 PANEL BEHAVIOUR AND MODES OF FAILURE

The tests carried out on brickwork infilled frames containing opening unlike solid panels showed no separation of the frame from the panel at the early stages of loading. Three modes of failure were observed, cracks at the interface of bricks and mortar, diagonal tensile cracks passing through bricks and mortar, and compression failure of the brickwork. Typical modes of failure are shown in plates (5,6).

The first crack appeared at a very low load, but notably higher than the load which could be carried by the frame alone, the load was less than 10% of the ultimate load depending on the size and type of the opening. A very fine crack appeared at the two corners of the opening along the compression diagonal, later extended along the interface between the bricks and mortar towards the frame columns. During this stage the stiffness of the panel was high, but decreasing slowly. The appearance of the first crack and its extension were gradual, not accompanied by sudden drop of load or sudden increase in deflection.

As the load increased more cracks appeared with smooth increase in deflection. Initial cracks appeared in the piers beside the opening/

Test No.	$h_w \times l_w$ (inches)	Opening a x b (inches)	Strength		Exp. Stiff.		Est. Stiff.	
			Crack (Ton)	Ultim. (Ton)	Initial (T/in)	Post-cr. (T/in)	Approx. (T/in)	F.E. (T/in)
WW5		3.375 x 3.126	0.35	4.52	64	22.7	97.0	50.7
WW6	15.75	3.375 x 3.126	0.375	4.32	80	25.0	97.0	50.7
WW1	x	6.75 x 6.25	0.35	2.75	28.5	19.6	31.7	32.9
WW3	15.75	6.75 x 6.25	0.25	2.85	33	18.5	31.7	32.9
WW2		11.25 x 9.50	0.20	2.025	6.3	5.4	6.06	9.8
WW4		11.25 x 9.50	0.15	1.98	9.7	5.7	6.06	9.8
WWA		4.5 x 6.5	0.45	4.45	83.0	29.5	73.0	57.5
WWA1	15.75	4.5 x 6.5	0.40	5.22	98.0	45.0	73.0	57.5
WWB	x	6.875 x 9.45	0.30	4.00	57.0	20.7	31.6	44.0
WWB1	25.25	6.875 x 9.45	0.20	3.94	82.0	18.0	31.6	44.0
WWC		9.0 x 15.75	0.125	2.20	18.75	13.0	11.0	19.3
WWC1		9.0 x 15.75	0.20	2.275	38.4	14.0	11.0	19.3
WD1	15.75 x	11.25 x 6.25	0.40	2.50	20.5	7.90	28.5	25.0
WD2	15.75	11.25 x 6.25	0.35	2.20	21.5	8.60	28.5	25.0

Table (5.2). Estimated and Experimental Results of Infilled Frames containing Opening.

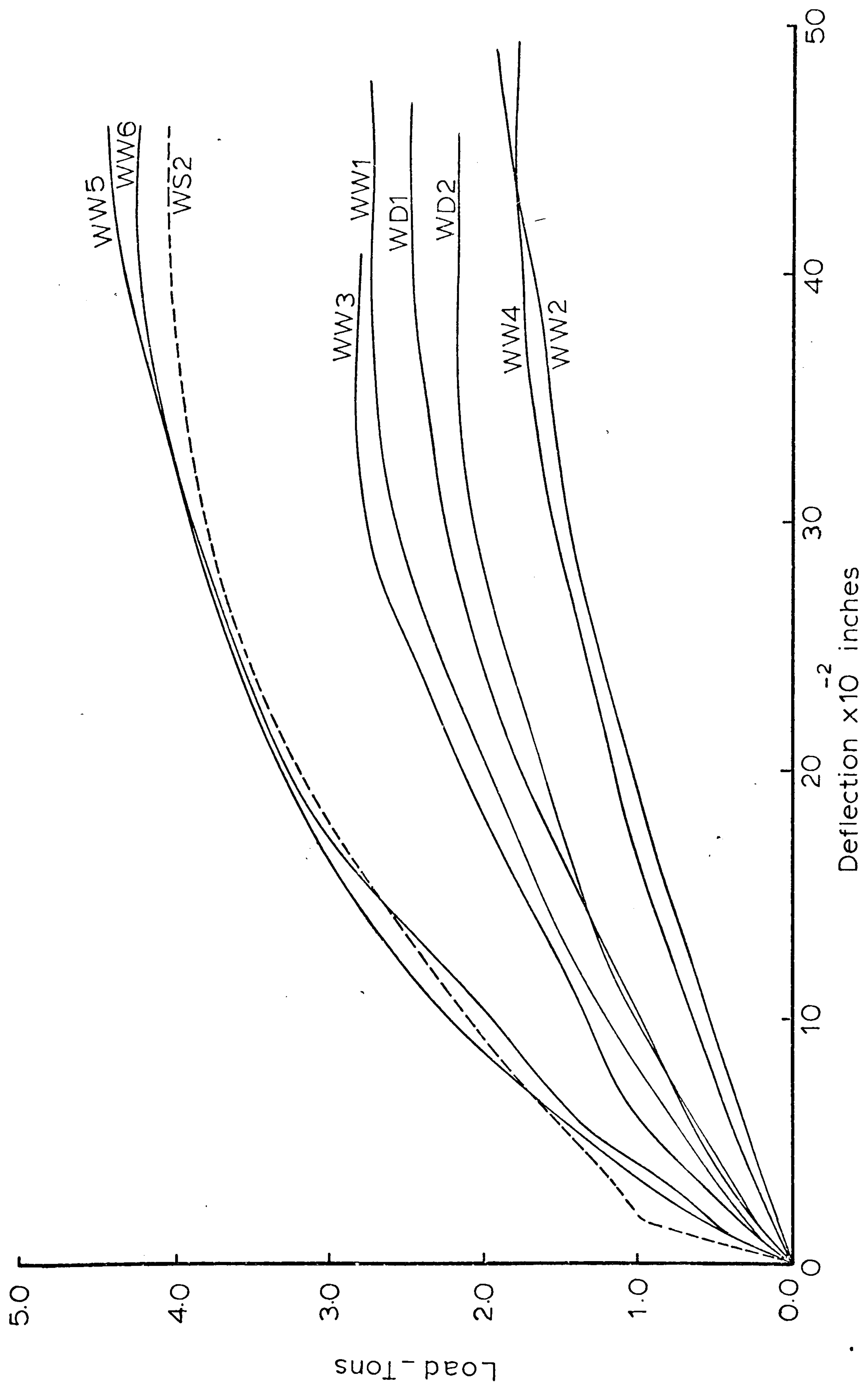

Fig.(5.1) Load deflection curves (square panels containing opening)

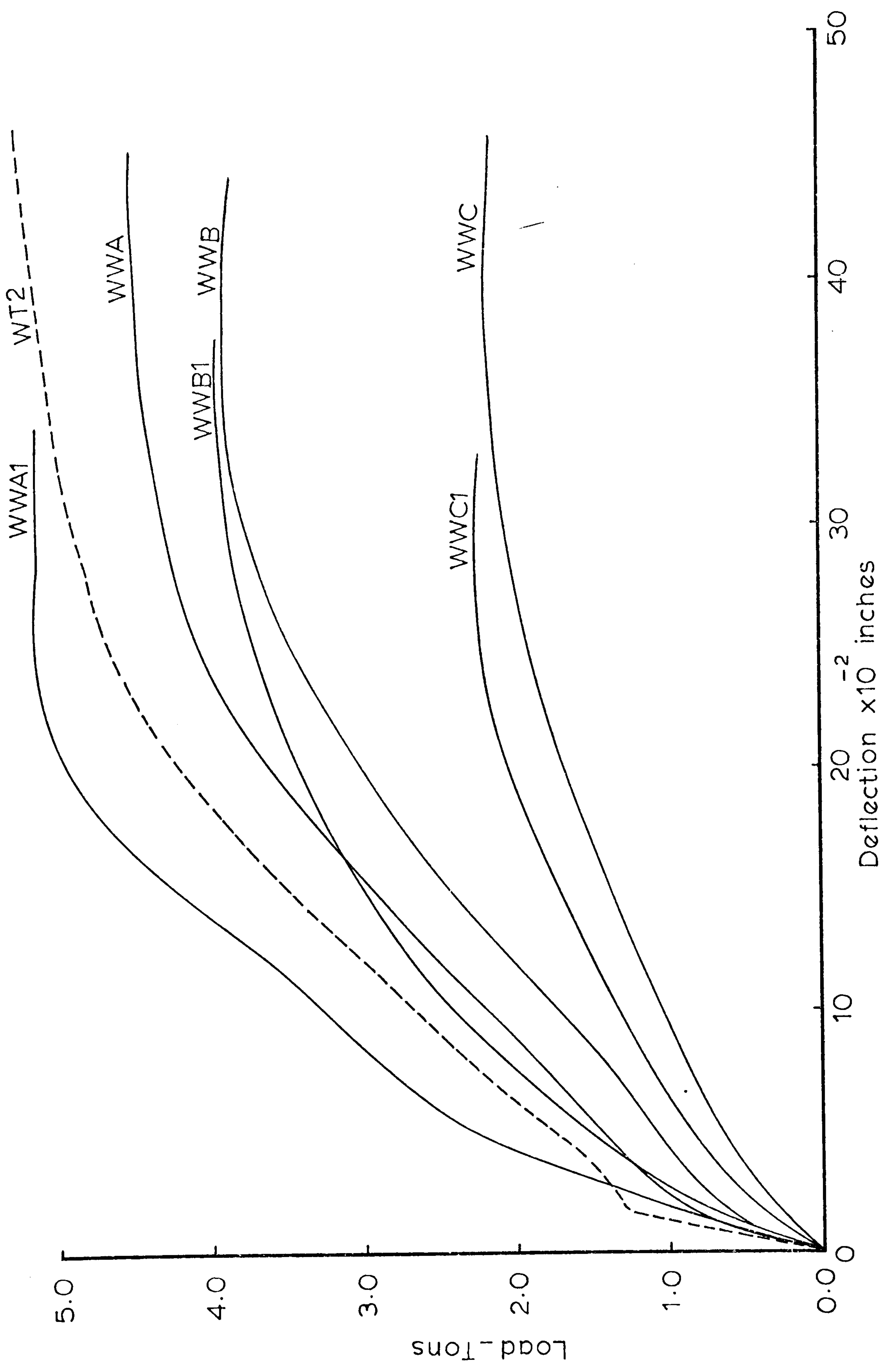
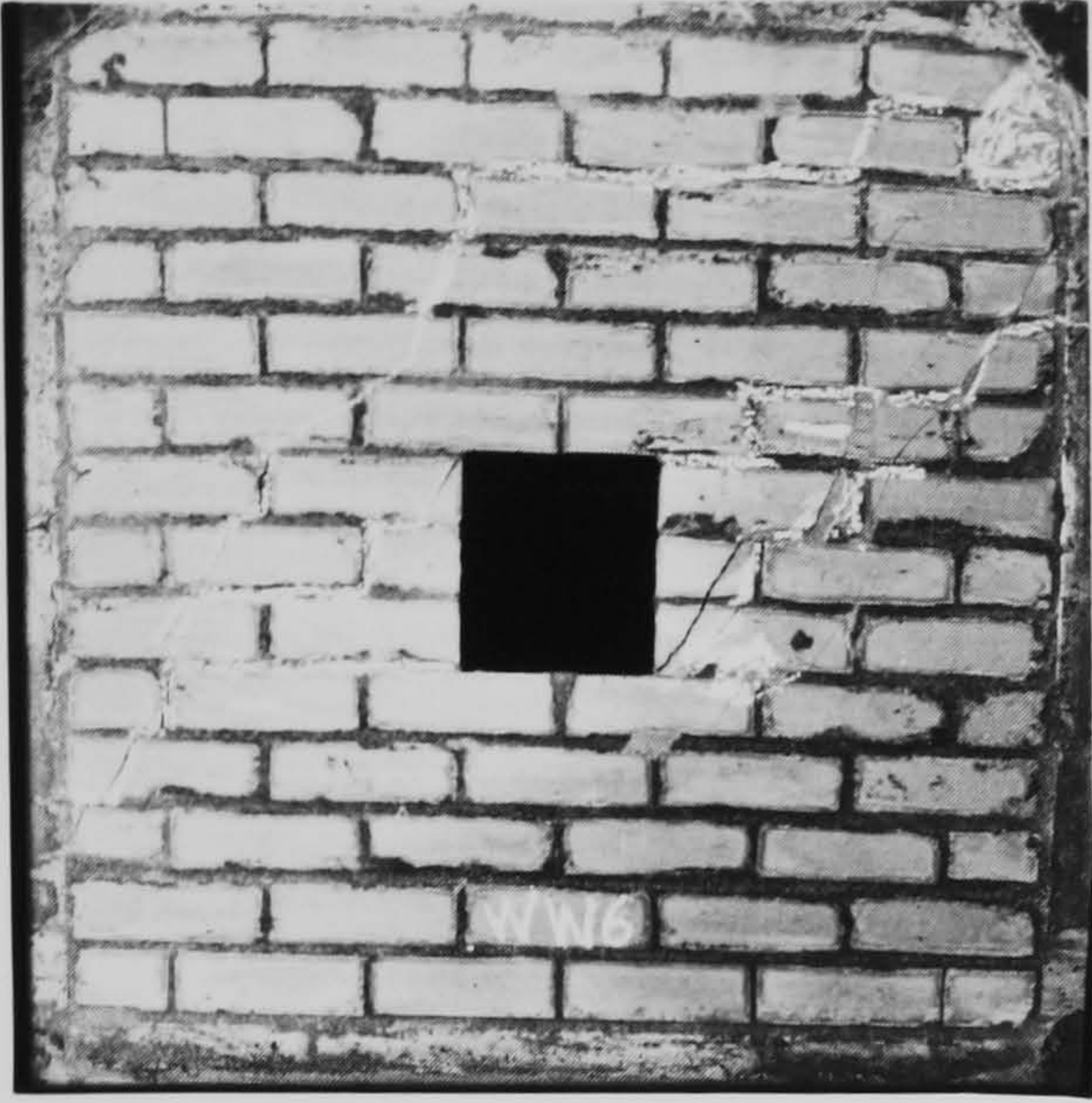

Fig.(5.2) Load- deflection curves (rect. panels containing opening)

A



W W 6

B

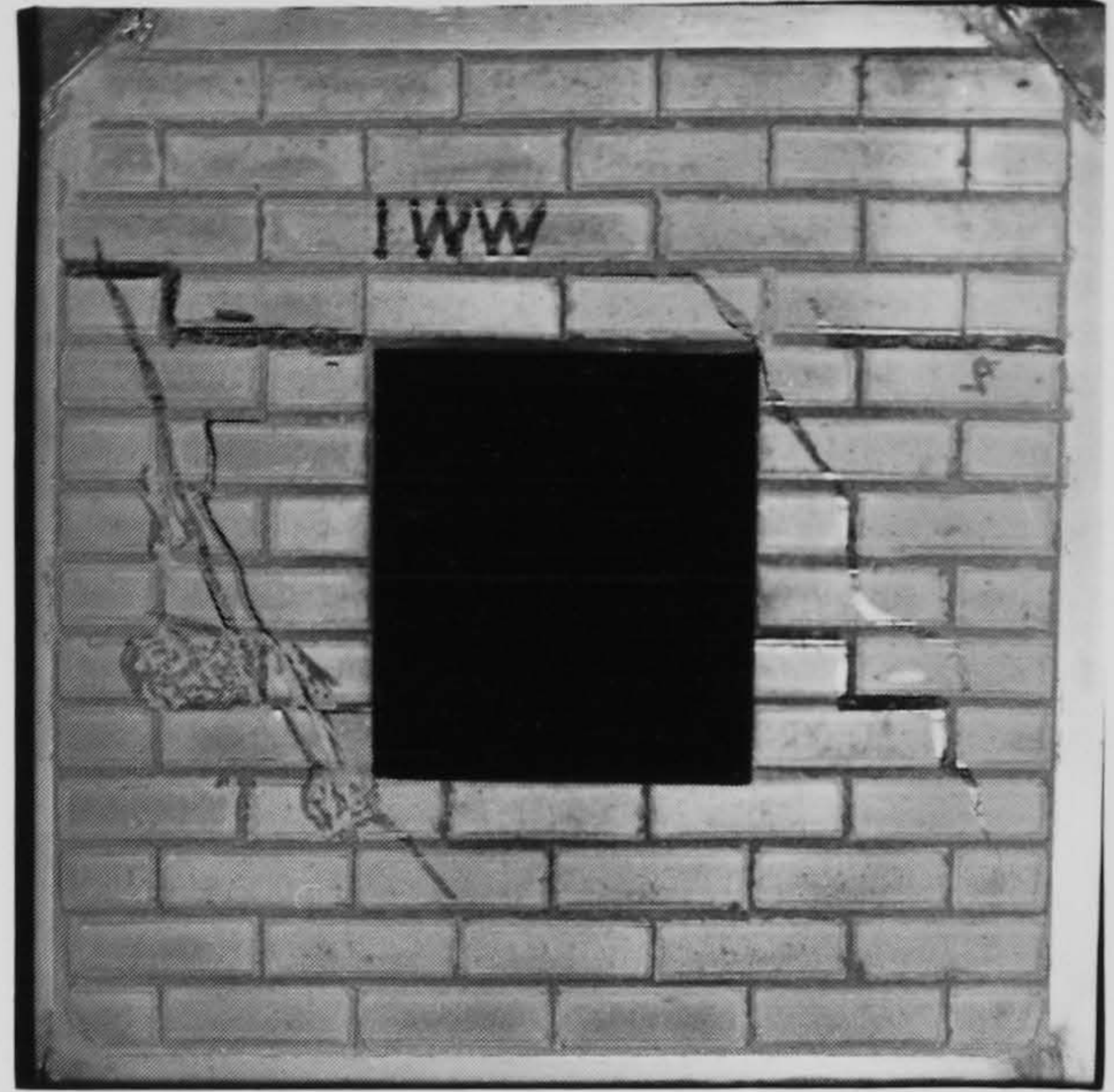

W W 1

C

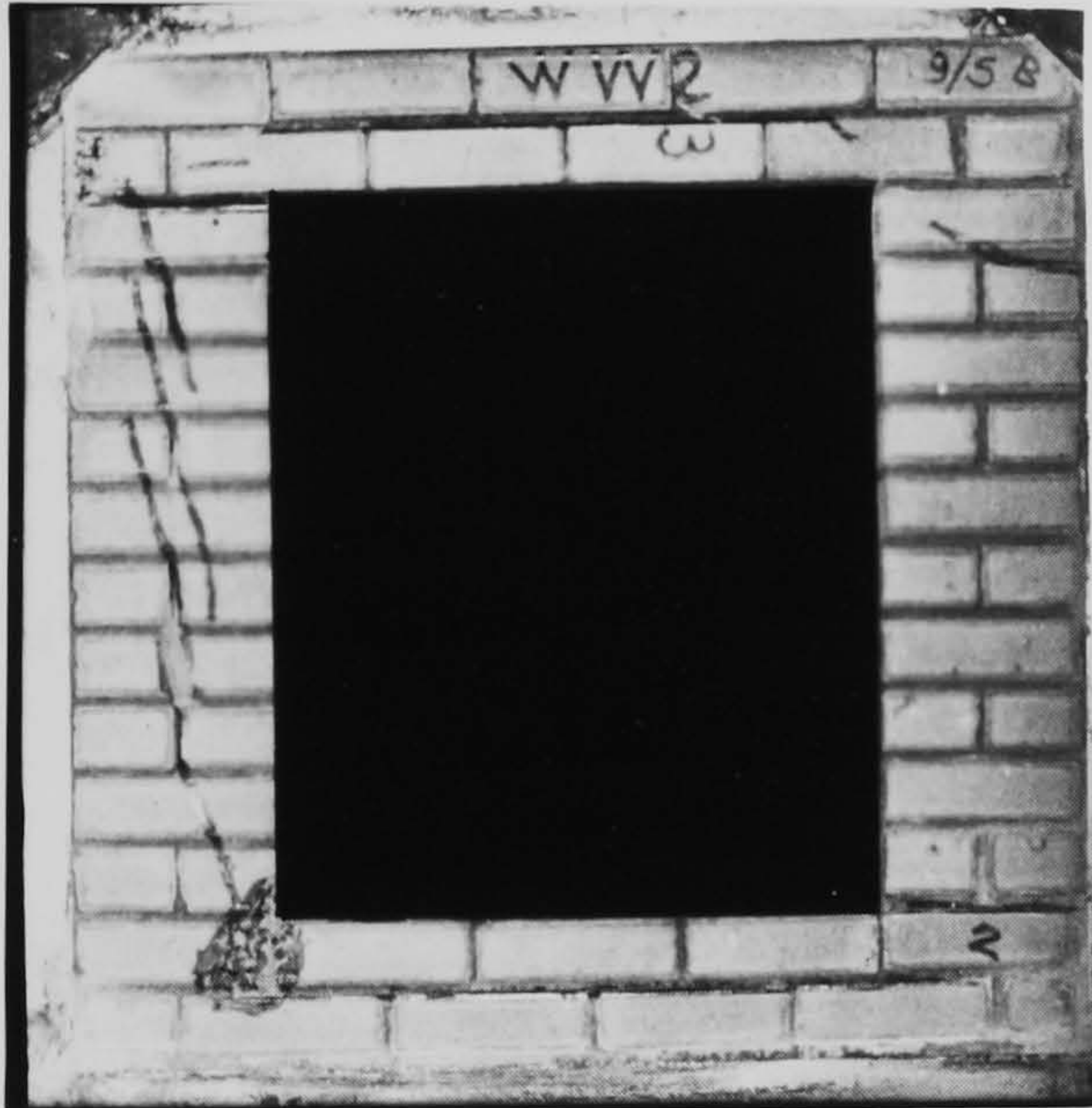

W W 2

D

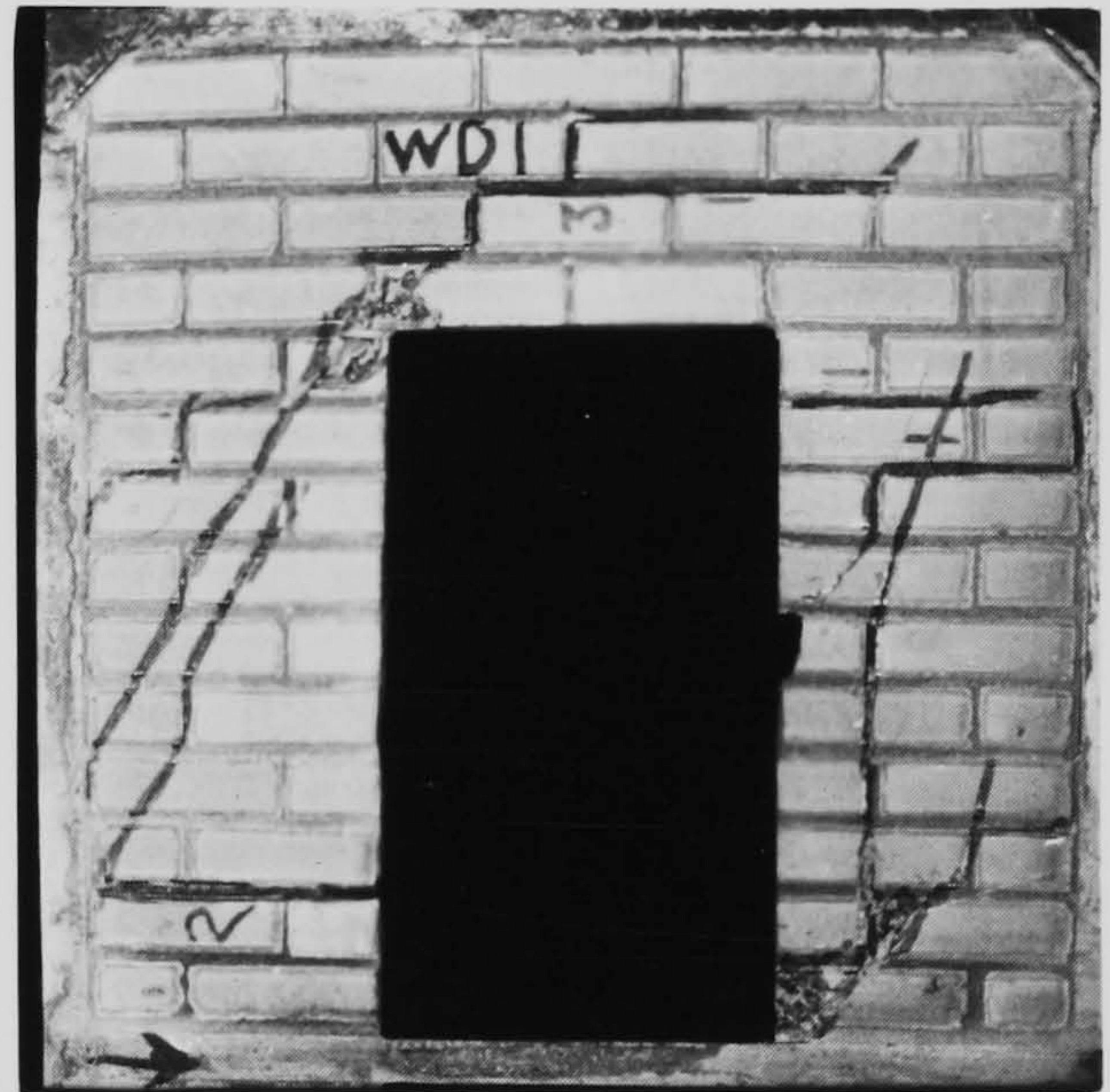

W D 1

PLATE (5) SQUARE PANELS CONTAINING
OPENING

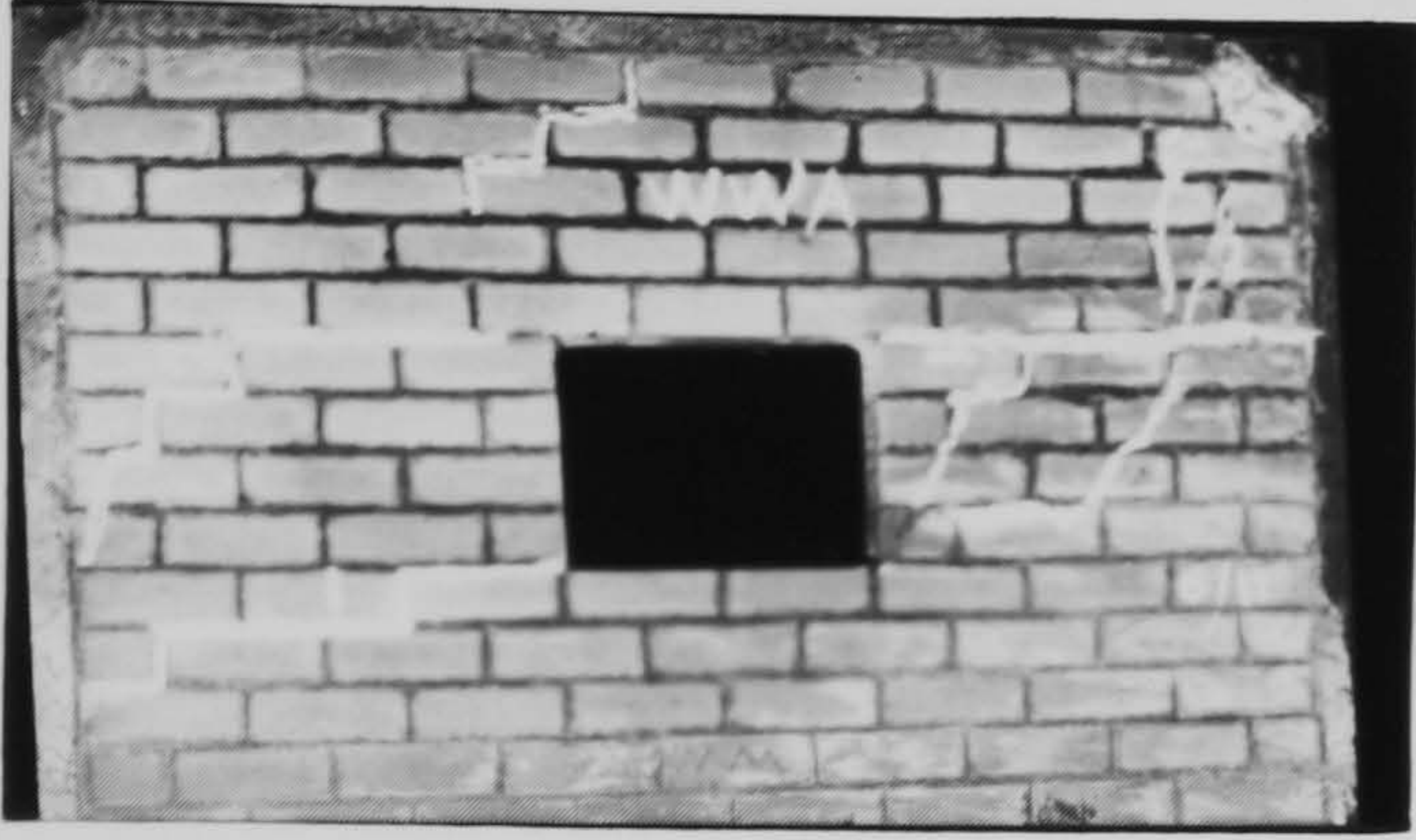

WVA

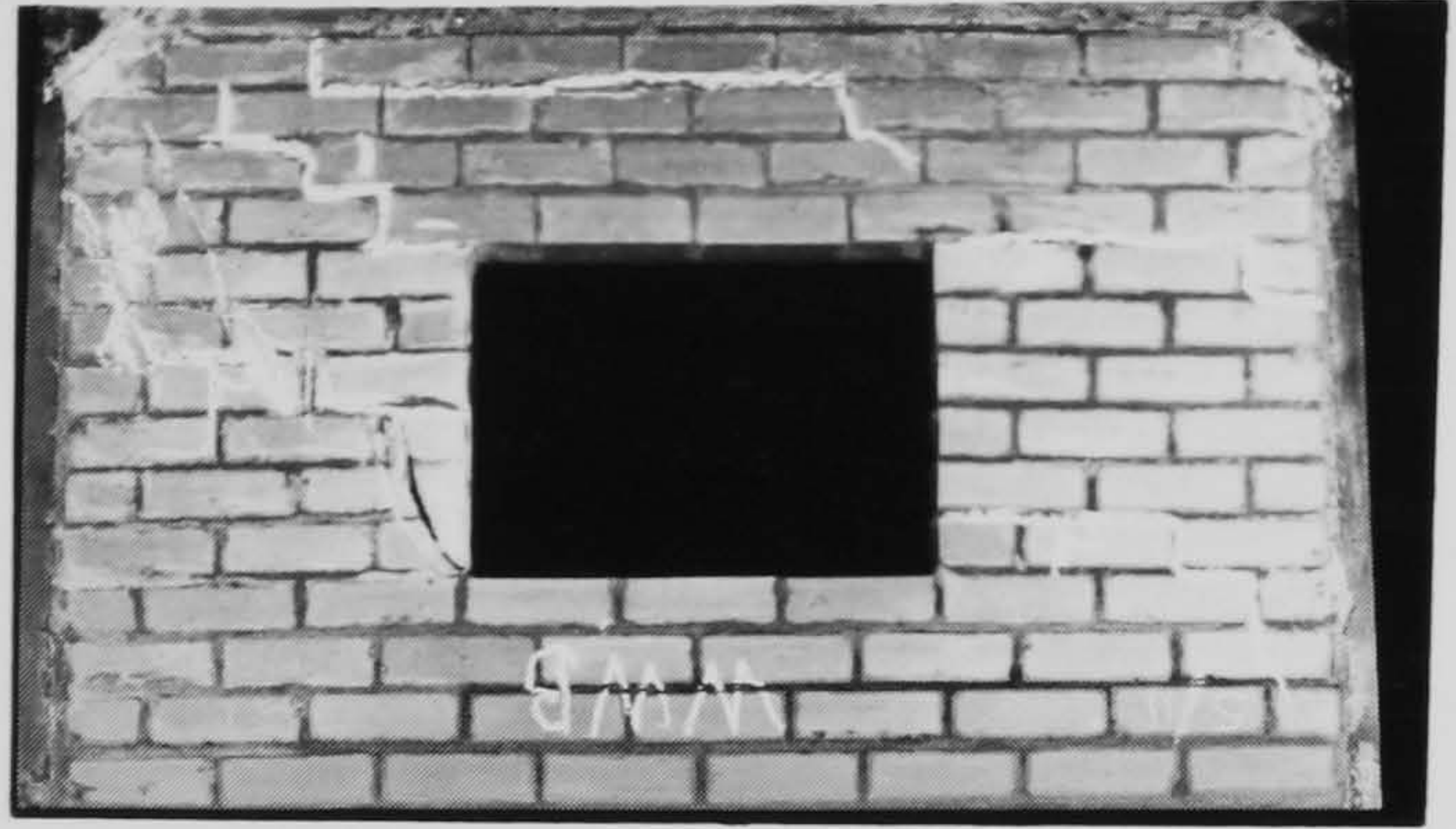

WVB

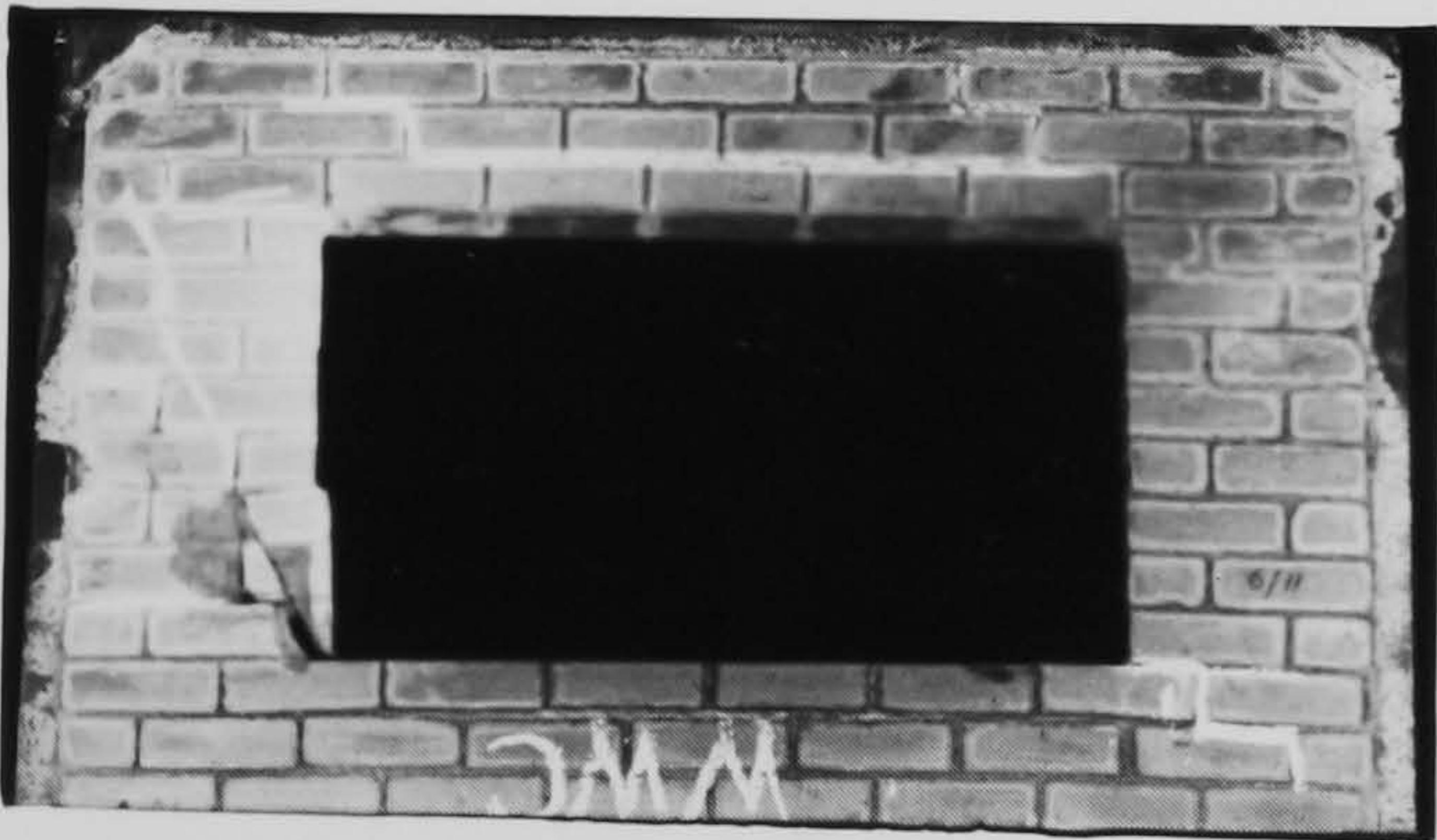

WVC

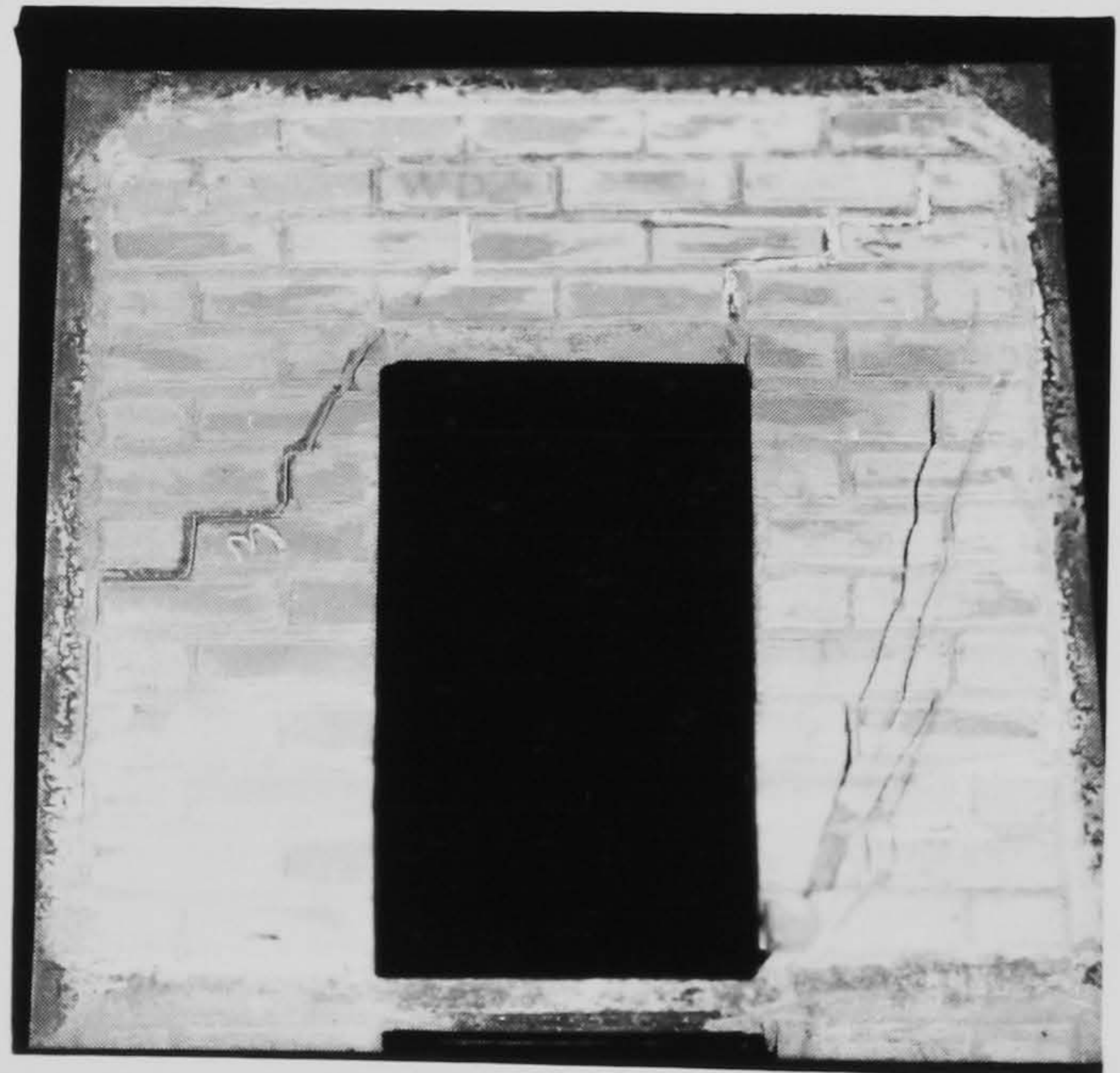

WD2

PLATE (6) PANELS WITH OPENING

opening followed in most cases by cracks above and below the opening. These cracks were either straight or stepping downwards. After cracking, separation of the frame from the panel occurred in some tests. At a load of about 70 - 90% of the ultimate load, the second mode of failure occurred. It appeared as a diagonal crack in the pier beside the windward column. In panels with small opening, this was followed by a diagonal crack in the other pier. The diagonal cracks passed through both bricks and mortar extending from the top corner of the pier to the opposite bottom corner along the compression diagonal. Diagonal cracks were sudden with a drop off load.

As the load increased, the diagonal cracks were followed by the third mode of failure, spalling and eventually crushing of the brickwork. The brickwork at the bottom corner of the windward pier along the compression diagonal started to spall off. As a resistance of the windward pier was decreased by spalling, most of the load was sustained by the opposite pier which in some cases led also to spalling there. As spalling and crushing increased, the load was then stopped. In some of the panels, soon after crushing, parts of the brickwork were about to come off the wall. At failure, the panels were still capable of sustaining 80 - 90% of the ultimate load, however, the deflection was increasing and the stiffness of the panel being almost equal to the stiffness of the bare frame. This stage defined the ultimate carrying capacity of the brickwork infilled frames containing opening.

Panels with openings reached their ultimate load at deflections less than the deflection of solid panels at failure. Panels containing very small opening were more like solid panels in their behaviour.

5.6 DISCUSSION AND EFFECT OF OPENINGS

The initial behaviour of the panels tested were notably different from the behaviour of panels without opening, for in solid panels as described earlier, after a short period of high or low stiffness the panel behaves as a diagonal bracing member inside the frame in which its response is almost linear, where in the panels containing opening, the initial stiffness was notably high and decreasing gradually up to the appearance of the first crack. This behaviour may be explained in this manner:

The walls were built tightly inside the frame (as in the case for solid panels), during the curing period shrinkage may occur which causes slight slackness of the panel inside the frame. This action is more apparent and considerable in solid panels rather than perforated panels. The initial bond which exists between the wall and the frame, although very weak, is still effective in case of panels with openings. The actual behaviour of the wall: in the case of full panels, the wall behaves as a solid panel and its deformation is very different from the deformation of the frame, where in panels with openings, especially with large openings, because of the flexibility of the perforated wall, its deformation is more analogous to the deformation of the frame, and the double arching action of the wall also may help to achieve this similarity.

All these factors prevent the separation of the wall from the frame, and they act in a manner close to the behaviour of a frame having composite members. However, this behaviour does not last long, as this produces tensile stresses at the corners of the opening along the compression diagonal which result in slight opening of the joints at/
at/

at these two corners then increases slowly towards the columns as the load increases. This explains the gradual decrease in the stiffness of the structure, and also explains the necessity for reinforcement at these locations in walls with low tensile strength materials such as masonry, where the weakest point is the bond between mortar and brick. The stiffness during this stage as well as the load at which the first crack appears are unpredictable, depending on the factors previously mentioned, and may produce very high stiffness even higher than that of a solid panel. Indeed panels (WW5), (WW6) and (WWA) showed higher stiffnesses, which were mostly due to the tight fit of the panel inside the frame. It is believed that this was mainly because of the curing. These walls as well as (WWA1) (WWB) (WWB1) and (WWC) had to be built outside the laboratory for some reasons, in a small room recently built, with no proper temperature and humidity control. Although the panels were tested after six weeks, it seemed that the walls were not dry enough, the moisture may have caused expansion of the brickwork resulting in a tighter fit inside the frame. As this initial behaviour is mainly time and workmanship dependent, it can not be relied upon in practice.

The first crack is actually not a shear type failure, it may be due to the tensile bond failure between the mortar and the brick which then extends outwards following the joints, straight or stepwise. In homogeneous materials such as concrete or mortar, these cracks extend towards the compression corners of the frame⁽⁹⁾.

The appearance of further cracks is random with a smooth increase of deflection, after the appearance of the first crack, the load deflection curves may be represented by an approximate straight line.

The/

The behaviour of the wall during this stage is analogous to a double arching action confined by the bounding frame. High diagonal forces are exerted on the two piers beside the opening, especially the one beside the windward columns, causing diagonal tensile cracks passing through both bricks and mortar, eventually resulting in spalling and crushing of the brickwork at the bottom corner of the pier along the compression diagonal defining the ultimate carrying capacity of the panel. This may be accompanied by spalling and crushing at the loaded corner of the frame. Because of the redistribution of the load, the panel is capable of sustaining a great portion of the load mainly carried by the opposite pier.

The two infilled frames with door opening behaved in a similar manner to panels with central opening. The first crack appeared at the top corner of the opening and at the joint with the base beam.

The infilled panels with central opening, as compared with solid panels, showed a reduction of about 60 - 85% of the cracking load and 0 - 58% in the ultimate load, depending on the size of the opening. Infilled panels with door opening showed reductions of 60% and 40% in the cracking and ultimate load respectively.

The initial lateral stiffness of the panels were difficult to estimate accurately, values given in Table (5.2) are approximate values, post-cracking values of lateral stiffness are also shown, these values represent the slope of the load-deflection curves after the appearance of first cracks.

5.7 AN APPROXIMATE METHOD TO DETERMINE THE STIFFNESS OF INFILLED FRAMES CONTAINING OPENING

5.7.1 Equivalent frame

One of the shortcomings of the method described in Chapter (4) is that/

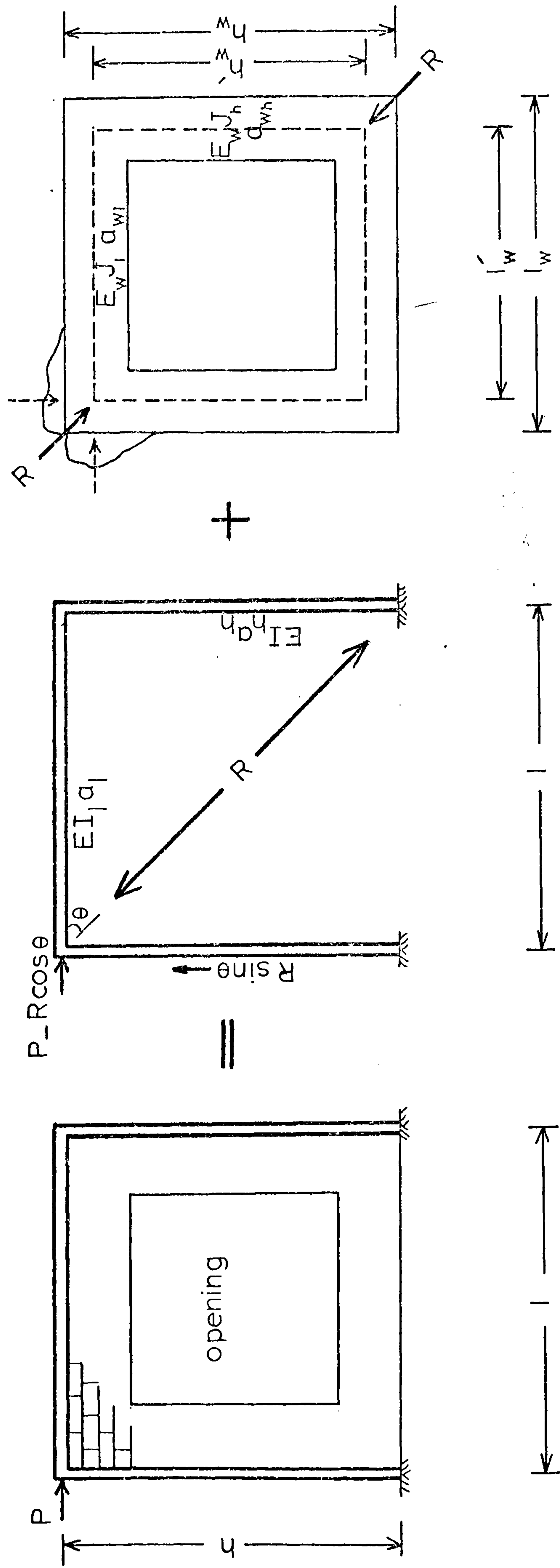

Fig.(5.3) Equivalent infilled frame containing opening.

that it cannot be applied to infilled frames containing opening.

With the presence of opening, an equivalent diagonal strut to replace the panel can not be assumed.

The following is an approximate method to analyse infilled frames containing opening, the method is based on the assumption that the panel acts separately inside the frame (the frame and the panel are not integral), as an equivalent frame acting diagonally along the compression corners. The method necessarily assumes that separation occurs between the frame and panel, and that the resultants of the reaction forces between the panel and the frame act at the centre lines of the equivalent frame members, hence producing a force along the panel diagonal Fig. (5.3), then the equivalent structure can be analysed to determine the lateral stiffness. The analysis which is derived in the following section, is only applied to infilled frame with opening at the centre of the panel.

5.7.2 Semi-composite lateral stiffness

The stiffness of an infilled frame containing opening may be predicted approximately as the sum of the lateral stiffness of the two components, i.e. frame and wall (equivalent frame).

The lateral stiffness of a bare frame K_f is :

$$K_f = \frac{12EI_h}{h_f^3} \left[\frac{6I_l h + I_h l}{3I_l h + 2I_h l} \right] \quad 5.1$$

The lateral stiffness of the equivalent diagonal frame K'_w is :

$$K'_w = \frac{24E_w}{h_w^2} \left[\frac{J_l J_h}{J_l h'_w + J_h l'_w} \right] \quad 5.2$$

Equation (5.2) is based on the lateral deflection at the intersection of the diagonal frame column and beam centre lines, from Fig (5.4),/

Fig. (5.4), the deflection at the centre line of the bounding frame beam, which is equal to the deflection of the bare frame; can be estimated approximately. Accurate determination of the deflection could be obtained from the values of angle of rotations at the joint, however, the method becomes more complicated and needs more calculations, the accuracy of this extra deflection is not essential considering the approximate nature of the method.

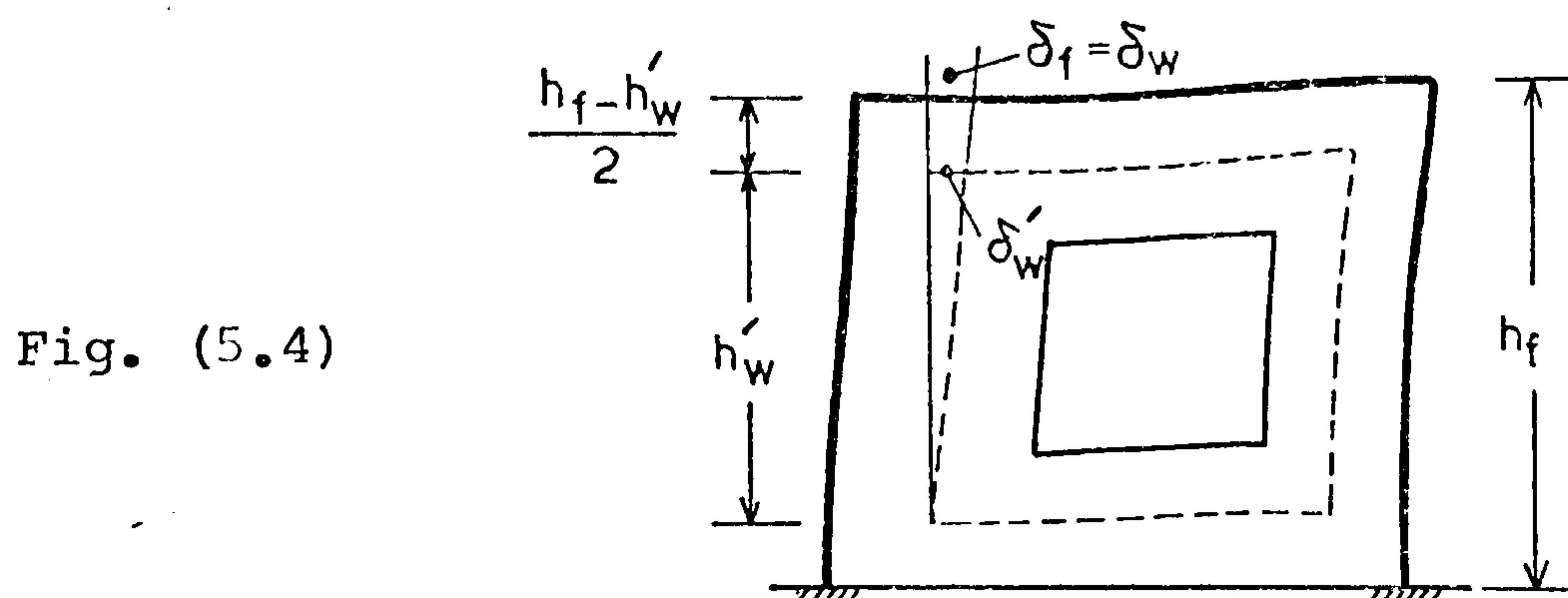

Fig. (5.4)

Referring to Fig. (5.4), from triangular similarities :

$$\delta_f = \delta_w = \frac{h'_w + h_f}{2h'_w} \delta'_w \quad 5.3$$

Combining equations (5.3) and (5.2), the lateral stiffness of the diagonal frame K_w becomes :

$$K_w = \frac{48 E_w}{h'_w (h'_w + h_f)} \left[\frac{J_l J_h}{J_l h'_w + J_h l'_w} \right] \quad 5.4$$

The sum of equations (5.1) and (5.4) gives the semi-composite lateral stiffness of the structure K :

$$K = \frac{12EI_h}{h_f^3} \left[\frac{6I_l h + I_h l}{3I_l h + 2I_h l} \right] + \frac{48 E_w}{h'_w (h'_w + h_f)} \left[\frac{J_l J_h}{J_l h'_w + J_h l'_w} \right] \quad 5.5$$

A more accurate estimation of the lateral stiffness based on the same principle can be made by the method of total strain energy as described in Chapter (4), taking into account, strain energy due to direct force in the windward column and bending moments for the bounding frame, strain energy due to diagonal bending and direct forces/

forces in all the members of the equivalent frame (wall). Equating the total strain energy and applying Castigliano's theorems: $\frac{\partial U_T}{\partial R} = 0$ and $\frac{\partial U_T}{\partial P} = \delta$, it can be shown that :

$$R = \frac{c}{\cos \theta (a+b+c+d)} P \quad 5.6$$

where R is diagonal load carried by the wall.

and lateral stiffness K :

$$K = \frac{(a+b+c+d)}{(a+b+d)c} \quad 5.7$$

where $a = \frac{\tan^2 \theta h_f^2}{a_h E}$, $b = \frac{h_w'^2}{24E_w} \left[\frac{J_l h_w' + J_h l_w'}{J_l J_h} \right]$

$$c = \frac{h_f^3}{12EI_h} \left[\frac{3I_l h + 2I_h l}{6I_l h + J_h l} \right] \quad \text{and} \quad d = \frac{1}{2E_w l_w'^2} \left[\frac{h_w'^3}{a_{wh}} + \frac{l_w'^3}{a_{wl}} \right]$$

Equation (5.7) gives results which are about 3.5% higher than results obtained from equation (5.5). The method could be extended to infilled frames containing door opening, if appropriate value of lateral stiffness is substituted in the second term of equation (5.5) by assuming an analogous equivalent frame such as a portal frame fixed or hinged at the base. Results given in Table (5.2) are estimated from the first method.

5.8 COMPARISON OF RESULTS

A close comparison between experimental and estimated values of stiffness could not be made because of the wide variation in experimental results obtained.

The estimated values in some cases are lower than the initial stiffness values and higher than the post-cracking stiffness values, in others the estimated values are either higher than both, or lower than/

than both experimental values. These variations could be due to many factors; the estimated values are based on an assumption that separation between the frame and panel occurs, and the method is applicable only to a pre-cracking stage. As for the initial values, since no separation occurred, the method therefore does not apply, the first crack then followed gradually at very low load which led to a deterioration in the stiffness of the panel, because of this cracking the method is also not applicable at this stage. If there had been a stage where separation was clear before the appearance of cracks, the method might have given a closer estimation of the stiffness of the structure. The behaviour of some of the panels as described in Section (5.6) may also have contributed in widening the difference between the experimental results.

For the panels with large opening area, the estimated values lay between the two values of measured stiffness. Since the high initial stiffness is mainly time, bond and lack of fit dependent, which can not be relied upon in practice, the estimated values may well give real estimation of stiffness of the structure.

The equivalent frame method itself is a very approximate representation of the actual structure, unless the opening is large; the panel would actually behave more like a solid panel than a frame. The stiffness would be over-estimated for panels with very small openings or with no opening at all.

As no separation occurred before cracking, the panel was thought to be acting as an integral composite structure. A method based on this approach has been presented by Liaw⁽²⁵⁾, which assumes that part of/

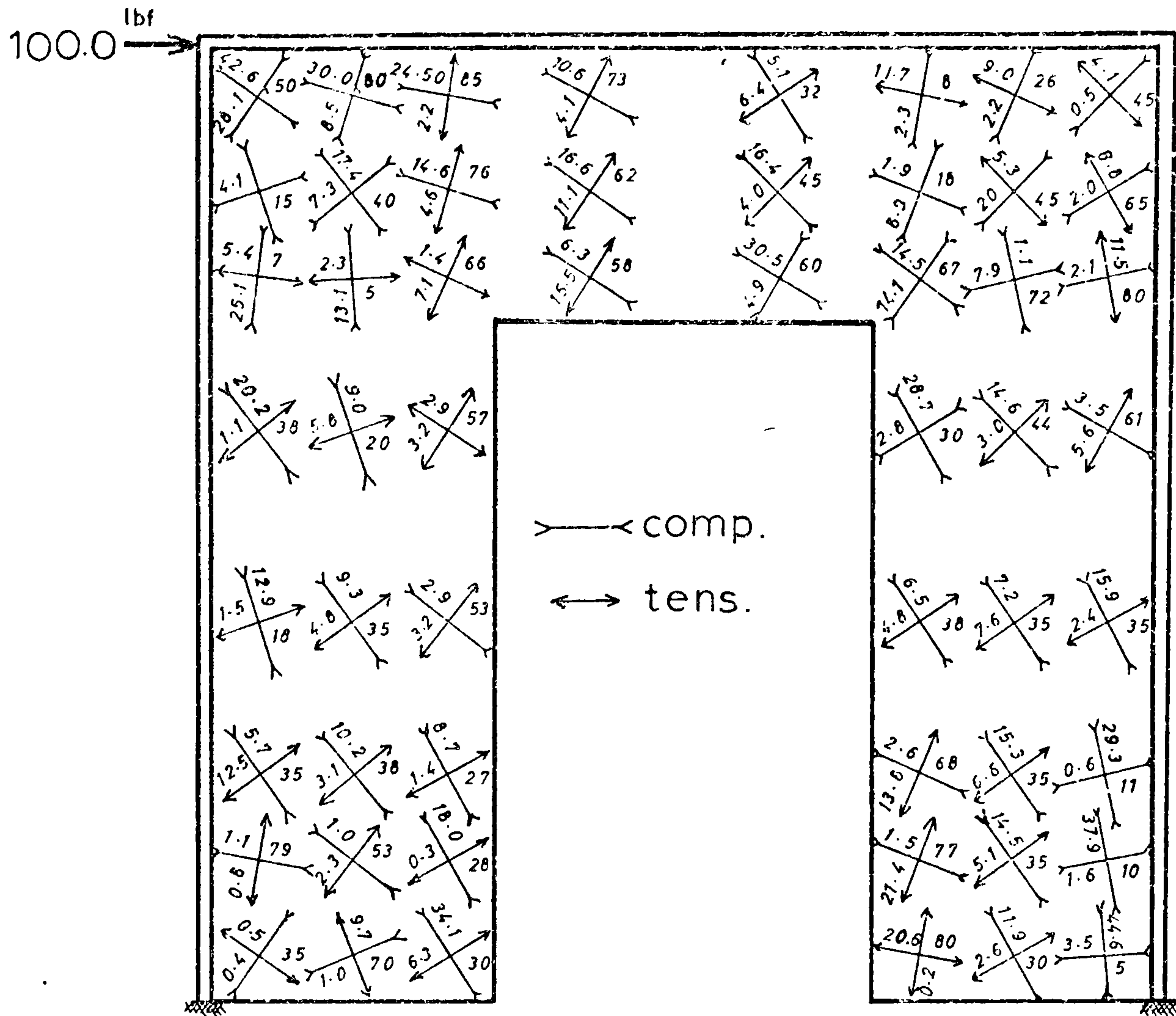

Fig.(5.5) Maximam principle stresses (WD)

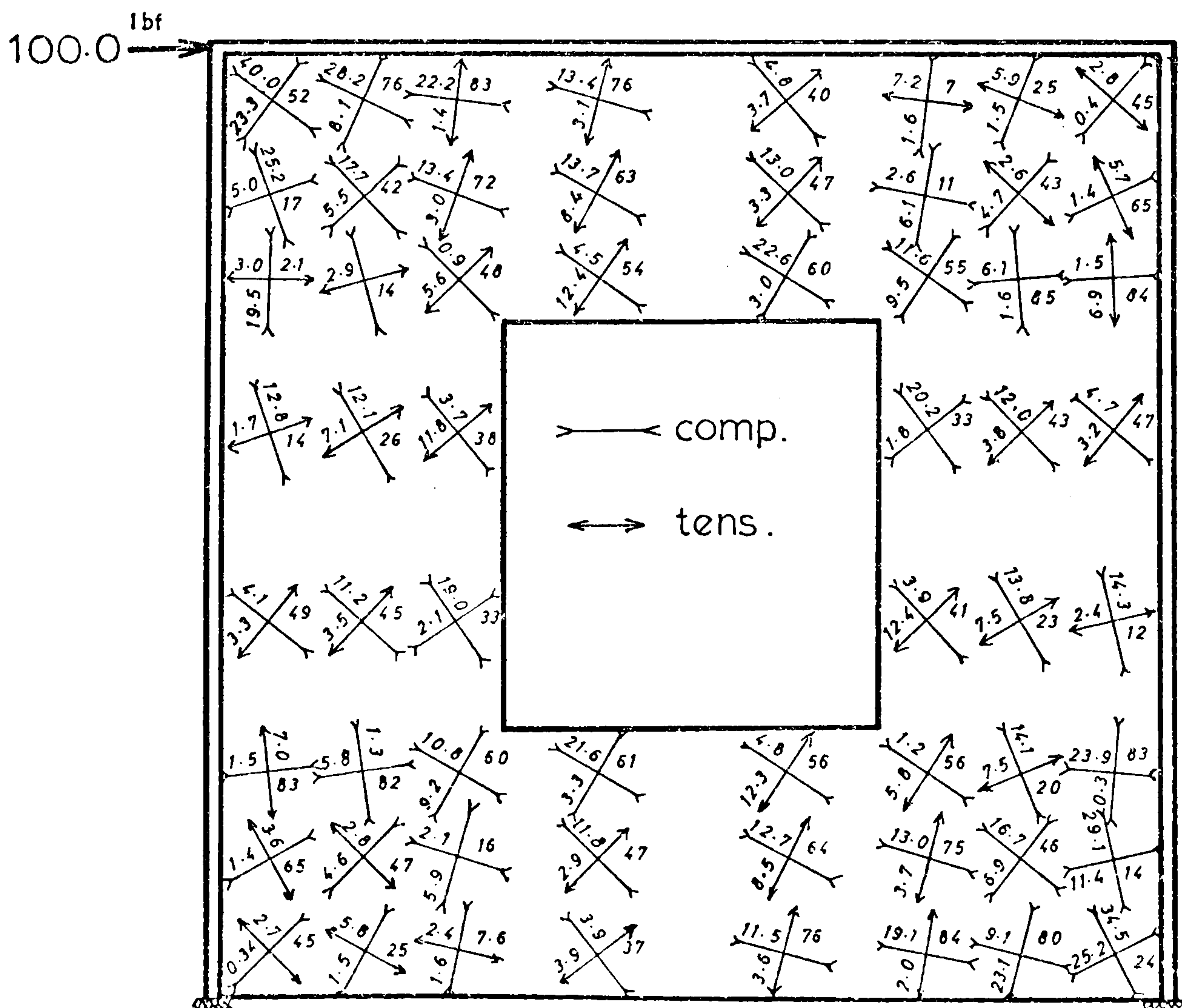

Fig. (5.6) Maximam principle stresses (WW1)

of the wall combined with the frame member would form a composite member. This method was applied to the panels tested, results were more than 100% higher than the experimental initial stiffness values. It seemed that the assumed separation by the author, although not accurate gave results closer to the experimental values.

Analyses were also carried out by the finite element method as described in Chapter (4). No friction forces were introduced, results are shown in Table (5.2). For panels with a large opening, results are comparable to the approximate method values. The maximum principle stresses for WD and WW1, are shown in Figs. (5.5) and (5.6). High tensile stresses are induced at the opening corners along the compression diagonal which explains the formation of initial cracks at such locations.

A few analyses were made where no separation between the frame and the panel were allowed, results were very much higher than the experimental results and closer to the values estimated by the method proposed by Liauw⁽²⁵⁾.

5.9 CONCLUSIONS

Because of the limited number of experiments carried out and the wide variation in results obtained, a definite conclusion could not be drawn, however, the investigation showed several findings which may be summarized as follows :

1. As would be expected the presence of a central opening in an infill panel reduces the stiffness and strength of the infilled frame. The amount of reduction depends on the size of the opening.
2. The initial stiffness may be very high depending upon many factors.
- 3./

3. The first cracks appear at the corners of the opening along the compression diagonal, extending along the interface between the mortar and bricks.
4. The ultimate load is reached when spalling of the brickwork occurs at the compression corners of the opening. After the compression failure, the panel is capable of sustaining 80 - 90% of the ultimate load, however, the stiffness of the panel at this stage is not much higher than the stiffness of a bare frame.
5. The stiffness of an infilled frame containing an opening may be approximately predicted by analysing the structure assuming the infill as an equivalent frame inside the frame acting along the diagonal.
6. A better analysis for an infilled frame with opening may be made by the method of finite elements.

CHAPTER 6MULTISTOREY INFILLED FRAMES6.1 INTRODUCTION

In the previous chapters, the behaviour of idealized single-storey single-bay infilled frames with or without opening has been discussed, and methods for predicting their behaviour have been presented. In order to obtain a wider picture of the behaviour of infill panels in actual structures, the investigation should be extended to the study of multi-storey and multi-bay infilled frames, for it is mostly in tall buildings that the effect of lateral forces becomes important and the governing factor in their design. Several factors may affect the behaviour of infill panels in framed structures, such as, the surrounding panels, vertical loadings if these were designed to be carried by the panel, change in panel length at a certain height of the structure, torsional forces and many other factors which affect the design of a multistorey structure. Detailed study of these factors is beyond the scope of this work, and because of the limited time available, this investigation was limited to a number of primary tests on multi-storey and two-bay single-storey infilled frames. It is hoped that further study is to be carried out in the near future.

In an attempt to simulate the restraints exerted on a panel by adjacent infills of a multi-storey multi-bay system, Mainstone⁽²⁸⁾ carried out tests on single storey infilled frames with very stiff members; a greater carrying capacity was observed. Tests on two-storey single bay model infilled frames have been reported by others.^(18,50) Smolira⁽⁵⁶⁾ has presented a paper describing a method of analysis for multi-storey infilled frames based on the concept of an equivalent diagonal/

diagonal strut, the analysis was carried out by the force-displacement method (details are given in Chapter 2). Smith⁽⁵²⁾ has recommended analysing infilled frame structures as an equivalent pin-jointed truss.

In this Chapter the behaviour of a number of two, three and four-storeys and single storey two-bay model brickwork infilled frames is discussed. An approximate method to analyse multi-storey infilled frames is presented, the method being based on a storey-stiffness approach which includes simple calculations described in Chapter (4).

6.2 MATERIALS, CONSTRUCTION AND TESTING DETAILS

Materials and construction method were as described in Chapter (4). The two-storey infilled frames with two points loading were tested on the back-to-back principle in a manner as shown in plate (7).

The four-storey frame was tested as a vertical cantilever, plate (9), the base was welded to a thick plate (26 x 10 x 1) inches, which was strongly bolted to the reinforced concrete laboratory floor. A single load was applied at the top floor beam level. The load was applied using a jack against a 3-ton load cell. The load was applied at an increment of 0.025 ton, deflections were measured at each floor level by means of 0.0001 inch dial gauges. A dial gauge was also put at the base to measure any rotation which might occur. The panel was restrained against lateral movements other than in the direction of the applied load.

The structure was loaded up to the appearance of the first crack, the load was then stopped and the panel was tested with the load at the third-storey level. The load was increased up to 50% of the cracking load and was then released. The top panel (wall and frame) was cut off from the structure and was re-tested again as a three-storey structure/

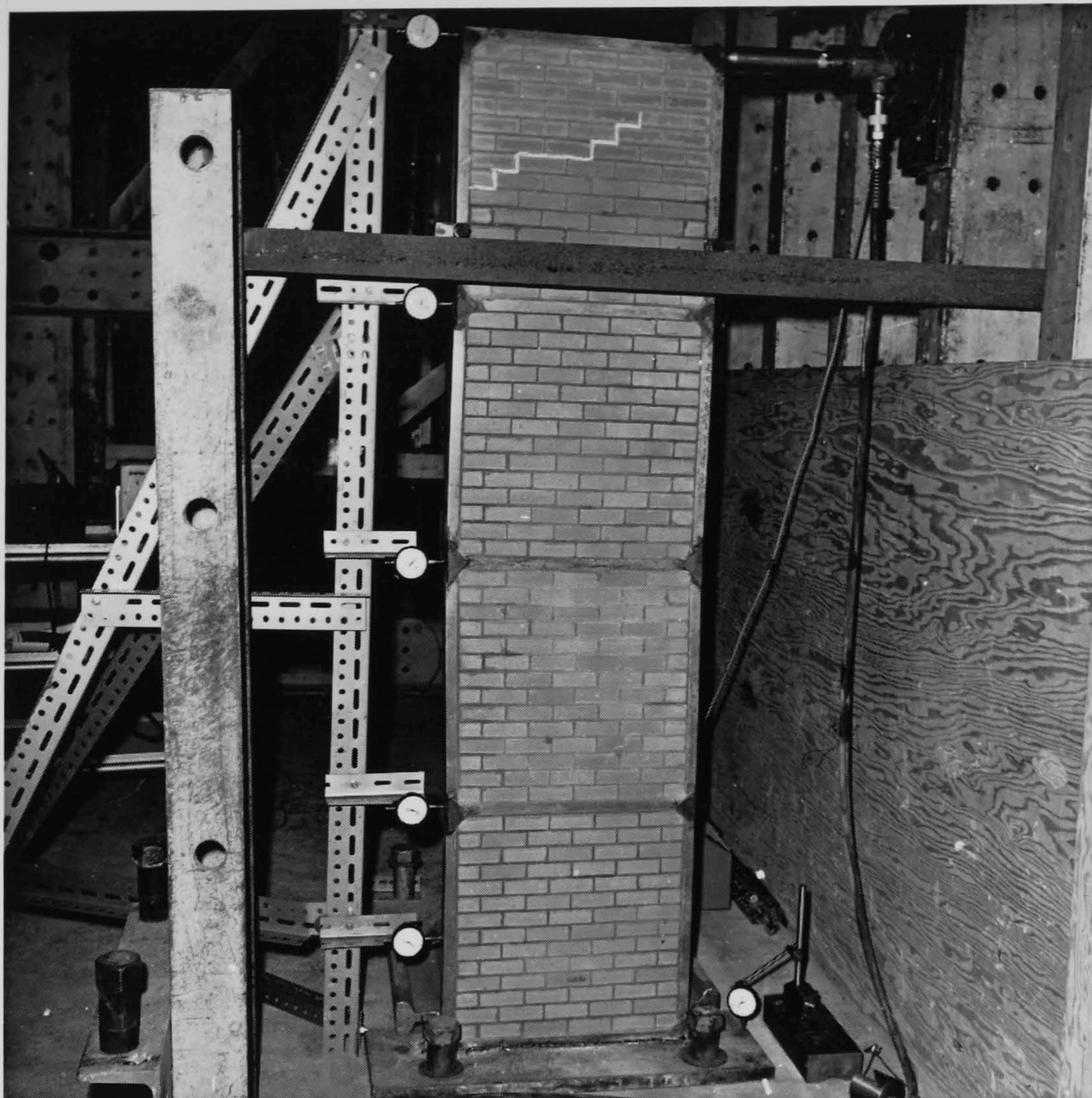

PLATE 9 TESTING ARRANGEMENT (4S)

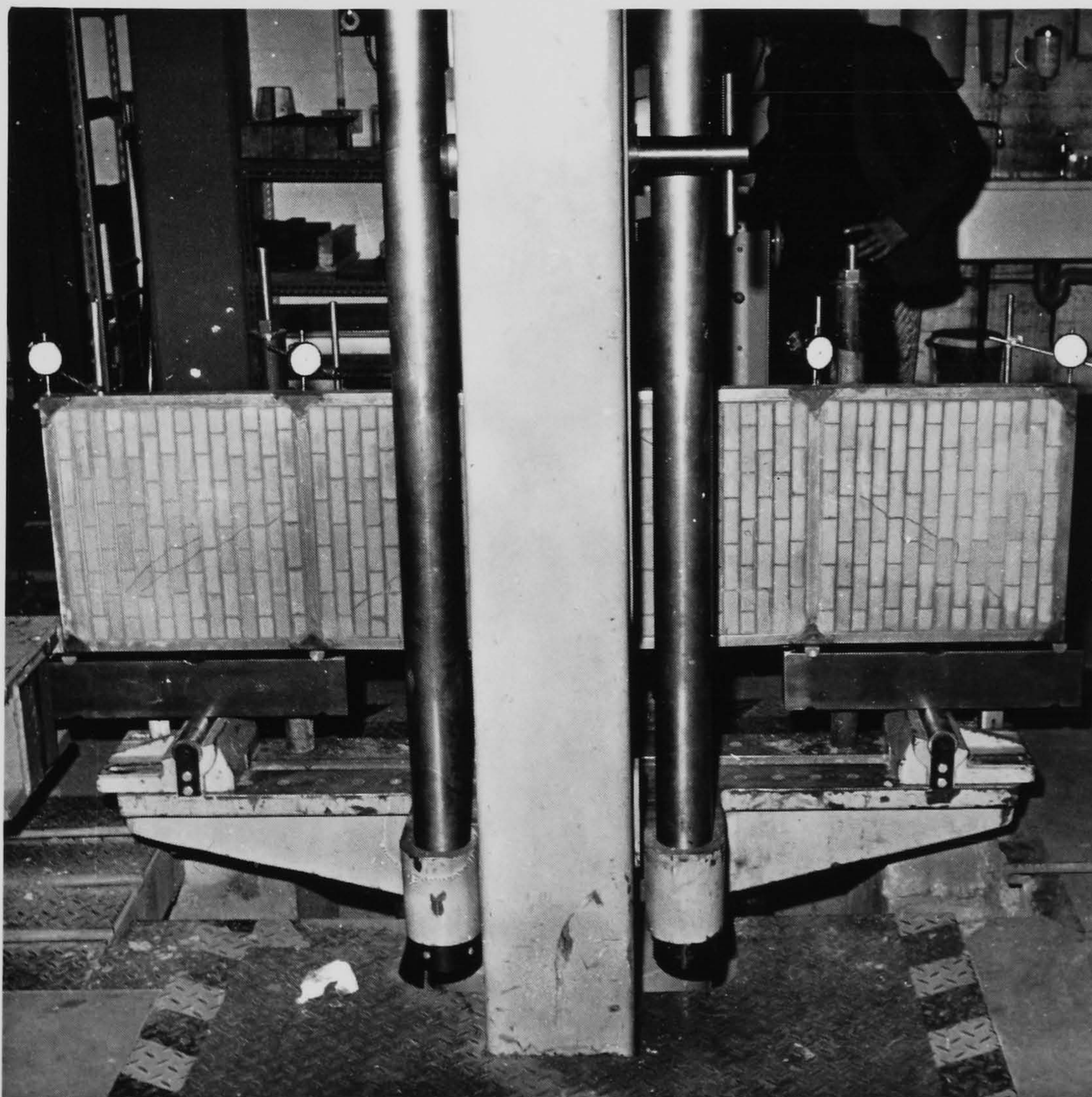

PLATE 7 TESTING ARRANGEMENT FOR
THE TWO-STOREY PANELS



TSI



TS4



WBI

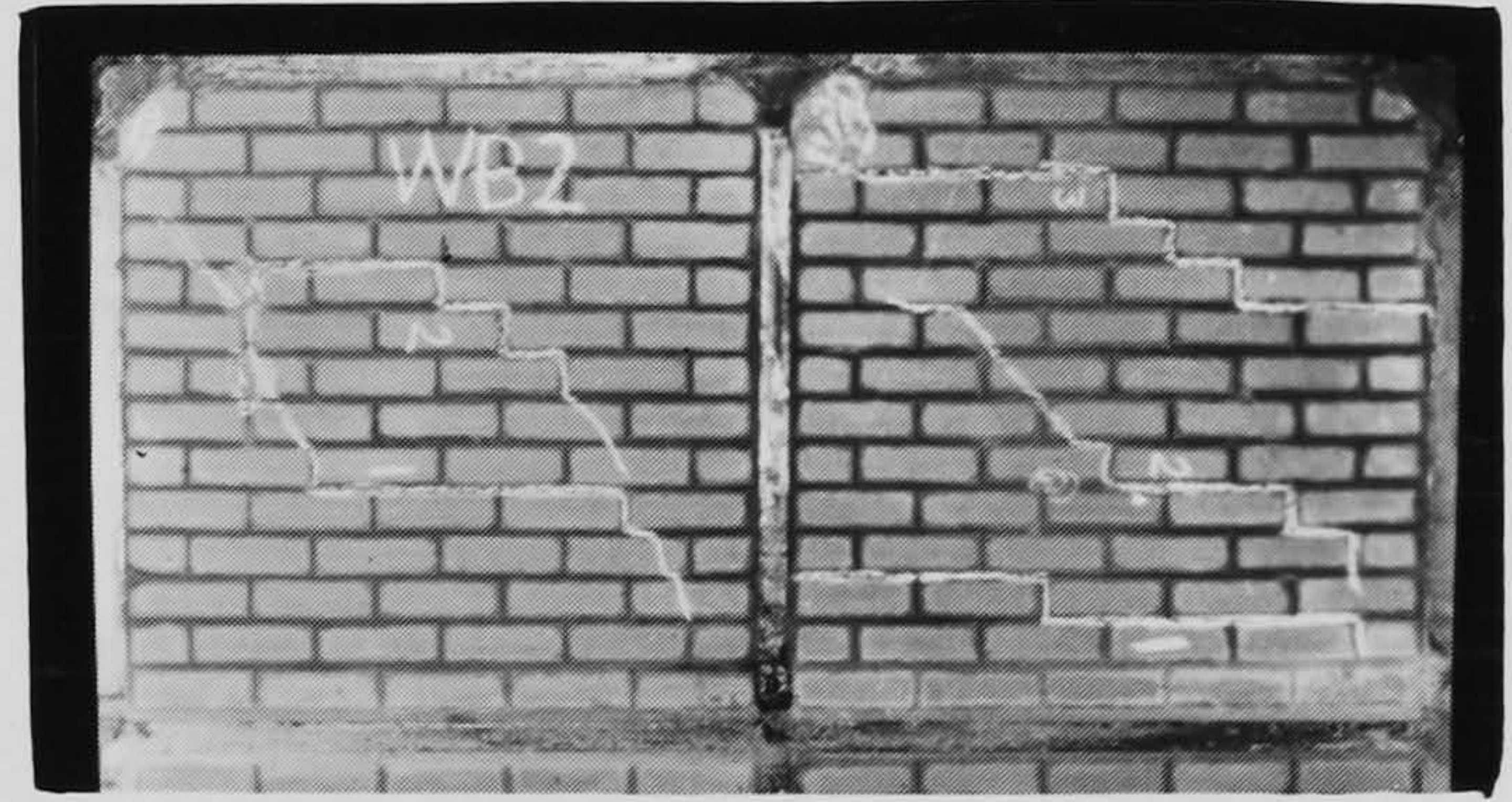

WB2

PLATE 8 TWO-STOREY & TWO-BAY
PANELS

structure up to cracking failure. This procedure was repeated and the structure was tested as two and one-storey infilled frames. The two-bay single-storey panels were tested in the duplicate form.

6.3 RESULTS

Load-deflection and storey-deflection curves are shown in Figs. (6.1) to (6.7). Table (6.1) shows the dimensions and cracking load for all the panels; the ultimate load for the two-storey panels with two point loading and for the single storey two-bay panels are also shown in Table (6.1).

6.4 DISCUSSION OF RESULTS

6.4.1 Multi-storey panels

The general behaviour of the panels TS1, TS2, TS3 and TS4 was similar to that of single storey panels. Separation at the early stages of loading was clearly observed in all the panels at both storeys. In all the tests separation occurred first at the lower storey and was then followed by the upper storey. The first shear crack, Plate(8), always occurred at the lower storey, the cracking load was higher than that of a single storey structure with the same properties. This was followed by more cracks before the appearance of the first cracks at the second storey. At a higher load shear cracks appeared at the upper storey, always as a set of discontinuous cracks near the middle of the panel, and in most cases, particularly in square panels, they passed through both bricks and mortar. Near ultimate load spalling of brickwork started at both corners along the compression diagonal at the lower storey, then extended inside the panel.

The ultimate load was reached before spalling began at the upper storey./

Test No	Type	Panel h x l (inches)	Frame (inches)	Cracking load (ton)	Ultimate load (ton)	Remarks
WB	One-storey- two-bay	15.75 x 15.75	0.75x1.50	1.40	10.25	
WB1		15.75 x 15.75	0.75x1.50	1.70	9.62	
WB2		15.75 x 15.75	0.75x1.50	2.20	10.00	
TS1	two-storey	15.75 x 15.75	0.75x1.50	1.10	4.76	Two-Point load (load = 2P)
TS2	two-storey	15.75 x 15.75	0.75x1.50	1.10	5.00	Two-Point load (load = 2P)
TS3	two-storey	25.25 x 15.75	0.75x1.50	1.30	8.50	Two-Point load (load = 2P)
TS4	two-storey	25.25 x 15.75	0.75x1.50	2.10	8.00	Two-Point load (load = 2P)
4S	four-storey	15.75 x 15.75	0.75x1.50	1.10	-	Single load at the top.
3S	three-storey	15.75 x 15.75	0.75x1.50	1.25	-	Single load at the top.
2S	two-storey	15.75 x 15.75	0.75x1.50	1.35	-	Single load at the top.
1S	one-storey	15.75 x 15.75	0.75x1.50	1.42	-	Tested as: 

Table (6.1). Multi-panel experimental results.

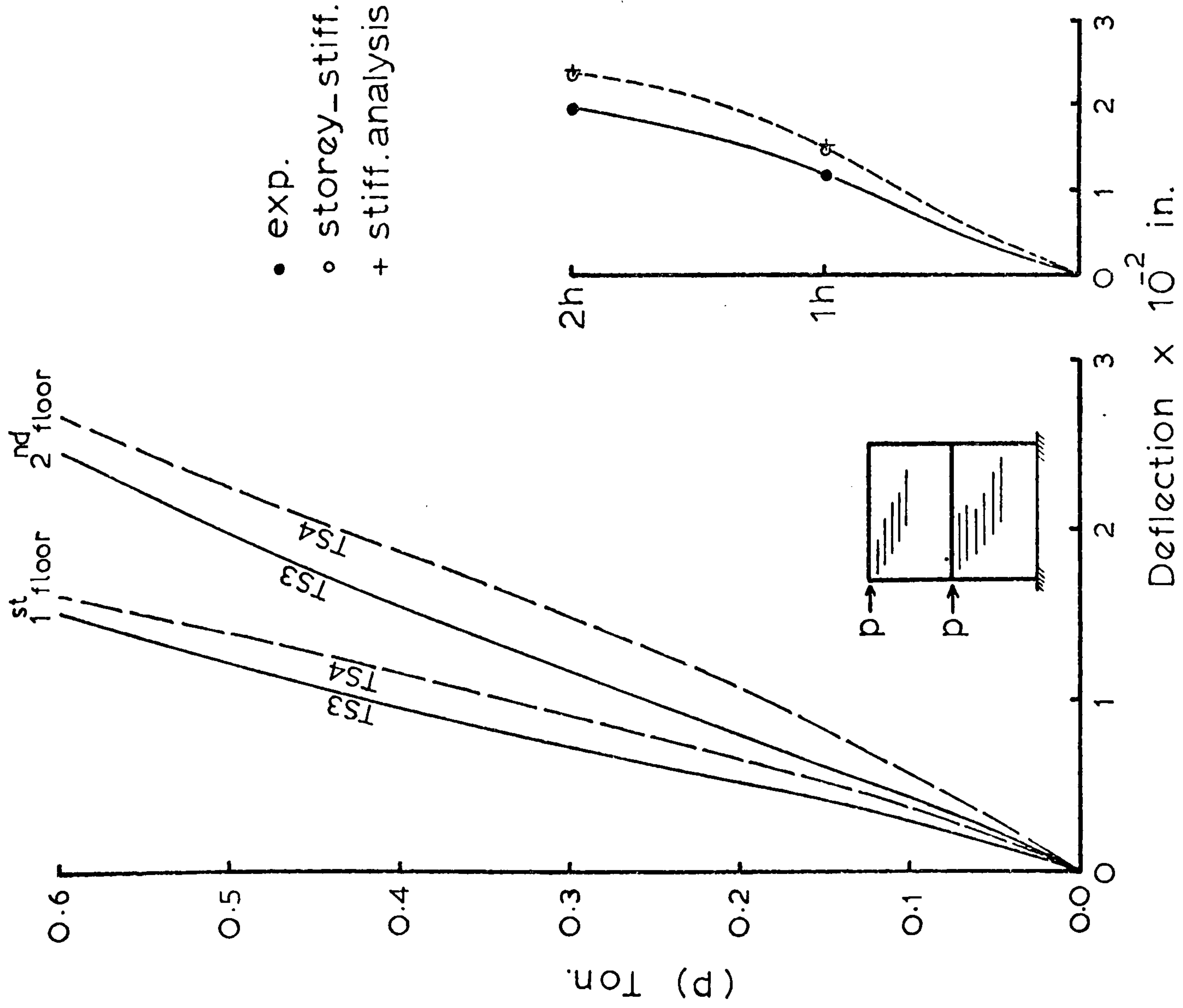

Fig.(6.1) Load & storey deflection curves
(two-storey rect.)

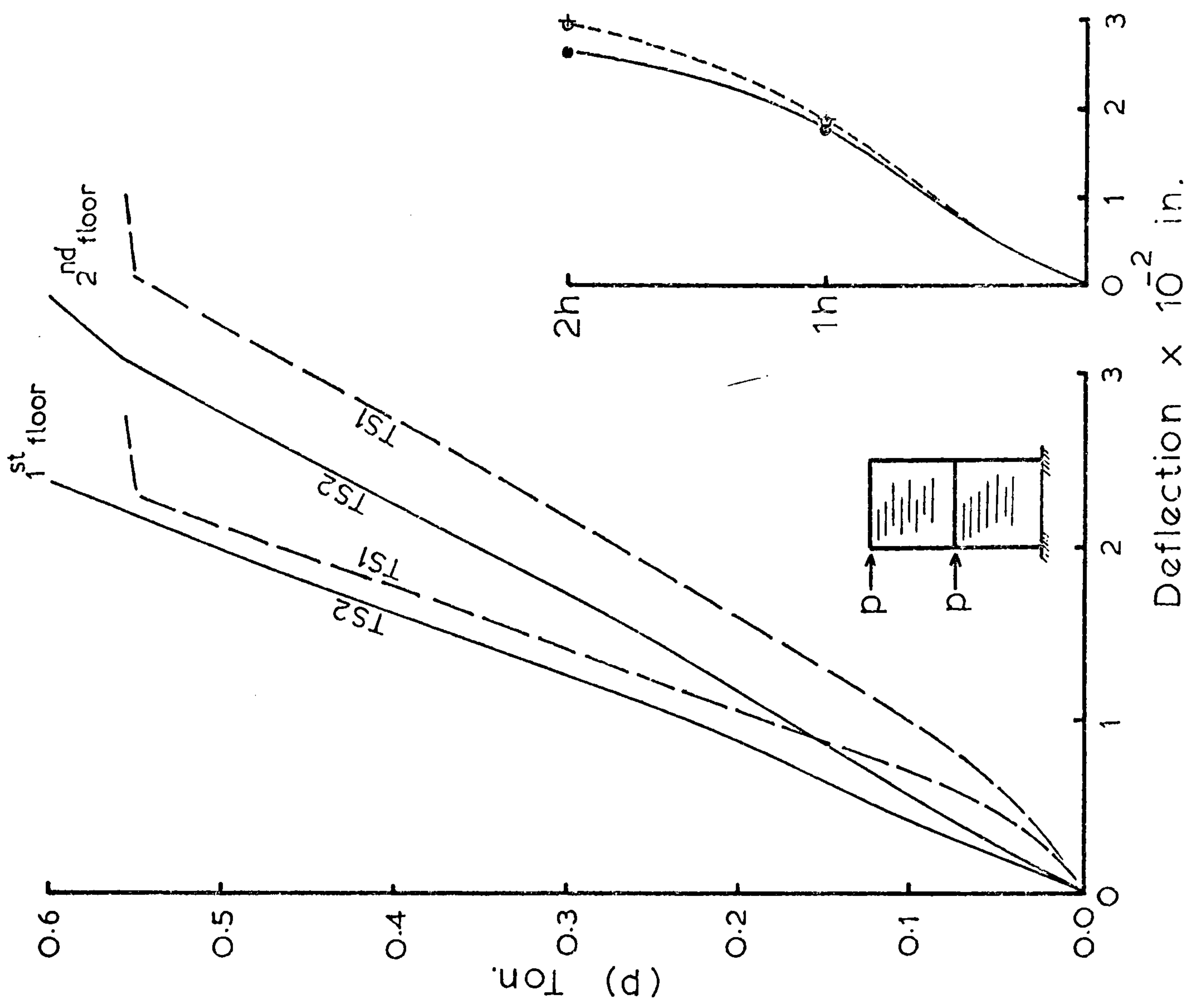

Fig.(6.2) Load & storey deflection curves
(two-storey square)



Figure 2: Storey deflection curves (4S)

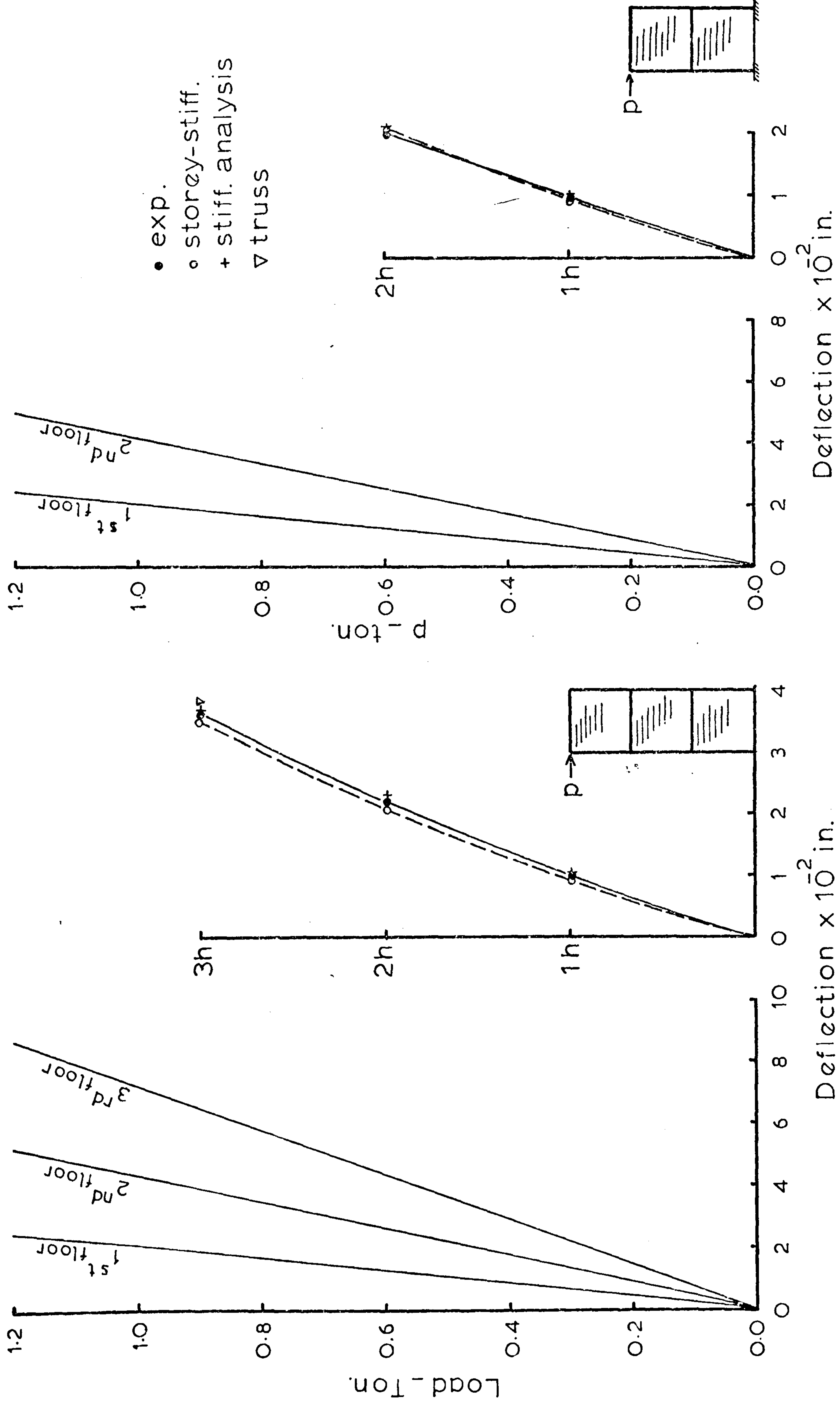

Fig.(6.4) Load & storey deflection curves (3S) · Fig.(6.5) Load & storey deflection curves (2S)

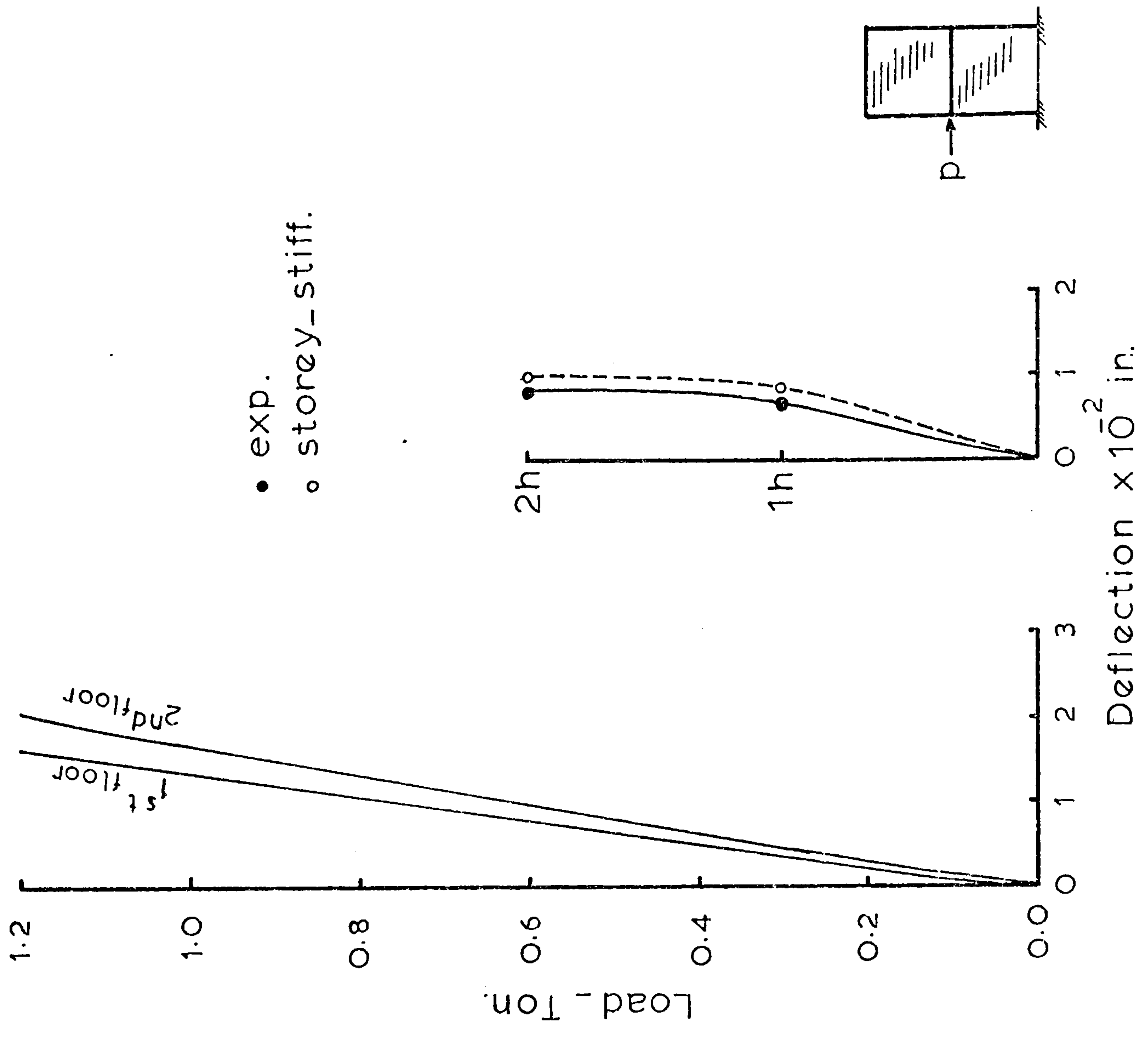
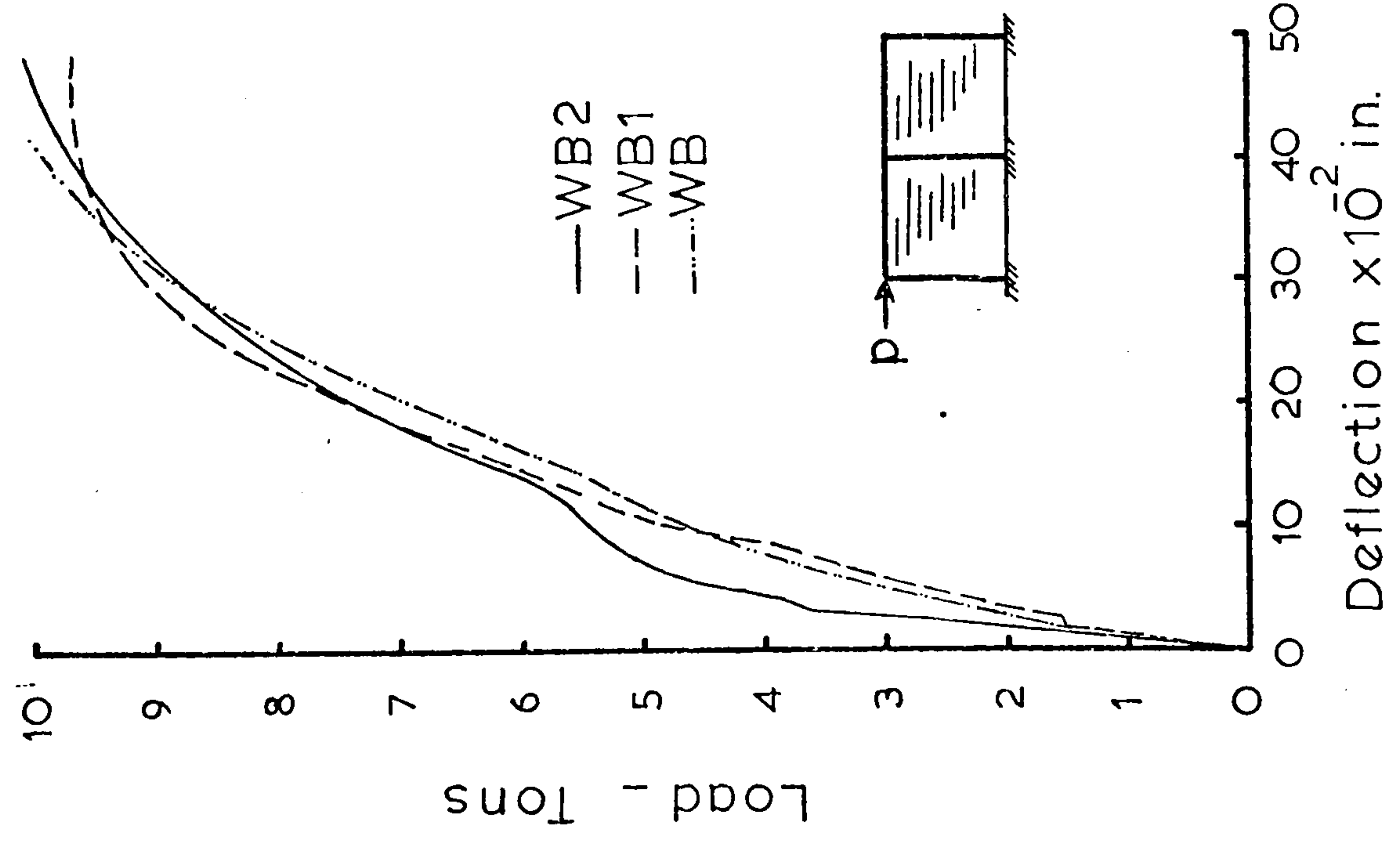

Fig.(6.6) Load-deflection curves (2-bay)

Fig.(6.7) Load & storey deflection curves (1S)

storey. The failure load ($2p$) was considerably higher than that of a single storey panel. These increases in strength, especially the ultimate strength, may be explained as follows: Because of the continuity of the structure and the presence of the upper panel, the stiffness of the first storey beam is increased and the rotations of the frame joints are reduced. These modify the interaction forces transmitted from the frame to the panel, maximum stresses are reduced and less concentrated at the corners. The prevention of joint rotation at the bottom storey was clearly demonstrated by the consequent appearance of spalling at both corners along the compression diagonal, as against the single storey panels in which spalling always occurred at the upper corner.

As for the multi-storey panels with a single point load, they were not tested up to failure. The first shear crack always appeared at the top panel, separation was clearly observed at the bottom storeys and not so clear at the top storeys. The cracking loads were always higher than the corresponding load for a single one-storey panel.

All the tests showed non-linear behaviour in the early stages of loading, Figs. (6.1) to (6.3), either because of the initial lack of fit, or because of the initial bond, after which the load-deflection curves are linear. However, for panels 3S, 2S and 1S, Figs. (6.4), (6.5) and (6.7), the load-deflection curves are linear. This is because during the first loading, i.e. when the panel was tested as a four-storey structure, the initial bond was broken, Fig. (6.3), and the walls were mainly resting within the frame.

The storey-deflection curves which are shown in Figs. (6.1) to (6.5)/

(6.5) are taken from the slope of the linear part of the curves, and they are corrected accordingly, for a load of $p = 0.5$ ton.

Tests 4S, 3S, 2S and 1S showed some rotation at the base plate, deflections due to base rotation have been measured and were subtracted from the total deflections, the curves shown in Figs. (6.3) to (6.5) and (6.7) are therefore the corrected curves.

6.4.2. Two-bay single-storey panels

Three identical tests WB, WB1 and WB2 were carried out on two-bay single-storey panels Fig. (6.7), their behaviour was similar to that of single-bay panels. Separation was clearly observed at both panels, initial cracking at both panels one followed the other, and spalling near the corners first appeared at the near bay then was followed by spalling at the other panel. However, because of similar reasons to those described earlier, their strength and stiffness were much higher than the sum of two single panels having the same properties. Results were also higher than that of a single rectangular panel with the same height and length but with no intermediate column (WL2 series). As a conservative measure, the stiffness and strength of a two-bay panel may be taken as the sum of two single-bay panels.

6.5 AN APPROXIMATE METHOD FOR DETERMINING THE DEFLECTION OF MULTI-STOREY INFILLED FRAMES.

A simple method to determine the deflection of multistorey infilled frames under lateral loading is described below, the method is termed "storey-stiffness" method. It is based on the measured or estimated stiffness of a single storey infilled frame. For a multi-storey infilled frame, the deflections of a number of storeys are added together to obtain the total deflection at each floor level. The deflection which/.

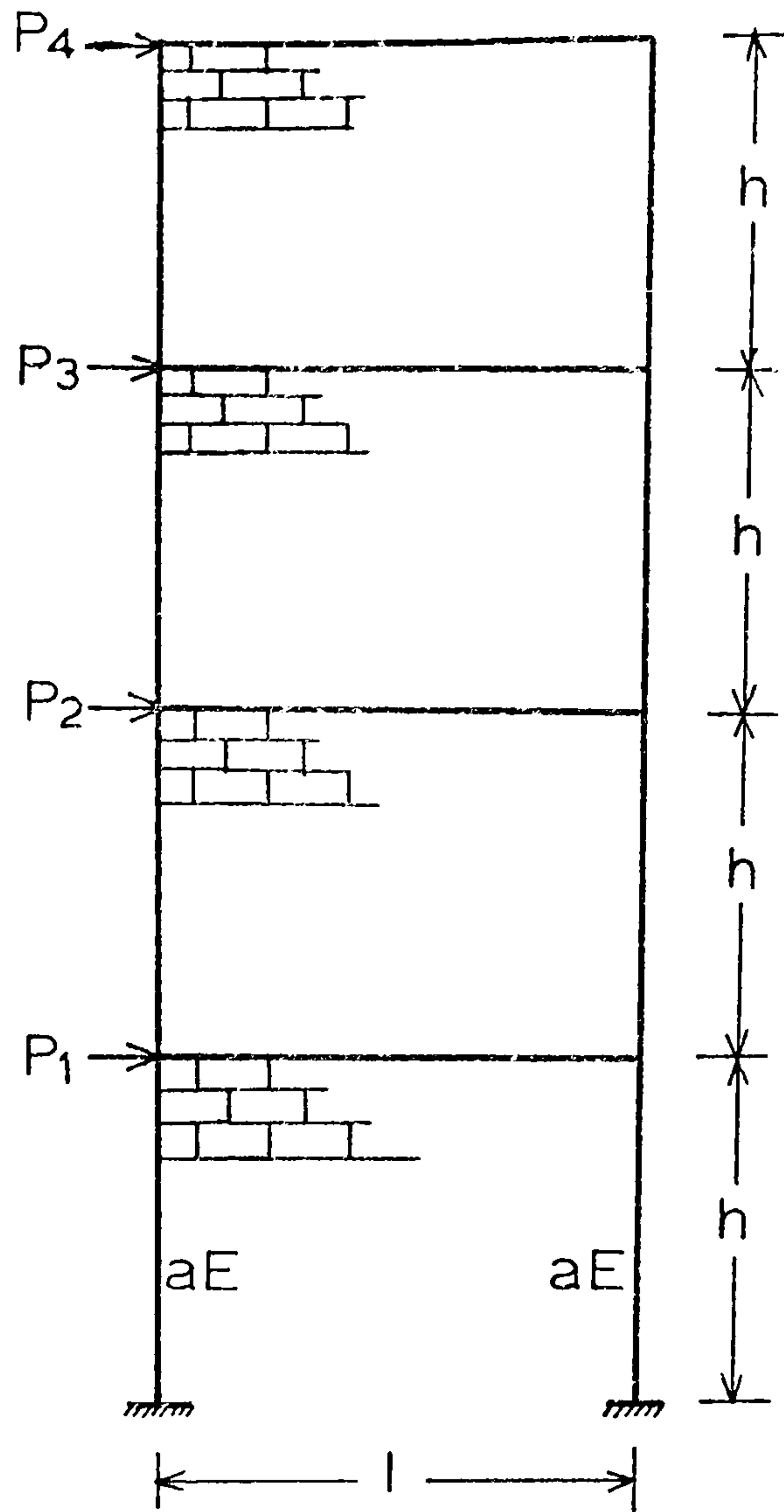

Fig.(6.8a)

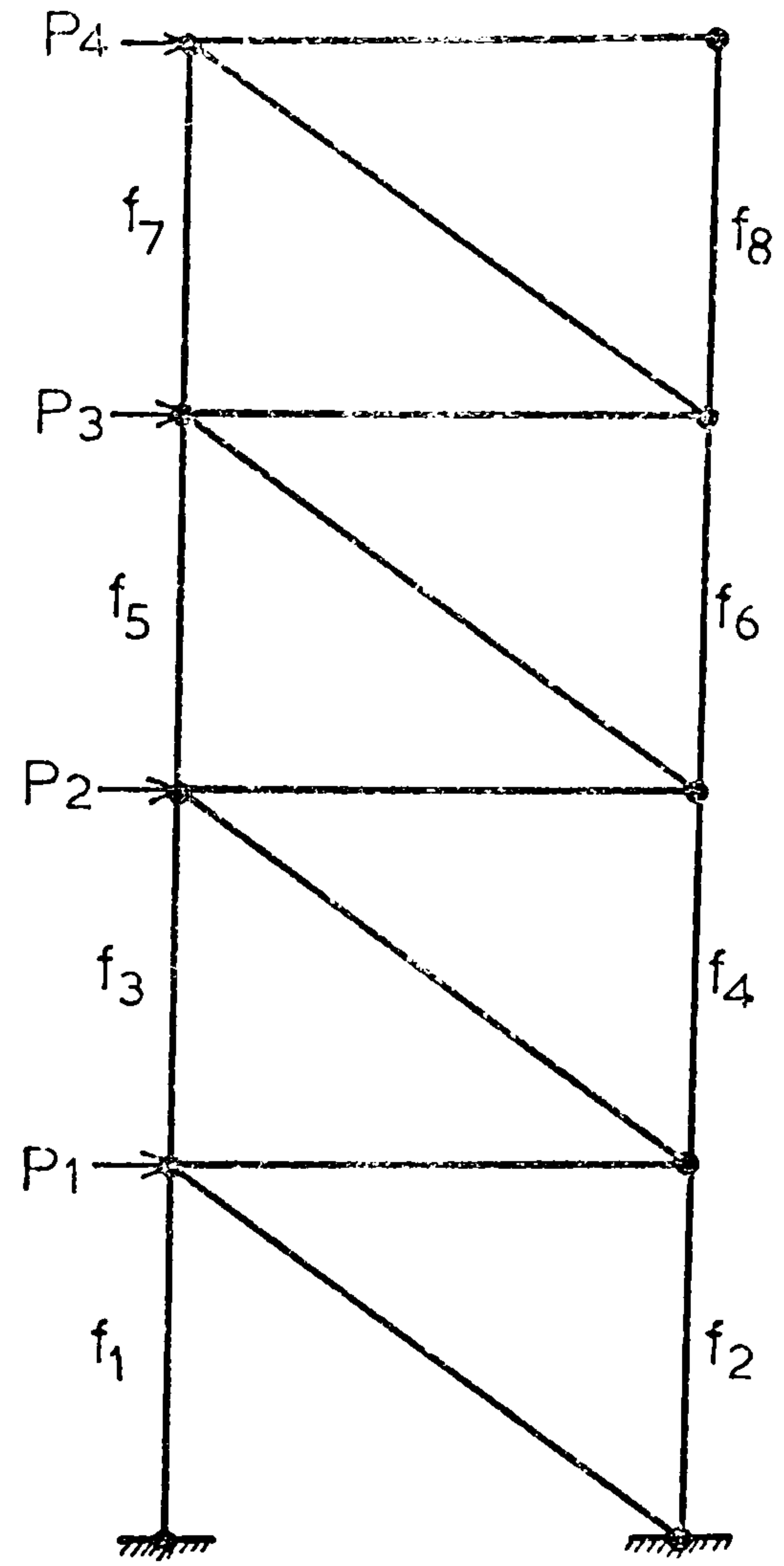

Fig.(6.8 b)

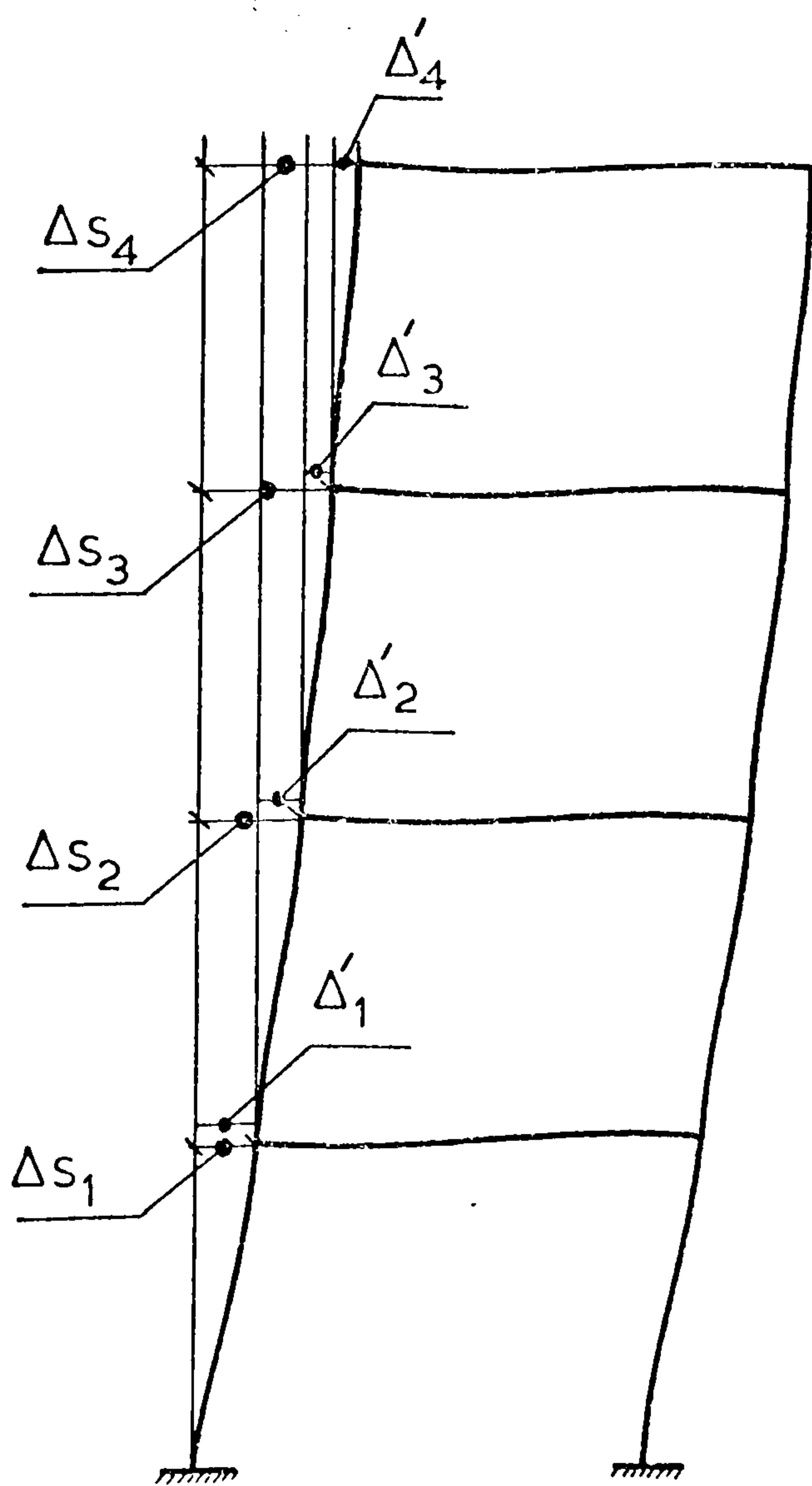

Fig.(6.8c)

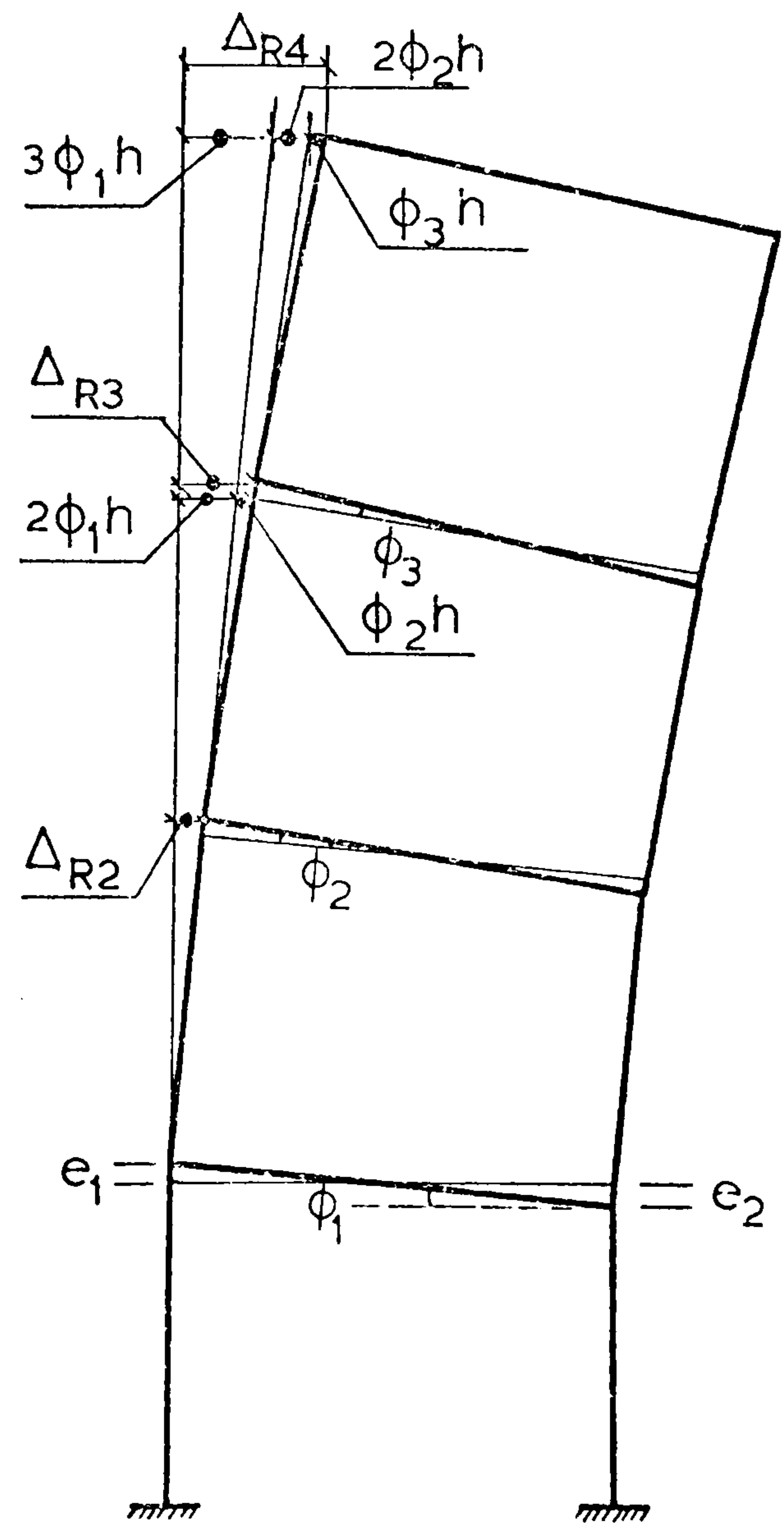

Fig.(6.8d)

of multi_storey infilled frame

which is caused by rigid rotation due to deformation of the columns of the storeys below is also added to the deflection at each floor level in order to obtain the final deflections due to lateral loading. The method is best illustrated in the following example:

Consider the four-storey infilled frame shown in Fig. (6.8a), the same properties and dimensions for each storey are assumed throughout the height of the structure.

(a) The stiffness of a single storey can be estimated by the methods described in Chapter (4), or can be measured experimentally.

The stiffness of a single storey $S = \frac{P}{\Delta}$

$$\Delta = \frac{P}{S} \quad 6.1$$

On the basis of this value, the deflection at each floor level is calculated as follows, assuming there is no rigid rotation of the beam of each floor. The deflection estimated from eq (6.1) is termed as Δ' , therefore Δ'_1 is the lateral deflection of the first floor measured at the beam centre-line.

$$\begin{aligned} \therefore \Delta'_1 &= (P_1 + P_2 + P_3 + P_4) / S &) \\ & &) \\ \Delta'_2 &= (P_2 + P_3 + P_4) / S &) \\ & &) \\ \Delta'_3 &= (P_3 + P_4) / S &) \\ & &) \\ \Delta'_4 &= P_4 / S &) \end{aligned} \quad 6.2$$

The total deflection at each floor Fig. (6.8c), is termed as Δ_S :

$$\begin{aligned} \Delta_{S1} &= \Delta'_1 &) \\ & &) \\ \Delta_{S2} &= \Delta_{S1} + \Delta'_2 &) \\ & &) \\ \Delta_{S3} &= \Delta_{S2} + \Delta'_3 &) \\ & &) \\ \Delta_{S4} &= \Delta_{S3} + \Delta'_4 &) \end{aligned} \quad 6.3$$

eq./

eq . (6.3) can be written in terms of $P_1, P_2 \dots$ and S :

$$\begin{aligned}
 \Delta_{S1} &= \frac{1}{S} (P_1 + P_2 + P_3 + P_4) &) \\
 & &) \\
 \Delta_{S2} &= \frac{1}{S} (P_1 + 2P_2 + 2P_3 + 2P_4) &) \\
 & &) \\
 \Delta_{S3} &= \frac{1}{S} (P_1 + 2P_2 + 3P_3 + 3P_4) &) \\
 & &) \\
 \Delta_{S4} &= \frac{1}{S} (P_1 + 2P_2 + 3P_3 + 4P_4) &)
 \end{aligned}
 \tag{6.4}$$

(b) In order to determine the direct forces f_1, f_2, \dots in the columns, the structure may be analysed as an equivalent truss structure Fig. (6.8b), the deformations of the columns, i.e. shortening and elongation, e_1, e_2, e_3, \dots due to the direct forces f_1, f_2, \dots can be estimated from:

$$e = \frac{fh}{aE}
 \tag{6.5}$$

The windward and leeward column deformations cause a rigid rotation of the storeys above Fig. (6.8d).

$$\begin{aligned}
 \text{Angle of rotation of the first storey beam: } & \phi_1 = \frac{e_1 + e_2}{1} &) \\
 \text{" " " " " second " " } & \phi_2 = \frac{e_3 + e_4}{1} &) \\
 \text{" " " " " third " " } & \phi_3 = \frac{e_5 + e_6}{1} &)
 \end{aligned}
 \tag{6.6}$$

Due to these rotations, deflection ΔR at each storey level will be as follows Fig. (6.8d):

$$\begin{aligned}
 \Delta R_1 &= 0 &) \\
 & &) \\
 \Delta R_2 &= \phi_1 h &) \\
 & &) \\
 \Delta R_3 &= 2\phi_1 h + \phi_2 h = h(2\phi_1 + \phi_2) &) \\
 & &) \\
 \Delta R_4 &= 3\phi_1 h + 2\phi_2 h + \phi_3 h = h(3\phi_1 + 2\phi_2 + \phi_3) &)
 \end{aligned}
 \tag{6.7}$$

(c) /

(c) The final deflection at each floor level is equal to the sum of deflections calculated from eq. (6.4) and eq. (6.7):

$$\begin{aligned}
 \Delta_1 &= \Delta_{S1} + \Delta_{R1} = \frac{1}{S} (P_1 + P_2 + P_3 + P_4) \\
 \Delta_2 &= \Delta_{S2} + \Delta_{R2} = \frac{1}{S} (P_1 + 2P_2 + 2P_3 + 2P_4) + \phi_1 h \\
 \Delta_3 &= \Delta_{S3} + \Delta_{R3} = \frac{1}{S} (P_1 + 2P_2 + 3P_3 + 3P_4) + h(2\phi_1 + \phi_2) \\
 \Delta_4 &= \Delta_{S4} + \Delta_{R4} = \frac{1}{S} (P_1 + 2P_2 + 3P_3 + 4P_4) + h(3\phi_1 + 2\phi_2 + \phi_3)
 \end{aligned} \tag{6.8}$$

eq. (6.8) can be written in a general form, eg: at the top floor of n-storey infilled frame :

$$\begin{aligned}
 \Delta_n &= \frac{1}{S} (P_1 + 2P_2 + 3P_3 + \dots + nP_n) + h((n-1)\phi_1 + (n-2)\phi_2 \\
 &\quad + (n-3)\phi_3 + \dots + \phi_{(n-1)})
 \end{aligned} \tag{6.9}$$

Δ_{n-1} , Δ_{n-2} , can be written in the same manner.

This method may be applied to any type of loading applied at the beam centre and may take into account several variables, such as: change in frame stiffness, change in panel thickness and material properties as long as the stiffness of the storey concerned can be estimated or measured experimentally, the proper stiffness value must be inserted in eq. (6.2). In the above example a constant stiffness has been assumed.

The method may also be applied to multi-bay multi-storey infilled frames knowing the stiffness of a single storey. Simplification may be made in determining Δ_R (deflection due to rotation) or may be neglected since the equivalent truss structure becomes a statically indeterminate truss. The method is also applicable to multi-storey infilled frames containing/

containing openings if the storey stiffness is known. The opening will not affect the calculation for direct forces in the equivalent truss, since it can be assumed as a diagonal member with pinned connections at the diagonal corners.

6.6 COMPARISON OF RESULTS

The experimental results for stiffness (Chapter 3) have been used for determination of lateral deflections of the multi-storey panels tested. The estimated values by the proposed method are comparable with the experimental deflections. The discrepancies are about 10% and 17% for the two-storey panels with two point loading, Figs. (6.1 and 6.2), and 30%, 4% and 2% for 4S, 3S and 2S panels respectively, Figs. (6.3, 6.4 and 6.5).

Considering the simplicity of the method, the comparisons are generally satisfactory except for the four-storey panel (4S). Studying the load-deflection and storey-deflection curves for 4S, 3S, 2S and 1S, they show that the deflection of the first storey in Figs. (6.4, 6.5 and 6.7) are reasonably comparable, but the deflection in Fig. (6.3) is almost twice the others. This seems rather surprising, for it should be comparable to the others and is believed to be due to a horizontal sliding along the base with the floor; unfortunately no measurement of this movement has been taken. When the panel was tested as a three storey-structure, a dial gauge was placed to measure this movement, but a negligible movement was observed, because it had already been taken up during the first test (4S). If these arguments are considered valid, then the storey-deflection curve for 4S, Fig. (6.3) may be corrected as shown in Fig. (6.3), curve (2). However, the experimental values are still 24% greater than the predicted values.

More/

More experiments will be required to verify the proposed method before any final conclusion or recommendation can be made. However, the method recognises the effect of axial deformation in the frame members, which must be taken into account in the design of tall buildings and which may cause large deflections as the building increases in height. The first term of the deflection is simply the sum of the individual storey deflections. This assumes that each storey in a multi-storey frame behaves the same way as a single-storey panel, this may be a reasonable assumption because of the adjacent panels, the interaction forces at the interfaces are modified and the rigidity of the beams are therefore greatly increased. In actual buildings this is increased further due to the composite action of the floor slab and the supporting beams, the base of each storey therefore may be assumed as fixed as the base of a single storey panel. This term is similar to shear deflection in shear wall structures, the second term then allows for the rigid rotation of the storeys due to axial deformation in the frame members, this is similar to the bending deflection in shear wall structure.

Test 1S, which is a two storey panel but the load was applied at the lower storey level Fig. (6.7), has shown greater stiffness than the idealize single storey panels. The other tests carried out (as described in section 6.2) on the four and three storey panels also showed similar behaviour.

For tests 4S and 3S, deflection at the top floor was also estimated by the method proposed by Smith⁽⁵²⁾, an equivalent pin-jointed truss structure. Since all the infills are under the same diagonal load, the same value of "effective width" was assumed for all the storeys, this/

this value has been taken from the Author's values (Chapter 4). The results are shown in Figs. (6.3) and (6.4), they are above the values predicted by the Author's proposed method.

The panels were also analysed by the stiffness method using "STRU DL" programme at E.R.C.C. The infills were replaced by equivalent diagonal struts, the value of the effective width was obtained from Chapter (4). Results are also shown in Figs. (6.1 to 6.5 and 6.7). The results compare satisfactorily with the values obtained from the approximate method (storey-stiffness), they are about 5% higher.

From these limited number of results and the various methods of analysis used, it can be seen that the simple storey-stiffness method, although approximate, gave good prediction of the lateral deflection of multi-storey infilled panels.

6.7 CONCLUSIONS

Within the limits of the investigation presented in this Chapter, the following conclusions may be drawn:

1. A multi-panel infilled frame behaves in a manner similar to a single storey infilled frame.
2. Due to the presence of adjacent panels the strength of an infilled frame is greatly increased and its stiffness is affected.
3. The deflection of a multi-storey infilled frame may be approximately predicted on the basis of a single storey deflection taking into account the axial deformation in the frame members.

CHAPTER 7GENERAL CONCLUSIONS AND SUGGESTIONS7.1 GENERAL CONCLUSIONS

A summary of the conclusions reached in the investigation presented in this thesis may be listed as follows:

1. In a masonry infilled panel under lateral loading, boundary cracks may occur at the early stages of loading separating the frame from the infill except at the loaded corners.
2. A masonry infilled panel without opening exhibits two types of failure:
 - (a) Shear cracks at the interface between bricks and mortar, or diagonal cracks passing through bricks and mortar depending upon the bond strength of the mortar.
 - (b) Crushing of the masonry near the loaded corners defining the ultimate strength of the panel.
3. The stiffness and strength of masonry infilled panels are influenced by :
 - (a) Height : length proportion of the infill.
 - (b) Stiffness of the frame.
 - (c) Gap between frame and infill.
 - (d) Rigidity of the frame joints.
 - (e) Bond strength of the mortar.
4. In a masonry infilled panel containing an opening, the first cracks appear at the corners of the opening along the loaded diagonal, crushing occurs at these two corners also.

5./

5. The presence of adjacent infills increases the stiffness and the strength of masonry infilled panels.
6. In an infilled panel, stresses are highly concentrated at the loaded corners inside the infill, bending moments are maximum at the loaded joints of the frame.
7. The load to cause the first crack in a masonry infilled panel may be approximately predicted on the basis of average shear and normal stresses taking into account the strength of the frame.
8. The ultimate load may be approximately predicted as sum of the loads carried by the frame and the infill as a composite system.
9. Analysis of infilled panels without openings may be made by replacing the infills by equivalent diagonal struts provided that appropriate value of the effective width is assumed, then applying established structural analysis methods.
10. An approximate analysis of infilled panels containing an opening may be made replacing the infill by an equivalent frame acting along the loaded diagonal.
11. The finite element method may be applied to predict the lateral stiffness of infilled panels with or without opening provided that appropriate boundary conditions at the interface between the frame and infill are assumed.
12. Multi-storey infilled frames may be analysed approximately on the basis of a single storey stiffness taking into account the axial deformation in frame members.

7.2 SUGGESTIONS AND COMMENTS

The complex composite nature of infilled frames, especially with a non-homogeneous material such as masonry, and the many factors affecting their behaviour are reflected in the wide variation observed in experimental results, which confirms doubts as to the usefulness of "more accurate" analyses of this type of structure. This suggests that simple approximate approaches are preferable; certainly further experimental results would be valuable and would serve the purpose of refining these approximate methods of analysis, and would add more information about factors affecting infilled frame type structures.

The tests were designed so that failure would always occur inside the panel, in reinforced concrete frame buildings the failure load may never be reached because of the failure of the frame. Detailed study and direct experiments are necessary in this respect, in order to study all types of failure and predictions of their loads.

Detailed study of panels containing openings is needed, in practical buildings openings always have lintels or perhaps bounding frames, which may increase the stiffness and strength of such panels.

Wind and earthquake loading are applied in both directions. A study of the behaviour of infilled frames under reversed loading during all stages of loading is therefore essential.

Infilled frames may be subjected to vertical loading transmitted from floor slabs and beams, the effect of such loading on the behaviour and strength of the panel requires detailed studies.

One of the factors which greatly affected the strength and stiffness of the brickwork infilled panels was the use of modified mortar. Such a mortar may produce a strong and rigid panel, but a detailed study/

study would be necessary before it could be applied to practical buildings.

Very little is known about reinforced masonry infilled frames.

Finally it would be of great academic and practical interest to study the behaviour of three-dimensional infilled frames under lateral loading (axial and eccentric).

The Author believes that the studies carried out in the last decade may provide enough information to design frame structures taking into account the infill as a structural component, bearing in mind that a high factor of safety is to be allowed in the case of masonry infills.

REFERENCES

1. Benjamin, J.C. and Williams, H.A. "The Behaviour of One-Story Reinforced Concrete Shear Walls". Proc. A.S.C.E. Vol. 83, No ST5, Paper No. 1254, 1957.
2. Benjamin, J.C. and Williams, H.A. "Behaviour of One-Storey Walls Containing Openings". Journal A.C.I. Vol. 30, pp. 605-18, 1958.
3. Benjamin, J.C. and Williams, H.A. "The Behaviour of One-Storey Brick Shear Walls". Proc. A.S.C.E. Vol. 84, No. ST4, Paper No. 1728, 1958.
4. Benjamin, J.C. and Williams, H.A. "Reinforced Concrete Shear Wall Assemblies". Proc. A.S.C.E., Vol. 86, No. ST8, Paper No. 2556, pp. 1-32, 1960.
5. Blume, J.A. "Period Determinations and other Earthquake Studies of a Fifteen-Storey Building". Proc. of World Conf. on Earthquake Eng. June, 1956, California.
6. Blume, J.A. "Structural Dynamics in Earthquake-Resistance Design". Jour. Str. Div. A.S.C.E., ST4, Paper No. 1695, July 1958.
7. Carter, C., Choudhury, J.R. and Smith, S. "The diagonal Tensile Strength of Masonry". Research Report No. CE/2/69 Nov. 1968, Dept. of Civil Engineering, University of Southampton.
8. Carter, C. and Smith, B.S. "On the Structural Behaviour of Masonry Infilled Frames Subjected to Racking Loads". Designing, Engineering and Construction with Masonry Products, pp. 51-57. Edited by F.B. Johnson, Houston, Texas, Gulf Publishing, 1969.

9. Coull, A. "The Influence of Concrete Infilling on the Strength and Stiffness of Steel Frames". Cement and Concrete Vol. 7, pp. 162-9, Oct.-Dec. 1966.
10. Foster, D. "Some Observation on the Design of Brickwork Cladding to Multi-storey Reinforced Concrete Framed Structures." B.D.A. Technical Note, No. 4, Vol. 1, Sept. 1971.
11. Freedman, I.L. "Brickwork Cladding". Building Technology and Management, Part 2, Vol. 11, pp. 11-13, 1973.
12. Grenley, D.G. and Cattaneo, L.E. "The Effect of Edge load on the Racking Strength of Clay Masonry". SIBMAC Proc. pp. 157-160, Published by the British Ceramic Research Association, 1971.
13. Haller, P. "Load Capacity of Brick Masonry". Designing, Engineering and Construction with Masonry Products, pp. 129-49. Edited by F.B. Johnson, Houston Texas, Gulf Publishing, 1969.
14. Hassan, S.S. "Private Communications". Department of Civil Engineering and Building Science, Edinburgh University, 1973.
15. Hendry, W.A. "Workmanship Factors in Brickwork Strength". Dept. of Civil Engineering and Building Science Publications, University of Edinburgh, Mar 1972.
16. Hetenyi, M. "Beams on Elastic Foundation". University of Michigan Press. Ann Arbor, 1946.
17. Holmes, M. "Steel Frames with Brickwork and Concrete Infilling". Proc. I.C.E. Vol. 19, pp. 473-8, Aug. 1961.
- 18./

18. Holmes, M. "Combined loading on Infilled Frames". Proc. I.C.E. Vol. 25, pp. 31-8, May 1963.
19. "Discussion on Paper by Holmes⁽¹⁷⁾". Proc. I.C.E. Vol. 23, pp. 93-104, 1962.
20. Johnson, F.B. and Thompson, J.N. "Development of Diametral Testing Procedures to Provide a Measure of Strength Characteristics of Masonry Assemblages". Designing, Engineering and Construction with Masonry Products, pp. 51-7. Edited by F.B. Johnson, Houston, Texas, Gulf Publishing, 1969.
21. Karamanski, T. "Calculating Infilled Frames by the Method of Finite Elements". Symposium on Tall Buildings, Edited by A. Coull and B.S. Smith, Pergamon Press, 1967.
22. Kalita, U.C. and Hendry, A.W. "An Experimental and Theoretical Investigation of the Stresses and Deflections in Model Cross-Wall Structures". SIBMAC Proc. Published by The British Ceramic Research Assoc. 1971.
23. Khoo, C.L. "A Failure Criterion for Brickwork in Axial Compression". Ph.D. Thesis, Edinburgh University, 1972.
24. Liaw, T.C. "Elastic Behaviour of Infilled Frames". Proc. I.C.E. Vol. 46, pp. 343-49, July 1970.
25. Liaw, T.C. "An Approximate Method of Analysis for Infilled Frames With or Without Opening". Building Science, Vol. 7, pp. 233-8, 1972.

26. Mainstone, R.J. "Discussion on the Composite Behaviour of Infilled Frames⁽⁵¹⁾". Symposium on Tall Buildings. Edited by A. Coull and B.S. Smith, Pergamon Press, 1967.
27. Mainstone, R.J. "On the Stiffness and Strengths of Infilled Frames". Proc. I.C.E. Supplement (iv) Paper (7360S) pp. 57-90, 1971.
28. Mainstone, R.J. and Weeks, G.A. "The Influence of a Bounding Frame on the Racking Stiffnesses and Strengths of Brick Walls". SIBMAC Proc. pp. 165-171, Published by The British Ceramic Research Association, 1971.
29. Mallick, D.V. and Severn, R.T. "The Behaviour of Infilled Frames Under Static Loading". Proc. I.C.E., Vol. 38, pp. 639-56, Dec. 1967.
30. Mallick, D.V. and Severn, R.T. "Dynamic Characteristics of Infilled Frames". Proc. I.C.E., Vol. 39, pp.261-87, Feb. 1968.
31. Mallick, D.V. and Garg, R.P. "Effect of Openings on the Lateral Stiffness of Infilled Frames". Proc. I.C.E. Vol. 49, pp. 193-209, June 1971.
32. Mihai, S., Cristian, Sc., Elena, L. and Sofia, F. "Recherches sur Modèles, Concernant le Comportement des Maçonneries sous l'action des Charges Horizontales". Inter. Symp. Testing Methodology and Technique of Full-Scale and Model Structures Under Static and Dynamic Loads. Bucuresti - 1969 (In French).
33. Murthy, C.K. "Model Studies Related to Load-Bearing Brickwork". Ph.D. Thesis, University of Liverpool, 1964.

34. Pieper, K. and Trantsch, W. "Shear Tests on Walls". SIBMAC Proc. pp. 140-3, Published by The British Ceramic Research Association, 1971.
35. Polyakov, S.V. "Masonry in Framed Buildings". 1956, English Translation by G.L. Cairns (1963).
36. Polyakov, S.V. "On The Interaction Between Masonry Filler Walls and Enclosing Frame When Loaded in the Plane of the Wall". Earthquake Engineering Research Institute, San Francisco, 1960.
37. Polyakov, S.V. "On The Strength and Deformation of Stone Masonry Filling in Framed Walls Under Shearing Load". Building Industry, No. 3, 1952, Moscow (In Russian).
38. Polyakov, S.V. "Some Investigations of the Problem of the Strength of Elements of Buildings Subjected to Horizontal Loads". Symposium on Tall Buildings, Edited by A. Coull and B.S. Smith, Pergamon Press, 1967.
39. "Research and Development Bulletin". No. RD5, Dec. 1967. Revertex Ltd. 51-55 Strand, London, WC2.
40. Rostampour, M. "Aspects of the Design of the Multi-storey Buildings in Light-Weight Concrete Blockwork". Ph.D. Thesis, Edinburgh University, 1973.
41. Ruthburn, I.C. "Wind Forces on a Tall Building". Proc. A.S.C.E. 64 (7), 1938.
42. Sachanski, S. "Analysis of the Earthquake Resistance of Frame Buildings Taking into Consideration the Carrying Capacity of the Filling Masonry". Proc. 2nd World Conf. on Earthquake Eng. Vol. III, pp. 2127-2141, Japan, 1960.

43. Scrivener, J.C. "Static Racking Tests on Concrete Masonry Walls".
Designing, Engineering and Construction with Masonry
Products, pp. 185-191. Edited by F.B. Johnson,
Houston, Texas, Gulf Publishing, 1969.
44. Sinha, B.P. "Model Studies Related to Load-Bearing Brickwork".
Ph.D. Thesis, Edinburgh University, 1967.
45. Sinha, B.P. and Hendry, A.W. "Racking Tests on Storey-Height
Shear-Wall Structures with Openings, Subjected to Pre-
Compression". B.R.C.A. Technical Note, No. 82,
March 1966.
46. Simms, L.G. "The Behaviour of No-fines Concrete Panels as the
Infill in Reinforced Concrete Frames". Civil
Engineering and Public Works Review, 62, (736),
pp. 1245-50, Nov. 1967.
47. Simms, L.G. "The Shear Strength of Some Storey-Height Brickwork
and Blockwork Walls". C.P.T.B. Technical Note,
Vol. 1, No. 5, Apr. 1964.
48. Smith, B.S. "Lateral Stiffness of Infilled Frames". Jour. Str.
Div., Proc. A.S.C.E., Vol. 88, ST6, pp. 183-99, Dec.
1962.
49. Smith, B.S. "Behaviour of Square Infilled Frames". Jour. Str.
Div. Proc. A.S.C.E., Vol. 92, ST1, pp. 381-403, Feb.
1966.
50. Smith, B.S. "Methods of Predicting the Lateral Stiffness and
Strength of Multi-Storey Infilled Frames".
Building Science, Vol. 2, pp. 247-57, 1967.

51. Smith, B.S. "The Composite Behaviour of Infilled Frames".
Symposium on Tall Buildings. pp. 481-492. Edited
by A. Coull and B.S. Smith, Pergamon Press, 1967.
52. Smith, B.S. and Carter, C. "A Method of Analysis for Infilled
Frames". Proc. I.C.E., Vol. 44, pp. 31-49, Sept. 1969.
53. Smith, B.S. and Rahman, K.M.K. "Variation of Stresses in Vertically
Loaded Brickwork Walls". Proc. I.C.E. Vol. 51, April
1972.
54. Smith, B.S. and Rahman, K.M.K. "The Variation of Stresses in
Brickwork Walls Subject to Shear Forces". Paper
presented in the Third International Brick Masonry
Conf. 1973 (To be published).
55. ICES STRUDL Vol. I & II. "The Structural Design
Language". Engineering User's Manual Research Report,
R68-92, Dept. of Civil Engineering, MIT, Massachusetts,
1969.
56. Smolira, M. "Analysis of Infilled Shear Walls". Proc. I.C.E.,
Part 2, Vol. 55, pp. 895-912, Dec. 1973.
57. Thomas, F.G. "The Strength of Brickwork". The Structural Engineer,
pp. 35-46, Feb. 1953.
58. "Technical Bulletin" No. 166, May 1969. Revertex
Ltd. 51-55 Strand, London WC2.
59. "Technical Bulletin" Sheet No. 166/1, 166/4 and
166/6, May 1969. Revertex Ltd., 51-55 Strand, London
WC2.

60. Watstein, D. and Allen, M.H. "Structural Performance of Clay
Masonry Assemblages Built with High-Bond Organic-
Modified Mortars!" SIBMAC Proc. pp. 99-112,
Published by The British Ceramic Research Association,
1971.
61. Whitney, C.S., Anderson, B.G. and Cohen, E. "Design of Blast-
Resistance Construction for Atomic Explosions".
Jour. A.C.I., Vol. 51, pp.655-673, 1955.
62. Wood, R.H. "The Stability of Tall Buildings". Proc. I.C.E.
Vol. 11, pp. 69-102, Sept. 1958.
63. Wood, R.H. " Discussion on the Stability of Tall Buildings".
Proc. I.C.E., Vol.12, pp. 502-22, 1959.
64. Wood, R.H. "Composite Construction". The Structural Engineer,
Jubilee Issue, pp. 135-139, July 1958.
65. Zienkiewicz, O.C. "The Finite Element Method in Engineering Science".
McGraw-Hill Publishing Company Limited, London 1971.

APPENDIX ABRICK, MORTAR AND BRICKWORK PROPERTIES (1 : 3 MORTAR).

Several tests have been carried out in order to determine the properties of the bricks and mortar used in the construction of the infilled panels described in the earlier chapters. Brick triplets, cross brick couplets and model brickwork walls were tested in order to obtain shear bond, tensile bond and compressive strength respectively.

Brick triplets as shown in Fig. (A1) were used to measure the shear bond between the mortar and the brick, although it does not represent the actual conditions obtained in shear walls or infilled panels; but it gives a direct measure of shear bond when no precompression is applied, and it has been widely used as such. Cross brick couplets Fig. (A2) are also widely used as a method to measure the direct tensile bond between the mortar and the brick, and accepted to give satisfactory results.

The following relationships between shear bond and tensile bond, have been put forward by Sinha⁽⁴⁴⁾ and Murthy⁽³³⁾ respectively:

$$V_b = 8.8 (f_t)^{0.5} \quad \text{and} \quad V_b = 2.3 f_t.$$

where :

V_b = shear bond strength

f_t = tensile bond strength.

The tests results generally agree with these proposed relationships.

Model brickwork walls were tested under axial uniformly distributed loading in order to obtain the ultimate compressive strength and the modulus of elasticity of the brickwork. 8 inch Demec gauges were used to measure the vertical and horizontal deformations, from which the modulus of elasticity and Poission's ratio of the model brickwork/

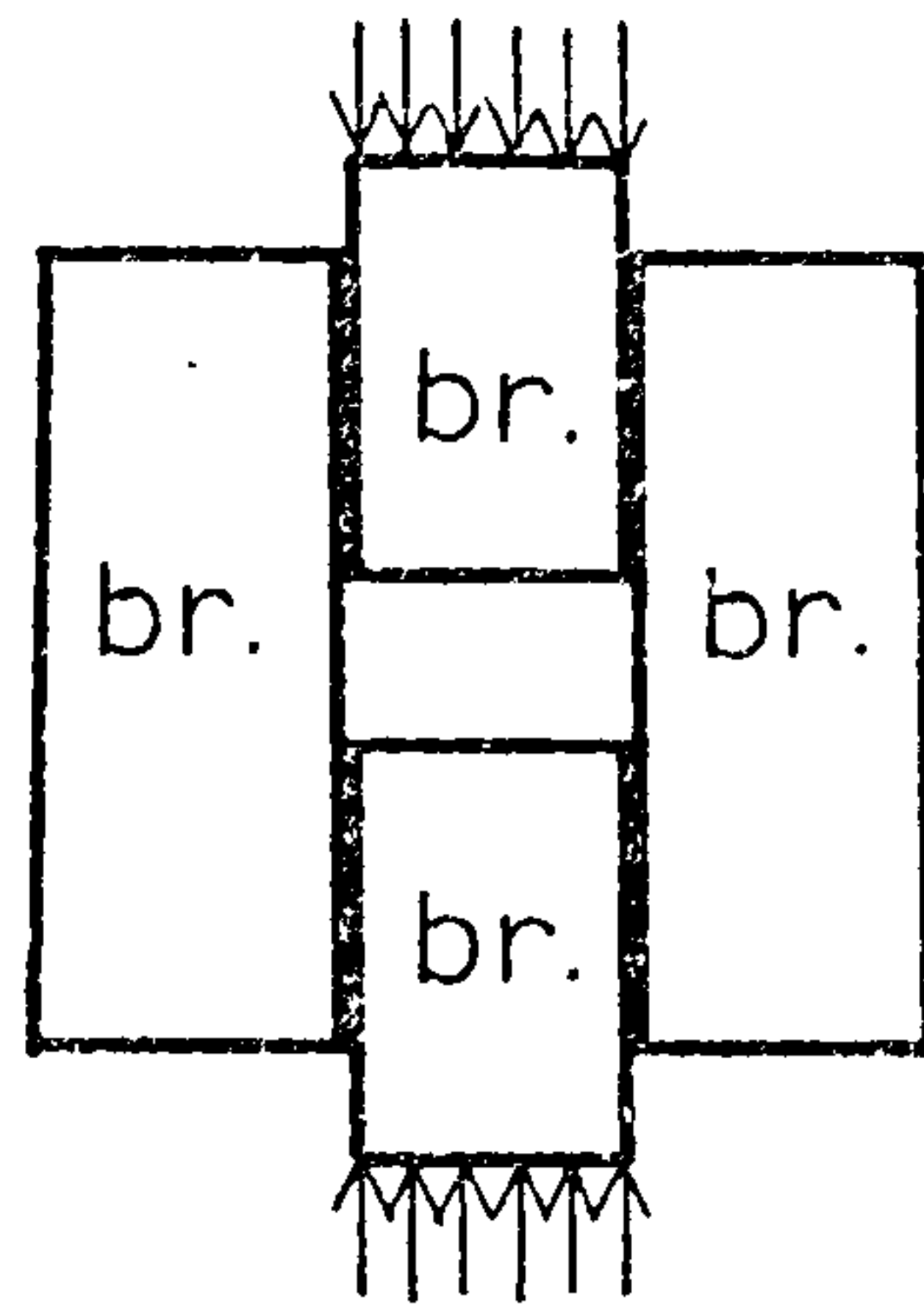

Fig.(A1) Brick triplet

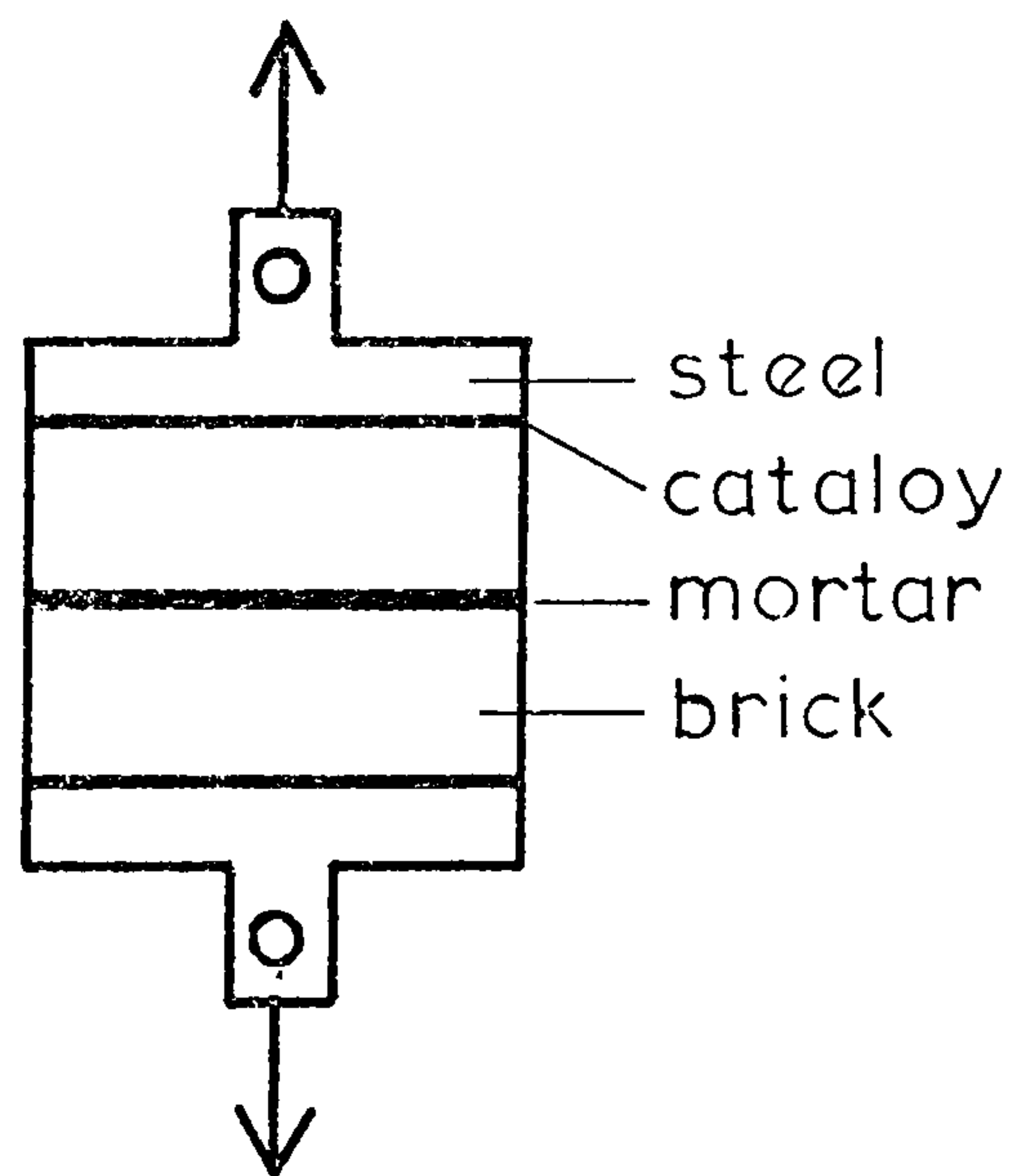

Fig.(A2) Cross-brick couplet

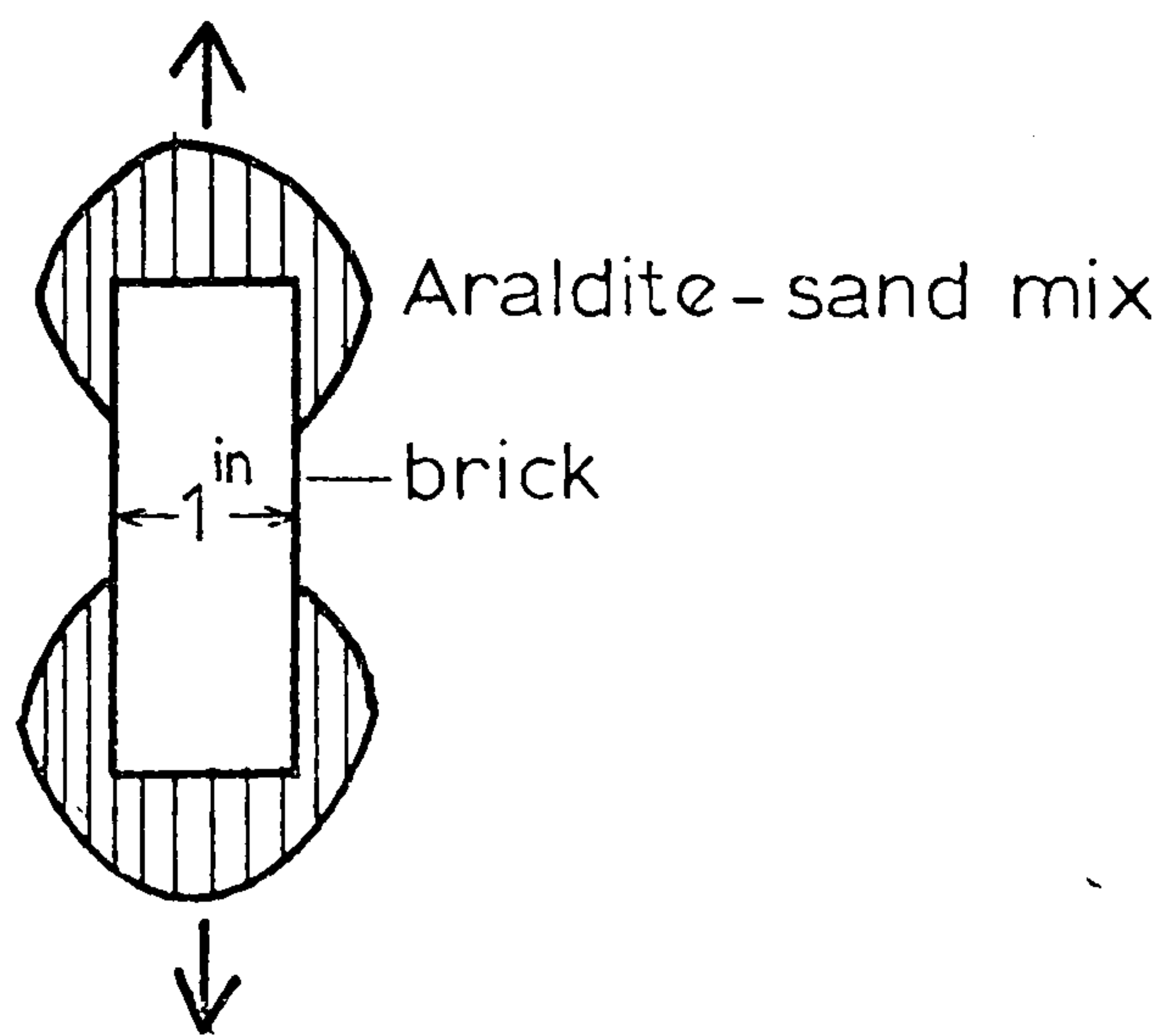

Fig.(A3) Brick tensile test

brickwork were estimated.

All the walls showed vertical cracks (tensile vertical splitting) at a load of about 70-80% of the ultimate load. This was followed by spalling and crushing of brickwork at various heights of the wall.

1 : 3 cement : sand by weight was used for all the tests carried out.

Bricks were selected from each of the three batches, and were tested for compressive strength and tensile strength. Brick tensile strength was measured directly in the standard machine for testing mortar in tension. The bricks were cut into 1 x 1 x 3 inches, and cast with Araldite sand mix into a bone-shape, Fig. (A3), in specially made wooden moulds. This method has been successfully used by Khoo⁽²³⁾.

The Araldite-sand mix used had the following proportions:

Araldite CY219	100 gm.
Hardner HY219	50 gm.
Accelerator DY219	6 gm.
Sand	600 gm.

Mould release Q219 was used for the wooden moulds.

RESULTS

One inch mortar cubs and brick strengths are shown in Table (A.1). Results of brickwork couplets and triplets are shown in Table (A.2). Dimensions and ultimate compressive strength of the walls are shown in Table (A.3). The stress-strain relationship of the walls is shown in Fig. (A.4). Variation in modulus of elasticity with compressive stress is shown in Fig. (A.5).

Table (A.1) Mortar and Brick strength

Properties	Test	Range (lbf/in ²)	Mean	Notes
1 : 3 Mortar	Comp. strength	1830 - 2486	2262	*
1 : 3 Mortar	tensile strength	385 - 470	432	
$\frac{1}{3}$ scale brick	comp. strength	3832 - 4754	4228	⊕
$\frac{1}{3}$ scale brick	tensile strength	160 - 240	189	

* One inch cubes from all the walls and panels tested, age varies from 2 weeks to 7 weeks.

⊕ Samples taken from the three patches used for construction of the panels and the walls.

All these tests were carried out according to B.S. Standards.

Table (A.2). Shear bond and tensile bond of brickwork (1:3 mortar)

Test	Strength lbf/in ²	No. of spec.	Stand. Dev.	C.V.%	Note
Shear bond	51.0	10	9.8	19.2	Failure at interface
Tensile bond	21.70	10	8.0	36.8	

Table (A.3). Model brickwork wall tests (1:3 mortar)

Wall No.	h x l x t (inches)	f_w (lbf/in ²)	mode of failure	Notes
W1	22 x 15.75 x 1.5	2758.1	Vert. splitting →)	
W2	22 x 15.75 x 1.5	2323.3	crushing)	
W3	22 x 15.75 x 1.5	2777.0	Vert. splitting →)	
W4	22 x 15.75 x 1.5	2740.6	crushing)	
W5	22 x 15.75 x 1.5	1801.5	Buckling .	⊕
W6	22 x 15.75 x 1.5	2352.0	Vert. splitting →)	(Av. of
B1W8	18 x 18 x 3	2469.3	crushing)	(3*
B1W12	36 x 18 x 3	2466.5	Vert. splitting →)	(Av. of
B1W18	54 x 18 x 3	2662.0	crushing)	(3*
WM6	9 x 18 x 1.5	2686.2	Vert. splitting →)	(Av. of
WM12	18 x 18 x 1.5	2785.1	crushing)	(3*
Mean strength (lbf/in ²)		2602.0		

⊕ Result is ignored.

* Tests carried out by Hassan (14).

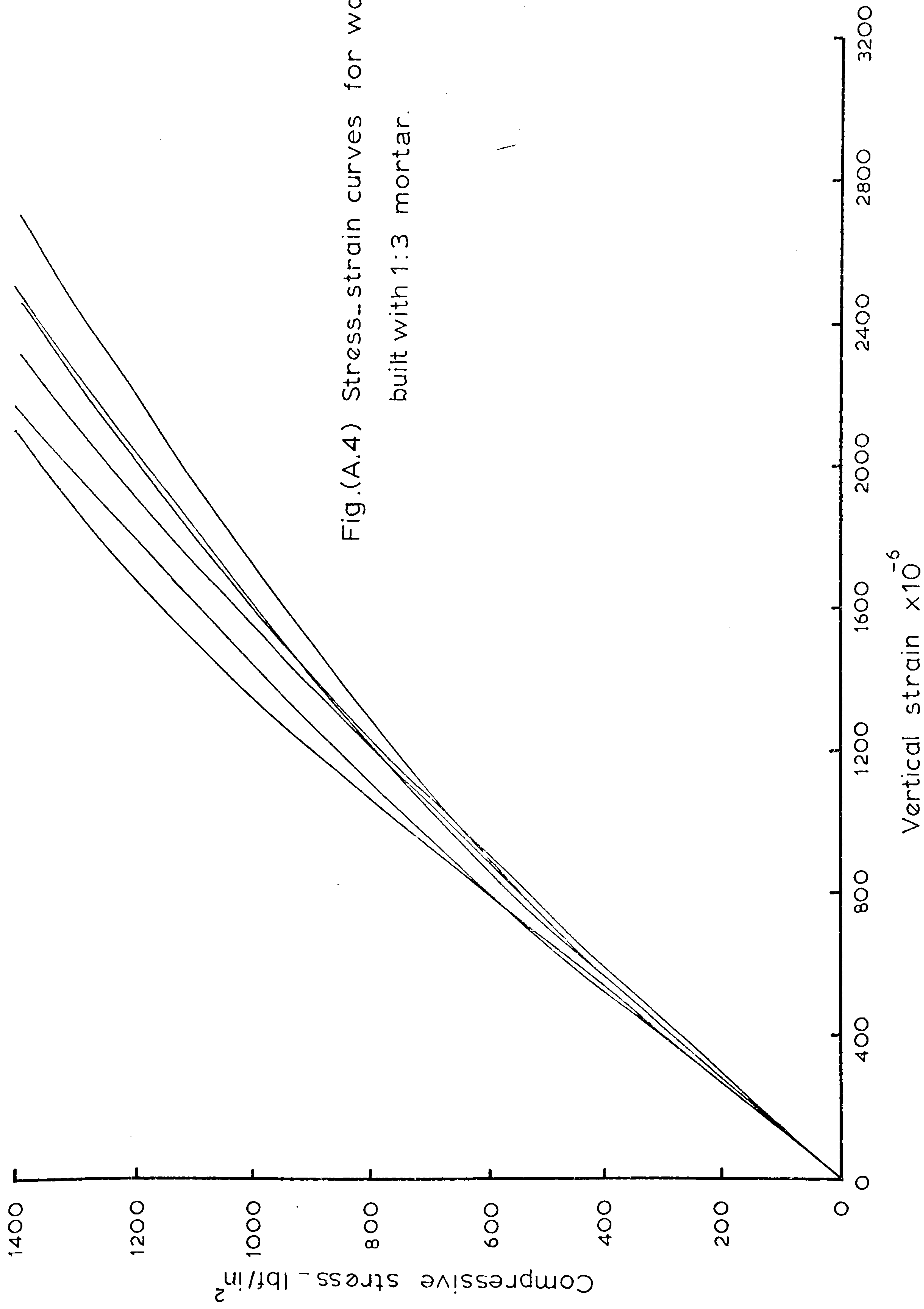
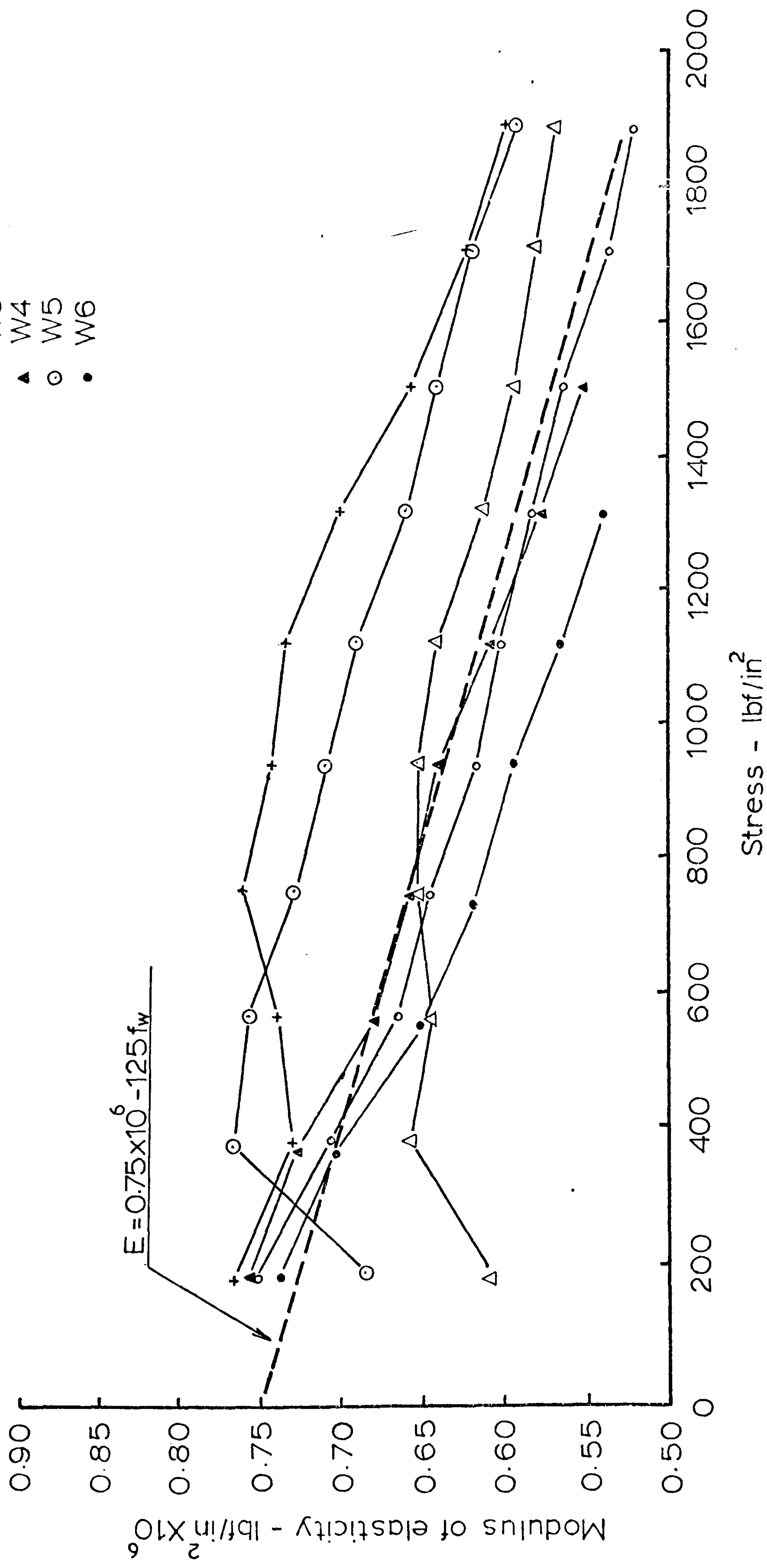

Fig.(A.4) Stress-strain curves for walls built with 1:3 mortar.



Fig(A.5) Variation of modulus of elasticity with compressive stress.

APPENDIX BBRICKWORK PROPERTIES, BUILT WITH MODIFIED MORTAR

All the tests were carried out as described in Appendix A, the mortar used was 1 : 3 : Revinex; Cement : Sand : (40% of cement wt) Revinex. (Revinex is the trade name).

Revinex 29Y40 is a synthetic rubber latex that has been specially developed as an admixture for use in cement compositions⁽³⁹⁾. It has the following typical properties:

Polymer type	Modified styrene/butadiene
Total solids	47%
Viscosity	50 c.p.s.
Specific gravity	1.0
PH	11

The manufacturers claim the following advantages when added to ordinary cement mixtures:

1. Greatly improved adhesion to most building surfaces.
2. Water proofing and improved chemical resistance.
3. Improved toughness and flexibility.
4. Better resistance to frost.
5. Improved trowelling properties.

Several suggested uses are also given in reference (58).

The mortar was prepared according to the manufacturers recommendations to obtain the best bond and tensile strengths. The Revinex was added at 40 parts per 100 parts cement by weight to the normal 1 : 3 cement : sand mortar. Water was added as required to adjust consistency, normally the water cement ratio was between 0.30 → 0.40. The mixing time/

time was increased as compared to the normal 1 : 3 mortar. The colour of the modified mortar is slightly darker than that of 1 : 3 mortar, and the workability time is slightly increased.

Tests on 1 : 3 : Revinex (40%) mortar have been carried out by the manufacturers, and the following are reported⁽⁵⁹⁾ :

Properties	1 : 3	Modified 1:3 (40%)	Notes
1. Tensile strength (lbf/in ²)	440	630	1 day dry + 6 days in water + 21 days dry.
2. Flexural strength (lbf/in ²)	1030	1540	1 day dry + 6 days in water + 21 days dry.
3. Adhesion to concrete (lbf/in ²)	10	500	28 days air drying.
4. Adhesion to concrete (lbf/in ²)	45	200	21 days air drying + 7 days in water.
5. Adhesion to steel (lbf/in ²)	0	230	28 days air drying.
6. Adhesion to steel (lbf/in ²)	0	190	21 days air drying + 7 days in water.
7. Shrinkage	0.07 ($\frac{w}{c}=0.4$)	0.01 ($\frac{w}{c}=0.3$)	
8. Resistance to water penetration (volume of water penetrated after 3 hours)	84 mls.	Nil	

RESULTS

Only the properties which are related to the subject under investigation were studied; compressive strength, shear bond and tensile bond strength between brick and the modified mortar, compressive and tensile strengths of the mortar.

All/

Table (B.1). Mortar and Brickwork properties (1:3 + Rev).

Properties	Test	Streng. lbf/in ²	No.	Stand. Dev.	Co. of Variat. %	Notes
1 : 3 + Rev. (40%)	Comp. strength	4510.0	12	435.0	9.64	Tested after 4 weeks.
1 : 3 + Rev. (40%)	Tensile strength	620.8	6	60	9.6	Tested after 4 weeks.
Brick triplets 1:3 + Rev.	Shear bond	207	6	-	-	Brick failure
Brick couplets 1:3 + Rev.	Tensile bond	165	6	-	-	Brick failure

Table (B.2). $\frac{1}{3}$ Brickwork Walls (1:3 + Revinex)

Wall No.	Dimensions H x L x t (inches)	ult. strength lbf/in ²	Type of failure
R ₁	22.0 x 15.75 x 1.5	2275.6	Vertical splitting → Spalling both sides
R ₂	22.0 x 15.75 x 1.5	2500.0	Vertical splitting → Spalling both sides
R ₃	22.0 x 15.75 x 1.5	2420.0	Vertical splitting → Spalling both sides
Average (lbf/in ²)		2401.8	

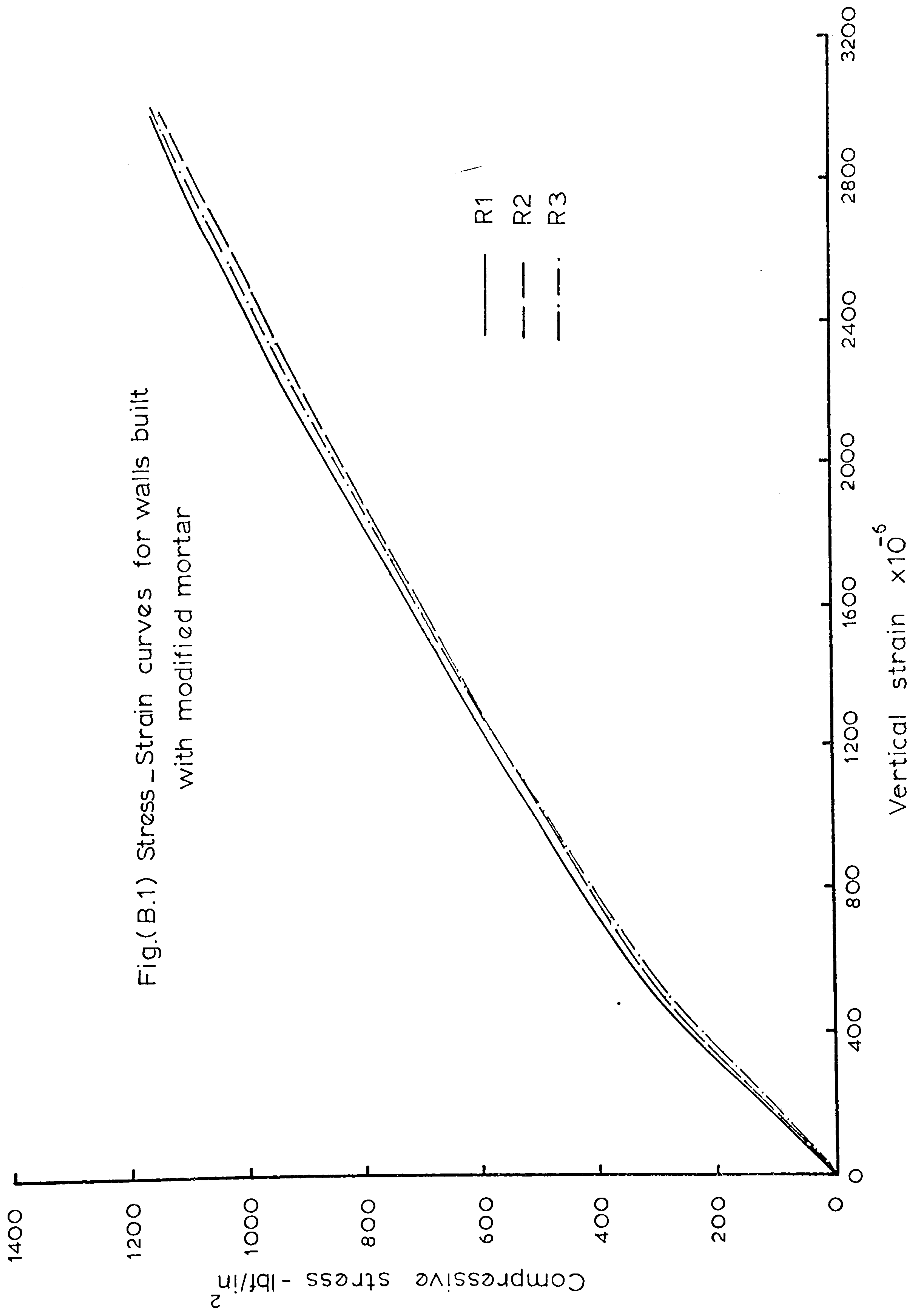

Fig.(B.1) Stress - Strain curves for walls built with modified mortar

All results are shown in Table (B.1), (B.2) and Fig. (B1). Because of the strong bond strength between the mortar and the brick, in the shear bond and the tensile bond tests, the failure occurred in the brick, therefore no values for these tests were obtained. The tensile and bond strength of the mortar are greater than the tensile strength of the bricks used. The tensile bond strength test revealed the tensile strength of the brick.

The compressive strength of the walls built with modified mortar were less than expected, and less than the compressive strength of the walls built with the ordinary 1 : 3 mortar. This may be due to the short curing period of the walls. The walls were tested after 10 → 14 days, all the walls showed several vertical cracks at load much less than the ultimate load, this was followed by spalling of the brickwork at the middle of the wall, and on both sides. After failure the mortar appeared to be still softer than an ordinary mortar considering the same curing period, which may have resulted in a great lateral deformation, thus causing an early vertical crack and failure. Indeed the modulus of elasticity is also well below the values of those obtained from walls built with 1 : 3 mortar. The same low compressive strength was observed when testing the one-inch mortar cubes at 14 days, however, the mortar cubes which were tested after 4-5 weeks gave higher results. To overcome this behaviour, the infilled panels built with the modified mortar were tested after at least 4 weeks. Results of tests carried out on mortar, cross-brick couplets and brick triplets are shown in Table (B.1). Results of the walls under compression loading are shown in Table (B.2). Fig.(B1) shows the stress-strain relationship of the walls tested.

APPENDIX C

Seddon⁺ has shown that when a concrete wall is loaded in compression over a fraction of the total wall length the ultimate load is given by:

ρ x The ultimate load of the wall (when the load is distributed along its entire length).

i.e. Mean stress over the full length of the wall in a partially loaded wall = ρ x mean stress in a totally loaded wall.

ρ varies with the ratio of loaded length to wall length fig.(C.1), the same relationship may be applied to masonry walls and it may be approximately taken as $\rho = \frac{\alpha}{l}$ (fig. C.1)

fig. (C.1)

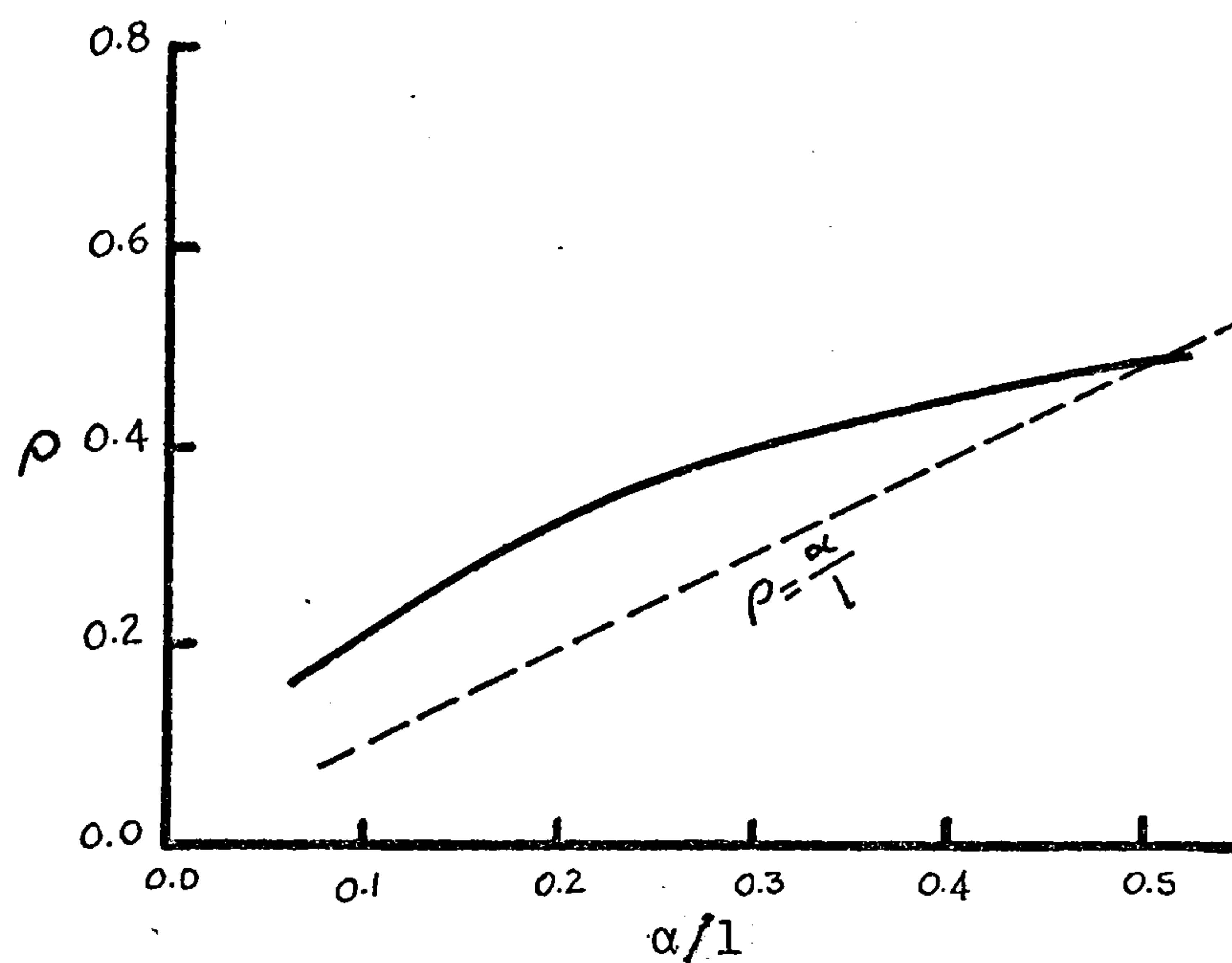

In Section 4.6.1 ($R \sin \theta$) is applied over the length α

∴ Mean normal stress at centre of the panel is approximately

$$: \frac{R \sin \theta}{lt} \frac{\alpha}{l}$$

⁺ A.E. SEDDON "The strength of concrete walls under axial and eccentric loads" Symp. strength conc. struct. Session D Paper No. 1 (1956).