

Study on Finite Element Analysis of Fine Solid Lines by Flexographic Printing in Printed Antennas for RFID Transponder

M. I. Maksud¹, M. S. Yusof¹, M. Mahadi Abdul Jamil²

¹Faculty of Mechanical & Manufacturing, ²Modelling and Simulation Research Laboratory, Faculty of Electrical & Electronic Engineering, Universiti Tun Hussein Onn Malaysia, Batu Pahat, Johor.

Received 1 October 2012; accepted 1 December 2012, available online 20 December 2012

Abstract: Printing is offering the feasibility of producing mass quantities of a wide variety of electronic components and devices quickly and at lower cost. Flexography is mainly used for packaging applications, but is also poses a potential method for the micro manufacture of electronic devices, smart packaging and RFID. The flexographic printing process poses as an attractive candidate for printing electronics for its high speed printing capabilities where such volume and large active areas need to be printed. Therefore an investigation for its potential usage in printing electronics are highly in demand hence a research for suitable conductive ink related to this process is vital. Multiple fine solid lines of high quality are essential to enable printing of ink tracks for electronic applications. A step by step approach by printing multiple solid lines, measurements of printing plates and printed images and finite element analysis (FEA) need to be carried out in advance to help comprehending this process that is influenced by many interacting parameters. Plate characteristics are among a number of process parameters that will influence print line quality, which will affect the electrical performance of printed tracks. Printing trials have also been carried out in comparison various ink to check the compatibility and the suitability of the ink developed for printing RFID antennas.

Keywords: Flexography Printing, RFID, Conductive Inks, FEA

1. Introduction

Electronic devices manufactured by printing are likely to increase. The use of printing processes both as impact and non-impact (i.e. ink jet) variants for electronic products such as displays, back planes, memory, antennas, batteries and other devices due to the advances in material and fundamental research related to the printing processes and electronics design [1]. A significant amount of research has been carried out on both impact and non-impact printing to fulfill the emerging demand of printing electronics. However, impact printing processes are much faster and capable of printing over large areas compared with non-impact printing [2]. In impact printing, screen printing has the advantages over the other type of printings due to its capabilities to deposit thick layers of ink over large areas [3]. It is currently being used extensively and will continue playing a leading role in printing electronic products. However there are some disadvantages that include speed where a high resolution web based arrangement runs at only around 40m/min. And although a web fed rotary type of screen printing can run at up to 150 m/min, regrettably this system is only capable of lower resolution [4] and this limits the feature sizes that may be printed. The alternative processes comprise offset lithography, flexography and gravure. These are all high

speed processes that are capable of high resolution printing achieving typically 50 μm [5] features for lines in the gravure process compared with 20 μm for flexography [6]. However, problems with electrical conductivity remain where a continuous solid line is vital. The image shown in Figure 1 highlights such potential discontinuity using gravure printing technique and this is needs to be addressed [7].

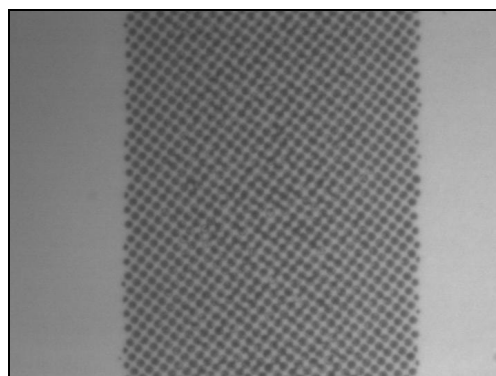

Figure 1: Gravure printed images with jagged lines

Flexographic printing process offers the possibility to print continuous fine solid lines [8]. While flexography is

a simple process and the image carrier is cheaper compared to gravure, a vast number of parameters affect this process which will ultimately affect the quality of the printed images. However, current research on printing plate technology [9] and investigation into critical parameters such as anilox rollers, ink rheology etc [10] help to comprehend the impact and the affects of these and other parameters on the final printed images. Further research on the application of finite element analysis (FEA) including both linear and non-linear models provides complementary work to predict the printing plate deformation [11] [12] and in understanding the ink spreading mechanism [13].

2. Flexography Printing

Flexography is a simple process. It is one of the most basic forms of printing as it simply transfers the image with its image carrier or printing plate onto the substrate. The plate is inked using an anilox roller and the process is similar to a rubber-stamping process. The anilox picks up the inks with it cells from the ink bath and metered using a doctor blade. The inks were transferred from the anilox to the relief image. The relief image on the printing plate where finally transfers the inked image onto the substrates. A simple schematic of the flexographic printing process can be seen Figure 2.

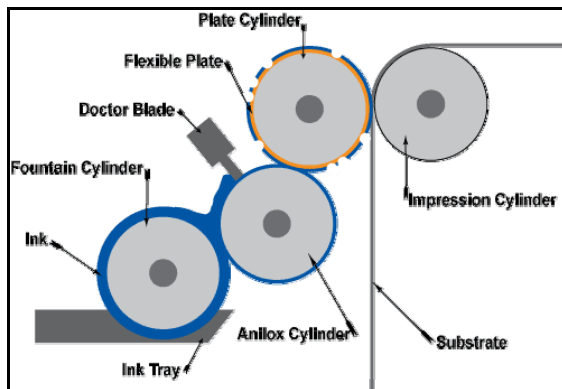

Figure 2: Schematic of Flexography printing process

Nevertheless researches in the flexographic printing are continuously carried out where the process itself is constantly being developed and now have a capability that approaches those of the high-speed processes. It is used dominantly in packaging printing and mainly used for graphic purposes but has recently evolved to many other technique depending on the applications as seen in Table-1. And since it is widely used as packaging printer, it has a big advantage in printing RFID antenna and other applications onto the packaging label itself.

Table-1: Markets that use flexography printing [14]

Corrugated boxes	Shipping containers, club stores, bulk packing etc,
------------------	---

Flexible packaging	Pet food, bread bags, disposable diaper packaging etc,
Folding cartons	Many frozen food packages and other assorted packages
Bags	Most fast food and grocery bags, both paper and plastic
Labels	Pressure sensitive labels for packaging and stickers
Other	Newspapers and magazines

3. Conductive Inks

Printing a conducting track is a vital requirement for printing future electronic products. In printing technologies there are a number of conductive inks currently being considered. Commonly used are inks with metallic particles such as silver, gold, nickel and platinum. Also there are polymeric, organic and inorganic conductive inks. In high volume printing, there is a requirement for rapid drying and the ability of the ink to adhere to the substrate [15] or previously printed layer where essential. The demand has lead to the development of conductive ink for various printing processes by many companies. A successful carbon black inks developed for this type of printing has been published by Yusof [16]. In non-impact printing method, ink jet or digital printing has been extensively explored recently to fulfil the demand [17]. It has been found that this could also lead to various electronic applications such as membrane switches, transistor and printing antennas for RFID. Particularly in the RFID field, this gives a wider range of antenna usage as a passive RFID with various wavelengths. However, cheaper and considerably faster printing method is still much needed and flexography is an attractive candidate for its low cost and high speed printing capabilities.

4. RFID

Recently, it has been known that the popularization of technology for automatic identification (Auto-ID) in industry, trade and academic, has become the focus of several researches. This interest meets the emerging demands in the automation process, which creates the need for more efficient applications to obtain and control information. The RFID technology (Radio Frequency Identification) is used for automated identification of objects. The superiority demonstrated by this technology in relation to other existing identification systems, presents two main characteristics: it has identification fields and it does not need a direct view to the object. The hardware of RFID consists of the following three items:

- Tags (Transponders)
- Readers (Electronic Interrogators)
- Middleware

There are two types of tags (transponder), active or passive tags. The word transponder is derived from transmitter/responder and describes how a tag functions - the tag responds to a transmitted signal from the reader.

Passive tags do not have their own power supply; communication with the reader is caused by minute electrical current or magnetic field induced by the antenna of the reader. The incoming radio frequency carries enough power for the tag to send a response back to the reader for verification and data exchanges. Passive tags can only transmit information over short distances, usually 10 feet or less. Passive tags are relatively inexpensive to manufacture and they are ideal for tracking low cost items. Many anti-theft systems described in the introduction use passive tags and stationary interrogators. Active tags have their own power supply and can transmit data over long ranges, typically over 100 over feet. The battery can last up to 10 years. They also possess larger storage capacities and can store information from the readers, effectively making them read and write enabled. The information is stored in a non-volatile memory. Usage and application of active tags are infinite such as container shipping tracking or the railroad tracking. However, due to the embedded battery pack and larger memory, active tags are physically bigger and more expensive than passive tags. Both types of tags contain a unique identifier called Electronic Product Code (EPC), which are pre-programmed by the manufacturer to identify a particular item. This identifier can be picked up by the reader and makes simultaneous readings of many tag possible [18]. Readers - An electronic device that uses radio frequency to read or interrogate the tags. When an RFID reader and tag communicate, two things happen; they share energy in the form of radio frequency which allows the exchange of information.

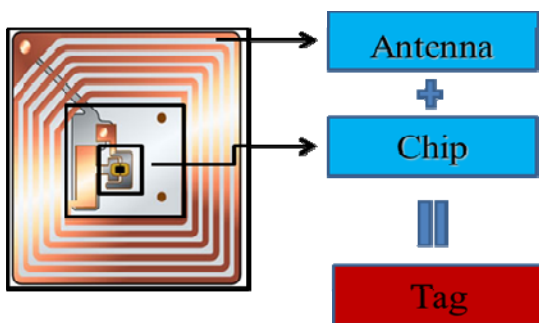

Figure 3: RFID tags components

5. Finite Element Analysis on Multiple Solid Line

Finite Element Analysis (FEA) has become a solution tool in design but along with the advances in computer technology the usage has extended to a diverse range of applications. A detailed explanation of finite element theory may be found in [19]. FEA has received application in exploration of a range of mechanisms that are associated with printing processes by many researchers such as [20] [21] [22] [23] [24]. The recent development and demand for printed electronic devices, has heightened the need for further understanding of the

solid line behaviour and a method of predicting the plate expansion under the printing nip. This research will explore the novel development of plate deformation on multiple solid lines under different engagement using FEA simulations. The methods used in predicting the barrelling of dot expansions under the printing presses in both two and three dimensions were successfully carried out by [20] [25]. In this research the first development will focus on a two dimensional linear model of multiple solid line. This assumes that the photopolymer plate, the double sided tape and the ink spreading mechanism are linear, however each will contribute differently to the overall result. In the second stage of model development in this chapter, the novel achievement of developing a model that includes materials' non-linearity will be explored and demonstrated. This includes carrying out a series of tests on the mechanical properties of the printing plate materials and comparing a series of material law evaluations. It is vital to identify the characteristic of the printing plate material and the material law to be assigned to it. This was completed successfully by carrying out a series of tests on the mechanical properties of the printing plate materials and conducting a series of material law evaluations.

6. Result and Discussion

Recently, it has been known that the popularization of technology for automatic identification (Auto-ID) in industry, trade and academic had become the focus of many researchers. The only problem with this of exceptionally cutting edge researches are to minimize the cost of production and the cost of materials to reproduce the products with the cheapest means possible. Undeniably printing technologies which has taken new form of functions in terms of printing electronics moving from conventional practice of printing graphics offers the possibilities of fast and cheap reproducibility using reel to reel productions. This study will investigate the fundamental properties and principles of several types of printed antennas such as carbon black inks or metallic particles filled inks i.e silver flake, argentums or the usage of organic inks. Figure 4, where the antenna made from etched copper embedded in the tag was selected as benchmarking.



Figure 4: RFID Tag Antennas from Copper Etched

From this investigation, the data acquired from the RFID readers will be utilized to evaluate the performance of the printed antennas with regards of read-range capabilities. The read range between the tag and the reader has been measured and the results are 97.5 mm in average as shown in Figure 5.

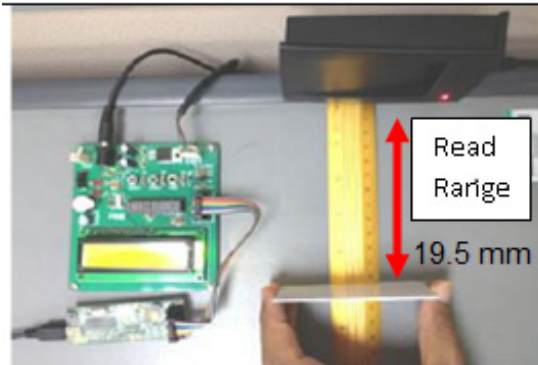
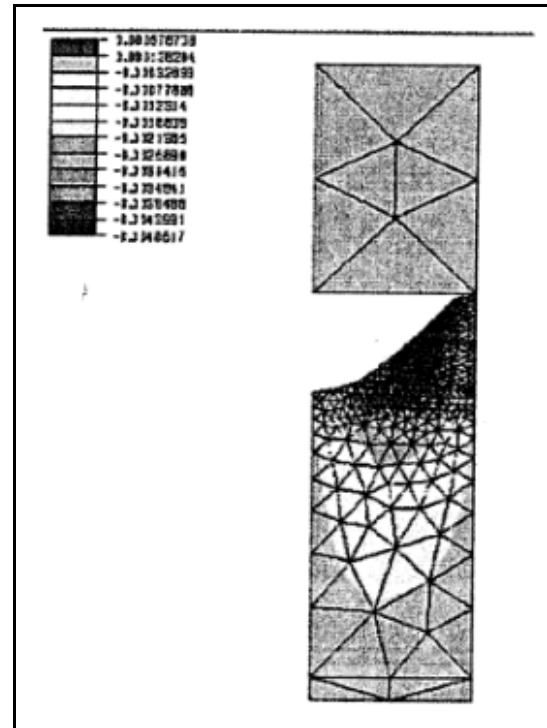

Figure 5: RFID Tag Read Range

The study on multiple solid lines using a Finite Element Analysis (FEA) which is novel to this work to comprehend the feasibility of printing closed articulated patterns of RFID antennas. The FEA will be used to simulate a 50µm line width. The model has been constructed as seen in figure 6(a) and (b) to predict the behavior of very fine solid lines under the printing nip.



(b)

Figure 6: (a) Structure of FEA model with 50 µm line. (b) The Contour Plot

The simulations were computed and the printing trials and the results are presented in figure 7. FEA result, conclude that the actual line width (inks transfer) increased with the increasing engagement. Mean the shoulder angle had deformed greatly compared with wider line widths. This also agreed by previous work by Bould, Hamblyn and M.S.Yusof. The printed line width is larger than that has been predicted through FEA (plate deformation) due to ink spreading mechanism. This study also conclude the need to further model on the pressure profiles upon the ink which will help to determine the ink spreading mechanism and whether this is the absolute cause of halo effects.

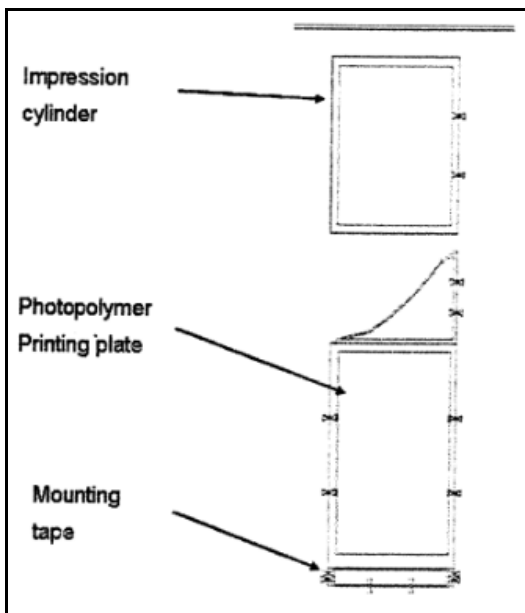

(a)

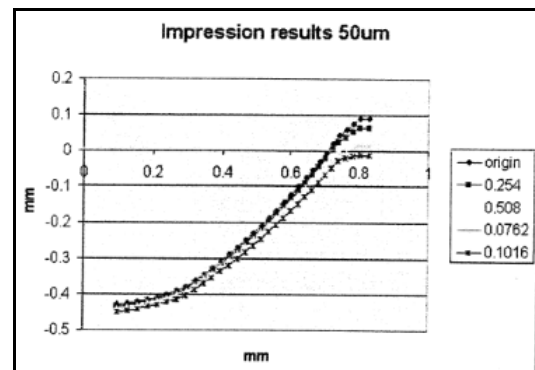

Figure 7: Impression results of 50 µm line width

A preliminary research of the same pattern and size (circle with 35mm inner diameter and 3mm thickness antenna) has been printed by flexography and the read range was compared using silver inks. In order to produce electronic component like RFID in an efficient and cost effective way, this preliminary study shows that printing processes may be chosen as an alternative process. Printed passive components are crucial for the development of low cost, flexible using printing technology such as RFID. Going forward, a remaining challenge is to improve the conductivity of printed patterns for antenna fabrications. For an optimum performance it is needed to conduct further research. In this article, the author presented and demonstrated that flexography printing technology may possibly capable of processing antennas for RFID.

References

- [1] Kleper, M.L., *Printed Electronics and the Automatic Identification of Objects*. 2004:GATF Press. 63.
- [2] Kippan, H., *Handbook of Print Media*. 2001, Berlin-Heidelberg: Soringer-Verlag.
- [3] Blayo A, Pineaux B. *Printing Processes and their Potential in Printing RFID* in Proceedings Smart Objects and Ambient Intelligence 2005, France.
- [4] Rigney, J. *Materials and Processes for High Speed Printing for Electronic Components*. In International Conference On Digital. Michigan, USA. 2004.
- [5] D.Gamota, P.B., K.Kalayasundram, J.Zhang, *Printed Organic and Molecular Electronics*. Massachusets 2004,; Kluwer Academic Publishers.
- [6] M.S.Yusof, T.V.K., F.M.Jachim, T.C.Claypole, D.T.Gethin. *Fine Line Printing for the Reproduction of Electrical Devices by Flexography*. in Technical Research Conference. 2006. Swansea University.
- [7] M.S.Yusof, T.C.C., D.T.Gethin. *Fine Line Printing by Flexography Printing*. in ESPRC International Colloquium on Integrated Manufacture by Printing Greygynog, UK. 2006.
- [8] M.S.Yusof, S.M.H., T.C.Claypole, D.T.Gethin. *Investigation into Ultra Fine Solid Lines in Flexographic Printing*. in Malaysian Research Group International Conference.Salford, UK. 2006
- [9] M.S.Yusof, S.M.H., T.C.Claypole, D.T.Gethin. *Measuring Solid Line Geometry on Flexographic Photopolymer Printing Plate*. in International Conference on Print and Media Technology. Chemnitz, Germany, 2005.: Verlag fur Wissenschaft und Fochung, Berlin.
- [10] M.S.Yusof, A.M.A.Z., T.C.Claypole, D.T.Gethin. *The Effects of Anilox Roller on Fine Line Printing in Flexographic Printing Process*. in 2nd International Conference on Print and Media Technology. 2007. Chemnitz, Germany: Verlag fur Wissenschaft und Forschung, Berlin.
- [11] M.S.Yusof, A.M.A.Z., T.C.Claypole, D.T.Gethin. *The Effects of Printing Plate on the Reproduction of Fine Solid Line Printing in Flexography*. in 2nd International Conference on Print and Media Technology. Chemnitz, Germany 2007.: Verlag fur Wissenschaft und Forschung, Berlin.
- [12] M.S.Yusof, T.C.C., D.T.Gethin. *Exploring Fine Line Reproduction in Flexography*. in 2nd International Colloquium on Integrated Manufacture by Printing,. Greygynog, UK. 2007.
- [13] M.S.Yusof, T.V.K., T.C.Claypole, D.T.Gethin. *An Investigation into Deformation of Photopolymer Plate During Printing Solid Line in Flexography*. in 5th European Conference on Constitutive Models for Rubber.. Paris, France: 2007 Taylor & Francis.
- [14] Kleper, M. L. *Printed Electronics and the Automatic Identification of Objects. The Emerging and Developing Technologies Related to the Generation Beyond Print-on-Paper*. GATF. 2004.
- [15] Jay Sperry, E.W., *Conductive Inks and In-line Flexo: An Investigation of Process Benchmarks for RFID Printing*, in Flexo Magazine. 2005.
- [16] M.S.Yusof, D.T.Gethin, *Investigation of Carbon Black Ink on Fine Solid Line In Flexography, Proceedings of 3rd WSEAS International Conferences on NanoTechnology, World Academic and Scientific Engineering Society, Cambridge University, UK 2011.*
- [17] Yuka Yoshioka, P. D. C., Ghassan E. Jabbour, *Simple Modification of Sheet Resistivity of Conducting Polymeric Anodes via Combinatorial Ink-Jet Printing Techniques*. *Inter Wiley*, **26** (4), pp. 238-246. 2005.
- [18] Schaeffe, stefen, IBM Corporation, 2004.
- [19] I.M.Smith and D.V.Griffitts, *Programming the Finite Element Method*. In: Vol. Third Edition. Wiley.1998
- [20] Bould, D. C., *An Investigation into Quality Improvements in Flexographic Printing*. PhD. Univeristy of Wales Swansea. 2001.
- [21] Hamblin, S. *The Role of the Plate in the Ink Transfer Process in Flexographic Printing*. PhD. University of Wales Swansea. 2004.
- [22] Ahmad, M. M. H. B. M., *Dot Analysis In Heat Set Web Offset Lithographic Printing*. PhD. University of Wales Swansea. 1996.
- [23] M.Holmvall; and T.Uesaka, *Nip Mechanics of Flexo Post-printing on Corrugated Board*. *Journal of Composite Materials*, **J41** (17), pp. 2129 - 2145. 2007.
- [24] Mirle, S. K. and Zettlemoyer, A. C. *Viscoelasticity Of Photopolymer Plates and Ink Hydrodynamics In Modelling Flexographic Printing*. *Math1 Comput. Modelling*, **11**, pp. 1162-1165. 1998.
- [25] Hamblin, S., *Numerical Modelling of Flexographic Halftone Dots*. In: *Welsh Center for Printing and Coating Summit Conference*. swansea: University of Wales Swansea. 2005.