

A CASE STUDY OF BRACED EXCAVATION USING STEEL SHEET PILE WALL IN THI VAI SOFT CLAY

Dao Thi Van Tram

*Faculty of Civil Engineering, University of Technology, HCM city, Vietnam
pcc_vantram@yahoo.com.vn*

Le Trong Nghia

*Faculty of Civil Engineering, University of Technology, Ho Chi Minh City, Vietnam,
nghiacehut@yahoo.com*

Nguyen Cong Oanh

*Posco Engineering, Representative Office, Ho Chi Minh City, Vietnam
nguyencongoanh@yahoo.com*

(Received:16/09/2013; Revised:06/12/2013; Accepted: 20/01/2014)

ABSTRACT

The paper presents a case study of braced excavation using sheet pile wall in Thi Vai soft clay in South East of Ho Chi Minh city, Vietnam. The study is focusing on stress-strain-displacement behavior with field monitoring of lateral displacement of the wall and settlement of the surrounding area while the 11m excavation of the pump pit was performed. Furthermore, comparison of calculated and monitored data is shown to get insight into actual behavior of the braced cut wall. It is finally found that the ratio between maximum lateral displacement to maximum excavation depth ranging from 1.12%, 3.08% and 3.35% respectively for inclinometers INC-01 to INC-03 and that between surface settlement to maximum excavation depth 0.93% without any failure of the braced excavation and effective stress analysis can be used for getting reasonable and practically accepted values of both lateral displacement and surface settlement.

Keywords: Soft clay, sheet pile, excavation, lateral displacement.

Introduction

The location of the project is South East of Ho Chi Minh city as shown in Figure 1. This river water intake structure is

built to get river water for heating purpose of refrigerated LPG so it is located very close to the shoreline of Thi Vai River with daily tidal cycle observed.

Figure 1. Location map of the site

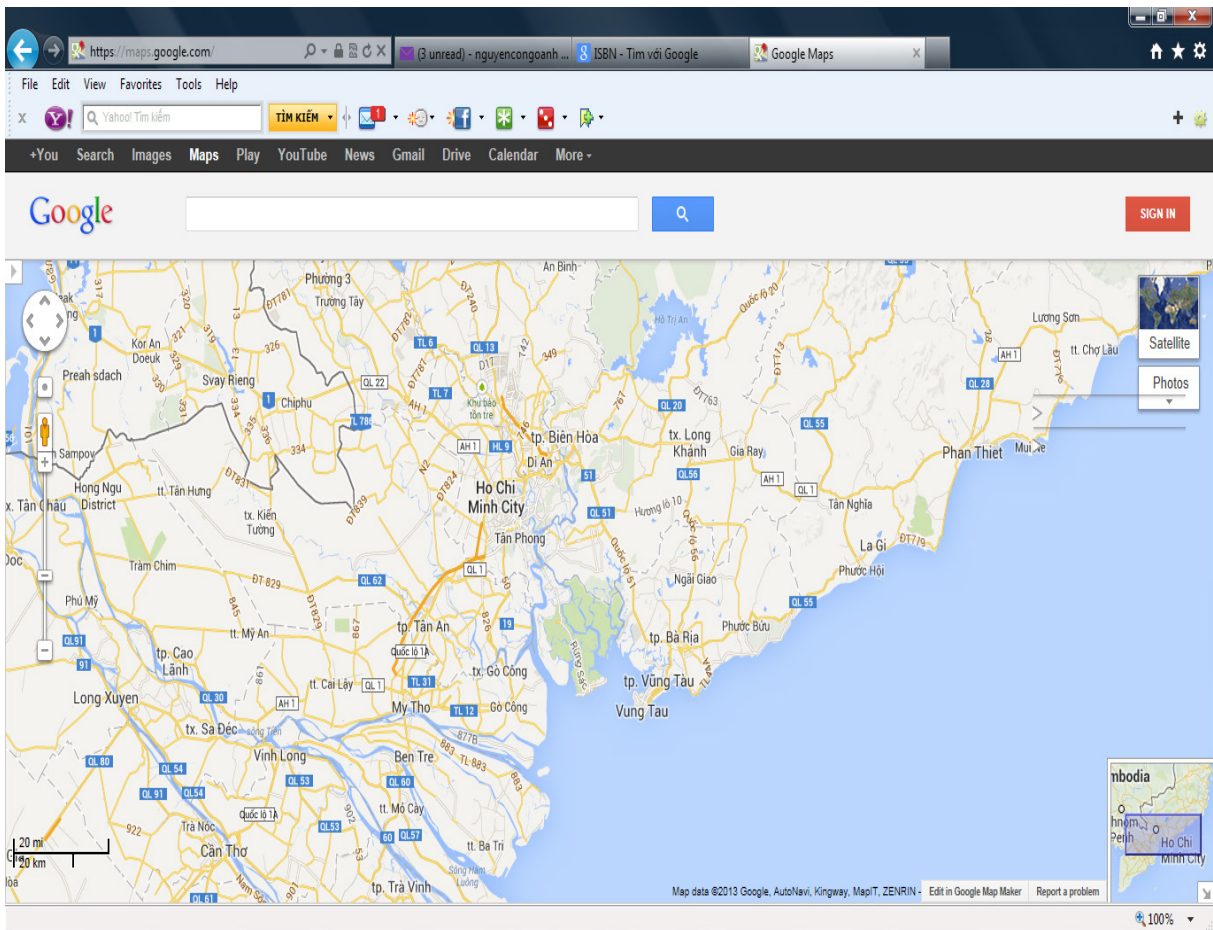

Due to the narrow and limited area of the existing LPG factory, braced excavation using sheet pile wall was implemented for the construction of this pump pit. Sheet pile type is of IV type and bracing beam is of H-400. The depth of the excavation is of 10.90m as average, from ground level ranging from +2.40m to +2.60m following National chart datum.

During the deep excavation work, the pit was kept drained by the submerged pumps installed in the drainage lines there. Therefore, pumping of water out of the excavation pit will generate residual water level up to 9.90m. The residual water level contributed lateral pressure to sheet pile wall. Furthermore, construction surface load of 30kPa was mobilized from the third excavation stage.

(Skempton and Ward, 1952) reported a full scale multi-propped excavation in

soft clay and finally stated that the factual data on soil conditions and monitoring output were more important than their interpretation, recognizing that methods of interpretation would develop with improved theory, while the data would always be useful for calibration of new analytical methods or as a contribution to empirical designs. In the mean while, (Wu and Berman 1953) presented a very deep cut in soft to medium clay and found that great restraint at the base of the wall of the case could restrict the ground movement and change the pressure distribution. Furthermore, (Bjerrum and Eide 1956) also presented many cases of excavation in soft clay with a bit different purposes. The paper had a profound influence on the design philosophy of braced excavations leading to dimensionless base stability numbers in later semi-empirical procedures

for predicting both ground movements and support loads as per stated in (Peck 1969) and (Clough and O'Rourke 1990) in which maximum movement for the cases of soft to medium clays are ranging from 2% to 5% of the deep of excavation.

Following the work on advantages and limitations of the observational method by (Peck 1969), there came many additional studies carried out by (Powderham 1994), (Glass and Powderham 1994), (Young and Ho 1994) and (Ikuta, Maruoka et al. 1994) which are referenced in CIRIA report R185 on the Observational method in ground engineering: Principles and application by (Nicholson, Tse et al. 1999). This publication now becomes a standard guidance for practical application of the observational method in UK construction.

(Zdravkovic, Potts et al. 2005) compared three dimensional analysis with various approximation of an excavation within a diaphragm wall and stated that in some extends, approximate two-dimensional analyses were adequate, in terms of both wall bending moments and ground movements.

Subsoil properties

Investigation was carried out in 2009 for FEED (Front End Engineering Design), and in 2010 for detailed design of the whole project. Unfortunately, there was no borehole or field test done near the location of the river water intake structure where the land had been reclaimed for almost ten years. Therefore, additional investigation with two boreholes BH-07 and BH-08 as shown in Figure 2, one piezocone penetration test CPTU-04 and one field vane shear test VST-05 was conducted just for the engineering design of this support structure before the start of the excavation work to get undisturbed samples for laboratory testing and good insight into the real soil condition of the reclaimed soil after ten years. The additional soil investigation is necessary for the design and construction of the braced excavation in soft ground condition. The ground includes around 2m of sand filling on the top, which was completed around ten years ago, underneath is 18m of soft clay with high water content and highly compressible characteristics.

Figure 2. Layout plan of soil investigation for the project site

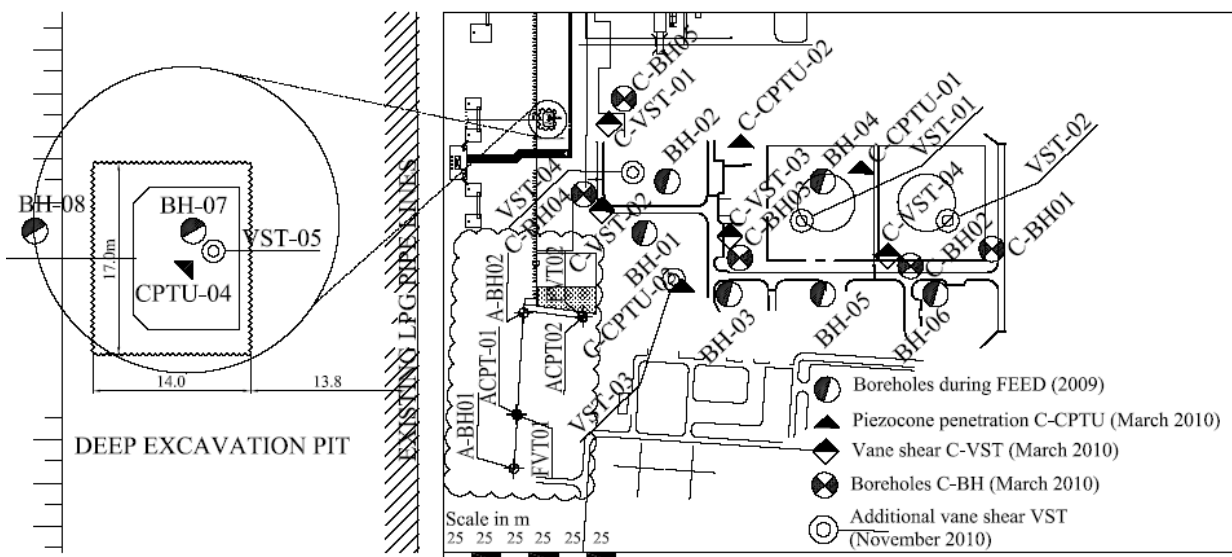
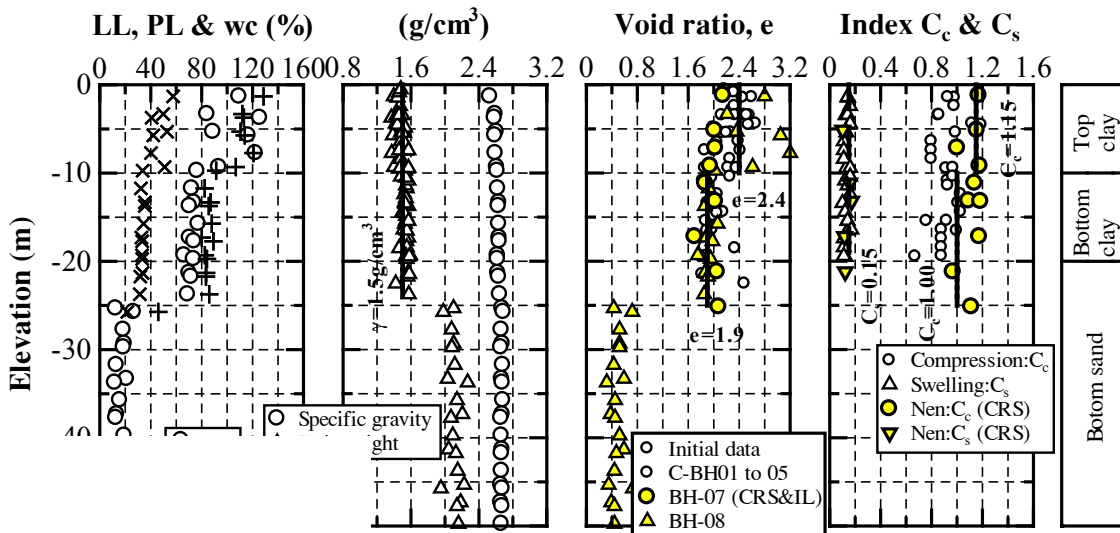

Figure 3. Physical mechanical properties



Sandy soil was found in boreholes BH-07 and BH-08 from the depth of 20 to 27m though its thickness is ranging from 18 to 25m for the whole site. Figure 2 shows the layout plan of soil investigation in the river water intake area. Figure 3

shows physical-mechanical property profiles which clearly separate two layers of soft soils in the ground. The soft clay has natural water content close to liquid limit, unit weight of around 15.0 g/cm³ and void ratio ranging from 1.7 to 3.20.

Figure 4. Piezocone penetration and field vane shear test results

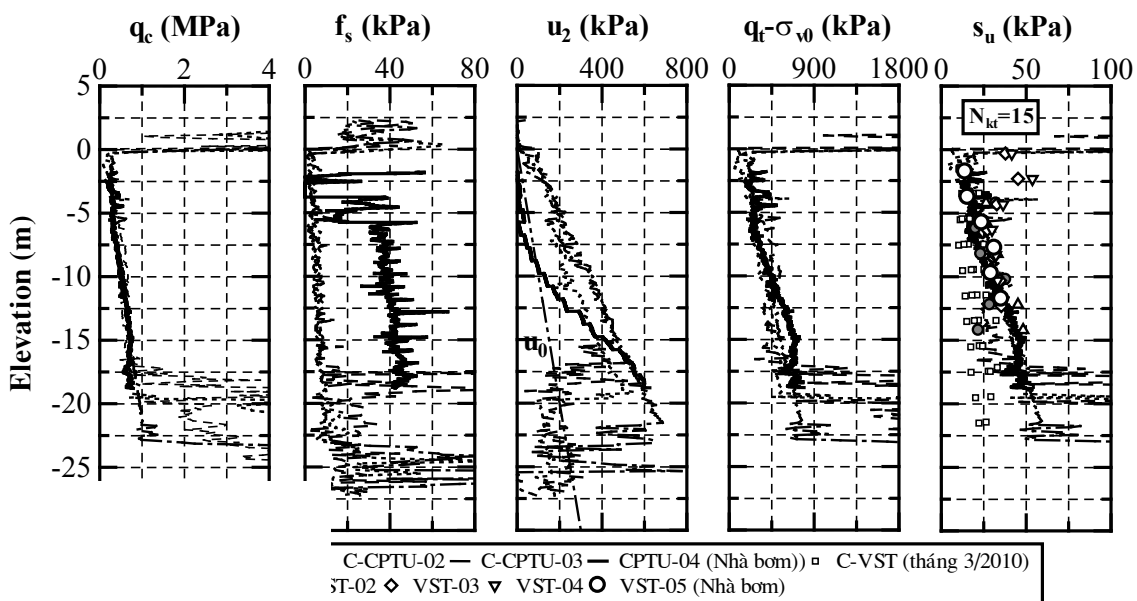

The void ratio to be used in the finite element analysis is 2.4 and 1.90 for top and bottom soft clay respectively. It is found that even the reclaimed sand have consolidated the soft clay by its self-weight. Not much effect from the reclaimed sand to the soft clay deposit resulted in the fact that the soft clay is now lightly over consolidated

with OCR ranging from 1.40 for top clay and 1.20 for bottom clay because the effective stress increase by the sand fill was not large enough to bring the soil to normally consolidated state. Piezocone penetration testing was done for the whole site to investigate the detail of soft clay profile from area to area. The field testing

results by piezocone penetration and vane shear test plotted in Figure 4 shows that the soft clay is almost same from top to bottom of the soft clay layer though there is sand seam found from elevation -1.0m to -5.0m with high un-drained shear strength at shallow depth as presented in Figure 5. Furthermore, the increase in $(q_t - \sigma'_{v0})$ in these depths confirm the existence of these sand seams. As found in the laboratory test results, un-drained shear strength to effective over-burdened stress ratio is of 0.23 as the average value according to vane shear test and piezocone penetration as shown in Figure 4 and

Figure 5. Moreover,, cone factor $N_{kt}=15$ is found to be consistent with vane shear test data. Soil properties for each layer are tabulated in

Table 2. There were six samples taken by hydraulic piston sampler for UTCT (Undrained Triaxial Compression Test) as presented in Figure 6 and Figure 7 to be done to get effective stress parameters for the analyses, vane shear test and piezocone penetration test are used in conjunction with UTCT for the estimation of the effective stress parameters of soft clay layers.

Figure 5. s_u vs. over-burdened stress ratio

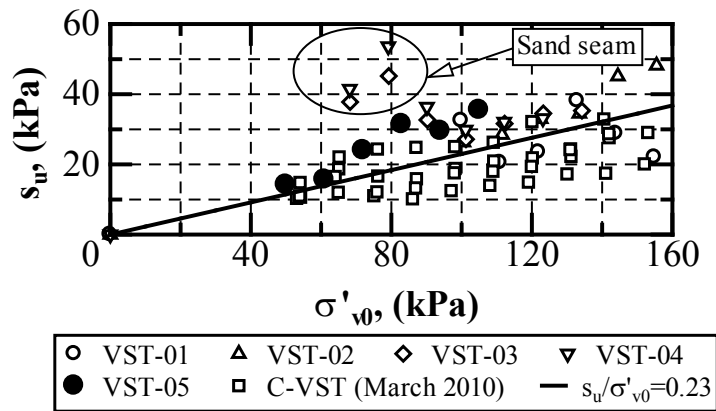

Figure 6. Triaxial test results for top soft clay

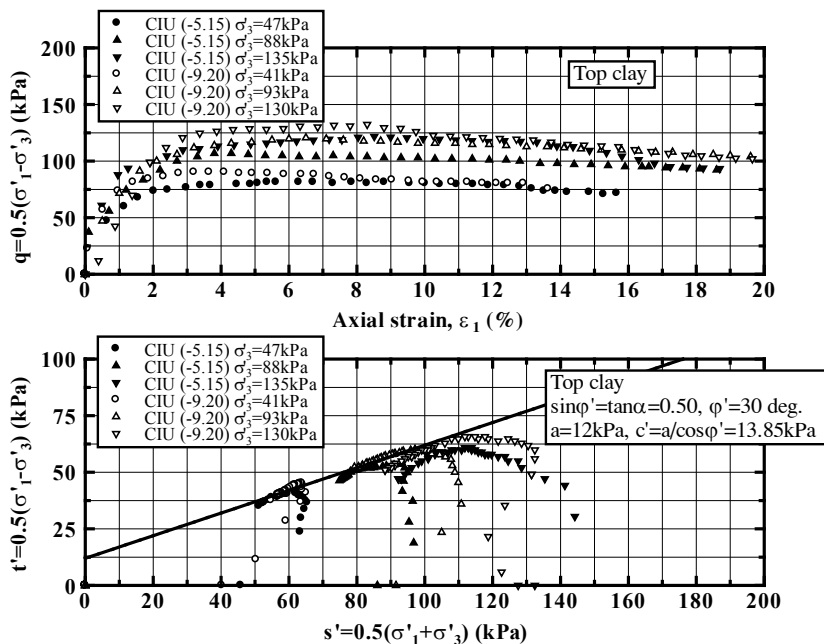
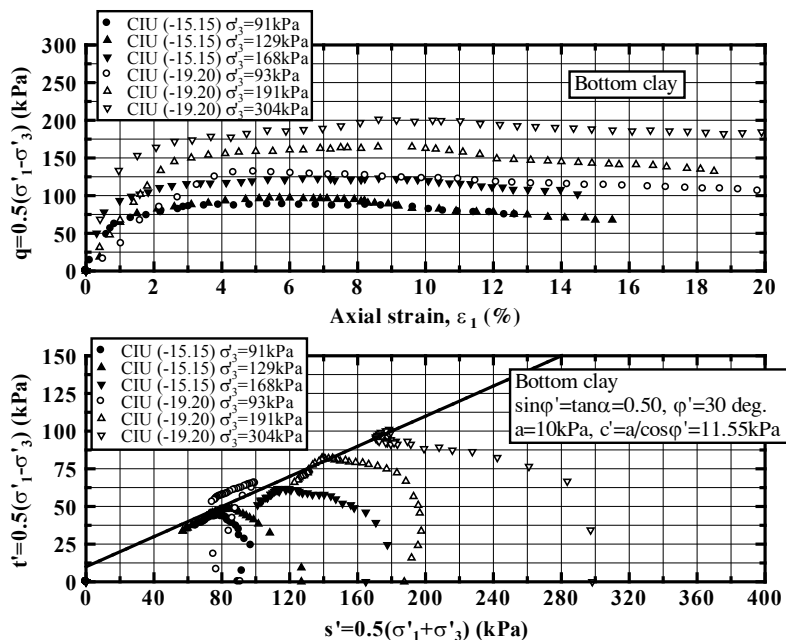

Figure 7. Triaxial test result for bottom soft clay



Monitoring instrumentations

For the safety control of deep excavation, field monitoring instrumentations including settlement plates from SP-01 to SP-07 and inclinometers from INC-01 to INC-03 were installed following the arrangement in Figure 8 and data were used for the evaluation of behaviors and safety factors of the excavation work. In the meanwhile, there are existing LPG pipelines, which need to be secured, about 13.80m from the sheet pile wall.

As shown in Figure 8 three inclinometers were installed around 2m

away from sheet pile wall line in order to avoid their damages during the installation of sheet piles. The main direction of inclinometer INC-01 is toward riverside or toward the excavation pit while INC-02 and INC-03 directions are toward riverside and toward the excavation pit. This arrangement gave the engineers the overall view of lateral movement of earth into the pit and toward the river because one side of the pit is close to Thi Vai River. In this case, it was very important to use inclinometers INC-02 and INC-03 for the assessment of factor of safety for land sliding issues too.

Figure 8. Arrangement of monitoring instrumentations (Dimension in m)

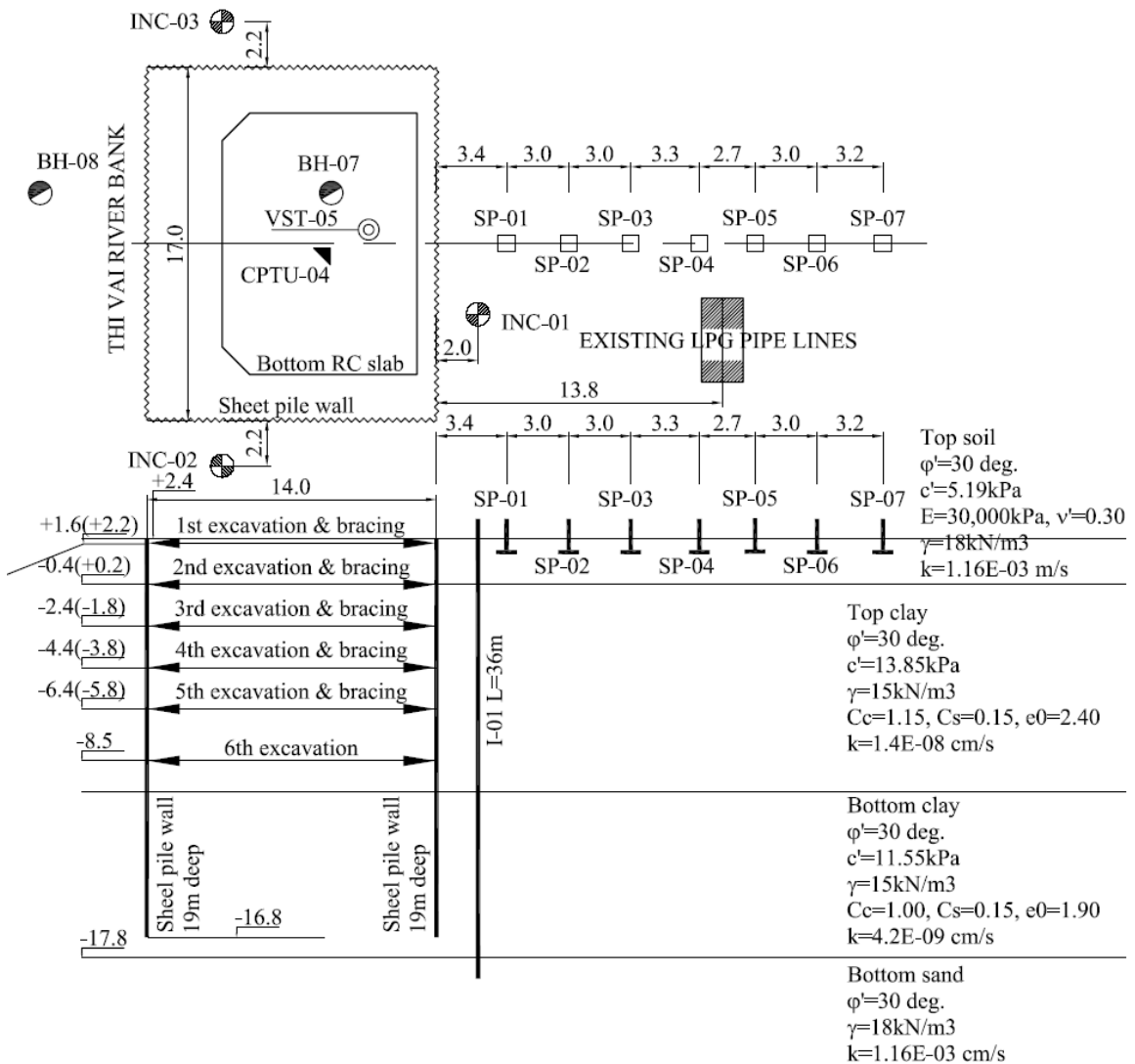

However, in this paper only data of inclinometer INC-01 is used for assessment of behavior of soft clay under braced excavation of the pit. Inclinometers and settlement plates were installed before sheet pile were driven by hydraulic pressing machine so the initial readings for these instrumentations will be determined as from the completion of sheet pile installation on 06 December 2011. The length of inclinometers installed is of 36m; however, the data considered are only 30m from the top of inclinometer casing. Top elevation of the casing is almost equal to existing ground elevation.

Analysis of braced sheet pile

FEM analysis was performed to study the behaviors of the braced sheet

pile wall in soft ground condition. Soft Soil model is used in the analysis with Plaxis, a finite element code, in order to simulate the behavior of soft clay layer while Mohr Coulomb model is applied for reclaimed sandy soil and sand layer at the bottom interested domain. The following construction sequences in Table 1 are applied in the analysis. Soft clay layer behaves in un-drained condition due to its low permeability coefficient while sandy soils in drained condition.

Table 2 shows all effective stress parameters for the four soils in finite element analysis. Section properties of structural elements as bracing beams, H-400 and sheet pile type IV are tabulated in Table 3.

Table 1. Construction sequences of the excavation work

	Construction sequences	Starting date	Finishing date
0	Sheet pile driving (GL. +2.40-+2.60)		6-12-11
1	First excavation to EL. +1.60	12-01-12	14-01-12
2	First bracing installation at EL. +2.20	15-01-12	17-01-12
3	Second excavation to EL. -0.40	02-02-12	07-02-12
4	Second bracing installation at EL. +0.20	10-02-12	11-02-12
5	Third excavation to EL. -2.40	12-02-12	17-02-12
6	Third bracing installation at EL. -1.80	23-02-12	27-02-12
7	Fourth excavation to EL. -4.40	28-02-12	08-03-12
8	Fourth bracing installation at EL. -3.80	10-03-12	13-03-12
9	Damage of first bracing	10-03-12	13-03-12
10	Fifth excavation to EL. -6.40	14-03-12	25-03-12
11	Fifth bracing installation at EL. -5.80	26-03-12	28-03-12
12	Sixth excavation to EL. -8.50	29-03-12	06-04-12

Table 2. Soil properties in finite element analysis

Soil layer	E'	ν'	$k_x=k_y$	φ'	c'	C_c	C_s	e_0	OCR
	[kPa]	[-]	[m/day]	[deg.]	[kPa]	[-]	[-]	[-]	[-]
Sand fill	30000	0.30	8.600E-02	30	5.19	N/A	N/A	N/A	N/A
Soft Clay I		0.15	1.206E-05	30	13.85	1.15	0.15	2.40	1.40
Soft Clay II		0.15	3.566E-06	30	11.55	1.00	0.15	1.90	1.20
Sand	30000	0.30	8.600E-02	30	5.19	N/A	N/A	N/A	N/A

Table 3. Section properties of structure elements

Structure Element	Area - A	Moment of Inertia - I	Young modulus - E	EA	EI	Weight
	[cm ²]	[cm ⁴ /m]	[kN/cm ²]	[kN/m]	[kNm ² /m]	[kg/m/m]
H-400	214.4	[-]	20000	4288000	[-]	[-]
Sheet pile type IV	242.5	38600	20000	4860000	77200	190

Figure 9. Monitoring data of lateral movement at all three inclinometers

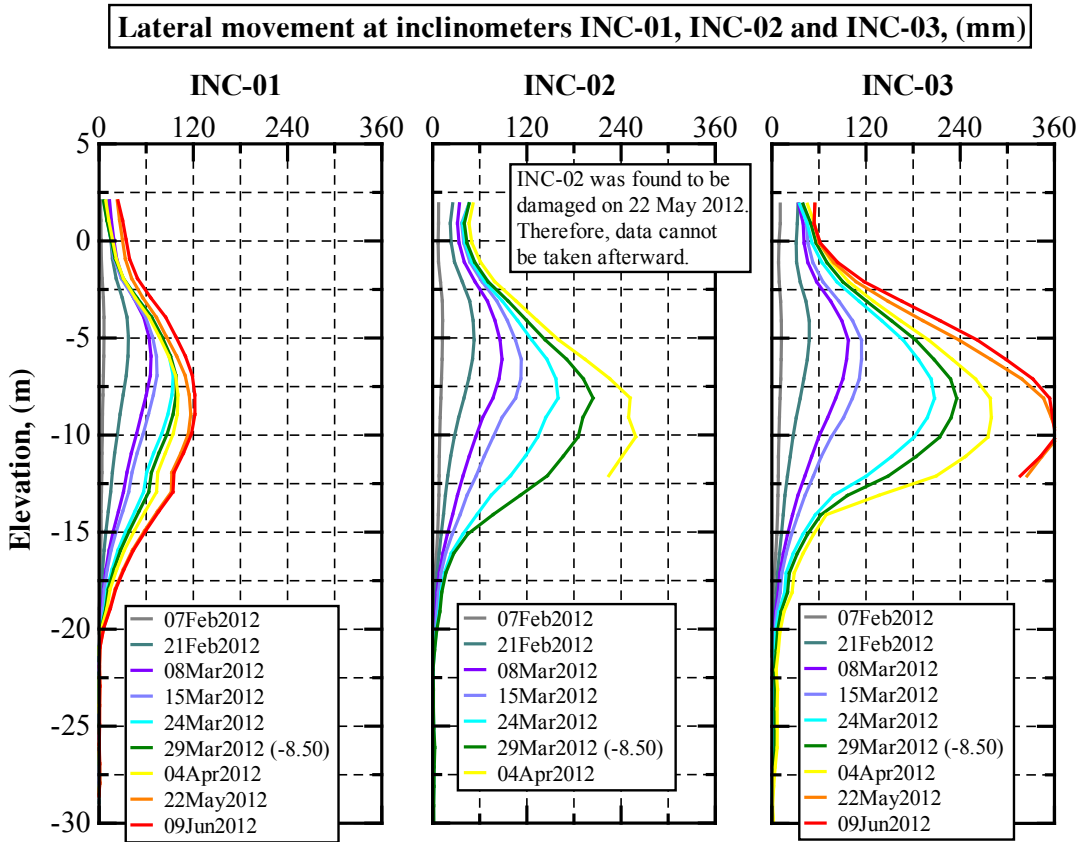

Finite element analysis with soft soil model is performed, under plane strain condition, to evaluate the behavior of the wall compared to field data. The results of FEA are presented in the below section. Figure 11 and Figure 12 show shaded total displacement and deformed finite element mesh of the whole domain after the 6th excavation. The maximum uplift movement of bottom of excavation pit is

around 127mm as shown in Figure 13. The uplift movement is increasing from sheet pile face to center of the excavation pit. However, outward of the pit, there is ground loss behavior and the ground loss at pit bottom elevation is ranging from 3mm to nearly 41mm at 6m from sheet pile wall. The total uplift movement here can be attributed to rebounding of soft clay and large lateral displacement of sheet pile.

Figure 10. Monitoring data of surface settlement at plates SP-01 to SP-07

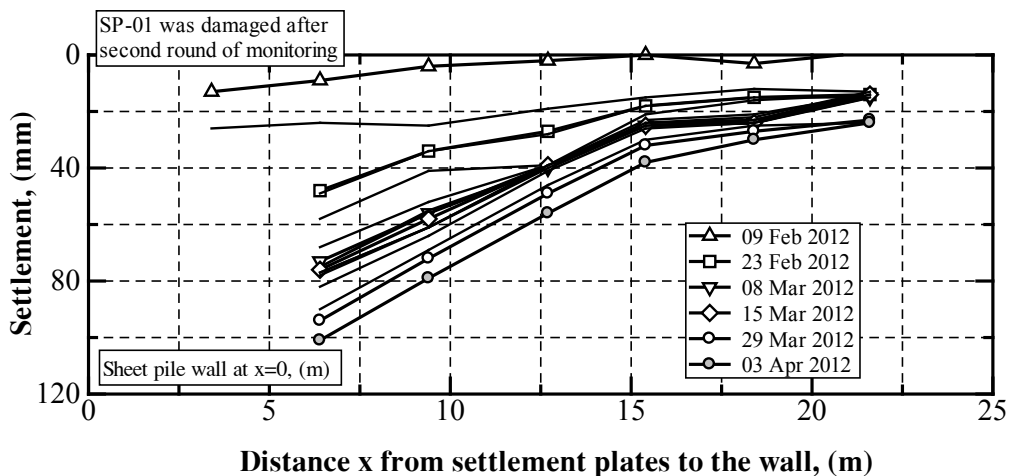

The results of lateral displacement vs elevation and surface settlement vs normalized distance from the wall are plotted in Figure 14 and Figure 15 right at the end of each excavation stage. Calculated lateral displacement and surface settlement show good agreement with monitored data. However, the monitoring data show that after the date of the last excavation on 29 March 2012, lateral movement and surface settlement was still increasing, this can be attributed to consolidation and/or degradation of modulus of highly compressible soft clay, which is not considered in this paper. The authors found that for practical purposes, an effective stress analysis with Soft Soil model in a finite element code can achieve

good results for both lateral movement and settlement in comparison with actual monitoring data. From 3rd to 6th excavation stage the results of the analysis show that calculated values are well agreed with monitored values of lateral displacement. At the 2nd stage, calculated lateral movement of inclinometer is larger than monitored values, and the monitored values from the 6th excavation are increasing over time.

The ground calculated loss profiles are well agreed with the monitored data as specified in Figure 15. The differences at lateral movement may be attributed to over-cutting of earth at some areas in the excavation pit, resulted in actual excavation depth was larger than that considered in finite element analysis.

Figure 11. Shaded displacement at 6th excavation

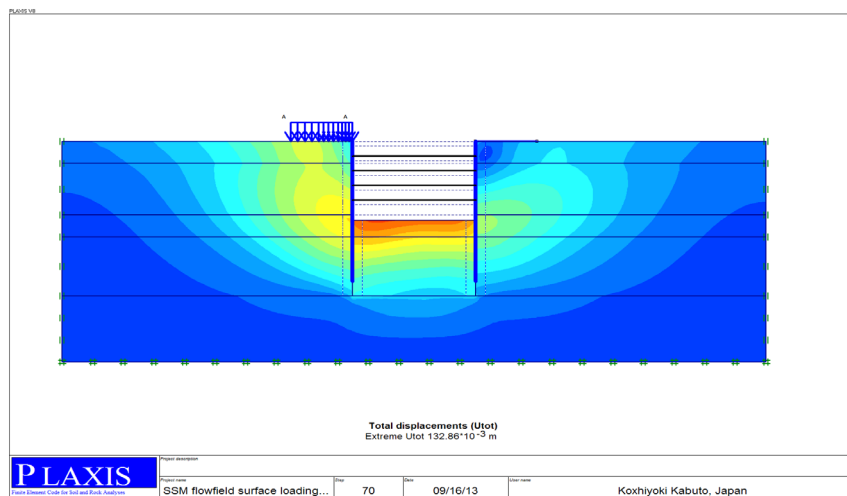

Figure 12. Deformed mesh at 6th excavation

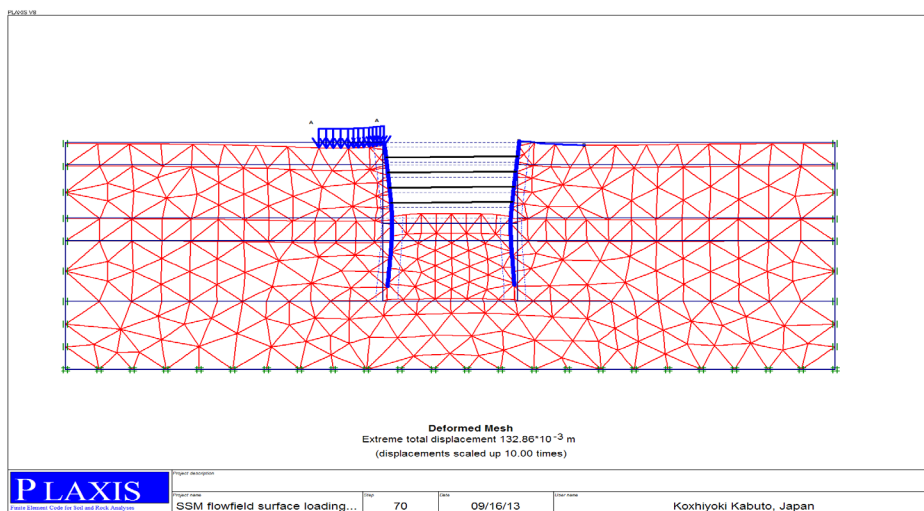

Figure 13. uplift at bottom of the excavation pit

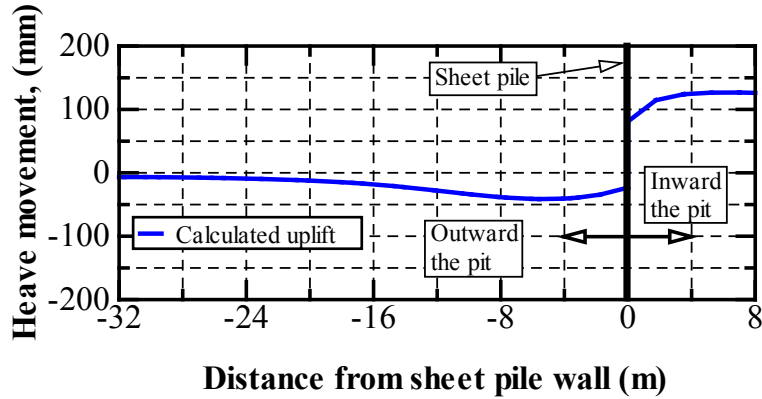

Figure 14. Comparison of calculated and monitored lateral movement at inclinometer

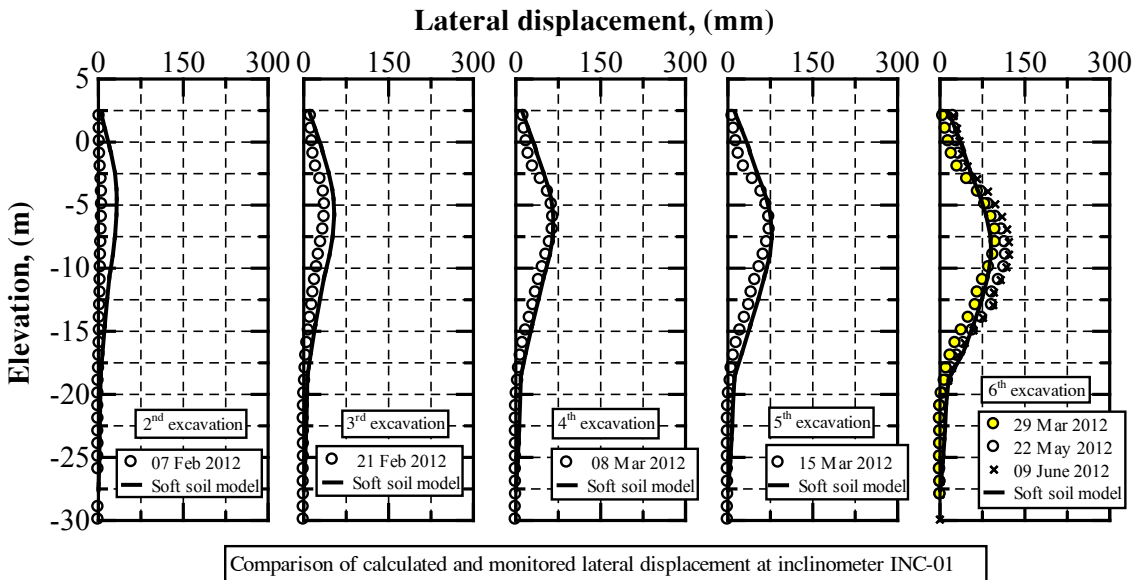
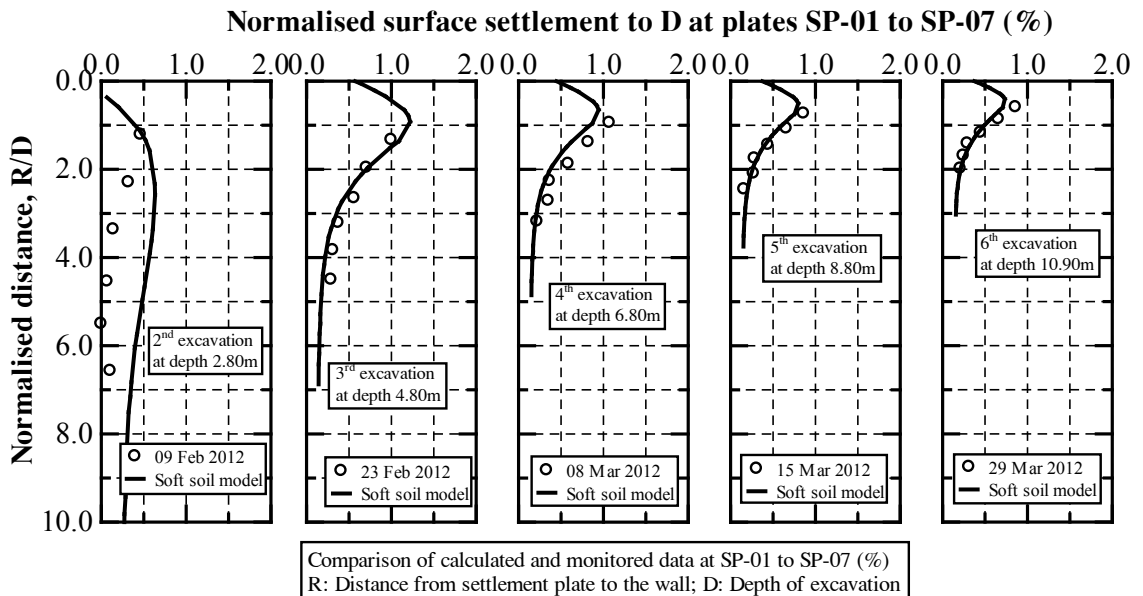

Figure 15. Comparison of calculated and monitored ground loss from the face of sheet pile wall

INC-01



To this end, even the lateral movement is ranging from 1.12-3.35% maximum depth of excavation, there is no signal of failure during the construction of this braced excavation. Furthermore, it was found that at the end of 4th and 5th excavation, there was twisting of bracing beam at level 4 and 5 from the top so lateral displacement increase aggressively. However, lateral movement of sheet pile has been stopped from 22 May 2012 to now because drastic action was taken as soon as there was evidence that the lateral movement of sheet pile was increasing more and more.

Conclusion

Lateral movement ranging from 1.12-3.35% and settlement of 0.93% to maximum depth of excavation will not cause any failure for deep cut in highly compressible soft clay with large thickness like Thi Vai soft clay.

Effective stress parameters can be used successfully in finite element analyses of braced excavation for Thi Vai soft clay and the results of those analyses show good agreement with monitored data in both lateral displacement and surface settlement

Observational method plays an important role in this deep excavation if used in conjunction with sufficient monitoring system of inclinometers and settlement plates. These instrumentations give full insight into Thi Vai soft clay behavior during the deep braced cut for the construction of river water intake pump station in shoreline area of Thi Vai, Vietnam.

Finite element analyses (FEA) with sophisticated boundary conditions and advanced parameters should be used in routine design and construction of braced excavation in soft clay.

REFERENCES

- Bjerrum, L. and O. Eide (1956). Stability of Strutted Excavations in Clay. *Geotechnique* 6(1): 32-48.
- Clough, G. W. and T. D. O'Rourke (1990). Construction induced movements of insitu walls. *Design and Performance of Earth Retaining Structures*. Geotechnical Special Publication. New York, NY, ASCE: 439-470.
- Glass, P. R. and A. J. Powderham (1994). Application of the observational method at the Limehouse Link. *Géotechnique* 44(4): 665-679.
- Ikuta, Y., M. Maruoka, et al. (1994). Application of the observational method to a deep basement excavated using the top-down method. *Géotechnique* 44(4): 655-664.
- Nicholson, D., C.-M. Tse, et al. (1999). *The observational method in ground engineering: Principles and applications*, R185. Construction Industry Research and Information Association.
- Peck, R. B. (1969). Advantages and limitations of the observational method in applied soil mechanics. *Geotechnique* 19(1): 171-187.
- Peck, R. B. (1969). State of the art report: Deep excavations and tunneling in soft ground. Seventh International Conference on Soil Mechanics and Foundation Engineering, Mexico City, Sociedad Mexicana de Mecanica de Suelos, A.C., Mexico.
- Powderham, A. J. (1994). An overview of the observational method: Development in cut and cover and bored tunnelling projects.» *Geotechnique* 44(4): 619-636.

- Skempton, A. W. and W. H. Ward (1952). Investigations concerning a deep cofferdam in the Thames Estuary clay at Shellhaven. *Géotechnique* 3(3): 119–139.
- Wu, T.-H. and S. Berman (1953). Earth pressure measurements in open cut: Contract D-8 Chicago subway. *Géotechnique* 3(3): 248–258.
- Young, D. K. and E. W. L. Ho (1994). The observational approach to design of a sheet-piled retaining wall. *Géotechnique* 44(4): 637–654.
- Zdravkovic, L., D. M. Potts, et al. (2005). Modelling of a 3D excavation in finite element analysis. *Géotechnique* 55(7): 497–513.