

Measurement of the Content of Water Using Light Penetration

Mohd Fahajumi Jumaah^a, Mohd Zikrillah Zawahir^a, Fazlul Rahman Mohd Yunus^a, Ruzairi Abdul Rahim^{a*}, Nor Muzakkir Nor Ayob^a, Muhammad Saiful Badri Mansor^a, Naizatul Shima Fadzil^a, Zulkarnay Zakaria^b, Mohd Hafiz Fazalul Rahiman^b, Mohd Ramzam Abdul Manaf^c

^aProcess Tomography and Instrumentation Engineering Research Group (PROTOM-i), Infocomm Research Alliance, Faculty of Electrical Engineering, Universiti Teknologi Malaysia, 81310 UTM Johor Bahru, Johor, Malaysia

^bTomography Imaging Research Group, School of Mechatronic Engineering, Universiti Malaysia Perlis, 02600, Arau, Perlis, Malaysia

^cFaculty Science Computer and Mathematics, Universiti Teknologi Mara, Malaysia

*Corresponding author: ruzairi@fke.utm.my

Article history

Received :5 February 2014

Received in revised form :

7 April 2014

Accepted :20 May 2014

Graphical abstract



Abstract

In this paper we use an electronic component to produce light which is applied in testing soft tissue penetration. We used bio tissue, a slice of apple, and non-bio tissue, paper. The voltage could be adjusted to brighten the light to view the penetration of the subject. The thickness of the tissue was constant and the results showed that the current and voltage were significant as the light penetrated the soft tissue.

Keywords: Electronic component; soft tissue; thickness; penetration; current; voltage

© 2014 Penerbit UTM Press. All rights reserved.

1.0 INTRODUCTION

Optical tomography systems use light sources to complete the system and the light source is the main material in the system. Normally, systems using this type of source are called non-invasive systems because they can be applied without cutting the structure of the subject. Previous studies have shown that the system can be applied to many substances, for example particles and liquids. The light can be produced by electricity, for example, fluorescent lights etc. [1]. The light can also be produced by using electronic components, for example lasers, light-emitting diode (LED), and infrared [2-4]. As we know, light is divided by two types. It is invisible and infrared light. Normally the visible and infrared light have different wavelength and normally the range of wavelength for visible light is around 400 until 760 nm [5-9] and for infrared wavelength range around 760 until 3000 nm. In this experiment we use 740 nm for visible light and 1000 nm wavelength for infrared light source [10-13]. The second properties of infrared light, the infrared light can't be seen by naked eyes but it can be seen by using the digital camera. The optical tomography system is suitable for use on bio tissue and non-bio tissue [9, 14-17]. However, the size of the subject must be considered first, as the subject must not be too small or too large. Also, we need to consider the light beam or the size of the light line. The brightness of the light can be increased or decreased depending on the situation or the properties of the phantom to be

scanned [14, 18, 19]. As we know, the brightness of the light can be controlled, using either electricity or electronic components, by the voltage and current supply. This is in accordance with Ohm's law shown in Equation 1. The electrical and electronic circuits must also be suitable for current and voltage supply in order to ensure the voltage and the current do not burn the circuit.

$$I = \frac{V}{R} \quad \text{or} \quad V = IR \quad \text{or} \quad R = \frac{V}{I} \quad (1)$$

Based on observation, light can penetrate many types of materials and the brightness of the light can be reduced after penetrating an object. The value of the light when it passes through an object before exposure to the endpoint must also be considered [2, 14, 20-23]. If the light value is low, then the light cannot pass through the subject and scanning cannot be undertaken. Thus, the brightness of the light cannot be measured. As mentioned above, the brightness of the light can be controlled by adjusting by the current and the voltage.

1.1 Subject Criteria

The experiment covers a slice of green apple which was exposed to the light to check the light penetration both with and without a lens [9, 23-26]. Based on previous studies, we chose an apple as the soft tissue subject as it has low water content in the tissue. In

addition, an apple with skin normally takes 19 days to be destroyed, and one without skin 10 days, due to the chemical reaction and changes in the structure of the tissue [27-31]. Based on previous studies, comparisons with other fruits and vegetables showed that the apple has less water and is more suited to such optical testing [32, 33]. As we know that water has a refractive index, by reducing the water quantity in the soft tissue, the error in the refraction index can be reduced [31, 34-36]. By putting the apple sample into the freezer we can extend the chemical reaction time. Other than that, it is not so easy to damage the subject tissue [24, 27-30]. Based on previous studies, the tissues of fruit are destroyed because of the water content inside and normally fruits with more water content are easy to damage, for example, compared to apples blackcurrants are easily damaged in less than a day [32, 36, 37]. In addition, the size of an apple makes it easy to cut and apples are more easily acquired in a normal market; both factors influencing our choice.

The materials of the apple tissue, including water, protein, fat, fibre, moisture, lipids and ash, among others, ensure that light is blocked when penetrating the tissue [30, 37-40]. Other than that, the properties of the materials inside the tissue, such as the quantity of acid, alkali, sugar, and others mineral contents, affect the refraction index when light penetrates the apple tissue [1, 4, 41]. The quantity of material and the refractive index cause the light penetration to diverge with many angles [1]. In addition, humidity is also important to ensure the fruits are in good condition [1, 42]. As we know, light also comes from heat and heat can make the subject (soft tissue) dry and cause cells to die [1, 41].

A second non-soft tissue subject, paper, was also chosen. The paper selected was an A4 70 g Indah Kiat (IK) yellow paper brand (made in Malaysia) and we choose the normal paper which is the white color paper. As we know, paper is produced from wood but paper normally only includes deadwood cells and so we assume that paper is a non-soft tissue. Before making this selection, we had already studied 90 g IK brand yellow paper, Double A paper, One paper and IK green paper, among others, with regard to the thickness of the paper and the light penetration integrity [25, 43]. From both tests, we chose the IK brand yellow paper as the subject for this study. The subject is low in thickness and more light can penetrate the paper compared to the other types. Previous studies have shown that the quality of the paper can be detected by using optical coherence tomography [43]. The low penetration of light (the high reading on the sensor) indicates a better quality paper compared to the others. To increase the paper thickness, the paper was stacked one leaf at time up to five leaves [9, 25].

Based on the subject criteria above, we know that the refractive index for paper can be ignored because paper is dry and there is less material inside the paper tissue. Based on that, we can assume that the value for soft tissue captured by the sensor will be less than that of paper. In the subjects selected, we will evaluate the refractive index to assess the changes between two types: with and without water.

1.2 Refractive Index

As we know, an optical system has optical absorbance, a refractive index or index of refraction, a thermo-optic coefficient and an index of variation [4]. Their use in immersion lithography and wavelength is important. The same applies to water properties [24, 37]. Water's chemical equation without other reagents or as solid water is H_2O [37]. Normally, the refractive index for this type of water is 1.33 and 1 for air [34-36, 44]. The refraction by water is shown in Figure 1.1 and the angle of the refraction depends on the properties of material.

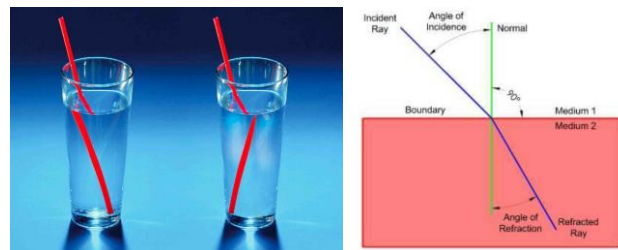

Figure 1.1 Refraction by water

1.3 Light Properties

Based on previous studies, every type of light has advantages and disadvantages based on their wavelengths and the color of the light produced by electric and electronic components [1]. Normally, light is either of the infrared or visible light type [4]. Based on the properties of the light, light can be used to eliminate bacteria, monitor food packing, monitor the quality of food, and much more [4, 45]. Based on eyesight, the color of light is not affected by penetration regardless of the type of material to which it is exposed. On the basis of color and wavelength, we conclude that the wavelength does not change after light penetration.

Many methods are used in conducting experiments. In industry, they use the skin of the fruit as there is no need to remove the skin in order to measure the quality of the fruit. However, in this experiment, we want to assess the effect of light depending on the quantity of minerals inside the tissue of the fruit [46]. In addition, light sources also are used in packaging in the food industry environment. By using this type of source we can maintain the quantity and freshness of the food. Furthermore, the light source does not have the reactive power to affect the food.

This experiment is based on the light source produced by electronic components [4]. The visible light source component produces red light and the wavelength range for red light is 700 nm [4, 24]. The brightness will be controlled by adjusting the voltage [2, 3, 8, 24, 47] and the current can be adjusted by using an adjustable power supply. The beam of the light will also be adjusted by using two types of lens: convex and concave [24]. As a reference, the light source without a lens is taken for data comparison. Based on the naked eye view, the angle of light will be increased but the distance of the light will be decreased.

1.4 Sensor Jig

In this test, sensor jigs are used to position the receiver and transmitter. Figure 1.2 shows the sensor jig design. As can be seen, they have four holes in which to place the transmitter and receiver [2, 21, 47]. For this experiment, we only use two holes as we have one pair of components: a transmitter and a receiver. The sensor jig's function is to ensure the light (transmitter) is 180° direct from the sensor (receiver) [2, 4, 47]. The subjects (the slice of green apple and the paper) are put at the centre of the sensor jig and the subject will be exposed to the light, as shown in Figure 1.3. The subject will block the light and the sensor will detect less light [21, 47]. Based on previous studies, for the best way to kill bacteria or to process packaged food, the light source must be closed in order to ensure the food is less exposed to the light and to maintain its freshness [1].

Based on previous studies, there are several recommended exposure distances for maximum exposition [1]. Accordingly, we fixed the average distance of the subject from the light source in at 0 to 10 cm as shown in Figure 1.2.

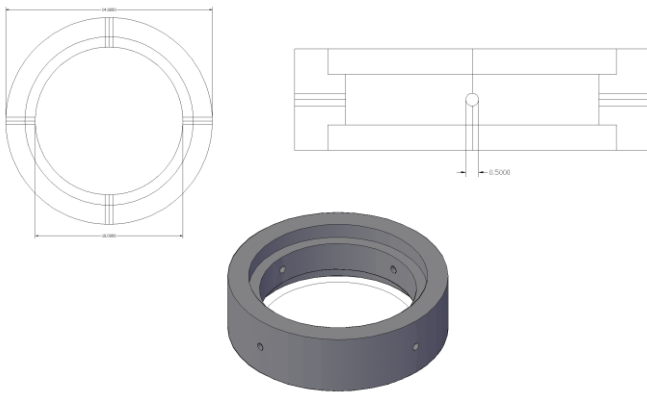

Figure 1.2 Sensor jig used in this test

2.0 EXPERIMENT SETUP

The experiment was set up by using a light source and a sensor applied to a jig to ensure that the light travels in a straight line [2, 14, 22, 48, 49]. The function of the jig was to fix the sensor and the light source in order to make them constant [22, 48, 49]. Based on light theory, the brightness of the light will be reduced depending on the thickness of the material or subject [16, 22, 48, 49]. The subject used in this test was a slice of apple and eight pieces of paper [16, 17, 45]. The paper and the slice of apple were put at the centre of the jig to block the light so as to reduce its brightness [17, 22, 45, 48, 49]. The value of the light reduced depending on the thickness of the material. From this point, the light was blocked and the brightness of light decreased. Figure 1.3 shows the jig and the experimental setup using both of the subjects. The inner diameter of the jig is equivalent to 10 cm and the size is equivalent to an industrial pipe [21, 50].

The distance of the sensor and light source were fixed at 10 cm [21, 50], equivalent to the size of the inner diameter of the jig. The 10-cm inner-diameter jig was chosen because the lower voltage of 3.1 V is needed in order to make the light source component function, from which the sensor will be able to detect the low brightness of the light produced from the light source component.

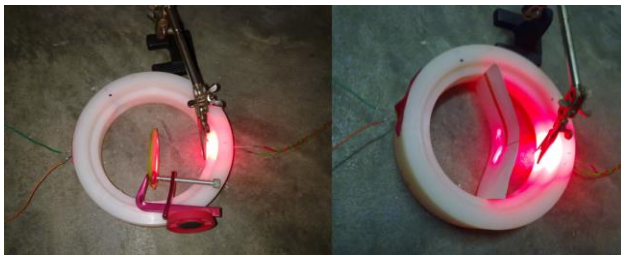

Figure 1.3 Experimental setup

Previous studies have shown that there are many subject exposure methods for fruit, both invasive and non-invasive, depending on what is to be tested. Normally, non-invasive techniques are used in industry because they are easier to undertake in the industrial environment as industry needs faster processing times [1, 51].

The main objective of this experiment is to assess the effect of light in penetrating soft tissue. In addition, we want to check the effect of light after penetration through a lens onto soft tissue

[1, 4, 41]. Sensors normally have blank spots or a maximum detection angle. As a result, the maximum angle that can be detected will be tested by using the sensor jig, as shown in Figure 1.3, to check the maximum point (angle) that can be detected via the sensor.

3.0 RESULT

In this section, we report the results of two subjects: a slice of apple and white paper. The value captured by the sensor is the voltage value straight from the sensor. The distance of the subject from the sensor was 50 mm on average as the subject is located at the centre of the sensor jig; similarly, the light source is also positioned at 50 mm from the subject (shown in Figure 1.3). The testing will be covered the reference data and will be conducted without any subject block the light. The distance of sensor to the light source is 0.2 cm. Base on light theory, the light can't go through if something solid present in front of the sensor or light source [2, 3, 8, 47, 52]. The light can go through if the blockers have properties can be penetrated by a light, the other factor can disturbing the moving the light is the refractive index and it will depend on the blockers properties [29, 30, 34, 42, 53-55].

3.1 Experiment Result for LED Light Source

The main objective of the first experiment was to monitor the different voltages that will affect the brightness of the light. Additionally, the experiment was undertaken to monitor the different brightness and to compare the values of the brightness with different voltages [2, 3, 8, 47, 52]. Based on Ohm's law, the voltage and current can be adjusted automatically until the law stabilises when the resistance is constant [2, 3, 8, 47]. Based on the test situation, the brightness will increase when the voltage and current increase. The result is as shown in Table 2.1 for LEDs used as the electronic light source. The results are without any block from the subject; only direct light from the light source to the sensor.

Table 2.1 Results of the voltage and brightness tests using LEDs as the light source

No	Transmitter		Receiver		
	Voltage (volt)	Current (amp)	Without lens (v)	Concave lens (V)	Convex lens (v)
1	3.5	0.01	0.2925	0.2529	0.2694
2	6.0	0.02	0.322	0.2814	0.3109
3	8.0	0.03	0.338	0.296	0.324
4	10.3	0.04	0.354	0.2913	0.331
5	12.3	0.05	0.365	0.3005	0.341

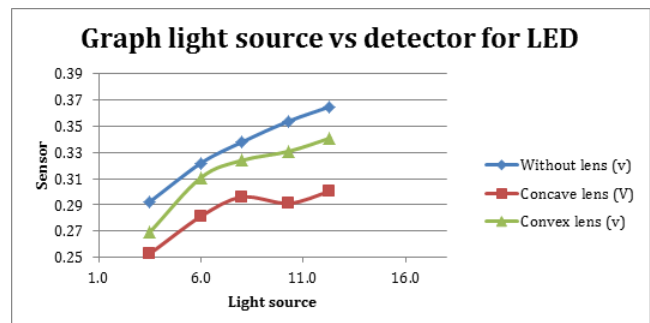

Figure 2.1 Voltage vs. brightness for LED light source

Table 2.1 and Figure 2.1 highlight that brightness is enhanced when the voltage is increased. Table 2.1 also shows that the voltage is proportional to the current as per the theory.

Based on Figure 2.1, the brightness value will be horizontal when the voltage is 12 V and above. From that we can conclude that the component is in good condition and will burn when the voltage increases. The data derived from using the lens are low compared to those without the lens. Based on the naked eye, the light is not 100% in focus when it is applied with the lens. The light cannot be focused because the jig does not block 100% of the unused light [18, 25]. The jig will require a chamber to block the unused light [18, 25]. The size of the lens also focuses the light more and can be used for penetration [18, 25, 33]. When we compare the concave and convex lenses, the convex lens performs better. The properties of the lens tend more towards a straight line

This experiment, by using a slice of apple and paper, only showed that the voltage and the brightness of the light are related to each other [16, 17], and that light penetrates into a material using biological and non-biological tissues [4].

3.1.1 Experiment Result for Biological Tissue and Non-biological Tissue

The previous paragraph showed that light penetrates both biological and non-biological tissues and the result can be seen in the graph below [25]. To focus the light beam a lens is applied to it. The result of this experiment can be seen in Figures 2.2 to 2.4 showing the value of brightness versus the thickness. As the graphs show, the light penetration is high when the tissue or the paper (subject) is thin. The graph patterns also show the same result indicating that when the thickness of the subject is high then the light penetration is low [9, 26, 33].

For the first LED test in this experiment, we want to check the light direct from the light source component. The aim is to ensure that the data error is low and for this test to serve as a reference for the next experiment with the LED light source (applied with a lens). The results are shown in Figure 2.2.

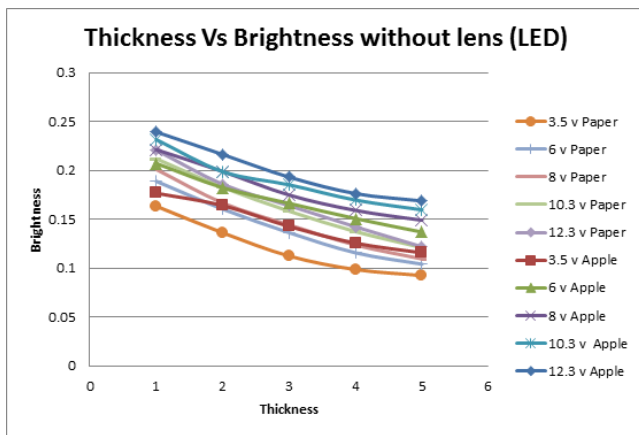

Figure 2.2 Thickness vs. brightness without lens

The experiment without a lens was undertaken to ensure that the properties of the light do not change and for it to be the reference for other experiments. The next experiment used changes in the light beam when a lens is applied in front of the light source. With regard to Figure 2.2, the trend of the graph has dropped slightly and this again depends on the thickness of the subject [24, 33]. The entire graph decreases slightly as the thickness increases. Based on the graph in Figure 2.2, the light

detected by a sensor is proportional to the thickness of the subject [9, 25, 43]. The graph also shows that the penetration of the apple is still the same as the paper but the value of penetration in the apple tissue is higher compared to the paper. Based on observations of the subject, we can see that the apple tissue is more transparent compared to the paper; this is because of the quantity of material inside the subject tissue [1, 4, 41]. Based on Figure 2.2, the result shows that paper can block more light than apple.

For the next test in this experiment, a convex lens is applied to the LED light system to verify the action or the effect of the light produced by LEDs through a convex lens. As we know, convex lenses diverge light after penetration but we must consider the focus point in this case [9, 23, 26]. The convex lens used had a 0.5 cm focus point distance. The collected data starts from that point to make it more accurate.

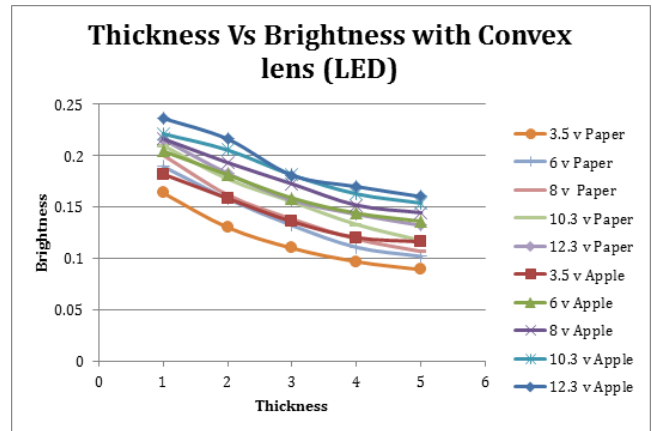

Figure 2.3 Thickness vs. brightness with convex lens

Figure 2.3 shows the result of applying a convex lens to the front of the LED component. The same voltages as before, that are 3.5, 6, 8, 10, and 12.3 V, were used to manage the brightness produced by the LED components. We also used the same subject matter, apple and paper, to assess light penetration. As mentioned above, we used a convex lens to check the effect of the light output from the lens and after penetrating the subject. From result for using 12.3 volt value we can see both of subjects (apple and paper) for convex lens testing. Based on the convex lens result shown in Figure 2.3, the effect of lens can only be seen on an apple as a result by using 12.3 volt as a voltage supply (at the top side) when the thickness is achieve to 1.5 cm. The graph of apple for 12.3 volt fall significantly once the thickness of apple is equal to 1 cm compared with other graph [16, 17]. The value showed, using 12.3 volt is higher compare with other result. The increases of data for other result is consistent but for this voltage value (12.3 volt), the data captured by the sensor is higher even other parameter are constant [9, 26, 33, 52]. Base on Figure 2.3 for other result 3.5, 6, 8, 10.3, and 12.3 volt for paper and 3.5, 6, 8, and 10.3 for apple subject, the graph pattern is quiet same which is when the voltage is increased, the data captured by the sensor also increases and when the thickness of the subject is increase the data captured by a sensor is decrease.

In the next experiment we used a concave lens to identify the light output effect after penetration. As we know, concave lenses make light diverge once the light emerges from the lens [9, 23, 26]. The rate of divergence depends on the internal lens properties [9, 23, 26]. We used a collimator to manage the excess light produced from the LED component.

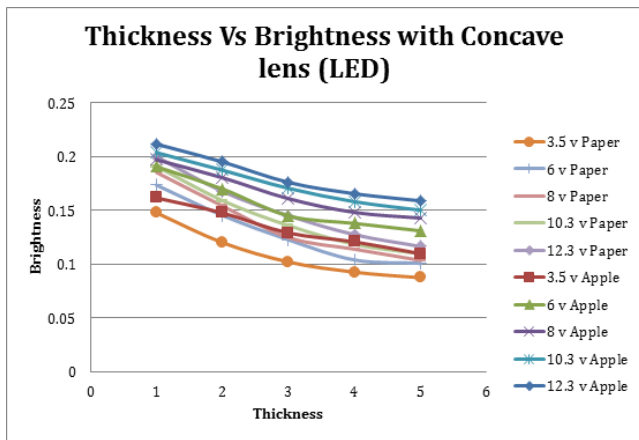

Figure 2.4 Thickness vs. brightness with concave lens (LED)

The graphs in Figures 2.3 and 2.4 show the same result as with the light source without a lens. From the graphs, the convex lens is brighter than concave lens. Based on lens theory, the light after penetrating the concave lens will diverge and the light has greater angles compared to normal light [37, 40, 52, 55, 56]. The outgoing light from the convex lens will be more focused and the thickness of the light beam more constant [37, 40, 52, 55, 56]. In this case and based on the properties of the light beam, the lens is more focused compared to light without a lens [37, 40, 52, 56]. However, the jig must include a chamber to ensure that the unused light is blocked [2]. Another factor that causes the inconsistent decrease in the graph is the material inside the tissue; for example, alkali, acid, water content, etc [30, 31, 34, 39, 44, 53, 57-59]. The refraction effect also makes the value captured by the sensor decrease rapidly. As can be seen from Figure 2.4, the significant point on the graph is at 6 V when the apple is 1 cm thick. Subsequently the graph is relatively stable compared to the point before where the thickness was 0.5 cm. The graph decreased dramatically from 0.5 to 1 cm thickness. If we compare the solid light produced by the LED component (without a lens), the graph for the concave lens decreased and increased dramatically at a thickness of 1 cm [9, 25]. Based on the observation of light coming from the lens which is outgoing from lens or the light after penetration of lens, when comparison value data base testing by applying concave lens (Figure 2.4) and the testing without lens (Figure 2.2), we can see the reduction of value captured by a sensor but it is still can be accepted because the percentage reduction is not more than 10% and for reference point (3.5 volt paper subject), the sensor captured without lens testing is equal to 0.1634 (figure 2.2) volt and for concave lens testing show 0.1479 volt [18, 33, 40, 41, 55].

Based on the three figures (2.2 to 2.4), we calculated the average, shown in Figure 2.5. The result shows the average of the three methods: tests with direct light from LED components, light from the LED component applying a concave lens and light from the LED component applying a convex lens.

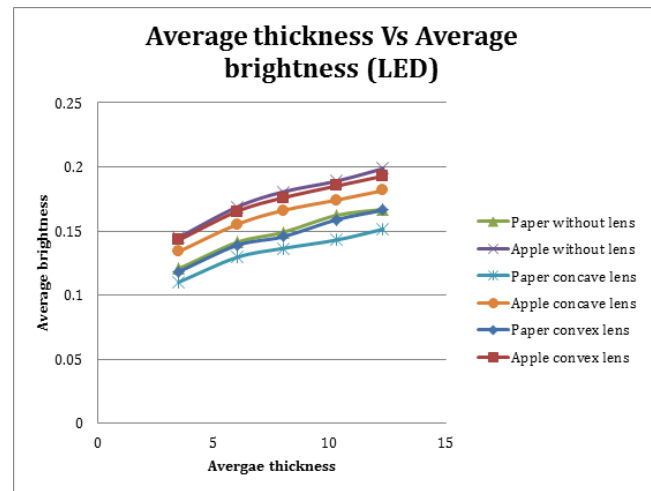

Figure 2.5 Average thickness vs. average brightness (LED)

Based on the average result, the brightness of the penetration will be slightly increased depending on the thickness of the material, the properties of the material and the voltage supply (brightness of light source) [4, 9, 25, 26, 33]. Based on the graph, the penetration using the convex lens is better than that using the concave lens. The angle of light also plays a distinctive role in the choice of lens [4]. The researcher must decide on the types of light source, the types of angle and the processes to be chosen for the outgoing properties of the light

As a conclusion based on result from Figure 2.1 until 2.5 for LED light source, we can conclude that the LED is not so effective when it applies to lens. The situation happens because the LED already has the thickness of light produced from LED component itself [14, 22, 48, 49, 60, 61]. The researchers also must consider the focus point produced after penetration of light to lens or in other word is the output after lens [18, 33, 40, 56]. Other than that, the material would to be penetrated must be considered to make the result is more effective [27, 44, 45, 49, 51, 62, 63].

3.2 Experiment result for Laser light source

The light from the laser produces the same effect as compared with the LED. A laser normally will produce a straight line [4, 23]. The angle produce by the laser can be increased by using lens without modifying the properties of light [4, 37, 40, 55, 56]. Based on the Ohm's law, when the resistance is same with the value of current, it will increase when the voltage of supply increases. Table below showed that the penetration will increase when the voltage increases.

In this experiment, we focused more on the effect of applying the lens to the straight light [23, 64-66]. The effect of lens will be investigated for soft tissue and paper tissue. As we know, when lights penetrate the lens, straight line light will be changed into a cone type pattern [2, 3, 8, 40, 47]. Normally, straight line light changes into cone type after penetration through the lens but the density, distance, brightness and other light effects will be increased or decreased to balance the energy [18, 33, 40, 52, 55].

Table 3.1 shows the result of using the laser as the light source to assess the light penetration of the subject, assessing whether the maximum voltage and current are accepted for the laser pointer component. The experiment was conducted using two types of lens: basic concave and convex lenses.

Table 3.1 Result of the voltage and brightness tests using a laser as a light source

No	Transmitter Voltage (volt)	Current (amp)	Receiver Without lens (v)	Concave lens (V)	Convex lens (v)
1	3.9	0.01	0.2466	0.2241	0.185
2	8.7	0.02	0.2867	0.2601	0.2279
3	9.9	0.03	0.3081	0.2783	0.2479
4	12.7	0.04	0.3113	0.2831	0.2344
5	15.6	0.05	0.3053	0.2113	0.1602

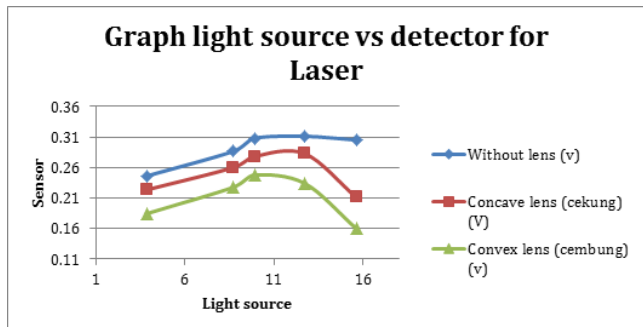

Figure 3.1 Graph of light source vs. detector for laser

Figures 3.1 to 3.4 show that light penetration also occurs through a lens [37, 40, 55, 56]. The graph patterns with and without the lenses are similar. Table 3.1 shows three columns for the receiver data: without a lens, with a concave lens and with a convex lens. As described above, the light from the laser component (straight line) will be transformed to a cone pattern and the data from the column without a lens will be used as the reference for this test. The graphs shown in Figure 3.1 are similar and from that we can assume that the light density is also similar [55, 56, 67-70]. In addition, the light penetration is also much the same and the brightness of light decreases when the voltage reaches 12.7. From this we know that the maximum voltage for the laser component is less than 12.

The next test covers penetration for soft tissue (apple) and paper. The apple was cut into slices and was superimposed with five layers with a maximum thickness equal to 2 cm [6, 27, 28, 32, 38, 46, 71]. The results are shown in Figure 3.2. The voltage used for this test ranged from 3.9 to 15 V. The results cover the solid light from the laser without a lens.

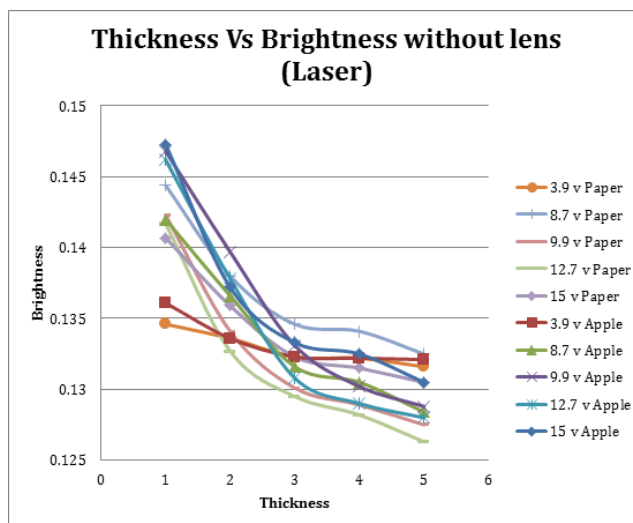

Figure 3.2 Thickness vs. brightness without a lens (laser)

This graph is not so smooth but a decreasing trend still appears as the thickness of the tissue increases. For example, the 3.9 V pair in Figure 3.2 shows a similar trend and a small difference in penetration value for all thicknesses [18, 26, 33, 41, 55, 56]. This is because the brightness is so small and light captured by the sensor is similar. Comparison of the 12.7 V pair can also be made from Figure 3.2. The apple is a blue starred line and the paper is a plain green line. The trends are similar but there is a huge difference in the penetration detected by the sensor [18, 33, 41]. Previous studies have shown that the value of properties such as acid and alkali, among others, make the light warp on the other side depending on the value of the material in the tissue [30, 31, 34, 36, 38, 39, 41, 44, 53, 57, 59]. The values for the 12 V data show that the difference between the two subjects is around ± 0.01 to ± 0.04 V [18, 33, 37, 40, 41, 52, 55, 56].

The next test covers the convex lens. As discussed above, once the light has passed through the lens, the inner properties of the light, the diameter or the thickness of the light will change. Based on convex lens theory, the light will focus more and increase after 0.5 cm; this is known as lens focus [18, 23, 24, 26, 33, 37, 40, 41, 52, 55, 56]. The lenses used in this test have a focus point at 0.5 cm. Light will be accepted beyond the focus point, in other words, light will be exposed beyond 0.5 cm from the lens.

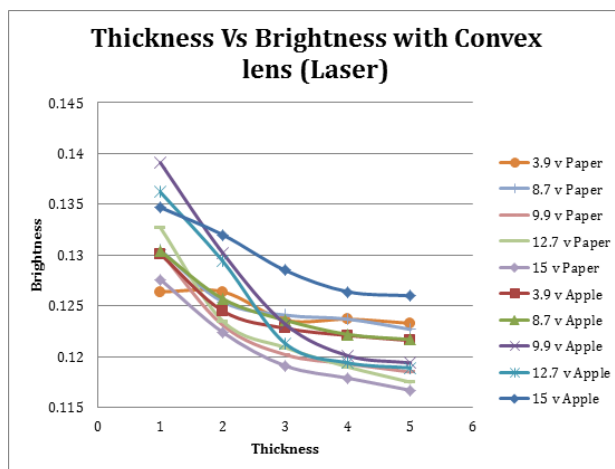

Figure 3.3 Thickness vs. brightness with convex lens (laser)

Figure 3.3 shows the light penetration activity using a convex lens through paper and apple. The graphs appear unstable but the pairings of the graphs are still the same for the light exposed with different types of subject. Figure 3.3 shows that two of the graphs decreased drastically, 9.9 and 12.7 V for the apple, becoming more stable after the thickness of the tissue reached around 1 cm. From that we can conclude that light is fully functional when the component is supplied with a suitable voltage [2, 3, 8, 23, 25, 47, 52]. The graphs for paper at 9.9 and 12.7 V show the same situation but the rate of changes is lower compared to the apple. As with the other method, this shows that the graph is stable once the thickness of the material and the rate of penetration are increased [1, 4, 18, 26, 33, 41, 52].

Figure 3.4 shows the test results using a laser with a concave lens which converts the light to a cone pattern with a focus spot in the centre of the light. As we know, a concave lens will make the light diverge once it emerges from the lens [18, 25, 33]. The rate of light divergence depends on the internal lens properties.

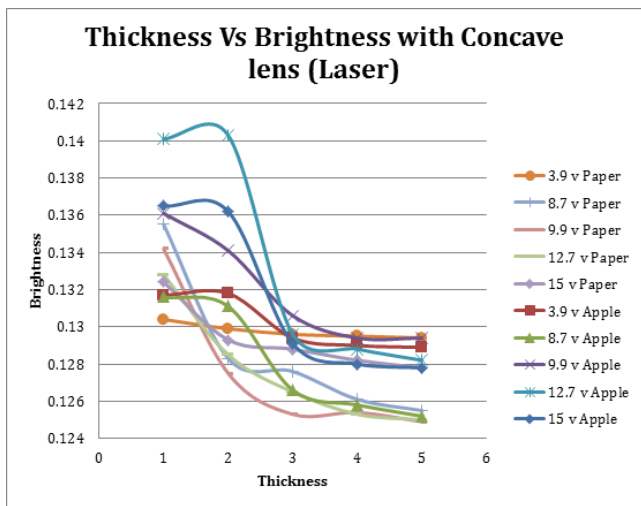

Figure 3.4 Thickness vs. brightness with concave lens (laser)

Figure 3.4 shows unstable graphs for several methods. With low brightness or low voltage the results show that the change in penetration is very small or penetration does not occur. This is because brightness cannot pass through into the tissue. Unstable graphs occur because the centre of the light output from the lens has a centre point making it focus more [9, 23, 26]. We have already fixed the subject, that is the material inside the tissue, particularly the apple [9, 25, 26, 33, 52]. The result is still unstable due to the output after the lens [9, 18, 23, 26, 52]. The output image normally has its focus point from the centre as in an eclipse [18, 23, 33, 40, 52, 56]. The graph in Figure 3.4 shows that point two is higher and the rate slows down to the next point. From that we know that the focus point for the lens is at point two. From that situation, they have no more due of the material inside the tissue but the lens make the value capture is not so stable for that point. As mention above, apple subject have properties of minerals itself. The minerals changed the refractive index of the apple and the refraction pattern inside the subject also uncontrolled and make the light go more on the sensor. The situation of that make the sensor captured more density of lights and the value come out from the measurement device is higher [18, 33, 37, 56].

Upcoming result show the average thickness for three methods which is without lens, basic convex lens, and basic concave lens it show in Figure 3.5. The data is combination of

data above which has been shown in Figure 3.1 until 3.4. The average result will be based on three methods which is the laser component without lens, the laser component is applied with the convex lens and the laser component applies with the concave lens.

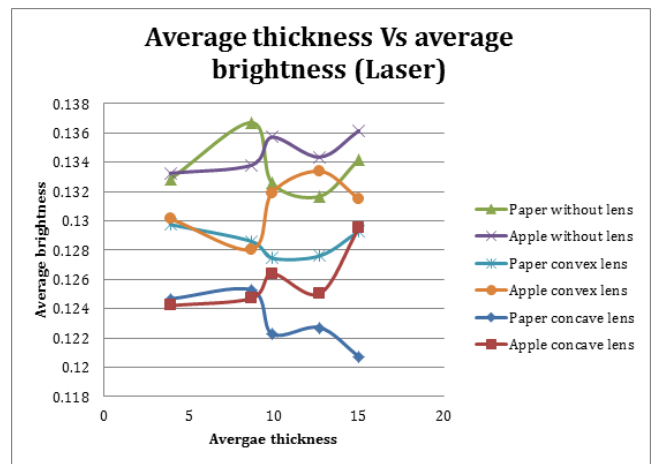

Figure 3.5 Average thickness vs. average brightness (laser)

Figure 3.5 shows the average of the results from the three tests above. From the figure we can calculate that the laser is effective with regard to penetration. The majority of paper graphs show slight decreases compared with the apple graphs [9, 18, 23-26, 33, 37, 40, 41, 52, 56]. The materials or the properties of the subject make the both of the graphs in two different sides. Based on the subject inside properties, the apple tissue has an alkali, acid, water content, etc. The minerals make the refractive index change other than that, the refraction pattern inside the subject also uncontrolled and make the light go more into the sensor. The situation of that make the sensor capture more light and the value come out from the device measurement is high [24, 30, 40, 41, 55, 56].

3.3 Experiment Result for Infrared Light Source

Infrared light is a special light and it cannot be seen with the naked eye. Infrared light can only be detected by using the correct sensor [2, 25]. The main property of infrared light is its wavelength which is set at 100 nm in this experiment [2, 25].

The infrared experiment included a brightness test using the three methods: solid infrared light without a lens, infrared light with a concave lens and infrared light with a convex lens. The results are shown in Figure 4.1 and the Table 4.1. The test used five voltages: 3.1, 5.0, 7.0, 9.2, and 11.3. The voltage was chosen by checking the current change from 0.01 until 0.05 at which points the stated voltages were chosen [14, 16, 17]. We used only one sensor to proceed with the infrared experiment to ensure a constant detected value [20, 72-79]. As we know, infrared can't be seen with the naked eye, we can see the pattern of infrared light coming out from the lens and from the infrared component itself [18, 26, 33, 37, 40, 41, 52, 55, 56]. In this case, the result symbolizes only a method to be used in this test to check whether or not the sensor is functioning. Digital cameras also use this method to ensure that the infrared component produces the infrared light. By using a digital camera we can see the infrared colour but in this device we cannot measure or assume the thickness of the infrared.

Table 4.1 Results for the voltage and brightness tests using infrared as a light source

No	Transmitter Voltage (volt)	Current (amp)	Receiver Without lens (v)	Concave lens (V)	Convex lens(v)
1	3.1	0.01	0.3041	0.2759	0.3245
2	5.0	0.02	0.326	0.2987	0.351
3	7.0	0.03	0.345	0.341	0.369
4	9.2	0.04	0.354	0.352	0.383
5	11.3	0.05	0.364	0.332	0.392

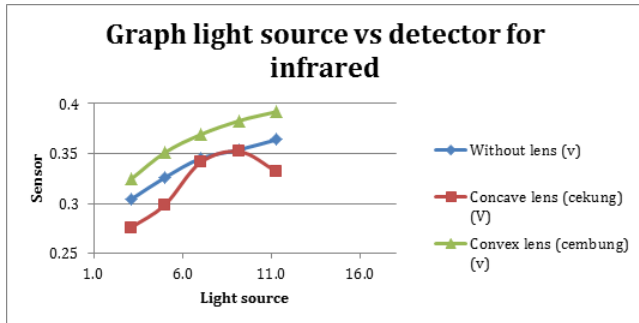

Figure 4.1: The voltage vs. the brightness for infrared light

Table 4.1 and Figure 4.1 show the results of the infrared tests. From Table 4.1 we produced the graph shown in Figure 4.1. Figure 4.1 shows a slightly increases trend for the infrared test without a lens and with a concave lens. The concave lens properties cause the light to pass through and modify, with the light becoming more focused and the distance between the light and the exposure is increased because of the deformation of the light [1, 33, 40, 52]. It is known that when the voltage increases the brightness of light also increases. However, this was not the case with the convex lens. As can be seen in Figure 4.1, the convex lens has two higher points compared to the test without a lens although the voltage supply was the same [80-85]. Based on observations, the laser component used reduces the brightness value when the voltage is more than ten [9, 18, 33, 41, 55]. The specification of the infrared component already includes resistance to protect the component itself. As a result, when the voltage is high and shoots into the component, the resistance will fix the current and reduce the brightness [9, 23, 26]. Based on the specification of the infrared component and Figure 4.1, the concave lens result shows that at two points on that graph the trend increased dramatically compared to the point after 9.2 V.

In the next test, the basic value will be captured by a sensor. The test will be conducted using a solid infrared light, that is, an infrared component without applying a lens to the front [9, 18, 23-26, 33, 37, 40, 52, 55, 56]. The main objective of this test is to verify the penetration of the infrared light into the slice of apple and the white paper and to assess when the subject is at the centre of the light line without the lens [1, 9, 18, 23-26, 40, 41, 52, 55, 56].

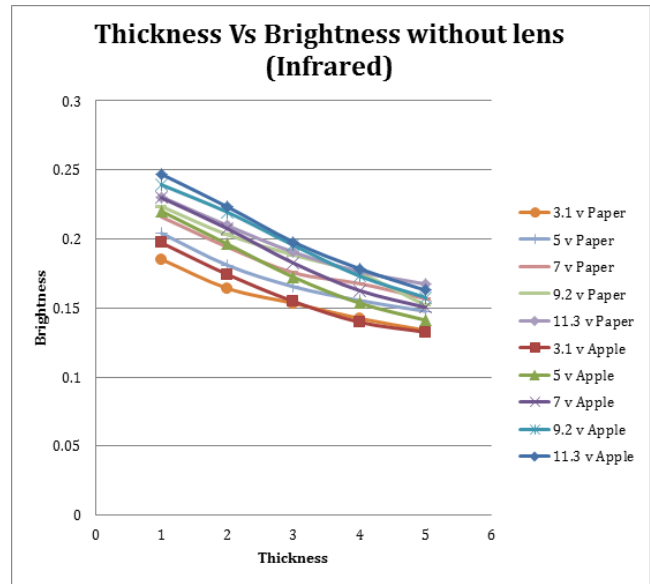

Figure 4.2 Thickness vs. brightness without lens (infrared)

Figure 4.2 shows the light penetration of the infrared source without a lens [10-13, 86]. The graph shows that the value captured by the sensor will be reduced as the thickness of the subject increases [1, 24-26, 37, 41, 52, 55, 56]. Based on the results, the value for the block of paper is higher than that of the apple. This happened because the properties of the material inside the tissue are different [1, 4, 28-31, 34, 36-39, 41, 44, 53, 55, 57-59]. As we know that water content of the apple tissue contains such things as acid, alkali etc., the gradient will be different [28, 29, 31, 34, 36, 38, 39, 44, 53, 57-59]. The gradient difference can be seen by observe the Figure 4.2 above in both of the subject which is apple and the paper subject. The changes for the gradient parameter for this testing are very small. This situation happens because this testing is not applied to the lens and the light is normally penetrated into the subject (apple and paper) and it can be seen in the next result.

This test will be used as a reference for the infrared experiment with the convex and concave lenses. The next test covers the convex lens and applies infrared light at the front of the infrared light component [2, 3, 8, 23, 24, 47, 52]. Based on the convex lens concept, the lens can focus the light that passes through to the lens or, in other words, is the focus point for this lens. In this test we used a convex lens with a 0.5-cm focus point, from which we know that the focus point is 0.5 cm from the lens. The light was considered in the test range beyond 0.5 cm from lens. For the next test we also used the same voltage source, which is 3.1, 5, 7, 9.2, and 11.3 V to control the brightness produced by an infrared component [2, 3, 8, 23-25, 47, 52].

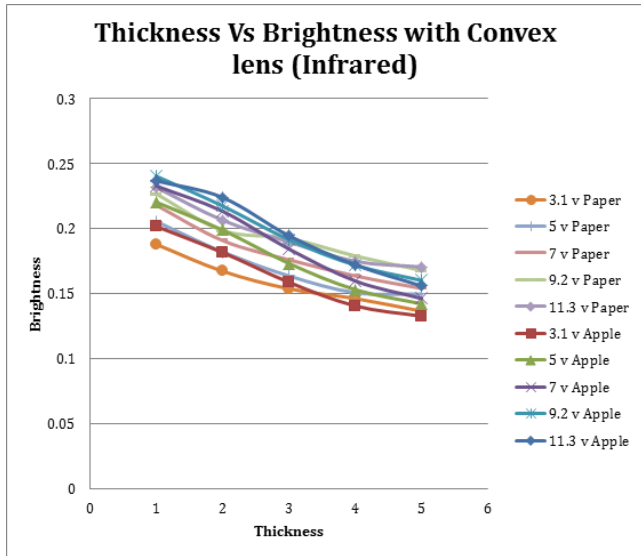

Figure 4.3 Thickness vs. brightness with convex lens (infrared)

Figure 4.3 shows the penetration results for the two subjects, the apple and the paper, using infrared with a convex lens as the light source. The graph pattern is no different to those produced by the infrared without a lens or the solid infrared produced by the infrared component. The comparison value captured by the sensor for the result without the lens and a convex lens are not so different but they still show a difference of around 0.01 V. In terms of the tests without a lens and with the convex lens, the values captured by the sensor are different; that for the convex lens is less than that without the lens. This happened due to the changing pattern of light when the convex lens was applied but the graph pattern is still the same due to the thickness making the reading from the sensor decrease [20, 22, 48, 49, 72-79]. Based on properties of tissue on the subject are used in this experiment, they have unstable refractive index because of the properties and make the data have different gradient happen and show in Figure 4.3. As an example, the 11.3 volt data are chosen to be elaborated, based on Figure 4.3 for convex lens testing the 11.3 volt data showed that decrease dramatically until the thickness of subject archive to 2 cm the value become lower compared to data for subject paper in same voltage value. These situations happen because of the material inside the apple tissue itself.

For the next testing, the basic concave lens will be applied in front of the infrared component to verify the effect of concave lens to infrared light [10-13, 86]. Based on the theory of the basic concave lens, the basic of concave lens makes the light go through into lens and changes the properties of the light pattern for example the straight line light go through into that lens the straight line will change into the cone pattern type [9, 23-26]. The experiment by using the concave will be conducted by using two subjects with is the paper and apple tissue [27-29, 32, 38, 46, 71]. The result for this testing will be show in Figure 4.4. The lens will be placed 0.5 cm in front of the infrared component and the lights consider in range 0.5 cm from lens [9, 18, 23-26, 37, 40, 52, 55, 56].

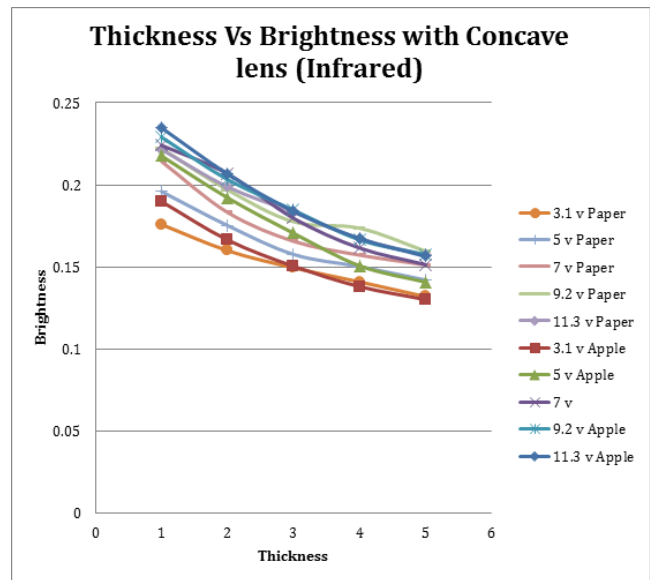

Figure 4.4 Thickness vs. brightness with concave lens (infrared)

As stated above, the results for the infrared light with the concave lens are shown in Figure 4.4, which shows the trend decreasing as the thickness of the subject increases. This is the same as in the previous test for infrared [28, 31, 34, 36, 38, 39, 44, 53, 57-59]. The results for the paper show a more consistent gradient for every brightness value produced by the infrared component [10-13, 86]. The gradient results for the apple are not so consistent. The graph is not as straight as that for paper, especially when the voltage is above 5 V.

From the three tests, infrared without a lens, infrared with a concave lens and infrared with a convex lens, the average result was calculated and is shown in Figure 4.5 [24, 37, 40, 55, 56]. The combination graph shows the effect of brightness versus the thickness of the subject.

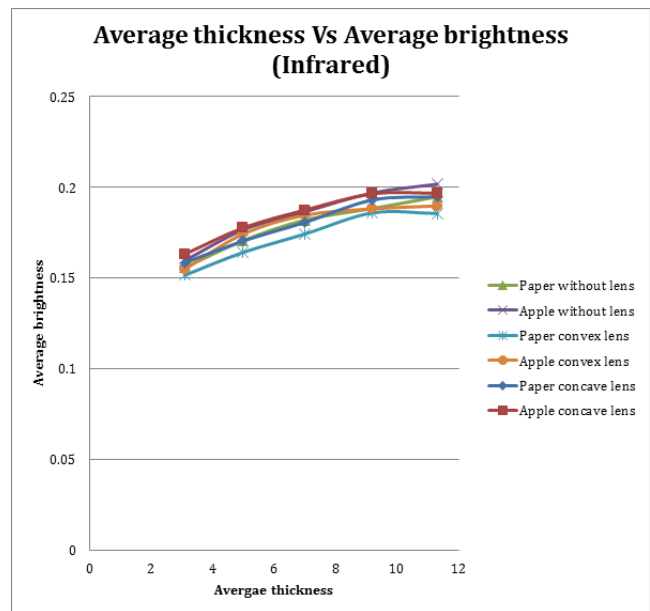

Figure 4.5 Average thickness vs. brightness (infrared)

Referring to Figure 4.5 we can see that the trend is slightly increased from subject thickness 0 until 1.5 cm for both the apple and the paper [27-29, 32, 38, 46, 71]. Based on that result, they have 6 graph pattern in that figure and one graph show the maintain penetration when the brightness of light is increases which is for paper without lens. The observations on the graph pattern show in Figure 4.5, the paper subject have maintain penetration for every parameter (lens) but the penetration will be decreases when the thickness will archive to last thickness. The graphs show the maintain increases of value after thickness achieve 1.5 cm compared other thickness and the value capture by a sensor directly and it show in graph apple with convex lens apply in the infrared light source [9, 43]. From the result, the small increase in value captured by a sensor before 1.5 cm thickness of subject tested the situation happen because of the property material inside of the subject itself [29-31, 34, 36, 53, 58, 59]. Base on the figure 4.5 result, the higher value capture by a sensor are show in apple without lens and the sec high is show in apple concave lens result and we know that happen because of the material inside the apple tissue.

Applying the lens in front of the infrared light component produces only a small effect. The effect normally happens when the brightness of the light successfully penetrates the subject. Previous studies have shown that light can also be used to destroy bacteria to make packaged food more durable [4, 45].

The 11.3 v are chosen as a reference for elaborated based on Figure 4.3 and 4.4. Base on the figures that are state before, the convex lens how the high value capture by a sensor compare to the concave lens. From that value, the convex lens is more effective to divergent the light and leveling light divisions compare with the concave lens. Base on the lens industry, the convex lens are popular apply and it easy in theory of the light divergent [87].

■4.0 DISCUSSION

The results above show that increased voltage produces brighter light. The experiments were undertaken in accordance with Ohm's law, that is, when voltage increases, the current also increases the voltage if the resistance (laser component) is constant. Figures 2.1 to 2.5, 3.1 to 3.5 and 4.1 to 4.5 show the experimental results for the penetration of light through two subjects paper and a slice of apple [4, 25]. The data showed positive penetration when the correct component and the correct voltage are used for the maximum performance of the component [14, 16, 17].

Penetration also depends on the subject properties, for example the moisture in the subject [4]. In comparison, apples contain more moisture than paper. Based on the results above, the entire light source can be used to penetrate tissue but we must first select a better voltage value to ensure that maximum penetration occurs [14, 16, 17].

Lenses can be used to create light properties, for example, with respect to a laser, by using a lens we can modify the light from a straight line to light with an angle [4]. The wavelength of the light does not change once the light has penetrated the lens. The wavelengths after penetration for a laser and an LED are still the same at 700nm and for infrared at 1000nm [3, 64, 66].

Based on naked eye view, the subject will be infringed by light and the light will fulfill the subject with maximum size of light in other word the light stuck in front or the surface of the subject [4]. The light pass the subject will be captured by a sensor and shown in measurement device. The sensor can capture high value when the refractive index of sensor is high but normally the

value can't be high if the value compare to the reference value. In this testing the reference value is refer to the data without lens.

■5.0 CONCLUSION

Based on the experimental results, we can conclude that voltage and the type of light are important in the process of scanning an object. The brightness must also be considered once the type of material to be scanned is known, as must the soft tissue properties before confirming the light intensity. For future work, the tests could be conducted using an electric component to make the light brighter.

Acknowledgement

The authors would like to thank the Ministry of Higher Education (MOHE) of Malaysia for supporting this work under MyBrain15 and Universiti Teknologi Malaysia's (UTM) support under Research University Fund (GUP - Q.J130000.2513.03H96).

References

- [1] G. Pataro, et al. 2011. Bacterial Inactivation in Fruit Juices Using a Continuous Flow Pulsed Light (PL) System. *Food Research International*. 44: 1642–1648.
- [2] R. A. R. Siti Zarina Mohd. Muji, Mohd Hafiz Fazalul Rahiman, Shafishuhaza Sahlan, Mohd Fadzli Abdul Shaib, Muhammad Jaysuman and Elmy Johana Mohamad. 2011. Optical Tomography: A Review On Sensor Array, Projection Arrangement and Image Reconstruction Algorithm. *International Journal of Innovative Computing, Information and Control*. 7: 1–17.
- [3] Y. M. Y. R. A. R. Siti Zarina Mohd Muji, Mohd Hafiz Fazalul Rahiman. 2011. Front End Development of Optical Tomography and Its Linearity. *Jurnal Teknologi Universiti Teknologi Malaysia*. 2: 1–9.
- [4] C. V. F. J. García-Ramos, I. Homer, J. Ortiz-Cañavate and M. Ruiz-Altisent. 2005. Non-destructive Fruit Firmness Sensors: A Review. *Spanish Journal of Agricultural Research*. 3: 61–73.
- [5] P. D. C. Radcliffe. 2007. LED Light Emitter and Detector. *Electronic Design*. 55: 1–4.
- [6] S. Hetz. 2006. First "All-LED" Rear Combination Lamp—Challenges and Opportunities.
- [7] L. G. Conn. 2002. Characterizing and Qualifying an LED for Automotive Exterior Signal Lamps.
- [8] R. A. R. a. K. S. Chan. 2002." Applying LED Source in Optical Tomography System. *Symposium on Process Tomography II*.
- [9] M. S. E. Kirill v. Larin, Massoud Motamedi, Rinat O. Esenaliev. 2002. Noninvasive Blood Glucose Monitoring With Optical Coherence Tomography. *Emerging Treatment and Technology*. 25: 2263–2268.
- [10] P. Daqing, et al. 2010. Alternative Transrectal Prostate Imaging: A Diffuse Optical Tomography Method. *Selected Topics in Quantum Electronics, IEEE Journal of*. 16: 715–729.
- [11] T. Mohammad. 2009. Using Ultrasonic and Infrared Sensors for Distance Measurement. *World Academy of Science, Engineering and Technology*. 51: 293–299.
- [12] K. Akasaka, et al. 2007. A Sensor for Simultaneously Capturing Texture and Shape by Projecting Structured Infrared Light. In *Institute of Scientific and Industrial Research*.
- [13] A. Jain, et al. 2004. A Two-axis Electrothermal Micromirror for Endoscopic Optical Coherence Tomography. *Selected Topics in Quantum Electronics, IEEE Journal of*. 10: 636–642.
- [14] R. A. R. Siti Zarina Mohd. Muji, Mohd Hafiz Fazalul Rahiman, Yusry Yunus, Zulkarnay Zakaria, Nor Muzakkir Nor Ayob. 2012. Development of Parallel and Fan-Shaped Beam Mixed-Projection Optical Tomography. *Sensors & Transducers Journal*. 140: 36–44.
- [15] J. Rosen and D. Abookasis. 2005. Noninvasive Optical Tomographic Imaging by Speckle Ensemble. *Optical Information Systems III*. 5908: 1–6.
- [16] J. Sharpe. 2004. Optical Projection Tomography. *Ar Journals*. 6: 209–235.
- [17] J. Sharpe. 2004. Optical Projection Tomography. *Annu. Rev. Biomed. Eng.* 209–227.

- [18] H. Kleine, et al. 2005. Laboratory-scale Blast Wave Phenomena—optical Diagnostics and Applications. *Shock Waves*. 14: 343–357.
- [19] S. Kang, et al. 2010. A Hardware Design for Portable Continuous Wave Diffuse Optical Tomography Database Theory and Application. Bio-Science and Bio-Technology. 118. Y. Zhang, et al. Eds. Springer Berlin Heidelberg, 9–18.
- [20] Z. Y.-n. LI Yang, YUE Hong-wei. 2005. Design of Fan Beam Optical Sensor and Its Application in Mass Flow Rate Measurement of Pneumatically Conveyed Solids. *Journal of Zhejiang University SCIENCE*. 6: 1430–1434.
- [21] L. L. C. Ruzairi Abdul Rahim, Chan Kok San & mohd. Hafiz Fazalul Rahiman. 2007. Investigating Multiple Fan Beam Projection Technique Using Optical Fibre Sensor In Process Tomography. *Jurnal Teknologi Universiti Teknologi Malaysia*. 47: 61–70.
- [22] R. A. R. M. Fadzli B Abdul Shaib, Siti Zarina M. Muji, Leow Pei Ling, M. Mahadi Abdul Jamil. 2012. A Study on Optical Sensors Orientation for Tomography System Development. *Sensors & Transducers Journal*. 140: 45–52.
- [23] N. N. Il'ichev, et al. 2002. Study of a Grating Induced in Water by the Radiation of a YSGG:Yb 3+ :Cr 3+ :Ho 3+ Laser with a Wavelength of 2.92 m m. *Laser Physics*. 13: 248–250.
- [24] M. K. Yang, et al. 2009. Index of Refraction of High-index Lithographic Immersion Fluids and Its Variability. *MOEMS Memos Moems*. 8: 023005-1 - 023005-6.
- [25] R. A. R. Siti Zarina Mohd Muji, David A. Johnson, Mohd Hafiz Fazalul Rahiman, Elmy Johana Mohamad, Hudabiyah Arshad Amani, Mohd Fadzli Abdul Sahib. 2011. Optical Tomography: Transmitter And Receiver Circuit Preparation. *Jurnal Teknologi Universiti Teknologi Malaysia*. 54: 13–22.
- [26] R. A. R. Siti Zarina Mohd. Muji, Mohd Hafiz Fazalul Rahiman, Zulkarnay Zakaria, Elmy Johana Mohamad, Mohd Safirin Karis. 2011. The Linearity of Optical Tomography: Sensor Model and Experimental Verification. *Sensors & Transducers Journal*. 132: 40–46.
- [27] S. Müller and H. Kunzek. 1998. Material properties of processed fruit and vegetables I. Effect of Extraction and Thermal Treatment on Apple Parenchyma. *Zeitschrift für Lebensmitteluntersuchung und -Forschung A*, 206: 264–272, 1998/04/01.
- [28] S. Vetter and H. Kunzek. 2001. Material Properties of Processed Fruit and Vegetables. II. *Water Hydration Properties of Cell Wall Materials from Apples*. Springer. 214: 43–51.
- [29] S. Rosnah, Wong, W. K., Noraziah, M. and Osman, H. 2012. Chemical Composition Changes of Two Water Apple (*Syzygium samaragense*). *International Food Research Journal*. 19: 167–174.
- [30] K. o. Sylvester-Hvid, et al. 2011. The Iterative Self-Consistent Reaction-Field Method: The Refractive Index of Pure Water. *International Journal of Quantum Chemistry*. 111: 904–913.
- [31] A. N. Bashkatov and E. A. Genina. 2002. Water Refractive Index in Dependence on Temperature and Wavelength: A Simple Approximation. *Optical Technologies in Biophysics and Medicine IV*. 5068: 393–396.
- [32] Robert Klewicki, et al. 2009. Sorption Isotherms for Osmo-convectively-Dried and Osmo-freezedried Apple, Sour Cherry, and Blackcurrant. *Journal of Horticultural Science & Biotechnology*. 75–79.
- [33] A. Cosentino, et al. 2012. Refractive Index Sensor Based on Slot Waveguide Cavity. *J. Europ. Opt. Soc. Rap. Public*. 7: 12039-1-12039-6.
- [34] C. Erlick. 2006. Effective Refractive Indices of Water and Sulfate Drops Containing Absorbing Inclusions. *Journal Of The Atmospheric Sciences*. 63: 754–763.
- [35] Kwangjoo Lee, et al. 2005. Amplification of the Index of Refraction of Aqueous Immersion Fluids by Ionic Surfactants. *Proc. of SPIE*. 5753: 537–553.
- [36] Z. W. Wilkes, et al. 2009. Direct Measurements of the Nonlinear Index of Refraction of Water at 815 and 407 Nm Using Single-Shot Supercontinuum Spectral Interferometry. *American Institute of Physics*. 94: 1–3.
- [37] Y. WANG, et al. 2009. Spr Approach For Determination Of Temperature Water Refractive Index Alterations. *GeoScience Engineering*. 4: 53–59.
- [38] F. Figuerola, et al. 2005. Fibre Concentrates from Apple Pomace and Citrus Peel as Potential Fibre Sources for Food Enrichment. *Food Chemistry*. 91: 395–401.
- [39] E. Maltinia, et al. 2003. Water activity and the preservation of plant foods. *Elsevier*. 82: 79–86.
- [40] M. U. Vera, et al. 2001. Scattering Optics of Foam. *Applied Optics*. 40: 4210–4215.
- [41] S. Wilfred, et al. 2010. Optimum Conditions for Expression of Oil From *Allanblackia Floribunda* Seeds and Assessing the Quality and Stability Of Pressed And Solvent Extracted Oil. *African Journal of Food Science*. 4: 563–570.
- [42] Christina m. Bavougian, et al. 2012. Training System Effects on Sunlight Penetration, Canopy Structure, Yield, and Fruit Characteristics of 'Frontenac' Grapevine (*Vitis* spp.). *International Journal of Fruit Science*. 12: 402–409.
- [43] T. Prykäri, et al. 2010. Optical Coherence Tomography as an Accurate Inspection and Quality Evaluation Technique in Paper Industry. *Optical Review*. 17: 218–222.
- [44] D. P. Subedi, et al. 2006. Study of Temperature and Concentration Dependence of Refractive Index of Liquids Using a Novel Technique. *Kathmandu University Journal Of Science, Engineering And Technology*. 11: 1–7.
- [45] V. M. Gómez-Lo'pez, et al. 2007. Pulsed Light for Food Decontamination: A Review. *Trends in Food Science & Technology*. 18: 464–473.
- [46] J. Lammertyn, et al. 2000. Light Penetration Properties of NIR Radiation in Fruit with Respect to Non-Destructive Quality Assessment. *Postharvest Biology and Technology*. 18: 121–132.
- [47] K. S. C. R. Abdul Rahim, J. F. Pang, L. C. Leong. 2005. A Hardware Development for Optical Tomography System Using Switch Mode Fan Beam Projection. *Elsevier*. 120: 277–290.
- [48] R. A. R. Siti Zarina Mohd Muji, Mohd Hafiz Fazalul Rahiman. Experimental Optical Tomography Setup: Sensor Detection, Projection And Processing Time Signal.
- [49] S. Z. M. Muji, et al. Experimental Optical Tomography Setup: Sensor Detection, Projection And Processing Time Signal.
- [50] P. J. F. Ruzairi Abdul Rahim, Chan Kok San, & Leong Lai Chean. 2005. Area-Based Concentration Measurement Using Optical Tomography Technique For Various Flow Patterns. *Jurnal Teknologi Universiti Teknologi Malaysia*. 113–132.
- [51] M. H. M. Hazir. 2011. Oil Palm Optical Characteristics from Two Different Planting Materials. Presented at the International Conference on Future Information Technology, Singapore.
- [52] Y. L. Chunsheng Yan, Shurong Lai and Zhixing Yang. 2003. Design of a Novel Optical Tomography Sensor Array. *IOP*. 14: 164–171.
- [53] M. H. Sharqawy, et al. 2010. Thermophysical Properties of Seawater: A Review of Existing Correlations and Data.
- [54] S. Tai-Ping and W. Chia-Hung, 2012. Specially Designed Driver Circuits to Stabilize LED Light Output Without a Photodetector. *Power Electronics, IEEE Transactions on*. 27: 4140–4152.
- [55] L. Weiss, et al. 2012. Water Density and Polarizability Deduced from the Refractive Index Determined by Interferometric Measurements Up to 250 MPa. *The Journal Of Chemical Physics*. 136: 136–145.
- [56] W. M. b. M. Yunus and A. b. A. Rahman. 1988. Refractive Index of Solutions at High Concentrations. *Applied Optics*. 27: 3341–3343.
- [57] R. Somaraju and J. Trumpf. Frequency, temperature and salinity variation of the permittivity of Seawater. *The Australian National University*. 1–10.
- [58] R. A. Rahim, et al. 2007. Hardware Development of Ultrasonic Tomography for Composition Determination of Water and Oil Flow. *Sensors & Transducers Journal*. 75: 904–913.
- [59] K. Chen, et al. 2009. A Localization Scheme for Underwater Wireless Sensor Networks. *International Journal of Advanced Science and Technology*. 4: 9–17.
- [60] M. M. Siti Zarina Mohd Muji, Ruzairi Abdul Rahim. 2009. Criteria for Sensor Selection in Optical Tomography. *IEEE*.
- [61] R. A. R. Siti Zarina Mohd Muji, Mohd Hafiz Fazalul Rahiman, and Zulkarnay Zakaria. 2011. Image Reconstruction Using Different Measurement Technique for Optical Tomography. *American Scientific Publishers*. 3: 241–248.
- [62] B. G. Pokusaev, et al. 2004. Immersion Tomography of a Gas-Liquid Medium in a Granular Bed. *Theoretical Foundations of Chemical Engineering*. 38: 1–5.
- [63] Q. Guofeng, et al. 2012. Bioimpedance Analysis for the Characterization of Breast Cancer Cells in Suspension. *Biomedical Engineering, IEEE Transactions on*. 59: 2321–2329.
- [64] Y. Shuai, et al. 2009. Concurrent Optical Coherence Tomography and Line-Scanning Laminar Optical Tomography. In *Lasers and Electro-Optics, 2009 and 2009 Conference on Quantum electronics and Laser Science Conference. CLEO/QELS 2009. Conference on*. 1–2.
- [65] S. Yuan, et al. 2009. Concurrent Optical Coherence Tomography and Line-Scanning Laminar Optical Tomography. *IEEE*. 1–2.
- [66] L. Wu and L. Fu. 2000. Novel Technique for the Systematic Measurement of Gain, Absolute Refractive Index Spectra, and Other Parameters of Semiconductor Lasers. *Quantum Electronics, IEEE Journal of*. 36: 721–727.
- [67] N. Giordano, et al. 2001. Effect of Electromagnetic Fields on Bone Mineral Density and Biochemical Markers of Bone Turnover in Osteoporosis: A Single-blind, Randomized Pilot Study. *Current Therapeutic Research*. 62: 187–193.

- [68] H. Ko, et al. 2004. Analysis of Density Distribution for Unsteady Butane Flow Using Three-dimensional Digital Speckle Tomography. *Journal of Mechanical Science and Technology*. 18: 1213–1221.
- [69] H. Sun, et al. 2008. New Equations for Density, Entropy, Heat Capacity, and Potential Temperature of a Saline Thermal Fluid. *Elsevier*. 1: 1304–1310.
- [70] S. Lederer, et al. 2008. Connectivity-based Localization of Large Scale Sensor Networks with Complex Shape. In *INFOCOM 2008. The 27th Conference on Computer Communications*. IEEE.
- [71] J. E. Sanders, et al. 2006. A Noncontact Sensor for Measurement of Distal Residual-limb Position During Walking. *JRRD*. 43: 509–516.
- [72] S. M. Huang, et al. 1992. Design of Sensor Electronics for Electrical Capacitance Tomography. *IEEE*, 139: 83–88.
- [73] Y. Sonoda. 1992. Magnetic Sensors and Medical Bio-technology Measuring Vibrations, Displacements, and Articulatory Movements. *IEEE*. 7: 714–721.
- [74] C. G. Xie, et al. 1992. Electrical Capacitance Tomography for Flow Imaging: System Model for Development of Image Reconstruction Algorithms and Design of Primary Sensors. *IEEE*. 139: 89–98.
- [75] D. Stoeckel and T. Waram. 1992. Use of Ni-Ti Shape Memory Alloys for Thermal Sensor-actuators. 382–387.
- [76] Y. Son &. 1995. Applications of Magnetometer Sensors to Observing Bio-Mechanical Movements. *IEEE*. 31: 1283–1290.
- [77] A. J. Jaworski and G. T. Bolton. 2000. The Design of an Electrical Capacitance Tomography Sensor for Use With Media of High Dielectric Permittivity. *Department of Chemical Engineering, University of Manchester Institute of Science and Technology (UMIST)*, 11: 743–757.
- [78] G. D. Finlayson and M. S. Drew. 2001. 4-Sensor Camera Calibration for Image Representation Invariant to Shading, Shadows, Lighting, and Specularities. *IEEE*. 473–480.
- [79] J. H. Merritt, et al. 2007. Intelligent Shape Sensor. Presented at the Southern Illinois University Carbondale Carbondale, IL, USA, USA.
- [80] Z. Ding, et al. 2002. High-resolution Optical Coherence Tomography Over a Large Depth Range with an Axicon Lens. *Optical Society of America*. 27: 243–246.
- [81] M. Sato, et al. 2003. Basic Study on Imaging Interferometer using Long Gradient-Index Lenses for Optical Coherence Tomography. *Optical Review*. 10: 452–455.
- [82] C. S. Premachandran, et al. 2009. Design, Fabrication, and Assembly of an Optical Biosensor Probe Package for OCT (Optical Coherence Tomography) Application. *Advanced Packaging, IEEE Transactions on*. 32: 417–422.
- [83] E. Kim, et al. 2009. Automated Analysis of OCT Images of the Crystalline Lens. *Ophthalmic Technologies XIX, edited by Fabrice Manns, Per G. Söderberg, Arthur Ho*. 7163: 1–10.
- [84] R. K. Manapuram, et al. 2010. Assessment of Wave Propagation on Surfaces of Crystalline Lens With Phase Sensitive Optical Coherence Tomography. *Laser Physics*. 8: 164–168.
- [85] S. O. Isikman, et al. 2011. Compact and Cost-effective Lensless Tomographic on-chip Microscope. Presented at the 15th International Conference on Miniaturized Systems for Chemistry and Life Sciences, Seattle, Washington, USA.
- [86] Y. Haider, et al. 2009. A Prototype System for Infrared Computed Tomography for Image Reconstruction. In *Multitopic Conference, 2009. INMIC 2009. IEEE 13th International*. 1–5.
- [87] H. Takanashi, et al. 2012. A Consideration of Shape of Sensor Holder for Portable Braille Reading Sensor. In *Advanced Mechatronic Systems (ICAMEchS), 2012 International Conference on*. 615–620.