

Northumbria Research Link

Citation: Erfanian Nakhchi Toosi, Mahdi, Hatami, M. and Rahmati, Mohammad (2021) Experimental investigation of performance improvement of double-pipe heat exchangers with novel perforated elliptic turbulators. *International Journal of Thermal Sciences*, 168. p. 107057. ISSN 1290-0729

Published by: Elsevier

URL: <https://doi.org/10.1016/j.ijthermalsci.2021.107057>
<<https://doi.org/10.1016/j.ijthermalsci.2021.107057>>

This version was downloaded from Northumbria Research Link:
<http://nrl.northumbria.ac.uk/id/eprint/46280/>

Northumbria University has developed Northumbria Research Link (NRL) to enable users to access the University's research output. Copyright © and moral rights for items on NRL are retained by the individual author(s) and/or other copyright owners. Single copies of full items can be reproduced, displayed or performed, and given to third parties in any format or medium for personal research or study, educational, or not-for-profit purposes without prior permission or charge, provided the authors, title and full bibliographic details are given, as well as a hyperlink and/or URL to the original metadata page. The content must not be changed in any way. Full items must not be sold commercially in any format or medium without formal permission of the copyright holder. The full policy is available online: <http://nrl.northumbria.ac.uk/policies.html>

This document may differ from the final, published version of the research and has been made available online in accordance with publisher policies. To read and/or cite from the published version of the research, please visit the publisher's website (a subscription may be required.)

Experimental Investigation of Performance Improvement of Double-Pipe Heat Exchangers with Novel Perforated Elliptic Turbulators

M. E. Nakhchi^a, M. Hatami^{b,c,1}, M. Rahmati^a

^a Faculty of Engineering and Environment, Northumbria University, Newcastle upon Tyne, NE1 8ST, UK

^b Department of Mechanical Engineering, Esfarayen University of Technology, Esfarayen, North Khorasan, Iran

^c Department of Mechanical Engineering, Ferdowsi University of Mashhad, P.O.B. 91775-1111 Mashhad, Iran

Abstract

In the present study, heat transfer and thermal efficiency of double-pipe heat exchangers with novel Double-Perforated Inclined Elliptic (DPIE) turbulators were experimentally investigated. The range of Reynolds number was between 5,000 and 18,000 under turbulent flow regime. The inclination angle of the elliptic inserts (α), and the perforation diameters (d) varied from 15° to 25° , and $0.5\text{mm} < d < 1.5\text{mm}$, respectively. The perforated vortex generators can significantly increase the flow perturbations and disrupt the thermal boundary layer to enhance the heat transfer without noticeable impact on the friction loss. The experiments revealed that the average Nusselt number was increased by 217.4% by using DPIE turbulators compared to the tube without vortex generators. The recirculations through the perforations of the elliptic turbulators, increase the fluid mixing between the walls and the core area. The maximum thermal efficiency parameter of 1.849 was obtained for DPIE vortex generators with $d/b=0.25$ and $\alpha = 25^\circ$. It was found that the heat transfer is increased around 39.4% by using DPIE inserts with $d/b=0.25$ compared to the typical louvered strips without perforations. The main benefits of the proposed novel turbulators are their much higher thermal efficiency compared to the previous turbulators at wide range of Reynolds numbers, and their simple installation together with low manufacturing costs.

¹ Corresponding author, M. Hatami, Tel/Fax: +98-935-860-2679, E-mail: m.hatami@xjtu.edu.cn

Keywords: Thermal performance enhancement; Double-pipe heat exchanger; Perforated elliptic turbulators; Nusselt number; Friction loss.

1. Introduction

Passive techniques have found many applications for enhancing heat transfer in thermal systems such as heat exchangers, boilers, cooling process, and microchannels in recent years. They have many advantages compared to active methods such as their relative simplicity, lower manufacturing costs and lower maintenance and repair costs [1-3]. In passive techniques increasing turbulence in the flow is the key aspect of heat transfer improvements, while the pressure drop or friction factor usually retains at a lower possible level. Several passive methods such as Baffles, ribs, winglets, perforated turbulators, louvered strips, inclined elliptical strips, different helical inserts, ring inserts and springs are the most commonly used turbulators to improve the thermal efficiency [4, 5].

Many researchers rely on parametric studies in order to analyse and enhance the capabilities of the turbulator used for passive techniques [6]. Hatami et al. [7] used a delta winglet turbulator to increase the heat recovery from the exhaust of a diesel engine. They found that a 50% improvement in exergy recovery can be obtained in comparison with the previous designs due to flow recirculation generated by winglets. Zheng et al. [8] reviewed the recent studies on the multi-longitudinal vortices and reported that the vortex generators improve the thermal-hydraulic performance of the heat exchangers. In another study, a simple perforated hollow cylinder insert is used by Singh et al. [9] to improve the heat transfer and pressure drop. They introduced some experimental correlations for the Nu and frictional loss according to the geometry of holes in perforated inserts. They found that heat transfer and friction factor were 150–230% and 160–450% greater than those of the plain tube values, respectively. Not only

making holes on the inserts enhance their performances, but also cutting the edges leads to even further heat transfer improvements. Nakhchi and Rahmati [10] used transverse-cut twisted turbulators (TCTT) in a numerical study to enhance the outcomes of Cu-water nanofluid heat transfer. Their results showed that TCTTs with deeper cuts ($b/c = 0.7$) can produce greater recirculations and flow disturbances and thus better performance compared to other geometries of cutting shapes. Self-rotating turbulators are other novel inserts used by Goh et al. [11] for increasing entropy generation and turbulent convection in heat exchangers. Their experiments revealed that maximum improvements of Nusselt number was 360% and 240%, for non-rotational and rotational inserts, respectively. Liou et al. [12] used the wing-shaped turbulators for their numerical study to investigate their effects on helical flows and wake regions in a channel. Also, Helical coils and spring shaped inserts are widely used by researchers as new techniques of heat transfer improvements. Panahi et al. [13] used helical wire turbulators for a shell and coiled tube heat exchanger and revealed that this type of turbulators considerably increased the average heat transfer parameter and pressure loss.

Using perforated vortex generators is another effective and novel method which increases the turbulence and consequently improves the heat transfer characteristics. Vaisi et al. [14] used the perforated twisted tapes in a double tube heat exchanger, experimentally. They reported that perforated discontinuous turbulator with circular and square perforations with the same hydraulic diameter as for discontinuous turbulator without perforation result in 20.8 % and 15 % growth in heat transfer and 27.7 %, 22.8 %, reduction in the pressure drop coefficient, respectively. The thermal performance parameter is an essential factor in the design of heat exchangers. Nearly all of the turbulators can increase the heat transfer rate, but they also increase the pressure drop, which is unfavourable. Therefore, a thermal efficiency parameter must be used to evaluate the impact of the proposed vortex generator on the heat transfer and friction loss at the same time. In a recent experimental study, Dagdevir and Ozceyhan [15]

investigated the effects of perforated and dimpled twisted tapes on thermal efficiency improvement of heat exchangers. They found that the highest thermal performance parameter of 1.42 can be achieved for perforated twisted tapes with pitch ratio (P_d/y) of 0.25. Nakhchi and Esfahani [16] numerically examined the effects of perforated hollow cylinders on thermal efficiency enhancement of heat exchangers. They investigated the effect of the perforated index, diameter ratio of the hollow cylinders and Reynolds numbers and found that maximum thermal performance will occur for $d/D=0.74$ and perforated index of 24%. In another numerical study, Nakhchi and Esfahani [17] performed a parametric study for the perforated conical rings inside heat exchanger pipes. They observed that Nusselt number decreased around 35.4% by increasing the perforations from 4 to 10. Also, they investigated the perforated conical rings, numerically and found with 4 holes, the Nusselt improved about 278.2% [18]. As a novel insert, Nakhchi et al. [18] investigated the effect of perforation of louvered strips in thermal systems and found that double louvered strip inserts with the angle of 15° and 25° , had 30.1% and 45.84% increment in Nusselt number, respectively. Additionally, cutting the inserts and the perforation of inserts are widely introduced by researchers as an efficient technique for improving the performance of different thermal systems [19-21].

Louvered strips and elliptic turbulators as efficient turbulators are widely used by researchers in both numerical and experimental techniques. For instance, Yaningsih et al. [22] investigated the effect of slant angle at three values of 15, 20 and 25 degrees and introduced some empirical correlations based on experimental results. They found that the louvered strips offered an increment in heat removal and friction loss by 77.0% and 335.0%, respectively. Also, in a similar study, Eiamsa-ard et al. [23] compared the results of backward and forward louvered strip inserts and reported that forward louvered inserts had better results in Nusselt number increment and friction loss at 284% and 413%, respectively. Rivier et al. [24] experimentally investigated the effects of the newly proposed elliptic turbulators on heat

transfer enhancement inside pipes at wide range Reynolds numbers under laminar and turbulent flow regimes. They concluded that the turbulators with a bend angle of 60° have better thermal efficiency factor. In the numerical study of Kim et al. [25], the authors performed an optimization analysis on heat transfer enhancement inside heat exchangers fitted with elliptic dimple turbulators. They used SST turbulence model for their simulations. They concluded that the optimal elliptic design improves Nu by 32.8% compared to the reference circular design. Rajaseenivasan et al. [26] used circular and V-shaped turbulators inside a solar heater to improve the thermal performance of the system. Their experiments revealed that maximum air temperature of 66°C can be achieved by using circular vortex generators. Fan et al. [27] and Mohammed et al. [28] used the louvered inserts numerically for the circular tube and DPHEs, respectively. They concluded that the Nusselt number is more responsive to inclination angles than the elliptic pitch and had maximum value at the maximum slant angle and minimum inserts pitch.

1.2. Novelty and objectives

Based on the literature review, the knowledge gap can be summarized as follows:

- The first gap is related to a limited number of studies in the field of perforated vortex generators. In addition, most of them are numerical papers, and there are no experimental studies in the field of elliptic turbulators with perforations.
- The second gap is concerning the thermal performance parameter. It is an essential factor in the design of heat exchangers. As discussed later, the proposed DPIE vortex generators provide a much higher thermal efficiency parameter in a wide range of Reynolds numbers than the previous models.

- The third gap is linked to the complex geometries of the previously proposed vortex generators, making them costly and inefficient to be utilized in realistic industrial applications.

To address these gaps, the present experimental study has the following objectives:

- Design of novel perforated elliptic turbulators with much higher thermal performance compared to the previous models.
- To design a simple and efficient vortex generator with easy installation and low manufacturing costs compared to previous complex turbulators.
- To Experimentally investigate the effects of hole diameters on heat transfer enhancement inside heat exchanger pipes.
- To develop dimensionless correlations to make them applicable in heat exchanger industries.

Moreover, recent studies revealed that using elliptic vortex generators and louvered strips can enhance the heat transfer rate up to 77.0%, which is considerably higher than the other proposed vortex generators in the past few years. However, there is no experimental research to investigate the effect of perforations on the elliptic turbulators. Using perforations can significantly improve the heat transfer rate and thermal efficiency, that is necessary in designing of heat exchangers and reduces the operating costs. This has motivated us to propose the newly designed perforated elliptic turbulators to experimentally examine the heat transfer improvement and thermal performance augmentation in the presence of these novel vortex generators. The geometrical parameters of the turbulators are chosen based on the experimental study of Yaningsih et al. [22] for validation and to investigate the thermo-hydraulic performance improvement compared to the recent studies. Moreover, we employed double strips instead of single strips at each pitch distance to achieve better heat transfer rates due to the increased recirculation flows near the holes of the turbulators. The impacts of the slant angle and hole diameters on the heat transfer rate will be investigated experimentally. One of

the other significant advantages of the proposed perforated inclined elliptic turbulators is their simple manufacturing and installation, which help the designers to increase the efficiency of the double-pipe heat exchangers with a low manufacturing cost.

2. Experimental Setup

Fig. 1 illustrates the schematic view of the experimental equipment with its turbulators used in the present study. The experimental setup contains a hot-water loop, double-pipe heat exchanger, cold-water loop, and measurement tools. The double pipe heat exchanger operates through conduction, where the heat from one flow is transferred across the inner tube walls, which is manufactured of copper. The double pipe heat exchanger is utilized in counterflow, where its fluids move in reverse direction (Fig. 1b). In this double-pipe heat exchanger, hot water moving throughout the inner tube transports its heat to cold water flow in the outer annular tube. The system operates in steady state conditions. The hot-water loop contains a hot water tank (35 Litre), a 2-kW heating element inside the tank, a 151-W circulating water pump (Wilo-RS25) with a maximum head of 7.8 m, a calibrated crystal-conical rotameter with (8 ± 0.1 LPM) capacity, piping system with some control valves and a $\frac{1}{2}$ " strainer. The rotameter was calibrated by using a precise low-pressure sampling pump with adjustable pumping power. The flow rate of the crystal rotameter was measured for specific flow rates in the design range. The calibration accuracy of the rotameter can be determined by comparing the flow rate at ten different flow measuring points. All hot-pipe system tools and the storing container are made of stainless steel with appropriate insulating width. The heating element is controlled by a highly precise BEM402-K1220 thermostat ($\pm 0.5\%$ FS) to maintain the inlet temperature of the hot water in the double-pipe heat exchanger test section at a specific temperature (80 °C). The cold-water loop includes an MT conical rotameter with the accuracy of ± 0.1 LPM, piping systems and two valves to control the water flow rate, and domestic urban water is used for the cooling system of the heat exchangers. The inlet temperature of domestic

cold water was steady and constant at 17.7 °C during the experiments. Some small valves are placed on the cold-water outer flow loop to make it possible to test both parallel-flow and counter-flow heat exchanger systems. The hot water flows through the inner tube while the outer annular tube is cooled with domestic cold water. Four TP101 digital thermometers with the operating temperature range of -50 to 300 centigrade degree and the calibration accuracy of ± 0.1 °C are utilized to measure the hot-and the cold-water temperatures at the inlet and outlet of the test section. The pressure drop amongst the inflow and the outlet of the inner pipe was evaluated by pressure taps and a digital pressure transducer (DPT) with a measurement error of ± 1 Pa. The experiments were performed in steady-state conditions. The external annular tube was thoroughly insulated with glass wool with 60mm thickness to diminish the heat transfer from the test section to the environment. Note that the insulations are not shown in Fig. 1-a to a better presentation of the test section.

The test section includes a double-pipe heat exchanger fitted by the double perforated inclined elliptic (DPIE) turbulators inside the hot-water tube. The double-pipe heat exchanger has an inner hot-water pipe made of copper with a thickness(t_1), diameter(d_1), and length(L_1) of 0.75 mm, 14.3 mm, and 855 mm, respectively. While the outer annular tube for the cold-water supply is made of steel with a thickness(t_2), Outer diameter(d_2), and length(L_2) of 1.0 mm, 23.4 mm, and 840 mm, respectively. The double perforated inclined elliptic turbulators are made of polished stainless steel and are fitted on a connecting rod ($t = 2mm$) passing through the inner tube. The details of the geometrical parameters of the DPIE vortex generators are presented in Fig. 2. For the purpose of validations and to investigate the improvements of the proposed model, the geometrical parameters of the turbulators are chosen according to the experimental study of Yaningsih et al. [22] for conventional single louvered turbulators with no perforations. The pitch (S) between the DPIE vortex generators is remained constant at 40 mm. The perforation numbers (N_p) varied from 0 to 5, and the diameter of the perforations (d) is in the

range of ($0\text{mm} < d < 1.5\text{mm}$). The inclination angle (α) between the DPIE strips and the linking shaft was between 15 to 25 degrees. The reason for selecting this range of the inclination angles, is the limitations in experimental equipment. To properly insert the elliptic turbulators inside the pipe, it is necessary that the inclination angle remain below 28 degrees. Moreover, if the inclination angle is reduced to lower than 15 degrees, then the installation of the elliptic turbulators on the connecting rod become noticeably difficult and it will cause intersection with the connecting rod. The thickness of the elliptic strips (δ) and the diameters of the elliptic turbulators (b , c) remained constant at 1mm, 6mm and 10mm, respectively. The perforation index (PI) can be expressed as the ratio of the perforated holes to the total elliptic area, and it be written as $Nd^2/4bc$. The details of the geometrical parameters of the test cases in the present study are provided in Table 1.



a) Experimental setup (before insulation)

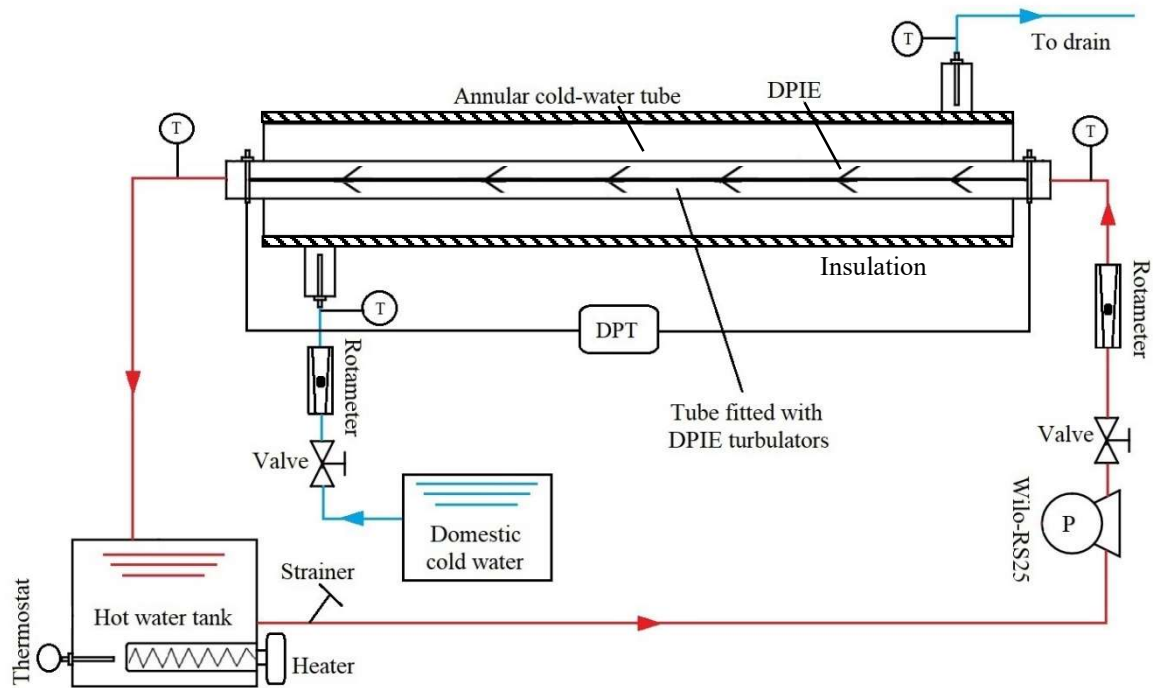

b) Schematic of the experimental apparatus

Fig. 1 Schematic view of the experimental setup improved by double-perforated inclined elliptic (DPIE) vortex generators.

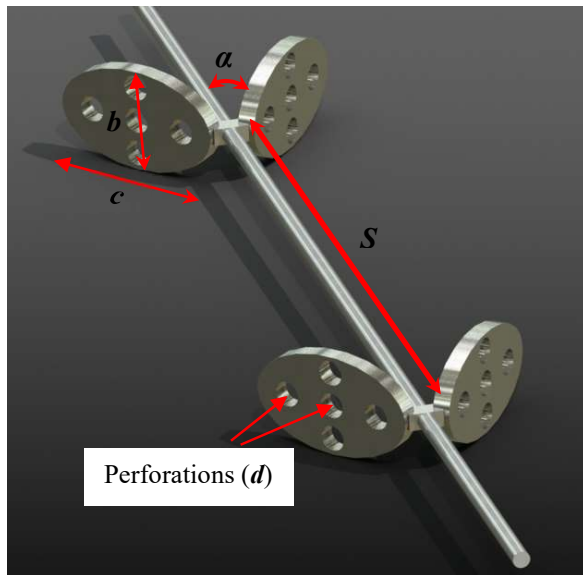

a) $\alpha = 25^\circ$, $d = 1.5\text{mm}$, $PI=4.68\%$

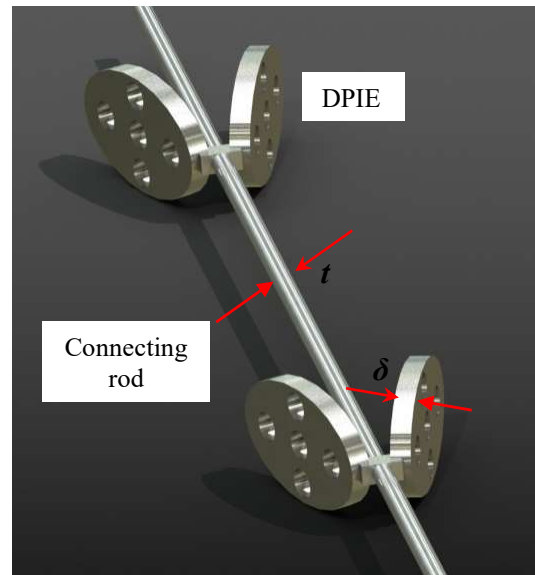

b) $\alpha = 15^\circ$, $d = 1.5\text{mm}$, $PI=4.68\%$

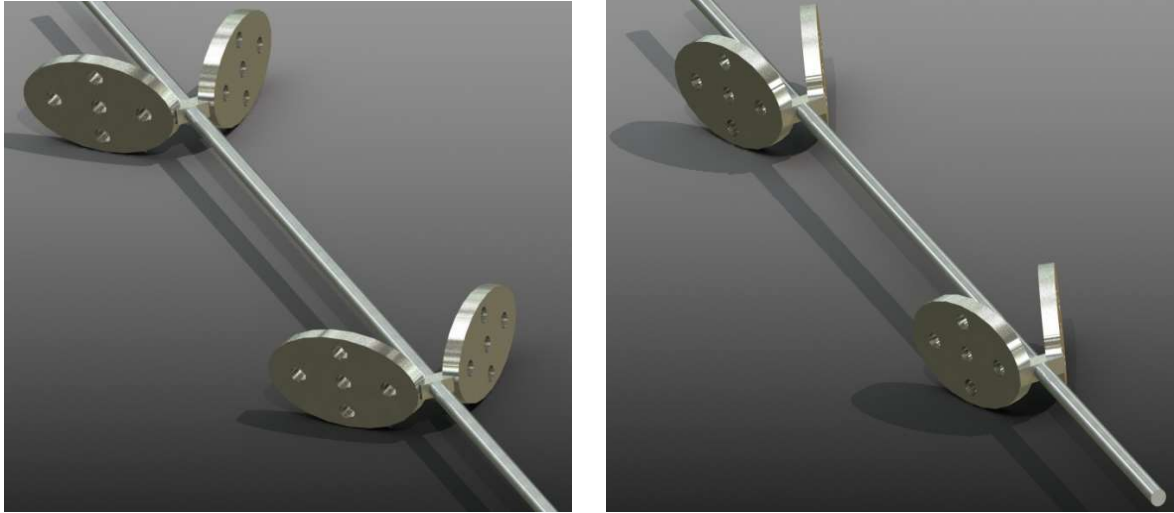

c) $\alpha = 25^\circ$, $d = 1\text{mm}$, $\text{PI}=2.08\%$

d) $\alpha = 15^\circ$, $d = 1\text{mm}$, $\text{PI}=2.08\%$

Fig. 2 Geometrical parameters of DPIE inserts with the connecting rod.

Table 1 Dimensions of the experimental cases.

Case	Slant angle (α)	Hole diameter (d , mm)	Perforation index (PI)	Pitch (S , mm)	Number of Perforations (N_p)	Type
1-3 (Validation)	15, 20, 25	0	0	40	0	Single VG
4-6	15	0.5-1.5	0.52-4.68	40	5	Double VG
7-9	20	0.5-1.5	0.52-4.68	40	5	Double VG
10-12	25	0.5-1.5	0.52-4.68	40	5	Double VG

3. Data Reduction

To calculate the heat transfer coefficient in the double-tube heat exchangers equipped by DPIE turbulators, it is necessary to calculate the heat absorption from the cold-water in the annular channel as [22]:

$$Q_c = \dot{m}_c C_{p,w} (T_{c,out} - T_{c,in}) \quad (1)$$

where \dot{m}_c [kg/s] is the mass flow rate, $C_{p,w}$ [J/(kg K)] is the specific heat, $T_{c,in}$ and $T_{c,out}$ [K] are the inlet and outlet temperatures of the water, respectively. The heat transferred from the hot water, Q_h [W] is calculated as:

$$Q_h = \dot{m}_h C_{p,w} (T_{h,in} - T_{h,out}) \quad (2)$$

where \dot{m}_h , $T_{c,in}$ and $T_{c,out}$ are the heated fluid mass flow rate, the inlet and outlet temperature of hot fluid, respectively. The thermal analysis showed that the total heat loss via the insulations to the environment by radiation and natural convection was less than 2% during the experiments. Therefore, the average value of the heat flow is selected for calculation of the average heat transfer coefficient (U) of the inner pipe by [23]:

$$Q_{avg} = \frac{Q_h + Q_c}{2} \quad (3)$$

$$Q_{avg} = UA_i \Delta T_{LMTD} \quad (4)$$

Where A_i is the surface of the inner copper tube of the text section and can be calculated as:

$$A_i = \pi D_i L \quad (5)$$

where D_i is the diameter of the inner tube of the double-pipe heat exchanger. In order to calculate the internal heat transfer coefficient, which is the main goal of the present study, h_i can be calculated as [22]:

$$h_i = \frac{1}{\left[\frac{1}{U} - \frac{D_i \ln \left(\frac{D_o}{D_i} \right)}{2k} - \frac{D_i}{D_o h_o} \right]} \quad (6)$$

where D_o is the diameter of the outer annular pipe of the double-pipe heat exchanger. To evaluate h_i , it is necessary to find the value of the outer heat transfer coefficient (h_o). This parameter is calculated by using the correlation of Dittus–Boelter as [29]:

$$Nu_o = \frac{h_o D_h}{k} = 0.023 Re^{0.8} Pr^{0.3} \quad (7)$$

where $D_h = D_o - D_i$ is the hydraulic diameter and Pr is the Prandtl number of the working fluid and $Re = \rho V D / \mu$ is the Reynolds number, and μ is the dynamic viscosity of the working fluid. The Reynolds number is varied from 6,000 to 18,000 in the present experimental study to achieve a fully turbulent flow structure. It must be pointed out that that the thermal conductivity k of the fluid is computed at the local mean bulk fluid temperature. Finally, the average Nusselt number of the central tube of the double-tube heat exchangers equipped by the elliptic turbulators can be determined as:

$$Nu_i = \frac{h_i D_i}{k} \quad (8)$$

The friction loss, (f) is determined by:

$$f = \frac{\Delta P}{\frac{1}{2} \rho V^2} \frac{D_i}{L} \quad (9)$$

V is the mean velocity in the internal heated tube. The thermal efficiency parameter (η) is specified as the ratio of the heat transfer augmentation ratio to the dimensionless friction ratio.

The overall thermal efficiency at constant pumping power can be written as [16]:

$$\eta = \frac{(Nu/Nu_s)}{(f/f_s)^{1/3}} \quad (10)$$

Where Nu_s and f_s are the Nusselt numbers and friction loss for a smooth pipe with no DPIE turbulators, respectively.

3.1. Uncertainty analysis

It is crucial to assess the error in the experimental calculations. The uncertainty analysis is important because the magnitude of the physical parameters needs to be considered when evaluating the heat transfer and pressure drop results of the proposed elliptic vortex generators

before performing further analysis. For the calibration of the TP101 temperature measurement devices, a two-point adjustment technique (ice mix and steaming water) is utilized. Furthermore, a mercury-based thermometer is used in the reference temperature bath to double-check the precision of the measurement. The measurements are done after achieving steady-state conditions. Table 2 shows the uncertainties of the measurement tools in the present experimental investigation.

Table 2 Uncertainties of the measurement tools

Name of devise	Working range	Measured parameter	Uncertainty
TP101 thermocouple	-50 to 300 [°C]	Water temperatures	±0.1[°C]
MT Rotameter	0 to 8 [Lit / min]	Volumetric flow rate	±0.1[LPM]
Differential pressure transducer	0 to 4000 [Pa]	Pressure	±1[Pa]
Omega Multi meter	0-220 [V], 1-20 [A]	Heating element	±0.2[V] ±0.002[A]
Digital Vernier	0 to 400 [mm]	Dimensions	±0.1[mm]
BEM402 Thermostat	0 - 400 [°C]	How-water tank temp.	± 0.5% FS

According to the approach suggested by Moffat [30] the uncertainties of Re , Nu_i and f are determined by:

$$\frac{\delta Re}{Re} = \left[\left(\frac{\delta \rho}{\rho} \right)^2 + \left(\frac{\delta U}{U} \right)^2 + \left(\frac{\delta D_h}{D_h} \right)^2 + \left(\frac{\delta \mu}{\mu} \right)^2 \right]^{1/2} \quad (11-a)$$

$$\frac{\delta Nu_i}{Nu_i} = \left[\left(\frac{\delta h}{h} \right)^2 + \left(\frac{\delta D_i}{D_i} \right)^2 + \left(\frac{\delta k}{k} \right)^2 \right]^{1/2} \quad (11-b)$$

$$\frac{\delta f}{f} = \left[\left(\frac{\delta \Delta P}{\Delta P} \right)^2 + \left(\frac{\delta D_i}{D_i} \right)^2 + \left(\frac{\delta L}{L} \right)^2 + \left(\frac{\delta \rho}{\rho} \right)^2 + \left(2 \frac{\delta V}{V} \right)^2 \right]^{1/2} \quad (11-c)$$

The highest uncertainty of the computed parameters is shown in Table 3. It is observed that the uncertainties for all of the output parameters are within a precise range. This means that the experiments are trustworthy due to the precise measurement tools employed in this work.

Table 3 Uncertainty values of the computed parameters

Parameter	Uncertainty
Reynolds number, (Re)	$\pm 3.1\%$
Nusselt number, (Nu_i)	$\pm 4.2\%$
Friction loss, (f)	$\pm 4.3\%$

4. Results and Discussion

4.1. Validation

At the first step of the analysis, an investigation is carried out for a simple inclined louvered strip to validate the results with the experimental data of Yaningsih et al. [22]. As seen in Fig. 3 (a-b) for the Nusselt number and friction loss, the obtained results in this study are in excellent agreements with the previous study, which confirms the accuracy of measurements in the current study. The results are depicted for two inclined angles of 15 and 25° for the louvered strips without any perforation. It can be seen from Fig. 3 that Nu number will be improved by increasing the slant angle. Moreover, the obtained experimental results are closer to the experiments at lower Reynolds numbers. It is observed that the heat transfer is increased by raising the inclination angle. This improvement is because of the stronger recirculations and more thermal boundary-layer disruption between the pipe surface and the vortex generators. A similar behaviour is also detected for the friction loss; the inclination angle plays an important role in the variations of the pressure drop in double-pipe heat exchangers.

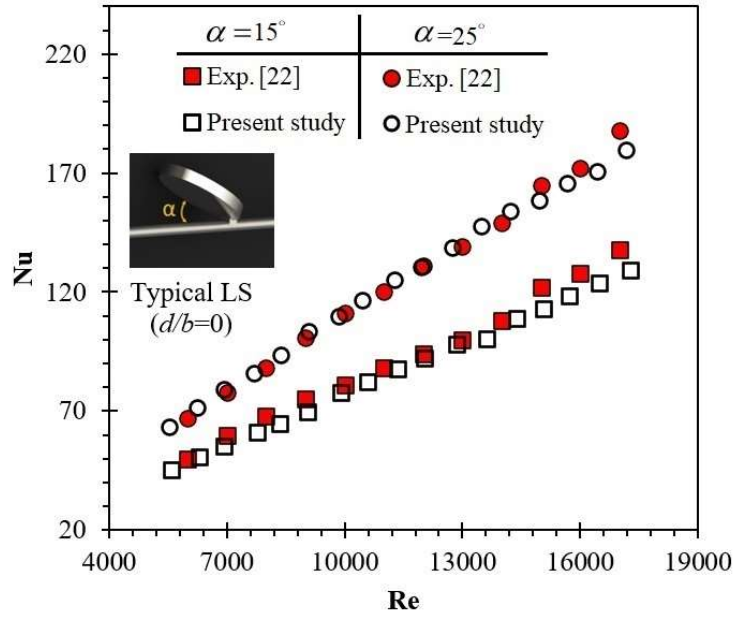

(a)

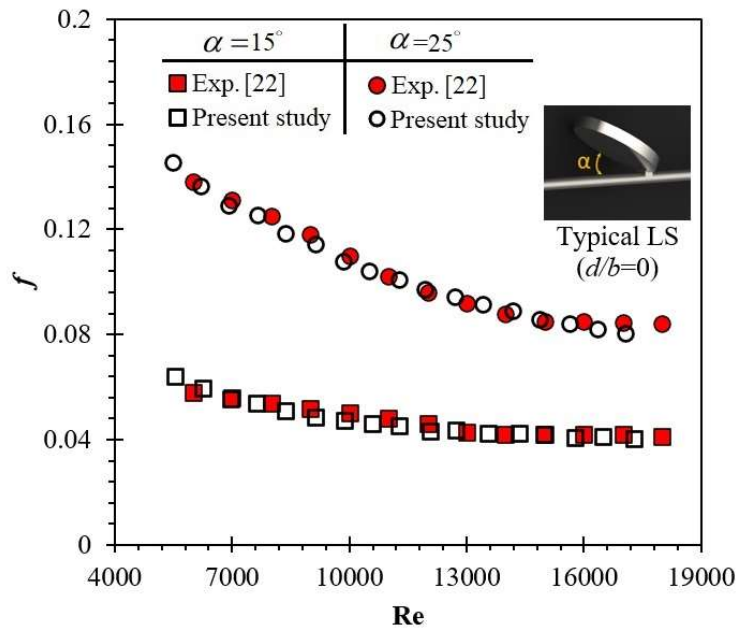

(b)

Fig. 3 Validation of results in this study for typical LS without perforations and the experimental data of Yaningsih et al. [22].

Based on the literature review, which concluded that perforation was an efficient method for enhancing the heat transfer through making more turbulence, double perforated inclined elliptic (DPIE) turbulators are designed with different geometries. Fig. 4 and Fig. 5

demonstrate the Nusselt number and friction parameter, respectively for DPIE with $d/b=0.25$ at three slant angles of 15, 20 and 25°. As seen in these figures, DPIE vortex generators have significant effects on the Nu and f compared to the plain tube, while the slant angle increment increases Nusselt number and friction factor due to more turbulence over the flow. So, the slant angle of 25° has the maximum value for both Nu number and pressure loss. The experiments illustrate that the heat transfer is augmented by 217.4% by using DPIE vortex generators compared to the plain pipe without turbulators. The highest Nu number of 243.1 is obtained for the perforated elliptic vortex generators with the inclination angle of 25 degrees and $d/b=0.25$ at $Re=18,000$. The main physical reason for the heat transfer enhancement in the presence of perforated elliptic turbulators with higher inclination angles, is the thermal boundary layer disruption near the heated pipe walls. The recirculation flows increase the fluid mixing between the cold centre region and the heated walls to improve the heat transfer rate. Moreover, the friction loss of the turbulent water flow inside the heat exchanger tube equipped with DPIE inserts is increased around 153.1% compared to the plain heat exchanger pipe without turbulators at $Re=18,000$. Raising the inclination angle, increase the flow perturbation between the pipe wall and the elliptic turbulators. The vortex generations near the holes of the perforated elliptic turbulators with larger inclination angles, become noticeable. Therefore, the pressure drop is expected to be increased by raising the inclination angle of the elliptic vortex generators

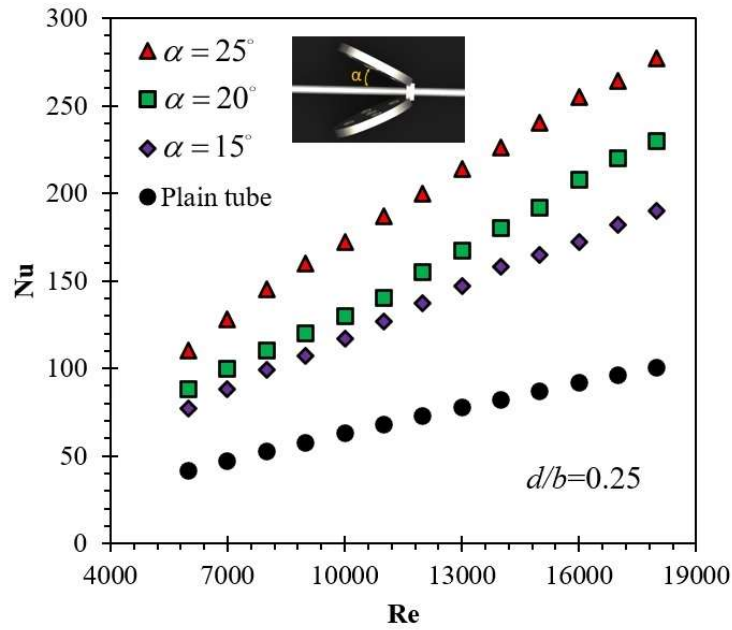

Fig. 4 The effects of DPIE slant angle (α) on the average heat transfer coefficient.

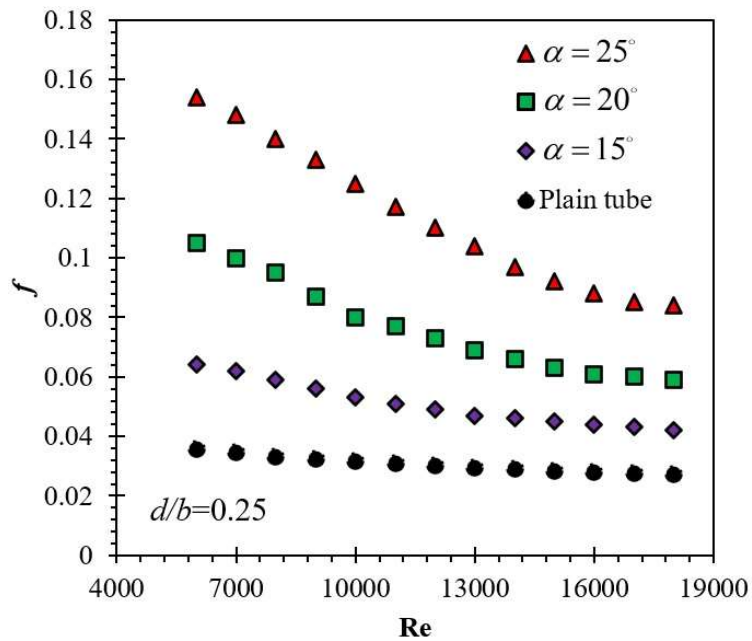

Fig. 5 The effects of DPIE inclination angle (α) on the friction factor coefficient.

The diameter ratio (i.e., the relation of perforation diameters to the elliptic strips diameter or d/b) is a significant parameter that has considerable impact on the heat transfer characteristics. Fig. 6 illustrates the effect of d/b on the Nusselt number against the Reynolds number for the inclined angle of 25° . As seen, d/b ratio is changed from 0, 0.083, 0.167 to 0.25

which physically means increased the perforation diameters. By increasing the d/b , the Nusselt number is also improved due to more flow through the larger perforations and making greater turbulence flow in the heat exchanger. Another important physical parameter for heat transfer augmentation in the existence of elliptic inserts with larger holes, is the additional recirculation flows between the pipe wall and core region through the larger perforations. These perturbations and vortex production disrupt the thermal boundary layer near the heated pipe walls and increase the temperature gradient in this region. It may be deduced that the heat transfer is increased around 39.4% by using perforated elliptic turbulators with $d/b=0.25$ compared to the typical louvered strips without perforations ($d/b=0$).

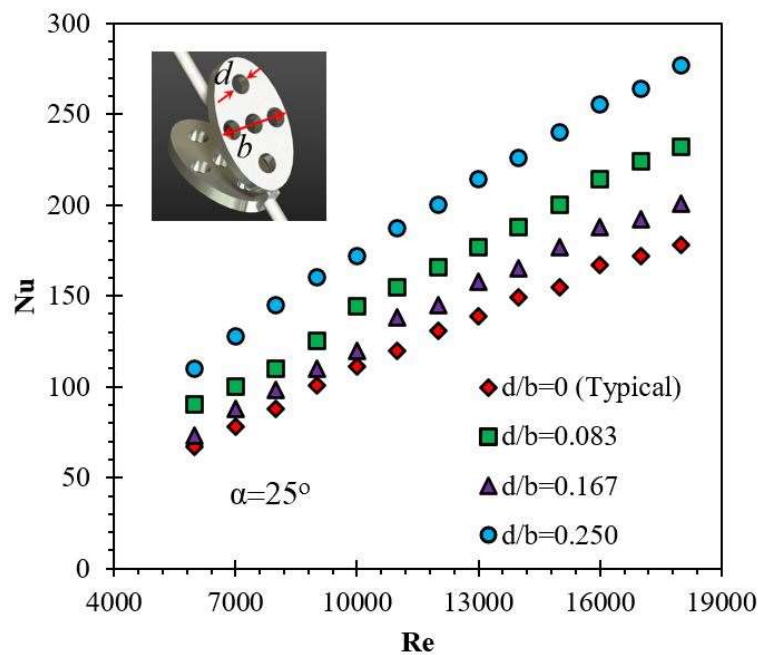

Fig. 6 The effects of diameter ratio (d/b) of the perforated elliptic turbulators on the average heat transfer coefficient.

Fig. 7 shows the impact of the perforation ratio on the friction loss of turbulent water flow inside the heat exchanger pipe. It is found that the pressure drop decline by raising the Re for all of the tested elliptic turbulators. The Friction factor increment of 9.5%, 11.2% and 14.0% are observed for the double perforated elliptic turbulators with $d/b=0.083$, 0.167 and 0.250,

respectively, compared to the typical elliptic inserts without perforations. It can be deduced that using perforated elliptic vortex generators improves the heat transfer rate (39.4%) with a small increment in the friction loss (14%). Consequently, the thermal performance can be increased by using the proposed DPIE inserts compared to the previous models.

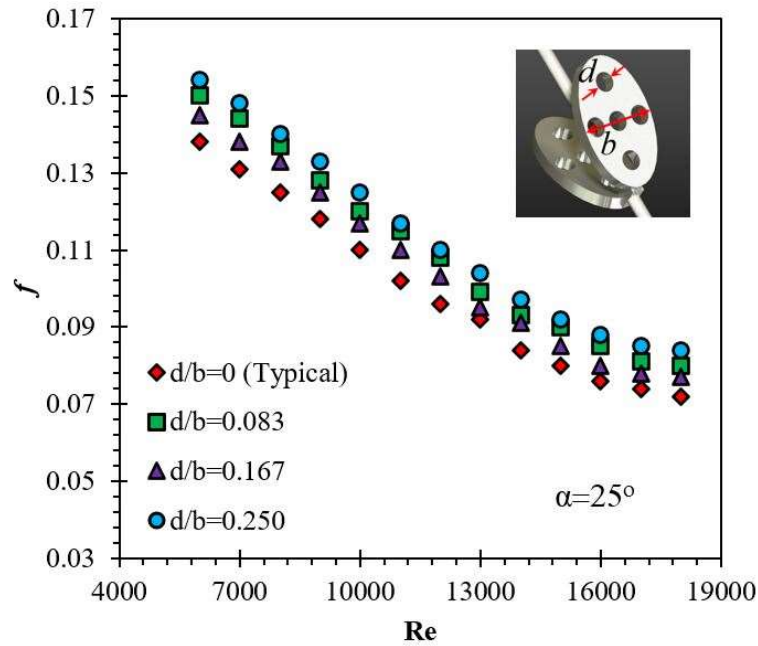

Fig. 7 The effects of diameter ratio (d/b) of the perforated elliptic turbulators on the friction loss coefficient.

Although in all cases the Nusselt number improved, the friction factor also increased. Therefore, in order to find the most efficient cases, an overall thermal performance is defined as presented in Eq. (10). In Fig. 8 the overall thermal efficiency is shown for various inclined angles and diameter ratios. As seen, among the tested cases, the case of $d/b=0.25$ and $\alpha=25^\circ$ can be introduced as the best efficient case with maximum thermal performance at all Reynolds number. Furthermore, as the second case, the case of $d/b=0.25$ with $\alpha=20^\circ$ at larger Reynolds number is efficient, while the case of $d/b=0.25$ with $\alpha=15^\circ$ is suitable for low Reynolds numbers. The results show that the thermal efficiency of the DPIE turbulators with larger holes is considerably greater than the typical elliptic inserts without holes. The thermal performance

is increased around 17.6% by increasing the inclination angle (α) from 15 to 25 at $Re=12000$ with the same diameter ratio ($d/b=0.25$).

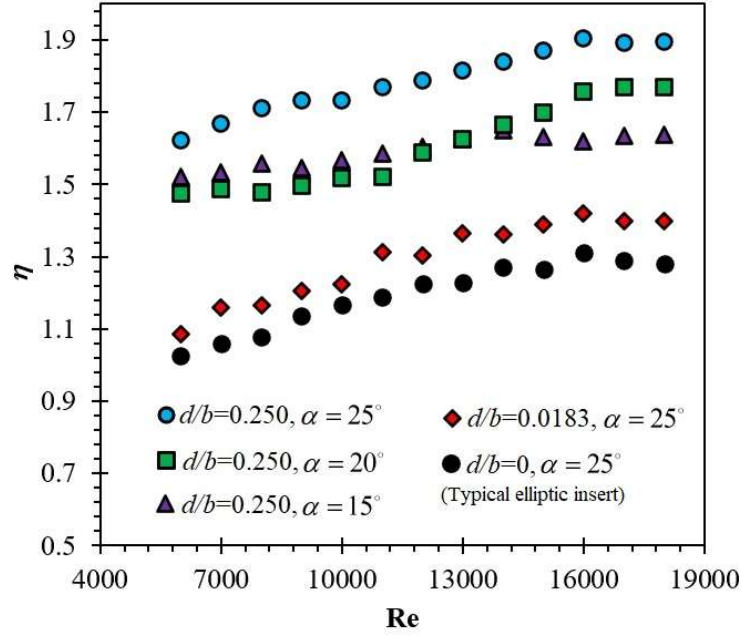

Fig. 8 Thermal performance factor against Re number for different DPIE turbulators.

The empirical correlations of the Nusselt number and the friction loss for double-pipe heat exchanger fitted by DPIE vortex generators are provided in Eqs. (12-13). The correlations are created by curve fitting of the experimental results. The Nusselt number and friction loss are functions of cut ratio ($0 \leq d/b \leq 0.25$), slant angle ($15^\circ \leq \alpha \leq 25^\circ$) and Reynolds number ($6000 \leq Re \leq 18000$) at the same time. According to the mean average deviation evaluation ($MAD = \sum_{i=1}^n |x_i - \bar{x}| / n$), the average and total deviations for Nu number correlation are 1.42% and 3.61%, respectively. The proposed correlations are as follows:

$$Nu = 0.061 Re^{0.898} Pr^{0.3} \left(\frac{\alpha}{90} \right)^{0.903} (1 + d/b)^{2.081} \quad (12)$$

$$f = 83.25 Re^{-0.540} \left(\frac{\alpha}{90} \right)^{1.368} (1 + d/b)^{0.625} \quad (13)$$

Figs. 9-10 shows a comparison among the predicted heat transfer coefficient and friction loss with the experimental measurements as functions of physical parameters and perforated diameter ratio of the inclined elliptic turbulators. It is observed that the correlations can predict the heat transfer rate and pressure loss with maximum errors of $\pm 10\%$, and 14% , relative to the experimental data.

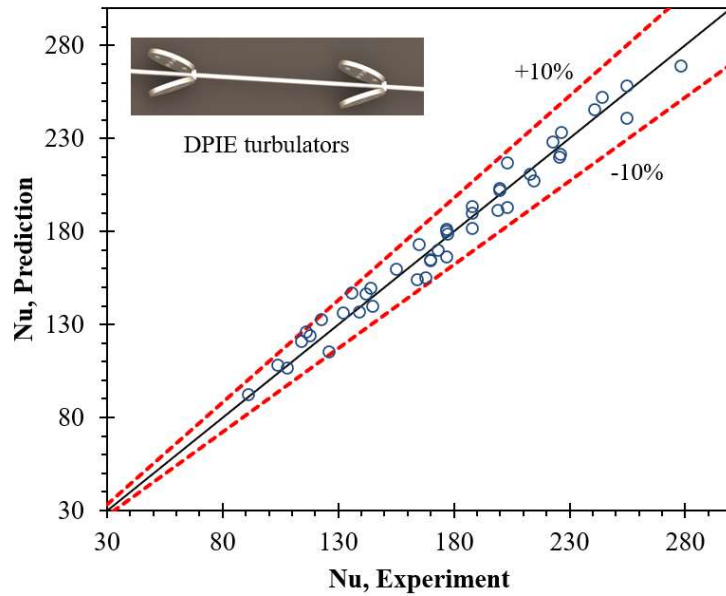

Fig. 9 Comparison of experimental average Nu number with predicted data for DPIE turbulators.

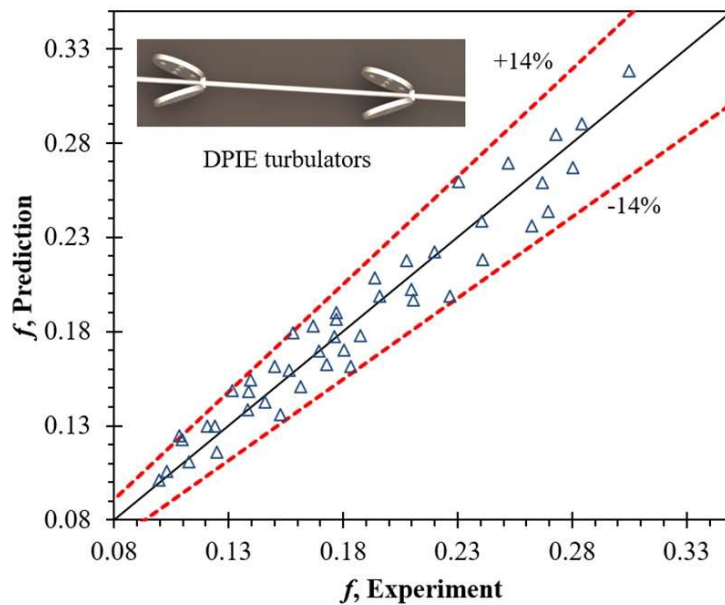

Fig. 10 Comparison of friction data with predicted data for DPIE turbulators.

Finally, a comparison among the thermal enhancement factor of present study when $d/b=1.25$ and $\alpha=25^\circ$ and previous other turbulators is provided in Fig. 11. As seen, among all cases, the presented double-perforated inclined elliptic vortex generator in this experimental study has the best values for thermal efficiency at a wide range of Reynolds numbers, which make it as most efficient passive device for heat transmission improvements. The maximum thermal efficiency parameter of 1.849 is achieved for DPIE vortex generators with $d/b=0.25$ and $\alpha = 25^\circ$ at $Re=16,000$, which is 15.5% higher than the highest thermal efficiency reported in the previous papers in the field of vortex generators. The novel perforated elliptic turbulators provide much higher thermal performance than the previous models in the range of $9000 \leq Re \leq 16000$. Moreover, the proposed vortex geometries can be manufactured and installed inside heat exchangers without raising the design costs compared to previous complex turbulators.

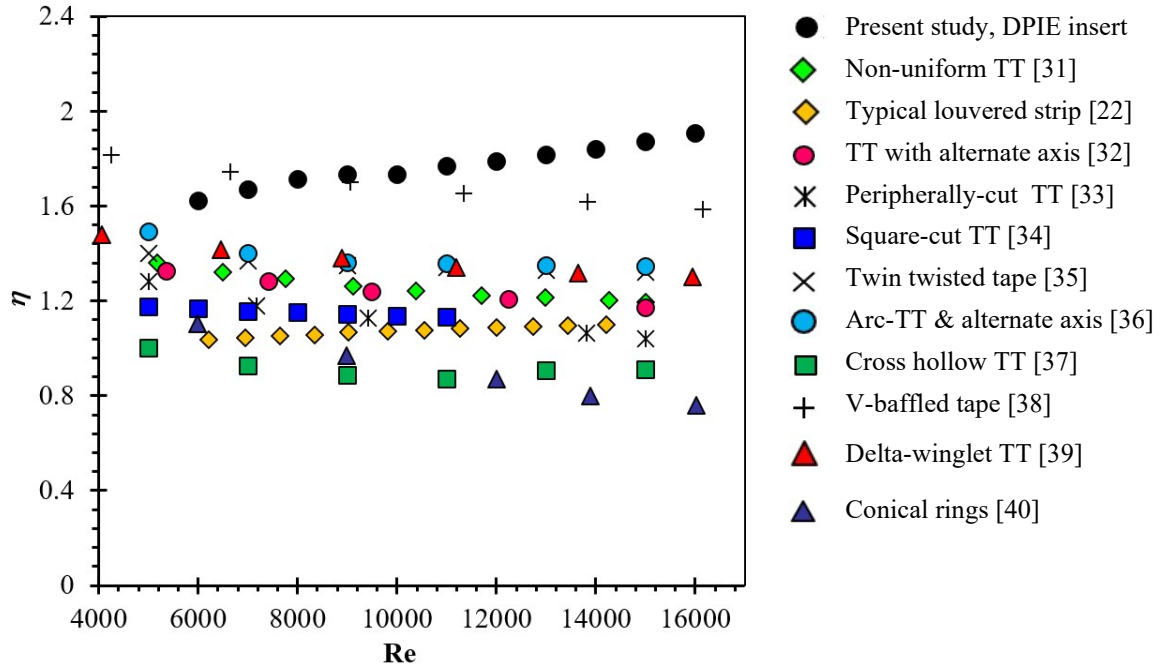

Fig. 11 Comparison amongst the thermal efficiency factor of the current study

$(d/b = 1.25, \alpha = 25^\circ)$ with previous other turbulator devices.

5. Conclusion

In the present research, experiments were done to examine the thermal efficiency of the double-pipe heat exchangers by proposing novel double-perforated inclined elliptic (DPIE) vortex generators. The flow was turbulent, and the Reynolds number, perforated diameter ratio (d/b), and the inclination angle of the elliptic inserts were in the range of $5000 \leq Re \leq 18,000$, $0 \leq d/b \leq 0.25$, and $15^\circ \leq \alpha \leq 25^\circ$, respectively. The main findings of the present study are as follows:

- It was found that the suggested perforated elliptic turbulators can noticeably improve the thermal efficiency factor of the double-pipe heat exchanger tubes. Two correlations were also proposed to calculate the average Nusselt number and friction loss as functions of the design parameters.
- The perforations intensify the recirculation flows and vortex production between the holes of the elliptic inserts and the walls of the heat exchanger. The thermal boundary-

layer disruption is the main physical reason for heat transfer enhancement compared to the typical louvered inserts.

- The experimental data revealed that the heat transfer can be increased up to 217.4% by using DPIE vortex generators with $d/b=0.25$ in comparison to the smooth pipe without vortex generators.
- The Friction factor increment of 9.5%, 11.2% and 14.0% are observed for the double perforated elliptic turbulators with $d/b=0.083$, 0.167 and 0.250, respectively, compared to the typical elliptic inserts without perforations.
- The highest Nu number of 243.1 is obtained for the perforated elliptic vortex generators with the inclination angle of 25 degrees and $d/b=0.25$ at $Re=18,000$.
- The thermal performance is increased around 17.6% by raising the inclination angle (α) from 15 to 25 at $Re=12000$ with the same diameter ratio ($d/b=0.25$). The highest thermal performance parameter (η) of 1.849 is achieved for DPIE vortex generators with $d/b=0.25$, and $\alpha = 25^\circ$ at $Re=16,000$.

References

- [1] E. Gokulnathan, S. Pradeep, N. Jayan, M.L.D. Bhatlu, S. Karthikeyan, Review of heat transfer enhancement on helical coil heat exchanger by additive passive method, *Materials Today: Proceedings*, DOI (2020).
- [2] H. Wu, J. Wang, Z. Tao, Passive heat transfer in a turbulent channel flow simulation using large eddy simulation based on the lattice Boltzmann method framework, *International journal of heat and fluid flow*, 32 (2011) 1111-1119.
- [3] J. Liang, K.K. Nielsen, K. Engelbrecht, C.R. Bahl, Heat transfer figures of merit for mapping passive regenerator performance to active regenerator cooling power, *Applied Thermal Engineering*, 181 (2020) 115993.

- [4] Z.S. Kareem, M.M. Jaafar, T.M. Lazim, S. Abdullah, A.F. Abdulwahid, Passive heat transfer enhancement review in corrugation, *Experimental Thermal and Fluid Science*, 68 (2015) 22-38.
- [5] S. Liu, M. Sakr, A comprehensive review on passive heat transfer enhancements in pipe exchangers, *Renewable and sustainable energy reviews*, 19 (2013) 64-81.
- [6] P. Sarma, T. Subramanyam, P. Kishore, V.D. Rao, S. Kakac, A new method to predict convective heat transfer in a tube with twisted tape inserts for turbulent flow, *International Journal of Thermal Sciences*, 41 (2002) 955-960.
- [7] M. Hatami, D. Ganji, M. Gorji-Bandpy, Experimental investigations of diesel exhaust exergy recovery using delta winglet vortex generator heat exchanger, *International Journal of Thermal Sciences*, 93 (2015) 52-63.
- [8] N. Zheng, F. Yan, K. Zhang, T. Zhou, Z. Sun, A review on single-phase convective heat transfer enhancement based on multi-longitudinal vortices in heat exchanger tubes, *Applied Thermal Engineering*, 164 (2020) 114475.
- [9] S.K. Singh, M. Kumar, A. Kumar, A. Gautam, S. Chamoli, Thermal and friction characteristics of a circular tube fitted with perforated hollow circular cylinder inserts, *Applied Thermal Engineering*, 130 (2018) 230-241.
- [10] M. Nakhchi, M. Rahmati, Entropy generation of turbulent Cu–water nanofluid flows inside thermal systems equipped with transverse-cut twisted turbulators, *Journal of Thermal Analysis and Calorimetry*, DOI (2020) 1-10.
- [11] L.H.K. Goh, Y.M. Hung, G. Chen, C. Tso, Entropy generation analysis of turbulent convection in a heat exchanger with self-rotating turbulator inserts, *International Journal of Thermal Sciences*, 160 (2021) 106652.

- [12] T.-M. Liou, C.-C. Chen, C.-S. Wang, E.-S. Wang, Thermal-fluidic correlations for turbulent flow in a serpentine heat exchanger with novel wing-shaped turbulators, *International Journal of Heat and Mass Transfer*, 160 (2020) 120220.
- [13] D. Panahi, K. Zamzamian, Heat transfer enhancement of shell-and-coiled tube heat exchanger utilizing helical wire turbulator, *Applied Thermal Engineering*, 115 (2017) 607-615.
- [14] A. Vaisi, R. Moosavi, M. Lashkari, M.M. Soltani, Experimental investigation of perforated twisted tapes turbulator on thermal performance in double pipe heat exchangers, *Chemical Engineering and Processing-Process Intensification*, 154 (2020) 108028.
- [15] T. Dagdevir, V. Ozceyhan, An experimental study on heat transfer enhancement and flow characteristics of a tube with plain, perforated and dimpled twisted tape inserts, *International Journal of Thermal Sciences*, 159 (2021) 106564.
- [16] M. Nakhchi, J. Esfahani, Numerical investigation of heat transfer enhancement inside heat exchanger tubes fitted with perforated hollow cylinders, *International Journal of Thermal Sciences*, 147 (2020) 106153.
- [17] M. Nakhchi, J. Esfahani, Numerical investigation of different geometrical parameters of perforated conical rings on flow structure and heat transfer in heat exchangers, *Applied Thermal Engineering*, 156 (2019) 494-505.
- [18] M. Nakhchi, J. Esfahani, K. Kim, Numerical study of turbulent flow inside heat exchangers using perforated louvered strip inserts, *International Journal of Heat and Mass Transfer*, 148 (2020) 119143.
- [19] M. Nakhchi, J. Esfahani, Numerical investigation of rectangular-cut twisted tape insert on performance improvement of heat exchangers, *International Journal of Thermal Sciences*, 138 (2019) 75-83.

- [20] M. Nakhchi, M. Hatami, M. Rahmati, Experimental investigation of heat transfer enhancement of a heat exchanger tube equipped with double-cut twisted tapes, *Applied Thermal Engineering*, 180 (2020) 115863.
- [21] A. Saravanan, S. Jaisankar, Heat transfer augmentation techniques in forced flow V-trough solar collector equipped with V-cut and square cut twisted tape, *International Journal of Thermal Sciences*, 140 (2019) 59-70.
- [22] I. Yaningsih, A.T. Wijayanta, T. Miyazaki, S. Koyama, Thermal hydraulic characteristics of turbulent single-phase flow in an enhanced tube using louvered strip insert with various slant angles, *International Journal of Thermal Sciences*, 134 (2018) 355-362.
- [23] S. Eiamsa-ard, S. Pethkool, C. Thianpong, P. Promvonge, Turbulent flow heat transfer and pressure loss in a double pipe heat exchanger with louvered strip inserts, *International Communications in Heat and Mass Transfer*, 35 (2008) 120-129.
- [24] M. Rivier, P. Sébastien, T. Goli, G. Raffray, A. Collignan, Heat transfer enhancement of a circular tube heat exchanger fitted with an elliptic shaped turbulator designed in the context of developing countries, *Applied Thermal Engineering*, 81 (2015) 92-101.
- [25] H.-M. Kim, M.-A. Moon, K.-Y. Kim, Multi-objective optimization of a cooling channel with staggered elliptic dimples, *Energy*, 36 (2011) 3419-3428.
- [26] T. Rajaseenivasan, S. Srinivasan, K. Srithar, Comprehensive study on solar air heater with circular and V-type turbulators attached on absorber plate, *Energy*, 88 (2015) 863-873.
- [27] A. Fan, J. Deng, A. Nakayama, W. Liu, Parametric study on turbulent heat transfer and flow characteristics in a circular tube fitted with louvered strip inserts, *International Journal of Heat and Mass Transfer*, 55 (2012) 5205-5213.
- [28] H. Mohammed, H.A. Hasan, M. Wahid, Heat transfer enhancement of nanofluids in a double pipe heat exchanger with louvered strip inserts, *International Communications in Heat and Mass Transfer*, 40 (2013) 36-46.

- [29] T.L. Bergman, F.P. Incropera, A.S. Lavine, D.P. Dewitt, Introduction to heat transfer, John Wiley & Sons 2011.
- [30] R.J. Moffat, Describing the uncertainties in experimental results, *Experimental thermal and fluid science*, 1 (1988) 3-17.
- [31] S. Eiamsa-Ard, P. Somkleang, C. Nuntadusit, C. Thianpong, Heat transfer enhancement in tube by inserting uniform/non-uniform twisted-tapes with alternate axes: Effect of rotated-axis length, *Applied Thermal Engineering*, 54 (2013) 289-309.
- [32] K. Wongcharee, S. Eiamsa-Ard, Enhancement of heat transfer using CuO/water nanofluid and twisted tape with alternate axis, *International Communications in Heat and Mass Transfer*, 38 (2011) 742-748.
- [33] S. Eiamsa-ard, P. Seemawute, K. Wongcharee, Influences of peripherally-cut twisted tape insert on heat transfer and thermal performance characteristics in laminar and turbulent tube flows, *Experimental Thermal and Fluid Science*, 34 (2010) 711-719.
- [34] P. Murugesan, K. Mayilsamy, S. Suresh, Turbulent heat transfer and pressure drop in tube fitted with square-cut twisted tape, *Chinese Journal of Chemical Engineering*, 18 (2010) 609-617.
- [35] S. Eiamsa-Ard, C. Thianpong, P. Eiamsa-Ard, Turbulent heat transfer enhancement by counter/co-swirling flow in a tube fitted with twin twisted tapes, *Experimental Thermal and Fluid Science*, 34 (2010) 53-62.
- [36] A. Saysroy, W. Changcharoen, S. Eiamsa-ard, Performance assessment of turbular heat exchanger tubes containing rectangular-cut twisted tapes with alternate axes, *Journal of Mechanical Science and Technology*, 32 (2018) 433-445.
- [37] Y. He, L. Liu, P. Li, L. Ma, Experimental study on heat transfer enhancement characteristics of tube with cross hollow twisted tape inserts, *Applied Thermal Engineering*, 131 (2018) 743-749.

- [38] P. Promvongse, S. Skullong, Augmented heat transfer in tubular heat exchanger fitted with V-baffled tapes, *International Journal of Thermal Sciences*, 155 (2020) 106429.
- [39] S. Eiamsa-Ard, K. Wongcharee, P. Eiamsa-Ard, C. Thianpong, Heat transfer enhancement in a tube using delta-winglet twisted tape inserts, *Applied Thermal Engineering*, 30 (2010) 310-318.
- [40] M.M. Ibrahim, M.A. Essa, N.H. Mostafa, A computational study of heat transfer analysis for a circular tube with conical ring turbulators, *International Journal of Thermal Sciences*, 137 (2019) 138-160.