

**A PROCESS INTEGRATION APPROACH TO THE STRATEGIC DESIGN AND
SCHEDULING OF BIOREFINERIES**

A Dissertation

by

RENÉ DAVINA ELMS

Submitted to the Office of Graduate Studies of
Texas A&M University
in partial fulfillment of the requirements for the degree of

DOCTOR OF PHILOSOPHY

December 2009

Major Subject: Chemical Engineering

**A PROCESS INTEGRATION APPROACH TO THE STRATEGIC DESIGN AND
SCHEDULING OF BIOREFINERIES**

A Dissertation

by

RENÉ DAVINA ELMS

Submitted to the Office of Graduate Studies of
Texas A&M University
in partial fulfillment of the requirements for the degree of

DOCTOR OF PHILOSOPHY

Approved by:

Chair of Committee,	Mahmoud M. El-Halwagi
Committee Members,	M. Sam Mannan
	Bruce McCarl
	Lale Yurttas
Head of Department,	Michael Pishko

December 2009

Major Subject: Chemical Engineering

ABSTRACT

A Process Integration Approach to the Strategic Design and
Scheduling of Biorefineries. (December 2009)

René Davina Elms, B.S.; B.S.; MS., Texas A&M University

Chair of Advisory Committee: Dr. Mahmoud M. El-Halwagi

This work focused upon design and operation of biodiesel production facilities in support of the broader goal of developing a strategic approach to the development of biorefineries. Biodiesel production provided an appropriate starting point for these efforts. The work was segregated into two stages.

Various feedstocks may be utilized to produce biodiesel, to include virgin vegetable oils and waste cooking oil. With changing prices, supply, and demand of feedstocks, a need exists to consider various feedstock options. The objective of the first stage was to develop a systematic procedure for scheduling and operation of flexible biodiesel plants accommodating a variety of feedstocks. This work employed a holistic approach and combination of process simulation, synthesis, and integration techniques to provide: process simulation of a biodiesel plant for various feedstocks, integration of energy and mass resources, optimization of process design and scheduling, and techno-economic assessment and sensitivity analysis of proposed schemes. An optimization formulation

was developed to determine scheduling and operation for various feedstocks and a case study solved to illustrate the merits of the devised procedure.

With increasing attention to the environmental impact of discharging greenhouse gases (GHGs), there has been growing public pressure to reduce the carbon footprint associated with fossil fuel use. In this context, one key strategy is substitution of fossil fuels with biofuels such as biodiesel. Design of biodiesel plants has traditionally been conducted based on technical and economic criteria. GHG policies have the potential to significantly alter design of these facilities, selection of feedstocks, and scheduling of multiple feedstocks. The objective of the second stage was to develop a systematic approach to design and scheduling of biodiesel production processes while accounting for the effect of GHG policies. An optimization formulation was developed to maximize profit of the process subject to flowsheet synthesis and performance modeling equations. The carbon footprint is accounted for through a life cycle analysis (LCA). The objective function includes a term reflecting the impact of the LCA of a feedstock and its processing to biodiesel. A multiperiod approach was used and a case study solved with several scenarios of feedstocks and GHG policies.

Dedicated to

My daughter Davina -

May you always reach for the stars and never settle for second best.

and my parents David and DeRenda Elms –

‘For I know the plans I have for you, plans to prosper you and not to harm you, to give

you hope and a future.’

with Love

ACKNOWLEDGEMENTS

Words cannot express the gratitude and appreciation I wish to extend to my committee chair, advisor, and mentor, Dr. Mahmoud El-Halwagi. Not only is he a phenomenal engineer and mentor, he is an exceptional human being - a constant source of inspiration and support, technically and otherwise. I could not have designed or imagined a better combination of guide, mentor, advisor, and teacher for this journey.

I will eternally be grateful to Dr. El-Halwagi for not only introducing me to the exciting world of process integration and shaping me as an engineer, but also for giving me wings for the continued journey.

I extend sincere thanks to Dr. Lale Yurttas for serving on my committee and for her support, honesty, and insight in a variety of arenas. Additionally, I am also thankful to Dr. Sam Mannan for his valuable input and insight's regarding 'the big picture.' I would also like to thank Dr. Bruce McCarl for his time and willingness to serve on my committee. I want to acknowledge my fellow group members, Grace Pokoo-Aikens and Dr. Eva Lovelady for their support and our many discussions. In addition, I would like to thank Dr. Theresa Good (University of Maryland Baltimore County) for her continued advice and support throughout the years.

Much appreciation is extended to Towanna Arnold for all her assistance with forms, OGS processes, etc., as well as answering of my incessant questions throughout the

years. I must also express thanks to Jeff Polasek for his prolific and unparalleled computing support and consistent encouragement.

I cannot reach this point in time without thanking Mrs. Janet Yauch, my 8th grade science teacher who taught me the scientific method, the fundamentals of data analysis, technical writing, and giving oral presentations. Her mentoring and support extended well beyond that year and through many successful science fairs and competitions. Teachers like Mrs. Yauch are the ones that lay the ground work for the breakthroughs of today and tomorrow. In addition, I must thank several previous foundational mentors, Dr. Marie Cassidy (formerly of George Washington University) and Dr. Michael Epstein, (formerly of the National Institute of Standards and Technology).

Many thanks to the various sources that supported my doctoral studies to include the NASA/Harriet G. Jenkins Predoctoral Fellowship, Texas Water Resource Institute Scholarship, the Mary Kay O'Connor Process Safety Center, Byogy, and TetraPoint Fuels. Special thanks to the entire 'Jenkins Family' for not just financial assistance, but also the immense wealth of support and encouragement - 'Once a Jenkins Fellow, always a Jenkins Fellow.'

To those whom were my first teachers, whom always told me to never be afraid to reach higher, that anything could be achieved with tenacity, commitment, and diligence, and second best wasn't an option - Mom and Dad – saying 'thank you' will never be enough.

They have faithfully helped me pursue my research endeavors – from accompanying me late nights in the lab when I was too young to even work without an adult present, countless weekends at science fairs, assistance with graphics, editing, and presentations, to helping my little girl understand why Mommy was still at work.

To my daughter, Davina, much appreciation for even at her young age being supportive in this endeavor when at times it meant time away from or a very tired Mommy. She was very often the needed inspiration and impetus to keep moving forward.

Finally, I want to thank my Lord and Savior, Jesus Christ. I can do nothing of any value without Him, and even in my expansive imperfection, He is always faithful.

TABLE OF CONTENTS

		Page
	ABSTRACT	iii
	DEDICATION	v
	ACKNOWLEDGEMENTS	vi
	TABLE OF CONTENTS	ix
	LIST OF FIGURES.....	xii
	LIST OF TABLES	xiv
 CHAPTER		
I	INTRODUCTION.....	1
	1.1 Dissertation Overview	3
II	BACKGROUND AND LITERATURE REVIEW - BIODIESEL.....	5
	2.1 Biodiesel History	5
	2.2 US Biodiesel Production and Capacity	7
	2.3 Comparison of Biodiesel and Petroleum-based Diesel	9
	2.4 Feedstocks	12
	2.5 Biodiesel Production Methods	17
	2.6 Transesterification.....	17
	2.6.1 Pretreatment of Less Refined Feedstocks	22
	2.7 Process Models.....	23
III	PROBLEM STATEMENT	27
	3.1 Stage 1	29
	3.2 Stage 2	30
IV	STAGE 1: OPTIMAL SCHEDULING AND OPERATION OF BIODIESEL PLANTS WITH MULTIPLE FEEDSTOCKS.....	33
	4.1 Summary	33

CHAPTER	Page
4.2 Introduction	34
4.3 Motivation and Problem Statement.....	38
4.4 Approach	42
4.4.1 Structural Representation	42
4.4.2 Mathematical Formulation	43
4.4.2.1 Pretreatment Units.....	43
4.4.2.1.1 Splitting of source j_u	44
4.4.2.1.2 Mixing of the split flowrate before i_v^{th} input to v^{th} common process unit	45
4.4.2.2 Common Process Units	46
4.4.2.2.1 Splitting of the j_v^{th} stream leaving the v^{th} common process unit.....	47
4.4.2.3 Product Streams.....	49
4.4.2.4 Waste Streams	49
4.4.2.5 Intermediate Streams Recycled Back into the Process.....	50
4.4.2.5.1 Mixing of the split flowrate before the i_b^{th} input to the intermediate block	50
4.4.2.6 Intermediate Block	50
4.4.2.6.1 Splitting of the j_b^{th} stream leaving the intermediate block	51
4.4.3 Constraints.....	51
4.4.4 Objective Function	53
4.5 Case Study.....	55
4.5.1 Economic Analysis.....	59
4.5.1.1 Estimation of Capital and Operating Costs	59
4.5.2 Scheduling Results	71
4.6 Conclusions	76
V STAGE 2: DESIGN AND SCHEDULING WITH INCORPORATED CO ₂ SUBSIDY OF BIODIESEL PLANTS WITH MULTIPLE FEEDSTOCKS.....	79
5.1 Summary	79
5.2 Introduction	80
5.2.1 Biodiesel.....	80
5.2.2 Environmental Benefits.....	81
5.2.3 Life Cycle Analysis and Biodiesel	82
5.2.4 Greenhouse Gas Policy Options.....	84
5.2.4.1 Carbon Tax.....	84
5.2.4.2 Cap and Trade	84
5.2.4.3 Carbon Subsidies.....	85

CHAPTER	Page
5.3 Motivation and Problem Statement.....	87
5.4 Approach	90
5.4.1 Structural Representation	90
5.4.2 Mathematical Formulation	92
5.4.2.1 Carbon Dioxide Emissions.....	92
5.4.2.2 Pretreatment Units.....	94
5.4.2.2.1 Splitting of source j_u	95
5.4.2.2.2 Mixing of the split flowrate prior to i_v th input to v th common process unit....	96
5.4.2.3 Common Process Units	97
5.4.2.3.1 Splitting of the j_v th stream leaving the v th common process unit.....	98
5.4.2.4 Product Streams.....	100
5.4.2.5 Waste Streams	100
5.4.2.6 Intermediate Streams Recycled Back into the Process.....	101
5.4.2.6.1 Mixing of the split flowrate prior to the i_b th input to the intermediate block .	101
5.4.2.7 Intermediate Block	102
5.4.2.7.1 Splitting of the j_b th stream leaving the intermediate block	102
5.4.3 Constraints.....	103
5.4.4 Objective Function	105
5.5 Case Study.....	107
5.5.1 Estimation of Capital and Operating Costs.....	109
5.5.2 Estimation of CO ₂ Emissions	111
5.6 Results	112
5.7 Conclusions	114
 VI CONCLUSIONS AND RECOMMENDATIONS FOR FUTURE WORK.....	116
NOMENCLATURE.....	123
REFERENCES.....	132
VITA	148

LIST OF FIGURES

FIGURE	Page
2.1 Estimated US Biodiesel Production by Fiscal Year for 1999-2008.....	8
2.2 Map of US Commercial Biodiesel Production Plants as of Jan 25, 2008..	9
2.3 Overall Transesterification Reaction.....	18
2.4 Transesterification Reactions of Glycerides with Methanol	19
2.5 Simplified Process Flow for Biodiesel Production via Transesterification	24
4.1 Overall Transesterification Reaction.....	38
4.2 Source Sink Flowchart	41
4.3 ASPEN Plus Flowsheet of Biodiesel Production Base-Case Design.....	56
4.4 Annual Profit for a 40 MMGPY Biodiesel Facility as a Function of Soy Oil Cost (\$/lb) and 3 Different Biodiesel Prices	63
4.5 Payback Period for a 40 MMGPY Biodiesel Facility as a Function of Soy Oil Cost (\$/lb) and 3 Different Biodiesel Prices	64
4.6 Return on Investment for a 40 MMGPY Biodiesel Facility as a Function of Soy Oil Cost (\$/lb) and 3 Different Biodiesel Prices	65
4.7 Annual Profit for a 40 MMGPY Biodiesel Facility as a Function of WCO Cost (\$/lb) and 3 Different Biodiesel Prices	66
4.8 Payback Period for a 40 MMGPY Biodiesel Facility as a Function of WCO Cost (\$/lb) and 3 Different Biodiesel Prices	67
4.9 Return on Investment for a 40 MMGPY Biodiesel Facility as a Function of WCO Cost (\$/lb) and 3 Different Biodiesel Prices	68
4.10 Glycerin Price Sensitivity - Annual Profit for a 40 MMGPY Biodiesel Facility as a Function of Soy Oil Cost (\$/lb) and Glycerin Price	69

FIGURE	Page
4.11 Glycerin Price Sensitivity - Annual Profit for a 40 MMGPY Biodiesel Facility as a Function of WCO Cost (\$/lb) and Glycerin Price	70
4.12 Amount (tons) per month of WCO and soy oil feedstocks scheduled in the production of biodiesel in order to maximize the gross profit. Scenario 1: 40 MMGPY facility in a city having a population of 3,000,000; \$0.034/lb WCO (50% FFA), \$0.497/lb refined soy oil.....	73
4.13 Amount (tons) per month of WCO and soy oil feedstocks scheduled in the production of biodiesel in order to maximize the gross profit. Scenario 2: 40 MMGPY facility in a city having a population of 3,000,000; \$0.102/lb WCO (50% FFA), a fluctuating refined soy oil Cost, as seen in Table 4-8.....	75
5.1 Source Sink Flowchart – Carbon Dioxide Emissions Included	91
5.2 Soy Biodiesel CO ₂ Life Cycle Overview	93

LIST OF TABLES

TABLE	Page
2.1 Feedstock Comparison Chart	16
4.1 Mass Flow of Selected Components for the ASPEN Simulation	57
4.2 Supply and Target Temperature, Δ Enthalpy, and Specific Heat Values for ASPEN Simulation Hot and Cold Streams	58
4.3 Savings from Process Integration.....	59
4.4 Capital Costs for Biodiesel Production (40MMGPY) with and without Pretreatment	61
4.5 Raw Material Costs	61
4.6 Operating Costs for Integrated Biodiesel Production (40 MMGPY).....	62
4.7 Product Selling Prices	63
4.8 Available WCO in tons for Feedstock Scheduling Scenarios 1 & 2 and Monthly Refined Soy Oil Cost for Scenario 2	72
5.1 Cases for 40 MMGPY Biodiesel Production	109
5.2 Capital and Operating Costs for Biodiesel Production (40 MMGPY) with and without Pretreatment	111
5.3 Raw Material Costs	111
5.4 CO ₂ Emissions for Biodiesel Produced from Soy Oil and WCO	112
5.5 Annual Profit, Annual Profit Corresponding to a 15% ROI, and Related Subsidies for a 15% ROI.....	113

CHAPTER I

INTRODUCTION

The National Renewable Energy Laboratory (NREL) defines a biorefinery as ‘a facility that integrates conversion processes and equipments to produce fuels, power, and chemicals from biomass.’ (NREL, 2009) Analogous to the refining of oil into its constituent components, biomass feedstocks are refined into what are referred to as building block components for direct use or conversion into subsequent products. (Kamm & Kamm, 2004, Kamm et al., 2006) Biomass feedstocks include trees, grasses, agricultural crops, agricultural residues, animal wastes, and municipal solid waste. The building blocks components of these feedstocks are carbohydrates, lignin, proteins, fats, and in smaller quantities, special substances such as vitamins, dyes, and flavors. (Fernando et al., 2006; Kamm & Kamm, 2004) Facility configurations, sizes, and potential products are varied, ranging from a simple facility with few processes producing a small number of products, to the large integrated biorefinery employing numerous processes and producing a variety of chemicals, fuels, and power.

Currently, many chemicals, fuels, and forms of energy are generated from finite, non-renewable resources. Requisite to long-term sustainable economic growth and

This dissertation follows the style of *International J. of Process Systems Engineering*.

availability of these products are utilization of sustainable resources. (Kamm et al., 2006) Biorefineries provide a new opportunity and frontier for sustainable manufacture of many existing products, as well as generation of a sustainable, innovative, and potentially revolutionary cadre of new chemicals, fuels, and energy sources.

Accompanying this opportunity are a host of new challenges, such as those related to increased competition for renewable yet finite resources, complexity of the raw materials, and de-centralized production of resources. Development of new processes and technologies will be necessary, as well as management of new logistical issues and adaptations for local and regional implementation. (Narodoslawsky et al., 2008) In addition, existing and future government environmental policies will impact design, operation, and profitability, playing a major role in effective decision-making.

Traditional process development and improvement approaches are limited in many respects. These approaches are time and money intensive, have a limited range of applicability, do not assure acquisition of solutions close to the optimum, which are sometimes intuitively non-obvious, and do not shed light on global insights and key characteristics of the process or problem. (El-Halwagi, 2006) For the full potential of the biorefinery concept to be realized, a holistic, methodical, and strategic approach to development and addressing the associated challenges is essential. Process integration provides a powerful alternative approach to traditional methods via systematic, fundamental, and generally applicable techniques.

It was decided to focus upon design and operation, fundamental activities to the viability of any facility. Biodiesel production provided an appropriate starting point for these efforts. In recent years, due to increasing oil costs, decreasing petroleum resources, and environmental concerns, renewable fuels have acquired great interest and attention. At present, biodiesel and ethanol are the two most predominate forms of biofuels in the market. As mentioned previously, fuel is one type of biorefinery product. A biodiesel production facility represents a biofuel-focused biorefinery of relatively simple form, producing biodiesel as the main product and glycerol as a by-product. In addition, biodiesel production is a likely potential component of large-scale integrated biorefineries.

1.1 Dissertation Overview

CHAPTER II presents background information and a review of literature pertaining to biodiesel.

CHAPTER III outlines the overall goal of the work; the development of a systematic decision-making approach for market sensitive scheduling and design of a biodiesel production process. The approach used involved decomposing the work into two stages. Therefore, the formal problem statement is presented to reflect this approach.

CHAPTER IV describes the first stage of the work, development of a systematic procedure for scheduling and operation of flexible biodiesel plants accommodating a variety of feedstocks. Presented are the results of a process simulation of a base-case design for a multiple feedstock biodiesel plant, integration of energy and mass resources, optimization of process design and scheduling, and techno-economic assessment and sensitivity analysis of proposed production schemes. The developed optimization formulation to determine scheduling and operation for multiple feedstocks is presented as well as the results of a case study.

CHAPTER V describes the second stage of the work, development of a systematic approach to the design and scheduling of biodiesel production processes while accounting for the effect of GHG policy. The resulting optimization formulation is presented, as well as the results of a case study utilizing several scenarios of feedstocks and GHG policies. The GHG policy utilized is a carbon subsidy.

CHAPTER VI outlines the major conclusions for each of the two stages and the work as a whole, as well as recommendations for future work.

CHAPTER II

BACKGROUND AND LITERATURE REVIEW - BIODIESEL

Diesel fuels serve an important role in an industrial economy, to include utilization for industrial and agricultural transport as well as operation of essential agricultural equipment. (Meher et al., 2006) Biodiesel is a renewable alternative fuel for diesel engines composed of methyl esters of long-chain fatty acids, or Fatty Acid Methyl Esters (FAME), that can be used in existing engines and offers similar power to petroleum diesel. (EPA, 2002) Many food and non-food feedstock options exist for biodiesel, to include virgin and recycled vegetable oils, animal fats, and tallow.

2.1 Biodiesel History

Rudolph Diesel received a patent in 1893 for his diesel engine, with subsequent exhibition of a workable engine in 1897. A variety of vegetable oils, including peanut and hemp oil served as fuel for Diesel's engines. In the 1920s, manufacturers began altering their engines to run on petroleum diesel, a less viscous fuel. Prior to this, vegetable oil was the fuel source for diesel engines. (Demirbas, 2008)

The first report of what we refer to today as biodiesel appeared in a Belgian patent granted to G. Chavanne in 1937, in which the use of ethyl esters of palm oil as a diesel

fuel is described and the use of methyl esters of other oils discussed. (Knothe, 2001) Subsequently, the first use of biodiesel occurred in South Africa in the Belgian Congo prior to World War II in heavy-duty vehicles. (Knothe, 2001; Demirbas, 2008)

The basic method by which biodiesel is produced, transesterification or alcoholysis, dates back to at least 1846 when Rochieder produced glycerol by ethanolysis of castor oil. (Formo, 1954) The majority of processes currently utilized in production of biodiesel were developed in the 1940s. These efforts were not related to fuel production, rather to soap production. Specifically, it was desired to develop a more straight-forward method for extraction of glycerol. Due to munitions needs during World War II, glycerol was in high demand for production of explosives. (Van Gerpen, 2005) Glycerol was obtained by converting oils and fats to methyl esters, then separating the insoluble glycerol backbone via settling or centrifugation. Via reaction with alkali, soap was produced from the glycerol-free methyl esters. This work is explained in a series of patents (Bradshaw, 1942; Bradshaw & Meuly, 1942, 1944; Allen & Kline, 1945; Arrowsmith & Ross, 1945; Dreger, 1945; Keim, 1945; Percy, 1945; Trent, 1945a, b) such as the ‘saponification via methylation of fat with high direct glycerine recovery’ described in US Patent 2,271,619. (Bradshaw, 1942; Bradshaw & Meuly, 1942) The patents were granted to researchers employed by two companies producing soap at that time, E.I. DuPont and Colgate-Palmolive-Peet.

Substantial research related to the use of esters of fatty acids as a possible fuel source did not take place until the late 1970s and 1980s. This surge of research activity was due to increased interest in alternative fuels as a result of high petroleum prices. Direct use of vegetable oils as a fuel was proposed and investigated, but was found to be challenging because of its greater viscosity when compared to diesel fuel. (Peterson et al., 1983; Fuls et al., 1984; Ryan et al., 1984) Other issues included oil thickening, crankcase oil dilution, and injector and piston deposits. To reconcile these issues, focus shifted to investigation of the conversion of the vegetable oils to alkyl esters as a means by which to reduce the viscosity and improve fuel properties in enable direct use in diesel engines.

2.2 US Biodiesel Production and Capacity

In recent years, biodiesel has received much interest as an alternative to petroleum-based diesel. Interest has increased due to a variety of social and economic issues. As can be seen in Figure 2.1, demand for biodiesel has increased steadily since 1999, experiencing a 300% increase from 2004 to 2005 following implementation of the Biodiesel Tax Incentive. (National Biodiesel Board, 2009a) This incentive provides a tax credit in the amount of \$1 per gallon of biodiesel produced. Currently, legislation providing extension of this credit beyond the current expiration of December 31, 2009 is under consideration. (U.S. Congress, 2009)

Figure 2.1: Estimated US Biodiesel Production by Fiscal Year for 1999-2008 (Source: National Biodiesel Board, 2009a)

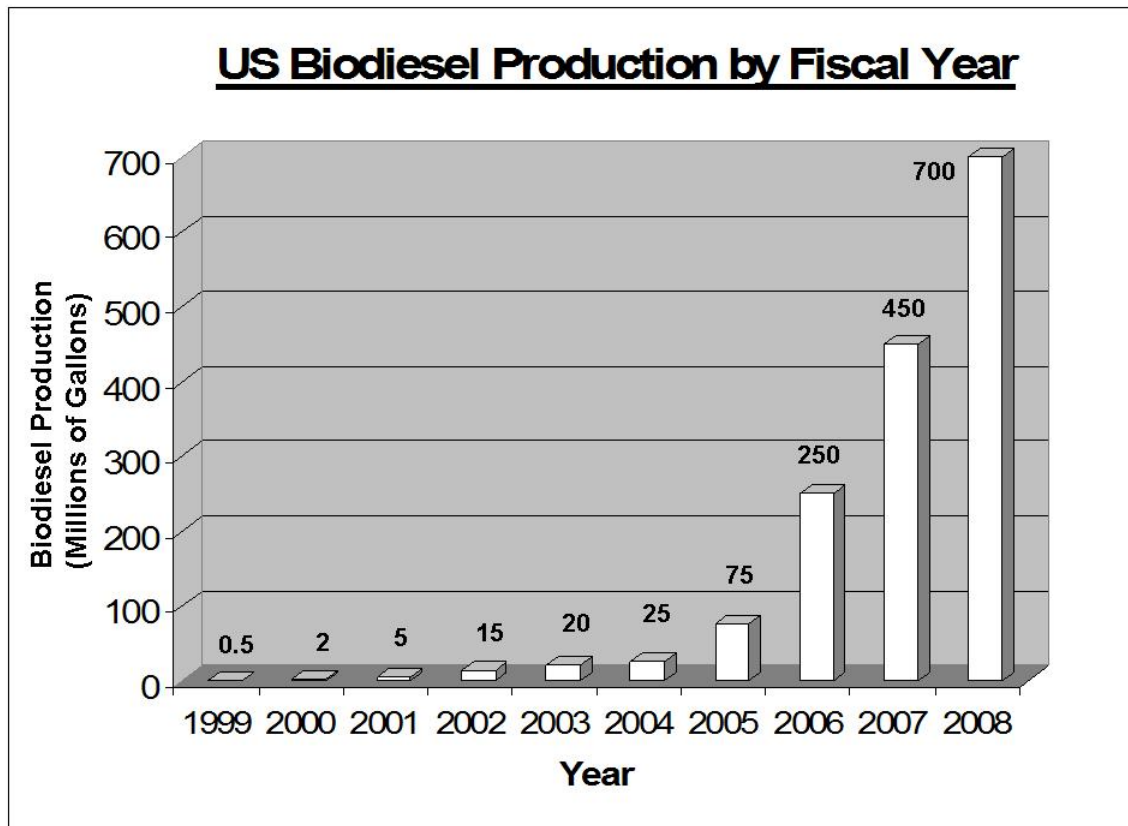

As of Jan 25, 2008, the National Biodiesel Board reported 171 biodiesel plants were operational, as seen in Figure 2.2. (National Biodiesel Board, 2008) In June 2009, 173 biodiesel production facilities were reported as actively marketing biodiesel in the US. The total annual production capacity for these facilities is 2.69 billion gallons per year. Currently, 30 production plants are either under construction or expanding existing

operations, representing a potential increase in biodiesel production capacity of 427.8 million gallons per year. (National Biodiesel Board, 2009b)

Figure 2.2: Map of U.S. Commercial Biodiesel Production Plants as of Jan 25, 2008

(Source: National Biodiesel Board, 2008)

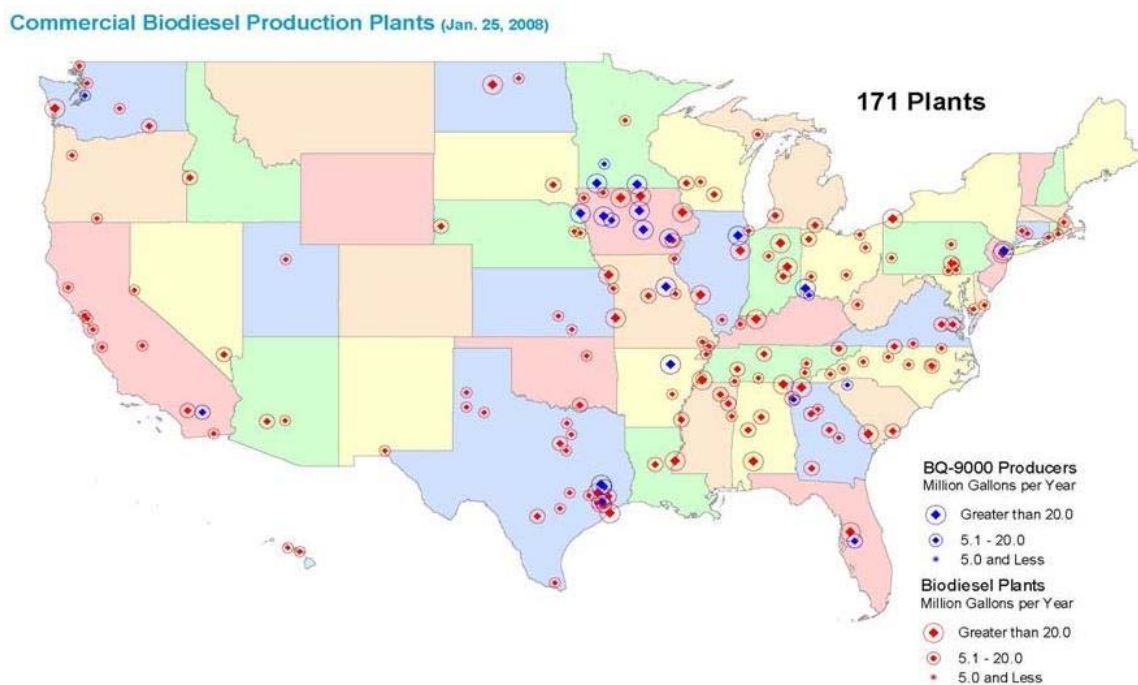

2.3 Comparison of Biodiesel and Petroleum-based Diesel

Biodiesel can be used in existing engines with no or minor modifications and offers similar power to petroleum diesel. (EPA, 2002) Pure biodiesel (B100) provides

approximately 90-95% of the energy contained in petroleum-based diesel and has various benefits and advantages as compared to petroleum diesel. (EPA, 2002; Lotero et al., 2005) Overall, benefits and advantages, as well as interests, associated with biodiesel appear to fall into 3 categories; 1.) sustainable energy, 2.) domestic energy independence, and 3.) environmental benefits. (Sheehan et al., 1998; Fukuda et al., 2001; Demirbas, 2003; Van Gerpen, 2005; Marchetti et al., 2007; Demirbas, 2008)

There are numerous renewable food and non-food feedstock options, including recycled or waste cooking oil. Virgin and used vegetable oils, animal fat, and tallow can be used as feedstock sources. In addition, feedstocks utilized for biodiesel production are available domestically, enabling some reduction of the use of imported oil sources to provide fuel for diesel engines. In order to utilize a domestic fuel source, among other reasons, in 2005 the U.S. Navy began using biodiesel in all its non-tactical diesel vessels. (Arny, 2005)

Biodiesel is considered to contribute less to climate change than traditional fossil-based fuels, since the carbon in the oil or fat feedstock predominately originated from CO₂ in the air. As compared to petroleum-based diesel, biodiesel reduces the net gain in CO₂ emissions by 78%. (Sheehan et al., 1998) In addition, diesel engines operating with biodiesel have a lower emission profile than when utilizing traditional diesel fuel, to include reduced emissions of CO and unburned hydrocarbons (Sheehan et al., 1998;

Carraretto et al., 2004; Van Gerpen, 2005; Hill et al., 2006; Demirbas, 2009a), as well as a 47% reduction in tailpipe emissions of particulate matter (Sheehan et al., 1998).

Biodiesel's oxygen content of 10-11%, as opposed to 0% for petroleum-based diesel, leads to more complete combustion, and hence lower emissions of CO, particulates, and visible smoke. (Carraretto et al., 2004; Lotero et al., 2005) In addition, biodiesel provides for a reduction in noxious fumes and odors. (Demirbas, 2003) Biodiesel produces no sulfur emissions and due to this characteristic is being used as an additive to ultra low sulfur diesel (ULSD).

Other advantages include a higher cetane number (CN), and its non-toxic and non-flammable nature. (Demirbas, 2003; Lotero et al., 2005; Demirbas, 2008) CN provides a metric as to the ignition quality of diesel fuels, with a higher CN value indicating a shorter ignition delay. Biodiesel has a higher flash point, 100-170°C as compared to 60-80°C for traditional diesel. (Demirbas, 2003; Lotero et al., 2005; Demirbas, 2008)

Disadvantages of biodiesel include a higher cloud point (CP) and pourpoint (PP), higher NO_x emissions, and often a higher price. (Demirbas, 2003; Carraretto et al., 2004; Demirbas, 2008) As parameters related to low temperature usage of a fuel, CP and PP indicate the temperatures at which wax first appears when a fuel is cooled and at which the amount of wax out of solution is significant enough to gel the fuel, respectively.

(Demirbas, 2008) Therefore, the higher CP and PP for biodiesel indicates its usage is more limited with respect to cooler weather and geographic regions.

Usage of B100 has been reported to increase NO_x life cycle emissions by 13%, with most of this increase being attributable to increases in NO_x tailpipe emissions. (Sheehan et al., 1998) Typically, biodiesel is more expensive than conventional diesel. The difference in price ranges from approximately \$0.30 to over \$1.00. In recent years, this price differential has drastically decreased at times when spikes in crude oil cost have occurred, causing a resultant increase in petroleum diesel price. (DOE, 2007a, b, 2008a, b, 2009a, b)

2.4 Feedstocks

Biodiesel can be produced from oil, fat, or grease sources. (Fukuda, 2001; Van Gerpen, 2005; Demirbas & Karslioglu, 2007; Marchetti et al., 2007; Demirbas, 2008) These sources can be categorized as virgin (fats/oils not previously used) or recycled (fats, oils, grease used previously for another purpose.) (Ginder, 2004) Virgin sources can be attained from both plants and animal sources (cattle, swine, poultry, fish.)

Potential vegetable oil feedstocks include refined or crude soy (predominate in the U.S.), rapeseed (predominate in Europe) (Peterson & Scarrah, 1984), canola (Singh et al., 2006), olive (Nelson et al., 1996; Dorado et al., 2004), sunflower (Siler-Marinkovic &

Tomasevic, 1998), palm (Kalam & Masjuki, 2002; Leevijit et al.; 2008) jatrohpa (Shah et al., 2004), camelina (Frohlich & Rice, 2005), and many more (Fukuda et al., 2001; Van Gerpen, 2005; Demirbas & Karslioglu, 2007; Marchetti et al., 2007; Demirbas, 2008). Typically, no pretreatment is needed for refined oil, but they are a more expensive feedstock. Animal (cattle, swine, poultry, fish) derived feedstock sources include renderings and tallow. Even extracted fat from meat and bone meal has been utilized as a feedstock. (Nebel & Mittelbach, 2006) These sources are less expensive, but have a higher free fatty acid (FFA) content, requiring pretreatment prior to use for biodiesel production.

Another interesting feedstock option is provided by corn-based ethanol production. Distillers dried grain (DDG) is a major by-product of such production, and is typically utilized as animal feed. DDG contains corn oil, which can be removed to produce a higher-protein animal feed and corn oil that is available for biodiesel production. (Jessen, 2006)

Recycled or waste oil, often referred to as waste cooking oil (WCO), can be either vegetable or animal derived. Examples include used restaurant cooking oil, yellow grease, and trap grease. These sources are typically inexpensive, but have higher FFA content and require pretreatment. Also, although utilized in food production, use of WCO as a feedstock does not impact availability or supply of a food resource.

More recently, oil from algae has received much attention as a potential feedstock. When deprived of nitrogen, algae shifts from converting CO₂ into sugars and proteins to producing mostly oil. (Sharma & Singh, 2009) Lipids from microalgal oil have been successfully used to produce biodiesel. (Miao & Wu, 2006) Emerging technology and successes in genetic engineering efforts to significantly increase lipid content of microalgae appear to provide good potential for microalgae to develop as a viable biodiesel feedstock. (Huang et al., 2009; Gouveia & Oliveira, 2009)

Various factors and considerations come into play with regards to biodiesel feedstock selection, to include:

1. Cost
2. Chemical content of feedstock
3. Variability in quality
4. Regular availability of the feedstock
5. Flexibility to increase supply of feedstock
6. Cost of transport and pretreatment
7. Regional availability (e.g. palm in tropical regions)
8. Regional agricultural and political requirements (e.g. EU's iodine value parameter eliminates use of soy)

It is generally stated that feedstock cost contributes the most to biodiesel production cost. (Singh et al., 2007; Sharma & Singh, 2009) Brown and yellow greases usually

have the lowest cost per unit of feedstock. These sources are typically recycled products from frying conducted in restaurants or food manufacturing facilities. As of 2004, costs for yellow grease have been identified as ~\$0.10 per pound, with some variability. (Ginder, 2004) Prices for virgin animal fats (lard, poultry fat, beef tallow) are lower than virgin plant based sources, but higher than recycled feedstocks. Virgin plant feedstocks could include soy, palm, rapeseed, sunflower, corn, cottonseed, canola oils, and many others. Historically, soy and sunflower have had the lowest price levels with other vegetable oils being 15-25% more expensive. (Ginder, 2004)

The chemical content (fatty acid content and profile) of a feedstock is extremely important and can vary greatly from one type of feedstock to another. These differences become even more critical to examine when considering production utilizing multiple feedstocks. In addition, there can be variations in content and profile within the same feedstock type. The least amount of variation is likely to be found in plant based virgin feedstocks, with animal-based products next. Obviously, recycled feedstocks have the most potential variability from lot to lot. Keeping variability in quality of the resultant biodiesel to an absolute minimum is crucial in maintaining biodiesel as a viable alternative fuel in the marketplace. A comparison of feedstock types can be seen in Table 2.1.

Table 2.1: Feedstock Comparison Chart

(Source: Ginder, 2004)

Biodiesel Feedstock	Cost/Unit	Supply/Growth Flexibility¹	Content/Quality Variability	Degree of Pretreatment Required
Virgin plant based (soy, corn, palm, etc.)	Moderate To high	Supply can be Expanded	Low variability	Modest
Virgin animal based (lard, tallow, chicken Fat, fish oil)	Moderate	Fixed (dependent on meat, poultry, fish, demand & processing)	Low to moderate variability	Modest To high
Recycled (yellow grease, brown grease)	Low	Fixed (dependent on restaurant, fryer activity)	High variability	High

¹ Ability to expand total supply available in response to price increases from demand shifts.

2.5 Biodiesel Production Methods

There are various alternatives for biodiesel production. At present, the most common method for biodiesel production is the transesterification reaction of triglycerides with methanol in the presence of a catalyst to produce methyl esters of fatty acids. The predominate feedstocks currently utilized for production are soybean oil (U.S.) and rapeseed oil (Europe). These esters can be used in neat form, or mixed with traditional diesel fuel to create a blend. Typically, methanol is utilized due to its lower cost and its small molecular mass. (Demirbas & Karslioglu, 2007) Other production methods include 1.) pyrolysis, 2.) blending, and 3.) emulsification. (Demirbas & Karslioglu, 2007; Meher et al., 2006) The literature is dominated by research related to transesterification with pyrolysis receiving some additional recent attention (Meher et al., 2006) and emerging methods including the use of supercritical CO₂. (Fukuda et al., 2001; Varma & Madras, 2007; Demirbas, 2009b)

2.6 Transesterification

Transesterification, or alcoholysis, is a reaction in which the alcohol from an ester is displaced by another alcohol. This is similar to hydrolysis, with alcohol being utilized instead of water. (Fukuda et al., 2001) Triglycerides are reacted with an alcohol to produce glycerol and esters. The overall stoichiometric transesterification reaction using methanol can be seen in Figure 2.3. The reactants are triglyceride, which is composed of

a glycerol backbone with 3 attached fatty acids, and methanol. Resulting products of the reaction are glycerol and methyl esters (biodiesel).

Figure 2.3: Overall Transesterification Reaction

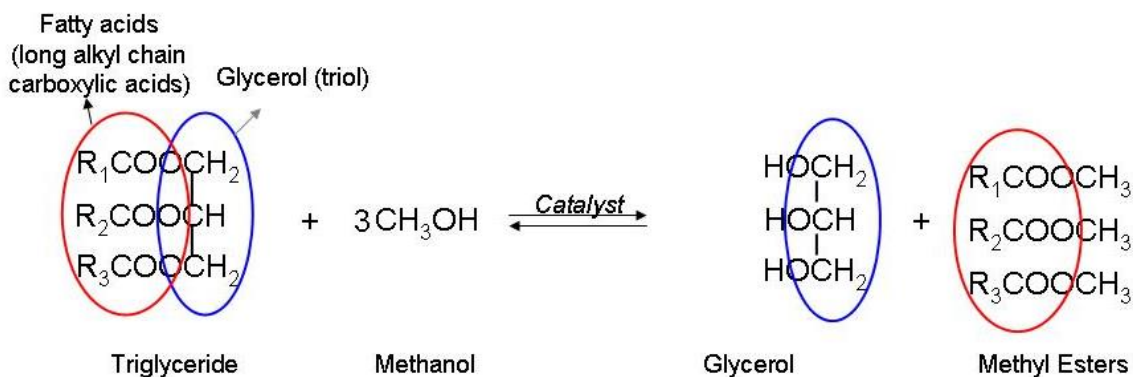

The transesterification reaction occurs in a 3-step process consisting of sequential reversible reactions shown in Figure 2.4. (Freedman et al., 1986; Nouredini & Zhu, 1997; Fukuda et al., 2001; Marchetti et al., 2007) The triglyceride is typically reacted with an excess of alcohol (here methanol) in the presence of a catalyst to produce glycerol and methyl esters (the biodiesel). In the first step, a fatty acid is removed from the triglyceride to produce a diglyceride and an ester. In the second steps, a fatty acid is removed from the diglyceride to produce a monoglyceride and an ester. In the final step, the remaining fatty acid is removed from the monoglyceride to produce yet another ester and glycerol.

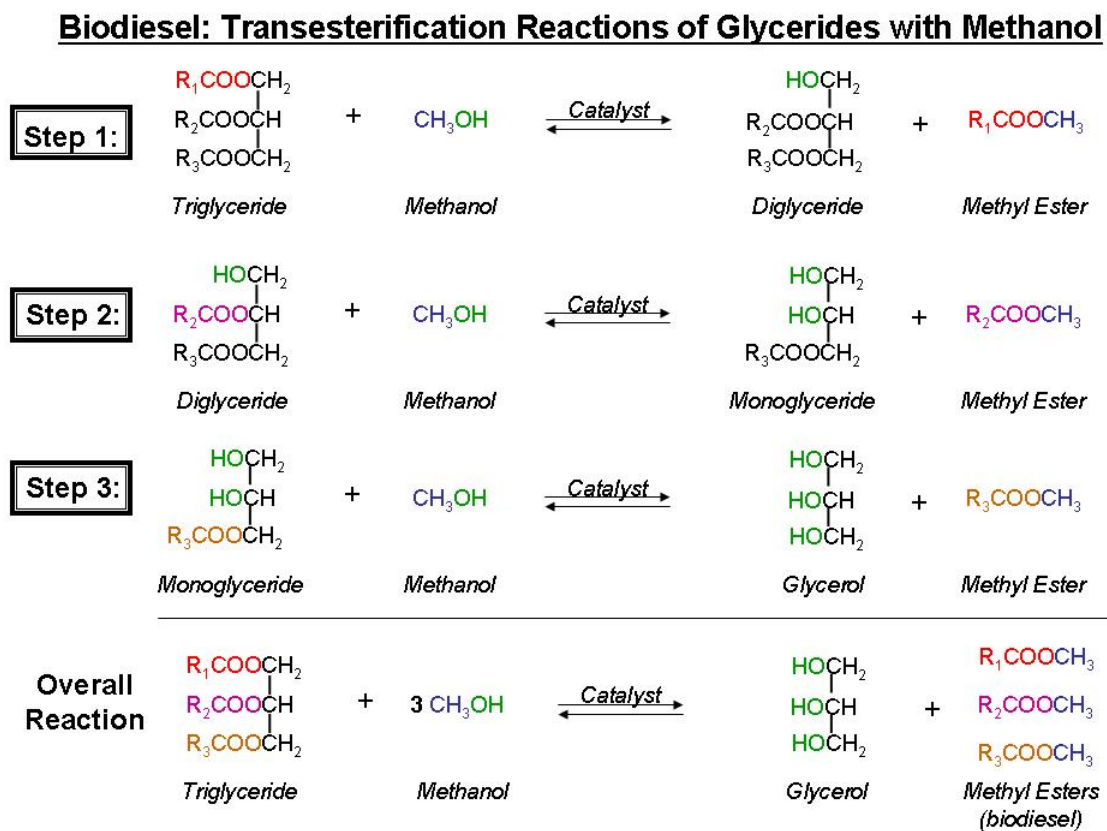
Figure 2.4: Transesterification Reactions of Glycerides with Methanol

The most pertinent process variables for transesterification are (Freedman et al., 1984, 1986; Fukuda et al., 2001; Demirbas & Karslioglu, 2007; Demirbas, 2008):

- 1.) Ratio of alcohol to oil
- 2.) Reaction temperature
- 3.) Oil used
- 4.) Type of catalyst
- 5.) Amount of catalyst

As can be seen from the overall reaction depicted in Figures 2.3 and 2.4, the stoichiometric relation between the alcohol and triglyceride, or oil, is 3:1. However, typically an excess of alcohol is used to shift the reactions towards the products. Freedman and colleagues (1984) studied the effect of the molar ratio of alcohol to oil on the yield of esters during transesterification, as well as reaction temperature, degree of refinement of the feedstock oil, and type of catalyst. Among their observations, the transesterification reaction went to completion in 1 hour at 60°C, and took 4 hours at 32°C. In terms of alcohol-to-oil ratio, Freedman, et al. found significant quantities of unreacted triglycerides and partially reacted di- and monoglycerides were present when the ratio was too low. The maximum conversion to esters was observed at a ratio of 6:1.

Freedman and colleagues (1984) confirmed previous observations from others that the moisture and free fatty acid content of the feedstock oil were important to maximizing yields. They reported a good yield could be obtained with a maximum value for the free fatty acid (FFA) content of the oil of 0.5%. Otherwise, ester yields were drastically reduced by formation of soap. Saponification, or soap formation, occurs when a base catalyst reacts with FFAs to form soap and water, which itself hinders ester yields.

(Loterio et al., 2005) In order to avoid these issues, pretreatment prior to transesterification is necessary to reduce FFA content to the appropriate level.

The catalyst type utilized for transesterification is so important that typically the process is categorized according to this factor. Since the use of alkali catalysts facilitate a

reaction rate that is 4000 times faster than when the same amount of an acidic catalyst is used (Formo, 1954), the most common industrial process for biodiesel production employs basic catalysts. NaOH, KOH, and NaOCH₃ are examples of utilized catalysts. NaOH and KOH are commonly used since they are typically inexpensive. (Akoh et al., 2007) NaOCH₃ is more effective than NaOH when using soybean oil, with approximately equal conversion values for a 6:1 alcohol-to-oil molar ratio for 1% wt NaOH and 0.5% wt NaOCH₃. (Freedman et al., 1986) For transesterification of beef tallow, NaOH has been reported to be a better catalyst than NaOCH₃. (Ma et al., 1998) As mentioned previously, moisture must be kept to a minimum when using basic catalysts, otherwise saponification occurs, hindering ester yields.

Acids that have been utilized for transesterification include sulfuric, phosphoric, hydrochloric, and organic sulfonic acids. Acid-catalyzed transesterification proceeds much more slowly than alkali-catalyzed transesterification. But, an acid catalyst is not greatly affected by a high FFA or moisture content, and is therefore appropriate for use with less refined feedstock oils such as waste cooking oil and greases. (Freedman et al., 1984; Lotero et al., 2005) In addition, an acid catalyst simultaneously facilitates esterification, conversion of FFA to esters, and transesterification. (Lotero et al., 2005) Therefore, development of acid-catalyzed transesterification processes for effective conversion of low-cost feedstocks has received attention. (Zhang et al., 2003a, b; Lotero et al., 2005; Zheng et al., 2006; West et al., 2007) Additional challenges related to acid

catalyst use include the necessity of higher reaction temperatures than for alkali-catalysts, environmental issues, and greater equipment corrosion. (Lotero et al., 2005)

Enzymatically-catalyzed transesterification has been demonstrated and reported. (Nelson et al., 1996; Fukuda et al., 2001; Shah et al., 2004; Akoh et al., 2007) Advantages as compared to chemical catalysts include less energy usage, ease of glycerol removal, no saponified products or sensitivity to moisture of feedstocks, lower reaction temperatures, and less waste production. The primary disadvantages that must be overcome to make this form of transesterification a viable option for biodiesel production include high catalyst production cost and enzyme inactivation by methanol with resulting loss of ester yield. (Fukuda et al., 2001; Akoh et al., 2007)

2.6.1 Pretreatment of Less Refined Feedstocks

As mentioned previously, due to their insensitivity to feedstock FFA and moisture content, acid catalysts are appropriate for use with less refined feedstock oils such as waste cooking oil and greases. (Freedman et al., 1984; Lotero et al., 2005) But, due to the disadvantages associated with the use of these catalysts, a 2-step catalyzed process was pursued and developed for production of biodiesel from less refined feedstock oils. (Lepper & Friesenhagen, 1986, 1987) In this process, an acid catalyst is utilized in the first step, or pretreatment, to convert FFAs to esters. During the second step, an alkali catalyst is employed to convert the glycerides into esters. This method enables minimal

use of the acid catalyst, and therefore minimizes issues related to corrosion, safety, and environmental concerns, while making use of its capability to convert the troublesome FFA content. The second step takes advantage of the reaction speed and conversions characteristic of an alkali catalyst. This 2-step method has become the most common means for processing waste cooking oil and other less refined feedstocks with higher free fatty acid content. (Canakci & Van Gerpen, 2001, 2003; Zhang, 2003a, b; Wang et al., 2006, 2007)

2.7 Process Models

Various process flow scenarios and models have been explored utilizing various catalysts, feedstocks, and operating conditions. A generalized process flow schematic for biodiesel production via transesterification is shown in Figure 2.5. The catalyst, alcohol, and feedstock oil are combined and mixed in a reactor for transesterification. The resulting mixture predominately contains the esters (biodiesel), crude glycerol, and alcohol. Following the reaction, the glycerol is removed from the esters and undergoes refining to yield glycerol and alcohol. The esters, or biodiesel, undergoes refining to remove alcohol from the reaction. In addition, acid is utilized to neutralize the remaining catalyst and split any formed soap. (Van Gerpen, 2005) The acid reacts with the soap to form a FFA and salt residue. Water washing is used to remove any remaining catalyst, soap, salts, alcohol, or glycerol from the final biodiesel product.

Figure 2.5: Simplified Process Flow for Biodiesel Production via Transesterification

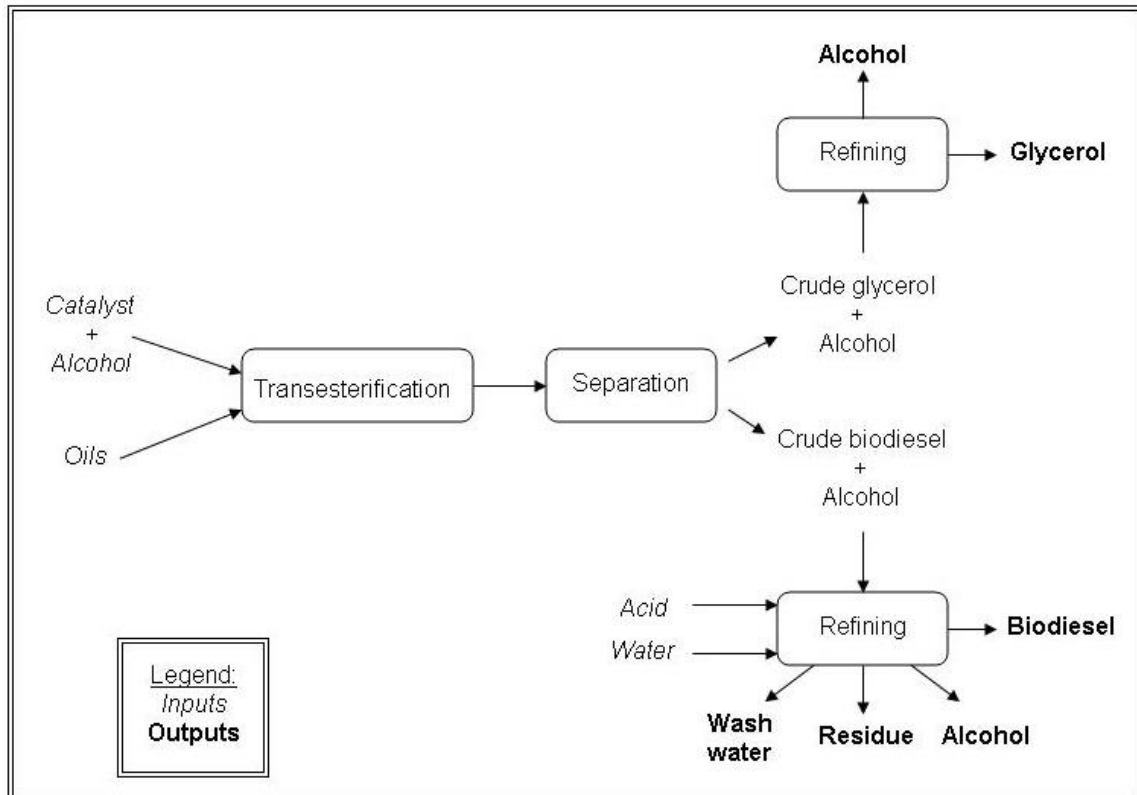

Zhang et al. (2003a) developed a HYSYS-based process simulation model to provide a technological evaluation of 4 different biodiesel production facility designs for vegetable oil and WCO feedstocks. It was reported that an alkali-catalyzed process for virgin oil required the fewest and smallest process units, but had the highest raw material cost. Utilizing WCO as a feedstock decreased the raw material cost and it was found that an acid-catalyzed process for WCO was technically feasible and with less complexity than the alkali-catalyzed process.

In a subsequent paper by Zhang and colleagues (2003b), evaluation of the economic feasibility of the 4 designs presented by Zhang et al. (2003a) was described. The alkali-catalyzed process for virgin oil processing had the lowest fixed capital cost. The acid-catalyzed process using WCO was the most economically feasible design. It was also reported that plant capacity, feedstock price, and biodiesel selling price were the most significant factors affecting the economic viability of a facility.

Tapasvi and associates (2005) developed a spreadsheet-based process model for evaluating economic feasibility studies of biodiesel production from crude soybean oil. The process modeled was continuous and utilized stirred-tank reactors, alkali catalysis, and methanol. Reported user-defined parameters include transesterification reaction efficiency, quantity of crude oil to be processed per day, the methanol:triglyceride molar ratio, and the FFA content of the crude oil.

A computer model for a biodiesel production facility utilizing ASPEN PLUS process simulation software was constructed to provide estimation of capital and production costs for a soybean oil feedstock with a preliminary level of detail. (Haas et al., 2006) Annual biodiesel production capacity was set at 10M gallons per year.

Transesterification was accomplished with methanol via alkali-catalysis, modeled as a continuous reaction in stirred tank reactors, with overall reaction efficiency of 99%. It was reported that feedstock cost was the single greatest contributor to cost.

West and colleagues (2007) reported simulation and case studies related to continuous biodiesel production with a solid acid catalyst, sulfated-zirconia, in a fixed bed reactor. The vegetable oil feedstock was presumed to contain 5% FFA, the conversion set at 90.4%, and biodiesel production rate of 8000 tonnes/yr. Several sensitivity analyses were conducted. In terms of the effect of reaction conversion on after tax rate of return (ATROR), it was found that the ATROR for the given process becomes negative for a conversion less than 83%. Plant capacity was observed to have a linear effect on the ATROR. Economy-of-scale was supported. For example, an increase in the feedstock flowrate of 100 kg/h resulted in an increase of the ATROR by 12 percentage points.

Myint (2007) and Myint and El-Halwagi (2009) reported results of process design, analysis, and optimization of soybean oil-based biodiesel production. Four possible configurations were developed and simulated using ASPEN Plus to study different post-transesterification separation sequences. Based on performance and economic criteria, one scenario was selected for further development. In this scenario, biodiesel and glycerol separation was performed first, followed by methanol removal, then water washing of the biodiesel. Next, mass and energy integration was performed and capital cost estimation completed using ICARUS software, and a profitability analysis performed. In agreement with previous studies, it was observed that feedstock cost was the single most significant contributor to production costs – 90% of the total annualized cost. It was also observed that payback period and return on investment quickly decreased with increasing soybean oil cost.

CHAPTER III

PROBLEM STATEMENT

While the majority of domestic biodiesel production utilizes soybean oil as the sole or primary feedstock, there are multiple incentives to identify additional feedstocks.

Among these incentives, competition with food resources and fluctuating prices. An increase in the cost of soybean oil will occur as its use in biodiesel production and other products increases. Sustainability and profitability of biodiesel will require attaining the capability to quickly and efficiently shift to/co feed more readily available and more economical feedstocks. To facilitate this capability, study of the techno-economics of feedstock options and integration of feedstock flexibility into the design and scheduling of biodiesel production facilities is needed.

In addition, due to the increase in environmental-centered interests, the advent of GHG policy development and implementation has the potential to affect the profitability of biodiesel production. So far, this factor has not been routinely considered in design or scheduling of biodiesel production. This work endeavors to begin satisfying this fissure via investigate of one potential GHG policy option with a systems approach rooted in true design consideration, with the goal of providing relevant information for both policy-makers and biodiesel producers related to the associated impacts on the financial viability of production.

The overall goal of this work is develop a systematic decision-making approach for market sensitive strategic scheduling and design of a biodiesel production process with the objective of increasing efficiency of biodiesel production facilities.

The approach taken involves decomposition of the problem into two stages. Stage one involved development of a systematic procedure that can determine feedstock selection, usage and scheduling, and process modifications, and pre-treatment selection and design so as to maximize the process profit. Stage two involved development of a systematic procedure that is market-sensitive and can determine process design, feedstock selection and scheduling, and requisite greenhouse gas subsidies so as to maximize the process profit.

The problem addressed in this work can be formally stated as follows:

Given is a biodiesel production facility of given design and production capacity. The process uses a certain feedstock. Available for consideration, a number (N_f) of alternative feedstocks that may be used in conjunction with or in lieu of the current feedstock.

3.1 Stage 1

It is desired to develop a systematic procedure for the retrofitting and scheduling of the facility to enable the use of the alternative feedstocks while maintaining the same production level and quality.

Related challenges involved in addressing the problem include answering the following questions:

- Which feedstock(s) should be used? How much should be fed to the process?
Should feedstocks be processed separately or co-fed? When?
- What retrofitting changes are needed?
- How should the process operation be scheduled?

The problem is stated as follows:

Given a continuous process with,

- A set of pre-treatment units $U = \{u | u = 1, 2, \dots, N_T\}$. Each pre-treatment unit, u , has a set of input streams $INPUT_u = \{i_u | i_u = 1, 2, \dots, N_u^{in}\}$ and a set of output streams $OUTPUT_u = \{j_u | j_u = 1, 2, \dots, N_u^{out}\}$. Input stream i_u has a flowrate of F_{i_u} and composition of component q of $X_{i_u,q}$. Output stream j_u has a flowrate of G_{j_u} and a composition of component q of $Y_{j_u,q}$.

- A set of common process units $V = \{v|v = 1, 2, \dots, N_{PU}\}$. Each pre-treatment unit, v , has a set of input streams $INPUT_v = \{i_v|i_v = 1, 2, \dots, N_v^{in}\}$ and a set of output streams $OUTPUT_v = \{j_v|j_v = 1, 2, \dots, N_v^{out}\}$. Input stream i_v has a flowrate of F_{i_v} and composition of component q of $X_{i_v,q}$. Output stream j_v has a flowrate of G_{j_v} and a composition of component q of $Y_{j_v,q}$.
- A set of product discharges for the process $P = \{p|p = 1, 2, \dots, N_p\}$.
- A set of waste discharges for the process $W = \{w|w = 1, 2, \dots, N_w\}$.
- A set of intermediate streams $B = \{b|b = 1, 2, \dots, N_b\}$ that are redirected back into the process. Input stream i_b has a flowrate of F_{i_b} and composition of component q of $X_{i_b,q}$. Output stream j_b has a flowrate of G_{j_b} and a composition of component of $Y_{j_b,q}$.
- A given decision-making time horizon (t_h). Within this horizon, the variations in the market conditions are anticipated and expressed in terms of time-dependent changes in quantities and prices of supply (feedstocks, reagents, etc.) and demand (products and byproducts).

3.2 Stage 2

It is desired to develop a systematic procedure for the design, operation, and scheduling of the facility with and without carbon subsidies.

Related challenges involved in addressing the problem include answering the following questions:

- What is the optimal flowrate of each feedstock?
- How should the flowrate of each feedstock be scheduled?
- Should the feedstocks be co-fed or utilized separately?
- How should the process design and scheduling be adjusted under different economic conditions (e.g. feedstock price?)
- Is there a need for a carbon subsidy to insure a minimum return on investment of the process for certain feedstocks? If so, what is the appropriate level of subsidy needed for each feedstocks and what is the impact of varying such subsidies?

The problem is stated as follows:

Given a continuous process with,

- A certain level of CO₂ emitted per ton feedstock to produced biodiesel, $E_{feedstock}^{CO_2}$.
- A set of pre-treatment units $U = \{u | u = 1, 2, \dots, N_T\}$. Each pre-treatment unit, u , has a set of input streams $INPUT_u = \{i_u | i_u = 1, 2, \dots, N_u^{in}\}$ and a set of output streams $OUTPUT_u = \{j_u | j_u = 1, 2, \dots, N_u^{out}\}$. Input stream i_u has a flowrate of F_{i_u} and composition of component q of $X_{i_u, q}$. Output stream j_u has a flowrate of G_{j_u} and a composition of component q of $Y_{j_u, q}$.

- A set of common process units $V = \{v|v = 1, 2, \dots, N_{PU}\}$. Each pre-treatment unit, v , has a set of input streams $INPUT_v = \{i_v|i_v = 1, 2, \dots, N_v^{in}\}$ and a set of output streams $OUTPUT_v = \{j_v|j_v = 1, 2, \dots, N_v^{out}\}$. Input stream i_v has a flowrate of F_{i_v} and composition of component q of $X_{i_v,q}$. Output stream j_v has a flowrate of G_{j_v} and a composition of component q of $Y_{j_v,q}$.
- A set of product discharges for the process $P = \{p|p = 1, 2, \dots, N_p\}$.
- A set of waste discharges for the process $W = \{w|w = 1, 2, \dots, N_w\}$.
- A set of intermediate streams $B = \{b|b = 1, 2, \dots, N_b\}$ that are redirected back into the process. Input stream i_b has a flowrate of F_{i_b} and composition of component q of $X_{i_b,q}$. Output stream j_b has a flowrate of G_{j_b} and a composition of component of $Y_{j_b,q}$.
- A given time horizon (t_h) for decision-making. Within this time horizon, the variations in the market conditions are anticipated and expressed in terms of time-dependent changes in prices and quantities of supply (reagents, feedstocks, etc.) and demand (products and byproducts).

CHAPTER IV

STAGE 1: OPTIMAL SCHEDULING AND OPERATION OF BIODIESEL PLANTS WITH MULTIPLE FEEDSTOCKS*

4.1 Summary

Various feedstocks may be utilized to produce biodiesel. These include soybean, palm, sunflower, jatropha, rapeseed, and safflower oils, as well as waste oil from the food industry. With changing prices, supply, and demand of feedstocks, a need exists to consider various feedstocks options for biodiesel production. The objective of this work is to develop a systematic procedure for scheduling and operation of flexible biodiesel plants accommodating a variety of feedstocks. This work employs a holistic approach and a combination of process simulation, synthesis, and integration techniques to provide:

1. Process simulation of a biodiesel plant for various feedstocks,
2. Integration of energy and mass resources,
3. Optimization of process design and scheduling,
4. Techno-economic assessment and sensitivity analysis of proposed schemes.

* Part of this chapter is reprinted with permission from Elms, R.D., El-Halwagi, M.M. (2009) "Optimal Scheduling and Operation of Biodiesel Plants with Multiple Feedstocks" *Int. J. Process Systems Engineering*. 1(1). pp.1-28., Copyright 2009 by Inderscience Publishers. DOI: 10.1504/IJPSE.2009.027998.

An optimization formulation is developed to determine scheduling and operation for various feedstocks. A case study is solved to illustrate the merits of the devised procedure.

4.2 Introduction

The global objective of process development and improvement is to develop and apply systematic procedures to design and operate optimal processes that operate ‘faster, better, cheaper, safer, and greener.’ Traditional approaches to tackle this objective include brainstorming among experienced engineers, heuristics based on experience-based rules, or evolutionary techniques (i.e. copy or adaptation of a previous design.) These traditional approaches are weak and limited in many respects. They are money and time intensive, unable to enumerate the infinite alternatives that exist for a given problem, do not assure acquisition of solutions close to the optimum, which are often non-obvious, are limited in applicability, do not promote novel or groundbreaking ideas, and of notable importance, do not provide global insight into the process of interest (El-Halwagi, 2006).

In light of the limitations inherent to traditional approaches, an alternative approach is needed to accomplish process related goals effectively, efficiently, and without the aforementioned limitations. Needed are techniques that are systematic, fundamental, and generally applicable in nature. Due to recent advances, this is possible through

process integration and its vital components, process synthesis and process analysis.

Process integration is a 'holistic approach to process design, retrofitting, and operation, which emphasizes the unity of the process.' (El-Halwagi, 2006) Process synthesis involves known or given process inputs and outputs, and unknown process structure and parameters. Process analysis involves given inputs and structure, with unknown or undefined process outputs. Of specific importance is targeting, one of the most powerful components of process integration. Targeting is the identification of performance benchmarks for the whole process ahead of detailed design. Specific performance targets include profitability improvement, yield enhancement, resource (mass and energy) conservation, pollution prevention/waste minimization, and safety improvement. (El-Halwagi, 2006) These techniques are now ready to be utilized for the development of emerging fields such as the design of integrated biorefineries and facilities producing biofuels, such as biodiesel.

Biodiesel is a renewable fuel consisting of esters of lower alcohol and fatty acids, or Fatty Acid Methyl Esters (FAME). The fatty acids are typically derived from vegetable oil, animal fat, or tallow. Biodiesel can be used in existing engines and offers similar power to petroleum diesel. (EPA, October 2002) Benefits of and interest in biodiesel can be roughly segregated into three main categories: 1.) sustainable energy, 2.) environmental responsibility, and 3.) domestic energy independence. Biodiesel is a renewal fuel source, with many food and non-food feedstock options, to include waste oil (cooking). In light of finite and diminishing fossil fuel resources, biodiesel provides

a means by which to reduce dependence on fossil fuels and replace usage of some of this finite source with a renewal fuel option. In terms of environmental issues, biodiesel abounds with benefits when compared to its petroleum-based counterpart. For example, as compared to petroleum-based diesel, biodiesel reduces the net gain in CO₂ emissions by 78%, in addition to a 47% reduction in tailpipe emissions of particulate matter (Sheehan et al., 1998). Biodiesel produces no sulfur emissions and due to this characteristic is being used as an additive to ultra low sulfur diesel (ULSD).

As a result of the aforementioned benefits, there has been a growing interest in biodiesel. U.S. demand for biodiesel has steadily increased since 1999 and experienced a 300% increase (from ~25 to 75 million gallons per year) from 2004 to 2005 after implementation of the Biodiesel Tax Incentive. 2007 U.S. Biodiesel sales reached 450 million gallons, and current US capacity was reported in January 2008 as 2.24 billion gallons per year (National Biodiesel Board, 2007, 2008). New plant construction and existing plant expansions appear to add another 1.26 billion gallons of annual capacity in 2008-2009. Of interest, the U.S. Navy, the largest consumer of diesel in the world, in 2005 began using biodiesel in all its non-tactical diesel vessels (Arny, 2005).

Biodiesel can be produced from virgin oils as well as recycled/waste oil. Virgin oils can be either vegetable or animal derived. Potential vegetable oil feedstocks include refined or crude soy (predominate in the U.S.), rapeseed (predominate in Europe), canola, sunflower, palm, jatropha, camelina, and many more. Typically, no pretreatment is

needed for refined oil, but they are a more expensive feedstock. Animal derived feedstock sources include renderings and tallow. These sources are less expensive, but have a higher free fatty acid (FFA) content, requiring pretreatment prior to use for biodiesel production. Recycled or waste oil, referred to as waste cooking oil (WCO) by some, can be either vegetable or animal derived. Examples include used restaurant cooking oil, yellow grease, and trap grease. These sources are typically inexpensive, but have higher FFA content and require pretreatment.

There are various alternatives for biodiesel production. Several pathways exist, such as the use of microemulsions and pyrolysis, with new emerging methods including use of supercritical CO₂. But currently, by far, biodiesel is predominately produced via transesterification. The overall triglyceride transesterification reaction using methanol can be seen in Figure 4.1. The transesterification reaction is accomplished by reacting the triglyceride with an excess of alcohol (here methanol) in the presence of a catalyst to produce glycerol and methyl esters (the biodiesel).

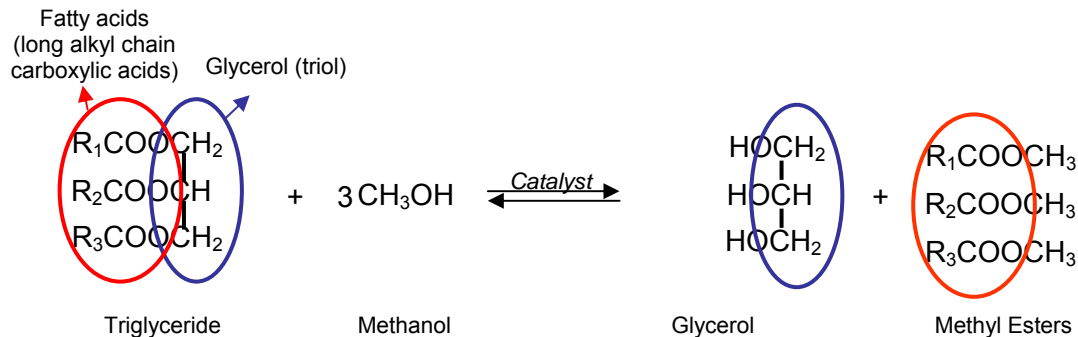
Figure 4.1: Overall Transesterification Reaction

4.3 Motivation and Problem Statement

While the majority of biodiesel is being produced using soybean oil as the primary feedstock, there are several incentives to identify additional feedstocks. These include competition with food resources and the fluctuating prices. As the use of soy for biodiesel production, as well as for other existing and future products, increases, its cost will rise. In order to ensure the sustainability and profitability of biodiesel, the capability to quickly and efficiently shift to (or co-feed) available and more economical feedstocks is essential. To accomplish this, we need to 1.) study the techno-economics of many feedstock options, and 2.) integrate feedstock flexibility into design and scheduling of the biodiesel production facilities. The overall goal of this work is develop a systematic decision-making approach for market sensitive strategic scheduling and

design of a biodiesel production process. The problem to be addressed in this can be formally stated as follows:

Given is a biodiesel production facility of given design and production. The process uses a certain feedstock. Available for consideration a number (N_f) of alternative feedstocks that may be used in conjunction with or in lieu of the current feedstock. It is desired to develop a systematic procedure for the retrofitting and scheduling of the facility to enable the use of the alternative feedstocks while maintaining the same production level and quality.

There are several challenges involved in addressing the problem. These include answering the following questions:

- Which feedstock(s) should be used? How much should be fed to the process?
Should feedstocks be processed separately or co-fed? When?
- What retrofitting changes are needed?
- How should the process operation be scheduled?

The problem is stated as follows:

Given a continuous process with,

- A set of pre-treatment units $U = \{u | u = 1, 2, \dots, N_T\}$. Each pre-treatment unit, u , has a set of input streams $INPUT_u = \{i_u | i_u = 1, 2, \dots, N_u^{in}\}$ and a set of output streams $OUTPUT_u = \{j_u | j_u = 1, 2, \dots, N_u^{out}\}$. Input stream i_u has a flowrate of F_{i_u}

and composition of component q of $X_{i_u,q}$. Output stream j_u has a flowrate of

G_{j_u} and a composition of component q of $Y_{j_u,q}$.

- A set of common process units $V = \{v | v = 1, 2, \dots, N_{PU}\}$. Each pre-treatment unit, v , has a set of input streams $INPUT_v = \{i_v | i_v = 1, 2, \dots, N_v^{in}\}$ and a set of output streams $OUTPUT_v = \{j_v | j_v = 1, 2, \dots, N_v^{out}\}$. Input stream i_v has a flowrate of F_{i_v} and composition of component q of $X_{i_v,q}$. Output stream j_v has a flowrate of G_{j_v} and a composition of component q of $Y_{j_v,q}$.
- A set of product discharges for the process $P = \{p | p = 1, 2, \dots, N_p\}$.
- A set of waste discharges for the process $W = \{w | w = 1, 2, \dots, N_w\}$.
- A set of intermediate streams $B = \{b | b = 1, 2, \dots, N_b\}$ that are redirected back into the process. Input stream i_b has a flowrate of F_{i_b} and composition of component q of $X_{i_b,q}$. Output stream j_b has a flowrate of G_{j_b} and a composition of component of $Y_{j_b,q}$.
- A given decision-making time horizon (t_h). Within this horizon, the variations in the market conditions are anticipated and expressed in terms of time-dependent changes in quantities and prices of supply (feedstocks, reagents, etc.) and demand (products and byproducts).

It is desired to produce a systematic procedure that can determine feedstock selection, usage and scheduling, and process modifications, and pre-treatment selection and design so as to maximize the process profit.

Figure 4.2: Source Sink Flowchart

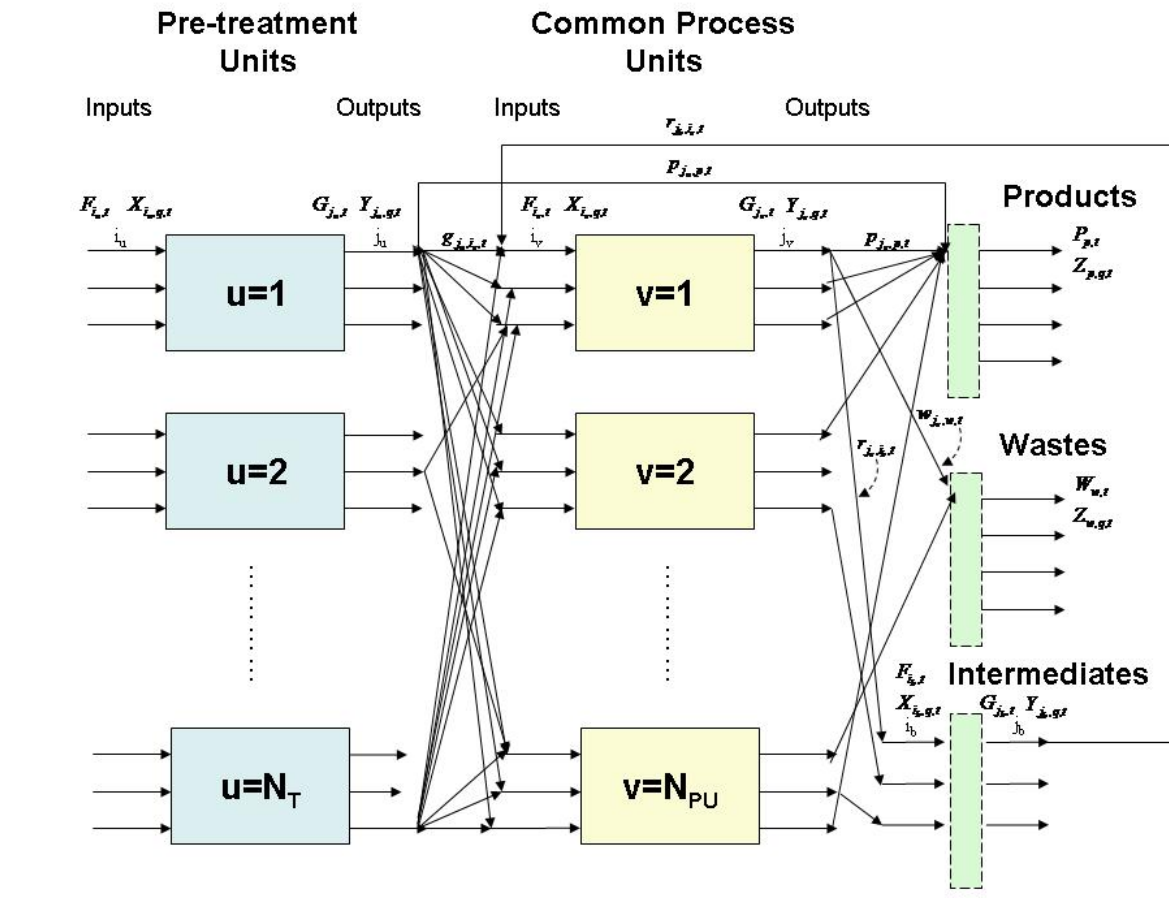

4.4 Approach

The following simplifying assumptions were made:

- The decision-making time horizon is discretized into N_t periods. This leads to a set of operation periods defined as $\text{PERIODS} = \{t|t= 1,2, \dots,N_t\}$. Within each time period, the process operates at steady-state. In addition, only intra-period integration is allowed. (No storage, integrations, or exchange of streams over more than one period.)
- Process modifications are limited to two options:
 - a) Manipulation of certain design and operating variables for each unit within specific ranges
 - b) Addition of new pretreatment units

4.4.1 Structural Representation

A source-sink structural representation of the problem is selected to allow for inclusive portrayal of the various potential configurations of interest. Figure 4.2 depicts a schematic of the structural representation. Outputs from the pretreatment units are split into fractions. These fractions include ones assigned to inputs of the common process units, assigned to inputs of pretreatment units, discharged as wastes, and ones discharged as final product streams. Each common process unit discharges several outputs as well. Outputs from the common process units are split into fractions. These fractions include

ones discharged as final products, and ones assigned to return back into the process as process inputs (intermediates).

4.4.2 Mathematical Formulation

4.4.2.1 Pretreatment Units

The mass balance for the pretreatment unit u during period t :

$$\sum_{j_u} G_{j_u,t} = \sum_{i_u} F_{i_u,t} \quad \forall u,t \quad (4.1)$$

The q^{th} component balance for unit u during period t is expressed as:

$$\sum_{j_u} G_{j_u,t} * Y_{j_u,q,t} = \sum_{i_u} (F_{i_u,t} * X_{i_u,q,t} + \text{Net_Gen}_{u,q,t}) \quad \forall q,u,t \quad (4.2)$$

Where the index, t , in the flowrate and composition terms refer to the time period over which the flowrates and compositions are considered. The performance model for unit u is expressed by a set of algebraic equations:

$$\begin{aligned} & (G_{j_u,t}, Y_{j_u,q,t} : j_u = 1,2,\dots, N_u^{\text{out}}, q = 1,2,\dots, N_{\text{Components}}) \\ & = f_u (F_{i_u,t}, X_{i_u,q,t} : i_u = 1,2,\dots, N_u^{\text{in}}, q = 1,2,\dots, N_{\text{Components}}, d_{u,t}, o_{u,t}) \quad \forall u, i_u, q, t \quad (4.3) \end{aligned}$$

4.4.2.1.1 Splitting of source j_u

The flowrate assigned from source j_u to destination i_v during period t is referred to as $g_{j_u, i_v, t}$ and the flowrate from source j_u to destination i_u during period t is referred to as $g_{j_u, i_u, t}$. The flowrate from the j_u^{th} source goes to other pretreatment units, to the common processing units, to final product streams, and to waste streams. Therefore, the material balance for the splitting of source j_u is given by:

$$G_{j_u, t} = \sum_u \sum_{i_u} g_{j_u, i_u, t} + \sum_v \sum_{i_v} g_{j_u, i_v, t} + \sum_p p_{j_u, p, t} + \sum_w w_{j_u, w, t} \quad \forall u, j_u, t \quad (4.4)$$

where $p_{j_u, p, t}$ is the flowrate assigned from j_u to the p^{th} product stream and $w_{j_u, w, t}$ is the flowrate from j_u to the w^{th} waste stream.

The total flowrate of the p^{th} product from the N_T pretreatment units in period t is expressed as:

$$P_{p, t}^T = \sum_u \sum_{j_u} p_{j_u, p, t} \quad \forall p, t \quad (4.5)$$

and the q^{th} component material balance for the p^{th} product stream coming from the N_T pretreatment units:

$$P_{p,t}^T * Z_{p,q,t}^T = \sum_v \sum_{j_u} P_{j_u,p,t} * Y_{j_u,q,t} \quad \forall w, q, t \quad (4.6)$$

The total flowrate of the w^{th} waste stream from the N_T pretreatment units during period t is expressed as:

$$W_{w,t}^T = \sum_u \sum_{j_u} w_{j_u,w,t} \quad \forall w, t \quad (4.7)$$

and the q^{th} component material balance for the w^{th} waste stream coming from the N_T pretreatment units:

$$W_{w,t}^T * Z_{w,q,t}^T = \sum_u \sum_{j_u} w_{j_u,w,t} * Y_{j_u,q,t} \quad \forall w, q, t \quad (4.8)$$

4.4.2.1.2 Mixing of the split flowrate before i_v^{th} input to v^{th} common process unit

The i_v^{th} input to the v^{th} common process unit consists of contributions from streams exiting the pretreatment units and from intermediate streams recycled from the common process units themselves. The flowrate assigned from intermediate source j_b to destination i_v during period t is referred to as $r_{j_b,i_v,t}$. Then, for the mixing of the split flowrate before the i_v^{th} input to the v^{th} common process unit, the material balance and q^{th} component balance during period t are expressed as:

$$F_{i_v,t} = \sum_u \sum_{j_u} g_{j_u,i_v,t} + \sum_b \sum_{j_b} r_{j_b,i_v,t} \quad \forall v, i_v, t \quad (4.9)$$

$$F_{i_v,t} * X_{i_v,q,t} = \sum_u \sum_{j_u} g_{j_u,i_v,t} * Y_{j_u,q,t} + \sum_b \sum_{j_b} r_{j_b,i_v,t} * Y_{j_b,q,t} \quad \forall v, i_v, q, t \quad (4.10)$$

4.4.2.2 Common Process Units

The mass balance equation for common process unit, v , during period t is expressed as:

$$\sum_{j_v} G_{j_v,t} = \sum_{i_v} F_{i_v,t} \quad \forall v, t \quad (4.11)$$

The q^{th} component balance for common process unit v during period t is expressed as:

$$\sum_{j_v} G_{j_v,t} * Y_{j_v,q,t} = \sum_{i_v} (F_{i_v,t} * X_{i_v,q,t} + \text{Net_Gen}_{v,q,t}) \quad \forall q, v, t \quad (4.12)$$

and the unit performance equation for the v^{th} common process unit is expressed as:

$$\begin{aligned} & (G_{j_v,t}, Y_{j_v,q,t} : j_v = 1, 2, \dots, N_v^{\text{out}}, q = 1, 2, \dots, N_{\text{Components}}) \\ & = f_v (F_{i_v,t}, X_{i_v,q,t} : i_v = 1, 2, \dots, N_v^{\text{in}}, q = 1, 2, \dots, N_{\text{Components}}, \mathbf{d}_{v,t}, \mathbf{o}_{v,t}) \quad \forall v, i_v, q, t \quad (4.13) \end{aligned}$$

4.4.2.2.1 Splitting of the j_v^{th} stream leaving the v^{th} common process unit

There are N_w waste streams and N_p product streams leaving the process, and N_B intermediate streams being rerouted back into the process. Each output stream j_v from a common process unit is split into several flowrates, some are assigned to waste outlets, some to product streams, and some to intermediate streams that will be recycled back into the process. The flowrate assigned to the w^{th} waste stream is referred to as $w_{j_v,w,t}$, the flowrate assigned to the p^{th} product stream is referred to as $p_{j_v,p,t}$, and the flowrate assigned to the b^{th} intermediate stream is referred to as $r_{j_v,b,t}$. Therefore, the material balance for the splitting of the j_v^{th} stream is expressed as:

$$G_{j_v,t} = \sum_w w_{j_v,w,t} + \sum_p p_{j_v,p,t} + \sum_b r_{j_v,b,t} \quad \forall v, j_v, t \quad (4.14)$$

The flowrate of the w^{th} waste stream from the N_{PU} common process units is given by:

$$W_{w,t}^{\text{PU}} = \sum_v \sum_{j_v} w_{j_v,w,t} \quad \forall w, t \quad (4.15)$$

and the q^{th} component material balance for the w^{th} waste stream from the N_{PU} common process units is given by:

$$W_{w,t}^{\text{PU}} * Z_{w,q,t}^{\text{PU}} = \sum_v \sum_{j_v} w_{j_v,w,t} * Y_{j_v,q,t} \quad \forall w, q, t \quad (4.16)$$

The flowrate of the p^{th} product stream from N_{PU} common process units is given by:

$$P_{p,t}^{PU} = \sum_v \sum_{j_v} P_{j_v,p,t} \quad \forall p,t \quad (4.17)$$

and the q^{th} component material balance for the p^{th} product stream from the N_{PU} common process units is given by:

$$P_{p,t}^{PU} * Z_{p,q,t}^{PU} = \sum_v \sum_{j_v} P_{j_v,p,t} * Y_{j_v,q,t} \quad \forall p,q,t \quad (4.18)$$

The flowrate of the b^{th} intermediate stream from the N_{PU} common process units is given by:

$$R_{b,t}^{PU} = \sum_v \sum_{j_v} r_{j_v,b,t} \quad \forall b,t \quad (4.19)$$

The q^{th} component material balance for the b^{th} intermediate stream from the N_{PU} common process units is given by:

$$R_{b,t}^{PU} * Z_{b,q,t}^{PU} = \sum_v \sum_{j_v} r_{j_v,b,t} * Y_{j_v,q,t} \quad \forall b,q,t \quad (4.20)$$

4.4.2.3 Product Streams

The flowrate of the p^{th} product out of the process is given by:

$$P_{p,t} = P_{p,t}^T + P_{p,t}^{PU} = \sum_u \sum_{j_u} p_{j_u,p,t} + \sum_v \sum_{j_v} p_{j_v,p,t} \quad \forall p,t \quad (4.21)$$

The q^{th} component material balance for the p^{th} product stream from the process is given by:

$$P_{p,t} * Z_{p,q,t} = (P_{p,t}^T * Z_{p,q,t}^T) + (P_{p,t}^{PU} * Z_{p,q,t}^{PU}) = \sum_u \sum_{j_u} p_{j_u,p,t} * Y_{j_u,q,t} + \sum_v \sum_{j_v} p_{j_v,p,t} * Y_{j_v,q,t} \quad \forall p,q,t \quad (4.22)$$

4.4.2.4 Waste Streams

The flowrate of the w^{th} waste stream out of the process is given by:

$$W_{w,t} = W_{w,t}^T + W_{w,t}^{PU} = \sum_u \sum_{j_u} w_{j_u,w,t} + \sum_v \sum_{j_v} w_{j_v,w,t} \quad \forall w,t \quad (4.23)$$

The q^{th} component material balance for the w^{th} waste stream from the process is given by:

$$W_{w,t} * Z_{w,q,t} = (W_{w,t}^T * Z_{w,q,t}^T) + (W_{w,t}^{PU} * Z_{w,q,t}^{PU}) = \sum_u \sum_{j_u} w_{j_u,w,t} * Y_{j_u,q,t} + \sum_v \sum_{j_v} w_{j_v,w,t} * Y_{j_v,q,t} \quad \forall w, q, t \quad (4.24)$$

4.4.2.5 Intermediate Streams Recycled Back into the Process

4.4.2.5.1 Mixing of the split flowrate before the i_b th input to the intermediate block

The i_b th input to the intermediate block consists of contributions from streams exiting the common process units. The flowrate assigned from source j_v to destination i_b during period t is referred to as $r_{j_v,i_b,t}$. Then, for the mixing of the split flowrate before the i_b th input to the intermediate block, the material balance and q th component balance during period t are expressed as:

$$F_{i_b,t} = \sum_{j_v} r_{j_v,i_b,t} \quad \forall b, i_b, t \quad (4.25)$$

$$F_{i_b,t} * X_{i_b,q,t} = \sum_{j_v} r_{j_v,i_b,t} * Y_{j_v,q,t} \quad \forall b, i_b, q, t \quad (4.26)$$

4.4.2.6 Intermediate Block

The mass balance equation for the intermediate block during time t is given by:

$$\sum_{j_b} G_{j_b,t} = \sum_{i_b} F_{i_b,t} \quad \forall b,t \quad (4.27)$$

The q^{th} component balance for the intermediate block during time t is given by:

$$\sum_{j_b} G_{j_b,t} * Y_{j_b,q,t} = \sum_{i_b} (F_{i_b,t} * X_{i_b,q,t}) \quad \forall q,b,t \quad (4.28)$$

4.4.2.6.1 Splitting of the j_b^{th} stream leaving the intermediate block

The flowrate assigned from source j_b to destination i_v during period t is represented by

$r_{j_b,i_v,t}$. Therefore, the material balance for the splitting of source j_b is given by:

$$G_{j_b,t} = \sum_v \sum_{i_v} r_{j_b,i_v,t} \quad \forall j_b,b,t \quad (4.29)$$

4.4.3 Constraints

The design and operating constraints for the pretreatment units and the common process units are:

$$d_u^{\min} \leq d_{u,t} \leq d_u^{\max} \quad (4.30)$$

$$d_v^{\min} \leq d_{v,t} \leq d_v^{\max} \quad (4.31)$$

$$o_u^{\min} \leq o_{u,t} \leq o_u^{\max} \quad (4.32)$$

and

$$o_v^{\min} \leq o_{v,t} \leq o_v^{\max} \quad (4.33)$$

The product demand and composition constraints are expressed as:

$$P_{p,t} \leq P_{p,t}^{Demand} \quad (4.34)$$

The flowrate and composition constraints for the i_u^{th} input to the process unit are given

by:

$$F_{i_u}^{\min} \leq F_{i_u,t} \leq F_{i_u}^{\max} \quad (4.35)$$

and

$$X_{i_u,q}^{\min} \leq X_{i_u,q,t} \leq X_{i_u,q}^{\max} \quad (4.36)$$

The flowrate and composition constraints for the i_v^{th} input to the v^{th} common process unit are given by:

$$F_{i_v}^{\min} \leq F_{i_v,t} \leq F_{i_v}^{\max} \quad (4.37)$$

and

$$X_{i_v,q}^{\min} \leq X_{i_v,q,t} \leq X_{i_v,q}^{\max} \quad (4.38)$$

4.4.4 Objective Function

The overall basis of the optimization formulation to maximize gross profit can be represented as revenue minus the cost of feedstocks and reactants, process operating cost, and pretreatment costs (if applicable):

$$\left(\begin{array}{c} \text{Product/Byproduct} \\ \text{Revenue} \end{array} \right) - \left(\begin{array}{c} \text{Cost of Feedstocks} \\ \text{and reactants} \end{array} \right) - \left(\begin{array}{c} \text{Process} \\ \text{Operating} \\ \text{Cost} \end{array} \right) - \left(\begin{array}{c} \text{Pretreatment} \\ \text{Cost} \end{array} \right)$$

To express it mathematically, a multi-period representation will be used. Let us consider a decision-making horizon t_h which is discretized into a number (N_t) of time intervals. This discretization may be uniform (e.g., monthly or quarterly) or event-based (e.g., to correspond to harvesting times or availability of feedstocks). The index t is used to represent the time intervals. As mentioned in the problem statement, there are (N_f) feedstock alternatives with an index (f). As such, the objective function is given by:

$$\sum_t \sum_p C_{p,t}^{product} * P_{p,t} - \sum_t \sum_f C_{f,t}^{feedstock} * F_{f,t} - \sum_t POC_t - TAC^{Pretreatment} \quad (4.39)$$

where $C_{p,t}^{product}$ is the unit selling price of product p during period t , $P_{p,t}$ is the production rate of product p during time t , $C_{f,t}^{feedstock}$ is the cost of feedstock f during period t , $F_{f,t}$ is the feed rate of feedstock f during time t , and POC_t represents the process operating cost

excluding feedstocks (e.g., utilities, labor, waste treatment, etc.) during period t . The term $TAC^{\text{Pretreatment}}$ is the total annualized cost of retrofitted pretreatment, which is defined as the sum of the annualized fixed costs (AFC) and the annual operating cost (AOC) and is expressed as:

$$TAC^{\text{Pretreatment}} = \sum_f I_f * AFC_f + \sum_t \sum_f AOC_{f,t}^{\text{Pretreatment}} \quad (4.40)$$

where I_f is a binary integer variable designating the presence or absence of the f^{th} feedstock and is determined through the following constraint:

$$\sum_t F_{f,t} \leq F_{f,t}^{\text{max}} * I_f \quad \forall f \quad (4.41)$$

Where $F_{f,t}^{\text{max}}$ is an upper bound on the allowable flowrate of feedstock f . When the flowrate is positive, the value of I_f is forced to be one. Otherwise, it takes the value of zero.

The previous constraints are developed for the various feedstocks and time intervals. The foregoing expressions presented comprise the mathematical program for the problem. The resulting formulation is a mixed integer nonlinear program (MINLP). This program can be solved in order to identify the optimal scheduling, process modifications and selection, as well as design of the pretreatment units and common process units. If the process models are linearized (which is a reasonable approach if the operation and

design changes are kept close to the nominal conditions), then the program becomes a mixed integer linear program (MILP). One of the advantages of the presented formulation is the flexibility and allowance for use of actual process and cost information. In addition, the decision-maker is able to make individual and custom choices pertaining to the type of collected information and the level of sensitivity and accuracy desired.

4.5 Case Study

A base-case design is considered for the processing of soybean oil to produce 40 MMPGY biodiesel via transesterification. The design is based on the configuration proposed by Myint (2007). Available for consideration is an additional feedstock: waste cooking oil. Therefore, the analysis will be conducted for the scheduling of two feedstocks, 1.) virgin refined soybean oil, and 2.) waste cooking oil (WCO) (50% FFA). Calculations are based upon an 8000 hour work year. The process flowsheet for base case is shown in Figure 4.3. Transesterification was accomplished by reacting soy oil with an excess of methanol in the presence of NaOH. The reaction occurred at 60°C for a duration of 1 hour, with a conversion of 0.97. The alcohol to triglyceride ratio was 6:1 and the soy oil was presumed to have no more than 0.5% free fatty acid content. (Freedman et al., 1984, 1986) Following transesterification, the glycerol was removed and subsequently purified. After glycerol removal, methanol was removed from the biodiesel, and the biodiesel was washed with water. The base-case design for processing

Figure 4.3: ASPEN Plus Flowsheet of Biodiesel Production Base-Case Design

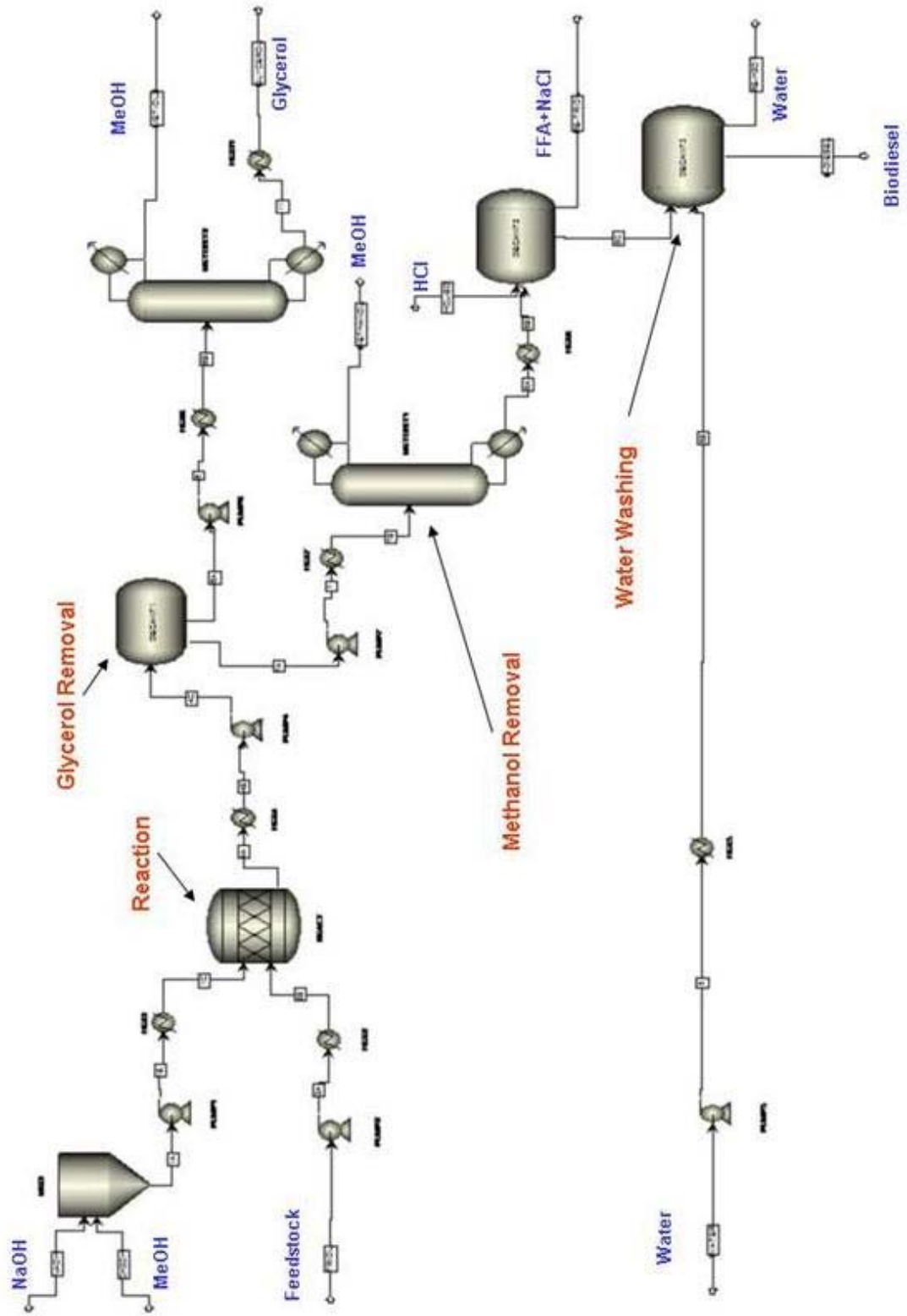

Table 4.1: Mass Flow of Selected Components for the ASPEN Simulation

Description	Stream Index	Mass Flow (lb/hr)				
		Biodiesel	Glycerin	Triglycerides	Methanol	Water
Reactor Input	S1	0	0	0	8094	0
	S2	0	0	37279	0	0
Reactor Output	S3	36326	3761	1118	4169	0
Glycerol Purification Output	S4	0	0.003	0.001	3185	0
	S5	0	3761	1.822	7.335	0
Methanol Distillation Output	S6	trace	Trace	trace	972	0
	S7	36326	0.113	1117	4.278	0
Water Washing Output	S8	0	0.113	0	3.551	5373
	S9	36326	Trace	0	0.721	31

of a single feedstock to produce 40 MPPGY biodiesel via transesterification was simulated using ASPEN Plus. The resulting biodiesel had a purity of 99.2%, and glycerol a purity of 98.5%. Table 4.1 shows mass flow information for biodiesel, glycerin, triglycerides (feedstock), methanol, and water in selected streams. Table 4.2 provides information concerning the hot and cold streams and the total cooling and heating utilities.

Next, mass integration was performed to conserve resources, specifically water and methanol. Heat integration was performed via the pinch analysis technique was carried out to minimize the heating and cooling utilities. Details on the steps involved in these procedures can be found in literature (El-Halwagi, 2006; 1997). Results of integrating

the base-case design yielded operating cost savings of ~\$8,800,000/yr. Heat integration was conducted via an algebraic approach to calculate the minimum heating and cooling utilities. Resultant savings are shown in Table 4.3. Since pure methanol is obtained from distillation, the methanol exiting distillation was recycled back to the reactor unit. This decreased the amount of fresh methanol needed (after start-up) to half of the pre-integrated amount, yielding savings of almost \$8,000,000/yr. (See Table 4.3). Discharge water from the biodiesel production process was treated by single stage

Table 4.2: Supply and Target Temperature, Δ Enthalpy, and Specific Heat Values for ASPEN Simulation Hot and Cold Streams

	Supply Temp (°F)	Target Temp (°F)	Δ Enthalpy (10^3 Btu hr ⁻¹)	Specific Heat (10^3 Btu hr ⁻¹ °F ⁻¹)
Hot Streams				
HEX4	140	77	1436.00	22.79
HEX8	470	77	8704.00	22.15
HEX11	303	77	578.00	2.56
MET-DIST1 (Condenser)	62	61	37647.00	37647.00
MET-DIST2 (Condenser)	62	61	11800.00	11800.00
REACT1	140	139	36901.00	36901.00
Total Cooling Utility			97066.00	
Cold Streams				
HEX1	133.9	140	45.00	7.38
HEX2	77	140	871.00	13.83
HEX5	77	140	769.00	12.21
HEX6	77	140	44888.00	712.51
HEX7	77	140	1137.00	18.05
MET-DIST1 (Reboiler)	468	469	10564.00	10564.00
MET-DIST2 (Reboiler)	302	303	11307.00	11307.00
Total Heating Utility			69581.00	

Table 4.3: Savings from Process Integration

	<u>Savings (\$/yr)</u>
Heat Integration	763,350
Methanol Integration	7,976,000
Water Integration	23,300.00
<i>Total Savings from Integration =</i>	<i>\$8,762,650 / yr</i>

Reverse Osmosis (El-Halwagi, 1997). Of the water discharged from the process, 40% could be recycled with the other 60% sent to wastewater treatment. The savings obtained are shown in Table 4.3.

4.5.1 Economic Analysis

4.5.1.1 Estimation of Capital and Operating Costs

Capital costs were developed from literature-based values brought up to scale for a 40 MMGPY process, then updated to 2007 dollars by use of the Chemical Engineering Plant Cost Index (CEPCI). (Chemical Engineering Plant Cost Index, 2004, 2007, 2008; Tyson et al., 2004; You et al., 2008; Zhang, 2002; Zhang et al., 2003a) Due to its significant contribution to capital costs, the transesterification reactor was sized and priced separately. Capital cost estimation for the waste cooking oil included pretreatment-related costs. Operating costs were developed

by use of literature values (Tyson et al., 2004; You et al., 2008; Zhang, 2002; Zhang et al., 2003a, b), standard rules of thumb, and current raw material costs.

Next, an economic analysis is carried out. Metrics used for economic analyses include Annual Profit, Payback Period (PBP), and Return on Investment (ROI). Values were calculated as seen below.

- $\text{Annual Profit} = \text{Annual Sales} - \text{Annualized Fixed Cost (AFC)} - \text{Annualized Operating Cost (AOC)}$
- $\text{Payback Period (PBP)} = \text{Fixed Capital Investment} / (\text{Annual Sales} - \text{AOC})$
- $\text{Return on Investment (ROI)} = (\text{Annual Profit} / \text{Total Capital Investment}) * 100\%$

Annual Profit, PBP, and ROI were calculated for single-feedstock 40 MMGPY biodiesel production facilities using virgin soy bean oil and waste cooking oil (50% FFA). All three of these metrics were calculated as a function of respective feedstock price and biodiesel selling price. Twenty feedstock prices were used, as well as three biodiesel selling prices (current, (current - \$0.50), (current + \$0.50)). In addition, sensitivity analysis was conducted to investigate the effect of the selling price of glycerol (current, (2*current), (current/2), \$0.00) on the economic viability of the given process. The capital costs for 40 MMGPY biodiesel production with and without pretreatment capability are shown in Table 4.4. Raw material costs and related sources are shown in Table 4.5. It should be noted that taxes and the biodiesel tax incentive are not explicitly accounted for in these calculations.

Table 4.4: Capital Costs for Biodiesel Production (40 MMGPY)
with and without Pretreatment

	<u>Without Pretreatment</u>	<u>With Pretreatment</u>
Fixed Capital Investment (FCI)	\$17,779,000	\$22,479,000
Annualized Fixed Cost (AFC)	\$2,072,000/yr	\$2,972,000

Table 4.5: Raw Material Costs

<u>Material</u>	<u>Cost (\$/lb)</u>
NaOH	1.26
Methanol	0.24
HCl	0.60
Refined Soy Oil	0.49
Waste Cooking Oil (50% FFA)	0.034

Table 4.6 contains the relevant operating costs. Additional annual operating costs related to pretreatment of the WCO amount to \$2,118,000/yr. (\$0.05/gal biodiesel) (Tyson et al., 2004). Values for the Annual Operating Cost (AOC), minus feedstock cost, are shown with and without pretreatment. Feedstock cost is not included in this table, since it is varied in the economic analyses. For reference, at current prices, and for

the given process, annual feedstock costs for refined soy oil and WCO (50% FFA) amount to \$152,387,000/yr and \$20,820,000/yr, respectively. At the current price for refined soy oil, it is quickly seen that feedstock cost by far dominates operating costs.

Table 4.6: Operating Costs for Integrated Biodiesel Production (40 MMGPY)

	<u>Annual Cost (\$/yr)</u>
Operating Labor	768,000
Supervisory Labor	80,000
Maintenance	533,000
Utilities (w/o electricity)	1,868,000
Electricity	21,000
Raw Materials (minus feedstock)	13,700,000
Annual Operating Cost (minus feedstock)	16,970,000
Annual Operating Cost with Pretreatment (minus feedstock)	19,089,000

As shown in Table 4.7, the base-case “current” price of biodiesel was selected to be \$3.38/gal, the value reported in the October 2007 issue of the DOE’s Clean Cities Alternative Fuel Report. (DOE, 2007b) As described previously, analyses were conducted using three prices of biodiesel; the current price, the current price less \$0.50, and the current price plus \$0.50. These values were \$2.88/gal, \$3.38/gal, and \$3.88/gal.

Table 4.7: Product Selling Prices

Product	Price	Date	Source
Biodiesel (B100)	\$3.38/gal	October 2007	DOE Alternative Fuel Report
Glycerol (non-kosher)	\$0.98/lb	April 2008	CLP Chemical

Results of the annual profit, payback period, and ROI calculations when using soy oil as the feedstock are shown in Figures 4.4-4.6, which show annual profit, payback period, and ROI as a function of soy oil cost and biodiesel price, respectively.

Figure 4.4: Annual Profit for a 40 MMGPY Biodiesel Facility as a Function of Soy Oil Cost (\$/lb) and 3 Different Biodiesel Prices. (Glycerol is at the current value of \$0.98/lb)

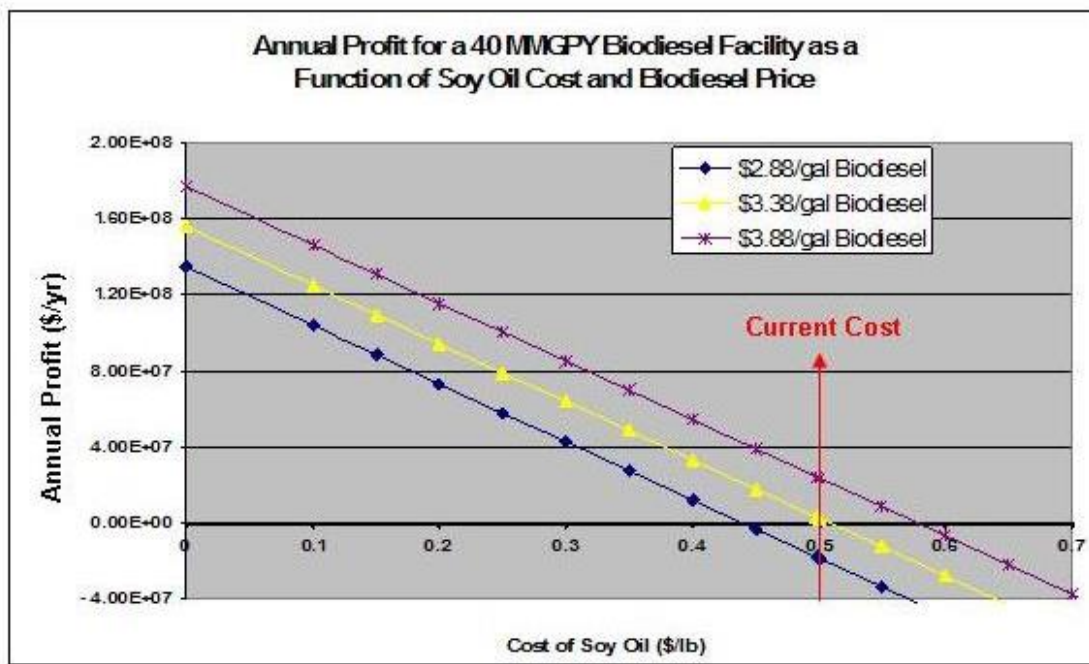

For all of these graphs, glycerol is at the current value of \$0.98/lb. In Figure 4.4, it can be seen that for the 'current' biodiesel price of \$3.38/gal and the current soy oil price of \$0.49/lb, the annual profit is \$3,300,000, just short of the break-even point. In addition, under these same conditions, the ROI is 14% (Figure 4.6) and the payback period 3 years (Figure 4.5). In Figure 4.5, it can also be seen that the payback period appears to approach infinity between \$0.50 and \$0.55. At the higher biodiesel price of \$3.88/gal, the annual profit is ~8 times greater, having a value of \$24,500,000. At the higher biodiesel price, the payback period is much less, 0.67 years, and the ROI (134%) almost an order of magnitude greater.

Figure 4.5: Payback Period for a 40 MMGPY Biodiesel Facility as a Function of Soy Oil Cost (\$/lb) and 3 Different Biodiesel Prices. (Glycerol is at the current value of \$0.98/lb)

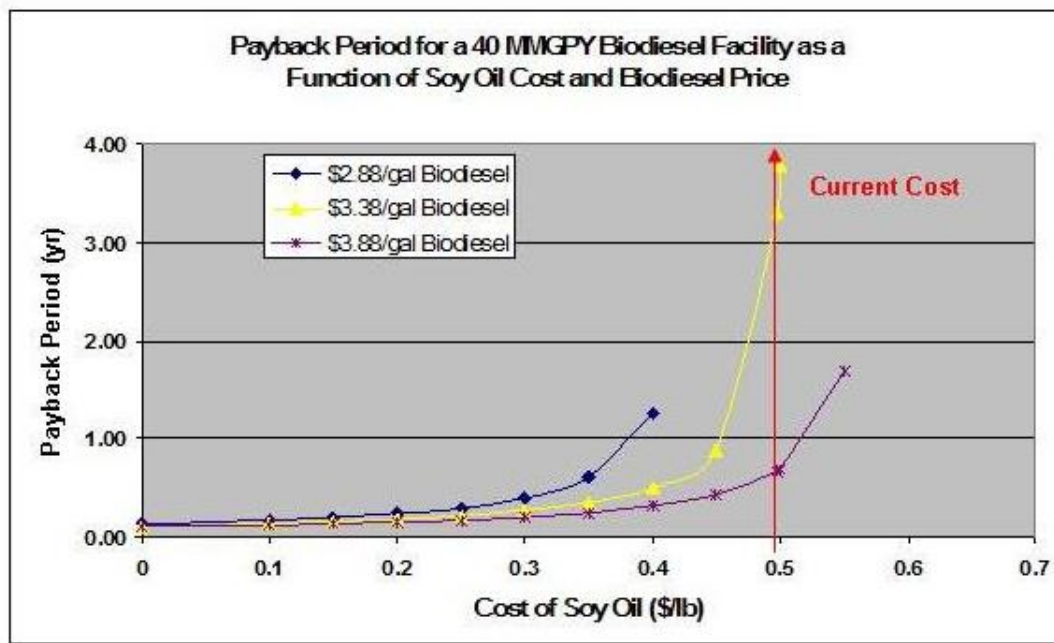
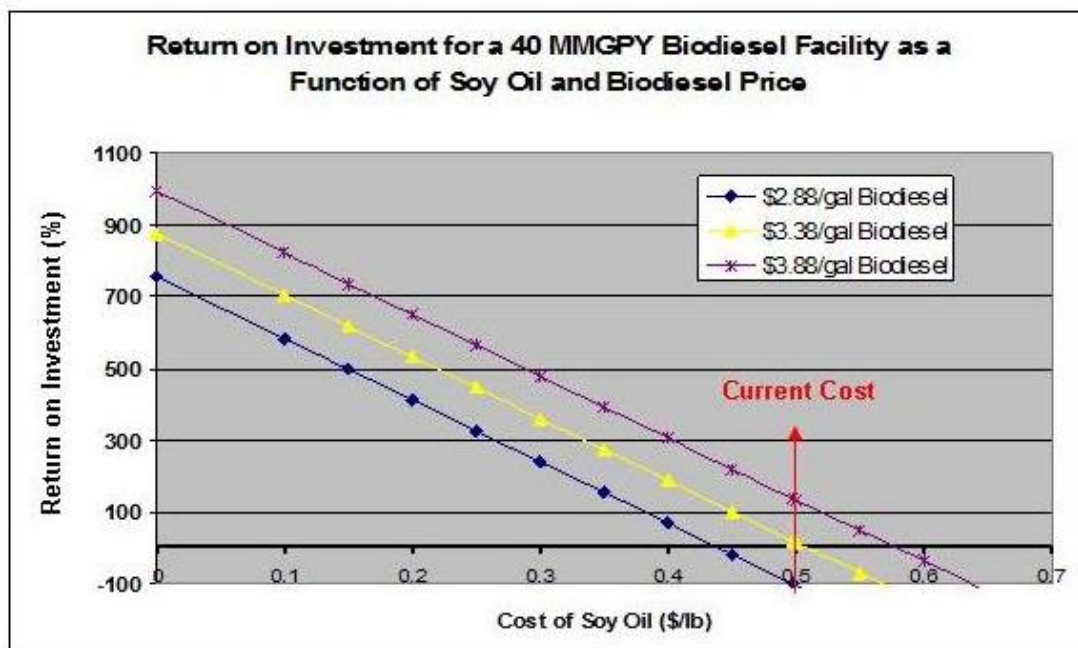

Figure 4.6: Return on Investment for a 40 MMGPY Biodiesel Facility as a Function of Soy Oil Cost (\$/lb) and 3 Different Biodiesel Prices. (Glycerol is at the current value of \$0.98/lb)



Conversely, the lower biodiesel price (at the current soy oil cost) results in a non-economically viable process. With the given conditions, the profitability of the process when using soy oil appears to be very sensitive to both soy oil cost and biodiesel price. A small increase in either the soy oil cost, or a decrease in biodiesel price make this process non-viable economically. In recent years, the price of soy oil was much lower, making for a much more profitable process using soy oil. Hence, the overwhelming use of soy oil as a biodiesel feedstock. But, recently, even in the last 12 months, soy oil

prices have risen substantially. This buttresses the need to obtain market-sensitive feedstock flexibility in biodiesel production.

Figure 4.7: Annual Profit for a 40 MMGPY Biodiesel Facility as a Function of WCO Cost (\$/lb) and 3 Different Biodiesel Prices. (Glycerol is at the current value of \$0.98/lb)

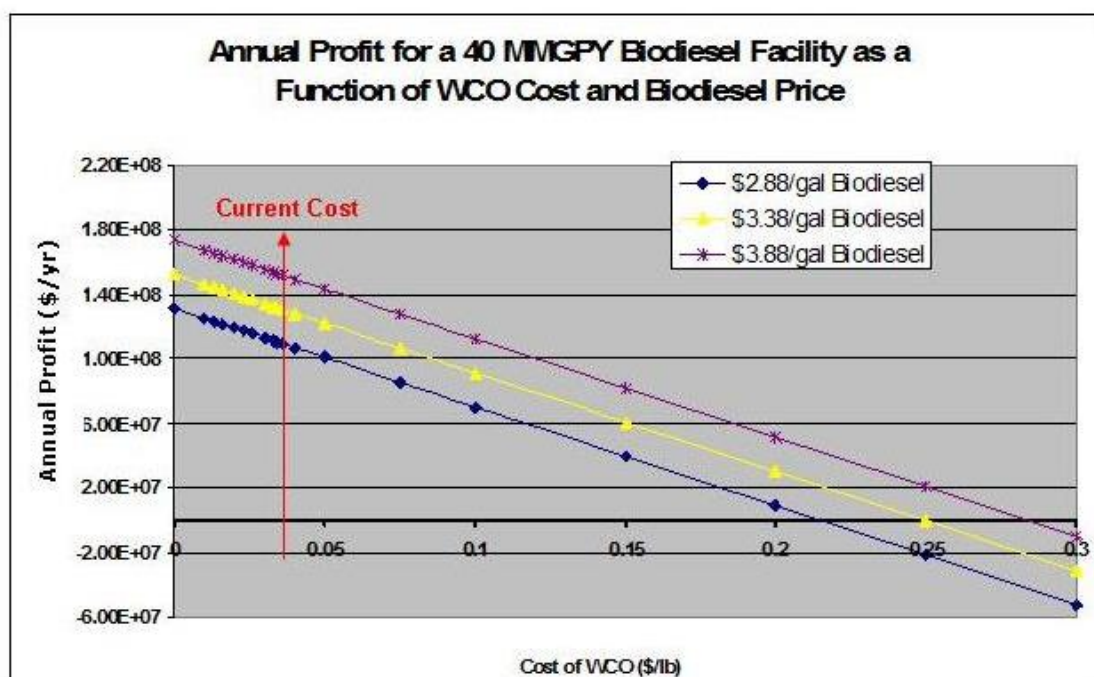

Results of the annual profit, payback period, and ROI calculations when using WCO as the feedstock are shown in Figures 4.7-4.9 which illustrate the annual profit, payback period, and ROI as a function of WCO cost and biodiesel price, respectively. For all of these graphs, glycerol is at the current value of \$0.98/lb. In Figure 4.7, it can be seen that for the 'current' biodiesel price of \$3.38/gal and the current WCO price of

\$0.034/lb, the annual profit is \$132,000,000, more than 5 times than that for soy oil. For these same conditions, the payback period is 0.14 yrs, and the ROI 590%. Even at the

Figure 4.8: Payback Period for a 40 MMGPY Biodiesel Facility as a Function of WCO Cost (\$/lb) and 3 Different Biodiesel Prices. (Glycerol is at the current value of \$0.98/lb)

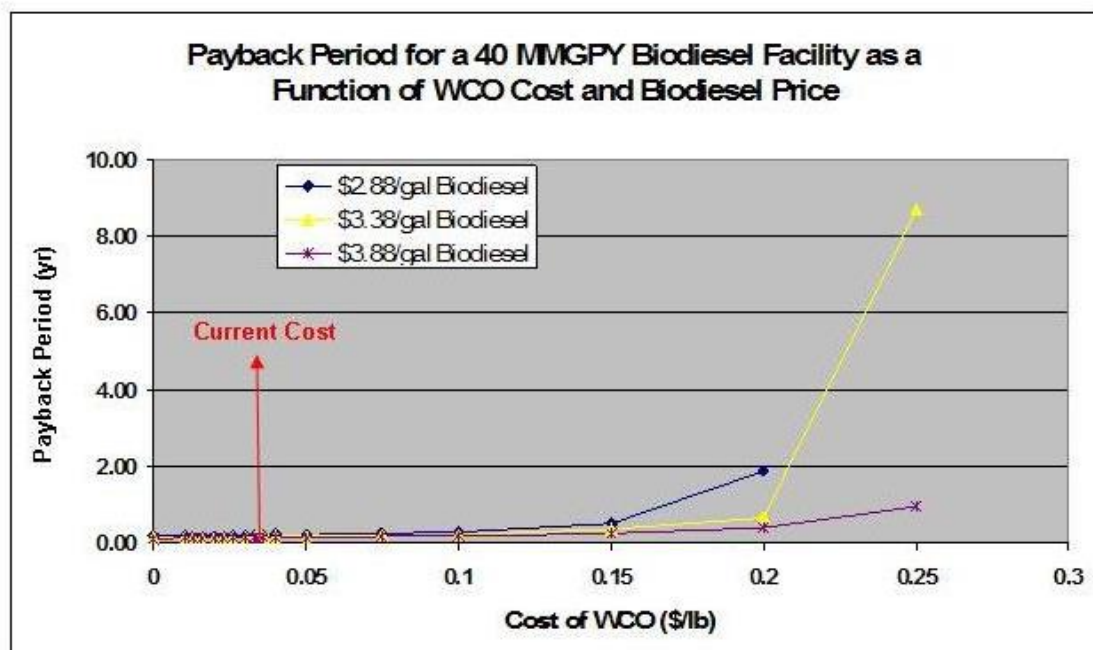
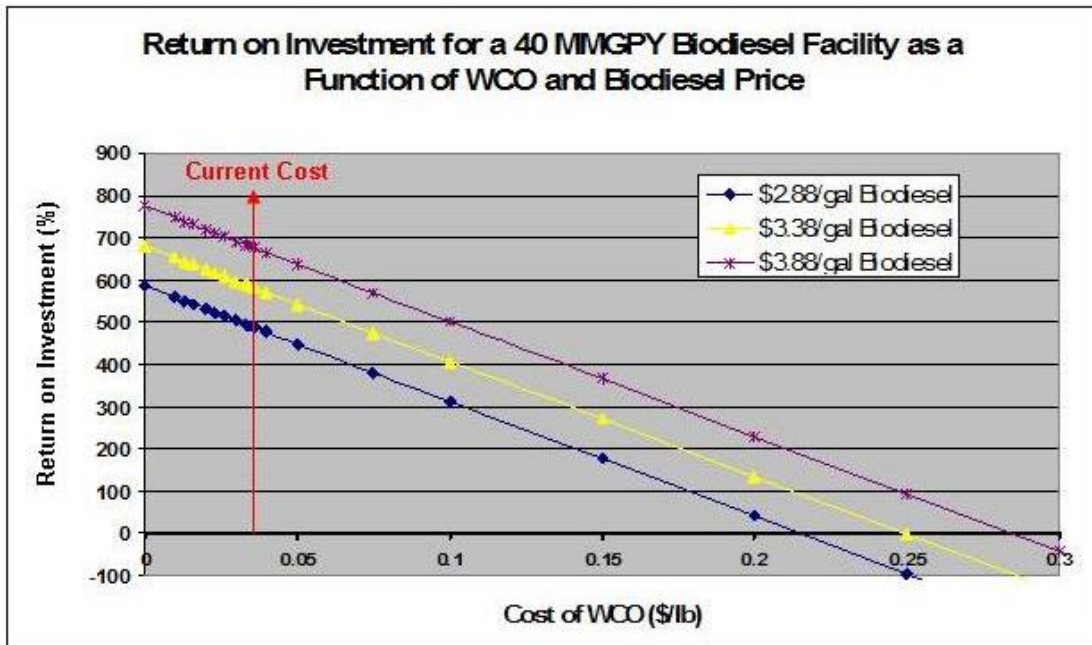

Figure 4.9: Return on Investment for a 40 MMGPY Biodiesel Facility as a Function of WCO Cost (\$/lb) and 3 Different Biodiesel Prices. (Glycerol is at the current value of \$0.98/lb)



lower biodiesel price, annual profit for the WCO process does not reach a break-even point until the feedstock price is above \$0.20/lb. For the current and high biodiesel prices, the break-even points occur at \$0.25/lb and \$0.28/lb, respectively. When WCO is the feedstock, all 3 of the biodiesel prices result in a much more profitable process than when soy oil is the feedstock. With the given conditions, even with the additional costs related to pretreatment, WCO appears to be a much more economical feedstock.

It should be noted that profit, PBP, and ROI were calculated based upon the assumption that selling price will remain the same during the time period of consideration. Whereas in a competitive fuel market, a potential decrease in production cost, such as one resulting from \$8,800,000 in process integration-based savings or use of a drastically less costly feedstock, might eventually result in a decreased biodiesel selling price.

Figure 4.10: Glycerin Price Sensitivity – Annual Profit for 40 MMGPY Biodiesel Facility as a Function of Soy Oil Cost (\$/lb) and Glycerin Price. (Biodiesel price is at the current value of \$3.38/gal)

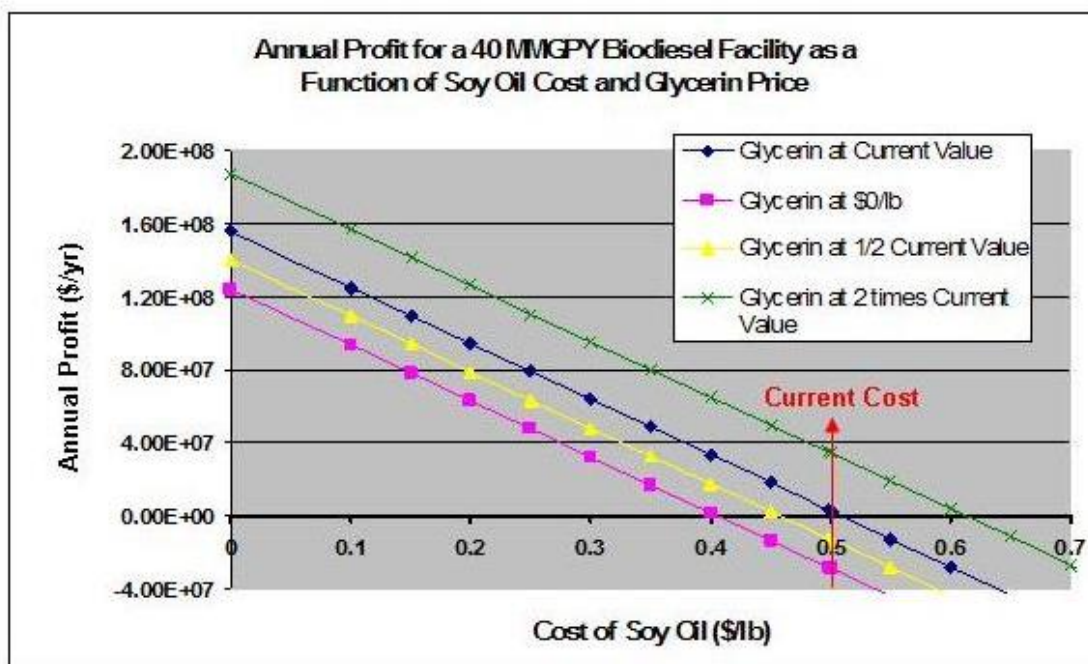

Figures 4.10 and 4.11 show the sensitivity of annual profit to glycerin price for soy oil and WCO, respectively (with the biodiesel price at \$3.38). At half of the current glycerin price (\$0.49/lb), the break-even point occurs at a soy oil cost of \$0.45/lb. When no revenue can be accrued via glycerin sales (glycerin at \$0.00/lb), the break-even point occurs at a soy oil cost of \$0.40/lb. For WCO, at half of the current glycerin price, the break-even point occurs at a feedstock cost of \$0.23/lb. With no revenue from glycerin

Figure 4.11: Glycerin Price Sensitivity – Annual Profit for 40 MMGPY Biodiesel Facility as a Function of WCO Cost (\$/lb) and Glycerin Price. (Biodiesel price is at the current value of \$3.38/gal)

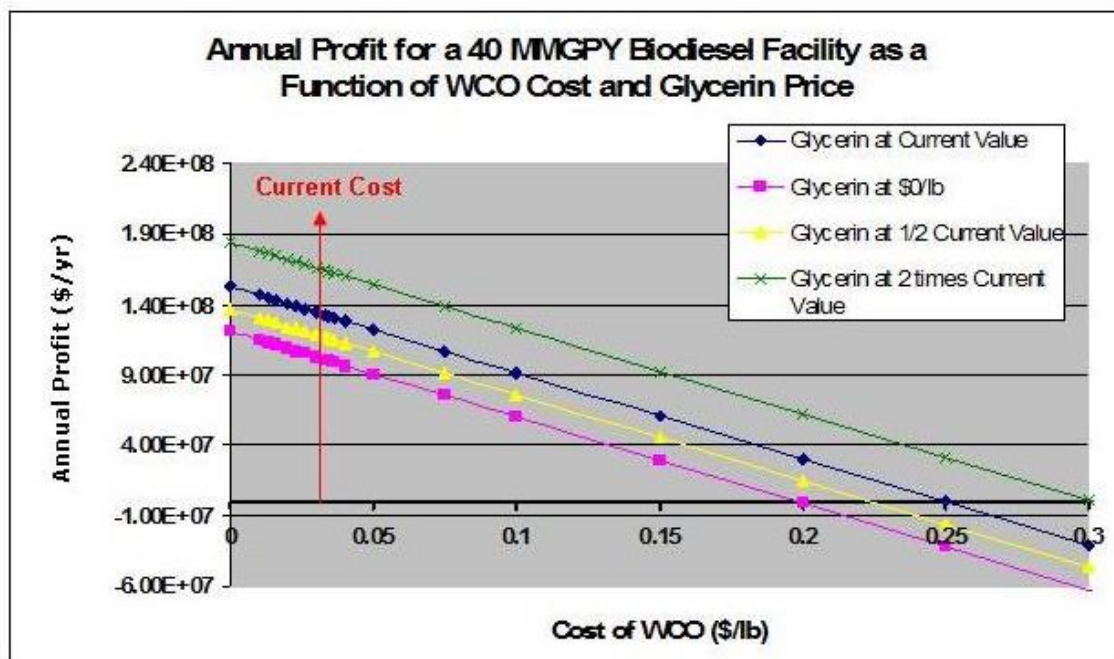

sales when using WCO, the break-even point occurs at a feedstock cost of \$0.20.

Therefore, under the given conditions, the viability of the process when using soy oil, is dependent upon glycerin sales. As can be seen in Figure 4.10, even a drop in glycerin price of less than 50% results in a non-profitable process. In contrast, with the WCO, even with no glycerin-based revenue, the process has an annual profit of over \$100,000,000. Therefore, under the given conditions and with the 'current' biodiesel price, the profitability of a WCO-based process is less sensitive to changes in glycerin price than a soy-based process.

4.5.2 Scheduling Results

Feedstock scheduling results were obtained for 2 scenarios related to the case study outlined previously. Both scenarios were developed for a large city, such as Houston, TX, having a population of 3,000,000. It was assumed that the monthly biodiesel production was the annual production divided by 12, or ~3.5 million gallons/month. Availability of WCO was determined by use of the annual per capital WCO production of 10 gal WCO/person/year. It was assumed that no limit existed on the availability of refined soy oil. WCO availability (tons) for both scenarios can be seen in Table 4.8.

Table 4.8: Available WCO in tons for Feedstock Scheduling Scenarios 1 & 2
And Monthly Refined Soy Oil Cost for Scenario 2

Month	Available WCO (ton)	Refined Soy Oil Cost: Scenario 2 (\$/lb soy oil)
January	3630	0.497
February	4537.5	0.20
March	5445	0.20
April	5445	0.20
May	7260	0.20
June	14520	0.21
July	21780	0.21
August	14520	0.21
September	9075	0.22
October	7260	0.22
November	4537.5	0.22
December	10890	0.22

In the first scenario, the WCO (50% free fatty acid content) cost remained stable at \$0.034/lb (\$0.249/gal) and the refined soy oil cost remained stable at \$0.497/lb. The resulting Feedstock Schedule for Scenario 1 can be seen in Figure 4.12.

In the second scenario, the WCO (50% free fatty acid content) cost remained stable at \$0.102/lb (\$1.50/gal) and the refined soy oil cost fluctuates. The monthly refined soy oil cost for Scenario 2 can be found in Table 4.8. The resulting Feedstock Schedule for Scenario 2 can be seen in Figure 4.13.

Scenario 1 is approximately congruent with the current market situation. The cost of WCO is much lower than refined soy oil. Even when the cost of pretreatment is factored

Figure 4.12: Amount (tons) per month of WCO and soy oil feedstocks scheduled in the production of biodiesel in order to maximize the gross profit. Scenario 1: 40 MMGPY facility in a city having a population of 3,000,000; \$0.034/lb WCO (50% FFA), \$0.497/lb refined soy oil.

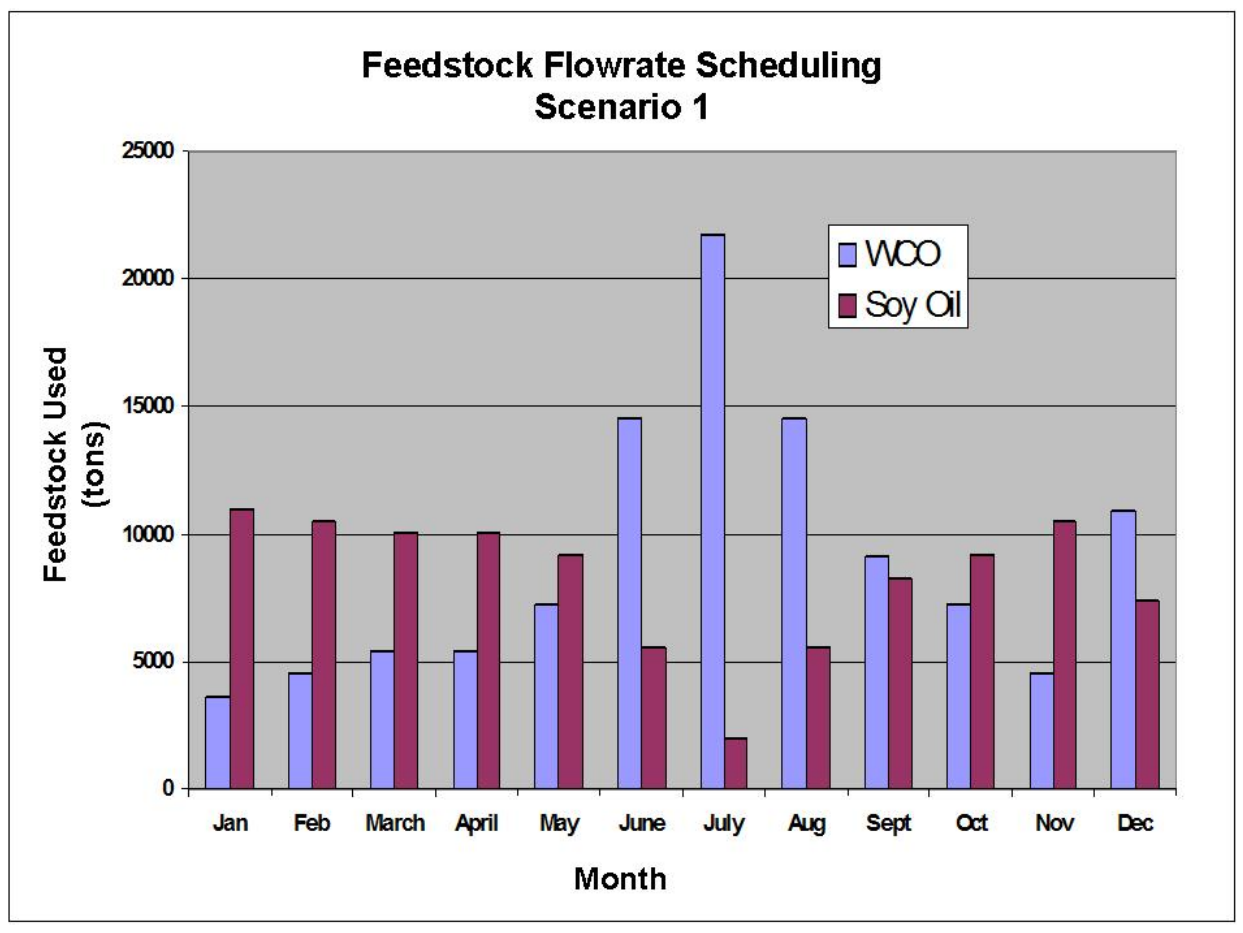

into manufacturing, it is much more beneficial to you use WCO than soy oil. Therefore, all of the available WCO is used every month and the remaining requisite feedstock is

brought up to volume by soy oil. It is interesting to note that with soy oil at a cost of \$0.497/lb, WCO cost would need to increase 700% (\$0.24/lb WCO) for the combined WCO feedstock and pretreatment costs to equate to the soy oil feedstock cost per gallon of biodiesel.

During Scenario 2, the WCO cost is increased 300% as compared to the Scenario 1 cost. During January, the soy oil cost retains the same value as during Scenario 1. February sees a drastic drop in the soy oil cost to \$0.20/lb, simulating a situation such as a sudden glut in the market or decrease in demand. This feedstock cost is maintained for 3 more months, then begins to slowly rise to \$0.21/lb for June through August, and to \$0.22/lb for September through December. In February, when the soy oil cost drops to \$0.20/lb, the use of soy oil becomes more favorable and is the sole feedstock processed until the soy oil cost rises to \$0.22/lb in September. At this point, once again, all of the available WCO is utilized, with the remaining requisite feedstock being brought to volume by soy oil.

Finally, given the fluctuations in petroleum prices, it is important to consider the impact on biodiesel economics. As mentioned previously, crude oil prices can change drastically and unexpectedly. There are two main components of biodiesel production that could be affected by a sudden shift in crude oil price; operating cost and fuel selling price. An increase in crude oil price would predominately impact facility operating cost via a corresponding increase in the utility cost of the process. In the presented case

study, the dominant operating cost is the price of the feedstock which is significantly larger than the utility cost. A change in crude oil price could proportionately impact the selling price of petroleum-based diesel. Even with a diesel selling price of \$2/gal, the

Figure 4.13: Amount (tons) per month of WCO and soy oil feedstocks scheduled in the production of biodiesel in order to maximize the gross profit. Scenario 2: 40 MMGPY facility in a city having a population of 3,000,000; \$0.102/lb WCO (50% FFA), a fluctuating refined soy oil cost, as seen in Table 4.8.

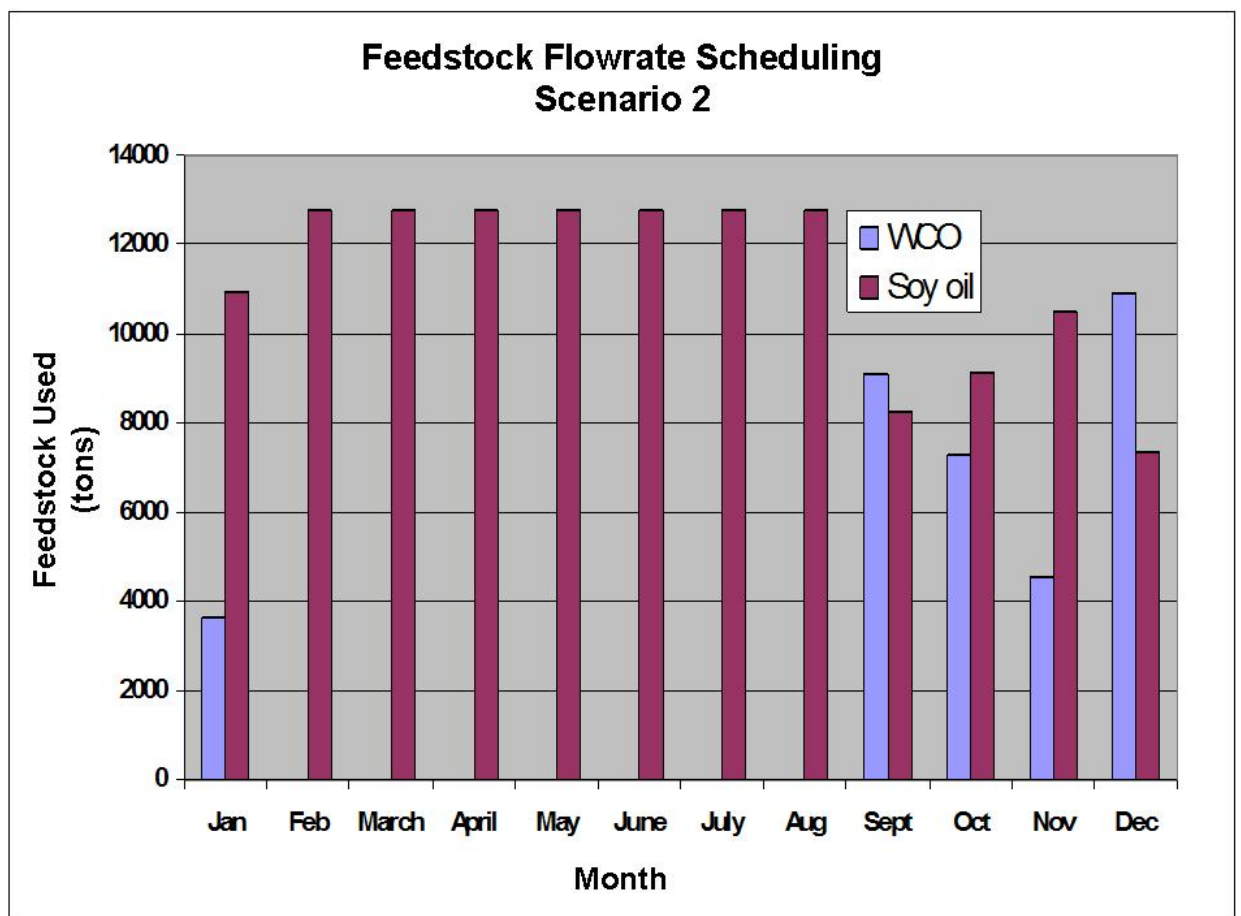

lower biodiesel selling price of \$2.58 is reasonable. This reduction in revenue may be offset if the cost of feedstock is kept low. An example is the case of using WCO as a feedstock. It is interesting to note that more than a 300% increase in the WCO cost would be required before biodiesel production would not be profitable at a selling price of \$2/gal biodiesel.

One of the key components of this work was the study of sensitivity of biodiesel production profitability to feedstock in order to provide insight toward biodiesel production that is more robust and resilient to market-changes and therefore more capable of sustaining a presence in the energy marketplace. The results presented previously and this discussion supports further the need for and benefit of such work.

4.6 Conclusions

A systematic procedure is being developed for the analysis and scheduling of biodiesel production facilities with multiple feedstocks. A base-case design has been developed for converting soybean oil to biodiesel via transesterification at a scale of 40 MMGPY. The process has been simulated using ASPEN Plus in order to identify mass and energy flows and basic sizing of key process equipment. Process integration techniques have been applied to conserve mass and energy resources, resulting in \$8,800,000 in annual savings. A techno-economic analysis for the given process has shown that at the current soy oil cost and the 'current' biodiesel price of \$3.38/gal, when using soy oil as a

feedstock, the annual profit is \$3,300,000, the break-even point ~\$0.52/lb, the payback period 3 yrs, and the ROI 14%. At a biodiesel price of \$3.88/gal, the annual profit is ~8 times greater (\$24,500,000), the payback period is much less (0.67 years), and the ROI (134%) almost an order of magnitude greater. A drop in the biodiesel price to \$2.88/gal makes the process non-viable economically.

A similar approach was adopted for converting WCO to biodiesel, with differing results from the related techno-economic analysis. In contrast to the soy oil analyses, under the given conditions, WCO as a feedstock results in a more profitable process. At the current WCO cost and 'current' biodiesel price of \$3.38/gal, the annual profit is \$132,000,000, the break-even point \$0.25/lb WCO, the payback period 0.14 yrs, and the ROI 590 %. Even at a lower biodiesel price (\$2.88/gal), the process still has an annual profit of \$110,000,000, 33 times greater than for soy oil at a biodiesel price of \$3.38/gal.

Glycerin sensitivity analyses demonstrate under the given conditions and with the 'current' biodiesel price, the profitability of a WCO-based process is less sensitive to changes in glycerin price than a soy-based process. The viability of the process when using soy oil, is dependent upon glycerin sales, with even a drop in glycerin price of less than 50% resulting in a non-profitable process. In contrast, even with no glycerin-based revenue, the process when using WCO offers a profitable operation as long as the price of the feedstock is kept low.

Feedstock scheduling results for 2 scenarios involving a 40 MMGPY biodiesel facility utilizing WCO and soy oil feedstocks in a large city (3,000,000 population) were obtained. Scenario 1 was congruent with the current market situation, with WCO feedstock cost being much lower than that for soy. It was demonstrated that under these conditions, all available WCO would be utilized prior to utilization of soy oil, and that a 700% increase in WCO cost would be necessary for the two feedstock costs to equate, including taking into account pretreatment costs. Scenario 2 involved a 300% increase in WCO feedstock cost and a sudden drop in soy oil cost. The initial lower soy oil cost placed it as the favored and sole feedstock utilized. A subsequent small increase in the soy oil cost resulted in WCO again becoming the favored feedstock.

CHAPTER V

STAGE 2: DESIGN AND SCHEDULING WITH INCORPORATED CO₂ SUBSIDY OF BIODIESEL PLANTS WITH MULTIPLE FEEDSTOCKS*

5.1 Summary

With the increasing attention to the environmental impact of discharging greenhouse gases, there has been a growing public pressure to reduce the carbon footprint associated with the use of fossil fuels. In this context, one of the key strategies is the substitution of fossil fuels with biofuels such as biodiesel. The design of biodiesel production facilities has traditionally been carried out based on technical and economic criteria. Greenhouse gas (GHG) policies (e.g., carbon tax, subsidy) have the potential to significantly alter the design of these facilities, the selection of the feedstocks, and the scheduling of multiple feedstocks. The objective of this stage is to develop a systematic approach to the design and scheduling of biodiesel production processes while accounting for the effect of GHG policies in addition to the technical, economic, and environmental aspects. An optimization formulation is developed to maximize the profit of the process subject to flowsheet synthesis and performance modeling equations. Furthermore, the carbon footprint is accounted for through a life cycle analysis (LCA). The objective function

* Part of this chapter is reprinted with permission from Elms, R.D., El-Halwagi., "The Effect of Greenhouse Gas Policy on the Design and Scheduling of Biodiesel Plants with Multiple Feedstocks." *Clean Technologies and Environmental Policy*, in press. Copyright 2009 by Springer Science + Business Media. DOI: 10.1007/s10098-009-0260-1. www.springeronline.com.

includes a term which reflects the impact of the LCA of a feedstock and its processing to biodiesel. A multiperiod approach is used to discretize the decision making horizon into time periods. During each period, decisions are made on the type and flowrate of the feedstocks as well as the associated design and operating variables. A case study is solved with several scenarios of feedstocks and GHG policies.

5.2 Introduction

5.2.1 Biodiesel

Interest in biodiesel as a renewable and more environmentally friendly alternative to petroleum based diesel has increased over the last 10 years, with demand increasing steadily since 1999. The advent of the Biodiesel Tax Incentive saw a 300% increase in biodiesel demand from 2004 to 2005. Current US biodiesel production capacity is 2.61 billion gallons, with 460 million gallons sold during the 2007 fiscal year. (National Biodiesel Board, 2007, 2008)

Biodiesel consists of esters of lower alcohol and fatty acids, or Fatty Acid Methyl Esters (FAME). Currently, triglyceride transesterification is the primary production method. The triglyceride is reacted with excess alcohol in the presence of a catalyst to yield glycerol and methyl esters. Various food and non-food feedstock options can be utilized, such as vegetable oil, animal fat, or tallow. Both virgin oils and recycled/waste oil can

be used as feedstock sources. Examples of vegetable-based feedstock oils include soy, rapeseed, canola, sunflower, palm, jatropha, camelina, and many more. Restaurant cooking oil, yellow grease, and trap grease are typical examples of recycled or waste oil feedstock sources. These sources are less expensive, but have a higher free fatty acid (FFA) content, requiring pretreatment prior to use for biodiesel production. Recycled or waste oil, referred to as waste cooking oil (WCO) by some, can be either vegetable or animal derived. Examples include used restaurant cooking oil, yellow grease, and trap grease. These sources are typically inexpensive, but have higher FFA content and require pretreatment. Currently, soy is the predominate feedstock oil source in the US, with rapeseed being the predominate source in Europe.

5.2.2 Environmental Benefits

In recent years, the subject of climate change has received much attention and interest. In particular, the mitigation of CO₂ production from use of petroleum-based fuels via replacement with renewable fuel options has been a main focus. Biodiesel offers a means by which to simultaneously reduce reliance on fossil fuels and environmental impact of fuel usage. Biodiesel has many environmental benefits when compared to its petroleum-based counterpart. (Demirbas, 2009a; Carraretto et al., 2004, Sheehan et al., 1998) Among these benefits are reduction of emissions of unburned hydrocarbons, CO₂, CO, sulfates, and particulate matter. (Demirbas, 2009a; Sheehan et al., 1998) Of

particular interest here, a reduction of 78% in the net gain of CO₂ emissions is obtained by using biodiesel as opposed to petroleum-based diesel. (Sheehan et al., 1998)

5.2.3 Life Cycle Analysis and Biodiesel

Life cycle analysis is an evaluation of the environmental burdens of an entity during its life cycle in order to provide a measure of its environmental impact. (DeBenetto & Klemes, 2009; Smith et al., 2007; Sheehan et al., 1998) Environmental and energy flows to and from the environment during the product life cycle can be assessed from the production of the raw materials through the end usage of the product. (DeBenetto & Klemes, 2009; Smith et al., 2007; Carraretto et al., 2004; Sheehan et al., 1998) The main steps in LCA are identification of goals and definition of scope, inventory analysis, impact assessment, and interpretation. (DeBenetto & Klemes, 2009) Various approaches and models for accomplishing LCA exist. Three of the most widely utilized models include greenhouse gases, regulated emissions, and energy use in transportation (GREET), economic input-output life cycle assessment (EIO-LCA), and SimaPro. GREET was developed by Argonne National Lab to provide for assessment of environmental impacts of using traditional and alternative transportation fuels. (Wang 1999, 2000) This model is process-based and focuses upon energy consumption and air emissions, utilizing EPA and other U.S. governmentally-derived data. (Miller & Theis, 2006) The EIO was originally developed by Leontief (1986) and provides a framework to model the interplay of sectors within an economy, quantifying economic

contributions, air emissions, and energy and water consumption. Hendrickson et al. (2006) coupled the EIO models with LCA. The basis of the EIO-LCA model is the 1992 U.S. Department of Commerce commodity input-output matrix of the U.S. economy, utilizing data from a variety of sources. (Miller & Theis, 2006) SimaPro, a software package developed by Pré Consultants, consists of modules of process-based data arranged by the user. Data from both U.S. and European sources are utilized, with most environmental impacts available for analysis. (Miller & Theis, 2006)

Recently, the sustainability and environmental benefit of large scale biofuel production has been questioned in light of emerging research pertaining to indirect and direct land use change. (Panchelli & Gnansounou, 2008; Searchinger et al., 2008; Majer et al., 2009) Several studies have begun to investigate and report the more intricate relationship between biofuel-related carbon savings, land conversion, feedstock type, and type of land utilized for feedstock growth. (Fargione et al., 2008; Panchelli & Gnansounou, 2008; Searchinger et al., 2008; Majer et al., 2009) Such work has elicited review and discussion of the appropriate system boundaries needed to accurately assess the life cycle and environmental impacts of biofuels.

Various studies have been conducted concerning the life cycle of biodiesel. One of the longest and most comprehensive studies has been reported by Sheehan and colleagues (1998) concerning soy-based biodiesel. A study of biodiesel life cycle energy balances from soybean and canola feedstocks was conducted by Smith et al. (2007) LCA results

for biodiesel produced from other feedstocks, palm oil-based (Thamsiroj & Murphy, 2009; Reijnders and Huijbregts, 2008; Wicke et al., 2008) and rapeseed-based (Lopez et al., 2009; Thamsiroj & Murphy, 2009), have also been reported.

5.2.4 Greenhouse Gas Policy Options

5.2.4.1 Carbon Tax

A carbon tax is a tax on carbon dioxide and other greenhouse gas emissions, with taxation of greenhouse gas emissions other than carbon dioxide typically expressed in terms of their equivalence to carbon dioxide. The impetus behind carbon taxation and the other policy options to be enumerated is protection of the environment and slowing of climate change via reduction of carbon dioxide emissions. Implementation can occur by taxation of fossil fuel usage in proportion to their carbon content. Purported advantages to such a policy are its simplicity and ease of implementation. (GAO, 2008)

5.2.4.2 Cap and Trade

A cap and trade program is a market-based policy tool utilized to provide environmental protection. The program institutes an overall cap on emissions that enumerates a maximum amount of emissions permitted from sources (those producing the emissions)

included in the program. Allowances, or individual authorizations, to emit a specific amount of a pollutant is determined by the program regulating authority. The sum of the allowances is equal to the level of the cap. Compliance is achieved by each source relinquishing allowances that equate to their actual emissions. Allowances can be bought or sold or reserved for future use (banked.) A source of emissions can lower their emissions in order to have allowances to trade, sell, or bank. Or, a source can continue producing emissions above their allowance holdings and purchase allowances to cover excess emissions. Each source has the flexibility to determine and/or adjust its strategy for compliance without government review or approval. From an environmental perspective, an advantage of this policy is a strict limitation on total emissions. Among potential disadvantages, the grandfathering of existing businesses at the time of implementation creates a potentially inequitable situation for development of new competitors. (GAO, 2008)

5.2.4.3 Carbon Subsidies

Subsidies can be implemented in various forms. Direct subsidies are the most simple form, involving a direct monetary transfer to the recipient, such as an agency outlay. The definition of indirect subsidies is extremely broad and is capable of encompassing many different forms, such as tax relief. Direct subsidies will be of focus in this investigation. A potential advantage of such a policy tool is transparency, while potential disadvantages being market distortion and production of inefficiencies. (GAO, 2008)

GHG policy may take various forms, but the general effect on biodiesel profitability should be the same, whether the framework is something akin to a subsidy, tax credit, or carbon permitting such as with a cap and trade scheme. A subsidy would provide a direct payment, a tax credit diminishes tax liability, and under a cap and trade scenario, operating costs pertaining to emissions permits would not be necessary or lessened. The extent of resultant assistance provided to the producer, and therefore the impact on profitability, will differ according to the policy form and details. Overall, regardless of form and details, the goal of the policy is to provide an economic benefit to biodiesel not given to petroleum-based diesel, thereby encouraging production by decreasing the existing disparity in production costs between the two.

The overarching questions to be addressed by this work lie at the interface of enhancing the performance of the process (which is desirable from the manufacturer's perspective) and incorporating the impact of GHG policies on process design and scheduling (which is desirable from the policy maker's viewpoint). Specifically, the paper addresses the following questions:

- How should a biodiesel production facility be designed to optimize economic objectives?
- When more than one feedstock is considered for the process, how should the multiple feedstocks be scheduled?
- If there is a carbon tax/credit, how does that impact process design and scheduling?

While the objectives of the manufacturer and the regulator are not necessarily aligned, the paper endeavors to develop a systematic approach as a framework for reconciling the different objectives on a consistent basis.

5.3 Motivation and Problem Statement

Due to the increase in environmental-centered interests, it was desired to investigate the effects of potential GHG policy on the profitability of biodiesel production. Various policies have been proposed and discussed in recent years. This work strives to investigate some of these options with a systems approach rooted in true design consideration, with the goal of providing relevant information for both policy-makers and biodiesel producers related to the associated impacts on the financial viability of production and provide analysis of related challenges or issues that need to be addressed. The value of such information to policy-makers is related to developing and formulating GHG policy decisions that will provide the desired incentive and/or outcome, while the value to producers is related to informed promotion of desired policies and/or preparation for policy enactment. The problem to be addressed in this can be formally stated as follows:

Given is a biodiesel production facility of given design and production capacity. The process can utilize N_f alternative feedstocks. It is desired to develop a systematic

procedure for the design, operation, and scheduling of the facility with and without carbon subsidies.

Relevant challenges and questions associated with addressing the problem include:

- What is the optimal flowrate of each feedstock?
- How should the flowrate of each feedstock be scheduled?
- Should the feedstocks be co-fed or utilized separately?
- How should the process design and scheduling be adjusted under different economic conditions (e.g. feedstock price?)
- Is there a need for a carbon subsidy to insure a minimum return on investment of the process for certain feedstocks? If so, what is the appropriate level of subsidy needed for each feedstocks and what is the impact of varying such subsidies?

The problem is stated as follows:

Given a continuous process with,

- A certain level of CO₂ emitted per ton feedstock to produced biodiesel, $E_{feedstock}^{CO_2}$.
- A set of pre-treatment units $U = \{u | u = 1, 2, \dots, N_T\}$. Each pre-treatment unit, u , has a set of input streams $INPUT_u = \{i_u | i_u = 1, 2, \dots, N_u^{in}\}$ and a set of output streams $OUTPUT_u = \{j_u | j_u = 1, 2, \dots, N_u^{out}\}$. Input stream i_u has a flowrate of F_{i_u}

and composition of component q of $X_{i_u,q}$. Output stream j_u has a flowrate of

G_{j_u} and a composition of component q of $Y_{j_u,q}$.

- A set of common process units $V = \{v | v = 1, 2, \dots, N_{PU}\}$. Each pre-treatment unit, v , has a set of input streams $INPUT_v = \{i_v | i_v = 1, 2, \dots, N_v^{in}\}$ and a set of output streams $OUTPUT_v = \{j_v | j_v = 1, 2, \dots, N_v^{out}\}$. Input stream i_v has a flowrate of F_{i_v} and composition of component q of $X_{i_v,q}$. Output stream j_v has a flowrate of G_{j_v} and a composition of component q of $Y_{j_v,q}$.
- A set of product discharges for the process $P = \{p | p = 1, 2, \dots, N_p\}$.
- A set of waste discharges for the process $W = \{w | w = 1, 2, \dots, N_w\}$.
- A set of intermediate streams $B = \{b | b = 1, 2, \dots, N_b\}$ that are redirected back into the process. Input stream i_b has a flowrate of F_{i_b} and composition of component q of $X_{i_b,q}$. Output stream j_b has a flowrate of G_{j_b} and a composition of component of $Y_{j_b,q}$.
- A given time horizon (t_h) for decision-making. Within this time horizon, the variations in the market conditions are anticipated and expressed in terms of time-dependent changes in prices and quantities of supply (reagents, feedstocks, etc.) and demand (products and byproducts).

It is desired to produce a systematic procedure that is market-sensitive and can determine process design, feedstock selection and scheduling, and requisite greenhouse gas subsidies so as to maximize the process profit.

5.4 Approach

The following simplifying assumptions were made:

- The decision-making time horizon is discretized into N_t periods. This results in a set of operation periods defined as $\text{PERIODS} = \{t|t= 1,2, \dots,N_t\}$. Within each time period, the process is operating at steady-state. In addition, only intra-period integration is allowed. (Therefore, no storage, integrations, or exchange of streams occurs over more than one period.)
- Only two options are available for process modifications:
 - a.) Adjustment of select design and operating variables for each unit within explicit ranges
 - b.) Addition of new pretreatment units

5.4.1 Structural Representation

To permit broad depiction of the assorted possible relevant configurations, a source-sink structural representation of the problem was chosen. Outputs from the pretreatment units are divided into different fractionated streams. These fractionated streams are allocated to inputs of the common process units, to inputs of pretreatment units, discharged as wastes, or discharged as final product streams. Each common process unit also discharges multiple outputs. As with the pretreatment units, outputs from the common

Figure 5.1: Source Sink Flowchart - Carbon Dioxide Emissions Included

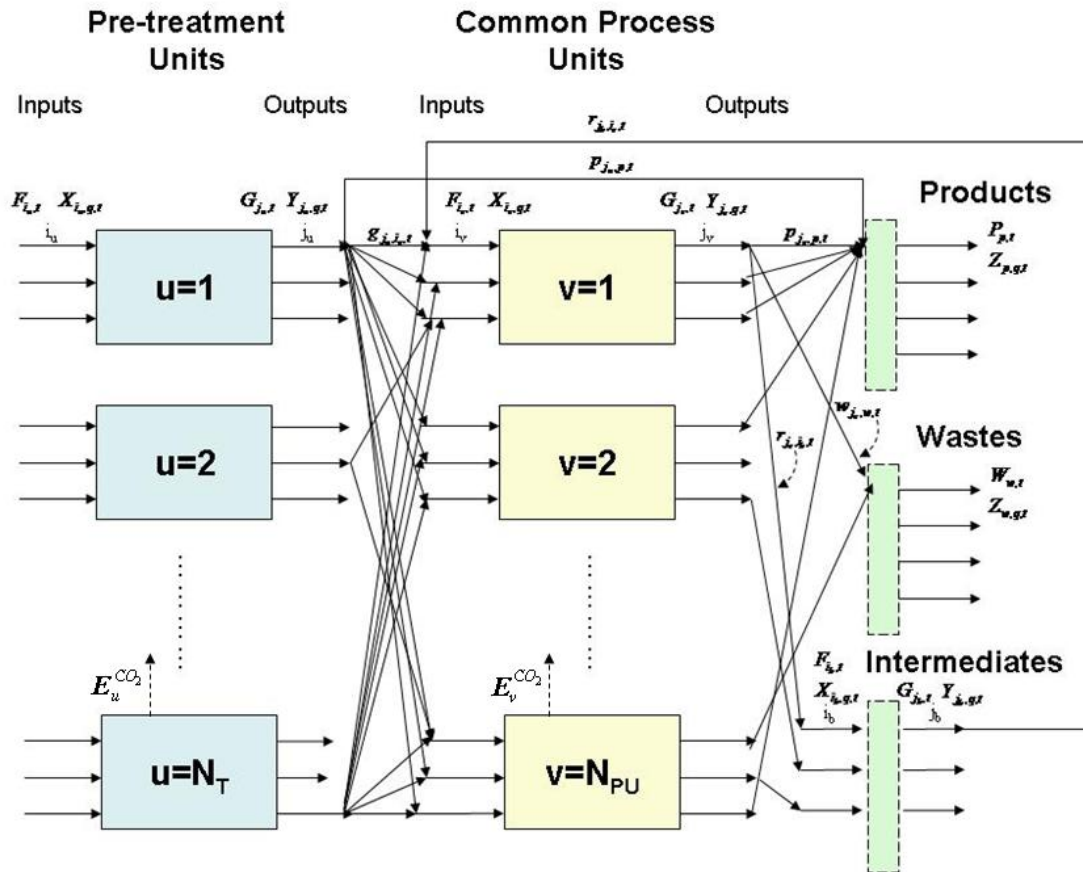

process units are divided into fractionated streams. These fractionated streams are discharged as final products, discharged as final product, or allocated to return back into the process as process inputs (intermediates). Figure 5.1 depicts a schematic of the structural representation. The CO₂ emissions from the uth pretreatment unit and vth common process unit are indicated with dashed arrows and quantified as $E_u^{CO_2}$ and $E_v^{CO_2}$, respectively.

5.4.2 Mathematical Formulation

5.4.2.1 Carbon Dioxide Emissions

Figure 5.2 gives an overview of the CO₂ life cycle for soy biodiesel. Each block could contain components facilitating either CO₂ sequestration or emission, hence the arrows pointing both downward and upward. The net CO₂ emission for each step in the process is shown in symbolic form. The sum of these terms equate to $E_{soy}^{CO_2}$, the CO₂ emitted per ton of soy oil used as a feedstock to produce biodiesel.

$$E_{soy}^{CO_2} = E_{soy}^{CO_2, growth} + E_{soy}^{CO_2, harvesting} + E_{soy}^{CO_2, seedPT} + E_{soy}^{CO_2, oilext} + E_{soy}^{CO_2, BDprod} + E_{soy}^{CO_2, BDtransport} + E_{soy}^{CO_2, BDuse} \quad (5.1)$$

The CO₂ emitted per ton of waste cooking oil (WCO) used as a feedstock to produce biodiesel is referred to as $E_{WCO}^{CO_2}$. The flowrate of soy oil feedstock into the process over

Figure 5.2: Soy Biodiesel CO₂ Life Cycle Overview

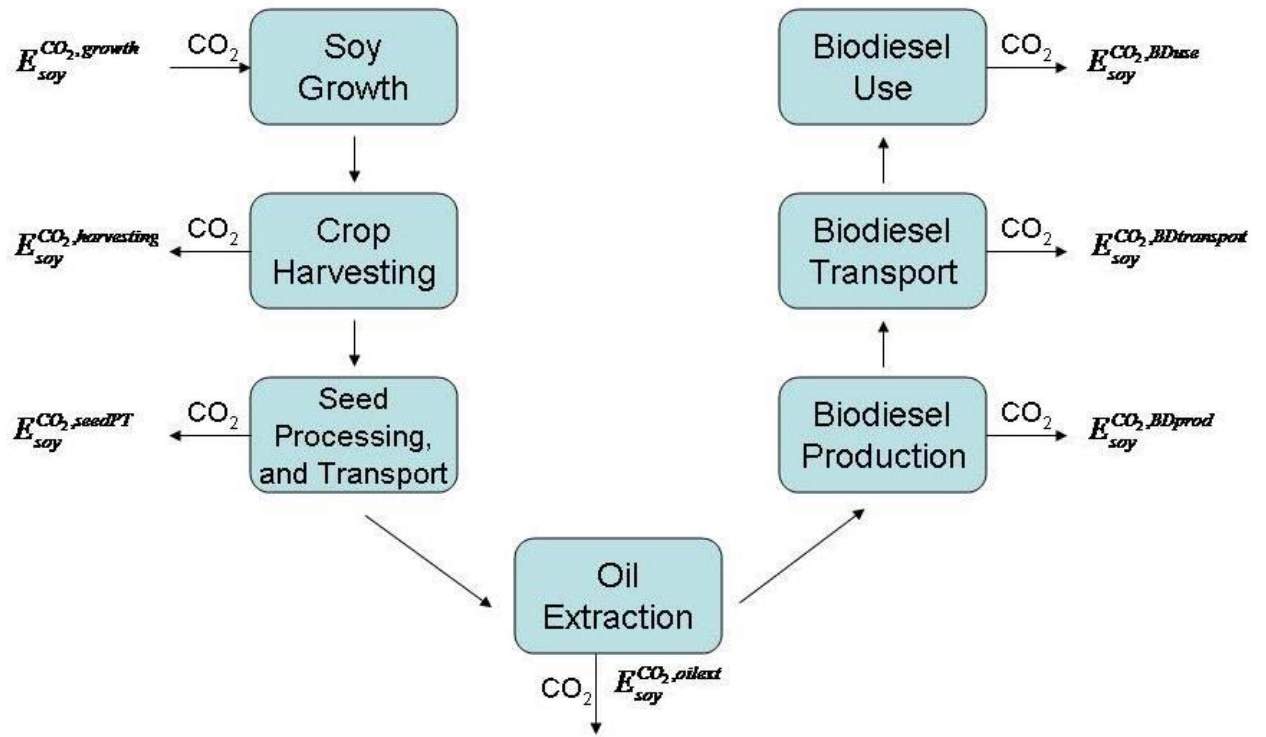

time t is referred to as $F_{soy,t}$, and the flowrate of WCO feedstock into the process over time t is referred to as $F_{WCO,t}$. For a given production rate of biodiesel $P_{BD,t}$, the total quantity of CO₂ emitted over time period t for biodiesel produced using soy oil and/or WCO as feedstock inputs is given by:

$$E_{BD}^{CO_2} = \sum_t \sum_{soy} F_{soy,t} * E_{soy}^{CO_2} + \sum_t \sum_{WCO} F_{WCO,t} * E_{WCO}^{CO_2} \quad (5.2)$$

For a given production rate of petroleum-based diesel $P_{D,t}$, the total quantity of CO₂ emitted over time period t for diesel produced is referred to as $E_D^{CO_2}$. For a given subsidy for reduction of CO₂ emissions (\$/ton CO₂ reduced), S^{CO_2} , the total subsidy attained for biodiesel produced from soy oil and/or WCO feedstocks is given by:

$$TS^{CO_2} = (E_D^{CO_2} - E_{BD}^{CO_2}) * S^{CO_2} \quad (5.3)$$

5.4.2.2 Pretreatment Units

for the pretreatment unit u during period t, the mass balance is given by:

$$\sum_{j_u} G_{j_u,t} = \sum_{i_u} F_{i_u,t} \quad \forall u,t \quad (5.4)$$

The unit u during period t, the qth component balance is expressed as:

$$\sum_{j_u} G_{j_u,t} * Y_{j_u,q,t} = \sum_{i_u} (F_{i_u,t} * X_{i_u,q,t} + \text{Net_Gen}_{u,q,t}) \quad \forall q,u,t \quad (5.5)$$

In equation 5, the index, t, in the flowrate and composition terms refer to the time period over which the compositions and flowrates are considered. The performance model for unit u is expressed by a set of algebraic equations:

$$\begin{aligned} & (G_{j_u,t}, Y_{j_u,q,t} : j_u = 1,2,\dots, N_u^{\text{out}}, q = 1,2,\dots, N_{\text{Components}}) \\ & = f_u(F_{i_u,t}, X_{i_u,q,t} : i_u = 1,2,\dots, N_u^{\text{in}}, q = 1,2,\dots, N_{\text{Components}}, d_{u,t}, o_{u,t}) \\ & \quad \forall u, i_u, q, t \end{aligned} \quad (5.6)$$

5.4.2.2.1 Splitting of source j_u

The flowrate allocated from source j_u to destination i_v during period t is designated as $g_{j_u, i_v, t}$ and the flowrate from source j_u to destination i_u during period t is designated as $g_{j_u, i_u, t}$. The flowrate from the j_u^{th} source is disseminated to other pretreatment units, to the common processing units, to final product streams, and to waste streams. Therefore, for the splitting of source j_u , the material balance is:

$$G_{j_u, t} = \sum_u \sum_{i_u} g_{j_u, i_u, t} + \sum_v \sum_{i_v} g_{j_u, i_v, t} + \sum_p p_{j_u, p, t} + \sum_w w_{j_u, w, t} \quad \forall u, j_u, t \quad (5.7)$$

where $p_{j_u, p, t}$ represents the flowrate assigned from j_u to the p^{th} product stream and $w_{j_u, w, t}$ represents the flowrate from j_u to the w^{th} waste stream.

The total flowrate of the p^{th} product from the N_T pretreatment units in period t is given by:

$$P_{p, t}^T = \sum_u \sum_{j_u} p_{j_u, p, t} \quad \forall p, t \quad (5.8)$$

For the p^{th} product stream coming from the N_T pretreatment units, the q^{th} component material balance is given by:

$$P_{p,t}^T * Z_{p,q,t}^T = \sum_v \sum_{j_u} P_{j_u,p,t} * Y_{j_u,q,t} \quad \forall w, q, t \quad (5.9)$$

The total flowrate of the w^{th} waste stream from the N_T pretreatment units during period t is given by:

$$W_{w,t}^T = \sum_u \sum_{j_u} w_{j_u,w,t} \quad \forall w, t \quad (5.10)$$

For the w^{th} waste stream coming from the N_T pretreatment units, the q^{th} component material balance is given by:

$$W_{w,t}^T * Z_{w,q,t}^T = \sum_u \sum_{j_u} w_{j_u,w,t} * Y_{j_u,q,t} \quad \forall w, q, t \quad (5.11)$$

5.4.2.2.2 Mixing of the split flowrate prior to i_v^{th} input to v^{th} common process unit

The i_v^{th} input to the v^{th} common process unit is composed of contributions from streams departing the pretreatment units and from intermediate streams recycled from the common process units themselves. The flowrate allocated from intermediate source j_b to destination i_v during period t is designated as $r_{j_b,i_v,t}$. The material balance and q^{th} component balance during period t for the mixing of the split flowrate before the i_v^{th} input to the v^{th} common process unit, are given by:

$$F_{i_v,t} = \sum_u \sum_{j_u} g_{j_u,i_v,t} + \sum_b \sum_{j_b} r_{j_b,i_v,t} \quad \forall v, i_v, t \quad (5.12)$$

$$F_{i_v,t} * X_{i_v,q,t} = \sum_u \sum_{j_u} g_{j_u,i_v,t} * Y_{j_u,q,t} + \sum_b \sum_{j_b} r_{j_b,i_v,t} * Y_{j_b,q,t} \quad \forall v, i_v, q, t \quad (5.13)$$

5.4.2.3 Common Process Units

For common process unit v , during period t , the mass balance equation is:

$$\sum_{j_v} G_{j_v,t} = \sum_{i_v} F_{i_v,t} \quad \forall v, t \quad (5.14)$$

For common process unit v , during period t , the q^{th} component balance is:

$$\sum_{j_v} G_{j_v,t} * Y_{j_v,q,t} = \sum_{i_v} (F_{i_v,t} * X_{i_v,q,t} + \text{Net_Gen}_{v,q,t}) \quad \forall q, v, t \quad (5.15)$$

For the v^{th} common process unit, the unit performance equation is:

$$\begin{aligned} & (G_{j_v,t}, Y_{j_v,q,t} : j_v = 1, 2, \dots, N_v^{\text{out}}, q = 1, 2, \dots, N_{\text{Components}}) \\ & = f_v (F_{i_v,t}, X_{i_v,q,t} : i_v = 1, 2, \dots, N_v^{\text{in}}, q = 1, 2, \dots, N_{\text{Components}}, \mathbf{d}_{v,t}, \mathbf{o}_{v,t}) \quad \forall v, i_v, q, t \quad (5.16) \end{aligned}$$

5.4.2.3.1 Splitting of the j_v^{th} stream leaving the v^{th} common process unit

N_w waste streams and N_p product streams leave the process. N_B intermediate streams are rerouted back into the process. Each output stream j_v from a common process unit is split into several flowrates, with some allocated to waste outlets, some to product streams, and some to intermediate streams that will be subsequently recycled back into the process. The flowrate assigned to the w^{th} waste stream is designated as $w_{j_v, w, t}$. The flowrate allocated to the p^{th} product stream is designated as $p_{j_v, p, t}$. The flowrate allocated to the b^{th} intermediate stream is designated as $r_{j_v, b, t}$. Therefore, for the splitting of the j_v^{th} stream, the material balance is given by:

$$G_{j_v, t} = \sum_w w_{j_v, w, t} + \sum_p p_{j_v, p, t} + \sum_b r_{j_v, b, t} \quad \forall v, j_v, t \quad (5.17)$$

From the N_{PU} common process units, the flowrate of the w^{th} waste stream is:

$$W_{w, t}^{PU} = \sum_v \sum_{j_v} w_{j_v, w, t} \quad \forall w, t \quad (5.18)$$

For the w^{th} waste stream from the N_{PU} common process units, the q^{th} component material balance is expressed as:

$$W_{w,t}^{PU} * Z_{w,q,t}^{PU} = \sum_v \sum_{j_v} w_{j_v,w,t} * Y_{j_v,q,t} \quad \forall w, q, t \quad (5.19)$$

From N_{PU} common process units, the flowrate of the p^{th} product stream is:

$$P_{p,t}^{PU} = \sum_v \sum_{j_v} p_{j_v,p,t} \quad \forall p, t \quad (5.20)$$

For the p^{th} product stream from the N_{PU} common process units, the q^{th} component material balance is:

$$P_{p,t}^{PU} * Z_{p,q,t}^{PU} = \sum_v \sum_{j_v} p_{j_v,p,t} * Y_{j_v,q,t} \quad \forall p, q, t \quad (5.21)$$

From the N_{PU} common process units, the flowrate of the b^{th} intermediate stream is:

$$R_{b,t}^{PU} = \sum_v \sum_{j_v} r_{j_v,b,t} \quad \forall b, t \quad (5.22)$$

For the b^{th} intermediate stream from the N_{PU} common process units, the q^{th} component material balance is:

$$R_{b,t}^{PU} * Z_{b,q,t}^{PU} = \sum_v \sum_{j_v} r_{j_v,b,t} * Y_{j_v,q,t} \quad \forall b, q, t \quad (5.23)$$

5.4.2.4 Product Streams

For the p^{th} product out of the process, the flowrate is:

$$P_{p,t} = P_{p,t}^T + P_{p,t}^{PU} = \sum_u \sum_{j_u} p_{j_u,p,t} + \sum_v \sum_{j_v} p_{j_v,p,t} \quad \forall p,t \quad (5.24)$$

For the p^{th} product stream from the process, the q^{th} component material balance is:

$$P_{p,t} * Z_{p,q,t} = (P_{p,t}^T * Z_{p,q,t}^T) + (P_{p,t}^{PU} * Z_{p,q,t}^{PU}) = \sum_u \sum_{j_u} p_{j_u,p,t} * Y_{j_u,q,t} + \sum_v \sum_{j_v} p_{j_v,p,t} * Y_{j_v,q,t} \quad \forall p,q,t \quad (5.25)$$

5.4.2.5 Waste Streams

For the w^{th} waste stream out of the process, the flowrate is:

$$W_{w,t} = W_{w,t}^T + W_{w,t}^{PU} = \sum_u \sum_{j_u} w_{j_u,w,t} + \sum_v \sum_{j_v} w_{j_v,w,t} \quad \forall w,t \quad (5.26)$$

For the w^{th} waste stream from the process, the q^{th} component material balance is:

$$W_{w,t} * Z_{w,q,t} = (W_{w,t}^T * Z_{w,q,t}^T) + (W_{w,t}^{PU} * Z_{w,q,t}^{PU}) = \sum_u \sum_{j_u} w_{j_u,w,t} * Y_{j_u,q,t} + \sum_v \sum_{j_v} w_{j_v,w,t} * Y_{j_v,q,t} \quad \forall w, q, t \quad (5.27)$$

5.4.2.6 Intermediate Streams Recycled Back into the Process

5.4.2.6.1 Mixing of the split flowrate prior to the i_b^{th} input to the intermediate block

The i_b^{th} input to the intermediate block is composed of contributions from streams departing the common process units. The flowrate allocated from source j_v to destination i_b during period t is designated as $r_{j_v,i_b,t}$. The material balance and q^{th} component balance during period t for the mixing of the split flowrate prior to the i_b^{th} input to the intermediate block, are given by:

$$F_{i_b,t} = \sum_{j_v} r_{j_v,i_b,t} \quad \forall b, i_b, t \quad (5.28)$$

$$F_{i_b,t} * X_{i_b,q,t} = \sum_{j_v} r_{j_v,i_b,t} * Y_{j_v,q,t} \quad \forall b, i_b, q, t \quad (5.29)$$

5.4.2.7 Intermediate block

For the intermediate block during time t, the mass balance equation is:

$$\sum_{j_b} G_{j_b,t} = \sum_{i_b} F_{i_b,t} \quad \forall b,t \quad (5.30)$$

For the intermediate block during time t, the q^{th} component balance is:

$$\sum_{j_b} G_{j_b,t} * Y_{j_b,q,t} = \sum_{i_b} (F_{i_b,t} * X_{i_b,q,t}) \quad \forall q,b,t \quad (5.31)$$

5.4.2.7.1 Splitting of the j_b^{th} stream leaving the intermediate block

The flowrate allocated from source j_b to destination i_v during period t is designated as

$r_{j_b,i_v,t}$. Therefore, the material balance for the splitting of source j_b is expressed as:

$$G_{j_b,t} = \sum_v \sum_{i_v} r_{j_b,i_v,t} \quad \forall j_b,b,t \quad (5.32)$$

5.4.3 Constraints

The operating and design constraints for the pretreatment units and the common process units are given by:

$$d_u^{\min} \leq d_{u,t} \leq d_u^{\max} \quad (5.33)$$

$$d_v^{\min} \leq d_{v,t} \leq d_v^{\max} \quad (5.34)$$

$$o_u^{\min} \leq o_{u,t} \leq o_u^{\max} \quad (5.35)$$

and

$$o_v^{\min} \leq o_{v,t} \leq o_v^{\max} \quad (5.36)$$

The product composition and demand constraints are given by:

$$P_{p,t} \leq P_{p,t}^{Demand} \quad (5.37)$$

For the i_u^{th} input to the process unit, the flowrate and composition constraints are expressed as:

$$F_{i_u}^{\min} \leq F_{i_u,t} \leq F_{i_u}^{\max} \quad (5.38)$$

and

$$X_{i_u,q}^{\min} \leq X_{i_u,q,t} \leq X_{i_u,q}^{\max} \quad (5.39)$$

For the i_v^{th} input to the v^{th} common process unit, the flowrate and composition constraints are expressed as:

$$F_{i_v}^{\min} \leq F_{i_v,t} \leq F_{i_v}^{\max} \quad (5.40)$$

and

$$X_{i_v,q}^{\min} \leq X_{i_v,q,t} \leq X_{i_v,q}^{\max} \quad (5.41)$$

The subsidy constraint is given by:

$$S^{CO_2,\min} \leq S^{CO_2} \leq S^{CO_2,\max}$$

As various potential feedstocks are agricultural products, a seasonality dimension may impact related constraints. Also, the resilience of some crops to certain storage scenarios may vary. Some feedstocks may be more prone to deterioration and degradation with time and/or environmental conditions related to time of year. Therefore, additional constraints would be necessary for utilization of such feedstocks.

5.4.4 Objective Function

Because of the generic nature of the devised approach and the associated optimization formulation, various objective functions may be used. For instance, the fixed capital investment may be annualized through a linear depreciation or amortized using a cash flow scheme which accounts for the time value of money. Also, the economic impact of a GHG policy may be modeled through a cap-and-trade scheme or a carbon subsidy. Consequently, the objective function may be described in numerous ways using the same proposed framework. For instance, the following optimization formulation is posed to maximize gross profit given by revenue minus the cost of feedstocks and reactants, process operating cost, and pretreatment costs (if applicable), plus the respective CO₂ reduction subsidy:

$$\left(\begin{array}{c} \text{Product/Byproduct} \\ \text{Revenue} \end{array} \right) - \left(\begin{array}{c} \text{Cost of Feedstocks} \\ \text{And Reactants} \end{array} \right) - \left(\begin{array}{c} \text{Process} \\ \text{Operating} \\ \text{Cost} \end{array} \right) - \left(\begin{array}{c} \text{Pretreatment} \\ \text{Cost} \end{array} \right) + \left(\begin{array}{c} \text{CO}_2 \\ \text{Reduction} \\ \text{Subsidy} \end{array} \right)$$

In terms of mathematical expression, a multi-period representation is used. Considering a given decision-making horizon t_h that is discretized into a number (N_t) of time intervals, the discretization may be uniform (e.g., monthly or quarterly) or event-based (e.g., to correspond to availability of feedstocks or crop harvesting times). The time intervals are represented by the index t . There exist (N_f) feedstock alternatives with an index (f). Therefore, the objective function is expressed as

$$\sum_t \sum_p C_{p,t}^{product} * P_{p,t} - \sum_t \sum_f C_{f,t}^{feedstock} * F_{f,t} - \sum_t POC_t - TAC^{Pretreatment} + TS^{CO_2} \quad (5.42)$$

where $C_{p,t}^{product}$ is the unit selling price of product p during period t, $P_{p,t}$ is the production rate of product p during time t, $C_{f,t}^{feedstock}$ is the cost of feedstock f during period t, $F_{f,t}$ is the feed rate of feedstock f during time t, and POC_t represents the process operating cost excluding feedstocks (e.g., utilities, labor, management, waste treatment, etc.) during period t. As previously defined, the total subsidy attained is referred to as TS^{CO_2} . The term $TAC^{Pretreatment}$ is the total annualized cost of retrofitted pretreatment. This is defined as the sum of the annualized fixed costs (AFC) and the annual operating cost (AOC) and is given by:

$$TAC^{Pretreatment} = \sum_f I_f * AFC_f + \sum_t \sum_f AOC_{f,t}^{Pretreatment} \quad (5.43)$$

I_f is a binary integer variable designating the presence or absence of the f^{th} feedstock and is determined through the following constraint:

$$\sum_t F_{f,t} \leq F_{f,t}^{max} * I_f \quad \forall f \quad (5.44)$$

$F_{f,t}^{\max}$ is an upper bound on the allowable flowrate of feedstock f . When the flowrate is positive, the value of I_f is forced to a value of one. Otherwise, it will take a value of zero.

The previously outlined constraints are developed for the various feedstocks and time intervals. The mathematical program for the problem is composed of the foregoing expressions and is a mixed integer nonlinear program (MINLP). This program can be solved in order to identify process modifications and selection, the optimal feedstock scheduling, design of the pretreatment units and common process units, and requisite carbon subsidy for attainment of a certain level of profitability. If the process models are linearized (which is reasonable if the operation and design changes are maintained close to the nominal conditions), then the program can be solved as a mixed integer linear program (MILP).

5.5 Case Study

Three different biodiesel production scenarios or cases were considered. Two feedstocks, refined soy oil and WCO (50% FFA), were utilized to produce B100. All three cases were based upon 40 MMGPY biodiesel production with a biodiesel selling price of \$2.88/gal. This selling price represents a value inbetween diesel and biodiesel selling prices over the last several months. (DOE, 2008b; 2009a, b) The cases investigated were:

- 1.) Biodiesel production using only refined soy oil as feedstock
- 2.) Biodiesel production using only WCO as feedstock
- 3.) Biodiesel production using multiple feedstocks (refined soy oil and WCO)

An overview of the three cases can be seen in Table 5.1. The soy oil feedstock price was set at \$0.49/lb, a high price seen in recent years. The WCO feedstock price was set at \$0.20/lb, a value much higher than current prices. The intent was to simulate a scenario in which demand, and therefore also price, had increased. In Case 3, 15 MMGPY of biodiesel was produced using WCO as a feedstock, with the remaining volume of biodiesel being produced using soy oil. This quantity of WCO-based biodiesel was determined using the available feedstock for a scenario consisting of a large city with a population of ~3 million people, producing ~10 gal of WCO/person/year. It was assumed that no limit existed on the availability of refined soy oil.

Facility design was based upon a biodiesel production configuration proposed by Myint (2007) and Myint and El-Halwagi (2009), as shown and discussed in CHAPTER IV. To review, the facility produces 40 MMPGY biodiesel via transesterification. Calculations are based upon an 8000 hour work year. Transesterification was accomplished by

Table 5.1: Cases for 40 MMGPY Biodiesel Production

Case	Description	Feedstock and Price
1	All Soy Feedstock	Soy, \$0.49/lb
2	All WCO Feedstock	WCO (50% FFA), \$0.20/lb
3	Multiple Feedstocks (15 MMGPY WCO-based biodiesel)	Soy, \$0.49/lb WCO (50% FFA), \$0.20/lb

reacting the feedstock oil with an excess of methanol in the presence of NaOH. The reaction occurred at 60°C for a duration of 1 hour, with a conversion of 0.97. The alcohol to triglyceride ratio was 6:1 and the soy oil was presumed to have no more than 0.5% free fatty acid content. (Freedman et al., 1986, 1984) Following transesterification, the glycerol was removed and subsequently purified. After glycerol removal, methanol was removed from the biodiesel, and the biodiesel was washed with water. The process products are biodiesel with a purity of 99.2% and glycerol with a purity of 98.5%. Mass and heat integration were conducted for the facility and is reflected in costing. For the facilities utilizing WCO (Cases 2 and 3,) pretreatment capability was added to the facility design.

5.5.1 Estimation of Capital and Operating Costs

Costing for the 40 MMGPY biodiesel (B100) production facility was developed, as previously described in CHAPTER IV. In short, capital costs were developed from

literature-based values brought up to scale for a 40 MMGPY process, then updated to 2007 dollars by use of the CEPCI. (Zhang, 2002; Zhang et al., 2003b; Chemical Engineering Plant Cost Index, 2004, 2007, 2008; Tyson et al., 2004; You et al., 2008) Due to its significant contribution to capital costs, the transesterification reactor was sized and priced separately. Capital cost estimation for the waste cooking oil included pretreatment-related costs. The facilities in both Cases 2 and 3 were developed to have the capability to produce all 40 MMGPY biodiesel using WCO as a feedstock.

Operating costs were developed by use of literature values (Zhang, 2002; Zhang et al., 2003b; Tyson, et al., 2004; You et al., 2008), standard rules of thumb, and current raw material costs. Additional annual operating costs related to pretreatment of the WCO amount to \$2,118,000/yr. (\$0.05/gal biodiesel) (Tyson et al., 2004).

The capital costs and the Annual Operating Cost (AOC) minus feedstock cost, are shown in Table 5.2, with and without pretreatment. Feedstock cost is not included in the AOC, since its value varies in each of the three cases. Raw material costs are shown in Table 5.3.

Table 5.2: Capital and Operating Costs for Biodiesel Production (40 MMGPY) with and without Pretreatment

	<u>Without Pretreatment</u>	<u>With Pretreatment</u>
Fixed Capital Investment (FCI)	\$17,779,000	\$22,479,000
Annualized Fixed Cost (AFC)	\$2,072,000/yr	\$2,972,000/yr
Annual Operating Cost (AOC) minus feedstock cost	\$16,970,000/yr	\$19,089,000/yr

Table 5.3: Raw Material Costs

<u>Material</u>	<u>Cost (\$/lb)</u>
NaOH	1.26
Methanol	0.24
HCl	0.60
Refined Soy Oil	0.49
Waste Cooking Oil (50% FFA)	0.20

5.5.2 Estimation of CO₂ Emissions

CO₂ emissions were estimated using information reported by Sheehan and colleagues (1998) with regards to life cycle CO₂ emissions for petroleum-based diesel and soy-based biodiesel, and are shown in Table 5.4. Values were from ‘cradle’ through end-

use. It was assumed that soy growth occurred on existing agricultural land and no potential indirect land use change effects were considered or taken into account. For WCO-based biodiesel, CO₂ emissions prior to biodiesel production were set to zero, since WCO is a waste product with the original pre-used oil produced for an unrelated use. For the purposes of this case study, the assumption is made that any emissions resulting from differences in biodiesel production from soy oil and WCO are negligible.

Table 5.4: CO₂ Emissions for Biodiesel Produced from Soy Oil and WCO

Feedstock	g CO ₂ emitted/ lb feedstock	g CO ₂ emitted/ gal biodiesel	Reduction of CO ₂ Emissions when Compared to Petroleum-based Diesel	
			g CO ₂ reduced/ lb feedstock	g CO ₂ reduced/ gal biodiesel
Soy	266.05	2048.62	968.74	7459.27
WCO (50% FFA)	74.25	1143.52	543.14	8364.38

5.6 Results

The profitability of the three cases and potential CO₂ subsidies were investigated. For each of the three cases, the annual profit was determined, as well as the annual profit corresponding to a 15% return on investment (ROI). In addition, the CO₂ subsidies needed for each case to facilitate the respective 15% ROI values, were ascertained.

Annual profit and ROI were defined as shown below. The selling price utilized for glycerol (non-kosher) was \$0.98/lb, a value obtained from CLP Chemical in April 2008.

- $\text{Annual Profit} = \text{Annual Sales} - \text{Annualized Fixed Cost (AFC)} - \text{Annualized Operating Cost (AOC)}$
- $\text{Return on Investment (ROI)} = (\text{Annual Profit} / \text{Total Capital Investment}) * 100\%$

Table 5.5 shows annual profit, annual profit corresponding to a 15% ROI, and subsidy values corresponding to facilitating a 15% ROI for each of the 3 cases.

Table 5.5: Annual Profit, Annual Profit Corresponding to a 15% ROI, and Related Subsidies for a 15% ROI

<u>Case</u>	<u>Annual Profit (\$/yr)</u>	<u>Annual Profit corresponding to 15% ROI (\$/yr)</u>	<u>Subsidy to facilitate 15% ROI (\$/ton CO₂ reduced)</u>
1	-15.5M	2.67M	56
2	-22.6M	3.37M	71
3	-9.88M	3.37M	39

A loss occurs for all three considered cases, with Case 2 (all WCO) having the largest loss of ~\$22.6M/yr, and Case 3 (multiple feedstock) the smallest loss of ~\$9.88M/yr.

The calculated CO₂ subsidies needed to facilitate a 15% ROI ranged from \$39/ton CO₂

reduced for Case 3 to \$71/ton CO₂ reduced for Case 2. These values are similar to subsidies seen in Europe.

Under the given conditions, this approach gives the range of subsidies needed to promote biodiesel production from soy oil and/or WCO at a certain level. The results indicate that if it is desired to promote WCO usage as a feedstock, a larger subsidy (by \$15/ton CO₂ reduced) will be needed than to promote soy. In addition, from these results, the insight is gained that the multi-feedstock scenario needs the least amount of assistance to be viable.

5.7 Conclusions

A systematic approach is being developed for the design and scheduling of biodiesel production processes taking into account the effect of GHG policies, in addition to the economic, technical, and environmental aspects of production. Traditionally, technical and economic factors have dominated design and scheduling considerations. The new approach presented here allows for inclusion of a previously neglected component, GHG policy, which has the potential to significantly affect design and scheduling of such facilities. Inclusion of this additional facet provides a robust, flexible, and market-sensitive decision-making tool for both policy-makers and producers.

This approach and the related formulation inherently contain enough flexibility to allow for utilization from various perspectives and for variance of a number of variables, including market-sensitive entities. In terms of the case study presented here, feedstock costs were fixed and related subsidies calculated for a desired level of ROI, thereby investigating potential requisite subsidies for promotion of biodiesel production. The same formulation can be utilized to investigate the effect of an arbitrary subsidy on various design and scheduling scenarios. Another powerful facet of this approach is the ease of inclusion of market variances from the perspective of feedstock cost, fuel selling price, and even capital cost.

CHAPTER VI

CONCLUSIONS AND RECOMMENDATIONS FOR FUTURE WORK

This work focused upon design and operation of biodiesel production facilities in support of the broader goal of developing a strategic approach to the development of biorefineries. Biodiesel production afforded a fitting initiation point for the work due to biodiesel's position and presence in the alternative fuel market. In addition, a biodiesel production facility represents a biorefinery of relatively simple form, and is a likely component of future large-scale integrated biorefineries.

The fundamental framework of a systematic decision-making approach was developed for market sensitive strategic scheduling and design of a biodiesel production process. The first stage of the work resulted in a systematic procedure for determining feedstock selection, usage and scheduling, process modification, and pre-treatment selection and design so as to maximize the process profit. A base-case design was developed for converting soybean oil to biodiesel via transesterification at a scale of 40 MMGPY. The process was simulated using ASPEN Plus in order to identify mass and energy flows and basic sizing of key process equipment. Process integration techniques were applied to conserve mass and energy resources, resulting in \$8,800,000 in annual savings.

The second stage of the work resulted in a procedure for determining process design, feedstock selection and scheduling, and requisite greenhouse gas subsidies so as to maximize the process profit. Traditionally, technical and economic factors have dominated design and scheduling considerations. The new approach presented here allows for inclusion of a previously neglected component, GHG policy, which has the potential to significantly affect design and scheduling of such facilities. Inclusion of this additional facet provides a robust, flexible, and market-sensitive decision-making tool for both policy-makers and producers. This approach and the related formulation inherently contain enough flexibility to allow for utilization from various perspectives and for variance of a number of variables, including market-sensitive entities.

Case studies provided demonstration of the efficacy of the developed approach, as well as insights for the specified conditions. During the first stage, a techno-economic analysis for the given process showed that at the current soy oil cost of \$0.49/lb and the 'current' biodiesel price of \$3.38/gal, when using soy oil as a feedstock, the annual profit is \$3,300,000, the break-even point ~\$0.52/lb, the payback period 3 yrs, and the ROI 14%. At a biodiesel price of \$3.88/gal, the annual profit is ~8 times greater (\$24,500,000), the payback period is much less (0.67 years), and the ROI (134%) almost an order of magnitude greater. A drop in the biodiesel price to \$2.88/gal makes the process non-viable economically.

In contrast to the soy oil analyses, WCO as a feedstock resulted in a more profitable process. At the current WCO cost (\$0.34/lb) and 'current' biodiesel price of \$3.38/gal, the annual profit is \$132,000,000, the break-even point \$0.25/lb WCO, the payback period 0.14 yrs, and the ROI 590 %. Even at a lower biodiesel price (\$2.88/gal), the process still has an annual profit of \$110,000,000, 33 times greater than for soy oil at a biodiesel price of \$3.38/gal.

Glycerin sensitivity analyses demonstrate under the given conditions (\$0.49/lb soy oil, \$0.034/lb WCO) and with the 'current' biodiesel price of \$3.38/gal, the profitability of a WCO-based process is less sensitive to changes in glycerin price than a soy-based process. The viability of the process when using soy oil, is dependent upon glycerin sales, with even a drop in glycerin price of less than 50% resulting in a non-profitable process. In contrast, even with no glycerin-based revenue, the process when using WCO offers a profitable operation as long as the price of the feedstock is kept low.

Feedstock scheduling results demonstrated that for the given conditions and WCO feedstock cost being much lower than that for soy, all available WCO would be utilized prior to utilization of soy oil. Also, it was observed that a 700% increase in WCO cost would be necessary for the two feedstock costs to equate, including taking into account pretreatment costs. For a scenario involving a 300% increase in WCO feedstock cost with a simultaneous sudden drop in soy oil cost to \$0.20/lb, the lower soy oil cost placed

it as the favored and sole feedstock utilized. But, a subsequent small increase in the soy oil cost to \$0.21/lb resulted in WCO again becoming the favored feedstock.

One of the key outcomes of this work was the study of sensitivity of biodiesel production profitability to feedstock in order to provide insight toward biodiesel production that is more robust and resilient to market-changes and therefore more capable of sustaining a presence in the energy marketplace. The results presented support further the need for and benefit of such work.

During the second stage of the work, the profitability of three different biodiesel production cases and potential CO₂ subsidies were investigated. For a 15% ROI and feedstock costs of \$0.49/lb soy and \$0.20/lb WCO, a loss occurred for all three cases considered (all soy, all WCO, multiple feedstock - soy and WCO). Case 2 (all WCO) exhibiting the largest loss at a value of ~\$22.6M/yr. Case 3 (multiple feedstock) had the smallest loss with a value of \$9.88M/yr. Therefore, under the conditions utilized for the case study, all three cases would require a subsidy to be economically viable. The calculated CO₂ subsidies requisite to providing a 15% ROI were \$39/ton CO₂ for Case 3 (multiple feedstock), \$56/ton CO₂ for Case 1 (all soy), and \$71/ton CO₂ reduced for Case 2 (all WCO). These values are similar to subsidies seen in Europe.

Under the given conditions, this approach gives the range of subsidies needed to promote biodiesel production from soy oil and/or WCO at a certain level. The results

indicate that if it is desired to promote WCO usage as a feedstock, a larger subsidy (by \$15/ton CO₂ reduced) will be needed than to promote soy. In addition, from these results, the insight is gained that the multi-feedstock scenario needs the least amount of assistance to be viable.

One of the major contributions provided by this work is the application of inclusion of scheduling issues into design of biodiesel plants. Standard design procedures neglect the inclusion or consideration of scheduling issues. Facility operators must work with the constraints inherent to the facility design when determining scheduling. As a result, unneeded initial capital expenditures for unused/underused equipment or the added expense of subsequent requisite retrofitting are a possibility. In addition, profitability might not be optimized due to inability to process a less expensive or more optimal feedstock. Not only do the procedures developed facilitate well informed decision-making for retrofitting of existing facilities to achieve feedstock flexibility, they also serve as a robust tool for grassroots facility design. In addition, novel inclusion of GHG issues into design and scheduling provides another layer of procedural robustness and utility to the user, whether the perspective of interest is policy or production-related.

Although these efforts focused upon and provided insights and conclusions related to biodiesel production, the significance of the work resides in the broad applicability of the developed procedures and formulations. Development was conducted in as generalized a form as possible to facilitate utilization with other products and facilities,

as well as provide a baseline platform for further development. The procedure can be readily adapted for other biofuels, bioproducts, and/or biorefinery concepts, or even serve as a component or module of a larger framework for development of a multi-faceted integrated biorefinery. Overall, the major contribution provided is the development of a generally applicable and systematic procedure for analysis, design and scheduling of biorefineries and the related optimization formulations, which will aid such facilities in terms of sustainability and economic viability by incorporating feedstock flexibility, market-sensitive scheduling, and effects of GHG policy. More widespread utilization of biomass as a feedstock, whether for biodiesel or other fuels and products, introduces issues for consideration that were previously unnecessary. As mentioned previously, one of the incentives for exploring and incorporating feedstock flexibility is competition with food resources. It should be noted that if desired, the developed model contains enough flexibility to allow for inclusion of a constraint to limit feedstock usage of food sources. The food versus fuel issue is a prime example of the unique challenges associated with development of the biorefinery concept. Although important and essential, profitability is not the only relevant metric for guiding design and operation of such facilities. Sustainability or sustainable design does not simply equate to consideration of environmental concerns or environmentally-conscious design. In order to effectively realize and maintain the potential of biomass resources to meet existing and new needs, related efforts will require assiduous and methodical consideration of and attention to a larger sphere of both influence and impact. Some related issues include the aforementioned issue of food versus fuel,

indirect and direct land use change, water usage, biodiversity-friendly agricultural practices, and land management,

\

The following topics are recommended for future work:

- Optimal plant size and location: tradeoffs between economy of scale and transportation of feedstock and products. Also, environmental implications (more efficient production versus GHG emissions associated with transportation).
Procedural development for managing logistical issues for local and regional-specific implementation.
- Design and scheduling for a more complex facility, such as a biorefinery producing interdependent products where a waste or by-product of one desired product serves as the feedstock for another product.
- Design under uncertainty (e.g., fluctuation in feedstock cost and selling price of products.)
- LCA for various biofuel production pathways and impact on land global climatic issues.
- Detailed analysis of impact of different types of GHG policies on biofuel production pathways, and selection of feedstocks and products.

NOMENCLATURE

In order of appearance:

FAME = fatty acid methyl esters

B100 = diesel fuel comprised of 100% biodiesel

ULSD = ultra low sulfur diesel

CN = cetane number

CP = cloud point

PP = pour point

FFA = free fatty acid

DDG = dried distiller's grain

WCO = waste cooking oil

ATROR = after tax rate of return

N_f = number of feedstock alternatives, f

f = index for feedstock alternatives

U = a set of pretreatment units

u = index for pretreatment units

N_T = number of pretreatment units, u

$INPUT_u$ = the set of input streams for pretreatment unit, u

i_u = index to represent input streams for pretreatment unit, u

N_u^{in} = number of input streams for pretreatment unit, u

$OUTPUT_u$ = the set of output streams for pretreatment unit, u

j_v = index to represent output streams for pretreatment unit, u

N_u^{out} = number of output streams for pretreatment unit, u

F_{i_u} = Flowrate of input stream i_u

$X_{i_u,q}$ = composition of component q in input stream i_u

G_{j_u} = Flowrate of output stream j_u

$Y_{j_u,q}$ = composition of component q in output stream j_u

V = a set of common process units

v = index for common process units

N_{PU} = number of common process units, v

$INPUT_v$ = the set of input streams for common process unit, v

i_v = index to represent input streams for common process unit, v

N_v^{in} = number of input streams for common process unit, v

$OUTPUT_v$ = the set of output streams for common process unit, v

j_v = index to represent output streams for common process unit, v

N_v^{out} = number of output streams for common process unit, v

F_{i_v} = Flowrate of input stream i_v

$X_{i_v,q}$ = composition of component q in input stream i_v

G_{j_v} = Flowrate of output stream j_v

$Y_{j_v,q}$ = composition of component q in output stream j_v

P = a set of product discharges

p = index for product discharges

N_p = number of product discharges, p

W = a set of waste discharges

w = index for waste discharges

N_w = number of waste discharges

B = a set of intermediate streams that are redirected back into the process

b = index for intermediate streams that are redirected back into the process

N_b = number of intermediate streams that are redirected back into the process

i_b = index to represent input stream for the ‘intermediate block’

F_{i_b} = Flowrate of input stream i_b

$X_{i_b,q}$ = composition of component q in input stream i_b

j_b = index to represent output stream for the ‘intermediate block’

G_{j_b} = Flowrate of output stream j_b

$Y_{j_b,q}$ = composition of component q in output stream j_b

t_h = decision-making time horizon

N_t = number of time intervals or periods, t

t = time interval or period

PERIODS = a set of operation intervals or periods

$Net_Gen_{u,q,t}$ = net generation of component q in pretreatment unit u during period t

$N_{components}$ = number of components, q

$d_{u,t}$ = vectors describing the design variables of unit u during period t

$o_{u,t}$ = vectors describing the operating variables of unit u during period t

$g_{j_u,i_v,t}$ = assigned from source j_u to destination i_v during period t

$g_{j_u, i_u, t}$ = flowrate from source j_u to destination i_u during period t

$p_{j_u, p, t}$ = flowrate assigned from j_u to the p^{th} product stream during period t

$w_{j_u, w, t}$ = flowrate from j_u to the w^{th} waste stream during period t

$P_{p, t}^T$ = total flowrate of the p^{th} product from the N_T pretreatment units in period t

$Z_{p, q, t}^T$ = composition of component q in the p^{th} product stream coming from the N_T pretreatment units during period t

$W_{w, t}^T$ = flowrate of the w^{th} waste stream from the N_T pretreatment units during period t

$Z_{w, q, t}^T$ = composition of component q in the w^{th} waste stream coming from the N_T pretreatment units during period t

$r_{j_b, i_v, t}$ = flowrate assigned from intermediate source j_b to destination i_v during period t

$\text{Net_Gen}_{v, q, t}$ = net generation of component q in common process unit v during period t

$d_{v, t}$ = vectors describing the design variables of unit v during period t

$o_{v, t}$ = vectors describing the operating variables of unit v during period t

$w_{j_v, w, t}$ = flowrate assigned from output stream j_v to the w^{th} waste stream during period t

$p_{j_v, p, t}$ = flowrate assigned from output stream j_v to the p^{th} product stream during period t

$r_{j_v, b, t}$ = flowrate assigned from output stream j_v to the b^{th} intermediate stream during period t

$W_{w, t}^{PU}$ = flowrate of the w^{th} waste stream from the N_{PU} common process units

$Z_{w,q,t}^{PU}$ = composition of component q in the w^{th} waste stream coming from the N_{PU}

common process units during period t

$P_{p,t}^{PU}$ = total flowrate of the p^{th} product from the N_{PU} common process units in period t

$Z_{p,q,t}^{PU}$ = composition of component q in the p^{th} product stream coming from the N_{PU}

common process units in period t

$R_{b,t}^{PU}$ = flowrate of the b^{th} intermediate stream from the N_{PU} common process units

during period t

$Z_{b,q,t}^{PU}$ = composition of component q in the b^{th} intermediate stream from the N_{PU}

common process units during period t

$P_{p,t}$ = flowrate of the p^{th} product out of the process

$Z_{p,q,t}$ = composition of component q in the p^{th} product stream out of the process during

period t

$W_{w,t}$ = flowrate of the w^{th} waste stream out of the process during period t

$Z_{w,q,t}$ = composition of component q in the w^{th} waste stream out of the process during

period t

$r_{j_v,i_b,t}$ = flowrate assigned from source j_v to destination i_b during period t

d_u^{\min}, d_u^{\max} = minimum and maximum vectors describing the design variables of unit

respectively

d_v^{\min}, d_v^{\max} = minimum and maximum vectors describing the design variables of unit v,

respectively

o_u^{\min}, o_u^{\max} = minimum and maximum vectors describing the operating variables of unit u,

respectively

o_v^{\min}, o_v^{\max} = minimum and maximum vectors describing the operating variables of unit

respectively

$P_{p,t}^{Demand}$ = Demand for product p during period t

$F_{i_u}^{\min}, F_{i_u}^{\max}$ = minimum and maximum flowrate for the i_u^{th} input to pretreatment unit u,

respectively

$X_{i_u,q}^{\min}, X_{i_u,q}^{\max}$ = minimum and maximum composition of component q for the i_u^{th} input to

pretreatment unit u, respectively

$F_{i_v}^{\min}, F_{i_v}^{\max}$ = minimum and maximum flowrate for the i_v^{th} input to common process unit

v, respectively

$X_{i_v,q}^{\min}, X_{i_v,q}^{\max}$ = minimum and maximum composition of component q for the i_v^{th} input to

pretreatment unit v, respectively

$C_{p,t}^{product}$ = unit selling price of product p during period t

$P_{p,t}$ = production rate of product p during time t

$C_{f,t}^{feedstock}$ = cost of feedstock f during period t

$F_{f,t}$ = feed rate of feedstock f during time t

POC_t = process operating cost excluding feedstock cost (e.g., utilities, labor, waste treatment, etc.) during period t

$TAC^{Pretreatment}$ = total annualized cost of retrofitted pretreatment

AFC = annualized fixed cost

AOC = annual operating cost

I_f = a binary integer variable designating the presence or absence of the f^{th} feedstock

$F_{f,t}$ = flowrate of feedstock f during period t

$F_{f,t}^{\max}$ = upper bound on the allowable flowrate of feedstock f

MINLP = mixed integer non-linear program

MILP = mixed integer linear program

MMGPY = millions of gallons per year

PBP = payback period

ROI = return on investment

FCI = fixed capital investment

GHG = greenhouse gas

LCA = life cycle analysis

REET = greenhouse gases, regulated emissions, and energy use in transportation

EIO-LCA = economic input-output life cycle assessment

$E_{feedstock}^{CO_2}$ = CO₂ emissions for a given feedstock

$E_u^{CO_2}$ = CO₂ emitted by pretreatment unit, u

$E_v^{CO_2}$ = CO₂ emitted by common process unit, v

$E_{soy}^{CO_2, growth}$ = CO₂ emitted for growth of soy feedstock

$E_{soy}^{CO_2, harvesting}$ = CO₂ emitted for harvesting of soy feedstock

$E_{soy}^{CO_2, seedPT}$ = CO₂ emitted for soy feedstock seed processing and transport

$E_{soy}^{CO_2, oilext}$ = CO₂ emitted for soy feedstock oil extraction

$E_{soy}^{CO_2, BDprod}$ = CO₂ emitted for biodiesel production from soy feedstock

$E_{soy}^{CO_2, BDtransport}$ = CO₂ emitted transport of biodiesel produced from soy feedstock

$E_{soy}^{CO_2, BDuse}$ = CO₂ emitted during use of biodiesel produced from soy feedstock

$E_{soy}^{CO_2}$ = CO₂ emitted per ton of soy oil used as a feedstock to produce biodiesel

$E_{WCO}^{CO_2}$ = CO₂ emitted per ton of WCO used as a feedstock to produce biodiesel

$F_{soy,t}$ = flowrate of soy oil feedstock into the process over time t

$F_{WCO,t}$ = flowrate of WCO feedstock into the process over time t

$P_{BD,t}$ = a given production rate of biodiesel over time t

$E_{BD}^{CO_2}$ = the total quantity of CO₂ emitted over time period t for biodiesel produced using soy oil and/or WCO as feedstock inputs

$P_{D,t}$ = a given production rate of petroleum-based diesel over time t

$E_D^{CO_2}$ = the total quantity of CO₂ emitted over time period t for production of petroleum-based diesel

S^{CO_2} = subsidy for reduction of CO₂ emissions (\$/ton CO₂ reduced)

TS^{CO_2} = total subsidy attained for biodiesel produced from soy oil and/or WCO

feedstocks

$S^{CO_2, \min}, S^{CO_2, \max}$ = minimum and maximum CO₂ subsidy, respectively

REFERENCES

Akoh, C.C., Chang, C., Lee, G., Shaw, J. (2007) 'Enzymatic approach to biodiesel production', *J Agric Food Chem*, Vol. 55, pp.8995-9005.

Allen, H.D., Kline, W.A. (1945) Process for treating fats and fatty oils. US Patent No. 2,383,579.

Army, W. (January 18, 2005) *Department of the Navy Environmental Policy Memorandum 05-01; Biodiesel Fuel Use in Diesel Engines*, U.S. Department of the Navy.

Arrowsmith, C.J., Ross, J. (1945) Treating fatty materials. US Patent No. 2,383,580.

Bradshaw, G.B. (May 1942) 'New soap process', *Soap and Chemical Specialties*, Vol. 18, pp.23-24 & 69-70.

Bradshaw, G.B., Meuly, W.C. (1942) Process of making pure soaps. US Patent No. 2,271,619.

Bradshaw, G.B., Meuly, W.C. (1944) Preparation of detergents. US Patent No. 2,360,844.

Canacki, M., Van Gerpen, J. (2001) 'Biodiesel production from oils and fats with high free fatty acids', *Trans ASAE*, Vol. 44, No 6, pp.1429-1436.

Canakci, M., Van Gerpen, J. (2003) 'A pilot plant to produce biodiesel from high free fatty acid feedstocks', *Trans ASAE*, Vol. 46, No 4, pp.945-954.

Carraretto, C., Macor, A., Mirandola, A., Stoppato, A., Tonon, S. (2004) 'Biodiesel as alternative fuel: Experimental analysis and energetic evaluations', *Energy*, Vol. 29, pp.2195-2211.

Chemical Engineering Plant Cost Index (CEPCI) (May 2004) *Chemical Engineering*, pp.72.

Chemical Engineering Plant Cost Index (CEPCI) (May 2007) *Chemical Engineering*, pp.96.

Chemical Engineering Plant Cost Index (CEPCI) (March 2008) *Chemical Engineering*, pp.78.

De Benetto, L., Klemes, J. (2009) 'The environmental performance strategy map: An integrated LCA approach to support the strategic decision-making process', *Journal of Cleaner Production*, Vol. 17, pp.900-906.

Demirbas, A. (2003) 'Biodiesel fuels from vegetable oils via catalytic and non-catalytic supercritical alcohol transesterifications and other methods: A survey', *Energy Conversion and Management*, Vol. 44, pp.2093-2109.

Demirbas, A., Karslioglu, S. (2007) 'Biodiesel production facilities from vegetable oils and animal fats', *Energy Sources, Part A*, Vol. 29, pp.133-141.

Demirbas, A. (2008) *Biodiesel – A realistic fuel alternative for diesel engines*, Springer-Verlag London Limited: London.

Demirbas, A. (2009a) 'Progress and recent trends in biodiesel fuels', *Energy Conversion and Management*, Vol. 50, pp.14-34.

Demirbas, A. (2009b) 'Production of biodiesel fuels from linseed oil using methanol and ethanol in non-catalytic SCF conditions', *Biomass and Bioenergy*, Vol. 33, pp.113-118.

DOE (July 2007a) *Clean Cities Alternative Price Report*.

DOE (October 2007b) *Clean Cities Alternative Price Report*.

DOE (January 2008a) *Clean Cities Alternative Price Report*.

DOE (October 2008b) *Clean Cities Alternative Price Report*.

DOE (January 2009a) *Clean Cities Alternative Price Report*.

DOE (April 2009b) *Clean Cities Alternative Price Report*.

Dorado, M.P., Ballesteros, E., Mittelbach, M., Lopez, F.J. (2004) 'Kinetic parameters affecting the alkali-catalyzed transesterification process of used olive oil', *Energy & Fuels*, Vol. 18, pp.1457-1462.

Dreger, E.E. (1945) Method of treating fatty glycerides. US Patent No. 2,383,596.

El-Halwagi, M.M. (1997) *Pollution Prevention Through Process Integration*. Academic Press: San Diego, California.

El-Halwagi, M.M. (2006) *Process Integration*, Elsevier: Amsterdam.

EPA (October 2002) *A Comprehensive Analysis of Biodiesel Impacts on Exhaust Emissions (EPA420-P-02-001)*.

Fargione, J., Hill, J., Tilman, D., Polasky, S., Hawthorne, P. (2008) 'Land clearing and the biofuel carbon debt', *Science*, Vol. 319, pp.1235-1238.

Fernando, S., Adhikari, S., Chandrapal, C., Murali, N. (2006) 'Biorefineries: Current status, challenges, and future direction', *Energy and Fuels*, Vol. 20, pp.1727-1737.

Formo, M.W. (1954) 'Ester reactions of fatty materials', *Journal of American Oil Chemist's Society*, Vol. 31, pp.548-559.

Freedman, B., Pryde, E. and Mounts, T. (1984) 'Variables affecting the yields of fatty esters from transesterified vegetable oils', *Journal of American Oil Chemist's Society*, Vol. 61, No 10, pp.1638-1643.

Freedman, B., Butterfield, R.O. and Pryde, E. (1986) 'Transesterification kinetics of soybean oil', *Journal of American Oil Chemist's Society*, Vol. 63, pp.1375-1380.

Frohlich, A, Rice, B. (2005) 'Evaluation of *Camelina sativa* oil as a feedstock for biodiesel production', *Industrial Crops and Products*, Vol. 21, pp.25-31.

Fukuda, H., Kondo, A., Noda, H. (2001) 'Biodiesel fuel production by transesterification of oils', *Journal of Bioscience and Bioengineering*, Vol. 92, No 5, pp.405-416.

Fuls, J., Hawkins, C.S., Hugo, F.J.C. (1984) 'Tractor engine performance on sunflower oil fuel', *J. Agric. Engng Res.*, Vol. 30, pp.29-35.

GAO (May 2008) *Report to Congressional Requesters: Climate Change – Expert Opinion on the Economics of Policy Options to Address Climate Change*, GAO-08-605.

Ginder, R. (July/August 2004) 'Evaluating biodiesel as a value-added opportunity', *Agricultural Marketing Resource Center Action*, Vol. 1, No 9, July/Aug 2004.

Obtained through the Internet:

http://www.agmrc.org/media/cms/biodieseloportunity_254411A7B6DAB.pdf

[accessed October 5, 2009]

Gouveia, L., Oliveira, A.C. (2009) 'Microalgae as a raw material for biofuels production', *J Ind Microbiol Biotechnol*, Vol. 36, pp.269-274. DOI 10.1007/s10295-008-0495-6.

Haas, M.J., McAloon, A.J., Yee, W.C., Foglia, T.A. (2006) 'A process model to estimate biodiesel production costs', *Bioresource Technology*, Vol. 97, pp.671-678.

Hendrickson, C. T., Lave, L. B., and Matthews, H. S. (2006) *Environmental Life Cycle Assessment of Goods and Services: An Input-Output Approach*, Resources for the Future Press: Washington, D.C..

Hill, J., Nelson, E., Tilman, D., Polasky, S., Tiffany, D. (2006) 'Environmental, economic, and energetic costs and benefits of biodiesel and ethanol biofuels', *PNAS*, Vol. 103, No 30, pp.11206-11210.

Huang, G., Chen, F., Wei, D., Zhang, X., Chen., G. (2009) 'Biodiesel production by microalgal biotechnology', *Applied Energy*,. DOI 10.1016/j.apenergy.2009.06.016.

Jessen, H. (November 2006) 'The Matchmaker', *Biodiesel Magazine*, http://www.biodieselmagazine.com/article.jsp?article_id=1248&q=&page=all. [accessed on 10/19/2009].

Kalam, M.A., Masjuki, H.H. (2002) 'Biodiesel from palmoil – an analysis of its properties and potential', *Biomass and Bioenergy*, Vol. 23, pp.471-479.

Kamm, B., Kamm, M. (2004) 'Principles of biorefineries', *Appl Microbiol Biotechnol*, Vol. 64, pp.137-145.

Kamm, B., Gruber, P.R., Kamm, M., Editors. (2006) *Biorefineries – Industrial Processes and Products – Status Quo and Future Directions*. Vol 1, Wiley-VCH: Weinheim, Germany.

Keim, G.I. (1945) Treating fats and fatty oils. US Patent No. 2,383,601.

Knothe, G., (2001) 'Historical perspectives on vegetable oil-based diesel fuels', *Inform*, Vol. 12, pp.1103-1107.

Leontief, W. (1986) *Input-output Economics*, Oxford University Press: New York.

Lepper, H., Friesenhagen, L. (August 26, 1986) Process for the production of fatty acid esters of short-chain aliphatic alcohols from fats and/or oils containing free fatty acids. US Patent No. 4,608,202.

Lepper, H., Friesenhagen, L. (March 24, 1987) Process for the production of fatty acid alkyl esters. US Patent No. 4,652,406.

Leevijit, T., Tongurai, C., Prateepchaikul, G., Wisutmethangoon, W. (2008) 'Performance test of a 6-stage continuous reactor for palm methyl ester production', *Bioresource Technology*, Vol. 99, pp.214-221.

Lopez, J., Gomez, A., Aparicio, F., Sanchez, J. (2009) 'Comparison of GHG emissions from diesel, biodiesel and natural gas refuse trucks of the city of madrid', *Applied Energy*, Vol. 86, pp.610-615.

Lotero, E., Liu, Y., Lopez, D.E., Suwannakarn, K., Bruce, D.A., Goodwin, J.G. (2005) 'Synthesis of biodiesel via acid catalysis', *Ind Eng Chem Res*, Vol. 44, pp.5353-5363.

Ma, F., Clements, L.D., Hanna, M.A. (1998) 'Biodiesel fuel from animal fat. Ancillary studies on transesterification of beef tallow', *Trans ASAE*, Vol. 41, No 5, pp.1261-1264.

Majer, S., Mueller-Langer, F., Zeller, V., Kaltschmitt, M. (2009) 'Implications of biodiesel production and utilization on global climate – A literature review', *Eur. J. Lipid Sci. Technol.* Vol. 111, pp.747-762.

Marchetti, J.M., Miguel, V.U., Errazu, A.F. (2007) 'Possible methods for biodiesel production', *Renewable and Sustainable Energy Reviews*, Vol. 11, pp.1300-1311.

Miller, S., Theis, T. (2006) 'Comparison of life-cycle inventory databases: A case study using soybean production', *Journal of Industrial Ecology*, Vol. 10, No 1-2, pp.133-147.

Meher, L.C., Sagar, D.V., Naik, S.N. (2006) 'Technical aspects of biodiesel production by transesterification – a review', *Renewable and Sustainable Energy Reviews*, Vol. 10, pp.248-268.

Miao, X., Wu, Q. (2006) 'Biodiesel production from heterotrophic microalgal oil', *Bioresource Technology*, Vol. 97, pp.841-6.

Myint, L. (2007) *Process Analysis and Optimization of Biodiesel Production from Vegetable Oils*. MS Thesis. Texas A&M University.

Myint, L.L, El-Halwagi, M.M. (2009) 'Process analysis and optimization of biodiesel production from soybean oil', *Clean Techn Environ Policy*, Vol. 11, pp.263-276.

DOI 10.1007/s10098-008-0156-5.

Narodoslawsky, M., Niederl-Schmidinger, A., Halasz, L. (2008) 'Utilising renewable resources economically: new challenges and chances for process development', *Journal of Cleaner Production*, Vol. 16, pp.164-170.

National Biodiesel Board (2007) Biodiesel Backgrounder. Obtained through the Internet: http://www.biodiesel.org/pdf_files/fuelfactsheets/backgrounder.pdf, [accessed 10/4/2008].

National Biodiesel Board (January 25, 2008) US Biodiesel Producers Map. Obtained through the Internet: [www.biodiesel.org/pdf_files/fuelfactsheets/Producers Map - existing.pdf](http://www.biodiesel.org/pdf_files/fuelfactsheets/Producers%20Map%20existing.pdf), [accessed 10/4/2008].

National Biodiesel Board. (2009a) Estimated US Biodiesel Production by Fiscal Year. Obtained through the Internet: www.biodiesel.org/pdf_files/fuelfactsheets/Production_Graph_Slide.pdf, [accessed 9/25/2009].

National Biodiesel Board (June 22, 2009b) US Biodiesel Production Capacity. Obtained through the Internet:

http://www.biodiesel.org/pdf_files/fuelfactsheets/Production_Capacity.pdf, [accessed 9/25/2009].

Nebel, B.A., Mittelbach, M. (2006) 'Biodiesel from extracted fat out of meat and bone meal', *Eur J Lipid Sci Technol*, Vol. 108, pp.398-403.

Nelson, L.A., Foglia, T.A., Marmer, W.N. (1996) 'Lipase-catalyzed production of biodiesel', *Journal of American Oil Chemist's Society*, Vol. 73, No 8, pp.1191-1195.

Noureddini, H., Zhu, D. (1997) 'Kinetics of Transesterification of Soybean Oil', *Journal of American Oil Chemist's Society*, Vol. 74, No 11, pp.1457-1463.

NREL, Conceptual biorefinery, <http://www.nrel.gov/biomass/biorefinery.html>
(September 28, 2009)

Panichelli, L., Gnansounou, E. (2008) 'Estimating greenhouse gas emissions from indirect land-use change in biofuels production: concepts and exploratory analysis for soybean-based biodiesel production', *J. Scientific and Industrial Research*, Vol. 67, pp.1017-1030.

Percy, J.H. (1945) Treatment of fatty glycerides. US Patent No. 2,383,580.

Peterson, C.L., Wagner, G.L., Auld, D.L. (1983) 'Vegetable oil substitutes for diesel fuel', *Trans ASAE*, Vol. 26, No 2, pp. 322.

Peterson, G.R., Scarrah, W.P. (1984) 'Rapeseed oil transesterification by heterogeneous catalysis', *Journal of American Oil Chemist's Society*, Vol. 61, No 10, pp.1593-1597.

Reijnders, L., Huijbregts, M. (2008) 'Palm oil and the emission of carbon-based greenhouse gases', *Journal of Cleaner Production*, Vol. 16, pp.477-482.

Ryan, T.W., Dodge, L.G., Callahan, T.J. (1984) 'The effects of vegetable oil properties on injection and combustion in two different diesel engines', *Journal of American Oil Chemist's Society*, Vol. 61, No 10, pp.1610-1619.

Searchinger, T., Heimlich, R., Houghton, R.A., Dong, F., Elobeid, A., Fabiosa, J., Tokgoz, S., Hayes, D., Yu, T. (2008) 'Use of U.S. croplands for biofuels increases greenhouse gases through emissions from land-use change', *Science*, Vol. 319, pp.1238-1240.

Shah, S., Sharma, S., Gupta, M.N. (2004) 'Biodiesel preparation by lipase-catalyzed transesterification of Jatropha Oil', *Energy & Fuels*, Vol. 18, pp.154-159.

Sharma, Y.C., Singh, B. (2009) 'Development of biodiesel: Current scenario', *Renewable and Sustainable Energy Reviews*, Vol. 13, pp.1646-1651.

Sheehan, J., Camobreco, V., Duffield, J., Graboski, M.mShapouri, H. (May 1998) *Live Cycle Inventory of Biodiesel and Petroleum Diesel for Use in an Urban Bus - NREL Final Report (NREL/SR-580-24089 UC Category 1503)*, U.S. National Renewable Energy Laboratory.

Siler-Marinkovic, A., Tomasevic, A. (1998) 'Transesterification of sunflower oil *in situ*', *Fuel*, Vol. 77, No 12, pp.1389-1391.

Singh, A., He, B., Thompson, J., Van Gerpen, J. (2006) 'Process optimization of biodiesel production using alkaline catalysts', *Applied Engineering in Agriculture*, Vol. 22, No 4, pp.597-600.

Singh, A., Cobb, K., Peterson, M. (2007) 'Biodiesel process selection – Rendered products vs. soybean oil', *Render*, February, pp.10-13.

Smith, E., Janzen, H., Newlands, N. (2007) 'Energy Balances of Biodiesel Production from Soybean and Canola in Canada', *Canadian Journal of Plant Science*, Vol. 87, pp.793-801.

- Tapasvi, D., Wiesenborn, D., Gustafson, C. (2005) 'Process model for biodiesel production from various feedstocks', *Trans ASAE*, Vol. 48, No 6, pp.2215-2221.
- Thamsiroj, T., Murphy, J. (2009) 'Is it better to import palm oil from thailand to produce biodiesel in Ireland than to produce biodiesel from indigenous Irish rape seed?', *Applied Energy*, Vol. 86, pp.595-604.
- Trent, W.R. (1945a) Process of treating fatty glycerides. US Patent No. 2,383,632.
- Trent, W.R. (1945b) Process for treating fatty glycerides. US Patent No. 2,383,633.
- Tyson, K.S., Bozell, J., Wallace, R., Petersen, E. and Moens, L. (June 2004) *Biomass Oil Analysis: Research Needs and Recommendations - NREL Technical Report (NREL/TP-510-34796)*, U.S. National Renewable Energy Laboratory.
- U.S. Congress. Senate. (August 6, 2009) 'Biodiesel Tax Incentive Reform and Extension Act of 2009' S. 1589. 111th Cong., 1st sess..
- Van Gerpen, J. (2005) 'Biodiesel processing and production', *Fuel Processing and Technology*, Vol. 86, pp.1097-1107.

Varma, M.N., Madras, G. (2007) 'Synthesis of biodiesel from castor oil and linseed oil in supercritical fluids', *Ind Eng Chem Res*, Vol. 46, pp.1-6.

Wang, M. (1999) *GREET 1.5 – Transportation Fuelcycle model, Volume 1 Methodology, Development, Use, and Results* (ANL/ESD-39), Argonne National Laboratory: Argonne, Illinois.

Wang, M. (2000) *GREET – Greenhouse gases, regulated emissions and energy use in transportation, v. 1.5a.*, Argonne National Laboratory: Argonne, Illinois.

Wang, Y., Ou, S., Liu, P., Xue, F., Tang, S. (2006) 'Comparison of two different processes to synthesize biodiesel by waste cooking oil', *J of Molecular Catalysis A: Chemical*, Vol. 252, pp.107-112.

Wang, Y., Ou, S., Liu, P., Zhang, Z. (2007) 'Preparation of biodiesel from waste cooking oil via two-step catalyzed process', *Energy Conversion and Management*, Vol. 48, pp.184-188.

West, A.H., Psarac, D., Ellis, N. (2007) 'Simulation, case studies and optimization of a biodiesel process with a solid acid catalyst', *Int J Chem Reactor Eng*, Vol. 5, pp.1-8.

Wicke, B., Dornburg, V., Junginger, M., Faaij, A. (2008) 'Different palm oil production systems for energy purposes and their greenhouse gas implications', *Biomass and Bioenergy*, Vol. 32, pp.1322-1337.

You, Y., Shie, J., Chang, C., Huang, S., Pai, C., Yu, Y. and Chang, C.H. (2008) 'Economic cost analysis of biodiesel production: Case in soybean oil', *Energy & Fuels*, Vol. 22, No. 1, pp.182-189.

Zhang, Y. (2002) *Design and Economic Assessment of Biodiesel Production from Waste Cooking Oil*. MS Thesis. University of Ottawa, Canada.

Zhang, Y., Dubé, M., McLean, D. and Kates, M. (2003a) 'Biodiesel from waste cooking oil: 1. Process design and technological assessment', *Bioresource Technology*. Vol. 89, pp.1-16.

Zhang, Y., Dubé, M., McLean, D. and Kates, M. (2003b) 'Biodiesel from waste cooking oil: 2. Economic assessment and sensitivity analysis', *Bioresource Technology*, Vol. 90, pp.229-240.

Zheng, S., Kates, M., Dubé, M.A., McLean, D.D. (2006) 'Acid-catalyzed production of biodiesel from waste frying oil', *Biomass and Bioenergy*, Vol. 30, pp.267-272.

VITA

Name: René Davina Elms

Address: Artie McFerrin Department of Chemical Engineering
Texas A&M University
Jack E. Brown Engineering Building
3122 TAMU Room 200
College Station, TX 77843-3122

Email Address: Rene.Elms@aggienetwork.com

Education: B.S., Biochemistry, Texas A&M University, 1998
B.S., Genetics, Texas A&M University, 1998
M.S., Chemical Engineering, Texas A&M University, 2002
Ph.D., Chemical Engineering, Texas A&M University, 2009