

THE EFFECTS OF SURROGATE CAREGIVERS ON
THE RELATIONSHIP BETWEEN FATHERLESS/FATHERLOSS
AFRICAN AMERICAN MALE YOUTHS AND THEIR
LEVEL OF DELINQUENT BEHAVIOR

A Dissertation

by

JAMES A. CARTER-HAITH JR.

Submitted to the Office of Graduate Studies of
Texas A&M University
in partial fulfillment of the requirements for the degree of

DOCTOR OF PHILOSOPHY

December 2008

Major Subject: Counseling Psychology

THE EFFECTS OF SURROGATE CAREGIVERS ON
THE RELATIONSHIP BETWEEN FATHERLESS/FATHERLOSS
AFRICAN AMERICAN MALE YOUTHS AND THEIR
LEVEL OF DELINQUENT BEHAVIOR

A Dissertation

by

JAMES A. CARTER-HAITH JR.

Submitted to the Office of Graduate Studies of
Texas A&M University
in partial fulfillment of the requirements for the degree of

DOCTOR OF PHILOSOPHY

Approved by:

| | |
|---------------------|-----------------|
| Chair of Committee, | Michael Duffy |
| Committee Members, | Victor Willson |
| | Arnold LeUnes |
| | Daniel Brossart |
| | Pamela Boveland |
| Head of Department, | Victor Willson |

December 2008

Major Subject: Counseling Psychology

ABSTRACT

The Effects of Surrogate Caregivers on the Relationship
Between Fatherless/Fatherloss African American Male Youths
and Their Level of Delinquent Behavior.

(December 2008)

James A. Carter-Haith Jr., B.A., Regents College,

University of the State of New York;

M.S., Tarleton State University

Chair of Advisory Committee: Dr. Michael Duffy

This study hypothesized that fathers and surrogates (male role models) contribute a unique set of factors that help guide African American male youths (N=496) during their normal developmental stages. This study hypothesized that surrogate caregivers would have an impact on the overall level of delinquent behavior of this population. A path analysis tested direct and mediated effects of exposure to violence on delinquent behavior, with anger/aggression level as a potential mediator for all three levels of caregiver presence or absence as a moderator.

In the analysis of archival data from 496 African American male youths, the findings did not support these hypotheses consistently. Exposure to family violence as a mediator consistently predicted level of anger, and level of anger negatively predicted delinquent behavior for the fatherless sample. However, exposure did not have a direct

positive effect on delinquent behavior in any of the three samples. Implications of these findings as well as other unpredicted findings with these three groups are explored.

DEDICATION

I would like to make a dual dedication of this dissertation my brother and father, both of whom urged me to follow my dream and passed before we could share in the fruits of my labor. You both are sorely missed daily, but never forgotten.

ACKNOWLEDGEMENTS

I would like to thank the members of my doctoral committee, Michael Duffy, Victor Willson, Arnold LeUnes, and Daniel Brossart for their continued support throughout my graduate career. I further appreciate their guidance in making this dissertation process more attainable.

I would like to give particular thanks to my dissertation chair, Dr. Duffy, who has provided ongoing guidance, encouragement, and moral support throughout my graduate experience. I greatly value the impact he has made on my growth as a professional.

I would also like to thank Michael Duffy for being so active in my personal development. I feel privileged to have worked with his during my tenure as a student at A&M. Additionally, I appreciate his chairing my committee, as I understand the countless hours of dedication afforded to students during this period of their careers.

I would also like to thank Tam Dao for his invaluable help with my statistical analyses. He volunteered to guide me through those countless hours. As a consummate professional and a dear friend he was extremely dedicated to helping a colleague fully understand the statistical process of this dissertation project. Again, I am truly appreciative of his generosity and guidance.

Further, I would like to thank Dr. Pamela Boveland for her support and the use of raw data from the Harris County Juvenile Probation Department. Her dedication and guidance proved invaluable to the collection and processing of this data.

TABLE OF CONTENTS

| | | Page |
|-------------------------|---|------|
| ABSTRACT | | iii |
| DEDICATION..... | | v |
| ACKNOWLEDGEMENTS | | vi |
| TABLE OF CONTENTS | | vii |
| LIST OF FIGURES | | ix |
| LIST OF TABLES..... | | x |
| CHAPTER | | |
| I | INTRODUCTION..... | 1 |
| | African American Male Youths' Delinquency | 2 |
| | Purpose of the Study | 3 |
| | Hypotheses | 5 |
| II | REVIEW OF THE LITERATURE | 7 |
| | The Effects of Fatherless/Fatherloss..... | 9 |
| | Father Characteristics..... | 10 |
| | Surrogate Caregiver | 12 |
| | Summary | 13 |
| III | METHODOLOGY | 15 |
| | Participants..... | 15 |
| | Procedures | 15 |
| | Operational Definitions..... | 16 |
| | Measures | 17 |
| | Descriptive Analysis of Variables | 20 |
| | Method of Analysis of Variables..... | 22 |
| IV | RESULTS | 24 |

| CHAPTER | Page |
|--|------|
| Main Data Analyses | 24 |
| Hypothesis 1 | 24 |
| Hypothesis 2 | 24 |
| Hypothesis 3 | 26 |
| V DISCUSSION | 34 |
| Hypothesis 1 | 34 |
| Hypothesis 2 | 37 |
| Hypothesis 3 | 38 |
| Limitations of Study | 40 |
| Implications for Future Research..... | 41 |
| Implications for Clinical Practice | 42 |
| VI CONCLUSION/SUMMARY | 44 |
| Summary | 44 |
| REFERENCES | 45 |
| APPENDIX A | 53 |
| APPENDIX B..... | 55 |
| APPENDIX C..... | 58 |
| APPENDIX D | 59 |
| APPENDIX E..... | 60 |
| APPENDIX F | 61 |
| APPENDIX G | 62 |
| VITA | 64 |

LIST OF FIGURES

| FIGURE | Page |
|--|------|
| 1 Path Analysis Examining Exposure to Family Violence, Anger/aggression Level and Delinquent Behaviors in Total Sample (EFV = Exposure to family violence. AAL = Anger/aggression level LDB = Level of Delinquent behavior) | 4 |
| 2 Path Analysis Examining Exposure to Family Violence, Anger/Aggression Level, and Delinquent Behaviors in Total Sample | 26 |
| 3 Anger/Aggression Level and Level of Delinquent Behavior among Father Present Sample | 29 |
| 4 Path Analysis Examining Exposure to Family Violence, Anger/Aggression Level and Level of Delinquent Behavior among Fatherless/Fatherloss Sample | 31 |
| 5 Path Analysis Examining Exposure to Family Violence, Anger/Aggression Level and level of Delinquent Behavior among Surrogate Caregiver Sample | 33 |

LIST OF TABLES

| TABLE | | Page |
|-------|--|------|
| 1 | Descriptive Statistic for Significance Testing Comparing Group-Specific Samples on Anger/Aggression Level and Level of Delinquent Behavior | 21 |
| 2 | Frequency Comparing Group-Specific Samples on Exposure to Family Violence | 22 |
| 3 | Standardized Effects Examining Exposure to Family Violence, Anger/Aggression Level and Level of Delinquent Behaviors in Total Sample | 26 |
| 4. | Standardized Effects Examining Exposure to Family Violence, Anger/Aggression Level, and Level of Delinquent Behavior among Father Present Sample | 29 |
| 5 | Standardized Effects Examining Exposure to Family Violence, Anger/Aggression Level and Level of Delinquent Behavior among Fatherless/Fatherloss Sample | 31 |
| 6 | Standardized Effects Examining Exposure to Family Violence, Anger/Aggression Level and Level of Delinquent Behavior among Surrogate Sample | 33 |

CHAPTER I

INTRODUCTION

This study posits that fathers or surrogates (male role models) contribute a unique set of factors that help guide African American male youths during their normal developmental stages. It has been suggested fathers or surrogate caregivers provide a separate and unique structure that helps decrease anger and negative behaviors in the lives of male youths that is not evident in single mother homes. If youths' biological fathers are absent, they most likely will respond to other male role models (surrogate caregivers). The absence of the father without a positive replacement can result in insurmountable negative impact on the emotional, intellectual, social, and behavioral development of children, specifically African American male youth (American Missionary Data on Fatherless Children. Sobering Facts.

www.ammissionary.org/sobering.htm (accessed September 26, 2008). See Appendix G.

The literature review in this paper evidences the importance of the surrogate caregiver to the fatherless/fatherloss youths. Much of the literature seems to suggest that the role of the surrogate caregiver, when the father-absence has occurred, is comparable to that of the father present households. Additional research supports the notion that youths raised in single mother homes are more likely to engage in juvenile delinquent behaviors, perform poorly academically, and may succumb to gang violence (Horn, 2002).

This dissertation follows the style of *Journal of Counseling Psychology*.

African American Male Youths' Delinquency

This study was designed to identify the positive influence of surrogate caregivers on African American male youths and their level of delinquent behaviors in the absence of a biological (role model during the initial offense). The MAYSI-2, Texas Common Application for Placement, actual juvenile paper-files, and juvenile automated files were used during this investigation. The information gathered on each youth was categorized based on the youth's father status (e.g., fatherless/fatherloss, father present, or surrogate caregiver present) during the time of the initial offense. It is hoped that this study will determine whether surrogate caregivers have a major influence on fatherless/fatherloss African American male youth (juveniles).

Studies conducted on the aggression level (anger/irritability) and level of juvenile delinquent behaviors of African American male youths in fatherless/fatherloss homes show an increase in the number of African American males in the juvenile detention centers (White, Moffitt, Earls, Robins, & Silva, 1990; Wisdom, 1989; Wolfgang, Figlio, & Sellin, 1972).

Few studies, however, examine the aggression levels and family violence in families with support systems (e.g. surrogate caregivers) as positive influences with this population (Bumpass, 1984; Demo & Acock, 1988). The overall effect that surrogate caregivers have on these youths is not clear. However, it is postulated that surrogate caregivers decrease delinquent behavior of African American male youths in fatherless/fatherloss homes. Many new fatherless/fatherloss African American male youths face a unique set of future circumstances (Nye, 1973; Shulman, & Collins, 1993).

These youths are fatherless through various means (e.g. abandonment, divorce, death, or absence at birth). Research has indicated that fatherless youths are at risk for negative and antisocial behaviors, such as early sexual activities, substance abuse, juvenile delinquent behaviors, and increased aggression (Dornbusch, Carlsmith, Bushwall, Ritter, Leiderman, Hastorf, & Gross, 1985).

Purpose of the Study

The purpose of this study was to determine if there is a positive effect of surrogate caregivers on the relationship between fatherless children's exposure to violence and level of anger with respect to level of delinquent behavior. The current study focused on the influence of father absence and father presence in the household of African American male youths. Results indicated that father presence or surrogate presence has a positive correlation with decreased levels of delinquent behavior in African American male youths. The hope is that this study will increase the interest of government bodies and legislatures in reinstatement of programs (e.g. Big Brothers, boys clubs, and school sports programs) that will support such influences in the lives of African American male youths. Additionally, results of this study should help support the need for positive African American role models in homes with fatherloss/fatherless African American male juveniles (youths).

Much of the literature on father presence or surrogate caregiver presence indicated (e.g., through a longitudinal study of youths from 14 to 17 years old) a significant influence of the father figure over the delinquency of male youths (Harper, & McLanahan, 1999; Kulik, Stein, & Sarbin, 1986). Additionally, this particular study

revealed that the youths placed with stepparents were equally or more likely to engage in antisocial behaviors resulting in incarceration. Other factors that were influenced by the presence of fathers or surrogate caregivers included appropriate development of the youth's emotional, academic, and social appropriate behaviors. Research indicates that youths who develop positive relationships with their surrogate caregivers on average are less likely to engage in juvenile delinquent behaviors (Draper & Belsky, 1990; Jaffe, Moffitt, Caspi, & Taylor, 2003).

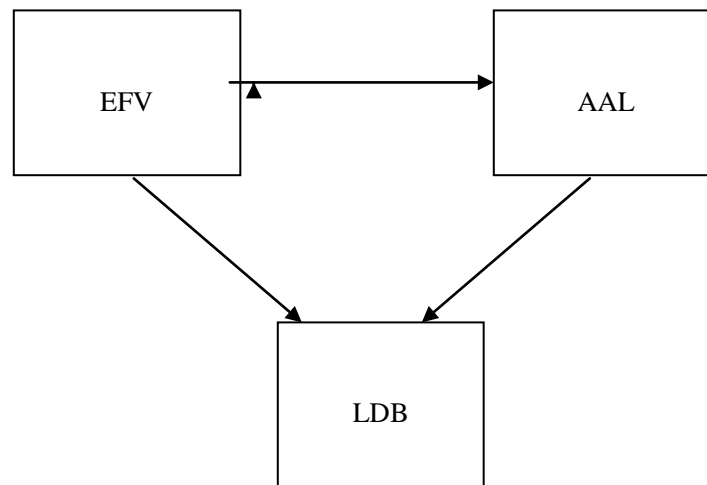

Figure 1.

Indicates the manner in which these variables were considered throughout this study
EFV = Exposure to family violence. AAL = Anger/Aggression level. LDB = Level of
Delinquent behavior. * $p < .05$

It is extremely important to identify methods/techniques necessary to minimize the negative effects of fatherless/fatherloss youths on today's society. Failure to aid children who are presenting with difficulties resulting from fatherless/fatherloss environments could have a major impact on the family unit, legislative issues, and the mental health concerns around the country.

At present surrogate caregivers seem to be a viable option for the fatherless/fatherloss homes of these African American male youths.

The following research questions guided this study:

1. Is there a significant difference in the level of delinquent behavior in African American male youth raised in father present homes, fatherless/fatherloss homes, and surrogate caregiver homes?
2. Is there an association between the exposure of to parental or household family violence and anger/aggression levels among African American male youth? In addition does this relationship influence the level of delinquent behavior among African American male youth.
3. Does father status influence anger/aggression and exposure to family violence of African American male youth?

Hypotheses

Hypothesis 1: The surrogate caregivers will have a positive effect on decreasing anger/aggression levels associated with the overall level of delinquent behavior in African American male youths.

Hypothesis 2: That exposure to parental or household family violence will have a positive correlation with the increased anger/aggression levels, thereby increasing the level of delinquent behavior level of the African American male youths.

Hypothesis 3: That African American male youths raised in a father present home are less likely to be influenced by anger issues or exposure to family violence and they are less likely to present with an increased level of delinquent behavior compared to African American male youths raised in fatherless/fatherloss or surrogate caregivers homes.

CHAPTER II

REVIEW OF THE LITERATURE

Fatherless/fatherloss can be defined in several ways (e.g. death, absence of father at birth, or divorce). There are countless other reasons that children to grow up fatherless, however there are mediating factors that deter some African American male youths from delinquent behaviors (Beaty, 1995; Bracki, Dolson, & Maurice, 1997; Copeland, 1974). The effects of fatherless homes are reported in numerous social and psychological research studies (Bandura, 1977; Biller, & Meridith, 1974). However, many studies fail to report the influence of surrogates on the relationship between level of aggression in fatherless homes and the increases level of juvenile delinquent behaviors. The relationship between father (fatherless homes) and delinquent juvenile behaviors appear to be affected by several varying factors (Gabel, 1992; Harris, 2000; Popenoe, 1997). These factors include the youth's aggression level, exposure to family violence, and surrogate type programs (e.g. big brother, boys club, and positive after school activity programs) (Amato & Keith, 1991; Nelson & Valliant, 1993).

According to Gregory (1965), the loss of a father by death or abandonment is not simply correlated with the African American male youth's aggression. However, he reports that the type and quality of relationship with the father created an environment influencing negative or positive behaviors in the youth. Other researchers, Mackey & Mackey (2003), seem to agree that the total absence of a male role model has a direct affect on the aggression level of the African American male youths.

This review will focus on developmental aspects of African American male youth. Social learning theory suggests that human behavior is learned through modeling (Bandura, 1977; Bryant & Zimmerman, 2003; Hetherington, 1966). This theory also emphasizes the need for parental involvement as primary socialization, because children typically imitate and learn from their parents. African American male youths, as with other male youths, tend to identify with their father as models for appropriate behaviors. Many of the values, attitudes, male sex-roles, gestures and emotions (feelings) are learned from their fathers (Biller, 1971, 1986; Greif, 1976) Moreover male youths, through observational learning, gain their moral and ethical characteristics from their fathers (Greif, 1976; Lamb, 1976; Radin, 1976).

According to Popenoe (1997), fathers are becoming an endangered species. He made no major distinction made between African American male youths and other ethnicities, but recognized problems with all children in fatherless/fatherloss homes. He noted that between 1960 and 1990 the percentage of children not living with their biological fathers more than doubled from seventeen percent to thirty-six percent. He also contended that neither researchers nor government officials were aware of, or even felt that there was a problem in this area.

It is suggested that the decline of father present homes is the major reason for many of the problems male youths face today. Problems in the form of crime and juvenile delinquency, premature sexuality and out-of-wedlock births to teens, deteriorating education achievement; depression, substance abuse and alienation among adolescents; and the growing number of African American male youths in poverty are

believed to stem from the absence of a father in the home (Elliott, Huizinga, & Ageton, 1985; Popenoe, 1997).

Popenoe (1997) and Hippman-West (2001), agrees with other researchers that the father's role not only complements the mother's parenting style, but his style of play, for example, serves several purposes. The father's play style is significant in that it is physically stimulating as well as exciting to the children. He reported that with adolescent boys, physical games and teamwork test the competitive physical and mental ability of the youths (Popenoe, 1997). He further contends that without this exposure from the father, fatherless male youths suffer major social and mental adjustments.

The Effects of Fatherless/Fatherloss

Fatherless households in various ways usually influence the affected male youths. Emotional disorders top the list of juvenile dysfunction. Others include an increased suicide rate, alcohol and drug abuse, poverty, and an increase in gang related activity among youths (Hippman-West, 2001; Popenoe, 1997).

Many fathers have a positive role within the household. Father's contributions include management emotions; intelligence and academic achievement; promoting self-control; monitoring and minimizing unacceptable negative behaviors. "According to one expert, children who roughhouse with their fathers quickly learn that biting, kicking and other forms of physical violence are not acceptable. They learn when to *"shut it down"*; these inappropriate behaviors through modeling (Hippman-West, 2001; Popenoe, 1997).

Father absence through divorce is another dimension of fatherlessness with which the African American youth has to contend; thus he is more likely to develop a

more antisocial and aggressive behavioral pattern (Amato & Keith, 1991; Demo & Acock, 1988; Duncan, Brooks-Gunn, & Klebanov, 1994; Hetherington, 1966; Hetherington, Bridges, & Insabella, 1998; Wells & Rankin, 1991).

Biological fathers frequently develop an emotionally distant relationship with their sons after the divorce (Gabel, 1992). Additional research indicates that the maintained positive contact that a divorced or separated father has with his son can mean the difference between pro-social behavior and antisocial delinquent behaviors displayed by the African American male youth (Boveland, 2002; Dunn, 2005; Eastin, 2003). However, many African American youths prefer to sever all ties with their fathers who display antisocial behaviors (Jaffe, Moffitt, Caspi, & Taylor, 2003).

Father Characteristics

Additionally, positive characteristics in the father-son relationship such as warmth, emotional closeness, support, authoritative parenting (involving affection, support and limit setting), and involvement were reasons stated by the youths to stay connected with their fathers (Dunn, 2005; Dunn, Cheng, & O'Connor, 2004).

The number of African American youths growing up without father, from birth to adult is at an alarming rate (Fost, 1996). Many of these youths are in households with a single parent (mother) income and the attention or monitoring normally given to the youth by either of the two-parent household is simple not maintained (Fost, 1996). According to Griffin, Botvin, Scheier, Diaz & Miller (2000), two parent households gave greater protection against antisocial and delinquent behaviors in African American male youths. A positive correlation was noted; the greater parental monitoring of the

youths, the fewer delinquent behaviors were present in the African American youths (Griffin et al, 2000; Moeller, 2001). Additional research recommends that parental monitoring could be especially important for at-risk African American male youths (e.g. older brothers of delinquent youth, for those living in single-parent homes, or living in ghetto type neighborhoods) (Laybourn, 1986; Pettit, Bates, Dodge, & Meece 1999; Wassermann, Miller, Pinner, & Jaramillo, 1996).

According to Frick, Lahey, Loeber, Stouthamer-Loeber, Christ, & Hanson (1992); and Jaffe, Moffitt, Caspi, & Taylor (2003), indications are that the level of delinquent behavior may be associated with the antisocial behaviors of the in-home father. Several other studies, Huesmann, Eron, Lefkowitz, & Walder (1984) have reported that the effects of being raised by both the biological mother and biological father has a global moderating effect on the level of self esteem and control of aggression which is directly related to delinquent behavior. The perfect situation would be a two-parent home, but when the two-parent home is clearly dysfunctional or chaotic (without structure), the children may be better served in a single parent home (Hippman-West, 2001; Popenoe, 1997). There are a number of reports supporting removal of a child from a dysfunctional home, but the fact remains that in most cases a child/youth benefits from a healthy relationship with both parents. This research indicates that fatherloss has a much greater effect on the delinquency of African American male youths than previously indicated (Mackey & Mackey, 2003).

Research reports a positive correlation between the quality of the father-child relationship and self-esteem, but does not solely identify fatherloss or the fatherless

home as a definitive cause of delinquent behavior (Harris, 2000; Mackey & Mackey, 2003). Moreover, the fathers' amount and quality of time spent with children was found to have a profound effect on male children's level of self-esteem and conduct problems was directly correlated with (Popenoe, 1997). Therefore, the level of in-home father's antisocial behavior is considered a major contributor to the delinquent behaviors displayed by the youths. These antisocial characteristics (e.g. high level of aggression) of the fathers will be passed on to African American male youth (Harris, 1998). For example, the lower the level of parental antisocial behavior the fewer conduct problems (i.e. delinquent behaviors) the children presented. In contrast, a higher level of antisocial behavior of the father is positively correlated with an increased number of conduct problems in the African American male youths (Jaffe, Moffitt, Caspi, & Taylor, 2003; Mackey & Mackey, 2003).

Surrogate Caregiver

Research that indicates adequate uses of external resources may protect fatherless/fatherloss African American male youths from an increased level of aggression and delinquent behavior (Griffin et al., 2000; Hippmann-West, 2001; Mackey & Mackey, 2003; Nelson & Valliant, 1993). Factors that were reported as having positive affect on these youth include placement in adult supervised after-school programs, Big Brother programs, surrogate caregiver involvement, and other adult positive male role models. These factors positively influence the level of hostile and aggression behaviors, as well as a decrease in delinquent behaviors of African American male youths (Nelson & Valliant, 1993).

Conversely, research has shown that when an African American male youth is haphazardly assigned a surrogate caregiver as a role model (e.g., his criminal older male sibling, an alcoholic male step-parent, or an older gang member as a role model, the youth is more likely to engaging in negative antisocial behaviors adopted as appropriate by African American male youths, thereby contributing to his delinquent behaviors (Bracki et al., 1997; Bryant & Zimmerman, 2003; Steinberg, 2000).

Finally, family or parental attachment issues, along with specific socially appropriate behaviors, must be addressed when researching the positive and negative effects of the fatherless relationship of the African American male youth.

Sokol-Katz, Dunham, & Zimmerman (1997), Goldberg, (1997); and Moeller, (2001), postulated that an insecure attachment that derives specifically from a father who presents with erratic and socially unacceptable behaviors that appear to be inconsistent with the youth's needs (e.g. lack of a structured environment) will illicit untrusting behaviors and practices that are consistent with antisocial or aggressive behaviors.

Summary

Fatherless/fatherloss African American male youth seem to have commonalities with other youth in the United States; however there seem to be a particular set of factors which guide their level of delinquent behavior in their fatherless homes. Accordingly, (Ancona, 1998; Beaty, 1995; Eastin, 2003; Popenoe, 1996a, 1996b, 1997) this particular juvenile group warrants attention and is presently growing at an alarming rate.

This study explored some of the factors to identify and develop future mechanisms to minimize the negative effect that fatherless/fatherloss has on African American male youths (e.g., additional intervention of surrogate caregivers).

CHAPTER III

METHODOLOGY

Participants

Archival data was collected on 496 inner-city African American male youths (ages 10 to 17) placed at Harris County Juvenile Probation Department, Houston, Texas for their initial offense. The data covered an eleven-year period (June 1996 to June 2007). The three categories considered in the data were: African American male youths that have a father living in the household (n=113); those who have no father living in the household (n=137); and those who had a male surrogate caregiver (n=246). Many of the youths came from families with low social economic status and many of these youths had been identified as having poor academic records.

Procedure

The procedures for the current study were approved by approval by the Institutional Review Board at Texas A&M University (see Appendix A) and categorized as exempt from full review (protocol number: 2007-0605). Additionally, the Harris County Juvenile Probation Department (HCJPD) gave written permission allowing for the processing of archival database information from 1996 to 2007. Demographic information was collected without identifying information in order to maintain the youth's confidentiality. The data collection administrator at the probation facility helped aid in the accurate collection of the information. This administrator also assisted in gaining permissions to obtain collected data from juvenile county organizations. Consent was also received to use the MAYSI-2, Texas Common Application (TCA

form), Texas Statutes of Family Code; Title 3 Juvenile Justice Code (1985), Harris County Juvenile Probation Department (HCJPD) official court document, Houston Texas, and HCJPD official psychological report, intake screening report, and the HCJPD risk behavior factor database.

Operational Definitions

Father: A person regarded as a biological male parent (*Merriam-Webster's Collegiate Dictionary*, 2003). For the purpose of this study the father present status is used if the biological father was living in the household when the youth committed his first referral/offense.

Fatherless/Fatherloss: is defined as father absent since child's birth, father abandonment, divorce, death of the father, imprisonment of the father, and never known (of mother's choosing or of biological father's choosing). There may be others reasons that identify father absence; however, for this study we will concentrate on the definition shown here.

Surrogate Caregiver: A Surrogate Caregiver is defined as someone who provides guidance for the fatherless/fatherloss youth and can be an uncle, grandfather, an older male sibling 21 years or older, or a stepfather; all of whom should reside in the home with the youth at the time of the initial referral (offense).

Juvenile: A youth at or below the oldest age for which a juvenile court has first authority or jurisdiction over an individual for violating the law according to the Office of Juvenile Justice and Delinquency Prevention (OJJDP, 2000) or Texas Statutes of Family Code; Title 3 Juvenile Justice Code (1985).

Delinquent: A legal term that means a child or adolescent had violated the law (*Merriam-Webster's Collegiate Dictionary*, 2003). This study will refer to an individual as juvenile, who has been adjudicated to a detention facility on an initial offense.

Delinquent Conduct: Is defined by the Juvenile Justice Code as conduct, other than a traffic offense, which violates a penal law of the state of Texas and is punishable by imprisonment or by confinement in jail; or a violation of reasonable and lawful order which was entered by a juvenile court. In general, juvenile delinquency under Texas law results from either violation of the Texas Statutes Family Code, Title 3 Juvenile Justice Code or any violation of conditions of probation.

Abuse: Is the use or treatment of something (a person, item, substance, concept, or vocabulary) that is seen as harmful. (*Merriam-Webster's Collegiate Dictionary*, 2003).

Sexual abuse: is the improper use of another person for sexual purposes, generally without their consent or under physical or psychological pressure (also, child sexual abuse, whether abused by parents, those in loco parentis or strangers).

Physical abuse: Where one person inflicts physical violence or pain on another.

Verbal abuse: When a person uses profanity, demeaning talk, or threatening statements.

Measures

In reference to reliability of the data collected, the primary instruments were official psychological reports and official court documents maintained at Harris County Juvenile Probation Department. Other Instruments/Forms Reviewed to Obtain Data:

MAYSI-2, Texas Common Application, Texas Family Code, automated and hard copy HCJPD court records/files, automated HCJPD psychological & juvenile court reports, intake screening reports, and the risk behavior factor databases.

The Texas Common Application for Placement (TCAP) was used to identify the birthing information (e.g. parental status, parental involvement, sibling interaction, and previous juvenile detentions).

The Massachusetts Youth Screening Instrument 2 (MAYSI-2) identifies preceptors to delinquent behaviors (e.g. substance abuse, anger, irritable, depression, anxiety, somatic complaints, suicide ideation, thought disturbance, and traumatic experiences). For purposes of this study only the initial MAYSI-2 results were used. The reliability of additional subsequent MAYSI-2 test results be subjected to test/retest reliability problems. Not all of this data was considered during this study in support of the stated hypotheses. The variables are as follows:

Emotional abuse or psychological abuse: coercion, humiliation, intimidation, relational aggression, parental alienation or covert incest: Where one person uses emotional or psychological coercion to compel another to do something they do not want, or is not in their best interests; or when one person manipulates another's emotional or psychological state for their own ends (see battered person syndrome), or commits psychological aggression using ostensibly non-violent methods to inflict mental or emotional violence or pain on another.

Domestic Violence: (also known as domestic abuse or spousal abuse) occurs when a family member, partner or ex-partner attempts to physically or psychologically

dominate another. Domestic violence often refers to violence between spouses, or spousal abuse but can also include cohabitants and non-married intimate partners. Domestic violence occurs in all cultures; people of all races, ethnicities, religions, sexes and classes can be perpetrators of domestic violence. Domestic violence is perpetrated by both men and women.

Exposure to Family Violence: The prevalence of the youth's exposure to domestic violence prior to his initial law violation/offense. For the purpose of this study exposure to family violence will be a combination of types of abuse and domestic violence occurrences.

Fatherloss/fatherless is defined as father absent since child's birth, father abandonment, divorce, death of the father, imprisonment of the father, and never known (of mother's choosing or of biological father's choosing). There may be others reasons that identify father absence; however, for this study we will concentrate on the definition shown here.

A Surrogate Caregiver is defined as someone who provides guidance for the fatherless/fatherloss youth and can be an uncle, grandfather, an older male sibling 21 years or older, or a stepfather; all of whom should reside in the home with the youth at the time of the initial referral (offense).

Variables used in this study from the master data file during data collection include:

Father status code = (fatherstatus) 1 father present; 2 fatherless/fatherloss, or 3 surrogate caregiver.

Level of delinquent behavior: = First Disposition/Offense Level (firstlvp) referral/offense severity; 1 to 11.

Anger/Aggression = (anger) experience frustration, lasting anger, moodiness; risk of angry reaction, fighting, aggressive behavior; 0 to 11.

Exposure to Family Violence = various types of abuse (e.g., physical, emotional, and sexual) and Domestic Violence (abuse and observed violence) coded as a Yes or No.

Additionally, variables used in this study during data analysis include:

EFV = Exposure to family violence (as indicated on the actual court report, psychological report, and on the initial intake screening form), AAL = Anger/aggression level, LDB = Level of Delinquent behavior, e-ANG = Error variance for AAL, and e-LDB = Error variance for LDB.

The following variable as measured by the MAYSI-2 Reference Card see appendix D (e.g., Anger/aggression level), which is a self-report measure completed by the youth. Additionally, two other variables were also measured —EFV = Exposure to family violence (as indicated on the actual court report, psychological report, and on the initial intake screening form—scaled Y or N)), and LDB = Level of Delinquent behavior as reported by HCJPD see appendix G (measurement variable codebook referral severity—rated 1-11) for the initial offense (e.g., referral/offense severity).

Descriptive Analysis of Variables

Structural Equation Modeling (SEM) Amos version 7.0 was conducted to investigate data in this study through simple path analysis; Statistical Package for the Social Sciences (SPSS) version 15.0 to for the Analysis of Variance (ANOVA) was also

used to analyze collected data. Three groups of data (father status) were analyzed to categorize data collected from African American male youths (e.g. father present, fatherless/fatherloss, and surrogate. Tables 1 and 2 provide descriptive statistics across the three subgroups for exposure to family violence, delinquent behavior, and anger/aggression level. Analysis of variance was conducted to see if the three groups (i.e., Father present, Fatherless, and Surrogate) were significantly different from each other across levels of delinquent behavior and anger/aggression. Based on Table 1, African American youth in the father present group reported the least amount of anger/aggression levels, followed by the fatherless and Surrogate groups, respectively. In regards to delinquent behavior levels, African American youth in the fatherless group had the most, followed by the Surrogate and Father present groups, respectively.

Table 1

Descriptive Statistics and Significance Testing Comparing Group-Specific Samples on Anger/Aggression and Delinquent Behavior Levels

| | Total (N = 496) | | Father Present (n = 113) | | Fatherless (n = 246) | | Surrogate (n = 137) | | p value* |
|---------------------|--------------------|------|--------------------------------|------|-------------------------|------|------------------------|------|----------|
| | M | SD | M | SD | M | SD | M | SD | |
| Anger | 4.20 | 2.71 | 3.68 | 2.73 | 4.30 | 2.78 | 4.47 | 2.52 | .055 |
| Delinquent Behavior | 6.53 | 4.7 | 6.8 | 4.2 | 7.26 | 4.3 | 6.87 | 4.3 | .386 |

Note. * Significance testing was conducted using ANOVA; yielded an (F=.948) and (df=2).

Table 2 provides the frequencies for exposure to family violence across the three subgroups. Chi square = (χ^2) analysis was conducted to determine whether the three groups differ significantly from each other on exposure to family violence. Based on chi square = (χ^2) analysis the frequencies of exposure to family violence were statistically significant at the .01 level.

Table 2
Frequency Comparing Group-Specific Samples on Exposure to Family Violence

| | Father Present (n = 113) | Fatherless (n = 246) | Surrogate (n = 137) | p value* |
|-----|-----------------------------|-------------------------|------------------------|----------|
| EFV | | | | <.0001 |
| Yes | 28 or ~25% | 61 or ~25% | 34 or ~25% | |
| No | 85 or ~75% | 185 or ~75% | 103 or ~75% | |

Note. EFV = Exposure to family violence. * Statistical testing using Chi square analysis.

Methods of Analysis of Variables

Hypothesis 1: The surrogate caregivers will have a positive effect on decreasing anger/aggression levels associated with the overall level of delinquent behavior in African American male youths.

To address hypothesis 1, analysis of variance (ANOVA) was conducted to determine whether surrogate caregivers will have a positive effect on decreasing anger/aggression levels associated with the overall level of delinquent behavior in African American male youth.

Hypothesis 2: That exposure to parental or household family violence will have a positive correlation with the increased anger/aggression levels, thereby increasing the level of delinquent behavior level of the African American male youths.

To address hypothesis 2, path analysis using AMOS version 7.0 was conducted to investigate whether exposure to parental violence or household family violence will have a positive correlation with increased anger/aggression levels as well as increasing the level of delinquent behavior among African American male youth.

Hypothesis 3: That African American male youths raised in a father present home are less likely to be influenced by anger issues or exposure to family violence and they are

less likely to present with an increased level of delinquent behavior compared to African American male youths raised in fatherless/fatherloss or surrogate caregivers homes.

To address hypothesis 3, three separate path analyses using AMOS version 7.0 was conducted on each subgroup (i.e., Father present, Fatherless, and Surrogate caregivers).

CHAPTER IV

RESULTS

Main Data Analysis

Hypothesis 1

The surrogate caregivers will have a positive effect on decreasing of surrogate caregivers will have a positive effect on decreasing anger/aggression levels associated with the overall level of delinquent behavior in African American male youth. As can be seen in Table 1, the Surrogate caregiver group had the highest level of anger/aggression compared to the Father present and the Fatherless groups. This suggests that African American youth may not benefit from having a Surrogate caregiver in regard to reducing their anger/aggression levels.

Hypothesis 2

That exposure to parental or household family violence will have a positive correlation with the increased anger/aggression levels, thereby increasing the level of delinquent behavior level of the African American male youths as a mediating effect on delinquent behavior through level of anger.

To examine Hypothesis 2, path analysis using AMOS version 7.0 was conducted to investigate whether exposure to parental violence or household family violence will have a positive correlation with increased anger/aggression levels as well as increasing the level of delinquent behavior among African American male youth as a complete mediation model.

The model, represented in Figure 2, was not consistent with the complete mediation hypothesis. Specifically, the hypothesis that the model was correct was not rejected ($\chi^2[0]=0.0, p<0.01$), the ratio of the chi-square statistic to the degrees of freedom was at 0.0, the root mean square error of approximation (RMSEA) was .076, was within that of the upper limit of 0.08 for acceptable fit and the adjusted goodness of fit index (.969), normed fit index (1.0), and the comparative fit index (1.) were greater than the typical target of 0.9 (Tate, 1998). Complete mediation, however, requires that both paths be significant, not found here since the path from anger to delinquent behavior was not significant (Kenny, Kashy, & Bolger, 1998).

Figure 2 illustrates the relationship between exposure to family violence, anger/aggression levels, and level of delinquent behaviors. An examination of Figure 2 indicates that exposure to family violence was statistically significant in predicting anger/aggression levels among African American male youths. However, anger/aggression levels were not statistically significant in predicting level of delinquent behaviors. A closer examination of Figure 2 is based on the analysis shown in Table 3 and indicates that there was a positive relationship between exposure to family violence and anger/aggression level. In other words, as exposure to family violence increases so does anger/aggression levels among African American youths. In contrast, there was a negative relationship between anger/aggression levels and level of delinquent behaviors.

Even though this relationship was not significant, the negative association was not hypothesized in the study. Thus, the data provided evidence to reject the hypothesis that there will be significant mediated positive association between exposure to family

violence and anger/aggression level to increasing the level of delinquent behavior in African American male youth.

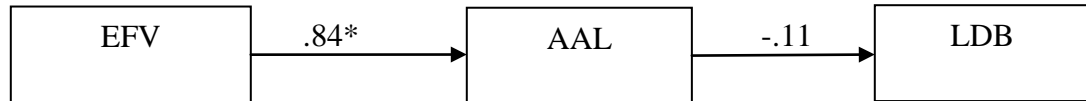

Figure 2

Path Analysis Examining Exposure to Family Violence, Anger/Aggression Levels, and Delinquent Behaviors in Total Sample (N = 496) EFV = Exposure to family violence. AAL = Anger/Aggression level. LDB = Level of Delinquent behavior. * $p < .05$. Standardized estimates yielded EFV to AAL (.15), AAL to LDB (-.07), and EFV to LDB was (-.02).

Table 3

Standardized Effects Examining Exposure to Family Violence, Anger/Aggression Levels, and Delinquent Behaviors in Total Sample (N = 496)

| Outcome | Determinant | Estimate | Standard Error |
|---------|-------------|----------|----------------|
| AAL | EFV | .84* | .279 |
| LDB | AAL | -.11 | .071 |

Note. EFV = Exposure to family violence. AAL = Anger/Aggression level. LDB = Level of Delinquent behavior. * $p < .05$. R^2 values for AAL and LDB were .018 and .005, respectively. In all three groups AAL had a mediator effect on LDB, albeit a negative and in some cases a “not significant” affect on LDB.

Hypothesis 3

That African American male youths raised in a father present home are less likely to be influenced by anger issues or exposure to family violence and are less likely to engage in an increased level of delinquent behavior compared to African American male youths raised in fatherless/fatherloss or surrogate caregivers homes.

To address Hypothesis 3, three separate path analyses using AMOS version 7.0 were conducted on each subgroup (i.e., Father present, Fatherless, and Surrogate caregivers).

When all three groups (Father Present, Fatherless, and Surrogate Caregiver) were tested in AMOS simultaneously for identical model fit. The chi square (X^2) test yielded (df=6) and “not significant” (1.717, $p > .94$) indicating all three models could be fit with the same model and parameter values. EFV to AAL were .885 ($p < .001$); AAL to LDB was -.12, ($p < .10$); and EFV to LDB was -.18 (not significant).

The model, represented in Figure 3, was consistent with the observed variances. Specifically, the hypothesis that the model was correct was not rejected ($\chi^2[6]=1.72, p > 0.01$), the ratio of the chi-square statistic to the degrees of freedom was at 0.0, the root mean square error of approximation (RMSEA) was .03, was within that of the upper limit of 0.08 for acceptable fit, normed fit index (1.0), and the comparative fit index (1.0) were greater than the typical target of 0.9 (Tate, 1998).

Figure 3 provides that path diagram examining the relations between exposure to family violence, anger/aggression levels, and level of delinquent behaviors among African American youth who were in the Father present group. The positive association between exposure to family violence and anger/aggression levels was statistically significant at the .05 level suggesting that as exposure to family violence increases so does anger/aggression levels for African American youth. However, the association between anger/aggression and levels of delinquent behaviors were negative for each group.

Even though this association was not significant, it does suggest that as levels of anger/aggression increase for African American youth in the Father present group, the level of delinquent behaviors decreases. Furthermore, counter to the hypothesis, the data indicates that there is a negative correlation between exposure to family violence and level of delinquent behavior. Again, even though this relationship is not significant at the .05 level, it does suggest that as exposure to family violence may slightly increase in African American youth in the Father present group this predicts a decrease in levels of delinquent behaviors.

The model, represented in Table 4, was consistent with the observed variances. Specifically, the hypothesis that the model was correct was not rejected ($\chi^2[6]=.82, p>0.01$), the ratio of the chi-square statistic to the degrees of freedom was at .82, the root mean square error of approximation (RMSEA) was .05, was within that of the upper limit of 0.08 for acceptable fit and the adjusted goodness of fit index(.95), normed fit index (1.0), and the comparative fit index (1.0.) were greater than the typical target of 0.9 (Tate, 1998).

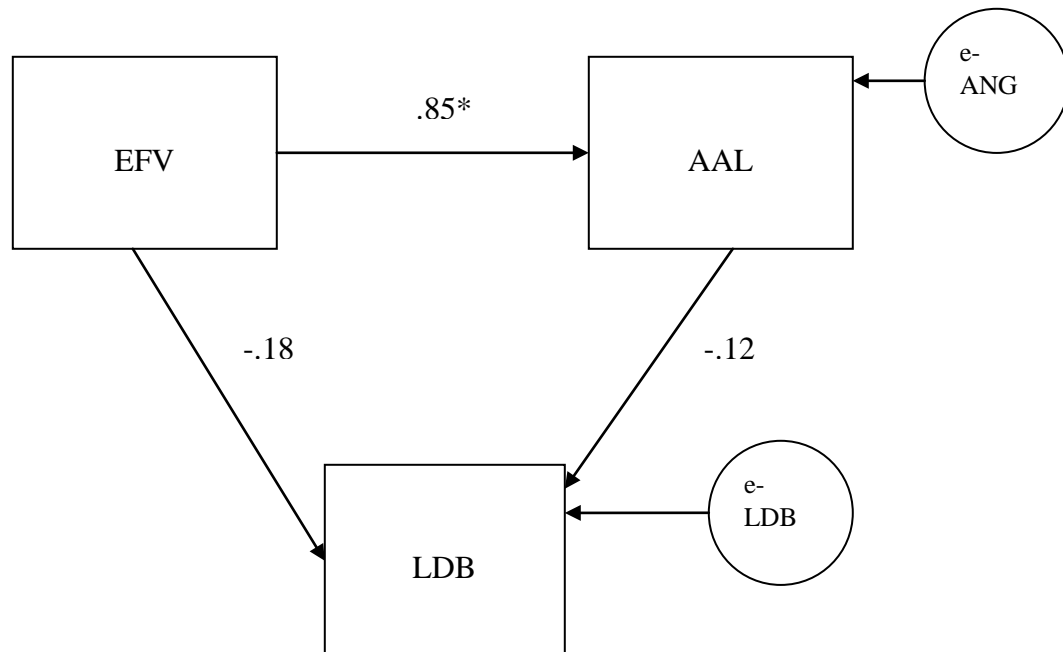

Figure 3

Path Analysis Examining Exposure to Family Violence, Anger/Aggression Level, and Level of Delinquent Behavior among Father Present Sample ($n = 113$) EFV = Exposure to family violence. AAL = Anger/Aggression level. LDB = Level of Delinquent behavior. * $p < .05$. e-ANG = Error variance for AAL. e-LDB = Error variance for LDB.

Table 4

Standardized Effects Examining Exposure to Family Violence, Anger/Aggression Level, and Level of Delinquent Behavior among Father Present Sample ($n = 113$)

| Outcome | Determinant | Estimate | Standard Error |
|---------|-------------|----------|----------------|
| AAL | EFV | .85* | .28 |
| LDB | EFV | -.18 | .45 |
| LDB | AAL | -.12 | .07 |

Note. EFV = Exposure to family violence. AAL = Anger/aggression level. LDB = Level of Delinquent behavior. * $p < .05$. R^2 values for AAL and LDB were .02 and .01, respectively.

Figure 4 provides that path diagram examining the relations between exposure to family violence, anger/aggression levels, and level of delinquent behaviors among African American youth who were in the Fatherless group. Similar to the Father present group, there was a positive association between exposure to family violence and anger/aggression levels and this association was statistically significant at the .05 level suggesting that as exposure to family violence increase so does anger/aggression levels for African American youth. As can be seen in Figure 4, the association between anger/aggression and levels of delinquent behaviors was negative. Unlike the Father present group, this association was significant at the .05 level suggesting that that as levels of anger/aggression increase for African American youth in the Fatherless group so does the level of delinquent behaviors. A closer examination of the table indicates that there is a negative correlation between exposure to family violence and level of delinquent behavior. Again, similar to the Father present group, this association was not significant at the .05 level; however, it still does suggest that the exposure to family violence predicts a decrease in levels of delinquent behaviors.

The model, represented in Table 5, was not consistent with the observed variances. Specifically, the hypothesis that the model was correct was not rejected ($\chi^2[6]=1.07, p<0.01$), the ratio of the chi-square statistic to the degrees of freedom was at 1.07, the root mean square error of approximation (RMSEA) was .04, was within that of the upper limit of 0.08 for acceptable fit and the adjusted goodness of fit index(.95), normed fit index (1.0), and the comparative fit index (0.0.) were greater than the typical target of 0.9 (Tate, 1998).

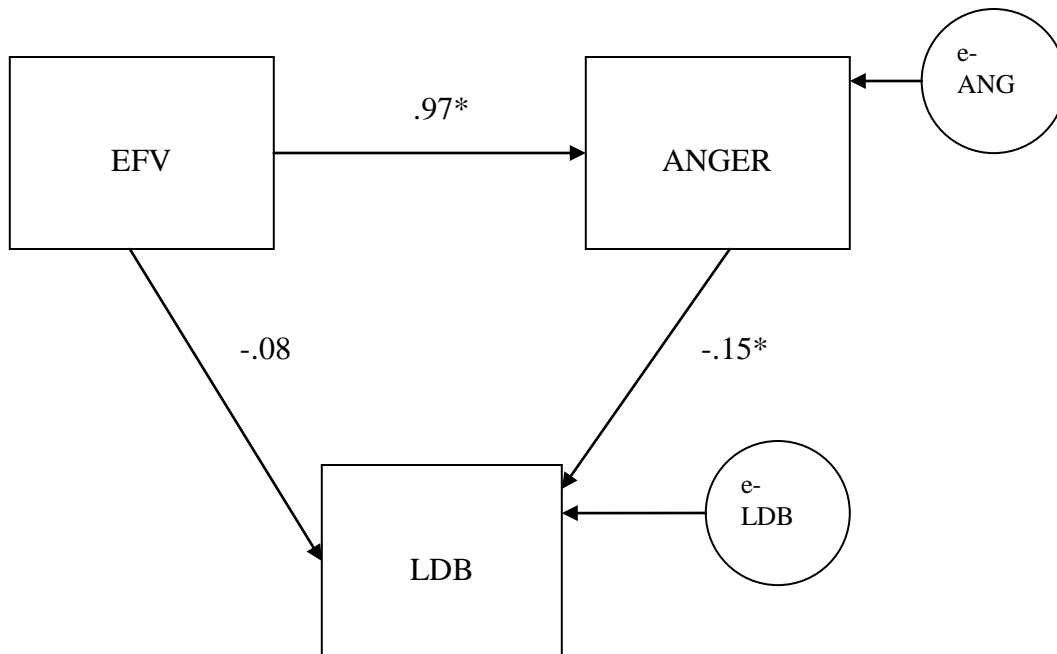

Figure 4

Path Analysis Examining Exposure to Family Violence, Anger/Aggression Level, and Level of Delinquent Behavior among Fatherless/Fatherloss Sample ($n = 246$). EFV = Exposure to family violence. AAL = Anger/aggression level. LDB = Level of Delinquent behavior. * $p < .05$. e-ANG = Error variance for AAL. e-LDB = Error variance for LDB.

Table 5

Standardized Effects Examining Exposure to Family Violence, Anger/aggression Level, and Level of Delinquent Behavior among Fatherless Sample ($n = 246$)

| Outcome | Determinant | Estimate | Standard Error |
|---------|-------------|----------|----------------|
| AAL | EFV | .97* | .25 |
| LDB | AAL | -.15* | .06 |
| LDB | EFV | -.08 | .39 |

Note. EFV = Exposure to family violence. AAL = Anger/aggression level. LDB = Level of Delinquent behavior. * $p < .05$. R^2 values for AAL and LDB were .02 and .01, respectively.

Figure 5 provides the path analysis examining exposure to family violence, anger/aggression level, and levels of delinquent behavior among African American youth in the Surrogate caregiver group. Based on Table 6, the association between exposure to family violence and anger/aggression was significant at the .05 level. This association was in the expected direction. Similar to the other subgroups, the association between anger/aggression was negatively associated with levels of delinquent behaviors. This association was not significant at the .05 level; however, it still conveys the message that as anger/aggression levels increase there is a decrease in levels of delinquent behaviors among African American youth who were in the Surrogate caregiver group. The data also suggest that there is a negative association between exposure to family violence and levels of delinquent behavior. Similar to the path analysis in the other subgroups, this association was not significant at the .05 level; however, it still does suggest that the exposure to family violence predicts a decrease in levels of delinquent behaviors.

The model, represented in Table 6, was consistent with the observed variances. Specifically, the hypothesis that the model was correct was not rejected ($\chi^2[6]=.82, p>0.01$), the ratio of the chi-square statistic to the degrees of freedom was at .82, the root mean square error of approximation (RMSEA) was .05, was within that of the upper limit of 0.08 for acceptable fit and the adjusted goodness of fit index (.95), normed fit index (1.0), and the comparative fit index (1.0.) were greater than the typical target of 0.9 (Tate, 1998).

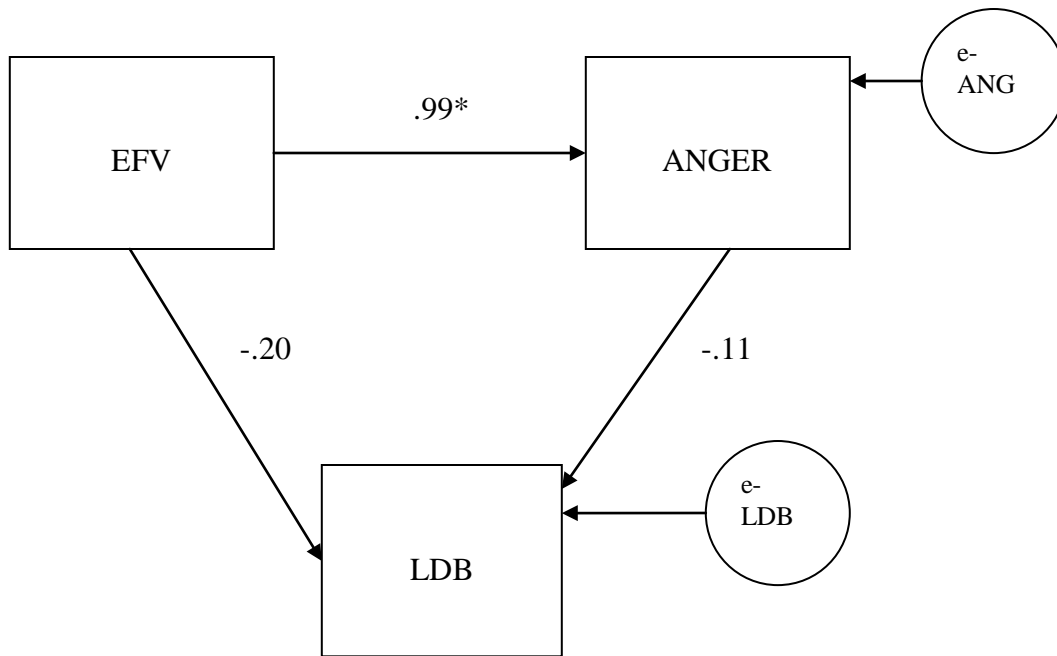

Figure 5

Path Analysis Examining Exposure to Family Violence, Anger/aggression Level, and Level of Delinquent Behavior among Surrogate Caregiver Sample ($n = 137$) EFV = Exposure to family violence. AAL = Anger/aggression level. LDB = Level of Delinquent behavior. * $p < .05$. e-ANG = Error variance for AAL. e-LDB = Error variance for LDB.

Table 6

Standardized Effects Examining Exposure to Family Violence, Anger/Aggression Level, and Level of Delinquent Behavior among Surrogate Sample ($n = 137$)

| Outcome | Determinant | Estimate | Standard Error |
|---------|-------------|----------|----------------|
| AAL | EFV | .99* | .26 |
| LDB | AAL | -.11 | .07 |
| LDB | EFV | -.20 | .44 |

Note. EFV = Exposure to family violence. AAL = Anger/aggression level. LDB = Level of Delinquent behavior. * $p < .05$. R^2 values for AAL and LDB were .03 and .01, respectively.

CHAPTER V

DISCUSSION

Hypothesis 1

The first hypothesis stated that surrogate caregivers will have a positive effect on decreasing anger/aggression levels associated with the overall level of delinquent behavior in African American male youths. The stated overall sample in this prediction was not supported during this study. Conversely, Table 1 indicates that the youth with surrogate caregivers presented with the highest level of anger/aggression of all three groups studied. This outcome may suggest that African American male youths may not benefit from having a surrogate caregiver, but additional variables are involved.

Father present, fatherless, and surrogate caregiver groups were significantly different in regard to overall level of delinquent behavior. However, the surrogate caregiver group did not have the predicted influence that was hypothesized with this group. In fact, the opposite was suggested with regards to anger/aggression levels related to delinquent behavior levels; these levels were negatively affected in the surrogate caregiver group. As expected, the father present group anger/aggression levels were significantly lower than those of the fatherless and surrogate caregiver groups (e.g., mean = 3.68, 4.30, and 4.47 respectively). However, the surrogate caregiver group's anger/aggression levels increased, thereby negatively affecting the overall outcome of the African American male youth's level of delinquent behavior.

These findings contradict the assertions made by some other authors (e.g., Adams et al, 1984; Andry, 1962; Eastin, 2003; Hetherington et al, 1998; Hindelang,

Hirschi, & Weis, 1979; Popenoe, 1997). Some of these authors propose a combination of missed opportunities to aid in filling the void with quality surrogate caregivers in the lives of African American male youths. The premise of most studies suggests that some parental interaction by surrogate caregivers is better than no parental interaction at all; however, this particular study and some others do not support that theory (Ancona, 1998; Andry, 1962; Eastin, 2003; Hindelang et al, 1979). Based on the data in this sample evidence does not support research results reported by other authors.

There are various possible reasons for this lack of support. First as previously mentioned, variables related to the quality of the surrogate caregiver relationship to the youth (e.g. abuse/substance use, circumstance of placement with surrogate caregiver, and previous relationship with the youth or his biological parents). As evidenced by past studies (Ainsworth et al, 1987; Eastin, 2003; Hetherington et al, 1998; Marcus, 1998; Popenoe, 1997) there are variables that need to be considered when identifying the relationship between anger/aggression and overall levels of delinquency in African American male youths. Exposure to abuse, substance dependence and drug usage by the surrogate caregiver group may play a major negative role in the relationship of the youth's response to living with a particular surrogate caregiver. Firstly, these aforementioned negative behaviors will certainly impact the relationship within the surrogate caregiver household. Prior to placement a thorough investigation and history of the surrogate caregiver's environment should be conducted to ensure the possible outcome for the youth placed there.

Secondly, considering placement circumstances that have been reported by some authors (Barber, 1998; Barber, 2000; Biller et al 1986; Eastin, 2003; Marcus, 1998; Popenoe, 1997) suggests that surrogate caregiver may not always provide the best environment for African American male youths. Many African American male youths and surrogate caregiver find themselves thrust together via foster care strictly base on convenience of available placement. This placement may be with a grandparent, an uncle, or an older sibling (e.g., 21 years old, or stepfather), all of whom that may have been unwilling participants in this child rearing process. However, their perceived family obligation or the monetary gains might have been the motivation for accepting the task of rearing these fatherless African American male youths.

A third explanation for these results may be related to the type of pre-existing relationship of the African American male youth with the youth's absent male parent. These particular relationships will have varying influences on the surrogate caregiver based on their previous personal interaction. Some reports (Beaty, 1995; Loeber, 1983; Marcus, 1998; Mosley, 1995; Shulman et al, 1993) identify the importance of the relationship between youths and the surrogate caregivers as a major predictor of delinquent behaviors presented in the youth. Some surrogate caregivers may view the youths as an extension of a relative where the family relationship was extremely strained and continue to use the youth as a conduit for this negativity. These theories should be investigated prior to placement of the youth to making assumptions about the African American male youth's level of delinquent behavior.

Hypothesis 2

The second hypothesis posited that exposure to parental or household family violence will have a positive correlation with the increased anger/aggression levels, thereby increasing the level of delinquent behavior among African American male youth.

This hypothesis was only partially confirmed. As indicated in Table 3 exposure to family violence was statistically significant in predicting anger/aggression levels among African American male youths. However, anger/aggression level did not significantly predict delinquent behaviors. Further, Figure 3 shows that there was a positive relationship between exposure to family violence and anger/aggression level. Moreover, as exposure to family violence increased, anger/aggression levels also increased among African American male youths. Conversely, there was a negative relationship between anger/aggression levels and level of delinquent behaviors.

These results indicate that current sample without consideration of additional variables identified in the MAYSI-2; several variables could further explain the results were most likely overlooked. This study could not confirm or disconfirm the results of past studies (Clark & Wenninger, 1962; Dornbusch et al, 1985; Popenoe 1997; Robinson, 1936) with regards to predicting the relationships between exposure to family violence and level of delinquent behaviors, or the relationships between exposure to family violence and level of delinquent behavior in African American male youth.

As noted earlier many uninvestigated variables (listed in the limitation section of this study) may have contributed to the resulting negative relationship between exposure

to family violence and anger/aggression, as well as exposure to family violence and the level of delinquent behavior in African American male youth.

Another possible reason for the reported negative relationships may be other confounding variables (e.g., limitations of this study); however alternative hypotheses should be developed to ascertain more appropriate findings regarding the reasons for the relationships between exposure to family violence and level of anger level, as well as exposure to family violence and level of delinquent behavior of African American male youth.

Hypothesis 3

The third hypothesis stated that African American male youths reared in a father present home are less likely to be influenced by anger/aggression issues or exposure to family violence, therefore being less likely to engage in increased level of delinquent behavior, than African American male youths raised in fatherless/fatherloss or surrogate caregiver homes. All three father status (father present, fatherless, and surrogate caregiver) groups were evaluated compared to confirm or disconfirm this hypothesis.

In examining the relations between exposure to family violence, anger/aggression levels, and level of delinquent behaviors among African American male youth who were in the Father present group. The positive association between exposure to family violence and anger/aggression levels was statistically significant at the .05 level suggesting that as exposure to family violence increase so does anger/aggression levels for African American youth. However, anger/aggression and levels of delinquent behaviors were negatively correlated with one another. Even though this association was

not significant, it does suggest that as levels of anger/aggression increase for African American male youth in the Father present group so does the level of delinquent behaviors. There seems to be an interaction effect between anger and aggression, however, the direction of the effect was not clearly identified in this study. Furthermore, data indicates that there is a negative correlation between exposure to family violence and level of delinquent behavior. Again, even though this relationship is not significant at the .05 level, it does suggest that as exposure to family violence increases in African American male youth in the Father present group leads to a decrease in levels of delinquent behaviors.

Next an examination of the relations between exposure to family violence, anger/aggression levels and level of delinquent behaviors among African American youth who were in the Fatherless group was conducted. Similar to the Father present group, there was a positive association between exposure to family violence and anger/aggression levels and this association was statistically significant at the .05 level suggesting that as exposure to family violence increase so does anger/aggression levels for African American male youth. As can be seen in Figure 4 the association between anger/aggression and levels of delinquent behaviors were negatively correlated with one another. Unlike the Father present group, this association was significant at the .05 level suggesting that that as levels of anger/aggression increase for African American youth in the Fatherless group so does the level of delinquent behaviors. A closer examination of the figure indicates that there is a negative correlation between exposure to family violence and level of delinquent behavior. Again, similar to the Father present group,

this association was not significant at the .05 level; however, it still does suggest that the exposure to family violence will lead to a decrease in levels of delinquent behaviors.

Here an examination exposure to family violence, anger/aggression level, and levels of delinquent behavior among African American youth in the Surrogate caregiver group was conducted. Based on Figure 4, the association between exposure to family violence and anger/aggression was significant at the .05 level. This association was in the expected direction. Similar to the other subgroups, the association between anger/aggression was negatively associated with levels of delinquent behaviors. This association was not significant at the .05 level; however, it still conveys the message that as anger/aggression levels increase there is a decrease in levels of delinquent behaviors among African American youth who were in the Surrogate caregiver group. The data suggest that there is a negative association between exposure to family violence and levels of delinquent behavior. Similar to the path analysis in the other subgroups, this association was not significant at the .05 level; however, it still does suggest that the exposure to family violence will lead to a decrease in levels of delinquent behaviors. Longitudinal study of the changes in anger and delinquent behavior might also shed light on the nature of their relationship.

Limitations of Study

There are a number of limitations in this study. The primary limitation was that the study was developed using archival data, where the collected information could not be manipulated by this author. Therefore, numerous variables were not controlled for in this study that could have influence the results.

Several considerations with respect to the surrogate caregiver that were not considered during this study were quality (e.g., substance abuser versus education level) of the surrogate caregiver, length of time the youth lived with the surrogate caregiver, parental skills of the surrogate caregiver, circumstances (e.g., volunteer placement versus court appointed placement) in which the youth was placed with the surrogate caregiver, the quality of time spent with the youth, any collateral abuse within the surrogate caregivers home, the relationship between the surrogate caregiver and the youth. Another very important variable that was not considered is the effect that the mother or female interaction (e.g., emotional and nurturing) has on the youth.

Additional limitations (variables) that were not controlled for included the selection of only male African American male youths at the Harrison County Juvenile Probation Department, selection of initial offense youths, psychological factors that influence the youths outlook on life (e.g., self-esteem, substance abuse/dependence, physical health-somatic complaints, depression/anxious, thought disturbance, and some traumatic experiences), gender considerations, and the challenges for male youths in reared in single mother homes.

Implications for Future Research

The findings and limitations of this study emphasized some points that should be considered in future research. The studies should include examining exposure to family violence, anger/aggression, and levels of delinquent behaviors controlling for variables mentioned above. One way of doing this is to look for variables in the literature that influence anger/aggression (e.g., depression, substance abuse, etc.), exposure to family

violence (e.g., parent education, income, etc), levels of delinquent behavior (e.g., age, family discord, education level, etc), and use these variables as covariates in future analysis. For example, one might run an Analysis of covariance to control for these variables, which may lead to a better understanding of the findings in this study.

There are other variables that may be related to delinquent behaviors that need to be addressed. This study targeted anger and exposure of family violence as they related to level of delinquent behavior. However, it might be useful to investigate other variables that might contribute to delinquent behavior. The MAYSI-2 has other variables that seem important and worth including in future study variable lists. For instance, depression levels, suicidal ideation, substance abuse, etc. It would be interesting to see which one of these variables was the best predictor of the level of delinquent behavior. Furthermore, it would be interesting to look at how these variables differ by gender and ethnicity. For instance, what might be the difference be if the data included male/female genders of Hispanic, Caucasian and other ethnic backgrounds?

Implications for Clinical Practice

Based on the results it might be beneficial to start an education intervention (e.g., appropriate parenting) with surrogate caregivers. Starting with educating surrogate caregivers might also be an opportunity to assess their level or parenting skill methods. Given that surrogate caregivers in this sample failed to help reduce anger/aggression levels in African American male youth, clinical interventions might focus on helping surrogate caregivers interact with this youth population more positively.

Finally, psychologists, educators, juvenile justice professionals, and legislatures could collectively help develop programs and curriculum that could aid in a better understanding of the mental health issues that affect the level of delinquent behavior of African American male youth including a prevention model for use prior to the offense. One major reason for prevention is to help decrease the need for growing numbers of juvenile detention centers through the use of better empirical psychological interventions prior to the youth's initial offenses. This prevention initiative should enable professionals to aid youths in enhancing various aspects of their emotional, psychological and behavioral wellbeing prior to their engaging in juvenile delinquent behaviors. In turn, such initiatives should help decrease the overall number of systemic burdens related to overcrowding of African American male youths in the juvenile justice system.

CHAPTER VI

CONCLUSION/SUMMARY

Summary

To further understand the relationships between father status, anger/aggression, exposure to family violence, and other variables outline on the MAYSI-2 additional research needs to be conducted as to identify the greatest to the least predictive variables on that measure (MAYSI-2). These findings may be significant for counselors, correction professional, and city/county legislatures in developing programs to aid in dealing with decreasing the level of delinquency in fatherless African American male youths across the US.

Furthermore, many of the factors or consideration not included in this study involve other predictive behavior factors and would be useful as preventative measure rather than post-predictive measures. All professional with involvement with youth (e.g., counselor, teachers, juvenile correction organizations, psychologist, psychiatrist, etc.,) should collective focus on prevention measure when dealing with decreasing the level of delinquent behavior of all youth, particularly those needing the positive influence of a father figure in the household.

REFERENCES

- Adams, P. L., Milner, J. R., & Schrepf, N. A. (1984). *Fatherless children*. New York: John Wiley & Sons.
- Ainsworth, M. D., Blehar, M. C., Waters, E., & Wall, S. (1987). *Patterns of attachment: A psychological study of the strange situation*. Hillsdale, NJ: Erlbaum.
- Amato, P.R., & Keith, B. (1991). Parental divorce and well-being of children: A meta-analysis. *Psychological Bulletin*, *110*, 26-46.
- American Missionary Data on Fatherless Children. Sobering Facts.*
www.aamissionary.org/sobering.htm. (accessed September 26, 2008).
- Ancona, F. (1998). *Crisis in America: Father absence*. Commack, NY: Nova Science.
- Andry, R. G. (1962). Parental and maternal roles in delinquency. *W.H.O. Public Health Paper*, *14*, 31-44.
- Bandura, A. (1977). *Social learning theory*. Englewood Cliffs, NJ: Prentice-Hall.
- Beaty, L. A. (1995). Effects of paternal absence on male adolescent's peer relations. *Adolescence*, *30*, 873-880.
- Biller, H. B. (1971). *Father, child, and sex role*. Lexington, MA: D. C. Heath.
- Biller, H. B., & Meridith, D. L. (1974). *Father power*. New York: David McKay.
- Biller, H. B., & Solomon, R. S. (1986). *Child maltreatment and paternal deprivation: A manifesto for research, prevention, and treatment*. Lexington, MA: D. C. Heath.
- Boveland, P. J. (2002) The impact of corrective response on juvenile recidivism. Ph.D. dissertation, University of Houston.

- Bracki, M.A., Dolson, B.M., Maurice, K. (1997). *Pre-teen gang members: The father connection*. Paper presented at the 105th annual meeting of the American Psychological Association (105th, Chicago, IL, August 15-19, 1997).
- Bryant, A.L., & Zimmerman, M.A. (2003). Role models and psychosocial outcomes among African American adolescents. *Journal of Adolescent Research, 18*, (1), 36-67.
- Cernkovich, S.A., & Giordano, P.C. (1987). Family relationships and delinquency. *Criminology, 25*, 295-321.
- Bumpass, L. L. (1984). Children and marital disruption: A replication and update. *Demography, 21*(1), 71-82.
- Clark, J. P., & Wenninger, E. P. (1962). Socioeconomic class and area as correlates of illegal behavior among juveniles. *American Sociological Review, 28*, 826-834.
- Copeland, A. D. (1974). Violent black gangs: Psycho- and sociodynamics. *Adolescent Psychiatry, 3*, 40-353.
- Demo, D.H., & Acock, A.C. (1988). The impact of divorce on children. *Journal of Marriage and the Family, 50*, 619-648.
- Dornbusch, S. M., Carlsmith, J. M., Bushwall, S. J., Ritter, P. L., Leiderman, H., Hastorf, A. H., & Gross, R. T. (1985). Single parents, extended households, and the control of adolescence. *Child Development, 56*, 326-341.
- Draper, P., & Belsky, J. (1990). Personality development in evolutionary perspective. *Journal of Personality and Social Psychology, 58*, 141-161.
- Duncan, G.J., Brooks-Gunn, J., & Klebanov, P.K. (1994). Economic deprivation and

- early childhood development. *Child Development*, 64, 296-318.
- Dunn, J. (2005). Daddy doesn't live here anymore. *The Psychologist*, 18, (1), 28-30.
- Dunn, J., Cheng, H., O'Connor, T.G., & Bridges, L. (2004). Children's perspectives on their relationships with their non-resident fathers: influences, outcomes and implication. *Journal of Child Psychology and Psychiatry*, 45, 553-566.
- Eastin, J. F. (2003) Impact of absent father-figures on male subjects and the correlation to juvenile delinquency: Findings and implications. Ph.D. dissertation, University of North Texas, Denton, TX. (UMI No. AAT 3106878).
- Elliott, D. S., Huizinga, D., & Ageton, J. (1985). *Explaining delinquency and drug use*. Beverly Hills, CA: Sage.
- Fost, D. (1996). The lost art of fatherhood. *American Demographics*, 18, (3), 16-19.
- Frick, P.J., Lahey, B.B., Loeber, R., Strouthamer-Loeber, M., Christ, M.A.G., & Hanson, K. (1992). Familial risk factors to oppositional defiant disorder and conduct disorder: Parental psychopathology and maternal parenting. *Journal of Consulting and Clinical Psychology*, 60, 49-55.
- Gabel, S. (1992). Behavioral problems in sons of incarcerated or otherwise absent fathers: The issue of separation. *Family Process*, 31, 303-314.
- Goldberg, S. (1997). Attachment and childhood behavior problems in normal, at-risk, and clinical samples. In L. Atkinson & K.J. Zucker (Eds.), *Attachment and psychopathology* (pp. 171-195). New York: Guilford.
- Gregory, I. (1965). Anterospective data following childhood loss of a parent: Delinquent high school dropout. *Archives of General Psychiatry*, 13, (2), 110-120.

- Greif, E. B. (1976). Fathers, children and moral development. In M. Lamb (Ed.), *The role of the father in child development*. New York: Wiley & Sons.
- Griffin, K.W., Botvin, G.J., Scheier, L.M., Diaz, T., & Miller, N.L. (2000). Parenting practices as predictors of substance use, delinquency, and aggression among urban minority youth: moderating effects of family structure and gender. *Psychology of Addictive Behaviors, 14*, (2), 174-184.
- Harper, C. C., & McLanahan, S. (1999). *Father absence and youth incarceration*. Princeton University Center on Child Well-being, Princeton, NJ.
- Harris, J.R. (2000). The outcome of parenting: What do we really know? *Journal of Personality, 68*, (3), 625-637.
- Hetherington, E.M. (1966). Effects of paternal absence on sex-typed behaviors in Negro and white predominant males. *Journal of Personality and Social Psychology, 4*, 87-91.
- Hetherington, E.M., Bridges, M., & Insabella, G.M. (1998). What matters: What does not? Five perspectives on the association between marital transitions and children's adjustment. *American Psychologist, 53*, 167-184.
- Hindelang, M. T., Hirschi, T., & Weis, J. G. (1979). Correlates of delinquency: The illusion of discrepancy between self-report and official measures. *American Sociological Review, 44*, 995-1014.
- Hippmann-West, D. K. (2001) A program to treat external locus of control

- and poor achievement motivation in male children raised in fatherless homes. Psy.D. dissertation, Carlos Albizu University, Miami, FL. (UMI No. AAT 3040652).
- Jaffee, S.R., Moffitt, T.E., Caspi, A., & Taylor, A. (2003). Life with (or without) father; the benefits of living with two biological parents depend on the father's antisocial behavior. *Child Development, 74*, (1), 109-126.
- Kulik, J. A., Stein, K. B., & Sarbin, T. R. (1986). Dimensions and patterns of adolescent antisocial behavior. *Journal of Counseling and Clinical Psychology, 32*, 375-382.
- Lamb, M. E. (1976). The role of the father: An overview. In M. Lamb (ed.), *The role of the father in child development*. (pp. 1-63) New York: Wiley & Sons.
- Laybourn, A. (1986). Traditional strict working class parenting-an undervalued system. *British Journal of Social Work, 16*, 625-644.
- Loeber, R., & Dishion, T. (1983). Early predictor of male delinquency: A review. *Bulletin, 94*, 68-99.
- Mackey, W.C., & Mackey, B. (2003). The presence of fathers in attenuating young male violence: Dad a social palliative. *Marriage & Family Review, 35*, (1-2), 63-75.
- Marcus, R. F., & Gray, L. (1998). Close relationships of violent and nonviolent African American delinquents. *Violence and Victims, 13*(1), 31-46.
- Merriam-Webster's Collegiate Dictionary (11th ed.)* (2003). Springfield, MA: Merriam-Webster Incorporated.
- Moeller, T.G. (2001). *Youth aggression and violence. A psychological approach*. Mahwah, NJ: Erlbaum.

- Mosley, J., & Thomson, E. (1995). Fathering behavior and child outcomes: The role of race and poverty. In W. Marsiglio (Ed.), *Fatherhood: Contemporary theory, research, and social policy*. (pp. 148-165). Thousand Oaks, CA: Sage.
- Nelson, C., & Valliant, P.M. (1993). Personality dynamics of adolescent boys where the father was absent. *Perceptual & Motor Skills*, 76, (2), 435-443.
- Nye, F. I. (1973). *Family relationships and delinquent behavior*. New York: Wiley and Sons.
- Office of Juvenile Justice and Delinquency Prevention (2000). *Youth Gang Programs and Strategies*. http://www.ncjrs.gov/html/ojjdp/summary_2000_8/home.html.
- Pettit, G.S., Bates, J.E., Dodge, K.A., & Meece, D.W. (1999). The impact of after-school peer contact on early adolescent externalizing problems in moderated by parental monitoring, perceived neighborhood safety, and prior adjustment. *Child Development*, 70, 768-778.
- Popenoe, D. (1996a). A world without fathers: Consequences of children living with fathers. *The Wilson Quarterly*, 20, 12-30
- Popenoe, D. (1996b). *Life without father*. New York: Free Press.
- Popenoe, D. (1997). *Life without father*. Paper presented at the 59th annual conference of the NCFR fatherhood and motherhood in a diverse and changing world. Arlington, VA, November 7-10, 1997.
- Radin, N. (1976). The role of the father in cognitive, academic and intellectual development. In M. Lamb (Ed.), *The role of the father in child development*. (pp. 237-276) New York: Wiley & Sons.

- Robinson, S. M. (1936). *Can delinquency be measured?* New York: Columbia University Press.
- Shulman, S., & Collins, W. A. (1993). *Father-adolescent relationships*. San Francisco, CA: Jossey-Bass.
- Slocum, W. L., & Stone, C. L. (1963). Family culture patterns and delinquent-type behavior. *Marriage and Family Living*, 25, 202-208.
- Sokol-Katz, J., Dunham, R., & Zimmerman, R. (1997). Family structure versus parental attachment in controlling adolescent deviant behavior: A social control model. *Adolescence*, 32, 199-215.
- Statistical Package for the Social Sciences (2004). *SPSS Base 15.0: Application guide*. Chicago, IL: SPSS Inc.
- Steinberg, L. (2000). Youth violence: do parents and families make a difference? *National Institute of Justice Journal*, 80, 31-38.
- Texas Statutes of Family Code; Title 3 Juvenile Justice Code (1985).
<http://law.justia.com/texas/codes/fa/003.00.000051.00.html>.
- Wasserman, G.A., Miller, L.S., Pinner, E., & Jaramillo, B. (1996). Parenting predictors of early conduct problems in urban, high-risk boys. *Journal of the American Academy of Child and Adolescent Psychiatry*, 35, 1227-1236.
- Wells, L.E., & Rankin, J.H. (1991). Families and delinquencies: A meta-analysis of the impact of broken homes. *Social Problems*, 38, 71-93.
- White, J., Moffitt, T., Earls, F., Robins, L., & Silva, P. (1990). How early can we tell? Predictors of childhood conduct disorder and adolescent delinquency.

Criminology, 28, 507-533.

Wisdom, C. S. (1989). The cycle of violence. *Science*, 244, 160-166.

Wolfgang, M. E., Figlio, R. M., & Sellin, T. (1972). *Delinquency in a birth cohort*.

Chicago, IL: University of Chicago Press.

APPENDIX A

LETTER OF APPROVAL FROM THE INSTITUTIONAL REVIEW BOARD

**TEXAS A&M UNIVERSITY
VICE PRESIDENT FOR RESEARCH - OFFICE OF RESEARCH COMPLIANCE**

1186 TAMU
College Station, TX 77843-1186
1500 Research Parkway, Suite B-150

979.458.1467
FAX 979.862.3176
<http://researchcompliance.tamu.edu>

Institutional Biosafety Committee Institutional Animal Care and Use Committee Institutional Review Board

DATE: 03-Apr-2007

MEMORANDUM

TO: CARTER-HAITH JR., JAMES A
TAMU-EDUCATIONAL PSYCHOLOGY(00031)

FROM: Office of Research Compliance
Institutional Review Board

SUBJECT: Initial Review

**Protocol
Number:** 2007-0174

Title: The Positive Effects of Surrogate Caregivers on the Relationship
Between Fatherless/Fatherloss African American Male Youths and
Level of Delinquent Behavior

**Review
Category:** Exempt from IRB Review

The Institutional Review Board (IRB) has determined that the referenced protocol application meets the criteria for exemption and no further review is required. However, any amendment or modification to the protocol must be reported to the IRB and reviewed before being implemented to ensure the protocol still meets the criteria for exemption.

This determination was based on the following Code of Federal Regulations:
(<http://www.hhs.gov/ohrp/humansubjects/guidance/45cfr46.htm>)

45 CFR 46.101(b)(4) Research involving the collection or study of existing data, documents, records, pathological specimens, or diagnostic specimens, if these sources are publicly available or if the information is recorded by the investigator in such a manner that subjects cannot be identified, directly or through identifiers linked to the subjects.

Provisions:

This electronic document provides notification of the review results by the Institutional Review Board.

APPENDIX B

AUTHORIZATION FOR RESEARCH ACCESS FROM HARRIS
COUNTY JUVENILE PROBATION DEPARTMENT

| | |
|--------------------------------------|---|
| Harris County |  |
| JUVENILE PROBATION DEPARTMENT | |

Whether research is informal or formal, when information is collected from or about youth referred to the Juvenile Probation Department, this Agency is responsible for protecting the confidentiality and rights of the youth.

(Ref: <http://ncjj.servehttp.com/irb>)

Research Guidelines

- 1) All projects are reviewed by the **Research Review Committee**. Each project is judged on its own merit. The project must have considerable practical application to operations of the Department and must be free of perceived logistical complications (i.e. problems concerning office space, computer accessibility, etc.) Considerable modifications to the research design are occasionally requested and made requisite to project approval.
- 2) Non-departmental personnel must submit a proposal (in both hard copy and electronic format) which can adequately answer questions relevant to the research objective, value (i.e., social, academic, program, or scientific), informed consent, subject protection, data collection and management, and informs about overall research methodology and data analysis.
- 3) The research review process may take a month or more. Formal notice of the Research Review Committee's decision will be provided to the researcher upon completion of the review process. Neither the proposed research nor the data collection process may begin until signed approval has been provided and all requested research forms have been received, unless otherwise stated.
- 4) The researcher is responsible for maintaining all data in such a manner that ensures the security and confidentiality of all research participants. Only aggregate data may be taken from the case histories. This is to ensure individual juvenile records remain unidentifiable.
- 5) Coordination of any and all files and records of the project should be through the Assistant Deputy Director of Budget and Information Technology Services or designee.
- 6) No report (verbal or written) of the findings of this research endeavor may be disseminated until the finished draft has been submitted and approved. The approval process should not take more than four weeks. In the event that the report is approved, one copy of the report (if a thesis or dissertation, it should be bound) should be submitted to the Assistant Deputy Director of Budget and Information Technology Services. Reprints of all articles should also be forwarded to the Assistant Deputy Director of Budget and Information Technology Services.

AUTHORIZATION FOR RESEARCH ACCESS

I, James A. Carter-Haith Jr., am a student enrolled in a Doctorate degree program at Texas A&M University, intend to pursue a research project which will require access to certain records, staff and/or juvenile clients of the Harris County Juvenile Probation Department. I therefore request, for the specific purposes outlined in my research proposal entitled "The positive effects of surrogate caregivers on the relationship between fatherless/fatherloss African American male youths and level delinquent behavior." that I be given access to the following records, staff and/or juvenile clients: Archival data will be collected on 280 to 300 African American male youths (ages ten to seventeen) placed at Harris County Juvenile Probation Department, Houston, Texas. The data will cover a ten-year period (June 1996 to June 2006). The three categories that data will be considered are African American male youths that (at time of first referral/first offense) had a father living in the household, that had no father living in the household, or that had a male surrogate caregiver for support. I am familiar with Section 58.005 of the Texas Family Code and the established policy of the Harris County Juvenile Probation Department which mandates that the files and records of their clients are confidential. I further agree that there will be no dissemination of any aggregate data, findings, presumptions, etc., until release of the proposed information has been approved pursuant to the "Research Guidelines", which I have previously examined and have signed. I further agree to return or destroy all client identifiable data compiled in furtherance of this project at the completion of the project to the Harris County Juvenile Probation Department, or its designee.

Signed on this 24th day of April 2007.

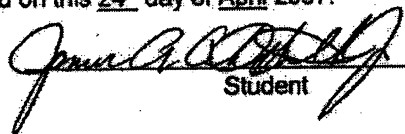
Student

Texas A&M University
University

SUBSCRIBED AND SWORN to before me this the 25 day of April
2007

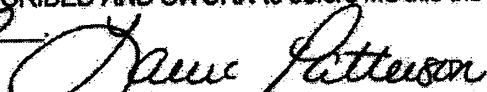

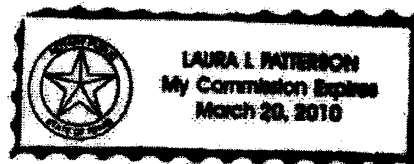
Notary Public in and for the State of Texas



AGREEMENT

I request authorization to access records and/or to have contact with juvenile clients or staff of the Harris County Juvenile Probation Department to facilitate my research entitled "The positive effects of surrogate caregivers on the relationship between fatherless/fatherless African American male youths and level delinquent behavior."

I have read and understand fully the above Research Guidelines and agree to conduct myself in accordance to the requirements above if the addressed research project is allowed to be performed.

 RESEARCHER SIGNATURE & DATE
James A. Carter-Haith Jr.
 NAME-PRINTED

SPONSORING AGENCY OR INSTITUTION

By

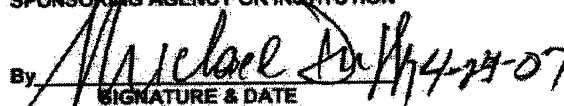
 SIGNATURE & DATE

Michael Duffy, Ph.D., ABPP
 NAME-PRINTED

Professor, Educational Psychology
Texas A&M University
 TITLE

APPENDIX C

THE MASSACHUSETTS YOUTH SCREENING INSTRUMENT SECOND VERSION (MAYSI-2) INSTRUCTION SHEET

Massachusetts Youth Screening Instrument (MAYSI-2)®

| Before Administering the Instrument | During Administration | After Administration |
|---|---|--|
| <ul style="list-style-type: none"> • Introduce the Test by saying: "These are some questions about things that sometimes happen to people. For each question, please answer yes or no to answer whether that question has been true for you in the past few months. Please answer these questions as well as you can." • Give the legal warnings by saying: "Any statement you make or any answer you give to the questions on this test cannot be used against you in any other hearing in juvenile or criminal court. Do you understand? Do you have any questions?" • Give the confidentiality warnings by saying: "While nothing you say while answering these questions can be used against you, there is one exception. If you disclose that you are the victim of child abuse or neglect, or if you disclose that you have committed an offense involving child abuse or neglect, that information must be reported to law enforcement." | <ul style="list-style-type: none"> • Monitor and supervise the room where child or children are completing the instrument. If administered in a group setting, ensure a quiet setting, adequate separation of youth, and limited distractions. • Answer questions as necessary and ensure you are available for any direction the juvenile may need to successfully complete the questionnaire. • If administering the manual version (paper and pencil version) of the MAYSI-2, it is helpful to point to the right side of the MAYSI and say to the juvenile, "circle Y for yes or N for no". In addition, point out that there are more questions that need to be answered on the back of the questionnaire. • If using the automated/computerized version of the MAYSI-2, please ensure that you have completed the section entitled "TO BE COMPLETED BY STAFF ONLY". | <ul style="list-style-type: none"> • Check to see if all questions have been answered • If not, ask child to complete any unanswered questions • Score the MAYSI-2 • Record the scores and perform follow-up actions recommended |

MAYSI-2 Post-Scoring Recommended Services

| SECONDARY SCREENING (by Juvenile Justice Staff) | PRIMARY SERVICES (by Mental Health Professionals) |
|--|--|
| <p>A. Monitoring of the Juvenile: Probation and/or detention staff should exercise greater vigilance and attention to the youth in order to make relevant observations.</p> <p>Complete Follow-Up Questionnaire</p> | <p>C. Clinical Consultation: Staff should seek expertise from clinical professionals/mental health professionals who can intervene to provide additional evaluations or emergency care.</p> |
| <p>B. Interviewing and Collateral Contacts: Staff should engage in focused discussions with the youth or with the youth's family and/or past service providers. The focus should explore the reasons for the youth's responses on relevant items of the MAYSI-2, as well as outside information that contradicts or is consistent with what the youth reported on the instrument.</p> <p>Complete Follow-Up Questionnaire</p> | <p>D. Evaluation Referral: Staff should arrange for a more comprehensive psychiatric or psychological evaluation to determine the nature and source of the youth's self-reported distress or disturbance.</p> |

Recommended Actions By Juvenile Justice Staff

| Suicide Ideation Scale Only | |
|---|---|
| Warning | Both A and B + Either C or D |
| Caution | Either A or B or Both |
| Angry/Irritable Scale Only | |
| Warning | Greater attention/vigilance by staff recommended for this youth due to greater risk of aggression and impulsive acts. |
| Any Combination of Scales (Except Suicide Ideation Scale) | |
| Warning | Warning + Either C or D or Both |
| Warning | Caution Both A + B |
| Warning | Either A or B or Both |
| Caution | Caution Caution + Either C or D or Both |
| Caution | Caution Caution Either A or B or Both |
| Caution | Caution Caution Either A or B or Both |

APPENDIX D

THE MASSACHUSETTS YOUTH SCREENING INSTRUMENT
SECOND VERSION (MAYSI-2) REFERENCE CARDMassachusetts Youth Screening Instrument *Second Version* (MAYSI-2)[©]
REFERENCE CARD

| MAYSI-2 Scale | Description of Scale/Measurement Components | Questions on Scale |
|------------------------------|--|--|
| Alcohol/Drug Use | <ul style="list-style-type: none"> Frequent use of alcohol/drugs Risk of substance abuse or psychological reaction to lack of access to substances | <ul style="list-style-type: none"> 10. Have you done anything you wish you hadn't, when you were drunk or high? 19. Have your parents or friends thought you drink too much? 23. Have you gotten in trouble when you've been high or have been drinking? 24. If yes [to #23], has the trouble been fighting? 33. Have you used alcohol or drugs to help you feel better? 37. Have you been drunk or high at school? 40. Have you used alcohol and drugs at the same time? 45. Have you been so drunk or high that you couldn't remember what happened? |
| Angry-Irritable | <ul style="list-style-type: none"> Experiences frustration, lasting anger, moodiness Risk of angry reaction, fighting, aggressive behavior | <ul style="list-style-type: none"> 2. Have you lost your temper easily, or had a "short fuse"? 6. Have you been easily upset? 7. Have you thought a lot about getting back at someone you have been angry at? 8. Have you been really jumpy or hyper? 13. Have you had too many bad moods? 36. Have you felt angry a lot? 39. Have you gotten frustrated easily? 42. When you have been mad, have you stayed mad for a long time? 44. Have you hurt or broken something on purpose, just because you were mad? |
| Depressed-Anxious | <ul style="list-style-type: none"> Experiences depressed and anxious feelings Risk of impairments in motivation, need for treatment | <ul style="list-style-type: none"> 3. Have nervous or worried feelings kept you from doing things you want to do? 14. Have you had nightmares that are bad enough to make you afraid to go to sleep? 17. Have you felt lonely too much of the time? 21. Has it seemed like some part of your body always hurts you? 34. Have you felt that you don't have fun with your friends anymore? 35. Have you felt angry a lot? 41. Has it been hard for you to feel close to people outside your family? 47. Have you given up hope for your life? 51. Have you had a lot of bad thoughts or dreams about a bad or scary event that happened to you? |
| Somatic Complaints | <ul style="list-style-type: none"> Experiences bodily discomforts associated with distress Risk of psychological distress not otherwise evident | <ul style="list-style-type: none"> When you have felt nervous or anxious... 27. Have you felt shaky? 28. Has your heart beat very fast? 29. Have you felt short of breath? 30. Have your hands felt sweaty? 31. Has your stomach been upset? 43. Have you had bad headaches? |
| Suicide Ideation | <ul style="list-style-type: none"> Thoughts and intentions to harm oneself Risk of suicide attempts or gestures | <ul style="list-style-type: none"> 11. Have you wished you were dead? 16. Have you felt like life was not worth living? 18. Have you felt like hurting yourself? 22. Have you felt like killing yourself? 47. Have you given up hope for your life? |
| Thought Disturbance | <ul style="list-style-type: none"> (Boys Only) Unusual beliefs and perceptions Risk of thought disorder | <ul style="list-style-type: none"> 9. Have you seen things other people say are not really there? 20. Have you heard voices other people can't hear? 25. Have other people been able to control your brain or your thoughts? 26. Have you had a bad feeling that things don't seem real, like you're in a dream? 32. Have you been able to make other people do things just by thinking about it? |
| Traumatic Experiences | <ul style="list-style-type: none"> Critical exposure to traumatic events (e.g. abuse, rape, observed violence). Questions refer youth to "ever" in the past, not "a few months" Risk of trauma-related instability in emotion/perception | <p>Girls</p> <ul style="list-style-type: none"> 48. Have you EVER IN YOUR WHOLE LIFE had something very bad or terrifying happen to you? 49. Have you ever been badly hurt, or been in danger of getting badly hurt or killed? 50. Have you ever been raped, or been in danger of getting raped? 51. Have you had a lot of bad thoughts or dreams about a bad or scary event that happened to you? 52. Have you ever seen someone severely injured or killed (in person—not in movies or on TV)? <p>Boys</p> <ul style="list-style-type: none"> 46. Have people talked about you when you're not there? 48. Have you EVER IN YOUR WHOLE LIFE had something very bad or terrifying happen to you? 50. Have you ever been badly hurt, or been in danger of getting badly hurt or killed? 51. Have you had a lot of bad thoughts or dreams about a bad or scary event that happened to you? 52. Have you ever seen someone severely injured or killed (in person—not in movies or on TV)? |

APPENDIX E

MAYSI-2 TABLE 15: "CAUTION"
AND "WARNING" CUT-OFF SCORES

| "CAUTION" CUT-OFFS | Cut-Off Score* | Percent of Sample Above Cut-Off | | Percent of Youths High on Comparison Scale Who Were High on MAYSI scale | | Percentage Above Cut-Off Who Were High on Comparison Measures** | |
|---------------------|----------------|---------------------------------|-------|---|-------|---|-------|
| | | Boys | Girls | Boys | Girls | Boys | Girls |
| Alcohol/Drug Use | 4 | 33 | 34 | 74 | 81 | 85 | 75 |
| Angry-Irritable | 5 | 38 | 54 | 72 | 71 | 82 | 54 |
| Depressed-Anxious | 3 | 31 | 47 | 71 | 79 | 37 | 48 |
| Somatic Complaints | 3 | 33 | 37 | 65 | 77 | 28 | 38 |
| Suicide Ideation | 2 | 13 | 35 | 79 | 83 | 31 | 42 |
| Thought Disturbance | 1 | 33 | | 71 | | 28 | |

| "WARNING" CUT-OFFS | Cut-Off Score* | Percent of Youths Who Were Above Cut-Off | | Percentage Above Cut-Off Who Were High on Parallel Measures** | |
|----------------------------|----------------|--|-------|---|-------|
| | | Boys | Girls | Boys | Girls |
| Alcohol/Drug Use | 7 | 10 | 12 | 90 | 94 |
| Angry-Irritable | 8 | 10 | 16 | 45 | 87 |
| Depressed-Anxious | 6 | 8 | 15 | 72 | 86 |
| Somatic Complaints | 6 | 6 | 12 | 49 | 55 |
| Suicide Ideation | 3 | 8 | 25 | 52 | 65 |
| Thought Disturbance (Boys) | 2 | 12 | | 45 | |

*This score or higher

**Parallel measures were MACI or CBCL scales that assess the same characteristics. See Table 14.

APPENDIX F

MEASUREMENT VARIABLE CODEBOOK-SERIOUSNESS INDEX SCORE (LEVEL OF
DELINQUENT BEHAVIORS) HARRIS COUNTY
JUVENILE PROBATION DEPARTMENT

| Measurement Variable | Level/Value/ Calculation | Definition |
|--|-----------------------------|------------------------------------|
| Level of Delinquent Behavior (Referral Severity- Serious Index Score) | 1 | Misdemeanor/City Ordinance Offense |
| | 2 | Status Offense |
| | 3 | Technical Violations |
| | 4 | All other Misdemeanors |
| | 5 | Drug Misdemeanors |
| | 6 | Property Misdemeanors |
| | 7 | Against Person Misdemeanors |
| | 8 | All Other Felonies |
| | 9 | Drug-related Felonies |
| | 10 | Property Felonies |
| | 11 | Against Person Felonies |

Note: To calculate level of delinquent behavior, add the value of each "Initial" offense(s) then total the sum of those values.

APPENDIX G

DATA ON FATHERLESS CHILDREN

The data below record the prevalence of physical fatherlessness, which affects more than 25,000,000 children. Emotional fatherlessness--when dad is in the home, but not emotionally engaged with his child's life--affects millions more.

1. Current Data

According to 72.2 % of the U.S. population, fatherlessness is the most significant family or social problem facing America.

An estimated 24.7 million children (36.3%) live absent their biological father.

The 1997 Gallup Youth Survey found the following among U.S. teens:

33 % live away from their father

43% of urban teens live away from their father

2. Trended Data

Children who were part of the "post war generation" could expect to grow up with two biological parents who were married to each other. Eighty percent did. Today, only about 50% of children will spend their entire childhood in an intact family.

With the increasing number of premarital births and a continuing high divorce rate, the proportion of children living with just one parent rose from 9 percent in 1960 to 28 percent in 1996. Currently, 57.7 percent of all black children, 31.8 percent of all Hispanic children, and 20.9 percent of all white children are living in single-parent homes.

March 1994., US Bureau of the Census, Current Population Report. p28-484. Washington, DC: GPO, 1996. US Bureau of the Census. **Statistical Abstract of the United States 1997**, Washington, DC: GPO, 1996.

| Year | 1960 | 1970 | 1980 | 1990 | 1995 |
|------|------|------|------|------|------|
| % | 8.0 | 10.8 | 18.0 | 21.6 | 23.4 |

DATA ON FATHERLESS CHILDREN (Continued)

White children born in the 1950-1954 period spent only 8% of their childhood with just one parent; black children spent 22%. Of those born in 1980, by one estimate, white children can be expected to spend 31% of their childhood years with one parent and black children 59%.

| Year | 1960 | 1970 | 1980 | 1990 | 1995 |
|----------------|-------------|-------------|-------------|-------------|-------------|
| % White | 6.1 | 7.8 | 13.5 | 16.2 | 18.3 |
| % Black | 19.1 | 29.5 | 43.9 | 51.2 | 58.3 |

VITA

Name: James A. Carter-Haith Jr.

Address: Department of Educational Psychology
College of Education
Texas A&M University
4225 TAMU
College Station, TX 77843-4225

Email Address: jcarterhaith@neo.tamu.edu

Education: B.A., Business and Psychology, Regents College, New York, 1999
M.S., Counseling Psychology, Tarleton State University, 2001
Ph.D., Counseling Psychology, Texas A&M University, 2008

APA Accredited Pre-doctoral Internship:

Michael E. DeBakey Veterans Administration (MEDVA), 2007-2008