

CREATION OF A WOODEN MODEL TOY CAR AS A LEARNING MODULE FOR
STUDENTS ENROLLED IN MANUFACTURING 152

by
Patrick Scott Brown II

A thesis submitted to the faculty of The University of Mississippi in partial fulfillment of
the requirements of the Sally McDonnell Barksdale Honors College.

Oxford
May 2021

Approved by

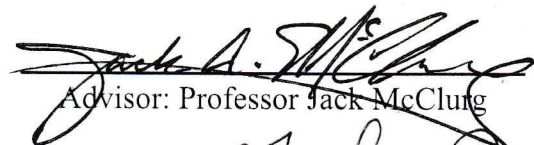
Advisor: Professor Jack McClung

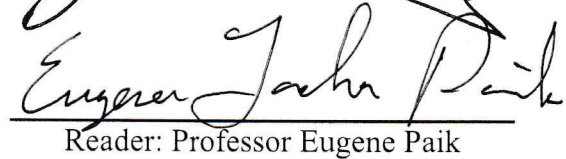
Reader: Professor Eugene Paik

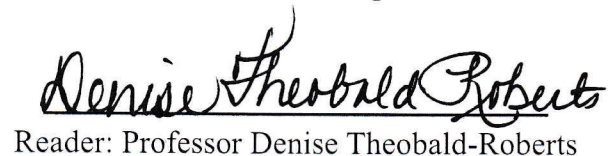
Reader: Professor Denise Theobald-Roberts

© 2021
Patrick Scott Brown II
ALL RIGHTS RESERVED

ACKNOWLEDGEMENTS

I would like to begin by acknowledging the help of my teammates in the CME for this senior capstone project: Taylor Lyle, Harrison McKinnis, and Tom Wells. I would also like to thank my advisor, Dr. Jack McClurg, and Professor Mike Gill for their help and advice on this venture. Additionally, I would like to thank our factory floor technicians Mr. Andy Gossett and Mr. Mark McAnally for helping us to best utilize the machines on the shop floor and ensuring our safety while doing so. I would also like to thank the entire staff of the Sally McDonnell Barksdale Honors College (SMBHC) and the Haley Barbour Center for Manufacturing Excellence (CME) for their support and encouragement throughout this process. Finally, I would like to thank my parents, Patrick and Ginger Brown, for their unending love and support, without which I would not be in the position I am today.

ABSTRACT

This project involved the design and manufacture of a children's wooden model toy car constructed on the CME factory floor. Apart from building a children's toy, the purpose of this project was to introduce younger CME students to a high-quality product made efficiently in regards to manufacture time and total cost. The design for the car required the inclusion of principles from different manufacturing philosophies taught in the CME such as LEAN Manufacturing, which works to eliminate waste from a process, and Design for Manufacture and Assembly, which seeks to reduce cost and cycle time for a product. Through the analysis of different machines, materials, methods, sizes, and safety considerations, an adequate balance was found between quality, time, and cost to create a visually appealing and fully functional toy car that is safe for children. As these cars are children toys, research was done on established toy manufacturing standards to ensure that the product was safe and to set proper age restrictions for children who can safely play with the toy. The choice to use hard maple wood and human-operated machinery, such as bandsaws and drill presses, provided the best opportunity to minimize cost and cycle time, while still creating a high-quality product. The dimensions of the car body were originally designed to be four-by-four-by-ten inches, but were later reduced to two-by-three-by-eight inches in order to reduce the mass of the car, so it is easier for small children to maneuver. Through the completion of this project, the project goals were successfully met in that a safe, visually appealing, fully-functional toy car was created using various manufacturing philosophies learned from coursework in the CME.

TABLE OF CONTENTS

LIST OF FIGURES.....	vi
LIST OF TABLES.....	vii
LIST OF ABBREVIATIONS.....	vii
I: INTRODUCTION.....	1
II: DESIGNING THE CAR.....	2
A. DESIGN CONSIDERATIONS.....	2
B. DESIGN PLAN OPTIONS.....	13
C. DESIGN PLAN CHOICE.....	21
III: MANUFACTURING THE CAR.....	23
A. FIRST DESIGN.....	23
B. DETERMINING ORDER OF OPERATIONS.....	28
C. FIRST PROTOTYPE AND IDEAS FOR REVISIONS.....	30
D. REVISED DESIGN & UPDATED COST ANALYSIS.....	32
E. UPDATED ORDER OF OPERATIONS & TIME ANALYSIS.....	38
F. FINAL PRODUCT.....	41
IV: CONCLUSION.....	43
LIST OF REFERENCES.....	45

LIST OF FIGURES

Figure 1: Provided Wheel and Fitting Axle.....	6
Figure 2: Hardness vs Price Graph for Various Woods.....	10
Figure 3: Cusp Height and Step-Over from CNC Machine.....	15
Figure 4: 3D Printed Parts With Various Layer Sizes.....	20
Figure 5: Original Car Design, Right Side View.....	23
Figure 6: Original Car Design, Front View.....	24
Figure 7: Fixture Design for Windshield Cuts.....	25
Figure 8: Fixture for Windshield Cuts.....	26
Figure 9: Fixture Design for Side Profile Cuts.....	27
Figure 10: Fixture for Side Profile Cuts.....	28
Figure 11: First Prototype.....	31
Figure 12: Updated Car Design, Right Side View.....	33
Figure 13: Updated Car Design, Front View.....	33
Figure 14: New Fixture Design for Windshield Cuts.....	34
Figure 15: New Fixture for Windshield Cuts.....	35
Figure 16: Finished Model Car.....	42

LIST OF TABLES

Table 1: Initial Cost Breakdown Analysis.....	12
Table 2: Updated Cost Breakdown Analysis.....	37
Table 3: Cycle Time Analysis.....	40

LIST OF ABBREVIATIONS

ASTM	American Society for Testing and Materials
CME	Center for Manufacturing Excellence
CNC	Computer Numerical Control
DFM	Design for Manufacture
DFA	Design for Assembly
DFMA	Design for Manufacture & Assembly

I. Introduction

The purpose of this project was to design and manufacture a wooden model toy car using the knowledge gained from coursework offered by the CME. This product was to be used as a learning module for freshman level CME students by showing how elements of different manufacturing philosophies can be included in a design. The design had to be made efficiently concerning both cycle time and investment capital, as the main purpose of this assignment was to introduce first-year CME students to methodologies such as DFMA (Design for Manufacturing and Assembly), LEAN manufacturing, and other principles by use of a product that had been designed with these philosophies in mind. Also, as the cars produced will eventually be used as children's toys, sufficient safety standards had to be analyzed in order to determine proper age restrictions for play with the car. All design specifications were left up the discernment of the designer, so it was necessary to determine how to balance quality, safety, cost, and time to manufacture. Because the finished cars will be used by children, the goal was to create them to be visually appealing and fundamentally safe for as many ages as possible. However, the primary purpose of this project was to create a learning module for freshman CME students, so all decisions in the design — material choice, size, machinery, etc. — had to be selected while keeping in mind these manufacturing and design principles. The car needed to exemplify an efficiently created product, so it was important to recognize that higher quality often coincides with an increase in cost and time to manufacture.

II. Designing the Car

A. Design Considerations

Before jumping into the design of the toy car, there were multiple important design considerations that needed to be taken into account to ensure that the design would accomplish the project goals and still result in a child-safe toy that can be used for years to come. The design of a product (rather than the actual manufacturing) holds the majority of influence over the final part's price, quality, and time to produce, so it was vitally important that the design of the car was created with the project goals in mind while using proper manufacturing principles. This section outlines DFMA and LEAN methodologies in addition to various considerations concerning size, safety, material choice, cost, and manufacturability as they pertain to a children's wooden car toy.

1. DFMA Principles^[1]

DFMA is a combination of the principles of DFM (design for manufacture) and DFA (design for assembly). DFA is concerned with reducing product assembly cost, while DFM is concerned with reducing overall part production costs. However, both methodologies seek to reduce overhead, labor, and material costs, so they are often used in conjunction with one another. DFMA's major principles include: minimizing part counts; standardizing parts and materials; minimizing the reorientation of parts during

assembly; identifying opportunities to error-proof the design; and simplifying and reducing the number of manufacturing operations. Keeping these principles in mind during the creation of the toy's design helped significantly in reducing the cost and cycle time for the model car.

2. LEAN Principles^[2]

In a broad scope, LEAN manufacturing involves eliminating wastes, or muda (Japanese for waste), from a process. There are many different types of wastes that can be found in all types of processes, and LEAN manufacturing involves recognizing and working to lessen these wastes. Though the scope of this project did not involve a continuous manufacturing production for a consumer product, there were still wastes inherent in the manufacturing process based off of the created design. The seven muda as defined by the LEAN manufacturing philosophy are: overproduction, correction, inventory, motion, conveyance, overprocessing, and waiting. Though these are all important areas of waste that should be considered in a normal manufacturing process, the goal of this project does not involve mass-producing the cars on a large consumer scale, so some of these muda, such as inventory and conveyance, are unnecessary to consider. For the purposes of this project, there were two specific areas of waste that had to be analyzed and lessened in terms of their waste: overprocessing and motion.

Overprocessing involves doing more work on or inputting more resources into a product than is actually needed or desired by the customer. Though the car needed to look nice, there were some extra processes that could be eliminated as they were not

essential to the final product. The goal was to create a simple, more geometrically-shaped wooden car, so performing excess manufacturing processes such as cutting out windows, forming front and back bumpers, or adding a car spoiler would ultimately be unnecessary and would only increase the time and money spent producing the car. The emphasis on overprocessing is what is directly wanted and valued by the customer. The design could include excess manufacturing processes like adding under-body wheel carriages, but would this really increase the value for the customer? As these cars will be primarily used by children, it was determined that a young child would not place much value on a car that has wheels underneath it or drawn on windows compared to one with the wheels on the exterior and no drawn-on windows. The primary function of the product is to be mobile in rolling across a floor or other surface, and adding processes to the manufacture of this product that do not increase the safety or functionality of the car are ultimately unnecessary.

The second type of waste outlined by LEAN manufacturing that pertained to this project, waste of motion, involves excessively walking or moving around to produce a product when the order of operations or machine locations can be adjusted in a way to greatly reduce this motion. If two operations are to be done on one machine, both of these operations should be done in conjunction with each other rather than doing one of the operations, moving to a different machine, and then coming back to the same machine to perform the second operation. To reduce waste of motion, an analysis of the CME factory floor and determination of which machines were required for the design were necessary, after which the order the operations of production could be arranged so that

the car was built in a more linear fashion in terms of operator motion. This way, the operator did not have to continually walk back and forth across the factory floor from machine to machine, thereby increasing the cycle time of the product.

3. Size

When assigned this project, all dimensions and aspects of the car (other than it being wooden) were left up to consideration. So, one of the first elements of the car's design that was considered was the size of the car. Obviously, using less material would decrease the cost to produce the car, but, if the car is too small, the chances of a child choking on the car, or on one of the car's parts, is significantly increased. However, if the car is too large, the material cost would be unnecessarily high, and some smaller children might not be able to maneuver the car easily. The car needed to be large enough that a young child would not try to put it in his or her mouth but also small enough so that a child would not try to sit on top of the car, possibly breaking it. It is also important to note that wooden blocks are not readily available at any given size; standard wooden blocks are cut with cross-sectional dimensions of two by four inches or four by four inches. For the purposes of this project, it was determined that a four-by-four inch block of wood approximately ten inches long would make a sufficient car size to discourage a young child from trying to ride on top the car or put part of the car in his or her mouth, but rather to encourage using the car for its intended purpose.

At the start of this project, we were given a few wooden wheels with a 2.5" diameter, 3/8" holes, and 3/8" diameter axles as a visual example of what the toy's parts

may look like; as the primary task is to design and produce the body of the car, the wheels and axles given at the project's introduction could be used in the final design of the car, but this was not required. Images of these wheels and axles are shown below in Figure 1.

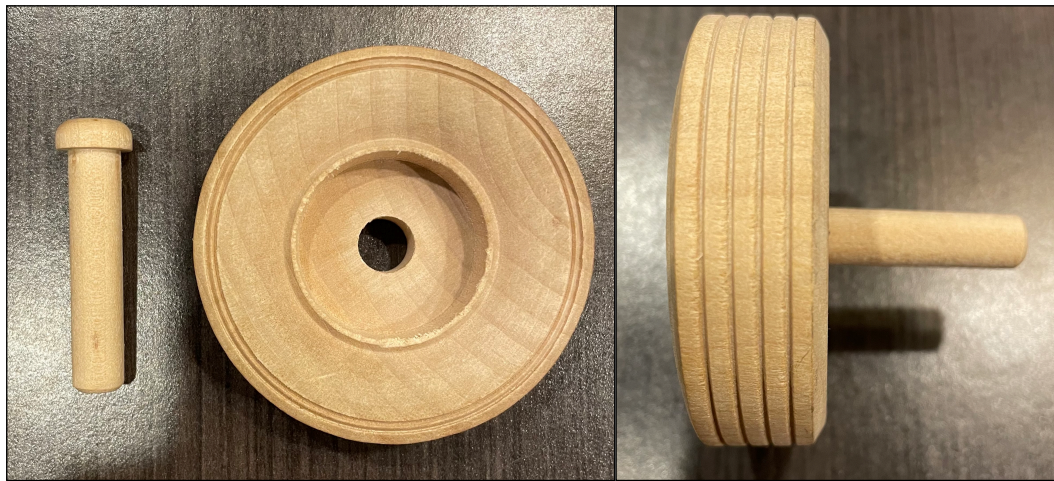

Figure 1: Provided Wheel and Fitting Axle

The decision was made to use the provided wheels to due to them being visually appealing and, because at 2.5 inches in diameter, they fit well with the block size we chose for our car body. However, the choice was made not to use the given axles since they only extend just over an inch past the inside of the wheel and would require four separately drilled holes in the car body. Rather than drilling four holes for four separate axles and attempting to line up the positioning of the holes on either side with respect to the car's body, two holes were drilled completely through the block so that only two longer axles were needed that extend throughout the car's body and were attached to a wheels at either side. This way, the number of parts in the assembly was decreased by

two, and this ensured that the two front wheels were horizontally and vertically aligned with each other with respect to the side of the car. One wheel was not slightly higher or lower to the ground than its counterpart on the car's other side, and this held true for the two back wheels as well. This decrease in part count and design to prevent errors in wheel locations are both examples of DFMA principles discussed earlier.

4. Safety^[3]

Concerning the safety of a wooden toy, the car needed to include smooth edges, no pinch points, non-toxic materials, and no splinters. In order to ensure proper safety precautions for our model car, ASTM Standard F963-17 (Standard Consumer Safety Specification for Toy Safety) was utilized. Though this standard does set general guidelines for proper age groupings and necessary safety features, it states multiple times that, "a parent remains the best judge of whether the child is at the appropriate development stage for safe play with a particular toy." According to this standard, children under the age of three are generally more likely to place inedible objects in their mouths. However, the completed car for this project did not include any readily accessible choking hazards, as the wheels were securely glued to each end of an axle with the car body between them, and it would be very difficult for a three year old to break the glued bonds or the axles themselves. The standard also lists seven categories of toys that are generally deemed acceptable for children under the age of three to play with, one of which is *Toy Vehicles* (cars, trucks, boats, and trains of simple chunky type). Because of this information, the minimum age limit for play with the toy car was set at 1 year old; at

this age, a child would still be interested in playing with a simple push-and-pull car, but a child younger than this may not understand how to play with the car or even possess the proper motor skills to move the car along a floor. Although a one-year-old may try to put an end of the car or wheel in his or her mouth, no piece would be small enough to swallow unless somehow broken off from the larger car assembly, which is next to impossible for a child so small to do. It was also determined that the use of non-toxic materials was a necessity to prevent children from becoming sick after potentially putting the car in their mouths.

Aside from choking hazards, other areas of safety concern for wooden toys involve the possibility of splinters or pinch points. To eliminate the chance for a child to get a splinter from the car, it was necessary to ensure that the car was made from a harder, firmer wood and that it was heavily sanded down after manufacture until smooth to the touch. All edges of the car also had to be significantly sanded down to where the car included only rounded-off, smooth areas rather than any sharp corners. To eliminate the possibility of a child being pinched by the car, the clearance between the wheels and the car body had to be small enough so that a child could not fit a finger in the gap and become pinched by the wheel and car body. The wheels had to be very close to the car body itself, but this design requirement coincided with the possibility of accidentally gluing the wheels or axles to the actual car body, which would prevent the car from rolling, so great care had to be taken when gluing the assembly together. Additionally, the glue we purchased for bonding the wheels to the axles had to be non-toxic, so if any

child does happen to put part of the car in his or her mouth, there is no chance of him or her becoming sick from doing so.

5. Material Choice

This project required that the car had to be wooden, but the choice of wood type was left up to consideration. A wood with a good visual quality was desired, and, as stated in the safety section, one that is relatively hard so as to reduce the risk of splinters. Though safety is a top priority, the goals of the project had to be kept in mind, and the potential wastes involved in possible overproduction had to be considered. A more expensive wood would give a better surface finish and increase the quality of the car, but would this increase in quality be worth the increase in price? Less expensive woods can also possess a good surface appearance, and the customer would likely not hold much value to what type of wood is used, as long as the car is visually appealing. Multiple different wood types were analyzed based on their costs and how significantly using a more expensive wood would affect the overall quality of our car. Additionally, it was discovered through research that there are far more wood allergies among the general population to exotic woods from other continents rather than to more common woods such as oak, maple, beech, etc.

In order to determine which wood choice would be the best for the car in terms of balancing cost and quality, research was conducted based on the hardness level and relative costs of various wood types. A popular method to determine the hardness of a wood is called the Janka Hardness test, which involves determining the force required to

press a 0.444 inch steel sphere into the cross-grain side of a block of wood until half of the sphere’s diameter is past the wood’s surface.[6] The Janka Hardness numbers are output in units of force (lbf or kN); these were compared to listed price values of various woods taken from Hearne Hardwoods retailers.[4] A graph displaying the relative prices and Janka Hardness of eight different woods are shown below in Figure 2.

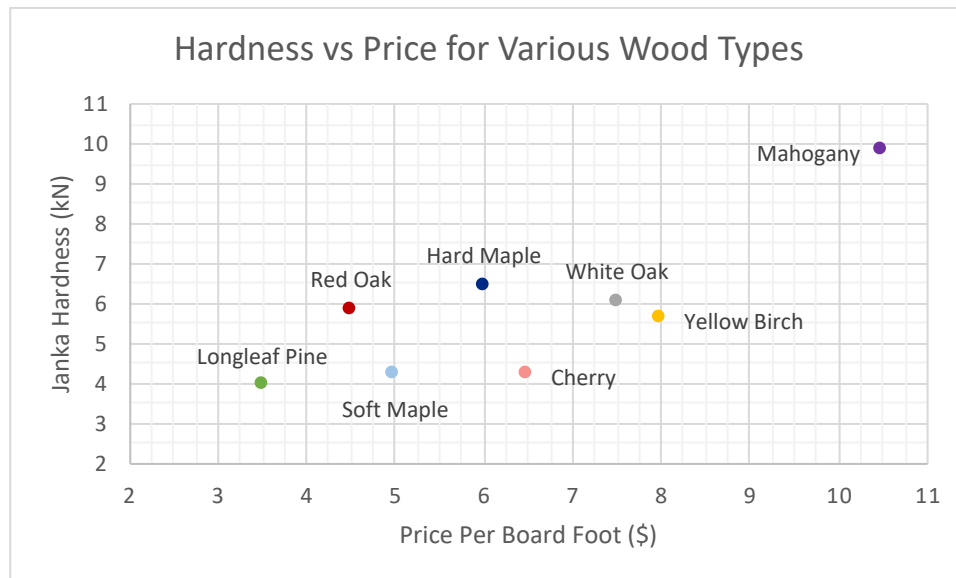

Figure 2: Hardness vs Price Graph for Various Woods^{[4][5]}

As shown in Figure 2, Longleaf Pine is both the cheapest and softest of the eight woods that were analyzed, and mahogany is, by far, the hardest and most expensive. Though mahogany is significantly harder than the next hardest wood in this graph (hard maple), it is also significantly more expensive than any other wood listed here. Though a hard wood was desired, the car did not need to be produced from a wood so hard that it is difficult to machine, as this would likely increase the manufacturing time and make the

manufacturing process more difficult. It was determined that the price of mahogany outweighed its hardness and visually appealing qualities, so another wood had to be selected. Based on the information in this graph, the choice was made to use hard maple as the wood for the car body. Hard maple is a relatively hard wood compared to others around the same price, and it has both a higher Janka Hardness and lower price per board foot than white oak, cherry, and yellow birch.

As stated previously, it was decided that the provided wheels would be used in the final assembly; these were birch wheels with a 2.5” diameter, 3/8” holes, and 3/4” thickness.^[8] Instead of using the given axles, the decision was made to buy 6” dowels, also birch, that are 3/8” in diameter so they can fit snugly into the holes of the wheels.

Although the dowels were already a tight fit for the wheel holes, wood glue was still needed to securely fasten the wheels to their respective axles. A four ounce bottle of Elmer’s carpenter’s wood glue was purchased because it is a non-toxic glue, it is relatively inexpensive compared to other wood glues available for purchase, and it claims to have a bond “stronger than wood.”^[6] After acquiring this glue, all the necessary materials to construct our car had been gathered, including: hard maple 4x4” block, 2.5” diameter wooden wheels, 3/8” diameter wooden axles, and Elmer’s wood glue.

6. Cost

Now that all the necessary materials needed had been determined, the initial cost for these materials could be calculated. The cost breakdown for one wooden model toy

car based on the total materials purchased and expected quantity required per part is shown below in Table 1.

Table 1: Initial Cost Breakdown Analysis^{[6][7][8][9]}

Material/Part	Quantity	Total Price	Quantity Per Car	Price Per Car
4x4x40.5" hard maple block	2	\$114.10	10" length	\$14.09
2.5" diameter birch wheels	12	\$15.50	4	\$5.17
6" long 3/8" diameter birch dowels	25	\$10.99	2	\$0.88
4 fl oz Elmer's carpenters wood glue	1	\$2.18	≈ 0.25 fl oz	\$0.14
Total cost	—	\$142.77	—	\$20.28

As outlined in table 1, the choice was made to initially purchase two hard maple four-by-fours, each 40.5" in length (dimensions established by retailer) so that a maximum of eight car bodies could be created with the design (each is 10" long). The wheels and dowels had to be purchased in certain quantities based on availability from the vendor. A pack of only 12 wheels was purchased after considering that some of the first prototypes may not meet proper quality standards and would be discarded rather than fully assembled, and more wheels could always be purchased if needed. Though 25 is more dowels than needed for eight car bodies, this was the lowest quantity of dowels available for purchase, and having extras handy could be useful in the case that some were lost or destroyed. The total material cost came out to around \$20.28 per car, which is very reasonable for a good-quality children's toy.

7. Ability to Manufacture

A final obstacle to consider before creating the design is, though anything can be designed on paper, there is not always a guarantee what is designed can be adequately reproduced on the CME factory floor. The design had to be created simply enough so that it would be readily reproduced in a relatively quick manner. Though there are a large number of machines on the factory floor that can perform many different operations, features such as open space within the car body, underbody wheel housing, and excessive curvature could be very difficult or even impossible to replicate on the actual car body. If it was desired to give the car an open cabin space, as if the “windows” were open and one could stick one’s hand through the car and hold it by the roof, it would be necessary to find a way to drill through the side of the car and make a shape within the car body without destroying the car’s roof. Semi-circular wheel housings could be designed for each of the wheels underneath the car, but this would require a programmable milling operation or something similar. Operations such as these could slightly increase the quality of the car, but these would be very complex and time consuming operations that add much more time and operating costs than they do value.

B. Design Plan Options

Five possible directions in which to take the car design were considered based on the necessary goals to accomplish and the resources/machines available to construct the car. The options were evaluated based on their capabilities to produce a high-quality car while keeping cycle time and input cost low, as well as the opportunities to include

DFMA and LEAN principles in the design. These five options are listed below and analyzed on their effectiveness and drawbacks.

Option 1: Using the CNC Machine

The CME has multiple Computer Numeric Control machines (CNC) which are very large and expensive machines and are controlled computer programs. If choosing this option, the machine that would be used is the Haas 3-axis CNC sheet router. This is a subtractive manufacturing machine which uses a computer program to move a tool head and shape a part out of existing material. Choosing this option would mean that our entire car body would be shaped using the CNC sheet router machine. Advantages and disadvantages to this option are discussed below.

- **Advantages:**

This option would only require a computer program written specifically for the design of this car and the correct placement of the wooden block within the fixture. Because this Haas machine is run with a computer program, this option would output virtually identical car bodies each time the machine program is run. This option would also likely give the best quality car body out of the five options listed here. The sheet router has the ability to create more curvature and replicate a sedan-type car much easier than could be done with the other machinery on the factory floor.

- **Disadvantages:**

Although the quality of the car body using this option would likely be the best of the five options listed, this increase in quality coincides with an increase in time and cost of manufacture. The operating costs of this CNC sheet router machine are already much higher than the majority of other machines found on the factory floor, and the machine would have to run for a significant amount of time (likely over an hour) in order to achieve a smooth surface finish. When the tool head of a CNC machine makes its path around the material, there is always a cusp left between two consecutive tool-head paths due to the shape of the tool. The size of this cusp is determined by the step-over, or distance between each pass of the machine's tool head.^[10] A diagram of step-over and the resulting cusp is shown below in Figure 3.

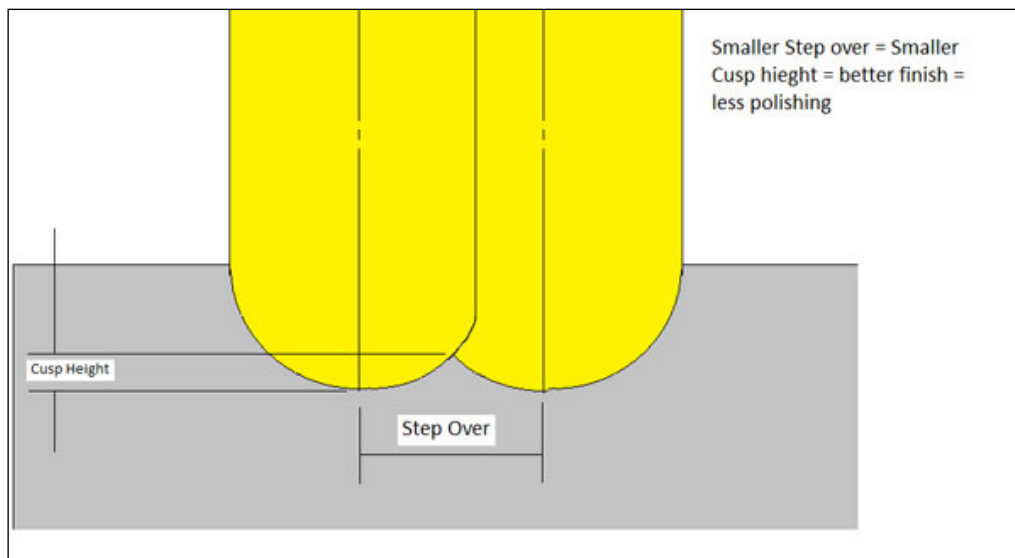

Figure 3: Cusp Height and Step-Over From CNC Machine^[11]

As shown in Figure 3, decreasing the step over will also decrease the cusp height and give a better surface finish, but doing so will further increase the time of manufacture for the car which would already be relatively high from using this machine at all.

Another disadvantage to this option is that there is only really one machine being used. As this project is a learning module, the design should allow freshmen CME students to experience using multiple machines on the factory floor and exemplifying how ordering the operations among different machines can help reduce cycle time for a product.

Option 2: Using Traditional Machines

The second option involves using more traditional machines than the Haas CNC sheet router, including a miter saw, a vertical bandsaw, and a drill press.

- **Advantages:**

This option would drastically decrease both the machining costs and manufacturing time for the car body. The manufacturing processes would be performed by an operator, so the speed of manufacture is primarily based on the speed of the operator in performing the proper manufacturing tasks. The cycle time is still dependent on the speed of the equipment in use, but these machines would be used to make singular cuts and holes rather than removing material from the entire car body, as would be the case using a sheet router machine. Fixtures could be created to ensure that all cuts and

holes are placed correctly, and any edges or rough finishes could be sanded down by hand after the main subtractive processes have been completed.

- **Disadvantages:**

Though this option saves significantly more time and money than the sheet router option, the trade-off is a likely decrease in quality. The bandsaw and other machines simply cannot create the curved profiles that can be attained using the CNC sheet router, so the car will likely be much more box-like and have straighter edges than a sedan or a similar car type. The design choices are much more limited using this option, and post-production sanding or some other sort of finishing process will be necessary to ensure a smooth and splinter-free surface.

Option 3: Combining Options 1 and 2

The third option we considered involves using traditional machining to create a blocky car base, while also using the CNC sheet router to machine a high-quality outer cover to be attached to the car's base.

- **Advantages:**

This option would give a high-quality surface finish very similar to Option 1, and it would likely decrease the time and cost to manufacture (though these would almost certainly still be higher than the time and cost associated with Option 2).

- **Disadvantages:**

Although this option would probably decrease the amount of time that the sheet router was required to run, it may not be a significant amount, and it would still be much more expensive and time consuming than using other machines (Option 2). This process also increases the total number of parts for our design, and including an attachable outer shell would greatly increase the chances of the car being broken, which in turn increases the safety concerns regarding the toy. Breaking the car could also create smaller fragments that may have sharp, dangerous edges or be potential choking hazards for younger children, which is an outcome that must be avoided. This design choice would also require the creation of a way in which to securely fasten the outer cover to the car's base, and this attachment would need to be strong enough that the two parts could not be separated by children.

Option 4: Utilizing 3D Printing

Our next idea was to create a design similar to Option 3 in that the car's base would be formed by bandsaws and other traditional machines, but the outer shell would be 3D printed rather than fabricated from the CNC sheet router machine.

- **Advantages:**

This option would give a higher quality appearance than Option 2 with traditional machining and would likely be less expensive to manufacture than Options 1 or 3 in

terms of material use. Using a 3D printer would also allow the car to be created in a variety of different colors, which would be visually appealing to young children. Additionally, even though 3D printing has technically been around since the 1980s^[12], it is still an innovative process that piques the interest of young minds everywhere, and would likely excite a child playing with the car who is old enough to understand the concept of 3D printing.

- **Disadvantages:**

Though the cost of manufacture would decrease slightly from Option 3, 3D printing still takes a significant amount of time to complete, so the cycle time would probably not decrease much, if at all. This option, similar to Option 3, also increases the total number of parts for the car and requires us to create a method to attach the 3D printed exterior to the wooden car. Also, the goal of this project was to create a wooden car, so using 3D printed plastics would be deviating from the original goals. The finish on the car would also likely be rougher than those formed completely from wood, as 3D printing is an additive manufacturing process which layers long lines of heated plastic together. For a smooth finish on a 3D printed part, the size of the printed layers would have to be decreased, but this would cause an increase in the time to manufacture. Four 3D printed parts made with various layer sizes from one program are shown in Figure 4.

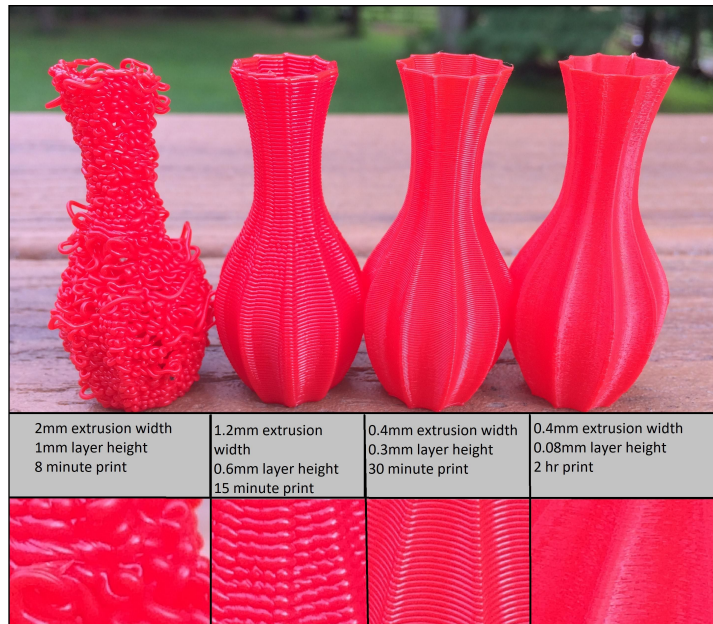

Figure 4: 3D Printed Parts With Various Layer Sizes^[13]

As can be seen in Figure 4, the issue with the 3D printer is similar to the Haas CNC sheet router machine in that a better surface finish coincides with a much longer manufacturing time (though the part on the far left may have had some issues other than improper layer height).

Option 5: Using a Pre-Made Car/Kit

The final option considered involved finding a previously designed toy car or car manufacturing kit which could be studied and then have an ordered assembly process created based on the given kit.

- **Advantages:**

The finish on this car would surely be of high quality, and the manufacturing process could be honed in on rather than the design of the car. A detailed step-by-step assembly plan that exemplifies various manufacturing principles could be created for the kit in order to teach first-year CME students about ordering manufacturing processes.

- **Disadvantages:**

Though this option would likely give a longer, more controlled assembly process, the car would still primarily be the work of an outside source. Another issue with this option is that the design is to be used as a way to introduce freshmen students to different machines on the CME factory floor by showing how they work and where they are located relative to one another, but this option would likely eliminate the use any of this stationary machinery like various saws and drill presses. As the project intentions are to design and manufacture the car internally, this option also does not really adhere to the goals set out for this venture.

C. Design Plan Choice

After careful consideration and weighing out the pros and cons of each of the five options listed above, the choice was made to use Option 2, or the use of traditional machines such as the miter saw, vertical bandsaw, drill press, etc. Because this project is primarily focused on introducing incoming CME students to efficient manufacturing

designs and principles, it was determined that the excessive monetary and time requirements associated with the sheet router machine and 3D printer were not worth the quality increase that went along with those options. Options 3 and 4 were ruled out because of their increased part numbers, chances of breaking/failure, and time to manufacture. Additionally, Option 5 was determined to be an inadequate choice based on it being too far off scope from the project goals.

It was determined that Option 2, though it comes with a slight sacrifice in quality, would be the best for creating an efficiently designed and manufactured car that is still safe and visually appealing. The only real loss of quality by choosing this option is that the car cannot be manufactured in with excessive curvature or in a sedan-type shape, but a high-quality car can still be made using these more traditional machines. The blueprints for the design are shown in the following section of the report.

III. Manufacturing the Car

A. First Design

After determining that the car would be manufactured using human-operated machinery, a design had to be created that would allow for the creation of a car body with a high-quality appearance that did not include too many unnecessary cuts or non-value added tasks. Due to the restrictions of the machinery that was used, it was important to not add too much curvature in the design, as this would be difficult to fabricate with a bandsaw. The original design plans for the toy car are shown below in Figures 5 and 6.

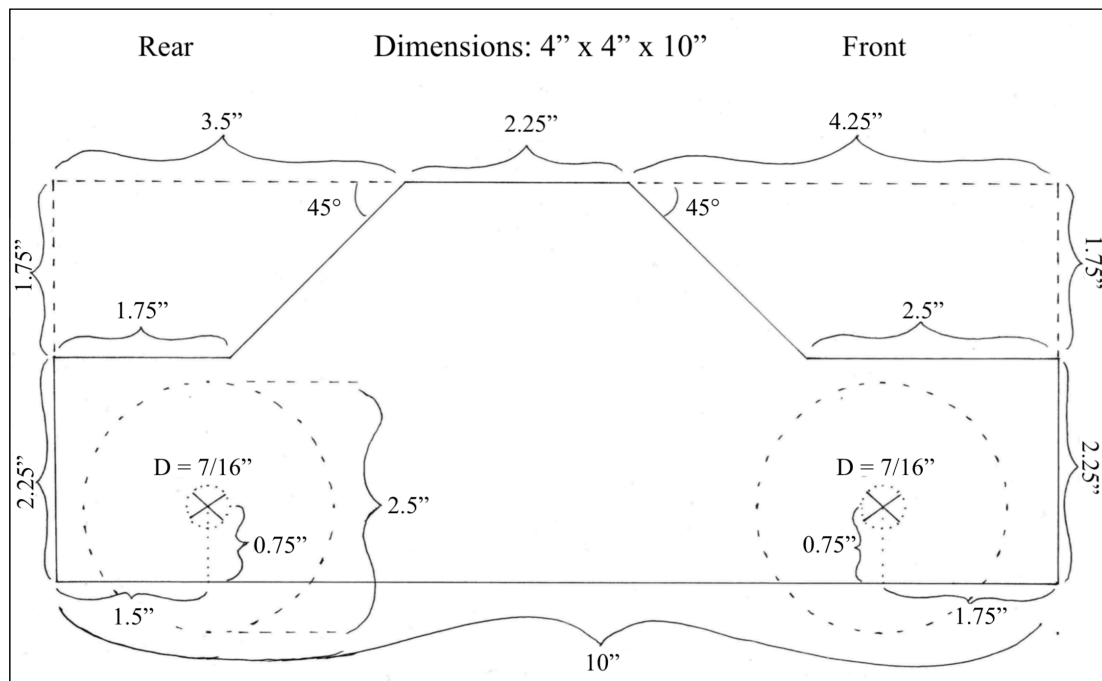

Figure 5: Original Car Design, Right Side View

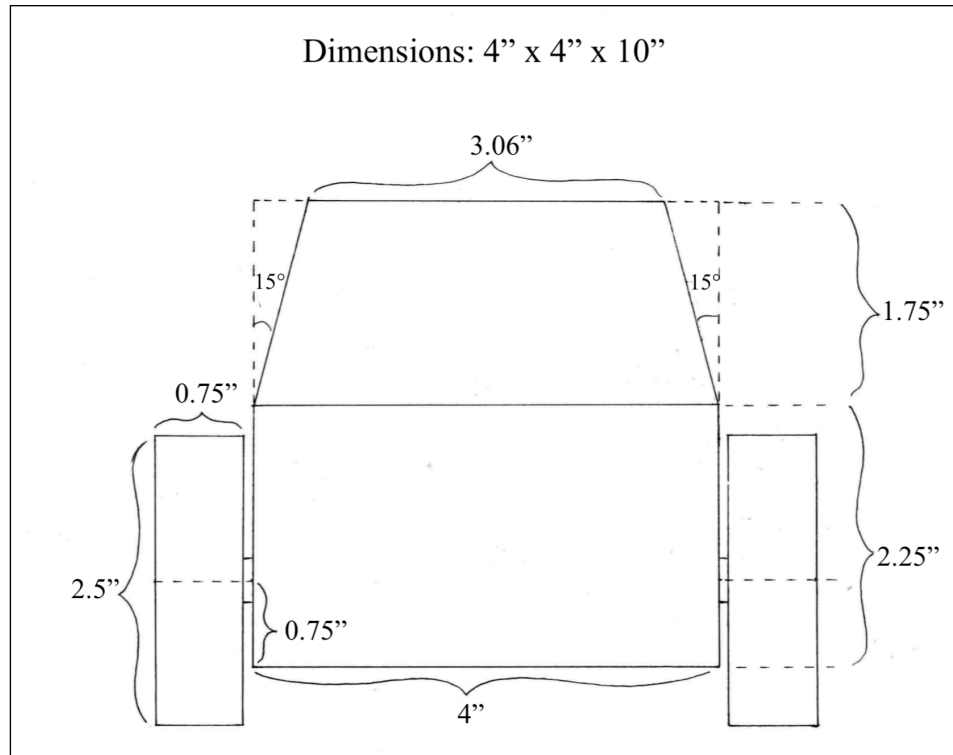

Figure 6: Original Car Design, Front View

As shown in Figures 5 and 6, the design is very geometrically shaped, and there are very few manufacturing processes that need to be done to the car body before it can be assembled. After the 10'' long block of hard maple is cut away from the 40.5'' block using the Miter saw, the design requires six cuts made with a vertical bandsaw: two 45° angle cuts for the front and back windshields, two 90° angle cuts for the front and back hoods, and two 15° cuts for the side profile of the windows. The only other processes for the car body involve drilling two 7/16'' holes through the entire length of the car and then sanding down the body to remove any rigid edges or rough surface finishes.

In order to repeatedly place the front and back windshield cuts correctly on the car bodies, the creation of a fixture was required to correctly orient the wooden blocks for

cutting and to ensure that these cuts would be placed and angled properly each time a car body was manufactured. The creation of this fixture also coincides with DFMA principles listed earlier to error-proof the design. An image of the design plans for this fixture are shown below in Figure 7.

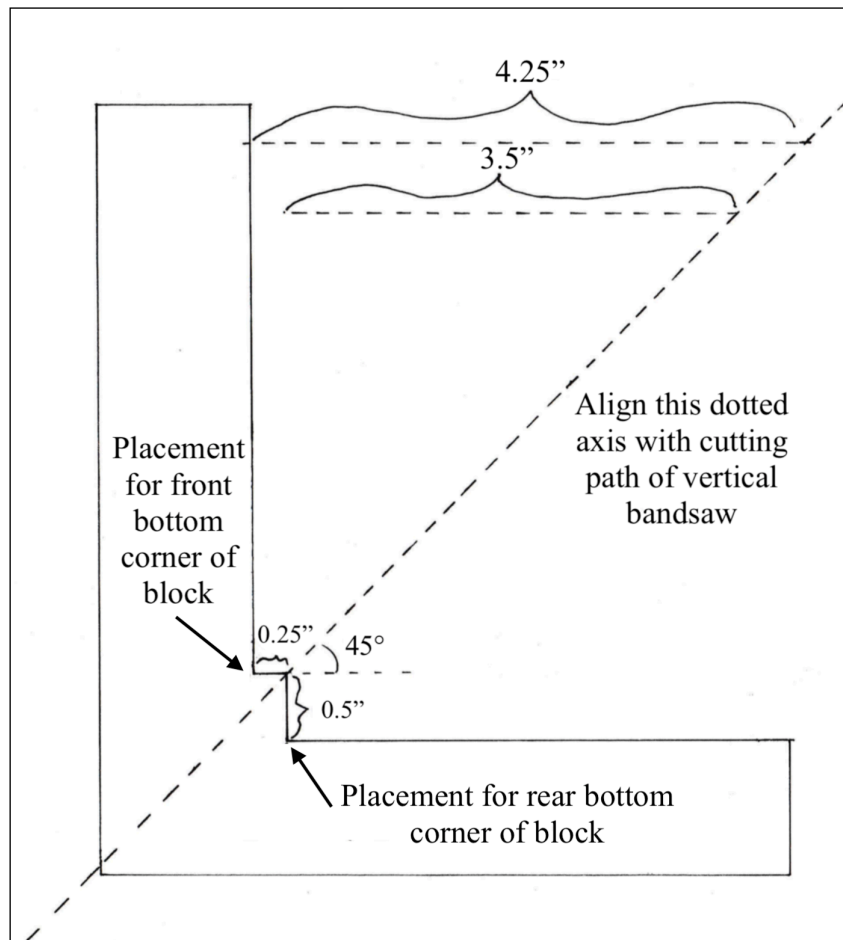

Figure 7: Fixture Design for Windshield Cuts

As shown in Figure 7, use of this fixture involves placing the bottom front corner of the 10" long hard maple block into its respective corner of the fixture, then lining up the cutting path of the bandsaw with the dotted axis line and cutting to a vertical depth of

1.5” relative to the car (around 1.76” actual cutting length). Then the same has to be done for the bottom rear corner of the block in the lower corner of the fixture. Aligning the cutting path with the diagonal dotted line shown above will cause the cut to begin 3.5” from the top edge of the car when the bottom corner is placed in the lower fixture corner and 4.5” from the top front edge of the car when the bottom corner is placed in the higher fixture corner. Designing this fixture to where both windshield cuts can be made with one jig helps to reduce material and time waste. The fixture we created from this design is shown below in Figure 8.

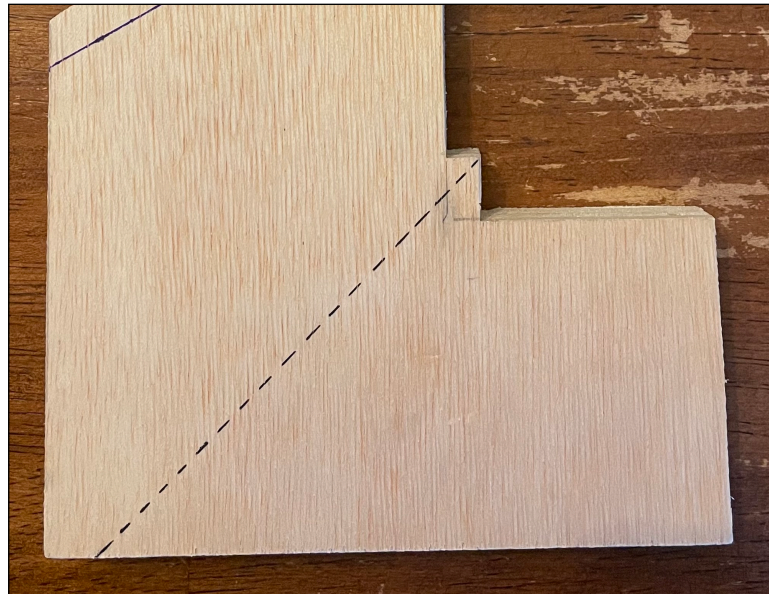

Figure 8: Fixture for Windshield Cuts

For ease of manufacture, it was decided that this fixture would be made out of leftover plywood and could be created using a vertical bandsaw. However, another poka-yoke device was still needed in order to properly align the 15° side profile cuts. A

second fixture was designed and created to error-proof this manufacturing process as well. The design of this fixture is shown below in Figure 9.

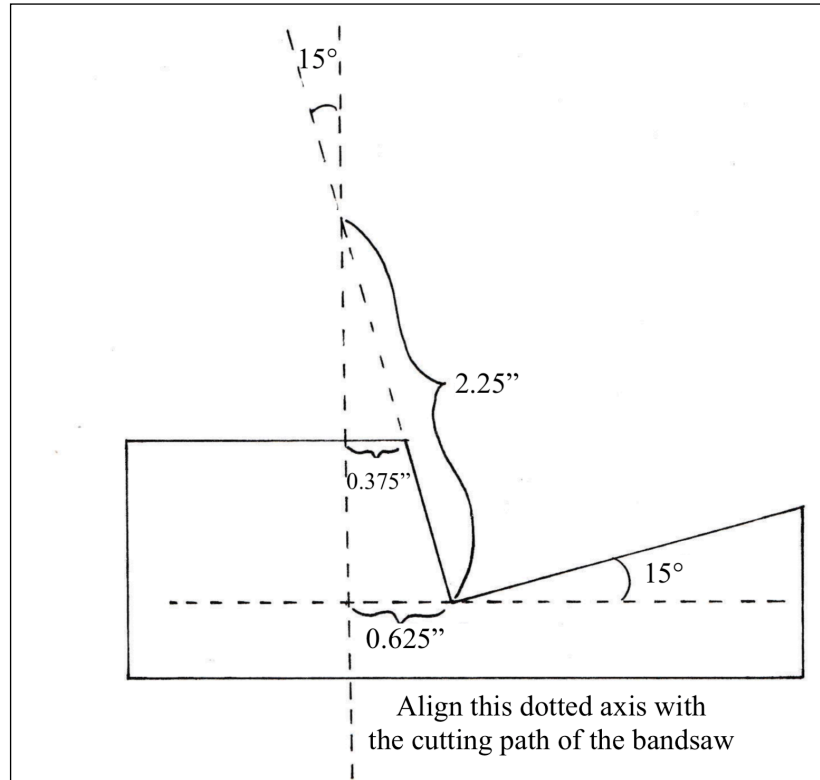

Figure 9: Fixture Design for Side Profile Cuts

To use the fixture shown in Figure 9, the bottom edge of the car body should be placed in the corner and the dotted axis lined up with the cutting path of the vertical bandsaw. Using this fixture allowed for cuts on both sides to be made at a vertical depth of 1.75" relative to the car, and the resulting sides should be nearly identical. The 2.25" dimension is in reference to the 2.25" of height (starting from the car's bottom) the car body should have before the sides begin to slope inward at 15°. A picture of the fixture we created based off of these designs is shown in Figure 10.

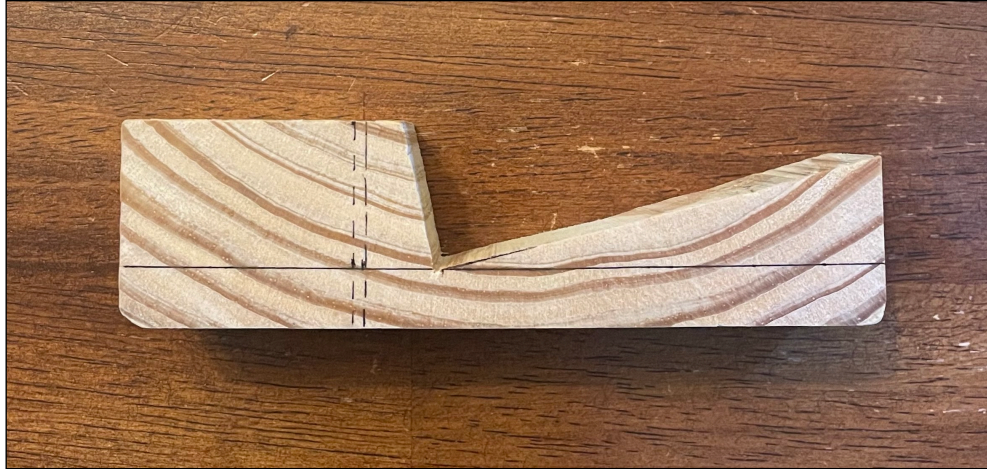

Figure 10: Fixture for Side Profile Cuts

Again, for ease of manufacture and to save material costs, the choice was made to create this fixture out of wood, using a spare 2"x6" plank. Now that the design plans and fixtures had been created, the steps in the operation had to be properly ordered.

B. Determining Order of Operations

The operations involved in creating this design include: cutting a 10" block from the hard maple four-by-four with a miter saw; cutting the windshields, hoods, and side profiles with a vertical bandsaw; drilling two 7/16" holes through the car body using a drill press; cutting the dowels from 6" to 5" to reduce clearance between wheels and car body; sanding down the edges and surfaces of the car body; and inserting the 5" dowels through the axle holes and gluing wheels to either side. Considerations were taken in regards to adding a finish to the car body, but it was decided that the hard maple had an untreated finish of high enough quality that the purchase of a wood finish would ultimately be extra cost that was not necessary for the goals of our project.

Obviously, this process must begin with cutting the block for the body from the hard maple four-by-four, and it ends with sanding the body and gluing the wheels in place. However, the order of the remaining processes can be rearranged; in terms of the final product, it does not matter which cuts are made first or when the holes are drilled. To properly sequence these operations in order to minimize motion waste, it was necessary to look at the relative location of each machine on the shop floor. A miter saw was used to remove the 10" starting block, and this machine is located near the front end of the floor. Nearby the miter saw is the vertical bandsaw, which was used to make all six cuts outlining the shape of the car body. Further down the floor is the drill press, which was used to cut the two axle holes in the car body. Based on the locations of the machinery required and the processes necessary to replicate our design, the manufacturing operations were ordered as follows:

1. Cut 10" block from four-by-four using miter saw
2. Cut two dowels from 6" to 5" using miter saw
3. Make 45° windshield cuts using vertical bandsaw
4. Make 90° hood cuts using vertical bandsaw
5. Make 15° side profile cuts using vertical bandsaw
6. Drill two 7/16" holes in car body using drill press
7. Sand down car body using handheld orbital sanding tool
8. Insert axles through car body and glue wheels to either side
9. Allow glue to cure

Using this order allows one to cut the axles without ever leaving the miter saw, then traveling to the vertical bandsaw to create the windshield and hood cuts. The choice was made to make the cuts before traveling to the drill press in order to lower the waste of motion that would have been present if the manufacturing operation involved using the miter saw, then traveling down the floor to the drill press, and finally all the way back up the shop floor to the vertical bandsaw. After the holes are drilled, the only step left was to sand down the car body, which was done with portable handheld sanding tools. The decision was made to use a Milwaukee sanding tool rather than just hand sanding using sandpaper in order to lower the manufacturing time for the car body. As previously mentioned, applying a surface finish on the body after its manufacture was considered, but it was decided that sufficient sanding of the car body would ensure the safety quality of the car, and purchasing a wood finish would increase the time and money put into a car that would already have a nice untreated outer appearance. The prototype that resulted from this process is shown in the next section.

C. First Prototype and Ideas for Revisions

The process outlined in the section above was used to create the first prototype. The process worked well and was efficient in that it did not require excess motion around the factory floor and the car body was formed from the starting block of hard maple relatively quickly compared to the time it would have taken to do so on the CNC sheet router or by a similar process. Figure 11 below shows our first prototype completed using the process above (NOTE: car body is not fully sanded in Figure 11).

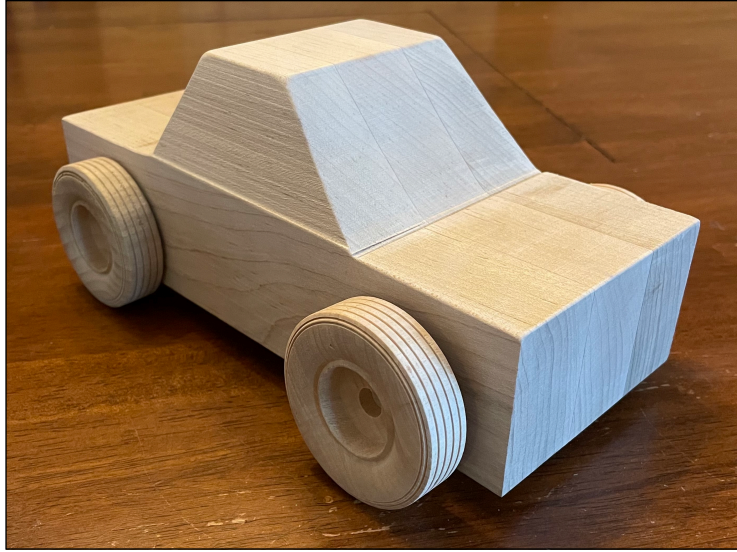

Figure 11: First Prototype

Although the design was successful in that the car was visually appealing and functional as a toy car, it was quickly realized that this prototype was too large and heavy to be played with by a one-year-old. The cuts were made well, the axles rolled easily with the wheels when moving the car, and the hard maple gave a nice, untreated finish, but it was determined that ways had to be found to decrease the size and overall mass of the car. The initial ideas on how to go about this involved decreasing the dimensions of the car. The 10" length of the car could be shortened down to 8", and that the height of the car could be lowered from 4" to 3". Although decreasing the height would create another step in the operation, this cut, along with the windshield and hood cuts, could be completed on the Laguna vertical bandsaw, and this added only one additional cut. Cutting an inch off the width of the car was also considered to further decrease the car's mass, but because of the excess of wasted material this would cause, a decision was made to decrease the width down to two inches by cutting the block in half. This way, two cars

could be manufactured from just 8” of length from the hard maple four-by-four. This both decreased the weight of the car significantly and nearly cut the material cost per car in half. Another idea to help reduce mass was to increase the angle of the windshield cuts with respect to the top of the car from 45° to 60°, further reducing the material included in the final product. Additionally, with the width of the car being decreased from four to two inches, the 15° side profile would make the top of the car too narrow, so it was concluded that these cuts were no longer necessary for our product. These two cuts do not contribute to the value of the car, so the decision was made to eliminate this step in the process as it was a non-value-adding task. The elimination of these two cuts also meant that the use of the Vectrax vertical bandsaw and the fixture shown in Figure 10 were no longer required for the manufacturing process. Removing this step in the process decreased both the time of manufacture and waste of motion from moving around the factory floor. The revised design is shown and discussed more in the following section.

D. Revised Design & Updated Cost Analysis

Utilizing the revision ideas stated in the previous section, a new design was drafted for a car body that was well under half the size of the original model. The overall dimensions were reduced from 4” x 4” x 10” to 2” x 3” x 8”, the windshield angles increased from 45° to 60° (with respect to the top plane of the car), and the two 15° side profile cuts were eliminated. The schematics for this updated design are shown below in Figures 12 and 13.

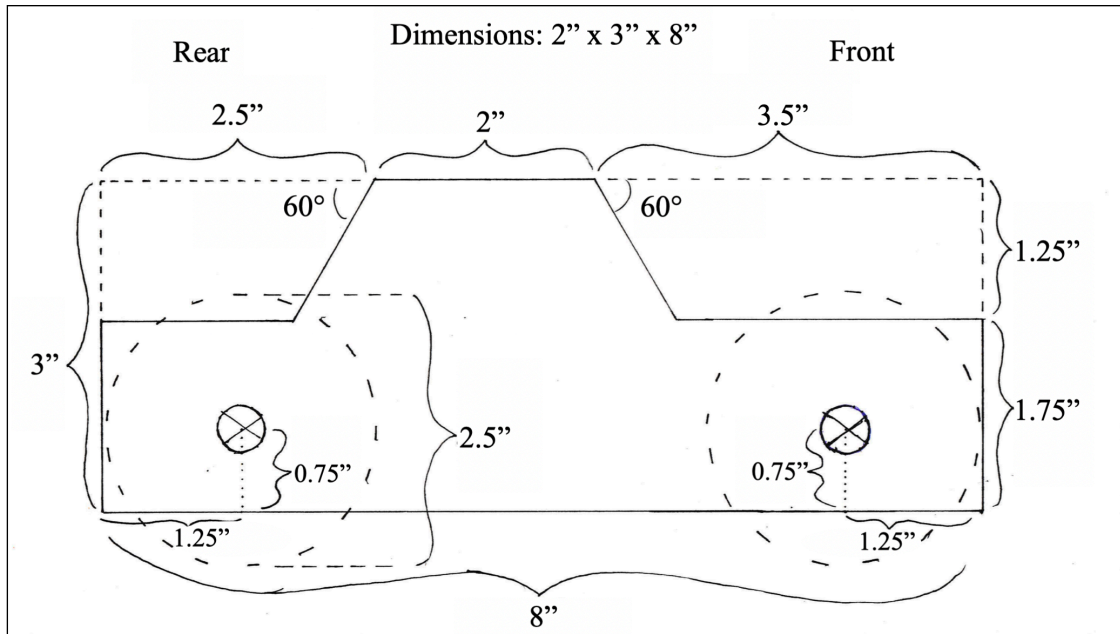

Figure 12: Updated Car Design, Right Side View

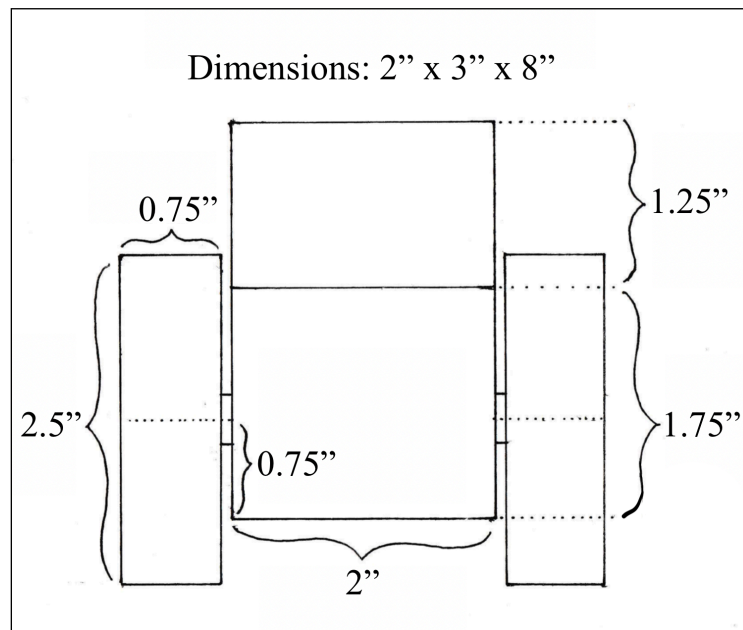

Figure 13: Updated Car Design, Front View

As shown in Figures 12 and 13, the revised car body is much smaller than we originally designed. Because the width of our car body was decreased from 4" to 2", the length of the axles had to be decreased as well. It was found that cutting the dowels in

half from 6" to 3" gave a near-perfect axle length for the new design, so now only one 6" dowel was required to form both the front and rear axle for one car, further reducing the material costs. All the machines that were used in the previous process were utilized again, including the miter saw, the vertical bandsaw, the drill press, and the handheld sanding tool. However, because the windshield angles were increased from 45° to 60°, an updated fixture was required to error-proof those two cuts and replace the fixture shown in Figure 7. The poka-yoke device designed for these updated cuts is shown below in Figure 14.

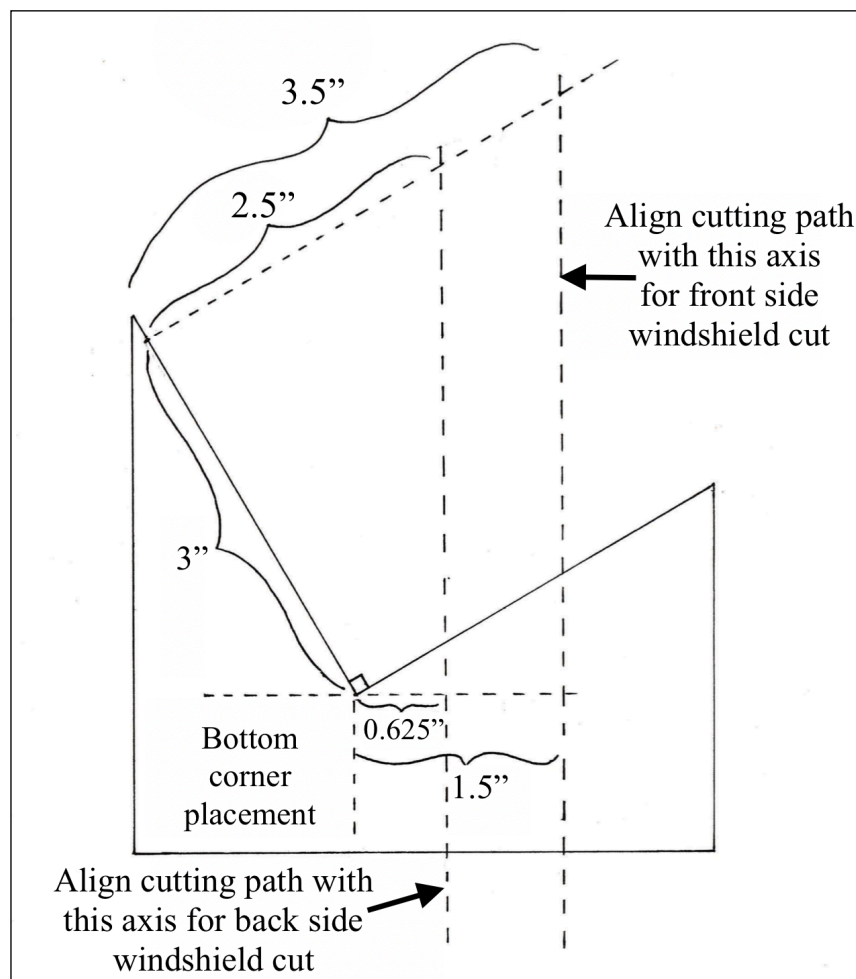

Figure 14: New Fixture Design for Windshield Cuts

Similar to the original fixture for the windshield cuts shown in Figures 7 and 8, the fixture shown in Figure 14 allowed for both the front windshield cut and the back windshield cut to be created with only one fixture, only this time each cut had a separate axis to be aligned with the bandsaw's cutting path rather than separate corners for placement. In order to save material, this new fixture was fashioned out of the plywood fixture that had already been created (Figures 6 and 7). This new fixture is shown below in Figure 15.

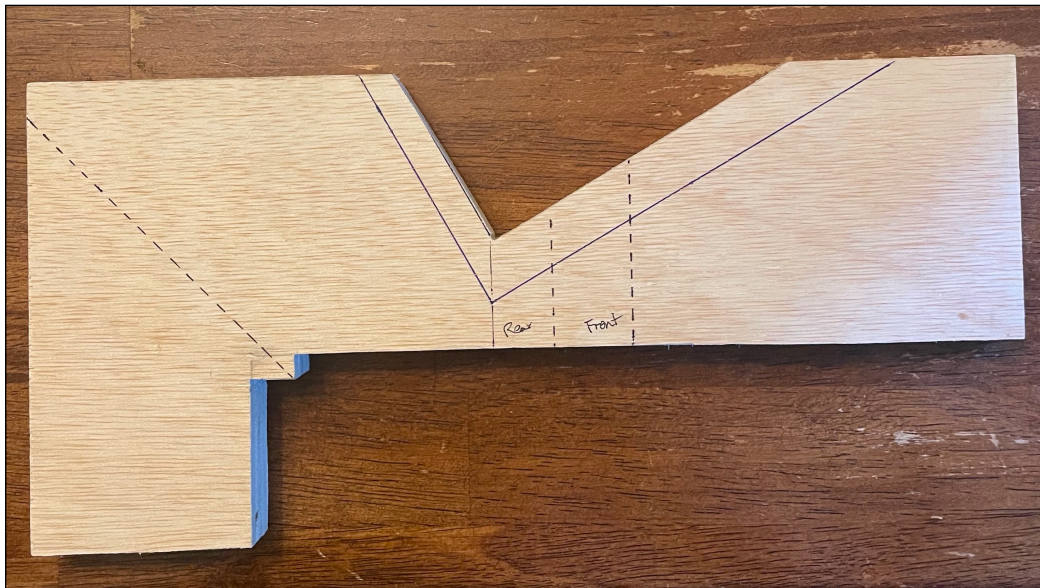

Figure 15: New Fixture for Windshield Cuts

As can be seen in Figure 15, this poka-yoke differs from the original fixture designed for the 45° cuts in that the required cutting axis is parallel to the sides of the fixture. Because it was designed this way, the left side of the fixture could be pushed against an adjustable side board attached to the bandsaw's cutting table to secure its

placement. By doing this, it was no longer necessary to visually approximate lining up the cutting path with the desired location on the car body for the full duration of the cut, and this new fixture ensured that the cut remained straight throughout the process with the fixture held flush against the side board. This further reduced the risk of error from making an improper cut in the part and decreased variance from one car body to another.

Another element that was considered while making the updated design was the final outside appearance of the car. It was stated earlier that the choice was made to not add a finish onto the wood in order to save time and money, but adding a wood finish was not the only action that could be taken in order to increase the visual quality of the product. It was determined that utilizing the CME's Fusion Pro laser engraver to etch a small design on either side of the car would be a process that could be completed quickly and would increase the quality of the part. The laser engraver transfers images with almost picture-perfect quality in a time-efficient manner, so it was determined that this was an opportunity that could be taken advantage of to increase the quality of the car without significantly increasing cycle time or manufacturing cost..

Because the design dimensions were changed so significantly, the cost per car significantly changed as well. The cost-breakdown analysis from Table 1 was recreated based on the new dimensions and part requirements. This updated cost data is shown below in Table 2.

Table 2: Updated Cost Breakdown Analysis^{[6][7][8][9]}

Material/Part	Quantity	Total Price	Quantity Per Car	Price Per Car
4x4x40.5" hard maple block	2	\$114.10	8" length per 2 cars	\$5.63
2.5" diameter birch wheels	12	\$15.50	4	\$5.17
6" long 3/8" diameter birch dowels	25	\$10.99	1	\$0.44
4 fl oz Elmer's carpenters wood glue	1	\$2.18	≈ 0.25 fl oz	\$0.14
Total cost	—	\$142.77	—	\$11.38

As can be seen in the above table, the dimensional changes that were made decreased the material cost per car from \$20.28 to \$11.38, a 43.95% decrease. Not only did these design changes make the toy car safer and easier to play with, but they also significantly decreased the cost to produce each car. It is also important to note that this cost breakdown only includes material costs; there are also costs associated with labor, machining, and overhead. If this were to be a continuous process, a company would first have to acquire the proper machines, which are each thousands of dollars. There are also costs associated with powering the machines, but this would be much less expensive than the machining costs attributed to the CNC sheet router. Finally, there would be labor costs to pay the operators manufacturing the car. This process could be done by one operator, but for a continuous process, a company would want to hire three or more operators, one for each machine, in order to decrease the time to manufacture the product. After the updated designs and the necessary operations had been determined, the manufacturing process could be re-ordered, which is done in the following section.

E. Updated Order of Operations & Time Analysis

For the updated car body design, the manufacture of the side profile cuts were eliminated and new operations were added into the process. In order to achieve the proper dimensions of the new design, it was necessary to include a step to cut an inch off the height of the car body, as well as a step to cut the width of the car body in half to create two 2" wide cars rather than one 4" wide car. Both of these steps could be done with the vertical bandsaw and allow for the creation of two car bodies from just eight inches of length from the starting block. The new order of operations is as follows:

1. Cut 8" block from four-by-four using miter saw
2. Cut 6" dowel in half (two 3" axles) using miter saw
3. Remove 1" from the height of the car body using vertical bandsaw
4. Make 60° windshield cuts using vertical bandsaw
5. Make 90° hood cuts using vertical bandsaw
6. Cut width of the car body in half using vertical bandsaw creating two 2" wide cars
7. Drill two 7/16" holes in car body using drill press
8. Etch designs on both sides of car body using Fusion Pro laser engraver
9. Sand down car body using handheld orbital sanding tool
10. Insert axles through car body and glue wheels to either side
11. Allow glue to cure

The decision was made to utilize the laser engraving technology before sanding down the car body for multiple reasons. Primarily, the sharp, defined edges of the pre-sanded car body help to properly align the car bodies within the Epilog laser engraver to ensure correct placement of the side etchings. Secondly, using the laser engraver leaves some residual darkened marks around the etching, but sanding down the car body removes these unwanted dark spots. The process listed above was used to create the next prototype, which ended up becoming the final design.

Each step in this manufacturing process (including walking from machine to machine) was timed for three different trials and averaged to find the cycle time for the toy car. The car would have to be sanded and assembled with the axles and wheels regardless of the method of manufacture, the car would have to be sanded down and the wheels and axles would have to be attached to the car body, so these two steps were omitted from this analysis. By omitting these steps, it is easier to see the difference in the cycle time using traditional machinery compared to using the CNC sheet router, which normally requires very long cycle times. This time breakdown analysis is shown below in Table 3.

Table 3: Cycle Time Analysis

	Trial 1 (s)	Trial 2 (s)	Trial 3 (s)	Average (s)
Cutting 8" block with miter saw	23.64	20.71	19.98	21.44
Cutting dowels in half	1.41	1.33	1.35	1.36
Moving from miter saw to bandsaw	4.93	4.79	4.73	4.82
1" height removal	42.07	39.05	44.56	41.89
Windshield cuts	25.78	24.12	24.34	24.75
Hood cuts	36.74	35.58	34.90	35.74
Cutting car body in half	29.46	28.87	29.14	29.16
Moving from bandsaw to drill press	13.12	13.06	12.85	13.01
Drilling Holes	24.47	24.18	23.79	24.15
Moving from drill press to laser engraver	24.53	25.37	24.78	24.89
Laser engraving	138	138	138	138
Total time	---	---	---	223.29s = 5.987 minutes

As can be seen in the table above, the cycle time for the production of this car (before sanding and assembling wheels and axles) is just under six minutes. This is an exponentially better manufacturing time compared to what would have been required with use of the sheet router; CNC machines can take hours to shape out parts of this size, and decreasing the step-over for a better surface finish would increase this time even more. Even with the laser engraving step included, the car body only takes six minutes to

create using the process outlined previously, which is very efficient. If this were to be a continuous operation with an operator at each machine, this cycle time would be decreased even more, as multiple car bodies could be worked on simultaneously at different steps in the process. The final product for the model toy car is shown in the following section.

F. Final Product

Using the process outlined in the previous section, a much smaller, safer car with a high-quality appearance was successfully created. The manufacturing process worked well and efficiently, and the final car that was output from this process was visually appealing and fully functional. The car rolls straight and is sturdy, and the bond between the wheels and axles is very strong and secure. Manufacturing the car using human-operated machines on the factory floor greatly reduced the time and money that would have been required if the body was created using the Haas CNC sheet router machine or something similar, and yet this process still output a high-quality wooden toy car that successfully met the project goals. An image of the final product is shown below in Figure 16.

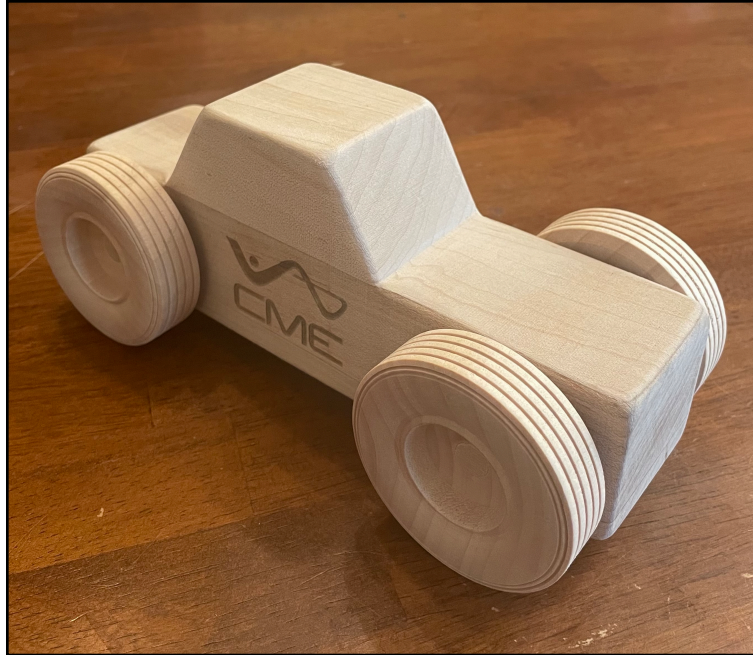

Figure 16: Finished Model Car

Figure 16 shows the resulting car body based on the updated designs and order of manufacturing operations. This output product met all of the project goals in that it was designed using principles and methodologies learned during our time in the CME, it was created efficiently in regards to manufacturing time and investment capital, it is safe for children to play with (ages 1 and up), it is a functional toy car that rolls easily and straight, and it is visually and texturally appealing. This design, though much less expensive, is much better suited for the purposes of this assignment rather than the original design plans.

IV. Conclusion

In conclusion, the goals set out for this project were successfully achieved in the creation of a children's wooden toy car that is visually appealing and fully functional, in addition to exemplifying a product created while keeping in mind the manufacturing philosophies taught at the CME. Option 2 (traditional machinery) was chosen among the options considered in order to keep cycle time and input cost for the product low, while not sacrificing too much potential quality. The choice of hard maple for the wood material output a durable car with an elegant unfinished surface which is very unlikely to splinter due to its hardness, and yet, it is still relatively inexpensive compared to other hard woods. To ensure that the car was completely safe, all corners and edges of the car body were significantly sanded down until they were smooth to the touch, and the possibility of pinch points was eliminated by decreasing the gap between the car body and its wheels. Only non-toxic materials were used in the assembly, and ASTM Standard F963-17 guidelines were utilized in order to set a minimum age requirement of 1 year old for play with this toy.

In terms of manufacturing philosophies, principles of DFMA were successfully achieved by reducing the part count in the assembly, error-proofing the design by creating poka-yoke fixtures, and simplifying and reducing the number of manufacturing operations needed to construct the car. LEAN principles were held to by minimizing the motion around the shop floor through properly ordering the manufacturing operations.

Keeping the design simple with the capability of being constructed by human-operated machinery also helped eliminate time and monetary waste that would be spent on the toy car if it were more complex in design or manufactured using more complex machinery. Also, the size of our car was greatly reduced in the middle of this process in order to decrease the material cost needed for each car, which was lowered from \$20.28 to \$11.38, as well as allowing for easier maneuverability of the toy for younger children.

This model toy car successfully accomplished the goals of this project, and much can be learned from the manufacture of this car as it exemplifies an efficiently-designed product, and it is additionally a high-quality children's toy that parents would consider purchasing for their children. Analysis of the design and the thoughts that went into the design choices that were made would be a much more interesting method to learn about LEAN and DFMA principles rather than reading about them straight from a textbook, and hopefully the future Manufacturing 152 students enjoy the process of learning about this philosophies through the product that was created with this process.

List of References:

1. Stienstra, David. "Introduction to (Cost Effective) Assembly and Manufacturing." *The George W. Woodruff School of Mechanical Engineering*, Georgia Institute of Technology, me.gatech.edu/files/capstone/L071ME4182DFA
2. "Chapter 4: Lean Concepts." *Lean Six Sigma Green Belt Certification Training Manual*, June 2018 Edition ed., Harmony Living, LLC, 2018, pp. 31–39.
3. ASTM F963–17, Standard Consumer Safety Specification for Toy Safety, ASTM International, West Conshohocken, PA, 2017, www.astm.org
4. "Relative Hardness Table for Domestic and Imported Woods." *Relative Wood Hardness Table*, Think & Tinker, Ltd., www.precisebits.com/reference/relative-hardness-table.htm.
5. "Hardwood Lumber Price List." *Hearne Hardwoods*, Hearne Hardwoods, Inc., www.hearnehardwoods.com/price-list/.
6. "Elmer's Products, Inc E7000 Carpenters Wood Glue4Oz, 4 Oz, Multicolor, 4 Fl Oz." *Amazon.com*, Amazon.com, Inc., www.amazon.com/Elmers-Products-E7000-Carpenters-Multicolor/dp/B001N7X1UA/ref=sr_1_6?dchild=1&keywords=wood%2Bglue&qid=1615562166&sr=8-6&th=1.
7. "2-1/2" Treaded Wooden Tires, 3/4" Thick, 3/8" Hole | Bag of 12." *Amazon.com*, Amazon.com, Inc., www.amazon.com/inch-Treaded-Wooden-Wheel-thick/dp/B01LWLTUVU1/ref=sr_1_9?dchild=1&keywords=wooden%2Bwheels%2B2.5%2Binch&qid=1615561661&sr=8-9&th=1.
8. "Dowel Rods Wood Sticks Wooden Dowel Rods — 3/8 x 6 Inch Unfinished Hardwood Sticks — for Crafts and DIYers — 25 Pieces by Woodpeckers." *Amazon.com*, Amazon.com, Inc., *¢*.
9. "Square Turning Blank (40 1/2" x 4")." *Osborne Wood Products*, Osborne Wood Products, Inc., www.osbornewood.com/1405004000.aspx.
10. Squires, Jonathan. "Stepover, Cusp Height, and Determining CNC Quality." *Styrotech CNC*, Styrotech CNC, Ltd. , 30 July 2013, www.styrotechcnc.co.nz/our-blog/understanding-stepover-and-cusp-height.
11. Mitchell, John. "Machining in 3-D." *Canadian Metalworkings*, FMA Communications, Inc., 15 Dec. 2014, www.canadianmetalworking.com/canadianindustrialmachinery/article/management/machining-in-3-d.

12. Sertoglu, Kubi, et al. "The Free Beginner's Guide." *3D Printing Industry*, 3D Printing Industry, 3 Aug. 2018, 3dprintingindustry.com/3d-printing-basics-free-beginners-guide/#02-history.
13. Imgur. "My Testing with Layer Height and Extrusion Width." *Imgur*, Imgur, Inc., 6 Aug. 2017, imgur.com/Kwrt2AM.