

**DEVELOPMENT AND ASSESSMENT OF ELECTRONIC MANUAL  
FOR WELL CONTROL AND BLOWOUT CONTAINMENT**

A Thesis

by

ODD EIRIK GRØTTHEIM

Submitted to the Office of Graduate Studies of  
Texas A&M University  
in partial fulfillment of the requirements for the degree of

MASTER OF SCIENCE

August 2005

Major Subject: Petroleum Engineering

**DEVELOPMENT AND ASSESSMENT OF ELECTRONIC MANUAL  
FOR WELL CONTROL AND BLOWOUT CONTAINMENT**

A Thesis

by

ODD EIRIK GRØTTHEIM

Submitted to the Office of Graduate Studies of  
Texas A&M University  
in partial fulfillment of the requirements for the degree of

MASTER OF SCIENCE

Approved by:

Chair of Committee,  
Committee Members,

Head of Department,

Jerome J. Schubert  
Hans C. Juvkam-Wold  
Ben D. Welch  
Stephen A. Holditch

August 2005

Major Subject: Petroleum Engineering

## ABSTRACT

Development and Assessment of Electronic Manual for Well Control and Blowout Containment.

(August 2005)

Odd Eirik Grøttheim, B.S., Texas A&M University

Chair of Advisory Committee: Dr. Jerome J. Schubert

*DEA – 63, Floating Vessel Blowout Control* is a blowout containment study which was completed in 1990, and it did not include discussions about operations in the water depths we currently operate in. As offshore drilling is continuously moving into deeper and deeper waters, a need to further investigate well control and blowout containment in ultradeep water has arisen.

This project describes the development and assessment of an electronic cross-reference tool for well control and blowout containment, with added focus on ultradeep water operations. The approach of this manual is fully electronic, thus being able to serve the needs of the engineer/driller with greater ease in both pre-planning and in a stressful on-the-job setting.

The cross-reference is a manual for the state of the art in well control and blowout containment methodology. It provides easy-to-use topical organization by categories and subcategories, and aims at providing clear links between symptoms, causes, and solutions. Clear explanations to complicated issues are provided, and confirmation of applicable blowout intervention procedures, be it conventional or unconventional, are discussed.

Human error and equipment failure are the causes of blowouts, and they are bound to happen in an ultradeep water environment. Well control events are harder to detect and

handle in ultradeep water, and quick reaction time is essential. After detection and shut-in, the Driller's method is the preferred circulation method in ultradeep water, due to its responsiveness and simplicity. In case kick handling is unsuccessful, contingency plans should be in place to handle a potential blowout. If a blowout does occur, and the blowing well does not self-kill through bridging, a dynamic kill through relief well intervention is likely to be necessary, as underwater intervention is difficult in ultradeep water. With new ultradeep water drilling technologies providing potential for increased performance, alternative well control methods might be necessary. Along with these new technologies follow new unfamiliar procedures, and proper education and training is essential.

## **DEDICATION**

I would like to dedicate this thesis to my family. To my Grandmother, Lollo: Thank you for being the source of the tenacity (read: stubbornness) needed to finish this work. To Mamma, Pappa, and Berin: Thank you for always supporting my decisions.

## ACKNOWLEDGEMENTS

I would like to give my sincere thanks to my advisor, Dr. Jerome J. Schubert. I appreciate you giving me the opportunity to work on this project, and thank you for your support.

I would also like to thank Dr. Hans C. Juvkam-Wold for being on my committee and always being available to answer whatever questions I might have. I have thoroughly enjoyed taking your classes and your friendship and input over the years have helped make my studies interesting.

Dr. Ben D. Welch also deserves warm thanks for being the non-Petroleum Engineer on my committee. Your lectures were always entertaining, and I know I speak for many students when I express my admiration of your passion and dedication to your students.

Thanks to all the faculty and staff at Texas A&M University, who have helped provide me with an excellent education within the field of Petroleum Engineering.

Without the funding from the Minerals Management Service, the Offshore Technology Research Center, Research Partnership to Secure Energy for America, and the Global Petroleum Research Institute, this project would not have been possible. Thank you.

The American Association of Drilling Engineers, Houston Chapter, deserves warm thanks for helping students at the graduate level pursue their goals, through their AADE Financial Grant Graduate Program. Thank you very much!

Last but not least, I would like to thank all of my beloved friends, near and far, for being there for me throughout the years. Without your friendship and love, this journey would not have been worth it.

## TABLE OF CONTENTS

	Page
ABSTRACT .....	iii
DEDICATION.....	v
ACKNOWLEDGEMENTS .....	vi
TABLE OF CONTENTS.....	vii
LIST OF FIGURES .....	xi
LIST OF TABLES.....	xiii
CHAPTER	
I INTRODUCTION.....	1
1.1 Blowouts.....	2
1.2 Types of Blowouts .....	3
1.2.1 Surface Blowouts.....	4
1.2.2 Subsurface Blowouts .....	5
1.2.3 Underground Blowouts.....	6
1.3 Blowout History .....	8
1.4 Blowout Statistics and Trends .....	10
1.4.1 Blowouts and Drilling Activity.....	10
1.4.2 Blowouts and Drilling Depth .....	12
1.4.3 Blowouts and Type of Well .....	14
1.4.4 Blowouts and Type of Operation .....	15
II DEVELOPMENT OF ELECTRONIC WELL CONTROL MANUAL .....	20
2.1 Objective of Study.....	20
2.2 Expected Contributions of Study .....	21
2.3 Structure and Organization .....	22
2.3.1 Organization of Information .....	22
2.3.2 Navigational Structure .....	24
2.4 Potential Future Content.....	25
III WELL CONTROL METHODS .....	28
3.1 Kicks.....	29
3.1.1 Kick Causes.....	29
Hole Not Kept Full of Mud.....	29
Swabbing .....	31
Lost Circulation.....	32
Mud Density too Low.....	33
Abnormal Pressure .....	34

CHAPTER	Page
Mud Cut .....	35
Post-Drilling Problems .....	36
3.1.2 Kick Detection .....	37
Drilling Break .....	37
Increase in Flow Rate and Pit Gain .....	38
Pump Speed Increase and Circulating Pressure Decrease .....	39
Change in Drillstring Weight .....	40
Mud Cut and Salinity Change .....	41
Flow With the Pumps Off .....	41
MWD and Sonic Kick Detection .....	42
3.2 Basic Well Control Equipment .....	43
3.2.1 High-Pressure Equipment .....	43
Casing, Well Heads and Spools .....	43
Annular Preventers .....	44
Ram Preventers .....	45
Kill and Chokeline Equipment .....	47
2.2.2 Low-Pressure Equipment .....	48
Manifold Lines .....	48
Mud/Gas Separators .....	48
Degassers .....	48
3.3 Well Control Procedures and Techniques .....	49
3.3.1 Shut-in Procedures .....	49
3.3.2 Conventional Kick Circulation .....	54
Driller's Method .....	54
Wait and Weight / Engineer's Method .....	55
Driller's Method vs. Wait and Weight Method .....	56
Alternative Methods .....	57
IV WELL CONTROL COMPLICATIONS AND CHALLENGES .....	59
4.1 Non-conventional Well Control Methods .....	59
4.1.1 Reverse Circulation Method .....	60
4.1.2 Dynamic Kill Technique .....	60
4.1.3 Bullheading .....	61
4.1.4 Volumetric Method .....	61
4.1.5 Lubricate and Bleed Method .....	63
4.1.6 Staging the Hole .....	63
4.2 Well Control Complications .....	64
4.2.1 Pipe Off-bottom or Out of the Hole .....	64
4.2.2 Excessive Pressures .....	65
4.2.3 Circulating System Blockage .....	67
4.2.4 Hole in Pipe .....	68
4.2.5 Loss of Circulating Power .....	69



CHAPTER	Page
4.2.6 Leak in Blowout Equipment or Choke Manifold .....	69
4.2.7 Lost Circulation .....	70
4.2.8 Complication Overview .....	71
4.3 Well Control Challenges .....	72
4.3.1 Directional and Horizontal Wells .....	73
4.3.2 Extended Reach Wells .....	75
4.3.3 Multiple Completions and Multilaterals .....	77
4.3.4 Slim Hole .....	78
4.3.5 Offshore Wells .....	79
Operational Difference .....	79
Kick Detection and Shut-in .....	81
Shallow Flows .....	82
Lost Circulation .....	83
Fracture Gradients .....	85
V BLOWOUT CONTROL METHODS .....	87
5.1 Surface Intervention .....	87
5.1.1 Firefighting and Debris/Equipment Removal .....	88
5.1.2 Conventional Capping .....	92
5.1.3 Alternative Methods .....	93
Stinger Operation .....	94
Junk Shots .....	95
Freezing and Hot Tapping .....	95
Plugs .....	96
Bridging .....	96
5.1.4 Bullheading .....	97
5.2 Subsurface/Relief Well Intervention .....	98
5.2.1 Subsurface Intervention .....	98
Momentum Kill .....	98
Dynamic Kill .....	99
5.2.2 Relief Well Intervention .....	100
Flooding .....	100
Well Intersection .....	101
Dynamic Kill .....	102
Relief Well Planning and Execution .....	103
VI ULTRA-DEEPWATER CONSIDERATIONS .....	105
6.1 Ultra-deepwater Equipment .....	105
6.1.1 Ultra-deepwater Well Control Equipment .....	106
6.1.2 Ultra-deepwater Blowout Control Equipment .....	106
6.2 Ultra-deepwater Well Control .....	108
6.2.1 Ultra-deep Water Kick Detection, Shut-in, and Hang-off Procedures .....	108

CHAPTER	Page
6.2.2 Ultra-deep Water Circulation Methods.....	109
6.2.3 Post-kill Procedures.....	111
6.3 Ultra-deep Water Blowout Control.....	112
6.3.1 Ultra-deep Water Underwater Intervention.....	112
6.3.2 Relief Well Operations in Ultra-deep Water.....	114
6.3 Ultra-deep Water Well Control Complications and Challenges.....	117
6.4 New Ultra-deep Water Technologies.....	119
6.4.1 Surface BOP Stacks in Ultra-deep Water Drilling.....	119
6.4.2 Expandable Casing.....	121
6.4.3 Ultra-deep Water Slim Riser Drilling.....	121
BOP Control System.....	122
6.4.4 Method Selection Guidelines.....	122
6.4.5 Dual-gradient and Managed Pressure Drilling in Ultra-deep Water.....	123
SubSea Mudlift Drilling.....	124
Controlled Mud Cap and Low Riser Return System.....	126
New Approach: SubSea Mudpump Kill.....	128
VII DISCUSSION, CONCLUSIONS, AND RECOMMENDATIONS.....	129
7.1 Development and Assessment of Electronic Well Control Manual.....	129
7.2 Well Control and Blowout Conclusions and Recommendations.....	130
7.3 Recommendations for Future Work.....	131
NOMENCLATURE.....	133
REFERENCES.....	136
APPENDIX A: SUBSEA MUDPUMP KILL.....	142
APPENDIX B: ELECTRONIC MANUAL ILLUSTRATION.....	144
VITA.....	146

## LIST OF FIGURES

	Page
Fig. 1.1 – The Piper Alpha incident killed 167 people, and destroyed the platform.....	3
Fig. 1.2 – A subsurface blowout exits at the mudline and appears at the sea level.....	6
Fig. 1.3 – Relief well intersecting blowing well through subsurface intervention.....	8
Fig. 1.4 – Spindletop Lucas well blowout (1901) .....	9
Fig. 1.5 – Blowout frequency is independent of drilling activity in Texas.....	11
Fig. 1.6 – Kick rate (number of kicks per 100 wells) did not seem to correlate positively with number of wells in Alberta from 1979 to 1988.....	12
Fig. 1.7 – More blowouts occur in shallow wells, since the quantity of shallow wells is higher than that of deep wells.....	13
Fig. 1.8 – Deeper wells experience higher kick rates in Alberta from 1979 to 1988.....	14
Fig. 3.1 – Swabbing in a kick.....	31
Fig. 3.2 – An aquifer outcropping at a higher elevation causes abnormal pressure.....	35
Fig. 3.3 – Float type pit level sensor.....	39
Fig. 3.4 – U-tube analogy and U-tube effect.....	40
Fig. 3.5 – Two types of annular preventers.....	45
Fig. 3.6 – Example of pipe ram preventer.....	46
Fig. 3.7 – Example of BOP stack configuration from Saudi Aramco.....	47
Fig 4.1 – Casing pressure response during Volumetric method.....	62
Fig. 4.2 – Bottomhole pressure response during Volumetric method.....	62
Fig. 4.3 – Plugged nozzle increases drillpipe pressure, but not casing pressure.....	67
Fig. 4.4 – Gas accumulation in washouts of deviated well.....	75
Fig. 4.5 – Wytch Farm M16 well: World’s longest ERD well.....	76
Fig. 4.6 – Multilateral completions may cause well control complications.....	77
Fig. 4.7 – Subsea BOP stack, LMRP, and riser.....	80
Fig. 4.8 – Window between fracture gradient and pore pressure is narrow in deepwater and casing setting depths are dictated by it.....	86

	Page
Fig. 5.1 –South Rumalia Well RU-67 flows vertically after production head removal, pre-sting and kill operation. ....	90
Fig. 5.2 – Hydra-Jet cutter cutting below wellhead with gelled sand/water slurry. ....	91
Fig. 5.3 – Two types of well capping stacks. ....	92
Fig. 5.4 – Dual stinger operation – Left: Stinging into casing valve, and pumping down stinger in tubing. Right: Post-sting and kill operation. ....	94
Fig. 5.5 – Comparison of kill methods between OCS and Texas from 1960 – 1996. ....	97
Fig. 5.6 – Momentum kill principle illustrated by head-on fluid collision. ....	99
Fig. 5.7 – Relief killing blowing well through depletion of waterflooding. ....	101
Fig. 5.8 – Three relief wells needed in Syria blowout in 1995: Two killing dynamically, and one flooding. ....	103
Fig. 6.1 – Gas plume causes less than 5% loss of buoyancy in ultradeep water. ....	112
Fig. 6.2 – Radius of gas plume at sea level is substantial in ultradeep water. ....	113
Fig. 6.3 – Dropped drillstring results in higher bottomhole pressure than hanging drillstring in the same wellbore. ....	116
Fig. 6.4 – Drilling with surface BOP, subsea BOP, and surface BOP with ESG. ....	120
Fig. 6.5 – SubSea Mudlift Drilling Dual-gradient system. ....	124
Fig. 6.6 – Low Riser Return and Mud-Lift System. ....	126
Fig. B.1 – By clicking the topic of interest in the main menu, a direct link directs the user to the related section in the main text. ....	144
Fig. B.2 – The manual’s main text is linked to related topics, references, figures, and tables. ....	145

## LIST OF TABLES

	Page
Table 1.1 – Tripping and drilling accounts for the majority of blowout situations in Louisiana, Texas and OCS during 1960-1996. ....	16
Table 1.2 – Equipment installation accounts for 46% of workover phase blowouts in Texas and OCS during 1960-1996. ....	17
Table 1.3 – Development and exploratory activities account for the majority of blowouts in offshore UK and Norway, as well as in US GoM OCS.....	18
Table 1.4 – Swabbing and failure to close BOPs are the two most common problems on losing primary and secondary barriers. ....	19
Table 3.1 – Soft and hard shut-in procedures for surface stacks. ....	51
Table 3.2 – Example of shut-in procedure for floating vessels. ....	52
Table 3.3 – Example of shut-in while tripping. ....	52
Table 3.4 – Shut-in while tripping on a floating vessel. ....	53
Table 3.5 – Driller’s method. ....	55
Table 3.6 – Wait and Weight method. ....	56
Table 4.1 – Summary of causes and solutions to pressure increases at surface. ....	71
Table 4.2 – Summary of causes and solutions to pressure decreases at surface. ....	72
Table 6.1 – Example of hang-off procedure. ....	109
Table 6.2 – Example of riser-kill procedure. ....	111
Table 6.3 – Guidelines for ultradeep water drilling method selection. ....	123

## CHAPTER I

### INTRODUCTION

The petroleum industry is a very mature industry with a great history. It is known to be a very traditional industry, where change is brought about through necessity. As the world has experienced an increasing need for hydrocarbons to cover its energy needs, the field of oil and gas exploration and production has had to push the frontiers of discovery. As resources were exploited onshore, there was a push to explore for hydrocarbons offshore. Once the barrier of operating in water was broken, one of the frontiers of today is the increasing water depth at which these operations take place. As the water depth increases, the costs and the risk go up. Thus, the reward for seeking these deep water reservoirs must be very high in order for the economics of the projects to meet the criteria of the operators. Hence, these are high-risk, high-return operations.

As developments are made in all aspects of the industry, be it in the fields of reservoir description and simulation, or subsea completions, opportunities are further opened up. However, drilling is at the very core of the industry, in that it simply would not be possible to reach the reservoir targets without it. As the targets become deeper and deeper, there are growing challenges of reaching them successfully. Specifically, as water depths become greater, the pressure envelope between the subsurface pore pressure and the fracture pressure becomes narrow. It often becomes a difficult task to be able to conduct drilling operations in this narrow pressure window, and the result may be an increased number of casing strings, just to be able to reach the target.<sup>1</sup>

Along with this deep environment of operation come challenges in regards to well control. Well control is one of the areas that have received increased focus in recent years, as it is of utmost importance to all parties involved in any operation. As increased

---

This thesis follows the style and format of *SPE Drilling and Completion*.

spending and research on well control doesn't have evident money-making impact compared to other areas of our industry, it is something that in the past had been lagging behind the rest of the industry.<sup>2</sup> With a renewed focus on health, safety, and environment (HSE), companies are realizing the incredible importance of well control in assuring safe operations for people, equipment, assets, and the environment.

### **1.1 Blowouts**

When drilling, the pressures of the formations are to be managed and kept under control. Conventionally, this is done by controlling the density of the drilling mud used, so that the hydrostatic pressure exerted by this fluid is high enough to overcome the pressure of the formation and prevent influx of formation fluids into the wellbore. When this is not achieved, there might be an unscheduled inflow of fluids into the well. Most commonly, the occurrence of a kick is due to the rig crew not doing their job of managing the well pressures adequately.

With the event of a kick follows the need for secondary well control; specifically, "kick detection, containment, and displacement from a well."<sup>3</sup> When there is a failure to handle the kick properly, the situation might escalate into a blowout. This is a very dangerous event where the lives of rig personnel are at risk, and is a situation that companies try to avoid at all cost. In addition to the risk of injury or death to people, great economic losses and damage to the environment are other potential results of this uncontrolled flow of formation-fluid.<sup>4</sup>

A blowout that serves as a terrible example of the consequences described above is the Piper Alpha blowout. Occidental Petroleum's production platform accounted for 10% of the UK's North Sea Oil Production at its peak.<sup>5</sup> In July 1988, the platform experienced a gas leak, which ignited and turned into a massive fire. The incident left 167 people dead, and burned and melted the entire platform.<sup>6</sup> The estimated costs of the blowout have

been estimated to approximately \$1.5 billion in lost revenue for Occidental Petroleum.<sup>5, 8</sup> Illustrated in **Fig. 1.1**, this terrible tragedy portrays the devastating consequences a blowout might have, and shows the importance of having proper procedures to deal with well control situations before they escalate to a blowout scenario.



**Fig. 1.1 – The Piper Alpha incident killed 167 people, and destroyed the platform.<sup>7</sup>**

## **1.2 Types of Blowouts**

When dealing with offshore operations, one can categorize blowouts into three classifications, like Oskarsen did.<sup>8</sup>

- Surface Blowouts
- Subsurface Blowouts
- Underground Blowouts



### 1.2.1 Surface Blowouts

The Piper Alpha blowout described above is an example of a surface blowout. It is recognized as one of the more famous examples of a surface blowout<sup>9,10</sup> due to its terrible consequences. As can be understood from the name, a surface blowout is an uncontrolled flow of fluids that reach the surface. The blowing fluids are most commonly natural gas, oil/condensate, and saltwater, but any other naturally or injected fluid would also be expelled from a blowing well.

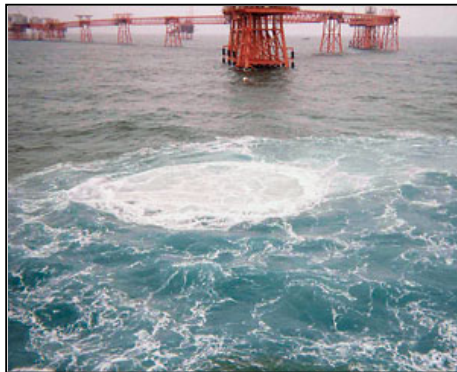
Due to their spectacular displays, surface blowouts tend to attract a lot of media interest. With the potential of taking lives, and destroying incredible value, not to mention cause environmental damage, these events are very newsworthy. Hence the petroleum industry has been tagged with a reputation of being an industry where the standards for HSE have been too low. With stories of wells blowing to the surface, and their accompanying images, the public opinion is inclined to lean towards the negative angle of the news coverage. Not only do surface blowouts cause significant direct losses of revenue, the effect of public opinion of the operator might in fact result in consequences for the operator's stock price.<sup>9</sup> Hence, it might be hard to put economic value on a potential blowout when it comes to contingency planning. Nonetheless, public opinion is a factor that can carry a cost, and is something that should not be forgotten.

According to the Willis Energy Loss Database, surface blowouts represent 34.2% of all blowouts. After such an event has occurred, it is very advantageous in regard to time and money, if the well is brought back under control using the well itself, and the existing equipment.<sup>3</sup> Surface blowouts might catch fire, and fighting these fires are an integral part of surface intervention. Additionally, the removal of debris and preparation of well location for further action is essential.<sup>11</sup> The following actions are incident-specific, and as blowout control operations are not everyday events, the experience of the blowout control personnel is invaluable.

### 1.2.2 Subsurface Blowouts

Subsurface blowouts, as indicated by the name, do not reach the surface facilities. They broach through and exit the well at the seafloor. Here, the exit conditions are largely governed by the seawater<sup>8</sup>. As the formation fluids do not reach the rig floor through the drillstring or riser, the direct threat of damages like the ones described earlier are reduced. However, there are consequences to a subsurface blowout as well.

Underwater blowouts are not very common, and very few have occurred in deepwater operations. As operations move into deeper and deeper waters, the expected flow rates of the target oil and gas wells need to increase in order to make the economics of the project attractive. If a subsurface blowout was to occur, this would mean a very high volume of formation fluid being spewed out at the mudline. As oil and gas are less dense than seawater, they will tend to move upwards and create a hydrocarbon plume.<sup>12</sup> As shown in **Fig. 1.2**, the blowout appears at the sea level, and the plume could potentially cause a decrease in buoyancy, compared to that exerted by the seawater. This could cause problems in deepwater operations in particular, as this is the environment in which floating vessels would operate in order to attempt to handle the blowout.<sup>12</sup> The effect the plume will have on buoyancy will depend on the hydrocarbon flow rate, the fluid density, and the water depth at which the blowout is occurring.<sup>8</sup>



**Fig. 1.2 – A subsurface blowout exits at the mudline and appears at the sea level.<sup>9</sup>**

Blowouts that broach through to the mudline can be very difficult to control, due to the obvious difficulties of accessing the exit point. The conditions for this type of broaching often occur in depths less than 3000 – 4000 feet below mudline.<sup>13</sup> In offshore operations, recent geologic formations are often encountered, and these unconsolidated sands increase the possibility of broaching to occur. In shallower waters, the broaching might cause structural problems for platforms or jack-ups if it occurs immediately beneath the rig.<sup>8</sup>

### **1.2.3 Underground Blowouts**

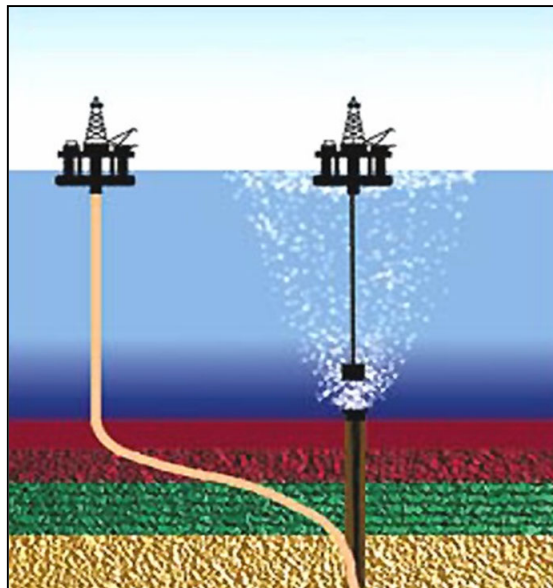
As opposed to the other two types of blowouts mentioned before, underground blowouts do not receive nearly the same media attention. This is due to the nature of the blowout, in that it does not present any warning signs directly visible at the surface. In fact, underground blowouts are “uncontrolled flow of formation fluids from one zone to another.”<sup>3</sup> This is possible when the pressure of the flowing formation is not controlled by the fluids in the well, and the resulting kick is able to flow into a formation of lower

pressure. This is also labeled crossflow in the industry, and most commonly the flow originates at a lower formation than the depth of the receiving zone.

Underground blowouts can occur in several different ways. An example of underground blowout occurrence in drilling operations can be when a highly pressured formation is penetrated and kicks. As a response, the rig crew might close the blowout preventers (BOPs) to arrest the flow. As formation fluids flow up the well, and pressures build, it is possible that a weaker formation might fracture as a result of this pressure increase. A result may be that the formation fluids take the path of least resistance and flow into this weak formation.<sup>14</sup>

Even though underground blowouts aren't as visible to the public as surface and subsurface blowouts can be, it doesn't mean they can't have severe consequences. As a matter of fact, this is the most common type of blowout, and it represents about 2/3 of all blowouts.<sup>9</sup> Underground blowouts can also be very hard to handle, and turn into a very costly affair. "The most effective way to control underground blowouts is to prevent them from happening."<sup>3</sup> This can only be accomplished through careful planning, monitoring, and careful execution throughout the life of the well.

Underground blowouts tend to have a higher cost to the operator than any other type of blowout. These situations are hard to handle, in that a surface intervention can be difficult. Subsurface intervention is most often necessary to get subsurface and underground blowouts under control. This implies that the existing workstring is utilized to kill the well if possible. Oftentimes, this is not an option, as the string and the well equipment might be damaged. In these cases, a relief well might be necessary, where a new well is drilled and targeted to intersect the blowing well or formation. The blowing well can then be killed dynamically, or through pressure depletion of the reservoir. **Fig. 1.3** shows a relief well intersecting a blowing well that has experienced broaching at the mudline.



**Fig. 1.3 – Relief well intersecting blowing well through subsurface intervention.**<sup>15</sup>

### 1.3 Blowout History

In the very beginning of our industry, there were no effective ways of dealing with blowouts in a controlled manner. Noynaert brings up a good example of this in the first well of the famous Spindletop field near Beaumont, Texas.<sup>16</sup> These blowing wells were known as gushers, and were considered a sign that you had hit it big. **Fig. 1.4** shows a picture of Lucas well blowing out.



**Fig. 1.4 – Spindletop Lucas well blowout (1901)<sup>17</sup>**

As the rotary rig took over for the cable tool rig, and the depth of the wells kept getting deeper, there was a need to control the higher pressures encountered. The developments of the industry had put forth a need, and this need was largely attended to with the development of the blowout preventer. In the early 1920's James Abercrombie and Harry Cameron created the first blowout preventer<sup>18</sup>, and it was quickly adopted by the industry as a necessity. By the late 1920's, US states were starting to require the use of BOPs in oil and gas drilling.

Well control and blowout control became increasingly important as the industry set its feet in water. The developments in offshore drilling demanded better control of the well, but when blowouts did occur, only a select few were able to handle the situation. Red Adair is probably the most famous personality in blowout control and oil and gas firefighting, and he was the go-to guy for decades, after having built a reputation as the "best in the business".<sup>19</sup> Still today, blowout control is handled by only very few companies with special expertise.

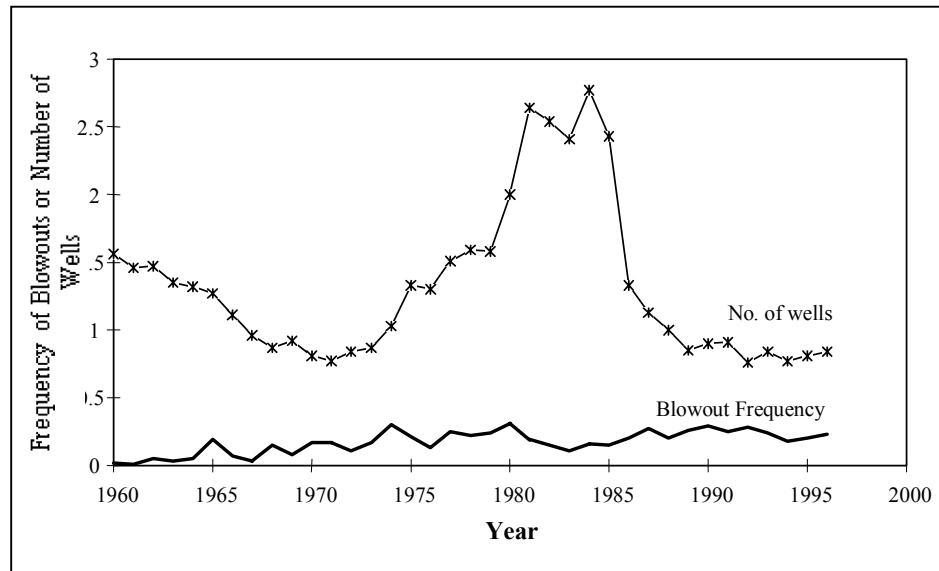
## 1.4 Blowout Statistics and Trends

As can be understood in the description above, blowouts have occurred since the industry's inception, and are likely to occur in the future as well. In the first part of the 20<sup>th</sup> century, blowouts were not commonly registered and categorized, and few studies were done to improve the safety records of drilling operations. During the last 40 years of the century, data started to be collected, and increased attention was directed towards studying well control and blowouts, and how to better the procedures and practices.

### 1.4.1 Blowouts and Drilling Activity

In 1973, blowout reporting became mandatory in all US States. This helped improve the data quality for US blowout studies<sup>20</sup>, which again helps the analysis of cause and effect in the field of well control. Through the studies of blowout data from the Gulf Coast area and the adjoining states, Skalle and Podio concluded that the “problem of detection, handling kicks, losing control does not seem to change much over the years.”<sup>20</sup> This might come as a surprise, as developments and improvements have been made to both drilling and well control equipment in this period. With the technological and regulatory improvements, one could possibly expect an improvement of the safety record of operations with regard to blowouts.

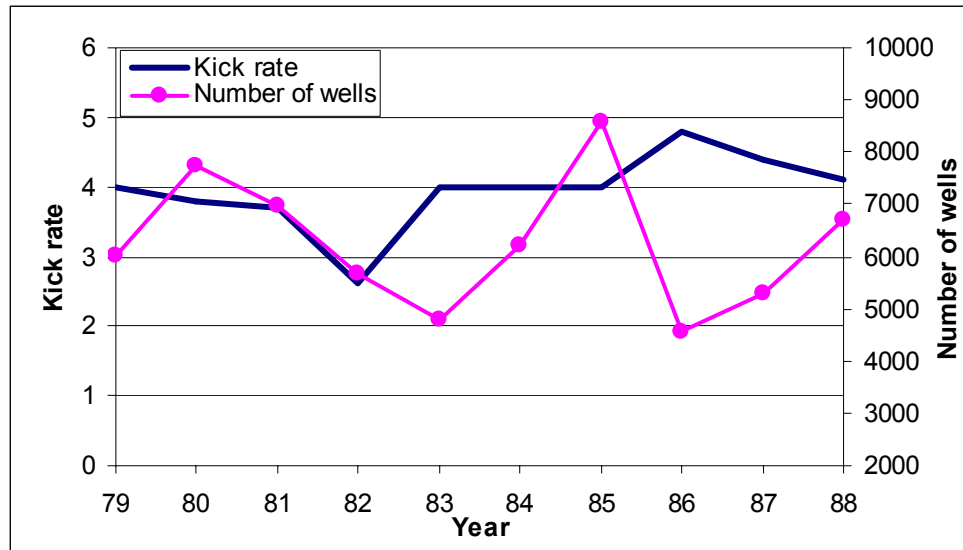
The oil industry has always been a very cyclical one. The 1980's manifest this, as a great boom in activity was experienced in the first part of the decade. Along with this increased activity, one would expect a higher occurrence of blowouts. The total number of blowouts in Texas and the Outer Continental Shelf (OCS) is higher when activity is high, but results of Skalle and Podio shown in **Fig. 1.5** indicate that the frequency of blowouts, as defined by blowouts per 100 wells, seems to be independent of the activity level.<sup>20</sup>



**Fig. 1.5 – Blowout frequency is independent of drilling activity in Texas.<sup>20</sup>**

Wylie and Visram studied well control event information from the Energy Resources Conservation Board in Alberta, Canada.<sup>21</sup> As shown in the representation of their data in **Fig. 1.6**, it is hard to conclude any direct correlation between the number of wells drilled, and the kick rate experienced in the respective year. Assuming that kick rates and blowout rates are positively correlated, this observation seems to align with the conclusions of Skalle and Podio from above.

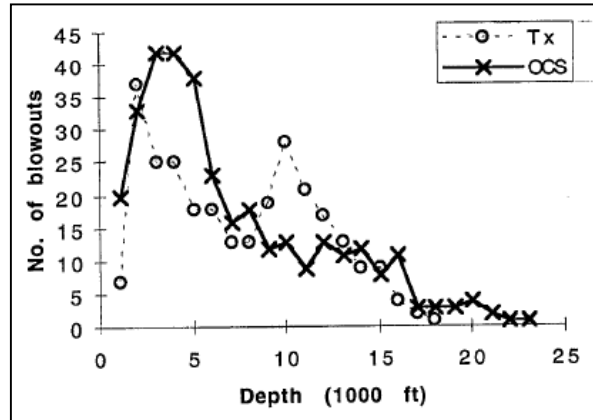




**Fig. 1.6 – Kick rate (number of kicks per 100 wells) did not seem to correlate positively with number of wells in Alberta from 1979 to 1988.<sup>21</sup>**

#### **1.4.2 Blowouts and Drilling Depth**

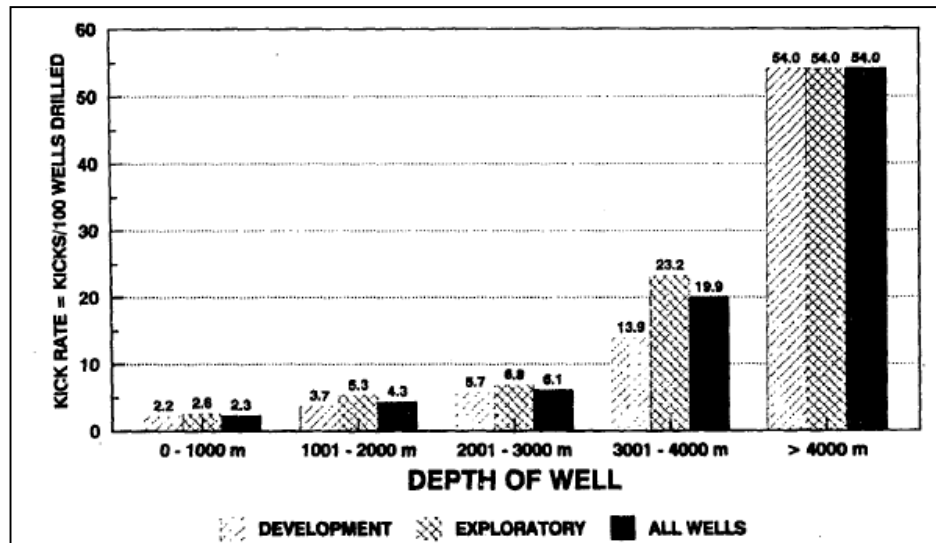
As Skalle and Podio discussed, it is natural to anticipate that the majority of blowouts occur at wells drilled at shallower depths. There are fewer deep wells drilled, so the mere fact that more wells are drilled at these shallow depths should indicate that the statistical chances of blowouts occurring in these wells are greater. This is indicated in **Fig. 1.7**.



**Fig. 1.7 – More blowouts occur in shallow wells, since the quantity of shallow wells is higher than that of deep wells.<sup>20</sup>**

On the other hand, it is also natural to expect the blowout frequency would be higher in deeper wells, on a per well basis. This can be attributed to the fact that these deep wells experience longer exposure times of the formation, in addition to the higher pressures experienced.<sup>20</sup> The risk of a kick occurring in a deep well is relatively high. These wells have longer open-hole sections, and the extended exposure time mentioned above adds to this risk.<sup>21</sup>

Wylie and Visram also point to the fact “deeper wells take longer to drill and have more trips,” which increases the risks of taking kicks. Other hole problems, such as lost circulation, might be other reasons for the increased kick occurrence with depth. **Fig 1.8** shows that the kick rate is increases as the depth of the wells increase. Wylie and Visram also present a similar plot showing that the kick rate increases as the depth at which the kick originates increases.



**Fig. 1.8 – Deeper wells experience higher kick rates in Alberta from 1979 to 1988.<sup>21</sup>**

### 1.4.3 Blowouts and Type of Well

**Fig 1.8** also points to a very different fact. It distinguishes exploratory wells from development wells. As can be seen from the figure, it is clear that exploratory wells seem to carry a greater risk of blowing out, as the kick rate is higher than for development wells of the same depth. This is also clear from the plot of kick rates by kick origin depth presented in Wylie and Visram's paper. The development wells drilled in Alberta in the period represented 70% of the total wells drilled, whereas exploratory wells accounted for 30%. The exploratory wells studied had a kick rate of 5.7 during the ten year period, while the development wells saw a kick rate of 3.2. This corresponds to a likelihood of exploratory wells experiencing a kick that is 1.8 times higher than that of a development well. More interestingly, the probability of an exploratory well suffering from a blowout is 2.8 times higher than a development blowout.<sup>21</sup> Relating back to the

relationship between kick rate and depth, it should be known that a “higher percentage of the wells are exploratory drilled in the deeper categories”<sup>21</sup>, which of course ties the two relationships together.

Blowouts can either be traced back to equipment failures of human error, and oftentimes, a series of unfortunate events tend to occur before a kick develops into a blowout. These may occur at different stages in the life of a well, and varying risks can be attached to these different operations.

#### **1.4.4 Blowouts and Type of Operation**

In the ten year study period of well control events in Alberta, the majority of kick occurred during tripping operations (48.5%). Almost an equally high percentage of kicks happened during drilling operations (44.7%). During exploration drilling, operations experienced more kicks during drilling than tripping, whereas the relationship was switched for development wells.<sup>21</sup>

In Louisiana, Texas and the OCS the trend is similar, where tripping activities accounts for the majority of blowouts, with drilling with bit on bottom follows closely as the second mode of operation where blowouts occur<sup>20</sup>. These results, along with a breakdown of other events, are presented in **Table 1.1**.

**Table 1.1 – Tripping and drilling accounts for the majority of blowout situations in Louisiana, Texas and OCS during 1960-1996.<sup>20</sup>**

Operation	BO	Activity	BO
Drilling activity	430	Tripping out/cnx/wiper	158
		Actual drilling (bit on bottom)	151
		Circulating	22
		Out of hole	17
		Tripping in	11
		Coring	5
		Other	34
		Missing activity data	32
Circulation	42	Circulating/killing	26
		Tripping	4
		Wait on order	2
		Other	5
		Missing activity data	5
Technical problem	26	Fishing	10
		Stuck pipe	9
		Killing	3
		Other	2
		Missing activity data	2
Well testing	10		
Abandon well	8		
Pressure testing	7		
Other	32		
Missing operation data	42		
Total	597		

Drilling activities accounted for about 72% of the total number of blowouts, and no other category came close in the drilling phase of the well. The workover phase of the well had a blowout occurrence almost 7 times less than that of the drilling phase. During this phase, equipment installation represented 46% of the blowouts.<sup>20</sup> **Table 1.2** shows the details of blowouts during the completion phase for Texas and OCS.

**Table 1.2 – Equipment installation accounts for 46% of workover phase blowouts in Texas and OCS during 1960-1996.<sup>20</sup>**

Operation	BO	Activity	BO
Installing equipment	41	WOC	17
		Nipple down BOP	5
		Run csg/tubics	4
		Set well plugs	3
		Cementing casing	2
		Initial production	2
		Other	4
		Missing activity data	3
Circulation	17	Killing	2
		Casing running	3
		Cleaning well	3
		Gas lifting/initiate prod.	3
		Other	3
		Missing activity data	3
Running well equipm.	9		
Well testing	8		
Perforation	5		
Other	4		
Missing operation data	5		
Total	89		

In this category, waiting on cement is the operation that has experienced the most blowouts. As suggested by Skalle and Podio, gas migration might be the contributing factor to this, and this needs to be monitored closer.

The Norwegian research and development (R&D) organization SINTEF administers a blowout database that is sponsored by industry participants. Hence, most of it is confidential, and only the sponsoring members have full access to the database. SINTEF does, however, publish limited information from the database, and **Table 1.3** is an example of this.

**Table 1.3 – Development and exploratory activities account for the majority of blowouts in offshore UK and Norway, as well as in US GoM OCS.<sup>22</sup>**

AREA	Dev. drlg	Expl. drlg	Unk. drlg	Completion	Workover	Production		Wireline	Unknown	Total
						External cause*	No ext. cause*			
Offshore (UK & Norway)	7	25	2	3	5	1	1	3		47
	14.9%	53.2%	4.3%	6.4%	10.6%	2.1%	2.1%	6.4%	0.0%	100.0%
US GoM OCS	45	45		12	29	6	8	4	2	151
	29.8%	29.8%	0.0%	7.9%	19.2%	4.0%	5.3%	2.6%	1.3%	100.0%
Total	52	70	2	15	34	7	9	7	2	198
	26.3%	35.4%	1.0%	7.6%	17.2%	3.5%	4.5%	3.5%	1.0%	100.0%

\* External causes are typical; storm, military activity, ship collision, fire and earthquake.

The table confirms the observations discussed earlier, and shows that the drilling phase experiences the highest percentage of blowouts in an offshore environment. Data for deepwater blowouts are hard to come by, which leads to a discussion of general blowout data, and other offshore data. The SINTEF data was initiated in 1984, and includes information on 515 offshore blowouts since 1955.<sup>22</sup>

Kick and blowout information can be further broken down in subcategories of primary and secondary boundaries. **Table 1.4** shows the distribution of the most frequent operation phase failures in Louisiana, Texas and OCS for the period of 1960-1996.<sup>21</sup> As can be seen from the table, swabbing in a kick is by far the most common way to introduce a kick into the well system. This is true for all operational phases, and aligns with the high percentage of kicks and blowouts associated with tripping operations discussed earlier.

**Table 1.4 – Swabbing and failure to close BOPs are the two most common problems on losing primary and secondary barriers.<sup>21</sup>**

Primary barrier	Blowouts		Distribution of specific failed barrier					
	Tx	OC S	Expl. drilling	Develop. drilling	Completion	Production	Workover	Wireline
Swabbing	217	31	77	96	9	-	75	5
Drilling break	73	14	52	32	-	-	2	-
Formation break down	58	6	38	16	3	3	4	-
Trapped/expanding gas	55	6	9	18	7	-	28	1
Gas cut mud	55	7	26	15	5	-	13	1
Too low mud weight	43	12	17	20	12	-	16	3
Wellhead failure	28	6	5	3	1	20	11	-
x-mas tree failure	23	5	-	-	1	25	6	-
While cement sets	21	10	5	5	23	-	2	-
Secondary barrier								
Failure to close BOP	152	7	66	56	6	2	38	3
BOP failed after closure	76	13	36	24	13	2	14	2
BOP not in place	60	10	9	11	20	-	39	1
Fracture at casing shoe	34	3	21	17	3	1	2	1
Failed to stab string valve	18	9	2	2	6	1	13	-
Casing leakage	30	6	10	6	2	17	6	1

The most common cause of losing the secondary barrier to a blowout is the failure to close the BOP. This might seem like something that is easy to implement, but with the added pressures of making money, and reducing down-time, field personnel not be as alert to kick indicators as they should be.



## CHAPTER II

### DEVELOPMENT OF ELECTRONIC WELL CONTROL MANUAL

The information contained in the electronic well control cross-reference is presented in this thesis. Through the proper organization and structuring, the manual will provide the users with helpful information on well control and blowout containment. It is designed in such a way, that future content can easily be added, and the manual may be revised and customized with great ease.

#### 2.1 Objective of Study

*DEA – 63, Floating Vessel Blowout Control* is a blowout containment study which was completed in 1990.<sup>23</sup> Since then, a lot of development has occurred in the ultra-deepwater exploration arena, and the containment study did not include discussions about operations in the water depths we currently operate in.<sup>24</sup>

Based on this, the U.S. Department of Interior - Minerals Management Service (MMS), Offshore Technology Research Center (OTRC), Global Petroleum Research Institute (GPRI), and Research Partnership to Secure Energy for America (REPSA) have funded a project in cooperation with Texas A&M University to investigate areas that were not covered in detail by *DEA – 63*, with a focus on applications in ultra-deepwater. Work has been done in investigating bridging tendencies in ultra-deepwater blowouts and a Java-based dynamic kill simulator has been developed<sup>8</sup>, and verified<sup>16</sup>. Currently, an industry representative is working on mechanical intervention of blowing wells in ultra-deepwater.

As an addition to the above-mentioned project, my part of the project was to develop an electronic cross-reference tool for well control issues. Obviously, there is a vast amount of information on well control procedures, case histories, and recommended practices already published. The approach of this manual is different in that it is fully electronic, hence able to serve the needs of the engineer/driller with greater ease in both pre-planning and in an on-the-job setting.

It is a user-friendly tool, where you can easily find the specific subject of interest, and by the click of a button, get the related information you are seeking. For instance, if certain symptoms are noticed in a well, you would locate the symptoms in the menu of the cross-reference, and by clicking the appropriate topic of interest; possible causes and consequences for these symptoms would be discussed. Furthermore, potential solutions to and references to information about these problems would be suggested.

The tool is useful in contingency planning, but maybe even more so; in a stressful emergency response operation, where you don't have time to dig through books or notes to get the quick confirmation that you need.

## **2.2 Expected Contributions of Study**

I have completed an electronic reference for well control issues. The cross-reference is expected to serve as a manual for the state of the art in well control and blowout containment equipment and methodology. It provides an easy-to-use organization of the topics by categories and subcategories, and aims to provide clear links between symptoms, causes, and solutions. The information of the well control manual is presented in this thesis, albeit without the electronic links between menus, submenus, and topics.

Although blowout containment can be very complicated, the electronic cross-reference aims to give clear explanations to these complicated issues. Additionally, it hopes to provide a confirmation of applicable blowout intervention procedures, be it conventional or unconventional.

This tool could also be used in an educational environment and for training purposes. It can be used as an electronic reference saved as a file, or accessed through the internet from anywhere in the world. In being easily accessible, it would help inform and educate the industry about well control issues in a cheap and logical way. Another important point is that this tool is easy to update. This is important in the sense that many companies have emergency response plans and catalogs of their own. These plans could be easily incorporated into these, and hence be customized in any way desirable.

## **2.3 Structure and Organization**

When creating the electronic well control manual, it was important to structure and organize it in a logical fashion. By achieving this, the user will be better able to find the information sought after, as well as linking the different topics together in a clear, easy-to-follow way.

### **2.3.1 Organization of Information**

By starting the manual with an overview of the topic, and giving a motivation for the study, the user can get a better idea of why the manual is useful. This is important in understanding the context and consequences of utilizing the information contained in the manual in a correct manner. A description of the potential consequence of suffering a blowout helps illustrate the seriousness of the topic, and by discussing the different types of blowouts, the foundation for the rest of the manual is laid. By further discussing the

statistics behind the occurrence of well control and blowout events, the user gets a better idea of the probabilities of occurrence, and what activities are more likely to cause well control events.

With the ballast of the background and statistical information, it is natural to move on to the different methods of controlling a well. In order to discuss well control methods, it is paramount to know what causes a kick. Hence, a discussion of the different kick causes in various phases of the well, the user gets a better understanding of what the underlying reasons for well control events are. Kick detection naturally follows, as early detection of kicks is essential in applying the correct well control methods appropriately. In order to be able to apply the proper actions in a well control event, it is important to have some working knowledge of the various well control equipment used. The well control equipment allows for the different kick containment methods to be applied, thus lending a smooth transition into the different shut-in and circulation methods.

All is well if the well is killed and the kick fluids circulated out of the hole properly. However, well control complications might arise, and these complications might call for alternative well control methods. Certain complications go hand in hand with certain non-conventional methods, and this link is emphasized in the discussion. Also, specific environments pose specific challenges with regard to keeping control of the well. By transitioning from well control complications to some of the different challenges, the manual aims to shed light on particular hazards to be aware of.

If the well control complications and challenges cannot be handled effectively, the situation might escalate into a blowout. The manual aims to show the clear progression of severity, from kick causes, detection, and containment, to complications, remedies, and the consequences of failure. When a situation has escalated into an uncontrolled kick, blowout containment is the next step. Depending on the environment in which the blowout occurs, combined with the severity of it, different methods can be applied. The

manual highlights these intervention methods, and provides links to the situations during which they are most appropriate.

The manual provides an additional focus on ultradeep water drilling and well control. The coverage is structured in a similar way as the rest of the manual, with discussions on the specialized equipment that is used, and how the ultradeep water environment affects well control and blowout control methods. Some of the particular challenges and complications that occur in ultradeep water are covered, and through this discussion, the user gets a better understanding of the links between the causes and effects of operating in this setting. As ultradeep water is an area within our industry that encompasses a lot of technical advancement, some of the new ultradeep water drilling technologies are also discussed in the manual. This highlights the fact that the petroleum industry is a very dynamic industry, and the need for continued revision and improvement in well control procedures is necessary.

### **2.3.2 Navigational Structure**

The content described above is interconnected in several ways. The first part of the electronic well control manual the user will meet, is the main menu. Similar to a table of contents, the information discussed will be organized through the use of descriptive topics and sub-topics. By the topic of interest located in the main menu, the manual will direct the user to the section that contains the information sought. Invariably, there will be other topics that relate to the discussion, and these are further linked through the use of hyperlinks. Thus, the user may navigate through the manual by pointing and clicking on the specific topics of interest. The user may also choose to follow the manual chronologically, and the cross-reference was intentionally structured in such a way that the user would be able to read it from beginning to end, or skip around from topic to topic.

If the user desires to further investigate a specific topic in greater depth, the manual provides careful referencing of sources. Again, by pointing and clicking on the superscripted source reference, the user will be brought to Reference section, where the reference of interest is described. Further, the user may click on this listing, and will be directed to an available abstract of the source. This enables to user to evaluate whether or not the detailed discussion of the source is relevant to the additional information sought after.

The electronic well control cross-reference was created in Microsoft Word. This choice was based on the fact that this software is easily available, compatible, and perfectly suited for text and information formatting. Through the extensive use of its hyperlink function, the information contained in the manual is interlinked to a high degree, and the navigation made very intuitive. This software is well suited for the initial version of the manual, yet still compatible for export into other help system software. The use of Microsoft Word has some consequences that are not desirable, however. The electronic file size tends to grow very large, as the manual includes descriptive figures and tables. The fact that Word is the industry standard for word processing, results in the users of the electronic manual having a good knowledge of its capabilities. This is an advantage, but the drawback is that this knowledge might lead to an impression of the cross-reference being rudimentary.

#### **2.4 Potential Future Content**

The topic of well control and blowout containment is a very large one, and the time and resource constraint of one graduate student's work is a limiting factor to the scope of the electronic well control manual. Hence, the design of the manual is intentionally made to be able to embrace additions and revisions very easily.

Some content that would be beneficial to add at a later date would include calculations,

external links, and lists of service providers. As the manual currently does not have a heavy technical focus, future sections on well control calculations could potentially be added. This would draw a fuller picture of the complexity of a well control event, and also help the user in obtaining technical results very quickly. The organization of such an addition could either be done by merging the technical sections with the discussion of the related topic, or by adding a separate chapter.

As the electronic well control manual is a part of a larger project, it might be natural to link it to some of the other work that has been accomplished. Specifically, a direct link to the bridging and dynamic kill simulators would provide the user with well control and blowout tools as a part of the total package. By providing the user with a suite of well control and blowout tools, the project as a whole will benefit more than what it would do in fractions. Additional links to resources on the internet could be incorporated easily into the well control cross-reference. Again, the user would be provided with a vast amount of knowledge consolidated and made available through one suite of well control tools.

Similar to the list provided in *DEA – 63, Floating Vessel Blowout Control*, a catalog of well control and blowout containment resources and contact information could be provided. By providing information on service companies with areas of expertise ranging from insurance and contingency planning, to equipment, firefighting, and relief well drilling, the electronic manual would not only provide information on what services the different companies perform, but also present the user with contact information for quick decision making.

Continuous revision of the manual is necessary, and a system for keeping it updated should be put in place. This could be accomplished in many ways. One such way would be to invite the industry to take direct ownership of it, or through the form of funding to educational institutions. One innovative and interactive way to expand and update the

manual is to set up an oversight committee that would invite certain industry experts to update and add to the manual through password protected direct access via the internet. Regardless of the method selected to maintain the electronic well control cross-reference, it is in need of regular revision.



## CHAPTER III

### WELL CONTROL METHODS

Having discussed some of the consequences of experiencing blowouts, it seems evident that focus should be on not losing control of the well in the first place. This is what the topic of well control is all about, and the severe consequences are what make it so important to the industry as a whole. If the causes of well control events can be understood, then more can be done to prevent these from happening. If, however, an influx of formation fluids do occur, quick detection of this influx is essential in order to make the appropriate corrective actions to handle the kick in a manner that is as safe as possible to the crew, equipment, and well.

In order to be successful at controlling a well, careful planning needs to be at the heart of every well that is drilled. This planning needs to include the equipment that is necessary to deal with a potential well control situation. Many times, operators become complacent when drilling in familiar environments and short cuts on the equipment side of the operation are taken. Through careful planning, this should be prevented, and complacency should not be allowed to occur.

There are many ways of dealing with a kick, but there are a couple of methods that are preferable, if possible: The Driller's Method and the Weight and Wait Method. These are ways of circulating the formation fluid influx out of the well in a safe manner. Kicks do occur, and they need to be planned for.

### **3.1 Kicks**

As described before, kicks are an unwanted influx of formation fluids into the well. Generally this happens when the pressures in the well are lower than that of the pressure encountered in the kicking formation. Also, the fluids in the formation have to be of low enough viscosity, so that they are able to flow. In order for these fluids to flow, the formation has to have a permeability significant enough to allow a flow path into the wellbore.

#### **3.1.1 Kick Causes**

As discussed, kicks occur in many different types of well phases and operations. Most well control procedures are designed with the drilling operation in mind, however, and a lot of the training focus only on this side of the operation. A lack of well control training when it comes to tripping operations is one of the causes of the confusion that often occurs when dealing with these events.<sup>13</sup>

According to the statistics presented earlier, kicks happen most frequently during tripping operations. As pulling pipe out the hole can be a tedious activity, operators sometimes tend to save time by increasing the running speed of the pipe. If proper care and respect is not applied in any operation, including tripping, things can go differently than planned.

#### ***Hole Not Kept Full of Mud***

When tripping pipe, the pumps are shut down. At this moment, the frictional pressure that is experienced in the well is removed, and the Equivalent Circulating Density (ECD), which is the sum of the frictional pressures in the annulus and the hydrostatic

pressure of the mud, decreases<sup>3</sup>. This reduces the total pressure “felt” at the bottom of the well, and might be enough to invite an influx into the well. Commonly, the hydrostatic pressure exerted by the static column of mud is sufficient to prevent a kick from occurring.

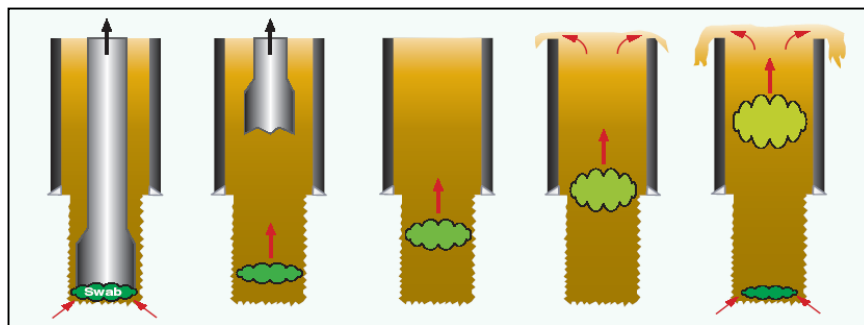
Also, tripping of the drillpipe involves removing a certain volume of steel from the wellbore at a specific rate. In order to prevent the mud volume in the hole from dropping, it is necessary to keep the hole filled up with the appropriate weight mud. If the hole is not kept full, hydrostatic pressure is lost, and the pressure could fall below that of the formation; inducing a kick.<sup>25</sup> According to Watson et al., “failing to keep a hole full of mud during a trip has caused more kicks and blowouts than any other single occurrence.”<sup>3</sup> Most commonly, the hole is kept full using either the rig pumps, or a trip tank. The rig pumps are used by stopping the tripping at certain intervals, and filling up the hole. It is important to measure how much mud the hole accepts, as it is supposed to accept the same amount as the volume of pipe coming out. The pump’s stroke counter is a way of figuring out this volume, since each stroke represents a certain volume. By using a trip tank, the volume is kept under closer scrutiny, as the trip tank is a tank with a small volume so that is calibrated for the correct volume of the fill.<sup>25</sup> The use of these types of tanks are the preferred method of filling up the hole. They offer a more accurate measure of the mud volume compared to the rig pumps. Also, using the one of the active pits would not be very practical, as the volume of these pits is too large to provide the necessary accuracy.<sup>4</sup> The trip tanks can either be gravity fed, or fed through a centrifugal pump.<sup>4,25</sup> Either configuration helps keep the hole full.

If continuous fill-up is not applied, it is common to have a fill-up schedule for the frequency of hole-filling. These would be policies of the operator, and might differ. Generally, the industry would fill up the pipe every five stands for drillpipe, every two to three stands for heavyweight drillpipe, and every stand for drill collars.<sup>25,26</sup>

### *Swabbing*

Swabbing is the effect that occurs when pipe is tripped out of the hole too fast. The pipe acts as a piston, and when pulled too fast, it will cause a suction effect that leaves a void to be filled by the mud falling down into the well. When the pipe is pulled too quickly, this void space is not filled fast enough, and a reduction in the bottomhole pressure occurs. This might invite formation fluids into the wellbore, which again will lighten the fluid column in the well even more, due to its lower density, and might further stimulate a continued flow of fluids into the well.<sup>25</sup> An example of this is shown in **Fig. 3.1**.

As shown in **Tables 1.1, 1.4**, tripping and swabbing are major causes of blowouts, and points to the fact that “insufficient attention is given to trip margin, keeping the well full and controlling speed of pipe movement.”<sup>20</sup> Again, complacency cannot be tolerated. Swabbing can pose different challenges, depending on the environment in which the well is being drilled. Regardless, special care should be taken when the pipe is starting its trip out of the hole.<sup>27</sup> Also, as the bottomhole assembly (BHA) approaches the casing shoe, high pressures are experienced, and these intervals need to be executed cautiously, even if calculations estimate the swab pressures to be acceptable. Plugged nozzles in a bit could cause swab pressures that are substantially higher than that calculated, and possibly swab in a kick.<sup>28</sup>



**Fig. 3.1 – Swabbing in a kick.**<sup>29</sup>

### ***Lost Circulation***

Lost circulation refers to the situation where the amount of fluid going into the hole does not equal the amount coming out. When the well is only giving partial returns, or when there is complete loss of circulation, the fluid is lost down-hole. Normally this is caused by a hydrostatic pressure that is higher than the fracture pressure of a formation in the open-hole section of the well. When this fracture pressure is exceeded, the fluid in the well might flow into the created fracture, hence preventing returns to the surface. If a significant amount of fluid is lost, the mud level in the well will drop, and if it is not filled properly, this might cause a drop in hydrostatic pressure to a point that is lower than the formation pressure of another formation. This, of course, is a perfect opportunity for this second formation to kick and cause further well-control problems.<sup>3,</sup>

<sup>25</sup> Lost circulation is not always caused by excessive mud-weights. The ECD of a well can be too high because of a very high frictional pressure. If this annular friction loss is sufficiently high, the formation might experience a bottomhole pressure that exceeds the fracture threshold.

Swabbing has its counterpart in surge pressure effects. Surge pressures are encountered when pipe is run into the hole, and if these running speeds are too high, the additional pressure surge ahead of the traveling pipe might cause lost circulation problems as well. Hence, it is not only important to monitor the running speeds of tripping out of the hole, but care should be given to tripping pipe into the hole as well.

When drilling in a field that has been producing for an extended period of time, it is common to have to drill through depleted formations. These are formations that have been produced through other wells in the past, thus having lower formation pressures than what they had in their virgin state. If not carefully planned for, these depleted formations can surprise you, and take fluid from the well being drilled. Again, the consequences might be a loss of fluid level in the wellbore, and a potential kick from

another formation. Naturally fractured or vugular formations might also take fluid, and cause well control problems if not handled correctly.<sup>3</sup>

### ***Mud Density too Low***

One of the most evident ways of inviting a kick into the wellbore would be to operate with a mud of insufficient density. If the drilling mud or completion fluid has a density that is too low, it doesn't matter if the well is kept full. The hydrostatic pressure that this fluid column represents is not sufficient to overbalance the formation pressure, hence increasing the risk of taking a kick. There are a few reasons to why the density might be too low.

A drilling mud has many different types of additives, and it is mixed continuously. If it were to be diluted too much, the amount of solids in the mud will be less than planned, hence reducing the density of the fluid system. Another type of dilution, not due to human error, is if there is heavy rainfall into the mud pits. This would have the same effect, and lessen the mud weight. With the use of mud tanks, this problem is in many instances avoided.

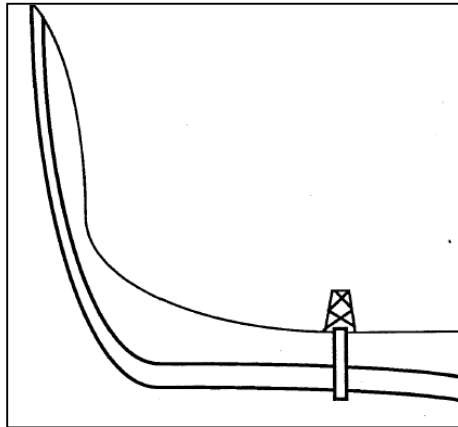
A common material used to weight-up the mud is Barite. This additive increases the density of the fluid due to it having a higher specific gravity than the rest of the fluid system. This can also cause it to settle at the bottom of the mud pits, if the mud is not kept properly mixed<sup>25</sup>. When the Barite settles in the pits, the rest of the mud that is circulated downhole has a lower density than calculated.

### *Abnormal Pressure*

Abnormal pressures are considered “pressures that are higher than normal for an area.”<sup>3</sup> Although a pressure lower than normal could also be considered abnormal, industry tends to label these as subnormal, leaving abnormal as the description of overpressure. There are many reasons for these geopressures, some of which will be described next. The main criterion that needs to be present for abnormal pressure to occur is a sealing mechanism for the pressure. These include dense caprocks, salt domes, massive shale sections, and sealing faults.<sup>3</sup> One example of overpressure is the compaction of rocks with trapped fluids. As these formations keep getting pushed down by new layers, the overburden pressure of the above sediment layers will push down on the formations and fluids below. If the fluids have nowhere to go, they will help the rock matrix carry the load of the overburden, hence experiencing a pressure higher than just the normal hydrostatic pressure. A similar process can occur for shales through a chemical alteration of clays and water under high temperatures and pressures (diagenesis).<sup>25</sup>

Another category could be generalized as trapped pressure at lower depths being brought up higher than naturally. Specifically, a formation that is intersected by a sealing fault, and pushed higher up through thrust faulting would serve as an example of this. The same goes for formations that are uplifted in any way, including salt diaper intrusion and anticlines.

When fluids migrate into shallower zones, they can cause abnormal pressures. As Schubert points out, this can happen naturally like in gas migration up a fault, or artificially through for example if “a poor cement job did not effect zonal isolation, or in the case of an underground blowout.”<sup>25</sup> Another fluid pressure that might cause overpressure is an aquifer that outcrops at a higher elevation than the rest of the formation; known as an Artesian source. **Fig. 3.2** shows an example of this.



**Fig. 3.2 – An aquifer outcropping at a higher elevation causes abnormal pressure.<sup>25</sup>**

### ***Mud Cut***

When drilling with water based muds (WBMs), the indication of a kick is fairly clear, as WBMs tend to act as an incompressible fluid. Also, the solubility of natural gas in this type of mud is often negligible, leading to a pit gain of approximately the same size as the formation fluid influx. When it comes to oil based mud (OBM) systems, they have different characteristics than the WBMs. Because of the differing chemistry, natural gas tends to go into solution with the OBM. If sand formations containing gas are drilled through at rates of penetration (ROP) that is too high, this gas will follow the cuttings into the mud system and go into solution.<sup>25</sup> This leads to pit gains that are smaller than the actual size of the kick. Hence, kick detection is more subtle for gas kicks in OBMs, and might cause well control problems because of this. If a gas kick goes undetected in an OBM system, the fluid column will lighten, and might invite more formation fluids into the well, making the situation even worse. Also, carbon dioxide and hydrogen sulfide are two other gases that are “extremely soluble in oil”<sup>13</sup>, and they are soluble in WBM systems as well.<sup>3</sup> As these gases are oftentimes encountered in drilling operations, they might cause similar hazards. This situation is referred to as gas cut mud, since then



mud carries the gas in solution with it, and the mud weight is cut as a result of this. According to Grace, gas cut mud “has always been considered a warning signal, but not necessarily a serious problem.”<sup>13</sup> Although gas cut mud only causes a mild reduction in the bottomhole pressure, special attention and awareness is necessary in order to avoid the problem to escalate out of hand. Special care needs to be given at shallow depths “Where a slight reduction in bottomhole pressure can result in a large decrease in equivalent density.”<sup>25</sup>

Drilling mud may also be cut by oil or water, and incompressible fluids like these “can cause more severe reductions in total hydrostatic and has caused serious well control problems, when a productive oil or gas zone is present.”<sup>13</sup>

### ***Post-Drilling Problems***

Although earlier discussion has shown that most kicks occur in drilling and tripping operations, we have also seen that kick do occur in the completion and workover phases of a well also. Waiting on cement (WOC) was discussed as the most common operation during which kicks occurred, and will be the focus of this section. Specifically, annular flow after a primary cement job is a “fairly common occurrence.”<sup>25</sup> After the spacer is pumped to clean out the well, cement is pumped to set the casing in place. When this cement starts to set, the weight of the fluid above the top of cement (TOC) starts to get supported by the hardening cement. As this happens, the lower formations are isolated from the hydrostatic pressure from the spacer fluid and mud, and formation fluid might start flowing into the well, As the cement is still in the process of hardening, some of this formation fluid might find its way up the setting cement, and cause a well control situation.<sup>10,25</sup> When planning for a cement job, it is important to carefully calculate the correct density of the spacer fluid, as a reduction of total hydrostatic is not desirable. Experience in the different operational areas is an important factor in determining the

correct practices, and service company simulations might help designing the correct cement job for each location.<sup>3</sup>

In addition to human failure, we have shown that equipment failure is the second reason for well control situations. For cement jobs, the float equipment might fail. As this opens up a channel for the cement to u-tube back into the casing, it will lower the fluid level in the annulus.<sup>25</sup> With a drop in the fluid level comes a drop in hydrostatic pressure, hence leading to a potential kick.

### **3.1.2 Kick Detection**

With the awareness of some of the causes of kicks, the next step is to recognize the warning signs of a kick. Time is a very important factor in any well control event, and early kick detection is crucial to handling a kick properly. Methods for calculating gas rise velocities have been developed and used in the industry for quite a while. Johnson and White showed that these gas rise velocities are in fact higher than previously anticipated.<sup>30</sup> The gas not only rises faster in the mud than previously expected, it will also most likely flow at a higher rate than previously believed. These conclusions further emphasize the need for early kick detection.

If symptoms are ignored or detected too late, a situation that originally could have been solved with a routine kick circulation might escalate into an uncontrollable blowout.

### ***Drilling Break***

When drilling along, the drilling bit penetrates the formations at different ROPs. A good knowledge of the geologic layers is an advantage, as different zones have different compositions, which lead to a different drilling rate. These changes in lithology are not

indicators of a kick, per se. However, a shale section can oftentimes be drilled underbalanced<sup>25</sup>, due to its compactness and lack of permeability. Tricone bits, or rock bits as they are also called, drill faster in sands than in shales.<sup>25</sup> As the bit leaves a shale zone and hits a sand layer, the permeability and porosity increases, and if the pressure is sufficient, this might cause the formation to kick.

Polycrystalline Diamond Compact (PDC) bits are designed different than rock bits, and instead of crushing the rock, the fixed cutters of a PDC bit tends to penetrate the formation with a scraping action. This leads to a different interplay between the rock and the bit, and PDC bits tend to drill faster in shale than sand.<sup>25</sup> Thus, when drilling with a PDC bit, a sudden decrease in ROP might indicate a kick.

Drilling breaks are not considered to be a primary kick detection method, but when one occurs, the driller knows to be extra alert to other indicators.<sup>3</sup>

### ***Increase in Flow Rate and Pit Gain***

When the pumps are running, the drilling mud going into the well normally comes out of the well at the same rate. When a formation kicks, the formation fluid might be displacing the mud from the annulus, and this mud return will be at a higher rate than before.<sup>25</sup> This is one of the primary kick indicators, and should be taken very seriously.<sup>3</sup> If the flow rate into the well is significant, the added volume of formation fluid will eventually lead to a volume gain in the pits. This is another indicator of high significance<sup>3</sup> that should never be ignored.<sup>13</sup> There are other actions that might cause a pit gain, such as addition of water or barite. However, the driller should always be notified of any operation that would cause an increase of the pit volume. Otherwise, any pit gain should be treated as a kick.<sup>25</sup>

Flow rate increases and pit gains are normally detected using flow indicators or pit-volume indicators. These are located on the mud return line and in the pits. The pit-volume indicators are generally of a float-type connected to a sensor system that could set off high and low alarms.<sup>3,4</sup> This system is called the pit volume totalizer (PVT) system, and is at the core of this important kick detection method. **Fig. 3.3** shows a float type pit level sensor. There are different types of flow rate indicators, but paddle-type meters are a common type installed in the flowline.

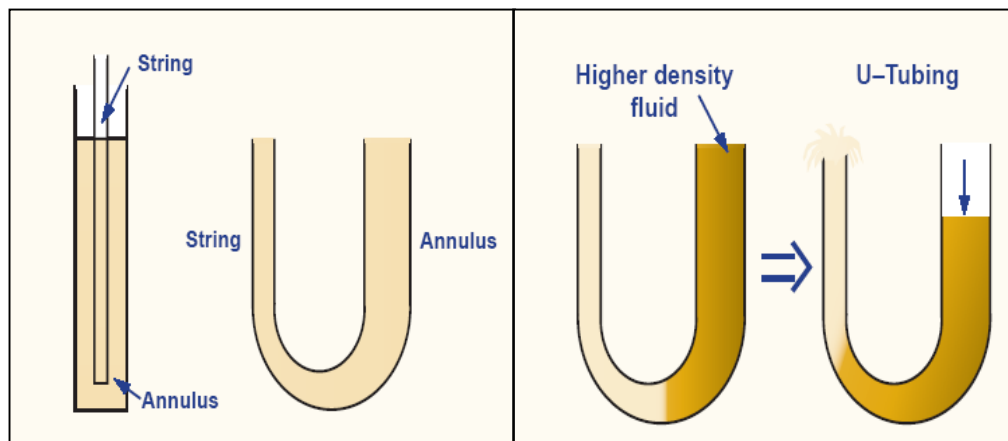


**Fig. 3.3 – Float type pit level sensor.**<sup>29</sup>

### ***Pump Speed Increase and Circulating Pressure Decrease***

When taking a kick, the formation fluid is most often lighter than the drilling mud in the hole. This, of course, will lighten the fluid column, hence reducing the hydrostatic pressure in the annulus. Since the mud column is lighter in the annulus than the column

inside the drillpipe, there is a pressure differential. The laws of nature will try to even out this pressure difference by allowing fluids to flow from the drillpipe to the annulus. This will equalize the pressure at the bottom of the well. This flow of fluids from the drillpipe to the annulus (or vice versa) is called the U-tube effect, and an example of this is pictured in **Fig. 3.4**. When this U-tubing occurs, the workload on the pumps is reduced, and an increase in the pump speed and decrease in the circulation pressure follow.<sup>13, 25</sup> This is not a very strong indication of a kick, as it is similar to the signs of a washout. Still, it serves as a warning to look for other kick indications.<sup>25</sup>



**Fig. 3.4 – U-tube analogy and U-tube effect.<sup>29</sup>**

### *Change in Drillstring Weight*

The loss of hydrostatic pressure may also lead to a loss in buoyancy. As lighter fluids enter the wellbore, the steel drillpipe will experience less buoyancy, and appear heavier at the weight indicator. A higher hook load is experienced. This is not a very good indicator by itself, as it is experienced after a large kick has entered the well.<sup>3, 14</sup>

If the influx from the formation is large, and the zone kicking has a high productivity, the kick might actually provide a lifting energy that will tend to push the pipe upward, and make the drillpipe appear lighter on the rig's weight indicator.<sup>3, 13</sup> Again, the use of the rig weight indicator as a kick detection method is mostly useful in affirming the kick along with other kick indicators detected earlier.<sup>13</sup>

### ***Mud Cut and Salinity Change***

Gas, oil, or water-cut mud was discussed earlier as one of the causes for a kick. It can also serve as a detection method. If a mud that is cut by potential formation fluids is observed in the mud return, it should serve as a warning sign. This commonly occurs in conjunction with some of the other symptoms discussed above, and is not regarded as a good indicator of a kick.<sup>3, 13</sup> As a matter of fact, Watson et al. consider this to be a method more suited for monitoring pore pressure and renders it “useless for proper kick detection.”<sup>3</sup>

### ***Flow With the Pumps Off***

When any of the kick indicators are noticed, they need to be verified in some way. The best way to verify a kick is to stop rotating and circulating, and picking the pipe off bottom to connection height. With the pumps off, watch for flow from the annulus. If the well keeps flowing after the pumps are shut off and the flow persists at a constant rate, it is likely that you are experiencing a kick. In this case, the well should be shut in.<sup>29</sup>

It is possible for the well to flow during a flowcheck, and not be kicking. One reason could be that the well is U-tubing due to unbalanced bottomhole conditions. Another one is a so-called “ballooning” effect, where the formation has taken fluid through small fractures or through expansion of the formation, and flows these fluids back after the

loss of frictional pressures due to the pumps being shut off. Flow from a ballooning formation will decrease after a while.<sup>25</sup> Regional experience and geological knowledge will help determine if the formation is giving back mud or not.

A flowing well should always be assumed to be a kick, and the well should be shut in. With the well shut, the next course of action is decided, and hopefully the kick was detected early enough to circulate out of the well in a safe and controlled manner.

### ***MWD and Sonic Kick Detection***

MWD stands for Measurement While Drilling, and it is a technology that uses mud-pulse telemetry to transmit downhole measurements to the surface. Specifically, the measurements made by the tool are transformed to binary code, and transmitted through pressure pulses sent in the drilling mud in the hole. The signals are received at the surface, and converted to meaningful data by computers. Sonic logs can be run on MWD tools, and these logs use recorded travel times in different fluids to identify free gas in the well.<sup>25</sup> If free gas is recorded, it might stem from a kick. The major advantage with MWD tools is that the information is received at the surface in real-time. With many of the other kick indicators discussed above, signals are not portrayed at the surface until the kick is well up the hole. With MWD, the indications occur when the kick occurs.

Other sonic detection methods have been developed lately. Much like the MWD approach, measurements are made on the travel time of sound in the different fluids. Some techniques use the fact that gas also lessens the amplitude and signal strength of the sound wave.<sup>3</sup> Some methods use signals from the standpipe, while other use annulus signals. All these different methods seek to improve on the traditional kick detection methods, and many of these are able to detect even very small kicks at a very early stage.

## **3.2 Basic Well Control Equipment**

One can know everything possible about the causes and detection of kicks, but if one does not have the appropriate equipment to handle these kicks, the knowledge is close to being useless. The blowout prevention equipment (BOPE) of a well consist of the circulation system, as well as the control system.<sup>3</sup> Successful well control operations are dependent on both high-pressure equipment and low-pressure equipment in order to handle kicks properly.

### **3.2.1 High-Pressure Equipment**

It is not possible to control a well without equipment that can handle the potentially high pressures experienced in a well control situation. The BOPE is designed for different pressure ratings, and appropriate well planning include planning for worst case scenarios that insure the proper equipment for the operation.

#### ***Casing, Well Heads and Spools***

Interestingly, casing is not commonly a topic included in well control equipment discussions. Watson et al. bring up the last casing string set in the well as the most important piece of well control equipment.<sup>3</sup> This is very logical, as a casing rupture would render all the other BOPE obsolete. The casing design of a well needs to be based on worst case scenarios for burst and collapse. A proper casing design should ensure the correct pressure rated casing for the well, leading to the kick being guided through the correct channels for a kill procedure. Like other BOPE, the casing should be tested for wear and pressure.

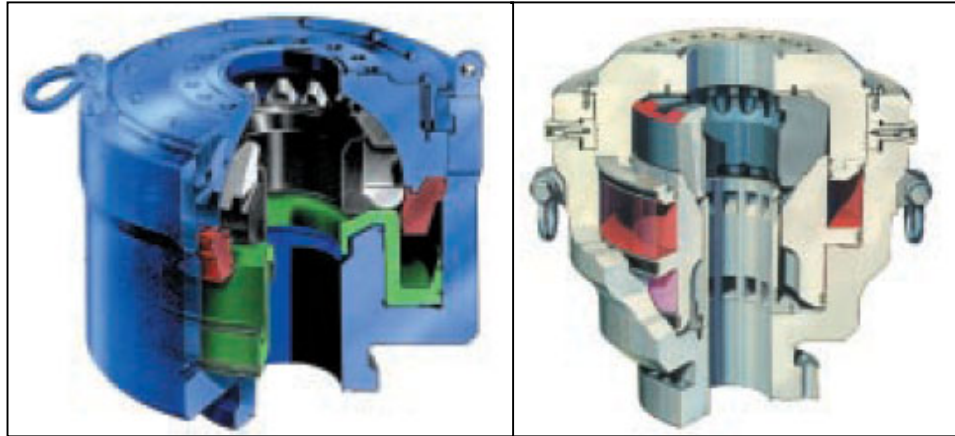


In order for BOPE to be attached to a well, there needs to be a wellhead on the casing. The wellhead serves as the supportive structure on which to attach the “BOP stack, tubing head and Christmas tree.”<sup>29</sup> It is the foundation for the surface equipment and thus needs to be sturdy enough to support this and still hold pressures to their working pressure rating. When strings are hung after having attached the wellhead to the surface casing, additional casing spools are added to support these. The spools serve as a way of sealing the different strings from each other, and are often used to add flexibility with regard to circulation through choke or kill lines, or for added spacing for stripping operations.<sup>29</sup> The spools need to be able to resist similar pressure to those of the BOPs.

### *Annular Preventers*

At the top of the BOP stack we normally find an annular type blowout preventer. Annular preventers are often shut-in first, due to their “versatility and position in the stack.”<sup>3</sup> As with the other components in a BOP stack, annular preventers are designed to seal off the well to the surroundings. Specifically, it is designed to seal the annular space of the well, and in certain cases, the open hole.

Annulars come in different varieties, but are generally designed to seal off the well through the use of a “circular rubber packer element, a piston, a body and a head (cap).”<sup>29</sup> The packer is closed by the hydraulic force applied by fluid to the closing chamber, provided by the pressure from the accumulator system. The use of this flexible rubber packer allows the annular preventer to seal against many different shapes and sizes of tools in the well, thus leading it to be very versatile compared to the other BOP stack components. The annular is unique in another sense, in that it is possible to move or strip the pipe in and out of the hole while closed. Examples of annular preventers are shown in **Fig. 3.5**.



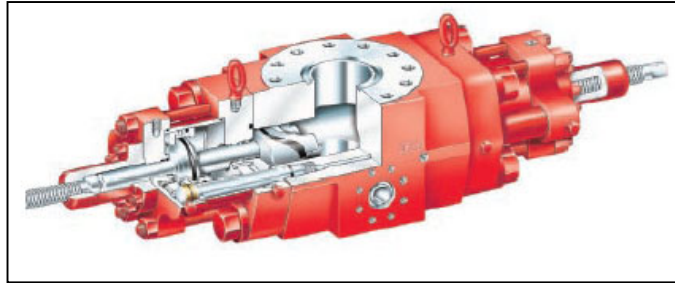
**Fig. 3.5 – Two types of annular preventers.<sup>29</sup>**

### ***Ram Preventers***

In a normal stack configuration, you will find ram preventers below the annular. This type of BOP does not have the versatility of the annular, but is specifically designed to close around, over, or through the pipe in the hole. There are different kinds of ram preventers.

*Pipe rams* are designed to close around the pipe in the hole, thus sealing off the annulus, to serve as a back-up for the annular.<sup>3</sup> They work on a similar principle, where a closing chamber is pumped full of hydraulic fluid, forcing a set of opposing rams to be forced toward the pipe to seal around it. Similarly, they are opened with hydraulic fluid being pumped to the opening chamber, which brings the pistons and rams out to the retracted position. **Fig. 3.6** illustrates one model of pipe rams. Another version of the pipe ram is the *variable bore ram*, which has the ability to close on different size pipes. These are particularly useful when a tapered string is in the hole.

Another type of ram preventer is the *blind ram*. Working in the same way, they differ in that the sealing element aims to seal on an open hole. The opposing rams are flat, and seal against each other with the pressure of the hydraulic fluid. Another ram that can close on an open hole is the *blind/shear ram*. This ram works like the blind ram when there is no pipe in the hole, but has cutting ability to shear off the pipe and seal the cut if necessary. This type of ram is mandatory for subsea BOP stacks.<sup>3</sup> *Shear rams* only have the shear capacity, and are not as versatile as the blind/shear ram.



**Fig. 3.6 – Example of pipe ram preventer.<sup>29</sup>**

The components of a BOP stack can be organized in many different ways. These often depend on company policy and preference, and the different configurations have advantages and disadvantages. Depending on the pressure rating needed for the BOPE, components are added or omitted. One example of a BOP stack is show in **Fig. 3.7**, which represents the company policy of Saudi Aramco for operation in the Kingdom of Saudi Arabia.<sup>26</sup>

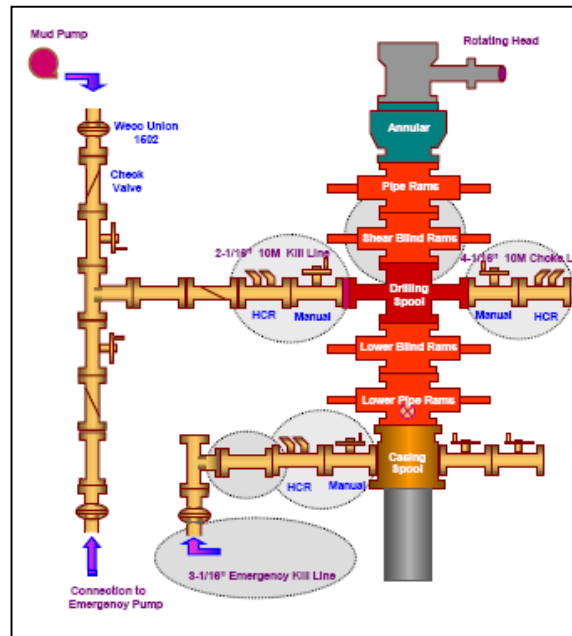


Fig. 3.7 – Example of BOP stack configuration from Saudi Aramco.<sup>26</sup>

### *Kill and Chokeline Equipment*

When dealing with a well control event, the chokeline acts as the conduit for circulating out the kick while remaining in control of the backpressure kept on the well. This line will bring the fluids safely to the surface, and direct them away from the rig and personnel through the choke manifold. Similarly, the kill line is used to pump fluids into the well in a kick situation, if normal kick handling methods are not possible. Both lines serve as a entry and exit points for the fluid in well control events, and both lines need to be rated to the same pressures as the BOP stack.<sup>3</sup> Other high-pressure components like valves and chokes also have to be of sufficient pressure rating, and should be able to withstand the erosional wear of the high velocity fluids. These are used to direct the fluid flow, and control the velocity at which it flows.

### **2.2.2 Low-Pressure Equipment**

As described above, most of the equipment in the well control system needs to be of a high pressure rating. However, not all of the equipment in the well control system operates under high pressure.

#### ***Manifold Lines***

After the fluids have been circulated to the surface through the choke line, and directed through the choke manifold, the pressure has been reduced to an amount that doesn't require high pressure ratings. The flow lines of the manifold still need to be of sufficient wall thickness and material to deal with the potentially high velocities stemming from expanding gas, however.<sup>3</sup> As with any fluids moving at high velocities, sharp bends should be avoided on the flowlines.<sup>4</sup>

#### ***Mud/Gas Separators***

As the name implies, the mud/gas separator is a device to separate the gas from the mud system as it arrives at the surface. Also called gas busters or poor boy degassers, they serve as a way of dealing with the free gas associated with a kick, and direct it out of the system, or to get flared.<sup>29</sup> This separation is done with the simple help of gravity.

#### ***Degassers***

Not all the gas is separated from the mud in a mud/gas separator, and the mud might need further treatment before being suitable for circulation down the hole again. By the use of vacuum, more of the gas is knocked out of solution, and hazards around the pits

are reduced due to the reduction of gas content.<sup>3</sup> There are degassers that work at atmospheric conditions as well, and these use centrifugal force to separate the gas gravitationally.<sup>29</sup>

### **3.3 Well Control Procedures and Techniques**

After the kick has been detected and verified, the rig crew needs react, and take the necessary steps to circulate the kick out of the well safely. The well will generally be shut-in to limit the influx of formation fluids, and then the kick will be circulated out of the well in a controlled manner. With proper knowledge, experience and training, the crew will perform these actions quickly and safely.

#### **3.3.1 Shut-in Procedures**

In order to limit the size of the kick, the blowout preventers are shut. This should be done as soon as the kick has been detected and verified. In drilling operations, there are two main procedures for shutting in a well. The major difference between the two is whether or not to close the BOPs on the well with the choke open or not.

A *hard shut-in* is a technique where the BOPs are closed on the well with the choke in the closed position, whereas a *soft shut-in* entails closing the BOPs with the choke open, and then shutting in the well by closing the choke. The main concern with these methods is formation damage and added time for influx entry.

When suddenly shutting off running water from a faucet one can sometimes experience the water pipes making noise due to the sudden pressure pulse sent through the water in it. This phenomenon is called water hammer. An analogy to this is believed to sometimes occur in the sudden shutting in of a well, where the sudden closure of a BOP

would cause pressure pulses to move down the wellbore and possibly cause formation damage. This has been a concern in the industry, and has led to some operators preferring the soft shut-in over a hard shut-in. The hard shut-in takes less time and is less complex than the soft shut-in, as it involves no opening and closing of the choke. This leads to the advantage of stopping the kick influx quicker, and reduces the risk of human error in the closing and opening of valves. Grace points out that advanced hydraulic controls has reduced complexity and time required to close valves, thus promoting soft shut-ins as the method of preference.<sup>13</sup>

On the other hand, other investigators have pointed out that the water hammer effect is smaller than previously assumed, and hold that the hard shut-in is advantageous due to the important fact that it limits the size of the influx to a minimum.<sup>31</sup> Theoretical and experimental tests show a lower “pressure pulse amplitude at the shoe and at the bit most probably due to dispersion effects in the well-bore.”<sup>31</sup> One company that previously used soft shut-ins consistently is Saudi Aramco. A recent evaluation of well control procedures has led to Saudi Aramco, along with other operators in the Persian Gulf, to adopt hard shut-ins as the preferred method of shutting in a well.<sup>26</sup>

Both methods of shutting in a well have advantages, and the decision on which to use is based on factors relating to past experience, geologic environment, and personal preference. However, the trend in the industry seems to be a greater appreciation of the benefits that a hard shut-in procedure brings with it. **Table 2.1** shows procedures for hard and soft shut-ins for land operations.

**Table 3.1 – Soft and hard shut-in procedures for surface stacks.<sup>25</sup>**

<u>Soft Shut-In</u>	<u>Hard Shut-In</u>
1. Pick up the kelly until the tool joint clears the floor.	1. Pick up the kelly until the tool joint clears the floor.
2. Shut down the pumps.	2. Shut down the pumps.
3. Check for flow.	3. Check for flow.
4. If flowing, open the hydraulically controlled remote valve (HCR, located on the side of the BOP stack).	4. If flowing, Close the BOPs.
5. Close the BOPs.	5. Open the HCR valve.
6. Close the Choke if open.	6. Close the Choke if open.
7. Notify the supervisor.	7. Notify the supervisor.
8. Read & record SIDPP, SICP, Pit gain, TVD, and time	8. Read & record SIDPP, SICP, Pit gain, TVD, and time
9. Prepare to implement kill procedures.	9. Prepare to implement kill procedures.

When possible, the annular preventer is the BOP to be closed first in a shut-in, due to its versatility in being able to close on anything in the hole. However, it depends on the closing speed of the annular compared to pipe rams. If closing the pipe rams is substantially quicker than closing the annular, this might be reason enough to close the pipe rams first.<sup>13</sup>

For floating offshore operations, the procedure will be different because of the different equipment that is in use. A floating drilling vessel has to compensate for the waves and currents of the sea, and commonly use subsea BOP stacks that are located on the ocean floor. These stacks are larger than the stacks used in land operations, which means that a tool joint will be located within the stack at any given time.<sup>25</sup> Knowing this, it is apparent that joint location must be monitored to prevent rams closing on it. One example of a shut-in procedure on a floater is presented in **Table 3.2**.



**Table 3.2 – Example of shut-in procedure for floating vessels.<sup>25</sup>**

1. Stop the rotary.
2. Pick up off bottom to remove kelly from the hole.
3. Space out to keep tool joint out of ram.
4. Stop pump.
5. Check for flow. If flowing;
6. Open fail safe valves on choke line.
7. Close the upper annular preventer.
8. Close the adjustable choke.
9. Notify supervisor.
10. Perform hang off procedure if needed (see below)
11. Read and record SIDPP, SICP, and pit gain.

This example shows a soft shut-in offshore, but more importantly, it illustrates that there is a difference between procedures of surface and subsea stack operations.

It is sometimes necessary to shut-in the well while not drilling. When taking a kick during tripping operations it is important not to try to beat the kick and get to the bottom to circulate it out. It is better to shut-in the well, and then decide the best way to get back to bottom to circulate the kick out.<sup>25</sup> **Table 3.3** shows a procedure for shutting in the well during a tripping operation which involves surface stacks.

**Table 3.3 – Example of shut-in while tripping.<sup>25</sup>**

1. Set the slips below the top tool joint.
2. Stab a full opening safety valve (e.g. TIW valve), and close it.
3. Open the HCR and close the BOPs, and choke.
4. Pick up and stab the kelly or a pump-in line.
5. Open the safety valve.
6. Notify supervisors.
7. Read and record SIDPP and SICP, Pit gain, TVD of well, TVD of bit, and time.
8. Prepare to implement kill procedures.

Again there is a difference procedure for shutting in while tripping on a floater. **Table 3.4** illustrates the differences.

**Table 3.4 – Shut-in while tripping on a floating vessel.**<sup>25</sup>

- |  |
|--|
| <ol style="list-style-type: none"> <li>1. Set slips below top tool joint.</li> <li>2. Install a fully opened, full opening safety valve, and close it.</li> <li>3. Open fail safe valves on chokeline.</li> <li>4. Close the upper annular preventer.</li> <li>5. Close the adjustable choke.</li> <li>6. Notify supervisor.</li> <li>7. Perform hang off procedure if needed.</li> <li>8. Pick up kelly or pump in line and make up on drillstring.</li> <li>9. Open safety valve.</li> <li>10. Pick up off slips.</li> <li>11. Read and record SIDPP, SICP, and pit gain.</li> </ol> |
|--|

If there is a “strong and calculated justification” to not shut a well in immediately, the well can be monitored and pipe run in the hole until not deemed safe any more.<sup>3</sup> As mentioned before, the rule of thumb is to shut the well in, and then decide the best course of action.

In offshore operations, we often encounter unconsolidated sands at shallow depths, and these shallow gas flows can be experienced. This poses a tricky problem in the decision to shut-in the well. If the kick occurs at a depth that is less than 3000-4000 feet, chances are that shutting in the well could cause the gas kick to broach to the seafloor.<sup>13</sup> This is a very dangerous situation, as fixed structures such as jack-ups and platforms could have their foundations destroyed due to the subsurface blowout. When drilling in formations with the possibility of taking shallow gas kicks, most operators use a diverter system to lead the kick to the surface and away from the rig, without shutting in the well.<sup>25</sup>

### 3.3.2 Conventional Kick Circulation

After having shut-in the well, the next step is to safely circulate the kick out of the well. Many different techniques have been used throughout the years, but conventional circulation methods today are generally taken to be either the Driller's method or the Engineer's method (a.k.a. Wait and Weight method). The principle behind both these methods (among others) is to keep the bottomhole pressure constant at or slightly above formation pressure during the kill operation.<sup>3, 25, 29</sup>

The procedures differ in the number of full circulations necessary to kill the well, and both have merit in handling a kick.

#### ***Driller's Method***

After shutting in the well, and checking for flow, the surface pressures are increasing. After a while, they start to stabilize, and Shut-in casing pressure (SICP) and shut-in drillpipe pressure (SIDPP) are recorded for kick calculations. The Driller's method, along with the Wait and Weight method, is a procedure that is based on monitoring the drillpipe pressure (DPP). This technique uses two circulations to kill the well: One to circulate the kick to the surface, and another one to circulate kill fluid to kill it.<sup>3, 13, 25</sup> The original mud is used to circulate the kick out. This ensures that the process can be started right away, and any further influx is prevented. While the kick is circulated out of the well, kill weight mud (KWM) is prepared. When the kick is circulated out of the hole, the KWM is pumped into the well, displacing all of the original weight mud (OWM).

The circulation follows a pre-determined schedule of calculations, known as a *kill sheet*. These calculations help maintain a constant bottomhole pressure, and assist in keeping the subsurface and surface pressures within safe limits. In a vertical well, the pressure decreases linearly from the initial circulating pressure (ICP) to the final circulating

pressure (FCP). In a directional or horizontal well, the kill sheet calculations are different, and following a straight line decline could possibly cause “an excessive overbalance and breakdown the formation, complicating the well kill with loss of circulation.”<sup>26</sup> **Table 3.5** outlines the procedures for killing a well using the Driller’s method.

**Table 3.5 – Driller’s method.**<sup>25</sup>

1. After a stabilized SIDPP is recorded, circulation is started immediately with OWM maintaining ICP on the drillpipe gauge.
2. Circulation with OWM is continued until all of the formation fluids are circulated out of the well (maintaining drillpipe pressure at ICP).
3. The well is shut in, and the mud is weighted up to KWM.
4. When the mud in the suction pit is at kill weight, circulation is started following the above procedure.
5. The drillpipe pressure is brought to initial circulating pressure, ICP.
6. The drillpipe pressure is allowed to decline to final circulating pressure, FCP, as per the kill sheet decline schedule until KWM reaches the bit.
7. After KWM reaches the bit, the drillpipe is maintained at FCP until KWM reaches the surface and the well is dead.
8. When KWM reaches the surface, shut the well in, and check for remaining pressure.
9. If there is no more pressure, crack the choke and check for flow.
10. If there is no flow, open the BOPs. At this point it is a good idea to circulate a third time (with a trip margin if deemed necessary) before drilling is resumed.

### ***Wait and Weight / Engineer’s Method***

The main difference between the Driller’s method and the Engineer’s method is that the kill is executed in one circulation. When the kick has been detected, verified, and shut-in, the crew immediately starts weighting up the mud in the tanks to kill weight mud. When the KWM is ready, the kick is circulated out by directly displacing the OWM and kick with KWM. The Wait and Weight method is a big more complex than the Driller’s method, as circulating out the kick and killing the well is done simultaneously. Again, the concept of maintaining a constant bottomhole pressure is applied, and kill-sheet

calculations help with the execution. **Table 3.6** describes the steps involved in using the Wait and Weight method.

**Table 3.6 – Wait and Weight method.<sup>25</sup>**

- |   |
|---|
| <ol style="list-style-type: none"> <li>1. As soon as a stabilized SIDPP is recorded, the mud in the suction pit is weighted up to KWM, and a kill sheet is filled out (discussed later).</li> <li>2. When the mud in the suction pit is at kill weight, circulation is started following the above procedure.</li> <li>3. The drillpipe pressure is brought to initial circulating pressure, ICP.</li> <li>4. The drillpipe pressure is allowed to decline to final circulating pressure, FCP, as per the kill sheet decline schedule until KWM reaches the bit.</li> <li>5. After KWM reaches the bit, the drillpipe is maintained at FCP until KWM reaches the surface and the well is dead.</li> <li>6. When KWM reaches the surface, shut the well in, and check for remaining pressure.</li> <li>7. If there is no more pressure, crack the choke and check for flow.</li> <li>8. If there is no flow, open the BOPs. At this point it is a good idea to circulate a second time (with a trip margin if deemed necessary) before drilling is resumed.</li> </ol> |
|---|

Many of the steps in the two procedures are the same, and steps 4-10 in **Table 3.5** are identical to steps 2-8 in **Table 3.6**.

### ***Driller's Method vs. Wait and Weight Method***

The Driller's method's main attribute is the fact that it is "simple and straightforward."<sup>29</sup> It does, however, take longer to kill a well using the Driller's method, and it may at times cause casing pressures that are higher than those of the Wait and Weight method.<sup>3,</sup>

<sup>29</sup> As a matter of fact, the Wait and Weight method is the method that provides the lowest surface and casing pressures.<sup>3,29</sup> This advantage might be argued when drilling in environments where the window between the pore pressure and fracture pressure is narrow. Then again, the added time of waiting for the weight-up might invite further

formation fluids into the well, and pressures might increase as a result of this. Grace points out that mud mixing capabilities have improved, and kill weight mud can be mixed “at up to 600 sacks per hour”, which would reduce the wait before KWM can be pumped down the well.<sup>13</sup> His conclusion is that the Wait and Weight is the preferred method of killing a well.

Some companies prefer the Driller’s method due to its simplicity, and time-saving. Crew members can start circulating out the kick right away, and calculations and weighting up can be done under more calm circumstances when the kick is out of the hole. Some companies actually design their wells so that they can handle the Driller’s method. The rationale being that the potential increase in casing shoe pressure using the Driller’s method can be incorporated into the well design, hence leaving the company free to use the simplest method. Also, if wells are designed in such a way that only the Wait and Weight method can be used, problems could occur if the mud mixing system or anything else fails.<sup>32</sup>

The preferred method of killing a well depends on many factors, such as well design, kick type, geologic setting and location, rig and well type, in addition to experience and personal preference.

### ***Alternative Methods***

There are other methods that are based on keeping the bottomhole pressure constant as well. The Circulate and Weight method and Concurrent method are examples of conventional methods that are based on this principle.

The Circulate and Weight method is a combination of the Driller’s method and the Wait and Weight method. The crew starts to circulate the kick out of the well immediately, using the original weight mud. At the same time, kill weight mud is mixed in a separate

pit, and as soon as it is ready, it will be pumped down the hole to continue displacing the kick and killing the well.<sup>3, 25</sup> The advantage to this method is that it reduces the time it takes to kill the well, while reducing the casing pressures and shut-in time.<sup>25</sup> The disadvantage is that it adds complexity to the operation compared to the Driller's method.

The concurrent method is a way of gradually increasing the mud weight while circulating out the kick. It is more complex than both the Driller's method and the Engineer's method, and does not always reduce the kill time.<sup>25</sup> According to Watson et al.; the concurrent method has previously also gone by "Circulate and Weight" or "Slow Weight-up" method.<sup>3, 29</sup>

There are many other circulation methods that are often applied in the industry, but the ones covered above represent the preferred methods for a conventional kill operation. If complications in the well control event occurs, the situation might demand alternative methods such as reverse circulation, bullheading, dynamic kills, lubricate and bleed, or Volumetric method.<sup>25, 29</sup>

## CHAPTER IV

### WELL CONTROL COMPLICATIONS AND CHALLENGES

As with any operation, things don't always go according to plan. This is certainly also the case for well control events. The previous chapter discussed some of the conventional control methods, where the kick is experienced at a depth at or above the end of the drillstring in the hole. There are instances where kicks cannot be circulated out of the hole using these conventional methods, and some of the alternative methods of killing a well have to be applied.

Depending on the well design and environment of operation, there are special considerations that might alter well control planning and execution. As drilling operations move into deeper waters, new challenges arise, be it related to water depth or increased occurrence of directional drilling. Well control operations often face many complications and challenges, and "experience and common sense will usually solve the problem."<sup>29</sup> Still, awareness of potential hazards and challenges is pertinent for a successful well plan.

#### 4.1 Non-conventional Well Control Methods

Some of the control methods to follow are based on the same constant bottomhole approach as the Driller's method and the Wait and Weight method, and some are not. Every well control operation is different, and has specific issues to be dealt with, and there is not always just one correct way of solving a problem. Some procedures are better suited for certain operations than others, and a careful evaluation is necessary to make the right choice.



#### 4.1.1 Reverse Circulation Method

As implied by the name, reverse circulation is opposite of the conventional circulation down the drillpipe with return up the annulus. The mud is pumped down the annulus on the casing side, and reversed up the string.<sup>29</sup> This type of circulation is most commonly used in completion and workover operations, as opposed to the drilling phase.<sup>3, 25</sup> In forward circulation, the friction pressure loss of the annulus is very small, and often ignored in calculating the effects on the bottomhole pressure. However, when the circulation is turned around, the effects of the friction pressure loss in the drillpipe/tubing is experienced at the bottomhole. Since the restriction of tubing causes higher pressure losses, these could have a big effect on the bottomhole pressure.<sup>25</sup> This needs to be taken into consideration so that the formation is not fractured due to excessive pressures. This is one of the main disadvantages of the procedure, and often makes it unsuitable for use in the drilling phase. There is also a greater chance of plugging the bit, or getting the pipe stuck.<sup>3, 13</sup>

In a producing well, the reverse circulation method can be advantageous in that the kick would be contained in the drillpipe/tubing, which would protect the rest of the wellbore from the increasing pressures, and gas kicks can be removed relatively quickly.<sup>3</sup>

#### 4.1.2 Dynamic Kill Technique

This type of procedure uses friction pressures to its advantage. The principle is to pump fluids at higher rates, so that the high annular friction pressures increase the ECD, hence bringing the well back to a balanced situation. Most often this technique is used on a well that is already blowing out, but it may also be applied to gas kicks in shallow formations.<sup>8, 25</sup> The fear of causing broaching to the surface when dealing with a shallow gas kick is eminent, and dynamic kills may be useful when dealing with these kicks.

### 4.1.3 Bullheading

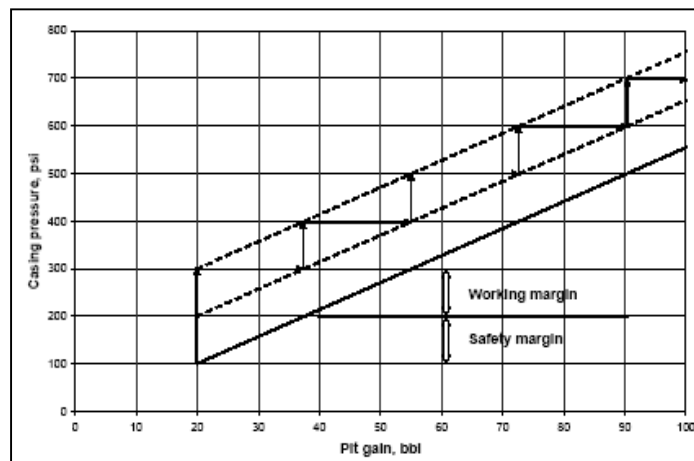
The two previous methods discussed are examples of constant bottomhole pressure methods.<sup>25</sup> With bullheading, however, the well fluids are pumped back into the wellbore with the intent of fracturing a formation for the kick to flow into.<sup>3, 8, 25, 29</sup> This procedure is sometimes called deadheading, and is based on pumping the fluids back down into the well with enough force to reverse the flow, and prevent the kick from reaching the surface. The technique is most often used in cased holes, and it is very simple to perform. Although it is not recommended for drilling operations, as it might actually cause greater harm than good, there are instances where it might be useful to bullhead in the drilling phase.<sup>3, 8, 29</sup> One such situation might be in the instance of an H<sub>2</sub>S kick. This gas is very poisonous and lethal if inhaled at high enough concentrations. Other reasons for using bullheading might be if circulation is not possible, or if conventional methods would cause pressures which the well was unable to tolerate.<sup>3</sup>

### 4.1.4 Volumetric Method

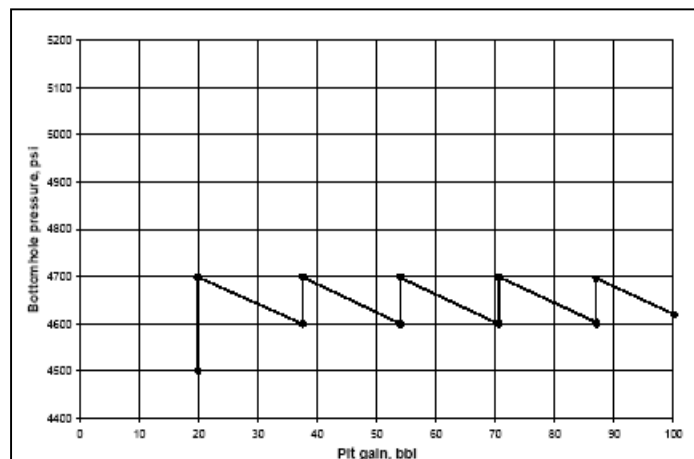
The Volumetric method is a way of handling pressures, if killing the kick is not possible right away. If circulation is not possible for any reason, be it rig power failure or a plugged drillstring, the Volumetric method offers a means to let the gas kick expand on its way up the well, thus preventing surface pressure to increase to undesired levels.<sup>25, 29</sup> As the method does not involve circulation, the driving method for the gas migration is buoyancy rather than pump pressures.<sup>3</sup>

**Fig. 4.1** shows an example of the Volumetric method: As gas migrates up the well, the casing pressure starts increasing. It is allowed to do so until it reaches a predetermined limit called the safety margin. Then an additional working margin is allowed, before the choke operator bleeds off a pre-calculated volume of mud from the well. This reduces the casing pressure to the safety margin again, and the process is repeated until the first

gas is noticed at the surface. This method controls the hydrostatic pressure (HSP) in intervals, as shown in **Fig. 4.2**, and helps constrain surface pressures. Casing pressure is monitored after the kick has reached the surface, and a way to kill the well is sought next.



**Fig 4.1 – Casing pressure response during Volumetric method.**<sup>14</sup>



**Fig. 4.2 – Bottomhole pressure response during Volumetric method.**<sup>14</sup>

#### 4.1.5 Lubricate and Bleed Method

As a follow-up to the Volumetric method, the Lubricate and Bleed method is often used. It is a procedure for handling the free gas that has reached the surface. The shut-in gas is to be replaced by mud in a safe way, and Lubrication is one way to accomplish this.<sup>3</sup> The principle is to pump a predetermined volume of kill fluid into the well, and let it fall through the free gas pocket. A calculated volume of gas is then bled from the well, and the process is repeated until the previously pumped mud starts exiting the well.<sup>25</sup> By replacing the gas with weighted mud, the well is brought back under hydrostatic control.

As indicated above, this method is useful when gas has migrated to the surface of a shut-in well, as after the Volumetric method has been employed, or otherwise. Also, when surface pressures are getting close to the limits of the wellhead equipment, it is sometimes used “to lower the surface pressure to allow bullheading”.<sup>25</sup>

#### 4.1.6 Staging the Hole

An example of a method that is most commonly used when the pipe is off-bottom, is staging the hole. This method aims to place a calculated volume of heavy mud on top of the original mud, thus creating added hydrostatic pressure in a well where the pipe is above the kick. As the pipe is run in the hole, however, the original mud tends to be displaced, and the heavy mud must compensate for this in order to still maintain pressure balance in the well. The process is repeated, with heavy mud added, and pipe run in the hole, until the pipe is back at the depth of the kick.<sup>3, 25, 29</sup>

This practice is not often recommended as many complications may occur.<sup>29</sup> One risk is that of the kick migrating and displacing fluids. This would complicate the process severely. If any indication of kick migration is detected, staging in the hole should not be considered.<sup>3</sup>

## 4.2 Well Control Complications

As described in some of the procedures above, there are situations that might require alternative well kill methods. These occur when a conventional kill is complicated in some way, and might be due to several reasons. It is important to be aware of these complications, and contingency planning is always a good idea.

### 4.2.1 Pipe Off-bottom or Out of the Hole

When the drillpipe is above the location of the formation fluid influx, conventional kill procedures do not apply.<sup>3</sup> This is due to the fact that we are no longer able to circulate the kick out with the flow of the mud pumped. If a kick is swabbed in, detected, and the hydrostatic pressure in the well has not been reduced to the point where the well is flowing; the pipe can be run back into the hole with caution, and the kick may be circulated out of the hole.<sup>25</sup> If the well is flowing, however, one should never try to bring the pipe back to bottom without having shut-in the well. The time it takes to bring the pipe back to bottom will only allow more formation fluid to enter the well, and a bigger problem is at hand.<sup>25</sup> As discussed earlier, shutting in the well would allow for better decision-making, and preventing a larger influx occurring.

After the well has been shut in, stripping the pipe back to bottom is considered a good option, as this would allow for conventional well kill procedures to be applied once on bottom.<sup>3, 25, 29</sup>

Stripping involves tripping the pipe in or out of the hole with the pipe experiencing an upward force from the well. This results in a process where the pipe is run into the hole under pressure, often by the use of the annular preventer, or sometimes the ram preventers.<sup>25, 29</sup> If the upward force from the kicking well is high enough to push the pipe out of the hole, an added force must be applied to push the pipe into the hole. This

process is called snubbing, and is sometimes necessary in bringing the pipe to bottom in a well control situation.

With the pipe out of the hole, the same principles apply when it comes to getting back in the hole, although a bit more complicated.<sup>25</sup> As the pipe is completely out of the hole, the BOPs need to be opened for a short period of time, so that some of the pipe can be brought back into the well. In order to do this, the upward force acting against the pipe to be run in the hole needs to be calculated, and a decision of tripping is made based on this.<sup>25</sup> Once in the hole, standard stripping or snubbing procedures would apply.

A top kill, or staging the hole, is another method that is sometimes employed in an off-bottom situation. As described above, there are many risks associated with this procedure, and this method should only be used when there are clear reasons backed by sound engineering calculations to support it.

If the original mud weight is high enough to balance the well, the Volumetric method can be used to bring the kick to the surface safely.<sup>3</sup> As discussed earlier, this sets up the Lubricate and Bleed method to replace the formation fluids with mud.

#### **4.2.2 Excessive Pressures**

During the shut-in of a well, the pressures will increase, and then hopefully stabilize. These recorded pressures serve as the basis for calculating kill weight mud, and if the pressures are found to be too high, a KWM that might be damaging to the kill operation might be mixed. Small pressure bleed-offs might be required to achieve a shut-in pressure that can be trusted.<sup>29</sup>

Another concern is the maximum allowable casing pressure (MACP) of a well. This is often the pressure rating of the casing (burst) or the BOP, but might also be determined

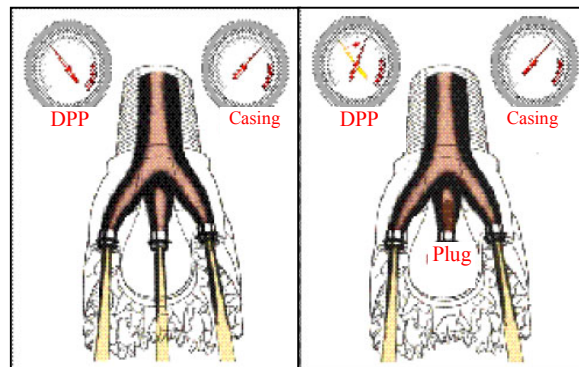
to be the fracture pressure of the formation below the casing shoe.<sup>25</sup> Normally, a sound well design will make sure the well can withstand the pressures experienced in a well control situation.<sup>3</sup> However, excessive casing pressures might sometimes occur as an unforeseen event, and these should then be monitored carefully. Preventive action, such as slowing the pumps down or shutting the well in, may have to be taken.<sup>25,29</sup> The risk of fracturing the formation or exceeding the limitations of the casing or BOPE is something that is treated seriously, and bleeding off some of the casing pressure might be necessary in order to stay within the MACP. As pressure is bled off, however, the bottomhole pressure is decreased, and if too much pressure is bled off, additional influx might be invited into the well, further complicating the situation.<sup>25</sup> That being said, it is usually better to let the formation fracture, and have an underground blowout, than risking the failure of surface equipment, and having a surface blowout.<sup>3,25</sup>

There are some ways that are designed to deal with high annulus pressures. One of these is the Low-Choke Method.<sup>3,25</sup> It is a way of preventing formation fracturing by opening the choke when the casing pressure reaches a pre-calculated maximum, based on fracture gradient and present mud weight.<sup>3</sup> This maximum allowable annulus surface pressure (MAASP) serves as the threshold for the bleed-off, and as mentioned before, this may invite more fluids into the hole through the reduction of the drillpipe pressure on the kill sheet.<sup>3,25</sup> This method is difficult to control, and conventional methods are normally desirable.<sup>25</sup>

Some of the non-conventional methods previously discussed are other ways of reducing the annulus pressure. Pumping overkill mud, or spotting a heavy-weight pill might help bring the well back into overbalance.<sup>3</sup> Reverse circulation contains the pressure in the drillstring, and is one way of dealing with a high annulus pressure, but the disadvantages discussed earlier warns about using this method in a drilling operation. Also discussed, above, bullheading will serve as a method to fracture the formation rather than experiencing a failure of the surface equipment.

### 4.2.3 Circulating System Blockage

Sometimes, the nozzles in the drill bit can get plugged with drill cuttings or barite. Due to this restriction of flow, there would be an increase in the circulating drillpipe pressure. However, there is no corresponding increase in casing pressure or pump speed<sup>3, 13, 25, 29</sup>, as shown in **Fig. 4.3**. A logical reaction of a choke operator would be to open the choke to keep the drillpipe pressure constant. Since the increase in pressure comes from the plugged nozzle, this would only lower the bottomhole pressure, and invite another kick into the hole. The correct action would be to continue circulating at a modified kill schedule, or to shut the well in if the pressures are too high.<sup>3, 25</sup>



**Fig. 4.3 – Plugged nozzle increases drillpipe pressure, but not casing pressure.**<sup>29</sup>

If the bit is totally plugged, the pump pressure will see a sudden increase, with a decrease in casing pressure. It is then necessary to try to unblock the nozzles. If surging the blockage with increasing and decreasing pump rates does not work, it might be necessary to detonate a string charge near the plugged nozzles, in hopes of blowing out the jets.<sup>3, 13, 25, 29</sup> Another option might be to perforate the drillstring in order to be able to circulate. Either way, the well needs to be shut-in and controlled volumetrically while the wireline units are rigged up to unplug or perforate.<sup>3, 25</sup>



A plugged choke behaves somewhat similarly, in that you will experience a rapid increase in the CDPP, like a plugged bit. However, you will also see higher casing pressures with a plugged choke. Here you have to consider the fact that the fracture pressure of the formation might be exceeded due to the increase in bottomhole pressure.<sup>3</sup> A blockage of the choke needs to be detected rapidly, and the kill operation put on hold, as the blockage is removed.

#### **4.2.4 Hole in Pipe**

Contrary to a bit blockage, a string leak or nozzle washout leads to a decrease in drillpipe pressure. Again, there is no loss in the annulus pressure or change in pump speed. A situation like this requires the well to be shut-in, so that the pressures can be analyzed, and a course of action decided upon.<sup>3, 13</sup> With a leak in the pipe, there is communication between the annulus and the inside of the string, which causes pressure communication and a new U-tube model. The analysis would attempt to locate the leak through calculation of the overlying hydrostatic pressure of the communication port.<sup>3</sup>

The petroleum industry is a technologically advanced one, but sometimes old techniques of interesting ingenuity just seem to work. One example of fixing a leak is to pump softline into the well, to plug the leak. A derivative of this method “is to tie knots on strips of nylon panty hose and pump them down the drillstring. The mud mixes in the mesh of the panty hose, forming a good seal in the washout.”<sup>25</sup> If a seal cannot be achieved by this interesting method, it is sometimes possible to circulate the kick out at a reduced CDPP. There is a risk of the washout growing bigger, and parting the string, which would lead to a situation similar to an off-bottom kill.

Other solutions include trying to strip or snub out of the hole, to replace the bad pipe section. The hole would have to be controlled volumetrically while the pipe is out of the hole.<sup>3</sup> Also, setting wireline plugs above and below the washout to replace the pipe

section could work. Other packer types, like straddle packers, might serve to seal off around the washout, and circulation could continue through the straddle packer.<sup>25</sup> Instead of using wireline solutions to remedy the problem, a coiled tubing unit could be used to run tubing through the drillpipe, and circulate through this tubing at bottom.<sup>25</sup> Regardless of the solutions, the first step of dealing with a leaky pipe is to shut the well in, and analyze the problem.

#### **4.2.5 Loss of Circulating Power**

If a pump breaks down, and the circulation power is lost, there is normally a back-up at hand. The characteristics of the second pump might not be exactly the same as the primary, and it might be necessary to re-record the circulating pressures of the new pump.<sup>3, 29</sup> For a new pump to be brought online, it might be necessary to shut the well in, and control it with Volumetric methods until the pump is fixed, or the secondary is ready for action.<sup>29</sup>

#### **4.2.6 Leak in Blowout Equipment or Choke Manifold**

BOPE failure should be a part of any contingency plan, and the BOPs are pressure tested regularly to prevent failures. Unexpected leaks can occur, however, and monitoring of the BOPE during a kill operation is a necessity.<sup>3, 29</sup> Leaks can sometimes be isolated, and fixed on the fly, but care has to be taken to prevent small problems from escalating into bigger ones. Sealing materials can be pumped into the area of interest, and serve as a temporary fix to get the job done.<sup>3</sup> With good planning, common sense, and attention to detail, BOP failures should be a rare occurrence that can be dealt with correctly. Choke manifolds are designed so that operators are able to reroute flows according to need. It is susceptible to washout and abrasion, and back-up chokes can be used while the primary is repaired.<sup>3, 29</sup>

#### 4.2.7 Lost Circulation

Lost circulation has been discussed before as a kick cause. When killing a well, an indication of lost circulation might be a fluctuation in gauge pressure. A decrease in the pit level while killing the well is also an indication that partial loss of circulation is occurring.<sup>29</sup> The danger of a partial loss during a conventional kill, depending on the severity, is the loss of well control or underground blowouts.<sup>3</sup> Seepage losses are minor, and pose no great threat if dealt with correctly. Partial losses become more expensive, as mud is lost to the formation.<sup>25</sup> The issue is to control the situation, and prevent full losses from occurring. With a total loss of returns happening, the column of mud in the well will decrease, and hydrostatic pressure is lost, which might induce another kick.<sup>25</sup>

With many different causes of lost circulation, there are different ways of dealing with it as well. If partial losses are experienced, it is beneficial to stay with the original plan, as full returns might be regained when the kick passes the loss zone.<sup>3</sup> There are steps, however, to help ensure the partial loss does not escalate into a total loss situation. It is useful to not incorporate a pressure safety margin if lost returns are anticipated.<sup>29</sup> Also, a slower circulation rate would reduce the frictional pressure loss in the annulus, reducing the bottomhole pressure. A new circulation pressure is established, and hopefully it will help “improve the ability to circulate.”<sup>3</sup>

Another method of dealing with lost circulation is the use of Lost Circulation Material (LCM). This is not always possible in a kill situation, but if feasible, the properties of the LCM need to be evaluated to avoid plugging of nozzles, which would further complicate the kill.<sup>3,25</sup> It is sometimes necessary to pump cement or so-called gunk plugs to seal off the thief zone.<sup>25</sup> The decision to either control the thief zone or the kick first, has to be made, and depending on the choice, several techniques ranging from gunk squeezes to spotting heavy pills of mud can be used.<sup>25</sup>

## 4.2.8 Complication Overview

As we have seen in some of the previous discussions, there are indicators that will stem from several possible causes, and hopefully we'll find some potential solutions. Some of these indicators might be changes in mud volume or pressure changes observed at the surface. **Table 4.1** shows a summary of cases where the drillpipe pressure or casing pressure increases in an easy-to-follow table, where symptoms, causes, and possible solutions are outlined.

**Table 4.1 – Summary of causes and solutions to pressure increases at surface.**<sup>29</sup>

MECHANICAL AND HOLE PROBLEMS					
DRILLPIPE PRESSURE	CASING PRESSURE	ACTIONS TO TAKE	RESULT	PROBLEM	SOLUTION
Up	Up about same amount as drillpipe	Check pump rate	Pump rate too fast	Circulating pressure is too high because pump is running faster than planned	Slow pump rate down to planned rate. If pressures come down, everything is okay. If not, continue down chart.
		Increase choke size	Drillpipe/casing pressures came down	Choke size was too small	If pressures come down when choke size was increased, everything is okay. If not, continue down chart.
		Open choke all the way	Drillpipe/casing pressures came down	Either choke size was too small or choke was trying to plug	If pressures come down, everything is okay. If not, continue down chart
		Stop the pump	Drillpipe/casing pressures came down	Choke manifold has started to plug up	Switch to alternate choke line and clear manifold. If pressures do not come down, continue down chart.
		Shut in the well	Pressures stay up	Manifold is plugged	Switch to alternate choke line. If pressures come down, go back to well killing. If not continue down chart.
				Manifold is plugged at or above the T	Close master valve on kill line. Release pressure from manifold and clean it out.
Up	Up but not very much	Check pump rate	Pump rate too fast	Circulating pressure is too high because pump rate is faster than planned	Slow pump to planned rate. If pressures come down, everything is okay. If not, continue down chart.
		Increase choke size	Drillpipe/casing pressures came down	Choke size was too small	If pressures come down, everything is okay. If not, continue down chart
			Casing pressure comes down but not drillpipe	Wait at least 2 minutes to see if there is a long lag between choke movement and drillpipe pressure	Allow for a long time lag with big gas kicks. If pressure does not come down, continue down chart.
			Drillpipe pressure does not come down	A mud ring or pack off near bit	Raise or reciprocate drillpipe. If drillpipe pressure comes down, everything is okay. If not, continue down chart.
				Plugged jet	Restore casing pressure to where it was before trouble started. Take changed drillpipe pressure as new constant circulating pressure. OR: Stop pump, shut well in, bleed pressure off drillpipe. Start up holding casing pressure constant until you reach a new pump rate. Use new circulating pressure as new constant circulating pressure.
Up abrupt change	No change	Check pump rate	Pump rate too fast	Circulating pressure too high because rate is faster than planned	Slow pump to planned rate. If pressure comes down, okay. If not, continue down chart.
		Increase choke size	Casing pressure gets very low before drillpipe pressure comes down	A mud ring or pack off near bit	Raise or reciprocate drillpipe. If drillpipe pressure comes down, okay. If not, continue down chart.
Up abrupt change	No change	Increase choke size	Casing pressure gets very low before drillpipe pressure comes down	Plugged bit	Take new drillpipe as constant circulating pressure. OR: Stop pump and shut well in. Bleed off drillpipe pressure. Start up holding casing pressure constant, until you reach a new pump rate. Use new circulating pressure as constant circulating pressure.
		Open choke	Drillpipe pressure does not come down	Plugged bit	Stop pump and shut in well. Try rocking pump to clear bit. You may have to shoot off or back off the bit.
				On marine rig with subsea wellhead/riser, possible plugged wellhead/riser kill line	

As can be seen from the table, it includes some of the topics discussed earlier, like plugged jets, bits, or manifold equipment. Causes of the pressure indicators are listed, along with suggested actions, and potential solutions. Experienced driller’s will know these indicators, problems, and solutions like the back of their hand, but a table like this is definitely useful in obtaining quick tips or confirmations. **Table 4.2** shows a similar table where the pressure indicators point to a decrease in drillpipe or casing pressure.

**Table 4.2 – Summary of causes and solutions to pressure decreases at surface.**<sup>29</sup>

No change	Down or no change	Increase or decrease in choke size	Pressures do not seem to respond to choke movement	Lost circulation, bad cement job, or hole in casing. Check pit volume	<ul style="list-style-type: none"> <li>• Pick a new slower circulating rate.</li> <li>• Add lost circulation material</li> <li>• Drop a barite plug</li> </ul>
		Check pit volume	Volume okay	Check choke for failure	Switch to alternate choke
Down	Down	Check pump rate	Pump rate too slow	Circulating pressure too low because pump is running slower than planned	Increase pump rate to planned rate. If pressure comes up, okay. If not, continue down chart.
		Decrease choke size	Drillpipe and casing pressure came up	Choke size was too large	If pressure go up when choke size decreased, okay. If not, continue down chart.
			No change in drillpipe/casing pressures	Lost circulating, bad cement job, or hole in casing. Check pit volume	See drillpipe pressure - no change.
Down	No change	Check pump rate	Pump rate too slow	Circulating pressure is too low because pump is running slower than planned	Increase pump rate to planned rate. If pressure comes up, okay. If not, continue down chart.
		Decrease choke size	Pressures increase	Choke size was too large	If pressures go up when choke size decreased, okay. If not, continue down chart.
			Pressures increase but kelly hose jumps and drillpipe pressure surges	Pump trouble	Change pumps or repair pump
		Continually decreasing choke size	Drillpipe pressure stays same, casing pressure goes up	Hole in drillpipe	Stop pump and shut in well. You may have to strip out to replace a joint of pipe
Abrupt change down	No change	Decrease choke size	Drillpipe and casing pressure go up	Washout on bit or drillpipe	

Issues such as string leaks and pump failures are sometimes causes of decreased drillpipe pressures, and **Table 4.2** suggests remedies to deal with these pressure symptoms.

**4.3 Well Control Challenges**

Having taken a look at some of the complications that can occur in a conventional kill operation, it should be evident that there are a lot of challenges associated with these types of operations. As we move into more complex drilling environments and well

designs, new issues arise to be overcome. Horizontal drilling has led to great increases in productivity in many parts of the world, and has become an integral part of reservoir development. Today we are using this technology to push out even further in extended reach drilling (ERD), and even drilling these types of wells from the same location with multilaterals. Along with the challenges of moving operations into deeper and deeper water depths, these wells pose specific concerns with regard to well control.

#### **4.3.1 Directional and Horizontal Wells**

Horizontal drilling is a routine operation in many areas today, and great advances have been made since its massive growth in the mid 80s. By drilling a well vertically, and then kicking off to build angle in a curved section, one can arrive at an angle of 90°. This horizontal section often intersects the reservoir of interest parallel, which enables production from a much longer interval than that of a vertical well. This has improved “production rates and recoveries.”<sup>33</sup> Along with these obvious advantages follow some well control considerations.

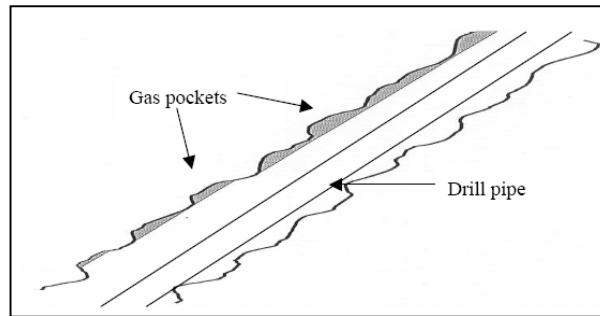
One evident, but important, fact in well control is that hydrostatic pressures are calculated based on true vertical depths (TVDs), whereas frictional pressures are calculated on the basis of measured depth (MD).<sup>29</sup> This is important in calculating the correct kill weight mud to use in the kill operation. In a vertical Wait and Weight kill, the major advantage is that a lower annular surface pressure is achieved. However, this advantage might disappear in the case of a horizontal well, as “the effect of the hydrostatic pressure gain is not realized until the kill fluid starts up the vertical portion of the hole.”<sup>29</sup> If the horizontal section is substantial, the kick might get circulated out of the well before the kill fluid reaches the annulus, thus having reached the pressure peak before this occurs.<sup>29</sup> In essence, the advantage of the Wait and Weight method over the Driller’s method is largely lost, leaving its only claim to fame to be the fact that the kick can be circulated out in one circulation. Also, by using the standard pressures sheets of a

vertical Wait and Weight method, with a linear relationship between the ICP and the FCP, an overbalance might occur if applied to a horizontal or deviated well.<sup>26,29</sup> A horizontal kill is better described with a curved pressure representation of the build and lateral sections.<sup>34</sup>

The Driller's method is well suited for horizontal well control, as immediate circulation is important. Kick detection is hard in horizontal and deviated wells, and drillers need to be extra alert to the kick indicators.<sup>29</sup> The Driller's method also steers away from the complicated pressure schedule calculations associated with the Wait and Weight method, and its simplicity again makes it the preferred choice in horizontal well control situations.

Santos found that horizontal wells have a SIDP and SICP are approximately equal, and that casing shoe pressures tend to be lower in horizontal wells than in vertical wells.<sup>33,35</sup> A greater tolerance for taking kicks without fracturing the formation is experienced in horizontal wells<sup>33,35</sup>, which also backs up the recommendation of using the Driller's method.

Another challenge of killing horizontal or deviated wells is the fact that gas might get trapped in hole-washouts in the deviated or horizontal section, as seen in **Fig. 4.4**. This gas accumulation might not follow the mud with a circulation of normal kill rate, and could cause further well control problems when the kick is out of the hole, and the well goes back to drilling mode.<sup>29</sup> With a higher circulation rate, the accumulated gas might start migrating up the hole, and with the well already at kill weight mud, the "Driller's Method should be used to finish circulating out."<sup>29</sup> One way of dealing with this accumulated gas is to start the kick circulation at a rate higher than the kill rate, and the slow down to kill rate.



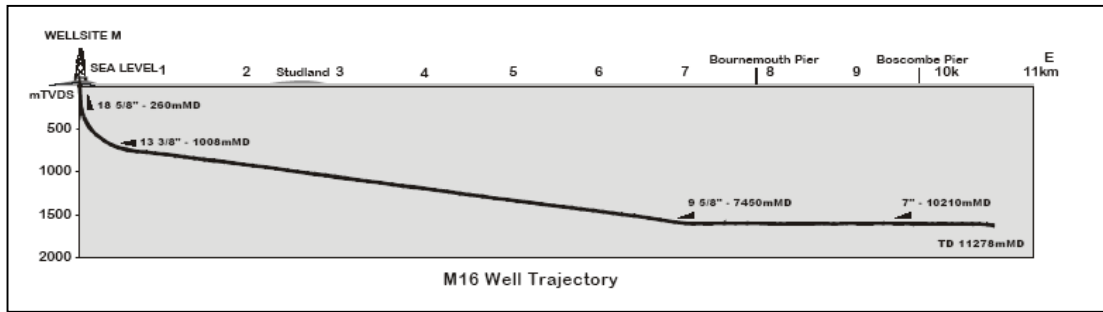
**Fig. 4.4 – Gas accumulation in washouts of deviated well.<sup>14</sup>**

Tripping operations are critical in a horizontal well. When pulling pipe out of a well where there is trapped gas in washouts of the deviated section, one might experience this gas being pulled into the vertical portion of the well, which might cause problems.<sup>29</sup> Since the formation or pore pressure does not change along the horizontal section of a well, the pressure drop depends on the measured depth, and swabbing in a kick is not unlikely.<sup>33</sup>

#### **4.3.2 Extended Reach Wells**

Extended reach drilling is a derivative of directional drilling, where the well is most often kicked off at a shallow depth, and then a lateral section with great horizontal departure (HD) is held. The well is then commonly kicked off again, to build to horizontal near the reservoir target. One definition of extended reach wells is that the horizontal departure is at least twice the TVD of the well.<sup>36</sup> **Fig. 4.5** shows BP's Wytch Farm M16 well, which is the world's longest ERD well at 11,278 meters measured depth (MD).





**Fig. 4.5 – Wytch Farm M16 well: World’s longest ERD well.<sup>37</sup>**

There are many operational challenges in drilling ERD wells, like torque and drag, drillstring and casing design, and hole cleaning.<sup>38</sup> Well control of ERD wells becomes increasingly complex as these types of wells have a greater chance of taking a kick.<sup>3</sup> ERD wells do have some advantages after a kick is taken, however, as gas migration rates are lower in high-angle wells.<sup>3,34</sup> As discussed before, deviated wells, including ERD wells, have added complications with trapped gas in rugose and/or highly deviated wellbores. The same considerations of tripping and circulation rates, with regard to the trapped gas, need to be evaluated for ERD wells.

As the casing shoe is normally close to total TVD in an ERD well, the fracture pressure at the shoe will not generally dictate the well kill method. The Driller’s method is again advantageous in ERD wells, as it provides the operational simplicity and effectiveness needed to circulate a kick out of a long lateral section in a timely manner.

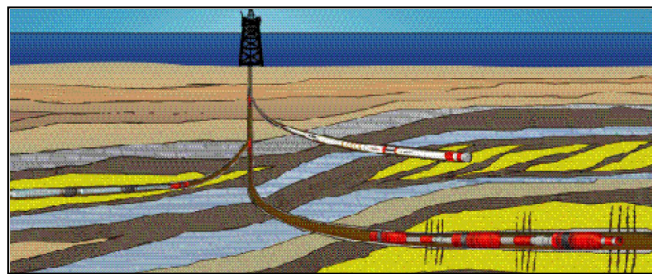
Most ERD wells have been drilled from onshore locations, and the ones that exist offshore have been in fairly shallow waters.<sup>39</sup> There is potential for ERD technology to move into deep waters, however, but careful simulation and planning of problem areas such as well planning, wellbore stability, sand control, and hole cleaning must be performed in order to be successful.<sup>39</sup> Certain deepwater fields might benefit from ERD technology in that larger offshore fields might be produced with “fewer wells and less

production units.”<sup>39</sup> With the combination of technologies, ERD and deepwater challenges will be combined, and well control operations will become increasingly complex.

### 4.3.3 Multiple Completions and Multilaterals

Certain wells are producing from several formations at the same time. This can be done with co-mingling of flows, or through production from multiple tubing strings, or packer separation.<sup>25</sup> As these formations generally will have different pressures and fracture tolerances, they may pose problems in a well control operation. If zonal isolation through mechanical separation (packers etc) is present, the well can sometimes be killed by using conventional techniques.<sup>29</sup> Another way of separating zones might be through fluid barriers or plugs. This might not be ideal, depending on the type of well.<sup>29</sup>

Where the zones are producing through different tubing, each tubing string has to be killed separately, and trapped pressure can cause problems when packers are disengaged.<sup>25</sup> All in all, multiple zones in one well, or multilateral wells add complexity to the operation, and careful care and background research on the completion types and pressure behavior has to be executed before a kill is to be performed. **Fig. 4.6** shows a multilateral well design.



**Fig. 4.6 – Multilateral completions may cause well control complications.**<sup>29</sup>

#### 4.3.4 Slim Hole

When considering slim holes, we are talking about holes that have a smaller diameter due to being drilled with smaller bits than the conventional wells of the same depth. One definition of a slim hole is a hole that is drilled with a bit diameter of 7" or less. Ultra slim holes are classified to be around 4" diameter.<sup>29</sup> These types of wellbores have a very narrow clearance of the annulus, and in fact drilling conditions get reversed: frictional pressure losses in the drillstring are now almost negligible, and annular frictional pressure losses are substantial.<sup>13,29</sup>

This high annular friction puts a larger stress on the bottomhole formation, and might lead to situations of lost circulation. Again, this loss of returns might lead to a reduction of the fluid column in the hole, and further kicks might be invited into the wellbore. However, the high friction pressures might keep the ECD above that of the pore pressure, and control of the well might be intact. Caution must therefore be applied when shutting off the pumps, as the loss of these frictional pressures might lead to a pressure reduction substantial enough to make the well flow.<sup>29</sup>

In addition to circulation rate and friction pressure considerations, slim holes also experience a greater risk of swabbing in kicks. This is due the smaller clearance between the pipe and the hole. Extra planning and calculations for tripping operations might be necessary.<sup>29</sup>

Yet another consideration is the fact that a kick would occupy a larger height in a slim hole, due to the small annulus area.<sup>13,29</sup> More mud will be displaced, and higher surface pressures are experienced because of this. Quick detection is paramount, as a slim hole kick can move up the well very quickly, and expand very fast.<sup>29</sup> When it comes to

detecting a kick in a slim hole, the indicators are the same as in a conventional hole. The kick would have to be detected at smaller pit gains and flow rates.<sup>29</sup>

#### **4.3.5 Offshore Wells**

Offshore operations started at very shallow water depths, which have increased dramatically over the years. Today, operations in excess of 10,000 ft of water have been successful, and the technological strides of the industry with regard to subsea operations have made this possible. At shallow waters operations are generally conducted through the use of fixed structures like jack-up rigs and platforms. This enables them to use similar BOPE to that of land operations, like surface BOPs. When water depths require the use of floating drilling, we generally no longer utilize surface BOPE. Subsea wellheads and BOP stacks are common, and along with their use follows some procedural modifications in deep water well control.<sup>3</sup>

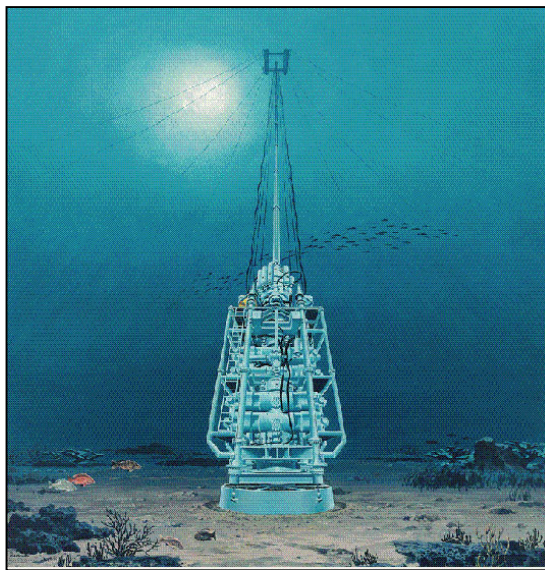
#### ***Operational Difference***

As mentioned before, the equipment used in floating drilling differs from that of onshore or fixed structure offshore operations. Drilling from jack-ups, for example, would entail the well control considerations discussed earlier. With the introduction of subsea equipment, well control procedures are modified slightly.

Floating drilling rigs, like semi-submersibles or drillships, provide a greater flexibility than fixed structures. With the motion of the ocean being felt on these floaters, a system for positioning, such as mooring lines, or dynamic positioning through thrusters is necessary. Also, the motion of the vessel makes it advantageous to locate the BOPE at the seafloor. These subsea BOP stacks are mounted onto subsea wellheads, installed with the use of a guidebase, and typically, a so-called riser is used to bring drilling

returns back to the floater after the surface hole is drilled. The subsea well control system includes the “BOP stack, Lower Marine Riser Package (LMRP), Control System, and Riser.”<sup>29</sup>

As the BOP stack is installed on the seafloor, it needs to be designed to incorporate the needs of the entire drilling program, Subsea stacks are substantially larger than surface stacks, and have some added specifications. Still, the principles of operation are the same. The LMRP connects to the top of the stack, and includes the upper annular, connector joint and riser adapter.<sup>29</sup> The ball or flex joint used in the LMRP helps allow for movement of the riser without damaging the stack or wellhead. In addition to the riser allowing for returns to sea level, the riser system includes the choke and kill lines, which are vital for well control. **Fig. 4.7** shows a typical subsea setup.



**Fig. 4.7 – Subsea BOP stack, LMRP, and riser.**<sup>29</sup>

The riser itself is a large diameter pipe, and thus does not have very high burst and collapse ratings. It needs to be of large size to accommodate the pipe and tools run through it. It is a solution to the fact that casing from the seafloor to sea level could not be supported by the rig.<sup>25</sup> If a gas kick migrates above the BOPs and up in the riser, it might start expanding and evacuating fluids. In this case, the collapse pressure imposed by the outside seawater might be exceeded.<sup>25</sup> Hopefully, the containment of kicks will occur below the BOPs at the seafloor.

Another integral part of subsea well control is the control system. With the necessity of having the accumulators, controls and pumps on the floater, there is an additional need of having a way of communicating with the subsea stack. For all the functions of a stack to operate properly, a hydraulic fluid line and subsea control pod helps actuate the correct functions in the stack.<sup>3</sup> There are many different types of control systems, often fitted to specific types of rigs. Work to enhance the reaction time to engage the critical BOP functions and retrofit systems for flexibility promises to potentially help reduce cost in deepwater operations.<sup>40</sup>

### ***Kick Detection and Shut-in***

When it comes to detecting a kick on a floating vessel, the process is complicated by the vessel movement. As the rig is affected by the motions of the sea in all directions, the monitoring of pit levels and flow rates is complicated.<sup>3,29</sup> Some of the same detection methods discussed before are used, but in order for them to be effective, modifications to some of the equipment is necessary. As an example, paddle-type flow sensor do not work very well in a moving environment like a floating vessels, and newer, more sophisticated return indicators or delta flow alarms are necessary to serve as kick indicators.<sup>25</sup> Also, the rig movement affects the PVT system, and baffles and more floats are added to the pits to calm some of the mud movement.<sup>3</sup> Other detection methods

include the use of standpipe pressure as an indicator, or MWD/LWD tools, depending on the well.<sup>29</sup>

When a kick indication has been noticed, it is best to shut-in the well quickly, according to company policies. As discussed earlier and verified by investigations by Martins Lage and Nakagawa, a hard shut-in is preferred for wells in deep water.<sup>41</sup> With the advantage of shutting the well in quickly and minimizing the kick size, it also seems natural to evaluate the procedure of flowchecks. A flowcheck is very common in verifying the kick, but as early detection is especially important in deep water well control, a flowcheck might not be such a good idea. In deepwater wells the targets tend to be of substantial ability to flow. Additionally, fracture gradients tend to be low in these deepwater environments, which should indicate that a flowcheck would give more time for a kick to flow into the wellbore, and complicate the narrow conditions of operation already existing. Hence, flowchecks are not recommended in deepwater drilling.<sup>41</sup>

### ***Shallow Flows***

When drilling the hole section for the conductor pipe, it is fairly common to drill with returns to the seafloor. The casing head and BOP stack would be installed after the conductor casing is set.<sup>3</sup> During this drilling without a riser, there is a risk of encountering shallow gas or water flows.

With overpressured gas in shallow sands, and no weighted mud column to counteract the pressures, the shallow gas will kick.<sup>29</sup> In situations of shallow gas flows, there is very little time to act before the kick will unload the wellbore totally.<sup>29</sup> For structures supported by the seafloor, these shallow gas flows will most likely broach to the mudline, and potentially cause structural damage to the platform. For floating vessels,

the underwater blowout will cause a gas plume to rise in the seawater, and might lead to a loss of buoyancy of the floater.<sup>12,29</sup>

Pump pressure changes might be an indication of a fluid influx when returns are taken to the seafloor. Other kick indicators discussed earlier are not applicable to a situation like this. Pump pressures will decrease as shallow gas lightens the wellbore column. It is a good idea to have weighted mud ready in a situation where the kick is detected early enough to act on.<sup>29</sup> Shallow water flows are harder to detect.

With good planning of a well, shallow flow hazards should be considered, and avoided if possible. This is the best way of dealing with them, and tools like seismic and offset well data might help in the well planning.<sup>3,29</sup>

### ***Lost Circulation***

One of the challenges of drilling in deepwater is the narrow pressure window between the pore pressure and fracture gradients. Oftentimes, the balance act of staying in this envelope fails, and lost circulation might result. Since the fracture gradients tend to be lower in deepwater environments than onshore, preventing lost circulation is an added challenge in this setting.<sup>42</sup> There are many causes for loss of returns, but some are more prevalent than others in deepwater.

Salt formations can not only be the cause of abnormal pressures, but also relate to lost circulation issues. Formations below the salt tend to be weaker, or fractured, causing fluid losses. Combined with occurrences of formations with higher pore pressures below the salt structures, it can be particularly complicating to encounter a sub-salt rubble zone.<sup>42</sup> Good analyses and planning ahead of the operation is necessary, as with any operation.



Less severe losses through seepage can be countered with the correct use of LCM. Pore size knowledge helps in determining the appropriate LCM, but studies have shown that synthetic graphite has been effective in healing some of the fractures behind these seepage losses.<sup>42</sup> In the deepwater basin of the Gulf of Mexico (GOM), running casing and cementing operations account for almost half of the lost circulation problems encountered.<sup>42</sup> Surge pressures when running the pipe in the hole need to be monitored, as well as pipe acceleration.<sup>28</sup> Having higher trip margins might be of help, but as the fracture gradients are generally very low in deepwater areas, the margins would be limited by these.<sup>3</sup>

When softer formations in a deepwater setting are drilled very aggressively, the high ROP might actually induce hole cleaning problems, and lead to the well packing off. Pack-offs of cuttings make it harder for fluids to be circulated, and can create pressure spikes that might fracture the formation.<sup>42</sup> ROP needs to be controlled to ensure good hole cleaning, and bit design included in the lost circulation pre-planning. Small fractures in formations might be opened by small pressure increases, and they start taking fluids. In certain cases, the fluids flow back into the wellbore when the pressure spike decreases again. This wellbore breathing is sometimes called ballooning. This is a risk for lost circulation in that it is sometimes interpreted as the well flowing, with a following action of shutting in the well and increasing mud weight. This weight increase might further fracture formations, and cause severe lost circulation.<sup>42</sup>

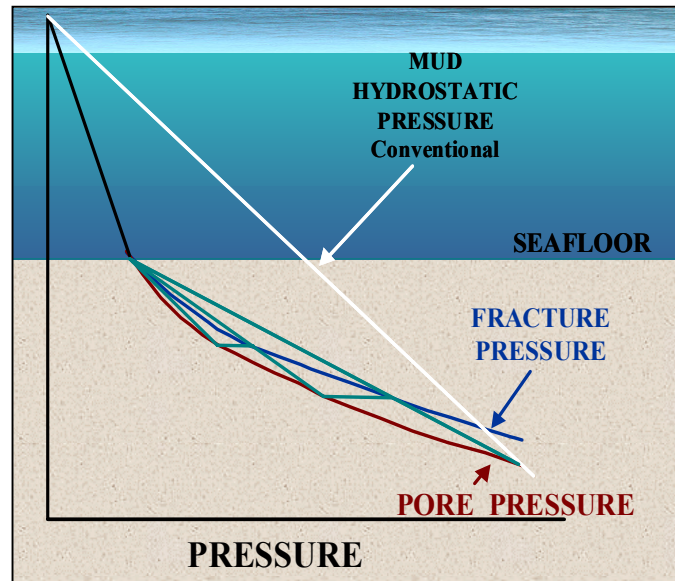
Due to the high friction pressures of the chokeline in a deepwater well, well control operations may in fact be another operation that might cause lost circulation problems. Breaking the casing shoe might be the consequence of excessive pressures (especially with a bad shoe test adding to the problems). Larger diameter of the chokeline would help reduce some of the pressure losses during a well control situation.<sup>42</sup> Again; the Driller's method is the well control method of choice for several reasons. With regard to

lost circulation, it allows for continuous circulation, which helps warm up the mud in the choke line, which again reduces frictional pressures.<sup>42</sup>

### ***Fracture Gradients***

As touched upon many times before, the fracture gradients of deepwater formations tend to be lower than onshore. The sediments offshore are generally of younger geologic origin and not as compacted and consolidated as onshore formations. Another important point is that shallow formations in deep waters only experience the overburden pressure of the seawater above. As water has a much lower density than rock, onshore formations at the same relative depth experience a much higher overburden pressure from the overlying formations.<sup>25</sup> As the window between pore pressures and fracture pressures is very narrow in deepwater formations, careful planning is a necessity, since there is not much room for error.

As reservoir targets get deeper and deeper, the low fracture gradients might become a limiting factor in reaching these targets. Casing design is dictated by the pore and fracture pressure, and with increasing depth, there will be a tapering effect on the casing string. One concern is to achieve a wellbore that would actually be able to reach the target with a large enough diameter to be able to produce the hydrocarbons at a rate sufficient to meet economic criteria. **Fig. 4.8** illustrates the narrow operating window between the pressure gradient and the fracture gradient.



**Fig. 4.8 – Window between fracture gradient and pore pressure is narrow in deepwater and casing setting depths are dictated by it.<sup>15</sup>**

## CHAPTER V

### BLOWOUT CONTROL METHODS

If a kick has gotten to the point where it is uncontrollable, it has turned into a blowout. Either human or equipment failures are at fault, be it in the kick detection phase or in containing the kick. A different type of well control is necessary: Blowout containment.

As statistics have shown, blowouts do occur, and contingency planning for these situations should be conducted during the planning phase of the well. Blowout control professionals, with specialized experience and expertise, should be consulted in emergency response planning, and a clear organization of responsibilities for such an event should be determined ahead of time.<sup>3</sup>

Just like there are categories of blowouts, we can also categorize blowout control methods. One way of classifying these is:

- Surface intervention
- Subsurface/Relief well intervention

#### 5.1 Surface Intervention

As the name implies, surface intervention is the approach where the blowing well is accessed through the surface equipment or the exit point of the blowing well. This approach is possible if the equipment is deemed accessible, either immediately, or by clearing the area around the wellhead for access. By being able to use the existing well and equipment, the time it takes to kill the well is generally reduced, and the intervention tends to be less expensive than otherwise.<sup>3</sup> In general, some preparation of the surface

location is necessary before the actual surface intervention may begin. Operations such as firefighting, debris and equipment removal, and flow control is integral to most surface interventions.<sup>3</sup>

### **5.1.1 Firefighting and Debris/Equipment Removal**

The mental image of a blowout in the public is that of a wild fire, out of control. However, most blowouts never catch fire, due to the water that also flows into a blowing well, reducing the chance of ignition.<sup>43</sup> With blowing fluids sometimes being of a volatile and flammable nature, it is important to restrict ignition sources. Gas condensate blowouts are the fluids that are most likely to catch fire in a blowout situation, depending on the fuel/oxygen mix.<sup>3, 43</sup>

As illustrated in **Fig. 1.1**, the explosive fires that can occur with a hydrocarbon feed can burn so hot that it melts steel. When oilfield firefighters work near a blowout on fire, they wear heavy aluminum hard hats, as plastic ones would melt, and they are continuously sprayed with water to stay somewhat cool. Still, they experience tremendous heat.<sup>43</sup> Access to water, and being able to pump it at sufficient rates are vital in a firefighting operation, as the water helps cool the surrounding structures, and a water fire protection system is installed on newer offshore rigs.<sup>43</sup> It is also possible to extinguish these powerful blowout fires with water alone, through it cooling the ignition temperature and displacing oxygen that feeds the fire. It can also displace the hydrocarbon feed to the fire, normally after ensuring vertical flow, thus putting it out. Regardless of these facts, it is most commonly used to allow firefighters to approach the blowing well and get access to equipment.<sup>43</sup>

Certain chemicals can be useful in fighting fires. Foam is one example of a method to handle gas condensate and oil fires, through the exclusion of oxygen, suppression of vapor emissions, and the absorption and removal of heat.<sup>43</sup> Unlike foams, dry chemicals

generally just act as a means to starve the fire of oxygen supply, and is useful in methane well fires where the use of explosives are not possible, and there is a lack of water.<sup>43</sup>

The use of explosives in controlling a well fire might seem contradictory at first thought. The use of dynamite in blowout control has been around since the 1920's, and the true pioneer of blowout containment, M. M. Kinley, is credited for inventing the method.<sup>43</sup> The principle behind it is based on the fact that the explosion will blast the fuel away from the flame propagation, and "briefly uses up the local oxygen."<sup>3</sup> The use of explosives is useful in situations where water supply or pump capacity is not sufficient to do the job alone.

One interesting approach to blowing well firefighting was displayed during the blowout containment of the oil fires of Kuwait after the Gulf War in 1991. With a massive task at their hands, many blowout control companies were involved in the relief effort, among these; Hungarian blowout control teams. Jet engines from old Russian MIG airplanes were attached to a Russian tank from the 1950's, and compromised the so-called "Big Wind" system.<sup>13</sup> By injecting water and fire suppressant fluids through the jet engines, they were able to bring the jet stream closer to the blowing well at increasing velocities. As the tank got closer to the fire, the speed of the jet engines was increased, thus blowing out the oil fire.<sup>13</sup>

As strange as it seems, there might be cases where you would want the wild well to be on fire. From an environmental point of view, a blowing offshore well on fire is definitely a better option than a blowing oil well polluting the sea. In an offshore setting, the fire would complicate the blowout containment. A land containment might actually be cheaper if the rig is allowed to burn, as environmental clean-up could both be more harmful and costly than the loss of a rig and wild well control of a well on fire.<sup>43</sup> Another reason for igniting a blowing well voluntarily is the fact that it may sometimes actually be safer to do so. A well on fire is more predictable than a well with a risk of

random ignition. Dangerous gases, like H<sub>2</sub>S, are another reason to ignite a fire, as it is a lethal gas in sufficient concentration.<sup>43</sup>

In order to access the wellhead of a surface blowout, there is a necessity of clearing any obstructions. As the derrick is most often in the way of accessing the wellhead of a blowing well, it is normally removed. Metal is cut with special equipment, and the use of bulldozers, cranes, and Athey wagons are common ways of clearing debris from around the wellhead.<sup>3</sup> A perfect example of this is, shown in **Fig. 5.1**, during the RU-67 sting operation in the Iraq war of 2003: “A track hoe was walked into the blaze prior to fighting the fire and pulled the production head from the top of the well. The extraction of the production head removed the obstruction of the fire, allowing it to flow upward and vertical.”<sup>11</sup>



**Fig. 5.1 –South Rumalia Well RU-67 flows vertically after production head removal, pre-sting and kill operation.<sup>11</sup>**

The Athey wagon is a useful vehicle in removing debris. It is moved around by a bulldozer, and its long, extending boom allows for hooks and other equipment to be attached to it and moved by the bulldozer's winch.<sup>3</sup> There are many other tools and types of equipment that are used to remove debris from a location, ranging from shaped explosive charges and cutting torches, to cables and hydraulic cutters.<sup>3</sup> By using water and abrasive material under extreme velocity through small nozzles, the pointed high-pressure hydraulic cutters are able to cut through wellheads, and thick pieces of metal.<sup>44</sup> **Fig. 5.2** shows a dual-action hydraulic cutter cutting off a wellhead. The cutter is attached to the Athey wagon, thus being able to be brought close to the blowing well, without requiring human presence next to the well.



**Fig. 5.2 – Hydra-Jet cutter cutting below wellhead with gelled sand/water slurry.<sup>44</sup>**

As there are many different debris and equipment removal techniques, the decision on which method to use depends on what method is deemed most effective for the specific circumstance, depending on reduction of risk, success probability and economics.<sup>45</sup>



Equipment availability and time constraints also play an important role, as locations for oil and gas blowouts aren't always in the most geographically desirable places. An example of this is a cutting operation in Eastern Venezuela that took 18 hours with a swab line. It would have taken two hours with a high pressure abrasive cutter, but as this was not available at the time, a swab line cut was decided to be the best option.<sup>45</sup>

### 5.1.2 Conventional Capping

One of the more common ways of performing a surface intervention is through a capping operation. Basically, the purpose of capping is to close down the flowpath of the blowing well by the introduction of a capping stack that is able to close off the flow through ball valves or blind rams.<sup>3</sup> Fig. 5.3 shows an example of two common types of capping stacks. They include spools for diverting and spacing, and rams and valves to control the flow.

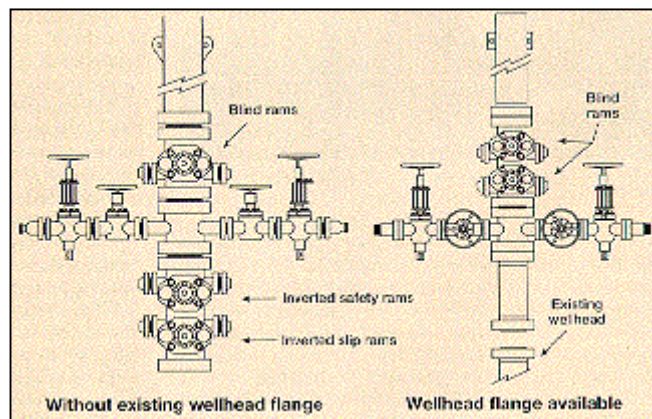


Fig. 5.3 – Two types of well capping stacks.<sup>45</sup>

The capping stacks are installed after the location has been cleared of debris and equipment, and normally after the burning well has been extinguished. There are

situations, as mentioned before, where the well is left on fire, and a stack would have to be installed on the burning well.<sup>45</sup> There are different ways of installing the stack, and every blowout is different.

On a well that is blowing at a relatively low velocity, the spin-on method might be an alternative. By hinging the flanges of the capping stack and wellhead with a long stud bolt, the stack can be swung back over the flow through a 180° rotation.<sup>45</sup> Of course, the stack is fully open, and the flow goes straight through it as the other bolts are tightened for a good seal. This method requires personnel to operate close to the stream, and as the stack is swung over the stream, the flow is redirected, with a risk of injuring workers.<sup>3</sup>

On wells with higher velocities and size, it is necessary to use different techniques. In fact, although the stack is very heavy, it needs to be snubbed down to the wellhead in these cases. By attaching snubbing cables through the flanges of the wellhead and stack, a winch is used to pull the opposing parts together, making for a safer operation.<sup>45</sup>

It is sometimes necessary to divert the well flow to reduce the sudden impact of shutting the well in. Hence, diverter spools are used to redirect the flow, and regulate it by the use of diverter lines and choke manifolds.<sup>45</sup> To reduce economic impact of the blowout, it is in certain cases possible to put the well on production through the diverter line, while operations are in progress to kill the well. However, each individual well blowout has to be evaluated for the correct post-capping action.<sup>3</sup>

### **5.1.3 Alternative Methods**

Even though capping is the most common method of approaching a surface intervention, there are other, specialized techniques that help blowout control experts do their job.

### *Stinger Operation*

A stinger is “an open-bore sub with a taper on the bottom end.”<sup>3</sup> Its operation is best understood with the help of **Fig. 5.4**, where two stingers are displayed: One in the tubing, and one in the casing valve. The full opening valve is open when the stinger is brought over the stream, and generally, high-pressure pipe and pumping equipment is attached to the stinger, and kill operations initiated once the stinger is in place.<sup>3,11</sup> As the force from the blowing well pushes the equipment upward, the stingers are run on Athey wagons, or track hoes, to get them in place, and then rigged and tied down.<sup>3,11</sup> This type of operation is suitable for wells that are possible to kill by bullheading, among other criterias.<sup>3</sup>



**Fig. 5.4 – Dual stinger operation – Left: Stinging into casing valve, and pumping down stinger in tubing. Right: Post-sting and kill operation.<sup>11</sup>**

### ***Junk Shots***

Junk shots are designed to seal flanges, BOPs, or valves that are leaking. It involves injecting different material into the flow path, thus plugging the leak before it grows bigger. Material such as “shredded rope, rubber, nut hull, ball sealers and even golf balls,”<sup>45</sup> are used to help plug the hole. In a stinging operation, the seal between the stinger and the exit of the blowing fluids is un-even and not sealed properly. Junk shots help seal it off.<sup>45</sup>

### ***Freezing and Hot Tapping***

As the word implies, freezing is actually a process of creating an ice plug of viscous bentonite and water, and acts as a temporary plug in order to replace or fix equipment.<sup>13,</sup>  
<sup>45</sup> Dry ice is normally used as the cooling agent, as direct application of liquid nitrogen would be too cold, and could make the steel brittle.<sup>13</sup> Freezing has not been used to control a blowout, but can be useful in other parts of a blowout operation.<sup>45</sup>

Hot tapping a well involves entering equipment under pressure, and is achieved by “drilling entry ports into the pressured equipment.”<sup>25</sup> It is a useful process when there are trapped pressures that hinder the normal operation of a valve. The pressured zone above or below it can be hot tapped, and the pressure bled off.<sup>13,25</sup> This type of equipment “has been used on blowouts to allow pumping into wellheads, tubulars or fire-frozen valves.”<sup>45</sup>

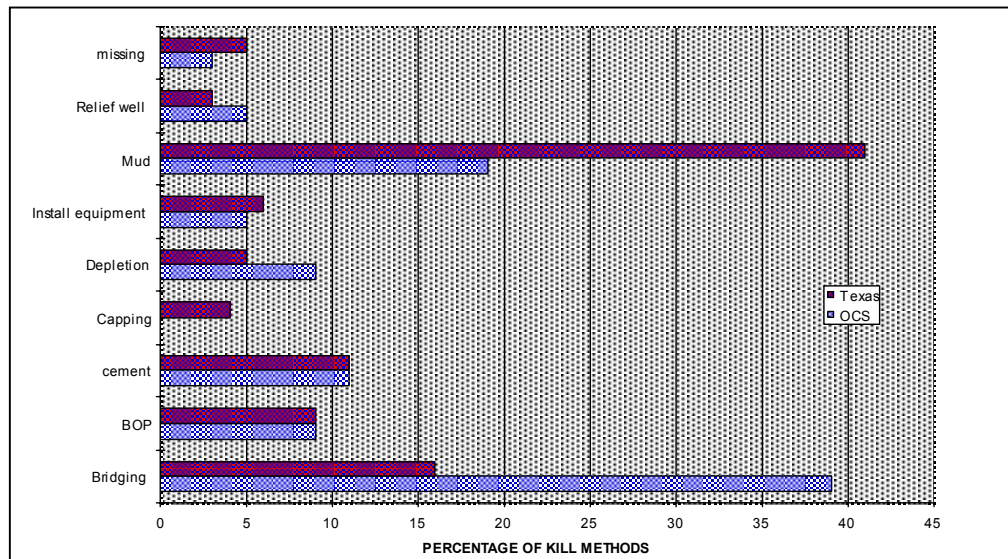
## *Plugs*

As a last resort, gunk or fast-acting cement plugs can be used to plug the flow path of the well. Gunk is a mix of cement, bentonite, and diesel, which will react with water<sup>46</sup> and turn into a thick gum-like substance. This method is sometimes used in underground blowouts, as it can isolate formations from pressures. The placement of a plug is critical, however, as a misplacement of the plug might “plug off the well above the underground flow and isolate the surface from the problem.”<sup>46</sup> There are variants of the above-mentioned gunk, such as salt gunk, which reacts with saltwater flows, or invert gunk, which reacts with oil flows or oil-based mud.<sup>46</sup>

Fast-acting cement is another material that might be used in creating plugs that are able to hold pressure, yet easy to drill through. Like gunk, it would be pumped down the wellbore through the wellhead or capping stack, and hopefully set before blowing fluids are able to push it out of the hole. As with gunk plugs, good placement is very important, and such a plug might cause more problems than already present. It is often difficult to ever regain control of a well in which a gunk or cement plug has been set.<sup>8</sup>

## *Bridging*

Bridging is a term describing when a formation is not able to withstand the pressure differential, and caves in to block off the hole. Studies have shown that bridging actually occurred in almost 40% of OCS blowouts, and in 16% of Texas blowouts for the period 1960-1996, illustrated in **Fig. 5.5**.<sup>47</sup> These natural bridging occurrences generally occur during the first 24 hours of the blowout, and the probability of bridging decreases as time goes by.<sup>48</sup> Inducing bridging is sometimes attempted, and can be accomplished by reducing the flowing bottomhole pressure (FBHP) by venting at the surface, and hoping to reduce the FBHP enough to drop below fracture pressure and force formation failure.<sup>46</sup>



**Fig. 5.5 – Comparison of kill methods between OCS and Texas from 1960 – 1996.**<sup>47</sup>

#### 5.1.4 Bullheading

As discussed before, bullheading aims at forcing the blowing fluids back into the hole, and potentially fracturing a formation. This is not advisable in a drilling situation, where a kick is to be handled, but the circumstances of a blowout are very different. As **Fig. 5.5** shows, bullheading is a very common kill method in both onshore and offshore blowout containment. It is a very easy and cost-effective way of killing a well, when there is access to the well through the surface.<sup>3</sup> At the end of a bullheading operation, the kill fluid has displaced all of the original mud and kick fluids, and hopefully the well is in hydrostatic equilibrium.

The dual stinger operation shown in **Fig. 5.4** set up a dual bullhead kill. The 2 inch by 4 inch stinger in the tubing, and the 5 inch by 8 inch stinger in the annulus both delivered 13 lb/gal (ppg) down the well, and the RU-64 was brought back under hydrostatic control.<sup>11</sup>

## 5.2 Subsurface/Relief Well Intervention

As opposed to surface interventions, relief wells attempt to kill the blowing well through intervention from a second well that is drilled specifically for this purpose. Different relief well techniques have been used throughout the years, ranging from depletion and flooding, to dynamic kills. Watson et al. define a subsurface intervention as a method where “a string of pipe is used in the blowout well to effect the kill.”<sup>3</sup>

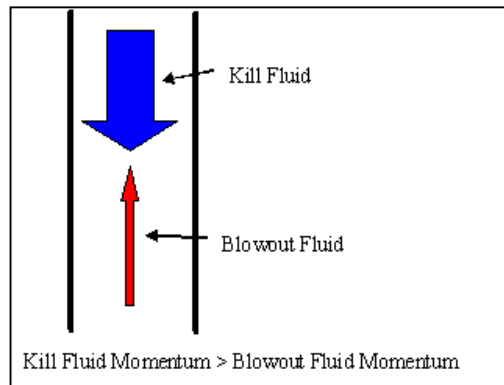
### 5.2.1 Subsurface Intervention

If the workstring is accessible through the surface equipment, a subsurface kill can be attempted. This is not always the case, and if possible, pipe may have to be run into the hole.<sup>3</sup> This could be done to a blowing well that has been diverted, or already has a capping stack in place. Most commonly, a subsurface kill would only be attempted in such a situation if regular surface kill is not preferable.<sup>3</sup>

#### *Momentum Kill*

In certain aspects, the momentum kill is somewhat similar to bullheading. However, a momentum kill is generally performed through pipe in a well that is not shut in. The principle is to pump a fluid at such a rate that the momentum of this fluid exceeds the momentum of the blowing well fluids.<sup>3, 13</sup> **Fig. 5.6** illustrates the concept. In a Momentum kill, the kill fluid is not always weighted enough to be able to statically kill the well, so the added frictional pressures of this high-rate pumping helps keep the bottomhole pressure balanced. Again, the objective is to force the formation fluids into a fractured formation after the reversal of formation fluid flow.<sup>3</sup> If the pipe is off-bottom, the pump requirements to achieve sufficient fluid-momentum might be very high. There are two ways of increasing the momentum of the fluid flow, and at the same time decrease

the pump rate: Either increase the mass of the system, i.e. the density of the kill fluid, or try to lower the string further into the hole, where the momentum of the formation fluids is lower.<sup>3</sup>



**Fig. 5.6 – Momentum kill principle illustrated by head-on fluid collision.<sup>16</sup>**

When killing a well blowing gas, high pump rates and densities are required, depending on the depth of the exit point of the pipe in the hole. When pumping at such a force, the pressure rating of the equipment should be calculated beforehand, so that potential ruptures are not initiated.<sup>3</sup> Momentum kills are a method of pumping into the well at a location below the exit point of the blowout. This means that snubbing pipe into a diverted well might be necessary.<sup>3</sup> If the well is blowing through the production tubing or drillstring; it is possible to perform a momentum kill by pumping down the backside.<sup>3</sup> The risk of conducting a momentum kill is that of creating an underground blowout.

### ***Dynamic Kill***

A dynamic kill uses frictional pressures to balance the well with the appropriate hydrostatic pressure. By weighting up the kill mud to a level of slight underbalance, or



equivalent to pore pressure, the dynamic kill method is able to achieve a kill by the use of the annular friction pressure. This approach is very common in relief wells, but can also be used in certain blowing wellbores.<sup>3</sup> The dynamic kill is similar to a momentum kill, in that it uses the high pump rates which add to the ECD of the wellbore. As this is a method that would use a string in the hole, it can be characterized as a subsurface intervention. But we will soon see that its greatest application is in relief well intervention.

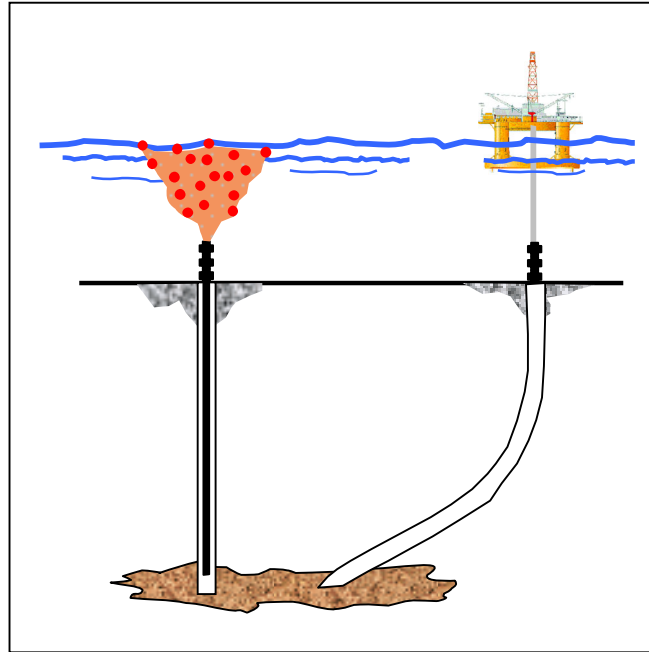
### **5.2.2 Relief Well Intervention**

Relief well intervention has changed a lot since its early days. The purpose of drilling a relief well was to provide pressure relief through drilling a vertical well next to the blowing well, thus producing from the same formation at a high rate, and reducing the flow in the blowing well.<sup>3</sup> This method would take a very long time, of course, but developments lead to designs where the reservoir was flooded with water, and later the dynamic kill made its way to relief well applications. **Fig. 5.7** shows a relief well kill.

#### ***Flooding***

In the early 1930's, the first relief well to be designed directionally was drilled, and as it aimed at the bottomhole location (BHL) near that of the blowing well, a method of pumping water into the relief well was applied.<sup>49</sup> By flooding the reservoir, the relative permeability relationships are altered, and the effective permeability to water compared to that of oil or gas is higher.<sup>3</sup> Due to the high flow rates of the blowing well, the water injected in the relief well was further drawn towards the blowing well, and when breakthrough was achieved, the well was killed. There is a lot of planning and reservoir engineering necessary to design a proper water flood, and care must be taken not to

create fractures that would propagate and lead the waterflood away from the blowing well.<sup>3</sup> The strategy of flooding the blowing well was the norm until the early 1970's.<sup>49</sup>



**Fig. 5.7 – Relief killing blowing well through depletion of waterflooding.<sup>16</sup>**

### ***Well Intersection***

In 1970, Shell experienced a blowout that was impossible to kill from the surface, and a relief well was necessary. However, instead of designing a well that would terminate at the great depth of the reservoir of the blowing well and then flooded, the well was designed to intersect the blowing well at an interval higher up.<sup>13</sup> In order to accomplish this, electric logs were used in determining the distance between the relief well and the blowing well. The wells intersected, and a perforation put the two wells in

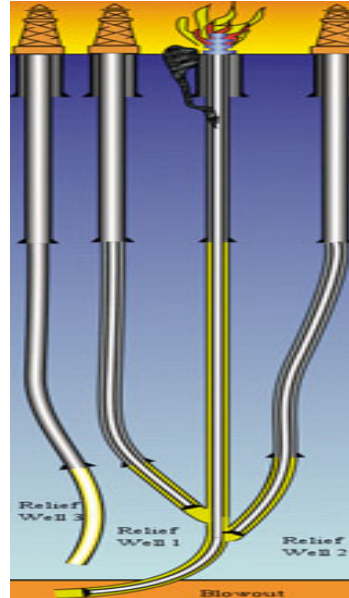
communication, leading to the solution of performing a kill by pumping water and mud directly into the blowing well through the relief well<sup>49</sup>

### *Dynamic Kill*

As directional control kept improving, the relief well design techniques kept getting better. The capability of intersecting the blowing wells lead to the development of the dynamic kill method. As discussed before, this method uses the added frictional pressures help to control the bottomhole pressure of the well. A relief well designed for dynamic kills would be targeted to intersect the blowing well at the bottom, and take advantage of the maximum possible friction pressures.

This method allows for a lighter fluid to be pumped down the relief well and yet be able to control the bottomhole pressure in a range sufficient to balance the pore pressure. By manipulating the pump rate, the fluid density can be increased, thus pressures in the wells are easier to handle, and eventually the well can be killed in a controlled manner.<sup>49</sup> Specifically, the lighter fluid, like seawater, is used to kill the well dynamically, and the introduction of the heavier mud ensures that the well is killed statically.

Since its inception in 1978, the dynamic kill method has become the relief well method of choice.<sup>3</sup> When a surface intervention is not possible, and the blowing well flows at a very high rate, the dynamic kill is a good choice. As a matter of fact, two or more relief wells might be required in very large blowouts, as shown in **Fig. 5.8**. The fact that huge blowouts can be contained by dynamic kills from relief wells is one of the advantages of this method. Another advantage is the added pressures control of regulating the bottomhole pressure through pump rate adjustments. In deepwater scenarios, where the fracture gradient and pore pressures differential poses a great challenge, the dynamic kill method could serve as a way of containing a blowout without damaging the wellbore.<sup>3</sup>



**Fig. 5.8 – Three relief wells needed in Syria blowout in 1995: Two killing dynamically, and one flooding.<sup>50</sup>**

For a relief well to be able to hit its target, electromagnetic detection methods are used to locate the casing of the blowing well.<sup>49</sup> In addition to advances in this area, huge progress has been made in directional drilling tools, and through steerable systems, relief well placement is more accurate than it has ever been. There are many factors that play into a successful dynamic kill from a relief well. Thorough work on contingency plans is one of them.

### ***Relief Well Planning and Execution***

Planning and executing a relief well operation is a huge task, and as each blowout is different, the relief well design will be dictated by the properties of the blowout at hand. Naturally, the blowout is first evaluated for a potential surface intervention, either by capping, or otherwise, and checked for a potential bullhead or subsurface intervention.<sup>49</sup>

A relief well plan should be started as soon as the potential need for one is realized, and when studies or attempts conclude that a surface intervention is not possible, the relief well should be started, sometimes even simultaneous to a capping operation.<sup>49</sup> There are many considerations to take when planning a relief well, and cost is always a major factor in blowout containment. However, safety and environmental concerns take precedent, and a relief well can oftentimes be a safer alternative than attempting a hazardous surface intervention.

By setting up specific teams for the relief well operation, the problem can be broken up in smaller pieces. Still, a clear birds-eye view of the operation is necessary, allowing for continuous evaluation of the process. The two major areas of planning a relief well intervention is the kill pumping program and the drilling and intersection program, and these two planning operations run at the same time.<sup>49</sup> The kill point of the well is the deciding factor in planning both areas, and based on the kill point, issues such as equipment requirements and availability, kill requirements, and execution of the plan can be addressed.<sup>3, 49</sup>

As the relief well operation is an operation that involves drilling, well control, logging, and directional solutions, the total management of the relief well intervention is of critical importance.<sup>13</sup>

## CHAPTER VI

### ULTRA-DEEPWATER CONSIDERATIONS

Exploration and production (E&P) in water depths over 5000 feet is not unusual today, and as operations move into deeper and deeper waters, the complexity of the task at hand increases. Along with the added operational complexity come some new challenges regarding well control of a deepwater well. Some of these challenges, like a narrow pressure window and shallow flows, we have touched upon, yet others are to be discussed. These challenges force solutions, and new technologies like dual-density and managed pressures drilling are examples of these. New technologies often bring new operational practices, and this is also the case for well control. With the arena of blowout containment being moved to a whole new environment, the game is changed, and it becomes a matter of being prepared for the conditions that face us.

#### 6.1 Ultra-deepwater Equipment

Some of the operational differences of offshore wells compared to onshore wells were discussed briefly in Chapter IV. In Ultra-deepwater drilling the only type of rig that is suitable is floaters; either semi-submersibles or drillships. The water depths are too large for fixed structures, and operations are affected because of this. Not only the drilling phase of an ultra-deepwater well is executed differently than on an onshore well, the well control considerations of such a deep well is also affected.

As discussed before, floaters move with the motions of the sea, and this necessitates some changes to the equipment used in a drilling operation. With increasing water depth follows a need for greater storage capacity. Floaters generally have less capacity than fixed structures, but with the development of fifth generation floaters specifically

designed for operation in up to 10,000 feet of water, this has been improved somewhat. With the vast amount of third and fourth generation rigs still in rotation, modifying these for use in ultra-deepwater is an option, and several papers have been written on this subject.

### **6.1.1 Ultra-deepwater Well Control Equipment**

The well control equipment used in ultra-deepwater drilling is similar to other deepwater equipment, in that commonly a subsea BOP stack, with choke and kill lines run up along the riser, is used. The pressure rating of the equipment is customized for the specific well, but in conventional ultradeep water drilling, the principles are the same as in other floating drilling.

The choke and kill lines in an ultradeep water well have a significant effect on pressure loss in the system. Compared to surface BOPs, where the lines are ran from the stack to the choke manifold in less than 75 feet, the friction pressures in choke and kill lines of several thousand feet is substantial.<sup>3,13</sup> The added frictional pressure adds backpressure that adds to the bottomhole pressure. On an already low fracture pressure, this is something that needs to be considered in a well control situation, as opposed to a situation involving a surface stack.<sup>3,25</sup> Chokeline friction pressure (CLFP) is measured routinely along with the SPP on drillships and semi-submersibles, and the casing pressure can be adjusted accordingly to maintain the bottomhole pressure when pumps are started on a kill procedure.<sup>25</sup>

### **6.1.2 Ultra-deepwater Blowout Control Equipment**

As discussed in the section about relief well planning, contingency plans should be in place before a blowout occurs. Although not required by the regulation, blowout

contingency plans are an extremely useful tool in handling blowouts in an effective and cost-efficient manner. Needs regarding blowout control equipment is incorporated into these plans, and involves many considerations.

Ultradeep water blowouts would more than likely be controlled by the use of relief wells. Relief well equipment like drilling rigs, pumping capacity, and kill fluids are essential, but each well location has specific challenges. Equipment requirements in an ultra-deepwater blowout are to be carefully detailed in the relief well planning. According to Wright et al., the “key to successful blowout control is fast and efficient mobilization of required support.”<sup>51</sup> The availability of floating vessels to perform relief well operations can be an issue, and in many cases it is advantageous to have pre-qualified and contractual “partnerships” with contractors and vendors, in case an emergency situation is to occur.<sup>51</sup> By having a continuous evaluation of potential equipment needs and availability, the operator is better prepared to start the blowout control effort when necessary. By hiring blowout control experts, the operator is buying experience and special knowledge that is not encountered by the operating company personnel routinely. Blowout control specialists come at a premium, but blowout control and firefighter pioneer Red Adair described it best when he said: “If you think it's expensive to hire a professional, try hiring an amateur first.”

Equipment requirements in a blowout situation greatly differ between onshore and offshore operation. Still, rig availability, pumping plants or frac boats, offshore cranes, supply boats, diver and anchor support vessels, and remotely operated vehicles (ROVs) are examples of some of the equipment that is essential in a relief well effort.<sup>51</sup> In the North Sea, Multi-service vessels (MSVs) are specifically designed to support in blowout containment of offshore fixed structures. In floating drilling operations, however, the same alternative is not available. In addition to the multitude of equipment requirements, necessary personnel need to be available on demand, and related services like helicopter transportation, financial management, and communication needs must be covered.<sup>51</sup>



Floating vessels in ultra-deepwater will have emergency disconnect capabilities<sup>3</sup>, which might enable the original semi-submersible or drillship to take part in the relief effort. In the blowout containment planning, blowout simulations are useful in calculating pumping requirements and the number of relief wells needed to kill the well. In addition to pump rate requirements, kill simulators can help with fluid selection, and intersection point selection. There are several commercial simulators on the market, and educational institutions, like Texas A&M University, have also developed dynamic kill simulators.<sup>8</sup>

## **6.2 Ultra-deepwater Well Control**

As discussed before, well control in offshore and deepwater environments adds increased complexity, and kick detection is more difficult in an ultra-deepwater setting. Still, kick indicators are the same as highlighted in conventional operations.

### **6.2.1 Ultradeep Water Kick Detection, Shut-in, and Hang-off Procedures**

The use of floaters adds vessel movement, and motion compensators do their best to handle the movements of the sea. Sophisticated flow and volume indicators are applied to ultra-deepwater well control equipment, but detection alarms might have to be set lower than they would on an onshore well. Again, checking for flow is not recommended in ultra-deepwater wells, and hard shut-ins are the preferred method of shutting in the well.<sup>41</sup>

When experiencing a gas kick in ultradeep water, the BOPs should be shut in immediately. In no situation should an escalating kick be attempted to be controlled by the diverter system.<sup>52</sup> In ultradeep water, the hydrostatic pressure generated by the seawater is very high, and this hydrostatic pressure helps reduce the flow rate of a potential gas blowout. When the diverter system is used for a control attempt on the gas

blowout, the backpressure generated by the seawater hydrostatic is lost, and a great risk of riser failure follows.<sup>52</sup> Additionally, gas flowing at a high rate would possibly erode the diverter system and by bringing the gas to the surface, the hazard of explosive fluids at surface is added.<sup>52</sup>

Another issue related to the pitch and heave of the floating vessel is the need to hang-off the drillpipe in the BOP stack. If slips are set at the surface, and the BOPs are closed, the vessel movement will move the drillpipe up and down through the BOP stack, sometimes damaging the seals.<sup>25</sup> By hanging the drillpipe on the top pipe ram, the drillpipe is kept static compared to the BOP stack, and wear of the sealing elements are much less. A procedure for hanging off the pipe is described in **Table 6.1**. One disadvantage in hanging off the pipe like this is that the lack of movement might cause stuck pipe problems.<sup>3</sup>

**Table 6.1 – Example of hang-off procedure.<sup>25</sup>**

- |   |
|---|
| <ol style="list-style-type: none"> <li>1. Reduce the closing pressure on the upper annular.</li> <li>2. Pick up the pipe until a tool joint is positioned just above the top pipe ram.</li> <li>3. Close the upper pipe rams.</li> <li>4. Slack off the drillstring until the tool joint rests on the ram block and the entire string weight is held by the pipe rams.</li> </ol> |
|---|

### 6.2.2 Ultradeep Water Circulation Methods

There are many well control circulation methods, as covered earlier, but the Driller's Method and the Wait and Weight Method are the two methods of choice in the industry. In ultradeep water drilling, the narrow operational pressure window is a concern, and concerns about fracturing the formation at the casing shoe is a risk during well control circulation. The Wait and Weight Method results in the lowest casing pressures at the

shoe if the kill mud reaches the bit before the gas kick enters the casing.<sup>41</sup> In many wells designed for ultradeep water, the gas kick is likely to reach the casing before the kill mud reaches the bit, and this benefit of the Wait and Weight Method is not realized.<sup>41</sup> Due to the advantages of the Driller's Method discussed earlier, including quick circulation start and operational simplicity, this method is the preferred method for ultradeep water drilling.

One example of a deepwater operation that shows similar concerns to those of ultradeep water, is the Girassol project in offshore Angola, West Africa. The margin between the pore pressure and fracture pressure is narrow, and the formations are of unconsolidated sands of high permeability and productivity.<sup>53</sup> With water depths around 4400 feet and a well design with long horizontal drains, there are both deepwater and horizontal well control concerns. Since most of the wells are drilled with OBMs, the kick detection is further complicated, due to the solubility of gas, and particular attention is paid to swabbed-in kicks.<sup>53</sup>

The choke and kill line frictional pressures are substantial, and need to be taken into account in a well control operation. When the gas enters the chokeline, mud is displaced and hydrostatic pressure in the line drops.<sup>53</sup> An increase in the backpressure is necessary to compensate for this, and the choke pressure applied depends on the gas volume expanding in the chokeline. When the gas starts exiting the chokeline and mud once again fills the chokeline, the hydrostatic pressure will increase, and care needs to be taken to avoid fracturing the formation.<sup>53</sup> Bertin et al. used an advanced kick simulator to evaluate these effects, and found that the formation is at greatest risk of fracturing when the kill mud enters the chokeline.<sup>53</sup> In order to deal with these challenges, a new "Advanced" Driller's Method was developed, based on an optimized Slow Circulating Rate (SCR).<sup>53</sup> By separating out two independent safety margins; the dynamic safety margin and the static safety margin, the "Advanced" Driller's Method aims at selecting the best control parameters for deepwater well control.<sup>53</sup> Although a modified procedure

was developed for the Girassol operation, Bertin et al. still arrive at the conclusion that the Driller's method is the preferred method in deepwater operations.<sup>53</sup>

### 6.2.3 Post-kill Procedures

When the kick has been circulated out of the hole, floating well control requires a flushing of the subsea stack. As opposed to a surface stack, the trapped fluids in the subsea stack can be under considerable pressure, and this pressure can be relieved through the closure of rams below the choke and kill lines, and pumping seawater down the kill line, through the stack, and up the chokeline.<sup>25</sup> By doing this, the hydrostatic pressure on the gas is lowered, and then bubble can be brought to the surface through safe expansion in the chokeline. The seawater is then displaced by kill weight mud.<sup>25</sup>

After this operation, the riser is still filled with mud of original weight, and the riser needs to be killed before the preventers can be re-opened. Otherwise, the HSP would be lowered, and in ultradeep water it is not unlikely that another kick could be invited into the wellbore.<sup>25</sup> **Table 6.2** shows the steps in killing the riser.

**Table 6.2 – Example of riser-kill procedure.**<sup>25</sup>

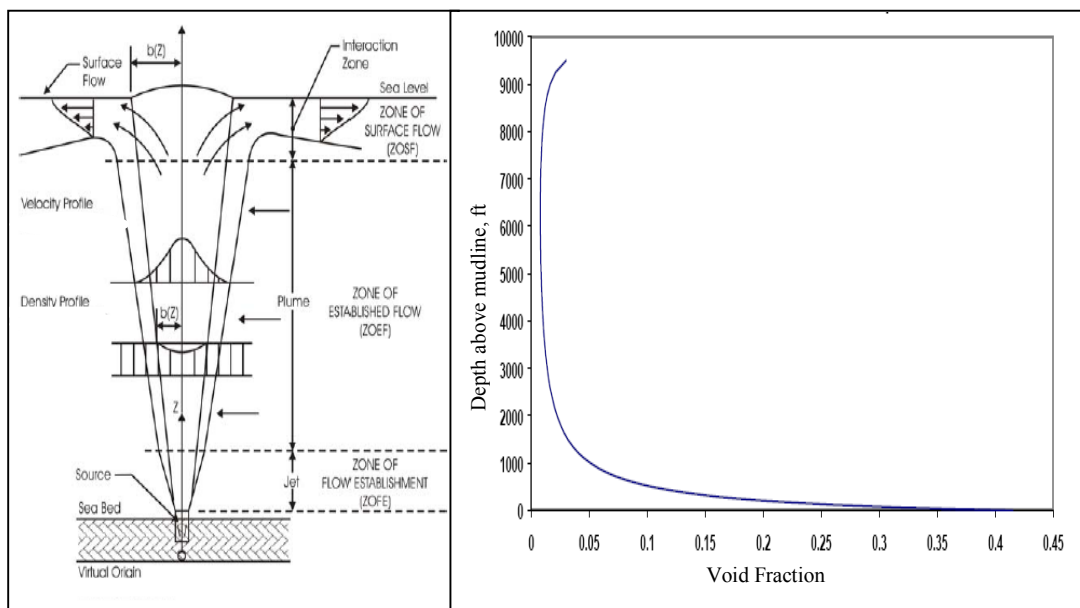
- |   |
|---|
| <ol style="list-style-type: none"> <li>1. Flush the gas from the stack with sea water as discussed above.</li> <li>2. After the gas has been flushed from the top of the stack, while keeping the lower rams closed, open the annular preventer.</li> <li>3. Allow the mud in the riser to reverse the sea water and remaining gas out of the choke and kill lines.</li> <li>4. Line up a pump on the kill line and circulate out the riser and choke line with KWM.</li> <li>5. With the riser full of KWM, we can now open the rams.</li> </ol> |
|---|

### 6.3 Ultradeep Water Blowout Control

Ultradeep water intervention will normally be handled through relief wells. However, the possibility of an underwater intervention should not be ruled out.

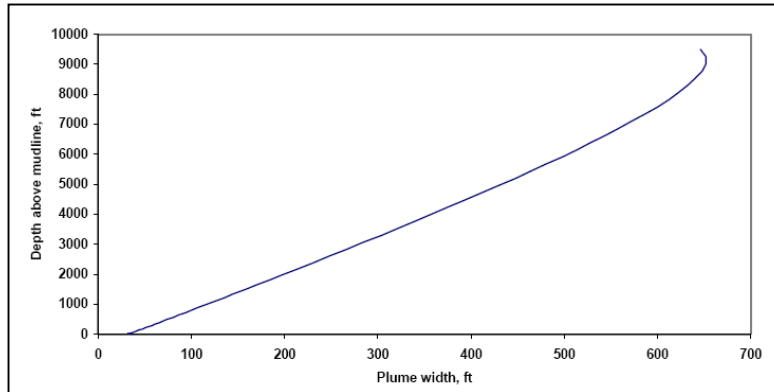
#### 6.3.1 Ultradeep Water Underwater Intervention

In shallow waters, the gas plume created by a blowout at the mudline will cause a significant loss of buoyancy at the sea level, and could cause floating vessels to sink as a result.<sup>3</sup> In ultradeep water, however, the increased water depth will help disperse the gas plume, and studies have shown that at these water depths, the buoyancy reduction is somewhere in the range of 5% or less, shown in **Fig. 6.1**.<sup>3, 12</sup> Hence, from a buoyancy perspective, semi-submersibles are the preferred floating vessel in attempting to access the wellhead at the seafloor, as a moored single-hull drillship might not be stable enough in a gas boil.<sup>48</sup>



**Fig. 6.1 – Gas plume causes less than 5% loss of buoyancy in ultradeep water.**<sup>12</sup>

As gas rises up, and reaches sea level, the gas gets vented to the atmosphere. Depending on water depth, blowout rate, and current conditions, the radius of plume at the surface can be substantial. Experimental calculations have shown that a gas blowout with rates ranging from 5 to 250 MMCFd in 5,000 feet of water could cause a plume radius of 325 feet, while the same blowout in 10,000 feet would have a radius of 650 feet at the surface.<sup>12</sup> This is illustrated in **Fig. 6.2**. As an underwater intervention could best be achieved with intervention operations located along the centerline of the well, the effects of operating in the plume have to be evaluated from a safety point of view.<sup>12</sup>



**Fig. 6.2 – Radius of gas plume at sea level is substantial in ultradeep water.**<sup>12</sup>

Before any potential underwater intervention is attempted, the well should be observed for self-killing through bridging. As shown earlier, bridging is the most common mode of control in the OCS<sup>47</sup>, and the probability of the blowing well self-killing passively through bridging is the highest in the first 24 hours of blowing out. Thus, if the well is still blowing after the initial evaluation period, planning for a possible top intervention should be further intensified.

With regard to the gas plume, deeper waters make the possibility of a vertical intervention more feasible. However, the added water depth does add certain limitations. If subsurface methods are to be applied, the blowing wellbore needs to be accessed through pipe. Trying to snub or strip into the subsea BOP stack of the blowing well in ultradeep water might be complicated, as water depths in the 5,000 to 10,000 feet range would possibly make the likelihood of the drillpipe buckling too great.<sup>2</sup>

Although no attempts have been made to vertically intervene in a blowing ultradeep water well, this is still the recommended first step of action after the initial evaluation period. As relief well operations can get extremely costly, the possibility of killing the well through underwater means is still attractive, and every possible way to access the wellbore should be attempted before deemed impossible. If an entrance to the wellbore is possible, and a subsurface intervention can be accomplished, the methods highlighted in Chapter V can be used. Momentum and Dynamic kills are options, along with other solutions like bullheading or plugging. The benefits of a successful underwater intervention are large enough to warrant continued efforts while relief well operations are planned.

### **6.3.2 Relief Well Operations in Ultradeep Water**

When a well control procedure fails, and the kick is uncontrollable, it is common practice to shut the BOPs in, and move the floater away from the well after having disconnected the riser. This would make the probability of an uncontrolled kick making it up to the deck of the rig very slim. As discussed above, underwater intervention should be attempted, but more likely than not, a relief well operation will have to be summoned in order to bring a ultradeep water blowout under control.

As in any relief well operation, the planning and execution made by the management team is of extreme importance. Issues like equipment availability have been touched

upon, and the overall relief well process in ultradeep water will be roughly the same as in any offshore relief well intervention. There are some added points for ultradeep water, however.

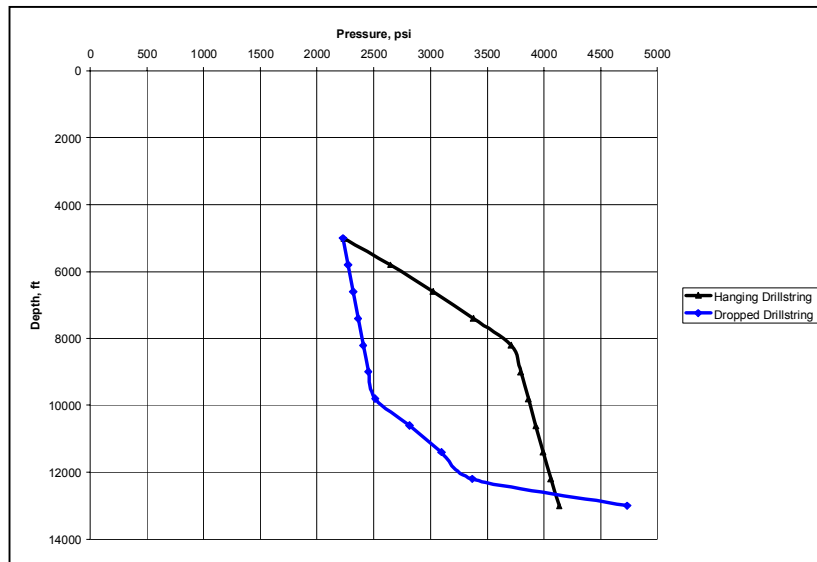
As in drilling the original well, ultradeep water drilling requires floaters that are designed to operate in this environment. Fifth generation floaters are often used, and riser and well design is affected by the large water depth. The relief well needs to be planned as carefully as time permits, and the lessons learned while drilling the original hole might prove useful in drilling the relief well. Also, simulation tools have proven their worth in calculating the kill requirements of the blowing well. These simulations help determine the number of relief wells necessary for the operation, as well as the relief well design.<sup>49</sup>

For hydrocarbon assets to be economic in ultradeep waters, the production rate needs to be high. One consequence of this is that a blowout from these reservoirs could potentially blow at a very high rate, thus requiring a higher kill rate.<sup>2</sup> A large wellbore in the blowing well will lead to less friction pressure being generated for a dynamic kill from a relief well, which in turn might lead to the well resisting a dynamic kill from a single relief well.<sup>2</sup> Santos showed this to be the case when a 12 ¼ inch wellbore with typical ultradeep water reservoir parameters required an injection rate of 7,000 gallons per minute (gpm).<sup>52</sup>

The narrow operating window between fracture pressure and pore pressure in ultradeep water environments is well known, and some of the issues have been discussed in earlier chapters. With regard to relief wells, the low fracture pressure plays a role in the decision whether or not to drop the drillstring in the blowing well, or to leave it hanging. Simulations show that a dropped drillstring will lower the kill rate required in the relief well, due to the increased bottomhole pressure that results.<sup>2</sup> This may seem like a great advantage in the kill at first glance, but since the fracture pressure is so low, it is likely



that the bottomhole pressure was already close to it. The dropped drillstring may in fact lead to an increase in bottomhole pressure that is high enough to fracture the formation, and cause further well control complications.<sup>2</sup> Simulators like COMASIM, developed at Texas A&M University, help in making the right decisions for the right scenario. **Fig 6.3** illustrates this point.



**Fig. 6.3 – Dropped drillstring results in higher bottomhole pressure than hanging drillstring in the same wellbore.<sup>16</sup>**

Another consideration in designing the relief well kill is the wellbore size of the relief well itself. A larger relief well annular inner diameter (ID) to drillpipe outer diameter (OD) ratio is beneficial in reducing the pump requirements of the relief well.<sup>2</sup> Also, by locating the relief well as close as possible to the blowing well, the MD/TVD ratio will be close to unity, which will lessen the pump requirements in the kill effort. Normally, seawater is used in an ultradeep water relief well kill, but it should be noted that a weighted mud would reduce the pump and kill rate requirements.<sup>2</sup>

One result of operating in this water depth does lend an advantage with regard to blowout gas rates. The hydrostatic pressure generated by the large water column does help reduce the blowing rate, and a blowout in ultradeep water blows at a lower rate than it would if the same well were located in shallower water depths.<sup>52</sup>

### **6.3 Ultradeep Water Well Control Complications and Challenges**

Many of the issues related to ultradeep water drilling were discussed in Chapter IV. Specifically, kick detection and shut-in differences were discussed, as well as shallow flows, lost circulation, and the challenges related to the narrow operating window between the pore pressures and the low fracture gradients. The friction pressure losses in the choke and kill lines are another issue of ultradeep water well control.

Some of the well control concerns of this deepwater operation are common to those experience in ultradeep water depths around the world. Low Leak-off test (LOT) values have been implied before with regard to the narrow operating window. At ultradeep water depths, the temperature is very low, and this affects the mud properties being pumped down the hole, and strong gelling effects might become an issue.<sup>53</sup> Another result of low temperature is the risk of hydrates forming.

Hydrates are a solid crystalline structure that resembles snow. Gas hydrates are formed when hydrocarbon gas combines with water under temperature and pressure conditions allowing this.<sup>54</sup> Of practical interest is the fact that this solid can form at temperatures in above the freezing point for water if the pressure is sufficient. In many ultra deepwater wells, this is the case. At a depth of 3000 feet, the water temperature in the Gulf of Mexico is around 41° F, and even lower in ultradeep water.<sup>3</sup> Due to the high hydrostatic pressures resulting from the great water depth, the conditions for hydrate formation are present, and these hydrates could potentially plug up lines or subsea equipment. Specifically, they can complicate the closing of BOPs, plug choke and kill lines, as well

as “interfere with the ability to read wellbore pressures.”<sup>3</sup> Thus, hydrates should be considered in any ultradeep water drill plan, and preventive actions might have to be taken. One way of dealing with hydrates is to pump inhibitors or water solutes, like alcohols, to help dissolve the hydrates<sup>54</sup>, and by conditioning the drilling fluids with salts, hydrates might be prevented in the first place.<sup>3</sup> With increasing water depth comes an increase in hydrostatic pressure and a decrease in temperature. Gas hydrates are a real threat in ultradeep waters.<sup>53</sup>

As we have seen, shallow gas flows can pose a major hazard in ultradeep waters. Another common shallow flow in these environments is that of water. Overpressured water formations at shallow depths are common in the ultradeep water regions of the world, and are typically encountered in the conductor pipe section.<sup>3</sup> The fact that these flows occurs at such shallow depths leads to the risk of the inflow breaching to the surface. As we know, the shallow formations in ultradeep water are often of an unconsolidated nature, which further increases the risk of the shallow water flow (SWF) washing out the sands up along the structural casing.<sup>3</sup> The great erosion that might follow can cause major damage to the subsea equipment, and a loss of the well could result.

As with many well control issues, the best way to deal with SWF is to prevent them from happening in the first place. Thorough preparation and planning is necessary. If a shallow water flow is encountered, it is in some cases possible to weight up the mud system, and drill with this mud, with returns to the seafloor.<sup>3</sup> This is a difficult task in ultradeep water, and might turn into a very expensive fix. Some of the preventive measures applied to SWF risks are to plan the hole by setting extra casing strings above and through the SWF section.<sup>3</sup> SWF diverters are another way of dealing with the flow, and chemicals have also been used to deal with the issue. This is a topic that has proven tricky for the industry, and further research is necessary to come up with better solutions to it.

In addition to hydrates and shallow flows, there are other geohazards that can affect ultradeep water operations. These include irregular seafloor topography, landslides, sea floor erosion, as well as the ever-present unconsolidated shallow formations.<sup>55</sup>

Predrilling geohazard studies for exploratory wells are highly recommended. This could entail using seismic analysis as well as potential sampling of the sea floor.<sup>55</sup>

## **6.4 New Ultradeep Water Technologies**

As deeper and deeper waters are tested, the limits of technology are put to the test. The challenges and complications of ultradeep water drilling stimulate innovation, and the methods which we use to drill our ultradeep water wells are continuously evaluated and improved. The use of surface stacks in deepwater drilling is one area that has been tested, and different solutions to drilling altogether, like dual-gradient drilling, is another one. The petroleum industry is truly viewing ultradeep waters as one of the last frontiers, and new technologies to reap the benefits of these fields are under constant development.

### **6.4.1 Surface BOP Stacks in Ultradeep Water Drilling**

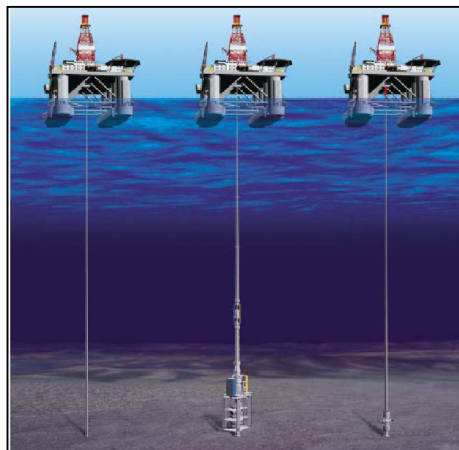
As discussed previously, the common practice for ultradeep water drilling is to use a large riser with a subsea BOP stack. The temperature and pressure conditions at these water depths are difficult, with complications like the ones described above, and alternative solutions have arisen. One of these techniques was the use of surface stacks on second and third generation drilling rigs in deep water.<sup>56</sup> Unocal pioneered this technique in Indonesia, and since then, other companies have followed.

Instead of the usual subsea BOP, surface BOP drilling involves hanging a land/jack-up surface stack below the moonpool of a floater.<sup>56,57</sup> In order to be able to use a surface stack, the riser has to be able to withstand greater pressure, and high-pressure risers are a

necessity. As an illustration, the operation can be likened to that of a jack-up rig, only from a floater in deep waters.<sup>56</sup> When first applied, the procedure was used in calm environments, with cost and time being shaved off the conventional drilling of these shallow water depths. The success further pushed the technology into deeper water depths, with cost savings in the areas of mooring systems, heave compensation systems, casing design, and time savings on equipment testing and configuration.<sup>56</sup> One of the major cost reducers is the fact that third generation semi-submersibles suffice in this type of operation. Where a fifth generation floating vessel would have day rates around \$200,000, the third generation rig with a surface stack would cost about \$80,000/day.<sup>57</sup> Also, running of subsea equipment is taken out of the equation and well control is simplified.<sup>57</sup>

With the original process being void of any means of controlling the well at the mudline, the technology had limitations with regard to operating environment. The development of an Environmental Safe Guard (ESG) has provided a means to shut the well off from a subsea location, thus enabling the system to operate in less benign environments.<sup>56, 57</sup>

**Fig. 6.4** shows examples subsea and surface BOP usage.



**Fig. 6.4 – Drilling with surface BOP, subsea BOP, and surface BOP with ESG.<sup>56</sup>**

Touboul et al. conclude that drilling with a surface BOP with ESG in ultradeep water enables older, smaller floaters to be utilized more effectively, and relieving some of the pressure in the ultradeep water rig market.<sup>56</sup> Also, they claim that surface BOP operations are more efficient, and can be operated more safely. The combination with the Environmental Safe Guard expands on the operational environment previously open to surface BOP drilling.<sup>56</sup>

#### **6.4.2 Expandable Casing**

The use of expandable casing has increased dramatically in the industry in recent years, and the application has diversified. In the surface BOP drilling cases discussed above, expandable casing was also incorporated into the well plan. Originally a part of the contingency plan, the expandables were in fact utilized, and helped salvage the well.<sup>57</sup> The OTI-1 well experienced shallow water flows, kicks, and severe lost circulation, and one casing string had to be set higher than planned. Expandable casing was run, and brought the well back to the diameter of the original plan with success.<sup>57</sup> The combination of technologies like surface BOP stacks, subsea shut-off devices, and expandable casing has proved to be useful in ultradeep water operations, this could be a step in the direction of increasing options for ultradeep water well architecture.<sup>56,57</sup>

#### **6.4.3 Ultradeep Water Slim Riser Drilling**

Another method for potentially reducing the costs of an ultradeep water well is the use of slim riser systems. As opposed to the conventional 21 inch riser with subsea BOP systems, the slim riser concept aims at using a riser with a smaller diameter in order to reduce the rig size requirements of the well.<sup>58</sup> The riser size reduction could lead to the possibility of using a third or fourth generation floater, with reduced riser tensioner loads, space, and storage capacity.<sup>58</sup> Slim riser technology is best suited for situations

where the well can be drilled with three or less casing strings needed for production. Also, the economics are most favorable when there is an extensive drilling campaign to warrant the rig conversion.<sup>58</sup>

The slimming of the riser also causes the casing design to be slimmed down. Again, a combination of technologies might help make this an economically viable solution. As discussed before, expandable casing has made great strides in recent years, and this is a technology that could help extend the casing setting depths of these slim riser wells.<sup>58</sup> Bicenter bits, which use pilot bits followed by a reamer, are complimentary to slim hole drilling.<sup>58</sup>

### ***BOP Control System***

With the modification of a drilling rig for a slim riser system follows modification of the BOP control system. One such retrofitable BOP control system is the EH Control System, which is a combination of electrical and hydraulic processes. This system has a reaction time equal to the more expensive MPX control systems, yet it is customizable to existing Piloted All-Hydraulic Control Systems often found on third and fourth generation floaters.<sup>40</sup> The installation of the BOP control system is very time consuming, and is one of the main reasons a slim riser system needs a long enough drilling program to warrant its application.<sup>58</sup>

#### **6.4.4 Method Selection Guidelines**

Childers and Quintero emphasizes the need to use the “right” system for the “right” application. They suggested a list of broad recommendations in selecting the best method for constructing an ultra-deep water well.<sup>58</sup> **Table 6.3** summarizes their

guidelines, and is meant as a way of provoking a discussion of the pros and cons of the different methodologies.

**Table 6.3 – Guidelines for ultradeep water drilling method selection.<sup>58</sup>**

<p>1. <u>Conventional best when:</u></p> <ul style="list-style-type: none"> <li>• Exploration with low confidence of number of casing strings.</li> <li>• More than 5 casing strings will be set and expandable casing is not an option.</li> <li>• MODU is not modified to use SBOP and/or Slim Riser and the drilling program is very short thus preventing a payout of the MODU modifications and equipment.</li> <li>• Wells to be kept for production and completion.</li> </ul> <p>3. <u>SBOP with SDS best when:</u></p> <ul style="list-style-type: none"> <li>• All of the bullet points in Item 2 are present and there is a significant shallow depth gas hazard that it is anticipated and will require a well kill operation.</li> <li>• All of the bullet points in Item 2 are present and there is the possibility for planned abandonment of the well (e.g., typhoon area).</li> </ul>	<p>2. <u>SBOP best when:</u></p> <ul style="list-style-type: none"> <li>• Extended number of wells to pay for MODU modifications, mooring systems, crew training and support systems.</li> <li>• Normal pressure, 3 or less strings of casing under the BOP setting and simple, straightforward wells.</li> <li>• Benign environment.</li> <li>• Wells are expendable.</li> </ul> <p>4. <u>Slim Riser Concept best when:</u></p> <ul style="list-style-type: none"> <li>• Three or less casing strings are required under the BOP setting.</li> <li>• Wells are to be kept for production.</li> <li>• Economics are extremely important and a 3<sup>rd</sup> or 4<sup>th</sup> Generation MODU is required to make the project viable. As of Summer 2004 day rates for qualified 4<sup>th</sup> Generation MODUs are approximately 30% to 50% less than 5<sup>th</sup> Generation units, i.e., \$40K to over \$100K per day, thus creating substantial savings.</li> <li>• Long enough program to pay for the Slim Riser equipment and MODU modifications.</li> <li>• Wells are more complicated and are longer than what can be done with SBOP. This would include extensive coring, well testing, formation problems, etc.</li> </ul>
--	---

#### 6.4.5 Dual-gradient and Managed Pressure Drilling in Ultradeep Water

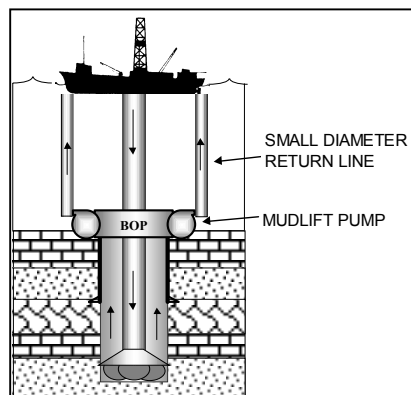
As we have seen in our previous discussions, the challenges of ultradeep water drilling are many, with the narrow operating pressure window perhaps standing out as the biggest one. Riser-technology is another issue that is reaching its current limits, and as a result, there have been several Joint Industry Projects (JIPs) to investigate the possibility of so-called dual-gradient drilling.



This technology is a step-change away from conventional riser drilling, and involves a system to reduce the wellbore pressures above the mudline, yet controlling the pressure below the mudline with a heavier fluid system.<sup>3</sup> The effect is a system with two separate pressure gradients; one above, and one below the mudline. Hence: The name dual-gradient drilling.

### ***SubSea Mudlift Drilling***

Many different approaches have been taken to this concept, including methods of lightening the mud column with hollow glass spheres, or through injection of nitrogen through gas-lift valves.<sup>3</sup> One system that has been proven in field tests is the SubSea Mudlift Drilling (SMD) system.<sup>59</sup> This systems achieves dual-gradients through the use of pumps at the seafloor which circulate the fluids and cuttings back to the surface through a small diameter return line (RL).<sup>60</sup> By letting the inlet pressure of the subsea pumps equal the hydrostatic pressure of seawater at the mudline, a heavier mud can be circulated downhole to stay in the window between pore and fracture pressure for a greater depth interval compared to conventional riser drilling.<sup>60</sup> **Fig. 6.5** shows the SMD principle.



**Fig. 6.5 – SubSea Mudlift Drilling Dual-gradient system.**<sup>61</sup>

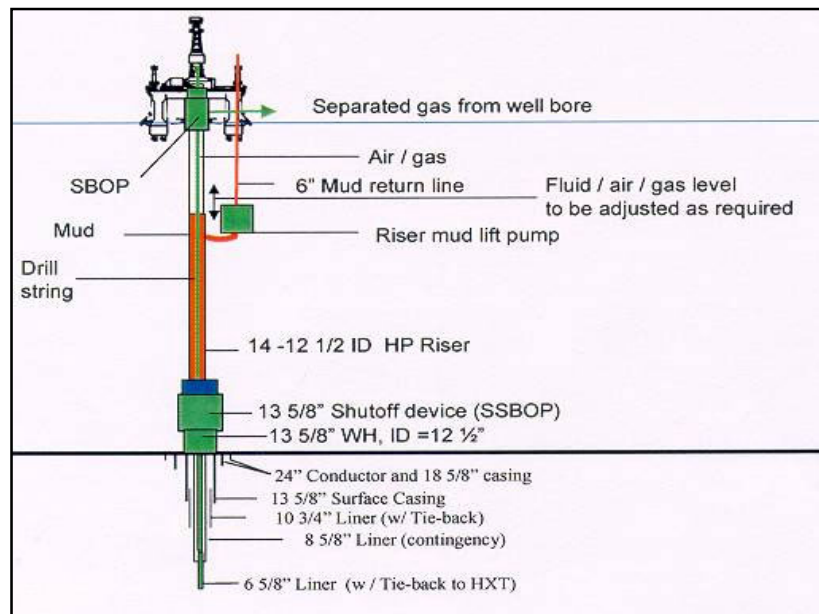
The fact that SMD allows for longer sections drilled before casing has to be set, leads to fewer casing strings, and the potential for reaching deeper targets in ultradeep water. Some of the additional advantages of dual-gradient drilling are the fact that less mud is required for the operation, and better station keeping.<sup>60</sup> Again, the use of second and third generation floaters offers a great source of cost reduction, and better use of these types of rigs. There is a potential for reducing drilling time with SMD, and as the target is reached with a larger hole size, due to the reduced number of casing strings, there is a potential for increased production rates and better overall economics of projects.<sup>60</sup>

As in conventional riser drilling in ultradeep water, early kick detection is equally important in dual-gradient drilling. Most conventional kick indicators apply to SMD as well, and some of them are enhanced.<sup>60</sup> As the seafloor pumps are monitored constantly, they can serve as a valuable kick detector, in that a kick would cause an increase in the subsea pump rate. Flow meters and pressure gauges on the pumps also help identify a kick quicker.<sup>60</sup> A drillstring valve (DSV) was specially designed for SMD to prevent u-tubing from occurring, and this has to be factored into procedures especially dealing with tripping procedures.<sup>60</sup> Also, the presence of the DSV enables the well to be shut-in immediately, similarly to conventional methods.

Dual-gradient drilling (DGD) is fundamentally different from conventional procedures, and although some of the well control procedures are similar, special training for DGD well control is paramount in achieving safe operations. Safe well control procedures have been developed for SMD, and although the use of a DSV complicates some issues with regard to the measurement of SIDPP and the preparation of the drillpipe pressure decline schedule, the procedures developed provide safe ways of detecting and handling kicks.<sup>60</sup>

### ***Controlled Mud Cap and Low Riser Return System***

Another method that uses pumps below sea level to bring the returns to the surface is the Low Riser Return and Mud-Lift System (LRRS).<sup>1</sup> There are similarities between LRRS and SMD, but there are also major differences. The principle behind LRRS is to use a smaller high pressures riser combined with surface and subsea BOPs. By connecting a subsea pump to the riser below sea level, and taking returns from the lower parts of the riser, a mud cap situation is created, where the mud level in the riser can be adjusted with the pump.<sup>1</sup> **Fig. 6.6** shows an overview of the process.



**Fig. 6.6 – Low Riser Return and Mud-Lift System.**<sup>62</sup>

Conventional pressure control involves adjusting the mud weight of the system to increase the hydrostatic pressure in the well, as well as controlling the friction pressures. The Deep Ocean Riser System with a Low Riser Return System (DORS w/ LRRS) is

able to adjust the mud level in the high-pressure riser, thus adjusting the bottomhole pressure accordingly. This controlled mud cap (CMC) method has many advantages. The use of heavier drilling fluid with a lower level in the riser enables kicks to be circulated out of the well without experiencing added frictional pressures.<sup>1</sup> Also, during conventional drilling in ultradeep water it is impossible to achieve a riser margin. On the contrary, the LRRS even makes it possible to drill an ultradeep water well underbalanced, and still have a riser margin. This is beneficial in that an emergency disconnect would actually increase the bottomhole pressure of the well, and help minimize the consequences of the blowing formation fluids.<sup>1</sup> As the top part of the riser will be filled with air and gas, this portion of the riser will act as gas knock-out separator due to the low pressures. The use of heavier mud at a lower level in the riser will in fact reduce the pressure at the mudline. Hydration formation is dependent on temperature and pressure, and because of this pressure reduction, the probabilities of hydrates forming are reduced.<sup>62</sup>

Well control with this system is greatly improved compared to conventional riser drilling. There are no choke or kill lines, and the annulus between the drillpipe and the riser will act as the return path for the fluids.<sup>62</sup> Many conventional kick indicators are still valid. Kick detection is improved, however, due to fact that formation flow will affect the pump speed, much like in Subsea Mudlift Drilling.<sup>62</sup> Additionally, the mud level in the riser will be monitored, and it will in fact serve as a very accurate trip tank when pumps are shut off, and flow can be detected easier than in a conventional scenario.<sup>62</sup>

After a kick has been detected, there is no need to wait for fluids to be weighted up to kill the well. An almost instantaneous increase of the mud level in the riser will bring the hydrostatic pressure into overbalance, and the flow is arrested. Since the well has been killed, the influx can be circulated out of the well in a manner similar to conventional circulation methods.

Dual-gradient and managed pressure techniques, like the one discussed above, promises great potential for the ultradeep water arena. As necessity brings about change in our industry, the pushing of the ultradeep water frontier will depend on technologies like these being fully developed and field tested. Although very different from conventional riser drilling, the advantages of these methods seem to greatly outweigh any added operational complexity. So until the day where we are drilling our ultradeep water wells with underbalanced expandable casing drilling, through the use of dual-gradient mudlift systems, these technological step-changes are taking us in the right direction.

### ***New Approach: SubSea Mudpump Kill***

An untested approach for performing a dynamic kill would be to drill the relief well using SMD technology. This in itself has not been performed before, but instead of killing the well conventionally through a dynamic kill through the drillstring, one could make use of the subsea pumps at the seafloor. As described before, these pumps help create the dual gradient that is achieved in SMD drilling, by taking annular returns from the wellbore and pumping them back through the return line to the surface. If the direction of the pumps were reversed, and seawater sucked in at the sea floor, these pumps could serve as a means of providing seawater as kill fluid down the annulus of the relief well, and perform a dynamic kill on the blowing well. Some of the advantages of this operation would be the unlimited supply of seawater as kill fluid, in addition to avoiding the pressure loss of pumping down a very long drillstring in the riser. A further discussion of this topic is presented in the Appendix.

## CHAPTER VII

### DISCUSSION, CONCLUSIONS, AND RECOMMENDATIONS

An electronic well-control manual has been developed, and an added focus on operations in ultradeep water has been included. The manual includes discussions on blowout statistics and trends, well control methods, well control complications and challenges, blowout control methods, and ultradeep water considerations.

#### 7.1 Development and Assessment of Electronic Well Control Manual

The information presented in this thesis represents the content of the electronic well control manual. Similar to the table of contents, the manual will have a main menu where the information of the manual is structured and organized in a logical, easy-to-find manner. By clicking on the topic of interest, the electronic cross-reference takes you to the section containing the information. This section is further linked to subjects relating to the topic, in addition to being carefully referenced. By pointing and clicking the superscripted references, the user is redirected to the source of information in the Reference section. If desirable, the user may investigate the sources further, as the abstract of the source document is provided through another link.

The electronic well control manual was created in Microsoft Word, as this is a very versatile software program with regard to text formatting, compatibility, and user availability. The hyperlink function of Word proved to be efficient in linking topics together, and the software was well suited for a first version of the electronic manual. There are some drawbacks to using Microsoft Word, however, including the fact that the electronic file sizes can get fairly large due to the figures and tables included. As the

software is the standard for word processing, the electronic well control manual is at risk of appearing unsophisticated.

## **7.2 Well Control and Blowout Conclusions and Recommendations**

Along with the added pressure and complexity of ultradeep water wells, the fact that the rate at which ultradeep water wells are drilled is increasing, leads to the unfortunate conclusion that blowouts are bound to occur. The industry is aware of this, and needs to take certain steps in order to be prepared for this.

- Human error or equipment failures are the cause of blowouts, and improvements are possible.
- Kick detection is more difficult in an ultradeep water environment, and greater attention to indications is necessary.
- Upon kick detection, an ultradeep water well should be closed in using a hard shut-in procedure, and no flow check should be performed, in order to avoid further formation fluid influx.
- The Driller's Method is the preferred method of conventional kick circulation in ultradeep water due to its simplicity and ability to start the circulation immediately.
- Contingency plans, including relief well intervention, should be conducted for every ultradeep water drilling operation.
- Bridging is the most common mode of control of blowouts in the Outer Continental Shelf, and if they do not occur during the first 24 hours of the blowout, alternative blowout containment is to be applied.
- Although buoyancy problems are manageable, underwater intervention is very difficult in ultradeep water, due to the necessary length of the intervention string, and the difficulty of subsea mechanical intervention operations.

- Dynamic kill simulators are an integral part of relief well design, and relief wells are the likely mode of blowout control in ultradeep water.
- Non-conventional drilling methods, like Surface BOP and slim riser drilling, add options to ultradeep water well design.
- Dual-gradient and Managed Pressure Drilling offer potential for better performance, and cost savings in ultradeep water. Well control procedures will be affected by these technologies, but with proper training and experience, kick detection and handling will be as good as, if not better than, conventional well control.

### **7.3 Recommendations for Future Work**

Other Help System Software packages, like Macromedia's Robohelp, should be evaluated for a further improvement of the electronic well control cross-reference. This type of software is especially designed for creating help systems, and results in systems that appear sophisticated and professional, yet are easy to use. Information can be imported from many sources, including Microsoft Word, and the current version of the electronic well control reference is easily convertible to a help system of this sort.

The task of creating an up-to-date source of well control and blowout containment techniques and considerations is a big one. Due to the incredible amount of knowledge and case histories, it is recommended to continue the work already described in this thesis. It is important to keep the information current, and there is also room for different aspects of well control to be included. An addition of more technical descriptions and calculations would be beneficial, and since the electronic well control manual is easily customizable and updateable, it has the potential to be expanded and updated continuously.



As a part of a bigger project, the well control reference should be made available to the public through the Texas A&M University Harold Vance Department of Petroleum Engineering website. Additionally, links to other parts of the project, like the COMASim dynamic kill simulator, should be created, and all work should be compiled and presented as a total package.

## NOMENCLATURE

BHA	Bottomhole Assembly
BHL	Bottomhole Location
BOP	Blowout Preventer
BOPE	Blowout Preventer Equipment
CDPP	Circulating Drillpipe Pressure
CLFP	Chokeline Friction Pressure
CMC	Controlled Mud Cap
DGD	Dual-Gradient Drilling
DORS	Deep Ocean Riser System
DPP	Drillpipe Pressure
DSV	Drillstring Safety Valve
E&P	Exploration & Production
ECD	Equivalent Circulating Density
EH	Electro-Hydraulic
ERD	Extended Reach Drilling
ESG	Environmental Safe Guard
FBHP	Flowing Bottomhole Pressure
FCP	Final Circulating Pressure
GoM	Gulf of Mexico
GPM	Gallons per Minute (gal/min)
GPRI	Global Petroleum Research Institute
H <sub>2</sub> S	Hydrogen Sulfide
HCR Valve	Remotely Operated Hydraulic Control Valve
HD	Horizontal Departure
HSE	Health, Environment, and Safety
HSP	Hydrostatic Pressure
ICP	Initial Circulating Pressure

ID	Inner Diameter
JIP	Joint Industry Project
KWM	Kill-Weight Mud
LCM	Lost Circulation Material
LMRP	Lower Marine Riser Package
LOT	Leak-off Test
LRRS	Low Riser Return and Mud-Lift System
LWD	Logging While Drilling
MAASP	Maximum Allowable Annular Surface Pressure
MACP	Maximum Allowable Casing Pressure
MD	Measured Depth
MMcfd	Million Cubic Feet per Day
MMS	Minerals Management Service
MODU	Mobile Offshore Drilling Unit
MPX	Multiplex
MSV	Multi-Service Vessel
MWD	Measurement While Drilling
OBM	Oil Based Mud
OCS	Outer Continental Shelf
OD	Outer Diameter
OTRC	Offshore Technology Research Center
OWM	Original Weight Mud
PDC	Polycrystalline Diamond Cutter
ppg	Pounds per Gallon (lb/gal)
PVT	Pit Volume Totalizer
R&D	Research & Development
REPSA	Research Partnership to Secure Energy for America
RL	Return Line
ROP	Rate of Penetration

ROV	Remotely Operated Vehicle
SCR	Slow Circulating Rate
SICP	Shut-in Casing Pressure
SIDPP	Shut-in Drillpipe Pressure
SMD	Subsea Mudlift Drilling
SWF	Shallow Water Flow
TIW	Texas Iron Works
TOC	Top of Cement
TVD	True Vertical Depths
WBM	Water Based Mud
WOC	Waiting on Cement
ZOEF	Zone of Established Flow
ZOFE	Zone of Flow Establishment
ZOSF	Zone of Surface Flow

## REFERENCES

1. Fossli, B. and Sangesland, S.: "Managed Pressure Drilling for Subsea Applications; Well Control Challenges in Deep Waters," paper SPE/IADC 91633 presented at the 2004 SPE/IADC Underbalanced Technology Conference and Exhibition, Houston, 11-12 October.
2. Noynaert, S.F. and Schubert J.J.: "Modeling Ultra-Deepwater Blowouts and Dynamic Kills and the Resulting Blowout Control Best Practices Recommendations," paper SPE/IADC 92626 presented at the 2005 SPE/IADC Drilling Conference, Amsterdam, 23-25 February.
3. Watson, D., Brittenham, T., and Moore, P.L.: *Advanced Well Control*, Text Book Series, SPE, Richardson, Texas (2003).
4. Bourgoyne, A.T. Jr., Chenevert, M.E., Millheim, K.K., and Young F.S. Jr.: *Applied Drilling Engineering*, second printing, Textbook Series, SPE, Richardson, Texas (1991).
5. Seacom: "An Overview of the Piper Alpha Incident," Canada, <http://www.seacomcanada.com/paeng.htm>, 19 March 2005.
6. Walters, K.B. and Henderson, G.: "Management Systems in Production Operations," paper SPE 25342 presented at the 1993 SPE Asia Pacific Oil and Gas Conference, Singapore, 8-10 February.
7. Brudvik, M.: "Skal sikre fremtiden," <http://www.uib.no/elin/elpub/uibmag/0102/sikkerhet.html>, 19 March 2005.
8. Oskarsen, R.T.: "Development of a Dynamic Kill Simulator for Ultradeep Water," PhD dissertation, Texas A&M U., College Station, Texas (2004).
9. Adams, N. and Young, R.: "Underground Blowouts: What You Need To Know," *World Oil* (January 2004).
10. Holand, P.: *Offshore Blowout Causes and Control*, Gulf Publishing Company, Houston (1997).

11. Garner, J. and Markus, W.: "Controlling Sabotaged Oil Wells in a War Zone: Between Iraq and a Hard Spot," *World Oil* (January 2004).
12. Adams, N. and Economides, M.J.: "Characterization of Blowout Behavior in Deepwater Environments," paper SPE 79879 presented 2003 SPE/IADC Drilling Conference, Amsterdam, 19-21 February.
13. Grace, R.D.: *Advanced Blowout and Well Control*, Gulf Professional Publishing, Houston (1994).
14. Gjorv, B.: "Well Control Procedures for Extended Reach Wells," M.S. Thesis, Texas A&M U., College Station, Texas (2003).
15. Oskarsen, R.T.: "Development of a Dynamic Kill Simulator for Blowouts Occuring in Ultra-Deepwater," AADE Poster Presentation, Houston, (2003)
16. Noeynaert, S.F.L "Ultradeep Water Blowouts: COMASIM Dynamic Kill Simulator Validation and Best Practices Recommendations," M.S. thesis, Texas A&M U., College Station, Texas (2004).
17. Paleontological Research Institute: "Spindletop- the birth of the modern oil industry," <http://www.priweb.org/ed/pgws/history/spindletop/spindletop.html>, 19 March 2005.
18. Society of Petroleum Engineers: "Drilling Technology," [http://www.spe.org/spe/jsp/basic/0,,1104\\_1714\\_1003922,00.html](http://www.spe.org/spe/jsp/basic/0,,1104_1714_1003922,00.html), 20 March 2005.
19. "Red Adair, Biography", [www.redadair.com](http://www.redadair.com), 20 March 2005.
20. Skalle, P. and Podio, A.L.: "Trends Extracted from 1200 Gulf Coast Blowouts During 1960-1996," paper SPE 39354 presented at the 1998 IADC/SPE Drilling Conference, Dallas, 3-6 March.
21. Wylie, W.W. and Visram, A.S.: "Drilling Kick Statistics," paper SPE 19914 presented at the 1990 IADC/SPE Drilling Conference, Houston, 27 February-2 March.
22. SINTEF Offshore Blowout Database, [http://www.sintef.no/content/page1\\_\\_\\_\\_4649.aspx](http://www.sintef.no/content/page1____4649.aspx), 21 March 2005.

23. "JIP for Evaluating Vessel Blowout Control – Final Report," DEA-63, govt. report - Mineral Management Service, Houston (1991).
24. Schubert, J. J., and Weddle, C. E. III: "A GPRI Project Proposal for Deepwater Access; Development of a Blowout Intervention Method and Dynamic Kill Simulator for Blowouts Occuring in Ultra-deepwater", JIP proposal, Mineral Management Service, Houston (October 2000).
25. Schubert, J.J.: "Well Control," M.Eng. report, Texas A&M U., College Station, TX (1995).
26. Al-Shammari, H.A. and Nordquist, D.G.: "Revised BOP and Well Control Policies in the Kingdom of Saudi Arabia," paper SPE 77227 presented at the 2002 IADC/SPE Asia Pacific Drilling Technology, Jakarta, 9-11 September.
27. Shaughnessy, J.M. and Romo, L.A.: "Problems of Ultra-Deep High-Temperature, High-Pressure Drilling," paper SPE 84555 presented at the 2003 SPE Annual Technical Conference and Exhibition, Denver, 5-8 October.
28. Manohar, L.: "Surge and Swab Modeling for Dynamic Pressures and Safe Trip Velocities," paper IADC/SPE 11412 presented at the 1983 Drilling Conference, New Orleans, 20-23 February.
29. System 21, "Well Control Manual", PDF files, March 22 2005.
30. Johnson, A.B. and White, D.B.: "Gas-Rise Velocities During Kicks," *SPEDE* (December 1991) 257.
31. Jardine, S.I., Johnson, A.B., White, D.B., and Stibbs, W.: "Hard or Soft Shut-In: Which Is the Best Approach?" paper SPE/IADC 25712 presented at the 1993 SPE/IADC Drilling Conference, Amsterdam, 23-25 February.
32. Grundt, G., Unocal, Personal Interview, AADE Technical Conference and Exhibition, Houston, April 5 2005.
33. Santos, O.L.A.: "Well Control Operations in Horizontal Wells," paper SPE 21105 presented at the 1990 SPE Latin American Petroleum Engineering Conference, Rio de Janeiro, 14-19 October.
34. Vefring, E.H., Wang, Z., Gaard, S., and Bach, G.F.: "An Advanced Kick

- Simulator for High Angle and Horizontal Wells – Part I,” paper SPE 29345 presented at the 1995 SPE/IADC Drilling Conference, Amsterdam, 28 February-2 March.
35. Santos, O.L.A.: “Important Aspects of Well Control for Horizontal Drilling Including Deepwater Situations,” paper SPE 21993 presented at the 1991 SPE/IADC Drilling Conference, Amsterdam, 11-14 March.
  36. Economides, M.J., Watters, L.T., and Dunn-Norman, S.: *Petroleum Well Construction*, John Wiley & Sons Ltd., London (1998).
  37. Meader, T., Allen, F., and Riley, G.: “To the Limit and Beyond – The Secret of World-Class Extended-Reach Drilling Performance at Wytch Farm,” paper SPE 59204 presented at the 2000 IADC/SPE Conference, New Orleans, 23-25 February.
  38. Payne, M., Cocking, D.A., and Hatch, A.J.: “Critical Technologies for Success in Extended Reach Drilling,” paper SPE 28293 presented at the 1994 SPE Annual Technical Conference and Exhibition, New Orleans, 25-28 September.
  39. Cunha, J.C., Martins, A.L., Sa, C.H.M., and Fernandes, P.D.: “Planning Extended Reach Wells for Deep Water,” paper SPE 74400 presented at the 2002 SPE International Petroleum Conference and Exhibition, Villahermosa, Mexico, 10-12 February.
  40. Childers, M.A., Buckley, M., Curtiss J.P.: “Fast Response Retrofittable Ultra Deepwater BOP Control System,” paper IADC/SPE 87156 presented at the 2004 IADC/SPE Drilling Conference, Dallas, 2-4 March.
  41. Martins Lage, A.C.V., and Nakagawa, E.Y.: “Well Control Procedures in Deep Water,” paper SPE 26952 presented at 1994 SPE Latin American/Caribbean Petroleum Engineering Conference, Buenos Aires, Argentina, 27-29 April.
  42. Power, D., Catalin, D.I., and Brooks, S.W.: “The Top 10 Lost Circulation Concerns in Deepwater Drilling,” paper SPE 81133 presented at the 2003 SPE Latin America and Caribbean Petroleum Engineering Conference, Port-of-Spain, Trinidad, 27-30 April.



43. Flak, L.H., and Matthews, C.: "Blowout Control, Part 9 - Firefighting," John Wright Company, [www.jwco.com](http://www.jwco.com), April 18 2005.
44. Edwards, T., Halliburton, Presentation at Texas A&M U. AADE meeting, March 29 2005.
45. Kelly, M.J., and Flak, L.: "Blowout Control, Part 10 – Surface Intervention Methods," John Wright Company, [www.jwco.com](http://www.jwco.com), 18 April 2005.
46. Tarr, B.A. and Flak, L.: "Blowout Control, Part 6 – Underground Blowouts," John Wright Company, [www.jwco.com](http://www.jwco.com), 19 April, 2005.
47. Skalle, P., Trondheim, J.H. and Podio A.L.: "Killing Methods and Consequences of 1120 Gulf Coast Blowouts During 1960-1996," paper SPE 53974 presented at the 1999 IADC/SPE Drilling Conference, Dallas, 3-6 March.
48. "Joint Industry Program for Floating Vessel Blowout Control (DEA-63)," Neal Adams Firefighters, Inc., Houston, (1991).
49. Wright, J.W. and Flak, L.: "Blowout Control, Part 11-Relief wells," John Wright Company, [www.jwco.com](http://www.jwco.com), 21 April 2005.
50. "Syria 1995 Case History", John Wright Company, <http://www.jwco.com/casehistoryframe.htm>, 22 April 2005.
51. Wright, J.W., Tuppen, J.A., and Flak, L.: "Blowout Control, Part 2 – Logistics," John Wright Company, [www.jwco.com](http://www.jwco.com), 4/24/05.
52. Santos, O.L.A: "A Study on Blowouts in Ultra Deep Waters," paper SPE 69530 presented at the 2001 SPE Latin American and Caribbean Petroleum Engineering Conference, Buenos Aires, 25-28 March.
53. Bertin, D., Lassus-Dessus, J., and Lopez, B.: "Well Control Guidelines for Girassol," paper SPE/IADC 52763 presented at the 1999 SPE/IADC Drilling Conference, Amsterdam, 9-11 March.
54. McCain, W.D. Jr.: *The Properties of Petroleum Fluids*, Second Edition, PennWell Publishing Co., Tulsa, Oklahoma (1988).

55. Cunha, J.C.: "Innovative Design for Deepwater Exploratory Wells," paper IADC/SPE 87154 presented at the 2004 IADC/SPE Drilling Conference, Dallas, 2-4 March.
56. Touboul, N., Womble, L., Kotrla, J., and Keith, N.: "New Technologies Combine to Reduce Drilling Costs in Ultradeepwater Applications," paper SPE 90830 presented at the 2004 SPE Annual Technical Conference and Exhibition, Houston, 26-29 September.
57. Simondin, A., MacPherson, D., Touboul, N., and Ragnes, G.: "A Deepwater Well Construction Alternative: Surface BOP Drilling Concept Using Environmental Safe Guard," paper IADC/SPE 87108 presented at the 2004 IADC/SPE Drilling Conference, Dallas, 2-4 March.
58. Childers, M. and Quintero, A.: "Slim Riser- A Cost-Effective Toll for Ultra Deepwater Drilling," paper IADC/SPE 87982 presented at the 2004 IADC/SPE Asia Pacific Drilling Technology Conference and Exhibition, Kuala Lumpur, Malaysia, 13-15 September.
59. Schumacher, J.P., Dowell, J.D., Ribbeck, L.R., and Eggemeyer, J.C.: "Planning and Preparing for the First Subsea Field Test of a Full-Scale Dual-Gradient Drilling System," *SPEDC* (December 2002) 194.
60. Schubert, J.J, Juvkam-Wold, H.C., and Choe, J.: "Well Control Procedures for Dual Gradient Drilling as Compared to Conventional Riser Drilling," paper SPE/IADC 79880 presented at the 2003 SPE/IADC Drilling Conference, Amsterdam, 19-21 February.
61. Oskarsen, R.T.: "Toolkit and Drillstring Valve for SubSea Mudlift Drilling," M.S. thesis, Texas A&M U., College Station, Texas (2001).
62. Fossli, B. and Sangesland, S.: "Managed Pressure Drilling for Subsea Applications; Well Control Challenges in Deep Waters," Proc., 14<sup>th</sup> Deep Offshore Technical Conference, New Orleans (2002).

## **APPENDIX A**

### **SUBSEA MUDPUMP KILL**

A novel approach to using Subsea Mudlift Drilling technology in blowout containment was brought up in the end of Chapter VI. By utilizing the pumping power of the subsea pumps at the seafloor, a dynamic kill can be performed by pumping seawater down the annulus of the relief well, thus avoiding the pressure losses of pumping down the length of the riser from the surface. Additionally, the annulus provides a greater flowpath for the kill fluid, in this case seawater, and the pumping requirements could be reduced. As the pumps would suck in seawater from its surroundings, there is no limit on the supply of kill fluid.

Another advantage of this method could be experienced in a relief effort of a well that is blowing at a very high flow rate. A conventional kill might require several relief wells in order to halt the flow of the blowing well. A possible combination of using surface pumps to pump down the drillstring, and the subsea pumps pumping down the annulus might suffice to perform the kill with one relief well. This could potentially save a lot of time and cost to the operator.

Further studies on this approach needs to be conducted, as only one SMD well has been drilled to date. Regardless, dual-gradient drilling offers many advantages, and specifically, relief well efforts using SMD technology might be one advantage not initially recognized.

As a first step, dynamic kill simulators, like COMASim, should be expanded to incorporate the simulation of dual-gradient drilled relief wells. By simulating a dynamic

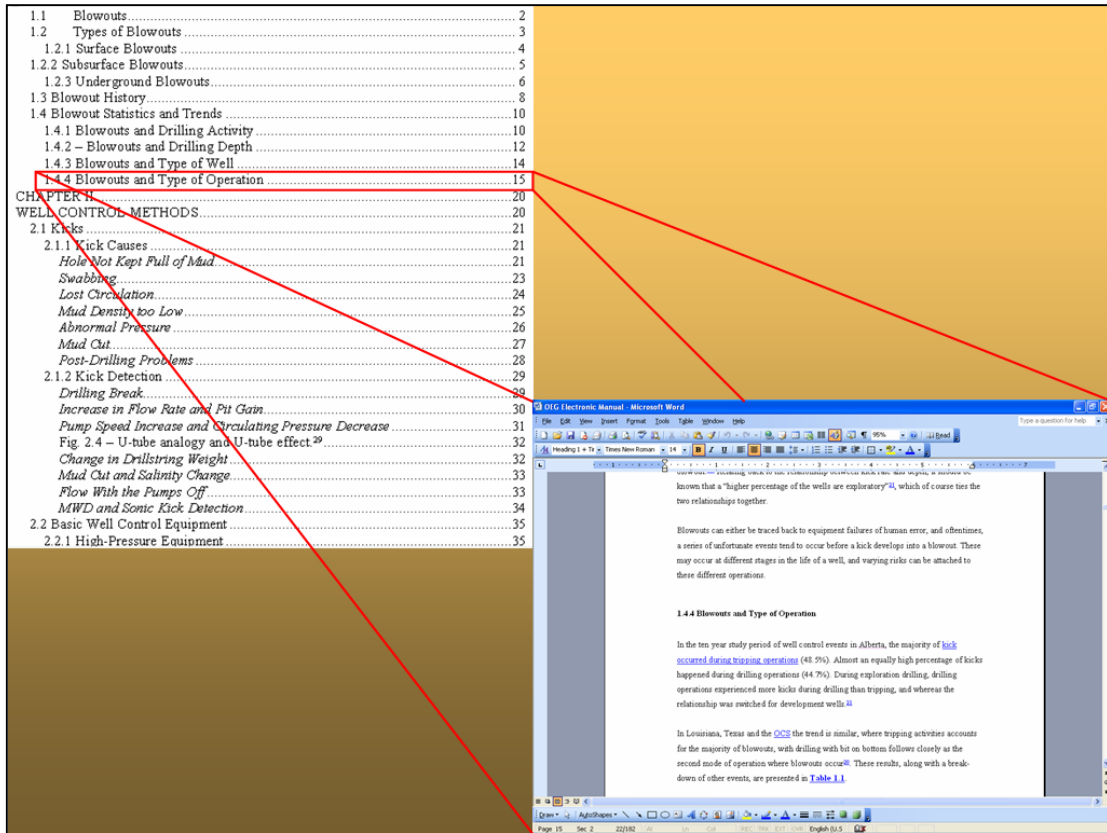
kill performed from the sea floor, a quantification of the friction pressure advantage would be possible, and pump requirements could be determined for the subsea pumps.

Potential modifications and additions to the equipment might be necessary. There is a need for a valve manifold to reverse the flow, and change the flow path. This could be accomplished through four valves, and two additional check valves downstream for backup, with a sufficient pressure rating and flow capabilities. Operation would best be performed through the use of ROVs.

## APPENDIX B

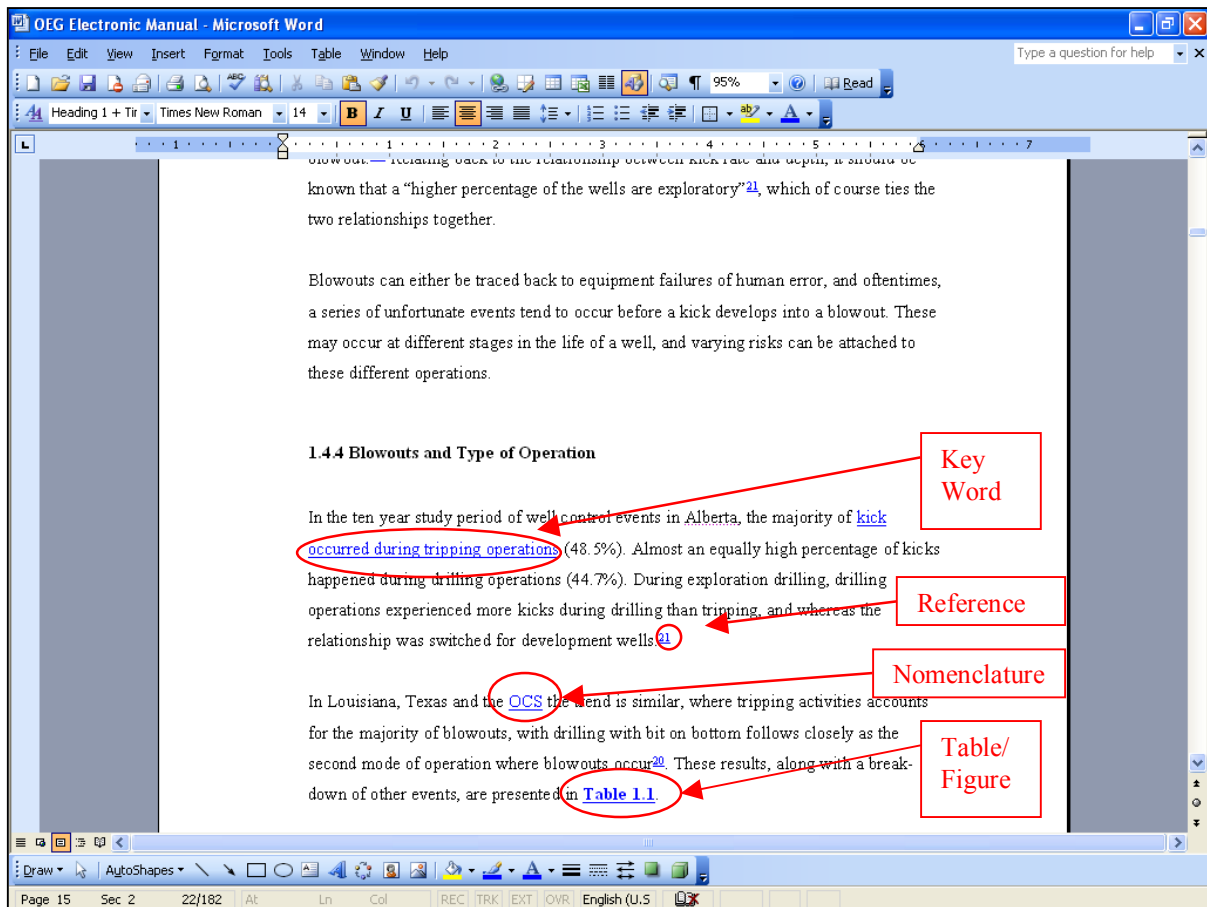
### ELECTRONIC MANUAL ILLUSTRATION

An electronic manual for well control and blowout containment has been presented in this thesis. **Fig. B.1** illustrates the link between the main menu, with its topics and subtopics, and the main text of the manual.



**Fig. B.1** – By clicking the topic of interest in the main menu, a direct link directs the user to the related section in the main text.

The section of interest appears by the click of the mouse, and key words and phrases are further hyperlinked for easy navigation. Links to key phrases, references, nomenclature, and tables are shown in **Fig. B.2**. Similar links are provided from the Reference section to the abstracts of the different references.



**Fig. B.2 – The manual’s main text is linked to related topics, references, figures, and tables.**

## VITA

**Name:** Odd Eirik Grøttheim

**Date of Birth:** March 30, 1978, Bodø, Norway

**Parents:** Mr. Odd Edgar Grøttheim  
Mrs. Marit Grøttheim

**Address:** Bunes Allé 17  
8900 Brønnøysund  
Norway

**Education:** Texas A&M University  
College Station, TX, USA  
B.S. in Petroleum Engineering (2003)

Texas A&M University,  
College Station, TX, USA  
M.S. in Petroleum Engineering (2005)

Institut Français du Pétrole, École du Pétrole et des Moteurs  
Rueil Malmaison, France  
M.S. in Petroleum Economics and Management (2005)