

CONCURRENT DESIGN OF FACILITY LAYOUT  
AND FLOW-BASED DEPARTMENT FORMATION

A Dissertation

by

JUNJAE CHAE

Submitted to the Office of Graduate Studies of  
Texas A&M University  
in partial fulfillment of the requirements for the degree of

DOCTOR OF PHILOSOPHY

December 2003

Major Subject: Industrial Engineering

CONCURRENT DESIGN OF FACILITY LAYOUT  
AND FLOW-BASED DEPARTMENT FORMATION

A Dissertation

by

JUNJAE CHAE

Submitted to Texas A&M University  
in partial fulfillment of the requirements  
for the degree of

DOCTOR OF PHILOSOPHY

Approved as to style and content by:

---

Brett A. Peters  
(Chair of Committee)

---

Guy L. Curry  
(Member)

---

César O. Malavé  
(Member)

---

P. Frederick Dahm  
(Member)

---

Brett A. Peters  
(Head of Department)

December 2003

Major Subject: Industrial Engineering

## ABSTRACT

Concurrent Design of Facility Layout and Flow-Based Department Formation.

(December 2003)

Junjae Chae, B.S., Ajou University;

M.S., Texas A&M University

Chair of Advisory Committee: Dr. Brett A. Peters

The design of facility layout takes into account a number of issues including the formation of departments, the layout of these, the determination of the material handling methods to be used, etc. To achieve an efficient layout, these issues should be examined simultaneously. However, in practice, these problems are generally formulated and solved sequentially due to the complicated nature of the integrated problem. Specifically, there is close interaction between the formation of departments and layout of these departments. These problems are treated as separate problems that are solved sequentially. This procedure is mainly due to the complexity of each problem and the interrelationships between them. In this research, we take a first step toward integrating the flow-based department formation and departmental layout into comprehensive mathematical models and develop appropriate solution procedures. It is expected that these mathematical models and the solution procedures developed will generate more efficient manufacturing system designs, insights into the nature of the concurrent facility layout problem, and new research directions.

## ACKNOWLEDGMENTS

I would like to thank Dr. Brett A. Peters for his patience and guidance throughout this dissertation. It would not have been possible without him and his concern for excellence. I would also like to thank Dr. Guy L. Curry, Dr. César O. Malavé, and Dr. P. Frederick Dahm for their benevolence, inspiration and help in my pursuit of this course of study and work.

I am grateful to my friend Dr. Vatcharapol Sukhotu (Joe) for sharing his insights in my research and to Christopher Sparks for his kind assistance in editing this dissertation.

There are many other people at Texas A&M who have helped me achieve this goal. I would like to thank all of them for their friendship and help over the years. In particular, I would like to thank Dr. Richard Feldman and Judy Meeks for their support and encouragement. Additional thanks go out to Mark Henry, Mark Hopcus, Denis Allen, and Katherine Edward.

A special thanks is extended to my parents, Mr. Hijoong Chae and Mrs. Younhee Kim, for their support in completing this degree. I would like to thank my wife, Jiah, and my daughter, Rachel (Hyemin), for their love and devotion during this endeavor. Without their patience and faith in me, it would not have been possible.

## TABLE OF CONTENTS

CHAPTER		Page
I	INTRODUCTION . . . . .	1
	A. Motivation . . . . .	1
	B. Background . . . . .	3
	C. Research Objective . . . . .	6
II	LITERATURE REVIEW . . . . .	8
III	INTEGRATION OF FLOW-BASED DEPARTMENT FOR- MATION INTO FACILITY LAYOUT DESIGN . . . . .	13
	A. Problem Description . . . . .	13
	B. Problem Formulation . . . . .	15
	1. General Facility Layout Problem . . . . .	15
	2. Concurrent Design Model . . . . .	17
	C. Linearization . . . . .	21
	1. Step 1: $\Phi_i \leq f_1(x_{0i})$ . . . . .	23
	2. Step 2: $f_2(x_{0i}) \leq lx_i \cdot ly_i$ . . . . .	26
	3. Maximum Error Estimation . . . . .	30
	a. Estimation of $\epsilon_1^{\max}$ . . . . .	31
	b. Estimation of $\epsilon_2^{\max}$ . . . . .	36
	D. Extending Department Area . . . . .	36
	E. Heuristic Approach . . . . .	37
	1. General Genetic Algorithms . . . . .	38
	2. Genetic Algorithm Implementation . . . . .	40
	a. Representation and Operators . . . . .	40
	b. Evolution Parameters . . . . .	43
	c. Evaluation and Penalty Function . . . . .	43
	F. Intra-department Layout Design . . . . .	44
	1. Separating as an Independent Problem . . . . .	44
	2. $\epsilon$ -Accurate Model . . . . .	45
	G. Computational Results . . . . .	45
	1. Level of Accuracy and Computational Time Con- sideration . . . . .	46
	2. The Small Test Problems . . . . .	48

CHAPTER	Page
3. The Mid-Sized Test Problems . . . . .	52
4. Within Department Design . . . . .	53
5. The Comparable Problems . . . . .	58
a. Problem - Morris and Tersine . . . . .	58
b. Problem - Co and Araar . . . . .	61
6. The Larger Problems . . . . .	64
H. Summary and Conclusion . . . . .	66
 IV LAYOUT DESIGN OF MULTI-BAY FACILITIES WITH LIMITED BAY FLEXIBILITY . . . . .	 68
A. Background . . . . .	68
B. Problem Description . . . . .	70
C. Problem Formulation . . . . .	71
D. Solution Procedure - Memetic Approach . . . . .	73
1. Representation and Operators . . . . .	74
a. Parent Selection . . . . .	75
b. Crossover . . . . .	75
c. Mutation . . . . .	76
d. The Local Search . . . . .	76
2. Evolution Parameters . . . . .	77
3. Penalty Function and Dummy Department . . . . .	77
E. Within-bay Layout . . . . .	78
F. Computational Results . . . . .	79
1. The BAP and FBAP . . . . .	79
2. GA and MA . . . . .	82
3. FBAP and MA . . . . .	89
4. Within-bay Configuration . . . . .	91
G. Summary and Conclusions . . . . .	95
 V CONCLUSIONS AND CONTRIBUTIONS . . . . .	 96
A. Contributions . . . . .	96
B. Conclusions . . . . .	97
 REFERENCES . . . . .	 99
 APPENDIX A . . . . .	 105
 APPENDIX B . . . . .	 108

VITA . . . . . 112

## LIST OF TABLES

TABLE		Page
I	Estimated max. error $\epsilon_1^{\max}$ and number of binary variables when $ABR = 4$ . . . . .	47
II	Error estimation based ( $\epsilon_1$ ) on the number of partitioned segments for M6 . . . . .	48
III	Computational results of FLP-DF . . . . .	49
IV	% errors $\epsilon_r$ in actual areas . . . . .	50
V	Result comparison for FLP-DF and GA . . . . .	51
VI	Computational results for mid-sized problems . . . . .	52
VII	Within-department layout for VC10 . . . . .	54
VIII	Within-department layout for B12 . . . . .	55
IX	Within-department layout for B14 . . . . .	56
X	Within-department layout for AB20 . . . . .	57
XI	Layout efficiency comparison for process layout and integrated layout with department formation . . . . .	59
XII	Result of integrated layout based on data in Co and Araar . . . . .	61
XIII	Data Structure of 100 sub-department example problems . . . . .	64
XIV	Computational results for larger problems . . . . .	65
XV	Comparison of BAP and FBAP for 11 and 15-department . . . . .	80
XVI	Comparison of BAP and FBAP for 21 and 40-department . . . . .	81
XVII	Comparison of GA and MA for 11 and 15-department . . . . .	84



TABLE	Page
XVIII	Comparison of GA and MA for 21 and 40-department . . . . . 85
XIX	GA with different parameters . . . . . 87
XX	Comparison of FBAP and MA for inter-bay material handling cost . 90
XXI	Solution to Stage 2 for problem 11-1 . . . . . 91
XXII	Solution to Stage 2 for problem 15 . . . . . 92
XXIII	Solution to Stage 2 for problem 21-1 . . . . . 93
XXIV	Solution to Stage 2 for problem 40 . . . . . 94

## LIST OF FIGURES

FIGURE		Page
1	Decision variable interactions . . . . .	2
2	Illustration of decision variables and parameters for FLP-1 . . . . .	16
3	Four cases of binary variable combinations . . . . .	20
4	The solution space of $a_i + \sum_{j,j \neq i} (1 - \gamma_{ij}) a_j = lx_i \cdot ly_i$ . . . . .	21
5	The relationship of $\Phi_i$ and $x_{0i}$ . . . . .	23
6	Linearization of $\Phi_i = x_{0i}^2$ . . . . .	25
7	Partition for the linearization of $\Phi_i = x_{0i}^2$ . . . . .	25
8	$\Phi_i = lx_i \cdot ly_i$ . . . . .	27
9	$lx_i \cdot ly_i = \Phi_i$ and $lb \leq lx_i, ly_i \leq ub$ . . . . .	28
10	Three tangential supports for the approximation to the area constraints . . . . .	28
11	Three tangential supports along the point of $x_{0i}$ . . . . .	29
12	Linearized solution space . . . . .	31
13	Estimation of $d_\epsilon$ . . . . .	32
14	Potential department shapes and areas when $ABR = 3$ . . . . .	34
15	Point $p$ for the minimum AB-ratio . . . . .	35
16	Error estimation for $\epsilon^{\max}$ . . . . .	37
17	General structure of a genetic algorithm . . . . .	39
18	Representation of the GA . . . . .	42

FIGURE	Page
19	Partitioning for area constraint linearization . . . . . 47
20	Department layout based on Morris and Tersine data . . . . . 59
21	Integrated layout (a) based on Morris and Tersine data . . . . . 60
22	Integrated layout (b) based on Morris and Tersine data . . . . . 60
23	Modified group layout from Co and Araar . . . . . 62
24	Integrated layout (a) based on Co and Araar data (Cost=87.4) . . . 63
25	Integrated layout (b) based on Co and Araar data (Cost=76.8) . . . 63
26	A multi-bay manufacturing facility . . . . . 69
27	Illustration of variables for a multi-bay facility layout . . . . . 72
28	Representation of chromosomes . . . . . 75
29	Comparison of the search procedures of the GA and MA for a 15-department with fixed bay width problem . . . . . 83
30	Various parameter sets in GA for a 21-department problem with 10% bay width flexibility . . . . . 88
31	Layout improvement based on bay-width flexibility . . . . . 89
32	Approximated block layout of a four-department problem from MIP and the incident matrix for the first step . . . . . 106
33	Block layout of the four-department problem and its correspond- ing incident matrix . . . . . 107
34	Cutting plane generation . . . . . 110

## CHAPTER I

## INTRODUCTION

## A. Motivation

Facilities can be broadly defined as buildings where resources, such as people, material, and machines, come together for a stated purpose - typically to make a physical product or provide a service [1]. Facility layout design can be described as an arrangement of these resources. Manufacturing companies spend a significant amount of time and money designing or redesigning their facilities because the design of a facility layout has a tremendous effect on the operation of the system that it houses. A poor facility layout can be costly and may result in poor system performance as well as customer dissatisfaction [1]. However, the design of an efficient manufacturing system must take into account a number of issues including the determination of the products to be manufactured, the manufacturing or service processes to be used, the quantity and type of equipment required, and the preliminary process plans. Additionally, the formation of the manufacturing departments and the layout of these, the determination of the material handling methods to be used, and the quantity and types of material handling devices needed to perform the required material handling are some of the more important issues to be addressed.

To achieve an efficient layout, ideally all of the items mentioned above should be examined simultaneously. However, in practice these problems are generally formulated and solved sequentially due to the complicated nature of the integrated problem. An integrated facility layout problem is defined as the simultaneous optimization of

---

The journal model is *IEEE Transactions on Automatic Control*.

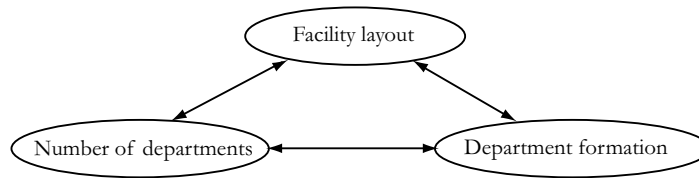

Fig. 1. Decision variable interactions

sub-problems, but, in fact, the interaction of the sub-problems makes an integrated facility layout problem difficult to formalize. Specifically, there is close interaction between the determination of the number of departments, the formation of departments, and the facility layout as depicted in Fig. 1.

Most research in facility layout assumes that the areas of the departments are known although the exact department shapes are typically not specified in advance. However, it is commonly assumed that departments will take rectangular shapes. The final solution of the layout problem is a block layout that shows the coordinate information including the dimensions and location of each department. This block layout does not show the assignment of the manufacturing components to departments. However, it is generally assumed that the procedure for assigning manufacturing units to pre-specified groups to form departments has been done *a priori*. It's also assumed that the number of departments, which is one of the parameters of the facility layout problem, has also been determined by this department formation procedure. This explains the interaction of those problems as in Fig. 1. The department formation and layout problems have traditionally been treated as problems to be solved separately and sequentially. This is mainly due to the complexity of each problem. However, it is important to consider these problems in an integrated manner. A small change in one department can affect the entire system layout, and a different layout may require different forms of departments for achieving the best system efficiency.

In this research, we integrate these problems into comprehensive mathematical

models. Formulating a model to explicitly represent interrelated decision variables is very difficult. In this research, we explore new ways of representing this integrated problem. The models address broader facility layout problems that attempt to capture several relevant aspects of the overall design problem. Specifically, the models intend to determine several essential factors that influence the structure of the manufacturing facility. Among these are the assignment of manufacturing components to departments, the number of departments created, the dimensions of each department, and the location of the departments in the floor space. This study, we believe, opens up new research directions that will lead to better layout solutions.

## B. Background

The facility layout problem seeks the best arrangement of a set of facilities. Facilities could be the rooms required in a building, pieces of machinery on an assembly line, logic blocks on an integrated circuit or something else [2]. Facilities are commonly assumed to be departments in a manufacturing system, where the department is defined as a collection of machines. The traditional objective in determining the arrangement is to minimize the transport costs that are generated by the manufacturing activity. The transportation requirements between machines, departments, or manufacturing units can be quantified in a from-to chart. Measuring the travel distance of material between departments is a general method for quantifying the significance of the paired department relationship. Typically, the centroid of each department is used as the measuring point.

The traditional layout design problem considers area information or assumes an equal size constraint for each department. A number of computer-based heuristic layout algorithms have been developed as construction or improvement layout design

algorithms using area information [3, 4, 5, 6, 7, 8, 9]. The computerized layout algorithm provides only an approximate layout design solution since it may result in undesired department shapes.

For the equal-sized department layout problem, the quadratic assignment problem (QAP) [10] is used to model the problem. This approach considers the problem of assigning  $n$  (equal-sized) departments to  $n$  pre-determined locations. However, the optimal solution cannot be obtained for a realistic problem because the QAP is NP-complete [11]. A modified QAP may model an unequal-area facility layout problem by breaking the departments and facility floor space into small grids [12]. However, it is difficult to solve even small problems optimally with this method because splitting departments into grids significantly increases the problem size. This solution difficulty has led some researchers to conclude that such discrete fashioned QAP-type models are not applicable for facility layout problems with unequal-sized departments [13]. A more detailed review of the traditional facility layout literature is provided in Chapter II.

The mixed integer program (MIP)-based formulation [14] finds the arrangement of all departments in continuous floor space without violating overlapping and boundary restrictions. Specifically, the facility layout problem (FLP) model is an MIP-based model for the facility layout problem [15]. In the FLP, the department shape is specified as rectangular and a bounded perimeter constraint is used as a surrogate area constraint because the actual area constraint is non-linear ( $w_i \cdot h_i = a_i$ , where  $w_i$ ,  $h_i$ ,  $a_i$  represent width, height, and area of department  $i$ , respectively). The MIP-based approach is powerful since it provides more specific information about the system, such as the dimensions of unequal-sized departments. However, even small size problems are still extremely difficult to solve optimally. Construction and improvement heuristics have been developed for the FLP to solve large-sized problems.

When considering unequal area departments, the area constraint  $w_i h_i = a_i$  is required to achieve authentic optimality. Since this area constraint is nonconvex and hyperbolic, most of the previous research on the facility layout problem with unequal area departments attempts to linearize this constraint. Montreuil [14], Meller *et al.* [15], and Lacksonen [16] used linearizations of the area constraint so that the model would be appropriate for general purpose optimization software packages for solving mixed-integer linear programming (MILP), such as CPLEX. However, all of those approaches were based on the assumption that the number of departments and department areas are known in advance.

A multi-bay structure is one way to incorporate department formation by restricting the layout types. Assignment of departments to bays is analogous to the process of department formation in the general facility layout problem. The facility layout problem in multi-bay environments is concerned with determining the most efficient assignment of departments to parallel bays, where the bays are connected at one or both ends by an inter-bay material handling system. This problem arises in the context of heavy manufacturing and in the semiconductor industry, where the inter-bay material handling system is cost dominant over material movement within the bays. Thus, the efficiency of the layout is measured mainly in terms of inter-bay material movement.

Only a few studies in the literature have documented research on multi-bay manufacturing facility layout [17, 18]. These works define the characteristics of multi-bay structures as follows: (1) material movement between the bays is limited to the ends of the bays, (2) inter-bay material handling costs dominate the material handling costs within the bay, (3) the number of bays and bay areas are known, and (4) the bay structure is typically designed to have a linear flow production pattern within each bay. Meller [17] and Castillo and Peters [18] developed models using



these characteristics of multi-bay manufacturing and presented two-stage solution procedures for solving this problem.

### C. Research Objective

The objective of this research is to develop integrated facility layout models. The ideal integrated layout design model would integrate all design factors such as department formation, material handling system selection, production and inventory control, etc. However, it has so far proved very difficult to create such a model, since, as noted above, the interactions of the sub-problems make the integrated facility layout problem difficult to formalize. Thus, we focus in this study on the formation of departments and the efficient spatial arrangement of those departments.

In order to achieve this design objective, we propose two integrated facility layout models that capture several aspects of the facility layout problem. These models and solution procedures can be applied to a variety of manufacturing settings with minor modifications. The proposed formulations and solution procedures make an important step towards the development of integrated facility layout models.

This dissertation is organized as follows. A review of the related literature is presented in Chapter II. Chapter III introduces the integrated department formation and layout design problem. In this chapter, we consider the determination of flow-based department formation and the layout design of these departments simultaneously. We discuss the linearization procedure, which is not determined *a priori* for approximating the department area. A solution procedure using a population-based algorithm is also presented in this chapter.

The layout design of a multi-bay manufacturing facility with limited bay flexibility is discussed in Chapter IV. A common characteristic of this facility layout problem

is that the inter-bay material handling costs typically dominate the within-bay material handling costs. Thus, at the facility layout design stage, efficiency is measured in terms of the inter-bay material handling movement. Bay width flexibility can reduce inter-bay material handling movement by increasing the opportunities for assigning departments with heavy interactions to a single bay. This assignment procedure is comparable to the process of department formation discussed in Chapter III. Here, a hybrid-genetic algorithm is presented and tested as a solution procedure. Finally, in Chapter V conclusions drawn from this research and its contributions to the field are presented.

## CHAPTER II

## LITERATURE REVIEW

Layout design is a well-known combinatorial optimization problem; it has been an active research area for the past few decades [12, 19]. The traditional layout design problem considers area information, or assumes an equal size constraint, for each department. The from-to chart, which indicates the transportation requirements between a pair of departments, or the relationship chart, which specifies the significance of paired department relationships, can be used as an input method in the traditional layout design problem. The centroid of a department is often used to represent the point that is specified as the pick-up/drop-off point in the department.

A number of computer based heuristic layout algorithms, which use provided area information, have been developed over the years. Departments are assigned to floor space one at a time with a construction type layout algorithm, *e.g.*, ALDEP [3], CORELAP [4], and PLANET [5], or an initial layout design is improved by an improvement layout design algorithm, *e.g.*, CRAFT [6], COFAD [7], MULTIPLE [8], and SABLE [9]. These computerized layout algorithms provide only an approximate layout design solution since they may result in an undesired department shape or an infeasible solution.

Koopmans and Beckman [10] introduced the quadratic assignment problem (QAP) to model the problem with equal areas and a known set of location sites. The QAP formulation assigns a department to one location which is fixed and known *a priori*; the efficiency of placing the department in a particular location is dependent on the location of interacting departments. Since QAP is NP-complete [11], which generally implies that it is a hard problem to solve, the optimal solution cannot be obtained for

a realistic problem. This approach is also incapable of solving layout design problems when the location sites are not specified in advance.

The unequal-area facility layout problem may be modeled as a modified QAP by splitting the department into small grids with equal area [12]. For grouping small grids in a department and ensuring that the original department does not become fragmented at the final block layout, a large artificial flow between the grids needs to be assigned. However, it is not possible to solve even small problems since the grids are then treated as departments and this increases the size of the problem.

Another approach is the adjacency graph-based algorithm, which uses adjacency relationships among departments, *e.g.*, [20, 21, 22, 23, 24]. Specific information about the size of the department, *i.e.*, the area and shape, is ignored and a node in the graph represents the department. The arcs connecting the nodes represents the department adjacency relationships. Three steps are required to develop a layout with this approach [25]: (1) develop an adjacency graph from the department relationships, (2) build a dual graph of the adjacency graph, and (3) convert the dual graph into a block layout. An adjacency graph is usually difficult to transform into a block layout design. It can result in an undesirable solution due to an umbrella effect where many departments are adjacent to a single department. Thus, it is necessary to limit the number of arcs incident at each department to facilitate the steps, and heuristics need to be used to construct a maximally weighted adjacency graph since such a problem is difficult in general. This approach does not guarantee optimal results for unequal-area layout problems such as the QAP [23].

As a more specific, continuous representation of a layout, a mixed-integer programming (MIP) formulation was presented by Montreuil [14]. The model is not based on the traditional discrete (QAP) structure. In MIP, the department shape specified as a rectangular and a bounded perimeter constraint is used as a surrogate

area constraint because the actual area constraint is non-linear ( $l_i \cdot w_i = a_i$ , where  $l_i, w_i, a_i$  represent length, width, and area of department  $i$ , respectively). Heragu and Kusiak [26] developed a special case of the model, where the length, width, and orientation of the department are known in advance.

Although the mixed-integer programming approach is capable of incorporating specific information about the problem and producing comprehensive results about the system, optimally solving even small sized problems is difficult. Since the MIP approach is unsolvable for realistic-sized instances, heuristics have been introduced to solve large-sized unequal-area problems utilizing continuous representations of the layout.

Tam [27, 28] introduced LOGIC (named for Layout Optimization using Guillotine-Induced Cuts), a slicing tree structure that is constructed recursively by partitioning a rectangular block. The tree structure has branches and interior nodes which represent the slicing operation, *e.g.*, left cut, right cut, bottom cut or top cut. A simulated annealing procedure is used to exchange slicing operators in the tree [27] and generate different rectangular partitioning schemes. For the same layout structure, a genetic algorithm can also be used for generating a differently partitioned layout [28].

Tate and Smith [29] developed FLEX-BAY, an improvement-type algorithm for continuous representation. The pre-specified rectangular area is divided in one direction into bays of varying width, and each bay is divided into one or more rectangular departments. A dynamic penalty function is used to restrict the shape of unequal area departments to maintain the feasibility of the layout. A genetic algorithm is used to evaluate and generate an efficient layout for a given structure. The number of bays and the number of departments in the bay are implemented by indicating where the break point exists.

While some research has focused attention on developing heuristics for unequal-

area department layout, there has been more effort directed at finding direct solutions for the underlying optimization problem, especially by linearizing the non-linear area constraints of a department so that the problem can be solved by widely available software packages. The MIP model of Montreuil [14] used perimeter-based area constraint linearization, but this model can lead to large errors in the final area of each department. Lacksonen [16] proposed piecewise linearization of the actual area constraint by adding two binary variables for each department to reduce the error. Meller *et al.* [15] improved the accuracy of perimeter-based linearization by adding one real variable for each department.

Research on the facility layout problem with emphasis on department formation has been conducted by a number of researchers. However, such research is primarily focused on the grouping of machines or manufacturing units into families to take advantage of their similarities in manufacturing and design [30]. The department may be formed based on the product family, the process, or a combination of both, and the part-machine incidence matrix is traditionally used to form the department. The fractal layout [31, 32], an extension of the product family layout, allows for distribution of machine replicas to multiple departments, so that machine accessibility from different departments is enhanced. Holonic layout [33] treats each machine as a self-governing entity that can be placed randomly throughout the manufacturing facility with no specific department boundary, while the product family and fractal layout assume that the number of departments and the maximum number of machines assigned to each department are known in advance. Some recent studies consider layout issues such as inter-department and intra-department material handling costs in the context of product family layouts [34, 35].

In brief, the traditional model of facility layout design which results in a block diagram has limitations in revealing the information necessary for designing manufac-

turing facilities. Further exploration of integrated facility layout models is necessary. In particular, formulations of layout designs that contain specific information about manufacturing systems and formulations that concurrently determine detailed department formation and specific department locations remain to be addressed.

## CHAPTER III

### INTEGRATION OF FLOW-BASED DEPARTMENT FORMATION INTO FACILITY LAYOUT DESIGN

The general facility layout problem seeks to find the most efficient arrangement of pre-specified departments. However, because the department formation problem is closely related to the layout problem, the two need to be integrated to achieve more efficient facility layouts. In this chapter, we consider the concurrent determination of layout design and flow-based department formation and attempt to determine the most efficient assignment of sub-departments to departments in a facility.

#### A. Problem Description

Arranging departments to minimize total flow distance is the main objective in our concurrent design problem (as it is in the traditional facility layout problem). Additionally, the number of departments and the flow-based department formation are determined simultaneously with the layout. As noted before, the integrated facility layout problem is difficult to formalize because of the interaction of these sub-problems. Thus, we limit our problem with several assumptions.

A department is defined as follows:

*A manageable-sized collection of machines, manufacturing units, or sub-departments, covered by a local material-handling device.*

We define the flow-based department formation problem as follows:

*Assignment or grouping of machines, manufacturing units, or sub-departments into the department to minimize inter-department traffic.*



In this research, we will use a group of unequal-sized sub-departments to form a department, where the sub-departments have unequal area and are considered to be indivisible. The grouping procedure does not consider the specific dimensions of each sub-department although the area of each sub-department is known. However, determination of the horizontal and vertical dimensions of each sub-department is conducted after the grouping procedure is complete.

The formed departments are arranged within the facility boundaries, which are assumed to form a rectangular shape. The interaction between two departments is obtained by aggregating the interactions between the sub-departments assigned to the two departments. Therefore, the layout arrangement depends on the allocation of sub-departments to the departments and the interaction of the sub-departments that are not in the same department.

The number of departments is a decision variable that relates to the allowable size of departments in the facility. Since each department's size is limited by an upper and lower bound, we are able to compute the maximum and minimum number of departments in advance. However, the exact number of departments for the facility is determined at the time of grouping the manufacturing units into departments.

In this concurrent design of facility layout and department formation problem, we consider the following:

- Determination of the number of departments,
- Assignment of sub-departments to departments,
- Determination of horizontal and vertical dimensions of each department, and
- Arrangement of departments to minimize the inter-department material handling cost.

Intra-department layout design is considered after configuring this integrated problem. Thus, the procedure can be conducted as two separate stages. The procedure of the first stage, the facility layout design and flow-based department formation, is demonstrated in Sections B to E. Section F presents the within-department layout procedure.

## B. Problem Formulation

### 1. General Facility Layout Problem

Consider the following parameters:

$f_{rs}$  : flow from department  $r$  to department  $s$

$A_r$  : area of department  $r$

$L^x, L^y$  : width and length of the facility

$lb_r, ub_r$  : lower and upper bounds of the dimensions of department  $r$

We can formulate the general facility layout problem as follows.

$$\text{(FLP-1)} \quad \min \sum_r \sum_s f_{rs} D_{rs} \quad (3.1)$$

$$s.t. \quad lx_r \cdot ly_r = A_r \quad \forall r \quad (3.2)$$

$$cx_r + \frac{lx_r}{2} \leq cx_s - \frac{lx_s}{2} + L^x(1 - \alpha_{rs}) \quad \forall r, s \quad (3.3)$$

$$cy_r + \frac{ly_r}{2} \leq cy_s - \frac{ly_s}{2} + L^y(1 - \beta_{rs}) \quad \forall r, s \quad (3.4)$$

$$\alpha_{rs} + \alpha_{sr} \leq 1 \quad \forall r, s \quad (3.5)$$

$$\beta_{rs} + \beta_{sr} \leq 1 \quad \forall r, s \quad (3.6)$$

$$\alpha_{rs} + \beta_{rs} \geq 1 \quad \forall r, s \quad (3.7)$$

$$D_{rs} = |cx_r - cx_s| + |cy_r - cy_s| \quad \forall r, s \quad (3.8)$$

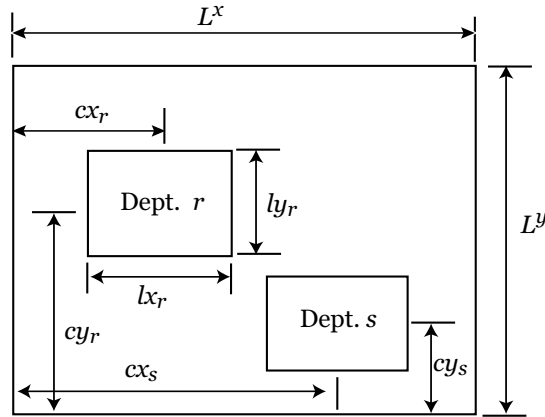

Fig. 2. Illustration of decision variables and parameters for FLP-1

$$\frac{l_{x_r}}{2} \leq c_{x_r} \leq L^x - \frac{l_{x_r}}{2} \quad \forall r \quad (3.9)$$

$$\frac{l_{y_r}}{2} \leq c_{y_r} \leq L^y - \frac{l_{y_r}}{2} \quad \forall r \quad (3.10)$$

$$lb_r \leq l_{x_r} \leq ub_r \quad \forall r \quad (3.11)$$

$$lb_r \leq l_{y_r} \leq ub_r \quad \forall r \quad (3.12)$$

$$\alpha_{rs}, \beta_{rs} \in \{0, 1\} \quad \forall r, s. \quad (3.13)$$

Constraint (3.2) denotes the departmental area, and constraints (3.3)-(3.7) ensure that no overlap is allowed between the departments.  $D_{rs}$  represents the rectilinear distance between the respective centroids  $(cx, cy)$  of departments  $r$  and  $s$ . We impose the boundary constraints (3.9) and (3.10) to guarantee that each department  $r$  is within the building  $(L^x \times L^y)$ . In addition, the width and length of each department  $r$   $(l_{x_r}, l_{y_r})$  are restricted by upper and lower bounds  $(ub_r, lb_r)$ . These bounds not only limit the department area to a manageable size but also capture the aspect ratio constraint, which delineates the maximum permissible ratio between the longest and shortest sides. The illustration of decision variables and parameters for FLP-1 is shown in Fig. 2.

The FLP-1 solves the layout design problem by determining the dimensions of each department and the location of the department in the facility. However, it does not consider the formation of each department. We remodel the problem to a concurrent design problem by modifying constraints (3.2)-(3.7). The explanation of the modification is presented in the following section.

## 2. Concurrent Design Model

We assign sub-departments to the departments by determining the location of each department in the facility in such a way as to minimize the inter-department material handling costs. In this problem, a department is formed by grouping one or more sub-departments, and the dimensions and location of each department are determined based on the sub-departments that are assigned to the department.

In department area constraint (3.2),  $A_r$  represents the area of department  $r$ . Also,  $A_r$  can be expressed as the sum of the sub-department areas ( $a_i$ ) in department  $r$ .

$$\sum_{i \in \Omega_r} a_i = A_r \quad (3.14)$$

where,  $\Omega_r$  is a set of sub-departments that are assigned to department  $r$ .

However, it is very difficult to formulate the problem that includes the variables for both sub-departments and departments because it would have to consider two different instances simultaneously in one formulation. We can eliminate the need to consider departmental variables by defining their formation as a result of sub-department location. We assume that the department has a pick-up/drop-off point at the centroid and use the fact that the sub-departments assigned to a department have the same pick-up/drop-off point for their inter-department material flow. Thus, we allow the centroid of sub-department  $i$  to be located at the same position as

the centroid of sub-department  $j$  if these sub-departments are assigned to the same department. The department that includes these sub-departments needs to be demarcated based on the area requirements of these sub-departments. The new constraint for grouping the sub-departments is as follows:

$$a_i + \sum_{j, j \neq i} (1 - \gamma_{ij}) a_j = lx_i \cdot ly_i \quad \forall i \quad (3.15)$$

where,

$$\gamma_{ij} = \begin{cases} 1 & \text{if sub-department } i \text{ and } j \text{ are not in the same department} \\ 0 & \text{otherwise.} \end{cases}$$

The left-hand side of equation (3.15) represents the area of the department that includes sub-department  $i$  and sub-department  $j$  when  $j \neq i$  and  $\gamma_{ij} = 0$ . According to constraint (3.15), the dimensions of sub-department  $i$  ( $lx_i, ly_i$ ) are not matched with the area of sub-department  $i$  ( $a_i$ ). The area of  $lx_i \cdot ly_i$  indicates the area of the department that includes sub-department  $i$ . This implies that all of the sub-departments in the same department have the same area with the same dimensions. It violates the restriction that the sum of the areas of the sub-departments can not exceed the total area of the facility. However, it is possible to house all of the sub-departments in the facility without the violation if we allow complete overlapping of sub-departments that are in the same department. The overlapping can be controlled by the following constraints:

$$cx_i + \frac{lx_i}{2} \leq cx_j - \frac{lx_j}{2} + L^x(1 - \alpha_{ij}) \quad \forall i, j \quad (3.16)$$

$$cy_i + \frac{ly_i}{2} \leq cy_j - \frac{ly_j}{2} + L^y(1 - \beta_{ij}) \quad \forall i, j \quad (3.17)$$

$$\alpha_{ij} + \alpha_{ji} \leq 1 \quad \forall i, j \quad (3.18)$$

$$\beta_{ij} + \beta_{ji} \leq 1 \quad \forall i, j \quad (3.19)$$

$$\alpha_{ij} + \alpha_{ji} + \beta_{ij} + \beta_{ji} \geq \gamma_{ij} \quad \forall i, j \quad (3.20)$$

$$\frac{\alpha_{ij} + \alpha_{ji} + \beta_{ij} + \beta_{ji}}{2} \leq \gamma_{ij} \quad \forall i, j \quad (3.21)$$

where  $\alpha$  and  $\beta$  are binary variables indicating horizontal and vertical spatial sequencing, respectively. Constraints (3.3)-(3.7) in FLP-1 control the relative location of departments and do not allow overlapping. However, constraints (3.16)-(3.21) selectively allow overlapping for sub-departments that are assigned to the same department. If sub-department  $i$  and  $j$  are in the same department, then  $\gamma_{ij} = 0$ . Then, the variables  $\alpha_{ij}, \alpha_{ji}, \beta_{ij}, \beta_{ji}$  should be zero according to constraint (3.21) and this makes the overlapping prevention constraints (3.16) and (3.17) ineffective. Four cases of relative location of sub-departments based on a combination of the binary variables,  $\alpha_{ij}, \beta_{ij}$ , and  $\gamma_{ij}$  are shown in Fig. 3.

Based on the above discussion, we develop model FLP-DF for concurrent design of the facility layout and department formation.

$$\text{(FLP-DF)} \quad \min \sum_{i=1}^n \sum_{j=1}^n f_{ij} D_{ij} \quad (3.22)$$

$$\text{s.t.} \quad \frac{lx_i}{2} \leq cx_i \leq L^x - \frac{lx_i}{2} \quad \forall i \quad (3.23)$$

$$\frac{ly_i}{2} \leq cy_i \leq L^y - \frac{ly_i}{2} \quad \forall i \quad (3.24)$$

$$cx_i + \frac{lx_i}{2} \leq cx_j - \frac{lx_j}{2} + L^x(1 - \alpha_{ij}) \quad \forall i, j \quad (3.25)$$

$$cy_i + \frac{ly_i}{2} \leq cy_j - \frac{ly_j}{2} + L^y(1 - \beta_{ij}) \quad \forall i, j \quad (3.26)$$

$$\alpha_{ij} + \alpha_{ji} \leq 1 \quad \forall i, j \quad (3.27)$$

$$\beta_{ij} + \beta_{ji} \leq 1 \quad \forall i, j \quad (3.28)$$

$$\alpha_{ij} + \alpha_{ji} + \beta_{ij} + \beta_{ji} \geq \gamma_{i,j} \quad \forall i, j \quad (3.29)$$

$$\frac{\alpha_{ij} + \alpha_{ji} + \beta_{ij} + \beta_{ji}}{2} \leq \gamma_{ij} \quad \forall i, j \quad (3.30)$$

$$lb \leq lx_i \leq ub \quad \forall i \quad (3.31)$$

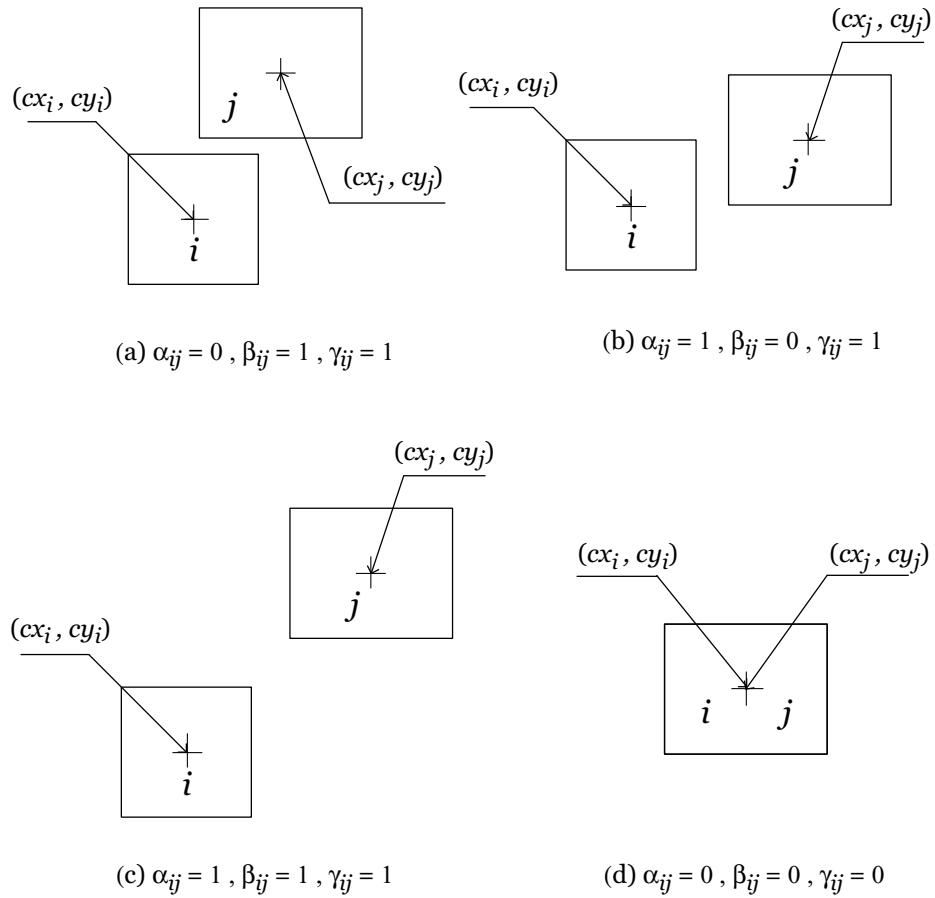

Fig. 3. Four cases of binary variable combinations

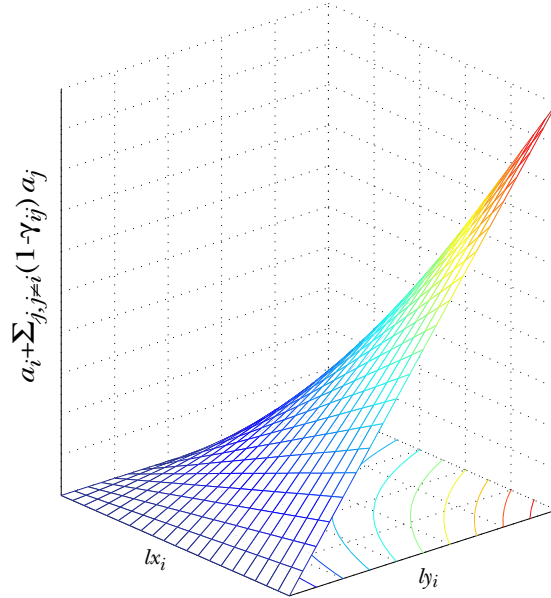

Fig. 4. The solution space of  $a_i + \sum_{j, j \neq i} (1 - \gamma_{ij}) a_j = l x_i \cdot l y_i$

$$lb \leq l y_i \leq ub \quad \forall i \quad (3.32)$$

$$a_i + \sum_{j, j \neq i} (1 - \gamma_{ij}) a_j \leq l x_i \cdot l y_i \quad \forall i \quad (3.33)$$

$$D_{ij} = |c x_i - c x_j| + |c y_i - c y_j| \quad \forall i, j \quad (3.34)$$

$$\alpha_{ij}, \beta_{ij}, \gamma_{ij} \in \{0, 1\} \quad \forall i, j \quad (3.35)$$

The unequal area constraint (3.33) is nonconvex and hyperbolic as depicted in Fig. 4. This complicated solution space needs to be linearized for the mixed-integer linear programming model (MILP) so that the problem can be solved with an optimization software package.

### C. Linearization

The linearization contains two parts: (1) determination of the department area ( $a_i + \sum_{j, j \neq i} (1 - \gamma_{ij}) a_j$ ) and (2) determination of the horizontal and vertical dimensions



of the department that is represented by the dimensions of any sub-department in the department  $(lx_i, ly_i)$ . Although these two parts can be linearized separately, we need to construct an integrated formulation since these variables are inter-related. The linearized constraints underestimate the actual area in order to avoid violating area constraints. As a result, the actual area of the department, which is the sum of the area of the sub-departments assigned to the department, is greater than, or equal to, the estimated department area. This creates a problem when we design the within-department layout of the sub-departments. Therefore, the dimensions of the department need to be adjusted for this purpose. Note that the dimensions of sub-department  $i$   $(lx_i, ly_i)$ , which are the same as the dimensions of the department that includes sub-department  $i$ , are only effective in the first stage. In stage 2, the actual dimensions  $a_i = lx_i \cdot ly_i$  will be used.

The meshed and curved surface in Fig. 4 represents the relationship of  $lx_i, ly_i$  and  $a_i + \sum_{j, j \neq i} (1 - \gamma_{ij})a_j$  in the solution space, and the curved lines on the plane are the projected space of each level of  $a_i + \sum_{j, j \neq i} (1 - \gamma_{ij})a_j$ . For linear approximation of this curved space, variable  $x_{0i}$  is introduced.  $x_{0i}$  works as a mediator and facilitator to link  $a_i + \sum_{j, j \neq i} (1 - \gamma_{ij})a_j$  to  $lx_i$  and  $ly_i$ . To simplify the notation, we set  $a_i + \sum_{j, j \neq i} (1 - \gamma_{ij})a_j$  as  $\Phi_i$ . We also introduce linear functions  $f_1(x_{0i})$  and  $f_2(x_{0i})$  to substitute for the non-linear area constraint. This linearization considers two separate cases. One is for determination of the department area, and the other is for determination of the dimensions of the department.

$$\Phi_i \leq lx_i \cdot ly_i \implies \Phi_i \leq f_1(x_{0i}) \quad \text{and} \quad f_2(x_{0i}) \leq lx_i \cdot ly_i \quad (3.36)$$

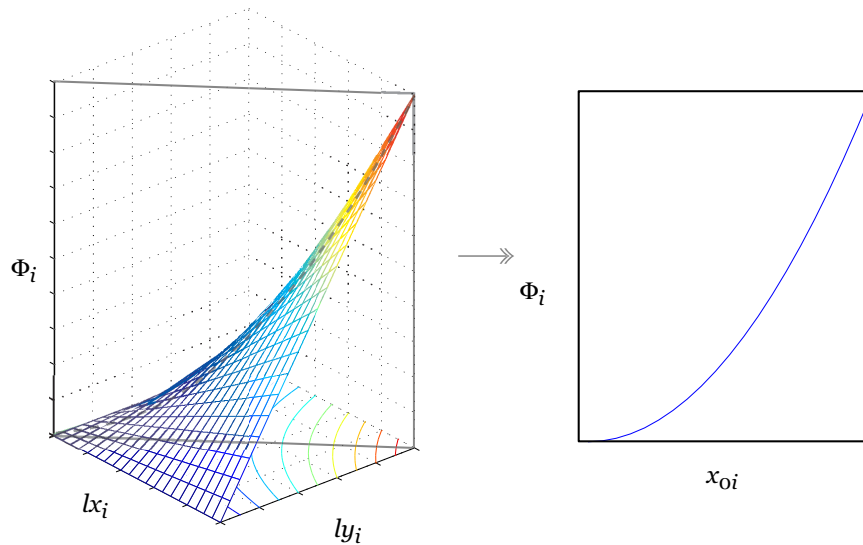

Fig. 5. The relationship of  $\Phi_i$  and  $x_{0i}$

1. Step 1:  $\Phi_i \leq f_1(x_{0i})$

The area  $\Phi_i$  reflects the multiplication of the width and the length. In other words, we need to have two pieces of information to express area. However, there is one instance when we can find the area with a single value of length or width – the case where the length and width are equal. We set the variable  $x_{0i}$  to represent this case. The plane vertically and diagonally bisecting the solution space shows the relationship between  $\Phi_i$  and  $x_{0i}$  in Fig. 5. In this case,  $f_1(x_{0i}) = x_{0i}^2$  and so the curve can be represented as

$$\Phi_i = x_{0i}^2. \quad (3.37)$$

Since the feasible region is the left hand side of the curve, we have to place the straight line of the linear approximation in the feasible region in order to underestimate the area. It could generate an infeasible solution if we set the line on the right hand side of the curve because the total area of the department could exceed

the desired floor space. We are able to set the function of the straight line that passes through the two intersections of  $lb, ub$  and  $\Phi_i = x_{0i}^2$  in Fig. 6. This line can be expressed as

$$f_1(x_{0i}) = (ub + lb)(x_{0i} - lb) + lb^2. \quad (3.38)$$

The gap between the actual area representation and the linearly relaxed line remains as an error term. The number of linear functions for the approximation is inversely proportional to the error. Two piecewise linear segments are shown in Fig. 7, and each line can be expressed as follows:

$$f_{1k}(x_{0i}) = (ub_k + lb_k)(x_{0i} - lb_k) + lb_k^2, \quad k = 0, 1. \quad (3.39)$$

A binary variable is used to determine the partition point between the two line segments. We use one binary variable,  $\rho_i$ , to recognize the two separated areas. Detailed discussions about accuracy and time considerations are in Section C.3 and Section G.1. The resulting constraints are

$$x_{0i} \leq ub_0 + M \cdot \rho_i, \quad \forall_i \quad (3.40)$$

$$f_{10}(x_{0i}) \leq (ub_0 + lb_0) \cdot x_{0i} - ub_0 lb_0 + M \cdot \rho_i, \quad \forall_i \quad (3.41)$$

$$lb_1 \leq x_{0i} + M \cdot (1 - \rho_i), \quad \forall_i \quad (3.42)$$

$$f_{11}(x_{0i}) \leq (ub_1 + lb_1) \cdot x_{0i} - ub_1 lb_1 + M \cdot (1 - \rho_i), \quad \forall_i \quad (3.43)$$

$$\rho_i \in \{0, 1\}, \quad \forall_i. \quad (3.44)$$

Since the point  $\sqrt{lb \cdot ub}$  is a partition of two separated linearizing areas with a minimized maximum error, it can be substituted for  $ub_0$  and  $lb_1$  ( $ub_0 = lb_1$ ), and  $f_{1k}(x_{0i})$  can be replaced with the area  $\Phi_i$ , which is equivalent to  $a_i + \sum_{j, j \neq i} (1 - \gamma_{ij}) \cdot a_j$ . These changes result in

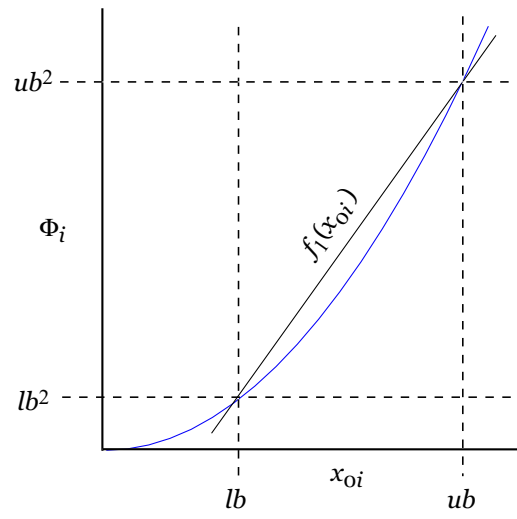

Fig. 6. Linearization of  $\Phi_i = x_{0i}^2$

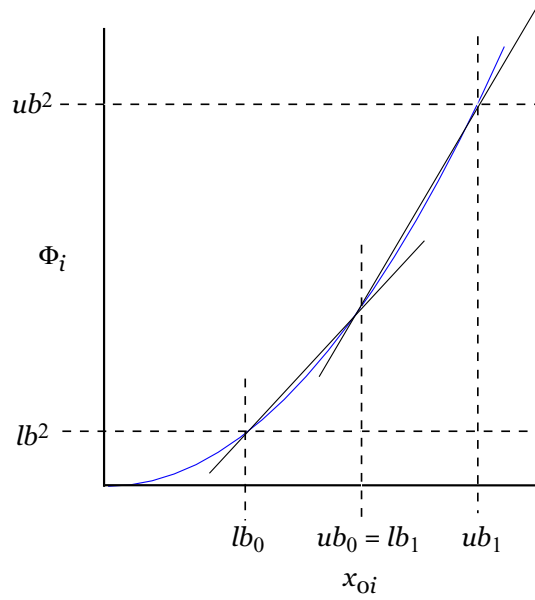

Fig. 7. Partition for the linearization of  $\Phi_i = x_{0i}^2$

$$x_{0i} \leq \sqrt{lb \cdot ub} + M\rho_i, \quad \forall_i \quad (3.45)$$

$$a_i + \sum_{j,j \neq i} (1 - \gamma_{ij})a_j \leq (lb + \sqrt{lb \cdot ub})x_{0i} - lb\sqrt{lb \cdot ub} + M\rho_i, \quad \forall_i \quad (3.46)$$

$$\sqrt{lb \cdot ub} \leq x_{0i} + M(1 - \rho_i), \quad \forall_i \quad (3.47)$$

$$a_i + \sum_{j,j \neq i} (1 - \gamma_{ij})a_j \leq (\sqrt{lb \cdot ub} + ub)x_{0i} - ub\sqrt{lb \cdot ub} + M(1 - \rho_i), \forall_i \quad (3.48)$$

$$\rho_i \in \{0, 1\}, \quad \forall_i. \quad (3.49)$$

## 2. Step 2: $f_2(x_{0i}) \leq lx_i \cdot ly_i$

The linearization discussed in the previous section is for a department area that can be flexibly changed by assigned sub-departments to the department. The procedure can not determine the specific dimensions of the department, although it approximates the size of the department in terms of  $x_{0i}$ . The curve on the plane generated by the horizontal cut in Fig. 8 is the point where  $lx_i \cdot ly_i$  generates equivalent values. Since we assume that the upper and lower bounds of the department area are known, we can approximate the curve ( $lx_i \cdot ly_i = \Phi_i$ ) between points  $P_1$  and  $P_2$  in Fig. 9 by a linear function.

Since we know points  $P_1$  and  $P_2$ , tangent lines can be obtained by differentiating the equation  $f(lx_i, ly_i) = lx_i \cdot ly_i$  at points  $P_1$  and  $P_2$ . The diagonal line in Fig. 10 represents the case where the value of  $lx$  is equivalent to  $ly$  so the department forms a square; this line is identical to the axis of  $x_{0i}$  in Fig. 5.  $(x_1, y_1)$ , and  $(x_2, y_2)$  are intersections of the tangent lines at points  $(P_1, x_{0i})$  and  $(P_2, x_{0i})$ .

The cutting plane at point  $P_2$  is

$$ly_i = -\frac{lb}{ub}(lx_i - x_2) + y_2, \quad (3.50)$$

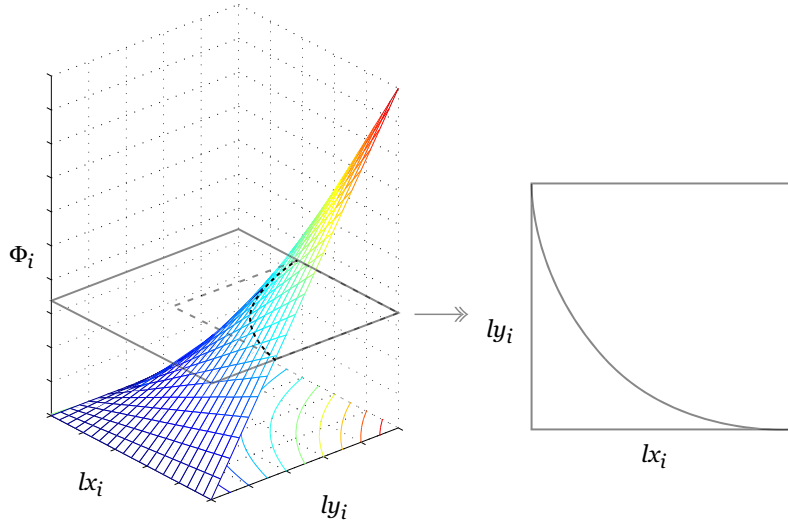

Fig. 8.  $\Phi_i = l x_i \cdot l y_i$

and this line intersects with the line

$$l y_i = -(l x_i - x_{0i}) + x_{0i}, \quad (3.51)$$

at  $x_{0i} = \sqrt{lb \cdot ub}$ . The point  $(x_2, y_2)$  can be calculated as the intersection of these two cutting planes

$$(x_2, y_2) = \left( \frac{2 \cdot (lb - \sqrt{ub \cdot lb}) \cdot ub}{lb - ub}, \frac{2 \cdot (\sqrt{ub \cdot lb} - ub) \cdot lb}{lb - ub} \right). \quad (3.52)$$

The distance between  $x_0$  and  $(x_2, y_2)$  is

$$|x_{0i} - x_2| = \left| \sqrt{lb \cdot ub} - \frac{2 \cdot (lb - \sqrt{ub \cdot lb}) \cdot ub}{lb - ub} \right| \quad (3.53)$$

$$|x_{0i} - y_2| = \left| \sqrt{lb \cdot ub} - \frac{2 \cdot (\sqrt{ub \cdot lb} - ub) \cdot lb}{lb - ub} \right|. \quad (3.54)$$

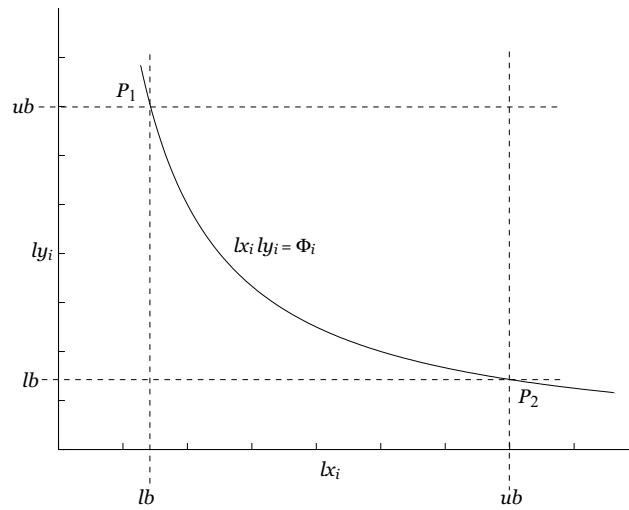

Fig. 9.  $lx_i \cdot ly_i = \Phi_i$  and  $lb \leq lx_i, ly_i \leq ub$

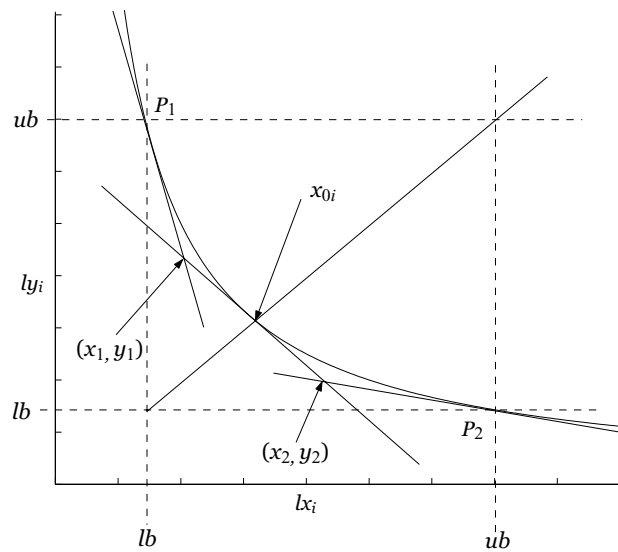

Fig. 10. Three tangential supports for the approximation to the area constraints

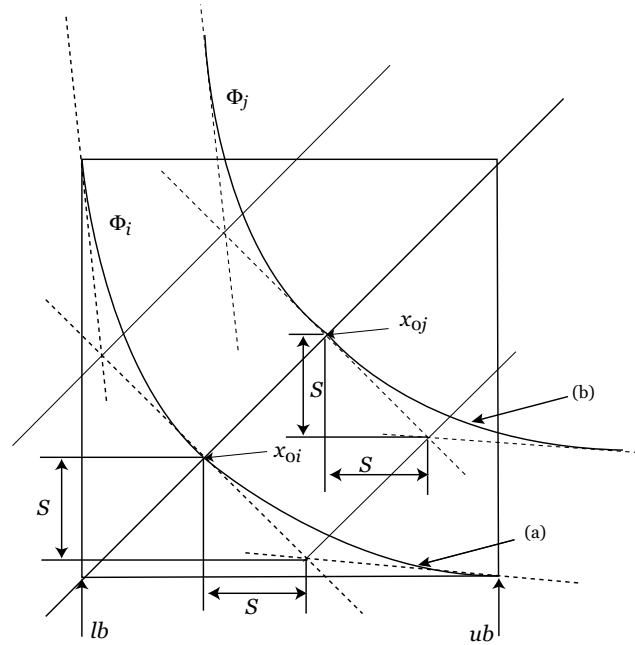

Fig. 11. Three tangential supports along the point of  $x_{0i}$

These two distances are equivalent because  $x_2$  and  $y_2$  are on the cutting plane generated by  $x_{0i}$ , and  $x_{0i}$  is the point where  $lx_i = ly_i$ . This distance is used to find the cutting plane even if  $x_{0i}$  is not equivalent to  $\sqrt{lb \cdot ub}$  as in the curve (b) shown in Fig. 11. The coordinates  $(x_1, y_1)$  can be calculated in the same way as  $(x_2, y_2)$  because the curve is symmetric.

Now, we can approximate the curve using three cutting planes, and we are able to define the plane as a function of  $x_{0i}$ . There are three separate regions for the variable  $lx_i$ ,  $[lb, x_1]$ ,  $[x_1, x_2]$ , and  $[x_2, ub]$ , and the plane can be chosen based on  $lx_i$  falling on one of the boundaries. As mentioned before, this linear approximation underestimates the actual size of the area. Otherwise, an infeasible solution results.

We introduce binary variables  $\lambda_i$  and  $\mu_i$  to distinguish each boundary. Three tangential supports are alternatively activated based on the combination of these



binary variables, which results in the following constraints:

$$x_{0i} + S \leq lx_i + M \cdot \lambda_i \quad \forall_i \quad (3.55)$$

$$\left(\frac{lb}{ub} + 1\right) \cdot x_{0i} \leq ly_i + \frac{lb}{ub}lx_i + \left(1 - \frac{lb}{ub}\right)S + M \cdot \lambda_i \quad \forall_i \quad (3.56)$$

$$lx_i \leq x_{0i} + S + M \cdot (2 - \lambda_i - \mu_i) \quad \forall_i \quad (3.57)$$

$$x_{0i} - S \leq lx_i + M \cdot (2 - \lambda_i - \mu_i) \quad \forall_i \quad (3.58)$$

$$x_{0i} \leq \frac{ly_i}{2} + \frac{lx_i}{2} + M \cdot (2 - \lambda_i - \mu_i) \quad \forall_i \quad (3.59)$$

$$lx_i \leq x_{0i} - S + M \cdot \mu_i \quad \forall_i \quad (3.60)$$

$$\left(\frac{ub}{lb} + 1\right) \cdot x_{0i} \leq ly_i + \frac{ub}{lb}lx_i + \left(\frac{ub}{lb} - 1\right)S + M \cdot \mu_i \quad \forall_i \quad (3.61)$$

$$\lambda_i + \mu_i \geq 1 \quad \forall_i \quad (3.62)$$

$$\lambda_i \in \{0, 1\} \quad \forall_i \quad (3.63)$$

$$\mu_i \in \{0, 1\} \quad \forall_i. \quad (3.64)$$

Our MILP model for optimal facility layout with flow-based department formation (FLP-DF) is formulated as follows.

$$\begin{aligned} \text{(FLP-DF)} \quad \min. \quad & \sum_i^n \sum_j^n f_{ij} D_{ij} \\ \text{s.t.} \quad & (3.23) - (3.32), (3.34), (3.35) \\ & (3.45) - (3.49), (3.55) - (3.64) \end{aligned}$$

Constraints (3.45) - (3.49) and (3.55) - (3.64) represent the cutting planes generated by the linearization of the curved surface as shown in Fig. 12.

### 3. Maximum Error Estimation

The department area is underestimated by the linear approximation, which can lead to estimation errors. These errors occur when (1) the size of the area of each

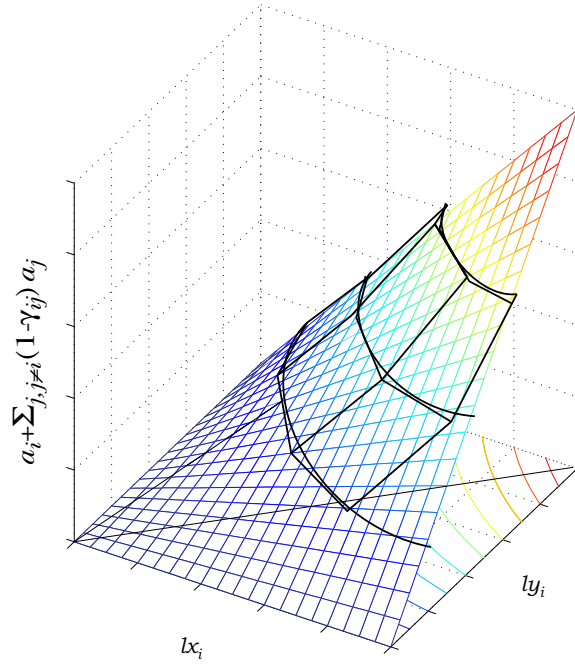
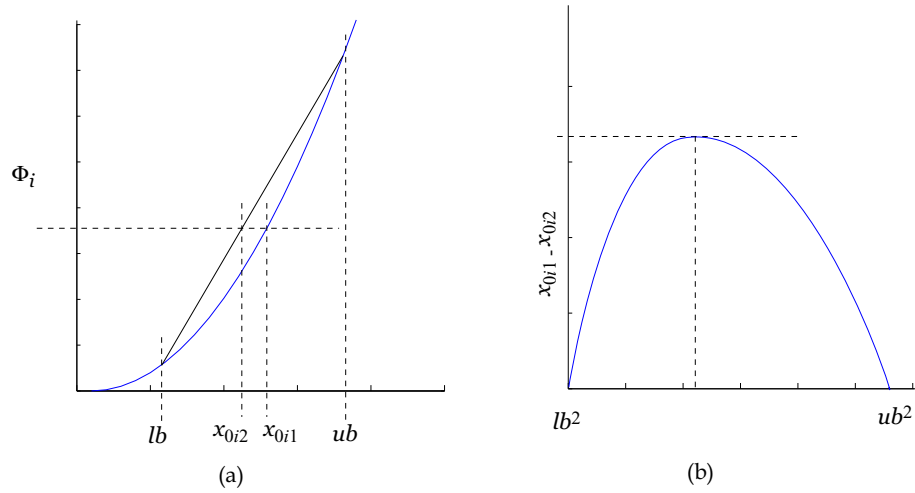

Fig. 12. Linearized solution space

department, which is represented as the square of a variable ( $x_{0i}$ ), is linearized and (2) inter-related variables  $lx_i, ly_i$ , which represent the width and the length of a department area, are linearized by three supporting tangential lines. The maximum error occurs at the intersection of two of the three tangential lines. Thus, the maximum error  $\epsilon^{\max}$  is the sum of the max errors  $\epsilon_1^{\max}$  and  $\epsilon_2^{\max}$ .

a. Estimation of  $\epsilon_1^{\max}$

Consider the case where one straight line passing through the point of  $lb, ub$  of  $\Phi_i = x_{0i}^2$  approximates the curved line of  $\Phi_i = x_{0i}^2$ . We expect that the maximum error occurs somewhere between  $lb$  and  $ub$ . To estimate this, the difference between the actual value ( $x_{0i1}$ ) and the approximated value ( $x_{0i2}$ ) is calculated as shown in Fig. 13 (b), and the highest point of the parabola can be estimated by differentiating

Fig. 13. Estimation of  $d_\epsilon$ 

the function  $G(x_{0i1}, x_{0i2}) = x_{0i1} - x_{0i2}$ . We define this difference as  $d_\epsilon$ , which considers only the difference between  $x_{0i1}$  and  $x_{0i2}$ .

Suppose  $G_\Phi$  to be a function of  $\Phi_i$ , then

$$G(x_{0i1}, x_{0i2}) = x_{0i1} - x_{0i2} \quad (3.65)$$

$$\Rightarrow G_\Phi(\Phi_i) = \sqrt{\Phi_i} - \left( \frac{\Phi_i}{lb + ub} + \frac{lb \cdot ub}{lb + ub} \right) \quad (3.66)$$

$$\Rightarrow \frac{dG_\Phi(\Phi_i)}{d\Phi_i} = \frac{1}{2\sqrt{\Phi_i}} - \frac{1}{lb + ub}. \quad (3.67)$$

We can set equation (3.67) to zero to calculate  $\Phi_i$ , the point of max difference,  $d_\epsilon^{\max}$ , and we have  $\Phi_i$  as

$$\Phi_i = \left( \frac{lb + ub}{2} \right)^2. \quad (3.68)$$

This indicates that the maximum difference,  $d_\epsilon^{\max}$ , occurs exactly at the midpoint of  $lb$  and  $ub$ , and the error at this point can be expressed as

$$\epsilon_d = \frac{(lb - ub)^2}{2(lb + ub)^2}. \quad (3.69)$$

This only shows the error based on the point of max-difference between the actual value and the estimated value. However, the maximum error based on the proportion of the area violation does not occur at the same point of  $d_e^{\max}$  in  $[lb, ub]$ .

The error function  $\epsilon_1(x)$  is

$$\epsilon_1(x) = \frac{(lb + ub)x - lbub - x^2}{(lb + ub)x - lbub}. \quad (3.70)$$

To find the point of max-error, we differentiate the function and set it to zero.

$$\begin{aligned} \frac{d\epsilon_1(x)}{dx} &= \frac{(lb + ub) - 2x}{(lb + ub)x - lbub} \\ &\quad - \frac{(lb + ub)(-x^2 + (lb + ub) - lbub)}{((lb + ub)x - lbub)^2} = 0, \end{aligned} \quad (3.71)$$

$$\Rightarrow x = \frac{2lbub}{(lb + ub)} \quad (3.72)$$

Thus, the max-error is calculated as follows:

$$\epsilon_1^{\max} = 1 - \frac{4lbub}{(lb + ub)^2}. \quad (3.73)$$

We can consider this estimated max-error in terms of the AB-ratio ( $ABR$ ). The AB-ratio is defined as the ratio of maximum width (or length) over the minimum length (or width) of a department, i.e., a maximum allowable ratio of the upper bound over the lower bound ( $ub/lb$ ). The bound restriction of the side length of a department limits the area of the department as well. Fig. 14 shows alternative department shapes and areas for a given AB-ratio.

Fig. 14 (a) shows the case of a department with minimum area when  $lb = 1$ . The department can be flexibly formed by selecting the side length in the range of the lower and upper bounds as shown in Fig. 14 (b), and the maximum available area is shown in Fig. 14 (c).

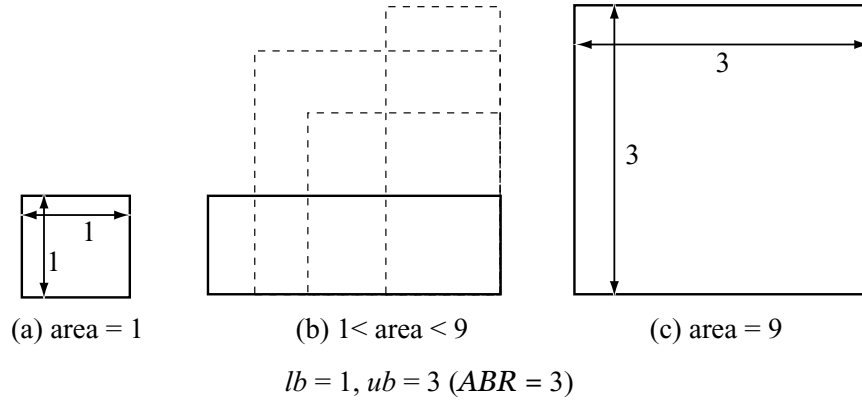

Fig. 14. Potential department shapes and areas when  $ABR = 3$

Now, equation (3.73) can be written as

$$\epsilon_1^{\max} = 1 - \frac{4 \cdot ABR}{(ABR + 1)^2}. \quad (3.74)$$

This indicates that the max-error depends only on the AB-ratio, and the max-error can be reduced by setting the  $ABR$  close to 1.

We can consider linearizations using more partitioned segments, which reduces the max error, but these involve more binary variables. When we consider the use of two linearization segments on  $\Phi_i \leq x_{0i}^2$ , the point of  $\frac{lb+ub}{2}$  can be set as a partition point of the two segments since this point divides the bounded region  $[lb, ub]$  exactly in half. However, as has been mentioned, partitioning at the exact mid-point does not minimize the maximum error. The point of partition that minimizes max-error can be computed using equation (3.74). Fig. 15 shows the  $ABR$  based on a point of partition located between  $lb$  and  $ub$ .

The AB-ratio  $ABR_1$  is linearly increased while  $ABR_2$  is decreased based on the location of  $p$  varying from  $lb$  to  $ub$ , and the AB-ratio applied to equation (3.74) is

$$ABR = \max\{ABR_1, ABR_2\} \quad (3.75)$$

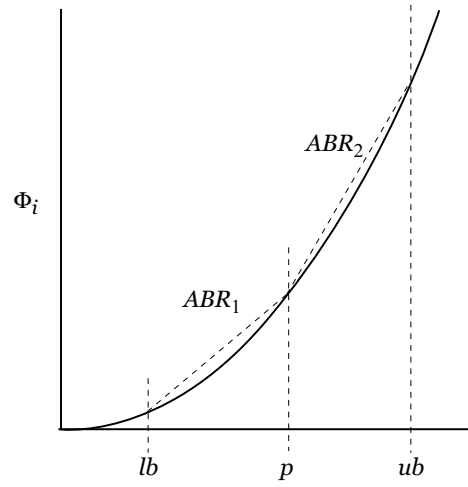

(a)

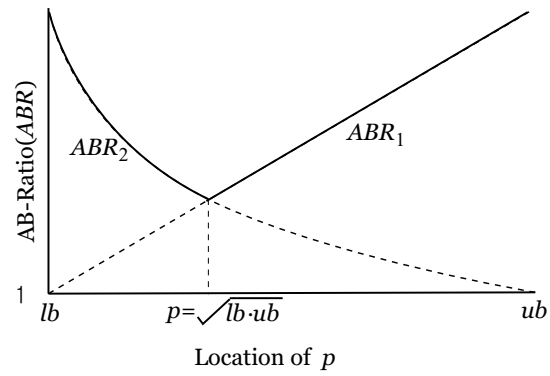

(b)

Fig. 15. Point  $p$  for the minimum AB-ratio

This term is minimized when  $ABR_1 = ABR_2$ . The point that minimizes the AB-ratio is at the intersection of the two lines  $ABR_1$  and  $ABR_2$  in Fig. 15 (b), and this is the point at which the AB-ratio of each segment is equivalent. Thus, the point that minimizes ABR is

$$\frac{p}{lb} = \frac{ub}{p} \quad (3.76)$$

$$\Rightarrow p = \sqrt{lb \cdot ub}. \quad (3.77)$$

b. Estimation of  $\epsilon_2^{\max}$

The maximum area constraint violation, the error  $\epsilon_2^{\max}$ , is found at the intersection of two tangential lines (as shown in Fig. 10) either at the point of  $(x_1, y_1)$  or  $(x_2, y_2)$ . Thus, the max error generated by the estimated length and width is

$$\epsilon_2^{\max} = \frac{ub \cdot lb - x_1 y_1}{ub \cdot lb}, \quad \text{or} \quad \frac{ub \cdot lb - x_2 y_2}{ub \cdot lb} \quad (3.78)$$

$$= 1 - \frac{4(lb - \sqrt{ul \cdot lb})(\sqrt{ub \cdot lb} - ub)}{(lb - ub)^2}. \quad (3.79)$$

The equation in terms of the AB-ratio is

$$\epsilon_2^{\max} = 1 - \frac{4(1 - \sqrt{ABR})(\sqrt{ABR} - ABR)}{(1 - ABR)^2}. \quad (3.80)$$

The possible overall area constraint violation is the sum of each maximum error as  $\epsilon^{\max} = \epsilon_1^{\max} + \epsilon_2^{\max}$ . Fig. 16 shows this case.

#### D. Extending Department Area

The FLP-DF solves the problem but the original department area is approximated and underestimated. Thus, the departments need to be enlarged to their original size since the area of the departments is used as the floor space for sub-

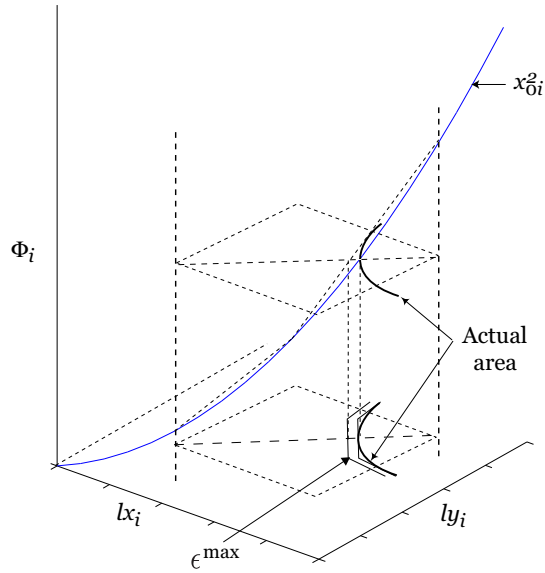

Fig. 16. Error estimation for  $\epsilon^{\max}$

departments placed within it.

The department placed in the floor space can be represented using an incident matrix consisting of elements 1, 0,  $-1$  to depict the relative location of departments. We use Sukhotu's partitioning technique to construct a block layout [36], which extends the underestimated area up to the original, using an incident matrix obtained from the MIP. A more detailed discussion of this procedure is provided in Appendix A.

#### E. Heuristic Approach

The mixed-integer program (MIP) for the general facility layout problem is known to be very difficult even for small instances ( $N \leq 9$ ). The concurrent design problem, FLP-DF, is far more difficult because it considers more aspects that better represent the system. Thus, to find the solution in a desirable amount of time, we use a heuristic approach.

Since genetic algorithms (GAs) have proven effective for finding favorable solu-



tions to facility layout problems, and their structural analysis is comparable to our concurrent design problem, we will use a GA in this study. GAs represent a population approach that is based on biological genetic mechanisms. In our application, the layout configuration compares to chromosomes and the sub-departments are analogous to genes. However, it is inevitable that the general genetic algorithm for a facility layout problem must be modified in order to handle characteristics such as the grouping of sub-departments into a department. Thus, we develop a modified genetic algorithm to cope with the specific attributes of inter-department layout and department formation.

### 1. General Genetic Algorithms

The category of genetic algorithms was developed in 1975 by Holland [37] who was inspired by biological systems that produce organisms that not only adapt to the environment successfully but also thrive. The survival of the fittest principle in natural biological systems has been applied to combinatorial optimization problems with remarkable success. GAs maintain a population of candidate solutions rather than generate a sequence of candidate solutions one at a time [29]. Genetic algorithms also have a number of unique features as listed below (see Tate and Smith [29], Liggett [38]):

- a representation consisting of data that describes a unique feasible solution
- a reproduction mechanism for generating new solutions by combining features from solutions in the existing population
- a mutation mechanism for generating new solutions by operating on a single previously known solution

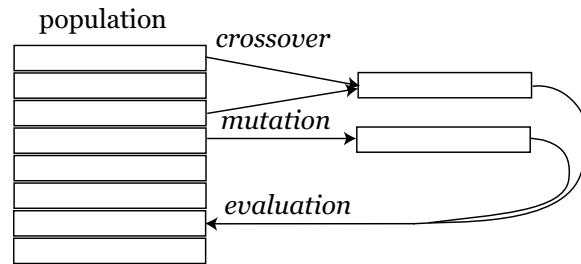

Fig. 17. General structure of a genetic algorithm

- an evaluation mechanism for selecting a set of solutions from the population(s), giving preference to those with better objective function values
- a culling mechanism for removing solutions from the population

An initial population of solutions can be generated randomly. This population is multiplied by a breeding mechanism that combines two chromosomes to produce offspring that possibly improves the solution and by mutation mechanism that changes the genes in the chromosome for new offspring. The population is improved by evaluating and culling the generations, and the iteration of these procedures leads to improved solutions. The general structure of a GA appears in Fig. 17.

Genetic search methods are highly parallel making it more likely they will settle on a global or near-global solution than other constructive or improvement procedures [38] because each population member searches many different possible directions. Genetic algorithms have proved to be fairly robust with varying parameter settings and problem particulars, and GAs usually find near optimal solutions as long as solutions with similar encodings do not have highly variant objective function values [29].

## 2. Genetic Algorithm Implementation

### a. Representation and Operators

We use the flexible bay structure developed by Tong [39] to place a department that is formed by grouping sub-departments. A pre-specified rectangular area is divided in one direction into bays of varying widths. Since each department is of different size, each bay is divided into rectangular departments of equal widths but different lengths. The bay width is flexibly adjusted for the departments assigned to the bay.

Tate and Smith [29] used the flexible bay structure and developed an algorithm named FLEX-BAY for unequal-area facility layout design. They used two distinct chromosomes to represent flexible bay solutions. The first chromosome represents the sequence of departments, and the second chromosome represents the number of bays and the break points of the sequence between the bays.

The representation of the concurrent design problem is more complicated than that of the FLEX-BAY algorithm. We use one chromosome to represent the solution. However, we additionally use another chromosome to examine the possible grouping and layout using the chromosomes generated for representing the solution. This additional chromosome is called a sub-chromosome to distinguish it from the chromosomes used to represent the solution. The procedure of grouping the sub-departments to form departments and determining the number of departments determining the total number of bays, and determining the number of departments to place in each bay is handled by the algorithm, which is modified to manage this complicated procedure. The representation is shown in Fig. 18.

A chromosome is composed of numbers that represent the sub-departments. There is no specific indication of the breaking points for the grouping of depart-

ments or bays. However, the sequentially arranged numbers can be grouped if they meet the condition of forming a department by adding a sub-department one by one, left to right. The feasible region in Fig. 18 (a) indicates the candidate breaking points for grouping a department when the summed area is in the range of the designated department size. Once the grouping procedure has determined a set of alternative groups, each group is numbered and used as a sub-chromosome. The general genetic algorithm is used to determine the best layout in a given chromosome using these sub-chromosomes. Determination of the bay break point, which indicates where bays occur, is the same as the grouping procedure shown in Fig. 18 (b).

For breeding, we use the partial matched crossover to avoid generating an infeasible solution. The number in a chromosome indicating sub-departments only appears once, and these numbers should not be duplicated in the procedure of reproduction. The partial matched crossover checks to see if there are two integer numbers, which are the same, in the new chromosome and swaps the number of the position in the chromosome instead of inserting the number from the other parent.

We used a swap mutation operator for the mutation. Two randomly selected positions are swapped to generate a new chromosome. As we mentioned with the breeding mechanism, the gene which represents sub-departments is unique in the chromosome and should not be duplicated. The standard mutation operator chooses one of the genes in the chromosome and changes its inheritance but, in this problem, the chromosome becomes an infeasible representation since the new gene would be one of the integer numbers in the chromosome or a number that is not one of the structural elements of the chromosome.

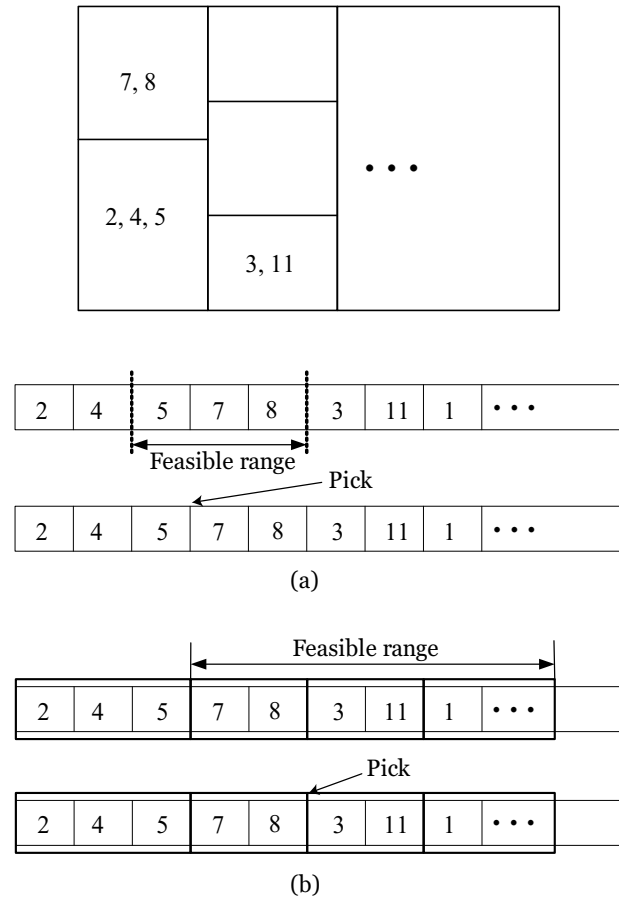

Fig. 18. Representation of the GA

## b. Evolution Parameters

Several trial experiments have been conducted to determine a good set of evolution parameters. Population sizes from 10 to 50, 50% to 90% as the crossover rate, and 10% to 50% as the mutation rate were tested. The percentage of individuals in a generation produced via mutation is typically very small (0.1%-1%) [1]. However, Tate and Smith [29] used a very flexible range of mutation rates to experiment for parameters (1% to 50%), and they found that a higher probability of mutation is required for culling to ensure population diversity. After examining the combinations of parameters, we set the population size at 10, the crossover rate at 60%, and the mutation rate at 10%. With a population close to 50, it takes longer to finish the iterative procedure without improving the solution quality. The parent selection for crossover and mutation is different in every generation with an average rate of 0.6 and 0.1, respectively.

## c. Evaluation and Penalty Function

The population size is maintained over the generations by a culling procedure with the selection based on certain evaluation principles for determining the nature of next generation. The GA retains a small percentage (typically 10%-30%) of the individuals from each previous generation based on their fitness value [1]. All of the offspring generated by the crossover and mutation mechanisms are members of the next generation.

The fitness value evaluated by calculating the total flow distance between departments, would be increased excessively by a penalty function if the configuration of the individuals is not feasible. This happens because each department has a limited length and width or AB-ratio (*ABR*) as explained in Section C.a and defined as

aspect ratio for this case by

$$ABR = \max\{lx_i, ly_i\} / \min\{lx_i, ly_i\} \quad (3.81)$$

where  $lb \leq lx_i, ly_i \leq ub$  and  $lx_i, ly_i$  are the width and length of sub-department  $i$  as well as of department  $r$  which contains sub-department  $i$ . We set the penalty by multiplying a number times the fitness value if the configuration of the individuals is not feasible. The objective of using a penalty function is to help find a feasible solution and exclude infeasible solutions from the population. However, if there are not enough feasible individuals from a generation, an infeasible individual may be included in the next generation for possible transformation into a quality solution.

#### F. Intra-department Layout Design

The intra-department layout problem can be considered as a general unequal-area facility layout problem. It can be solved using CPLEX if the problem size is small as in Section G.3; the maximum number of sub-departments in a department is 6 in the problem of 20 sub-departments. However, this problem also needs to be linearized for unequal-area constraints although it's not as complicated as a concurrent design problem because the area of each sub-department is known in advance.

##### 1. Separating as an Independent Problem

Each department layout is solved as a separate problem but interaction between sub-departments that are not in the same department should also be considered. The previous procedure assumed that the pick-up/drop-off point of each department is its centroid and that the material flow from a sub-department to another sub-department in a different department passes through the p/d point of each department. Thus,

the flow matrix given for the concurrent design problem can be separated for each within-department layout problem by considering the flow between p/d point and sub-departments  $i$  as follows.

$$f_{i,p/d} = \sum_j f_{ij} \gamma_{ij} \quad (3.82)$$

$$f_{p/d,i} = \sum_j f_{ji} \gamma_{ji} \quad (3.83)$$

## 2. $\epsilon$ -Accurate Model

We adopted the  $\epsilon$ -Accurate Model FLP $\epsilon$  [40] to solve the problem. The model linearizes unequal-area constraints with error  $\epsilon$ .  $\epsilon$  can be controlled by the number of cutting planes that linearize the curve of the area constraints without introducing binary variables for linearizing. This model assumes that the area of each department is known *a priori* so that the model can generate the number of cutting planes necessary to achieve the desired error range for the known area constraints. Thus, the number of linear constraints is inversely proportional to the max-error. A detailed discussion of the model is provided in Appendix B.

## G. Computational Results

Since literature does not yet exist for an integrated model that considers layout design and flow-based department formation, there is no comparable data for us to use. However, unequal-area sub-departments can be treated as departments and then we can use existing data for department layout problems although we are unable to compare layout solution efficiency. We took a problem set for 6 to 9 sub-departments and ran these in CPLEX. The genetic algorithm was implemented using C++ to test mid-sized problems. We tested some well-known problems for 10 to 14 sub-



departments from studies published by van Camp *et al.* [41], Bazaraa [42], and Hassan *et al.* [43] and also tested a larger sized problem (20 sub-departments) from Armour and Buffa [6]. We define these data sets as VC10, B12, B14 and AB20 respectively.

We additionally have tested for the problems in Morris and Tersine [44], Co and Araar [45] to compare the grouping and layout efficiency of the solution procedure. Finally, we tested the large size problems for 100 sub-department problems.

### 1. Level of Accuracy and Computational Time Consideration

Maximum error based on boundary restriction must be estimated to decide the level of accuracy and the time consumed in solving the problem. The more binary variables that are introduced to linearize the problem, the less error there is generated in the department area and the more time there is consumed in solving the problem. As discussed in section C, the linearization procedure has two parts. The part where we determine the specific dimensions of the sub-departments uses three cutting planes for linearization. The other part where we determine the area of the sub-departments can have more cutting planes for reducing maximum possible error, but this means increasing the number of binary variables and therefore, the computational time. The boundary restrictions are set at 2 for the lower bound and 6 to 8 for the upper bound, and three possible cases are considered for this linearization as shown in Fig. 19.

These errors  $\epsilon_1^{\max}$  are calculated based on equation (3.74). Table I shows the estimated maximum error  $\epsilon_1^{\max}$  for each case of Fig. 19 when  $[lb, ub] = [2, 8]$ .

Two partitioned segments reduce the error dramatically from the case of no partition. However, binary variables need to be introduced to identify each segment if it is partitioned for linearization. Partitioning the line into three segments requires  $2n$  binary variables, which is the same number of binary variables needed for 4 partitioned segments. This takes much more time compared to a case with  $n$  binary variables.

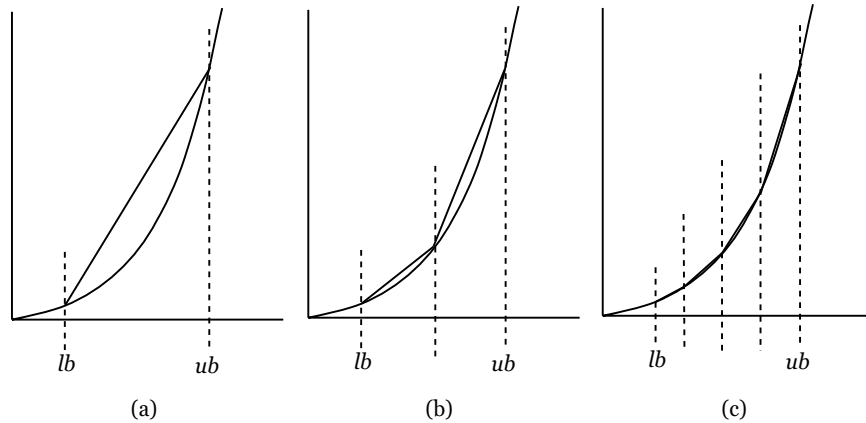

Fig. 19. Partitioning for area constraint linearization

We have tested the problem M6 ( $[lb, ub] = [2, 6]$  and  $ABR = 3$ ), which is taken from [15], to compare the CPU time in each case in Fig 19 using a Pentium 4 class computer, 2.2Ghz CPU, 512Mb of physical memory operating under MS-Windows XP Professional. Table II shows the results of this comparison.

The extended cost in the results indicates that all three cases generate the same layout configuration. However, the OFV for (a) is quite different from the extended OFV which is assumed to be the original, and (c) takes a much longer time to generate the solution although the result of (c) is very close to the original. Problem M6 has been tested by setting different partition schemes. Table II shows the detailed results of the computational time and accuracy. Three of the cases generate an

Table I. Estimated max. error  $\epsilon_1^{\max}$  and number of binary variables when  $ABR = 4$

	number of segments	maximum error	number of binary variables
(a)	1	0.36	0
(b)	2	0.11	$n$
(c)	4	0.03	$2 \cdot n$

Table II. Error estimation ( $\epsilon_1$ ) based on the number of partitioned segments for M6

	Estimated	M6				
	Max. Error	CPU		Extended	Max. Error	Error
	$\epsilon_1^{\max} + \epsilon_2^{\max}$	time	Cost	Cost	Error	Overall
(a)	32.2%	0.0	57.54	69.0	26.2%	19.6%
(b)	14.4%	2157.47	64.62	69.0	9.6%	8.2%
(c)	9.1%	65,781.31†	67.24	69.0	6.2%	4.6%

†Not solved optimally due to insufficient memory. The optimality gap is 21.47%

identical layout solution for problem M6; the extended costs of all three are equivalent. However, the max-error for case (a) is 26.2% with a 19.6% overall error. Case (c) generated a solution that is close to the extended area solution but the procedure's run time is extremely long (in fact, it did not finish because the search tree consumed all of the available memory in the computer system). Thus, we use the two-partitioned segmentation approach for the linearization process for the remainder of the test problems.

## 2. The Small Test Problems

We performed a computational test for a 6 to 9 sub-department problem on FLP-DF. As was mentioned, the solution to this problem set is not directly comparable since there is no previous literature on this problem. We took the problem from [13] and [15], and we considered the departments as sub-departments. The test was performed on the same system used in the previous section - a CPLEX 6.5 in AMPL interface with a Pentium 4 class computer, 2.2 GHz, and 512 Mb of physical memory. Table III shows the computational results for these small problems.

Table III. Computational results of FLP-DF

	Cost	CPU time	Optimality gap	# of dept.	[lb,ub]
M6	64.62	2,157.47	0%	4	[2,6]
M7	93.52	86,400	7.16%	6	[2,6]
FO7	19.39	9,560.15	61.20%	6	[2,7]
FO8	30.20	7,074.30	75.44%	7	[2,7]
FO9	n/a†				[2,8]
O7	131.30	8,287.92	78.43%	6	[2,7]
O8	310.72	9,410.39	74.90%	7	[2,7]
O9	n/a†				[2,8]

†No feasible solution found before memory limit was exceeded.

The result shows that only the 6 sub-department problem can be solved to optimality. The number of binary variables used for the problem is  $3N^2$ ;  $3N$  is for linearization and  $3N(N - 1)$  is for the relative locations between sub-departments. Thus, even a small sized problem can have many binary variables that cause the solution procedure to be incomplete in a desirable time frame or with a limited memory source. Problems sized from 7 to 9 sub-departments could not finish the search procedure because of lack of memory in the computer system.

These results are from the formulation that underestimates the department area. Table IV lists the errors  $\epsilon_r = (A_r - lx_rly_r)/A_r \times 100(\%)$  in the actual area of all departments in the feasible solution corresponding to FLP-DF, where  $A_r$  represents the area of department  $r$ . The departments are numbered arbitrarily since there was no physical department indicated, and they are represented by the grouping of sub-departments.

Table IV. % errors  $\epsilon_r$  in actual areas

Problem	department								Maximum error(%)	Estimated Max. error(%)
	1	2	3	4	5	6	7	8		
M6	9.6 (1,2)	8.1 (3,4)	9.3 (5)	6.5 (6)					9.6	14.36
M7	6.6 (1)	0.0 (2)	8.1 (3,4)	0.0 (5)	6.5 (6)	5.5 (7)			6.6	14.36
FO7	11.6 (1)	11.6 (2)	4.8 (3)	8.8 (4)	0.0 (5,6)	14.0 (7)			11.6	18.39
FO8	11.3 (1)	11.3 (2)	2.0 (3)	7.5 (4)	2.7 (5,6)	12.9 (7)	16.9 (8)		16.9	18.39
O7	5.6 (1)	13.0 (2,6)	0 (3)	6.9 (4)	0 (5)	11.8 (7)			13.0	18.39
O8	11.6 (1)	11.6 (2)	9.0 (3)	2.6 (4,6)	7.1 (5)	8.7 (7)	16.9 (8)		16.9	18.39

% errors (sub-department assigned to the department)

The estimated maximum errors  $\epsilon_1^{\max}$  are 14.36%, 18.39%, 22.22% for  $ABR = 3, 3.5, 4$  respectively. Larger aspect ratios lead to larger errors. The GA uses actual area constraints to configure feasible solutions. Thus, the error term should be excluded when comparing the results of FLP-DF and GA. These extended areas are used as floor space in the intra-department layout as well. The results generated by CPLEX for FLP-DF are refined by extending the areas [36] as was mentioned in Section D. Table V shows the comparison of results based on extending the area from the underestimated feasible solutions and the solutions generated by GA.

Table V. Result comparison for FLP-DF and GA

	FLP-DF	Extended	GA	
	Cost(optimality gap)	Cost	Cost	CPU sec
M6	64.62(0%)	69.0	69.0	10.61
M7	93.52(7.16%)	99.26	99.26	11.45
FO7	19.39(61.20%)	21.76	20.48	11.5
FO8	30.20(75.44%)	30.68	23.35	12.5
FO9	n/a†		18.58	13.52
O7	131.30(78.43%)	137.94	131.11	11.56
O8	310.72(74.90%)	312.55	245.60	12.67
O9	n/a†		219.47	13.31

†No feasible solution found in given memory source

The GA generates the solutions quite efficiently. It configures M6 and M7 as FLP-DF using the extension method. The GA also provides better solutions for the rest of the problems (FO7,FO8,O7, and O8), than those found by CPLEX.

### 3. The Mid-Sized Test Problems

Since we know that the genetic algorithm for the concurrent design problem efficiently finds solutions for smaller problems, we now apply the search procedure to mid-sized problems. We take some widely known unequal-area facility layout test problems and modify them for use in this study. van Camp 10 [41], Bazarra 12 and 14 [42, 43] specified minimum side length in their papers but we only restricted the size of department, not of sub-departments. We used the Bazarra problems that were modified in [29]: there are 4 departments that are not interactive in Bazarra 12 and 1 department that does not have side length or shape restriction in Bazarra 14.

There is no fixed minimum side length in the 20-department problem [6]. However, we set the maximum AB-ratio of the departments as on our other test problems. Table VI shows the computational results for these larger problems.

A higher aspect ratio generates fewer departments with lower inter-department material handling costs. The number of departments generated for the problems of AB20 are not reduced by increasing the aspect ratio. However, the material handling cost can be reduced by grouping sub-departments differently. The maximum number of sub-departments in a department in AB20 with  $ABR = 4$  is 6 and with  $ABR = 3.5$  is 5.

Table VI. Computational results for mid-sized problems

	$ABR = 3.5$			$ABR = 4.0$		
	Cost	Time(sec.)	# of dept.	Cost	Time(sec.)	# of dept.
VC10	17,570.5	13.7	8	13,138.5	13.5	7
B12	11,127.4	44.5	10	10,330.5	29.9	8
B14	6,107.1	35.2	7	5,620.9	23.8	6
AB20	674.9	35.3	7	607.0	45.6	7

#### 4. Within Department Design

The number of sub-departments assigned to each department varies. However, in the small problems, each department generated by the FLP-DF has less than three sub-departments, and the design of the layouts within these departments is almost trivial. The departments generated by the GA also consist of one or two sub-departments. Thus, we will focus on configurations in larger problems.

The  $\epsilon$ -accurate model used in this problem is set at 0.01% of the max-error. Accuracy requires adding many linear constraints. However, the solution time for the problem is not significantly increased since it does not require adding binary variables.

The side length restriction originally set for departments in VC10 [41], B12 and B14 [42, 43], and AB20 [6], is applied to this within-department layout as the side length restriction for the sub-departments. However, some of the problems do not have a feasible solution with the given restriction of side length. This is because some of departments consist of two or three sub-departments and there are not enough feasible alternatives for placing the sub-departments. Specially, when the sub-department area or shape is restricted to a square ( $1 \times 1$ ), it is hard to find a feasible configuration. In this case, we free the shape restriction for a specific sub-department.

The test was executed in CPLEX 6.0 on a Silicon Graphics Power Challenge workstation operating under IRIX64 Release 6.5. Tables VII, VIII, IX and X show the computational results for each of the within-department layouts.



Table VII. Within-department layout for VC10

Dept. No.	$ABR = 3.5$			$ABR = 4.0$		
	Cost	CPUs (Second)	No. of sub-dept.	Cost	CPUs (Second)	No. of sub-dept.
1	13,038.4	0.11	3	2,908.2	0.20	2
		{7,8,9}			{1,6}	
2				1,577.5	0.02	2
					{4,7}	
3				13,424.5	0.16	3
					{5,8,10}	

{ · } = sub-department assigned to the department

Table VIII. Within-department layout for B12

Dept. No.	$ABR = 3.5$			$ABR = 4.0$		
	Cost	CPUs (Second)	No. of sub-dept.	Cost	CPUs (Second)	No. of sub-dept.
1	665.9	0.05	2	597.9†	0.04	2
		{4,5}			{3,7}	
2	479.9	0.03	2	186.6†	0.03	2
		{8,10}			{4,9}	
3				416.2	0.02	2
					{6,10}	
4				1,067.6	0.10	3
					{2,8,14}	

{ · } = sub-department assigned to the department

†No side length limit applied since no feasible configuration in given side length restriction

Table IX. Within-department layout for B14

Dept. No.	$ABR = 3.5$			$ABR = 4.0$		
	Cost	CPUs (Second)	No. of sub-dept.	Cost	CPUs (Second)	No. of sub-dept.
1	129.3 <sup>†</sup>	0.04	2	729.0	0.05	2
		{2,11}			{1,5}	
2	395.7 <sup>†</sup>	0.04	2	385.6	0.02	2
		{3,8}			{3,10}	
3	266.7 <sup>†</sup>	0.04	2	240.3	0.01	2
		{5,6}			{6,11}	
4	243.6 <sup>†</sup>	0.14	3	26.0 <sup>‡</sup>	0.08	2
		{1,9,12}			{12,14}	
5	159.2	0.17	3	439.3 <sup>§</sup>	0.09	3
		{7,10,13}			{2,8,13}	
6				709.8	0.12	3
					{4,7,9}	

{ · } = sub-department assigned to the department

<sup>†</sup>No side length limit applied

<sup>‡</sup>Free of restriction sub-department 12

<sup>§</sup>Free of restriction sub-department 13

Table X. Within-department layout for AB20

Dept. No.	$ABR = 3.5$			$ABR = 4.0$		
	Cost	CPUs (Second)	No. of sub-dept.	Cost	CPUs (Second)	No. of sub-dept.
1	12.5	0.04	2	29.1	0.05	2
		{1,3}			{2,20}	
2	36.6	0.04	2	11.2	0.05	2
		{11,12}			{5,12}	
3	24.9	0.04	2	39.7	0.05	2
		{17,18}			{11,17}	
4	52.9	1.39	4	130.4	381.59	6
		{2,4,5,9}			{1,4,7,8,13,19}	
5	40.5	0.54	4	104.2	248.35	6
		{10,14,15,19}			{3,6,9,10,14,15}	
6	96.2	15.48	5			
		{6,7,8,13,20}				

{ · } = sub-department assigned to the department

## 5. The Comparable Problems

Several problems were tested to evaluate the GA developed in this research. Unfortunately, there is no directly comparable data set. Thus, we have modified some problems from the literature related to department formation or GT (Group Technology) for cellular manufacturing.

### a. Problem - Morris and Tersine

Morris and Tersine [44] configured a process layout for 40 parts and 8 processes with 30 machines. Their final layout does not appear in the publication. To address this, we assume that each machine has one unit of area and a total of 30 units for the floor space. This process layout has 8 departments and each department has 3 or 4 machines. We used a genetic algorithm with FLEX-BAY [29] type of configuration to generate layouts of these 8 departments.

To make this department layout problem comparable to our integrated problem we set the maximum allowable machines in a department to 4: we set the minimum department area to greater than 1 and the upper bound of department length to 2.2. The floor space for the layout was set at  $7.5 \times 4$  for both the original process layout and the integrated problem. We additionally tested the problem allowing the department to have more machines (up to 7) by setting the upper bound of department length to 3.

Table XI shows the results of these layouts. The search procedure for the integrated layout with department formation was assisted by an initial chromosome (which was grouped based on the flow between machines) to accelerate the search. We also increased the number of iterations for the grouping procedure in the algorithm in order to generate good department representations in the solution.

6,12,22	1,3,7,9	11,13,15,24	4,5,10,29
14,16,20	8,18,19,26	17,21,23,30	2,25,27,28

Fig. 20. Department layout based on Morris and Tersine data

The layout generated by the integrated method with comparable size restriction improves the efficiency of inter-department material flow 58.9% from the original process layout. The layouts are similar, but the machine assignments to departments is radically distinct from the original layout as shown in Fig. 20 and Fig. 21. In these figures, the numbers in the departments indicate the machines assigned to that department. Layout efficiency can be improved by allowing departments to have more space – integrated layout (b). As the space of each department sets bigger, the total number of departments in the facility is reduced. The integrated layout (b) improves the efficiency by 34.6% from the integrated layout (a), and 74.4% from the original process layout (shown in Fig. 22).

Table XI. Layout efficiency comparison for process layout and integrated layout with department formation

	Cost			CPU sec		
	Min.	Ave.	Std.	Min.	Ave.	Std.
Dept. layout	322.3	339.1	12.4	0.02	0.02	0
Integrated layout (a)	132.5	203.2	69.4	717.8	721.3	2.9
Integrated layout (b)	86.7	98.5	21.5	580.4	585.9	4.7

6,8,9,21	16,22,24,28	2,3,10,13	18,23,25
14,19,27,29	1,5,11,30	4,7,12,15	17,20,26

Fig. 21. Integrated layout (a) based on Morris and Tersine data

6,14,19,27,29	2,4,7,15,17	1,5,11,18,23,25,30
	8,9,12,20,21,26	
22,24,28		3,10,13,16

Fig. 22. Integrated layout (b) based on Morris and Tersine data

b. Problem - Co and Araar

Co and Araar [45] provided a modified group layout for 10 machine types and 15 job types. They used 64 machine replica to increase the machine accessibility and minimize flow-distance. To make our problems comparable, we assume that we have 64 different sub-departments each with 1 unit of area. Since the layout provided in the literature has 72 units of area ( $8 \times 9$ ), we generated 8 dummy sub-departments to include in the problem.

The maximum area of the department in the given layout is 20 ( $4 \times 5$ ), so we set the maximum area of department to 20 and the maximum allowable side length to 5. We also tested the problem with more flexibility in department size by setting maximum number of machines to 25 and the maximum allowable side length to 6.

Table XII shows the results of the integrated layout with department formation. We used the grouped departments in the literature as one of the initial representations of the solution to assist in the search procedure. We also increase the number of iterations for the grouping procedure in the algorithm in order to generate good department representations in the solution.

The integrated procedure generates a more efficient layout because it inherently considers machine grouping in its solution. The inter-department material handling cost for the modified group layout from Co and Araar [45] is 109. When we set

Table XII. Result of integrated layout based on data in Co and Araar

	Cost			CPU sec		
	Min.	Ave.	Std.	Min.	Ave.	Std.
(a)	87.4	93.1	4.7	2,723.9	2,732.4	7.1
(b)	76.8	84.1	6.0	2,713.0	2,716.1	2.2



3(20+0)	6(15+1)
2(8+0)	5(5+3)
1(7+1)	4(9+3)

Fig. 23. Modified group layout from Co and Araar (cost = 109)

the parameters comparable to the original layout, the genetic search in this research generated a layout with an inter-department material handling cost of 87.4 - an improvement of 19.8%. Fig. 23 and Fig. 24 show the layouts. The number in the parenthesis indicates the number of machines assigned to the department. The next number in the parenthesis in Fig. 23 indicates unused space in the department. These unused spaces, which are treated as dummy departments in the integrated procedure, are gathered in department 3 in Fig. 24.

In the case that the maximum allowable department area and the maximum allowable number of machines in departments are increased, the search method provided further layout improvement ((b) in Table XII). It improved the layout efficiency by 12.1% from the layout (a) and 29.5% from the original layout. As mentioned, this increase led to fewer departments in the facility as shown in Fig. 25.

3(0+8)	6(8+0)
2(9+0)	5(12+0)
1(16+0)	4(19+0)

Fig. 24. Integrated layout (a) based on Co and Araar data (Cost=87.4)

3(16)	5(10)
2(10)	
1(25)	4(11)

Fig. 25. Integrated layout (b) based on Co and Araar data (Cost=76.8)

## 6. The Larger Problems

We generated larger data sets with 100 sub-departments to further test GA. Two different AB-ratios were tested on five different 100 sub-department problems. Table XIII shows the difference in data structures for the example problems.

Table XIII. Data Structure of 100 sub-department example problems

Flow	a: range of 0 to 12 (100-1,100-4,100-5)
	b: range of 0 to 100 (100-2,100-3)
Sub-dept. area	a: varied in range of 1 to 10 (100-1,100-3)
	b: identical area = 1 (100-2)
	c: identical area = 1.84 (100-4,100-5)
Aspect ratio	a: 1.56 (100-1,100-3,100-5)
of floor space	b: 1.39 (100-2,100-4)
Minimum length	a: 1 (100-1,100-2,100-3)
of department	b: 1.35 (100-4,100-5)

The example problems have two flow patterns as shown in Table XIII. The first group (100-1, 100-4, 100-5) has flow in the range of 0 to 12. The second group (100-2, 100-3) has flow in the range of 0 to 100 and the flows are biased to certain pairs of sub-departments. This explains the difference of the cost between these two groups as shown in Table XIV. For problems 100-1 and 100-3, only 1 and 2 feasible solutions, respectively, were found during 10 runs. However, feasible solution were found 9 or 10 out of 10 runs for remainder of the problems. The area variations of the sub-departments sometimes make it difficult for the search procedure to find feasible solutions.

Table XIV. Computational results for larger problems

		<i>ABR</i> = 3.5										<i>ABR</i> = 4									
		Cost					CPU sec					Cost					CPU sec				
		Min.	Ave.	Std.		Min.	Ave.	Std.		Min.	Ave.	Std.		Min.	Ave.	Std.		Min.	Ave.	Std.	
100-1	171,643.0				538.2	168,533.0	176,563.0	6,164.4	535.8	540.8	8.0										
				{27, 1}												{15, 4}					
100-2	42,634.8	44,379.8	912.4	529.0	532.0	2.3	40,426.0	42,255.7	1384.8	530.1	532.6	1.6									
				{14, 10}												{9, 10}					
100-3	64,675.1	67,426.6	3,891.1	532.1	532.9	1.1	60,240.0	68,910.9	5591.3	529.8	532.0	2.1									
				{25, 2}												{18, 5}					
100-4	175,486.0	177,571.3	1,822.3	526.1	528.3	1.4	171,622.0	173,349.5	981.5	524.8	526.4	1.1									
				{15, 9}												{12, 10}					
100-5	175,048.0	175,663.1	466.8	523.0	526.4	2.3	172,247.0	174,047.4	1,089.6	522.1	525.3	2.3									
				{13, 10}												{11, 10}					

{a = number of departments., b = number of feasible solutions out of 10}

The run time for the procedure seems independent of either the AB-ratios or the area variations of the sub-departments. The CPU time of the search in this procedure is also consistent for the various types of data structures, but the ease of finding feasible solutions is highly dependent on the data structure, particularly on the sub-department area variations.

The AB-ratio represents not only the acceptable ratio of max-to-min side length of each department, but also the allowable area for the department. As a result, higher *ABR* leads to fewer departments and lower material handling costs overall.

## H. Summary and Conclusion

In this chapter, the concurrent design problem for facility layout and flow-based department formation has been presented. The design of facility layout simultaneously considers the assignment of sub-departments to departments. We developed a model that incorporates these two problems. The actual department area constraint in the model is nonconvex and hyperbolic, and it must be linearized to apply standard algorithms and widely available optimization software packages for solving mixed-integer linear programming (MILP) models, such as CPLEX. The proposed formulation, which is an MILP and named FLP-DF, provides integrated solutions for flow-based department formation and efficient spatial arrangement of these departments. However, the model includes many binary variables ( $3N^2$ ) and cannot solve the problem in a desirable time with limited computer memory resources. Only the 6-sub-department problem has been solved optimally. A heuristic method based on genetic algorithms has been developed to solve this integrated problem more efficiently.

The intra-department layout problem has been discussed and configured using

the  $\epsilon$ -accurate model  $FLP\epsilon$  developed by Castillo and Westerlund [40]. Each department area generated by the model  $FLP$ -DF needs to be extended for an intra-department layout since the model underestimates the department area. We used Sukhotu's method [36] for this extension.

Although the proposed model could not solve problems involving more than 6-sub-departments in a desirable time, it does capture the department formation problem and the layout problem for those departments. In contrast to the traditional facility layout problem, the number of departments and the dimensions of each department are not imposed in advance on the final layout solution. The proposed heuristic approach also accurately captures these issues and provides solutions for larger problems.

We believe that the facility layout problem with flow-based department formation presented in this Chapter raises many interesting questions and directions for future research. One such area would be the development of more effective and efficient models, particularly for large problems. Developing more accurate models by reducing the max-error on area constraints without losing time efficiency would be another important area for future attention. Assuming pick-up/drop-off points that are not at the centroid of the department would be yet another promising area for future research.

## CHAPTER IV

LAYOUT DESIGN OF MULTI-BAY FACILITIES WITH LIMITED BAY  
FLEXIBILITY

In this chapter, we consider the concurrent layout design and assignment of departments to bays on the basis of the multi-bay manufacturing facility layout problem. The facility layout problem in multi-bay environments is concerned with determining the most efficient assignment of departments to parallel bays, where the bays are connected at one or both ends by an inter-bay material handling system as shown in Fig. 26. This problem arises in the contexts of heavy manufacturing and the semiconductor industry [17], where the inter-bay material handling system is cost dominant over material movement within the bays. Thus, the efficiency of the layout is primarily measured in terms of inter-bay material movement.

Traditionally, in the multi-bay manufacturing facility layout problem, it is assumed that the area of each bay is predetermined prior to assigning departments to bays. This inflexibility could be a hinderance to improvement in layout configuration. Thus, we abandon the assumption of uniformly arranged bays in a given floor space and allow for some flexibility in bay area, which can improve efficiency.

The research in this chapter extends the design of the bays by adopting flexibility of bay width beyond that in traditional studies. To address this problem, it introduces an innovative mathematical formulation for the multi-bay facility layout problem.

## A. Background

Only a few works in the literature have focused on multi-bay manufacturing facility layout [17, 40], and the problem is not even mentioned in the most recently

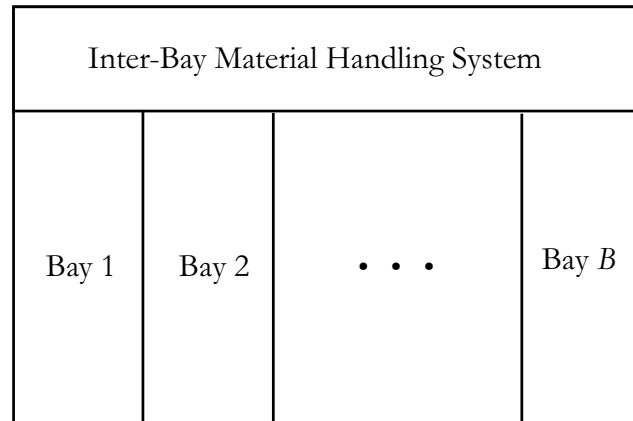

Fig. 26. A multi-bay manufacturing facility

published facility layout problem review [19]. However, there are some similarities between this problem and the multi-floor facility layout problem, and a detailed discussion of the comparison can be found in Meller [17].

The characteristics of multi-bay manufacturing are as follows:

- Material movement between bays is limited to the end of the bays.
- Inter-bay material handling costs dominate intra-bay material handling costs.
- The number of bays and bay areas are known.
- The bay structure is typically designed to have a linear flow production pattern within each bay.

Meller [17] incorporated these characteristics into a two-stage solution methodology. A mixed-integer program is used to assign departments to the bays in Stage 1. The layout within the bays is configured using a dynamic programming approach called a linear ordering problem, which was developed by Picard and Queyranne [46].

Castillo and Peters [40] developed a model for a distributed multi-bay manufacturing facility layout problem by employing replicas of a department type. A



two-stage approach was used, and in Stage 1 a heuristic was adopted to solve a bay assignment and a flow allocation problem among the department replicas. In Stage 2, the Picard and Queyranne [46] solution procedure was used to determine within-bay layout.

In this chapter, we consider a multi-bay facility layout problem with bays that have flexible widths. The width of the bays are determined at the time of assigning departments to the bays. The flexibility is controlled by upper and lower bounds on the width. This is main difference with FLEX-BAY approach: the bay width in FLEX-BAY is controlled by the departments assigned to the bay. In the context of the multi-bay manufacturing facility layout problem, bay flexibility allows the facility layout configuration to be much more efficient.

The solution methodology for this problem also consists of two stages. In Stage 1, we solve for the assignment of departments to bays by determining the width of each bay. In Stage 2, the layout within each bay is determined. The methodology for Stage 1 is presented in Sections B to D; for Stage 2, it is presented in Section E.

## B. Problem Description

We define the multi-bay facility layout problem with limited bay flexibility as the assignment of departments to bays where the width of the bays has flexibility within a given range so that inter-bay material movement can be minimized. The specification of the number of bays is an important issue but its subjectivity makes it difficult to formalize [47]. In this research, the number of bays is determined when each bay area is configured based on the assignment of the departments to the bay. This is the aspect that differs from the traditional multi-bay layout problem.

### C. Problem Formulation

Consider the following parameters:

$f_{ij}$  : the flow from department  $i$  to department  $j$ .

$a_i$  : the minimum required area for department  $i$ .

$W$ : the width of the available floor space.

$L$ : the length of the available floor space.

$lb, ub$  : the lower and upper bounds on the bay width.

The objective of the problem is to minimize the material handling movement between bays. We sum the material handling movements between the departments that are assigned to different bays. Let  $\delta_{ij}$  be the binary variable indicating the relative position of a department in floor space, where

$$\delta_{ij} = \begin{cases} 1 & \text{if department } i \text{ is on the left side of department } j \\ 0 & \text{otherwise.} \end{cases} \quad (4.1)$$

We then define the formulation of the flexible bay assignment problem with the following mixed-integer program:

#### FBAP

$$\min \sum_i \sum_j f_{ij} D_{ij} \quad (4.2)$$

$$\pi_i + \frac{w_i}{2} \leq \pi_j - \frac{w_j}{2} + W(1 - \delta_{ij}) \quad \forall i, j \quad (4.3)$$

$$\frac{w_i}{2} \leq \pi_i \leq W - \frac{w_i}{2} \quad \forall i \quad (4.4)$$

$$a_i + \sum_{j(j \neq i)} (1 - \delta_{ij} - \delta_{ji}) a_j \leq w_i \cdot L \quad \forall i \quad (4.5)$$

$$\delta_{ij} + \delta_{ji} \leq 1 \quad \forall i, j \quad (4.6)$$

$$lb \leq w_i \leq ub \quad \forall i \quad (4.7)$$

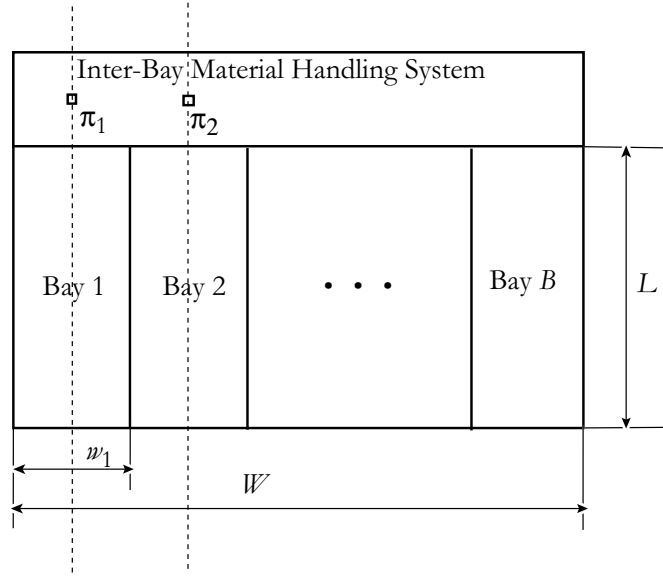

Fig. 27. Illustration of variables for a multi-bay facility layout

$$D_{ij} = |\pi_i - \pi_j| \quad \forall i, j \quad (4.8)$$

$$\delta_{ij} = \{0, 1\} \quad \forall i, j \quad (4.9)$$

where  $D_{ij}$  represents the horizontal distance between departments  $i$  and  $j$ . Constraint (4.3) is for overlap prevention, where  $\pi_i$  represents the horizontal coordinate of the centroid of department  $i$  and  $w_i$  represents the width of department  $i$  which is the same as the width of the bay that holds department  $i$ .

Each bay area ( $w_i \cdot L$ ) is expressed by the sum of the area of the departments ( $a_i$ ) that are assigned to it as constraint (4.5). The limited bay flexibility is controlled by preset parameters,  $ub, lb$ , which represent the allowable upper and lower bounds of the bay width as constraint (4.7). The illustration of variables for a multi-bay facility layout is shown in Fig. 27. Note that there is no explicit decision variable denoting the assignment of each department to a bay. The assignment of a department is implicitly provided by grouping the departments that have the same p/d point,  $\pi$ .

#### D. Solution Procedure - Memetic Approach

The number of binary variables for FBAP is  $N(N - 1)$ , when there are  $N$  departments. A branch-and-bound algorithm is used to solve the problem through CPLEX optimization software. However, the computational time of the algorithm increases exponentially as the problem size gets larger, and this concern leads to a meta-heuristic approach.

Evolutionary algorithms have been applied to many fields of optimization, and it has been shown that augmenting evolutionary algorithms with problem-specific heuristics can lead to highly effective approaches [48]. A Memetic algorithm [49] is a hybrid evolutionary algorithm that combines a population-based search approach and a local search heuristic. MAs are similar to genetic algorithms (GAs). However, GAs are based on biological evolution while MAs imitate cultural evolution - *memes* [50] can be modified during an individual's life time but *genes* can not. Thus, MAs have more opportunity to improve the quality of an individual. A detailed comparison of the result of GA and MA applied to this problem is provided in Section F. 2.

The pseudo code [48] of the MA used in this study is as follows:

```

Procedure MA;
  begin
    initialize population  $P$ 
    forEach individual  $i \in P$  do  $i := \text{Local-Search}(i)$ ;
    forEach individual  $i \in P$  do  $\text{Evaluate-Fitness}(i)$ ;
    repeat
      for  $i := 1$  to  $\#crossover$  do
        select two parents  $i_a, i_b \in P$  randomly;
         $i_c := \text{Crossover}(i_a, i_b)$ ;
         $i_c := \text{Local-Search}(i_c)$ ;
        individual  $i_c \subseteq$  offspring;
      endfor
      for  $i := 1$  to  $\#mutations$  do
        select an individual  $i \in P$  randomly;
         $i_m := \text{Mutate}(i)$ ;
  
```

```

         $i_m := \text{Local-Search}(i_m);$ 
        individual  $i_m \subseteq \text{offspring};$ 
    endfor
    select best  $n$  individuals  $i \in P;$ 
    add individual  $i_n$  to offspring;
     $P = \text{offspring};$ 
until terminate =true;
end;

```

## 1. Representation and Operators

We use a flexible bay structure as in Chapter III to place departments. The bay width is flexibly adjusted for departments assigned to the bay. However, we concentrate on the location of the bay rather than on the arrangement of the departments.

The representation of this multi-bay structure is simpler than that in Chapter III since specific department locations in the bay are not involved in the first stage. This simpler structure allows us to adopt MA for this problem without difficulty. However, the structure of the chromosomes and the mechanisms for grouping departments into bays are identical.

A chromosome is composed of numbers that represent the departments and there is no indication of breaking points for grouping into bays. However, the sequentially arranged numbers can be grouped if they meet the conditions for forming a bay when the areas of the departments are added one by one, left to right. The feasible region in Fig. 28 indicates the candidates' breaking points for grouping as a bay when the summed area is in the range of the designated bay size. This feasible region depends on the flexibility of the bay width.

The operators for crossover and mutation used in this chapter are the same as in Chapter III, and the parent selection policy is also equivalent. The only difference is that there is an operation performed for local search so that the chromosomes are improved for a given generation not only by the breeding and mutating mechanism

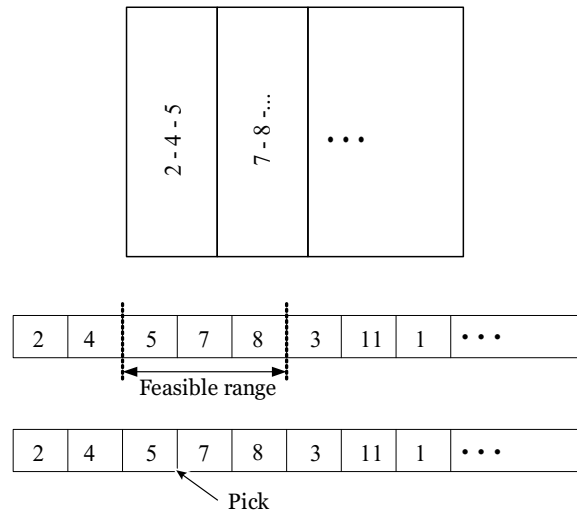

Fig. 28. Representation of chromosomes

but also by the search procedure.

a. Parent Selection

The very first parents are uniformly randomly generated, and the selection of the parents for the next generation is also random. While the parents are sometimes chosen by a tournament, this increases the selective pressure that guides the search procedure to converge to a local optima [51]. However, the best solution comes from continuing on the next generation.

b. Crossover

The partial matched crossover is used to avoid generating an infeasible solution. The integer number in a chromosome, which indicates the department, should not be duplicated in a chromosome after the process of crossover is finished. The partial matched crossover checks to see if there are two of the same integer numbers in a new chromosome and swaps the number of that position in the chromosome instead

of inserting the number from the other parent.

c. Mutation

The swap mutation operator, which simply selects two positions at random and swaps them, is used. As explained in Chapter III, it is different from the standard mutation operator, where a bit of an offspring is flipped with some probability.

d. The Local Search

A simple *2-opt* algorithm, also known as a pairwise interchange heuristic, was used to enhance the GA to generate a MA. The *2-opt* algorithm consists of three steps:

Step 1 Let  $S$  be the initial solution and  $z$  its objective function value (OFV).

Set  $S^* = s, z^* = z, i = 1$  and  $j = i + 1 = 2$ .

Step 2 Consider the exchange between the positions of departments  $i$  and  $j$  in the solution  $S$ . If the exchange results in a solution  $S'$  that has OFV  $z' \leq z^*$ , set  $z^* = z'$  and  $S^* = S'$ . If  $j \leq n$ , set  $j = j + 1$ ; otherwise, set  $i = i + 1$ . If  $i \leq n$ , repeat step 2; otherwise go to step 3.

Step 3 If  $S \neq S^*$ , set  $S = S^*, z = z^*, i = 1, j = i + 1 = 2$  and go to step 2.

Otherwise, return  $S^*$  as the best solution. Stop.

The *2-opt* algorithm considers only two departments at a time for exchange, and whenever a better solution is found, the algorithm discards the previous best solution. The total possible exchanges for step 2 are  $\frac{n(n-1)}{2}$  because each department can be exchanged with  $n - 1$  other departments and there are  $n$  departments in total, and the exchange of  $i$  with  $j$  is identical to the exchange of  $j$  with  $i$ .

## 2. Evolution Parameters

The procedure for assigning departments to bays is much simpler, but the procedures for improving each representation is more complicated than those in Chapter III. However, the parameters are set the same way as in Chapter III since the trial experiments indicate that the parameter set used in the previous chapter is reasonable. After examining the combinations of the parameters, we set the population size at 10, the crossover rate at 60%, and the mutation rate at 10%.

## 3. Penalty Function and Dummy Department

The fitness value evaluated by calculating total flow distance between bays would be increased excessively by a penalty function if the configuration of the individual is not feasible. Although the departments arranged in bays do not have an aspect ratio, a penalty function needs to be introduced in this problem since the bay widths are restricted based on the flexibility.

If the sum of the area of each department is not equal to the floor space (area compactness is less than 100%), a dummy department could help design better configurations. The BAP [17] and FBAP are able to assign the departments to bays and the empty space in each bay is calculated. However, the heuristic method needs to consider the possibility of having empty space in each bay since the procedure orderly determines the bay area by filling the limited floor space from left to right. Whenever the summed area of the department reaches the size limit of the bay, the procedure fixes the area as a bay and proceeds to the next bay. Only the last bay can have empty space based on this procedure. Introducing a dummy department provides more opportunity for each bay to have empty space, and therefore the search procedure to have more chance of finding better solutions.



### E. Within-bay Layout

The objective of the Stage 2 problem is to minimize the material handling costs within the bays. We assume that there is one material handling system and that the within-bay costs are dependent on the within-bay distances between departments  $i$  and  $j$ , which are determined by the solutions to Stage 1 and Stage 2. If departments  $i$  and  $j$  are not assigned to the same bay, then we can define the distance as  $d_{ij} = d_{i\text{MHS}} + d_{j\text{MHS}}$  where  $d_{i\text{MHS}}$  corresponds to the vertical distance between department  $i$  and the material handling system.

The objective function for the layout problem in Stage 2 is

$$\min \sum_i \sum_j f_{ij} d_{ij}. \quad (4.10)$$

The within bay layout problem can be considered as a single-row department layout problem [26] since we assume a linear flow production pattern within each bay. The problem in Stage 2 is to determine the layout of each bay independently. To do so, we introduce  $f_{i\text{MHS}}$  as the product flow from department  $i$  to the automated material handling system and  $f_{\text{MHS}i}$  as the product flow from the automated material handling system to department  $i$ . That is,

$$f_{i\text{MHS}} = \sum_j f_{ij} (\delta_{ij} + \delta_{ji}) \quad \text{and} \quad (4.11)$$

$$f_{\text{MHS}i} = \sum_j f_{ji} (\delta_{ij} + \delta_{ji}). \quad (4.12)$$

The length of department  $i$  is equal to the area of department  $i$ ,  $a_i$ , divided by the width of the bay that department  $i$  is assigned to. We assume all distances are measured rectilinearly between department centroids.

## F. Computational Results

The two-stage solution methodology proceeds as follows: in Stage 1, we use the FBAP to find an optimal solution for the assignment of departments to bays. The memetic approach can be used to find solutions for large problems. In Stage 2, the individual within-bay layout is configured as a single-row facility layout problem [26]. The data sets is taken from Meller [17], which was originally taken from Meller and Bozer [19] and Bozer *et al.* [8]. Each data set consists of departmental areas, flow data, bay dimensions, and a specification of fixed departments. We use 11, 15, 21, and 40 department problems, and the bays in each problem have 10%, 20%, and 30% flexibility.

### 1. The BAP and FBAP

Table XV and XVI shows the comparison of the BAP and FBAP. The problem sets are tested using an AMPL interface with CPLEX 6.5 on a Pentium 4 class computer, 2.2 GHz CPU and 512Mb of physical memory operated under MS-Windows XP Professional. Note that distance (Dist.) refers to the total flow times the appropriate distance. Since the FBAP has more binary variables ( $N(N - 1)$ ) than the BAP ( $NB$ , when there are  $B$  bays), it takes a much longer time to solve the FBAP than the BAP for large sized problems. It takes only a second to get the solution for a 40-department, 4 bay problem in the BAP, but the FBAP cannot generate an optimal solution in 12 hours. The solution procedure for a 40-department problem with no bay width flexibility with FBAP was interrupted at 17.45 hours with a 76% of an optimality gap due to insufficient memory.

Table XV. Comparison of BAP and FBAP for 11 and 15-department

Data Set	BAP			FBAP			Improvement for Dist.(%)	
	Flexibility(%)	Dist.	Time	No. of bays	Dist.	Time		No. of bays
11-1	0	282.0	0.0	2	282.0	0.0	2	0
	10				282.0	0.0	2	0
	20				162.0	0.0	2	42.6
	30				132.0	0.0	2	53.2
15	0	6,700	0.0	3	6,700.0	0.9	3	0
	10				5,314.8	10.6	3	20.7
	20				5,042.3	16.9	3	24.7
	30				4,769.8	225.9	3	28.8

Table XVI. Comparison of BAP and FBAP for 21 and 40-department

Data Set	BAP			FBAP			Improvement for Dist. (%)
	Flexibility (%)	Dist.	No. of bays	Time	Dist.	No. of bays	
21-1	0	981	4	0.2	981.0	4	0
	10				960.5†	4	2.1
	20				780.0	3	20.5
	30				747.0	3	23.9
40	0	870	4	1.0	2,290.0†	4	
	10				2,065.0†	4	
	20				n/a‡		
	30				3,346.7†	5	

†Not solved optimally due to insufficient memory. The optimality gap is 8.68%, 75.98%, 72.57%, and 90.66% respectively.

‡No feasible solution found before memory limit was exceeded.

The inter-bay material handling cost is dramatically reduced when bay width flexibility exists. The number of bays is determined when the departments are assigned to bays. However, we can get the minimum number of bays before the assignment since we know the maximum width of the bays. That is,

$$n = \left\lceil \frac{\sum_i^N a_i}{L \cdot ub} \right\rceil. \quad (4.13)$$

The number of bays is decreased from 4 to 3 in a 20-department problem with 20% and 30% bay flexibility. Since we assume that the inter-bay material handling costs dominant, a reduction in the number of bays leads to a reduction in inter-bay material handling cost.

## 2. GA and MA

The MA is a hybrid GA. The mechanism of the MA for improving individuals is almost identical to the general GA except for the addition of the local search step. Because of the local search, the time for the procedure is also longer. If there were no difference in the search results observed between these two heuristics, there would be no reason to use the MA since it is less time efficient. However, we do observe that the MA found more favorable solutions than did the GA.

We experimented with the GA and MA using the same parameter set as operators. To compare the search procedures of these two heuristics under the same conditions, we tested and plotted the solutions of each iteration for a 15-department problem with a fixed bay width. Fig. 29 shows the results at the end of each generation, and Table XVII and XVIII show the comparison of the GA and MA for the whole problem set.

The solutions for problem sets 15, 21, and 40 shown in Tables XVII and XVIII are based on an experiment with different numbers of dummy departments since

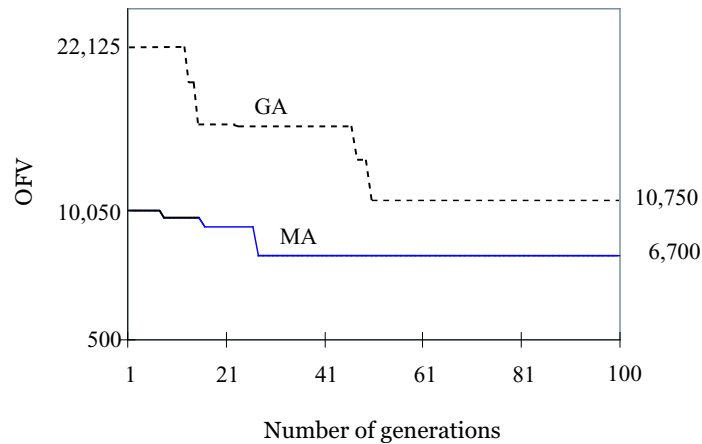

Fig. 29. Comparison of the search procedures of the GA and MA for a 15-department with fixed bay width problem

these problem sets had area compactness of less than 100%. The best solution can be chosen from among these various experiments. Then the best average can be taken from the set of experiments with the varying numbers of dummies.

The solutions generated by GA are not close to optimal except for the 11-department problem. It is reasonable for a facility to have a more efficient layout if the bay widths are more flexible. However, the solutions of the 15 and 40-department problems by the GA do not follow this trend, and the 21-department problem only shows this trend in its averages.

Table XVII. Comparison of GA and MA for 11 and 15-department

Data Set	Bay Flexibility(%)	GA			MA		
		Dist.(best)	Dist.(Ave.)	Time	Dist.(best)	Dist.(Ave.)	Time
11-1	0	282.0†	282.0	0.02	282.0†	282.0	0.79
	10	282.0†	282.0	0.02	282.0†	282.0	0.78
	20	162.0†	162.0	0.02	162.0†	162.0	0.8
	30	132.0†	162.0	0.02	132.0†	132.0.0	0.8
15	0	8,450.0	9,367.5	0.06	6,700.0†	6,700.0	2.88
	10	6,055.7	8,487.6	0.04	5,314.8†	5,317.9	13.56
	20	6,038.0	7,162.0	0.06	5,042.3†	5,042.3	3.97
	30	7,008.0	8,332.8	0.03	4,769.8†	4,769.8	12.38

†Known to be optimal solution by FBAP.

Table XVIII. Comparison of GA and MA for 21 and 40-department

Data Set	Bay Flexibility(%)	GA			MA		
		Dist.(best)	Dist.(Ave.)	Time	Dist.(best)	Dist.(Ave.)	Time
21-1	0	1,161.0	1,513.2	0.08	981.0†	981.0	13.14
	10	1,244.7	1,322.9	0.08	915.5	915.5	13.78
	20	1,166.3	1,166.3	0.06	780.0†	780.0	14.26
	30	1,002.1	1,002.1	0.09	747.0†	761.9	13.90
40	0	1,298.0	1,578.6	0.22	870.0‡	886.4	256.24
	10	1,358.8	1,559.0	0.22	838.5	860.1	270.26
	20	1,374.6	1,658.9	0.27	838.5	918.8	374.37
	30	1,113.4	1,537.9	0.23	774.3	776.1	184.21

†Known to be optimal solution by FBAP.

‡Known to be optimal solution by BAP.



Among the MA generated solutions, the best and the average are the same for almost every experiment, and all are much better than those of the GA. However, the search procedure of the MA takes a much longer time as was mentioned before. This fact led to speculation that perhaps the GA could produce a better solution if the search procedure took more time to explore for solution space. Therefore, we changed the parameter set of the GA for the 15, 21, and 40-department problems and tested again to see how the solution was affected. Table XIX shows the results of doubling the number of generations and the size of populations.

Changing the parameter set did, in fact, seem to affect the final results. Increasing the number of generations and the population size enabled the search procedure to find better solutions. We also tested the 21-department problem with 10% bay width flexibility to see the effectiveness of a different parameter set for the number of generations and population size. Fig. 30 shows the resulting trends.

According to the results for the 21-department problem in Fig. 30, increasing the maximum number of generations and the population size appears to facilitate the procedure in finding a better solution. However, increasing those parameters with a GA cannot guarantee that the search procedure will always find a better solution than that of the procedure with fewer generations and a smaller population. Numerous attempts with the GA for the 21-department problem with various parameter sets could not generate a solution as good as the one provided by the MA, even with 1,000 as the maximum number of generations, which is ten times more than the MA uses.

Table XIX. GA with different parameters

Data Set	Bay Flexibility(%)	(a)Max. generation(100) × 2	(b)population size(10) × 2
		Dist.(best) Time	Dist.(best) Dist.(Ave.) Time
15	0	6,700.0	9,135.0 0.20 6,700.0 10,971.3 0.14
	10	6,063.0	8,513.4 0.10 6,077.7 9,874.5 0.19
	20	5,136.7	7,162.0 0.06 6,077.7 9,151.0 0.14
	30	5,136.7	7,547.1 0.08 5,408.0 8,349.0 0.08
21-1	0	1,170.0	1,488.3 0.14 1,164.0 1,487.3 0.18
	10	1,088.5	1,321.7 0.14 1,164.0 1,550.7 0.14
	20	822.5	1,199.2 0.13 831.6 1,257.0 0.14
	30	822.5	1,134.71 0.15 831.6 1,255.6 0.16
40	0	1,206.0	1,432.1 0.54 1,284.0 1,592.2 0.49
	10	1,206.0	1,452.5 0.50 1,227.3 1,601.1 0.44
	20	1,206.0	1,478.2 0.55 1,132.8 1,599.9 0.44
	30	1,157.3	1,377.2 0.46 1,132.8 1,657.1 0.44

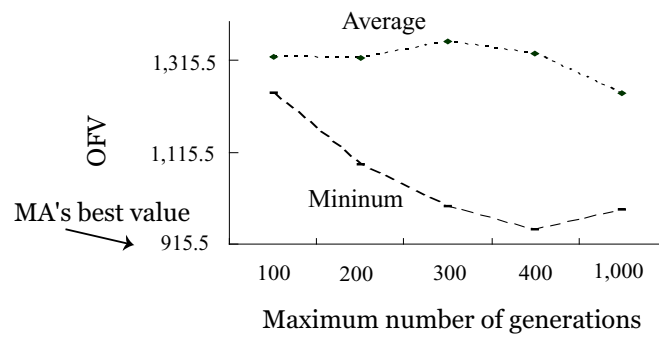

(a)

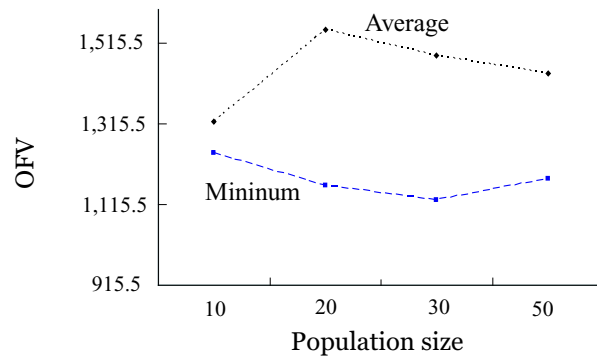

(b)

Fig. 30. Various parameter sets in GA for a 21-department problem with 10% bay width flexibility

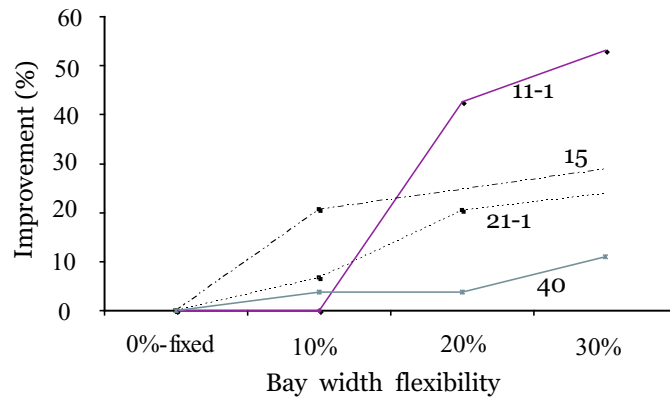

Fig. 31. Layout improvement based on bay-width flexibility

### 3. FBAP and MA

The memetic approach used in Stage 1, finds solutions which are known as optimal in given problems: 12 out of 16 problems were verified as optimal by FBAP and BAP. The time to solve 11-1 is less than 0.05 of a second in the FBAP and 0.8 of a second in the MA. However, the MA finds the solution for the 21-1 and 40 in a very short time compared to the FBAP, without degrading the quality of the solution. The MA found a solution with objective value of 870 for the 40 department problem with no bay flexibility problem to 870, which is the optimal solution from BAP. Thus we would expect that the solution for the 40 department problem with 10, 20, and 30% bay flexibility is near optimal as well, although this hasn't been verified. Table XX shows the comparison of these results.

Bay width flexibility clearly makes layout more efficient and in some problems even a small amount of flexibility can yield large improvement. The proposed methodology using the FBAP efficiently finds the solution. The inter-bay material handling cost improvement resulting from bay width flexibility compared to layouts with fixed identical bay areas is summarized in Fig. 31.

The improvement is in proportion to the bay width flexibility and inversely pro-

Table XX. Comparison of FBAP and MA for inter-bay material handling cost

Data	Bay	FBAP		MA	
Set	Flexibility(%)	Dist.	Time	Dist.	Time
11-1	0	282.0	0.0	282.0	0.79
	10	282.0	0.0	282.0	0.78
	20	162.0	0.0	162.0	0.8
	30	162.0	0.0	132.0	0.8
15	0	6,700.0	0.0	6,700.0	2.88
	10	5,314.8	10.6	5,314.8	13.56
	20	5,042.3	16.9	5,042.3	3.97
	30	4,769.8	225.9	4,769.8	12.38
21-1	0	981.0	4,403.1	981.0	13.14
	10	960.5†	41,026.8	915.5	13.78
	20	780.0	1,630.6	780.0	14.26
	30	747.0	5,998.2	747.0	13.90
40	0	2,290.0†	62,807.0	870.0§	265.24
	10	2,065.0†	44,272.0	838.5	270.26
	20	n/a‡		838.5	374.37
	30	3,346.7†	37,124.3	774.3	183.21

†Not solved optimally due to insufficient memory.

‡No feasible solution found before memory limit was exceeded.

§Known optimal solution by BAP.

portional to the size of problem. It is reasonable that higher flexibility provides more chances for a better solution and that the area of a department in a large sized problem is not as significant as in a small sized problem; 30% of bay width flexibility in the 11-department problem improves the inter-bay material handling cost more than 50% while flexibility improves the cost only 11% in the 40-department problem.

#### 4. Within-bay Configuration

Table XXI, XXII, XXIII, and XXIV show the layout solutions in Stage 2. The optimal solutions of each problem with the FBAP and the best solutions of each problem with the MA, if there is no optimal solution found with the FBAP, are used to configure the within-bay layout. Each bay used an individual flow matrix that is constructed by splitting original flow matrix with consideration of the flow to and from the MHS. The time to solve the problems 11-1, 15, and 21-1 were less than 0.1 second since the number of departments assigned to a bay is relatively small. However, the computation is significant on problem 40 since some of the bays have many departments.

Table XXI. Solution to Stage 2 for problem 11-1

Data	Bay	Bay			
Set	Flexibility(%)	#	Layout solution sequence	Dist.	Time
11-1	0 and 10	1	MHS:11-1-5-10-9-6-2	1,103.3	0.0
		2	MHS:7-8-3-4	232.7	0.0
	20	1	MHS:11-10-9-1-5-6-7	975.3	0.0
		2	MHS:2-8-3-4	169.1	0.0
	30	1	MHS:11-10-9-1-5-6-7-2	938.6	0.0
		2	MHS:8-3-4	142.4	0.0

Table XXII. Solution to Stage 2 for problem 15

Data	Bay	Bay			
Set	Flexibility(%)	#	Layout solution sequence	Dist.	Time
15	0	1	MHS:15-12-14-5	11,390.0	0.0
		2	MHS:9-10-4-3-1-2	11,887.5	0.0
		3	MHS:6-8-13-7-11	8,043.0	0.0
	10	1	MHS:15-12-14-5-1-2	12,893.3	0.0
		2	MHS:9-10-4-3	9,950.0	0.0
		3	MHS:6-8-13-7-11	8,600.0	0.0
	20	1	MHS:15-12-14-5-1-2	12,893.3	0.0
		2	MHS:9-10-4-3	11,153.1	0.0
		3	MHS:6-8-13-7-11	8,600.0	0.0
30	1	MHS:15-12-14-5-1-2	12,893.3	0.0	
	2	MHS:9-10-4-3	12,700.0	0.0	
	3	MHS:6-8-13-7-11	8,600.0	0.0	

Table XXIII. Solution to Stage 2 for problem 21-1

Data	Bay	Bay				
Set	Flexibility(%)	#	Layout solution sequence	Dist.	Time	
21-1	0	1	MHS:21-20-19	319.3	0.0	
		2	MHS:17-9-13-8-5-1-11	1,125.8	0.0	
		3	MHS:18-15-16-14-4-3-2	513.3	0.0	
		4	MHS:10-7-6-12	137.3	0.0	
10		1	MHS:21-1-8-5	1,035.8	0.0	
		2	MHS:11-13-9-17-18-15-16-14	779.0	0.0	
		3	MHS:20-19-7-10-4-3-2	394.3	0.0	
		4	MHS:6-12	38.7	0.0	
20		1	MHS:21-8-5-1-11	935.2	0.0	
		2	MHS:13-9-17-18-15-16-14-20-19	686.9	0.0	
		3	MHS:4-3-2-10-7-6-12	294.0	0.0	
30		1	MHS:21-14-16-15-20-19	563.1	0.0	
		2	MHS:1-5-8-11-18-17-9-13	1,106.7	0.0	
		3	MHS:4-3-2-10-7-6-12	294.0	0.0	



Table XXIV. Solution to Stage 2 for problem 40

Data Set	Bay Flexibility(%)	Bay #	Layout solution sequence	Dist.	Time
40	0	1	MHS:40-2-8-29-28-26-27	1,295.8	0.0
		2	MHS:30-1-5-6-23-11-3-4-9-10	2,908.0	5.6
		3	MHS:34-15-25-33-39-38-31-32-37-36-12-24-7-35	898.0	880.6
		4	MHS:22-20-21-14-18-19-13-17-16	297.25	0.4
10		1	MHS:40-2-8-29-28-26-27	1,295.8	0.0
		2	MHS:34-30-1-5-6-23-11-3-4-9-10	2,969.6	20.5
		3	MHS:15-25-33-39-38-31-32-37-36-12-7-24-35	908.3	141.4
		4	MHS:22-20-21-14-18-19-13-17-16	328.1	0.0
20		1	MHS:40-2-8-29-28-26-27	1,295.8	0.0
		2	MHS:34-30-1-5-6-23-11-3-4-9-10	2,969.6	20.5
		3	MHS:15-25-33-39-38-31-32-37-36-12-7-24-35	908.3	141.4
		4	MHS:22-20-21-14-18-19-13-17-16	328.1	0.0
30		1	MHS:40-36-30-1-5-6-11-3-4-9-10	3,091.7	3.6
		2	MHS:23-15-2-34-8-29-28-33-39-38-31-37-32	1,615.0	1,139.5
		3	MHS:26-27-12-7-24-25-22-20-21-14-18-19-13-17-16-35	455.3	369.5
		4	MHS:22-20-21-14-18-19-13-17-16	328.1	0.0

## G. Summary and Conclusions

In this chapter, we have introduced layout design of a multi-bay facility with limited bay flexibility. The characteristic of inter-bay material handling costs dominating within-bay material handling costs leads to a two-stage approach for solving the problem. For the case where the facility operates with one inter-bay MHS, the bays are connected at one end, and the layout within each bay follows a linear production pattern, we have developed an efficient approach to find a favorable solution.

We formulated a mixed-integer program that takes into account bay flexibility. The bay area flexibility provides more opportunities for better solutions. An MIP-based model, FBAP, simultaneously determines the assignment of departments to bays and the corresponding bay areas. MA, a population based search algorithm that combines genetic algorithms and local search, has been used to solve large sized problems. The MA finds the known optimal solution for most of the example problems within a few minutes.

The model FBAP provides optimal solutions for the case where one inter-bay MHS is operated at the end of the bays. It can be adapted to other cases of multi-bay layout; however, additional variables and constraints would be required to represent other layout cases. Thus, developing more generally applicable models is a future research priority. In addition, the incorporation of other concerns, such as production planning, should also be investigated.

## CHAPTER V

## CONCLUSIONS AND CONTRIBUTIONS

## A. Contributions

This dissertation develops concurrent design models for integrating facility layout and department formation problems and creates solution procedures to contend with the associated increases in complexity. This research develops models that address broader facility layout design problems and as such generate versatile insight about their nature, thus leading the way to improved solutions.

Addressing integrated facility layout problems necessitated the creation of a novel modeling technique. Having developed these models to contend with the discussed problems and their associated application areas, new solution procedures had to be devised as well. Since these areas represent many design structures in manufacturing systems, the proposed formulations serve as a critical step toward integrated facility layout.

The model presented in Chapter III was concerned with concurrent determination of flow-based department formation and layout of these departments within a facility. The flow-based department formation problem has been defined and identified. The model for the concurrent design problem makes it possible to consider several decision factors related to layout design and department formation simultaneously instead of solving those problems sequentially as in traditional facility layout problems. The problem specific genetic algorithm presented in Chapter III provides solutions for larger problems known to be difficult to solve optimally even when considering only the layout problem.

The model presented in Chapter IV extends the design of bays to have flexi-

bility beyond those traditionally studied in multi-bay manufacturing facility layout problems. This specific problem is concerned with determining the most efficient assignment of departments to bays in a facility that is defined by parallel bays arranged along a connecting aisle and served by an automated material handling system. Traditionally, in the multi-bay manufacturing problem, it is assumed that all the bay widths are known within a facility. We allow these bays to have widths that are flexible but limited for reasonable bay shapes and departmental assignments. From a practical standpoint, such extensions allow significant cost savings compared to traditional, multi-bay approaches with identical bays.

The evolutionary algorithm for the multi-bay manufacturing facility layout problem, based on a memetic algorithm, provides a solution approach for larger problems that cannot be solved optimally in a reasonable time. The heuristic algorithm is a hybrid genetic algorithm that combines local search with each generation of genetic searches. Its performance is superior to that of a general genetic search, and the procedure is able to efficiently find solutions for a range of problems.

## B. Conclusions

The interaction between facility layout and department formation is widely recognized. However, developing an integrated model that simultaneously determines the formation of departments and the layout of those departments is a difficult task. The traditional approach to addressing the problems is to sequentially solve the restricted problems with necessary assumptions.

This research circumvents the limitations of traditional modelling by integrating department formation and facility layout into comprehensive mathematical formulations while still developing effective solution procedures. The expectation here is

that these developments will enhance facility layout solution quality, develop insight about the nature of layout formulation, and generate new research directions.

Although the models provide desirable information for facility layout design, some restrictions for modelling the system are still necessary. Thus, future research directions include the development of more generally applicable models with more effective and efficient solution procedures. In addition, the incorporation of other factors that are needed for the formation of departments, such as part-machine relationships, production volume, part flows, and material handling equipment, should be investigated. The variable cost of intra-department material handling, which is affected not only by material handling equipment but also by the size of the department, should also be explored.

## REFERENCES

- [1] S. S. Heragu, *Facilities Design*, Boston, MA: PWS Publishing, 1997.
- [2] S.A. Irvine and I. Rinsma-Melchert, “A new approach to the block layout problem,” *International Journal of Production Research*, vol. 35, no. 8, pp. 2359–2376, 1997.
- [3] J. M. Seehof and W. O. Evans, “Automated layout design program,” *Journal of Industrial Engineering*, vol. 18, pp. 690–695, 1967.
- [4] R. Lee and J. M. Moore, “CORELAP- computerized relationship layout planning,” *Journal of Industrial Engineering*, vol. 18, pp. 195–200, 1967.
- [5] M. P. Deisenroth and J. M. Apple, “A computerized plant layout analysis and evaluation technique,” Technical report, Annual AIIE Conference, Norcross, GA, 1972.
- [6] G. C. Armour and E. S. Buffa, “A heuristic algorithm and simulation approach to relative location of facilities,” *Management Science*, vol. 9, no. 2, pp. 294–309, 1963.
- [7] J. A. Tompkins and R. Reed, “An applied model for facilities design problem,” *International Journal of Production Research*, vol. 14, no. 5, pp. 583–595, 1976.
- [8] Y.A. Bozer, R.D. Meller, and S.J. Erlebacher, “An improvement-type layout algorithm for single and multiple floor facilities,” *Management Science*, vol. 40, no. 7, pp. 918–932, 1994.

- [9] R. D. Meller and Y. A. Bozer, “A new simulated annealing algorithm for the facility layout problem,” *International Journal of Production Research*, vol. 34, no. 6, pp. 1675–1692, 1996.
- [10] T. C. Koopmans and M. Beckman, “Assignment problem and the location of economic activities,” *Econometrica*, vol. 25, pp. 53–76, 1957.
- [11] S. Sahni and T. Gonzalez, “P-complete approximation problem,” *Journal of the ACM*, vol. 23, no. 3, pp. 555–565, 1976.
- [12] A. Kusiak and S. S. Heragu, “The facility layout problem,” *European Journal of Operational Research*, vol. 29, pp. 229–251, 1987.
- [13] Y.A. Bozer and R.D. Meller, “A re-examination of the distance based facility layout problem,” *IIE Transactions*, vol. 29, no. 7, pp. 549–560, 1997.
- [14] B. Montreuil, Ed., *A Modeling Framework for Integrating Layout Design and Flow Network Design*, Hebron, KY: Material Handling Research Colloquium, 1990.
- [15] R. D. Meller, V. Narayanan, and P. H. Vance, “Optimal facility layout design,” *Operations Research Letters*, vol. 23, pp. 117–127, 1999.
- [16] T. A. Lacksonen, “Static and dynamic layout problems with varying areas,” *Journal of the Operational Research Society*, vol. 45, no. 1, pp. 59–69, 1994.
- [17] R. D. Meller, “The multi-bay manufacturing facility layout problem,” *International Journal of Production Research*, vol. 35, no. 5, pp. 1229–1237, 1997.
- [18] I. Castillo and B. A. Peters, “Integrating design and production planning consideration in multi-bay manufacturing facility layout,” *European Journal of Operational Research*, Forthcoming.

- [19] R. D. Meller and K.-Y. Gau, “The facility layout problem : recent and emerging trends and perspectives,” *Journal of Manufacturing Systems*, vol. 15, no. 5, pp. 351–366, 1996.
- [20] L. R. Foulds and D. F. Robinson, “Graph theoretic heuristics for the plant layout problem,” *International Journal of Production Research*, vol. 16, no. 1, pp. 27–37, 1978.
- [21] L. R. Foulds, “Techniques for facilities layout: deciding which pairs of activities should be adjacent,” *Management Science*, vol. 29, no. 12, pp. 1414–1426, 1983.
- [22] L. R. Foulds, P. B. Gibbons, and J. W. Giffin, “Facility layout adjacency determination: an experimental comparison of three graph theoretic heuristics,” *Operations Research*, vol. 33, no. 5, pp. 1091–1106, 1985.
- [23] M. M. Hassan and G. L. Hogg, “A review of graph theory application to the facility layout problem,” *OMEGA*, vol. 15, no. 4, pp. 291–300, 1987.
- [24] Z. Drezner, “DISCON: a new method for the layout problem,” *Operations Research*, vol. 28, no. 6, pp. 1375–1384, 1980.
- [25] M. M. Hassan and G. L. Hogg, “On converting a dual graph into a block layout,” *International Journal of Production Research*, vol. 27, no. 7, pp. 1149–1160, 1989.
- [26] S. S. Heragu and A. Kusiak, “Efficient models for the facility layout problem,” *European Journal of Operational Research*, vol. 53, pp. 1–13, 1991.
- [27] K. Tam, “Simulated annealing algorithm for allocating space to manufacturing cells,” *International Journal of Production Research*, vol. 30, no. 1, pp. 63–87, 1992.



- [28] K. Tam, “Genetic algorithms, function optimization and facility layout design,” *European Journal of Operational Research*, vol. 63, pp. 322–346, 1992.
- [29] D. M. Tate and A. E. Smith, “Unequal area facility layout using genetic search,” *IIE Transactions*, vol. 27, no. 4, pp. 465–472, 1995.
- [30] H. M. Selim, R. G. Askin, and A. J. Vakharia, “Cell formation in group technology: review, evaluation and directions for future research,” *Computers & Industrial Engineering*, vol. 34, no. 1, pp. 3–20, 1998.
- [31] U. Venkatadri, R. L. Rardin, and B. Montreuil, “A design methodology for fractal layout organization,” *IIE Transactions*, vol. 29, pp. 911–924, 1997.
- [32] B. Montreuil, U. Venkatadri, and R. L. Rardin, “Fractal layout organization for job shop environments,” *International Journal of Production Research*, vol. 37, no. 3, pp. 501–521, 1999.
- [33] R. G. Askin, F. W. Ciarallo, and N. H. Lundgren, “An empirical evaluation of holonic and fractal layouts,” *International Journal of Production Research*, vol. 37, no. 5, pp. 961–978, 1999.
- [34] R. G. Askin, H. M. Selim, and A.J. Vakharia, “A methodology for designing flexible cellular manufacturing systems,” *IIE Transactions*, vol. 29, pp. 599–610, 1997.
- [35] S. S. Heragu and S. R. Kakuturi, “Grouping and placement of machine cells,” *IIE Transactions*, vol. 29, pp. 560–571, 1997.
- [36] V. Sukhotu, “Material handling system models and block layout approaches for facility design,” Ph.D. dissertation, Texas A&M Univeristy, College Station, 2002.

- [37] J. H. Holland, *Adaptation in Natural and Artificial Systems*, Ann Arbor, MI: University of Michigan Press, 1975.
- [38] R. S. Liggett, “Automated facility layout: past, present and future,” *Automation In Construction*, vol. 9, pp. 197–215, 2000.
- [39] X. Tong, “SECOT: a sequential construction technique for facility design,” Ph.D. dissertation, University of Pittsburgh, Pittsburgh, PA, 1991.
- [40] I. Castillo and T. Westerlund, “An  $\epsilon$ -accurate model for optimal unequal-area facility layout,” *Computers & Industrial Engineering*, Forthcoming.
- [41] D. J. van Camp, M. W. Carter, and A. Vannelli, “A nonlinear optimization approach for solving facility layout problem,” *European Journal of Operational Research*, vol. 57, pp. 174–189, 1991.
- [42] M. S. Bazaraa, “Computerized layout design; a branch and bound approach,” *AIIE Transactions*, vol. 7, pp. 432–438, 1975.
- [43] M. M. D. Hassan, G. L. Hogg, and D. R. Smith, “SHAPE: a construction algorithm for area placement evaluation,” *International Journal of Production Research*, vol. 24, no. 5, pp. 1283–1295, 1986.
- [44] J. S. Morris and R. J. Tersine, “A simulation analysis of factors influencing the attractiveness of group technology cellular layouts,” *Management Science*, vol. 36, no. 12, pp. 1567–1578, 1990.
- [45] H. C. Co and A. Araar, “Configuring cellular manufacturing systems,” *International Journal of Production Research*, vol. 26, no. 9, pp. 1511–1522, 1988.
- [46] J. C. Picard and M. Queyranne, “On the one-dimensional space allocation problem,” *Operations Research*, vol. 29, no. 2, pp. 371–391, 1981.

- [47] I. Castillo, “Concurrent consideration of design and operational issues in manufacturing facility layout,” Ph.D. dissertation, Texas A&M University, College Station, 2001.
- [48] P. Merz and B. Freisleben, “Fitness landscape analysis and memetic algorithms for the quadratic assignment problem,” *IEEE Transactions on Evolutionary Computation*, vol. 4, no. 4, pp. 337–352, 2000.
- [49] P. Moscato, “On evolution, search, optimization, genetic algorithms and martial arts: towards memetic algorithms,” Caltech Concurrent Computation Program, Pasadena, CA, 1989.
- [50] R. Dawkins, *The Selfish Gene*, Oxford, U.K.: Oxford University Press, 1976.
- [51] J. Valenzuela and A. E. Smith, “A seeded memetic algorithm for large unit commitment problems,” *Journal of Heuristics*, vol. 8, pp. 173–195, 2002.

## APPENDIX A

## EXTENSION OF AN UNDERESTIMATED DEPARTMENT AREA

The solutions from an MILP with area linearization can be extended to the original area. Let  $\Omega$  be the 'approximate' block layout obtained from an MILP, and consider the following parameters.

$a_i$  : area requirement for department  $i$

$x_i^\Omega$  : horizontal coordinate of centroid of department  $i$  in  $\Omega$

$y_i^\Omega$  : vertical coordinate of centroid of department  $i$  in  $\Omega$

$h_i^\Omega$  : height of department  $i$  in  $\Omega$

$w_i^\Omega$  : width of department  $i$  in  $\Omega$

$n$  : number of departments

We define

$$u_i^\Omega = y_i^\Omega + \frac{h_i^\Omega}{2} \quad \text{and} \quad l_i^\Omega = y_i^\Omega - \frac{h_i^\Omega}{2} \quad (\text{A.1})$$

and

$$q(i, j) = \| (x_i^\Omega, u_i^\Omega) - (x_j^\Omega, l_j^\Omega) \| \quad (\text{A.2})$$

To compute the coordinates and dimensions of all of the departments in the facility, an incident matrix needs to be constructed as in [36]. Let  $\mathbf{\Pi}$  be the incidence matrix with elements  $\pi(i, j)$ ,  $i = 1, \dots, np$  and  $j = 1, \dots, n$ , where  $np$  is the number of partitions. The incident matrix generating algorithm for this problem is as follows.

Set  $np = n$  and  $\mathbf{\Pi} = \mathbf{0}$   
**for**  $i = 1$  **to**  $n$

```

if  $u_i^\Omega > l_j^\Omega, \forall j$  then  $\pi(1, j) = 1$ 
if  $l_i^\Omega < u_j^\Omega, \forall j$  then  $\pi(np, j) = -1$ 
next  $i$ 

 $k = 1$ 
for  $i = 1$  to  $n$ 
  if  $\pi(j, i) = 1, \exists j$  then  $k = k + 1$ 
     $r = \arg \min_j q(j, i), \forall j$ 
    if  $\pi(j, i) = 1, \exists j$  then  $\pi(j, i) = -1$ 
    else  $\pi(k, i) = -1$  and  $\pi(k, r) = 1$ 
  next  $i$ 

for  $i = 1$  to  $n$ 
  if  $\pi(j, i) \leq 0, \forall j$  then
     $r = \arg \min_j q(i, j), \forall j$  and  $\pi(k_r, i) = -1$  where  $\pi(k_r, r) = -1$ 
  next  $i$ 

Sort  $\Pi$  such that  $a < b \quad \forall \{a, b : \pi(a, i) = 1 \text{ and } \pi(b, i) = -1, i = 1, \dots, n\}$ 

for  $i = 1$  to  $n$ 
  if  $\pi(i, j) = 0, \forall j$  then delete  $\Pi(i, :)$ 
next  $i$ 

```

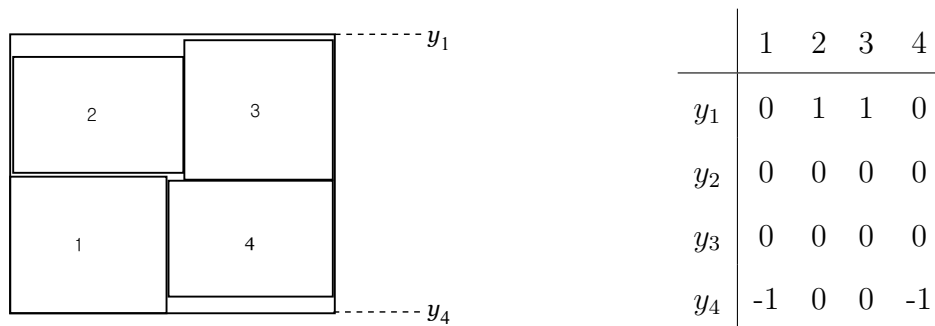

Fig. 32. Approximated block layout of a four department problem from MIP and the incident matrix for the first step

The first step begins with placing the departments that set the upper and lower floor boundaries. Then the distance from the upper bound of one department to the lower bound of another department is measured and compared to configure the relative location. The approximated block layout from the MIP and the matrix for

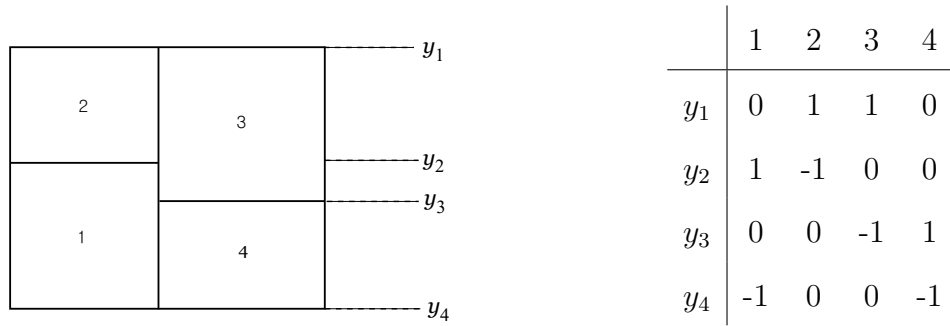

Fig. 33. Block layout of the four department problem and its corresponding incident matrix

the first step of the algorithm are shown in Fig. 32.

The algorithm works by identifying the spacial relations of each department and finalizes by deleting unnecessary rows of the matrix. The algorithm finds the layout based on a given approximation. The extended block layout and the corresponding incident matrix are shown in Fig. 33.

## APPENDIX B

 $\epsilon$ -ACCURATE MODEL

Castillo and Westerlund [40] developed the  $\epsilon$ -accurate model that linearizes area constraints without adding binary variables. The linearized area is underestimated to be feasible in its produced area with its dimensions.  $\epsilon$  indicates the controllable error by the cutting planes generated along the curve of the area constraint.

**FLP $\epsilon$ :**

$$\min \sum_{i=1}^{n-1} \sum_{j=i+1}^n f_{ij}(|x_i - x_j| + |y_i + y_j|) \quad (\text{B.1})$$

$$\text{s.t.} \quad \frac{1}{2}(lx_i + lx_j) - (x_i - x_j) \leq L^x(X_{ij} + Y_{ij}), \forall 1 \leq i \leq j \leq n, \quad (\text{B.2})$$

$$\frac{1}{2}(lx_i + lx_j) - (x_j - x_i) \leq L^x(1 + X_{ij} - Y_{ij}), \forall 1 \leq i \leq j \leq n, \quad (\text{B.3})$$

$$\frac{1}{2}(ly_i + ly_j) - (y_i - y_j) \leq L^y(1 - X_{ij} + Y_{ij}), \forall 1 \leq i \leq j \leq n, \quad (\text{B.4})$$

$$\frac{1}{2}(ly_i + ly_j) - (y_j - y_i) \leq L^y(2 - X_{ij} - Y_{ij}), \forall 1 \leq i \leq j \leq n, \quad (\text{B.5})$$

$$x_i + \frac{1}{2}lx_i \leq L^x, i = 1, \dots, n, \quad (\text{B.6})$$

$$x_i - \frac{1}{2}lx_i \geq 0, i = 1, \dots, n, \quad (\text{B.7})$$

$$y_i + \frac{1}{2}ly_i \leq L^y, i = 1, \dots, n, \quad (\text{B.8})$$

$$y_j - \frac{1}{2}ly_i \geq 0, i = 1, \dots, n, \quad (\text{B.9})$$

$$lx_i^{\text{low}} \leq lx_i \leq lx_i^{\text{up}}, i = 1, \dots, n, \quad (\text{B.10})$$

$$ly_i^{\text{low}} \leq ly_i \leq ly_i^{\text{up}}, i = 1, \dots, n, \quad (\text{B.11})$$

$$-lx_i - \frac{a_i}{lx_{ik}^2}lx_i \leq -2\frac{a_i}{lx_{ik}}, k = 0, \dots, C_i, i = 1, \dots, n. \quad (\text{B.12})$$

$$X_{ij}, Y_{ij} \in \{0, 1\}, \forall 1 \leq i \leq j \leq n, \quad (\text{B.13})$$

The floor area is a rectangle of size  $L^x \times L^y$ . For each sub-department  $i$ ,  $(x_i, y_i)$  indicates the coordinates of its centroid and  $lx_i, ly_i$  represent its width and height dimensions, respectively. The combination of binary variables  $X_{ij}$  and  $Y_{ij}$  indicates the relative location of sub-departments  $i$  and  $j$ .  $C_i$  in constraint (B.12) is an integer number obtained by

$$C_i = \left\lceil \frac{\ln(lx_i^{\text{up}}/lx_i^{\text{low}})}{\ln((1 + \sqrt{\epsilon})/(1 - \sqrt{\epsilon}))} \right\rceil \quad (\text{B.14})$$

and  $\bar{lx}_{ik}$  represents a point between  $lx_i^{\text{low}}$  and  $lx_i^{\text{up}}$  generating a cutting plane. This point is computed as follows:

$$\bar{lx}_{ik} = \bar{lx}_{i,k-1} \left( \frac{lx_i^{\text{up}}}{lx_i^{\text{low}}} \right)^{1/C_i}, \quad k = 1, \dots, C_i, \quad (\text{B.15})$$

where  $\bar{lx}_{i0} = lx_i^{\text{low}}$

$C_i$  is the total number of sub-intervals in the interval  $lx_i^{\text{low}}$  to  $lx_i^{\text{up}}$ . Thus, the total number of cutting planes to be generated for department  $i$  is  $C_i + 1$ . This number of cutting planes is inversely proportional to  $\epsilon$ . A more detailed explanation of the cutting planes follows.

The cutting plane generated by the tangential support at point  $\bar{lx}_{i0} = lx_i^{\text{low}}$  and a cutting plane at point  $\bar{lx}_{i0} < \bar{lx}_{i1} \leq lx_i^{\text{up}}$  intersect at coordinates  $(\bar{lx}_{i01}^{\text{max}}, \bar{ly}_{i01}^{\text{max}})$  as shown in Fig 34. This intersection is the point of maximum area constraint violation represented by

$$\bar{lx}_{i01}^{\text{max}} = 2 \frac{1/\bar{lx}_{i1} - 1/\bar{lx}_{i0}}{1/\bar{lx}_{i1}^2 - 1/\bar{lx}_{i0}^2} \quad (\text{B.16})$$

$$\bar{ly}_{i01}^{\text{max}} = -\frac{a_i}{\bar{lx}_{i0}^2} \bar{lx}_{i01}^{\text{max}} + 2 \frac{a_i}{\bar{lx}_{i0}} \quad (\text{B.17})$$

with an area constraint violation of

$$\epsilon_{i01}^{\text{max}} = 1 - \frac{\bar{lx}_{i01}^{\text{max}} \bar{ly}_{i01}^{\text{max}}}{a_i} = \left( \frac{\bar{lx}_{i1} - \bar{lx}_{i0}}{\bar{lx}_{i1} + \bar{lx}_{i0}} \right)^2. \quad (\text{B.18})$$



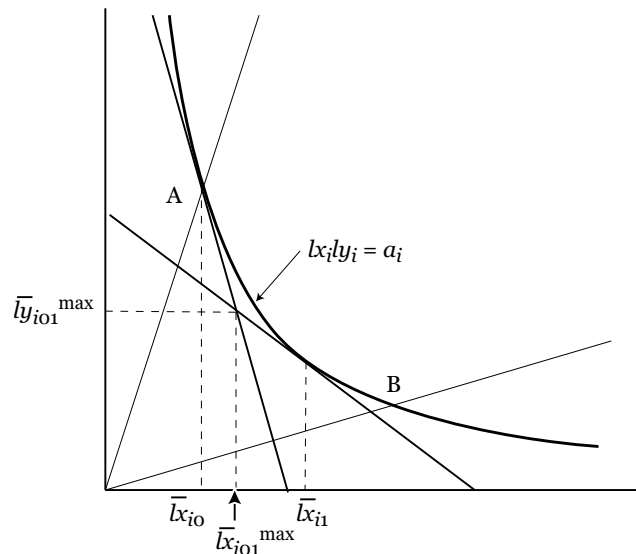

Fig. 34. Cutting plane generation

The coordinates  $(\bar{x}_{i01}^{\max}, \bar{y}_{i01}^{\max})$  are derived from the the convex lower bound  $-ly_i + a_i/lx_i \leq 0$ . The cutting plane that underestimates such a convex lower bound at a point  $\bar{x}_{i0}$  follows:

$$-ly_i - \frac{a_i}{\bar{x}_{i0}^2} lx_i \leq -2 \frac{a_i}{\bar{x}_{i0}} \quad (\text{B.19})$$

If a maximum area constraint violation  $\epsilon$  is given, the point of generating cutting plane can be found. The following equation can be obtained from (B.18).

$$\frac{\bar{x}_{i1}}{\bar{x}_{i0}} = \frac{1 + \sqrt{\epsilon}}{1 - \sqrt{\epsilon}}. \quad (\text{B.20})$$

As it is possible to find the point  $\bar{x}_{i1}$  from  $\bar{x}_{i0}$  with a maximum violation  $\epsilon$ , it is also possible to find the next point  $\bar{x}_{i2}$  from  $\bar{x}_{i1}$  with a maximum violation  $\epsilon$  in the interval  $\bar{x}_{i1}$  to  $\bar{x}_{i2}$  until  $lx_i^{\text{up}}$  is reached. As is explained about  $C_i$ , the following equation is valid.

$$\frac{\bar{x}_{iC_i}}{\bar{x}_{i0}} = \frac{\bar{x}_{i1}}{\bar{x}_{i0}} \frac{\bar{x}_{i2}}{\bar{x}_{i1}} \dots \frac{\bar{x}_{iC_i}}{\bar{x}_{iC_i-1}} = \left( \frac{\bar{x}_{i1}}{\bar{x}_{i0}} \right)^{C_i} = \left( \frac{1 + \sqrt{\epsilon}}{1 - \sqrt{\epsilon}} \right)^{C_i}. \quad (\text{B.21})$$

Thus, the total number of cutting planes for department  $i$  can be found using the valid implied lower and upper bounds  $lx_i^{\text{low}}$  and  $lx_i^{\text{up}}$  on  $\bar{x}_{0i}$  and  $\bar{x}_{iC_i}$ . The equation (B.14) is obtained from this equation (B.21).

## VITA

Junjae Chae graduated from Ajou University (South Korea) in 1995 with a B.S. in industrial engineering. He was employed as a production engineer for E-Land Group in Seoul from 1994 until his departure for graduate education in the United States. He left Korea in 1997 to continue studying industrial engineering at Texas A&M University, where he was awarded a M.S. in 1999. His teaching and research interests include facilities design, material handling systems design, and the modeling, analysis, and control of manufacturing systems. Junjae is a member of the Institute of Industrial Engineers (IIE) and the Institute for Operations Research and Management Sciences (INFORMS). His permanent address is 422-32 Pajang-dong, Suwon, Kyunggi, South Korea.