

McNamara, A. M., Goodey, R.J. & Taylor, R.N. (2009). Apparatus for centrifuge modelling of top down basement construction with heave reducing piles. *International Journal of Physical Modelling in Geotechnics*, 9(1), pp. 1-14. doi: 10.1680/ijpmg.2009.9.1.01



**CITY UNIVERSITY
LONDON**

[City Research Online](#)

Original citation: McNamara, A. M., Goodey, R.J. & Taylor, R.N. (2009). Apparatus for centrifuge modelling of top down basement construction with heave reducing piles. *International Journal of Physical Modelling in Geotechnics*, 9(1), pp. 1-14. doi: 10.1680/ijpmg.2009.9.1.01

Permanent City Research Online URL: <http://openaccess.city.ac.uk/8065/>

Copyright & reuse

City University London has developed City Research Online so that its users may access the research outputs of City University London's staff. Copyright © and Moral Rights for this paper are retained by the individual author(s) and/ or other copyright holders. All material in City Research Online is checked for eligibility for copyright before being made available in the live archive. URLs from City Research Online may be freely distributed and linked to from other web pages.

Versions of research

The version in City Research Online may differ from the final published version. Users are advised to check the Permanent City Research Online URL above for the status of the paper.

Enquiries

If you have any enquiries about any aspect of City Research Online, or if you wish to make contact with the author(s) of this paper, please email the team at publications@city.ac.uk.

APPARATUS FOR CENTRIFUGE MODELLING OF TOP DOWN BASEMENT CONSTRUCTION WITH HEAVE REDUCING PILES

A.M. McNAMARAⁱ⁾, R.J. GOODEYⁱⁱ⁾ AND R.N. TAYLORⁱⁱ⁾

ABSTRACT

The construction of deep basements in urban areas is associated with many risks and problems among which is the possible damage to existing structures and services resulting from settlements near the excavation. A number of methods are routinely employed to attempt to control these movements (e.g. top-down construction, use of stiff diaphragm walls). This paper discusses the methodology and practicalities of a series of centrifuge model tests designed to investigate the effect of deep basement construction. Two sets of experimental apparatus are described in detail and their effectiveness in terms of robustness and generation of repeatable data are assessed. It is shown that using relatively simple techniques and equipment it is possible to model many of the features associated with top-down construction.

Key words: Centrifuge, excavation, construction process, apparatus development

INTRODUCTION

Centrifuge model testing concerning deep excavations in clay pose significant problems related to the accurate simulation of the construction process. The key difficulty is the simulation of or actual removal of soil from the model to form the excavation. A number of methods have been developed with varying degrees of complexity and success. Zhu & Yi (1988) excavated the soil behind a model quay wall manually, involving stopping and starting the centrifuge in order to remove and investigate the effect of each layer of soil. It should be noted that this method does not necessarily model the correct stress state due to the cycles of increasing and decreasing gravity associated with starting a stopping the centrifuge.

A more common approach is to simulate excavation in flight by the draining of a heavy fluid (density approximately equal to the soil being used) which provides horizontal support to the retaining wall (e.g. Bolton et al., 1988). The primary disadvantage of this technique is that the fluid can only provide support to give $K_0=1$ which is rarely the case for in-situ soils. Allersma (1998) attempted to correct the problem of correct K_0 modelling by implementing a system that rolls slices of clay out of the excavation using a geotextile band arranged suitably between slices of clay. However, it may be argued that the arrangement of the band in the clay alters the stress state sufficiently to influence the observed displacements.

At the more complex end of the scale is the use of in-flight excavators attached to remotely operated robotic arms (e.g. Takemura et al., 1999). Whilst this approach may seem to offer the ideal solution it is not without its problems primarily associated with where the spoil from the excavation is stored after excavation. It cannot be dropped from the centrifuge as this would create an imbalance in the system due to the reduction in weight of the package and it must therefore remain on the arm. Most systems have an area to one side within the strongbox for the spoil but in the package size available at City University this would reduce the useful model size to an impractically small scale.

This paper describes developments in apparatus which allow the stress changes associated with a deep excavation to be modelled in-flight using the heavy fluid support technique. Modifications are presented that allow for the modelling of $K_0 \neq 1$ amongst other developments that allow propping of the wall and simulation of superstructure construction post-excavation. This is achieved without resort to the manufacture of complex apparatus associated with in-flight excavation.

The purpose of the research was to explore the influence of piles installed beneath excavation formation level in overconsolidated clay as a means of reducing ground movements associated with the construction process

i) Geotechnical Engineering Research Centre, City University, London

ii) Professor, ditto

(Fig. 1). The first test series (McNamara, 2001; McNamara and Taylor, 2004) established that the presence of piles could significantly reduce ground movements using the Apparatus A described below. Subsequent to this, Apparatus

B was developed in order to perform a second series of tests (Goodey et al., 2006) that investigated the influence of pile loading following excavation. Both apparatus are described in detail and typical test results are presented.

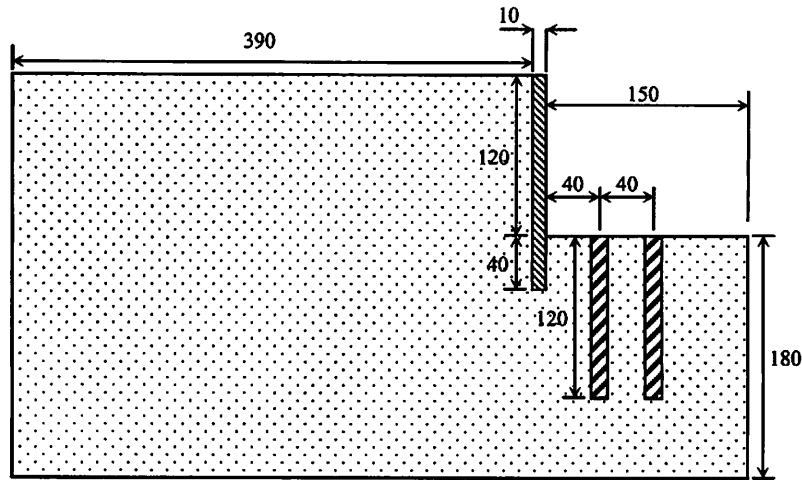

Fig. 1 Schematic section through the centrifuge model showing one possible arrangement of piles

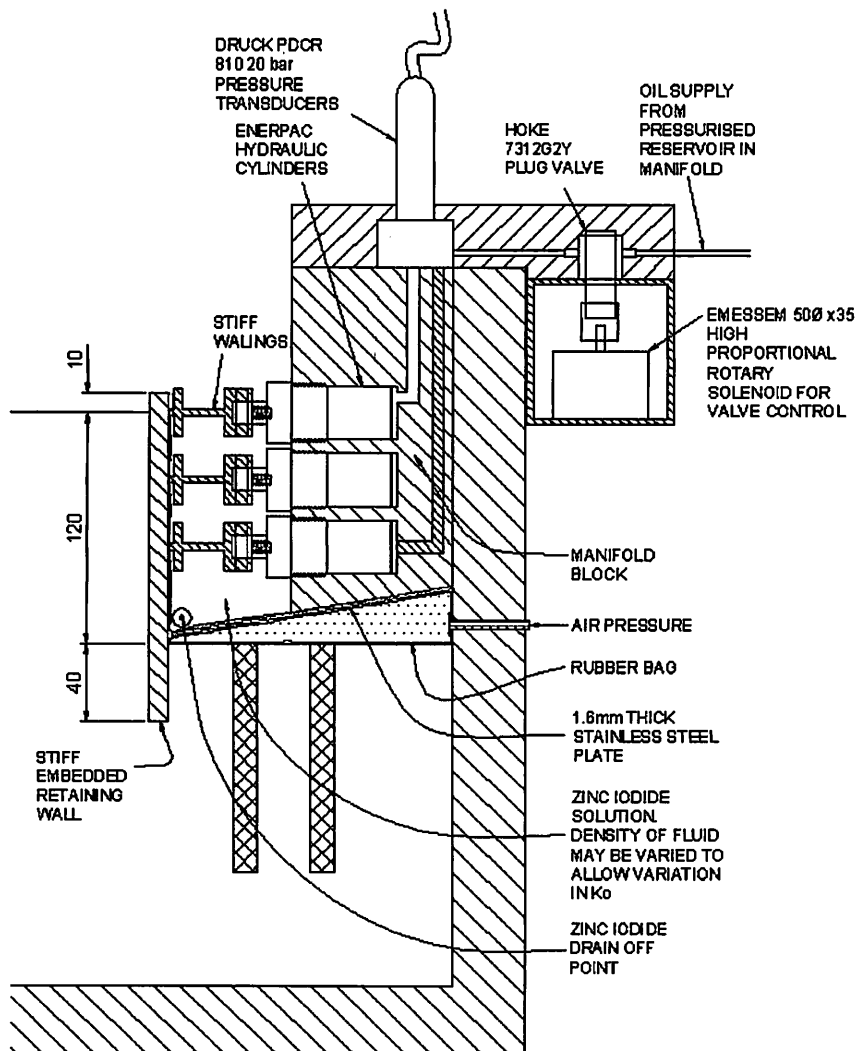

Fig. 2 Schematic section through apparatus used to model the influence of unloaded heave reducing piles

APPARATUS FOR SIMULATING EXCAVATION WITH UNLOADED HEAVE REDUCING PILES (APPARATUS A)

Introduction

The basic plane strain model geometry is shown in Fig. 1. The model consisted of a preformed excavation with a stiff embedded wall that was initially supported in flight by fluid pressures acting both against the retaining wall and the excavation formation level. During the test the fluid pressures were simultaneously reduced to simulate the stress changes resulting from excavation whilst a series of props were placed against the retaining wall to provide lateral support. The formation remained unsupported following excavation and any piles installed below the formation level (Fig. 1) were not axially loaded post-excavation. The aim of the apparatus was to provide a stiff propping system that would minimise horizontal displacements but allow movements associated with base heave following excavation to occur.

Apparatus details

In Fig. 2 Apparatus A is shown in detail. The complete system comprised three integrated elements each performing a separate function:

- i A propping system.
- ii A system for applying horizontal stress to the retaining wall.
- iii A system for applying vertical stress to the excavation formation.

Propping system

The main body comprised a solid block of aluminium primarily housing the propping system but onto which all elements of the system were mounted. Three levels of walings were constructed in such a way that they could be advanced against the retaining wall in flight. The walings had an equivalent stiffness to a reinforced concrete slab of 300 mm, a realistic prototype thickness, with a contact height against the retaining wall of 3 mm. Three miniature hydraulic cylinders, actuated by light hydraulic oil, advanced the walings (Fig. 3). Oil pressure was supplied by a 150 mm deep by 25 mm diameter reservoir which was pressurised during testing by the enhanced weight of a 100 mm long phosphor bronze piston sealed with double 'O' rings against the reamed bore. At 100 g this system generated approximately 8 bar of oil pressure. Oil flow into the hydraulic cylinders was controlled with three miniature motorised valves made from components available commercially. Once the prop had been advanced during the test it could be locked into position by closing the valve. A pressure transducer on the prop side of the valve allowed measurement of any changes in the oil pressure resulting from wall movements which could then be used to calculate prop loads.

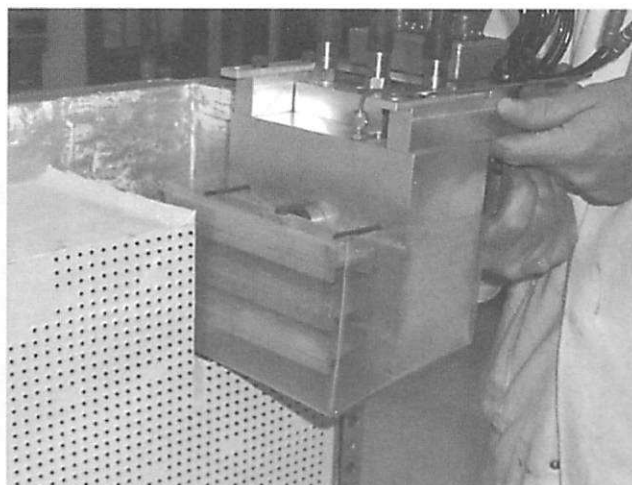

Fig. 3 Walings attached to miniature hydraulics cylinders and mounted in main body of apparatus. Also shown is the polyethylene bag used to contain the heavy fluid for horizontal support of the wall

Horizontal stress control system

The aluminium block containing the hydraulic cylinders together with the walings was surrounded by a membrane (Fig. 3) containing a low viscosity dense fluid (Zinc Iodide, later Sodium Polytungstate) that applied horizontal total stress to the retaining wall for support during the equilibrium phase on the centrifuge. The membrane was required to remain trapped between the props and the wall during the test necessitating a relatively stiff material to minimise flexibility in the propping system. Tests confirmed that polyethylene could be easily and accurately heat sealed to form an appropriately shaped container which was flexible enough to resist puncture, even at a relatively thin gauge. Bags with a single heat sealed seam at each corner were determined to be most reliable although the ability to produce only a simple geometry partially governed the overall design of the apparatus. Draining of the heavy fluid from the polyethylene bag during flight was achieved via a drain at the lowest point. A hole was punched into the bag through which a fitting was passed which aligned with a hole in the centrifuge strongbox (Fig. 4). Great care was required to ensure integrity of the seal of this fitting against the bag as preliminary testing had shown this to be a potential weak point in the system owing to the high fluid pressures involved.

Vertical stress control system

Beneath the main body of the apparatus support to the pre-excavated formation was required. A specially manufactured dipped latex bag was used which, when supplied with compressed air at the appropriate pressure, imposed a stress at formation level equivalent to that of

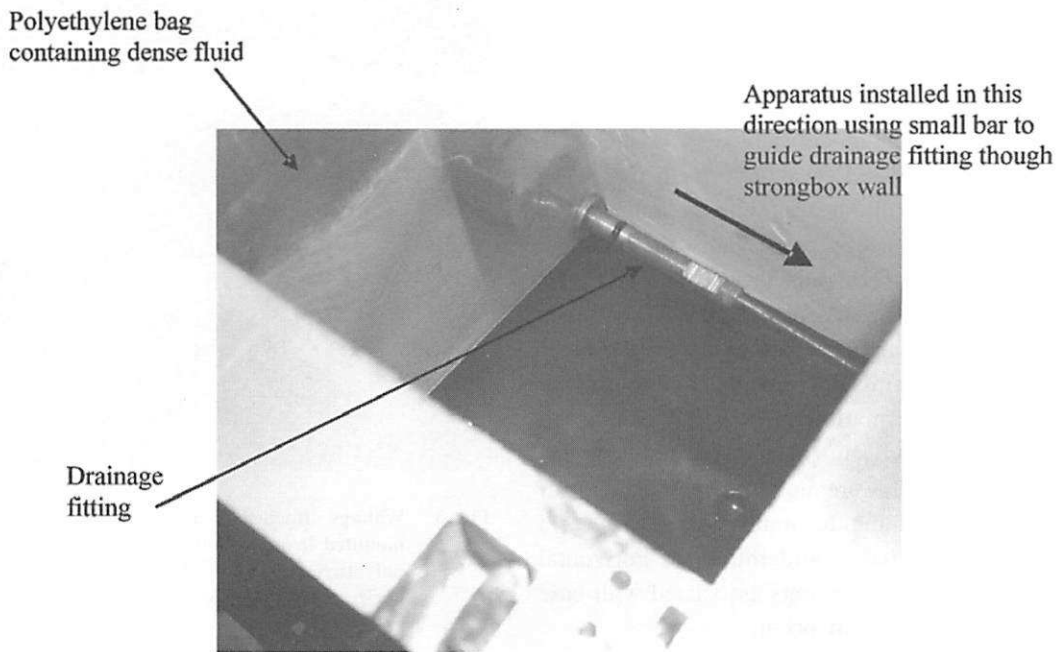

Fig. 4 Method of drainage of heavy fluid

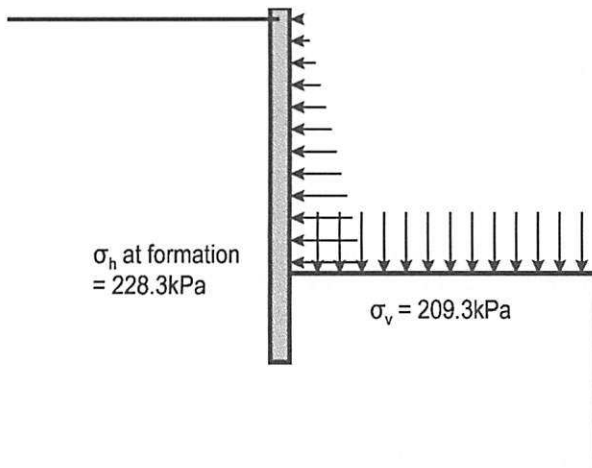

Fig. 5 Imposed horizontal and vertical total stresses acting within excavation during consolidation on the centrifuge

the total stress prior to excavation. However, due to K_0 not equalling 1, the pressure required was approximately 20 kPa less than that resulting from the fluid (Fig. 5) contained within the polyethylene bag and a stiff plate was therefore necessary to both separate the membranes and resist the excess pressure from the polyethylene bag. It was important that the plate must neither interfere with the retaining wall nor prevent movement of the excavation formation. A clearance of 2 mm both horizontally and vertically at the junction of the retaining wall and formation level was therefore allowed for movement and a 1.6 mm thick stainless steel plate was used.

APPARATUS FOR SIMULATING EXCAVATION WITH LOADED HEAVE REDUCING PILES (APPARATUS B)

Introduction

A second apparatus to simulate the excavation of a basement of the same prototype dimensions but that allowed subsequent loading of the piles was developed. This development was undertaken in order to investigate the effect on ground movements behind the retaining wall when the piles beneath the excavation were loaded.

Apparatus details

The complete apparatus is shown in Fig. 6. The apparatus is based around a large aluminium block, as before, around which the remainder of the system is built. The complete system comprised three sub-systems:

- i A pile loading system.
- ii A system for horizontal support of the retaining wall.
- iii A system for applying vertical stress to the excavation formation.

Pile loading system

The piles below the formation level were axially loaded using silver steel rods which had a mass such that, under acceleration of 100 g, a load equivalent to half of the estimated ultimate load capacity of the pile was applied. The pile loading rods passed through PTFE bushings to minimise friction. Pile loading was achieved by lowering the silver steel rods onto the exposed ends of the cast model piles.

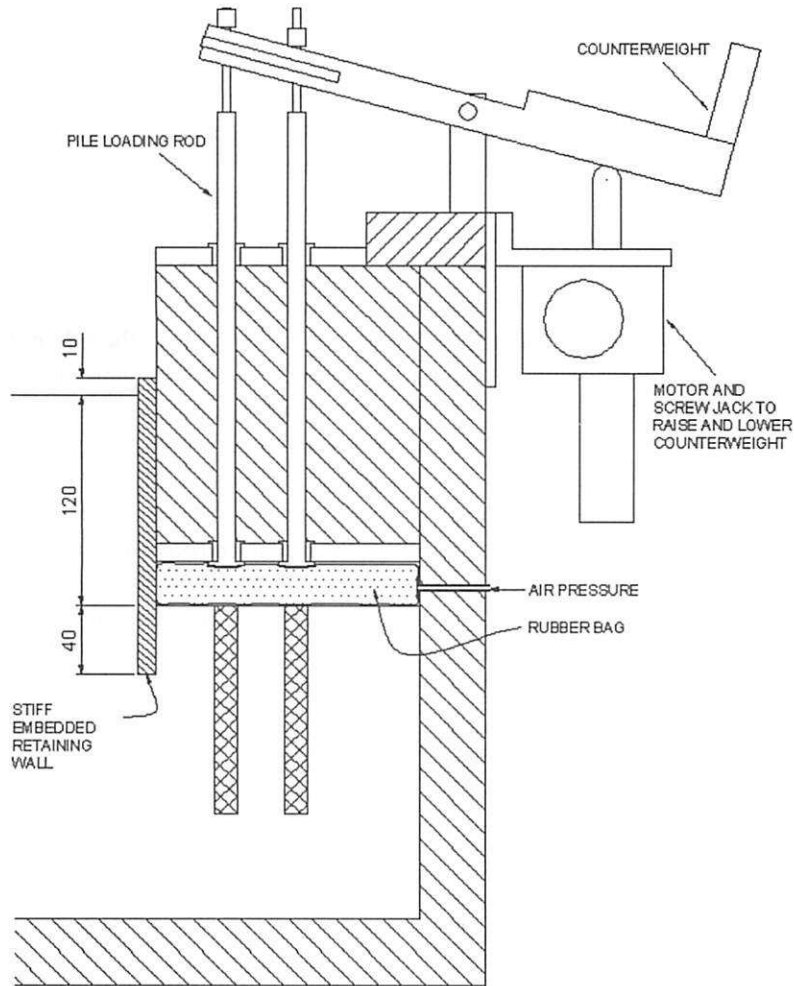

Fig. 6 Schematic section used to model the influence of loaded heave reducing piles

Prior to the excavation simulation (i.e. during the equilibrium phase) the rods were held suspended above the pile heads, in the upper position shown in Fig. 6, by the counterweight on the right hand side of the pivoting plate. A screw actuator driven by an electric motor provided a supporting stop for the counterweight during this phase. When the load was to be applied the actuator was driven in such a way as to lift the counterweight causing the silver steel rods to be lowered onto the pile heads. The motor was halted in a position that allowed the rods to float freely, but restrained laterally by the PTFE bushings, thereby allowing heave or settlement of the piles. The system with the loading rods in the initial and pile loading positions is shown in Fig. 7.

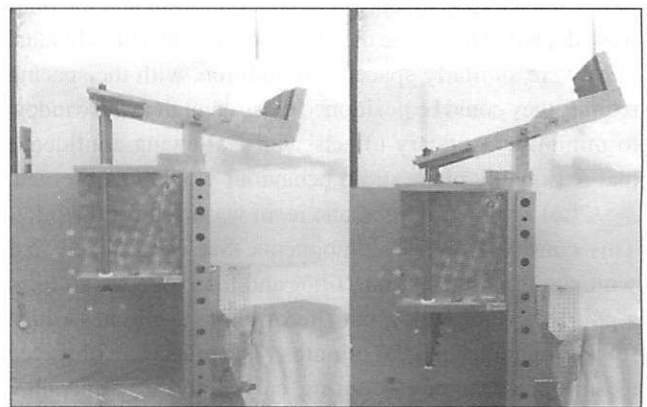

Fig. 7 Pile loading rods in the upper (unloaded) and lower (loaded) positions

Horizontal support and vertical stress control system

Owing to the arrangement of the pile loading rods it was no longer practically possible to support the wall laterally using heavy fluid. The wall was therefore supported by the main body of the apparatus although it was neither fixed to the strongbox nor the apparatus. The rigid support

block prevented only movement of the upper portion of the wall towards the excavation thus it was possible for horizontal movements away from the excavation or vertical movements to occur. As with Apparatus A the formation level was initially supported in flight by a pressurised rubber bag. The inclined plate separating this air bag from

the fluid bag was no longer required and the air bag therefore was constrained at its upper surface by the main aluminium block.

COMMON ELEMENTS FOR BOTH TEST SERIES

Model wall

The same model wall was used in all tests and had a stiffness that corresponded to a prototype concrete wall approximately 1.35 m thick. It was manufactured from 10 mm thick aluminium plate and was sealed against the back wall of the strongbox and the Perspex window using cast silicone rubber seals (Powrie, 1986).

Model piles

The optimal position, depth and layout of the model piles was difficult to determine at the outset since the mechanism involved in their contribution to reduction of ground movements was not known. An embedded pile length of 120 mm, equal to the depth of the excavation, was deemed acceptable since there would be a thick layer of clay between the toe of the piles and the base of the model (Fig. 1). A fairly arbitrary positioning was eventually adopted owing to the assumption that the piles would merely provide a general stiffening effect to the formation rather than acting purely in tension and thereby anchoring down the excavated surface. A method was developed for the installation of the cast in situ piles using a thin walled hypodermic steel tube to create the bored holes. The available range of tube size was limited, especially for very thin walled varieties, and this in part contributed to the selection of $1/2$ " (12.7 mm) diameter piles which, in turn, largely predetermined their location. A standard three pile diameter spacing between the model wall and the piles was adopted to minimise the effect on the wall and individual piles were similarly spaced. In addition, with the spacing regime, they could be positioned close enough to the window to minimise boundary effects whilst allowing confidence that reasonably plane strain behaviour would be observed.

A fast setting polyurethane resin was used for the piles. This consisted of two components that were mixed first with aluminium trihydrate filler and then together to form a pourable fluid with a pot life of about 2 minutes whilst full curing took about 20 minutes. The piles were observed to shrink less than 1% during curing and a temperature sensor embedded in a pile hole indicated that the curing exotherm was minimal. The addition of filler to the resin at a rate of 100 g filler to 100 g resin resulted in an easily pourable fluid that filled the pile holes leaving few, if any, voids and produced a material of $1,200 \text{ kg/m}^3$ density. This density, being lower than the surrounding soil, was chosen so that any observed reduction in formation heave could be attributed to effects other than a general "dragging down" of the soil that might occur if a pile of density higher than

the soil were used. Axial tension and compression tests on a recovered pile indicated stiffness to be approximately 800 MPa.

Some model piles used in the second series of experiments were instrumented by embedding strain gauges within them. Strain gauges suitable for plastics and epoxies were used. In order to locate the gauge accurately within the pile a small strip of resin was created in a mould to which the gauges were mounted (Fig. 8). During model making the pile hole was cut into the clay as before, backfilled approximately halfway with resin and the pre-made strip inserted in the correct orientation. The lead wires from the gauges were positioned away from the pile heads and exited the model via a small recess in Apparatus B. The presence of this recess permitted a pathway that allowed a small seepage of water into the excavation despite being sealed with silicone grease. During the time taken for conditions of pore pressure equilibrium to be established it was found that the excavation could fill with water and a drainage point, controlled with a solenoid valve, was therefore added to the strongbox in order that this water could be removed immediately prior to the start of the excavation simulation.

The instrumented piles were recovered after the completion of the test and calibrated against axial load in a specially constructed jig. Checks were made to determine whether the lateral stress change in the soil associated with the excavation would cause a Poisson effect in the pile resulting in false axial load readings. For the range of stress changes expected in these tests the error in strain gauge reading caused by this effect was found to be in the order of 3%.

Stress history of soil used in the tests

In common with normal practice the speswhite kaolin samples for the tests were prepared from slurry at a water content of 120% (e. g. Dean et al., 1998; Loganathan et al., 2000). A preconsolidation pressure of 500 kPa

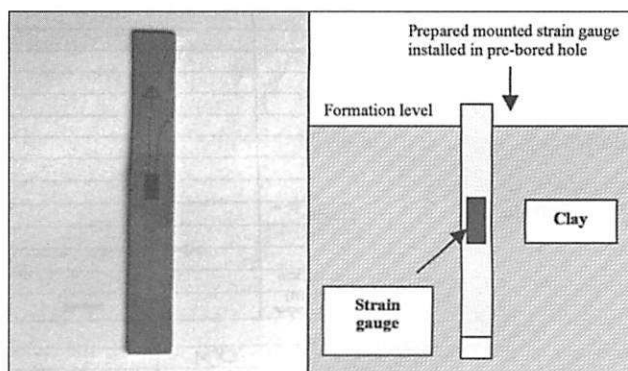

Fig. 8 Strain gauged insert for instrumented heave reducing piles

followed by swelling to 250 kPa followed by in-flight consolidation was used for all tests giving an overconsolidation ratio variation with depth as shown in Fig. 9. From Equation 1 (Mayne and Kulhawy, 1982) the calculated variation of K_0 with depth is shown in Fig. 10.

$$K_0 = (1 - \sin \phi') \text{OCR}^{\sin \phi'} \quad (1)$$

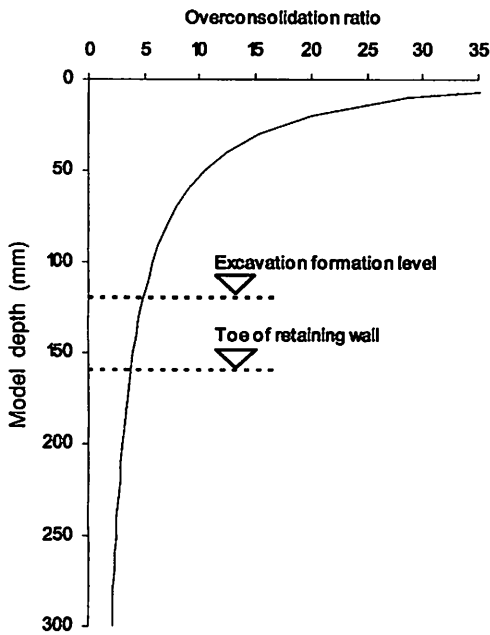

Fig. 9 Variation of overconsolidation ratio with depth in model

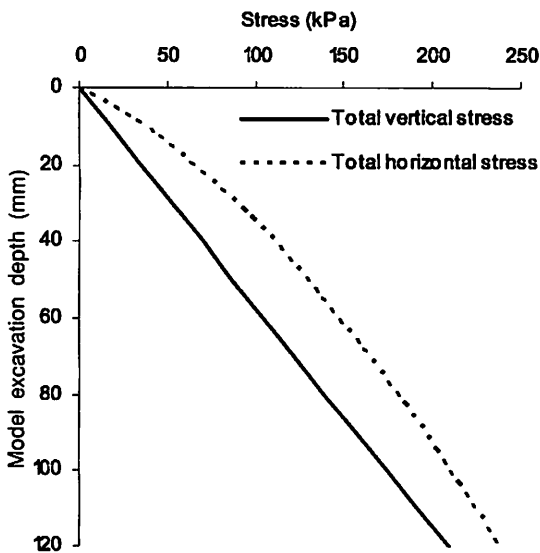

Fig. 10 Theoretical vertical and horizontal total stress distribution over depth of excavation

At the end of preparation in the consolidation press the effective stress and total stress throughout the depth of the sample were equal at 250 kPa. Therefore, when removed from the press the soil samples were subjected to high negative pore pressures as the load was removed and the total stress was essentially zero. Closing the base drainage valves and sealing the exposed surfaces of the clay prior to and during model making sought to minimise dissipation of these pressures such that the effective stress remained as close to 250 kPa as possible.

Once on the centrifuge swing the model underwent a further period of consolidation under its enhanced self weight. This resulted in additional swelling throughout the depth of the model although the degree of swelling of any element was dependent upon its depth within the model. The distribution of pore pressure throughout the model was monitored using standard Druck pore pressure transducers embedded within the clay sample. The theoretical vertical and horizontal total stresses just prior to excavation simulation are shown in Fig. 11.

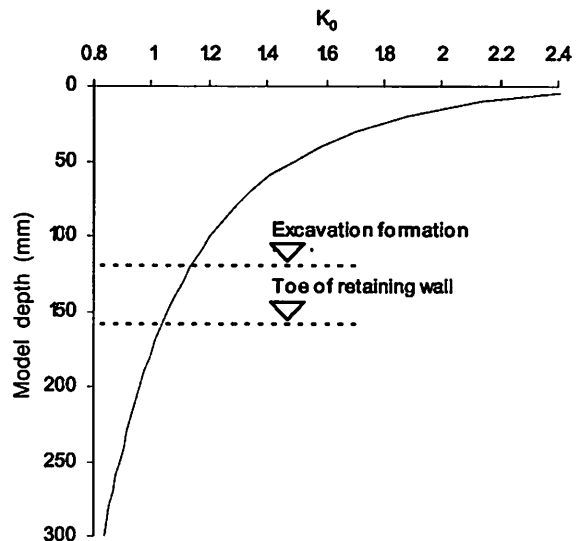

Fig. 11 Variation of K_0 with depth over depth of model

Model making

The top surface of the model was trimmed to the required level using an aluminium box section cutting tool guided by a specially constructed jig bolted to the strongbox (Fig. 12). When the required level was achieved this surface was sealed with silicone oil to prevent drying of the sample. Another jig was used to form the remainder of the cut faces that completed the model (Fig. 13). An approximately 10 mm high ramp of unexcavated clay was left immediately behind the position of the retaining wall. A bead of thick silicone grease was then applied at the joints between strongbox and the upper clay surface to seal any gaps. The

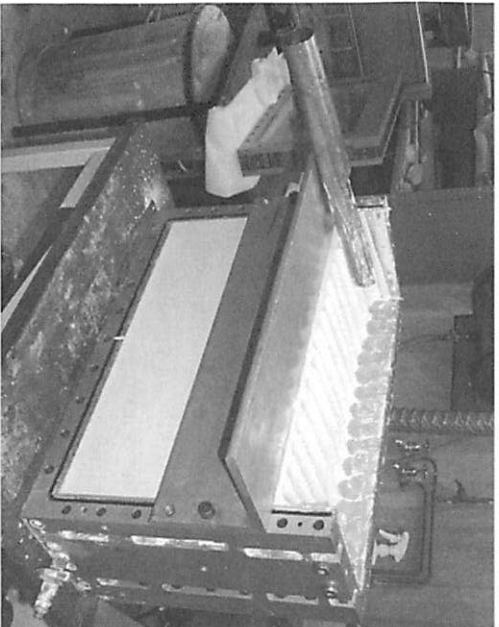

Fig. 12 Trimming the upper surface of the prepared clay sample

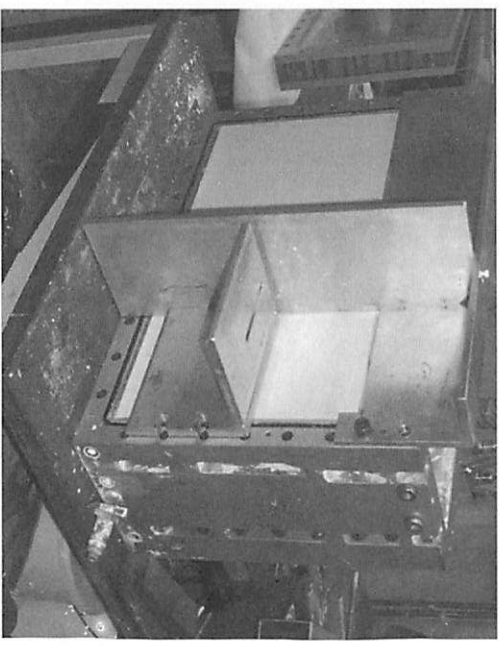

Fig. 13 Jig for forming the excavation



Fig. 14 Track guided cutting tool in use

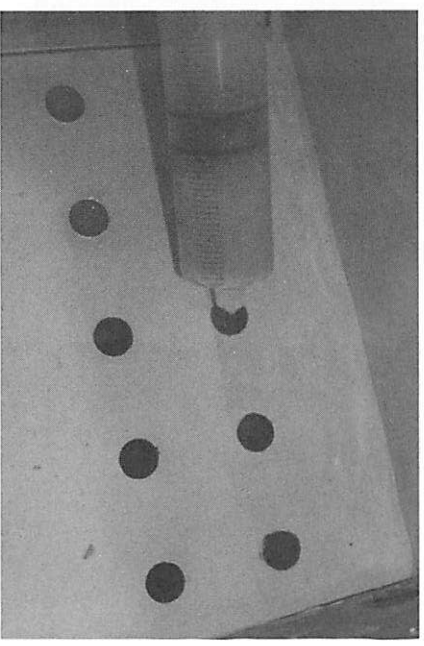

Fig. 15 Dispensing resin into pre-formed pile bores

purpose of both the grease bead and the clay ramp were to prevent the loss of silicone oil from the clay surface during consolidation on the centrifuge.

The trench for the retaining wall toe embedment required a special tool. This cutter was guided on a track, shown in use in Fig. 14, and had an adjustable blade that allowed the depth of cut to be varied with each pass. The cutting blade was of hardened steel and oversized slightly to give clearance for the model wall to be inserted whilst ensuring the minimum amount of movement during testing.

If the test incorporated piles below the formation level the holes for these were formed using a thin-walled hypodermic tubing cutter guided by an appropriate jig. The mixed liquid resin was carefully dispensed into the pile bores using a syringe (Fig. 15). In the case of the instrumented piles the prepared strain gauge units were inserted and positioned at this point. This method was found to be extremely effective and produced consistent piles with few imperfections. It is noted that during the pile construction process the surfaces of both the excavation formation and that behind the retaining wall and trench were exposed and susceptible to drying. It was therefore

necessary to work quickly but carefully at this stage in order to prevent drying of the clay as much as possible.

At this stage the preparation of the clay was complete and required only the apparatus to be placed. The rubber bag at excavation formation level was positioned and the air supply fitting clamped through the end wall of the strongbox. The main apparatus was then installed (Fig. 16 a and b). Before the model wall was positioned the cast silicone rubber seals were filled with silicone grease to limit friction against the Perspex window and the back wall of the strongbox and also to provide a good seal against groundwater flow into the excavation.

When the apparatus had been placed and fixed into position the Perspex window, incorporating image processing control targets, was bolted in place. The window was first lubricated using a high viscosity, clear, silicone oil to reduce interface friction. A rack containing LYDTs was bolted on top of the strongbox to record vertical displacements of the ground surface behind the retaining wall and allowed comparison of displacements measured with image processing (McNamara and Taylor, 2004).

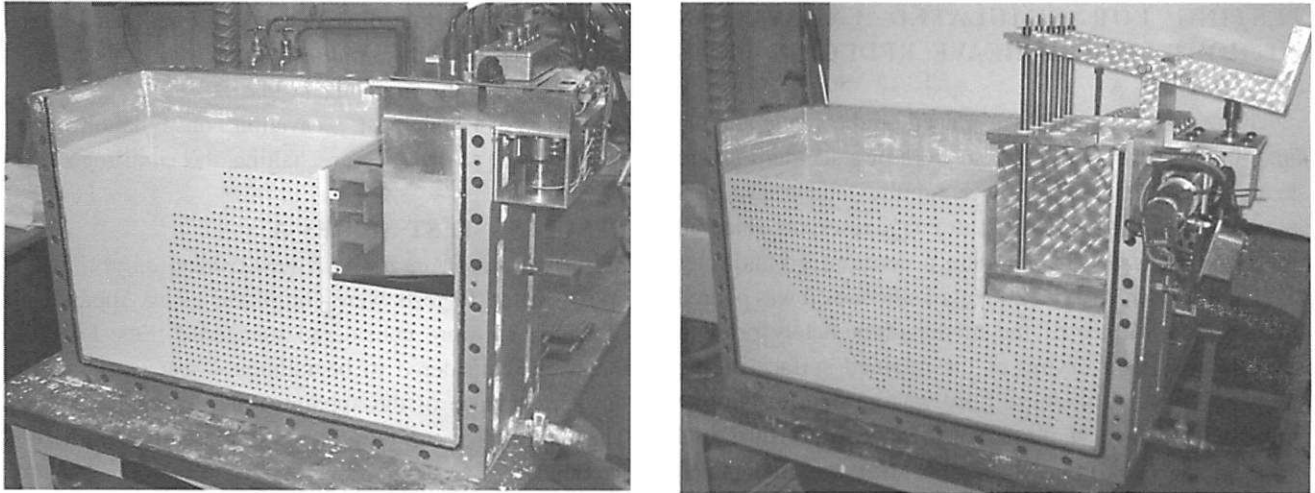

Fig. 16 Completed models prior to placement on the centrifuge
 a) Unloaded heave reducing piles b) Loaded heave reducing piles

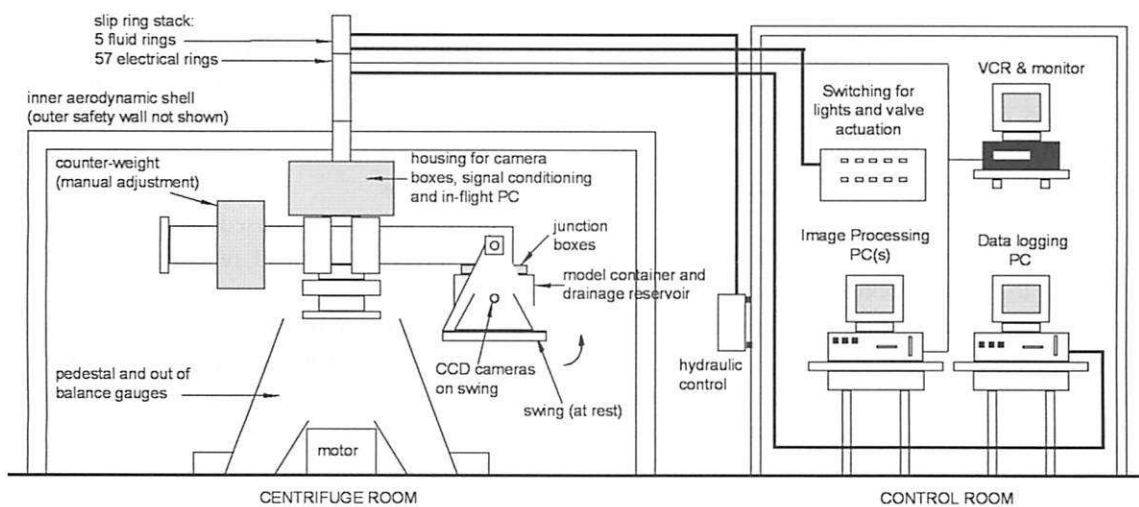

Fig. 17 Schematic diagram of the Acutronic 661 geotechnical testing facility at City University, London - capacity 40 g.tonnes, radius 1.8 m to swing base in flight (after Grant, 1998)

The centrifuge

Schofield and Taylor (1988) describe the Acutronic 661 centrifuge, shown schematically in Fig. 17, used by the Geotechnical Engineering Research Centre at City University. The swinging platform at one end of the rotor has overall dimensions of 500 mm x 700 mm with a usable height of 500 mm. The centrifuge is a 40 g-tonne machine and the package is balanced by a 1.45 tonne counterweight that is moved radially along the centrifuge arm by a screw mechanism. The radius to the swinging platform is 1.8 m giving a working radius of between 1.5 m and 1.6 m requiring an operating speed of approximately 240 rpm to give an acceleration of 100 g at 1.55 m radius.

Electrical and hydraulic connections are available at the swinging platform and are supplied through a stack of slip rings. 55 slip rings are electrical and 5 fluid with 15 bar capacity. Of the electrical slip rings 5 are used to transmit transducer signals, which are converted from analogue to digital by the on-board computer and may be amplified prior to transmission in bits. The remaining slip rings are used for communicating closed circuit television signals, supplying power for lights or operating solenoids or motors as necessary. The fluid slip rings may be used for water, oil, or compressed gas.

TESTING FOR SIMULATED EXCAVATION WITHOUT LOADED HEAVE REDUCING PILES (APPARATUS A)

The completed model was placed on the swing and the final preparations made. These were of a standard nature involving connection of power supplies and transducers as well as compressed air, fluid drainage reservoir, solenoid valve and standpipe to maintain a constant groundwater level in the model. About 200 ml of silicone oil was poured onto the top surface of the model immediately prior to spin-up to prevent drying of the retained surface during the experiment. The dense fluid was introduced into the polyethylene bag at the last stage. Since the vertical total stress at the excavation formation level was maintained and controlled using a rubber bag supplied with compressed air it was necessary, during spin-up, to increase the pressure incrementally with the centrifuge speed. This ensured that the vertical and horizontal total stresses were in the correct ratio at all times. When the model reached 100 g it was left, at least overnight but more often for about 30 hours, for the pore pressures to come into equilibrium (measured via Druck pore pressure transducers).

The procedure for the tests was as follows:

- i Advance top prop and lock into position.
- ii Drain fluid to level of middle prop whilst simultaneously reducing air pressure at formation to suit rate of drainage.
- iii Advance middle prop and lock into position
- iv Drain fluid to level of bottom prop whilst simultaneously reducing air pressure at formation to suit rate of drainage.
- v Advance bottom prop and lock into position
- vi Drain remainder of fluid whilst simultaneously reducing air pressure at formation to suit rate of drainage.

The duration of the excavation procedure was mainly controlled by the rate of fluid drainage and the air pressure was therefore manually adjusted to maintain the vertical total stress acting at formation relative to the unexcavated height. Although the procedure was involved and labour intensive the test itself was typically completed in less than 8 minutes. Once the excavation had been completed the model was left on the centrifuge for up to 2 hours in order to allow longer term movements to develop.

TESTING FOR SIMULATED EXCAVATION WITH LOADED HEAVE REDUCING PILES (APPARATUS B)

As in the previous series of tests the model was spun up to 100 g and the formation level stress ratio kept constant by controlling the air pressure in the rubber bag. After the pore pressures had reached equilibrium the test procedure was as follows:

- i Drain water (if any) that had accumulated in the excavation.

- ii Reduce formation bag air pressure over a fixed period (usually 3 minutes).
- iii Lower rods onto pile heads.

As before a 2 hour post excavation consolidation period was allowed to pass before halting the centrifuge.

RESULTS - TEST SERIES A

Performance of Apparatus A (excavation only)

A total of 19 tests were completed using Apparatus A of which 13 were considered successful tests. Of the 6 that were considered to be failures 4 were attributed to the performance of the apparatus and 2 to other factors. The reasons for the failure of each test are summarised in Table 1.

Due to the large number of individual elements involved in each test a number of other problems were encountered which impacted on the performance of the system but did not cause the test to be aborted. These are summarised below.

- The propping system, being based upon a hydraulic circuit, proved difficult to bleed completely. This resulted in the propping system being less stiff than anticipated and, in at least one test, air was suspected as the cause of one prop attracting no load at all. This of course affected the load observed in the other two props.
- In one test the resin used to create the piles suffered an adverse chemical reaction and failed to cure properly.
- On a number of occasions the valve controlling the drainage of the heavy fluid from the excavation was either slow to open or did not open at all. Changing from a proprietary solenoid valve to a rotary valve actuated by a rotary solenoid improved this situation.

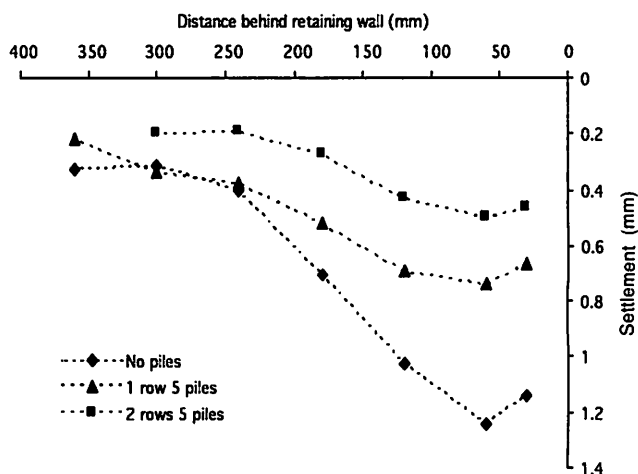

Fig. 18 Comparison of settlement behind retaining wall 30 minutes from commencement of excavation for tests with and without piles using Apparatus A

- The air bag supporting the formation burst on two occasions. This was rectified at the time and the test was able to continue although significant delays occurred.

Observed ground movements

Fig. 18 shows the settlements at the retained surface for tests with and without piles installed below the excavation formation level. The observed form and magnitudes of these settlements shows general agreement with published data for multi-propped excavations (e.g. Clough and O'Rourke, 1990). In the tests where piles were used retained

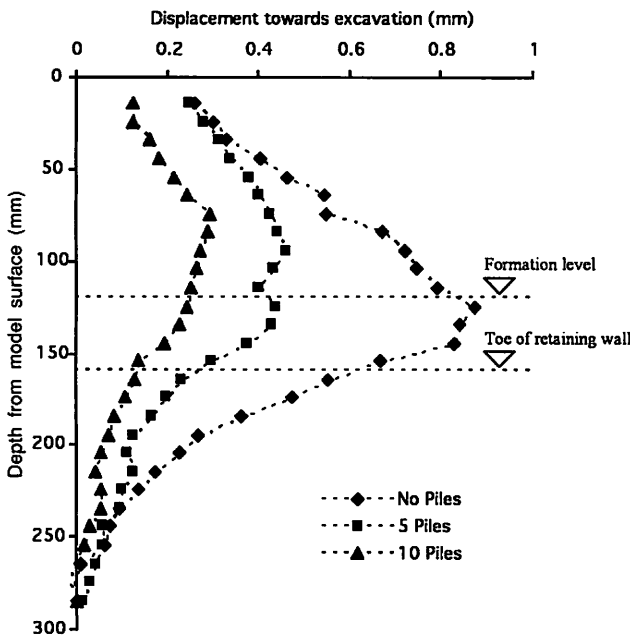

Fig. 19 Horizontal displacements behind the wall for different arrangement of piles 30 minutes from commencement of excavation

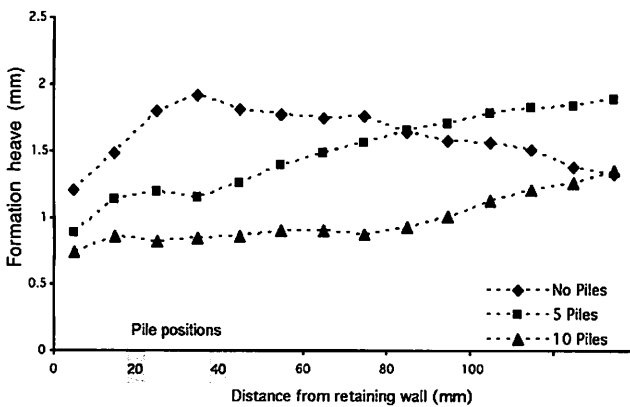

Fig. 20 Comparison of excavation formation displacements measured using image processing for tests with and without piles

ground surface displacements were reduced in comparison to those seen in tests without piles. Maximum settlements were consistently seen at 0.5H, where H is the depth of the excavation, behind the wall. Overall, the settlement of the retained ground surface was less pronounced and was subject to less variation in the tests that included piles. Horizontal displacements, measured immediately behind the retaining wall, were also similarly reduced (Fig. 19).

At the excavation formation (Fig. 20) heave was reduced significantly in the tests where piles were used. Marked reductions in displacement were seen around the positions of the piles leading to a more uniform distribution of heave. Near to the end wall of the strongbox and at depth displacements for all tests were similar indicating that boundary effects had some influence on displacements.

Prop loads

The use of a multi propped wall with stiff props enabled the prototype excavation process to be modelled more realistically than would otherwise have been possible using different techniques. However, accurately determining horizontal load at various levels was not possible owing to the combination of several props and the very stiff retaining wall. Consequently, prop forces that were deduced from the transducers measuring oil pressure in the hydraulic cylinders appeared to be influenced greatly by small variations in stiffness between props. In general, the two stiffest props would carry a disproportionate amount of the total load owing to the absence of flexibility in the wall.

In general, a pattern emerged whereby most of the horizontal load during the excavation stage of the test was taken by the most recently installed prop. A typical pattern of prop forces during the simulated excavation stage is shown in Fig. 21 and indicates that successive prop installations generally attracted most of the load and in some tests had the effect of reducing load on the previously installed props.

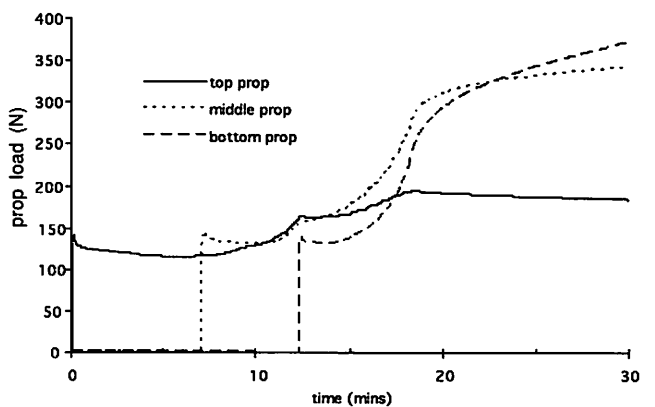

Fig. 21 Development of prop forces during simulated excavation stage of a typical test

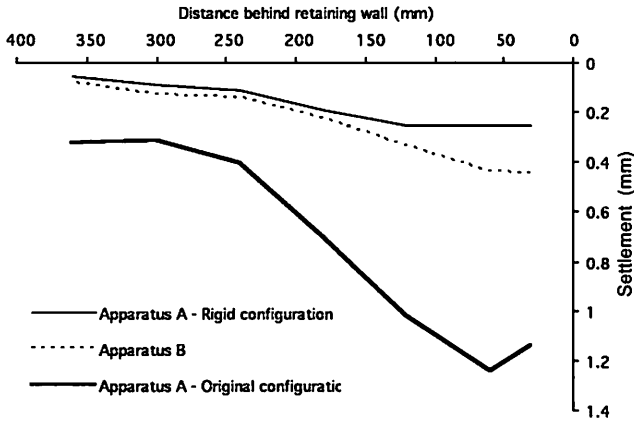

Fig. 22 Comparison of ground movements in both apparatus 30 minutes from start of excavation simulation

RESULTS - TEST SERIES B

Performance of Apparatus B (excavation simulation followed by pile loading)

A total of 20 tests were completed using Apparatus B of which 18 were considered successful tests. Of the 2 that were considered to be failures both were attributed to the performance of the apparatus. The reasons for the failure of each test is summarised in Table 2.

A number of other problems were encountered which impacted the performance of the system but did not cause the test to be abandoned completely.

- In one test the motor used to lower the loading rods onto the piles failed. The test was completed as an unloaded pile test.

- In one test the solenoid valve draining accumulated water from the pre-formed excavation prior to simulation failed and the test was carried out under a small amount of water.
- Twice the air bag supporting the formation burst. This was rectified at the time and the test was able to continue.

Comparison of results obtained from both apparatus

During test series A a small modification was made to three of the experiments whereby the wall was not propped by the heavy fluid and the walings but by a rigid spacer between the wall and the main body of the apparatus. This effectively provided a propping system exactly the same as that used by Apparatus B. It is therefore possible to directly compare results obtained from both test series. Fig. 22 shows the settlements behind the retaining wall 30 minutes after the commencement of the excavation for reference tests with no piles using both sets of apparatus. For comparison results from a test using the original apparatus in its intended mode of operation are shown. The rigid propping system used in the second series of tests very much reduces the overall magnitude of the vertical settlements indicating the stiffness of the propping system is crucial to control of ground movements as previously recognised (e.g. Gaba et al., 2003). The level of agreement seen between the two sets of apparatus when the wall is rigidly propped gave confidence that both systems were performing in a very similar way for this case and that the tests showed good repeatability.

Table 1 Reasons for failures in Test Series A

Test Reference	Reason for failure
AM1	Leakage from heavy fluid bag from the outset of the test
AM3	Leakage from heavy fluid bag
AM4	Failure of heavy fluid drainage valve to open
AM8	Leakage from heavy fluid bag from the outset of the test
AM16	Leakage from heavy fluid bag from the outset of the test
AM18	Problems with electronics and hydraulics on centrifuge

Table 2 Reasons for failures in Test Series B

Test Reference	Reason for failure
RG6	Inadequate water supply to clay
RG11	Loss of oil from surface causing clay to dry and harden

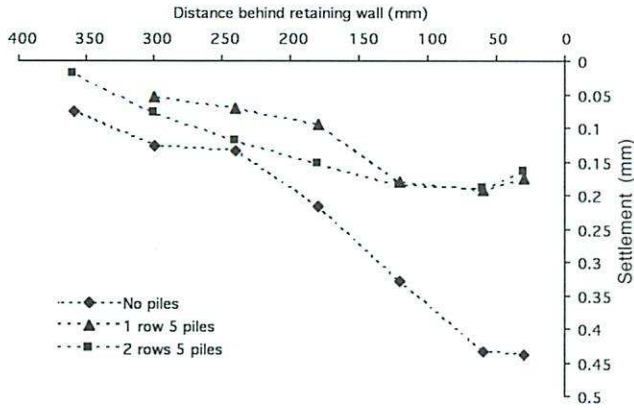

Fig. 23 Comparison of settlement behind retaining wall 30 minutes from commencement of excavation for tests with loaded piles using Apparatus B

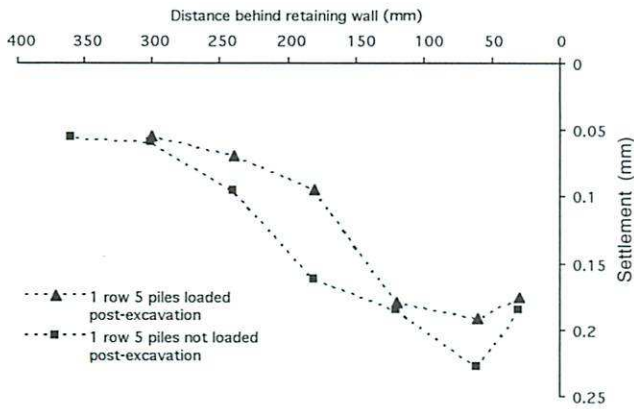

Fig. 24 Comparison of settlement behind retaining wall 30 minutes from commencement of excavation for loaded and not loaded piles using Apparatus B

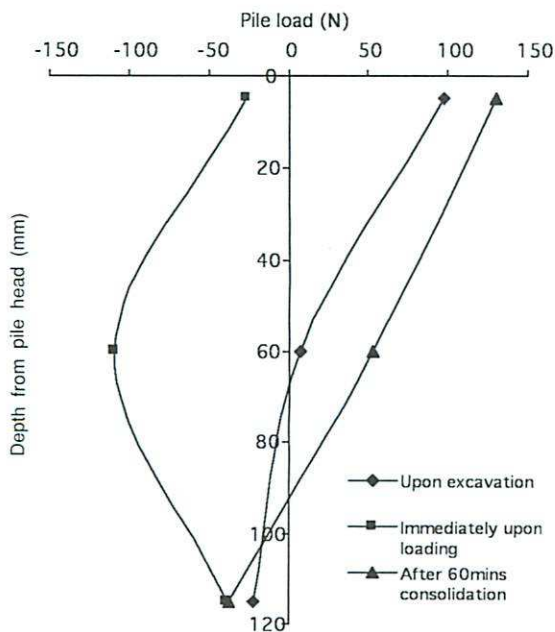

Fig. 25 Loads measured in instrumented pile

Ground movements

As in test series A there was a significant reduction in surface settlements behind the retaining wall when piles were present compared with those tests without. The layout of piles was the same as used in test series A (i.e. 1 or 2 rows of 5 piles) and similar patterns of settlement were seen with the maximum value being immediately behind the wall in all tests (Fig. 23). The high stiffness of the wall and propping system resulted in generally lower overall ground movements than those seen in test series A.

Fig. 24 shows the settlements behind the retaining wall comparing 1 row of 5 piles (with a rigid wall) when they are either loaded or not loaded post-excavation. An overall reduction in settlements is seen, with reduction in maximum settlement of around 20% observed when incorporating pile loads into the simulation.

Axial pile forces

The inclusion of strain gauges to record pile forces allows study of the mechanisms involved around the wall and excavation. An example of the output obtained is shown in Fig. 25. The pile examined is the front central pile in a test using 1 row of piles. Axial forces down the pile are shown with tension being plotted as negative. There are 3 clear and distinct phases to the experiment; unloading (excavation simulation), reloading (via construction loads) and long term consolidation/heave. Results from these 3 phases are shown in Fig. 25 and show the development and transfer of load to the soil in the pile. These results compare well with observed field data from instrumented piles such as that of Bourne-Webb et al. (2006). The use of instrumented piles has provided insight into mechanisms surrounding formation heave in this project but the methods described could easily be transferred to other centrifuge based piling projects.

CONCLUSIONS

Two series of experiments have been performed to model the same excavation but studying different aspects of the construction. The behaviour seen in the centrifuge tests using both sets of apparatus has been remarkably consistent with a low number of tests viewed as failures. The higher incidence of failure in test series A reflects the more complicated process of attempting to model top-down construction with props that can be actuated in-flight.

The use of piles at excavation formation level has been shown to be beneficial in reducing ground movements. In general, piles near to the retaining wall have been found to provide substantial reductions in both vertical and horizontal ground movement and increasing the density of piles, by providing an additional row towards the centre of the excavation, has a small additional benefit.

The maximum settlement behind the retaining wall occurs at a distance of $0.5H$, where H is the depth of excavation, and significant displacements are apparent over the full length of retained soil, up to $3H$ behind the retaining wall consistent with previously observed patterns (e.g. Clough and O'Rourke, 1990). The influence of piles on settlement is limited to a distance of about $2H$.

The introduction of piles at excavation formation level created a general stiffening effect that reduced horizontal movement at the toe of the retaining wall and led to reductions in overall prop load.

In simulations where the piles are loaded subsequent to the excavation being performed there is a further reduction in vertical movements at both the formation level and at the retained surface. These reductions are in the order of 20% (looking at maximum settlements) when compared with a similar arrangement of heave piles that are not loaded.

REFERENCES

- 1) Allersma, H.G.B. (1998): "Development of cheap equipment for small centrifuges," Centrifuge 98, Tokyo, Kimura et al. (Ed.), Balkema.
- 2) Bolton, M.D., Stewart, D.I. and Powrie, W. (1988): "The design of deep in-situ walls," Centrifuge 88, Paris, Corte (Ed.), Balkema.
- 3) Bourne-Webb, P., Fernie, R., Tester, P., Vaziri, M. and Hartlib, T. (2006): "Pile response to excavation induced heave and construction loading," RUFUS Conference, BRE, Watford.
- 4) Clough, W. and O'Rourke, T.D. (1990): "Construction induced movements of in situ walls. Proceedings of design and performance of earth retaining structures," Ithaca, NY, ASCE GSP 25, 430-470.
- 5) Dean, E.T.R., James, R.G., Schofield, A.N. and Tsukamoto, Y. (1998): "Drum centrifuge study of three-leg jackup models on clay," Geotechnique, Vol. 48, No. 6, pp. 761-785.
- 6) Gaba, A.R., Simpson, B., Powrie, W. and Beadman, D. R. (2003): "Embedded retaining walls - Guidance for economic design," CIRIA C580.
- 7) Goodey, R.J., McNamara, A.M. and Taylor, R.N. (2006): "The influence of piles as a ground movement control device during deep basement construction," 6th International Conference on Physical Modelling in Geotechnics, Hong Kong.
- 8) Loganathan, N., Poulos, H.G. and Stewart, D.P. (2000): "Centrifuge model testing of tunnelling-induced ground and pile deformations," Geotechnique, Vol. 50, No. 3, pp. 283-294.
- 9) Mayne, P.W. and Kulhawy, F.H. (1982): " K_0 -OCR relationships in soil," Journal of the Geotechnical Engineering Division, ASCE, Vol. 108, GT6, pp. 851-872.
- 10) McNamara, A.M. (2001): "Influence of heave reducing piles on ground movements around excavations," PhD Thesis, City University, London.
- 11) McNamara, A.M. and Taylor, R.N. (2004): "The influence of enhanced excavation base stiffness on prop loads and ground movements during basement construction," The Structural Engineer, Vol. 82, No. 4, pp. 30-36.
- 12) Powrie, W. (1986): "The behaviour of diaphragm walls in clay," PhD Thesis, University of Cambridge.
- 13) Schofield, A.N. and Taylor, R.N. (1988): "Development of standard geotechnical centrifuge operations," Centrifuge 88, Paris, Corte (Ed.), Balkema.
- 14) Takemura, J., Kondoh, M., Esaki, T., Kouda, M. and Kusakabe, O. (1999): "Centrifuge model tests on double propped wall excavation in soft clay," Soils & Foundations, Vol. 39, No. 3, pp. 75-87.
- 15) Zhu, W. and Yi, J. (1988): "Application of centrifuge modelling to study a failed quay wall," Centrifuge 88, Paris, Corte (Ed.), Balkema.