

Smith, G.M. (1989). Improving the decision usefulness of the corporate annual report.  
(Unpublished Doctoral thesis, City University London)



**CITY UNIVERSITY  
LONDON**

[City Research Online](#)

**Original citation:** Smith, G.M. (1989). Improving the decision usefulness of the corporate annual report. (Unpublished Doctoral thesis, City University London)

**Permanent City Research Online URL:** <http://openaccess.city.ac.uk/7406/>

#### **Copyright & reuse**

City University London has developed City Research Online so that its users may access the research outputs of City University London's staff. Copyright © and Moral Rights for this paper are retained by the individual author(s) and/ or other copyright holders. All material in City Research Online is checked for eligibility for copyright before being made available in the live archive. URLs from City Research Online may be freely distributed and linked to from other web pages.

#### **Versions of research**

The version in City Research Online may differ from the final published version. Users are advised to check the Permanent City Research Online URL above for the status of the paper.

#### **Enquiries**

If you have any enquiries about any aspect of City Research Online, or if you wish to make contact with the author(s) of this paper, please email the team at [publications@city.ac.uk](mailto:publications@city.ac.uk).

GEORGE MALCOLM SMITH  
SCHOOL OF ACCOUNTING  
CURTIN UNIVERSITY OF TECHNOLOGY  
PERTH, WESTERN AUSTRALIA

IMPROVING THE DECISION USEFULNESS OF THE  
CORPORATE ANNUAL REPORT

This thesis is submitted as a  
requirement of the degree Doctor  
of Philosophy at the City University

September 1989

# IMPROVING THE DECISION USEFULNESS OF THE CORPORATE ANNUAL REPORT

## TABLE OF CONTENTS

	PAGE
List of Tables	5
List of Figures	6
List of Appendices	7
Acknowledgements	9
University declaration	10
ABSTRACT	11
<b>1 INTRODUCTION</b>	<b>12</b>
1.1 Objectives	12
1.2 Empirical Overview	15
1.3 Approach and Methodology	19
1.4 Specific Propositions	25
1.4.1 Financial Information - Information Processing	25
1.4.2 Financial Information - Dimensionality	26
1.4.3 Narrative Statements - Presentation	27
1.4.4 Narrative Statements - Content	28
1.4.5 Accounting Statements - Content	29
1.4.6 Accounting Statements - Presentation	29
<b>2 OBJECTIVES OF THE CORPORATE REPORT</b>	<b>31</b>
2.1 Voluntary Disclosures	37
2.2 The Information Needs of Users	40
<b>3 THE QUALITATIVE CHARACTERISTICS OF FINANCIAL INFORMATION</b>	<b>51</b>
3.1 The Corporate Report (1975)	51
3.2 Financial Accounting Standards Board (1980)	53
3.3 Australian Accounting Research Foundation (1987)	54
3.4 Canadian Institute of Chartered Accountants (1980)	55
3.5 The Dimensionality of Financial Information	58
3.5.1 An Empirical approach to Measurement	60
3.5.2 Empirical Results	64
3.5.3 Conclusions	67
<b>4 BARRIERS TO AN EFFECTIVE COMMUNICATION PROCESS</b>	<b>69</b>
4.1 The Language of Accounting Disclosures	69
4.2 Intuitive Statistics in the Processing of Accounting Narratives	71
4.3 Heuristics Experiment: Methodology	73
4.3.1 Case: Representativeness	74
4.3.2 Case: Integration	77
4.3.3 Case: Anchoring and Adjustment	80
4.3.4 Case: Availability	83
4.4 Summary of findings	85

5	DATA SELECTION AND SAMPLING OF COMPANIES	87
5.1	Objectives of Sampling Procedure	87
5.2	Sampling Methodology	89
5.3	Subsampling for Chairman's Narrative Experiment	92
5.4	Subsampling for the Facial Profiles Experiment	95
6	COMMUNICATION OF NARRATIVE AND ACCOUNTING INFORMATION IN ANNUAL REPORTS	98
6.1	Shared Meaning in Accounting Narratives	98
6.2	Measures of Readability	99
	6.2.1 Alternative Readability Formulae	100
	6.2.2 Experimental Procedure	105
	6.2.3 Experimental Results	107
	6.2.4 Conclusions	111
7	INFORMATION CONTENT OF NARRATIVE DISCLOSURES	114
7.1	Content Analysis applications in the Accounting Environment	117
	7.1.1 Classificatory systems for Content Analysis	121
	7.1.2 Experimental Procedure: Word Content	122
	7.1.3 Experimental Procedure: Sentence Content	124
	7.1.4 Experimental Procedure: Management Actions	128
	7.1.5 Experimental Procedure: Hypotheses	130
7.2	Content Analysis: Tests of Hypotheses	131
	7.2.1 Linear Discriminant Analysis Methodology	131
	7.2.2 Content Analysis: Word Occurrences	135
	7.2.3 Content Analysis: Thematic Content	139
	7.2.4 Content Analysis: First Sentence Message	141
	7.2.5 Content Analysis: Management Actions	144
	7.2.6 Content Analysis: Word/Theme/Strategy Combination	147
	7.2.7 Content Analysis: Conclusions	149
8	THE COMMUNICATION OF ACCOUNTING INFORMATION IN THE ANNUAL REPORT	153
8.1	Independence of Information Sources	154
8.2	Experimental Methodology	156
	8.2.1 Specific Propositions	157
8.3	Experimental Procedure	157
8.4	Experimental Results	159
	8.4.1 Conclusions	170
9	IMPROVING THE PRESENTATION OF FINANCIAL INFORMATION	173
9.1	Tabular Presentations	173
9.2	Graphical methods	175
9.3	Facial Representations	179
	9.3.1 Faces as a Means of Communication	182
	9.3.2 The Saliency of Facial Features	184
	9.3.3 Information Processing in Facial Examination	185
	9.3.4 The Assignment of Variables to Facial Features	192
	9.3.5 Implications for Financial Applications	194

10	APPLICATION OF THE FACIAL PROFILE TECHNIQUE IN A FINANCIAL ENVIRONMENT	197
10.1	The Classification of Failed/Non-Failed Companies	198
10.2	The Detection of Performance Trends over Time	201
10.3	Prediction of Failure using alternative Presentation Forms	205
	10.3.1 Methodology - Experiment 1	206
	10.3.2 Results - Experiment 1	208
	10.3.3 Experiment 1 - A Reappraisal	214
	10.3.4 Design - Experiment 2	216
	10.3.5 Results - Experiment 2	218
	10.3.6 Facial Profiles Experiment: Conclusions	223
11	SUMMARY AND CONCLUSIONS	225
11.1	The Content of Accounting Narratives	226
11.2	The Presentation of Accounting Narratives	227
11.3	The Content of Accounting Statement Information	228
11.4	The Presentation of Accounting Statement Information	229
11.5	Directions for Future Research	230
11.6	Research Implications	234
	APPENDICES	235
	BIBLIOGRAPHY	295

## LIST OF TABLES

	PAGE	
2.2.1	Shareholder Surveys of Source Rankings for Decision Usefulness	41
2.2.2	Ranking of Information Sources for Investment Decisions	42
2.2.3	Shareholder Surveys of Annual Report Readership	43
2.2.4	Shareholder Survey of Decision Usefulness	43
2.2.5	Ranking of Annual Report Items for Usefulness in Investment Decisions	44
3.2.1	Information Specific Qualities of Information	54
6.2.1	Correlation Coefficients: Statement Length/Size	108
6.2.2	Correlation Coefficients: Readability/Performance	108
6.2.3	Readability Comparisons: Failed/Non-Failed Companies	108
6.2.4	Mean LIX Readability Scores: Alternative versions	109
6.2.5	CLOZE Scores and Readability Scores	111
7.1.1	Theme Components in Content Analysis	127
7.2.1	Correlation coefficients between Company Status and Word Variables	136
7.2.2	Words: Discriminant Model Explanatory Power	139
7.2.3	Words: Correlation Coefficient Matrix	139
7.2.4	Correlation coefficients between Status and Theme variables	140
7.2.5	Themes: Discriminant Model Explanatory Power	141
7.2.6	Themes: Correlation coefficient matrix	141
7.2.7	First-Sentence message: Distribution of Themes	142
7.2.8	First-Sentence message: Correlation between Themes and Status	143
7.2.9	First-Sentence message: Explanatory Power of Discriminant Variables	144
7.2.10	First-Sentence message: Correlation Coefficient Matrix	144
7.2.11	Correlation Coefficients between Actions and Company Status	145
7.2.12	Actions: Distribution of Occurrences	146
7.2.13	Actions: Discriminant Model Explanatory Power	147
7.2.14	Actions: Correlation coefficient matrix	147
7.2.15	Distribution of Misclassified cases across Alternative Variables	148
7.2.16	Mixed Model: Explanatory Power of Discriminant Variables	149
7.2.17	Mixed Model: Correlation Coefficient Matrix	149
8.4.1	Classification Errors - Incremental Financial Information	164
8.4.2	% Respondents reporting changed classification performance compared to that based on Chairman's Narrative alone	166
8.4.3	Case Misclassifications compared to Narrative Performance	166
8.4.4	Classifications Differences: Narrative Superior	167
8.4.5	Classification Differences: Financial Statements Superior	168
8.4.6	% Cases correctly classified by Alternative Sources	170
10.1.1	Financial Ratios and Dimensions represented in Linear Discriminant Model	198
10.2.1	Financial Ratios and Dimensions represented	202
10.3.1	Mean Error Classification for Experiment 1	209
10.3.2	Mean Processing Times in Experiment 1	210
10.3.3	Experiment 1: Misclassification Combinations	212
10.3.4	Experimental Design: Distribution of Tasks	217
10.3.5	Facial Profiles Experiment: Effects of Alternative Ordering of Processing	219
10.3.6	Facial Profiles Experiment: Distribution of Misclassifications	220
10.3.7	Facial Profiles Experiment: Mean Misclassification Errors	221
10.3.8	Facial Profiles Experiment: Mean Number of Misclassification Errors per respondent	222

## LIST OF FIGURES

	PAGE
1.1 Schematic Overview: The Communication of Financial Information	14
3.5.1 Scree Diagram in the Determination of Dimensionality	65
7.1 The Communication Process: Shannon and Weaver	114
7.2 The Communication Process: McCroskey	115
10.1.1 Failure Classification: Assignment of Financial Variables to Facial Characteristics	199
10.1.2 Facial Portraits in Failed/Non-Failed Classification	200
10.2.1 Relative Performance Trends: Assignment of Financial Variables to Facial Characteristics	203
10.2.2 Berwick Timpo (31/12/78 to 31/12/81)	204
10.2.3 Southern Constructions (31/12/75 to 31/12/78)	204
10.2.4 Sir Joseph Causton (30/9/76 to 30/9/79)	205

LIST OF APPENDICES

	PAGE	
3.1	Qualitative Characteristics in Alternative Studies	236
3.2	Abstract from the Corporate Report: ASSC ICAEW (1975)	237
3.3 a)	Test Material: Property Trade Offs: Desirable Properties	238
3.3 b)	Test Material: Experimental Task	239/240
3.4 a)	MDS Indscal Scores Useful/Usable v Bias/Punctuality	241
3.4 b)	MDS Indscal Scores Bias/Punctuality v Quantity/Quality	242
3.4 c)	MDS Indscal Scores Quantity/Quality v Useful/Usable	243
5.1	Matched sample of companies	244
5.2	CLOZE procedure: preliminary results: divisional groupings	245
5.3	Chairman's Statement Analysis: preliminary results: divisional groupings	246
5.4	Experimental Design: Distribution of Cases for Narrative Analysis	247
5.5	Facial Profiles Experiment: Sample Financial Ratios	248
5.6	Facial Profiles Experiment: Ratio Distribution of Sample Cases	249
6.2.1	Readability scores for sample companies	250
6.2.2a)	The CLOZE Procedure: Instructions to Respondents	251
6.2.2b)	The CLOZE Procedure: Test Instrument for Case No. 2: ACROW PLC	252
6.2.3	Readability Study: Descriptive statistics for 66 companies	253
6.2.4	CLOZE Procedure: Ranking of Cases by Respondents of differing sophistication	254
6.2.5	Distribution of Readability Levels for Accounting Narrative Disclosures	255
7.1.1	Content Analysis: Distribution of Pre-Sample Companies	256
7.1.2	Word Distribution in Content Analysis of Narrative	257/8
7.2.1	Content Analysis: Alternative Discriminant Models	259/260
7.2.2	Content Analysis: Descriptive Statistics	261
8.1	Financial Ratio Indicators in Narrative Statements	262
8.3.1a)	Test Materials: Chairman's Statement Analysis	263
8.3.1b)	Test Materials: Case 48: Nova (Jersey) Knit	264
8.3.2a)	Materials for Financial Statement Analysis: Case 63 - George Spencer	265/6/7
8.3.2b)	Materials for Financial Ratio Analysis: Case 9-George Spencer	268/9
8.4.1	t-statistics in the comparison of the no. of failed decisions with the no. of failed cases	270
8.4.2	t-statistics in the comparison of the no. of classification errors with the no. of failed cases	271
8.4.3	Mean classification errors in the analysis of Chairman's Narrative	272
8.4.4	Chairman's Statement Analysis: Case Misclassifications	273
8.4.5	Mean No. of Classification Errors and Failed Decisions	274
8.4.6	Distribution of % Misclassifications across All Cases	275
9.2.1	Alternative Graphical Formats	276/7
9.2.2	Computer Generated Facial Portraits	278
10.3.1	Experiment 1 Materials: a) Financial Statements	279
	b) Financial Ratios	280
	c) Facial Portrait Data	280
10.3.2	Experiment 1: Sample Companies	281
10.3.3	Experiment 1: Distribution of Misclassifications	282
10.3.4	Experiment 1: Misclassified Cases for Alternative Processing Strategies	283
10.3.5	Experiment 1: Facial Profiles for Failed Cases	284
10.3.6	Experiment 1: Facial Profiles for Non-Failed Cases	285
10.3.7	Experiment 1: Assignment of Financial Variables to Facial Features	286
10.3.8	Experiment 2: Sample Guide to the Assignment of	



	Variables	287
10.3.9	Experiment 2: Alternative Variable Assignments	288
10.3.10	Experiment 2: Facial Profile Information	289/290
10.3.11	Experiment 2: Effects of Alternative Ordering of Processing	291
10.3.12	Experiment 2: Effects of Alternative Failure Base Rates	292
10.3.13	Experiment 2: Misclassification with Alternative Instruments	293
10.3.14	Experiment 2: Misclassifications resulting from Alternative Classification Strategies	294

## ACKNOWLEDGEMENTS

The guidance and direction of my supervisor, Professor Richard Taffler, Head of Accounting Division, City University Business School, has been fundamental in bringing this extensive research study to fruition.

The suggestions of Dr Lynda White, Department of Statistics, University of London, with respect to statistical sampling and experimental design have been most helpful and are much appreciated.

The quality of word-processing and textual formatting of the thesis owe much to the patience and forbearance of Ms Kylie Cugini, School of Accounting, Curtin University of Technology.

The support for this research project provided by my previous academic institution, Cambridgeshire College of Arts and Technology, is acknowledged.

## DECLARATION

A copy of this thesis may be lodged in the City University library, and single copies of particular sections abstracted for educational purposes. The author grants discretion to the University Librarian to allow such copies to be made without further reference to the author, subject to the normal conditions of acknowledgement.

## ABSTRACT

Shareholder surveys consistently demonstrate users' perceptions of the importance of annual report disclosures in the decision-making process and their readership of the Chairman's narrative. Yet existing empirical evidence casts doubt on the informational content of any part of the annual report.

This study offers a partial explanation of this anomaly by demonstrating the decision usefulness of annual report disclosures, focusing on improvements made possible by a more detailed analysis of the content and its presentation.

The Chairman's narrative provides a voluntary disclosure acting as a vehicle for signalling the intentions of the executive, but also as an opportunity to convey information incremental to the financial statements. The absence of a shared meaning for accounting terms between the users and preparers of the accounts provides a further opportunity for miscommunication and misinformation. Such differences may be attributable to either the complexity of content or the complexity of presentation. Both are addressed in this study.

With regard to content, the study examines the environmental predictability of the semantic content by constructing explanatory models of the financial performance of the enterprise.

With regard to presentation, both the readability and cognisability of the narrative are evaluated with reference to the size and financial performance of the enterprise.

The study concludes with an examination of alternative methods for the presentation of financial information, focusing on the use of schematic faces as a potentially unique format with specific portrayal advantages. The facial format is shown to be an efficient method of processing, producing decisions of comparable quality to those with financial statement information, and in a much shorter time. An approach is adopted which rectifies the deficiencies of earlier studies by incorporating the full force of the existing psychological evidence and by generating an optimum feature assignment experimentally.

## CHAPTER ONE

### INTRODUCTION

#### 1.1 OBJECTIVES

Surveys of shareholders, financial analysts and investors consistently demonstrate the preference of users for annual report information, together with their perception of the relative importance of different disclosed items to the decision-making process (Lee and Tweedie (1975); Wilton and Tabb (1978); Winfield (1978), Anderson (1979); Chang, Most and Brain (1983)).

The Chairman's Statement has been shown to be the most read section of the report (Lee and Tweedie (1975)), and the US Trueblood Committee (1973) recognises that the achievement of an objective 'to provide information useful for making economic decisions' cannot rely solely on quantitative accounting data but requires the additional use of narrative disclosures for descriptive and explanatory purposes.

The Efficient Markets Hypothesis (Fama (1970)) casts doubt on the usefulness of the annual report on the grounds that it comprises information already in the public domain and that its content is largely pre-empted by the preliminary announcement of earnings. However, the decision-usefulness of financial statement numbers has been demonstrated by a number of studies across three distinct areas (Patton (1982)):

- i) the analysis of business transactions in markets that may not be efficient;
- ii) the imposition of contractual limits based on financial ratios;
- iii) the prediction of performance and evaluation of risk in an efficient market.

This final area is the focus of study in this thesis, following the models of Taffler and Sudarsanam (1980), for the measurement of relative financial performance and Taffler (1982), for the identification of financial distress. The aim of the thesis is to improve the predictive ability of existing models by increasing the decision usefulness of existing annual report disclosures. By focusing on linguistic and visual means of communication it suggests a means of improving the communicative ability of financial statement numbers, and formulates a methodology whereby narrative information may be used to complement financial statement information in the measurement of performance. By making better use of existing information, the intention is to provide the user with the opportunity to make more informed decisions.

This study examines the incremental information that might aid a distinction between failed and non-failed companies, focusing on improvements made possible by a more detailed analysis of the content and presentation of narrative disclosures. As such it provides an illustration of a typical application within a specific task environment. Systematic research into the application of content analysis techniques to accounting messages is long overdue both in terms of tests of the relevance of this methodology and for the predictive insights that might derive. This study attempts to redress the balance.

Figure 1.1 provides a schematic overview of this thesis, which focuses on the dual aspects of content and presentation in the context of both quantitative and narrative financial disclosures:

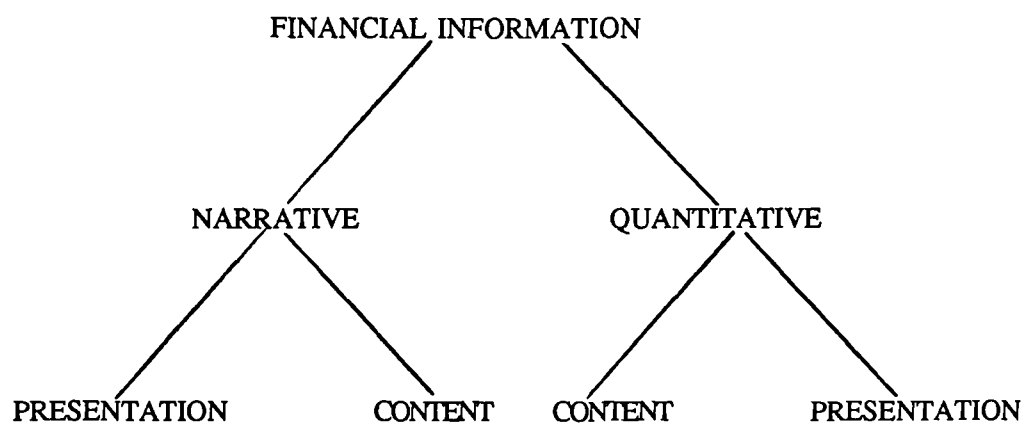

FIGURE 1.1: SCHEMATIC OVERVIEW: THE COMMUNICATION OF FINANCIAL INFORMATION

This distinction between content and presentation of information allows the predictive ability of each branch of the schematic tree to be examined. Thus the Narrative-Content branch is concerned with the incremental information conveyed by the structure and message of the Chairman's narrative. The objective is to improve on the explanatory power of existing financial models through the inclusion of qualitative variables. The Narrative-Presentation branch is concerned with the motives and implications associated with messages of low readability and poor levels of understandability. The objective is to determine whether such occurrences are indicative of current performance or predictive of future performance. The Quantitative-Content branch examines existing predictive models comprising financial ratio combinations, with the objective of determining their environmental predictability and the source of case misclassifications. The Quantitative-Presentation branch is concerned with alternative means of representing financial statement data, notably the adoption of graphical methods. The objective is to develop a better means of presentation to ease the communication of financial statement information and assist in its efficient processing. This work aims to offer empirical evidence in

each of the above areas to demonstrate the decision usefulness of both the incremental information content of narrative disclosures and graphical representation of financial statement data.

## 1.2 EMPIRICAL OVERVIEW

Empirical evidence suggests a lack of information content of annual report disclosures, in terms of their impact on share prices, largely attributable to the lack of timeliness associated with this form of accounting data. A strong body of evidence, notably Beaver (1968) and Ball and Brown (1968), exists to support the notion that the release of interim and annual earnings numbers is associated with both increased trading volume and share price effects. Even so, their findings suggest that the information content of the income number has already been substantially reflected in share prices, to the extent of 85 to 90 per cent, attributable to more timely media.

Firth (1981), using weekly data, found the annual report to have information content on a par with that of the interim report. Chambers and Penman (1984) found that the interim report had a greater price effect than the preliminary announcement of earnings and dividend figures. McNichols and Manegold (1983) provide empirical evidence to support the contention that 'the marginal information content of an annual report is greater when it has not been preceded by interim reports'. But conflicting evidence is provided by Foster, Jenkins and Vickrey (1986) who found the annual report to contain no useful incremental information for the valuation of shares.



These findings are directly at variance with the findings of user surveys of shareholders, by Lee and Tweedie (1981) and of professional analysts, by Chang and Most (1977). These demonstrate the perceived importance of the Chairman's Statement, the Profit and Loss Account and the Balance Sheet in the decision-making process.

However, the survey study of Chang, Most and Brain (1983) demonstrates a remarkable congruence in the perceptions of analysts and investors across three continents. The corporate annual report occupies a prominent position among information sources, but the narrative sections (notably the President's Letter and the Auditor's Report) are not highly regarded.

Shareholders perceptions of the importance of the Chairman's Statement are therefore apparently not matched by those of the professional analyst.

Accounting research typically focuses on quantitative data and either ignores, or at most gives only passing reference to, the incremental information that might be contained in alternative disclosures.

But research has revealed that other forms of disclosure do have informational content in that they provide signalling devices to investors of management's intentions. Thus, Waymire (1984) reported security price effects in response to management's forecast of earnings and Dielman and Oppenheimer (1984) observed dividend announcements having an effect consistent with their representing information regarding future earnings prospects. The timeliness, as well as the content, of disclosures was found to be important too; Chambers and Penman (1984) observed that 'early' and 'late' releases were consistent with

expectations of 'good' and 'bad' news respectively, generating positive and negative security price effects.

It is possible that the information conveyed in the Chairman's Statement takes on a greater significance when there is a paucity of competing information. Zeghal (1984) hypothesises that since less information is available about small firms than large firms, because they are less well-researched, then a higher risk is associated with investment therein. This argument is in accord with the empirical findings of Banz (1981), Reinganum (1981) and Dimson and Marsh (1986) who report an inverse relationship between size of company and the excess stock returns earned.

This work is concerned with the potential decision usefulness of other accounting information, notably the content and form of presentation of annual report disclosures. To date there is little evidence to attribute importance to the content of the annual report, other than confirmatory support for the numbers of the prior announcement. Such evidence as exists is conflicting and unconvincing because of the associated empirical problems of timing and disaggregation (eg: see Stober (1986) on footnotes relating to inventory liquidations and Bailey (1982) with regard to audit reports).

Narrative disclosures in the annual report, in particular, have been much neglected in the accounting research literature and this work attempts to redress the balance by examining the potential decision usefulness to the users of accounts of the content and presentation of such releases. The second focus is on the **presentation** rather than the **numerical content** of quantitative accounting statements, exploring the success of alternative formats, in the communication of financial information and their relative decision usefulness.

Since more attention is paid to accounting numbers than to non-accounting information, the opportunity exists, in theory, for management to convey an alternative message in its discretionary narrative disclosures (Bowman (1984)). If this information is neglected we run the risk of overlooking incremental information with regard to management's attitude, confidence and expectations about the future. This work explores the potential for missed opportunities by focusing primarily on non-accounting information, using the Chairman's Statement as representative of such discretionary disclosures.

Few studies have attempted to evaluate the incremental content of non-accounting over and above accounting information in annual reports. (Exceptions include Belkaoui and Cousineau (1977), Peel, Peel and Pope (1985), Keasey and Watson (1986) and Curtis (1986)).

Most studies of narrative disclosures, among them Buzby (1974), Firth (1978) and Moizer and Arnold (1984), are more concerned with information disclosure and an analysis of the perceptions of importance of different items of information to different user-groups. The focus here is more on what has been said and the manner in which the information has been communicated.

Just as the majority of accounting research papers have been devoted to quantitative, rather than qualitative aspects, so the focus in the past has tended to be on content rather than presentation. Studies by such as Ehrenberg (1977), Moriarity (1979), and Smith and Taffler (1984) have been devoted to presentational format, but even so, of quantitative content only.

### 1.3 APPROACH AND METHODOLOGY

The Chairman's Statement was chosen as the representative narrative disclosure since a number of studies, notably that of Lee and Tweedie (1975), have shown it to be the section most read by private shareholders. Lee and Tweedie (1977 and 1981) and Adelberg (1979b) have shown that both sophisticated and unsophisticated users have difficulty in reading and correctly comprehending the contents of annual reports. As a consequence secondary narrative sources, such as stockbrokers circulars and financial press reports may be preferred information sources. It may be that such sources represent a loss of information content compared to the original narrative disclosure and this paper investigates whether the Chairman's Statement in its original form represents a valid source of incremental information over and above the audited financial statements in the annual report.

The empirical evidence regarding the information content of the Chairman's Statement is in direct conflict with its perceived importance to readers. Chapter 2 examines the alternative objectives of corporate reporting, discussing users' perceptions of the relative importance of different sections of the report. The emphasis is placed firmly on the potential usefulness of the Chairman's narrative in providing evidence of strategies, attitudes and pointers for future performance.

The information science literature, notably Larcker and Lessig (1980), Gallagher (1974) and Zmud (1980) provides a theoretical framework for the analysis of the dimensionality of accounting information. A Multidimensional Scaling (MDS) approach is adopted to map users' perceptions of the desirable characteristics of accounting communication. Chapter 3 provides empirical evidence to support the loading of accounting characteristics onto two basic

dimensions - namely content and presentation. The experimental design examines the trade-off which user groups, of differing sophistication, are prepared to tolerate when desirable qualities cannot be achieved simultaneously. The different attitudes of alternative user-groups to enforced compromise suggests an extension of this research area in the future to examine trade-offs associated with particular decision-making contexts.

Barriers to effective communication are associated with failure concerning content which is too complex and means of presentation, which are either inadequate or inappropriate to the target audience.

Each of these aspects is discussed with reference to the communication literature. Li (1963) and Parker (1981) provide a framework for the consideration of problems in both the preparation and interpretation of accounting communications. In Chapter 4 inefficiencies of information processing are addressed regarding statistical misconceptions and the adoption of heuristics, following Slovic (1974) and Kahnemann and Tversky (1972). Empirical evidence is provided which is supportive of the findings of Ashton (1984) and Joyce and Biddle (1981), regarding the use of intuitive statistics in information processing, and of the findings of Lichtenstein and Slovic (1971), regarding uncertainty. This work highlights the errors in the decision-making process associated with prior probabilities and the quantification of uncertainty in accounting narratives.

The major thrust of this thesis concerns a number of empirical studies involving the comparison of financial messages communicated through narrative and quantitative means across a large sample of companies. The concerns of prior probabilities and the interpretation of narrative are central to the experimental results generated. Chapter 5 details the selection of sample companies in order to provide a common base for studies related to readability, cognizability, content analysis, failure prediction and pictorial representation. A consistent approach is adopted in the selection of companies in failed and non-failed groups, with each pair of companies matched on financial status, size, industrial sector, and financial year-end. Pilot testing of the experimental materials using student respondents, across the whole sample of companies, allows judicious sub-sampling to take place in experimental designs which optimise the discriminatory power of the tests when applied to more sophisticated audiences.

Chapter 6 addresses issues of shared meaning and user expectations following Haried (1973) and Houghton (1987), and considers alternative measures of readability, and the implications of particular levels of readability of narrative disclosures for predicting Company performance. Several studies have assessed various readability techniques, Pashalian and Crissy (1950), Soper and Dolphin (1964), Smith and Smith (1971), Still (1972), Adelberg (1979a), Parker (1982), Lewis, Parker, Pound and Sutcliffe (1986) and Curtis (1986), among them. Although several alternative measures have been used, few studies have paid sufficient attention to the LIX and CLOZE procedures, potentially the most appropriate to the accounting environment. This work explores the utility of these procedures.

Most studies to date have been content to measure the readability of narrative accounting disclosures in comparison to that of more traditional reading materials. They have employed fixed readability indices (notably the FLESCH and FOG formulae) which are based on word and sentence complexity, but whose formulation is independent of the meaning of the message or the target audience. This work highlights the use of techniques to measure the cognizability of accounting narrative and demonstrates significant differences in perceptions associated with the sophistication of the user.

Few studies (eg: Curtis (1986)) have attempted to relate the derived readability scores to current financial performance, none to use such scores as a basis for predicting performance. This work tests whether the readability of Chairman's Statements of companies prior to failure is predictive of their financial status.

This direction of argument is extended in Chapter 7 by a consideration of the message conveyed by the narrative as a whole. Evidence is presented which compares the perceptions of respondents as to the financial performance of groups of companies when provided with narrative and/or accounting information. Of particular interest are those companies who convey conflicting messages to users from their alternative information sources. The information content of narrative disclosures is then explored by directing attention specifically to the words and phrases employed and the future strategies identified. Only Ingram and Frazier (1983), Bowman (1984) and Frazier, Ingram and Tennyson (1984) have explored the significance of particular word occurrences in narrative disclosures, mainly to examine potential economic determinants. The present study tests whether the informational content of the narrative disclosures of failed and surviving companies is predictive of their future prospects.

Ogilvie (1966) and Oliver (1974) provide a theoretical framework on which to base the construction of linear discriminant models to distinguish between failed and non-failed companies on the bases of specific aspects of the content of their narrative, notably, word patterns, thematic structure, initial messages and management strategies conveyed.

The environmental predictability of models based on narrative content is compared, in Chapter 8, with those based on financial ratio combinations. The relative power of the models is discussed together with an analysis of alternative model and respondent misclassifications. Empirical evidence is presented which examines the decision-making models of respondents when confronted with incremental, potentially conflicting, information sources.

Chapter 9 commences by considering Financial Ratios as just one of the alternative formats available for the representation of accounting information. Various numerical alternatives are considered, referring to Ehrenberg (1977), in order to establish formats which improve the effective communication of the intended message, and provide an appropriate comparative base. An extensive review of the psychological literature identifies the nature and testing of alternative graphical forms of representation. Powerful evidence, Yin (1969), Goldstein and Chance (1971) and Cuceloglu (1970), is provided to support the use of a schematic human face in the representation of information. The work of Izard (1971) and Ekman (1973) provides a theoretical framework to allow the matching of facial characteristics with financial variables on the basis of perceived importance, while Chernoff (1973) and Bruckner (1978) have provided the means of generating computer-constructed schematic faces. Empirical evidence is presented in Chapter 10 which compares the ability of



respondents to make failed/non failed decisions on the basis of information presented in the form of accounting statements, financial ratios and facial profiles. Experiments have been designed to vary, the order of processing, to evaluate learning and fatigue effects; the number of failed cases, to evaluate the effect of prior probabilities; the assignment of financial variables to facial features, to evaluate optimal assignment strategies, and the sophistication of the user, to evaluate experiential and educational differences.

The work concludes with pointers for future research, most notably the testing and development of the empirical models to evaluate their efficiency over time, and an extension of the methodology employed to provide incremental information, complementary to the quantitative financial type, in order to assist performance appraisal and predictive ability of future status. A summary of the findings of this work emphasises the decision usefulness of the procedures adopted thus far, both in the analysis of narrative content to determine predictors of future performance, and in the presentation of information to facilitate a more efficient decision-making process.

Reference to the aforementioned literature allows the development of a number of specific propositions for testing, and these are detailed in the following section.

#### 1.4 SPECIFIC PROPOSITIONS

Much of the literature already referenced originates in psychological and information science journals; in most instances they identify sources and methodologies which have received scant attention in the accounting literature. Application of these arguments to the domain of financial information allows the development of a number of specific propositions. These are formulated and tested in each of the empirical areas of this thesis providing results which represent substantially original findings.

The propositions are best grouped in terms of the schematic diagram in Figure 1.1 presented above and follow the continuity of argument of the complete work.

##### 1.4.1 FINANCIAL INFORMATION - INFORMATION PROCESSING

Chapters 4, 6 and 8 examine the interpretation of accounting narrative in experimental settings. Two propositions are tested:

P1: Following on from the work of Bell (1984 a and b), Kahnemann and Tversky (1972), Joyce and Biddle (1981), Ashton (1984) and Dupree (1985), we would expect representative users to demonstrate an ignorance of prior probabilities in an experimental setting, with a preference for narrative rather than numerical information.

Such findings would have potentially serious implications for the processing of narrative and quantitative disclosures, especially when the two sources are conveying apparently conflicting messages. Chapters 4 and 8 examine these implications in an experimental setting.

P2: Following the work of Cohen, Dearnley and Hansel (1958) and Lichtenstein and Newman (1967), we would expect representative users to demonstrate significant differences in their perceptions of the quantification of narrative uncertainties. We expect such differences to be associated with educational and experiential differences and with the contextual framework of the narrative.

Such findings would have implications for the manner in which accounting narratives are processed and interpreted. The effect on the resultant decisions may have economic consequences.

#### 1.4.2 FINANCIAL INFORMATION - DIMENSIONALITY

An experiment is designed and conducted in Chapter 3 to examine and quantify the extent of property trade-offs and test the following propositions:

P3: Following the work of Larcker and Lessig (1980) and Zmud (1978) we would expect that user perception of the relative desirability of the qualitative characteristics of accounting statements will be consistent with a trade-off between two major dimensions, namely Content and Presentation. If supported, this proposition would suggest that more attention be paid to the manner in which accounting information is structured and presented, as well as to its content and quality. Such findings would be consistent with those of Bettman and Kakkar (1977), for consumers, and Iselin (1989) for accounting statement users.

P4: Different user groups will have different perceptions of this compromise dependent upon education and experiential differences and the contextual framework of the decision task. Such findings would support the argument for differential reporting, with disclosures destined for different target audiences.

#### 1.4.3 NARRATIVE STATEMENTS - PRESENTATION

Chapter 6 addresses the issues of readability and cognizability in accounting narratives, using both accounting students and practitioners as experimental subjects. The following propositions are tested:

P5: Following the work of Taylor (1953), Miller and Coleman (1967) and Adelberg and Razek (1984), we would expect that the readability of narrative statements, as measured by formulae based on word and sentence complexity, is related to, but not identical with, user understandability of the message. Reading ease will not necessarily correspond with the successful communication of a message, such that the receiver confers on it the same meaning as the sender. Accounting communications thus deemed 'acceptable' in terms of reading formulae may require further adjustment if they are to provide effective communication.

P6: The length of the Chairman's Statement is a function of the size of the enterprise.

P7: Following the work of Morton (1974) we would expect that the readability of the Chairman's Statement is a function of the financial health of the enterprise. If supported, this proposition would provide us with an additional explanatory variable which might improve the predictive power of existing performance based models.

P8: The readability and cognizability of the statements of failed companies are significantly lower than those of surviving matched enterprises.

P9: The cognizability of narrative statements will differ significantly among user groups, variances being associated with educational and experiential differences. Such findings would support those of Adelberg and Farrelly (1989) who evidence a serious communication problem in the transferring of the subjective meaning of financial statement terms between producers and users. The full significance of particular narrative messages may, thus, only be apparent to sub-sections of users.

#### 1.4.4 NARRATIVE STATEMENTS - CONTENT

Chapter 7 examines the potential for the predictability of distress, or the construction of a wider performance measure, based on narrative information alone. Several propositions are tested which, if supported, would generate new predictive models or provide additional explanatory variables to be used in conjunction with financial variables:-

P10: Following the work of Osgood, Suci and Tannenbaum (1957), Belkaoui (1978), Ingram and Frazier (1983) and Houghton (1987), we would expect, a priori, that the narrative content of the Chairman's Statement provides sufficient information to discriminate between failed and non-failed enterprises. Such discrimination, based on word patterns, thematic content and management strategies can form the basis of a model to predict financial distress.

P11: The reporting of 'good news' and 'bad news' will coincide with explanations attributable to 'superior management performance' and 'external factors beyond our control', respectively.

#### 1.4.5 ACCOUNTING STATEMENTS - CONTENT

Chapter 8 examines the incremental effect of the availability of additional financial information on the decisions made by groups of representative users.

Two propositions are tested:

P12: Following the work of Peel, Peel and Pope (1985) and Keasey and Watson (1986) among others, we would expect that users can make improved decisions, in a failure prediction context, when provided with both narrative and financial statement data.

P13: Where alternative messages are conveyed by the narrative and financial statements such conflict is consistent with attempts to lessen the impact of 'bad news'. The incidence of such conflict might, therefore, be evidence of poor future performance.

#### 1.4.6 ACCOUNTING STATEMENTS - PRESENTATION

Chapters 9 and 10 examine the adoption of a facial means of representation in an experimental setting. Its usefulness is addressed as both a screening device and communication facilitator in management information systems, through the testing of a number of propositions:

P14: Following the work of Chernoff (1973) and Moriarity (1979), Stock and Watson (1984) and Smith and Taffler (1984), we would expect facial profiles to provide an efficient means of representing financial statement data, both in the depiction of overall performance and of financial trends.

- P15: In decision-making tasks facial profiles can be processed more quickly, and with lower error rates than either accounting statements or financial ratios conveying like information.
- P16: Following the work of Chernoff and Rizvi (1975) we would expect that an optimum allocation of financial variables to facial characteristics can be achieved which minimises classification errors.
- P17: The classificatory ability of respondents, when employing facial profiles, is independent of their accounting sophistication.

These specific propositions in their entirety span the whole breadth of the empirical content of the thesis. They embrace a number of original and potentially important notions regarding the content and presentation of both narrative and quantitative financial statements. The support of these propositions will have potentially far-reaching implications for both the analysis and communication of financial information which will significantly aid the usefulness of corporate annual disclosures.

In preparation for the empirical studies of Chapters 5 to 10, Chapters 2 and 3 are concerned with the nature and dimensionality of accounting information and Chapter 4 with information processing strategies.

## CHAPTER TWO

### OBJECTIVES OF THE CORPORATE REPORT

In countries where the setting of accounting rules is the prerogative of government legislative assemblies (e.g: France, Germany, Japan, Sweden) the accounting profession is monitored to ensure its actions are in the public interest and no conceptual framework projects have been undertaken.

Where standard setting is the responsibility of self-policing accounting bodies (e.g: US, UK, Canada, Australia) with monopolistic control over some areas of work, a process of 'accountability' is necessary to demonstrate that the bodies are objective and consistent in their actions. Where accounting standards are perceived as having the potential to change income distribution and resource allocation - typically governmental roles - then some form of legitimacy is sought in the form of a body of knowledge demonstrating that accountability. In each of the latter four countries, attempts have been made to develop a core body of accounting knowledge - a conceptual framework - to provide a base against which standards and procedures might be validated.

In the main, these research efforts have been commissioned in response to mounting public and professional pressure with regard to the nature of corporate reporting and deficiencies in the accounting standard setting process. Peasnell (1982) with respect to the FASB conceptual framework observes: 'it perceives a need to show that its heart and mind are in the right place: to demonstrate that it is trying by logical means to develop accounting standards based on principles of general appeal.' If accounting standards, and the resulting disclosures, are to meet the varying and potentially conflicting, needs of all user groups, then such standards should be adaptive to the changing requirements of interested parties.



Stamp (1982) identifies three elements that he perceives to be essential components of a conceptual framework:

- 1 General agreement on the overall objectives of financial reporting;
- 2 General agreement as to the nature and needs of the various groups of users of financial reports;
- 3 Identification of a set of criteria to be used in choosing between alternative solutions to standard-setting problems and in assessing the quality and utility of financial reports.

These elements provide the basis for discussion in this Chapter, and might be considered an aggregation of the eight areas identified, in the US by the Financial Accounting Standards Board (FASB) (1980) within which formal propositions might be developed:

- i) objectives
- ii) qualitative characteristics
- iii) elements of financial statements
- iv) criteria for accounting recognition
- v) accounting measurement
- vi) means of reporting
- vii) reporting of income
- viii) reporting of flows and liquidity

Of central concern in this study is the content of the report ( i), ii) and iii) above) and its means of presentation (vi). This section of the thesis is concerned with the objectives of disclosure and the information requirements of users. The qualitative characteristics viewed essential for

the fulfilment of these objectives and the achievement of user requirements, are considered in Chapter 3.

In the US the AICPA, Trueblood Committee (1973) have specified the basic objective of financial statements as being "to provide information useful for making economic decisions." They recognise that the achievement of such an objective cannot rely solely on quantitative accounting data and recommend the additional use of narrative disclosures for descriptive and explanatory purposes. They see such statements as serving primarily the needs of those users from whom the financial report offers the major, perhaps only, sources of relevant information, and accordingly suggest three principal sub-objectives:-

- i) "to provide information useful to investors and creditors for predicting, comparing and evaluating potential cash flows to them in terms of amount, timing and related uncertainty."
- ii) "to supply information useful in judging management's ability to utilise enterprise resources effectively in achieving the primary enterprise goal."
- iii) "to provide factual and interpretive information about transactions and other events which is useful for predicting, comparing and evaluating enterprise earning power. Basic underlying assumptions with respect to matters subject to interpretation, evaluation, prediction or estimation should be disclosed."

The underlying recommendation is, therefore, that the shareholder and other interested parties should be provided with sufficient information to be able to assess the company's performance and to estimate the likely risk of their future involvement. In the UK the ICAEW Corporate Report (1975) reiterates the fundamental objective as "to communicate economic

measurements of and information about the resources and performance of the reporting entity useful to those having reasonable rights to such information." The content is much the same as that of the Trueblood Committee but the emphasis has shifted away from mere 'provision' towards 'communication'.

More recently the Australian Accounting Research Foundation (AARF) (1987) proposed that 'general purpose financial reporting shall provide information useful to users for making and evaluating decisions on the allocation of scarce resources.' They identified three categories of user, deemed 'primary users' of general purpose financial reports.

- a) Resource Providers - including employees, lenders, creditors, suppliers, investors and contributors.
- b) Recipients of Goods and Services - including customers, beneficiaries, ratepayers, taxpayers and members of professional associations.
- c) Parties performing a review or oversight function - including government and regulatory agencies, analysts, labour unions, employer groups, media and special interest community groups.

They proposed that the common information needs of these groups should dictate the nature of the information to be disclosed, but this may imply a lack of awareness of the potential usefulness of some undisclosed items to the decision-making process.

Firth (1979) criticises the woeful level of information reporting, "... disclosure levels are very low and there is a big demand by some users of accounts for greater amounts of information to be released in annual reports." However, it is difficult not to be of the opinion that some user

groups will always demand more information, however much is disclosed, even when full and efficient use is not being made of that information already provided.

The arguments favouring expanded data disclosure tend to overlook economic consequences: the increased costs of data collection and communication, and the cost of less effective decision making. Lee (1976) recognises that communication may already have been reduced by the extension of disclosure, through successive companies acts and professional body requirements, such that the increased complexity of technical documents has exceeded the information limitations of users. Revsine (1970) emphasises the complexity and multidimensionality of the information contained in financial reports, necessitating the simultaneous analysis of many variables in order to establish future expectations and a user who is capable of the complex differentiation and integration of data. He considers expanded reports to be dimensionally richer only if new data increases their complexity by providing information regarding previously ignored elements of the financial environment.

It is well established that there is an upper limit to the amount of information that the human observer can process. Bieri (1970), in an experiment utilising musical tones, identifies between 5 and 9 aural stimuli as being the maximum number that can successfully be discriminated. If information overload can be shown to exist in the accounting environment and that data expansion might lower users' conceptual levels and reduce the effectiveness of decisions, then the implications for broadening the scope of existing reports are serious.

Schroder, Driver and Streufert (1967) note the importance of the task environment and user skill levels in the incidence of information overload, and demonstrate empirically that increases in the information processor's environment beyond an optimal point results in a lowering of the processor's ability to make judgements. Such findings question the advisability of the expansion of existing financial reports. Schroder (1970) notes that "... the flexibility of integration involved in information processing will increase as the environment becomes richer (presents more diverse information) until an optimal level of functioning is reached. If the complexity of the environment is increased beyond this point, the level of integration involved in performance begins to decrease." This model suggest that at first increases in information evoke increases in the complexity of the information processing from concrete to abstract, with more stimuli being detected. But when the cognitive structure becomes overtaxed by the number of stimuli it must combine, resources previously committed to the perception of stimuli are now deployed in their integration, so that new stimuli are less well perceived.

Evidence in support of the implications of information overload, rare in the financial environment, is provided by Casey (1980), Jacoby (1977) and Jacoby, Speller and Kohn (1974), but it is reasonable to expect firms to extend their voluntary disclosures while they feel such disclosures to be of benefit to the company.

More attention needs to be devoted to the content and presentation of these disclosures if the additional content is to be communicated effectively, and its usefulness reflected in a decision-making context.

## 2.1 VOLUNTARY DISCLOSURES

Minimum levels of corporate disclosure are determined by the provisions of the Companies Acts, by Stock Exchange listing requirements and by the pressures exerted by the professional accounting bodies. Historically, this level of disclosure is designed to protect investors and creditors (fulfilling a stewardship role), but is not necessarily sufficient to ensure the communication of a true and fair view (and the fulfilment of a decision-usefulness objective).

There is no legal requirement in the UK for the Chairman to report separately from his directors. Nevertheless it is now rare among publicly quoted companies for the Chairman not to take this opportunity of communicating with shareholders, when it is clear that the Chairman's Statement is the most widely read portion of the report.

The motives for voluntary disclosure are rooted firmly in agency theory with disclosure agreements in an unregulated environment designed to reduce agency costs. The interests of the manager (AGENT) may not coincide with those of shareholders or bondholders (PRINCIPALS) so that the incentive exists for the agent to act in a self-interested manner to the detriment of shareholders. Disclosure practices will vary between firms, and within firms over time, in accord with the degree of bonding perceived necessary to control the worst of managerial excesses. Thus Chow (1982) reports on the provision of voluntary audit reports, Watts (1977) on external financial reporting and Leftwich, Watts and Zimmerman (1981) on the provision of interim reports, their frequency and frequency-switches.

The nature of voluntary disclosures is likely to be company specific. Anton (1954) found the provision of voluntary funds statements to be positively

correlated with size. Salamon and Dhaliwal (1980) found a similar size relation in the disclosure of segmented sales data.

Ruland (1979) and Waymire (1985) separately reported findings of greater stability of earnings in instances where earnings forecasts were provided voluntarily.

On the downside, voluntary disclosure (eg: of earnings forecasts) may turn out to be overly optimistic or may be used to their own advantage by competitors (eg: research and development expenditure, or advertising budgets). The disclosure of short-term objectives may also unduly constrain management to ensure that they are satisfied, while consequently sacrificing longer-term objectives of greater benefit to the organisation.

On the other hand, voluntary disclosures provide an opportunity for creating a beneficial public perception of a company and its shares through, at best, biased or, at worst, misleading reports.

Signalling theory suggests that firms will provide financial statements as a guarantee of the high quality of their securities. However, Gonedes (1978) identifies the opportunities for dishonest suppliers of financial statements to report in circumstances in which users are unable to distinguish between honest and dishonest financial reports.

Both Chambers and Penman (1984) and Kross and Schroeder (1984) report that 'good news' and 'bad news' releases are not symmetrically distributed around announcement dates. Firms with 'good news' are more likely to announce it earlier than the expected reporting date, while those with 'bad news' are more likely to announce it after the expected reporting date.

Similar findings are associated with the timing of announcements within the day. Patell and Wolfson (1982) found only 10.7% of earnings *increases* to be released after trading, while 34.6% of earnings *decreases* were released after trading hours.

Although there are incentives to provide voluntary disclosures, incentives exist for the suppression of 'bad news' information. Risk averse individuals will wish to buy time in order to hedge themselves against the impact of the information and potential losses.

Voluntary disclosures increase the opportunities for conveying misleading financial messages. But Foster (1986:32) identifies four mechanisms which exist to reduce the likelihood of misrepresentations in financial statements:

- i) the reputation of the firm: any short-term gain from financial misrepresentation may subsequently damage the credibility of the company and prove costly in the long-term. Firms might be prompted into making further voluntary disclosures in order to correct the misleading, and potentially damaging, allegations of external analysts;
- ii) the reputation of the management: individual managers have a vested interest in maintaining their credibility since misrepresentations may irreparably damage their career paths;
- iii) third-party certification: monitoring by external auditors, non-executive directors, investment bankers and underwriters should reduce the opportunities for misrepresentation;
- iv) legal penalties: the fraudulent provision of false or misleading financial representations may result in corporate financial loss and personal loss of freedom.



Where information (eg: earnings forecasts, future outlook, management strategies) is not disclosed elsewhere in the annual report, the Chairman's statement performs a vital function in satisfying the user-needs of report readers.

## 2.2 THE INFORMATION NEEDS OF USERS

Just as different people require different information for different purposes, it is reasonable to expect that they will have different perceptions of usefulness of individual items.

For the purposes of determining the usefulness of the annual report, the definition of immediate share-market reaction is too simplistic. Hines (1982) suggests three major reasons why immediate market responses might not be generated:

- i) the interpretation of annual report disclosures may take place over a period of time, generating longer time price reactions, overlooked by research studies. This suggestion is consistent with timeliness being assigned a lesser role than the interpretability of information.
- ii) the nature of the new information contained in the annual report will not be so critical as to overcome the transactions cost deterrent and cause immediate substantial trading.
- iii) much of the annual report disclosures (eg: auditors report) will be confirmatory in nature, fulfilling a validatory role without engendering changed decisions. The findings of Firth (1978) and Ball, Walker and Whitted (1979) are consistent with the auditors report providing confirmatory information validating the message communicated in the prior earnings announcement.

Ball, Brown and Finn (1977) corrected a common misconception with regard to market efficiency in that security prices are based only on *expectations* of future returns and while new information is reflected in price in an unbiased manner, superior fundamental analysis can yield abnormal returns. This perception was reinforced by the survey results of US financial analysts by Mayer-Sommer (1979), finding that over 86% of them rejected the proposition that fundamental analysis of public domain information cannot yield abnormal returns.

The apparent usefulness of the annual report is doubly damned by the Efficient Markets Hypothesis in that i) it comprises information already in the public domain and ii) its content is largely pre-empted by the preliminary announcement of earnings.

However, these suggestions are in conflict with the findings of various shareholder surveys, which show annual reports to rank prominently, along with press and stockbroker sources, as decision-useful information media:

PERCENTAGE OF SHAREHOLDERS VIEWING SOURCE AS VERY/MOST IMPORTANT FOR INVESTMENT DECISION-MAKING

	BAKER & HASLEM (1973):US	CHANG & MOST (1977):US	CHENHALL & JUCHAU (1977):AUS	ANDERSON (1979):AUS
Stockbrokers	46.8	33.3	27.5	46.4
Annual Reports	7.9	46.8	30.0	38.6
Newspapers/ Magazines	14.8	38.0	16.6	38.1
Advisory Services	15.6	32.1	7.6	10.7
Advice of Friends	9.7	13.1	3.2	6.9
Company Visits	*	*	*	6.9
Bank Manager	*	*	*	4.2
Government Publications	*	*	*	4.1
Tips & Rumours	5.2	7.8	15.1	2.5
Proxy Statements	*	16.6	*	*

TABLE 2.2.1 SHAREHOLDER SURVEYS OF SOURCE RANKINGS FOR DECISION USEFULNESS

(Source: RD Hines (1982) \* - Not reported separately)

A similar perception emerges in surveys of investors, with the annual report highly regarded as an information source for investment purposes:

	Individual Investors			Institutional Investors			Financial Analysts		
	US	UK	NZ	US	UK	NZ	US	UK	NZ
Corporate annual reports	1	3	3	1	1	2	1	2	1
Corporate interim reports	-	-	-	-	-	-	4	4	2
Stockbroker's advice	4	2	2	4	2	1	-	-	-
Advisory services	3	5	5	2	5	3	5	8	8
Newspapers and Magazines	2	1	1	3	4	5	8	5	7
Proxy statements	5	4	4	5	3	4	7	7	6
Corporate press releases	-	-	-	-	-	-	6	6	4
Prospectuses	-	-	-	-	-	-	2	3	5
Communications with management	-	-	-	-	-	-	3	1	3
Advice of Friends	6	6	6	6	6	6	-	-	-
Tips and rumours	7	7	7	7	7	7	-	-	-

TABLE 2.2.2 RANKING OF INFORMATION SOURCES FOR INVESTMENT DECISIONS

(Source: Chang, Most and Brain (1983))

A similar view emerges with the examination of the corporate report to determine those sections which are i) the most widely read and ii) considered the most decision useful. Although the results of individual surveys may be subject to bias in various forms, the results of many such shareholder surveys (Lee and Tweedie (1975); Wilton and Tabb (1978); Winfield (1978); Anderson (1979)) are remarkably consistent. The Chairman's Statement is the most read section of the report, with almost all respondents indicating at least a casual study, and over half a thorough reading.

Table 2.2.3 illustrates the consistency of findings.

PERCENTAGE OF RESPONDENTS INDICATING THOROUGH READING

	LEE & TWEEDIE (1975) (UK)	WILTON & TABB (1978) (NZ)	ANDERSON (1979) (AUS)
Chairman's Report	51.6	51.0	52.8
Profit & Loss Statement	46.5	48.5	48.8
Directors' Report	35.0	37.0	40.1
Balance Sheet	34.0	40.6	36.0
Statistical summary	26.5	29.7	33.0
Funds statement	*	*	24.6
Notes to Accounts	29.4	22.4	21.6
Auditor's Report	17.4	11.5	17.0
Statement of Accounting Policies	*	*	14.5

TABLE 2.2.3: SHAREHOLDER SURVEYS OF ANNUAL REPORT READERSHIP

(Adapted from RD Hines (1982) \* - Items not reported)

A similar consistency results in the findings of surveys of section preference, with the profit and loss account consistently ranked by shareholders as the most important part of the report for decision making purposes. Table 2.2.4 demonstrates the variations in rankings.

RANKING OF ANNUAL REPORT SECTIONS FOR PERCEIVED IMPORTANCE IN DECISION-MAKING

	LEE & TWEEDIE (1975) (UK)	WILTON & TABB (1978) (NZ)	ANDERSON (1979) (AUS)
Profit & Loss Statement	1	1	1
Balance Sheet	3	2	2
Chairman's Statement	2	3	3
Statistical Summary	*	6	4
Directors Report	*	4	5
Funds Statement	*	*	6
Notes to Accounts	*	5	7
Auditor's Report	*	7	8
Statement of Accounting Policies	*	*	9

TABLE 2.2.4: SHAREHOLDER SURVEYS OF DECISION USEFULNESS

(Source: RD Hines (1982) \* Items not reported)

More variation is apparent in the results of the Chang, Most and Brain (1983) survey of individual and institutional investors and financial analysts. Non-response bias is a potential problem here, with a UK response rate of only 21.3%, and the results are subject to the usual survey-based deficiency of cost-free provision of information in a hypothetical study. Nevertheless, the income statement and the balance sheet are, respectively, consistently the most highly ranked items.

	INDIVIDUAL INVESTORS			INSTITUTIONAL INVESTORS			FINANCIAL ANALYSTS		
	US	UK	NZ	US	UK	NZ	US	UK	NZ
Balance Sheet	3	3	3	2	1.5	3	2	2	2
Income Statement	1	2	2	1	1.5	1	1	1	1
Statement of changes in financial position	4	4	4	3	3	2	3	3	5
Summary of operations: 5-10 years	2	1	1	5	8	4	6	9	3
Management's discussion of operations	6	5	5	9	6	5	8	5	4
Sales and income by product line	5	6	6	7	7	6	4.5	4	7
President's letter	10	7	7	10	9	7	10	8	6
Auditor's report	9	9	10	8	10	10	9	10	10
Accounting policies	8	8	8	6	4	8	4.5	6	9
other footnotes	7	10	9	4	5	9	7	7	8

TABLE 2.2.5: RANKING OF ANNUAL REPORT ITEMS FOR USEFULNESS IN INVESTMENT DECISIONS

(Source: Chang, Most and Brain (1983))

Differences in the perceptions of shareholders and investors are to be expected. There will be no unanimous agreement on the ranking of disclosures for importance because different user-groups will each have a diverse focus of interest. Nevertheless, Spearman's Coefficient of Rank Correlation reveals measures in excess of 0.9 within and between user groups in all cases.

Despite any reservations regarding the reliability of survey findings, empirical evidence consistently suggests that i) the corporate report is perceived as an important information source for decision-making, and that ii) financial and narrative disclosures are regarded as useful.

However, the disclosure of financial information is set against the context of the almost total absence of detailed knowledge of the needs of users of financial statements. Lee and Tweedie's (1977) study found that information relating to profitability, future prospects and dividends were the most sought after items, and Chambers (1979) views evidence of this nature as sufficient to ignore further the users of information. He argues for a generalised report since accountants cannot estimate the degree of relevance of particular items of information to specific user groups: "... any party interested in the financial affairs of an enterprise is interested in its solvency, debt-dependence, its asset composition and its rate of return." However, the distinction between the provision and communication of accounting information is succinctly recognised by Craswell (1969): "... the ability of accounting reports to communicate will depend, to a large extent, upon the identification of the users of reports and the types of decisions these users are likely to make. It is not only imperative that users of accounting reports be identified but they must also be specified so as to avoid unintended use."

Stamp (1980) considers user needs to be determined by studying users' decision models and reports a list of thirteen such needs, though without making reference to the research on users' decision processes. He recognises the difficulty of the task, associated with the diversity of users, their decision-making models and the degrees of rationality with which these models are employed.

The Corporate Report (1975) casts doubt on the ability of general purpose reports to satisfy the needs of all user groups since if financial statements are to satisfy the information needs of all those with a reasonable right to information, then a single entity would be required which simultaneously satisfied shareholders, creditors, employees, customers, competitors, analysts, advisers, government and the public. The Corporate Report identifies fourteen ways in which financial statements can contribute to user information needs, by providing data in three important areas: i) organisational performance; ii) organisational background and iii) indicators of likely future performance.

The authors of the Corporate Report consider profit and loss accounts, balance sheets and statements of sources and application of funds alone as insufficient to meet the total needs of users. When it was published, this aspect of the Corporate Report caused great controversy within both business and the accounting profession, so much so that its findings have been largely ignored in the setting of subsequent standards.

The objectives of corporate reporting and the needs of information users can only be satisfied by employing appropriate means of transmission. The Corporate Report (1975) notes that "... an important aspect of communication is that the means of transmission and the form and presentation of the information transmitted must be selected as being relevant to the receiver. In particular the information transmitted must be understandable." The implications are the provision of financial measurements and explanatory statements avoiding technical jargon but paying appropriate attention to design and layout in order to achieve clarity and visual impact.

An understanding of the varied impact of alternative transmission means on different individuals is essential if the nature of accounting disclosures is to be appropriate to the communication methods used. Bedford (1973) identifies two determinants of the effectiveness of accounting disclosures - the means of transmission employed and the comprehension capacity of receivers - where the interpretation of disclosures may be influenced both by the means of transmission and the terminology used, and where comprehension capacity is influenced by the needs of the recipient and the noise in the reception process. Within the transmission process Smith and Smith (1971) identify three essential elements of communication: i) Communication only takes place when the receiver of the information assigns the same meaning to it as intended by the preparer; ii) effective communication when the information is useful to the receiver, and iii) influential communication when the receiver responds as intended by the preparer of the accounts. In this respect Craswell (1969) provides a useful differentiation between information and data; "effective communication can only be appreciated when it contains useful information rather than merely data; information relevant to one particular decision may be irrelevant data for another decision."



The work of Bedford (1973), Hammill (1979), Hilton (1978), Stevens (1977/78), and Ehrenberg (1977) establishes a useful consensus for improvements in the presentation and effective communication of financial information. Effective reporting requires firstly the technical ability to assemble the appropriate information, and secondly the ability to identify and communicate that information to users. The report should attract the attention of the user by making a clear visual impact and by creating a clear set of objectives to be achieved. It should relate information relevant to the needs of the user, disclosing significant relationships without resorting to the use of complex technical jargon. The report should maintain the interest of the user by emphasising a few basic points and maintaining a common theme throughout. Wherever possible the information should be personalised and relate to the environment. A uniform practice should be adopted with respect to quantitative information, using averages to reduce the number and size of figures. Finally, the report should stimulate action on the part of the user which may or may not be that intended by the preparers of the accounts. If the report produced is to be both readable and unambiguous then uniform accounting standards and practices are essential. Without these any communication taking place would not be effective communication. As Chambers (1964) notes, "... accounting statements are exercises in communication, whose objective is to transfer information from one group of people to another. Totally effective communication would be achieved only if the language system in use gave to those who received signals exactly the same information as would direct perception of the objects which the signals represent."

The evidence of Lee and Tweedie (1977) suggests that the existing corporate report is not fulfilling its communication objectives: "... the chairman's report was the most widely read section of the corporate financial report, with 52% of the respondents reading it thoroughly, 39% paid the same degree

of attention to the profit and loss account but the other sections of the report (including the auditor's report) typically were poorly used, most being read only briefly for interest." The findings establish the importance of narrative disclosures, but even so no section of the corporate report was as widely read as the financial press reports.

Lee and Tweedie recognise that "... reporting accountants are failing to communicate adequately with a very large number of individuals, and that existing financial reports have become documents which are prepared by "accountants for accountants" and suggesting a four-pronged attack:

- i) simplification of existing financial statements
- ii) accurate definition of the accounting terminology employed
- iii) the provision of explanations and comments on reported results
- iv) the continuing search for alternative systems of reporting which are more meaningful to the unsophisticated user.

This final point seems to cast doubt on whether simplified financial statements are really the answer after all, and Lee and Tweedie express concern at the apparent lack of interest in financial reporting exhibited by shareholders, since were this to be confirmed "... neither user education nor report simplification will increase the number of readers and the understanding of financial statements." Bedford (1973) sees the provision of redundant information as a possible means of increasing the success of simplified statements. Repeated disclosure should reduce or eliminate the noise associated with accounting statements, aiding comprehension and reducing confusion. He suggests four alternative ways of introducing redundancy into reports:

- i) through the addition of a 'highlights' or 'summary' section
- ii) through pictorial and graphical supplements
- iii) by the use of frequent summaries
- iv) through verbal reports and comments on the content of quantitative disclosures.

Lothian (1976) notes that "... redundancy guards against misinterpretation" and Lee and Tweedie support the idea as a means of achieving their communication objectives by "... reinforcement and guarantee."

Hammill (1979) on the other hand, is more sceptical, considering the use of redundant information as an invalid technique which contributes to information overload - though he includes no empirical evidence to substantiate such a contention.

The inability of the corporate report either to attract or maintain the interest of the majority of its potential users highlights the problems faced by the preparers of accounts in attempting to communicate financial information to unsophisticated users. The situation is made even worse by the inability of all but the most sophisticated of users to comprehend the content of financial statements. Clearly a revised approach is required to communication through the financial report in order for its decision-usefulness to be fully exploited.

## CHAPTER THREE

### THE QUALITATIVE CHARACTERISTICS OF FINANCIAL INFORMATION

A number of studies have addressed the criteria for the evaluation of the usefulness of accounting information. These include, in the US (AICPA (1962 and 1973), AAA (1966) and FASB (1980)) in the UK (ASSC (1975)) in Australia (AARF (1972) and (1987)) and in Canada (CICA (1980)). Details of the characteristics deemed desirable in each of these research studies are provided in Appendix 3.

Notable among these studies are those that raised the ire of the accounting profession by calling for disclosure deemed 'inappropriate' - Sprouse and Moonitz (1962), whose study for the AICPA, sought stable measuring units and the Corporate Report (1975), for the ASSC of the ICAEW, by recommending the provision of earnings forecasts. Of the more successful early studies, the Trueblood Report (1973) for the AICPA formed the basis of the FASB (1980) documentation. The most recent developments across four countries (UK, US, Australia and Canada) are worthy of more detailed consideration in order to demonstrate significant similarities and differences.

#### 3.1 THE CORPORATE REPORT (1975)

This report of the Accounting Standards Steering Committee of the ICAEW identifies seven qualitative characteristics viewed as desirable for the fulfilment of their fundamental objective:

- i) relevance
- ii) understandability
- iii) reliability
- iv) completeness
- v) objectivity
- vi) comparability
- vii) timeliness

That these characteristics are desirable is not in doubt, rather the problem is that they are not simultaneously achievable (and may, in any case, be ambiguous in meaning). Their very nature makes a conflict of objectives inevitable.

According to The Corporate Report disclosed financial statement information should be relevant in that it satisfies users' information needs and is appropriate to their decision-making requirements. In practice the information conveyed tends to be directed towards a standardised decision-making model associated with the rational, utility-maximising, consistent user. Thus while some sophisticated users are provided with insufficient relevant information, others receive information irrelevant to their decision-making needs. Craswell (1969) and Lee (1976) argue for multiple specialist reports, in addition to a simpler generalised report, as a potential solution, though this will necessarily increase complexity and reduce understandability.

The reverse argument emphasises understandability achieved through improvements in readability and comprehension by simplifying both content and format and improving presentation. Several authors take this approach in the search for improved understanding (eg: Adelberg (1979a), Lothian (1978), Hammill (1979), Lee and Tweedie (1977), Ehrenberg (1977), Moriarity (1979) and Smith and Taffler (1984)). Inevitably such a line might reduce the quality and extent of information provided and, in addition, reduce comparability.

The credibility of financial information is vital to users and confidence in accuracy and reliability of accounting statement information is of paramount importance. If this credibility is to be backed by audit, and the provision of statistical measures of probability, then both relevance and timeliness may need to be sacrificed because of the increased lag before publication (McDonald et al (1975)). Such improvements will also increase complexity and reduce the understandability of the accounts for all but the most sophisticated of users (Wright (1980)).

Attempts to provide more information, in search of completeness, are likely further to increase complexity. Jensen (1976) expresses doubt about the reliability of some of the aggregation methods involved in providing a rounded picture, while Chambers (1979) identifies a potential conflict with objectivity, through the provision of partial or mis-information where subjective judgements are made regarding items for inclusion.

Bedford (1973) argues for greater standardisation in the provision of information to improve objectivity, while Adelberg (1979a) provides empirical evidence supporting the existence of reporting which is

management rather than user-orientated. Both Morton (1974) and Salamon and Smith (1979) provide evidence for potential manipulation of the financial messages conveyed. Once again, less ambiguity is likely to mean more complexity and greater potential for confusion. Parker (1981) argues that 'standardisation does not really help the lay investor, since it is not a substitute for clarity or effective communication'. Similar arguments apply for improvements in comparability through standardised accounting concepts and measurement methods, with similar consequences.

Several authors (notably Gilling (1977), Courtis (1976), Dyer and McHugh (1975) and Whittred (1980)) provide compelling evidence for the improvement of timeliness in the provision of disclosures in order to ensure relevance, though prompt reporting might reduce both the reliability and completeness of disclosures.

The Corporate Report provides no indication of perceived importance of the desirable attributes. Importantly, recognition is evident that all may not necessarily be capable of simultaneous achievement.

Clearly some compromise position is necessary in order to satisfy this inevitable conflict in objectives. The desirable compromise position, and the permitted trade-off between properties, will likely depend on both the user-group and the decision-making context.

### 3.2 FASB - STATEMENT OF FINANCIAL ACCOUNTING CONCEPT 2 (1980)

The FASB (1980) concept statement offers an alternative approach, providing a hierarchy of accounting qualities which recognises both potential conflict and relative decision usefulness. The statement makes a clear distinction between those qualities viewed as user-specific and those inherent in the information. Table 3.2.1 provides a graphic illustration of the perceived relationships:

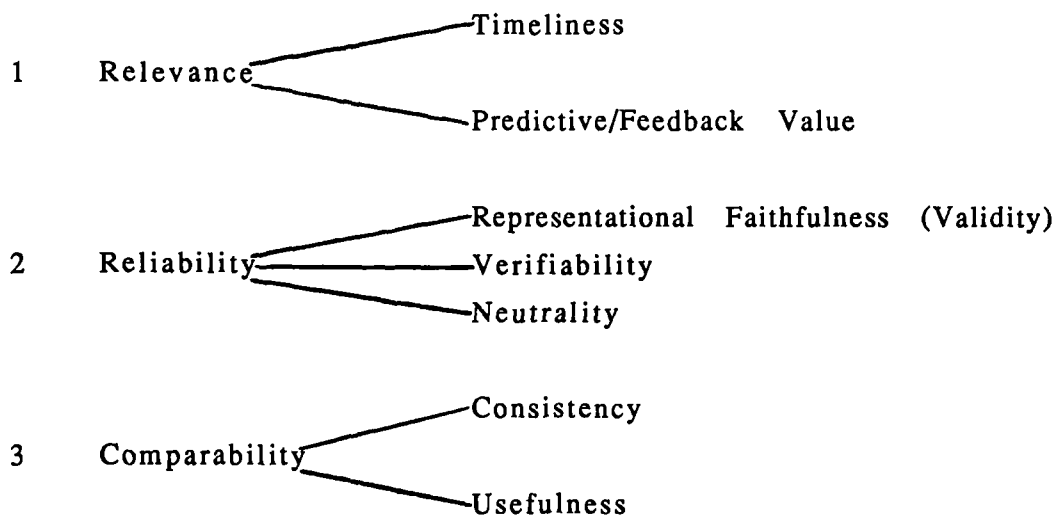

**TABLE 3.2.1: INFORMATION SPECIFIC QUALITIES OF INFORMATION**

Relevance, reliability and comparability are viewed as the key attributes, with other characteristics viewed as sub-attributes contributing to the fulfilment of the key properties. A 'materiality threshold' is suggested such that the benefits provided by the disclosure of information should exceed its cost.

FASB admits that there may be a trade-off between relevance and reliability: 'Though, ideally the choice of an accounting alternative should produce information that is both more reliable and more relevant, it may be necessary to sacrifice some of one quality for a gain in another.'

Understandability is viewed as a user-specific property, desirable, but one whose importance is played down: 'The understandability of the information is related to both the characteristics of the information and of the information-user making it difficult to evaluate without reference to a particular set of decision makers.'

Given that information can only be useful if it can be understood, even though it may be reliable and relevant to the decision-making context, this lack of emphasis may not be wholly appropriate.

### 3.3 AUSTRALIAN ACCOUNTING RESEARCH FOUNDATION (1987)

The AARF (1987) takes a similar line but makes a different distinction, between

- i) selection of information
- ii) presentation of information

In i) above, two primary characteristics, relevance and reliability are identified. The statement recognises that the one may need to be balanced against the other, but makes no ranking decision between the two. Again the concept of materiality is employed to gauge the importance of any omission or misstatement, and again timeliness and cost-benefit are viewed as constraints on the achievement of relevance and reliability.

In ii) comparability (embracing both consistency and uniformity) and understandability are identified as desirable presentational properties. But the statement recognises that complex transactions may be incapable of simple reporting without the sacrifice of relevance and/or reliability. Understandability is, therefore, clearly considered subservient to the 'primary' characteristics.

#### 3.4 CANADIAN INSTITUTE OF CHARTERED ACCOUNTANTS (1980)

The Accounting Standards Committee of the Canadian Institute produced a much more voluminous set of desirable characteristics, ranking 20 criteria in accordance with the perceived preferences of its nineteen members:

- 1 Relevance
- 2 Clarity
- 3 Substance over Form
- 4 Timeliness
- 5 Comparability
- 6 Materiality
- 7 Freedom from Bias
- 8 Objectivity
- 9 Rationality
- 10 Full disclosure (Completeness)
- 11 Consistency
- 12 Isomorphism
- 13 Verifiability
- 14 Cost/Benefit effectiveness
- 15 Non-arbitrariness
- 16 Data availability
- 17 Flexibility
- 18 Uniformity
- 19 Precision
- 20 Conservatism



The list of attributes is deliberately long to avoid any omissions, even though this introduces obvious overlaps, notably: verifiability/data availability, rationality/non-arbitrariness, relevance/comparability and objectivity/verifiability/precision.

Of particular interest is the wide agreement on the criteria at the extreme ends of the distribution. All members of the committee viewed 'relevance' as the most important single criterion, and 'conservatism' was almost uniformly viewed to be the least desirable. These findings are consistent with the AARF pronouncements in that while 'relevance' assumes adherence to a 'substance over form' reporting of transactions, and 'reliability' assumes the adoption of 'prudence' in dealing with uncertainties in the measurement process, such assumptions are at odds with a 'conservatism' principle which would lead to deliberate bias and the consistent understatement of assets.

An analysis of the standard deviations of the rankings is revealing and illustrative of the dangers of this kind of analysis. The term 'isomorphism' recorded a ranking variability far in excess of any other attribute possibly indicating differences in the perceived meaning, as well as the perceived importance, of the attribute.

Stamp (1981) recognises this as a key area of difficulty for accountants:

'Although accounting deals with figures, many of its most important problems arise because of accountants' uncertainty about the meaning of the words they use. ... we shall never attain the empyrean where everyone is at all times agreed on precisely what is meant by the criteria being applied but this is no reason why we should continue to ignore semantics.'

Stamp (1982), operating within a Canadian context, emphasises that not only is 'understandability' user-specific, but so is 'relevance', since any judgement of relevance must be made relative to user needs and the decision-making context. He identifies several pairs of criteria that might be perceived to be in conflict, so much so that a trade-off is necessitated in their fulfilment:

1	Relevance	-----	Objectivity
2	Comparability	-----	Verifiability
3	Timeliness	-----	Precision
4	Clarity	-----	Completeness
5	Conservatism	-----	Freedom from Bias
6	Uniformity	-----	Flexibility
7	Materiality	-----	Precision

However, he makes no attempt to quantify the nature and extent of such trade-offs, preferring to develop absolute weighting scores for each of the criteria. He identifies several areas of difficulty associated with such an approach:

- i) there are no generally accepted definitions of the criteria employed and semantic differences may influence user preferences;
- ii) the criteria employed are neither mutually exclusive nor collectively exhaustive. Their meanings clearly overlap and it is possible that all desirable aspects have not been completely covered;
- iii) it may be unrealistic to expect a consistent assignment of numerical weightings to qualitative criteria, so the ranking system generated may rest on shaky foundations. Such assignments are investigated empirically in Chapter 4.

This final point is particularly problematical, since any absolute weighting assigned to a particular attribute is likely to be decision specific. In such circumstances it may be more appropriate to evaluate relative weightings by examining the trade-off between conflicting characteristics.

An empirical evaluation of this trade-off is examined in section 3.5, using the seven criteria of the Corporate Report as representative. Despite the improvements likely in a relative-weighting approach, some reservations must still remain regarding the decision specificity of the attributes.

Of even greater consequence is the weighting attributed to the qualitative characteristics, in toto, by the standard setting bodies. At best they seem to be regarded as peripheral, with their conflict with accounting standards, and the standard setting procedure, (Hines (1989)), remaining unaddressed.

### 3.5 THE DIMENSIONALITY OF FINANCIAL INFORMATION

The concept of 'usefulness' of information is not one which is confined solely to accounting information.

The empirical findings of information scientists can be generalized to the accounting information environment. Swanson (1974) developed a 16 item instrument to measure the relative value of management information systems to users. Eight of these related to an evaluation of information and were seen as components of perceived usefulness:

- |                               |                           |
|-------------------------------|---------------------------|
| i) timely/untimely            | ii) relevant/irrelevant   |
| iii) unique/redundant         | iv) accurate/inaccurate   |
| v) instructive/misinstructive | vi) concise/diffuse       |
| vii) clear/ambiguous          | viii) readable/unreadable |

The first six of these might be thought to relate to the quality of informational content, the last two to the quality of presentation.

Gallagher (1974) developed a very similar measurement scale, but with a more extensive list of semantic adjectives. Zmud (1978) argues that user perception of information has four basic dimensions:

- i) significance, usefulness or helpfulness
- ii) accuracy, factualness and timeliness
- iii) quality of format, physical presentation or readability
- iv) meaningfulness or reasonableness of the information

Again this classification might be split between informational content [(i), (ii) and (iv)] and presentation of content [(iii)]. Larcker and Lessig (1980) saw the perceived usefulness of information to be a function of two factors:

- i) Perceived importance - information is thought to be relevant, informative, meaningful, important, helpful and significant
- ii) Perceived usability - information is thought to be unambiguous, clear and readable.

They admitted that information accuracy and timeliness might provide additional dimensions of perceived usefulness that had possibly been ignored. Even so their important/usable split might be thought to

correspond to one concerned with quality of informational content/quality of presentation.

Such divisions are consistent with the approaches of the accounting standard setting bodies. Thus FASB (1980) adopted a division of

- i) information-specific : relevance, reliability, comparability
- ii) user-specific : understandability.

Similarly AARF (1987) proposes:

- i) information selection : relevance, reliability
- ii) information presentation : understandability, comparability.

The 20 characteristics of the Canadian ASC (1980) might, a priori, be aggregated as follows:

Relevance	]		]	
Substance over Form	]		]	
Timeliness	]	Relevance	]	
Materiality	]		]	
Cost-Benefit	]		]	
Isomorphism	]		]	
Precision	]		]	
Non-arbitrariness	]	Accuracy	]	QUALITY OF <u>CONTENT</u>
Verifiability	]		]	
Freedom from Bias	]		]	
Data availability	]		]	
Objectivity	]		]	
Rationality	]		]	
Consistency	]	Validity	]	
Uniformity	]		]	
Conservatism	]		]	
Comparability	]	Usefulness	]	
Flexibility	]		]	
Full disclosure	]	Completeness	]	
Clarity	]	Understandability	]	QUALITY OF <u>PRESENTATION</u>

Similarly, the sevenfold classification of the Corporate Report (1975) might be aggregated as follows:

Relevance	]		]
Comparability	]	Usefulness	]
Reliability	]		]
Timeliness	]	Accuracy	] <u>QUALITY OF CONTENT</u>
Completeness	]		]
Objectivity	]	Validity	]
Understandability	]	Readability	] <u>QUALITY OF PRESENTATION</u>

Each of these analyses identifies content and presentation as the fundamental features of information, so it appears reasonable to carry out a further empirical investigation, to determine the underlying dimensionality of information, within the accounting environment. A mapping procedure was employed involving the use of a multidimensional scaling technique to convert perceived preferences, in the form of measurable trade-offs between potentially conflicting characteristics, to a multidimensional graphical output.

### 3.5.1 AN EMPIRICAL APPROACH TO MEASUREMENT

The Multidimensional Scaling (MDS) technique provides the solution to an inverse mapping problem; given the distances between a set of points the procedure establishes the relative positions of the points in multidimensional space.

The data distances input are measures of similarity or dissimilarity between all combinations of points and provide a correlation matrix of the variables under consideration. A map can then be constructed in such a way that high correlations produce points which are close together, and vice-versa.

The MDS approach is very similar to that of factor analysis, but whereas MDS is based on the distances between points the latter is based on the angles between vectors. In addition, by imposing an assumption of linear relationships factor analysis often produces an unmanageably large number of dimensions. MDS makes no such assumption and normally provides more readily interpretable solutions of lower dimensionality.

We use MDS to form homogenous groupings of decision-makers with common perceptions of the meanings of accounting information items. By evaluating similarity judgements 'perceptual spaces' are generated which provide spacial representations of the structure and dimensions of the stimuli

(judgements) being studied. The geometric position of these points corresponds to their relative ranking by respondents.

The pioneering application of MDS to a financial environment is provided by Green and Maheshwari: (1969) in gauging the perception of respondents to the similarity of shares, based on financial ratio variables. Belkaoui and Cousineau (1977) adopt a behavioural accounting approach to respondents' perceptions in the same area. In each case a two-dimensional plot was suggested, labelled as 'perceived growth' and 'perceived risk'.

Libby (1979) used the INDSCAL routine of MDS, due to Carroll and Chang (1970), to examine the perceptions of auditors and bankers to the message communicated by the audit report. This study was repeated by Bailey, Bylinski and Shields (1983) using CPA candidates and final-year accounting undergraduates as subjects. In each case a two-dimensional solution was generated attributable to 'information content' and 'user judgement'.

In this INDSCAL application of this present study the dissimilarity scores are generated by the trade-off measurements, perceived by respondents, between the property variables.

The major difficulty in the solution of the mapping problem is the determination of the number of dimensions in which the map should be drawn. Kruskal and Carroll (1969) introduce the concept of 'stress' as a measure of 'badness of fit' being a normalised residual sum of squares which should be minimised. Stress is thus analogous to the  $R^2$  of regression analysis, with a stress factor of zero corresponding to a perfect fit, of one corresponding to no material relationship. Kruskal (1970) advances the use of the 'scree' diagram to determine the most appropriate number of dimensions : a plot of '% stress' on the vertical against the 'number of dimensions' on the horizontal will often display a kink at the optimum number of dimensions. If the diagram is constructed in too few dimensions the diagram will be uninterpretable because too many variables will simultaneously be competing for expression. However, Watkins (1984) is critical of researchers who rely solely on stress to determine dimensionality, recommending the use of alternative diagnostic measures to evaluate the interpretability of the derived configuration. Shepard (1974) is similarly concerned that by using 'stress' alone, researchers extract too many dimensions and ignore the more important contributions of statistical stability and substantive interpretability.

Davies and Coxon (1981) provide the MDS (X) series of programs in which the INDSCAL routine generates solutions in each of the possible dimensions from the highest specified to the lowest. Each of these alternative solutions may then be examined to identify other diagnostic measures:

- i) large negative weights in the subject-weights matrix for each dimension cannot be interpreted, and are indicative of a dimensionality that is too high;
- ii) the sums of squares of subject-weights on the main diagonal of the matrix for each dimension show the relative importance of each dimension to the final solution;
- iii) the sums of products of off-diagonal elements show the degree of correlation between dimensions. Large values again suggest that dimensionality is too high.

Like the Libby (1979) and Bailey et al (1983) studies, this work is concerned with similarity measurements in the perception of meaning of accounting terminology. Likewise, therefore, the INDSCAL routine is used here. Compared to alternative routines, INDSCAL has the further advantage of developing sensible and meaningful solutions of low dimensionality, provided that the data set is reasonably reliable.

This application is concerned with 21 similarity judgements (i.e.  ${}^7C_2$  being all combinations of two qualitative properties from the seven (stimuli) deemed desirable by the Corporate Report). Schiffman, Reynolds and Young (1981) recommend the recording of respondents' similarity judgements by using a 5 inch scale. They suggest that a 4 inch line will compress results, while a 6 inch line will encourage the non-use of the right-hand scale. The line used is not differentiated in any way (i.e. no boxes, numbers, synonyms or verbal descriptors) to avoid the potential for bias. Accordingly these suggestions are incorporated into the test instrument detailed in Appendix 3.3(b).

Hypotheses: H01 Null Hypothesis - no clear dimensions determinable.

H1 User perception of the relative desirability of the properties of accounting statements will load onto two major dimensions concerned, respectively with Content and Presentation.

H02 Null Hypothesis - no difference in the perceptions of different user groups.

H2 Different user groups will have different perceptions of this relative desirability breakdown for the use of accounting statement information in different contexts.

To explore the potential of the research approach in a preliminary manner a respondent group of 30 MBA Finance students at the City University Business School was used who were already familiar with those properties deemed desirable in accounting communications. They were supplied, as a reminder, with an abstract from 'The Corporate Report' by the Accounting Standards Steering Committee of the ICAEW (1975) in which the properties are designated (Appendix 3.2). As an initial exercise, respondents were asked to rank the seven properties into the order they perceived to be most appropriate, using a system which designated 1 - most important, 2 - next etc., so that the property ranked 7 was perceived as the least desirable.

Respondents were then presented with the test material proper (Appendix 3.3) which comprises a brief reinforcement of each of the seven properties, and their meaning, and a statement of the task requirements. Respondents were required to quantify their relative ordering by indicating their preference between pairs of properties. This preference was to be stated in a measurable way by showing the trade-off that each respondent thought permissible; that compromise position whereby a degree of one property might be sacrificed for part of the other. The 21 pairs of properties (all combinations of 2 from 7) were distributed randomly, for order and for left/right handedness, to ensure, as far as possible, that 21 separate decisions were made.



The result and responses represented the satisfaction of inter-property conflict on an individual basis and provided the basis for the generation of dissimilarity matrices and the mapping of perceptual preferences using the INDSCAL routine of the MDS (X) set of programs.

A forty point measurement scale was used. A score of 20 represented indifference between the two properties, 0 of absolute preference for the second, and 40 absolute preference for the first of the properties. The resulting scores were used as an INDSCAL data set.

The experiment was later repeated with a further group of thirty final year UK business undergraduates, to determine the effect of educational attainment.

In this respect we follow Ashton (1976) who justifies the use of students as surrogates for accounting professionals in the use of accounting statements.

### 3.5.2 EMPIRICAL RESULTS

H<sub>1</sub>: The INDSCAL routine generates solutions in alternative dimensions from 1 to 4:

No of Dimensions	Explanatory Power (%)	Stress (%)
1	29.4	70.0
2	44.4	54.9
3	60.6	38.2
4	69.7	27.2

Maximisation of explanatory power suggests the adoption of a four-dimensional solution ( $R^2=0.697$ ), as does the minimisation of the stress criterion (% stress = 27.2). Such a preference is not surprising since stress will decrease and correlations increase as the number of dimensions increases. The danger is of extracting too many dimensions and generating a statistically unstable solution. Further diagnostics are therefore sought.

The 'Scree' Test depicted in Figure 3.5.1 reveals the hint of a Kink, or elbow, centred on three dimensions, though the diagram is not of sufficient clarity to be totally convincing.

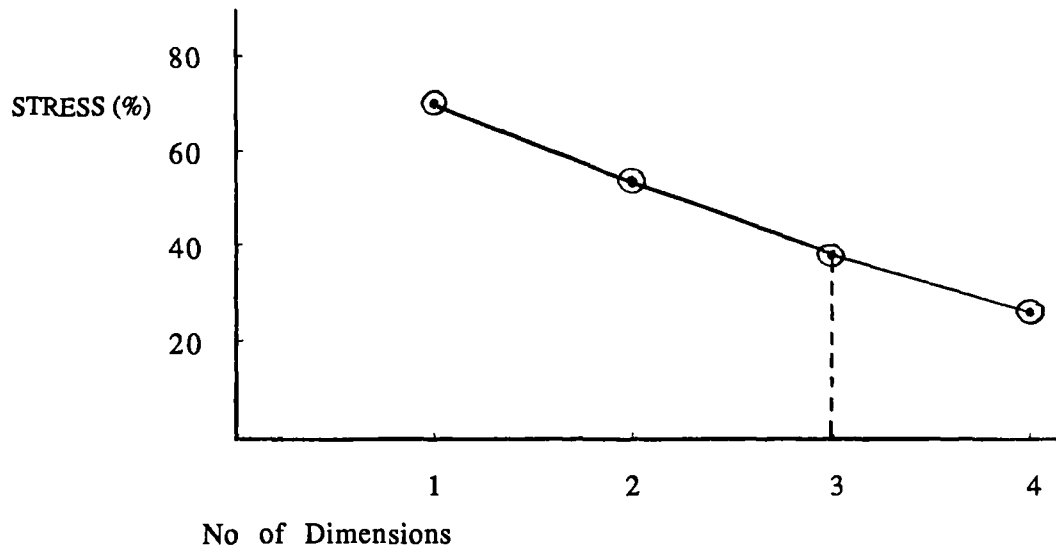

FIGURE 3.5.1: SCREE TEST FOR THE DETERMINATION OF DIMENSIONALITY

Further consideration of the output from the INDSCAL routine helps to clarify the configuration:

- i) examination of the normalised subject spaces reveals very few negative subject weightings in any of the alternative configurations. Little evidence is provided to suggest the adoption of a level of dimensionality which is too high.
- ii) examination of the group space product sums reveals the angle between the dimensions in each of the alternative solutions. Orthogonality between the axes is sought, with an optimum 90 degree angle indicated by an intercorrelation measure of  $r=0$ . The closer to zero is the correlation coefficient the better the configuration.

NUMBER OF DIMENSIONS

	2	3	4
r1.2	-0.145 (98.3°)	-0.145 (98.3°)	-0.145 (98.3°)
r1.3		0.101 (82.2°)	0.101 (84.2°)
r2.3		0.059 (86.7°)	0.059 (86.7°)
r1.4			-0.217 (102.4°)
r2.4			0.153 (81.2°)
r3.4			-0.117 (96.7°)

The four-dimensional solution clearly demonstrates large divergences from the optimum, and is rejected accordingly. The three-dimensional solution offers a configuration close to orthogonality.

iii) examination of the subject space product sums identifies the relative importance of the dimensions, while the graphical plots of the group space configurations allows an interpretation of the dimensions to be made.

#### TWO-DIMENSIONAL SOLUTION

	VARIATION EXPLAINED(%)	PROPERTIES	TRADE-OFF
DIM 1	25.7	Completeness - Reliability	Quantity - Quality
DIM 2	<u>18.6</u>	Timeliness - Objectivity	Punctuality - Bias
	Sum : 44.3		

#### THREE-DIMENSIONAL SOLUTION

	VARIATION EXPLAINED (%)	PROPERTIES	TRADE-OFF
DIM1	25.4	Completeness - Reliability	Quantity - Quality
DIM 2	18.5	Timeliness - Objectivity	Punctuality - Bias
DIM 3	<u>16.7</u>	Relevance - Understandability	Useful - Usable
	Sum : 60.6		

The diagnostic measures suggest a preference for a three-dimensional configuration which maximises explanatory power at 60.6% while generating acceptably orthogonal axes. The first two of these dimensions focus attention on the informational content of the communication, the third on the manner of its presentation. The specification of a Content-Presentation split therefore emerges.

Appendix 3.4 illustrates each of the two-dimensional maps generated by plotting the respondents (numbered 1 to 30) and the qualitative properties (numbered 1 to 7) on common axes. The properties at the extreme end of each axis allow an interpretation of the dimensions as above. The subjects lying closest to a 45 degree line in the north-east quadrant represent, in each case, the respondents with perceptions closest to the mean.

Results from a repeat of the experiment with a less sophisticated audience of accounting undergraduates were very similar and are not reported separately here. This might suggest that both groups may have taken attributes at their face value without a full appreciation of their accounting implications. It is possible that a more sophisticated audience of accounting

practitioners might generate alternative responses, but this remains to be tested. However, Bailey et al (1983) report that subject groups with differing levels of audit report knowledge (CPA candidates and undergraduate accounting students) showed a high level of interstudy statistical similarity, with no significant difference in their perception of audit report messages. Libby (1979) similarly reports little difference in the perceptions of auditors and commercial lending officers in the same decision-making environment.

Watkins (1984) expresses the hope that the MDS technique might be applied more widely in the accounting and finance environment, but reports of such applications remain scarce in the accounting literature.

H<sub>2</sub>: The rank ordering exercise reveals a strong preference for reliability and relevance among the thirty respondents in their perceived importance of the different properties:

RANK	PROPERTY	MEAN RANK SCORE	STANDARD DEVIATION
1	Reliability	2.3	1.5
2	Relevance	3.2	1.9
3	Timeliness	4.0	1.9
4	Objectivity	4.1	1.7
5	Understandability	4.6	2.1
6	Comparability	4.8	1.9
7	Completeness	5.0	1.4

These results are significantly at variance with those of Stamp (1982) as considered in Section 3.4. The latter reported a clear preference for 'relevance' among accounting professionals. This conflict suggests that differences attributable to education and experience may be important and that such issues need to be further explored.

### 3.5.3 CONCLUSIONS

The empirical findings for MBA Finance students demonstrate preferences which suggest that these users are prepared to sacrifice completeness, objectivity and understandability of disclosures in return for, respectively, reliability, timeliness and relevance. This preference for reliability and relevance (with timeliness a contributory factor) is consistent with the proposals of both FASB (1980) and AARF (1987). Respondents perception of the importance of understandability is apparently consistent with the subservience attached to it by the accounting standard setters. It is difficult

to reconcile such a stance with the overriding objective of 'Communicating decision-useful information', since:

- i) if a message is not understood effective communication has not taken place
- ii) without understanding, relevant and reliable information will not impact appropriately.

Given the apparent acceptance of the complexity of content, more attention needs to be paid to appropriate means of presentation, if the current imbalance is to be repaired. Chapter 4 extends this argument by exploring respondents' perceptions of content alternatively presented, in narrative or numerical form.

## CHAPTER FOUR

### BARRIERS TO AN EFFECTIVE COMMUNICATION PROCESS

#### 4.1 THE LANGUAGE OF ACCOUNTING DISCLOSURES

A language system has a set of symbols (the lexicon) and a set of rules for relating these symbols (syntax). On this basis both mathematics and music have been regarded as language systems, and accountancy too must qualify with its symbols (words and numerals) and rules (procedures, conventions and standards).

Cherry (1966) distinguishes between factual information - 'semantic information conveyed by sentences in the language' - and useful information - information conveyed for the benefit of a particular user.

Li (1963) argues that, at the semantic level, accountancy is not concerned with the usefulness of information but rather with its factual content. This distinction is consistent with a general-purpose annual report in which information is stated, rather than communicated, to an unspecified audience.

The effectiveness of any communication that takes place is dependent on the satisfaction of three conditions (Smith (1971)):

- i) the message transmitter successfully encodes the required meaning into language.
- ii) the message is transmitted through a channel of communication (e.g., written report)
- iii) the receiver decodes the language and confers on it the meaning intended by the transmitter.

The breakdown of the communication process may be attributable to problems of content and presentation:

- i) the content of the communication is perceived as being too complex to be understood by unsophisticated users. The suggestion is that there exists a need for more education (Lee and Tweedie (1977) ) or for simplified accounts (Hammill (1979)).

- ii) the means of presentation is perceived as being inadequate to meet the needs of the target audience. The suggestion is that the communication fails to meet the information needs of the sophisticated user and that specialist user-based reports (Bedford (1973)) are required.

Such fundamental problems are consequent upon the production of a general purpose annual report, whose objectives and target audience are largely unspecified.

The stated objectives of financial reports are essentially non-specific, especially with regard to the potential audience. The Trueblood Committee (1973) specified the basic objective as being 'to provide information useful for making economic decisions' for an audience comprising 'the shareholder and other interested parties'. The Corporate Report (1975), in a similar fashion, specified the fundamental objective of communicating 'economic measurements of and information about the resources and performance of the reporting entity' to an audience comprising 'those having reasonable rights to such information'.

In each instance the generalisation of the user-group designation presupposes the production of a single all-purpose report, which may fail to satisfy the information requirements of any of its potential user-groups. At least the latter specifies the need for communication, but provides little guidance of the patterns to be adopted if this is to be effective over a diverse audience. Parker (1982) correctly observes that 'some company managements may be quite unconcerned about their annual report readership levels'.

Dupree (1985) argues 'the impossibility of communicating to all shareholders, regardless of literacy or ability' and apparently abandons any idea of communicating with the 27.2% of US shareholders without a college education. Instead he explores the simplification route, replacing technical accounting terms with descriptive alternatives. Such an approach appears fraught with danger while the two accounting terminology problems identified by Haried (1972) still persist:

- i) technical meanings are assigned to words with other meanings in every day use,

ii) there is insufficient standardisation of the terms used in financial reports.

The empirical work of Haried (1973), Oliver (1974) and Belkaoui and Cousineau (1976), evaluating the semantic meaning of accounting concepts, reveal a startling lack of conformity between different user-groups in terms of perceptions of their meaning.

Chapter 6 is concerned with the complexity of presentation of narrative disclosures and the potential consequences of obfuscation. The remainder of this chapter is concerned with the problems consequent upon the perceived complexity of narrative disclosures.

Where complexity distorts the decision-making process, because the information processing mechanism is impaired, the potential exists for damaging economic consequences. While damaging results following on from distorting complexity are intuitively appropriate, the empirical evidence providing support for such economic effects is sadly lacking. What is not in doubt is the effect on information processing methods consequent upon information which is complex in volume and nature. Simplifying procedures will be adopted to integrate alternative information cues and to accommodate the uncertainty associated with different messages from alternative sources.

#### 4.2 INTUITIVE STATISTICS IN THE PROCESSING OF ACCOUNTING NARRATIVES

Decisions in the accounting environment require an information processing capability which allows the accommodation of uncertainty. Too often inference, prediction and diagnosis of events result in biased judgements following the adoption of subjective statistical inaccuracies. Inappropriate heuristic devices and guidelines to simplify the decision-making process may lead to sub-optimal judgements and the inefficient use of the available information.

The nature of decision rules and their potential implications for the processing of information under conditions of uncertainty in a psychological environment has been researched and documented by Slovic (1974) and Kahnemann and Tversky (1974). This analysis was extended to the accounting environment by Swieringa et al (1976) and in particular to the audit environment by Joyce and



Biddle (1981). In the main these studies are devised to demonstrate the inadequacies of common statistical heuristics, though Thorngate (1980) has shown that in some circumstances such heuristics can lead to optimal responses.

This section adopts an empirical approach to the investigation of the relationship between quantitative and qualitative information sources, focusing on the manner in which numerical and narrative information is employed in a decision-making context. Three issues are addressed:

- i) the reaction of respondents to the provision of numeric base rates as an indication of the likelihood of outcomes. This issue is of particular relevance to the empirical studies conducted in Chapters 8 and 10 where respondents are required to process test materials involving sets of companies, in which the base-rate for failed companies is a controlled variable.
- ii) the nature and extent of the integration of narrative and numerical information when both are available, especially when the message conveyed is to some extent conflicting and information preferences are apparent. This issue is of particular relevance to the empirical study reported in Chapter 8, where respondents are required to combine numeric and narrative information from alternative sources in determining a failed-non-failed decision.
- iii) the consistency with which respondents attempt to attach numerical rankings to qualitative measures of uncertainty. This issue is of particular relevance to the interpretation of the Chairman's narrative reflected in the empirical studies of readability (in Chapter 6) and of disclosed message (in Chapter 8).

Ashton (1984) documented a variety of cases employed in the earlier sources in order to extend the evaluation of auditing judgements into the classroom, using students as surrogate decision-makers.

In order to illustrate the three issues above, four simple cases have been selected which demonstrate the adoption of heuristic devices to facilitate processing. In particular:

- i) representativeness - the making of decisions on flimsy evidence which ignores prior probabilities. Case 1 is designed to examine the emphasis placed on questionable narrative sources compared to impeccable numerical information relating to base rates.
- ii) integration - the adoption of inconsistent simplification to combine information from alternative sources. Case 2 examines the manner in which numerical indicators of size, and qualitative indicators of reliability are combined with an existing body of information.
- iii) anchoring and adjustment - overconfidence in estimates resulting from adjustments, made with additional information, to unreliable initial guesses. Case 3 seeks to appraise the reaction of respondents to the availability of new (numerical) information complementary to the existing narrative.
- iv) availability - judgemental bias resulting from undue emphasis on recent or imaginable instances. Case 4 demonstrates how respondents attitudes to risk and uncertainty might impair the consistency of their estimates.

Ashton and Kramer (1980) observed sizeable discrepancies in the opinions of students in behavioural accounting research, when compared to practitioners, in questions of attitudes and attitude changes. When decision making studies were examined, however, the information processing abilities of students suggest that they are reasonable surrogates for practitioners. This study attempts to evaluate differences in the performance of accounting undergraduates and practitioners in questions devoted to both attitude measurements and information processing.

#### 4.3 HEURISTICS EXPERIMENT: METHODOLOGY

A test was conducted using 250 final year Australian undergraduate accounting students, who were asked to complete a test instrument independently within a one-hour time constraint. No case completion order was specified and some individuals failed to complete the entire test instrument.

Thirty-two different versions of the test instrument were prepared to reflect the 8 alternative versions of Case 2 and the 4 alternative versions of Case 3. Both Cases 1 and 4 comprised single versions without variations. The test instrument was administered randomly to the subject group to ensure that each version was considered approximately eight times by different individuals. This treatment allowed the assessment of the effects, if any, of subtle numerical and narrative changes within the text of the four cases.

4.3.1 CASE 1: REPRESENTATIVENESS

SOURCE: D KAHNEMANN and A TVERSKY  
 'Subjective Probability: A Judgement of Representativeness'  
 COGNITIVE PSYCHOLOGY (July 1972) pp 430-454

Case adapted by the author to an Australian tertiary environment.

In 1987 the number of equivalent full-time students enrolled at this University, totalled 6,720. They were distributed as follows:

Accounting	532	
Architecture	308	
Art & Design	375	
Biology	138	
Business & Administration	1429	
Chemistry	201	
Communication Studies	583	
Computer Science	379	
Education	552	
Engineering	634	
Library Studies	147	
Physics	240	
Social Studies	1120	
Surveying	82	

One such student, Tom W, is in the final year of an undergraduate course. The following description of him was made by a psychologist, resulting from a projective test prior to the commencement of his undergraduate studies:

'Tom is highly intelligent, although lacking in true creativity. He has a need for order and clarity, and for neat and tidy systems in which every detail finds its appropriate place. His writing is rather dull and mechanical, occasionally enlivened by somewhat corny puns and by flashes of imagination of the sci-fi type. He has a strong drive for competence. He seems to have little feel and little sympathy for other people, and does not enjoy interacting with others. Self-centred, he nonetheless has a deep moral sense.'

### The Task

Please rank the above fourteen fields of study in order to identify that field in which you consider the likelihood of Tom being a student is the highest.

Place your ranks in the grid above, with a Rank = 1 indicating the most probable choice.

## RESULTS

A total of 244 usable replies were generated:

Prior Probabilities suggest the following rank order:

Rank	Field of Study	No. of Students		Observed Incidence of Rank = 1	
		Actual	(%)	No. of Students Actual	(%)
1	Business Admin	1429	21.3	23	9.4
2	Social Studies	1120	16.7	1	0.4
3	Engineering	634	9.4	48	19.7
4	Communications	583	8.7	2	0.8
5	Education	552	8.2	2	0.8
6	Accounting	532	7.9	14	5.7
7	Computer Science	379	5.6	76	31.2
8	Art & Design	375	5.9	5	2.1
9	Architecture	308	4.6	4	1.6
10	Physics	240	3.6	32	13.1
11	Chemistry	201	3.0	15	6.2
12	Library Studies	147	2.2	10	4.1
13	Biology	138	2.0	2	0.8
14	Surveying	82	1.2	10	4.1
	TOTAL	6720	100%	244	100%

Significant differences between observed and expected frequencies are apparent, particularly with regard to Business Administration, Social Studies, Engineering, Computer Science and Physics. Respondent preferences in the first three ranked positions shared just four fields: Computer Science (140), Physics (129), Engineering (127) and Chemistry (91) to occupy over 66% of the top ranks.

On prior probabilities their expected proportion of the student body represents only 21%. A chi-squared test confirmed a highly significant difference between actual and expected subject rankings, at the 5% test level.

These results are consistent with Ashton's observation that base-rate information is consistently underutilised - except in instances where it is the only form of information available.

In this decision framework the base-rate information is paramount but subjects were apparently unable to integrate this information with their 'representativeness' perceptions - the similarity between the brief description and a typical student on each of the courses.

The implications of this result are potentially significant to the outcome of the study in Chapter 8. Where different messages are being conveyed by the Chairman's Report and the Financial Accounts, the emphasis accorded to the narrative/numerical messages, when both are available, might suggest an inappropriately high weighting being accorded the narrative because of its warmth and apparent saliency.

Further, the apparent ignorance of base rates, even when explicitly stated in numerical form is disturbing. It suggests potential difficulties in changing respondents' perceptions of base rates in instances where the base rate may vary widely. Such difficulties are apparent in the findings reported in Chapters 8 and 10.

#### 4.3.2 CASE 2: INTEGRATION

SOURCE: E.J. JOYCE and G.C. BIDDLE  
'Are Auditors' Judgements sufficiently regressive?'  
JOURNAL OF ACCOUNTING RESEARCH (Autumn 1981b) pp 323-349

As part of the regular year-end audit of a client - a consumer electronics wholesaler - you are reviewing the adequacy of the allowance for uncollectable receivables.

You prepare an ageing schedule of accounts receivable and note a very large account is six months past due. The customer has returned you positive confirmation verifying the client's balance as correct. You know from your experience with this client that approximately 70 per cent of account balances

six months past due, are unrecoverable. Assume this single account balance is a material item. It is the controller's opinion that the entire amount will be recovered and that there is no need to provide for the loss.

A further investigation of the customer by *the client's credit manager*, yields the following description:

The customer is a rapidly expanding merchandiser of television, radio, stereo, and other consumer electronics equipment. It began as a single-store operation in 1974 and now operates a total of 12 stores across four States. Further expansion is planned in the near future. Earnings growth has been strong since 1974. As the firm expanded, its average payment time on accounts receivable has steadily increased. This is due to an inadequate accounting system rather than to cash difficulties. A new computerised accounting system is presently being installed and is expected to remedy the firm's payment problems.

Given the above information, what is your estimate of the probability that the accounts receivable will be collected in full next year?

.00	.10	.20	.30	.40	.50	.60	.70	.80	.90	1.00
-----	-----	-----	-----	-----	-----	-----	-----	-----	-----	------

TICK ONE BOX

The italics of '70 percent' are used for illustration only. This figure was varied so that each of four groups of respondents received a different estimate - 50%, 60%, 70% and 80% respectively.

Similarly the description 'the client's credit manager' was changed so that the source of the credit information - and perception of its reliability might be varied - through the use of an alternative description '*an independent credit agency*'.

Prior probabilities suggest expectations of complete recovery of account balances to regress towards the base rates, 0.50, 0.40, 0.30 and 0.20 respectively. The extent of this regression will be dependent upon the importance attributable to the description of the customer, and the reliability of the latter.

Such differences may be considerable in this case, because of the extent of the potential conflict between the messages conveyed by narrative and numbers.

Despite the weakness of the narrative information we might expect it to be predominant in an integration of two independent sources. Assignment of independence for the source of credit information might be expected to reduce the variability associated with the outcome of the narrative.

## RESULTS

### PRIOR PROBABILITIES OF % ACCOUNT BALANCES RECOVERABLE

<u>STATED</u> <u>PROBABILITY</u>	<u>DISTRIBUTION</u>					<u>SOURCE</u>	
	80%	70%	60%	50%	Overall	'Client'	'Independent'
0.0	0	1	0	0	1	1	0
0.1	2	1	0	1	4	2	2
0.2	2	1	4	2	9	5	4
0.3	3	5	6	3	17	10	7
0.4	7	6	7	6	26	12	14
0.5	14	8	4	7	33	18	15
0.6	8	10	6	6	30	14	16
0.7	8	9	16	14	47	25	22
0.8	9	12	9	14	44	20	24
0.9	6	3	3	5	17	10	7
1.0	<u>3</u>	<u>0</u>	<u>1</u>	<u>0</u>	<u>4</u>	<u>3</u>	<u>1</u>
TOTAL	62	56	56	58	232	120	112
MEAN	0.602	0.586	0.591	0.623	0.602	0.599	0.604
STD DEVN	0.219	0.206	0.209	0.197	0.209	0.217	0.199

There is insufficient difference between the group means to suggest that they are other than samples from the overall distribution, at a 5% level of significance. Such evidence is consistent with judgements made with disregard for the importance of prior probabilities, and total reliance on the narrative passage.

The overall mean probability of 0.602 (Standard deviation = 0.209) compares with the Joyce and Biddle finding of a mean probability of 0.705 in their corresponding





- 2 In the square below, put your estimate of the number of Big Eight clients per 1,000 that experience significant executive-level management fraud.

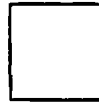

Italics are added for illustration of the variable items within the case. Four different anchors were provided to different groups of students as a 'guide' to the number of executive-level management frauds:

- ten (ie, one percent)
- twenty (ie, two percent)
- fifty (ie, five percent)
- one hundred (ie, ten percent)

The 'guide' number provides no new information relevant to the judgement process but, nevertheless, might be expected to influence the quantification of expectations.

## **RESULTS**

Total of 244 usable replies were generated:

Respondent Group	Sample Size	Specified No. of	Observed Mean	Standard Deviation	Median	Coefficient of Skewness
		Executive Level Management Frauds				
1	65	10	64.46	111.53	20	1.196
2	59	20	45.58	68.45	15	1.340
3	61	50	71.30	64.69	40	1.452
4	59	100	91.19	108.45	50	1.139
<hr/>						
OVERALL	244		68.07	92.71	40	0.908

The mean scores for respondents in Groups 2 and 4 differ significantly from the overall mean at a 5% level, but the overriding features are the very high degrees of variation together with the significant positive distribution skews.

The linear correlation coefficient between the No. of specified Frauds and actual estimates,  $r=0.1489$  is significant at a 5% level, but observations are more consistent with an adjusting upwards from the extreme low anchor, and downwards from the extreme high anchor. Such results are consistent with the existence of non-monotonic anchoring effects observed in psychophysics research (Helson and Masters [1966]).

Joyce and Biddle's corresponding experiment with auditors produced the following results:

Respondent Group	Sample Size	Specified No. of Executive Level		Observed Mean	Standard Deviation
		Management Frauds			
1	25	10		16.52	22.41
2	25	200		43.11	36.97
<b>OVERALL</b>	<b>50</b>			<b>29.81</b>	<b>33.33</b>

These results are consistent with the 'anchoring and adjustment' principle and the increased variability at the upper anchor is amplified in the present study by the high standard deviations corresponding with the extreme anchor points, though the precise effect of such a measure is dependent on the symmetry of the distribution. Prior probabilities in terms of an expected base-rate for executive level management fraud are likely to be beyond the experience of accounting undergraduates, contributing to the wide difference in mean incidence expectations.

These results are important in indicating the manner in which variations in base rates might be processed by respondents. They foreshadow difficulties in Chapters 8 and 10 concerned with changing users' perceptions of likely failed-non-failed combinations in material sets of ten companies; they suggest processing around an expectation of 'about 5' failed companies, together with adjustments based on the actual characteristics of the cases.

#### 4.3.4 CASE 4: AVAILABILITY

Examination of the semantic differential by Haried (1973) and Houghton (1987) has identified and quantified changes in users perceptions of the meaning of accounting terms. Perceived differences in meaning may have economic consequences via their effect on decision processes.

Attempts to quantify narrative terms in order to accommodate measures of uncertainty are currently an area of concern for Accounting Standard - Setting bodies worldwide.

SOURCE: S. LICHTENSTEIN and J.R. NEWMAN  
'Empirical Scaling of Common Verbal Phrases associated with  
Numerical Probabilities'  
PSYCHONOMIC SCIENCE (1967) Vol. 9(10) pp 563-4

Listed below are 5 common words or phrases that are used to express degrees of certainty or uncertainty. Beside each item please write the probability (numbered 0.01 to 0.99) which most clearly reflects the degree of probability implied by each word or phrase.

Unlikely  
Likely  
Minimal Likelihood  
Very Unlikely  
Very Likely

#### RESULTS

A total of 230 usable responses generated revealed the following:

	<u>Perceived Probabilities</u>		
	Mean	Std Devn	Median
Very Unlikely	0.12	0.12	0.10
Minimal Likelihood	0.20	0.15	0.15
Unlikely	0.24	0.15	0.20
Likely	0.66	0.13	0.70
Very Likely	0.81	0.12	0.80

All mean values are significantly different at a 5% level of significance.

Interestingly there is no 'mirror image' of corresponding descriptions.

ie, Likely (0.66) + Unlikely (0.24) < 1.00

Very Likely (0.81) + Very Unlikely (0.12) < 1.00

This skewness is consistent with the earlier results of Lichtenstein and Newman, who found a similar lack of correspondence in 8 of 11 matched pairs.

Reference to earlier studies does, however, highlight two factors contributing to differences in perceptions of the quantification of uncertainty:

- i) educational and experiential differences of the respondents;
- ii) the contextual framework of the quantification exercise.

Thus, this study with n=230 accounting undergraduates generated a mean probability of 0.66 for 'Likely', whereas the corresponding score of 0.72 documented by Lichtenstein and Newman was based on the n=188 scorable replies from a postal survey of male employees of a U.S. corporation; a highly significant level of difference in mean scores.

The earlier study by Cohen et al (1958) used n=125 adults attending evening classes to generate scores of 0.56 and 0.63 in two different forecasting contexts, attributable respectively to meteorological (weather forecast) and political (election forecast) probabilities.

These marked differences suggest that the contextual environment is of paramount importance, a critical factor in the examination of accounting communications, and in particular the evaluation of shared meaning between the preparers and users of accounting narrative.

Such results suggest that non-formula based measures of readability, including content-dependent measures of cognizability like the CLOZE score considered in Chapter 6, will be experience dependent. The degree of accounting sophistication of respondents may therefore be expected to have a positive effect on recorded scores, though not necessarily rank ordering, in the results of that chapter.

Similar effects might be expected in the interpretation of narrative messages and the emphasis accorded them relative to financial statements when both information sources are combined in the results of Chapter 8.

#### 4.4 SUMMARY OF FINDINGS

The experimental results of this paper are largely consistent with the psychological literature in lending support to the adoption of intuitive statistics in the decision-making process.

Cases 1 and 2 illustrate the ignorance of prior probabilities and the preference of respondents for 'soft' information - narrative providing only flimsy evidence - rather than the 'hard' information available in the form of numeric frequencies where both are available. This preference is consistent with the information selection processes suggested by Bell (1984a) when the information sources are respectively numeric and narrative.

Case 3 demonstrates the opportunities for influencing the decision-making process with irrelevant, or at best obscure, information.

However, whereas the pattern of results is generally similar to those generated by accounting practitioners, the differences in means and the variability of responses suggests that the use of student surrogates is hampered by an ignorance of population base rates that may be attributable to experience, and a lack of complexity in the information processing task. Such findings are consistent with the suggestions of Ashton and Kramer (1980) and Bouwman (1984).

Einhorn and Hogarth (1981) suggest that the nature of the judgemental task largely determines the decision strategies employed, and a concern for task structure suggests the development of a more realistic contextual framework in order to generate more reliable results from information processing.

The findings of these short narrative pieces point to potential difficulties in the operation of the respondent-based experiments in the latter part of this study. Expectations might include:

- i) a difficulty in changing the perceptions of respondents as to the base rates for failed proportions in sets of companies. Despite explicit information regarding the possible range of base rates, decision-makers will rely on central expectations and adjust around this anchor in accord with the characteristics of particular observations. The resultant distribution of outcomes might be expected to be curvilinear in shape, reflecting an undue proportion of errors when the materials set comprises an extreme number of failed cases.
- ii) a difficulty on the part of respondents in developing a consistent additive model through which to integrate findings from narrative and numeric sources. An undue emphasis on the qualitative information, where both sources are available, may lead to a marginal positive or negative effect on decision-making capabilities when apparently complementary information is provided.
- iii) measures of narrative message might be expected to be both context and experience dependent. It is therefore reasonable to expect improved performance from accounting practitioners, especially those seasoned in narrative financial statement analysis, in questions of comprehension and interpretation of narrative disclosures.

In order to test the findings of this chapter in an accounting environment, a sample of companies was selected for which both narrative and quantitative information sources were available. Chapter 5 details the selection of such a sample together with the objectives of each of the intended experiments.

## CHAPTER FIVE

### DATA SELECTION AND SAMPLING OF COMPANIES

#### 5.1 OBJECTIVES OF SAMPLING PROCEDURE

Each of the foregoing chapters, 6 through to 10, is concerned with extensive empirical exercises making use of a common set of companies. Details of the administration of the individual experiments are contained in the corresponding chapter, but here we describe the basis of construction of the common dataset and of selection of the subsequent samples.

Experiments in the next five chapters are conducted to examine the content and presentation of both narrative and accounting statement information, utilising as far as possible the same companies, in order to facilitate comparisons both between companies and between alternative analytical procedures.

Throughout we use the failed/non-failed decision as an initial task environment since there is already a wealth of literature in this area. If the techniques employed can be shown to be applicable to this task environment they may then be extended elsewhere.

- i) Chapter 6 is concerned with the presentation of narrative and reports on the administration of a CLOZE experiment, to determine how well subjects of varying degrees of sophistication, can interpret narrative financial messages. The intention is to demonstrate a difference between 'readability' (as measured by standard formulae) and 'understandability' (as measured by target respondent) and to examine their implications for the prediction of future company performance.
- ii) Chapter 7 is concerned with the content of narrative and reports on the administration of a content analysis, to determine the nature and extent of the information conveyed in the chairman's narrative statement.
- iii) Chapter 8 is concerned with the content of accounting statements and reports on the administration of an experiment in which the decision-making capabilities of respondents are compared in situations where their information sources are varied, comprising either/both narrative or/and accounting statements. The intention is to determine the incremental information content of the chairman's narrative over and above that contained in the quantitative financial statements.



- iv) Chapter 9 and 10 are concerned with the presentation of accounting statements and report on the administration of an experiment to determine the relative facility of respondents when making decisions using traditional information sources (accounting statements and financial ratios) and non-traditional sources (facial profiles). Here we seek to explore the potential for improving the decision-usefulness of financial information by varying the format in which it is presented.

A set of companies is required which is large enough to encompass the whole range of performance possibilities, but small enough to allow the generation of efficient experimental designs consistent with the realistic administration of empirical work.

A matching principle was therefore envisaged in order to sample pairs of companies with many matching attributes, but differing significantly in aspects of their financial performance. A number of essential characteristics of the matched pair was specified.

- i) the two companies will comprise a failed/non-failed combination. One company will have failed and ceased trading the other will be apparently healthy and still trading;
- ii) the two companies must display Z-scores of opposite signs. The failed company is predictable as 'distressed' on the basis of its final published annual disclosure prior to failure, recording a negative Z-score based on Taffler and Tisshaw (1977), while the non-failed enterprise records a positive sign. The environmental predictability of the sampled pair is therefore high, with both distinguishable on the basis of their past financial profiles. Ideally the two companies will represent extremes of relative financial performance, exhibiting a clear distinction, rather than a combination of marginal-negative with marginal-positive Z-score;
- iii) the Chairman must report separately from his directors, in order to provide a sample narrative suitable for analysis;
- iv) the length of the narrative must satisfy certain minimum requirements in order to facilitate the efficient administration of tests of the content and presentation of narrative statements;

- v) the two firms will be members of a common industrial sector, and ideally have common product areas;
- vi) the firms must be of the same 'order' of size; ideally they will have sales turnover figures which do not differ significantly;
- vii) the firms should have common financial year ends to facilitate comparison and minimise the effects of external economic factors.

No constraints on the size of the sample were imposed at this stage; the objective was to generate as large a sample as possible of matched companies, each match to include a recent failure. It was anticipated that further subsampling might be necessary to generate efficient designs for the respondent-based experiments.

In the only comparative accounting based study of narrative disclosures in the literature Ingram and Frazier (1983) confine their attention to companies within a particular industrial sector in order to avoid potential intra-industry complications, such as those associated with specific technical processes. However, this study, in attempting to discriminate between failed and solvent companies, would have been intolerably constrained by such an imposition - restricting the sample to maximum of about five companies within a particular sector. We therefore seek as large a sample of companies as possible, to facilitate statistical analysis of the results, consistent with a requirement to overcome difficulties associated with technical language.

## 5.2 SAMPLING METHODOLOGY

To avoid industrial specific peculiarities companies were matched by industry and then a further matching procedure was carried out in order to pair-off these sector based companies. By matching simultaneously on sales turnover and financial year end, both size and time differences should be eliminated, or at least alleviated.

The initial selection of companies to form part of the narrative analysis, therefore, followed the procedure below:

- i) Failed manufacturing companies were identified with a final year-end prior to failure not earlier than 31 December 1978. Receivership,

voluntary liquidation and compulsory liquidation were taken to be evidence of failure.

- ii) Failed companies which were not exhibiting signs of financial distress at the time of failure, were eliminated from the sample. A negative Z-score based on the PAS formula (Taffler (1984)) was used as evidence of financial distress. No companies were eliminated from consideration on this condition.
- iii) For each of the above companies narratives were sought in which the Chairman reported separately from the Directors in the final Report and Accounts. Norvic Shoe failed to satisfy this condition and was eliminated from the sample. Scotcros was allowed to remain, even though it was the Managing Director who reported separately, in the place of a newly incumbent Chairman.
- iv) The Chairman's Statement was considered of sufficient length to facilitate the use of the Cloze procedure in measuring cognizability of text. A minimum length of about 150 words is suggested by Taylor (1953) and Miller and Coleman (1967) to allow between 30 and 50 deletions in text mutilation. Melody Mills, with only 51 words in the Chairman's narrative was eliminated on this condition, but Woodrow Wyatt, with only 147 words, allowed to remain.
- v) For each remaining failed company a surviving enterprise was identified which provided a close match on each of the following conditions. Where no suitable matching company could be identified, the corresponding failed company was removed from the sample:
  - a) a common industrial sector, wherever possible based on major product area, otherwise on Stock Exchange Classification. Where companies were widely diversified matching was attempted on their chief area of activity.
  - b) equivalent size, as measured by sales turnover, external to the organisation and net of sales taxes. Wherever possible this matching was completed on the basis of a direct numerical comparison, but in difficult cases some matching was completed on the basis of 'small' (turnover < £10m) or 'very large' (turnover >£100m).
  - c) a common financial year end. Where month differences varied a 3-month difference was sought, but a 6-month difference tolerated where there was no suitable alternative.

- d) an indication of financial well-being to demonstrate a status diametrically opposed to the distress of the failed set. Again the PAS Z-score formula was employed, with a positive score being sought. A significantly higher relative performance score, compared to the corresponding failed company, was considered essential. The relative performance (or PAS) score is constructed by ranking firms in a particular year by their Z-score in order to provide a measure on a scale from 0 to 100. The PAS Score then indicates, on a holistic basis, the percentage of companies doing less well in any year and provides an intertemporal measure of relative performance in the manufacturing and construction sector. A PAS-score difference in excess of 20 points was employed as the acceptability criterion.

Two of the surviving companies failed to satisfy this condition. M Y Dart (Z-score = -0.82) was eliminated along with Mettoy (Z-score = -8.25), its matched failure in the toy sector. Similarly, Smith Whitworth (Z-score = -2.57) and Wilshaw Securities (Z-score = -6.22) were eliminated on the grounds of a common distressed profile.

- e) Chairman reporting separately from his Directors. Hence, Tomkinsons, Early's of Witney and Sumrie could not be considered as potential matches for failed companies within their respective sectors.
- f) Chairman's narrative satisfying the 150 word minimum length condition. Forminster (81 words) failed to satisfy this criterion.

A match was sought which simultaneously satisfied each of these conditions.

Where potential matching companies failed to meet a critical criterion re-matching was carried out on a next-best basis. Where no suitable matching company could be identified, the corresponding failed company was removed from the sample. This inability to identify a suitably close matching pair of companies drastically reduced the number of companies under consideration. The original database comprised the 54 failed companies from the quoted manufacturing sector with last published accounts within the period December 1978 to June 1985, but the resulting sample was reduced to 33 matched pairs (ie 66 companies). The companies, and matching criteria, are to be found in Appendix 5.1.

### 5.3 SUBSAMPLING FOR CHAIRMAN'S NARRATIVE EXPERIMENT

(Ref: Chapters 6 and 8)

The above sample of 66 companies was used at the pre-test stage with student respondents to establish two aspects with regard to the communication of narrative:

- i) an indication of the range of difficulty experienced in understanding the narrative message, as a prelude to the generation of a main test instrument employed in Chapter 6 to measure cognizability.
- ii) the extent to which the identity of failed and non-failed companies might be misjudged on the basis of the Chairman's Statement alone. The ease with which the message was comprehended, and the interpretation placed on that understanding in terms of the financial message conveyed, formed the basis of the test instrument employed in Chapter 8.

A large sample of responses from 146 final year undergraduate finance students from CCAT (Cambridge), with a limited exposure to the content of voluntary narrative disclosures, allowed the generation of ranked groupings based on degree of difficulty.

- i) Each student processed five CLOZE manipulations to ensure that each case had been completed at least nine times. The systematic manipulation of text tests its comprehension by allowing content to be predicted on the base of its adjacent context. Appendix 6.2.2 provides an example of the test instrument.

Three groupings, of 22 companies each, emerged based on average CLOZE score, as a measure of the ease with which a narrative message was conveyed. These were recorded and termed:

DIFFICULT	for scores in the range of 0% to 45%
MEDIUM	for scores in the range of 45% to 52%
EASY	for scores in the range of 52% to 60%

The percentage score indicates the success with which respondents can 'predict' words in a mutilated message. The actual range of scores, overall, was from 33.2% to 64.2%. Although the numerical division between the groupings was somewhat arbitrary, classification on the basis of equal proportions allowed the identification of cases at extreme ends of the cognizability scale, and facilitated further sub-sampling.

- ii) Each student processed ten examples of the Chairman's narrative in order to make a failed/non-failed decision on the basis of this source alone. Each case was examined at least 15 times.

Three groupings, of 22 companies each, emerged based on the extent to which a particular company was misclassified (ie: classified as failed when actually non-failed, or classified as non-failed when actually failed), based entirely on the interpretation of the content of the Chairman's narrative. Appendix 8.3.1 a) provides an example of the test instrument.

The % Misclassification score was recorded for each of the 66 companies and termed:

DIFFICULT	for scores in the range of 100% to 37%
MEDIUM	for scores in the range of 37% to 18%
EASY	for scores in the range of 18% to 0%

The actual range of scores recorded was actually from 0% (case never misclassified) to 100% (case always misclassified).

Again, an arbitrary numerical division between the groupings resulted, but one which highlighted the degree of divergence between cases and provided a classification on the basis of equal proportions.

Appendix 5.2 and Appendix 5.3 contain, respectively, details of the preliminary company groupings based on the CLOZE Procedure, and the Chairman's Statement Analysis. This dual three-fold split formed the basis of a more elaborate experimental design, where the intention was to carry out an in-depth study of a smaller number of cases selected from across the whole range of narrative difficulty. The revised sample set ideally had several desirable properties:

- i) an equal number of failed and non-failed companies, to facilitate variations in the proportions of each in the test materials;
- ii) an equal number of Difficult/Medium/Easy cases from each of the classification in order to generate an efficient experimental design;
- iii) a relatively small number of cases overall to reduce the number of sophisticated users required to repeat the test;
- iv) a number of cases which would permit the randomising of the order of processing for cases of different degrees of difficulty in order to improve the internal validity of the test instrument;
- v) a design permitting respondents to be tested on both aspects of the analysis (ie CLOZE and Chairman's Statement) without identical cases reappearing, and without exceeding a time constraint of about two hours.

These conditions could not be satisfied simultaneously using a random means of selection. The unevenness of distribution of the failed cases made systematic methods difficult, and it proved impossible to produce a suitable set of CLOZE procedures all of which comprised a mixture of failed and non-failed cases. A 'next-best' approach was employed to devise a scheme which employed only 36 companies in all (of which half were failed). The

distribution of companies allowed the generation of 18 sets of eleven companies each.

This number allowed:

- i) the running of a CLOZE procedure of 3 companies simultaneously with one based on the analysis of 8 Chairman's Statements. None of the companies from each part of the test were coincident;
- ii) the number of failed cases in each of the Statement sets could be varied from zero up to eight, in order to test for the effects of varying base-rate probabilities;
- iii) the CLOZE tests employed comprised one of each from the Difficult/Medium/Easy groupings for each material set based on % CLOZE Score, with ordering of processing varied to cover all possibilities;
- iv) the Chairman's Statement analysis comprised representatives from each of the Difficult/Medium/Easy groupings based on % Misclassifications, with the 3:3:2 distribution of cases varied to cover all possibilities;
- v) the 36 companies selected comprised 12 each from the three % Misclassification groups. Of these, 18 companies (of which 11 failed) were used in the CLOZE test, 6 each from the three difficulty groups.

The resulting experimental design for the major test instrument is detailed in Appendix 5.4. The administration of the experiment and the results generated are discussed in Chapters 6 and 7.

#### 5.4 SUB-SAMPLING FOR THE FACIAL PROFILES EXPERIMENT

(Ref: Chapter 10)

As well as the linguistic aspects of communication, examined in Chapters 6 to 8, this study also investigates visual aspects of presentation. Initial impressions and perceptions of information are important to the manner with which it is used and the degree of reliability placed upon it. Bell (1984a), among others, examines differences in perceptions between narrative and numerical sources; Wright (1968) and Ehrenberg (1977),



among others, comment on the relative advantages of tabular-numerical and graphical displays. Cleveland and McGill (1987) suggest that graphical perception, the visual decoding process, is a controlling factor in the ability of a graph to convey information.

Chapters 9 and 10 look at graphical methods of presenting accounting information, culminating in an empirical study involving the use of computer-generated graphics, in the form of facial portraits (termed 'picites' by Harrison (1964)). The objective is to examine the relative advantages that such a visual display might have over more traditional methods of presenting financial statements.

The first experiment with the use of facial profiles in the representation of financial information identified potential deficiencies in the procedures adopted in the initial experimental study of Section 10.2. The test was, therefore, repeated using a revised sample design employing a sub-sample of the 66 companies identified above, and in Appendix 5.1.

Sample companies were selected on the bases of the values of three financial ratios and their corresponding PAS (relative performance percentile) scores. The ratios, indicating respectively profitability, financial risk and liquidity, together provide a measure of overall performance. These ratios represent the three most important dimensions identified by Sudarsanam and Taffler (1980) in a principal components analysis of the relative financial performance of companies in the manufacturing and construction sector.

The following criteria were sought:

- i) a diverse set of financial profiles based on the use of only three ratios, in order to allow all possible variations of assignment to be employed within a viable materials set;
- ii) a sub-sample representative of the whole matched sample, containing equal numbers of failed and non-failed companies and ideally a series of matched pairs;
- iii) a lack of duplication of ratio profiles, in order to avoid identical facial portraits;
- iv) avoidance of multicollinearity between the ratio sets.

A sub-sample of 30 companies was selected which largely satisfied the above conditions. Appendix 5.5 details the financial ratios and PAS profiles of the chosen set. Appendix 5.6 details the distribution of ratio values compared with the complete matched sample, demonstrating the choice of a representative group of companies with ratio values spread across the whole of the percentile range.

In the eventuality only seven matched pairs (14 companies) were able to satisfy the criteria for inclusion in the sub-sample.

The pooled within-groups correlation coefficient matrix of financial ratio values reveals relationships, not statistically significant at the 5% level, between RISK ( $TL/NW$ ) and LIQUIDITY ( $QA/CL$ ) with  $r = -0.23$ , between RISK and PROFIT ( $PBIT/TA$ ), where  $r = -0.29$ , and between PROFIT and LIQUIDITY where  $r = 0.2$ . The analysis by Sudarsanam and Taffler (1980) suggests that for a large sample of companies ( $n = 547$ ) these dimensions are orthogonal.

Random sampling was employed within the 30 company sets to generate materials comprising ten companies each, with the number of failed cases varying between zero and ten. This sample design then provided a framework for the test instrument employed in Chapter 10 to evaluate the decision usefulness of a facial profiles format.

Chapters 1 and 5 together establish, respectively, the experimental objectives and sampling base fundamental to the empirical work of this thesis. Chapters 6 to 10 detail the methodologies employed and the investigative procedures undertaken in the administration of the experiments.

## CHAPTER SIX

### COMMUNICATION OF NARRATIVE AND ACCOUNTING INFORMATION IN ANNUAL ACCOUNTS

#### 6.1 SHARED MEANING IN ACCOUNTING NARRATIVES

The measurement of meaning is an important research area in accounting, not least since the absence of a shared meaning between producer and user may have damaging decision-useful consequences. This chapter focuses on the potential misinformation that might be conveyed by the Chairman's narrative, and the different levels of understanding attributable to users of varying degrees of sophistication.

The pioneering work of Haried (1972 and 1973) and Houghton (1987a, 1987b and 1988) has largely been word based and restricted to financial statement vocabulary. Thus Haried (1972) used the antecedent-consequent technique to measure the denotative meaning of accounting terminology, ie perceptions of an objective definition of events, and used the semantic-differential to measure connotative meaning, ie subjective attitudes towards the same events. Houghton (1987a) used the semantic differential technique to measure inter-temporal changes in connotative meaning and Houghton (1987b) demonstrates a lack of shared meaning for the concept 'true and fair view' between accountants and shareholders.

Oliver (1974) extended the scope of Haried's studies from accounting statement terminology to the concepts underlying their construction, demonstrating a lack of communication between producers and users, and marked differences in interpretation between accounting academics and other groups.

This thesis develops this initial work in two directions:

- i) by extending word-based research from accounting concepts and accounting statement terminology to the narrative content of accounting disclosures
- ii) by moving from a purely word-based approach to one that is concerned with the message conveyed by phrases, sentences and thematic content of the narrative.

Chapter 7 is concerned with the analysis of the content of the narrative. The remainder of this chapter is concerned with the manner in which that message is presented and in particular its degree of difficulty.

If the message intended by the preparers of accounting disclosures is to be successfully conveyed the receiver must be able to both read and understand it. Adelberg and Razek (1984) incorrectly make no distinction between the terms 'readable' and 'understandable'. This work will demonstrate that the differences between the two are both measurable and significant.

## 6.2 MEASURES OF READABILITY

Studies of readability of narrative accounting statements have focused on two aspects:

- i) the understandability of the text and success in the communication of accounting messages
- ii) the implications of particular levels of readability for other aspects of financial performance.

The majority of research effort has thus far been directed towards the former. Both Smith and Smith (1971) in the US and Healy (1977) in New Zealand have raised serious doubts about the comprehensibility of footnotes appearing in accounting disclosures. Smith and Smith found that less than 20% of the US adult population had achieved an educational level sufficient to comprehend the messages appearing in 86% of the notes to financial statements. On the basis of similar findings Healy noted: 'the majority of footnotes to financial statements are of low readability, and this prevents many investors from gaining the information which may be necessary for rational economic decision making'.

Still (1972) used the Flesch reading ease formula to assess the readability of a systematic sample of 50 UK Chairman's Statements, finding that 77% of the reports required a level of reading ability which was beyond that of 80.7% of US adults.

Stevens, Stevens and Raabe (1983) used the CLOZE procedure to measure the readability of FASB statements, identifying two potential user groups who found them unreadable. They emphasised the reliability of their procedure in comparison to those based on sentence length and word difficulty and

recommended improvements to readability through the minimisation of obscure technical jargon and a reduction in lengthy sentence patterns.

Adelberg (1979b) also used the CLOZE procedure on narrative disclosures, finding that accounting policies, footnotes, managements' analysis of operations and other narrative disclosures were not well understood by a group of trainee bank loan officers. He further suggested the use of CLOZE to replicate the study by Morton (1974), to determine whether message manipulation was a function of understandability and operating performance. The latter had established a positive correlation between the understandability of disclosures in financial statement footnotes and favourable nature of the content of these footnotes. His findings suggested that negative disclosures may be shrouded in unnecessary complexity by the preparers of accounts quite intentionally.

The Morton study is one of few which have attempted to relate readability and financial performance. Another more recent one by Courtis (1986) reviewed the limitations of readability formulae and applied the FLESCH (1974) and FOG (1968) formulae to the Chairman's address and footnotes in a sample of Canadian annual reports. He found no evidence to suggest that low readability was related to either low profitability or high risk. This latter study is notable for the manner in which it fails to give detailed consideration to the LIX (Anderson (1983) and Bjornsson (1983)) and CLOZE (Taylor (1953)) procedures, arguably preferable as readability measures in an accounting environment. This prompts a discussion of the relative advantages of the alternatives.

### 6.2.1 ALTERNATIVE READABILITY FORMULAE

Readability formulae have been widely adopted as alternatives to reader-feedback and comprehension tests in assessing the difficulty of narrative passages. They are all based on two features:

- i) word length (w) - related to speed of recognition, and
- ii) sentence length (s) - related to a recall of words in the immediate memory.

Word and sentence complexity cause the greatest difficulty, but mere length is much easier to measure. Several authors, notably Klare (1974-75) and Davison and Kantor (1982) have argued that reducing sentence length will

not necessarily improve matters, since the addition of subordinate clauses often aids comprehension.

The following abstracts are illustrative of the differences in complexity of Chairman's Statements attributable to sentence length:

The Annual Report for George Spencer PLC at 31 December 1983, the last prior to failure, includes the following within the Chairman's Statement:

"In the Dyeing and Finishing area we have found it necessary to establish and fund an operation alternative to that previously conducted by Saxby in order to reduce a potentially extremely large claim for damages in respect of the three year agreement with Nova which would fall on Saxby to the detriment of creditors of the company and would also have led to a claim against George Spencer PLC by reason of its guarantee of Saxby's obligations under the agreement".

A sentence of 80 words in length, without any punctuation whatsoever.

In contrast the Report of Ruberoid PLC (a financially sound company) at 31 December 1981, has the following paragraph in the Chairman's Statement:

"Contracting

This Division is mainly concerned with roofing and cladding. Contrary to popular experience our level of completed contracts and profits shows a marked improvement. The incidence of completed contracts has a noticeable effect on profits. This year was particularly good".

Four short sentences in all in a simple paragraph of only 40 words, and an average of only 10 words per sentence. A paragraph typical of the style of the statement as a whole.

It is interesting to note that statements disclosed by other companies under the common chairmanship of Thomas Kenny are written with a similar style and clarity to that of Ruberoid. Thus Grimshawe Holdings (30 April 1981) a failed company, exhibits similar low levels of both word and sentence complexity. Words per sentence of 16.27 (Ruberoid 14.38) and syllables per word of 1.61 (Ruberoid 1.66). Jones (1988) details the results of a case study devoted to the examination of the readability of the narrative of one company (H-P Bulmer) over a period of time. His findings suggest that readability is a

function of company size and personality of chairman, as well as declining over time. In these instances the chairman clearly has close control over the content and presentation of the narrative, but there is no authoritative literature to confirm that this is a widespread phenomenon.

Different readability formulae arise because of different measures of 'word length' and different weightings applied to the component parts. Three representatives of the infinite possible alternatives are worthy of detailed consideration:

i) 
$$\text{FLESCH} = 206.385 - 0.846W - 1.015S$$
  
where  $W =$  Word length = no of syllables per 100 words and  
 $S =$  sentence length = total no of words/total no  
of sentences

The formula is simple to compute apart from the tedious necessity of counting all of the syllables and determining the number of syllables in certain problem words (eg, stopped, USA and 1987).

The calculation represents a deduction from the base constant for both word and sentence complexity, so that the higher the score the easier the readability (ie, 80+ for comic journals, but less than 50 for academic literature, and less than 30 for technical and scientific articles. Most accounting communications would be expected to coincide with the academic literature category since they do not contain the same level of technical jargon as academic journals).

ii) 
$$\text{FOG INDEX} = 0.4(W + S)$$
  
where  $S =$  average number of words per sentence  
and  $W =$  % of 'hard' words in the passage

The definition of a 'hard' word is most ambiguous and is a considerable weakness in the use of this formula (Kwolek (1973)) Such words include abbreviations, words having three or more syllables and symbols. But these exclude arithmetic operator symbols, capitalised words, combinations of easy words and verb forms ending -es, -ed or -ing. Thus 'profitable' might be a hard word but not 'profiting' or 'bookkeeper'.

The calculation is incremental with increased complexity so that the higher the score the more difficult the readability (ie, less than 14 for newspapers and comics, but greater than 17 for scientific and technical literature).

iii) LIX FORMULA = S + W

where S = average number of words per sentence

and W = % of words of seven or more letters

The advantage of using a particular word length is great both for speed and reliability of calculation. Harrison (1980) and Anderson (1983) found the application of LIX both reliable and consistent for passages over five languages, so, since we have defined accounting as a language in Section 4.1, it would appear reasonable to extend this consideration to narrative statements in the annual report. The choice of seven letters as the cut-off point identifying difficult words seems somewhat arbitrary and it may be that a higher cut-off is more appropriate for complex technical literature in the accounting environment. This possibility is tested in Section 6.2.3.

Whereas these three measures predict readability without reference to context, the CLOZE procedure, importantly, differs in predicting the understandability of a complete passage based on a measure of comprehension of the contents of a sample of text. The procedure is a simple one and involves the mutilation of narrative passages by the deletion of every nth word and its replacement by a blank space. Respondents are then required to predict the correct insertion for the blank based on the surrounding context.

Taylor (1953) has shown that deletion of every fifth word gives optimum results and that a variety of subjects will provide near identical rankings of different passages. For passages containing unusual content he found CLOZE more reliable than standard formulae like FLESCHE and FOG. Bormuth (1968) found CLOZE test scores of 44% and 57% on English comprehension passages to be comparable to multiple-choice test results of 75% and 95% respectively. The percentage of correct replies is so low because only exact responses are treated as valid.

Miller and Coleman (1967) appear to have conducted the most extensive validation of the CLOZE procedure to date finding cross-correlation results of greater than 0.9 for:



- i) Five versions of the fifth word deletion to cover every word in each position in the sentence.
- ii) Multiple versions with only one word deleted from the passage.
- iii) An every-word deletion system with incremental information provided by revealing succeeding words one at a time.

They also experimented with alternative scoring systems comparing the traditional method, allowing only exact insertions, with a weighted version scoring 3 for exact word; 2 for synonym; 1 for correct word form. Since the systems correlated at 0.99 they concluded that the simpler, traditional method of measurement was preferable.

Follow up studies by Erickson and Hansen (1974) and by Bartoo (1975) have found no significant difference in CLOZE scores when either 'buffer zones' of unmutilated text are inserted, or when the amount of unmutilated text preceding the first CLOZE blank is varied.

Nestvold (1972) and Aquino (1969) have found that CLOZE procedure scores correlate highly with readers perceptions of the degree of difficulty of narrative. These studies would thus appear to go some way in alleviating Adelberg's (1979b) concern that CLOZE procedures must be shown empirically to be valid measures of reading comprehension if they are to be used to measure readability in the accounting environment. But Haried (1972) warns that 'reliance on empirical evidence generated by researchers in fields such as psychology, sociology and economics may be inappropriate when used to support hypotheses in accounting research'. Such a concern might suggest that further research is necessary to confirm that the 57% CLOZE criterion level is appropriate to technical accounting communications. Adelberg and Razek (1984) applied the CLOZE procedure to discriminate between accounting textbooks and recommend its further validation with accounting communications.

This study recognises the relative neglect of LIX and CLOZE procedures for assessing readability/understandability in the accounting environment and addresses the situation by testing the hypotheses below.

### Hypotheses:

H<sub>01</sub>: Null Hypothesis: no relationship between company size and length of narrative.

H<sub>1</sub>: The length of the Chairman's Statement is a positive function of the size of the enterprise.

H<sub>02</sub>: Null Hypothesis: no relationship between readability and financial performance.

H<sub>2</sub>: The readability of the Chairman's Statement is a function of the financial health of the enterprise, as measured by its Z-score.

H<sub>03</sub>: Null Hypothesis: no relationship between readability and company status.

H<sub>3</sub>: The readability of the statements of failed companies is significantly lower than that of surviving matched enterprises.

### 6.2.2 EXPERIMENTAL PROCEDURE

A sample of 66 companies was selected in accordance with the matching procedure detailed in Chapter 5. The Chairman's Statements for each of these companies were entered onto computer file and the Oxford Concordance Program (OCP) (Hockey and Martin (1988)) developed by Oxford University's Quantitative Linguistics School, used to generate a series of indicators:

- i) the total number of words in each statement;
- ii) a keyword sort based on word length, to identify the incidence and distribution of long words;
- iii) the total number of sentences;
- iv) an alphabetical sort of words, to allow the compilation of a statement dictionary;
- v) a concordance of the context of the incidence of all potential keywords.

This information allowed the calculation of:

- i) LIX scores as measures of readability
- ii) measures of correlation between turnover, readability, Z-score and length of statement
- iii) tests of significance for readability differences between matched pairs of companies.

The following normal conventions were adopted:

- i) Year dates (eg, 1987) treated as one word
- ii) Numerical product names treated as words (eg, S10 = one word, Dragon 32 = two words)
- iii) Initials (eg, PLC, UK, USA, EEC, ECGD) treated as one word
- iv) Non-date numbers not counted as words
- v) Hyphenated words treated separately except when they are unable to stand alone in the text:  
(eg, long-term = two words, co-operate = one word)
- vi) Apostrophes discounted except where meaning is affected  
(eg, company's treated as a 7-letter word; but care exercised in distinguishing we'll from well).

Appendix 6.2.1 details the calculated values of LIX and FLESCH readability scores for each of the 33 failed and 33 non-failed companies. The development of the research instrument, to conduct the CLOZE experiment, followed the application of the mutilation procedure to each of the Chairman's Statements, or to a sample of text from the statement, where its length precluded the use of the statement in its entirety.

Taylor (1953) suggests the use of 'about 50' deletions in the CLOZE test, while Miller and Coleman (1967) used 30 deletions in each of their validation studies. Pilot runs of the CLOZE procedure with a group of 20 business undergraduates suggested that deletions in excess of 100 took too long to process and caused respondent fatigue.

Accordingly the whole statement is used only when it is short enough to provide around 30 to 50 deletions (ie, word length of 150 to 250 words). In all other cases, the divisional review is eliminated from the statement and CLOZE fifth-word deletions carried out on the remainder. The common core of narrative therefore comprises an overall review of operations, strategy and future performance projections. In some cases this results in more than 50 deletions, and overall variations in the number of deletions range between 30 to 80.

The resulting statements are retyped and mutilated so that every fifth word is replaced by a line '.....' in each case of fifteen-character width. The deletions commence at the fifth word in the passage and continue at equal intervals throughout except for the incidence of proper names, dates and numbers.

The revised passages were pre-tested on a group of 146 undergraduate finance students, with each CLOZE statement measured on at least nine separate occasions by different respondents. Each respondent completed five such statements. Appendix 6.2.2 provides an example of the research instrument, together with the instructions issued to respondents.

### 6.2.3 EXPERIMENTAL RESULTS

The computation of LIX and FLESCH scores and the administration of the CLOZE procedure on a student audience allowed the testing of the Hypotheses of Section 6.2.1:

H<sub>1</sub>: Table 6.2.1 demonstrates that the length of statement, measured in terms of both Number of Words and Number of Sentences was found to be significantly related to the size of the company, as measured by Sales Turnover. The numerical content of the statements too was significantly related to size.

The Null Hypothesis H<sub>01</sub> is therefore rejected at the 5% level of significance and the alternative H<sub>1</sub> accepted.

SALES TURNOVER

	<u>FAILED COMPANIES</u>	<u>NON-FAILED COMPANIES</u>	<u>ALL COMPANIES</u>
No of Words	0.483	0.594	0.439
No of Sentences	0.490	0.613	0.484
No of Numbers	0.382	0.643	0.434

TABLE 6.2.1: CORRELATION COEFFICIENTS: STATEMENT LENGTH/SIZE

H<sub>2</sub>: Table 6.2.2 shows that Readability, measured in terms of word and sentence complexity by the LIX and FLESCH scores, was found to be significantly related to financial performance. The level of intercorrelation between the two scores was significantly high ( $r = -0.78$ ). The Null Hypothesis H<sub>02</sub> is rejected at the 5% level of significance and the alternative H<sub>2</sub> accepted.

FINANCIAL PERFORMANCE (Z-SCORE)

	<u>FAILED COMPANIES</u>	<u>NON-FAILED COMPANIES</u>	<u>ALL COMPANIES (Z-score)</u>	<u>STATUS (0.1)</u>
LIX SCORE	0.055	-0.253	-0.317	-0.278
FLESCH SCORE	-0.181	0.406	0.410	0.344

TABLE 6.2.2: CORRELATION COEFFICIENTS : READABILITY/PERFORMANCE

H<sub>3</sub>: A comparison of the readability of the statements of failed and non-failed companies in Table 6.2.3 on the basis of overall groupings, and on the basis of a matched pair-wise comparison, reveals significant differences. The statements of failed companies exhibit significantly lower readability. The Null Hypothesis H<sub>03</sub> is therefore rejected at the 5% level of significance and the alternative H<sub>3</sub> accepted.

		<u>FAILED COMPANIES</u>	<u>NON-FAILED COMPANIES</u>	<u>PAIRWISE DIFFERENCE</u>
LIX SCORE	Mean:	56.71	53.68	3.03
	SD:	4.33	5.87 (t=2.67)	6.37 (t=2.32)
FLESCH SCORE	Mean:	33.11	38.32	5.21
	SD:	6.09	7.98 (t=3.16)	9.17 (t=2.89)

TABLE 6.2.3 READABILITY COMPARISONS: FAILED/NON-FAILED COMPANIES

A further analysis of the LIX formula was undertaken to examine its operation in an accounting environment. Alternative versions of the LIX score were calculated to test the arbitrary nature of its traditional definition :

$$\text{LIX SCORE} = \frac{\text{WORDS}}{\text{SENTENCES}} + \% \text{ Hard Words}$$

where Hard Word = one with 7 or more letters.

Alternative definitions were examined for 8, 9, 10, 11 and 12 or more letters and the corresponding LIX scores computed. The significance of the difference in scores, on each basis, was tested between Failed and Non-failed companies and the results displayed in Table 6.2.4. The score calculated on the basis of the traditional definition of 'hard word' proved the most significant.

	FAILED COMPANIES	NON-FAILED COMPANIES	t-STATISTICS
Difficult Word = 7 or more letters	56.71	53.68	2.42
Difficult Word = 8 or more letters	47.06	45.64	2.25
Difficult Word = 9 or more letters	39.92	38.53	2.39
Difficult Word = 10 or more letters	34.43	33.45	1.96
Difficult Word = 11 or more letters	31.05	29.92	1.79
Difficult Word = 12 or more letters	28.77	27.66	1.68

TABLE 6.2.4: MEAN LIX READABILITY SCORES: ALTERNATIVE VERSIONS

CLOZE scores computed for the complete sample of companies using student respondents generated the results reproduced in Appendix 5.2. A comparison of readability scores (LIX, FLESCH) with understandability scores (CLOZE) revealed a low but significant level of correlation between the two.

However, while the two formula based scores (LIX and FLESCH) are highly correlated ( $r=-0.78$ ), their correlation with the CLOZE score is relatively low, respectively ( $r=-0.23$ ) and ( $r=0.30$ ). This marked difference suggests that 'readability' and 'understandability' are indeed different concepts.

Appendix 6.2.3 details descriptive statistics for the entire readability study.

Student respondents were also asked to rank their CLOZE statements in accordance with their perceived difficulty in completion. The rankings of Perception of difficulty and actual CLOZE score were significantly positively correlated ( $r=0.303$  with  $t=2.545$ ) but the level of correlation lower than that attributable to the findings of Nestvold (1972).

The CLOZE score computations above allowed divisions according to degree of difficulty to be made in accordance with Section 5.3 and Appendix 5.2 facilitating the selection of a subsample of companies for testing on a more sophisticated audience. An experimental design (detailed in Appendix 5.4) was formulated which specified 18 separate sets of test materials. Each of these sets comprised 3 CLOZE cases - one designated 'easy', one 'medium' and one 'difficult' - corresponding to one, two or three failed companies. Failure base rates were incorporated into the experimental design by varying the proportion of failed cases in the set. Of the 18 material sets 6 contained 1 failure, 9 contained 2 failures and 3 comprised 3 failures.

The design of the experiment allowed for a repeat of the cases so that only 18 companies were included. The administration of the complete experiment, of 18 material sets to 18 respondents therefore allowed each of the 18 companies to be processed three times.

The experiment was administered to a group of ( $n=18$ ) accounting practitioners from the London Office of a Big 8 company and comprising 3 partners, 6 managers, 6 seniors and 3 assistants. Appendix 6.2.4 details the mean CLOZE scores recorded for each of the 18 cases, together with a comparison of the associated student-based scores. Table 6.2.5 displays the overall mean scores for accounting practitioners together with mean CLOZE scores for accounting undergraduates, and associated readability scores for

the same cases. Ranked order of difficulty is similar throughout, but absolute differences in scores are statistically significant ( $t=3.04$ ), with the practitioners outperforming the students. There is no suggestion in this size of sample ( $n=18$ ) that failure base rates influence the scores, but this needs to be tested on a larger audience.

	CLOZE SCORES (%)		LIX SCORES	FLESCH SCORES
	ACCOUNTANTS ( $n=18$ )	STUDENTS ( $n=146$ )		
MEAN	57.7	48.5	56.5	34.2
STANDARD DEVIATION	8.8	8.8	4.2	6.2

TABLE 6.2.5: CLOZE SCORES AND READABILITY SCORES

Interestingly the practitioners recorded higher CLOZE scores than did the students on every single case. The correspondence of the Accountant's mean CLOZE score with the 57% readability criterion suggested by Bormuth (1968) is notable.

Out of the 7 non-failed cases in the sample of 18 companies, 4 of these were considered the easiest to process, with CLOZE scores in excess of 66%. Of the 8 cases with scores less than 55%, 6 of these were failed companies.

Appendix 6.2.5 details the distribution of Readability and Cognizability (understandability) scores, establishing a reference for degree of difficulty related to the sophistication of the user. This distribution adds CLOZE scores to those of Anderson (1983) for LIX scores and Curtis (1986) for FLESCH scores.

#### 6.2.4 CONCLUSIONS

The experimental results provide empirical support for the hypotheses advanced above.

- i) the length of the Chairman's Statement (measured in terms of the number of words, sentences and numerical references) is positively related to the size of the enterprise (measured by its sales turnover). This may be attributable to the complexity of the organisation and diversity of functions.



- ii) the readability of the Chairman's Statement, in terms of word and sentence complexity, as measured by the LIX and FLESCH indicators is significantly correlated with the financial performance of the enterprise, as measured by the Z-score. Low readability is associated with poor financial performance, and in some instances may be consistent with deliberate obfuscation in order to conceal poor results.

This conclusion is in direct conflict with that of Courtis (1986), who found no systematic relationship between low readability, and high risk.

- iii) a matched comparison of failed and surviving enterprises revealed a significant difference in the level of readability. Readability scores among the failed group were significantly lower than among the survivors, suggesting that the readability index has potential predictive power in the identification of failure candidates.

- iv) the understandability of the Chairman's Statement, as measured by the CLOZE score, was not highly correlated with associated measures of readability, suggesting that different concepts are being measured by these indicators. These results, in an accounting environment, differ from those detailed by Bormuth (1968) with other narrative sources.

The absolute level of CLOZE score differed significantly according to the level of accounting sophistication of the user. This suggests that understandability is related to context and to education and experience, and constitutes a different measure to readability indices calculated independently of either context or user. Any attempt to measure the understandability of accounting narrative messages should be related to the target audience, suggesting a preference for the CLOZE procedure.

The findings of this chapter suggest that the readability of the Chairman's narrative is performance related and that complexity of presentation is associated with the communication of 'bad news'. This relationship suggests that a measure of readability might constitute a useful explanatory variable in the construction of models classifying potentially failed companies.

Chapter 7 goes beyond merely a consideration of the presentation of narrative, to a detailed analysis of the content of that narrative. The potential implications are correspondingly decision useful in that narrative-based variables might be identified which improve on the predictive ability of existing performance related models.

**CHAPTER SEVEN**

**INFORMATION CONTENT OF NARRATIVE DISCLOSURES**

Shannon and Weaver (1949) modelled the communication process in a manner suitable to describe the effect of accounting disclosures:

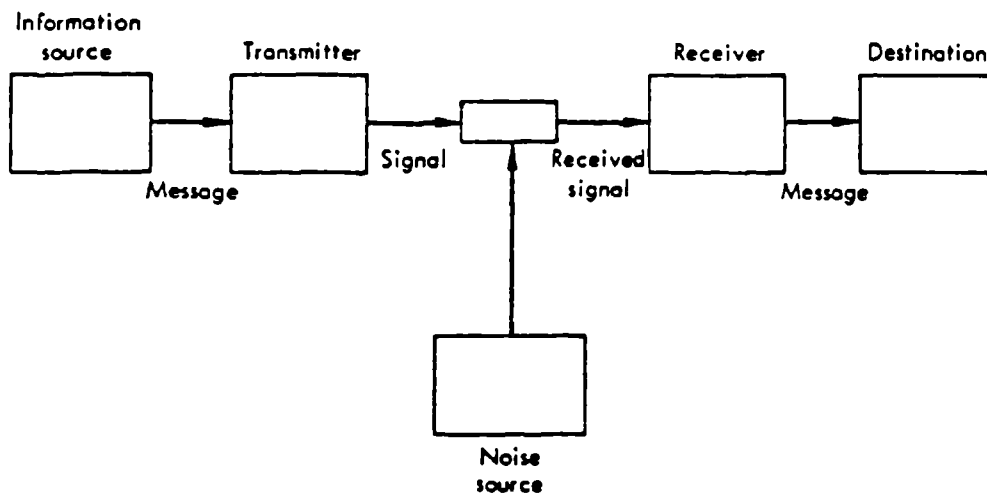

**FIGURE 7.1: THE COMMUNICATION PROCESS (SHANNON AND WEAVER)**

'Noise' can be any disturbance in the channels of communication that interferes with the signal transmitted and causes a different signal to be received than the one intended. The source of 'noise' may be attributable to the potential conflict arising from the simultaneous disclosure of several pieces of accounting information, or to educational and experiential differences which cause a breakdown in the communication process. Laswell (1948) emphasises the importance of 'Effect' to the right hand side of such a diagram, an appropriate addition for accounting communications in which the decision-usefulness of information is of central consideration.

McCroskey (1968) provides a more detailed version of the process in which a feedback channel is added, with the potential to influence future communications, and alternative sources of 'noise' identified in the 'encoding' and 'decoding' processes.

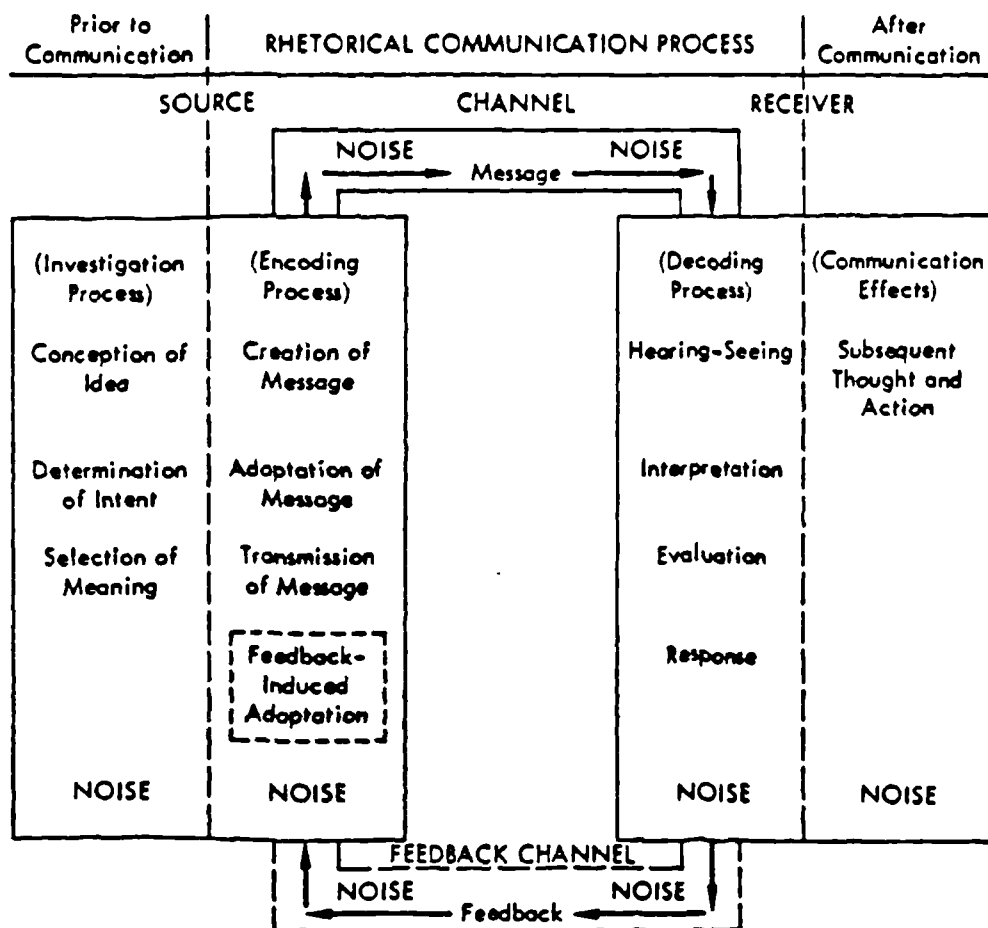

FIGURE 7.2: THE COMMUNICATION PROCESS (McCROSKEY)

Noise in the encoding process may be attributable to the adoption of language or tone inappropriate to the target audience. It may arise as a result of misunderstanding of the message to be conveyed.

Noise in the decoding process may be attributable to educational, experiential or differences apparent between the user and the preparer of the communication. Where general purpose annual accounting disclosures predominate, with no specific audience targetted, misunderstandings resulting from noise are inevitable.

If the intended message conveyed by the preparers of narrative statements differs from that received by users, two alternatives are possible:

- i) the receipt of misinformation, or at least only partial information,
- ii) the receipt of incremental information unintentionally disclosed.

A systematic analysis of the application of content analysis to accounting messages is long overdue, particularly in terms of our objective of improving their decision usefulness. This study attempts to redress the balance by conducting a content analysis of Chairman's Statements to determine whether they convey information which is different to that apparent from the financial statements.

Krippendorff (1980) has defined content analysis as 'a research technique for making replicable and valid inferences from data to their context'. In using narrative passages the basic unit of data is the word, and most inferences in content analysis studies have been made on the incidence of individual words and of collocations of one or more words.

Content analysis has received only fleeting reference in the accounting literature to date, with principal applications elsewhere. Statistical studies of literary style to solve disputes about the authenticity of writings began as far back as 1851 (Kenny (1982)) but without great success until the 1940's, by which time they were being applied in the psychological field. In this respect Moskovich (1977) cites the use of the co-occurrence of words in letters as indicators of the corresponding connections in the minds of mental patients.

Morton (1978) makes the following word classification:

- nouns - indicative of the subject matter of the text without indicating anything of the author;
- verbs, adjectives, adverbs - influenced by textual content, but also likely to be author dependent, since 'though used a variable number of times by different authors, [they] seem to be drawn by each author from a constant stock and so be typical of an author'.
- function words - particles (eg, a, an) and connectives (eg, and, but)
  - not influenced by textual content, but reflective of style and authorship.

Authorship studies have therefore been massed around non-noun words. Mosteller and Wallace (1963) constructed a linear discriminant model allowing them to distinguish the disputed authorship of Federalist papers based on the incidence of the words 'whilst', 'upon' and 'enough'. Stone and Hunt (1963) adopted a similar approach in following the pioneering work of Osgood and Walker (1959), by distinguishing between fake and genuine suicide notes on the basis of the use of concrete references to things and persons, the word 'love', and reference to thoughts and decisions.

Though successful in the analysis of word patterns and sequences, fewer studies have been devoted to an analysis of meaning, and the hidden messages conveyed in narratives. Berelson (1952) discusses the use of content analysis to expose propoganda techniques in political speeches, and in a similar context Ertel (1976) developed a 'dogmatism quotient' based on the choice of dogmatic and tentative alternatives in the works of philosophers and politicians, to measure the tone of the communication. Of perhaps wider application, Janis and Fadner (1965) produced a 'coefficient of imbalance' to measure the degree to which favourable statements outnumber unfavourable ones, when attempting to determine future intentions from political statements.

#### 7.1 CONTENT ANALYSIS APPLICATIONS IN THE ACCOUNTING ENVIRONMENT

As indicated above there have been few applications to accounting narratives. This might be considered surprising in that annual reports might variously be viewed as 'an undisguised advertisement' or 'platforms for preaching [management's] philosophies and [for] touting themselves and their companies' (Ingram (1983)), and the hypothesised misrepresentation of firms performance by management (Salamon and Smith (1979)). Bowman (1984) used the number of occurrences of the word 'new' in the Chairman's

firms performance by management (Salamon and Smith (1979)). Bowman (1984) used the number of occurrences of the word 'new' in the Chairman's Statement as a measure of managerial risk, and emphasised the advantages of content analysis as an unobtrusive measurement, since the statements are written for purposes and audiences different from those constituted by content analysts.

Several attempts have been made, notably by Peel et al (1985) and Keasey and Watson (1986), following Argenti (1976), to include non-quantitative variables in bankruptcy prediction models as proxies for financial ratios. These have included the shareholding and resignations of directors and the introduction of share capital but this approach strays from a content analysis based on word-meanings and occurrences.

We are all familiar with references in the Chairman's Statement to 'being poised to take advantage of any upturn' and of expressing 'appreciation of the support and understanding of our bankers'. This study is concerned with the significance that might attach to such references.

More specifically, we are faced with Mettoy's (1982) admission:

'the much greater improvement in performance which was anticipated did not arise since the foreseen increase in turnover did not occur'.

And that of Cocksedge (1984):

'Recovery is taking longer than we had hoped but I believe there are now grounds for cautious optimism'.

Both companies subsequently failed.

Although damning in isolation such remarks should be considered within the context of the remainder of the Chairman's Statement in a systematic analysis of content. Rather than emphasising anecdotal instances, this study conducts such a formal analysis.

Krippendorff (1980) identifies the major components of content analysis methodology, using the 'word' as the basic 'unit' of measurement:

- i) Data making - the counting of all separate units, or sampling where the number of units is unmanageably large. The measurement of units may be in absolute terms, or relative to the total number of units.
- ii) Data reduction - contextual classification of units either through a factor analysis or by allocation to investigator-specified categories. This process may be eased through predetermined or synonym dictionaries.
- iii) Statistical Inference - test of difference of number of occurrences between subjects or comparison of the observed number of occurrences with that expected if occurrences were to be distributed proportionally over all observations.
- iv) Analysis - identification of the key discriminatory features.
- v) Validation - test of qualitative standards and reliability.

The type of approach recommended has been used by Frazier et al (1984) with a program call WORDS, originally developed by Iker (1974) for use in a psychoanalytic environment. The program employs objective procedures in its analysis of narrative accounting disclosures and is not restricted by the need to preassign semantic tags.

WORDS isolates the most frequent content words, deleting function words, and tags and lemmatises them into their root forms. Intercorrelations between words are obtained, the assumption being that high correlations correspond with particular content references. A factor analysis then determines the dimensions which account for the obtained correlations, and these are subjectively interpreted. The technique therefore relies on frequency of occurrence and redundancy of language: repeated words and phrases are conveying the important messages in the communication.

Lothian (1976) addressed the question of redundant information in the annual report and regarded it as a factor which guarded against misinterpretation, while Lee and Tweedie (1977) thought it reinforced their communication objectives. Luhn (1957) thought that redundancy and thematic repetition be characterised by what he described as the 'major notion':



'a notion occurring at least twice in the same paragraph ... [or] which occurs also in the immediately preceding or succeeding paragraph ... even though it appears only once in the paragraph under consideration'.

This continuing repetition of a common theme and persistence in returning to a particular topic is common among Chairman's Statements. Witness, for example, the report of subsequently failing Berwick Timpo PLC for year ending 31 December 1981. A complete paragraph is devoted to a detailed examination of falsification of accounting records, but these irregularities are also mentioned in four other paragraphs of the statement, three preceding and one succeeding. Such exposure ensures that 'major notion' status be devoted to their theme.

Similarly, the five-paragraph statement of failing Nova (Jersey) Knit PLC for year ending 31 March 1984 contains four with detailed reference to the relocation of the Dyeing and Finishing plant.

There are, however, potential difficulties in several aspects of the application of content analysis. Hockey (1980) has recommended the use of prose text of at least 100 consecutive sentences - thankfully, a rare occurrence among UK Chairman's Statements. Oakman (1984) has stressed that although the instances of words and phrases in text can be identified systematically, they must usually be channelled into categories which are investigator-specified. Baker (1962) observes that discrimination between documents based on keywords is highly dependent on the choice of keywords, which in the face of an overwhelming variety of potential word-variables, must be investigator specified.

Such difficulties are recognised and addressed in this study:

- i) a copy of the WORDS package was secured, but discarded on the grounds of complexity and rigidity. A combination of text analysis with the Oxford Concordance Program (OCP) (Hockey and Martin (1988)) together with a comprehensive statistical package (SPSS-X) (Nie and Hull (1984)) was preferred on the grounds of flexibility and ease of operation.

- ii) the need for investigator-specification of keywords was recognised and a literature search performed in order to establish a suitable classificatory framework.

#### 7.1.1 CLASSIFICATORY SYSTEMS FOR CONTENT ANALYSIS

Osgood, Suci and Tannenbaum (1957) identify two classification systems worthy of consideration, each designed to analyse group differences and allow content characteristics to be related to quantifiable variables outside of the text analysis:

- i) The semantic analysis of content. The semantic differential offers a method of mapping certain aspects of a passage so that objects can be represented in multidimensional factor space. Experiments reveal roughly the same three dimensions:

EVALUATIVE:	Positive evaluation - Negative evaluation
POTENCY:	Strong - Weak
ACTIVITY:	Active - Passive

Houghton (1988) provides results which are substantially supportive of those of Osgood et al. In an intertemporal study of meaning in accounting he identifies a four-factor cognitive structure:

EVALUATIVE:	Beneficial - Adverse
POTENCY:	Tangible - Intangible
ACTIVITY:	Dynamic - Static
MANAGEABILITY:	Expected - Unexpected

ii) A structural analysis of language using the Need - Achievement (N-Ach) scoring system. This suggests a classification under the following achievement tags (with sample words to illustrate each category):

NEED	(wants, desires, hopes)
TO-BE	(become, becoming)
COMPETE	(win, gain, surpass)
VERB-POSITIVE	(doing, making, working)
ADVERB-POSITIVE	(carefully, cautiously, thoroughly)
ADJECTIVE POSITIVE	(great, powerful, promising)
VALUE-POSITIVE	(discovery, creation, intelligence)
ROLE-POSITIVE	(lawyer, executive, professor)
BLOCK	(broken, damage, crisis)
SUCCESS	(fame, glory, honour)
FAILURE	(error, incorrect, mistake)
AFFECT-POSITIVE	(happy, cheerful, delighted)
AFFECT-NEGATIVE	(sad, anxious, sorry)
TIME	(lifetime, life, years)

Some of these categories are clearly more applicable to narrative accounting statements than others, so a pilot study was carried out using a combination of the two approaches suggested above.

#### 7.1.2 EXPERIMENTAL PROCEDURE: WORD CONTENT

A pre-sample of 12 companies (not part of the final sample of 66 companies) was used to develop rules for the identification of content within narrative statements. Data had been collected on these companies with the original intention of their being included in the study, but they had been eliminated for failure to comply with the constraints of Chapter 5.

Six 'distressed' and six 'healthy' companies were selected reporting over the period 1981 to 1984. The two sets were drawn from diverse sectors of manufacturing industry (including engineering, construction, industrial plant, motor components, electrical and textiles) in an attempt to replicate the technical and environmental language to be expected in the major sample.

These companies, detailed in Appendix 7.1.1, comprised two sets:

- i) a financially distressed set of companies, all having negative Z-scores, but comprising 2 failed companies (Mettoy, Wilshaw), one taken over as an alternative to failure (Dunlop) and 3 companies who continue to trade (BSR, Smith Whitworth and MY Dart).
- ii) a relatively healthy set of successfully trading companies.

The Chairman's narrative for each of these companies was subjected to the Oxford Concordance Program to provide an alphabetic sort and concordance for each of the words occurring.

Using the concordance to verify coincidence of meaning, words were lemmatised to allow counts of those words with common roots (eg, profit, profits, profitable, profitability), and then allocated to message categories.

Function words, not influenced by textual context, were eliminated from consideration and the remaining keywords allocated to appropriate meaning categories. Independent verification was carried out independently by two other accounting academics, with a substantially similar categorisation.

The resulting classification provides eight categories to form the basis of an analysis of keyword content:

- 1 Uncertainty regarding the future
- 2 Vagueness about the past/present
- 3 Emphasis on maintaining the status quo
- 4 Reluctant need to take action
- 5 Dependence on external economic factors
- 6 Reference to measures of past performance
- 7 Detailing of Positive achievements
- 8 Detailing of Negative occurrences

These categories are consistent with the classifications of Osgood and Houghton, above:

EVALUATIVE:	Beneficial (Positive Achievement) - <u>Adverse</u> (Negative Occurrence)
POTENCY:	Tangible (Degree of Certainty) - <u>Intangible</u> (Vagueness)
ACTIVITY:	Dynamic (Measure of Performance) - <u>Static</u> (Reluctant Action)
MANAGEABILITY:	Expected (Status Quo) - <u>Unexpected</u> (External Factors)

Appendix 7.1.2 details the keywords (168 in all) identified under each of the classification categories.

### 7.1.3 EXPERIMENTAL PROCEDURE: SENTENCE CONTENT

A similar procedure was conducted on the pre-sample in order to establish the thematic content of each sentence in the narrative. This procedure is common to that adopted with the main sample and is therefore presented here in some detail.

Each sentence registered a theme score of 1 unit. Where a sentence comprised several separable themes then this unit was subdivided to register the relative importance of that theme in the narrative. No distinction was made between the length of sub-classes in any sentence, so that if a sentence comprised four themes, each was accorded a theme-score of 0.25. The overall score accorded any particular theme was perceived to be indicative of its importance within the narrative. Thus the narrative for Acrow PLC (31/3/83) comprised seven sentences thematically sub-divided as follows:

Declining markets	0.5
Weak engineering industry	0.5
Intensity of competition	0.25
Maintenance of sales	0.25
Reduction in margins	0.25
Substantial losses incurred	0.25
Dividend payment	1.0
Uncertainty in markets	0.5
Product leadership	0.5
Strength of sales force	2.0
Return to prosperity	<u>1.0</u>
TOTAL	7.0

Trading conditions and future uncertainty predominate, without the development of company specific themes.

Independent verification of the themes again produced a close correspondence. An alternative approach to the measurement of themes was also examined, according each theme mentioned a score of 1.0 on its appearance. This methodology produced no significant difference in the resulting proportion of good/bad/neutral themes, so the initial methodology was retained.

Kelly-Newton (1980) adopts an identical procedure, to the measure of themes adopted here, in her content analysis of the general comments section of a sample of replacement cost footnotes, examining management's reaction to disclosure requirements.

Nova Jersey Knit PLC (31/3/84) provides a stark contrast in the thematic breakdown of its 12 sentence narrative:

Plant Relocation	3.0
Joint Venture agreement	1.0
Profitability	0.5
Overheads	0.5
Diversification	2.0
Losses	0.5
Extraordinary costs	0.5
Damage claims	2.0
Loan Finance	1.0
Dividends	<u>1.0</u>
TOTAL	12.0

Eight of the twelve sentences revolve around common central themes - plant relocation to achieve a product diversification, with disastrous consequences. This case is clearly exceptional, but so is the extremely negative message conveyed by the narrative. Krippendorff (1980: 130) warns against the potential unreliability of self-applied investigator-developed recording instructions. He emphasises three aspects of the process:

- i) stability - intertemporal coding differences in the same observer should be insignificant.
- ii) reproducibility - coding rules should be such as to allow different coders in different locations to agree substantially on their assignments.
- iii) accuracy - the performance of coders should largely comply with a known 'right' answer.

There is no generally agreed level of correlation in performances which may be deemed satisfactory, but the pre-sample cases were tested for their conformity to the above aspects, as follows:

- i) the investigator replicated the original coding at an interval of approximately one month, with no discernible difference;
- ii) the coding exercise was replicated with a group of 15 UK final year undergraduate business students, but confined to only four of the original pre-test sample (Dunlop, Mettoy, Jarvis and Sound Diffusion). A substantial coincidence of thematic recognition resulted. Such differences as occurred were attributable to varying degrees of collectivism (i.e. factors like interest rate, exchange rate and inflationary effects were accorded separate theme status, rather than being attributed to 'external economic factors'), and to the use of a variety of semantic descriptions attributable to common themes;
- iii) the investigator-generated thematic structure was perceived as an 'ideal' except in instances where external coders identified a preferable degree of aggregation. This categorisation does not provide a judgement-free 'right' answer in terms of Krippendorff's definition, since this study is concerned with achieving a level of aggregation which will generate an optimum explanatory model of company financial performance.

Any level of validation may be subject to criticism. It might be argued that the content analysis performed here should be replicated over a longer period of time and with larger groups of coders. Such replications should take place to guarantee the internal validity of the test instrument, but results thus far are sufficiently encouraging to suggest that the content analysis of the complete sample should proceed

Accordingly, a general thematic framework was developed and applied to reduce the opportunities for variation within cases and to highlight the themes common between cases.

The major thrust of this framework was within Osgood's Evaluative dimension, identifying different components of the beneficial - adverse factor.

Five components were identified providing themes contributing to an overall balance between Positive (Good News) and Negative (Bad News). Table 7.1.1 below identifies the components, together with typical explanatory factors:

	POSITIVE	NEGATIVE
PERFORMANCE	Profits, Turnover, Productivity, Dividends	Losses, Debt, Borrowings, Banker's Support, No Dividend
TRADING CONDITIONS	Demand, Orders	Recession, Downturn, Competition, Margins
EXTERNAL FACTORS	Economic recovery	Strikes, Weather, Interest Rates, Exchange Rates
GROWTH	Expansion, Acquisitions, Investment, Development, Progress	Contractions, Closure, Disposal, Redundancy, Rationalisation
CHANGE	Innovations, New products, New technology, Diversification, New Markets	Major difficulties, Litigation, Failed product or acquisition, Damage claims, Technical problems, Lack of financial control, With- drawal of support, Partners sought

TABLE 7.1.1 THEME COMPONENTS IN CONTENT ANALYSIS

This framework made compatible alternative descriptions of common themes while reducing the impact of technical factors, complexities of process and other industry specific and company specific factors. While welcoming the guidance provided, it was not considered desirable to generalise the analysis



at this stage when unnecessary. Accordingly the major sample was analysed using a wide-ranging set of themes in order not to obscure the potential explanatory power of quite specific aspects. The framework provided the possibility of alternative dimensions in the analytic process, both a five component split and the 'good news - bad news' fall back position.

#### 7.1.4 EXPERIMENTAL PROCEDURE: MANAGEMENT ACTIONS

The approach outlined above generates conclusions on the basis of a summation of a sentence-by-sentence thematic analysis. An alternative approach is to identify predominant themes within paragraphs or even from the whole narrative. This approach seeks to identify indications of attitude, confidence, future intentions and forward strategies.

The study by Bowman (1984) suggested the coding and counting of lines of prose on issues of:

- corporate social responsibility
- acquisitions
- international activities
- price control
- foreign joint ventures
- strategic planning

A similar US study by Ingram and Frazier (1983) across three industries, metal manufacturing and fabricating, oil, and chemicals, identified the following predominant themes in the President's Letter:

- 1 Environmental quality control
- 2 Impact of modernisation of capital facilities
- 3 Increased levels of earnings and sales
- 4 Changes in operations to improve profits and strengthen company
- 5 Growth by investment and future expansion
- 6 Impact of strikes
- 7 Impact of foreign imports
- 8 Outlook for improvement
- 9 Major successes of last quarter operations
- 10 Maintenance of programme of operations in the face of advertising.

The follow-up study by Frazier, Ingram and Tennyson (1984) generated the following twelve factor-themes from management analysis data and concluded that their overall findings were consistent with the hypothesis that such narrative data was useful for predicting future performance:

- 1 Continued progress, strength of future position
- 2 Tax effects
- 3 Increases in debt
- 4 Environmental improvements
- 5 Domestic decline accompanied by foreign growth
- 6 Comparison of earnings with previous year
- 7 Effect of strikes
- 8 Substantial recent improvements in performance
- 9 Effect of raw material costs on profits
- 10 Increase in dividends
- 11 Decrease in revenue resulting from price increases
- 12 Effect of government regulations

Such categories are clearly industry dependent, especially where extractive industries are under consideration, otherwise these findings are largely consistent with the five-component classification detailed above.

An examination of the pre-sample cases revealed three factors of interest to further analysis:

- i) a very similar structure to each of the Chairman's narrative, in that, although no common ordering of items was observed, topic coverage was almost identical:

- |   |                    |   |
|---|--------------------|---|
| 1 | Trading Activities | - sales turnover; profits; acquisitions/investments; disposals/closures; exports/overseas ventures; new products/diversification; rationalisation/restructuring |
| 2 | Dividends          |   |
| 3 | Finance            | - capital expenditure; modernisation costs; liquidity; borrowings/overdrafts; extraordinary costs   |
| 4 | Accounting Changes |   |
| 5 | Economic Climate   | - Competition; recession; inflation; interest rates; exchange rate  |
| 6 | Divisional Review  |   |
| 7 | Personnel -        | Board changes   |
| 8 | Future Prospects   |   |

These categories provide a framework for the analysis of management strategies and specific action in particular areas.

- ii) the paucity of identified future strategies did not bode well for further analysis. Instances where a well argued case for future directions supplanted blind rhetoric were notable by their almost total absence. This suggested that attitudes to change and confidence in the future (justified or otherwise) might be a more fruitful direction for research.
- iii) in the great majority of cases the first impressions created by the opening paragraph were extreme in their wording or tone. Where these conveyed good or bad news there was little in the remainder of the narrative to alter the impression created. It was therefore determined to extend the thematic analysis to an examination of common features in the initial statement, using the framework of Table 7.1.1 as a recognition guide.

#### 7.1.5 EXPERIMENTAL PROCEDURE: HYPOTHESES

- H<sub>0</sub>1: Failed and non-failed companies cannot be discriminated on the basis of their narrative content.
- H<sub>1</sub>: A combination of key words and phrases will exist which allow discrimination between failed and non-failed companies based on the content of the Chairman's Statement.

- H02: Potential failures cannot be identified on the basis of management actions conveyed in the Chairman's Narrative.
- H2: The management actions outlined in Chairman's Statements differ sufficiently to allow the identification of likely subsequent failures.
- H03: The financial status of the enterprise is independent of the initial impression conveyed by the Chairman's Narrative.
- H3: The initial impression created by the narrative is indicative of the message conveyed by the whole, and the financial status of the enterprise.
- H04: Reference to external factors in the Chairman's Narrative will not be performance related.
- H4: Poor performance will be attributed to external factors, with an emphasis on features thought to be 'beyond our control'.
- H05: Successful performance will not be attributed more to management action than it is trading conditions.
- H5: Successful performance will be attributed to appropriate management action, with an emphasis on sales turnover and profitability.

## 7.2 CONTENT ANALYSIS: TESTS OF HYPOTHESES

The guidelines established above for the pre-sample were employed in the analysis of the matched sample of 66 companies. Each of the content areas identified: words, sentence themes, first-sentence message and managerial actions were examined to determine any significant relationships. Appendix 6.2.1 details the distribution of words and sentences; Appendix 7.2.2 details the distribution of themes, over each of the company cases.

### 7.2.1 LINEAR DISCRIMINANT ANALYSIS METHODOLOGY

The classification of failed and non-failed companies, on the basis of their narrative content, is considered within the context of a two-group case of the linear discriminant model. Alternative methods, notably probit and logit, are detailed in the literature, but neither has been shown to be significantly superior to discriminant analysis (Taffler and Abassi (1984)). Several studies report no material difference in the classifications generated by discriminant and logistic analysis for either continuous or binary variables (e.g. Saini and Bates (1978), Ball and Tscheogl (1982), Press and Wilson (1977)). Efron (1975) and O'Neill (1980) even go so far as to suggest that a logistic approach might induce a loss in efficiency, particularly where the

groups are well separated and normality and covariance assumptions satisfied. In these circumstances, and with the potential importance of binary variables for the models of this chapter, the linear discriminant model was retained throughout.

We seek to transform the n-dimensional company narrative data into a single discriminant score which efficiently distinguishes between failed and non-failed cases. The discriminant function is of the form:

$$Z = C_0 + d_1v_1 + d_2v_2 + d_3v_3 + \dots$$

where Z is the discriminant score, the  $v_j$  are the variables selected for inclusion in the analysis, the  $d_j$  are the optimal variable weightings and  $C_0$ , the constant term, is the cut-off criterion between groups. A stepwise discriminant routine of the SPSS-X group of packages (Nie et al (1984)) is used to determine that vector of discriminant coefficients ( $d_1$ ) which best separate the two company groups. The optimum condition is the maximisation of Wilks' Lambda, where

$$\text{Lambda} = \frac{\text{between-group variation}}{\text{within-group variation}}$$

and its maximisation will minimise the probability of a company being classified in the wrong group.

The Fisher classification function coefficients are given by the subtraction of separate group coefficients, with the constant term ( $C_0$ ) adjusted for the pre-set prior probabilities. Where prior probabilities of 1:10 are considered appropriate for the population proportions of failed:non-failed companies this suggests an adjustment to the constant term of  $\text{Log}_e(1/10) = -2.3$ . A cut-off point of  $Z=-2.3$  (rather than  $Z=0$ ) between the two groups would therefore reflect the expected incidence of such companies in the population. Such prior probabilities are employed here to reflect the status of the population of companies over the time period considered.

Altman, Haldeman and Narayanan (1977), in the context of the loan decision, argue that the cost of a Type II error, predicting that a loan applicant will not pay when it subsequently could, is extremely small. They estimate that the cost of a Type I error, predicting a loan applicant will repay, when it subsequently does not, is 35 times more costly than the opportunity cost of a Type II error.

Zmijewski (1983) extended this approach to error analysis to the prediction of bankruptcy. He analysed how predictive ability varied with different

assumptions on the relative cost of Type I (a healthy decision in a failed case) and Type II (a failed decision in a healthy case) errors, demonstrating the efficiency of alternative models using weightings of 1:1, 2:1, 20:1 and 38:1.

The effect of such differential misclassification costs suggests a further adjustment of the cut-off point, to distinguish between Type I and Type II errors. i.e. an overall adjustment of  $\log_e (P \cdot C)$

where  $P$  = the prior probability ratio =  $1/10$

and  $C$  = the misclassification cost ratio =  $\frac{\text{cost of Type I error}}{\text{cost of Type II error}}$

=  $40/1$  (Approximately)

This produces an adjustment of  $\log_e (1/10 \cdot 40/1) = \log_e (4) = \underline{1.39}$  and would have the effect of moving the population towards the smaller group in order to minimise the costs of misclassifying failed companies. This adjustment is employed in each of the models constructed in this chapter.

The application of the Linear Discriminant technique is based on a number of underlying assumptions:

- i) the two groups to be distinguished are distinct. Our definition of 'failed' and 'non-failed' and selection of group cases ensures the validity of this assumption.
- ii) separate multivariate normality should exist in each of the two groups. This is difficult to test for in practice, since separate univariate normality, though a necessary condition, is an insufficient one. Separate univariate normality is sought through variable transformation and data winsorisation. It is generally accepted that constituent model variables will be bounded and transformed to normality (Lachenbruch, Sneeringer and Revo (1973)), suggesting the use of transformations to reduce skewness and Kurtosis and the replacement of outliers with points at 2.5 standard deviations from the mean of the remaining observations. The distributions of discriminant variables in this study are detailed in Appendix 7.2.2. No transformations were undertaken in the final analysis because of the high incidence of zero values.
- iii) dispersion matrices should be equal. Any inequality covariance matrices would suggest a likely preference for a quadratic discriminant function, but since none of the literature has

demonstrated the superiority of the latter, the linear discriminant function is retained here.

- iv) Multicollinearity constitutes a potentially serious problem in the practical application of discriminant analysis (Pinches (1980); Taffler (1982)) suggesting a detailed investigation of variable intercorrelations. When it exists, multicollinearity can influence both the signs and stability of discriminant coefficients. A factor analysis was performed, but loadings of greater than 0.5 accounted for less than 35% of the total variation and were loaded into 15 dimensions, most of which were unexplainable. Accordingly the emphasis here was placed on an examination of the correlation coefficient matrix appropriate to each model.

The fitted model is tested in several different aspects:

- i) Wilks Lambda is used in the testing of the overall goodness of fit of the model, through a chi-squared measure of statistical significance.
- ii) Box's M-statistic provides a test for the equality of dispersion matrices, though in practice it is more sensitive to departures from multivariate normality.
- iii) The classificatory ability of the model provides a measure of its explanatory power. The concept of an 'overall correct' classification rate is meaningless when the cost of Type I and Type II errors differs significantly. Morrison (1969) and Joy and Tollefson (1975) suggest that the errors be considered separately and this is how they have been presented here.
- iv) The explanatory power of each of the variables in the model is measured using the Mosteller-Wallace method. By dividing up the Mahalanobis distance ( $D^2$ ) - the distance between the two group centroids - the percentage contribution of each variable to the model is computed. Since explanatory power is a function of both the size of the discriminant coefficient ( $d_1$ ) and the relative size of the variables, as measured by the difference between within-groups centroids,  $(x_{1j} - x_{2j})$ , the method represents a compromise between the two by computing

$$d_j(\bar{x}_{1j} - \bar{x}_{2j}) * 100\%$$
$$\sum d_j(\bar{x}_{1j} - \bar{x}_{2j})$$

- v) The Lachenbruch Holdout Test (Lachenbruch (1967)) is used to permit the computation of almost unbiased estimates of the true misclassification proportions of the discriminant model. By computing  $(n_1 + n_2)$  discriminant functions from the  $(n_1 + n_2 - 1)$  company cases, leaving out a different case each time, the held-out case is classified by that discriminant function estimated without the use of that case in the dataset.
- vi) The stability of variable coefficients is assessed by deriving discriminant functions for a number of random subsets of the cases. In this section groups of 60 of the 66 cases were used to establish a substantial degree of coefficient stability.

### 7.2.2 CONTENT ANALYSIS: WORD OCCURRENCES

The Oxford Concordance Program provides a total word count, and a count of individual occurrences within each of the narratives. This allowed the construction of ratio variables for each of the keywords of Appendix 7.1.2 on the basis of

$$\frac{\text{number of common meaning occurrences}}{\text{total number of words in narrative.}}$$

The resulting data set was used as source material with the SPSS-X statistical package. A factor analysis of the words variables was carried out, with loadings in excess of 0.5 revealing six factors. However, together they explained less than 40% of the total variation, and no meaningful relationships were discernible. More revealing was a correlation coefficient matrix, and in particular the association between certain words, and word combinations, and the STATUS variable (a 0,1 dummy identifying companies as failed or non-failed respectively).

Table 7.2.1 shows the most prominent variable groupings for the strongest measures of association.



	SYMBOL	WORD	CORRELATION COEFFICIENT WITH STATUS (0.1)
PROFITABILITY	PR	PROFIT	0.407
	RP	REDUCED PROFIT	0.216
	FP	FUTURE PROFIT	-0.171
	FL	FUTURE LOSS	-0.248
	LO	LOSS	-0.498
	UNP	UNPROFITABLE	-0.279
HXW = (PR + RP + FP) - (UNP + LO + FL) ]			0.612
PRW = (PR + RP) - (UNP + LO) ]			RELATIVE 0.645
RPW = PR - (RP + UNP + LO) ]			PROFITABILITY 0.629
BORROWINGS	HF	OVERDRAFT	-0.299
	HH	LOANS	-0.305
	HG	BORROWING	-0.330
HQW = (HF + HH + HG) ] BORROWING			-0.436
<u>CLOSURES</u>	BA	CLOSURE	-0.489
	BB	DISPOSAL	-0.323
	BP	SALE	-0.309
BZW = (BA + BB + BP) ] CLOSURES			-0.573
GROWTH	DA	GROWTH	0.170
	DB	EXPANSION	0.186
DZW = (DA + DB) ] GROWTH			0.223
CEW ECONOMY			0.276
CCW RECESSION			-0.219

TABLE 7.2.1: CORRELATION COEFFICIENTS BETWEEN COMPANY STATUS AND WORD VARIABLES

The generalisability of the symbols identified in Table 7.2.1 need to be tested over a wider variety of companies and over a longer period of time. It is conceivable that other themes might be prominent outside the parameters set in this study.

Linear combinations of symbols are used throughout to generate composite variables (e.g. HQW = HF + HH + HG for Borrowings, above). It is possible that such a simple linear additive model may not be statistically optimum, and that regression methods might generate improved relationships, with differential weightings and a non-linear mathematical form. However, Ashton (1976) advances the benefits of linear additive models, in terms of their simplicity and robustness, and they are retained here.

The three alternative measures of relative profitability, each contrasting the occurrence of 'profit' with 'loss' and 'unprofitable', recorded the highest

correlation coefficients. The word combinations conveying messages relating to borrowings and closures recorded the highest negative coefficients. An intuitive correspondence between profit, on the one hand, and borrowings and closures, on the other, therefore exists.

Two further word occurrences were accorded special treatment because of their perceived importance: (i) The word 'banker' occurred with regard to the 'provision of support' and 'continued confidence'. The word never appeared more than once in any statement, but of the 17 statements containing the reference, 16 were of companies which subsequently failed.

Consequently both the 'Banker Support' (BF) and 'Dividend' (NOMDIV) variables were treated as (0,1) variates representing their presence, or otherwise, in the narrative.

Because of its singular occurrence deflation of the variable by the normal word count was considered inappropriate, since this would merely have reduced the variable to a reciprocal of length of narrative. (ii) Similarly, dividend declarations for the current year were one-off references confined to a specific portion of the narrative, most notably when a negative message was being conveyed in the form of 'no dividend' or 'nominal dividend'. Of the 17 statements containing these singular references all were of companies which subsequently failed.

An initial linear discriminant model was formulated using variables reflecting the information content of the profit and loss account (i.e. PRW (profit) NOMDIV (dividends)).

A conventional stepwise Fisher approach was used, employing prior probabilities which reflected both population groupings and relative misclassification costs. The following function was generated:

$$Z = -1.29 + 302.12 (\text{PRW}) - 3.492 (\text{NOMDIV})$$

and produced 14 misclassifications: 1 Type I error (3%) and 13 Type II errors (39.4%), the only failure misclassification being Case 55: RIVINGTON REED. Wilks Lambda at 0.474 gives a chi-square of 47.06 with two degrees of freedom, which when compared with the critical value of  $\chi^2_{0.05, 2} = 5.99$  suggests the existence of a highly significant relationship.

A second model was generated to gauge the incremental effect of the inclusion of balance sheet information (i.e. HQW (borrowings)). The three-variable function was:

$$Z = 0.619 + 322.4 (\text{PRW}) - 6.0 (\text{NOMDIV}) - 1006.7 (\text{HQW})$$

and produced only 5 misclassifications, but 4 of these were Type I errors (12.1%) and one Type II error (3%). The non-failed misclassification was Case 32: HAWTIN, the missed failures Cases 44 (MIDLAND), 46 (MOSS), 55 (REED), and 58 (SCOTCROS). Wilks Lambda at 0.196 gives a chi-square of 98.9 with nine degrees of freedom again confirming the significance of the overall relationship.

A third linear Discriminant model was fitted to explain company status in terms of word-based variables, by submitting the five other variables of Table 7.2.1 reflecting non-financial statement information: closures, growth, economy, recession and banker support. Of the eight variables submitted in total seven entered the model:

$$Z = 1.22 + 364.64 (\text{PRW}) + 1005.04 (\text{CEW}) - 557.80 (\text{BZW}) - 6.35 (\text{NOMDIV}) \\ - 1004.97 (\text{HQW}) - 2.77 (\text{BF}) - 718.94 (\text{CCW})$$

This model produces only one misclassification, again the non-failed company Case 32: HAWTIN. (i.e. Type I error (0%), Type II error (3%)). Wilks Lambda at 0.240 gives a chi-square of 86.28 with seven degrees of freedom, which when compared with the critical value of  $\chi^2_{0.05,7} = 14.07$  confirms the significance of the overall relationship. The Lachenbruch U-test reveals an identical classification.

Interestingly the one misclassification is of the only non-failed case in which the Chairman's narrative conveys support from its bankers.

Table 7.2.2 shows the results of a Mosteller-Wallace test to determine the explanatory power of the discriminatory variables.

VARIABLES		% EXPLANATORY POWER
NOMDIV	= (NO DIVIDEND + NOMINAL DIVIDEND)	26.7
PRW	= PROFIT	24.7
HQW	= BORROWINGS	15.9
BZW	= CLOSURES	13.3
BF	= BANKERS' SUPPORT	10.3
CEW	= ECONOMY	6.3
CCW	= RECESSION	2.9
		100.0%

TABLE 7.2.2: WORDS: DISCRIMINANT MODEL EXPLANATORY POWER

The signs and weightings of the explanatory variables are largely consistent with expectations suggested by Table 7.2.1. The presence of the CEW (economy) variable as a positive influence may be attributable to a long-term outlook, rather than a future confined to overcoming short-term crises.

The pooled within groups correlation coefficient matrix of Table 7.2.3 reveals the potential multicollinearity problems concerning the dividend/profit/closures/bankers variables. Coefficients in excess of 0.26 are statistically significant at the 5% level and therefore potentially hazardous, but none of the interrelationships appear dangerously high.

	CEW	BZW	NOMDIV	HQW	BF	CCW
PRW	-0.205	0.056	-0.121	0.102	-0.087	-0.031
CEW		-0.136	0.087	-0.007	-0.152	0.129
BZW			-0.002	0.178	0.085	0.034
NOMDIV				<b>-0.438</b>	-0.028	-0.018
HQW					-0.043	-0.090
BF						-0.040

TABLE 7.2.3: WORDS: CORRELATION COEFFICIENT MATRIX

### 7.2.3 CONTENT ANALYSIS: THEMATIC CONTENT

Theme-scores per sentence were computed for all 66 companies following the procedure of 7.1.3. Ratio variables were then computed for each theme on the basis of

### Sum of Theme Scores

Total Number of Sentences,  
to provide an indicator of the perceived importance of that theme to the narrative.

Correlation of the theme variables with company STATUS are presented in Table 7.2.4 within the matrix of observed themes:

	POSITIVE		NEGATIVE	
PERFORMANCE	SPS (positive)	0.571	SMS (negative)	-0.638
	SDE (dividend)	*0.252	SDES (no dividend)	** -0.309
TRADING CONDITIONS	OPT (optimism)	0.124		
	POI (poised to take advantage)	0.049		
EXTERNAL FACTORS	SES (externals)	0.055		
GROWTH	SGS (growth)	0.274	SCS (contraction)	-0.537
CHANGE	DIV (diversification)	0.172		
	SNS (new products)	0.213		

TABLE 7.2.4: CORRELATION COEFFICIENTS BETWEEN STATUS AND THEME VARIABLES

\* dividend increased or maintained

\*\* dividend reduced, not declared, or a nominal declaration.

The strongest relationships are consistent with previous findings, identifying

GOOD NEWS = (positive performance and beneficial dividend news),  
BAD NEWS = (negative performance and adverse dividend news), and the negative growth of the enterprise (contraction).

A Linear Discriminant Model was fitted to explain company status in terms of theme-based variables, and the following equation generated:

$$Z = 0.407 + 10.375 (\text{GOOD}) - 17.012 (\text{BAD}) - 14.538 (\text{SCS})$$

Wilks Lambda at 0.351 gives a chi-square of 65.4 with three degrees of freedom compared with a critical value of  $\chi^2_{0.05,3} = 7.81$ , confirming the significance of the overall relationship. Box's M-statistic at 75.3 gives an approximate F-test of 11.9, confirming the equality of group variances.

The Lachenbruch test provides 3 Type I errors (9.1%) and no Type II errors (0%). The three misclassifications were all failed cases: (44) MIDLAND, (53) PULLMAN and (55) RIVINGTON REED. In each case the company reported pre-tax profits together with a maintenance of dividends, 'good news' regarding past profit performance which overshadowed balance sheet difficulties.

Table 7.2.5 shows the results of a Mosteller-Wallace test to determine the explanatory power of the discriminatory variables.

	VARIABLES	% EXPLANATORY POWER
BAD =	Adverse themes + bad dividend news	38.4
GOOD=	Beneficial themes + good dividend news	35.5
SCS =	Contraction	<u>26.1</u>
		100.0%

TABLE 7.2.5 THEMES: DISCRIMINANT MODEL EXPLANATORY POWER

The signs and weightings of the explanatory variables are intuitively acceptable. The within-groups correlation coefficient matrix of Table 7.2.6 illustrates the absence of multicollinearity problems arising from these relationships.

	BAD	SCS
GOOD	-0.061	-0.081
BAD		-0.216

TABLE 7.2.6 THEMES: CORRELATION COEFFICIENT MATRIX

#### 7.2.4 CONTENT ANALYSIS: FIRST SENTENCE MESSAGE

Analysis of the themes conveyed in the first sentence of the Chairman's narrative of the 66 companies revealed the distribution shown in Table 7.2.7.

		FAILED	NON-FAILED		FAILED	NON-FAILED
PERFORMANCE	PROFIT	4	17	LOSS	10	
	PLEASURE	1	4	DISPLEASURE	1	1
	PRODUCTION OBJECTIVES ACHIEVED	1	1			
TRADING CONDITIONS	IMPROVED TC		1	DIFFICULT TC	8	6
				WORST TC	5	
				REGRETS	5	
EXTERNAL FACTORS GROWTH			ECONOMIC OUTLOOK	2		
CHANGE	DISCLOSURE FORMAT		1	NEW CHAIRMAN	1	
				RATIONALISATION	1	
				RECONSTRUCTION	1	
				RELOCATION	1	

TABLE 7.2.7: FIRST-SENTENCE MESSAGE: DISTRIBUTION OF THEMES

(The 66 cases generate 73 initial themes since they include:

- 1 case combining 'worst' and 'loss'
- 1 case combining 'reconstruction' and 'profit'
- 2 cases expressing 'regret' and 'loss'
- 3 cases expressing 'pleasure' and 'profit')

Considerations of past performance and trading conditions predominate, but relatively few themes appear to discriminate well between failed and non-failed companies. With the exception of 'profit' and 'loss' the most promising themes (worst ..., regrets, economic outlook and reorganisation = (rationalisation + reconstruction + relocation)) have relatively few occurrences. Measures of correlation between these themes and company STATUS show profit and loss to have the greatest potential explanatory power:

PLE	Pleased	-0.218
REG	Regrettably	-0.286
LOS	Loss	-0.423
PRO	Profit	0.477
WOR	Worst ...	-0.286
REO	Reorganisation	-0.218

TABLE 7.2.8 FIRST-SENTENCE MESSAGE: CORRELATION BETWEEN THEMES AND STATUS

The construction of a linear discriminant model produced five significant explanatory variables in an equation which generated 3 Type I errors (9.1%) and 14 Type II errors (42.4%):

$$Z = 0.91 - 3.72 (\text{LOS}) + 2.09 (\text{PRO}) - 3.72 (\text{WOR}) - 4.79 (\text{REO}) - 1.86 (\text{REG})$$

The three failure misclassifications, Cases 6 (BLACKMAN), 29 (FODENS) and 55 (RIVINGTON REED) are all initially concerned with profits.

The blandness of the opening remarks with reference to recent trading conditions, common among both failed and non-failed companies, remains the greatest single source of misclassification. Such non-failed cases, numbered: 1, 9, 12, 13, 18, 23, 30, 32, 37, 38, 57, 64, 65 and 70. Wilks Lambda at 0.536 generates a chi-square of 38.4 with 5 degrees of freedom, a highly significant overall relationship, when compared with the critical value of  $\chi^2_{0.05,5} = 11.07$ .

The Mosteller-Wallace test of Table 7.2.9 reveals the predominance of profit/loss in the explanatory power of the variables, and the within-groups correlation coefficient matrix of Table 7.2.10 the absence of relationships which might be a potential source of multicollinearity.



	VARIABLES	% EXPLANATORY POWER
LOS	Losses	33.5
PRO	Profits	28.3
WOR	Worst ...	16.8
REO	Reorganisation	13.0
REG	Regrettably	<u>8.4</u>
		100.0%

TABLE 7.2.9: FIRST-SENTENCE MESSAGE: EXPLANATORY POWER OF DISCRIMINANT VARIABLES

	LOS	WOR	REO	REG
PRO	-0.135	-0.086	0.113	-0.086
LOS		<b>-0.279</b>	-0.209	0.089
WOR			-0.134	0.057
REO				-0.134

TABLE 7.2.10: FIRST-SENTENCE MESSAGE: CORRELATION COEFFICIENT MATRIX

### 7.2.5 CONTENT ANALYSIS: MANAGEMENT ACTIONS

As foreshadowed in 7.1.3 the identification of distinct strategies is obscured by the lack of information provided in the narrative. In terms of 'attitudes' there are many expressions of confidence, but few substantiated. In terms of 'direction' there are few which provide a clear indication of proposed action. Case 8 (BODYCOTE) is exceptional in providing a well-argued case for its diversification intentions. Actions could be identified within five broad areas:

- i) Board movements
- ii) Dividend policy
- iii) Investment
- iv) Contraction
- v) Problem solving

Accordingly variables were constructed in each of these areas, scoring on the basis of their inclusion in the narrative on a one-off basis. Calculation of correlation coefficients between these variables and company STATUS reveals the following distribution.

**BOARD MOVEMENTS**

CHRES	Chairman Resigns	-0.316
CHRET	Chairman Retires	-0.105
MDR	Managing Director Resigns	-0.218
NMD	New MD Appointed	-0.285
CHAIR =	(CHRES + CHRET) Chairman	-0.286
CHMD =	(CHRES + MDR) Resignations	-0.323

**DIVIDEND POLICY**

ND	No dividend	-0.471
NOMD	Nominal dividend	-0.286
NDM	No dividend mention	-0.108
REDD	Reduced dividend	0.246
INCD	Increased dividend	0.495
MAIND	Dividend maintained	0.041
NOMDIV =	(ND + NOMD)	-0.580
NOMINDIV =	(ND + NOMD + NDM)	-0.598

**INVESTMENT**

INV	Manufacturing investment	0.242
NEW	New product launch	0.336

**CONTRACTION**

CLO	Closures	-0.541
DIS	Disposals	-0.413
RED	Redundancies	-0.441

**PROBLEM SOLVING**

OUT	Outside help sought	-0.344
LAC	Lack of financial control	-0.371
LIT	Litigation	-0.254
BF	Bankers support	-0.520

**TABLE 7.2.11: CORRELATION COEFFICIENTS BETWEEN ACTIONS AND COMPANY STATUS**

A linear discriminant model constructed using this variable set generated a five variable model which produced ten misclassifications: Only one Type I error (3%) but 9 Type II errors (27.3%).

$$Z = 3.53 - 3.79 (\text{NOMINDIV}) - 4.03 (\text{CLO}) - 2.67 (\text{BF}) - 5.11 (\text{OUT}) - 3.66 (\text{LAC})$$

Wilks Lambda at 0.339 gives a chi-square statistic of 66.5 with 5 degrees of freedom confirming the goodness of the overall fit of the relationship, when compared with the critical value of  $\chi^2_{0.05,5} = 11.07$ .

The most prominent variable concerned with Board Movements, that concerning resignations of Chairman and Managing Director (CHMD), was not sufficiently significant statistically to enter the model. The ten misclassifications comprise one failed case, (29) FODENS, and 9 non-failed cases: 1, 3, 12, 18, 25, 32, 64 and 65. The reasons underlying these misclassifications are revealed by an examination of the incidence of occurrence of the five key variables:

	FAILED	NON FAILED
NOMINDIV	26	6
CLO	20	3
OUT	7	0
LAC	14	0
BF	16	1

TABLE 7.2.12 ACTIONS: DISTRIBUTION OF OCCURRENCES

As noted in Section 7.2.1 HAWTIN is the only non-failed case in the sample to express support from its bankers. The other misclassifications illustrate the inadequacy of models comprising only action indicators, with no inclusion of the profit/loss variables so prominent in the preceding models.

The Mosteller-Wallace test reveals the importance of dividend policy to the explanatory power of the model.

	VARIABLES	% EXPLANATORY POWER
NOMINDIV =	Dividend Policy	30.4
CLO =	Closures	27.5
BF =	Bankers' Support	16.1
OUT =	Outside Help Sought	14.3
LAC =	Lack of Control	<u>11.7</u>
		100.0%

TABLE 7.2.13 ACTIONS : DISCRIMINANT MODEL EXPLANATORY POWER

The within-groups correlation coefficient matrix of Table 7.2.14 reveals potential multicollinearity problems associated with the relationship between dividend policy and growth. All of the coefficients in excess of 0.3 are statistically significant at the 5% level.

	CLO	OUT	LAC	BF
NOMINDIV	-0.029	-0.068	0.088	0.022
CLO		<b>-0.293</b>	-0.106	0.224
BF			-0.121	-0.055
OUT				-0.118

TABLE 7.2.14 ACTIONS : CORRELATION COEFFICIENT MATRIX

#### 7.2.6 CONTENT ANALYSIS: WORD/THEME/STRATEGY COMBINATION

Table 7.2.15 below reveals the cases misclassified by each of the foregoing models. A close examination shows there to be no misclassifications common throughout, though case 32: Hawtin is misclassified 3 times and failed cases 29: Fodens and 55: Reed twice by alternative models. Non-failed companies 1, 12, 18, 64 and 65 are too each twice misclassified. The potential therefore exists to improve on the performance of Model 1 (WORDS) through the incremental consideration of themes and strategies.

MODEL:

1 WORDS		2 THEMES		3 FIRST-SENTENCE MESSAGE		4 STRATEGIES	
FAILED	NON-FAILED	FAILED	NON-FAILED	FAILED	NON-FAILED	FAILED	NON-FAILED
-	32	44	-	6, 29, 55	1, 9, 12, 13, 18, 23, 30, 32, 37, 38, 57, 64, 65, 70	29	1,3, 12, 18, 25, 32, 36, 64, 65

TABLE 7.2.15 DISTRIBUTION OF MISCLASSIFIED CASES ACROSS ALTERNATIVE MODELS

A new linear discriminant model was therefore constructed on the basis of the seven variables of the Words Model together with variants from other models which involved alternative calculation methods for variables of similar meaning. A nine variable model was generated but did not improve on the WORDS model. One misclassification was apparent, this time a Type I error with Case 55 a missed failure.

$$Z = 3.86 + 418.4 (\text{PRW}) - 5.69 (\text{NOMDIV}) - 4.91 (\text{CLO}) - 1171.1 (\text{HQW}) - 5.84 (\text{OUT}) - 2.49 (\text{BF}) - 3.94 (\text{LAC}) + 1012.8 (\text{CEW}) - 1148.5 (\text{CCW})$$

Six of these variables were common to the Words Model, the seventh BZW (Closures) was replaced by CLO, an alternative closures variable computed on the basis of strategy mention rather than word weighting. Wilks Lambda at 0.196 gives a chi-square of 96.9 with nine degrees of freedom, confirming a significant overall fit when compared to the critical value of  $\chi^2_{0.05,9} = 16.9$ . The Lachenbruch U-test revealed the same classification matrix.

The Mosteller-Wallace test reveals that the explanatory power attributable to the Closures variable has improved from 13.3% to 15.9% as a result of the switch, but this is not a material change.

	VARIABLES	% EXPLANATORY POWER
PRW =	Profit	21.9
NOMDIV =	No Dividend	18.5
CLO =	Closures	15.9
HQW =	Borrowings	14.4
OUT =	Outside Help Sought	7.8
BF =	Bankers' Support	7.1
LAC =	Lack of control evident	6.0
CEW =	Economy	4.9
CCW =	Recession	<u>3.5</u>
		100.0%

TABLE 7.2.16 MATRIX MODEL: EXPLANATORY POWER OF DISCRIMINANT VARIABLES

The within-groups correlation coefficient matrix reveals potential multicollinearity difficulties associated with the relationship between profit/dividends/closures/control. The coefficients in excess of 0.3 are all statistically significant.

	CEW	NOMDIV	CLO	CCW	LAC	OUT	HQW	BF
PRW	-0.205	-0.121	0.168	-0.031	-0.156	0.075	0.102	-0.087
CEW		0.087	0.100	0.129	-0.014	-0.066	0.007	-0.052
NOMDIV			-0.032	-0.018	<b>0.266</b>	0.058	<b>-0.438</b>	-0.028
CLO				-0.012	-0.106	-0.293	0.108	0.224
CCW					0.002	-0.229	-0.090	-0.040
LAC						-0.121	-0.328	-0.118
OUT							0.008	-0.055
HQW								-0.043

TABLE 7.2.17 MIXED MODEL: CORRELATION COEFFICIENT MATRIX

### 7.2.7 CONTENT ANALYSIS: CONCLUSIONS

Appendix 7.2.1 provides a summary of the discriminant models computed, together with variable definitions.

Hypothesis 1: A combination of key words and phrases will exist which allow discrimination between failed and non-failed companies based on the content of the Chairman's Statement.

The linear discriminant models constructed provide weighty evidence to substantiate this hypothesis. Model 3 shows that 49 of the cases (30 failed, 19 non-failed) can be correctly classified on the basis of the thematic content of the first sentence of the chairman's narrative alone. This proportion improves enormously when more sophisticated measures of the complete narrative are applied. Model 2, founded on a sentence-based measure of themes, correctly classifies 63 cases 90.9% of failed and 100% of non-failed cases, and Model 1 based on the weight of word patterns correctly classifies all but one non-failed case.

In each model the signs and variable weightings are intuitively appropriate. Therefore we reject the Null Hypothesis  $H_{01}$  at the 5% level of significance.

Hypothesis 2: The management actions outlined in Chairman's Statements differ sufficiently to allow the identification of likely subsequent failures.

Model 4 substantially supports this proposition by providing a model based on strategies which correctly classifies 92.42% of cases 97% of failed and 72.7% of non-failed cases. The Null Hypotheses  $H_{02}$  may therefore be rejected at the 5% level. However, in doing so it identifies the inadequacies of such a simplistic model. Three of the misclassifications were not made by any of the other models - models which included as central explanatory variables those concerning profitability. The message is a clear one, variables based on management strategies do have useful discriminant ability, especially when employed in conjunction with financial measures of performance, either qualitative or quantitative.

The exploratory version of Model 1 (WORDS) is a clear reflection of this, showing 61 cases correctly classified on the basis of narrative references to balance sheet and profit and loss references alone.

Model 5 shows that this can be done, providing a mixed narrative model which correctly classifies all but one case. It is conceivable that a model including financial ratio variables as well as strategy indicators, may operate more efficiently. Such a model remains an area for future research.

Hypothesis 3: The initial impression created by the narrative is indicative of the message conveyed by the whole, and the financial status of the enterprise.

As noted above, Model 3 shows that the great majority of enterprises can be correctly classified on the basis of the first sentence of the chairman's narrative and the Null Hypothesis  $H_03$  is consequently rejected at the 5% level. Those instances of extreme performance, good or poor, are most easily recognised. However, the frequent presence of a bland introductory paragraph devoted to external factors, makes this discriminatory method relatively unreliable. Style of narrative often dictates an opening statement bemoaning the 'severe' or 'deteriorating trading conditions' over which the company has triumphed, or alternatively, which have contributed to its downfall. The use of this device is common to failed and non-failed companies, making discrimination much more difficult.

Hypothesis 4: Poor performance will be attributed to external factors, with an emphasis on features thought to be beyond our control.

There is a wealth of anecdotal evidence within the sample linking poor performance with external factors, most notably to trading conditions, competition, interest and exchange rates, strikes and the weather. However, a systematic analysis of these statements was unable to provide any conclusive evidence to suggest that such references were closely linked with future financial status; the Null Hypothesis  $H_04$  could not therefore be rejected at the 5% level of significance. Variables concerned with the need to take reluctant action had low correlation measures of association with status (Forced (-0.117); Had to ... (-0.116)), similarly those above, concerned with short-term problems attributable to external factors. Neither of these variables entered any of the discriminant models, despite having intuitively appropriate signs.

Those external variables which were found to be significant were those consistent with a more long-term view of performance. Thus 'the economy' ( $r = 0.276$ ) and 'recession' ( $r = -0.219$ ) both exhibited sufficiently strong relationships for them to enter MODEL 1, based on word patterns. Where used, references to the 'economy' were consistently expressed by non-failed companies looking beyond short-term crises, apparently not perceived to be terminal. References to 'recession' and its debilitating effects were largely confined to the failed group of companies, hence the negative correlation coefficient. This variable must be considered the only one which offers any consistent support for the hypothesis above.



Hypothesis 5: Successful performance will be attributable to appropriate management action, with an emphasis on sales turnover and profitability.

Models 1, 2, 3 and 5 all support the contention of a strong relationship between positive performance and profitability. The attribution of this success to positive management action is less strong, but still highly significant. The analysis of management strategies in Model 4 reveals positive correlations between expansionist management policies and non-failed status:

Acquisitions strategy (0.186); Investment strategy (0.242); New product launch (0.336).

The signs of these variables are all intuitively appropriate and provide support for the above hypothesis. However, none of these variables is sufficiently strong to enter Model 4 as a significant discriminator, since the model is dominated by negative strategies consistent with management incompetence, rather than achievement. The Null Hypothesis  $H_0$  cannot therefore be rejected at the 5% level of significance.

This analysis strongly supports the notion that narrative information alone is an excellent means of classifying companies by performance. The suggestion is that such information might be incremental to that provided by the financial statements. This remains to be investigated, and an experiment is detailed in Chapter 8 to allow such an investigation to take place.

## CHAPTER EIGHT

### THE COMMUNICATION OF ACCOUNTING INFORMATION IN THE ANNUAL REPORT

Fama (1970:416) concludes that 'the evidence in support of the efficient markets model is extensive, and contrary evidence is sparse'; but since that date a large number of studies have provided evidence which is inconsistent with the efficient markets model. Publicly observable variables have been used, in models of varying degrees of sophistication, to discriminate between securities with subsequent differential abnormal returns. Basu (1983) demonstrates a significant relationship between P/E ratios and risk-adjusted returns, with securities on a low P/E rating outperforming those on high ratings. Foster (1985) reports on the use of accounting information, already in the public domain, by an analyst, Abraham Briloff, whose criticism resulted in immediate and permanent reductions in the prices of the securities concerned.

Altman (1968) in the US and Taffler (1982) in the UK, among others, provide evidence of the ability of financial ratio combinations to predict future failure. Such studies report that as early as three to five years prior to failure, the financial ratios of failed firms exhibit behaviour different to those of non-failed firms. Research on financial distress has documented empirical regularities in the profiles of financially-distressed and non-distressed firms, but economic theory has played a minor role in the development of such models. The absence of a substantive theoretical underpinning has generated much criticism of the work in this area, but the results are demonstrably decision-useful for creditors, investors and managers alike. The variable combinations included in most linear discriminant bankruptcy models are almost entirely firm oriented, and largely derived from quantitative financial statements and stockmarket price data. Rose, Andrews and Giroux (1982) provide evidence that macroeconomic variables (eg, interest rates and employment rate changes) are influential factors in determining the timing of failures; Foster (1986) suggests that microeconomic variables (eg, firm size and industry) are important variables, which paired-sample designs matching on these same variables effectively preclude as financial distress indicators. There may, therefore, be scope for improving the predictive power of existing models through the inclusion of other economic indicators.

Information, often in a non-numerical form, on the firm's perception of the importance of economic and industry-specific factors is frequently contained in the Chairman's narrative. This chapter examines the nature of this additional information and provides an experimental methodology to determine its incremental effect in a decision-making context.

### 8.1 INDEPENDENCE OF INFORMATION SOURCES

Cherry (1966) and Oliver (1972) argue that numbers imply measurement, so that for many users numerical messages must be assumed to be both more precise and more authoritative than non-numerical messages. Bell (1984b), on the other hand, found that users expressed more confidence in non-numerically presented information because it had been placed in a contextual frame of reference.

The present study is confined to the information content of the Chairman's narrative, the accounting information in the financial statements, and to financial ratios derived from the financial statements. These sources are not independent, since some narratives will inevitably comment on the content of the financial statements. A preliminary examination of the content of the sample narratives was therefore conducted to determine the extent of this information overlap.

Reference to profitability, or lack of it, is common among Chairman's narratives; in the current study, all 66 companies under detailed consideration included such instances.

However, reference to balance sheet measures is extremely rare; only ten instances, six of them among failed companies. This lack of emphasis reflects the weighting placed on profit and loss account items in decision-making compared to the content of the balance sheet. Of these ten instances seven refer to liquidity issues and three to gearing. Only one case, Case 13: BURGESS, a healthy enterprise, provides a numerical measure within the narrative:

'The gearing adjustment reveals that less than 30% of the Group's average fixed assets and working capital during the year was financed by borrowing'

Different perceptions of the seriousness of liquidity ratios in the lowest 20% of all companies are revealed by two references:

CASE 5: BERWICK TIMPO 'there is no restriction on product development, and liquidity is not a problem'

CASE 14: BURRELL 'During a period of formidable trading losses such as has been experienced during 1979, it is unsurprising that the Company's liquidity position has come under considerable strain from time to time'

Both companies subsequently failed, and it is difficult to conclude other than that liquidity difficulties contributed significantly to each failure. Appendix 8.1 provides abstracts from the narratives of these ten companies, classifying them according to whether the references are liquidity or gearing based and by the failed/non-failed status of the companies. Supporting ratio calculations are also provided together with PAS-scores through which to gauge the relative performance of the companies. (Refer to Section 5.2 for an explanation of the PAS-score methodology). A statistical analysis of the usefulness of balance sheet references in the prediction of financial performance was thought desirable, but the incidence of occurrence was viewed to be too low to justify such an analysis. In a more extensive study Williamson (1984) examined the financial ratios cited in the annual report and found three (return on equity; current ratio; return on sales) which were higher when cited than when they were not disclosed. He concluded that 'selective reporting by Fortune 500 companies does occur for some ratios'.

The implication would appear to be that the narrative statements are providing a significantly different source, compared to the numerical financial statements, especially with regard to balance sheet information. The prominence of profit and dividend references suggest that the difference is not so marked with respect to the profit and loss account. References to current action, future strategies and intended policies are totally divorced from those to be found in the financial statements.

Financial ratio information is derived from the accounting statements, though not explicitly stated in the latter. Processing differences between these two sources will arise and may be attributable to experiential or educational differences, or to the adoption of heuristics using only stated information rather than its implication.

An experimental methodology was devised to compare processing differences between alternative information sources, and the resultant effects of information integration.

## 8.2 EXPERIMENTAL METHODOLOGY

The environmental predictability of financial ratio data is well established. The linear discriminant models of Altman (1968) and Taffler (1982) have demonstrated that such models can achieve almost 100% classificatory ability of failed and non-failed cases. Even simple additive linear models can be surprisingly robust in differentiation exercises and help to overcome the undue emphasis that may otherwise be placed on the profit variable.

The environmental predictability of narrative statement information is much less clear. The empirical evidence provided in Chapter 6 suggests that the readability of narrative is performance related, and the linear discriminant models of Chapter 7 that the semantic content of narrative may be used to identify potential failed cases. The misclassification of cases based on narrative information, needs to be examined and the attributes of the misclassified cases identified. Where cases are consistently misclassified under experimental conditions, contrary to the expectations of a predictive model, the explanatory variables which are being underemphasised might be identified. Where these misclassifications conflict with those associated with alternative information sources the nature of the difference in perceptions needs to be examined to determine whether processing difficulties exist or whether there is deliberate obfuscation in the communication of the message.

In realistic decision-making circumstances all financial statement information will be available simultaneously, in addition to outside sources. The initial experiments of Chapter 4 provide some reservations regarding the nature of the integration of this information, notably regarding the emphasis placed on segments of dubious reliability and the consistency with which information conflicts are overcome. The place of the narrative in this overall decision-making context, and the nature of the information processing need to be determined.

Accordingly a series of experiments was devised to gauge the facility of respondents with narrative materials; to compare this facility with that apparent with numerical materials, and to observe the manner in which numerical and narrative sources were integrated.

### 8.2.1 SPECIFIC PROPOSITIONS

- P1: The classification of Chairman's statements will support the notion that the narrative provides an excellent discriminator between failed and non-failed cases.
- P2: The information provided by the narrative will be incremental to that provided by the financial statements, so that improved decisions result from the employment of both sources in an integrated manner.
- P3: Experimental results will be highly dependent on the prior probability of failure within the material sets. Results will likely demonstrate an inability to influence the base rate expectations of respondents, following the results of Chapter 4 and supporting the findings of Houghton (1986), though conflicting with those of Casey (1983).
- P4: Experimental results will follow those of Chapter 4 by demonstrating an inappropriate emphasis accorded to narrative information of a flimsy nature, when more reliable financial statement data is also available.
- P5: The misclassification of cases resulting from an apparent conflict in the message being conveyed by narrative and financial statements will be attributable to:
- i) the presentation of the narrative - its length and readability - so that insufficient information is conveyed;
  - ii) the content of the narrative - the creation of a mistaken impression, possibly deliberately, by adopting an overly optimistic or pessimistic posture.

### 8.3 EXPERIMENTAL PROCEDURE

A sample of n=146 final year UK undergraduate business students, familiar with the format of the Chairman's narrative, was employed in the classification of cases. The intention was to appraise the clarity with which the financial message was conveyed. Each respondent received a set of materials comprising the Chairman's narrative of ten companies, with the requirement that they classify the companies as failed or non-failed. Each

set of materials included a combination of failed: non-failed cases varying in proportion from 0:10 to 10:0.

In each case the statement provided was complete and unabridged except that the names of the company, its major subsidiaries, trading partners, key personnel and branded products had been deleted so as not to divulge the identity of the company in question.

An analysis of classification errors allowed the cases to be grouped into a three-way classification of difficulty in accordance with the regularity with which a case was misclassified. This grouping formed the basis of a revised sampling frame destined for a more sophisticated audience. Twelve companies were chosen from each of the 22-strong groupings to provide an approximately equal mix of failed and non-failed companies.

The selection of companies for the main test instrument was made in accord with the experimental design detailed in Appendix 5.4 and clarified in Section 5.3. The requirement was of an efficient sample design to allow the simultaneous processing of CLOZE experiments and chairman's narratives without duplication of companies. This was accomplished by using 36 companies in all, 18 of which were used in the CLOZE experiment.

The new set of materials was prepared each comprising the Chairman's narrative of eight companies, so that the set included representatives of 'easy', 'medium' and 'difficult' cases. In addition the materials sets were varied so that combinations of failed and non-failed cases ranged from 0:8 to 8:0. These 18 different sets of materials were administered to groups of i)  $n=234$  final year UK accounting undergraduates and ii)  $n=18$  professional accountants with the London office of a Big 8 company, in order to compare outcomes and gauge the importance of experiential affects. Appendix 8.3.1 provides an abstract of the materials.

For each set of narrative materials corresponding sets of numerical materials were prepared comprising i) profit and loss account and balance sheet and ii) a set of financial ratios, together with industry averages, for each of the companies. Financial statement information was supplied for one year only so that it corresponded exactly with the period of the narrative. In the case of failed companies, these materials were all provided by the annual disclosure immediately prior to failure. Appendix 8.3.2 provides a sample of the experimental materials employed. These new sets of materials were

administered separately to a sample of  $n=234$  accounting undergraduates immediately after they had processed their sets of narratives. Different numerical codings were employed to prevent comparisons, and students were informed that they were appraising  $3 \times 8 = 24$  different companies.

All respondents processed the materials in the same order:

i) Chairman's narratives ii) financial statements iii) financial ratios.

No attempt was made to vary the order since the intention was to assess the effect of the additional information provided by the financial statements on decisions already made on the basis of the narrative information alone.

Replication of this experiment should include order of processing as a potential explanatory variable.

On completion of the decision-making task involving separate materials, students were informed of the coding system employed so that they were able to reconcile narrative-statements-ratios for each of their eight companies. They were then asked to review their original decisions and make a new set of decisions based on the expanded information base. This final part of the experiment was not undertaken with the accounting practitioners and replication is required to gauge further experiential effects.

#### 8.4 EXPERIMENTAL RESULTS

The preliminary sample allowed each of the 66 company cases to be assessed approximately twenty times by different respondents. The resulting classifications based on narrative disclosures showed one case (Case 53: R & J PULLMAN: Failed) always to be misclassified. Six other cases (five of them failed companies) were misclassified on over 70% of the occasions they were processed. At the other extreme, six cases were never misclassified.

A case classification was designated 'difficult' if misclassified in over 37% of cases; as 'easy' if misclassified in fewer than 18% of cases. The remaining cases were designated an 'intermediate' status. The percentage figures used here are arbitrary, but allow the company cases to be split on the basis of equal proportions. A complete distribution of the percentage misclassifications is detailed in Appendix 5.3.

Examination of these results revealed that the Number of Failed Decisions was only marginally significantly related to the Number of Failed Cases in the sample ( $r=0.280$ )  $t=2.33$  and to the Number of Misclassification Errors ( $r=0.208$ )



t=2.29. The only significant variation in the number of classification errors, relative to the number of failed cases in the sample set, occurred when 9 or 10 of the ten cases were failed. These results are consistent with those anticipated from our tests in Chapter 4, where prior probabilities were vastly different from expectations, and explicit instructions had failed to change perceptions of expectations. Respondents apparently perceived a 'mixture' of failed and non-failed cases to mean a combination comprising at least two cases of each description, since the number of failed decisions was significantly different when the materials comprised eight or more cases of common status. Appendix 8.4.1 details the t-statistics in the comparison of the Number of Failed Cases with those of the Number of Failed Decisions, and Appendix 8.4.2 those in the comparison of the Number of Failed Cases with the Number of Type I and Type II Classification Errors.

The mean number of classification errors was 3.56 (Type I:2.18, Type II:1.38) but the distribution of errors non-linear. Appendix 8.4.3 details the classification error pattern, identifying a deterioration in processing capability at the extremes of the distribution.

A repeat of this narrative part of the experiment with groups of final-year accounting undergraduates and accounting practitioners revealed very similar classification patterns. The eight most-misclassified cases were common to accounting undergraduates and business students, and the five most misclassified common to all groups. Any test of the experiential factors affecting this error pattern is limited by the extremely small number (n=18) of accounting practitioners in the sample. Appendix 8.4.4 details the case misclassification percentages across the three participating groups.

An examination of the most commonly misclassified cases, those consistently misclassified more than 70% of the time, is illuminating, providing indicators of potential problem cases, even when complementary financial statement data is available. All the narrative cases are correctly predictable using the sophisticated content-models of Chapter 7. Some elements of these will be unavailable to experimental respondents who are more likely to process on the basis of keywords or on an impression conveyed by future strategies and the positive balance of the content. Within this context some of the consistent misclassifications are revealing:

- CASE 53: R & J PULLMAN (Failed) - consistently the most misclassified case, attributable to a lengthy positive narrative indicating an expansive and acquisitive approach leading to healthy profit margins. Levels of gearing are not mentioned, but an expression of confidence in their bankers provides a clue that all is not well.
- CASE 12: A F BULGIN (Non-Failed) - a very short narrative (only 324 words) conveying a mixed impression message of loss-making subsidiaries balanced by a profitable manufacturing division. Justification of the 'mild optimism' experienced is clearly dependent on the success of new product launches.
- CASE 46: MOSS ENGINEERING (Failed) - similar to Case 53 in that an expansive and acquisitive posture has been rewarded with profits. But this has taken place against a background of reconstruction and redundancies in which lack of tight financial control is evident and gearing levels extremely high, and expected to remain so.
- CASE 39: FAIRBAIRN LAWSON (Failed) - again an acquisitive posture producing increased profits, though reduced margins, and a substantial increase in dividends. But a major shareholder has disposed of significant holdings and the company is actively pursuing merger opportunities to provide a sounder base.
- CASE 44: MIDLAND INDUSTRIES (Failed) - profits reduced but dividends maintained, with acquisitions and investments both to extend the product range and to seek new technology to replace traditional markets.

The common feature is that profitability, or lack of it, is allowed to dominate all other aspects of the information conveyed.

The accounting undergraduates recorded a mean number of classification errors of 2.49 (Type I:1.64; Type II:0.85) significantly lower than that recorded by the business students, suggesting experiential improvement. However, the pattern of errors was very similar, with the largest number of misclassifications registered in material sets comprising the largest and fewest number of failed cases respectively; evidence again consistent with an inability to influence the respondents' perceptions of failure base rate. The number of failed decisions recorded was positively correlated ( $r=0.51$ ) with the number of failed cases in the set. Details of these distributions are included in Appendix 8.4.5.

When the same cases were administered to the accounting undergraduates, in the form of alternative information media, significantly fewer errors were recorded:

accounting statements, mean 1.89 (Type I:1.37;Type II:0.52)  
financial ratios, mean 2.00 (Type I:1.25;Type II:0.75)

But the pattern of error distribution persisted, consistent with anchoring around 50% (4 failures) expected and adjustments around this figure.

When respondents were made aware of the coincidence of cases in the three material sets they were asked to reconsider their original decisions. The vast majority of respondents did not attempt a fundamental analysis of the revised materials, but instead attempted to combine their original decisions in some way. Several alternative means of integration are available in order to overcome conflict at the individual level.

Schroder (1970) has identified some of the major characteristics of information processing at the lowest levels that are dependent upon single rule structures:

"a greater tendency toward bifurcated thinking; absolutistic standards and an apparent dependence on these fixed standards as the only authority; a great inability to generate conflict or ambiguity and an habitual avoidance of ambiguity - an orientation in which the world is bent to fit the rule; a greater tendency to standardise judgements in a novel situation; a great inability to interrelate perspectives; a poorer delineation between means and ends; the availability of fewer pathways for achieving ends; a poorer capacity to act "as if" and to understand the other's perspectives; and less potential to perceive the self as a causal agent in interacting with the environment."

Anderson & Shanteau (1970), among others, have shown that the use of simple decision rules, notably the linear additive model in which users compute a weighted sum of relevant items, can produce surprisingly accurate predictions when the relevant components are known.

Jensen (1976) has suggested that it may be unrealistic to think only in terms of a linear additive model and that configural models, where the weights vary with the configuration of other factors, should gain greater prominence.

Studies by Bowman (1963), Kunreuther (1969) and Goldberg (1970) have shown that configural models can lead to decisions which are better than

those of the individuals being modelled. By filtering out the error in human judgemental processes the model can outperform its human originator in decision making ability.

Behling, Gifford and Tolliver (1980) have established that simplification of data-handling through the categorisation of data is a commonly used technique in the context of information processing limitations. Although the grouping of data on a subjective basis might be considered as error, it has been shown to be an important means of coping with the complexity in overload situations, especially where greater precision is not required.

The decision making process might then be considered to be a combination of four rules: (i) manipulation of category labels rather than exact values, (ii) problemistic rather than opportunistic search, (iii) sequential rather than parallel consideration of alternatives, and (iv) satisficing rather than maximising.

The experiments and references of Chapter 4 provide strong evidence to suggest that human judges actually "satisfice" rather than optimise in their decision making processes, employing heuristic rules and simple linear models on a subset of the available information, and introducing errors and bias into the process as a result.

Montgomery and Svenson (1976) identify four major components to be considered in studies of cognitive processes leading to single decisions:

- i) subjective representation of the decision alternatives
- ii) decision rules for finding the best alternative
- iii) procedures for processing the information about the alternatives
- iv) principles for the order of application of particular decision rules.

Where 'satisficing' is apparent we might expect that decision rules will be applied to a subset of the information, after an incomplete data search. This is consistent with the action of respondents in integrating their original findings rather than indulging in further fundamental analysis.

Svenson (1979) provides a framework of processing strategies for choosing between alternatives which allows the consistency of respondent behaviour to be examined:

- i) 'attractiveness of most important aspect': only those cases considered failed by one particular method (perceived by the respondent to be the most reliable) are designated failed overall. Slovic (1975) observes that the majority of subjects in empirical studies consistently select this 'most important' approach.
- ii) 'single attribute dominance': a lowest common denominator approach, in that a case considered failed on any one individual source is designated failed overall.
- iii) 'greatest attractive difference': a highest common factor approach, in that only those cases considered failed on every source separately' are designated failed overall.
- iv) 'maximum number of aspects': a classification reached by aggregating the decisions based on alternative sources - commonly failure on any two of three sources considered sufficient for designation as failure overall.
- v) 'weighted algebraic model': decisions reached on alternative sources are weighted in accordance with their perceived relative importance to generate an overall outcome.

The resulting mean number of misclassification errors, 1.99 (Type I:1.47; Type II:0.52) is significantly fewer than for the Chairman's narrative alone (2.49) but not significantly different from the accounting statements (1.89) or financial ratios (2.00) alone.

Table 8.4.1 below summarises the error types across the alternative information sources recorded by the accounting undergraduates:

	Mean No of Classification Errors	Type I (Healthy When Failed Error)	Type II (Failed When Healthy Error)
Chairman's Narrative	2.49	1.64	0.85
Accounting Statements	1.89	1.37	0.52
Financial Ratios	2.00	1.25	0.75
Integrated Sources	1.99	1.47	0.52

TABLE 8.4.1: CLASSIFICATION ERRORS - INCREMENTAL FINANCIAL INFORMATION

An examination of the processing decisions employed by respondents when able to reconcile the alternative information sources is largely consistent with the framework outlined above:

- i) 47% of responses were consistent with focus on a single processing media - in three-quarters of these cases this was the accounting statements.
- ii) 10% of responses were consistent with the operation of a lowest common denominator across all sources - a failure anywhere was deemed a failure in the overall reckoning.
- iii) 15% of responses were consistent with a search for the highest common factor - overall recognition of a failure only followed from separate corresponding recognition on each of the processing media.
- iv) 15% of responses were consistent with the operation of a simple decision-making model designating a case as failed if any two of the three media sources provided supporting evidence.
- v) 13% of responses were consistent with the use of some form of weighting - most commonly anchoring on one source together with adjustments made for variations elsewhere.

Studies by Altman et al (1977) and Zmijewski (1983), referred to in Section 7.2.1, argue that the cost of a Type I error is much greater than a Type II error. They suggest the relative importance of the Type I error to the decision-making context, without quantifying its precise superiority. On this basis the financial ratios provide the preferable information source, overall, and the results on the integrated materials represent a compromise which places undue emphasis on the, less reliable, narrative. The results are consistent with those presented in Chapter 4, where respondents relied inappropriately on 'soft' qualitative information even when 'hard' numerical information was available.

Since no attempt had been made to vary the order of processing of materials in the experimental procedure, ordering effects may have influenced the reliability of misclassification scores for separate processing media. Even so a comparison of respondent performance across the three processes is illuminating, showing a greater improvement in performance when all information sources have been employed. Comparisons are based on the number of errors made, with no distinction between Type I and Type II errors.

	Accounting Statements	Financial Ratios	Integrated Sources
Improved Performance (%) (ie fewer errors)	53	57	62
Worse Performance (%) (ie more errors)	22	27	23
No Change (%)	25	16	15

**TABLE 8.4.2: % RESPONDENTS REPORTING CHANGED CLASSIFICATION PERFORMANCE COMPARED TO THAT BASED ON CHAIRMAN'S NARRATIVE ALONE**

An analysis of the individual cases reveals a similar pattern of improvement in performance over the 36 cases.

	Accounting Statements	Financial Ratios	Integrated Sources
Improved Classification	23	20	25
Worse	10	15	7
No Change	3	1	4
<hr/>			
Mean % Improvement	7.9	2.0	6.5

**TABLE 8.4.3: CASE MISCLASSIFICATIONS COMPARED TO NARRATIVE PERFORMANCE**

Appendix 8.4.6 details the distribution of case misclassifications on the basis of alternative information sources. It is interesting to note those instances of major differences in the classificatory ability of alternative media, since this suggests conflicting media messages.

There were only two instances, both failed companies, in which % misclassification was higher for all sources than for the Chairman's Statement alone:

**% MISCLASSIFICATION**

	<b>Chairman's Narrative</b>	<b>Accounting Statements</b>	<b>Financial Ratios</b>	<b>All Sources</b>
<b>Case 48: Nova (Jersey) Knit</b>	<b>52</b>	<b>89</b>	<b>96</b>	<b>94</b>
<b>Case 63: George Spencer</b>	<b>13</b>	<b>24</b>	<b>24</b>	<b>24</b>

**TABLE 8.4.4 CLASSIFICATIONS DIFFERENCES: NARRATIVE SUPERIOR**

In each instance the message conveyed by the narrative is apparently clearer than that from the financial statements. This may well be true for these two cases; the narratives are exceptional in each being an unmitigated tale of woe reporting a sequence of physical and financial mishaps. Appendix 8.3.1 includes the Nova (Jersey) Knit narrative for illustration.

The financial statement data is much less clear-cut; although both cases yield comfortably negative Z-scores their financial profiles include some encouraging aspects of performance, Nova (profitability) and Spencer (gearing), to compensate for disasters elsewhere. Financial statements for Case 63: George Spencer are provided in Appendix 8.3.2 for illustration.

Eleven companies, four of them failed, yield significant improvements (>10%) in misclassification percentage as a result of the processing of incremental financial statement information.



	% MISCLASSIFICATIONS				
	CHAIRMAN'S NARRATIVE	ACCOUNTING STATEMENTS	FINANCIAL RATIOS	ALL SOURCES	INTEGRATED IMPROVEMENT (%)
CASE 39:	80	10	0	29	51
CASE 12:	82	44	21	43	39
CASE 4:	33	4	8	4	29
CASE 57:	36	11	30	15	20
CASE 35:	46	24	38	29	17
CASE 18:	52		20	48	37
		15			
CASE 28:	30	11	30	15	15
CASE 53:	94	69	58	80	14
CASE 34:	25	6	2	12	13
CASE 1:	22	4	19	9	13
CASE 66:	22	14	9	10	12

**TABLE 8.4.5: CLASSIFICATION DIFFERENCES: FINANCIAL STATEMENTS  
SUPERIOR**

Integration of accounting statement and financial ratio information consistently classifies correctly cases 39, 4, 57, 28, 34, 1 and 66. Cases 12, 35 and 18 are regularly classified failed in error, attributable to poor profitability, though more than adequately compensated by low gearing and high liquidity. Case 53 is regularly classified non-failed, despite extreme high gearing, because of its high profitability.

The misinterpretation of the narrative may be attributable to several factors:

- i) length of narrative statement: Cases 1, 57, 12 at respectively 203, 291 and 324 words are among the 20% of shortest narratives, all more than one standard deviation below the mean number of words. Case 4 at 346 words lies just outside this bound, and Case 19 with only 203 words lies just outside the group of eleven cases of highest misclassification improvement.

The suggestion appears to be that these narrative statements are too short to convey a clear message. On the other hand, statements of a similar length were able to demonstrate failure (Case 69:147 words; Case 48:274 words) or non-failure (Case 33:273 words; Case 59:294 words) within the same constraint.

- ii) readability of narrative statement: Cases 57, 35 and 28 were among the highest quartile of 'difficult' cases based on cognizability and the CLOZE scores recorded. But cases 63, 46 and 33 were all considered more difficult without demonstrating the same kind of conflict. Cases 57, 39 and 4 were among the highest quartile of 'difficult' cases based on the LIX readability measure. But cases 15 and 63 demonstrated a similar order of score without posing significant classification difficulties. Cases 4 and 57 are notable in that they combine brevity with difficulty, making them doubly problematical.
- iii) tone of narrative content: Cases 53, 39 and 12 have been considered in detail earlier in Section 8.4, providing examples of cases in which undue emphasis on profitability will produce misclassifications.

The remaining failed cases (4 and 34) both convey news of enormous losses together with an absence of dividends. Case 34 also refers to balance sheet difficulties: 'The losses placed a severe strain on the company's liquidity'. The only redeeming feature in either narrative to convey optimism is that attributable to new products launched and new orders won.

The remaining non-failed cases (57, 35, 18, 28, 1 and 66) all convey news of profits earned and dividends declared, but are depressingly pessimistic about the future. The narrative for Case 57 is technically and structurally the most complex, obscuring a message of balance sheet strength: 'the group's improved liquidity reduced net interest costs for the year to under 7000 on the higher turnover'. Case 1 reports profits doubled on a slightly lower turnover, but is not encouraging regarding future market conditions. Cases 35, 18, 28 and 66 all report reduced profits and are decidedly pessimistic about

prospects for recovery in the UK market. Such remarks apparently contributed to the misclassification of these cases, even though, as detailed in Chapter 7, references to difficult trading conditions are commonplace across all companies, and do not provide a useful discriminatory variable.

- iv) perceptions of actual failure rates: although the identity of each company was obscured by the emasculation of the report, in order to maintain the readability of the narrative, often sufficient information remained for an assessment to be made of the industry sector, the size of company and the length of its existence. Increases in the experience and sophistication of respondents would be expected to coincide with a realisation that small, young companies in vulnerable sectors are more likely to fail. The sample matching procedure adopted in this study makes an assessment of these factors difficult and none was attempted. Perceptions of industry vulnerability is a particularly interesting and potentially important factor, but would require the examination of a large number of failed and non-failed cases of equivalent product-ranges.

#### 8.4.1 CONCLUSIONS

- 1 The empirical evidence from groups of varying accounting sophistication substantiate the claim that the narrative provides an excellent discriminator between failed and non-failed cases, though inferior to financial statement information and to integrated information sources. Third year accounting undergraduates correctly classified 69% of cases based on the narratives alone. Table 8.4.6 compares this performance with that corresponding to the alternative sources:

	FAILED CASES	NON-FAILED CASES	ALL CASES
CHAIRMAN'S NARRATIVE	62.1	77.1	69.0
ACCOUNTING STATEMENTS	68.3	85.9	76.4
FINANCIAL RATIOS	71.6	80.1	75.6
INTEGRATED SOURCES	66.0	85.9	75.2

TABLE 8.4.6: % CASES CORRECTLY CLASSIFIED BY ALTERNATIVE SOURCES

- 2 The number of misclassification errors recorded, per respondent and per case, by the simultaneous processing of the financial statement information together with the Chairman's narrative, provided a significant improvement over those recorded with the narrative alone.

Results thus far are based entirely on a student audience. The experiment needs to be replicated with professionals who process accounting information, perhaps bank lending officers. An experimental design has been formulated corresponding to a simplified version of that referenced in Section 5.4. Such a design would allow the order of processing of narrative, ratio and accounting statements to be varied, and experiential effects to be gauged, but this remains to be tested and will form part of a future research project.

- 3 Misclassification patterns are consistent with an inability to change respondents perceptions of failure base rates. This is well illustrated by the low correlation coefficient ( $r=0.28$ ) for business students between the number of failed decisions and the number of failed cases in the sample. The number of failed decisions therefore remains relatively constant, consistent with processing on the basis of adjustments around an anchor of 50% failures expected. The effects on the distribution of classification errors is to produce a non-linear pattern with more errors occurring at the extremes of the distribution. This conclusion coincides with that of Houghton (1984) but conflicts with that of Casey (1983). The latter observed loan officers' judgements to be unaffected by disclosure of the objective prior probability of failure, an observation which may be specific to the particular circumstances of the experiment.
- 4 Where an apparent conflict exists between the message conveyed by the narrative and the financial statements, attempts to reconcile the conflict do frequently result in undue emphasis being placed on the less reliable source. Thus for Case 53 (R & J Pullman), only 59% of respondents misclassified the case on the basis of the financial ratios compared to 94% using the Chairman's narrative. However, when integrated, the positive message from the narrative source was over-weighted compared to an extraordinarily high gearing ratio, so that an 80% misclassification rate still persisted.

Similarly for Case 39 (Fairbairn Lawson), no one misclassified this case on the basis of a clearly failed financial ratio profile, but 80% of respondents misinterpreted an overly optimistic narrative. A 20% misclassification rate still persisted as a result of the use of integrated sources.

- 5 There is some evidence that the brevity and complexity of the narrative contributes to misclassification as does a narrative tone which is optimistic/pessimistic when viewed in conjunction with the financial profiles. But such evidence is largely anecdotal, and statistically unconvincing.

Gestalt psychologists (eg: Yin (1969), Smith and Nielsen (1970) and Reed (1972)) argue that decision-makers acquisition and organisation of information within dimensions is perceived in terms of an overall impression and that stimuli are processed in a holistic manner. Such conclusions have serious implications for the communication of multi-dimensional financial information, suggesting the need for comprehensible non-conflicting sources.

## CHAPTER NINE

### IMPROVING THE PRESENTATION OF FINANCIAL INFORMATION

Chapter 8 has highlighted difficulties associated with the processing of information when presented in the form of narrative and numerical statements. The relative complexity of the content of alternative sources generates misleading messages which lead to decision-making errors. This chapter extends the study by considering the manner in which the financial information is presented and in so doing completes the final branch of the schematic overview detailed in Figure 1.1.

Difficulties in the complexity of both content and presentation of annual accounting statements pose problems for users of all levels of sophistication. The particular problems associated with format (Adelberg - 1979), footnotes (Smith and Smith - 1971), jargon (Morton - 1974) and difficult language (Lee and Tweedie - 1977) are all well documented.

Very little attention has been paid by accounting academics to the question of improving the communicative ability of financial statements. Consequently it is hardly surprising that the user pays most attention to the least complex portions of the annual statement - the Chairman's Review and the profit figure. Comparatively little attention is therefore devoted to the information that might be conveyed by the Balance Sheet and other supporting statements. Accounting data is essentially multivariate and its assessment depends on the simultaneous effect of several variables in different spheres of activity. The complex tabular presentation currently employed does not facilitate an integration of the key features of the accounts. The segmented multi-column format leaves an indication of separate performance areas rather than overall success. An alternative means of presentation is needed to provide a clear and efficient representation, either through new methods or through improvements in existing methods. The remaining sections of this chapter examines alternative methods.

#### 9.1 TABULAR PRESENTATIONS

In this section we explore one particular representational method, that has been advocated in other task environments and areas, that may overcome some of the problems associated with traditional methods of representing accounting information. Most recently, Iselin (1989) has addressed this issue, but this chapter takes an alternative, though related, approach.

The patterns of data in a table should be clear in order to highlight exceptions and discrepancies. Most multi-column formats fail to meet this requirement by providing opportunities for obfuscation. On the other hand, the simplest of tables may not be necessary at all since their message can be conveyed efficiently in narrative form. However, the evidence (eg Lothian - 1976) suggests that some deliberate redundancy in the disclosure process may aid communication. Ehrenberg (1977) suggests six general procedures for improving the format of tabular presentations, which might be applied to accounting disclosures:

- i) rounding of all numbers to two significant figures;
- ii) the use of row and column means, where applicable, to provide both a visual focus and a summary;
- iii) arranging figures in columns to facilitate their comparison;
- iv) ordering of rows and columns by size to ease the comparison of small and large numbers;
- v) placing of figures which are meant to be compared adjacent to each other, to facilitate the process;
- vi) the use of spacing and layout to guide the reader through the table.

The adoption of some of these principles could significantly improve the readability of profit and loss statements and balance sheets, though the rounding condition suggests some conflict between our 'accuracy' and 'understandability' properties.

Wright (1968), in the information systems field, found that different tabular formats influenced the ability to extract information. In an accounting environment, Iselin (1989) demonstrates a preference among accounting undergraduates for a report format (rather than account format) for the quantitative accounting statements, with the former associated with a higher extraction performance in terms of both speed and accuracy.

Ehrenberg has little to say in favour of graphs as a means of communicating the quantitative aspects of data, preferring a well-designed table. He highlights instances where many variables are involved, the ranges of data are extensive and detailed numerical analysis required as being beyond the scope of graphical methods. What he may imply is that new graphical

methods are required, more sophisticated than traditional means, in order to overcome these problems.

Tukey (1977) argues that 'a good graph forces us to notice what we never expected to see'. Wainer and Thissen (1981), while accepting the usefulness of properly prepared tables, emphasise the need for more experimentation to test the perceptual efficiency of the alternative representational techniques. The search for an enhanced means of reporting focuses naturally on the use of visual methods for representing relationships, making them both easier to grasp and retain. Currently numerical and narrative exposition is employed in circumstances where graphical or pictorial methods might be more appropriate.

## 9.2 GRAPHICAL METHODS

In situations where information overload limits successful extensions of accounting disclosures Bedford (1973) recognises that new methods of disclosure will have to be developed. He identifies moving-picture presentations, charts, graphs and trend lines as possible alternatives. Similarly different methods of presentation will be necessary to deal with different decision-making models and this may require a distinction being made between those for which a graphical exposition is preferred and those for which a numerical exposition is more appropriate. The existing transmission of financial information is a one-way communication and therefore corporate reports must be self-explanatory and couched in precise language.

Jensen (1976) is enthusiastic about the advantages of visual displays of different kinds in communicating financial information: "... an advantage of visual display is the tremendous ability and flexibility of humans for detecting spatially and temporally distributed features in data. Mathematical models, though often an aid in discovering relationships, have much less flexibility and adaptive innovation ability."

Lothian (1976) recognises that "... more research is required to establish the potential value of reports presented to users in different styles. The novelty of such notions may be exceeded only by their effectiveness in communicating with users of financial statements."



Clearly alternative means of communicating multivariate financial data are still sought. Pictorial methods, especially those able to represent several dimensions simultaneously in a form that may be perceived as a Gestalt, may potentially be useful. Gestalt psychologists, among them Yin (1969), Smith and Nielsen (1970) and Reed (1972), have argued that the acquisition and organisation of information within dimensions, by decision makers, is perceived in terms of an overall impression so that stimuli are processed in a holistic manner. The implications of this work are central to the communication of multidimensional financial information, where simplified and comprehensible means of presentation are needed. These methods may appear trivial and even frivolous to existing users, but the test of their usefulness will be in the successful communication of financial information.

Conventional pictorial methods are extremely limited in their application. Traditional graphs and charts work well in only 2 or 3 dimensions and quickly become overcomplicated when multivariate information is employed. Working within three dimensions is extremely advantageous from a communications point of view, but in many practical instances this is rarely possible if more than a superficial overview is to be conveyed. Many alternative pictorial methods have been employed in an attempt to facilitate the communication of information - ranging from the familiar bar and pie charts and pictograms to more obscure forms. The pie-chart, bar chart and trend graph have become familiar and acceptable in the financial report as alternatives to the narrative and numerical form. However, they have not been entirely satisfactory in their representation of financial data. Chernoff (1978) emphasises that 'while everyone ought to know what a pie chart is, there are many intelligent people who do not tend naturally to think in terms of graphs and who find it relatively difficult to be innovative in the use of graphs and charts.'

A further difficulty arises in that existing graphs and charts are limited to describing the relationship between only two variables, whereas financial information is both complex and multidimensional. If a complete picture is to emerge, rather than a series of financial relationships, then additional graphical methods are required which will adequately represent the multivariate nature of financial data. Chernoff (1971) provides a suitable definition of the methods sought to represent adequately multivariate data: 'the purpose for graphical representation of multivariate data is to enhance the ability of the analyst to detect and comprehend important phenomena, serve as a mnemonic device for remembering major conclusions,

communicate major conclusions to others, and provide a means for doing complex and relatively accurate calculations informally.' Several alternative figures have been suggested as means of representation of multivariate cases. Appendix 9.2.1 provides illustrations:

- i) 'profiles' are the simplest of the alternatives since they allow a bar chart representation for each of the variables in a single diagram. As such it is difficult to interpret the resulting figure as any more than the sum of several two-dimensional representations.
- ii) Anderson's (1960) 'glyphs' provide a simple figure comprising a circle of fixed radius from whose boundary emanate rays of various lengths and directions, representing the values of the variables.
- iii) Siegel, Farrell, Goldwyn and Friedman (1972) adapted the simple glyph by ignoring the rays, but joining up their extreme points to produce a 'polygon' figure, more recognisable than either profiles or glyphs. The Pickett and White (1966) triangles are a special case of this general approach.
- iv) A further adaptation of the glyph has the rays emanating from the centre of the circle to produce a 'star' with a number of vertices equal to the number of variables under consideration.
- v) Andrews (1972) has incorporated variable values into a Fourier series allowing the construction of distinct 'curves' which facilitate the grouping of variables on the basis of their similarity.
- vi) Chernoff (1971) has initiated the idea of 'faces' whose features can be made to vary in size and shape according to the value of the assigned variable. The original form of portrait has been adapted by Bruckner (1978) to provide greater variation and by Frith (1978) and by Flury and Riedwyl (1981) to provide greater realism.
- vii) Kleiner and Hartigan (1981) have examined the use of 'trees' and 'castles', producing figures reminiscent of the dendrogram of hierarchical cluster analysis.

Appendix 9.2.2 shows the extreme cases for facial presentations. Profiles, glyphs, trees and castles create very little impact and the Andrews curves are very difficult to interpret but the stars, polygons and faces seem potentially useful in the analysis of multivariate data. The latter group are able to produce a gestalt whose effect may be more than the sum of the individual variables.

Schmid (1954) has identified five advantages of using charts and graphs rather than tabular or purely verbal presentations, and a consideration of these allows a more educated choice from among the alternatives outlined above as to the most appropriate form of representation:

- i) well-designed charts can be more effective both in creating interest and by demanding the attention of the reader through their visual impact.
- ii) visual relationships are more easily comprehended and more clearly retained.
- iii) large quantities of statistical data can be condensed to a form whose essential meaning can easily be visualised.
- iv) the provision of a picture makes a complete and improved understanding of the problem possible.
- v) the disclosure of apparently hidden relationships through graphical methods can stimulate further investigation.

The impact of graphical representation is an important attribute since a forceful picture must be produced which allows new stimuli from a complex data set to be perceived while existing stimuli are being integrated. The characteristic shape of stars, polygons and faces suggest that they can demand attention, while in addition faces are able to trigger an emotional reaction which enhances their overall impact. However, we may speculate that the impact associated with an uncomplicated and attractive format may generate negative reactions in that emotional barriers may be raised to the use of novel means of communication.

Most graphical and pictorial methods sacrifice some degree of accuracy in the cause of visual impact but this is only satisfactory if the resulting distortion does not impair the decision usefulness of the data. The data should be communicated precisely through an appropriate graphical form without opportunities for the manipulation of scales and axes leading to

misrepresentations such as those identified by Huff (1954). The use of cartoon and schematic faces in data representation is one format where a precise mapping of data might cause disfigurement of the overall portrait. Bounds have to be created in order to preserve a familiar human facial form, by the introduction of constraints to prevent facial features (e.g. eyes, mouth) from being mapped outside the confines of the facial outline.

While graphical representations should be comprehensive they must not be so complicated as to impair efficient and effective processing. Ideally they will be simple, familiar and easily integrated.

### 9.3 FACIAL REPRESENTATIONS

Attempts to communicate too much information may detract from the important facts and reduce the overall appeal of the chart. Of the alternatives so far considered, facial representation seems to offer the best opportunity of conveying simultaneously information about many variables, but there may be an optimum number of facial features which can usefully be varied. Bruckner (1978) considers the use of many varying features a plus point in facial representation since it makes the creation of a total impression, rather than a composition of many separate stimuli, more likely. However, he recognises the possible dangers of overexpanding the dimensions of the face, considering fifteen variables to be a practical maximum.

The self-explanatory nature of many graphical methods is an important attribute which poses difficulties for some of the newer graphical methods, like the Andrews' functions and the Chernoff faces. The latter may only provide speedier means of communication if users are trained in their application and interpretation. Certainly Chernoff emphasises the importance of user education in the use of faces to communicate information, but Jacob (1978) has produced experimental evidence to show that faces may be used successfully to transmit data without prior training, and Moriarity (1979) has produced experimental results which suggest 'even persons unfamiliar with the faces can use them more efficiently than account balances or financial ratios'.

It is essential to identify the underlying dimensionality of the data in any analysis since standard graphical methods are quite effective for two dimensions or where the data may conveniently be reduced to two dimensions. The handling of high degrees of dimensionality is eased when

the chart can be viewed as a whole rather than as the sum of its component parts, and in this respect faces and stars seem to offer a much more efficient method of presentation than do profiles or Andrews curves.

Very little work has been directed towards a comparison of the power of alternative graphical methods. Mezzich and Worthington (1978) examined multidimensional scaling, factor analysis and Chernoff faces in a clustering environment and attributed the differences in the perceptions of respondents to the potential for reduction to a traditional two-dimensional picture.

Experiments by Yin (1969) with faces, houses, airplanes and men-in-motion found that the recognition of difference was much the best for normally presented faces. Jacob's (1978) work with digits, glyphs, polygons and faces confirmed these findings which he attributed to simple decision-making strategies that were made possible by facial familiarity: 'humans look at and process faces constantly. They have become well adapted to this task and are extremely good at performing it. Hence humans would be expected to perform visual processing on faces better than on otherwise comparable visual stimuli'.

The informational content of facial familiarity was further emphasised by Yin (1969) in his experiments with photographic negatives and inverted faces, each with the same geometric characteristics as normal faces. Upside-down faces produced a much worse performance in difference recognition than other objects, suggesting that 'while all upside-down faces are disproportionately affected. These findings suggest that the difficulty in looking at upside-down faces involves two factors: a) a general factor of familiarity with mono-oriented objects; and b) a special factor related only to faces'.

The familiarity of faces and their ease of recognition and description makes them superior to other pictorial forms of representation. Morton and Johnson (1989) note that faces are special more than by virtue of their being visible parts of the human form since they can signal their intentions. This is so even though there is no convincing evidence that they are processed any differently from other objects which we require to discriminate amongst.

These conclusions are summarised by Chernoff (1973), 'we perceive the face as a Gestalt and our built-in computer is quick to pick out the relevant information and to filter out the noise' and the conclusion of Jacob (1978) 'the overall value of one multidimensional datum would be represented by a single face. Its overall expression - the observer's own synthesis of the various individual features - would contribute a single image depicting the overall position of the point in its multidimensional space'.

However the facial information is perceived and interpreted it is clear that the variation in a set of numerical data could be represented by a variety of facial expressions. The variation of the dimensions and features of the human face offers a very special means of presenting information, as recognised by Bradshaw (1969) 'the human face is largely unique in its dual role of communication and identification'.

The importance of the face as a source of visual stimuli derives from developmental changes in infants, whereby they quickly learn to respond to more differentiated forms. Schaffer (1971) observes that with increasing age the overriding importance of the eyes as a source of recognition and attraction is complemented by increasing attention to other facial features, facilitating the differentiation between various expressions. The similar reaction of infants to real faces, photographic representations and schematic line drawings, forms the basis of their reaction as adults to the messages provided by cartoon faces.

Although graphic data displays using charts, histograms or scatter diagrams can provide simple and effective means of communicating information they are severely limited in the extent to which they can convey relationships. Huff and Black (1978) emphasise the usefulness of faces as a special stimulus category in displaying multidimensional data.

The unique nature of faces as conveyors of information has received much attention in the psychological literature with extensive implications for their future use. Ellis (1975) notes that 'faces obviously constitute a rather special class of visual input because of their complexity, the familiarity with which we experience them, the motivation which we have to remember them, and the ways in which they can convey non-verbal information'.

Ekman (1973) too is concerned with the use of the face as a complex information source though he warns of the inherent difficulties 'the very richness of the face, the number of different facial behaviours, the number of different kinds of information we may derive from observing the face, and the uncertainty about whether we are obtaining correct, incorrect, or even purposefully misleading information, can give rise to confusion'. These doubts are echoed by Bruckner (1978) in highlighting the facial abuse that might allow misinterpretation and the 'built-in dependencies among facial features may distort the data representation enough to cause erroneous impressions'.

### 9.3.1 FACES AS A MEANS OF COMMUNICATION

Ekman (1973) concludes that 'such agreement (about interpretation of a particular facial expression) must mean that these judges had common experiences with this particular facial appearance, so that they could agree about what it means without hearing the person's voice or words, without any knowledge of the content, and without knowledge of what went before or came after this facial expression'. The implications of such conclusions are extremely encouraging for the use of facial representations to communicate information without additional support literature and without the extensive training envisaged by Chernoff. Cuceloglu (1970) reached similar conclusions after tests using line drawings as a means of overcoming the problems associated with the different facial expressions of a single person 'the results of the present study indicate clearly that some static facial features are regarded as distinctive in the expression of a given emotion and some are not. Some of these distinctive features are shown across cultures reflecting what seems to be universals in facial communication... . There seems to be a facial code employed in the communication of effective meaning which is to a great extent, although not wholly, common to different cultures'. Cuceloglu's findings emphasised the importance of using schematic faces which show appearances which observers have encountered before, and which avoid expressions that might be interpreted as being a blend of different emotions.

These findings suggest that the successful communication of information through facial representation should be concentrated on realistic expressions, which means the elimination of those combinations of components which produce impossible or unlikely facial portraits. In the construction of schematic faces resulting from a mapping of numerical data,

this implies the imposition of constraints to prevent the generation of faces which are either difficult to interpret or divorced from reality.

Jacob (1978) suggests that 'reducing the range of variation on most parameters gave a more realistic set of faces; these were preferred because people are especially attuned to very small variations in realistic faces'.

Chernoff (1978) provides a firm viewpoint, although providing no specific evidence in support of his conjecture: 'experience with caricatures and cartoons would seem to indicate that the need for realistic faces on pictures is not great and that lack of realism is compensated for, at least in part, by the ability to caricature'. Supporting evidence is supplied by Diamond and Carey (1986) who find respondents to prefer schematic cartoon faces to real faces in recognition exercises.

Experimental investigations employing the Frith-Everitt (1978) version of the face to depict financial trends does suggest that there may be limitations on the extent to which useful realism may be introduced into facial portraits. Exploratory comparisons of the Chernoff and Frith faces in the representation of financial information were undertaken with a group of 40 undergraduate business students. The two facial methods were each employed in a decision-making context involving a failed/non-failed classification based on the facial profiles of 20 companies, ten of each status, and seven financial variables.

The results generated a clear preference for the Chernoff faces in this experiment. The distinction between the two formats is analagous to that evidenced by Johnson (forthcoming), who finds that young children initially recognise faces on the basis of outline and hair, and can only distinguish faces on the basis of individual features in subsequent development.

The Frith emphasis on hair-line and chin-curve, as opposed to internal facial features, appears to be counterproductive. Galper and Hochberg (1971) allude to this problem: 'faces are not remembered and recognised solely by the combination of those characteristics which survive in negative (eg face shape, hair style)'.

Bruckner (1978) identifies a further advantage in that facial characteristics can be linked to the physical meaning of the variables, in a way that other forms of pictorial representation would find impossible. Thus the degree of



success or failure might be represented by the extent of the smile produced through the variation of mouth curvature.

### 9.3.2 THE SALIENCY OF FACIAL FEATURES

In his cross-cultural analysis using simple line drawings Cuceloglu (1970) employed 60 possible facial combinations made up of 4 eye-brow types, 3 eye types and 5 mouth types. Principal components analysis on the emotions associated with particular facial expressions revealed that 80.9% of the total variation was accounted for by six factors, of which 72.4% was accounted for by just three, which he labelled: pleasantness (32.3%), irritation (29.8%) and non-receptivity (10.3%). Among these mouth curvature proved to be the most important 'pleasantness' feature, while a combination of mouth curvature with eyebrow slant appeared to be the most important 'irritation' feature. The 'non-receptivity' feature was best characterised by a combination of eye-closure with eyebrow slant.

Even this simple study highlights some of the difficulties associated with the saliency of particular facial features: saliency seems to depend upon the particular emotion being displayed, the dimensionality of variation within the information source and the information medium itself.

Bradshaw's (1969) experiments based on very simple schematic faces produced comparable results; where the nose and mouth were represented only by straight lines, and without mouth curvature or eyebrow slant, he identified a descending order of importance from eye height (and hence length of forehead) through nose length and mouth width, down to eye width. The experiments of Friedman, Reed and Carterette (1970) with similarly simple faces showed the eyes to be the most important discriminatory feature, followed by the nose and the forehead with roughly the same degree of saliency. However, their findings seem to offer some evidence in support of the 'composite' effect since differences between two faces were often detected without recognition of the actual feature that was different.

Further support for the eyes as the most salient feature has been provided by Goldstein and Mackenberg (1966), Laughery, Alexander and Lane (1971) and by Grant (1970). The latter identifies three main expressive areas, the eyes (especially direction of gaze), the eyebrows and forehead and the mouth in order of importance and links movements with particular emotions.

Laughery et al (1971) emphasise the importance of the eyes, and the relative insignificance of the ears in their study: 'Certain areas, namely the eye and mouth regions, are more mobile than others and so convey more information about an individual's mood which can assist us in comprehending what they are trying to communicate to us. Therefore we might pay more attention to, and learn to differentiate, those features more effectively'.

Against this formidable display of evidence favouring the saliency of forehead and eye areas can be ranged a corresponding array of apparently conflicting findings (e.g. Dunlop in Izard (1971) offered evidence for the superiority of the mouth area specifically in conveying 'happy' emotions).

Frois-Wittman (1930) found certain muscle groups that were typically involved in particular facial expressions, but could find no consistent dominance of either eyes (and the upper face generally) or mouth (and lower face) in the interpretation of expression. He emphasises the consideration of patterns of components across facial areas rather than each component separately and argues against a simple division of the face into top-and-bottom on the grounds of a more extensive dependence of facial features.

Ekman, Friesen and Ellsworth (1972) express no surprise at the contradictory nature of the findings of other investigators because of the implied use of the unwarranted assumption of the independence of facial areas. In the absence of a generalised procedure for measuring the changes in facial components they developed a Facial Affect Scoring Technique concentrating on movement in three areas of the face: i) brows, forehead area ii) eyes, eyelids iii) lower face, including cheeks, nose, mouth and chin. More recent evidence from Bruce (1988) suggests that more attention be paid to the spacing of facial characteristics (e.g. inter-ocular distance) since this provides a major facial recognition cue in adults.

### 9.3.3 INFORMATION PROCESSING IN FACIAL EXAMINATION

Chernoff (1978) seems convinced of the face being regarded as a total portrait rather than the sum of a number of components, and correspondingly views the scanning process as being template-based: 'our ability to distinguish between very similar faces involves a mechanism where the brain converts the face to a mental caricature on which it operates. Hence the cartoon caricatures of faces which resemble our mental caricature will probably be more effective as a graphical representation

than either more realistic drawings or freakish caricatures far moved from our mental ones'. However, he offers no empirical support for his views and much of the psychological literature is in direct conflict.

Braine (1965) found that 'adults appeared to scan by starting at the top of the figures (regardless of the position of the focal part) and then continued downwards', and Smith and Nielsen (1970) suggest a top-to-bottom sequential scanning of facial features.

Ellis, Shepherd and Davies (1975) working with more realistic photo-fit drawings suggest a link between saliency of feature and scanning procedure: 'it is evident that the characteristic strategy among most subjects is to reconstruct the face from forehead, through eyes, nose, mouth and chin'.

Egeth (1966) expresses concern about the state of knowledge regarding scanning for pertinent data cues in the absence of theories for filtering out the 'noise' of unwanted or unimportant cues: 'until more is known about the processing of irrelevant information it will be difficult, if not impossible, to achieve a good understanding of the processing of relevant information'. He identifies the alternative scanning procedures that might be used:

- i) Serial Models: serial/self-terminating involving the scanning of features one by one in either a fixed (top-to-bottom) or random order until sufficient cues have been established to make a decision.
- ii) Parallel Models: involving a simultaneous feature comparison, either exhaustive if all such comparisons are made, or self-terminating when sufficient comparisons have been made.
- iii) Template Models: based on a stored notion of an ideal picture used for comparison purposes and therefore very similar to the parallel/exhaustive model.

An experimental examination by Smith and Nielsen (1970) of the alternatives suggested that the template model was a reasonable one for judgements of whether two faces were the same, but that a parallel model was more likely for judgements of the nature of such differences. They found the use of

serial models to be characterised by long reaction times and a tendency for stored features of the original face to be converted into a verbal description prior to comparison. Empirical evidence from Bradshaw and Wallace (1971), using identikit comparison, found no evidence to support the hypothesis that faces were treated in a holistic fashion, nor that features were processed to any significant extent in parallel. They found a serial self-terminating process to be the most applicable with task difficulty, as determined by the number of critical features present: 'processing time will tend toward a line or function of the number of features to be encoded, one after the other, before a decision can be reached; at this point processing stops'.

Despite the apparent importance of individual facial cues in the scanning process much of the empirical evidence supports the hypothesis that a Gestalt effect is important as a classification strategy since it enables the use of a simple decision-making rule.

Yin (1969) found the dominant strategy used for the classification of faces was an attempt 'to get a general impression of the whole picture' while for houses, airplanes and men-in-motion respondents were 'searching for some distinguishing feature'.

Tversky and Krantz (1969) found that the differences in face shape, eyes and mouth which determine similar features in schematic faces 'lends some support to the thesis that formation of overall impressions can be analysed into the formation of a priori specifiable subimpressions and the combination of these independent subimpressions'.

Jacob (1978) considers that 'synthesis by the observer himself of the various graphical elements of the facial display into a single gestalt is one of the principal advantages of this type of iconic display'.

Reed (1972) in experiments designed to determine how subjects make categorical classifications without logical decision rules found that 'the predominant strategy, as revealed by successful models, was to abstract a prototype representing each category and to compare the distance of novel patterns to each prototype, emphasising those features which best discriminated the two categories'.

The dominance of the 'holistic' approach is apparent from Reed's results. The adoption of such an integrative weighted-feature approach parallels that

where company performance is judged by weighting key financial ratio indicators. Messick and Damarin (1964) highlight the effects of user differences in the adoption of alternative classification strategies influenced by education and training.

Another important aspect of the classification procedure is how users will react to different levels of information when provided with data in a facial form. This information might be of a verbal or textual nature and could introduce conflicting stimuli.

Moriarity (1979), working with financial statement data, examines the use of multidimensional graphics as a technique for describing the financial status of the firm. He suggests that unsupported faces may provide an excellent framework for decision-making when produced as an alternative to information conveyed in more traditional fashion. Moriarity asked respondents to classify 22 retail companies as failed or non-failed, without knowledge of prior probabilities, when presented with appropriate financial information in each of four alternative formats:

- i) schematic faces with no explanation of the assignment of financial variables to facial features;
- ii) schematic faces with a brief explanation of the representations;
- iii) selected Key Dun and Bradstreet business ratios relating to each of the companies, together with, in each case, an indication of industry averages for a six-year period;
- iv) the actual financial statement balances required to calculate the ratios.

Each of the alternative forms reflected the same changes in the financial statement information but Moriarity's respondents found the changes most easily detected in the faces. 'Faces without explanation' were classified faster and more accurately than either the raw accounting numbers or the derived ratios by both accounting students and practising accountants. In addition, errors of classification were significantly higher for both students and accounting professionals for data presented in a ratio format, which was attributed to a lack of understanding of what the ratios really represented. The Lee and Tweedie (1981) survey tends to confirm this view, suggesting that financial 'experts' have a less than clear understanding of the meaning of some of the most familiar financial ratios.

Moriarity also claimed that his schematic faces outperformed Altman's 1968 Z-model (1968) for the discrimination between bankrupt and solvent companies. But it should be pointed out that Altman's model was derived from small manufacturing companies, and erroneously applied (Altman (1980)) by Moriarity to a sample of large retail firms.

Libby (1981) suggests that the use of such multidimensional graphics in the audit environment might facilitate auditor detection of inconsistencies during routine analytic reviews.

The psychological literature emphasises the relative importance of facial information compared to contextual information, especially when there is apparent ambiguity. Ekman (1973) examines the empirical evidence to support the alternative propositions of Fernberger (1954) and Bruner and Tagiari (1954).

Fernberger proposes that 'if a stimulus situation is indicated, the emotional state will be judged in accordance with that situation rather than in accordance with the facial expression' while the additive hypothesis of Bruner and Tagiari suggests that judgements based on the face alone can only be improved by additional contextual information. Ekman finds that the additive hypothesis is not supported and questions Fernberger's proposition since there is no evidence to suggest that face judgements were more important than contextual information: 'no consistent pattern to suggest that the combination of face and context is always better than the source which is superior when observed alone'.

Bugenthal (1976) notes that when facial expression contradicts informational content, of a verbal or contextual nature, respondents made no attempt to resolve the discrepancy. When exposed to conflict subjects were always influenced by the least pleasant channel whichever it was. Such findings have a potentially serious impact on the manner in which multiple features and multiple media sources are processed.

Clearly facial information alone appears to be a powerful tool even when used in the absence of detailed explanation. The evidence would seem to question the need for extensive training in the use of schematic faces for interpretative or discriminatory purposes, other than a familiarisation exercise in order to overcome excessive emphasis on individual features.

Chernoff (1973) hypothesises that 'small and barely measurable differences are easily detected and evoke emotional reactions from a long catalogue buried in the memory. Relatively large differences go unnoticed in circumstances where they are not important'. Jacob (1978) supports the view that people are capable of detecting very small variations in facial form, but does not supply any quantifiable evidence of the nature of that which might be derived from using a measuring and scoring technique for facial components like Ekman's (1973). This assumption is critical to the successful operation of a system of schematic faces in clustering and trend detection, since as Crouch, Brindle and Frye (1978) point out 'the graphical analysis of multivariable data using Chernoff faces relies on an analyst's ability to recognise changes in facial expressions'.

Clustering experiments of this type would represent a further development of the studies detailed in Chapter 10 and provide a potentially useful area for future research. An exploratory exercise based on the perceived similarity of performance of 20 retail outlets using facial representation of seven financial variables showed both Chernoff and Frith formats to be useful in this context.

It is difficult to support Chernoff's views about large unnoticed differences in view of the comments of Egeth (1966) regarding irrelevant information and the possibility that the 'noise' created by the presence of many minor variables in an analysis may tend to disrupt the filtering process and reduce the discriminatory ability of faces:

The computer-based construction of schematic faces using a graph plotter was initiated by Chernoff (1971) and adjustments to this basic program have been made through the addition of ears and the replacement of the line nose with a triangular nose, and by the variation of the facial ellipses, respectively by Davis (1974) and Bruckner (1978).

The original Chernoff face made possible the variation of 18 facial features and the additions made this up to 20 (face width, ear level, face height, upper and lower face eccentricities, nose length, mouth centre, mouth length, mouth curvature, eye height, eye separation, eye slant, eye eccentricity, eye length, position of pupils, eyebrow height, brow angle, brow length, radius of ear and nose width). Others could be included but the empirical evidence indicated by Smith and Taffler (1984) suggests that the dimensionality of the

data could be substantially reduced without a significant loss of explanatory ability.

Bruckner feels that 15 is a practical maximum to the number of features that may be varied, while Huff and Black (1978) found only seven to be significant in their experiments. Savich (1977) found only five financial variables to be significant in his experiments with accounting students examining their hold-buy-sell decision making process. Such findings, if confirmed by further investigation could have significant implications both for facial representations and for financial statement disclosure.

The major difficulty with the construction remains the question of interdependence of facial features - necessary in order to ensure the production of a human face. Some features (face height, the three facial eccentricities, eye slant, ear level and ear size) depend only on the input data for the corresponding facial variable value, but others are highly interdependent:

- i) pupil position is dependent in order to ensure that it remains in the eye.
- ii) mouth structure is a function of face height, face width, ear level, lower face eccentricity, nose length and the three mouth parameters.
- iii) eye height is a function of nose length and face height.
- iv) eye separation is a function of upper face eccentricity and face height.

Because of these interdependent relationships some faces will exhibit different sensitivities to changes in features, and strenuous efforts to produce orthogonal variables will be partly neutralised by the imposition of a forced dependence. The existence of such problems questions the need for precision in the necessary financial information employed when a precise mapping of this information may not be possible. If the facial profiles are to be processed as Gestalts then the interactions between the different characteristics may be as important as the size and shape of individual features. In the assignment of ratio values to features an appreciation of the overall effect of a combination of ratios may be more important than the precision of the individual ratios.



Chernoff (1978) suggests a normalisation of the faces to keep face height and width constant in order to reduce, though not eliminate interdependence.

Deakin (1976) has shown the normal assumption to be incorrect in most cases, of the eleven major ratios he considered only Total Debt/Total Assets was not significantly differently distributed from the normal. The use of a log transformation on Current Assets/Current Liabilities and a square root transformation on Net Income/Total Assets renders them very close to a normal distribution but other simple transformations were of no assistance with the remaining ratios.

The Frith version of the schematic face, with minor amendments by Everitt (1978), produces more of a cartoon face. As such the pictorial representation is much more realistic (although Chernoff among others considers this a disadvantage) and pays more attention to hairline and forehead height, which the psychological literature suggest are important in recognition and clustering exercises. Only nine facial features are variable (upper hair, chin curve, lower hair, eye size, mouth size, eye space, eye slant, mouth curve and face size). While more visually appealing than the Chernoff faces, these cartoons suffer from similar problems of feature interdependence and identical problems of data input.

Even where the input data has been amended to a satisfactory form the problem of the most appropriate assignment of variables to facial features remains.

#### 9.3.4 THE ASSIGNMENT OF VARIABLES TO FACIAL FEATURES

Empirical evidence on the detection of facial cues and the interpretation of faces suggest that the assignment of appropriate variables to facial components is important. The studies of Moriarity (1979) and Bruckner (1978) involve random and author-selected assignment of variables to facial features. Stock and Watson (1984) also pay insufficient attention to the relevant psychological literature on feature saliency. Smith and Taffler (1984) reference the appropriate literature but fail to suggest an optimal feature assignment.

Everitt (1978) justifies a random assignment procedure as a means of reducing the problem of subjectivity caused by different observers using different features of the face to judge their similarity 'a possible procedure for attempting to overcome such problems is to produce several sets of faces

for the data, each set involving a different permutation of variables to features'.

Similarly, McDonald and Ayers (1978) suggest that an appropriate strategy would be 'to permute the variables which do control the individual features and monitor the invariance (or lack of invariance) in the resulting visual clusters'. The possibility of introducing a subjective bias by the arbitrary assignment of variables to features is also noted by Newton (1978), who considers that all the consequences might not necessarily be disadvantageous: 'in fact some distortions might attract attention to relationships that should be studied further'.

Experimental evidence from Chernoff and Rizvi (1975) reveals that 'random permutation in the assignment of (facial) parameters may effect the error rate in a classification task using these faces by a factor of about 25 per cent'. Their results established that certain facial features carry little significant information under certain conditions without permitting a clear indication of the relative efficiency of different facial features.

Although the significance of the dimensionality of the data in influencing discriminatory ability remains in doubt, the need for a clear decision on the assignment of features is well established, and the psychological literature on saliency should be of great assistance here.

Experiments by Huff and Black (1978) involved the arbitrary assignment of facial features to variables but rankings by the forty students involved of the features perceived to be the most important revealed an order much as would be expected from a reading of the psychological literature; in declining order of importance: length of eyes, eccentricity of eyes, angle of eyebrow, curvature of mouth, length of nose, width of nose, and diameter of ears. They assigned variables to features on the basis of relative importance as determined by an analysis of variance. The discriminatory power of their faces improved significantly as a result.

Andrews (1972) has suggested the use of principal components analysis to determine the relative importance of variables and has assigned terms in his sine function accordingly. This procedure might easily be adapted to the faces problem by assigning those variables, revealed as most important by principal components analysis, to those features suggested by relevant psychological literature as being most pertinent.

### 9.3.5 IMPLICATIONS FOR FINANCIAL APPLICATIONS

Graphical techniques generally should be particularly sensitive to small changes so that they can emphasise differences and identify outlying observations. Psychological evidence from Ekman (1973) and Izard (1971) suggests extreme sensitivity in facial representations in that the slightest changes may be detected.

The literature discussed above provides convincing evidence of the superiority of the facial portrait over other pictorial formats. It also provides guidance in three areas of critical importance for the application of the facial technique in the financial environment:

- i) alternative facial media
- ii) task dependency
- iii) feature assignments.

The literature considers empirical evidence regarding several forms of facial representation, of increasing order of sophistication:

- i) schematic faces - straight lines only - Bradshaw (1969)
- ii) schematic faces - with mouth curvature - Cuceloglu (1970)
- iii) computer-constructed schematic faces with multiple features-Chernoff (1971)
- iv) artist constructed cartoon faces - Smith and Nielsen (1970)
- v) computer-constructed cartoon faces - Frith (1978)
- vi) identikit drawings of facial components - Ellis et al (1975)
- vii) photofit based depictions - Bradshaw and Wallace (1971).

The choice of a particular facial format is task dependent and the empirical evidence covers experiments associated with recognition, recall, discrimination and clustering as well as the communication of meaning.

Observation of facial processing in a Gestalt manner by Friedman, Reed and Carterette (1970) suggests that the simplest of line drawings will suffice in questions of recognition, recall and similarity. McDonald and Ayers (1978)

suggest emphasis on facial outline (hairline and chin curve) rather than eyes/mouth might prove advantageous in clustering exercises.

But where the facial portrait is required to communicate a message the emphasis must be placed on the mobile features. Thus Grant (1970) and Laughery et al (1971) emphasise the expressive areas associated with the mouth, eyes, eyebrows and direction of gaze. These features can be varied efficiently with the Chernoff-Bruckner (1978) formulation to facilitate the interpretation of the overall portrait. The difficulty of interpretation of the Frith-Everitt (1978) faces precludes their further consideration in the context of financial variables. The lack of emphasis on internal facial features in the latter means that the only suggestion of financial well-being in these representations is the fleshy-faced appearance that might be associated with health and nourishment.

Although the Chernoff faces offer the facility to vary simultaneously over twenty facial features, strong evidence suggests that this is too many for efficient processing. Savich's (1977) suggestion that as few as five features may be more realistic, is a view strongly supported by this work.

The influence of relatively few financial variables, representing the key performance areas, can therefore be concentrated on the three key 'expressive' areas identified above.

The question of an optimum assignment of financial variables to facial features remains unclear at this stage. Conflicting evidence has been presented favouring the eyes (Laughery et al - 1971) and the mouth (Dunlop - 1971) as the most important single feature at work in conveying emotion. A similar problem exists with respect to the financial variables, in that the priority accorded them may vary depending on the task at hand. Thus Taffler and Tisshaw (1977) and Taffler and Sudarsanam (1980) use different ratio combinations when explaining, respectively, i) financial distress and impending failure, and ii) relative financial performance.

The suggestion is that different financial variables and alternative facial assignments might be appropriate for different decision-making tasks. This issue is addressed with respect to the two financial environments above, in Chapter 10.1.

What is clear from preliminary experimental findings is the danger that the mouth may so completely dominate the face, when profitability is assigned to it, that the other features/variables may be considered insignificant in comparison. Where profit is the key financial area it may be more appropriate to assign it to a less dominant feature in order to prevent it from obscuring other relevant influences. This issue is examined empirically in Chapter 10.2.

McKelvie (1973) conducted a study in which respondents compared schematic faces comprising systematic variations of eyebrow slant, mouth curvature, nose length, eye height and eye shape. The perceived meaningfulness of the face was found to be at its greatest when both the eyebrows and mouth curvature varied from an average position. The suggestion is that the interaction of eyebrow slant and mouth curvature provides an effective force in the communication of meaning in facial expressions.

These findings are consistent with the psychological evidence provided by Laughery et al (1971) and have been employed in the facial constructions in this study. Strangely in the accounting applications published thus far, Moriarity (1979) did not attempt to manipulate eyebrow slant and Stock and Watson (1984) employed feature direction the inverse of that suggested by the literature. Further, Stock and Watson (1984) accorded the nose a prominent position in the assignment of financial variables to facial features. In these respects and in the provision of an extensive sampling design, the present study represents a distinct improvement over its predecessors.

## CHAPTER TEN

### APPLICATION OF THE FACIAL PROFILE TECHNIQUE IN A FINANCIAL ENVIRONMENT

The application of the psychological literature of Chapter 9 to a financial environment suggests that facial extremes can be used to depict overall performance without the need to comment on the individual features. This chapter explores the opportunity that this presents for alternative, and potentially improved, means of representing financial information. In the context of the thesis as a whole, a methodology is suggested for representing complex financial content in a manner which facilitates its use for decision making.

The implications for the Gestalt processing of facial information are that the single image representing multidimensional data is an entity in which the whole is worth more than merely the sum of the parts, just as the overall informational content of a set of accounts is greater than the sum of its constituent elements.

Interpretation problems may, however, potentially arise because of the overriding prominence of one or two facial characteristics. Nonetheless, similar problems can also arise in financial analysis from an overemphasis on an individual accounting variable, such as the profit number.

A further advantage lies in the fact that the facial representation may not be restricted only to identifying change, but may also communicate the effect through changes in expression in a manner impossible for other pictorial methods.

The question of the assignment of financial variables to facial features is a problematic one, but less critical in depicting differences than in communicating absolute meaning. Where we are concerned with identifying trends over time, the detection of even slight differences in a series of portraits is facilitated by adjacent comparison references. The assignment of variables may be less critical in this context than in a failed/non failed classification task, where no corresponding classificatory template is readily available.

Our familiarity with faces makes an interpretation of the portraits possible without a detailed knowledge of the information used or the facial assignments employed. Provided that due attention is paid to the combination of facial features, without overemphasis on dominant features, it is possible

that an integrative picture might emerge to give a clear indication of overall performance. If we wish to attribute aspects of this performance to particular financial attributes then we might do so by referring to the feature assignment key.

To illustrate the potential benefits for the financial analyst from the use of schematic faces, two examples are provided:

- i) as a screening device to facilitate the examination of large amounts of financial information and allow the classification of observations. Here the bankrupt/solvent decision is employed;
- ii) the detection of change in performance over time, in which the faces act as gauges measuring financial position, facilitating the detection of abnormal performance and highlighting areas for action. Three examples are provided here, two of companies in decline, culminating in eventual failure, and one of a company effecting a recovery from a distressed state.

Like those of Moriarity, the preliminary results presented suggest that the facial format may have a useful part to play in the detection, control and communication of financial performance.

#### 10.1 THE CLASSIFICATION OF FAILED/NON-FAILED COMPANIES

Taffler and Tisshaw (1977) used a linear discriminant model with a sample of 92 companies in order to distinguish between solvent and bankrupt manufacturing companies on the basis of their Z-scores. The constituent variables of their model are listed in Table 10.1.1

RATIO	REPRESENTING DIMENSION OF ACCOUNTING INFORMATION .
<u>Profit Before Tax (PBT)</u>	Profitability
Current Liabilities (CL)	
<u>Current Assets (CA)</u>	Working Capital Position
Total Liabilities (TL)	
<u>Current Liabilities (CL)</u>	Financial Leverage
Total Assets (TA)	
No Credit Interval (days)	Liquidity

TABLE 10.1.1: FINANCIAL RATIOS AND DIMENSIONS REPRESENTED IN LINEAR DISCRIMINANT MODEL

The Taffler and Tisshaw Z-model ratios were assigned to facial features in accordance with Figure 10.1.1 below to provide extremes of Chernoff portraits as shown. The aim was to produce faces which reflected the financial performance of the company and which could be interpreted without the need for a detailed explanation of the variables employed or the feature assignments.

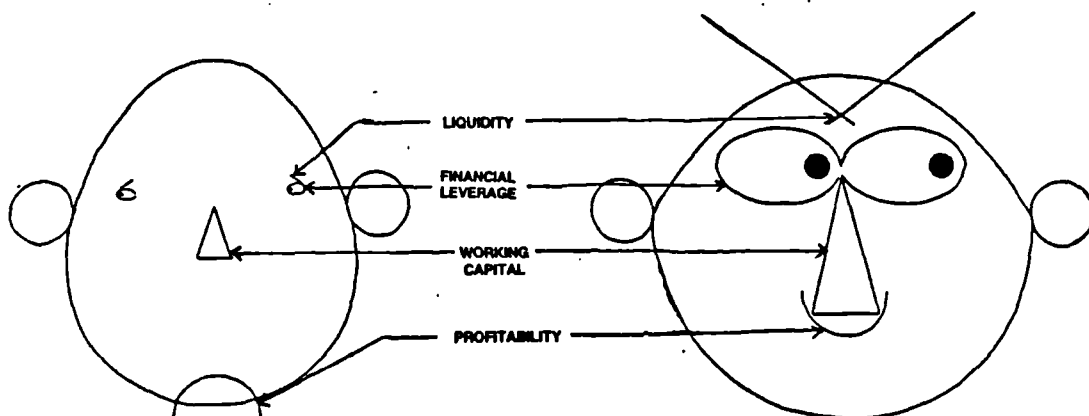
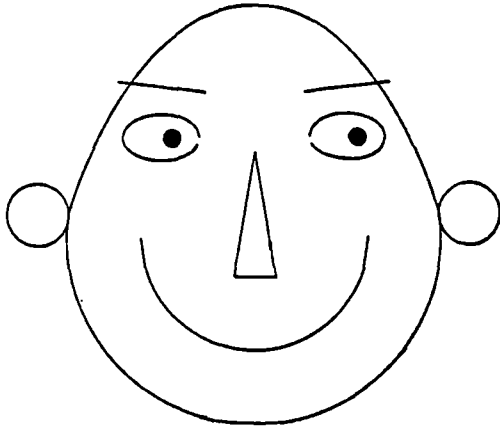

FIGURE 10.1.1: FAILURE CLASSIFICATION - ASSIGNMENT OF FINANCIAL VARIABLES TO FACIAL CHARACTERISTICS



SOLVENT COMPANIES



HAWKER SIDDELEY (31/12/80)  
FAILED COMPANIES

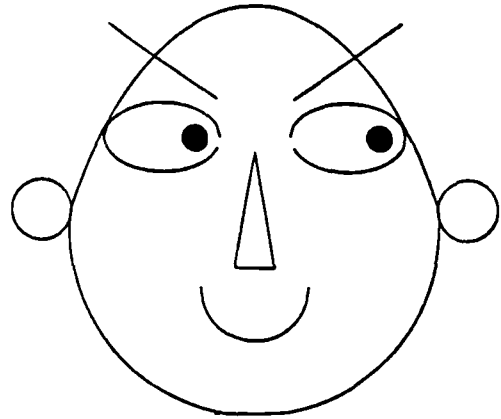

BLUE CIRCLE (31/12/80)

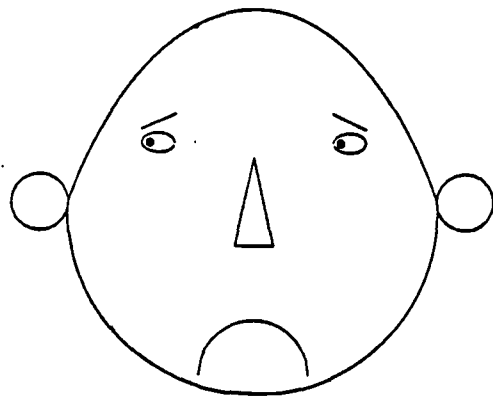

FODENS (31/3/79)

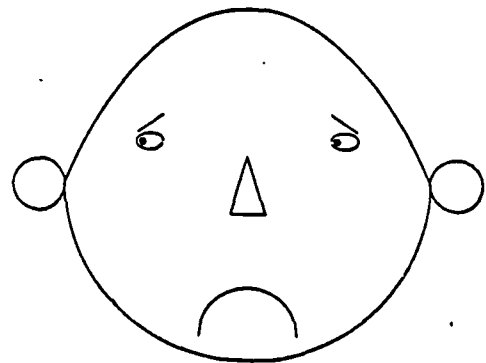

AIRFIX (31/3/80)

FIGURE 10.1.2 FACIAL PORTRAITS IN FAILED/NON-FAILED CLASSIFICATION

Figure 10.1.2 illustrates the use of the technique by showing pictics for four companies, two solvent and two failed. Thus Hawker Siddeley and Blue Circle exhibit large smiling faces with long noses and large rightward-looking eyes, features consistent with highly profitable concerns with strong no-credit intervals and respectable working capital positions. The larger mouth of the former, however, indicates greater relative profitability, while the larger eyes and flying eyebrows of the latter indicate the longer no-credit interval and lower leverage figure of a stronger balance sheet.

The failed pair on the other hand, based on their last accounts prior to failure, exhibit a similarly forlorn appearance. Fodens and Airfix both have down-turned mouths, perplexed eyebrows and small backward-glancing eyes, indicative of extremely poor profitability, poor asset positions and weak no-credit intervals within a high-risk situation. However, Fodens provides some marginal respite in the longer face and nose of a slightly better current asset position.

These examples are interesting in that they suggest that pictics may potentially provide a clearer indication of the financial state of an enterprise than is apparent from its accounting ratios alone.

The ease of detection of facial differences appears to facilitate the distinction between failed and solvent companies within a large data set. An experimental examination, to test this hypothesis, is detailed in Section 10.3 below.

## 10.2 THE DETECTION OF PERFORMANCE TRENDS OVER TIME

Taffler and Sudarsanam (1980) applied factor analysis to identify the underlying dimensionality within a set of 80 financial ratios calculated for 547 manufacturing companies. Six ratios, loaded on independent factors, were selected for the purposes of further analysis. These are listed in Table 10.2.1. Taffler and Sudarsanam argue that performance in any year is a relative, not an absolute, concept, and emphasise the importance of using a ranked position measure compared to other companies rather than the more conventional raw ratio approach. In this way first order effects of changes in the economic environment may be removed, allowing valid inter-temporal comparisons.

<u>RATIO</u>	<u>REPRESENTING DIMENSION OF ACCOUNTING INFORMATION.</u>
<u>Earnings before Interest and Tax (EBIT)</u>	Profitability
Average Total Assets (ATA)	
<u>Total Liabilities (TL)</u>	Financial Leverage
Total Net Worth (TNW)	
<u>Working Capital (WC)</u>	Working Capital Position
Net Capital Employed (NCE)	
<u>Quick Assets (QA)</u>	Liquidity
Current Liabilities (CL)	
<u>Average Current Assets (ACA)</u>	Asset Turnover
Sales (S)	
<u>Value Added (VA)</u>	Value Added
Average Total Assets (ATA)	

TABLE 10.2.1 FINANCIAL RATIOS AND DIMENSIONS REPRESENTED

To illustrate the manner in which inter-temporal performance comparison may be made using 'pictics', two deteriorating companies, Berwick Timpo (receivership) and Southern Constructions (receivership) are considered along with one which effects a recovery from a distressed state, Sir Joseph Causton.

For each concern the financial ratios of Table 10.2.1 are calculated and converted into percentile scores to reflect relative company performance on each measure, in each year separately, compared to manufacturing industry as a whole.

The resulting variables are assigned to particular features of the face, so that 'better than average' performance is matched with a pleasant facial appearance.

Figure 10.2.1 below indicates the assignment of variables to facial features that is used to match those variables highlighted by the factor analysis with the facial features identified as prominent by Laughery et al (1971).

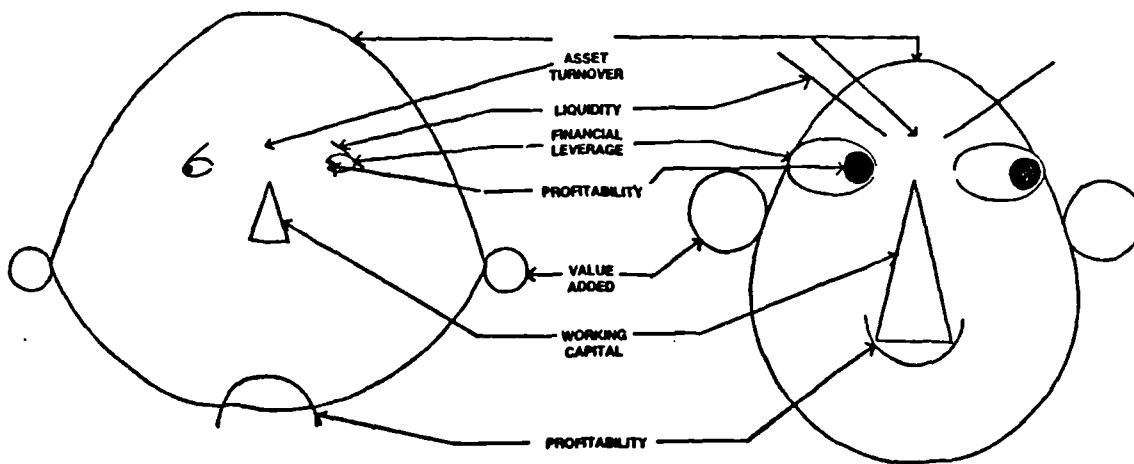
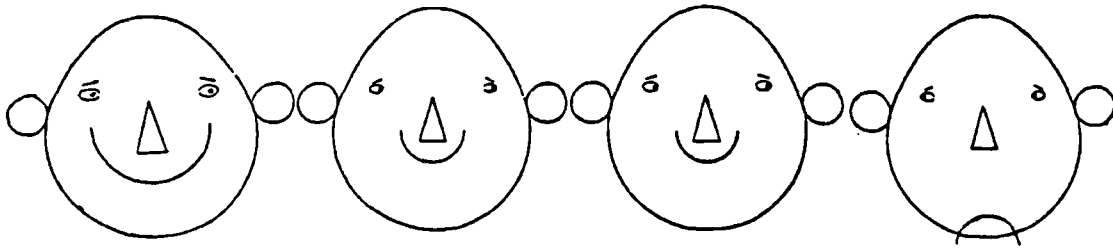

FIGURE 10.2.1: RELATIVE PERFORMANCE TRENDS - ASSIGNMENT OF FINANCIAL VARIABLES TO FACIAL CHARACTERISTICS

The feature assignment also illustrates the way in which changes in the variable values can produce extremes in the overall Chernoff portrait. In this way a visual impression of the personality of each company is created which may even allow some speculation as to its corporate identity and attributes. This visual representation of performance, based on accounting numbers, complements the idea of 'corporate personality' developed in a numerical sense by Sorter, Becker, Archibald and Beaver (1966).

A healthy, profitable and secure company might be expected to have a round smiling face with large, bright, forward-looking eyes, while a company in financial distress might wear a worried frown on a long face, with a low-slung, down-turned mouth. The eyes would be small and close together, exhibiting furtive backward-looking glances. The addition of a small pinched nose might also add to the overall message by creating the impression of the empty, washed-out face of an impoverished enterprise. Figures 10.2.2/3/4 show the resulting trends in relative performance for the three companies using the Chernoff program, and facilitate the detection of change over the four-year time period under consideration.



**FIGURE 10.2.2: BERWICK TIMPO (31/12/78 TO 31/12/1981)**

The facial profiles of Berwick Timpo in the year prior to receivership are typical of companies in the toy sector (Lines Bros., Dunbee Combex Marx, Airfix, and Lesney Products all had almost identical pictics prior to their demise). Despite the smile of profitability, the warning signs are apparent in 1978; the eyes are small and the brows perplexed, indicating respectively debt and liquidity difficulties. These worsen further over the next two years but profitability is maintained. The collapse of profits in 1981 compounds balance sheet difficulties; the mouth becomes down-turned and all facial features are consistent with a distressed financial performance.

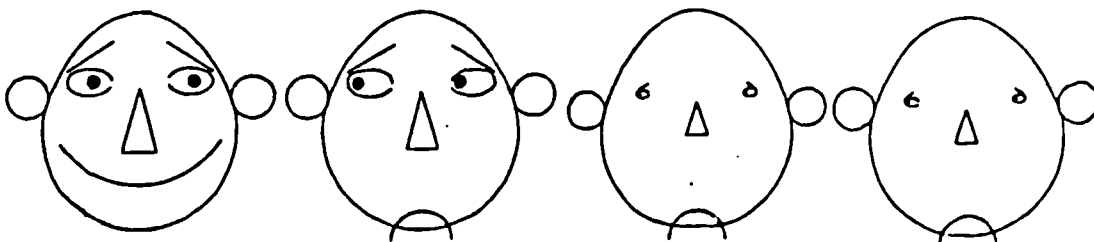

**FIGURE 10.2.3: SOUTHERN CONSTRUCTIONS (31/12/1975 TO 31/12/1978)**

Again the warning signs are apparent in the portrait for 1975. Despite the smile of profitability the perplexed eyebrows convey a poor liquidity position. Profitability has disappeared by 1976, but the eyes and nose remain large so neither the debt position nor the working capital position is yet critical. The portraits for 1977 and 1978 convey unrelieved misery, very poor performance in all key financial aspects. Receivership in 1977, one year prior to actuality, might not have been surprising in the circumstances.

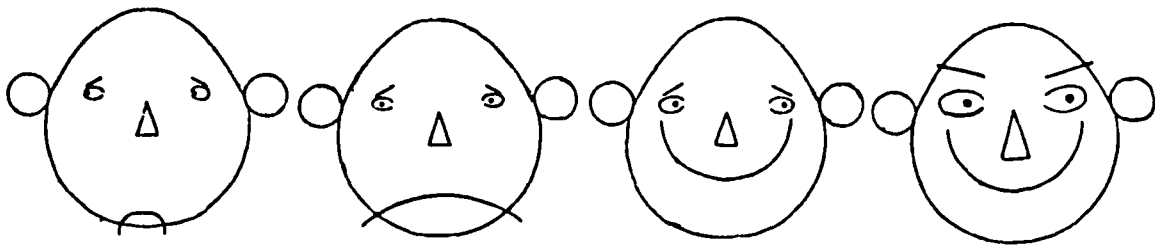

FIGURE 10.2.4: SIR JOSEPH CAUSTON (30/9/1976 TO 30/9/1979)

Causton depicts the classic recovery profile, from the distressed state of 1976, with all features depressed, to 1979 where a happy picture is conveyed. The transformation is gradual, with improvements in profits yielding a smile by 1978, but the balance sheet remains poor. The correction in liquidity, debt position and working capital does not arise until 1979 with a reversal of brow angle and increases in eye and nose size.

A scanning of these figures indicates how the profiles allow the detection of even the smallest changes. When allied to the feature assignment these facial expressions clearly convey changes in financial performance.

### 10.3 PREDICTION OF FAILURE USING ALTERNATIVE PRESENTATION FORMS

The clarity with which the foregoing figures convey their financial messages, in the absence of a detailed narrative explanation, provides the impetus for a detailed analysis of the relative explanatory power of alternative presentation formats. A substantial literature, summarised by Foster (1986), highlights the prediction of performance on the basis of the trends supplied by financial ratios and accounting statements. The ease of processing facial profiles suggests that they might provide a more efficient means of making the same analysis.

### 10.3.1 EXPERIMENTAL METHODOLOGY - EXPERIMENT 1

While the simplicity of the facial technique is a positive feature in communicating financial information - especially to the less sophisticated of users of accounting information - it can be a barrier preventing its widespread use. It has to be demonstrated that, apart from the novelty of approach, this method can improve on or complement existing methods. To test the hypothesis that facial profiles might provide an efficient means of representing financial variables, an experiment was devised to test the reactions of respondents to financial information expressed in alternative forms -

- i) accounting statements
- ii) financial ratios derived from these statements and
- iii) 'faces' constructed by the application of financial ratios to particular facial features.

A pilot experiment was conducted with the co-operation of academics from City University Business School and the Universities of Leeds, Lancaster and Birmingham and that of accounting professionals through Dun and Bradstreet and First Co-operative Finance over a period of three months during 1982. Together they provided a sample size of 121, comprising 52 accounting academics, 23 practitioners and 46 MBA Finance Majors.

The respondents consisted of skilled users, who employed accounting information and financial statement data regularly, and users who, though not practitioners, had an extensive knowledge of accounting terminology and format. Respondents who were unfamiliar with accounting information were excluded from the sample, since prior experiments had shown that, for them the faces were the only medium to convey any meaning. A sample of 20 companies was chosen, with the intention of providing a majority that were still trading and a minority of failures. Since a random sample of a company database would be unlikely to give many (if any) failures, a 14:6 split was chosen to avoid an even distribution of companies while providing enough variety in the sample to illustrate the performance range. Companies were therefore chosen to reflect the clearly healthy/clearly failed extremes as well as several marginal cases, but at no time were the respondents aware of the 14:6 division.

Previous experiments have shown that respondents tend to assume an equal division of failed and healthy companies unless told that this is not necessarily the case. Where specific prior probabilities have been indicated in previous studies (Libby (1975)) respondents may fail to treat each case on its individual merits, preferring to rank cases on a best-to-worst basis and then group on the basis of the given failure base rate. The importance, or otherwise, of knowledge of prior probabilities to the experimental process has been the source of much disagreement in the accounting literature. Casey (1983) and Houghton (1984) are illustrative of the diversity of opinion.

Accounting statements and financial ratios were prepared and faces constructed for each of the 20 companies over five year periods and a random numbering systems used to separate the statements/ratios/faces information bases. The statements related to financial information over accounting years 28/12/74 to 31/3/80, and in the case of failed companies information for the final year was based on the last accounts published prior to failure. Prior to the commencement of the experiment respondents were issued with sample information sheets to illustrate the manner in which the statements and ratios would be depicted and with an illustration of the assignment of ratios to features in the facial representations. Appendix 10.3.1 provides examples of the experimental materials.

Each respondent was provided with a set of accounting statements and asked to make failed/healthy decisions for each of the 20 cases, together with the total time spent in processing the statements.

On completion, respondents were provided with 20 sets of company financial ratios. They were informed that the companies were different from the original set, and asked to repeat the exercise with the ratios.

On completion, respondents were asked to complete a third test, this time with the faces, again on what was apparently a completely new set of companies. There was some suspicion among the respondents that the companies had, in fact, been identical on each occasion, but the different numbering systems made comparisons odious and helped to allay such fears.

Different processing orders were used on a sub-sample of audiences so that all six possible orderings of statements-ratios-faces, statements-faces-ratios, etc., were included. This mechanism was employed to test for any effect that



order might have on processing times and decisions made. In particular, processing of the accounts might occupy a shorter time period when in position 3, compared to that in position 1, for a variety of reasons, including peer pressure and task familiarity. On completion of the experiment respondents were informed of the identity of the companies, of the white lies regarding three unique sets of 20, and of the correct failed/healthy decisions.

Appendix 10.3.2 reveals the identities of the 20 companies employed in the test. Respondent classifications on each of the three different bases were analysed to determine the extent of the errors made and of the time differences involved. The two possible types of error were distinguished: errors of healthy classification when actually failed (Type I), and a failed classification when actually healthy (Type II). Interestingly, conducting the experiment with credit managers revealed that many believed only the former (Type I) to be an error (ie failure to observe a potential bad debt was an error, but a missed lending opportunity that proved to be safe was not!). Any analysis of errors of classification should take into account weightings for relative importance of errors made and the associated misclassification costs.

An analysis of the misclassified cases was carried out, with two aims:

- i) to identify those cases which had proved to be the most difficult
- ii) to determine an information processing model consistent with the misclassifications made.

### 10.3.2 EXPERIMENTAL RESULTS - EXPERIMENT 1

Tests conducted to determine the homogeneity of the sample respondents showed that performance levels did not differ significantly within the sophisticated user group.

Classificatory results for the complete sample of 121 respondents are detailed below in Table 10.3.1 together with an indication of the performance of each of the separate user groups:

	<u>Mean No of Classification Errors</u>					<u>Classification Time (Mins)</u>			
	TYPE I		TYPE II						
	(Healthy when Failed)		(Failed when Healthy)						
<b>Academics</b>									
(n = 52)	1.88	1.90	0.65	2.17	2.84	2.32	11.84	8.77	4.18
<b>Accountants</b>									
(n = 23)	2.00	2.11	0.63	2.09	2.69	2.04	11.24	8.21	3.80
<b>MBA Students</b>									
(n = 46)	1.74	2.00	0.57	1.96	2.91	2.17	11.78	8.43	3.96
<hr/>									
<b>Total (n=121)</b>	1.9	2.0	0.6	2.1	2.8	2.2	11.6	8.5	4.0

**TABLE 10.3.1: MEAN ERROR CLASSIFICATION FOR EXPERIMENT 1**

Since 20 cases had been employed throughout, split 14 healthy to 6 failed, the nature of possible errors made reduced to:

- classifying a company as failed when actually healthy
  - there being 14 opportunities for such an error
- classifying a company as healthy when actually failed
  - there being 6 opportunities for such an error

This 14:6 (i.e. 70%:30%) split between non-failed and failed companies in the sample was felt justified because it conformed closely with the 75%:25% split at the time between healthy and distressed companies in the population, based on their computed Z-scores.

In percentage terms, showing the proportion of potential errors that were made, the final lines of Table 10.3.1 would show:

Classified as Healthy when Failed (Type I Errors)			Classified as Failed when Healthy (Type II errors)		
Acctg Stats	Ratios	Faces	Acctg Stats	Ratios	Faces
31.8%	33.1%	10.9%	14.7%	19.6%	16.4%

An analysis of these results highlights two differences, each statistically significant at the 5% level:

- i) the proportion of failed cases misclassified is very much higher than that of the non-failed cases . This is a potentially important

feature of the results if, as suspected, the 'missed failure' is a relatively more important misclassification.

- ii) the time spent processing the facial profiles is less than half that spent on either accounting statements or financial profiles.

The attempt to vary the order of processing of the test materials, by adjusting the experimental procedure was made largely as an afterthought, and the great majority (97) of useful responses were based on an Accounts-Ratios-Faces ordering. The results generated, below in Table 10.3.2, suggest that order of processing is not important, but the strength of conclusions is restricted by the size of sample employed.

	Mean Processing Time (Minutes)		
	Processed	Processed	Processed
	First	Second	Third
Accounting Statements	12.09	11.25	11.23
Financial Ratios	11.79	8.02	7.54
Faces	5.40	4.53	3.61

TABLE 10.3.2: MEAN PROCESSING TIMES IN EXPERIMENT 1

Paired-case t-tests were employed to compare the performance of individual respondents for each of the means of presentation, with the following results:

- i) respondents exhibited significantly more Type II errors when using ratios than for either faces (t= 2.33) or accounting statements (t= 3.45)
- ii) no significant difference existed even at the 10% level in the number of Type II errors made using accounts or faces (t=1.02)
- iii) significantly fewer Type I errors were made with the faces than with either the accounts (t= 11.6) or ratios (t= 11.8)
- iv) no significant difference existed even at the 10% level in the Type I errors resulting from the use of either accounts or ratios (t= 0.35)

v) faces were processed significantly more quickly than either the accounts (t= 21.1) or the ratios (t= 15.0)

vi) ratios were processed significantly more quickly than the accounts (t= 7.41)

Faces were, therefore, processed significantly quicker and produced significantly fewer Type I errors, than either the accounting statements or the financial ratios. The faces produced fewer Type II errors than the ratios, but not the statements.

The facial profiles have therefore generated decisions at least as good, and often better, than using other sources, and much quicker.

Appendix 10.3.3 provides a detailed analysis of the percentage misclassification of each of the cases employed. Of the failed cases 3,4 and 16 caused the most errors in each of the methods of classification, but the improvement in performance when faces are employed is startling. Of the healthy cases, 15 and 17 are consistently misclassified by all three methods, but case 1 is notable in that the faces exhibit far more errors than either the accounting statements or the financial ratios.

An analysis of misclassification combinations among respondents reveals the likely decision-making models being employed. Table 10.3.3 below shows all of the common misclassification patterns (ie those exhibited by 15% or more of respondents).

CASE: COMBINATIONS	% MISCLASSIFICATIONS		
	ACCOUNTING STATEMENTS	RATIOS	FACES
3,4	22	25	5
3,16	34	44	4
4,16	29	27	1
3,4,16	18	20	1
15,17	29	22	36
1,15	7	7	48
1,17	6	12	34
13,15	12	8	24
13,15,17	6	5	17
1,15,17	5	5	28
1,13,15,17	2	1	15

TABLE 10.3.3 EXPERIMENT 1: MISCLASSIFICATION COMBINATIONS

The pattern of misclassifications for accounts and ratio processing methods is remarkably similar with a preponderance of misclassified failed companies. However, for facial classifications it is rare for any respondents to produce as many as two failed misclassifications and accordingly the figures at the top of the table are extremely low.

This distinction in error patterns can be explained by looking more closely at the manner of information processing in order to deduce the decision-making models that might have produced the observed pattern of errors.

Alternative linear models were constructed for combinations of accounting statement items and financial ratios in order to generate the above misclassification patterns. Ashton (1976) demonstrates the robustness of simple linear models of the type used here, even though more precise weightings might be generated by regression procedures. A similar process was employed with the qualitative facial information. The variable combinations identified are detailed in Appendix 10.3.4.

A simultaneous consideration of profitability, short term debt and balance sheet strength is sufficient to avoid any errors of classification. Over-emphasis on the profit item produces the familiar error pattern: 3,4,16 of the

failed cases; 15,17 from the non-failed set. The simultaneous consideration of leverage leaves only Case 4 misclassified.

Alternative classification models using individual facial features and combinations of features reveals a very different error pattern.

Concentration on the profitability feature (mouth) produces the (1,13,15,17) error combination - but correctly identifies all the failed cases. Classification on the eyes (leverage) alone or the eyebrows (liquidity) alone produce error patterns of (1, 6, 11, 19, 20) and (5, 14, 20) respectively, which never occurred in practice among respondents, suggesting that they were never considered separately from the mouth.

The combination of all three features - mouth, eyes, eyebrows - corresponding to profitability, leverage, and liquidity ratios, produces a perfect classification.

Appendix 10.3.5 shows the faces for the six failed companies and reveals the reasons for so few misclassifications. Only in Case 4: (Brocks Group) is there an element of compensation in the eye size, otherwise the combination of eyes, mouth and eyebrows is consistent with the extreme of financial distress.

Among the non-failed group, the most common misclassifications, cases: 1,13,15,17 all required a more complex processing than the remaining ten cases to illicit a correct response. Some compromise was required to balance the message conveyed by the different facial features. These cases are illustrated in Appendix 10.3.6.

For Case 1: (Associated Fisheries), the down-turned mouth and smallish eyes of poor profitability and high debt are compensated by the flying eyebrows of an excellent liquidity position. Both Case 13: (LRC) and Case 15: (Petbow) exhibit poor profitability, but have large eyes, large noses and flying eyebrows consistent with good debt, working capital, and liquidity positions. Case 17: (Sanderson, Murray and Elder) compensates for poor liquidity and profitability with respectable debt and working capital positions.

This remarkable difference in error patterns when the same financial information is processed through different media suggests that potential improvements in the decision-usefulness of the information might be made by varying the format of the presentation.

### 10.3.3 EXPERIMENT 1: A REAPPRAISAL

During the execution of the experimental procedures and subsequent workshopping of results several areas of concern emerged. Questions were raised both with respect to the experimental design employed and with the nature of the comparison being attempted. One fundamental issue, raised by Barron (1984), related to the equivalence of the information sources. The construction of the facial profiles is dependent upon the use of mean and standard deviation values for the ratios employed in order to map the features appropriately. This information did not accompany either the accounting statement or financial ratio sources, so that it might be argued that a comparison is being made between 'absolute' and 'relative' financial measures. It was therefore determined to redesign the experiment and repeat the procedure in a manner which overcame the principal points at issue, notably:

- i) the accounting statement information was perceived as being too complex; it was therefore revised and simplified in both content and format to comply more with the principles advocated by Ehrenberg (1977). A similar procedure was adopted for the financial ratios, reducing the number computed and clarifying their presentation.
- ii) respondent feedback revealed that the 5-year data provided was not being used in the decision-making process. Only one (the most recent) or at most two years' data were being considered. The volume of information was therefore reduced fivefold with the provision of only one years' data, for failed companies that being the last disclosure prior to failure.
- iii) the means and standard deviations of financial ratio variables were provided, since they had already implicitly been employed in the construction of facial profiles. The aim here was to ensure that equivalent information was conveyed by each of the three media sources.
- iv) the number of financial variables used for facial mapping, along with the number of variable facial characteristics were both reduced to reduce the complexity of the overall impression.

- v) a single assignment of financial variables-to-facial features had been used throughout the initial study, as detailed in Appendix 10.3.7. This presumed advance knowledge of an optimum assignment, where such knowledge did not exist. Chernoff and Rizvi (1975) commented on the likely variation in results from alternative assignments; it was therefore determined to examine all of the alternative multiple combinations under experimental conditions. The reduction in variables outlined in iv) above allowed this all embracing process to take place without the need to extend the scope of the experiment unduly.
  
- vi) the testing of the effects on processing of varying the order of materials had been inadequately examined at this initial stage, because of sample difficulties. The revised experimental design envisaged a systematic procedure whereby all alternative processing orders would be analysed thoroughly.
  
- vii) the initial test materials comprised 20 companies resulting in extensive experimental periods (in excess of an hour for many respondents). In an effort to reduce the potential effects of subject fatigue, and of peer group pressure, inducing the hurried completion of the final tasks, the number of companies was reduced to ten.
  
- viii) the proportion of failed companies (6 of 20) in the first experiment was arbitrarily determined. In view of the potential effects of alternative failure probabilities the revised experimental design incorporated sets of test materials containing, respectively, 1,3,5,7 and 9 failed cases.
  
- ix) concerns were voiced regarding the non-random selection of case samples in order to generate what were perceived to be a preponderance of deliberately difficult cases. A complex matching procedure, detailed in Chapter 5, was therefore employed in order to provide a sample from which a complete range of profiles could be selected.

A sub-sample of 30 companies was selected from a matched major sample of 66 companies (33 failed and 33 non-failed). These companies provided a diverse set of financial profiles, based on only three financial ratios, to allow a test



instrument comprising all possible variations of feature assignment, together with the opportunity of varying the base rate for failed companies.

As a consequence of the results of Experiment 1, together with the appropriate psychological literature, a series of propositions was developed for further testing:

- P1: Facial profiles will be processed significantly quicker than either financial ratios or accounting statements.
- P2: The number of misclassification errors resulting will be dependent upon the assignment of financial variables to facial characteristics.
- P3: The classification decisions made using the facial profiles will be as good as, or better than, those made with either the financial ratios or accounting statements.
- P4: The order of processing of the alternative information sources will not significantly influence the classification decisions made.
- P5: The number of misclassification errors recorded will be a function of the failure base rate in the sample set.

#### 10.3.4 EXPERIMENT 2 - EXPERIMENTAL DESIGN

A group of 100 MBA students nearing the end of their introductory accounting course at the City University Business School comprised the revised sample. This group was divided into 10 sub-groups of equal size.

A total of nine experimental tasks was to be considered simultaneously:

- A: analysis of accounting statements
- R: analysis of financial ratios
- F<sub>1</sub> to F<sub>6</sub>: the six assignments possible of 3 financial variables to 3 facial variables.

Each participant had 5 tasks in all (A, R and 3 of the F's in some order) and generated three responses for each task:

- a) the time taken
- b) the number of failed companies correctly detected

- c) the number of non-failed companies correctly detected.

Table 10.3.4 below shows the assignment of tasks for each of the ten members of any one sub-group:

		SUB-GROUP									
		1	2	3	4	5	6	7	8	9	10
<u>Order of Presentation</u>	1	A	A	F <sub>3</sub>	F <sub>4</sub>	F <sub>2</sub>	R	R	F <sub>6</sub>	F <sub>5</sub>	F <sub>1</sub>
	2	F <sub>1</sub>	F <sub>2</sub>	A	A	F <sub>4</sub>	F <sub>5</sub>	F <sub>6</sub>	R	R	F <sub>3</sub>
	3	R	F <sub>6</sub>	F <sub>5</sub>	F <sub>3</sub>	A	A	F <sub>2</sub>	F <sub>1</sub>	F <sub>4</sub>	R
	4	F <sub>2</sub>	R	R	F <sub>6</sub>	F <sub>5</sub>	F <sub>3</sub>	A	A	F <sub>1</sub>	F <sub>4</sub>
	5	F <sub>3</sub>	F <sub>4</sub>	F <sub>6</sub>	R	R	F <sub>2</sub>	F <sub>1</sub>	F <sub>5</sub>	A	A

TABLE 10.3.4: EXPERIMENTAL DESIGN: DISTRIBUTION OF TASKS

Thus in any sub-group of ten persons:

- i) each respondent processes the accounting statements;
- ii) each respondent processes the financial ratios;
- iii) each respondent processes three sets of faces, so that each set of faces is processed five times;
- iv) the accounting statements and the financial ratios each appear twice in every position of the processing order. Each set of faces appears once in every position.
- v) each sub-group's experimental materials comprise the same companies with, therefore, a common number of failed companies. The potential exists for the variation of this proportion between sub-groups. In practice, two sub-groups each tackled sets of cases with common numbers of failed companies.

This revised design therefore allows processing time and misclassification errors to be considered as a function of:

- i) the number of failed cases
- ii) the order of processing
- iii) the variable-feature assignment
- iv) the alternative information source employed.

The second experiment was administered in accordance with the above design, in order to test the earlier propositions. Appendix 8.3.2 gives an illustration of the test materials for the accounting statement and financial ratio exercises. The six alternative assignments of financial variables to facial characteristics (F<sub>1</sub> to F<sub>6</sub> in the experimental design) were denoted A to F for the purpose of labelling the test instrument. Respondents were provided with pictorial guidance (along the lines of Appendix 10.3.8) as to which feature assignments had been employed in each set of faces with which they had been provided. Appendix 10.3.9 details the six alternatives together with their effect on one particular case. Sample materials for the facial profile exercise are provided in Appendix 10.3.10. In each part of the exercise respondents were requested to process the financial information relating to ten companies sequentially with each case presented on a separate sheet of A4 paper. Respondents were informed that the ten companies were different in each section, and random numbering systems ensured that cases could not be compared meaningfully. They were further informed that any number of their cases could be those of failed companies, but that it was most likely that the set comprised a mixture of failed and non-failed companies.

#### 10.3.5 EXPERIMENT 2 - RESULTS

Reduction in the size and complexity of the experimental task reduced the mean overall processing time to around 40 minutes, minimising the potential for student fatigue and reducing the opportunities for peer group pressure. Table 10.3.5 shows the mean processing times for each information source over the five alternative processing orders.

ORDER OF PROCESSING	MEAN PROCESSING TIME (MINUTES)							
	ACCOUNTING STATEMENTS	FINANCIAL RATIOS	ALTERNATIVE FACIAL ASSIGNMENTS					
			A	B	C	D	E	F
1	16.5	10.8	5.9	5.5	5.2	7.4	7.6	5.7
2	19.1	8.6	5.7	6.4	5.2	5.9	7.5	5.1
3	18.5	6.4	4.6	4.4	4.1	5.7	4.8	5.2
4	12.6	7.6	6.5	4.5	5.2	4.3	4.7	4.3
5	15.6	8.2	3.9	5.5	3.8	5.4	3.3	3.7
OVERALL	16.5	8.3	5.3	5.3	4.7	5.7	5.6	4.8

TABLE 10.3.5 : FACIAL PROFILES EXPERIMENT - EFFECTS OF ALTERNATIVE ORDERING OF PROCESSING

The testing of Propositions highlights several important features:

- i) no significant processing time differences at the 5% level between the alternative facial assignments as measured with a t-test;
- ii) no significant difference at the 5% level in processing times at any position in the ordering process
- iii) a significant reduction in the processing time as we progress from the accounting statements through to the financial ratios and facial profiles.

All of these results are confirmatory of the tentative conclusions drawn at the initial study stage, providing evidence supporting the validity of these preliminary results.

Table 10.3.6 provides a summary of the misclassifications that were generated.

MISCLASSIFICATIONS	ACCOUNTING STATEMENTS	FINANCIAL RATIOS	ALTERNATIVE FACIAL ASSIGNMENTS					
			A	B	C	D	E	F
FAILED WHEN HEALTHY ERRORS (Type II)	94	92	46	46	42	25	44	30
HEALTHY WHEN FAILED ERRORS (Type I)	157	184	76	80	67	75	71	89
TOTAL MISCLASSIFICATIONS	251	276	122	126	109	100	115	119
No OF CASES	1000	1000	500	500	500	500	500	500
% MISCLASSIFICATION	25.1	27.6	24.4	25.2	21.8	20	23	23.8

**TABLE 10.3.6: FACIAL PROFILES EXPERIMENT - DISTRIBUTION OF MISCLASSIFICATIONS**

These results highlight several features with respect to the second proposition:

- P2: i) where the opportunities for each type of misclassification error were equal, the number of failed-company misclassifications was significantly higher for all forms of processing.
- ii) Assignment D recorded a lower proportion of misclassifications than did any of the other facial assignments - largely attributable to significantly fewer failed-when-healthy (Type II) errors.
- iii) Assignment C produced the fewest failed-company misclassifications, suggesting that any assignment preference must be dependent on the relative weighting accorded to each of these errors. Where relative misclassification costs accord a 40:1 weighting in favour of Type I errors (following Altman et al (1977)) this suggests that Assignment C is optimal.

A consideration of the mean number of processing errors per respondent per 10 companies reveals the following:

	ACCOUNTING STATEMENTS	FINANCIAL RATIOS	FACIAL PROFILES
FAILED WHEN HEALTHY ERRORS (Type II)	0.94(1.40)	0.92(1.15)	0.78(1.33)
HEALTHY WHEN FAILED ERRORS (Type I)	1.57(1.81)	1.84(2.02)	1.52(1.84)
OVERALL MEAN	2.51(1.65)	2.76(1.71)	2.30(1.56)

TABLE 10.3.7: FACIAL PROFILE EXPERIMENT: MEAN MISCLASSIFICATION ERRORS

(Standard Deviations in parentheses)

The results highlight several features with respect to the third proposition:

- P3: i) there were fewer errors overall made in processing the faces than with the financial ratios, a difference significant at the 5% level ( $t= 2.38$ ); the difference compared to the accounting statements, though fewer, was not statistically significant ( $t= 1.12$ ).
- ii) similarly the reduced number of errors made with the statements was not statistically significant compared to that made with the ratios ( $t= 1.05$ ).
- iii) although fewer misclassifications were made with the faces in both the Failed when Healthy, and Healthy when Failed aspects the extent of these differences was not statistically significant at the 5% level ( $t= 1.02$  and  $t= 1.40$ ).

With respect to the fourth proposition (P4) Appendix 10.3.11 details the distribution of classification errors according to the order in which the alternative information sources were processed. There are no significant differences in performance attributable to the order of processing.

With respect to the fifth proposition (P5) Appendix 10.3.12 details the distribution of classification errors according to the number of failed cases in the material set. Table 10.3.8 provides a brief summary of this appendix and highlights the differences that are attributable to base rates.

NO OF FAILED CASES	ACCOUNTING STATEMENTS	FINANCIAL RATIOS	FACIAL PROFILES
1	1.80	1.45	1.67
3	2.40	1.85	1.50
5	1.90	2.75	1.45
7	2.50	2.95	2.85
9	3.95	4.80	4.05
OVERALL	2.51	2.76	2.30

TABLE 10.3.8: FACIAL PROFILES EXPERIMENT - MEAN NUMBER OF MISCLASSIFICATION ERRORS PER RESPONDENT

The non-linear relationship is consistent with a failure to adjust the prior probabilities of the respondents. For each format the mean number of misclassification errors is at its highest where the set of cases includes 7 or 9 failures. Despite the instruction that the materials set might contain any number up to ten failed cases respondents clearly expect some number below this figure. The relative increase in misclassifications for low and high base rates, apparent for accounts and faces, is consistent with the anchoring and adjustment heuristic (Kahnemann and Tversky (1972)). The pattern of results is largely consistent with the existence of the non-monotonic anchoring effects as observed in psychophysics research by Helson and Masters (1966).

An analysis of the misclassification of particular cases, when processed by alternative means, is detailed in Appendix 10.3.13.

Appendix 10.3.14 shows the misclassifications that would result from the adoption of particular processing strategies. The repeated misclassification of the failed cases 6,44,46,48,50 and 53 is consistent with overemphasis on the profit figure; so too is the misclassification of the non-failed cases 18, 35 and 57.

Where the facial profiles produce misclassifications not apparent with the other processing media, this is consistent with undue overemphasis on the mouth as a facial characteristic. Where profitability is assigned to the mouth such overemphasis is further amplified.

#### 10.3.6 FACIAL PROFILES EXPERIMENT: CONCLUSIONS

The results of the retest are largely supportive of the prior experimental work. Observed differences appear in the same directions as earlier, but the tighter experimental design at this stage provides greater credence to the statistical testing. Several aspects are worthy of re-emphasis:

- i) facial profiles provide an efficient means of processing financial information, allowing decisions of at least comparable quality to be made more quickly. The validity of the results of the first experiment suggests that such findings are generalisable to respondents of varying degrees of sophistication. The common processing time between students and practitioners is consistent with the results of Stock and Watson (1984).
- ii) the order of processing of materials proves to be unimportant.
- iii) the base rate of failed cases per set is a highly significant determinant of the extent of misclassification, supporting the conclusions of Houghton (1984). The pattern of errors is consistent with the adoption of an 'anchoring and adjustment' heuristic around an expected failure rate.
- iv) evidence is generated towards the provision of an Optimum Assignment of Financial variables to Facial characteristics, though the preference between assignments C and D is ultimately dependent on the cost of a wrong decision in each alternative direction. If the cost of a missed-failure error is more than twice as much as that of a misclassified healthy company preference switches from D to C. Such a switch would be consistent with the findings of Altman et al (1977) as employed by Zmijewski (1983) suggesting differential misclassification costs of the order of 38 times greater. Most notably, both alternatives C and D assign the liquidity ratio to the most prominent facial feature, the mouth.
- v) feedback from respondents suggests that knowledge of the actual feature assignments was unimportant, most decisions being made independent of the reference guide provided. This finding is consistent with that of Moriarity (1979), suggesting that the facial profile is processed as a compromise between features within a facial context, without the necessity of referring to financial meaning. The use of faces, rather than



the choice of a particular feature assignment, appears to be of paramount importance.

- vi) feedback also suggests that very little use is made of the means and standard deviations of the financial ratios provided. This may be attributable to a lack of statistical education or a lack of facility with matters statistical. Either way a potentially powerful piece of information with which to gauge relative financial performance is largely ignored. This may contribute to faces outperforming financial ratios as an information source. The former implicitly include mean and standard deviation measures in their construction. They thus ensure that potentially important items of information cannot be ignored entirely.

The empirical findings detailed in this chapter substantiate the propositions generated by the earlier psychological literature. Respondents of varying degrees of accounting sophistication are able to process facial profiles efficiently and to make speedy decisions of a quality comparable with, if not better than, those associated with alternative financial formats in this particular simplified analytical task. Whether such results are generalisable to other, more complex tasks, is subject to further testing. The suggestion here is that opportunities exist for improving the decision-usefulness of financial statement information by experimenting with alternative presentation forms. By highlighting the specific advantages of a facial profiles approach, this chapter directs further work towards the accommodation of this new methodology into the financial environment.

## CHAPTER ELEVEN

### SUMMARY AND CONCLUSIONS

Shareholder surveys, like those of Lee and Tweedie (1981) and Chang and Most (1981), consistently demonstrate users' perceptions of the importance of annual report disclosures in the decision-making process. Lee and Tweedie (1975) identify the Chairman's narrative statement as the single most read portion of the disclosure. Yet existing empirical evidence casts doubt on the informational content of any part of the annual report.

Hines (1982) attributes this anomaly to the longer time effects required in order for lengthy fundamental analysis to take place, suggesting that existing empirical evidence has not digested the full import of the annual disclosure. This study substantiates such a suggestion by demonstrating the improvements in decision-usefulness that are possible through a more detailed analysis of the content and presentation of annual report disclosures.

Conceptual Framework studies in the US, UK, Canada and Australia have emerged as part of the process of 'accountability' sought by professional bodies and standard setters. These studies have largely agreed on the objectives of corporate reporting and the qualitative characteristics of information viewed essential for the fulfilment of the objectives and the satisfaction of users' perceived information requirements.

The Chairman's narrative provides a vehicle for the perpetuation of 'accountability' at the company level, providing a voluntary disclosure signalling the intentions of the executive to act in the interests of shareholders and the community. Opportunities for misleading the public exist by conveying inappropriate 'good news', but Foster (1986) suggests that such misrepresentation is unlikely to persist into the long-term because of potential damage to personal and corporate credibility.

If such misrepresentation is to be avoided disclosures must convey their message in a meaningful way. To be useful they must possess certain desirable qualities. The desirable qualities of accounting information are by no means mutually exclusive, and Stamp (1982) identifies a number of likely trade-offs that would be necessary in practice. He makes no attempt to quantify the nature and extent of any trade-off, but this study conducts such an evaluation, investigating the dimensionality of financial information, and presenting original empirical findings. A Multidimensional Scaling

approach to the analysis of respondents' perceptions is adopted, revealing two major dimensions:

- i) the quality of content and
- ii) the quality of presentation.

This distinction provides the framework for a dual analysis of the narrative and quantitative aspects of the corporate report, focusing respectively on content and presentation.

### 11.1 THE CONTENT OF ACCOUNTING NARRATIVES (Ref: Chapter Seven)

The stated objectives of financial reports are largely non-specific with regard to a target audience. The consequent generalisation of user-group designation pre-supposes all-purpose reporting which may neither satisfy the information needs nor the communication potential of users.

This thesis provides experimental evidence to illustrate different interpretations and the alternative processing methods adopted with narrative sources. The use of heuristics is highlighted as leading to potentially dysfunctional decision-making in an accounting environment associated with:

- i) inefficient integration of narrative and quantitative information, with inappropriate emphasis where both sources are available, and
- ii) inconsistency in the attachment of numerical rankings to qualitative measures of uncertainty.

The first of these points is further addressed by comparing the information conveyed in the Chairman's narrative with that contained in the financial statements. The incremental effect of the provision of narrative information is evaluated and the conflict investigated. The brevity, complexity and low levels of readability of narrative are all apparently contributory factors in their misinterpretation. The placing of undue emphasis on a less reliable source, in an attempt to reconcile any conflict is entirely consistent with Kahnemann and Tversky (1972), Joyce and Biddle (1981b) and Ashton (1984), and the adoption of simplifying heuristics.

In order to demonstrate the environmental predictability of models employing qualitative information, a content analysis of Chairman's Statements was carried out.

Oliver and Walker (1959), Stone and Hunt (1963), Mosteller and Wallace (1963), Morton (1978) and Burrows (1986) have all demonstrated the discriminatory ability of textual information in non-accounting environments.

This study extends the content methodology into the financial environment by ascertaining the significance of the terminology employed. A classificatory system is employed, consistent with those of Osgood et al (1957) and Houghton (1988), to identify the nature of semantic content. This then forms the basis for the construction of a number of discriminant models distinguishing between failed and non-failed companies through combinations of, respectively, words, sentences, themes and perceived strategies. The application of such a methodology to accounting narratives is new to the literature, and the findings original. The resulting models are most successful when identifying the key aspects of a 'good news'/'bad news' split, most notably the positive perception of profit, dividends and growth, and the negative perception of losses, borrowings, closures, the support of bankers and failure to mention a dividend. Such disclosures may, however, be time specific and further research needs to be undertaken to determine the effects of time trends on the usefulness of the models.

#### 11.2 THE PRESENTATION OF ACCOUNTING NARRATIVES (Ref: Chapter Six)

Haried (1972, 1973), Oliver (1974) and Houghton (1987a, 1987b, 1988) have each demonstrated a lack of shared meaning existing between the users and preparers of accounting information which might be a potential source of information. Haried (1972) identifies semantic difficulties associated with

- i) conflict between technical and layman's interpretation of terminology and
- ii) insufficient levels of standardisation of financial terms,

either of which may distort the communication of narrative.

This study extends the existing research, confined to an understanding of concepts and terminology, to the message conveyed by the totality of words employed. Difficulties of readability and understanding are associated partly with word complexity, but also with sentence structure and presentation. Several studies, including Smith and Smith (1971), Still (1972), Healy (1977), Adelberg (1979b), Stevens et al (1983) and Curtis (1986) have addressed the readability of accounting literature. This study examines readability on a relative basis in order to determine whether it is predictive of present or future performance and measures understandability by reference to the target audience rather than through standard formulae. Such a distinction between 'readability' and 'understandability' is new to the accounting literature and the findings with respect to the predictive power of narrative complexity, original.

The Ingram and Frazier (1983) study of narrative disclosures was confined to a particular industrial sector, whereas this study attempts to overcome inter-industry complications through a careful matching procedure based on size, industrial sector, performance and financial year-end. An additional constraint is supplied by the requirement of a disclosure in which a Chairman reports separately from his directors in sufficient depth for cognisability measures to be reliable.

The length of Chairman's narrative was found to be positively dependent on company size. Readability is significantly related to financial performance, a result consistent with, but not causally related to, obfuscation in order to conceal deficiencies.

### 11.3 THE CONTENT OF ACCOUNTING STATEMENT INFORMATION

(Ref: Chapter Eight)

The disclosure of the annual report apparently has no information content in terms of its effect on share prices, and Foster et al (1986) use its lack of timeliness to attribute no useful incremental information to the report for the purposes of share valuation.

However, the decision-usefulness of predictive numerical models, making use of accounting information already in the public domain, cast doubt on, at least, the weak-form version of the efficient markets hypothesis. Altman (1968) and Taffler (1984), among others, demonstrate the environmental predictability of the failed/non-failed decision on the basis of financial ratio combinations. Belkaoui and Cousineau (1977), Peel et al (1985), Keasey and

Watson (1986) and Courtis (1986) have all speculated on the potential for improvement of existing models through the incremental effects of non-accounting information. The latter addressed the issue of risk-relatedness to the complexity of narratives, the remainder addressed the usefulness of non-accounting variables in making a failed/non-failed classification.

This study accepts the decision-usefulness of existing models, while recognising the frailty of the underlying theoretical framework, and demonstrates the efficiency of similar models constructed around narrative aspects.

The study then proceeds to address the issue of the information content of the sum of annual disclosures, quantitative and narrative, by conducting an experiment to investigate the incremental nature of additional information sources. Evidence is presented which demonstrates that representative users can make improved decisions, in a failure prediction context, when provided with both narrative and financial statement data. The issue of conflict between the messages conveyed by narrative and financial statements is addressed, and alternative processing strategies suggested for the reconciliation of conflict.

#### 11.4 THE PRESENTATION OF ACCOUNTING INFORMATION

(Ref: Chapters Nine, Ten)

The study examines alternative tabular, graphical and pictorial methods for the presentation of financial information. It concludes that the schematic face has a potentially unique format with specific advantages for the portrayal of company performance and personality.

Cuceloglu (1970) and McKelive (1973) demonstrate the power of simple line drawings in conveying facial messages which are cross-culturally consistent. Goldstein and Mackenberg (1966), Grant (1970) and Laughery et al (1971) provide supporting psychological evidence detailing the saliency of facial features.

Financial information is multidimensional and the face provides an efficient means of integrating diverse aspects in order to generate a unified message. Previous studies, Moriarity (1979), Stock and Watson (1984) and Smith and Taffler (1984) have intimated the potential for facial applications in the financial area. Thus far they have failed to incorporate the full force of the

existing psychological evidence into the choice of either feature saliency or variable assignments. This study rectifies these deficiencies while allowing an optimum feature assignment to be generated experimentally.

The use of schematic faces is demonstrated in two decision-making contexts:

- i) as a screening device to distinguish between failed and non-failed companies;
- ii) as a means of detecting performance trends over time.

In an experimental procedure comparing the use of accounting statements, financial ratios and schematic faces, the facial format is shown to be an efficient method of processing, producing decisions of at least comparable quality much more quickly.

An optimum feature assignment is suggested which minimises the number of failed company misclassifications. This assignment balances the relative saliency of facial features and financial variables by attaching Liquidity-Mouth, Profitability-Eyes and Financial Risk-Eyebrows. A slightly different assignment (though still with Liquidity-Mouth) minimises the total number of case misclassifications made, but Altman et al (1977) and Zjmewski (1983) suggest that the missed failed-case represents a much more costly omission.

#### 11.5 DIRECTIONS FOR FUTURE RESEARCH

- i) The great majority of the empirical evidence presented in this study has relied on students, of varying degrees of sophistication, acting as subjects. In order to appraise the generality of conclusions to accounting practitioners, and to gauge experiential effects, the studies must be repeated on a professional audience.

Where accounting practitioners have been used, the results have been most encouraging, providing similar results but with improvements consistent with education and experience. However, increased sample sizes are advisable to verify the statistical validity.

- ii) The evaluation of similarity judgements in Chapter 3 allowed the generation of a three-dimensional solution to the issue of information

preferences, concerned with the Content and Presentation of accounting information.

Similar results were generated by student audiences of varying degrees of sophistication, but the experiment should be repeated with a group of accounting practitioners in order to gauge reliable educational and experiential effects;

UK student rankings of the perceived importance of informational properties were notably at odds with those of practitioners in Canada and US. A repeated experiment with UK practitioners would identify any apparent cultural differences.

- iii) There have still been remarkably few applications of the Multidimensional Scaling methodology in the accounting literature. The presentational aspects of MDS are potentially most rewarding and it is to be hoped that the application of Chapter 3 might generate renewed interest in the technique among accounting academics.
- iv) The experiments of Chapter 4 reveal the adoption of heuristics by accounting students to ease information processing complexity.

Further experiments with accounting practitioners are required to gauge the comparable educational and experiential effects.

The potential economic consequences of the adoption of alternative processing rules in decision-making remains unaddressed and an area for further development.

- v) Chapter 4 also highlights the potential problems associated with inconsistent quantitative rankings being attached to qualitative indicators of uncertainty. Where probabilistic efforts are to be made to introduce expected values into financial disclosures, the economic consequences may be significant indeed. Further research is justified in this area in order to specify quantitative ranges associated with accounting terminology conveying uncertainty.
- vi) Measures of readability and understandability in Chapter 6 have been confined to the Chairman's narrative in this study. They might usefully be extended to a consideration of the Directors Statement and



the Auditors' Report to determine any performance related aspects of complexity.

- vii) This present study has addressed the complexity of the narrative, for any one company, in one particular year. An examination of time trends for a group of companies might confirm the generalisability of such results.
- viii) The Chairman's Statement bears the unmistakeable stamp of the chairman, though the detailed content may owe much to the finance director and the legal and public relations departments. A further study directed towards companies under common chairmanship might remove one variable from the complex narrative-performance relationship, and ease its evaluation.
- ix) The CLOZE scores attributable to accounting professionals demonstrated a common ranking of companies for difficulty, but a marked superiority in performance. This experiment needs to be repeated with a larger audience of professionals in order to gauge the precise educational and/or experiential factors leading to an improved ability to predict the content of narrative.
- x) The readability of the Chairman's Statement was significantly correlated with financial performance, where the subject companies were clearly distinguishable in terms of their financial status (i.e. failed and non-failed). This experiment needs to be repeated with companies of similar financial profiles (e.g. distressed and failed/distressed but recovered) to determine whether similar differences are discernible.
- xi) Models constructed to identify distress on the basis of content and readability need to be post-tested on new data in order to validate the generality of these conclusions. They might then be applied in several distinct areas:
  - a) as indicators of performance over time
  - b) as measures of relative performance

- c) as possible indicators of recovery potential among firms designated as distressed.
- xii) The discriminant models of Chapter 7 demonstrate that key words, phrases, themes and actions can be used successfully to distinguish between failed and non-failed companies. This area of research should be extended:
- i) with a new sample of data;
  - ii) across a revised time frame, to confirm that the results are generalisable and the models robust to technical and temporal changes.
- xiii) The content analysis methodology of Chapter 7 might usefully be extended to determine whether it can be used to detect differences between companies whose financial profiles are substantially similar. Narrative differences may exist between companies that are 'distressed and failed', and those 'distressed but recovering'. Further research is required in this area to determine whether new content-based models might be able to make such a distinction.
- xiv) In each of the experiments of Chapters 8 and 10 where failed/non-failed decisions were made, misclassification patterns were consistent with an inability to change respondents' perceptions of failure base rates. In view of the controversy in this area of recent accounting literature, further research may be appropriate.
- xv) The experimental design of Chapter 8, evaluating the incremental effect of new information on decision-making needs to be applied to an audience of accounting professionals, or possibly bank lending officers. The results generated by student audiences suggest an improvement in decision-making performance when qualitative and quantitative information is integrated, but such findings may not be generalisable to respondents of greater accounting sophistication.

Protocol analysis might provide a useful means of determining precisely how the information is being processed and how the integration of separate, potentially conflicting, sources is being accomplished. Such an analysis might aid an understanding of the

factors contributing to apparently conflicting messages conveyed by narrative and quantitative statements.

- xvi) Experimental work with facial profiles reveals a technique with potentially rewarding applications in several financial areas. The usefulness of the profiles as a clustering device is referred to in the text but not addressed in detail. This area is one which requires further development, so that the results of the audience-dependent facial profiles technique might be compared systematically with those which are algorithm based.

## 11.6 RESEARCH IMPLICATIONS

By examining some of the alternative methodologies available for the fundamental analysis of content and the effect of alternative presentation formats, this thesis highlights the opportunities that exist for improving the decision usefulness of financial information. The CLOZE procedure for measuring understandability of narrative and the facial portraits methodology for displaying quantitative financial information are both concerned with presentation. In each case they are user-specific and make suggestions for changes in format which will allow easier and more effective analysis by decision makers dependent upon the corporate report. The use of content analysis in the examination of the Chairman's narrative highlights the neglect of non-quantitative information in financial analysis. Recognition of the important role of the narrative and its incremental value when considered alongside the quantitative statements should further enhance the decision usefulness of the corporate annual report.

The underlying conclusion drawn must be that better decisions do not necessarily require more information. Improved use of the existing information base, through the superior fundamental analysis of Chapters 6 and 7 and the potentially superior presentational methods of Chapters 9 and 10 provide ample evidence of the opportunities for such improvements.

This thesis provides a first step in illustrating the applicability of the new methodologies to the simplistic failed/non-failed classification, and in so doing demonstrates the potential of further extension to less narrow aspects of performance appraisal.

## APPENDICES

AICPA (1962):  
Sprouse & Moonitz

Continuity  
Objectivity  
Consistency  
Stable Measuring Unit  
Disclosure

AAA (1966):  
ASOBAT

Relevance  
Verifiability  
Freedom from Bias  
Quantifiability  
Uniformity  
Consistency

AARF (1972):  
Staubus & Kenley

Relevance  
Reliability  
Comparability  
Neutrality  
Timeliness  
Understandability  
Optimal Disclosure  
Format

AICPA (1973):  
Trueblood

Relevance  
Reliability  
Materiality  
Substance/Form  
Understandability  
Freedom from Bias  
Consistency  
Comparability

ASSC (1975):  
Corporate Report

Relevance  
Objectivity  
Reliability  
Timeliness  
Comparability  
Completeness  
Understandability

FASB (1980):  
SFAC2

Relevance  
Reliability  
Materiality  
Representational  
Faithfulness  
Understandability  
Neutrality  
Consistency  
Comparability  
Verifiability  
Cost/Benefit  
Timeliness  
Predictive Value  
Feedback Value

CICA (1980):  
Canadian Institute (Stamp)

Relevance  
Clarity  
Substance over Form  
Comparability  
Timeliness  
Materiality  
Freedom from Bias  
Objectivity  
Consistency

Full disclosure  
Isomorphism  
Verifiability  
Cost/Benefit  
effectiveness  
Non-arbitrariness  
Flexibility  
Data availability  
Precision  
Conservatism

AARF (1987)

Relevance  
Reliability  
Materiality  
Timeliness  
Cost-Benefit  
Comparability  
Consistency  
Understandability

### APPENDIX 3.1

### Qualitative Characteristics in Alternative Studies

## The objective of corporate reports

### The fundamental objective

The fundamental objective of corporate reports is to communicate economic measurements of and information about the resources and performance of the reporting entity useful to those having reasonable rights to such information.

### Desirable characteristics

If corporate reports are to be useful and to fulfil their fundamental objective we believe they must possess the following characteristics.

They must be:

- Relevant
- Understandable
- Reliable
- Complete
- Objective
- Timely
- Comparable

1 Relevance is the characteristic which embodies the fundamental notion that corporate reports should seek to satisfy, as far as possible, users' information needs. Whilst this notion is the essence of the objective of corporate reports, it has to be recognised that the users themselves are free to define their own objectives and the information with which they wish to be supplied. Such information needs are unlikely to be static but will evolve.

2 Understandability does not necessarily mean simplicity, or that information must be presented in elementary terms, for that may not be consistent with the proper description of complex economic activities. It does mean that judgement needs to be applied in holding the balance between the need to ensure that all material matters are disclosed and the need to avoid confusing users by the provision of too much detail. Understandability calls for the provision, in the clearest possible form, of all the information which the reasonably instructed reader can make use of and the parallel presentation of the main features for the use of the less sophisticated.

3 The information presented should be reliable in that users should be able to assess what degree of confidence may be reposed in it. The credibility of the information contained in corporate reports is enhanced if it is independently verified although in certain circumstances it may be useful for an entity to supply information which is not verifiable in this way.

4 The information presented should be complete in that it provides users, as far as possible, with a rounded picture of the economic activities of the reporting entity. Since this is likely to be complex it follows that corporate reports as we define them are likely to be complex rather than simple documents.

5 The information presented should be objective or unbiased in that it should meet all proper user needs and neutral in that the perception of the measurer should not be biased towards the interest of any one user group. This implies the need for reporting standards which are themselves neutral as between competing interests.

6 The information presented should be timely in the sense that the date of its publication should be reasonably soon after the end of the period to which it relates so that it contributes meaningful new information about the entity and in the sense that corporate reports are more useful if they contain up to date measures of value.

7 The information should be expressed in terms which enable the user to compare the entity's results over time and with other similar entities. Consistency in the application of accounting concepts and policies is one means of achieving comparability, particularly for the comparison of the entity against itself. But consistency is a desirable characteristic only to the extent that it contributes to comparability and understandability. It is recognised that an unthinkingly mechanical application of generally accepted standards does not inevitably produce a fair presentation.

## DESIRABLE PROPERTIES OF CORPORATE REPORTS

The Accounting Standards Steering Committee (ASSC) of the Institute of Chartered Accountants in England and Wales (ICAEW) define the fundamental objective of the Corporate Report as:

'to communicate economic measurements of and information about the resources and performance of the reporting entity useful to those having reasonable rights to such information'.

They identify seven characteristics which they feel should be apparent in financial statements if their fundamental objective is to be satisfied:

1. RELEVANCE - financial statement information satisfies the information needs of users and is appropriate and sufficient to their decision making requirements.
2. UNDERSTANDABILITY - financial statements are readable and avoid such complexity as is likely to induce confusion and reduce comprehensibility.
3. RELIABILITY - the credibility of financial information is such that its accuracy is verified by an outside agency.
4. COMPLETENESS - the corporate report provides a rounded picture of all of the activities of the reporting organisation.
5. OBJECTIVITY - financial reports should neutrally reflect the measurement of economic and accounting items, and should not be subject to preparer bias nor seek to misinform or mislead users.
6. TIMELINESS - the publication of financial reports should quickly follow year-ends in order to provide users with up-to-date information. This delay should certainly be less than six months for satisfactory reporting.
7. COMPARABILITY - accounting concepts and measurement methods should be employed consistently, to allow comparisons with the company itself on a time series basis and with other companies on a cross-section basis.

The conflicting nature of several of these criteria make it impossible to satisfy each absolutely. (e.g. the provision of a totally COMPLETE and RELIABLE report will inevitably conflict with the TIMELINESS requirement).

Some compromise must be reached through a trade-off between 'desirable properties' so that an acceptable balance of characteristics is reached.

### APPENDIX 3.3 a) Test Material: Property Trade Offs: Desirable Properties

PERCEPTION OF AN 'ACCEPTABLE' TRADE-OFF BETWEEN PROPERTIES FOR DIFFERENT  
USER-GROUPS: AN EXPERIMENTAL TASK

The seven desirable properties of the Corporate Report together provide twenty-one pairs of properties.

You are asked to consider each of these pairs of properties and to decide where you believe the balance of trade-off between the two should lie.

In each case you will be faced with a five-inch line separating the two attributes and be asked to mark with a 'X' your view of the appropriate trade off between the two:

e.g.

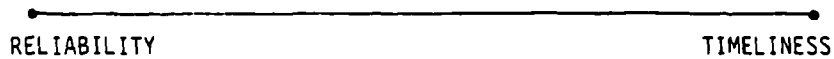

If you believe that all reliability must be sacrificed for immediate information then you would produce a judgement:

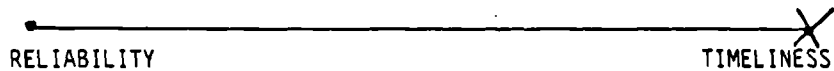

On the other hand, if you believe that information must be totally accurate and reliable to be credible, no matter how long it takes to produce, the following will result:

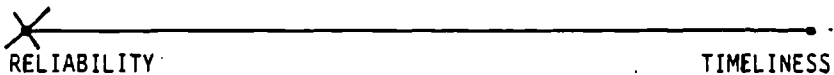

You may, however, approve some compromise between the two attributes by registering your perception of the relative importance of the two attributes. The closer the 'X' is marked to a particular property, the more important is that property perceived to be.

Now adopt this procedure for the pairs of properties on the following sheet.



EXPERIMENTAL TASK: PROPERTY TRADE-OFFS

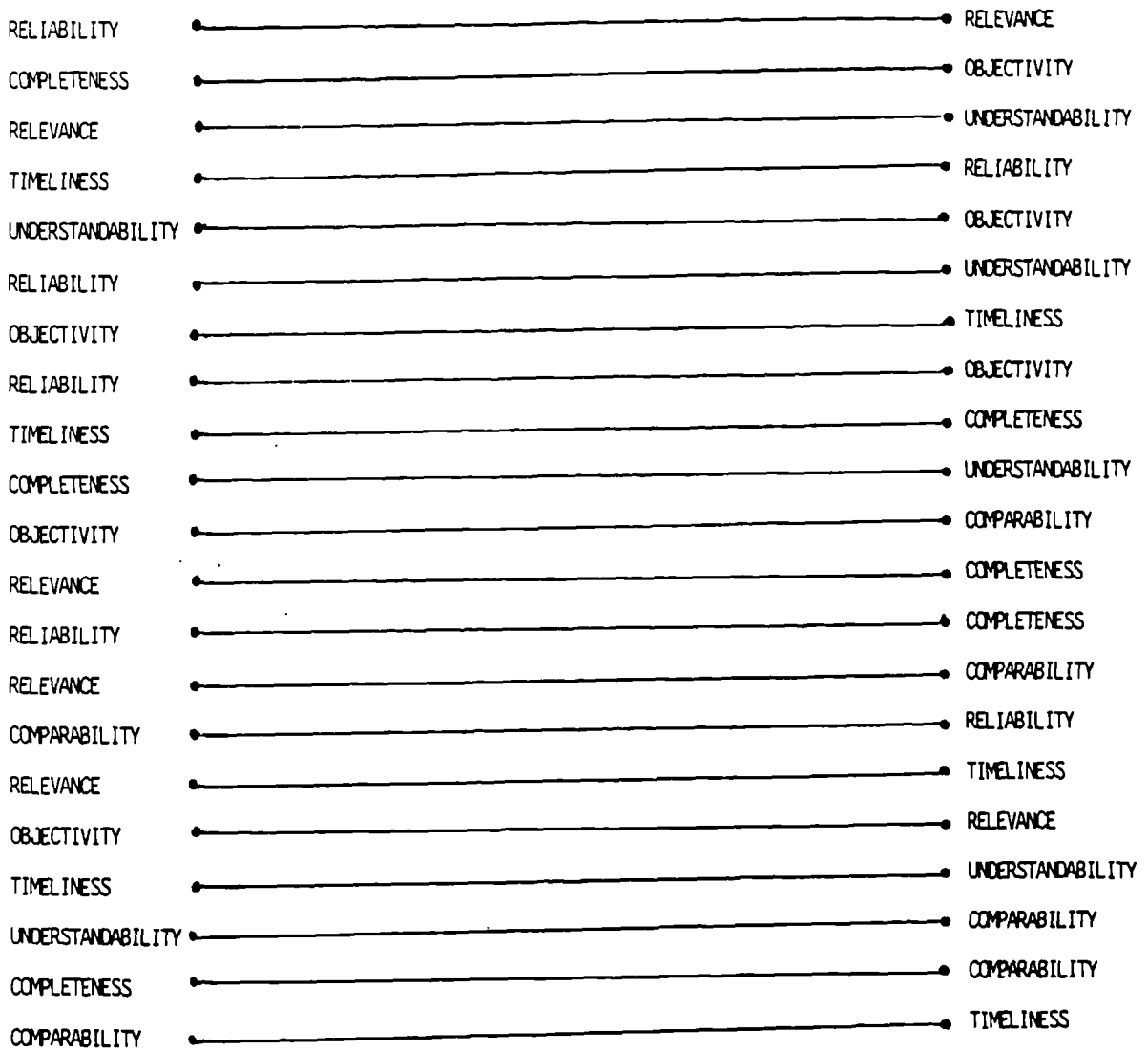

APPENDIX 3.3 b) Test Material: Experimental Task

MULTIDIMENSIONAL SCALING

INDSCAL MGA SCORES  
SUBJECT SPACE  
FINAL CONFIGURATION  
DIMENSION 3 PLOTTED AGAINST DIMENSION 2

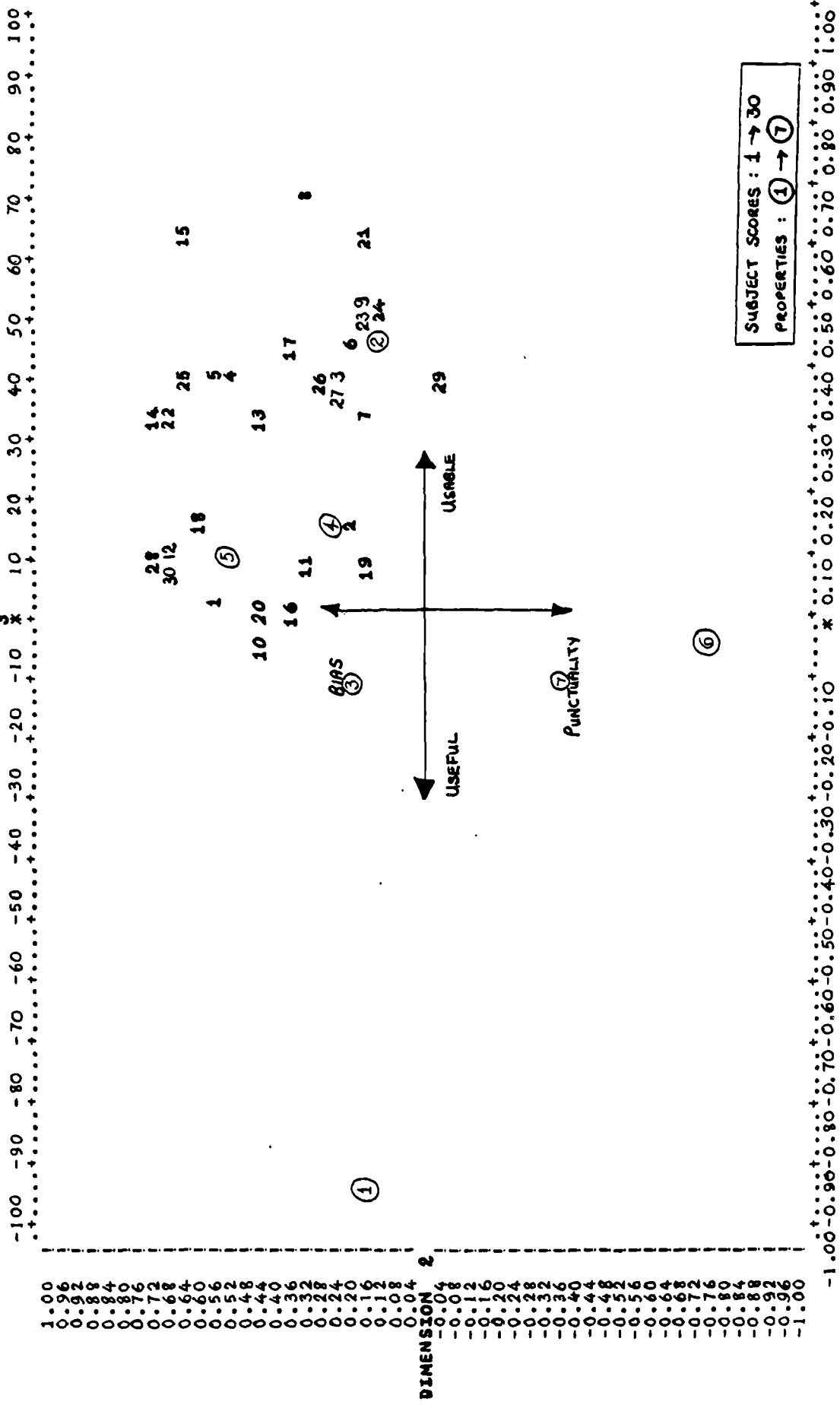

APPENDIX 3.4 a) MDS Indscal Scores: USEFUL/USABLE v  
BIAS/PUNCTUALITY

MULTIDIMENSIONAL SCALING

INDSCAL MDS SCORES  
SUBJECT SPACE FINAL CONFIGURATION  
DIMENSION 2 PLOTTED AGAINST DIMENSION 1

-100 -90 -80 -70 -60 -50 -40 -30 -20 -10 0 10 20 30 40 50 60 70 80 90 100

1.00  
0.92  
0.84  
0.76  
0.68  
0.60  
0.56  
0.52  
0.44  
0.36  
0.28  
0.20  
0.12  
0.04  
0.00  
0.04  
0.08  
0.12  
0.16  
0.20  
0.24  
0.28  
0.32  
0.36  
0.40  
0.44  
0.48  
0.52  
0.56  
0.60  
0.64  
0.68  
0.72  
0.76  
0.80  
0.84  
0.88  
0.92  
0.96  
1.00

DIMENSION

2

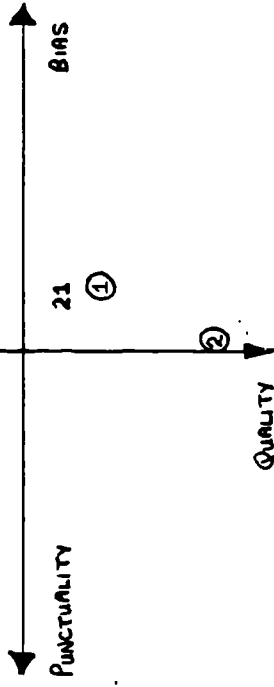
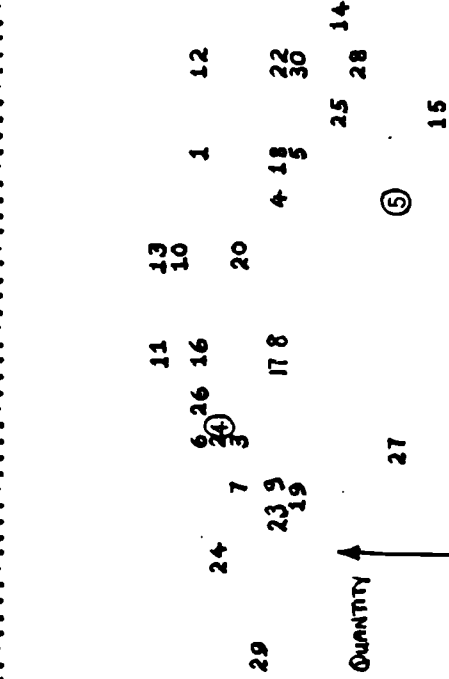

SUBJECT SCORES : 1 → 30  
PROPERTIES : ① → ⑦

-1.00 -0.90 -0.80 -0.70 -0.60 -0.50 -0.40 -0.30 -0.20 -0.10 0.10 0.20 0.30 0.40 0.50 0.60 0.70 0.80 0.90 1.00

APPENDIX 3.4 b) MDS Indscal Scores: BIAS/PUNCTUALITY v QUANTITY/QUALITY

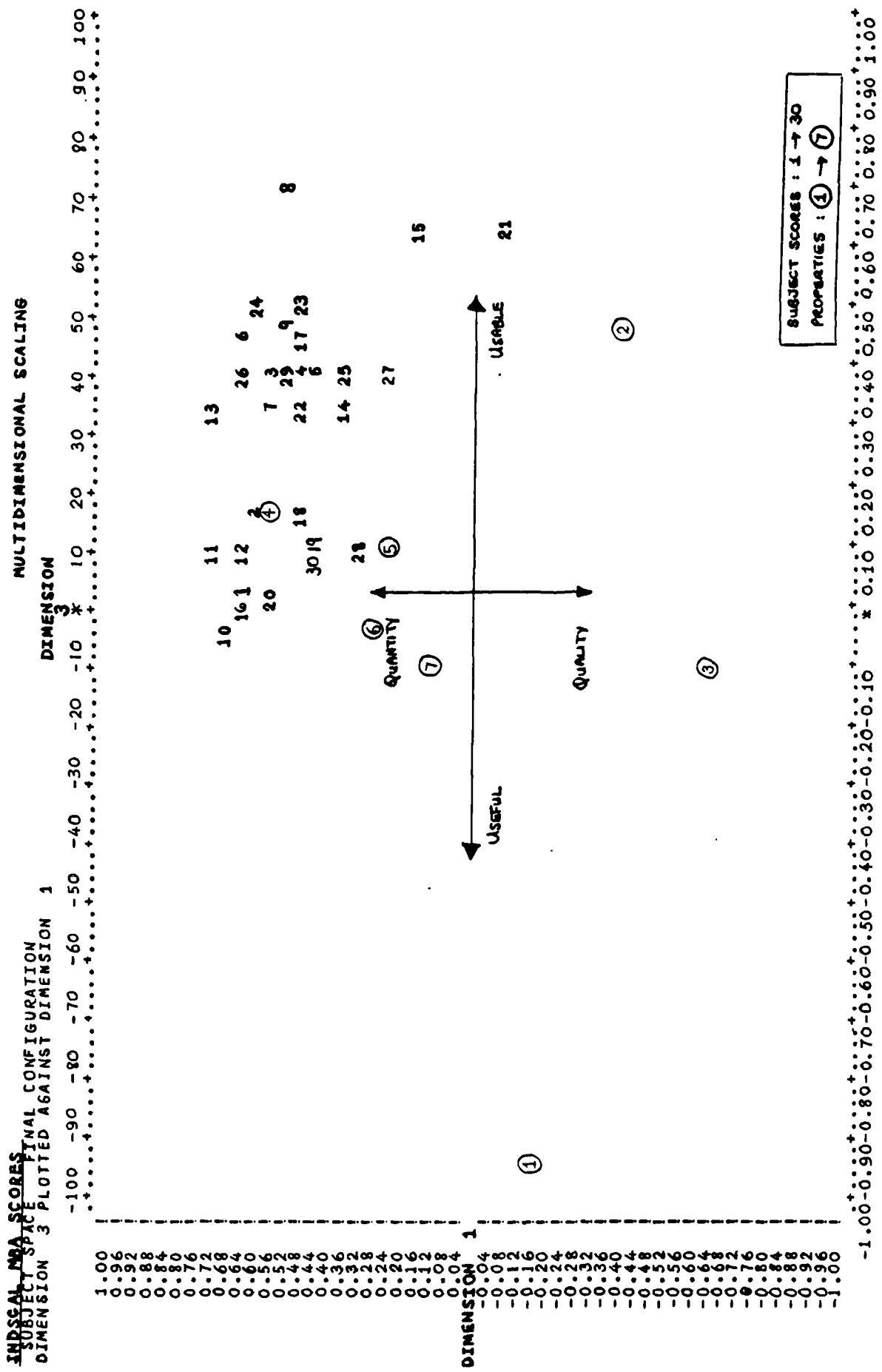

APPENDIX 3.4 c) MDS Indscal Scores: QUANTITY/QUALITY v  
USEFUL/USABLE

APPENDIX 5.1

Matched sample of companies

MATCH	INDUSTRIAL ACTIVITY	FAILED COMPANIES			NON-FAILED COMPANIES			
		FINANCIAL YEAR END	SALES TURNOVER	Z-SCORE	FINANCIAL YEAR END	SALES TURNOVER	Z-SCORE	
1	Industrial Plant							
2	Industrial Plant				William Boulton	30. 6. 78	20.2	4. 90
3	Construction	Gen Eng Co (Radcliffe)	31.12.78	16.2	Hunstet Holdings	6. 8. 78	8. 8	10.76
4	Textiles	Southern Constructions	31.12.78	6.9*	J Smart	31. 7. 78	10.9	13.81
5	Motor Vehicles	Rivington Reed	31.12.78	23.2	Bodycote International	31.12.78	29.9	4.97
6	Chemicals	Fodens	31. 3. 79	51.1	ERF Holdings	31. 3. 79	68.2	3.84
7	Clothing	Burrell & Co	31.12.79	9.9	Yorkshire Chemicals	31.12.79	18.0	4.33
8	Carpets	Blackman Conrad	31. 1. 80	7.5	Hawtin	31. 1. 80	12.1	5.14
9	Industrial Plant	Blackwood Morton	30. 6. 80	21.9	Gaskeil Broadloom	31.12.80	12.5	3.29
10	Printing	Stone-Platt	31.12.80	193.5	APV Holdings	31.12.80	282.1	4.71
11	Textiles	Oxley Printing	31.12.80	27.7	Richard Clay	2. 1. 81	18.2	8.20
12	Clothing	William Pickles	31.12.80	22.3	Marling Industries	31. 3. 81	19.8	0.29
13	Clothing	W. Pawson	28. 2. 81	26.1	IJ Dewhirst	16. 1. 81	20.9	10.27
14	Textiles	Woodrow Wyatt	31. 3. 81	8.4	Usher-Walker	31.12.80	7. 8	6.50
15	Furniture	Cawdaw Industrial	31. 3. 81	11.6	Hicking Pentecost	31. 3. 81	11.4	3.03
16	Mechanical Eng	F Austin (Leyton)	3. 7. 81	7.3	Stoinehill Holdings	31. 3. 81	18.5	3.76
17	Caravans	Moss Engineering	31. 8. 81	16.7	Burgess Products	1. 8. 81	22.8	4.69
18	Toys & Games	Caravans International	31. 8. 81	63.6	Ace Belmont	31. 8. 81	36.4	3.87
19	Electricals	Berwick Timpo	31.12.81	13.2	JM Spear	31.12.81	14.7	5.02
20	Builders Materials	Derritron	31.12.81	8.6	AF Bulgin	31. 1. 82	5.0	14.84
21	Clothing	Carron Co	21.12.81	31.7	Ruberoid	31.12.81	52.8	7.25
22	Foundries	R&J Pullman	30. 4. 82	24.0	IJ Dewhirst	14. 1. 82	23.2	10.80
23	Clothing	Midland Industries	31.12.82	24.7	Mitchell Somers	2. 4. 83	32.7	3.08
24	Food Manufacturing	Mellins	31.12.82	1.7	Ladies Pride	30.11.82	6.4	13.66
25	Mechanical Handling	Scotcross	31. 3. 83	46.4	Hazlewood	31. 3. 83	30.0	1.12
26	Construction	Acrow	31. 3. 83	163.1	JH Fenner	28. 8. 82	144.2	2.83
27	Furniture	Crouch Group	31. 3. 83	21.0	Tyson (Contractors)	31.12.82	24.2	3.80
28	Steels	Metamec Jentique	30. 6. 83	9.3	Elson & Robbins	30. 9. 83	18.2	6.64
29	Clothing	Danks Gowerton	30. 6. 83	18.1	J Saville Gordon	30. 4. 83	18.0	3.73
30	Wool	George Spencer	31.12.83	9.9	Towles	29. 2. 84	13.4	10.86
31	Construction	Nova (Jersey)Knit	31. 3. 84	8.0	Sanderson, Murray & Elder	30. 6. 84	5.6	9.01
32	Electricals	Cocksedge Holdings	31. 3. 84	3.5	Braithwaite	31. 3. 84	7.6	5.75
33	Steels	Herman Smith	30. 6. 84	10.3	Kode International	31.12.83	12.5	6.37
		SW Farmer	31.12.84	19.1	Grasway	27. 4. 85	22.3	5.83

\*Turnover for a 9-month accounting period. A proportionate increase provides a figure of £9.2m which corresponds with the previous year's total.

<u>DIFFICULT CASES</u>			<u>MEDIUM CASES</u>			<u>EASY CASES</u>		
<u>RANK ORDER</u>	<u>CASE NUMBER</u>	<u>CLOZE SCORE (%)</u>	<u>RANK ORDER</u>	<u>CASE NUMBER</u>	<u>CLOZE SCORE (%)</u>	<u>RANK ORDER</u>	<u>CASE NUMBER</u>	<u>CLOZE SCORE (%)</u>
1.	49	33.2	23.	1	45.2	45.	53	52.0
2.	63	33.2	24.	8	46.0	46.	3	52.0
3.	46	34.8	25.	29	46.0	47.	70	52.2
4.	32	35.0	26.	23	46.2	48.	30	53.0
5.	33	37.4	27.	69	46.8	49.	6	53.2
6.	57	38.6	28.	27	47.0	50.	40	53.5
7.	11	38.7	29.	10	47.2	51.	42	54.0
8.	15	39.3	30.	45	47.4	52.	21	54.0
9.	52	39.4	31.	25	47.8	53.	16	54.0
10.	54	39.4	32.	36	47.8	54.	22	54.3
11.	9	40.8	33.	44	48.6	55.	39	54.4
12.	61	41.4	34.	64	48.6	56.	51	55.5
13.	26	42.0	35.	13	48.8	57.	5	55.6
14.	12	42.0	36.	17	49.6	58.	4	56.2
15.	28	42.5	37.	18	49.7	59.	58	56.6
16.	20	43.0	38.	2	50.5	60.	65	56.8
17.	35	43.2	39.	56	50.8	61.	37	57.7
18.	31	43.2	40.	55	51.0	62.	7	58.2
19.	48	43.5	41.	34	51.0	63.	24	58.8
20.	38	44.0	42.	50	51.2	64.	19	61.8
21.	62	44.2	43.	66	51.5	65.	59	62.7
22.	14	44.9	44.	67	51.5	66.	41	64.2

(Failed Cases emboldened)

APPENDIX 5.2      CLOZE procedure: preliminary results:  
divisional groupings

<u>DIFFICULT CASES</u>			<u>MEDIUM CASES</u>			<u>EASY CASES</u>		
<u>RANK ORDER</u>	<u>CASE NUMBER</u>	<u>MISCLASSIFICATION SCORE (%)</u>	<u>RANK ORDER</u>	<u>CASE NUMBER</u>	<u>CLOZE SCORE (%)</u>	<u>RANK ORDER</u>	<u>CASE NUMBER</u>	<u>MISCLASSIFICATION SCORE (%)</u>
1.	53	100.0	23.	32	36.7	45.	21	17.9
2.	44	89.3	24.	36	36.4	46.	54	16.7
3.	6	86.2	25.	10	34.8	47.	7	15.8
4.	46	83.9	26.	14	33.3	48.	5	15.8
5.	39	77.4	27.	51	33.3	49.	20	14.3
6.	48	71.4	28.	28	31.6	50.	50	14.3
7.	12	70.6	29.	29	31.3	51.	3	13.3
8.	61	64.5	30.	57	31.0	52.	25	12.5
9.	18	64.3	31.	19	30.0	53.	56	10.7
10.	22	60.0	32.	42	29.4	54.	24	8.3
11.	62	58.3	33.	59	27.8	55.	23	8.3
12.	64	58.3	34.	16	25.0	56.	11	8.0
13.	35	55.0	35.	1	24.0	57.	9	7.7
14.	66	48.0	36.	8	23.1	58.	15	7.1
15.	41	47.4	37.	34	22.9	59.	63	6.7
16.	38	47.1	38.	65	22.6	60.	4	5.6
17.	58	42.9	39.	49	22.6	61.	31	0.0
18.	55	42.9	40.	27	22.6	62.	26	0.0
19.	2	41.2	41.	13	19.4	63.	33	0.0
20.	30	40.0	42.	67	19.2	64.	17	0.0
21.	52	40.0	43.	70	18.9	65.	37	0.0
22.	45	37.5	44.	40	18.8	66.	69	0.0

(Failed Cases emboldened)

### APPENDIX 5.3

### Chairman's Statement Analysis: preliminary results: divisional groupings

CLOZE PROCEDURECHAIRMAN'S STATEMENT ANALYSIS

TEST MATERIALS NO	NO OF FAILED CASES			NO OF FAILED CASES				
	<u>EASY</u>	<u>MEDIUM</u>	<u>DIFFICULT</u>	<u>EASY</u>	<u>MEDIUM</u>	<u>DIFFICULT</u>		
1	2	4	44	57	0	33, 37	8, 28, 65	18, 62, 66
2	3	39	17	46	0	31, 33	1, 28, 59	12, 35, 62
3	2	37	34	63	1	9, 31	1, 8, 29	12, 35, 64
4	3	19	50	15	1	11, 26, 33	34, 59, 65	18, 64
5	1	59	17	33	2	4, 15, 37	1, 8, 57	12, 64
6	2	39	44	28	2	4, 11, 17	57, 59	18, 62, 66
7	2	4	17	57	3	15, 26, 50	42, 59, 65	35, 64
8	2	59	44	46	3	9, 26, 50	34, 57	6, 35, 66
9	2	59	34	15	4	9, 26, 63	29, 51	12, 53, 62
10	3	4	50	63	4	15, 17, 31	8, 28	44, 46, 66
11	1	37	64	46	5	11, 50, 69	34, 65	18, 48, 53
12	2	51	34	28	5	9, 37, 50	1, 16, 19	39, 48
13	2	51	18	63	6	15, 33, 37	16, 51	6, 39, 46
14	1	37	50	57	6	11, 31, 69	16, 19, 42	39, 46
15	1	51	18	33	7	4, 63	19, 28, 42	44, 46, 48
16	2	19	64	15	7	17, 63, 69	16, 29, 57	39, 44
17	1	19	18	28	8	17, 69	29, 34, 51	6, 44, 53
18	1	39	64	33	8	4, 63	19, 42, 51	6, 48, 53

(Failed cases emboldened)

## APPENDIX 5.4

Experimental Design: Distribution of Cases  
for Narrative Analysis



FAILED COMPANIES

NO	PROFITABILITY (PBIT/TA)	FINANCIAL		PAS-SCORE PROFILE (%)		
		RISK (TL/NW)	LIQUIDITY (QA/CL)	PBIT/TA	TL/NW	QA/CL
5	0.03	1.46	0.48	8	79	17
6	0.06	2.84	0.18	13	96	3
7	-0.05	0.80	0.49	2	33	18
21	-0.06	0.90	0.69	2	44	45
27	-0.09	1.95	0.88	1	91	76
29	0.02	2.17	0.36	7	92	7
41	-0.30	5.50	0.38	0	99	8
44	0.06	1.14	0.58	13	62	29
46	0.08	1.81	0.68	29	88	42
48	0.08	1.21	0.80	25	68	65
49	-0.08	3.90	0.65	1	98	89
50	0.08	2.83	0.55	25	96	25
51	-0.04	1.01	0.58	2	51	31
53	0.18	2.65	0.37	89	96	7
69	0.06	3.59	0.37	16	98	8

NON-FAILED COMPANIES

1	0.08	0.81	0.78	23	33	62
9	0.09	0.92	0.91	32	43	79
18	0.03	0.28	1.31	9	2	95
24	0.15	0.51	1.15	78	11	93
25	0.09	0.64	0.95	37	21	82
26	0.14	1.16	0.48	73	63	17
28	0.11	1.91	0.80	57	90	64
35	0.06	0.65	0.71	14	22	49
37	0.10	0.69	1.19	43	25	93
40	0.08	1.49	0.79	24	81	63
45	0.11	0.76	0.85	52	29	72
56	0.12	0.84	1.13	61	36	92
57	0.04	0.33	0.72	11	3	50
62	0.09	0.65	0.75	33	22	56
66	0.13	0.91	0.73	72	44	52

## APPENDIX 5.5

Facial Profiles Experiment: Sample Financial Ratios

APPENDIX 5.6

Facial Profiles Experiment:  
Ratio Distribution of Sample Cases

PAS-SCORE PERCENTILE RANGE	PROFITABILITY SUB-SAMPLE (n=30) NON-		(PBIT/TA) COMPLETE (n=66) NON-		FINANCIAL RISK SUB-SAMPLE (n=30) NON-		(TL/MM) COMPLETE (n=66) NON-		LIQUIDITY SUB-SAMPLE (n=30) NON-		(OV/CL) COMPLETE (n=66) NON-	
	FAILED	TOTAL	FAILED	TOTAL	FAILED	TOTAL	FAILED	TOTAL	FAILED	TOTAL	FAILED	TOTAL
0-10	9	10	26	28	0	2	0	7	5	0	8	9
10-20	2	4	3	11	0	1	1	3	2	1	10	11
20-30	2	4	2	6	0	5	0	9	2	0	3	3
30-40	0	3	0	4	1	2	1	3	1	0	6	7
40-50	1	2	1	3	1	2	1	3	2	1	3	5
50-60	0	2	0	3	2	0	3	2	0	3	0	4
60-70	0	1	0	2	2	1	4	2	1	3	1	5
70-80	0	3	0	6	1	0	1	0	1	2	1	9
80-90	1	0	1	3	1	1	3	2	1	1	1	7
90-100	0	0	0	0	7	1	19	2	0	4	0	6

<u>FAILED COMPANIES</u>					<u>NON-FAILED COMPANIES</u>				
<u>CASE</u>			<u>LIX</u>	<u>FLESCH</u>	<u>CASE</u>			<u>LIX</u>	<u>FLESCH</u>
<u>NO.</u>	<u>WORDS</u>	<u>SENTENCES</u>	<u>SCORE</u>	<u>SCORE</u>	<u>NO.</u>	<u>WORDS</u>	<u>SENTENCES</u>	<u>SCORE</u>	<u>SCORE</u>
2	241	8	61.25	33.03	1	203	7	56.59	31.54
4	346	12	58.60	31.35	3	1346	57	51.79	30.51
5	1017	39	55.87	35.21	8	1309	51	55.08	35.17
6	376	13	56.05	34.60	9	740	28	55.21	36.65
7	960	31	61.49	26.82	10	1056	42	56.49	33.91
14	1668	43	67.93	20.53	11	823	27	54.54	41.44
15	1088	33	62.57	27.19	12	324	17	46.22	46.49
16	1335	53	50.43	48.00	13	1137	41	59.75	30.84
17	822	31	55.47	37.89	18	2295	81	56.22	38.18
19	203	6	61.42	34.97	23	944	38	53.23	44.95
20	1379	42	65.83	38.05	24	1021	48	48.79	47.61
21	1158	46	54.10	37.87	25	385	19	45.46	47.83
22	949	47	48.64	45.22	26	1236	49	53.78	33.80
27	516	23	51.31	40.93	28	1953	80	57.34	30.27
29	743	28	57.36	33.13	30	411	15	55.87	39.05
34	797	30	57.56	34.77	31	390	14	57.34	35.39
39	1268	50	58.72	30.51	32	1140	28	72.21	21.10
41	304	11	53.95	32.40	33	273	14	47.71	38.92
42	613	26	55.22	30.68	35	888	31	55.33	38.09
44	680	24	57.75	34.63	36	545	17	61.05	28.07
46	1313	51	56.44	34.12	37	671	27	51.98	42.54
48	274	13	52.46	26.74	38	312	13	52.21	40.93
49	1318	48	58.72	31.14	40	940	35	53.35	38.91
50	399	16	55.01	26.74	45	406	22	45.55	45.99
51	815	31	55.86	28.70	56	1107	77	42.74	51.70
52	3164	121	56.21	28.87	57	291	9	63.26	28.95
53	982	32	55.23	41.12	59	294	12	48.31	49.31
54	1313	51	53.54	35.92	62	525	24	51.21	32.67
55	550	23	55.37	32.90	64	344	13	53.50	41.03
58	1384	47	58.93	33.48	65	509	21	43.10	54.92
61	498	21	56.24	20.53	66	805	30	57.39	30.16
63	986	33	59.49	24.81	67	227	10	46.93	50.37
69	147	8	46.27	39.70	70	765	14	61.06	27.15

APPENDIX 6.2.1 Readability scores for sample companies

## THE CLOZE PROCEDURE

This task consists of a series of abstracts from the Chairman's Statement of the Company Annual Report and Accounts.

In each case a number of words have been deleted from the passage and replaced by a broken line. The broken lines are all of the same size and do not indicate the length of the words they replace. Your task is to replace the missing word with your best estimate of the precise word that has been deleted.

Your ability to make correct predictions will reflect your understanding of the passage and the ease with which the Chairman's message is being conveyed. Use all the evidence that is available to you in the surrounding text, because the context in which successive deletions appear, and punctuation, will help to provide you with clues.

Some gaps will be easier to fill than others (eg, words like 'the', 'and', 'in', 'of', 'to'). Others will be much less obvious, and you may need to re-read whole paragraphs before you can confidently predict the deletions.

In each case make the best guess that you can and avoid leaving any blanks.

Consider the following example:

The problem facing ..... toy and games industry ..... little sign of easing.  
..... looks as though many ....., reflecting the pressures which ..... are  
under, will place ..... later in the year ..... usual.

The correct prediction of each omission reveals

The problems facing THE toy and games industry SHOW little sign of  
easing. IT looks as though many DEALERS, reflecting the pressures  
which THEY are under, will place ORDERS later in the year THAN usual.

## APPENDIX 6.2.2a) The CLOZE Procedure: Instructions to Respondents

During 1982 Acrow companies ..... to be affected by ..... problem of declining markets ..... continued weakness in the ..... and heavy construction industry.

..... our sales at £163 ..... were close to the ..... year's record of £167 million, ..... competition in these declining ..... has had its serious ..... on margins resulting in ..... substantial loss for the .....

Retrenchment through factory closures ..... cost savings, together with ..... rationalisation and efficiency improvements ..... been achieved since the ..... of Norman Cunningham as ..... Managing Director and Chief ..... in December 1981.

The Board ..... Directors recommends that no ..... on the Ordinary Share ..... be paid for the ..... financial year.

The climate ..... uncertainty in world markets - ..... so much a lack ..... need, but a lack ..... funds - should not, however, ..... the fact that many ..... the Acrow Group products ..... leaders in their respective ..... and our export achievement ..... rewarded by winning the ..... Award for the sixth ..... . Acrow is proud of ..... quality of its sales ..... throughout the world. Priority ..... being given by top ..... to give maximum support ..... their efforts.

Both management ..... employees are working together ..... a concerted manner to ..... a return to prosperity ..... the Group, and I ..... like to extend my ..... to all members of ..... Acrow team throughout the ..... for their efforts ..... loyalty during this difficult .....

APPENDIX 6.2.2b) The CLOZE Procedure: Test Instrument for  
Case No. 2: ACROW PLC

		FAILED COMPANIES	NON-FAILED COMPANIES	ALL COMPANIES
SALES TURNOVER: (£M.)	MEAN	28.52	31.80	30.16
	S.D.	40.49	50.77	45.95
Z-SCORE:	MEAN	- 3.94	6.27	1.16
	S.D.	1.93	3.63	5.88
LIX SCORE:	MEAN	56.71	53.68	55.20
	S.D.	4.33	5.87	5.32
FLESCH SCORE:	MEAN	33.11	38.32	35.71
	S.D.	6.09	7.98	7.59
CLOZE SCORE:	MEAN	49.01	47.47	48.24
	S.D.	7.77	8.66	8.26
No OF WORDS:	MEAN	897	776	836
	S.D.	572	505	539
No OF SENTENCES:	MEAN	33	31	32
	S.D.	21	20	21

APPENDIX 6.2.3 Readability Study: Descriptive statistics  
for 66 companies

CASE No.	<u>COGNIZABILITY SCORES</u>				<u>READABILITY SCORES</u>			
	ACCOUNTANTS CLOZE		STUDENTS CLOZE		LIX		FLESCH	
	SCORE (%)	RANK	SCORE (%)	RANK	SCORE	RANK	SCORE	RANK
59	72.9	1	62.7	1	48.31	2	49.31	1
37	71.6	2	57.7	3	51.98	3	42.54	2
64	71.0	3	48.8	11	53.50	4	41.03	3
33	67.3	4	37.4	16	47.71	1	38.92	4
19	65.8	5	61.8	2	61.42	16	34.97	7
51	61.3	6	55.5	5	55.86	7	28.70	15
39	61.2	7	54.4	6	58.72	14	30.51	12
4	57.5	8	56.2	4	58.60	13	31.35	11
34	55.9	9	51.0	8	57.56	11	34.77	8
18	55.6	10	49.7	9	56.22	8	38.18	5
17	54.9	11	49.6	10	55.47	6	37.89	6
15	53.2	12	39.3	14	62.57	17	27.19	16
44	52.9	13	48.6	12	57.75	12	34.63	9
50	51.9	14	51.2	7	55.01	5	26.74	17
28	51.4	15	42.5	13	57.34	10	30.27	13
46	45.8	16	34.8	17	56.44	9	34.12	10
57	45.2	17	38.6	15	63.26	18	28.95	14
63	43.5	18	33.2	18	59.49	15	24.81	18

(Scores corresponding to Failed Cases are emboldened)

APPENDIX 6.2.4 CLOZE Procedure: Ranking of Cases by Respondents of differing sophistication

Readability Level

	FLESCH		LIX		CLOZE SCORE			
	SCORE	(%)	SCORE	(%)	<u>ACCOUNTING</u> <u>STUDENTS</u>	(%)	<u>ACCOUNTING</u> <u>PRACTITIONERS</u>	(%)
Very Difficult	0- 30	19	60-80	15	30-40	15	40-50	16
Difficult	30- 50	77	45-60	82	40-60	80	50-70	67
Fairly Difficult	50- 60	4	40-45	3	60-65	5	70-75	17
Standard	60- 70		35-40					
Fairly Easy	70- 80		30-35					
Easy	80- 90		25-30					
Very Easy	90-100		0-25					

**APPENDIX 6.2.5 Distribution of Readability Levels for Accounting Narrative Disclosures**



	'Distressed Group'	'Healthy Group'
DUNLOP HOLDINGS (31/12/81)	MOTOR COMPONENTS	TACE (30/9/81) ENGINEERING
METTOY (31/12/82)	TOYS	STEINBERG GROUP (28/3/81) CLOTHING
MY DART (31/12/82)	SPORTS AND LEISURE	SOUND DIFFUSION (31/12/81) ELECTRICAL
WILSHAW SECURITIES (31/7/82)	INDUSTRIAL PLANT	BBA GROUP (31/12/82) MOTOR COMPONENTS
SMITH WHITWORTH (31/3/82)	INDUSTRIAL PLANT	J JARVIS (31/3/83) CONSTRUCTION
BSR (31/12/82)	ELECTRONICS	T MARSHALL (LOXLEY) (31/12/84) INDUSTRIAL PLANT

#### APPENDIX 7.1.1

#### Content Analysis:

#### Distribution of Pre-Sample Companies

1	<b>UNCERTAINTY REGARDING THE FUTURE</b>		
	Anticipated	If ...	Potential
	Could	Might	Possibility
	Expectations	May	Prospects
	Future	New .	Research
	Forecast	Opportunity	Should ...
	Hopeful	Optimistic	Uncertainty
	Introduction	Proposal	
2	<b>VAGUENESS ABOUT THE PAST/PRESENT</b>		
	Assumed	Encouraging	Obscure
	Change	A number of ...	Something
3	<b>EMPHASIS ON MAINTAINING THE STATUS QUO</b>		
	Adjustment	Continue	Remain
	Circumstances	Maintain	
4	<b>RELUCTANT NEED TO TAKE ACTION</b>		
	Bankers support	Involvement	Relocation
	Had to ...	Must	Reluctance
	Incurred	Necessity	Unavoidable
	Inescapable	Obliged	Turnround
	Inevitable	Requirement	Unfortunately
5	<b>DEPENDENCE ON EXTERNAL ECONOMIC FACTORS</b>		
	Competition	Interest Rates	Unusually
	Downturn	Recession	Unexpected
	Economy	Strike	Upturn
	External	Unemployment	Weather
	Government	Unprecedented	Winter
	Inflation	Unforeseen	
6	<b>REFERENCE TO MEASURES OF PAST PERFORMANCE</b>		
	Assets	Liabilities	Performance
	Borrowing	Liquidity	Profitability
	Debt	Loans	Productivity
	Earnings	Margins	Results
	Gearing	Overdraft	Sales
7	<b>DETAILING OF POSITIVE ACHIEVEMENTS</b>		
	Achievement	Expansion	Launch
	Acquisition	Extension	Penetration
	Additional	Favourable	Pleased
	Advance	Gain	Profit
	Benefits	Good	Progress
	Better	Great	Recovery
	Best	Growth	Record
	Can	Increase	Resurgence
	Development	Investment	Success
	Diversification	Improvement	Strength

8	<b>DETAILING OF NEGATIVE ACHIEVEMENTS</b>			
	<b>Adverse</b>	<b>Disposal</b>	<b>Problem</b>	<b>Reduction</b>
	<b>Disastrous</b>	<b>Deficit</b>	<b>Pressure</b>	<b>Restricted</b>
	<b>Bad</b>	<b>Difficult</b>	<b>Provision</b>	<b>Sale</b>
	<b>Burden</b>	<b>Distress</b>	<b>Poor</b>	<b>Serious</b>
	<b>Closure</b>	<b>Damages</b>	<b>Resignation</b>	<b>Severe</b>
	<b>Crisis</b>	<b>Depressed</b>	<b>Retirement</b>	<b>Set-back</b>
	<b>Collapse</b>	<b>Excess</b>	<b>Reorganisation</b>	<b>Unfavourable</b>
	<b>Costs</b>	<b>Extraordinary</b>	<b>Reconstruction</b>	<b>Unpalatable</b>
	<b>Cannot</b>	<b>Exceptional</b>	<b>Restructure</b>	<b>Unsatisfactory</b>
	<b>Disappointing</b>	<b>Failure</b>	<b>Refinancing</b>	<b>Unprofitable</b>
	<b>Damaging</b>	<b>Fall</b>	<b>Rationalisation</b>	<b>Weakness</b>
	<b>Drastic</b>	<b>Imprudent</b>	<b>Realignment</b>	<b>Worst</b>
	<b>Decline</b>	<b>Impossible</b>	<b>Redundancy</b>	
	<b>Decrease</b>	<b>Low</b>	<b>Retrenchment</b>	
	<b>Deteriorate</b>	<b>Loss</b>	<b>Regrettably</b>	
	<b>Disruption</b>	<b>Not ...</b>	<b>Reversal</b>	

**APPENDIX 7.1.2 Word Distribution in Content Analysis of Narrative**

#### MODEL 1 (WORDS)

$$Z = 1.22 - 6.35 (\text{NOMDIV}) + 364.64 (\text{PRW}) - 1004.97 (\text{HQW}) \\ - 557.80 (\text{BZW}) - 2.77 (\text{BF}) + 1005.04 (\text{CEW}) - 718.94 (\text{CCW})$$

where NOMDIV = No dividend + Nominal dividend  
PRW = (Profit - Loss - Unprofitable)/WORDS  
HQW = (Overdraft + Loans + Borrowings)/WORDS  
BZW = (Closure + Disposals + Sale)/WORDS  
BF = Bankers Support  
CEW = Economy/WORDS  
CCW = Recession/WORDS

#### MODEL 2 (THEMES)

$$Z = 0.407 - 17.012 (\text{BAD}) + 10.375 (\text{GOOD}) - 14.538 (\text{SCS})$$

where BAD =  $\frac{(\text{Adverse themes} + \text{Bad dividend})}{\text{SENTENCES}}$   
GOOD =  $\frac{(\text{Beneficial themes} + \text{Good dividend})}{\text{SENTENCES}}$   
SCS = Contractions/SENTENCES

#### MODEL 3 (FIRST SENTENCE)

$$Z = -0.911 - 3.723 (\text{LOS}) + 2.094 (\text{PRO}) - 3.273 (\text{WOR}) - 4.794 (\text{REO}) \\ - 1.862 (\text{REG})$$

where LOS = Loss  
PRO = Profit  
WOR = Worst ...  
REO = Reorganisation  
REG = Regrettably

#### MODEL 4 (STRATEGIES)

$$Z = 3.531 - 3.791 (\text{NOMINDIV}) - 4.033 (\text{CLO}) - 2.670 (\text{BF}) - 5.109 (\text{OUT}) \\ - 3.663 (\text{LAC})$$

where NOMINDIV = No dividend or Nominal dividend or No dividend mention  
CLO = Closures  
BF = Bankers Support  
OUT = Outside Help Sought  
LAC = Lack of control evident

MODEL 5 (MIXED)

$$Z = 3.861 + 418.41 (\text{PRW}) - 5.690 (\text{NOMDIV}) - 4.906 (\text{CLO}) \\ - 1171.11 (\text{HQW}) - 5.836 (\text{OUT}) - 2.491 (\text{BF}) - 3.937 (\text{LAC}) \\ + 1012.76 (\text{CEW}) - 1148.51 (\text{CCW})$$

where

PRW =	(Profit - Loss - Unprofitable)/WORDS
NOMDIV =	No dividend + Nominal dividend
	Closures
CLO =	Closures
HQW =	(Overdraft + Loans + Borrowings)/WORDS
OUT =	Outside Help Sought
BF =	Bankers Support
LAC =	Lack of control evident
CEW =	Economy/WORDS
CCW =	Recession/WORDS

APPENDIX 7.2.1 Content Analysis: Alternative Discriminant Models

VARIABLE	FAILED COMPANIES				NON-FAILED COMPANIES			
	MEAN	S.D.	COEFFICIENTS OF SKEW- NESS	KURT- OSIS	MEAN	S.D.	COEFFICIENTS OF SKEW- NESS	KURT- OSIS
<u>MODEL 1 WORDS</u>								
PRW	-0.00	0.00	-0.49	1.43	0.01	0.01	1.51	2.61
CEW	0.00	0.00	3.10	9.99	0.00	0.00	1.29	0.75
BZW	0.00	0.00	0.30	-0.94	0.00	0.00	4.35	21.31
NOMDIV	0.52	0.51	-0.06	-2.13	0.00	0.00	0.00	0.00
HQW	0.00	0.00	2.21	7.11	0.00	0.00	2.13	3.98
BF	0.48	0.51	0.06	-2.13	0.03	0.17	5.74	33.00
CCW	0.00	0.00	0.80	-0.96	0.00	0.00	2.74	7.10
<u>MODEL 2 THEMES</u>								
GOOD	0.10	0.09	2.29	8.23	0.27	0.14	0.95	0.43
BAD	0.24	0.16	0.89	1.54	0.04	0.04	1.97	4.11
SCS	0.18	0.14	1.38	2.27	0.04	0.05	1.64	2.65
<u>MODEL 3 FIRST-SENTENCE MESSAGE</u>								
PRO	0.12	0.33	2.43	4.17	0.58	0.50	-0.32	-2.02
LOS	0.30	0.47	0.90	-1.27	0.00	0.00	0.00	0.00
WOR	0.15	0.36	2.04	2.29	0.00	0.00	0.00	0.00
REO	0.09	0.29	2.98	7.34	0.00	0.00	0.00	0.00
REG	0.15	0.36	2.04	2.29	0.00	0.00	0.00	0.00
<u>MODEL 4 STRATEGIES</u>								
NOMDIV	0.78	0.42	-1.48	0.19	0.18	0.39	1.73	1.05
CLO	0.61	0.50	-0.46	-1.91	0.09	0.29	2.98	7.34
OUT	0.21	0.42	1.48	0.19	0.00	0.00	0.00	0.00
LAC	0.24	0.44	1.26	-0.44	0.00	0.00	0.00	0.00
BF	0.48	0.51	0.06	-2.13	0.03	0.17	5.74	33.00
<u>MODEL 5 MIXED NARRATIVE</u>								
PRW	-0.00	0.00	-0.49	1.43	0.01	0.01	1.51	2.61
CEW	0.00	0.00	3.10	9.99	0.00	0.00	1.29	0.75
NOMDIV	0.52	0.51	-0.06	-2.13	0.00	0.00	0.00	0.00
CLO	0.61	0.50	-0.46	-1.91	0.09	0.29	2.98	7.34
CCW	0.00	0.00	0.80	-0.96	0.00	0.00	2.74	7.10
LAC	0.24	0.44	1.26	-0.44	0.00	0.00	0.00	0.00
OUT	0.21	0.42	1.48	0.19	0.00	0.00	0.00	0.00
HQW	0.00	0.00	2.21	7.11	0.00	0.00	2.13	3.98
BF	0.48	0.51	0.06	-2.13	0.03	0.17	5.74	33.00

## APPENDIX 7.2.2 Content Analysis: Descriptive Statistics

## FAILED COMPANIES

### LIQUIDITY MEASURES

#### CASE 5: BERWICK TIMPO

'There is no restriction on product development, and liquidity is not a problem'

QA = 0.478 (P=17)

CL

#### CASE 14: BURRELL

'During a period of formidable trading losses such as has been experienced during 1979, it is unsurprising that the Company's liquidity position has come under considerable strain from time to time' QA = 0.453 (P=14)

CL

#### CASE 19: COCKSEGE

'we have recently taken steps which improve our long term liquidity'

QA = 0.423 (P=11)

CL

#### CASE 34: HERMAN SMITH

'The losses placed a severe strain on the company's liquidity'

QA = (P=15)

CL

#### CASE 21: DANKS GOWERTON

'In the light of the need ... to preserve Group liquidity your Directors are not seeking powers to purchase any more shares for the time being'

QA = 0.686 (P=45)

CL

### GEARING MEASURES

#### CASE 46: MOSS ENGINEERING

'Our gearing will remain high, until the second half of 1982 when our projections indicate a return to more comfortable levels'

TL = 1.807 (P=88)

NW

## NON-FAILED COMPANIES

#### CASE 36: HUNSLET

'Whilst such (tax) deferment makes a helpful contribution to the company's liquidity, deferment is dependent upon the annual level of stock' QA = 0.951 (P=82)

CL

#### CASE 57: SANDERSON, MURRAY & ELDER

'The group's improved liquidity reduced net interest costs for the year' QA = 0.717 (P=50)

CL

#### CASE 8: BODYCOTE

'In recent years we have pursued an active policy of de-gearing in the optimistic hope that the level of inflation would continue to fall' TL = 0.876 (P=41)

NW

#### CASE 13: BURGESS

'The gearing adjustment reveals that less than 30% of the Group's average fixed assets and working capital during the year was financed by borrowing' TL = 0.812 (P=33)

NW

**CHAIRMAN'S STATEMENT ANALYSIS**

The attached package includes copies of the Chairman's Statement taken from EIGHT Annual Company Reports and Accounts.

These eight statements have been selected randomly from a sample of SEVENTY such statements, comprising a mixture of statements from healthy companies, together with those which proved to be the final Chairman's statement prior to the failure of that particular company.

It is possible that your sample could contain the statements of eight failures and none from healthy companies, or vice versa, but it is much more likely that you will have a mixture of healthy and failed enterprises, although the proportions of failed/healthy will vary among respondents.

In each instance the names of the company, its major subsidiaries and trading partners, have been deleted so as not to divulge the identity of the company in question. In some instances, the names of key personnel and products have been similarly treated.

**THE TASK**

Use your skill and experience to assess the information provided and decide which, if any, of your statements have been made by failed companies. Then fill in the following table to record your decision.

In each case the statement provided is complete and unabridged, so that some are quite lengthy. You may decide that some sections (eg, those dealing with personnel or divisional reviews) are less relevant to your decision than others. Just use as much of the information as you feel appropriate in the making of a reliable decision.

NUMBER	FAILED COMPANY	HEALTHY COMPANY
1		
19		
16		
37		
39		
50		
9		
48		

Name:  
 Full-Time Student  
 Part-Time Student  
 No. of months of Business Work  
 Experience (excluding holiday jobs)

**APPENDIX 8.3.1a) Test Materials: Chairman's Statement Analysis**



In August 1983 your company's dyeing and finishing operations were transferred from South Wales to Nottingham amidst considerable controversy. This move was made following a combined management and production agreement with [REDACTED] and its Subsidiary, [REDACTED] subsequently ceased trading but a new contract between another subsidiary of [REDACTED] and ourselves, although less favourable to us than the original agreement, enabled us to continue profitable operations.

As a result of the move, your company's overheads have been pruned to a level where it can operate profitably on a more flexible level of turnover than heretofore.

Your group has also diversified into consumer textiles, the products of which compete successfully for a share of the market both at home and abroad. This area of activity will become increasingly important in the future.

During the move to Nottingham certain key machinery was seriously damaged resulting in a loss of turnover for the year estimated at £2.7m. This machinery was insured for both material damage and consequential loss covering a maximum indemnity period of 2 1/2 years from the date of damage. Our advisors have assessed the claim to 31st March, 1984 in the sum of £1.2m., representing the loss of gross (not net) profit for the period. A further claim will be made in respect of 1984/85.

The move to Nottingham caused your group to incur considerable extraordinary costs including the repayment of regional development grants. In addition a term loan granted as selective assistance was repaid in full during the year and required refinancing. In consequence the Board can recommend only a nominal final dividend of 1/2p per share on this occasion.

APPENDIX 8.3.1b) Test Materials: Case 48: Nova Jersey Knit

## FINANCIAL STATEMENT ANALYSIS

The attached package contains abstracts from the Profit + Loss Account and Balance Sheet taken from EIGHT Annual Company Report and Accounts.

These eight sets of accounts have been selected randomly from a sample of SEVENTY such statements, comprising a mixture of accounting statements from healthy companies together with those which proved to be the final accounts prior to the failure of that particular company.

It is possible that your sample could contain the accounts of eight failures and none from healthy companies, or vice versa. But it is much more likely that you will have a mixture of healthy and failed enterprises, although the proportions of failed/healthy will vary among respondents.

### THE TASK

Use your skill and experience to assess the financial profile provided and decide which if any, of your accounting statements have been made by failed companies. Then fill in the following table to record your decision.

Number	Failed Company	Healthy Company
4		
19		
28		
42		
44		
46		
48		
63		

**4                      19                      28                      42**

<u>PROFIT AND LOSS ACCOUNT</u>	(£000)	(£000)	(£000)	(£000)
Sales Turnover	7,292	3,526	144,167	9,338
Trading Profit	-1,471	402	15,839	-398
Depreciation	196	418	3,313	408
Pre-Interest Profit	-1,667	-16	12,526	-806
Interest	198	128	4,385	272
Pre-Tax Profit	-1,865	-145	8,108	-1,078
Tax	-482	0	3,784	0
Profit after Tax	1,384	-145	4,324	-1,078
Dividends	0	0	2,789	1
Extraordinary Items	-163	0	-288	0
Retained Profits	-1,547	-145	3,434	-1,079
Earnings per Share	-11.53p	-10.3p	12.03p	-11.98p
 <u>BALANCE SHEET</u>				
Stocks	1,413	176	45,993	2,210
Debtors	1,331	857	31,657	1,422
Cash	<u>3</u>	<u>1</u>	<u>2,536</u>	<u>14</u>
Current Assets	<u>2,747</u>	<u>1,035</u>	<u>80,186</u>	<u>3,732</u>
Creditors	1,434	1,032	23,560	1,001
Overdraft and Short-Term Loans	1,708	865	14,275	1,979
Tax	0	0	2,139	0
Dividends	<u>0</u>	<u>0</u>		<u>2,769</u>
Current Liabilities	<u>3,142</u>	<u>2,029</u>	<u>42,743</u>	<u>3,437</u>
Net Current Assets	-395	-994	37,443	295
Fixed Assets	3,057	1,844	29,398	3,002
Share Capital and Reserves	2,626	807	26,904	3,081
Long Term Loans	0	23	20,253	216
Minority Interests	0	0	2,810	0
Deferred Tax	0	0	3,335	0

**44                  46                  48                  63**

<u>PROFIT AND LOSS ACCOUNT</u>	(£000)	(£000)	(£000)	(£000)
Sales Turnover	24,746	16,740	7,978	9,894
Trading Profit	2,871	1,640	719	1,106
Depreciation	1,127	251	182	2,013
Pre-Interest Profit	1,744	1,389	537	-907
Interest	1,193	788	92	105
Pre-Tax Profit	551	601	445	-1,013
Tax	99	-39	181	23
Profit after Tax	452	640	264	-1,036
Dividends	231	333	44	18
Extraordinary Items	-187	-1164	-437	-1,139
Retained Profits	34	-857	-217	-2,183
Earnings per Share	3.49p	10.41p	8.69p	-17.2p
<u>BALANCE SHEET</u>				
Stocks	3,922	5,309	1,518	1,724
Debtors	6,121	7,101	2,939	945
Cash	<u>760</u>	<u>22</u>	<u>2</u>	<u>43</u>
Current Assets	<u>10,803</u>	<u>12,613</u>	<u>4,460</u>	<u>2,713</u>
Creditors	3,673	5,623	1,356	711
Overdraft and Short-Term Loans	4,482	2,344	1,068	693
Tax	0	313	466	107
Dividends	<u>132</u>	<u>236</u>	<u>46</u>	<u>0</u>
Current Liabilities	<u>11,998</u>	<u>10,517</u>	<u>3,656</u>	<u>1,516</u>
Net Current Assets	-1,195	2,096	804	1,197
Fixed Assets	20,387	3,726	2,206	2,524
Share Capital and Reserves	14,573	5,999	2,940	2,624
Long Term Loans	4,676	389	0	0
Minority Interests	0	0	0	0
Deferred Tax	0	35	75	0

**APPENDIX 8.3.2a) Materials for Financial Statement Analysis:**

**Case 63 - George Spencer**

### FINANCIAL RATIO ANALYSIS

The attached package contains financial ratios calculated from information in the Profit + Loss Account and Balance Sheet taken from EIGHT Annual Company Report and Accounts.

These eight sets of ratios have been selected randomly from a sample of SEVENTY such statements, comprising a mixture of accounting statements from healthy companies together with those which proved to be the final accounts prior to the failure of that particular company.

In each instance three ratios have been calculated representing respectively, profitability, financial risk and liquidity:

$$\text{PROFITABILITY} \quad \frac{\text{PBIT}}{\text{TA}} = \frac{\text{Profit before Interest and Tax}}{\text{Total Assets}}$$

$$\text{FINANCIAL RISK} \quad \frac{\text{TL}}{\text{NW}} = \frac{\text{Total Liabilities}}{\text{Net Worth}}$$

$$= \frac{\text{Current Liabilities} + \text{Long Term Loans}}{\text{Shareholders Funds} + \text{Deferred Tax} + \text{Minority Interests}}$$

$$\text{LIQUIDITY} \quad \frac{\text{QA}}{\text{CL}} = \frac{\text{Quick Assets}}{\text{Current Liabilities}} = \frac{\text{Current Assets} - \text{Stocks}}{\text{Current Liabilities}}$$

For each ratio the corresponding mean value and standard deviation are supplied, for companies in the manufacturing and construction sectors of industry.

It is possible that your sample could contain the ratios of eight failures and none from healthy companies, or vice versa. But it is much more likely that you will have a mixture of healthy and failed enterprises, although the proportions of failed/healthy will vary among respondents.

#### THE TASK

Use your skill and experience to assess the financial profile provided and decide which, if any, of your ratios are those of failed companies.

Number	Failed Company	Healthy Company
9		
10		
16		
27		
30		
32		
33		
38		

F I N A N C I A L   R A T I O S

<u>Case</u>	<u>PROFITABILITY</u>	<u>LEVERAGE</u>	<u>LIQUIDITY</u>
	<u>PBIT/TA</u>	<u>TL/NW</u>	<u>QA/CL</u>
<b>9</b>	-0.173	0.578	0.652
<b>10</b>	-0.006	2.543	0.423
<b>16</b>	-0.287	1.196	0.425
<b>27</b>	0.114	1.906	0.800
<b>30</b>	-0.120	1.186	0.418
<b>32</b>	0.056	1.144	0.574
<b>33</b>	0.081	1.213	0.804
<b>38</b>	0.085	1.807	0.677
=====			
Mean	0.07	1.12	0.82
Standard Deviation	0.06	1.28	0.11

APPENDIX 8.3.2b) Materials for Financial Ratio Analysis:

Case 9 - George Spencer

NUMBER OF FAILED DECISIONS										
Number of Failed Cases	1	2	3	4	5	6	7	8	9	10
0	0.32	1.04	0.87	1.32	1.95	1.20	2.25	2.22	2.37	1.84
1		0.81	0.62	1.12	1.86	0.98	2.21	2.13	2.35	1.73
2			0.21	0.14	0.75	0.06	1.10	1.23	1.28	0.66
3				0.40	1.06	0.21	1.42	1.50	1.60	0.96
4					0.80	0.28	1.25	1.32	1.45	0.67
5						1.24	0.56	0.80	0.84	0.11
6							1.74	1.63	1.90	1.07
7								0.41	0.33	0.63
8									0.14	0.86
9										0.90

APPENDIX 8.4.1 t-statistics in the comparison of the no. of failed decisions with the no. of failed cases

NUMBER OF CLASSIFICATION ERRORS										
NUMBER OF FAILED CASES	1	2	3	4	5	6	7	8	9	10
0	0.43	1.35	0.96	0.06	0.12	0.02	0.24	0.11	1.90	<u>2.88</u>
1		2.06	1.49	0.53	0.43	0.63	0.28	0.36	<u>2.77</u>	<u>3.99</u>
2			0.24	2.02	2.02	1.93	2.13	1.64	0.58	1.77
3				1.29	1.32	1.22	1.43	1.15	0.72	1.65
4					0.10	0.14	0.29	0.08	3.00	<u>4.81</u>
5						0.23	0.18	0.00	<u>2.94</u>	<u>4.61</u>
6							0.42	0.17	<u>2.90</u>	<u>4.72</u>
7								0.14	<u>3.03</u>	<u>4.64</u>
8									<u>2.29</u>	<u>3.45</u>
9										<u>1.30</u>

APPENDIX 8.4.2 t-statistics in the comparison of the no. of classification errors with the no. of failed cases



MEAN NUMBER OF CLASSIFICATION ERRORS

NUMBER OF FAILED CASES	BUSINESS STUDENTS		ACCOUNTING UNDERGRADUATES		ACCOUNTING PRACTITIONERS	
	TYPE I	TYPE II	TYPE I	TYPE II	TYPE I	TYPE II
0	0.0	3.1	0.0	2.6	0.0	3.0
1	0.4	2.7	0.3	1.6	0.5	3.5
2	1.1	3.2	0.1	1.5	0.0	2.0
3	1.6	2.5	0.8	0.8	1.5	1.0
4	1.4	1.6	1.2	1.3	2.5	2.0
5	1.7	1.3	1.8	0.3	2.5	1.0
6	2.5	0.6	2.4	0.0	3.0	0.0
7	2.5	0.4	2.6	0.2	3.0	0.5
8	2.9	0.1	3.7	0.0	2.5	0.0
9	4.3	0.4				
10	5.4	0.0				

APPENDIX 8.4.3 Mean classification errors in the analysis of  
Chairman's Narrative

CASE NUMBER	ACCOUNTING UNDERGRADUATES (n=237)		BUSINESS STUDENTS (n=146)		ACCOUNTING PRACTITIONERS (n=18)	
	<u>MISCLASSIFIED</u> (%)	RANK	<u>MISCLASSIFIED</u> (%)	RANK	<u>MISCLASSIFIED</u> (%)	RANK
53	<u>94</u>	1	<u>100</u>	1	<u>100</u>	1.5
46	<u>82</u>	2	<u>84</u>	4	<u>75</u>	5.5
12	<u>82</u>	3	<u>71</u>	7	<u>75</u>	5.5
39	<u>80</u>	4	<u>77</u>	5	<u>75</u>	5.5
44	<u>75</u>	5	<u>89</u>	2	<u>100</u>	1.5
6	<u>67</u>	6	<u>86</u>	3	<u>25</u>	23.5
48	<u>52</u>	7	<u>71</u>	6	<u>50</u>	13
18	<u>52</u>	8	<u>64</u>	8	<u>50</u>	13
35	<u>46</u>	9	<u>55</u>	11	<u>50</u>	13
57	<u>36</u>	10	<u>31</u>	16	<u>25</u>	23.5
29	<u>35</u>	11	<u>31</u>	15	<u>25</u>	23.5
4	<u>33</u>	12	<u>6</u>	30	<u>25</u>	23.5
62	<u>33</u>	13	<u>58</u>	9	<u>50</u>	13
28	<u>30</u>	14	<u>32</u>	14	<u>50</u>	13
50	<u>27</u>	15	<u>14</u>	25	<u>50</u>	13
34	<u>25</u>	16	<u>23</u>	23	<u>25</u>	23.5
19	<u>24</u>	17	<u>30</u>	17	<u>75</u>	5.5
42	<u>23</u>	18	<u>29</u>	18	<u>0</u>	34
64	<u>23</u>	19	<u>58</u>	10	<u>25</u>	23.5
65	<u>23</u>	20	<u>23</u>	24	<u>50</u>	13
66	<u>22</u>	21	<u>48</u>	12	<u>75</u>	5.5
1	<u>22</u>	22	<u>24</u>	21	<u>50</u>	13
8	<u>17</u>	23	<u>23</u>	22	<u>50</u>	13
16	<u>16</u>	24	<u>25</u>	20	<u>25</u>	23.5
15	<u>13</u>	25	<u>7</u>	28	<u>25</u>	23.5
63	<u>13</u>	26	<u>7</u>	29	<u>75</u>	5.5
31	<u>10</u>	27	<u>0</u>	31	<u>25</u>	23.5
69	<u>9</u>	28	<u>0</u>	36	<u>0</u>	34
51	<u>9</u>	29	<u>33</u>	13	<u>0</u>	34
59	<u>7</u>	30	<u>28</u>	19	<u>0</u>	34
17	<u>5</u>	31	<u>0</u>	34	<u>25</u>	23.5
37	<u>4</u>	32	<u>0</u>	35	<u>25</u>	23.5
9	<u>4</u>	33	<u>8</u>	27	<u>25</u>	23.5
26	<u>2</u>	34	<u>0</u>	32	<u>0</u>	34
33	<u>0</u>	35	<u>0</u>	33	<u>0</u>	34
11	<u>0</u>	36	<u>8</u>	26	<u>0</u>	34

(Scores for Failed Cases Underlined)

(Percentage scores rounded to whole numbers, but decimal differences considered in the assignment of ranks)

APPENDIX 8.4.4 Chairman's Statement Analysis: Case Misclassifications

<u>NO. OF FAILED CASES</u>	<u>CHAIRMAN'S NARRATIVE</u>		<u>ACCOUNTING STATEMENTS</u>		<u>FINANCIAL RATIOS</u>		<u>INTEGRATED SOURCES</u>	
	<u>ERRORS</u>	<u>DEC'S</u>	<u>ERRORS</u>	<u>DEC'S</u>	<u>ERRORS</u>	<u>DEC'S</u>	<u>ERRORS</u>	<u>DEC'S</u>
8	3.65	4.35	3.45	4.55	2.83	5.17	3.62	4.38
7	2.79	4.62	2.55	4.64	2.30	5.04	2.85	4.25
6	2.48	3.52	1.92	4.26	1.48	4.61	1.84	4.25
5	2.08	3.46	1.42	3.75	2.04	3.52	1.91	3.36
4	2.56	3.81	1.56	3.41	1.20	3.60	1.36	3.36
3	1.57	3.09	0.82	2.91	1.73	3.32	0.95	3.14
2	1.64	3.17	0.33	2.33	1.24	3.05	0.95	2.59
1	1.91	2.55	1.76	2.57	2.13	2.96	1.36	2.09
0	2.52	2.52	1.95	1.96	2.39	2.39	2.11	2.10

APPENDIX 8.4.5 Mean No. of Classification Errors  
and Failed Decisions

<u>FAILED CASES</u>				<u>NON-FAILED CASES</u>					
<u>&amp; MISCLASSIFICATIONS</u>				<u>&amp; MISCLASSIFICATIONS</u>					
CASE NO.	CHMN NARR	ACC STAT	FINAN RATIO	ALL	CASE NO.	CHMN NARR	ACC STAT	FINAN RATIO	ALL
53	94	69	58	80	12	82	44	21	43
46	82	88	74	82	18	52	20	48	37
39	80	10	0	29	35	46	24	38	29
44	75	73	72	81	57	36	11	25	16
6	67	74	35	65	62	33	33	21	24
48	52	89	96	94	28	30	11	30	15
29	35	31	24	28	64	23	32	46	22
4	33	4	8	4	65	23	2	25	19
50	27	13	40	18	66	22	14	9	10
34	25	6	2	12	1	22	4	19	9
19	24	12	7	15	8	17	7	6	7
42	23	13	9	20	31	10	25	17	7
16	16	21	13	22	59	7	12	14	7
15	13	0	11	7	37	4	0	9	2
63	13	24	24	24	9	4	8	7	4
69	9	5	21	8	26	2	4	17	6
51	9	25	16	12	33	0	0	2	0
17	5	4	2	2	11	0	0	18	2

APPENDIX 8.4.6 . Distribution of % Misclassifications across All Cases

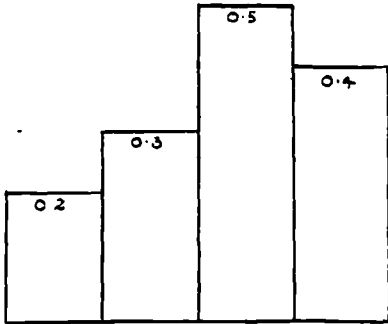

a) PROFILES

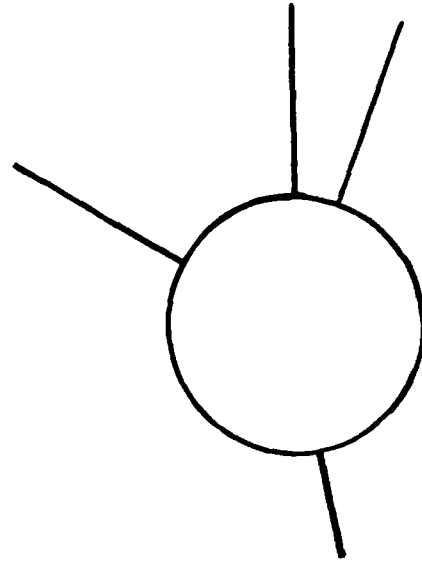

b) ANDERSON'S GLYPH

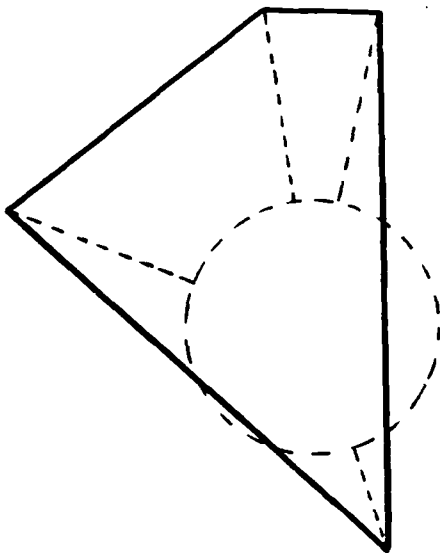

c) POLYGON

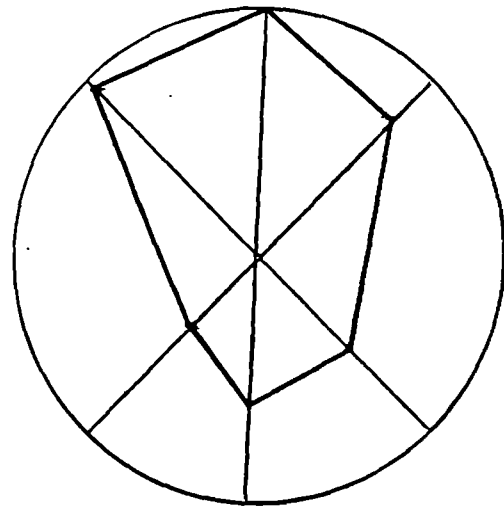

d) STARS

**APPENDIX 9.2.1 Graphical Representations**

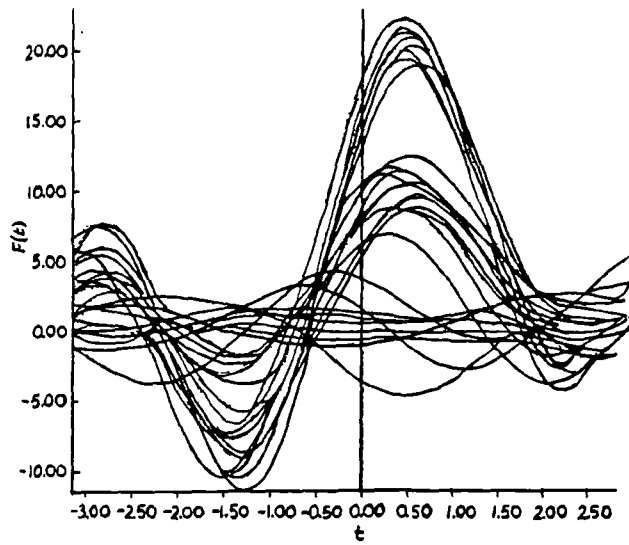

e) ANDREWS CURVES

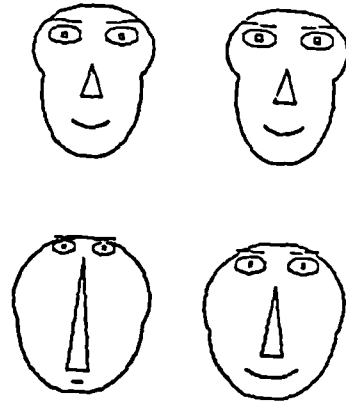

f) CHERNOFF'S SCHEMATIC FACES

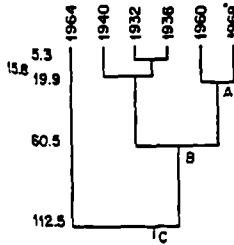

g) TREES

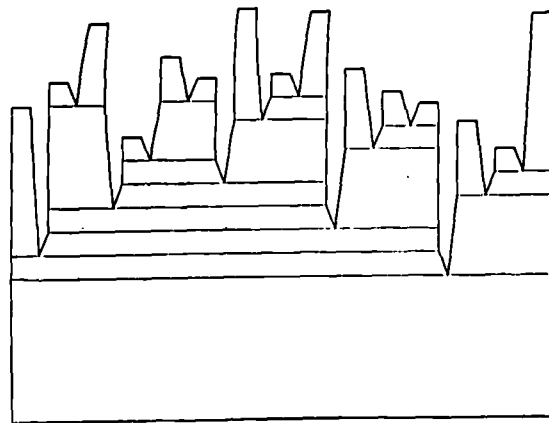
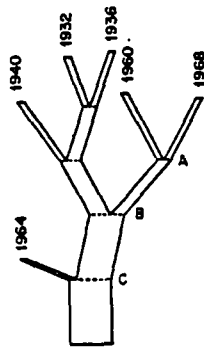

h) CASTLES

APPENDIX 9.2.1 Alternative Graphical Formats

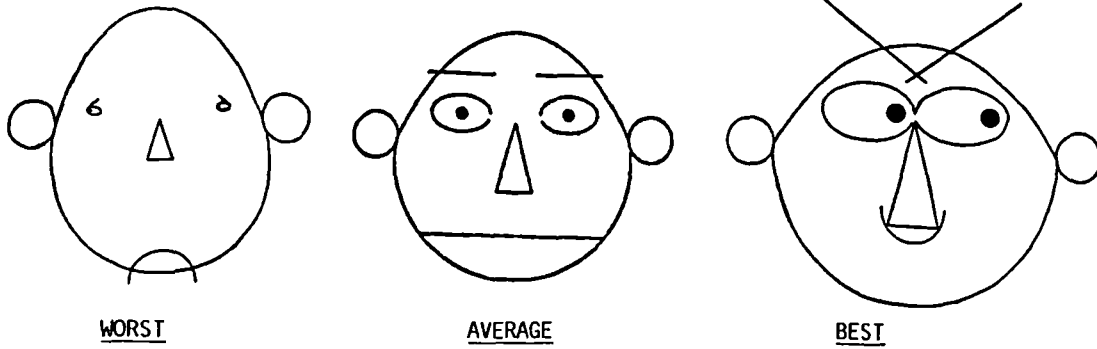

a) CHERNOFF FACES (with additions by Bruckner)

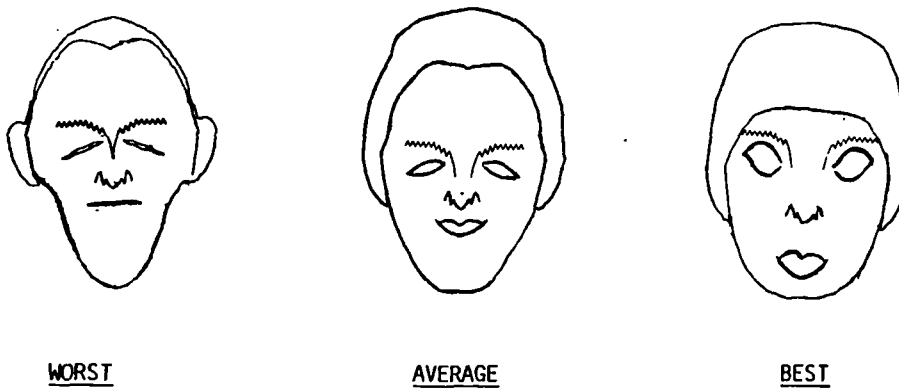

b) FRITH FACES (with additions by Everitt)

APPENDIX 9.2.2 Computer Generated Facial Portraits

CASE 5: MATTHEW BROWN PLC - PROFIT AND LOSS ACCOUNT					
	31/12/X1	31/12/X2	31/12/X3	31/12/X4	31/12/X5
Sales/Turnover	11428	15657	17278	20012	22851
Operating Expenses	9011	12514	13750	16020	18234
Operating Income	2417	3143	3528	3992	4647
Depreciation	263	375	496	547	694
Trading Profit	2149	2768	3032	3445	3953
Associated Co. Profits	0	0	0	0	0
Other Income	11	1	35	49	146
Pre-Interest Profit	2160	2769	3067	3494	4099
Interest	67	195	44	30	28
Pre-Tax Profit	2093	2574	3023	3464	4071
Tax	1101	1343	1576	1615	1444
Profit after Tax	992	1231	1447	1845	2627
Minority Interest	3	-2	1	4	5
Dividends	396	568	663	740	860
Retained Profits	593	665	783	1102	1762
	=====	=====	=====	=====	=====
Value Added	3985	5298	5852	6931	8273
Wages & Salaries	1568	2155	2324	2939	3626

CASE 5: MATTHEW BROWN PLC - BALANCE SHEET					
	31/12/X1	31/12/X2	31/12/X3	31/12/X4	31/12/X5
<u>Current Assets</u>					
Stocks & WIP	875	891	1193	1474	1804
Debtors	1486	1427	1636	1743	2035
Cash & Equivalent	163	24	51	53	124
Other	0	1409	400	1615	1485
	<u>2524</u>	<u>3751</u>	<u>3280</u>	<u>4885</u>	<u>5448</u>
<u>Current Liabilities</u>					
Creditors	2497	1647	1566	1956	3466
O/D & Short Term Loans	1101	813	355	669	179
Tax	920	1414	1398	1830	2313
Dividends & Other	279	440	494	554	649
	<u>4797</u>	<u>4314</u>	<u>3813</u>	<u>5009</u>	<u>6607</u>
Net Current Assets	-2273	-563	-533	-124	-1159
Fixed Assets	15281	15875	17149	17826	19704
Assocs. & Other	953	950	1118	1257	2189
Goodwill	0	0	0	0	0
NET CAPITAL EMPLOYED	13961	16262	17734	18959	20734
	=====	=====	=====	=====	=====
<u>Financed By -</u>					
Share Capital & Res	12160	14213	15078	17026	18853
Minority Interest	49	40	39	42	0
Long Term Loans	262	258	253	249	244
Deferred Tax Acc	1490	1751	2364	1642	1637
NET CAPITAL EMPLOYED	13961	16262	17734	18959	20734
	=====	=====	=====	=====	=====

### APPENDIX 10.3.1 Experiment 1 Materials: a) Financial Statements



**CASE 5: MATTHEW BROWN PLC - FINANCIAL RATIOS**

=====

	31/12/X1	31/12/X2	31/12/X3	31/12/X4	31/12/X5
<u>PROFIT BEFORE INTEREST &amp; TAX</u> TOTAL ASSETS	0.1152	0.1346	0.1423	0.1453	0.1499
<u>TOTAL LIABILITIES</u> NET WORTH	0.3693	0.2857	0.2326	0.2810	0.3344
<u>WORKING CAPITAL</u>	-0.1628	-0.0346	-0.0301	-0.0065	-0.0559
<u>NET CAPITAL EMPLOYED</u>					
ACID TEST	0.3438	0.3363	0.4424	0.3586	0.3268
<u>CURRENT ASSET TURNOVER</u>	4.5277	4.1741	5.2677	4.0966	4.1999
<u>VALUE ADDED</u> TOTAL ASSETS	0.2124	0.2575	0.2716	0.2892	0.3026

APPENDIX 10.3.1 Experiment 1: b) Financial Ratios

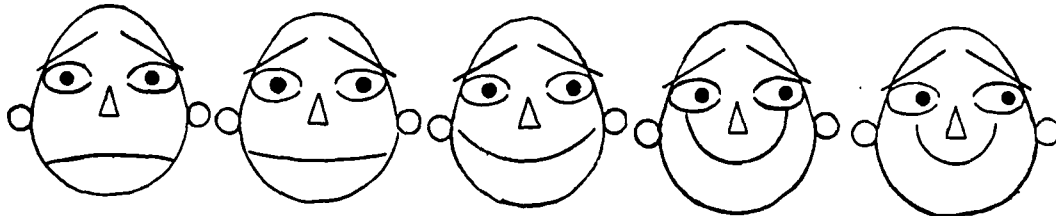

APPENDIX 10.3.1 Experiment 1: c) Facial Portrait Data

IDENTITY NUMBER	COMPANY NAME	STATUS
1	Associated Fisheries	Solvent
2	Beatson, Clark & Co	Solvent
3	Blackman and Conrad	Failed
4	Brocks Group	Failed
5	Matthew Brown	Solvent
6	Sir Joseph Causton	Solvent
7	Elson and Robbins	Solvent
8	Fairbairn Lawson	Failed
9	Thomas French	Solvent
10	General Engineering Co. (Radcliffe)	Failed
11	James Halstead	Solvent
12	Low and Bonar Group	Solvent
13	LRC International	Solvent
14	Bernard Matthews	Solvent
15	Petbow	Solvent
16	Rivington Reed	Failed
17	Sanderson, Murray and Elder	Solvent
18	Southern Constructions	Failed
19	Tecalemit	Solvent
20	United Engineering Industries	Solvent

APPENDIX 10.3.2 Experiment 1: Sample Companies

<u>CASE NUMBER</u>	<u>% MISCLASSIFICATION</u>		
<u>FAILED CASES</u>	<u>ACCOUNTING STATEMENTS</u>	<u>FINANCIAL RATIOS</u>	<u>FACIAL PROFILES</u>
3	55	57	16
4	36	38	23
8	13	15	6
10	9	6	1
16	64	68	13
18	14	15	5
<u>NON-FAILED CASES</u>			
1	10	16	65
2	8	11	1
5	21	21	2
6	13	14	2
7	3	23	1
9	4	8	0
11	5	5	6
12	4	8	14
13	14	14	26
14	7	16	1
15	59	38	67
17	44	52	41
19	5	17	1
20	8	28	4

APPENDIX 10.3.3 Experiment 1: Distribution of Misclassifications

a) ACCOUNTING VARIABLES

<u>VARIABLES</u>	<u>PROCESSING STRATEGY FAILED CASE IF:</u>	No.	<u>ERRORS OF CLASSIFICATION</u>	
			<u>FAILED WHEN HEALTHY (CASES)</u>	<u>HEALTHY WHEN FAILED (CASES)</u>
Profitability	PBIT/TA < 0	5	15,17	3,4,16
Risk	TL/NW > 1	6	1,6,11,19, 20	4
Liquidity	QA/CL < 0.5	3	5,14	16
(Profit - Risk + Liquid) < 0		5	1,6,11,19, 20	-
Profitability	PBIT/TA < Mean (0.108)	4	1,13,15,17	-
Risk	TL/NW > Mean (0.985)	7	1,6,9,11, 19,20	4
Liquidity	QA/CL < Mean(0.715)	5	5,11,14,17, 20	-
(Profit - Risk + Liquid) < Mean (-0.162)		4	1,11,19,20	-

b) FACIAL PROFILES

<u>VARIABLES</u>	<u>PROCESSING STRATEGY FAILED CASE IF:</u>	No.	<u>ERRORS OF CLASSIFICATION</u>	
			<u>FAILED WHEN HEALTHY (CASES)</u>	<u>HEALTHY WHEN FAILED (CASES)</u>
PROFITABILITY	DOWN-TURNED MOUTH	4	1,13,15,17	-
LEVERAGE	SMALL EYES	5	1,6,11,19,20	-
LIQUIDITY	PEPLEXED EYEBROWS	3	5,14,20	-
PROFITABILITY LEVERAGE	DOWN-TURNED MOUTH AND SMALL EYES	1	1	-
LEVERAGE LIQUIDITY	SMALL EYES AND PEPLEXED EYEBROWS	1	20	-
PROFITABILITY LEVERAGE LIQUIDITY	DOWN-TURNED MOUTH AND SMALL EYES AND PEPLEXED EYEBROWS	0	-	-

APPENDIX 10.3.4 Experiment 1: Misclassified Cases for Alternative Processing Strategies

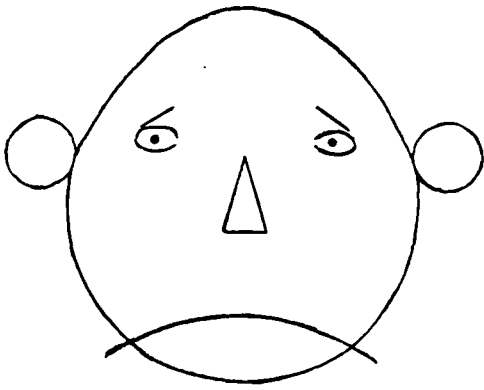

3. BLACKMAN AND CONRAD (31/1/80)

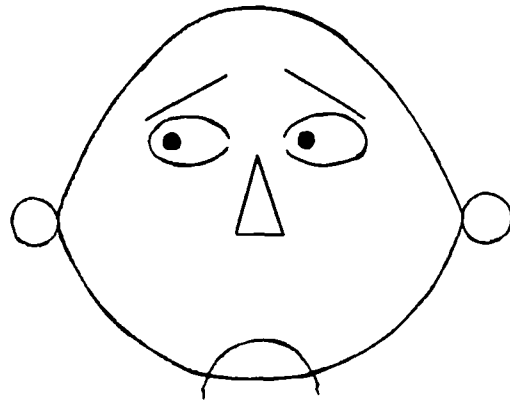

8. BROCKS GROUP (31/12/79)

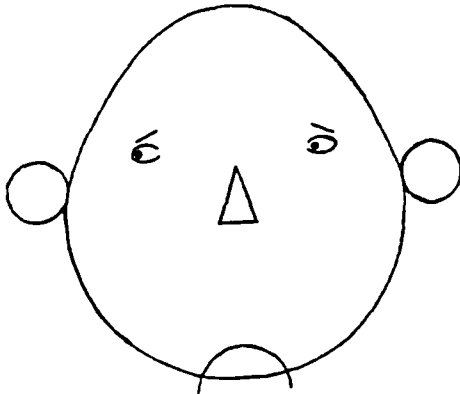

8. FAIRBAIRN LAWSON (31/12/78)

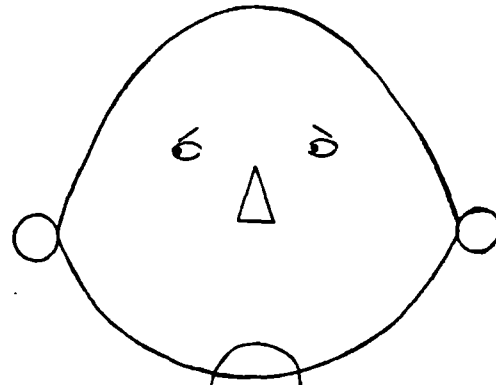

10. GENERAL ENGINEERING (RADCLIFFE)  
(31/12/78)

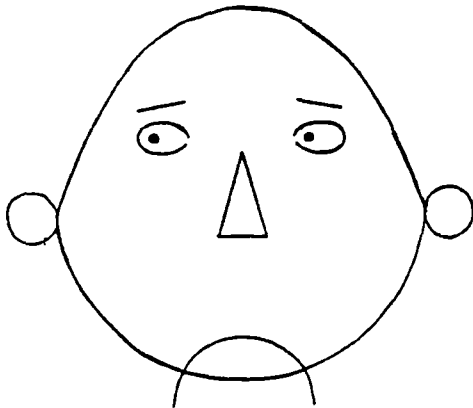

16. RIVINGTON REED (31/3/79)

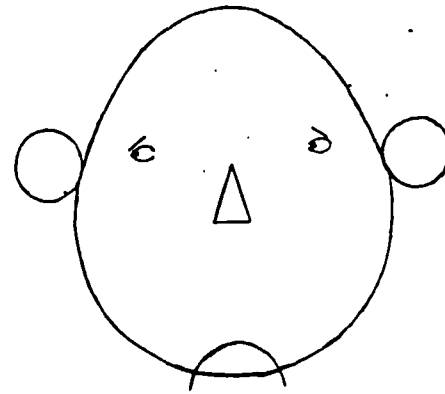

18. SOUTHERN CONSTRUCTIONS  
(31/12/78)

APPENDIX 10.3.5 Experiment 1: Facial Profiles for Failed Cases

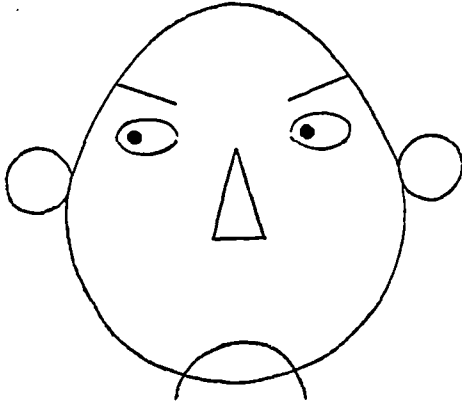

1. ASSOCIATED FISHERIES (30/9/79)

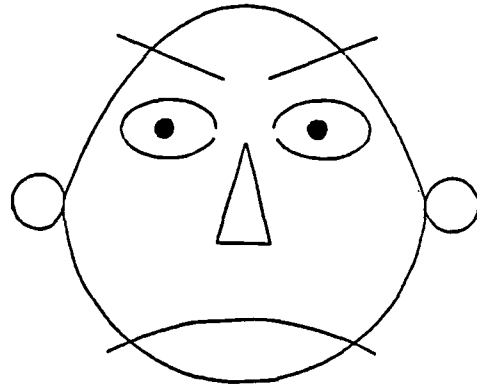

13. LRC INTERNATIONAL (31/3/79)

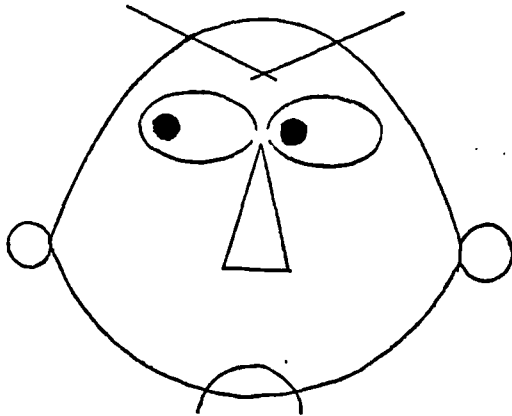

15. PETBOW HOLDINGS (31/3/80)

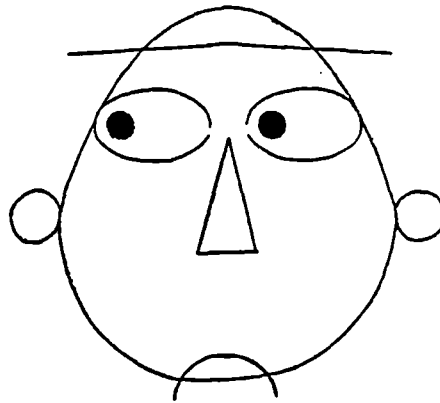

17. SANDERSON, MURRAY & ELDER (31/6/79)

APPENDIX 10.3.6 Experiment 1: Facial Profiles for Non-Failed Cases

RATIO	REPRESENTING DIMENSION OF ACCOUNTING INFORMATION	FACIAL ASSIGNMENT
<u>Profit before Interest &amp; Tax</u> Total Assets (PBIT/TA)	Profitability	Mouth Curvature Mouth Length Pupil Position
<u>Total Liabilities</u> Net Worth (TL/NW)	Financial Leverage	Eye Size Eyebrow Length
<u>Working Capital</u> Net Capital Employed (WC/NCE)	Working Capital Position	Nose Length Nose Width
<u>Quick Assets</u> Current Liabilities (QA/CL)	Liquidity	Eyebrow Angle
<u>Current Assets</u> Sales (CA/S)	Asset Turnover	Face Size
<u>Value Added</u> Total Assets (VA/TA)	Value Added	Ear Level

APPENDIX 10.3.7 Experiment 1: Assignment of Financial Variables  
to Facial Features

# ASSIGNMENT D

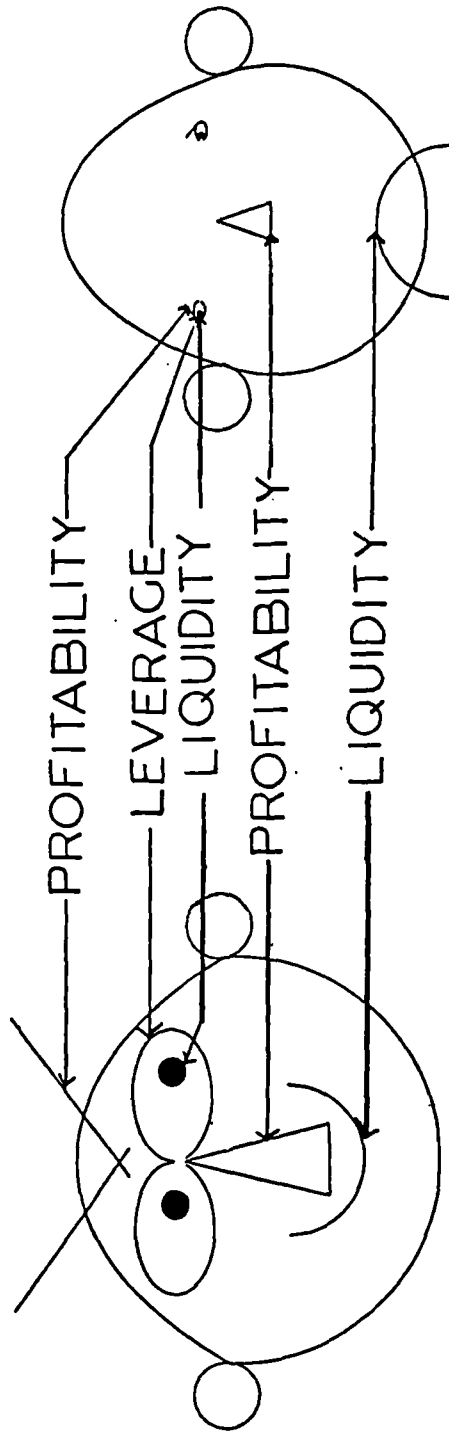

APPENDIX 10.3.8 Experiment 2: Sample Guide to the Assignment of Variables



**FACIAL FEATURE**

**ALTERNATIVE ASSIGNMENTS**

	A	B	C	D	E	F
MOUTH CURVATURE	PROFIT- ABILITY	PROFIT- ABILITY	LIQUID- ITY	LIQUID- ITY	FINANCIAL RISK	FINANCIAL RISK
MOUTH LENGTH						
EYE SIZE	FINAN- CIAL RISK	LIQUID- ITY	PROFIT- ABILITY	FINAN- CIAL RISK	PROFIT- ABILITY	LIQUID- ITY
PUPIL POSITION						
EYEBROW ANGLE	LIQUID- ITY	FINAN- CIAL RISK	FINAN- CIAL RISK	PROFIT- ABILITY	LIQUID- ITY	PROFIT- ABILITY
NOSE LENGTH						

a) FACIAL FEATURE - FINANCIAL VARIABLE COMBINATIONS

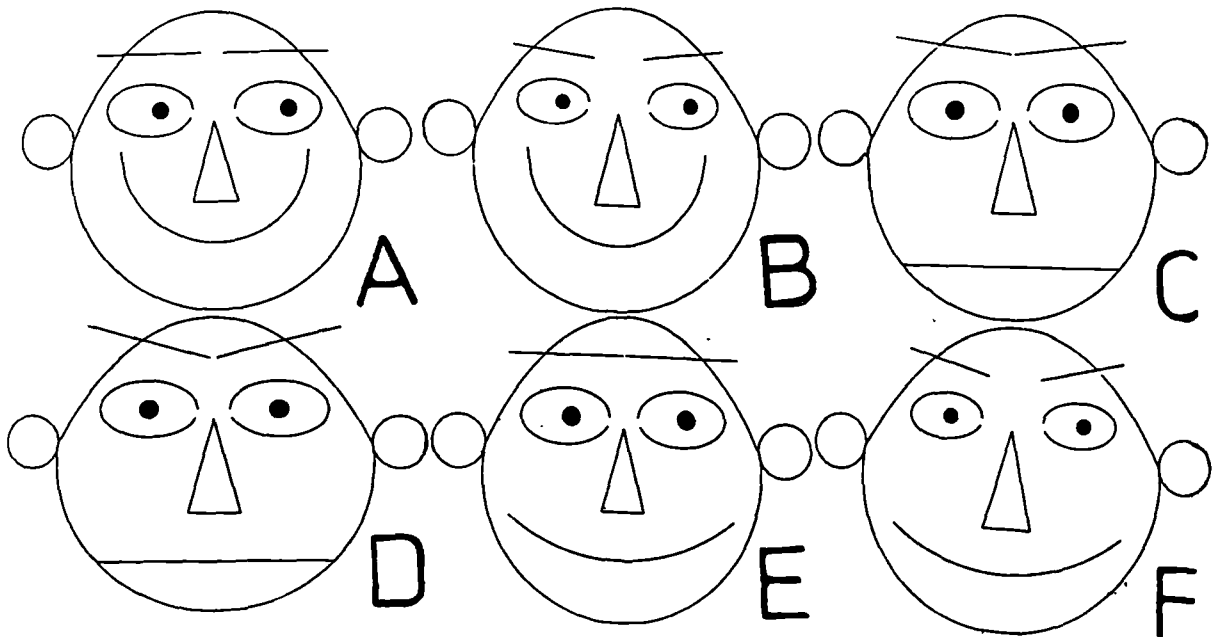

b) Effect of Alternative Assignments on a Single Case: Case 24 - DEWHIRST

APPENDIX 10.3.9 Experiment 2: Alternative Variable Assignments

## FINANCIAL GRAPHICS ANALYSIS

The attached package contains facial portraits computer-generated from financial ratios extracted from the Profit and Loss Account and Balance Sheet taken from TEN Annual Company Report and Accounts.

These ten portraits (or 'pictics') have been constructed and selected from a sample of SEVENTY such portraits, comprising a mixture of healthy companies and failed companies.

In each instance, three ratios have been calculated:-

$\frac{\text{Profit Before Interest and Tax}}{\text{Total Assets}}$  to represent Profitability

$\frac{\text{Total Liabilities}}{\text{Net Worth}}$  to represent Financial Leverage

$\frac{\text{Quick Assets}}{\text{Current Liabilities}}$  to represent Liquidity

Each ratio value has been mapped onto facial characteristics in accordance with the attached assignment, using the mean and standard deviation of the ratio values to provide the range for the shape and length of features.

It is possible that your sample could contain the facial portraits of ten failures and none from healthy companies, or vice versa. But it is much more likely that you will have a mixture of healthy and failed enterprises, although the proportions of failed/healthy will vary among respondents.

## THE TASK

Use your skill and experience to assess the financial profile provided and decide which, if any, of your facial portraits are those of failed companies.

NUMBER	FAILED COMPANY	HEALTHY COMPANY
9D		
22D		
26D		
27D		
30D		
31D		
34D		
38D		
49D		
51D		

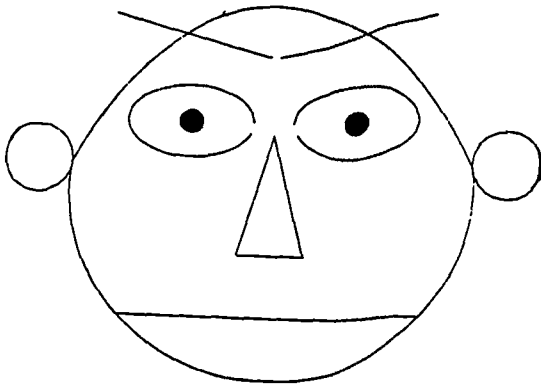

9D

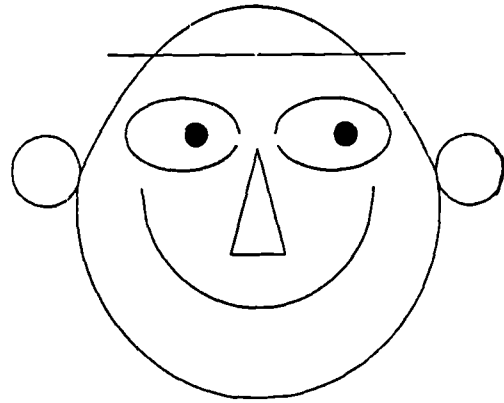

30D

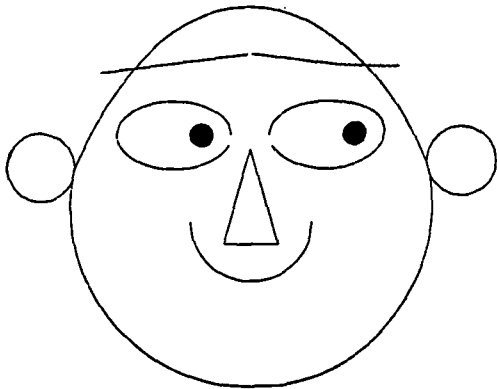

38D

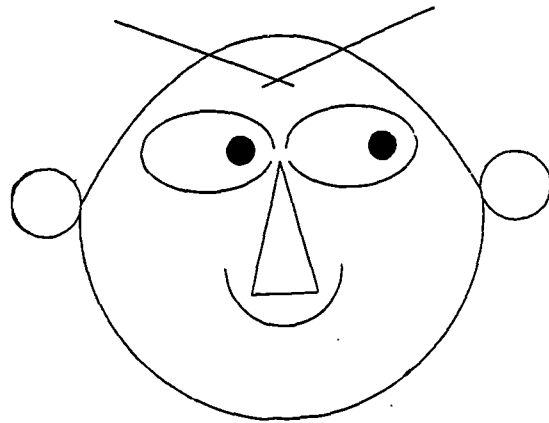

51D

APPENDIX 10.3.10 Experiment 2: Facial Profile Information



MEAN NUMBER OF CLASSIFICATION ERRORS PER RESPONDENT

NO. OF FAILED CASES PER SET	ACCOUNTING STATEMENTS		FINANCIAL RATIOS		A		B		C		D		E		F									
	Error Type		Error Type		Error Type		Error Type		Error Type		Error Type		Error Type		Error Type									
	II	I Tot	II	I Tot	II	I Tot	II	I Tot	II	I Tot	II	I Tot	II	I Tot	II	I Tot								
1	1.70	0.10	1.80	0.15	1.45	1.5	0.1	1.6	1.4	0.2	1.6	1.7	0.0	1.7	1.3	0.2	1.5	1.6	0.3	1.9	1.2	0.5	1.7	
3	1.85	0.55	2.40	1.45	0.40	1.85	1.3	0.2	1.5	1.6	0.3	1.9	1.3	0.6	1.9	0.6	0.7	1.3	1.6	0.0	1.6	0.7	0.1	0.8
5	1.05	0.85	1.90	1.40	1.35	2.75	0.7	0.5	1.2	1.1	0.7	1.8	1.0	0.7	1.7	0.3	0.3	0.6	0.8	0.9	1.7	0.6	1.1	1.7
7	0.10	2.40	2.50	0.35	2.60	2.95	0.6	2.9	3.5	0.3	2.8	3.1	0.2	1.6	1.8	0.3	2.1	2.4	0.3	2.8	3.1	0.3	2.9	3.2
9	0.00	3.95	3.95	0.10	4.70	4.80	0.5	3.9	4.4	0.2	4.0	4.2	0.0	3.8	3.8	0.0	4.2	4.2	0.1	3.1	3.2	0.2	4.3	4.5
OVERALL	0.94	1.57		0.92	1.84		0.92	1.52		0.92	1.60		0.84	1.34		0.50	1.50		0.88	1.42		0.60	1.78	

TYPE II ERROR: COMPANY CLASSIFIED AS FAILED WHEN IN FACT STILL HEALTHY  
 TYPE I ERROR: COMPANY CLASSIFIED AS HEALTHY WHEN IN FACT FAILED

APPENDIX 10.3.12 Experiment 2: Effects of Alternative Failure Base Rates

CASE No	ACCOUNTING STATEMENTS	FINANCIAL RATIOS	ALTERNATIVE FACIAL ASSIGNMENTS					
	(%)		(%)	A (%)	B (%)	C (%)	D (%)	E (%)
48	83	83	67	80	80	100	20	33
44	80	75	60	40	30	50	40	50
46	65	65	0	25	35	20	40	50
6	47	73	44	14	73	60	40	20
28	42	17	15	15	15	30	30	5
50	41	41	0	7	13	0	43	30
51	40	25	70	50	25	20	20	60
53	40	40	60	80	60	40	80	0
35	40	30	7	34	44	7	40	0
26	35	40	20	30	50	20	50	80
21	28	30	65	60	15	40	65	65
57	28	42	48	20	40	28	28	16
1	24	16	28	20	20	8	8	12
18	20	17	20	28	40	7	28	20
66	17	10	0	6	0	6	0	0
9	15	5	10	30	10	0	10	0
62	13	30	7	26	7	7	7	0
7	12	18	50	40	5	15	45	60
29	10	0	0	0	0	0	0	10
5	10	8	12	0	0	4	0	8
56	10	7	0	0	0	0	0	0
27	8	32	40	70	60	60	15	55
41	8	10	0	0	5	5	5	0
25	8	8	5	10	0	0	0	5
40	8	25	65	35	15	20	45	45
49	7	13	14	49	35	35	14	42
37	7	3	14	6	6	0	6	6
45	5	10	0	0	0	0	10	0
24	5	5	0	0	0	0	0	0
69	0	10	0	0	0	0	0	0

APPENDIX 10.3.13 Experiment 2: Misclassification with Alternative Instruments

<u>ALTERNATIVE PROCESSING STRATEGIES</u>	<u>FINANCIAL RATIOS</u>	<u>ALTERNATIVE FACIAL ASSIGNMENTS</u>				
		A	B	C	D	E
Failure Classification if:						
1. Profitability (PBII/TA) < 0	5,6,29,44,46 48,50,53,69	18,35,46,48 50,53,57	18,35,46,48 50,53,57	18,35,46,48 50,53,57	26,27,28,35 57,62,66	26,28,51 26,28,51
2. Profitability (PBII/TA) < Mean (0.07)	10,35,46,48 50,53,57	18,35,46,48 50,53,57	18,35,46,48 50,53,57	18,35,46,48 50,53,57	26,27,28,35 57,62,66	26,28,51 26,28,51
3. Financial Risk (TL/NM) < Mean (0.82)	26,28,51	26,28,51	26,28,51	26,28,51	26,28,51	26,28,51
4. Liquidity (QV/CL) < Mean (1.12)	26,27,28,35, 57,62,66	26,28,66	26,28,66	26,28,66	26,28,66	26,28,66
5. [PBII/TA - TL/NM + QV/CL] < 0	26,28,66	26,28,66	26,28,66	26,28,66	26,28,66	26,28,66
6. [PBII/TA - TL/NM + QV/CL] < Mean (-0.23)	26,28	26,28	26,28	26,28	26,28	26,28
7. Down-Turned Mouth		18,35,46,48 50,53,57	18,35,46,48 50,53,57	18,35,46,48 50,53,57	26,27,28,35 57,62,66	26,28,51 26,28,51
8. Small Eyes		26,28,51	26,27,28,35 57,62,66	18,35,46,48 50,53,57	26,28,51	18,35,46,48 50,53,57
9. Perplexed Eyebrows		26,27,28,35 57,62,66	26,28,51	26,28,51	18,35,46,48 50,53,57	26,27,28,35 57,62,66

APPENDIX 10.3.14 Experiment 2: Misclassifications resulting from Alternative Classification Strategies

## BIBLIOGRAPHY



- AMERICAN ACCOUNTING ASSOCIATION (AAA) "A Statement of Basic Accounting Theory"  
COMMITTEE TO PREPARE A STATEMENT OF ACCOUNTING THEORY (1966)
- AUSTRALIAN ACCOUNTING RESEARCH FOUNDATION (AARF) "Objectives and Concepts of Financial Statements"  
ARS No 3 MELBOURNE (1972)
- AARF "Proposed Statements of Accounting Concepts: Qualitative Characteristics of Financial Information" Exposure Draft 42B (December 1987)
- ADELBERG A H "Narrative disclosures contained in Financial Reports: Means of communication or manipulation"  
ACCOUNTING AND BUSINESS RESEARCH (Summer 1979) (a):179-90
- ADELBERG A H "A methodology for Measuring the Understandability of Financial Report Messages"  
JOURNAL OF ACCOUNTING RESEARCH (Autumn 1979) (b):565-592
- ADELBERG AH & FARRELLY GE "Measuring the Meaning of Financial Statement Terminology: A Psycholinguistics Approach"  
ACCOUNTING AND FINANCE Vol.29 (May 1989):33-59
- ADELBERG A H & RAZEK J R "The Cloze Procedure: A Methodology for Determining the Understandability of Accounting Textbooks"  
THE ACCOUNTING REVIEW VOL. 59 NO. 1 (January 1984):109-122

- AMERICAN INSTITUTE OF  
CERTIFIED PUBLIC ACCOUNTANTS  
(AICPA)
- AICPA
- ALTMAN E I, HALDEMAN RG  
& NARAYANAN P
- ALTMAN E I
- ANDERSON E
- ANDERSON J
- ANDERSON N H & SHANTEAU J C
- ANDERSON R H
- "A Tentative Set of Broad Accounting Principles for Business Enterprises" (1962)
- "Objectives of Financial Statements" REPORT OF THE ACCOUNTING OBJECTIVES STUDY GROUP (CHAIRMAN R M TRUEBLOOD) (1973)
- "Zeta Analysis: A New Model to Identify Bankruptcy Risk of Corporations" JOURNAL OF BANKING AND FINANCE (June 1977):29-54
- "Financial Ratios, discriminant analysis and the prediction of corporation bankruptcy" JOURNAL OF FINANCE 23 (1968):589-609
- "A Semigraphical Method for the Analysis of Complex Problems" TECHNOMETRICS 2 No 3 (August 1960):387-91
- "Lix & Rix: Variations on a Little-known Readability Index" JOURNAL OF READING (March 1983):490-496
- "Information integration in Risky Decision Making" JOURNAL OF EXPERIMENTAL PSYCHOLOGY Vol 84 No 3 (1970):441-451
- "The Usefulness of Annual Reports to Australian Investors" PAPER PRESENTED TO AAANZ CONFERENCE, UNIVERSITY OF MELBOURNE (1979)

- ANDREWS D F "Plots of High Dimensional Data"  
BIOMETRICS 28 (1972):125-136
- ANTON H R "Funds Statement Practices in the  
United States and Canada"  
THE ACCOUNTING REVIEW (October  
1954):620-27
- AQUINO M R "The Validity of the Miller-Coleman  
Readability Scale"  
READING RESEARCH QUARTERLY  
(Spring 1969) Vol. 4:342-357
- ARGENTI J "Corporate Collapse; The Causes and  
Symptoms"  
(MCGRAW-HILL) LONDON (1976)
- ASHTON R H "The Robustness of Linear Models for  
Decision-Making"  
OMEGA Vol 4 No 5 (1976):609-615
- ASHTON R H "Integrating Research and Teaching  
in Auditing: Fifteen Cases on  
Judgement and Decision Making"  
THE ACCOUNTING REVIEW Vol LIX No 1  
(January 1984):78-97
- ASHTON R H & KRAMER S S "Students as Surrogates in Behavioural  
Accounting Research: Some Evidence"  
JOURNAL OF ACCOUNTING RESEARCH  
Vol 18 No 1 (Spring 1980):1-15
- BAILEY W T "An Appraisal of Research Designs  
used to Investigate the Information  
Content of Audit Reports"  
VOL LVII No 1 (January 1982):141-146

- BAILEY K E III, BYLINSKI J H &  
SHIELDS M D "Effects of Audit Report Wording  
Changes on the Perceived Message"  
JOURNAL OF ACCOUNTING RESEARCH  
(Autumn 1983):355-370
- BAKER F B "Information Retrieval based upon  
Latent Class Analysis"  
JOURNAL OF THE ASSOCIATION OF  
COMPUTER MACHINERY (1962) Vol 9 No  
4:512-521
- BALL R & BROWN P "An Empirical Evaluation of  
Accounting Income Numbers"  
JOURNAL OF ACCOUNTING RESEARCH  
(Autumn 1968):159-178
- BALL R, BROWN P & FINN F J "Published Investment  
Recommendations and Share Market  
Efficiency"  
AUSTRALIAN GRADUATE SCHOOL OF  
MANAGEMENT, UNIVERSITY OF NSW  
(NOVEMBER 1977)
- BALL C A & TSCHOEGL A E "The decision to establish a foreign  
branch bank or subsidiary: and  
aplication of binary classification  
procedures"  
JOURNAL OF FINANCIAL AND  
QUANTITATIVE ANALYSIS 17  
(1982):411-424
- BALL R, WALKER R G &  
WHITTRED G P "Audit Qualifications and Share  
Prices"  
ABACUS (June 1979):23-34
- BANZ R W "The Relationship between return and  
Market Value of Common Stock"  
JOURNAL OF FINANCIAL ECONOMICS 9  
(1981):3-18

- BARRIFF M L & LUSK E J  
"Cognitive and personality tests for the Design of Management Information Systems"  
MANAGEMENT SCIENCE Vol 23 No 8  
(1977):820-9
- BARRON M J  
"What we know about Schematic Faces"  
WORKING PAPER, LONDON BUSINESS SCHOOL (1984)
- BARTOO R K  
"The Effect of Cumulative Context upon Cloze Task Performance of Tenth Graders" JOURNAL OF EDUCATIONAL MEASUREMENT (1975):229-255
- BASU S  
"The Relationship between Earnings' Yield, Market Value and Return for NYSE Common Stocks: Further Evidence"  
JOURNAL OF FINANCIAL ECONOMICS  
(June 1983):129-156
- BEAVER W H  
"The Information Content of Annual Earnings Announcements"  
EMPIRICAL RESEARCH IN ACCOUNTING: SELECTED STUDIES Supplement to JOURNAL OF ACCOUNTING RESEARCH  
(1968):67-92
- BEDFORD N M  
"Extension in Accounting Disclosure"  
NEW YORK (1973)
- BEHLING O, GIFFORD W E & TOLLIVER J M  
"Effects of Grouping Information on Decision Making under Risk"  
DECISION SCIENCES Vol 11 No 2 (April 1980):272-283

- BELKAOUI A "Linguistic Relativity in Accounting"  
ACCOUNTING ORGANISATIONS AND  
SOCIETY Vol 3 No 2 (1978):97-104
- BELKAOUI A & COUSINEAU A "Accounting Information,  
Nonaccounting Information and  
Common Stock Perception"  
JOURNAL OF BUSINESS (July 1977):334-  
343
- BELL J "The Effect of Presentation form on  
the use of Information in Annual  
Reports"  
MANAGEMENT SCIENCE Vol 30 No 2  
February (1984a):169-185
- BELL J "The Effect of Presentation Form on  
Judgement Confidence in Performance  
Evaluation"  
JOURNAL OF BUSINESS FINANCE AND  
ACCOUNTING 11(3) Autumn  
(1984b):327-346
- BERELSON B "Content Analysis in Communications  
Research"  
(FREE PRESS), LONDON (1952)
- BETTMAN J R & KAKKAR P "Effects of Information Presentation  
Format on Consumer Information  
Acquisition"  
JOURNAL OF CONSUMER RESEARCH  
(March 1977):233-40
- BIERI J "Cognitive Structures in Personality"  
in H M SCHRODER AND P SUEDFELD (ed)  
"Personality Theory and Information  
Processing"  
NEW YORK (1970)

- BJORNSSON C H "Readability of Newspapers in 11 Languages"  
READING RESEARCH QUARTERLY  
(Summer 1983):480-497
- BORMUTH J R "Cloze Test Readability: Criterion Reference Scores"  
JOURNAL OF EDUCATIONAL MEASUREMENT Vol 5 No 3 (Fall 1968):189-196
- BOUWMAN M J "Expert v Novice Decision Making in Accounting: A Summary"  
ACCOUNTING, ORGANISATIONS AND SOCIETY Vol 9 No 3 (1984):325-27
- BOWMAN E H "Consistency and Optimality in Managerial Decision-making"  
MANAGEMENT SCIENCE 9 (January 1963):310-321
- BOWMAN E H "Content Analysis of Annual Reports for Corporate Strategy and Risk"  
INTERFACES 14 (Jan-Feb 1984):61-71
- BRADSHAW J L "The Information conveyed by varying the dimensions of features in human outline faces"  
PERCEPTION AND PSYCHOPHYSICS 6 (1969):5-9
- BRADSHAW J L & WALLACE G "Models for the processing and identification of faces"  
PERCEPTION AND PSYCHOPHYSICS Vol 9 (5) (1971):443-8
- BRAINE L G "Age Changes in the mode of perceiving geometric forms"  
PSYCHONOMIC SCIENCE 2 (1965):155-6

- BRUCE V "Recognising Faces"  
(LAWRENCE ERLBAUM) LONDON (1988)
- BRUCKNER L A "On Chernoff Faces" in P C C WANG (ed)  
"Graphical Representation of  
Multivariate Data" (1978)
- BRUNER J S & TAGIURI R "The Perception of People" in G  
LINDZEY (ed.) "Handbook of Social  
Psychology" Vol II (Addison-Wesley)  
Cambridge, Mass. (1954)
- BUGENTAL D B, HENKER B  
& WHALEN C K "Attributional antecedents of verbal  
and vocal assertiveness"  
JOURNAL OF PERSONALITY AND SOCIAL  
PSYCHOLOGY VOL 34 No 3 (1976):405-  
411
- BURROWS J F "Computation into Criticism: A Study of  
Jane Austen's Novels and Experiment  
in Method"  
(CLARENDON PRESS) OXFORD (1986)
- BUZBY S L "The Nature of Adequate Disclosure"  
JOURNAL OF ACCOUNTANCY April  
(1974a)
- BUZBY S L "Selected Items of Information and  
their Disclosure in Annual Reports"  
ACCOUNTING REVIEW July (1974b):423-  
435
- CANADIAN INSTITUTE OF  
CHARTERED ACCOUNTANTS (CICA) "Corporate Reporting: Its Future  
Evolution" (1980)
- CARROLL J D & CHANG J J "Analysis of Individual Differences in  
Multi-Dimensional Scaling via an N-  
Way generalisation of 'Eckart-Young'  
Decomposition"  
PSYCHOMETRICA (Sept 1970):283-319



- CASEY C J "Variations in Accounting Information Load: The Effect on Loan Officers' Predictions of Bankruptcy" THE ACCOUNTING REVIEW (January 1980):36-49
- CASEY C J "Prior probability disclosure and Loan Officers' judgements: Some evidence of Impact" JOURNAL OF ACCOUNTING RESEARCH (Spring 1983):300-307
- CASEY C J & SELLING T I "The Effect of Task Predictability and Prior Probability Disclosure on Judgement Quality and Confidence" THE ACCOUNTING REVIEW Vol LXI No 2 (April 1986):302-317
- CHAMBERS A E & PENMAN S H "Timeliness of Reporting and the Stock Price Reaction to Earnings Announcements" JOURNAL OF ACCOUNTING RESEARCH (Spring 1984):21-47
- CHAMBERS R J "The Role of Information Systems in Decision-Making" MANAGEMENT TECHNOLOGY (June 1964)
- CHAMBERS R J "Usefulness - the Vanishing Premise in Accounting Standard Setting" ABACUS (December 1979):71-92
- CHANG L S & MOST K S "Investor Uses of Financial Statements: An Empirical Study" SINGAPORE ACCOUNTANT VOL 12 (1977):83-91

- CHANG L S, MOST K S &  
BRAIN C W "The Utility of Annual Reports: An  
International Study"  
JOURNAL OF INTERNATIONAL BUSINESS  
STUDIES (Spring/Summer 1983):63-84
- CHERNOFF H "The Use of Faces to represent points  
in  $n$  - dimensional space graphically"  
TECHNICAL REPORT No 71, DEPT. OF  
STATISTICS, STANFORD UNIVERSITY  
(1971)
- CHERNOFF H "Using Faces to represent points in  $k$  -  
dimensional space graphically"  
JOURNAL OF THE AMERICAN  
STATISTICAL ASSOCIATION 68  
(1973):361-68
- CHERNOFF H "Graphical Representations as a  
Discipline" in P C C WANG (ed)  
"Graphical Representation of  
Multivariate Data" (1978)
- CHERNOFF H & RIZVI H M "Effect on Classification Error of  
Random Permutations of features in  
representing multivariate data by  
Faces" JOURNAL OF THE AMERICAN  
STATISTICAL ASSOCIATION 70  
(1975):548-54
- CHERRY C "On Human Communication"  
CAMBRIDGE M I T (1966)
- CHOW C W "The Demand for External Auditing:  
Size, Debt and Ownership Influences"  
ACCOUNTING REVIEW 57 (April  
1982):272-291

- CLEVELAND W S & MCGILL R "Graphical Perception: The Visual Decoding of Quantitative Information on Graphical Displays of Data" JOURNAL OF THE ROYAL STATISTICAL SOCIETY (Series A) 150 Part 3 (1987):192-229
- COHEN J, DEARNLY E J & HANSEL C E M "A Question Study of Meaning" BRITISH JOURNAL OF EDUCATIONAL PSYCHOLOGY (1958) 28:141-148
- COURTIS J K "An Investigation into Annual Report Readability and Corporate Risk-Return relationships" ACCOUNTING AND BUSINESS RESEARCH (Autumn 1986):285-294
- COURTIS J K "Relationship between timeliness in corporate reporting and corporate attributes" ACCOUNTING AND BUSINESS RESEARCH 6 (Winter 1976):45-46
- CRASWELL A T "Accounting Reports ... Do They Communicate?" THE CHARTERED ACCOUNTANT IN AUSTRALIA VOL 40 No 6 (June 1969):4-10
- CROUCH W W, BRINDLE B & FRYE J K "The Syracuse Person Perception Test: A Measure of Responsiveness to Facial and Verbal Cues" in P C C WANG (ed) "Graphical Representation of Multivariate Data" (1978)
- CUCELOGLU D M "Perception of facial expressions in three cultures" ERGONOMICS (1970):93-100

- DAVIES P M & COXON A P M "The MDS (X) Series of  
Multidimensional Scaling Programs"  
INTER-UNIVERSITY RESEARCH  
COUNCIL SERIES (January 1981) Report  
No 51
- DAVISON A & KANTOR R N "On the Failure of Readability Formulas  
to Define Readable Texts: A Case Study  
from Adaptations"  
READING RESEARCH QUARTERLY No 2  
(1982):187-209
- DEAKIN E B "Distribution of Financial Ratios: Some  
empirical evidence"  
ACCOUNTING REVIEW 51 (January  
1976):90-96
- DIAMOND R & CAREY S "Why faces are and are not special: An  
effect of expertise"  
JOURNAL OF EXPERIMENTAL  
PSYCHOLOGY: GENERAL 115 (1986):107-  
117
- DIELMAN T E & "An Examination of investor  
OPPENHEIMER H R Behaviour During periods of Large  
Dividend Changes"  
JOURNAL OF FINANCIAL AND  
QUANTITATIVE ANALYSIS (June  
1984):197-216
- DIMSON E & MARSH P R "Event study methodologies and the  
Size Effect"  
JOURNAL OF FINANCIAL ECONOMICS 17  
(1986):113-142
- DUPREE J M "User's Preferences for Descriptive v.  
Technical Accounting Terms"  
ACCOUNTING AND BUSINESS RESEARCH  
(Autumn 1985):281-290

- DYCKMAN T R, DOWNES D H & MAGEE R P "Efficient Capital Markets and Accounting: A Critical Analysis" NEW YORK (1975)
- DYER J C & MCHUGH A J "The Timeliness of the Australian Annual Report" JOURNAL OF ACCOUNTING RESEARCH 13 (Autumn 1975):204-219
- EFRON B "The Efficiency of Logistic Regression compared to normal Discriminant Analysis" JOURNAL OF THE AMERICAN STATISTICAL ASSOCIATION 70 (1975):892-898
- EGETH H E "Parallel versus serial processes in multidimensional stimulus discrimination" PERCEPTION AND PSYCHOPHYSICS 1 (1966):245-52
- EHRENBERG A S C "Rudiments of Numeracy" JOURNAL OF THE ROYAL STATISTICAL SOCIETY (Series A) 140 part 3 (1977):277-297
- EINHORN H & HOGARTH R "Behavioural Decision Theory: Processes of Judgement and Choice" ANNUAL REVIEW OF PSYCHOLOGY (1981):53-88
- EKMAN P (ed) "Darwin and Facial Expression" NEW YORK (1973)
- EKMAN P, FRIESEN W V & ELLSWORTH P "Emotion in the Human Face" (PERGAMON PRESS) NEW YORK (1972)

- ELLIS H D "Recognising Faces"  
BRITISH JOURNAL OF PSYCHOLOGY 66 4  
(November 1975):409-426
- ELLIS H D, SHEPHERD J &  
DAVIES G "Use of the Photofit technique for  
recalling faces"  
BRITISH JOURNAL OF PSYCHOLOGY 66  
(February 1975):29-37
- ERICKSON L & HANSEN L H "Performance on Cloze passages in and  
out of context"  
JOURNAL OF EDUCATIONAL  
MEASUREMENT (1974)
- ERTEL S "Dogmatism: an approach to  
personality" in A DIECHSEL AND K  
HOLSENSCHECK (eds) "Maschinelle  
Inhaltsanalyse, Materialien I"  
HAMBURG (1976):34-44
- EUSKE K J & MATTHEWS W M "The Use of the Integrative Complexity  
of the President's Letter in the Annual  
Report as an Indicator of Impending  
Bankruptcy"  
PAPER PRESENTED TO THE  
INTERNATIONAL SYMPOSIUM ON  
FORECASTING, LONDON BUSINESS  
SCHOOL (July 1984)
- EVERITT B S "Graphical Techniques for  
Multivariate Data"  
(HEINEMANN) LONDON (1978)
- FAMA E F "Efficient Capital Markets: A Review of  
Theory and Empirical Work"  
THE JOURNAL OF FINANCE (May  
1970):383-417

- FINANCIAL ACCOUNTING  
STANDARDS BOARD (FASB) "Statement of Financial Accounting  
Concepts No 2: Qualitative  
Characteristics of Accounting  
Information" (1980):
- FIRTH M "A Study of the Consensus of the  
Perceived Importance of Disclosure of  
Individual Items in Corporate Annual  
Reports"  
INTERNATIONAL JOURNAL OF  
ACCOUNTING (Fall 1978):57-70
- FIRTH M "The Disclosure of Information by  
Companies"  
OMEGA Vol 7 No 2 (1979):129-135
- FIRTH M "The Relative Information Content of  
the Release of Financial Results Data  
by Firms"  
JOURNAL OF ACCOUNTING RESEARCH 19  
(1981):521-529
- FLESCH R "The Art of Readable Writing"  
(HARPER & ROW) NEW YORK (1974):
- FLURY B & RIEDWYL H "Graphical Representation of  
Multivariate Data by Means of  
Asymmetrical Faces"  
JOURNAL OF THE AMERICAN  
STATISTICAL ASSOCIATION Vol 76 No  
376 (December 1981):757-65
- FOSTER G "Briloff and the Capital Market:  
Further Evidence"  
WORKING PAPER, STANFORD  
UNIVERSITY (1985):
- FOSTER G "Financial Statement Analysis"  
(PRENTICE HALL) NEW JERSEY (1986):

- FOSTER III T W, JENKINS D R  
& VICKREY D W
- "The Incremental information content  
of the annual report"  
ACCOUNTING AND BUSINESS RESEARCH  
(Spring 1986):91-98
- FRAZIER K B, INGRAM R W &  
TENNYSON B M
- "A Methodology for the Analysis of  
Narrative Accounting Disclosures"  
JOURNAL OF ACCOUNTING RESEARCH  
Vol 22 No 1 (Spring 1984):318-331
- FRIEDMAN M P, REED S K &  
CARTERETTE E C
- "Feature saliency and recognition  
memory for schematic faces"  
PERCEPTION AND PSYCHOPHYSICS 10  
(1971):47-50
- FROIS-WITTMAN J
- "The Judgement of Facial Expression"  
JOURNAL OF EXPERIMENTAL  
PSYCHOLOGY 13 (1930):113-151
- GALLAGHER C A
- "Perceptions of the Value of a  
Management Information System"  
ACADEMY OF MANAGEMENT JOURNAL  
Vol 17 No 1 (1974):46-55
- GALPER R E & HOCHBERG J
- "Recognition memory for photographs  
of faces"  
AMERICAN JOURNAL OF PSYCHOLOGY  
Vol 84 No 3 (1971):351-4
- GILLING D M
- "Timeliness in Corporate Reporting;  
Some further comment"  
ACCOUNTING AND BUSINESS RESEARCH  
Vol 8 (Winter 1977):34-6
- GOLDBERG L R
- "Man Versus Model of Man: A Rationale  
plus some evidence, for a method of  
improving on clinical inferences"  
PSYCHOLOGICAL BULLETIN 73 (June  
1970):422-32



- GOLDSTEIN A G & CHANCE J "Visual recognition memory for complex configurations"  
PERCEPTION AND PSYCHOPHYSICS 9 (1971):237-41
- GOLDSTEIN AG & MACKENBERG EG "Recognition of human faces from isolated facial features: a developmental study"  
PSYCHONOMIC SCIENCE 6 (1966):149-50
- GONEDES NJ "Corporate Signalling, External Accounting and Capital Market Equilibrium: Evidence on Dividends, Income and Extraordinary Items"  
JOURNAL OF ACCOUNTING RESEARCH (Spring 1978):26-79
- GRANT E "Face to Face"  
NEW SOCIETY (7 May 1970):769-771
- GREEN P E & MAHESHWARI A "Common Stock Perception and Preference: An Application of Multidimensional Scaling"  
JOURNAL OF BUSINESS 42 (October 1969):439-57
- GUNNING R "The Fog Index after Twenty Years"  
JOURNAL OF BUSINESS COMMUNICATION (Winter 1968):3-13
- HAMMILL A E "Simplified Financial Statements"  
ACCOUNTANT'S MAGAZINE (June 1979):241-243
- HARIED A A "The Semantic Dimensions of Financial Statements"  
JOURNAL OF ACCOUNTING RESEARCH (Autumn 1972):376-391

- HARIED A A "The Measurement of Meaning in Financial Reports"  
JOURNAL OF ACCOUNTING RESEARCH  
(Spring 1973):117-145
- HARRISON C "Readability in the Classroom"  
(C U P) CAMBRIDGE, ENGLAND (1980):
- HARRISON R P "Pictic Analysis: Towards a Vocabulary and Syntax for the Pictorial Code with Research on Facial Communication"  
Unpublished PhD Thesis, Michigan State University (1964)
- HEALY P "Can you Understand the Footnotes to Financial Statements?"  
ACCOUNTANTS JOURNAL (July 1977):219-222
- HELSON H & MASTERS H "A Study of Inflection-Points in the Locus of Adaptation-Levels as a Function of Anchor-Stimuli"  
AMERICAN JOURNAL OF PSYCHOLOGY  
(1966):400-408
- HILTON A "Employee Reports - How to Communicate Financial Information to Employees" CAMBRIDGE (1978)
- HINES R D "The Usefulness of Annual Reports: the Anomaly between the Efficient Markets Hypothesis and Shareholder Surveys"  
ACCOUNTING AND BUSINESS RESEARCH  
VOL 12 48 (Autumn 1982):296-309

- HINES R D "Financial Accounting Knowledge, Conceptual Framework Projects and the Social Construction of the Accounting Profession"  
ACCOUNTING, AUDITING AND ACCOUNTABILITY (FORTHCOMING)  
(1989)
- HOCKEY S "A Guide to Computer Applications in the Humanities"  
DUCKWORTH, LONDON (1980)
- HOCKEY S & MARTIN J "Oxford Concordance Program: Users Manual 2"  
OXFORD UNIVERSITY COMPUTING SERVICE (1988)
- HOUGHTON K A "Accounting Data and the Prediction of Business Failure: The Setting of Priors and the Age of Data"  
JOURNAL OF ACCOUNTING RESEARCH (Spring 1984):361-368
- HOUGHTON K A "The Development of Meaning in Accounting: An Intertemporal Study"  
ACCOUNTING AND FINANCE Vol 27 No 2 (November 1987a):25-40
- HOUGHTON K A "True and Fair View: An Empirical Study of Connotative Meaning"  
ACCOUNTING, ORGANISATIONS AND SOCIETY VOL 12 NO 2 (1987b):143-152
- HOUGHTON K A "The Measurement of Meaning in Accounting: A Critical Analysis of the Principal Evidence"  
ACCOUNTING, ORGANISATIONS AND SOCIETY (1988):263-280

- HOWELLS T H "A Study of the Ability to recognise faces"  
JOURNAL OF ABNORMAL SOCIAL PSYCHOLOGY 33 (1938):124-27
- HUFF D "How to Lie with Statistics"  
NEW YORK (1954)
- HUFF D L & BLACK W "A Multivariate Graphic Display for Regional Analysis"  
in P C C WANG (ed) "Graphical Representation of Multivariate Data" (1978)
- INSTITUTE OF CHARTERED ACCOUNTANTS IN ENGLAND AND WALES (ICAEW) "The Corporate Report" ACCOUNTING STANDARDS STEERING COMMITTEE (1975)
- IKER H P & KLEIN R "Words: A Computer System for the Analysis of Content"  
BEHAVIOUR RESEARCH METHODS AND INSTRUMENTATION 6 (1974):430-438
- INGRAM R W & FRAZIER K B "Narrative Disclosures in Annual Reports"  
JOURNAL OF BUSINESS RESEARCH 11 (1983):49-60
- ISELIN E R "The Effects of Format on the Extraction of Information from Accounting Statements"  
ACCOUNTING AND FINANCE Vol 29 (May 1989):73-94
- IZARD C E "The Face of Emotion"  
NEW YORK (1971)

- JACOB R J K "Facial Representation of Multivariate Data"  
in P C C WANG (ed) "Graphical Representation of Multivariate Data" (1978)
- JACOBY J "Information Load and Decision Quality: Some Contested Issues"  
JOURNAL OF MARKETING RESEARCH Vol XIV (November 1977):569-73
- JACOBY J, SPELLER DE & KOHN CA "Brand Choice Behaviour as a Function of Information Load"  
JOURNAL OF MARKETING RESEARCH Vol XI (February 1974):63-9
- JANIS I L & FADNER R H "The Co-efficient of Imbalance"  
in H D LASSWELL ed.  
"Language of Politics: Studies in Quantitative Semantics"  
CAMBRIDGE M I T PRESS (1965):55-82
- JENSEN R E "Phantasmagoric Accounting"  
AMERICAN ACCOUNTING ASSOCIATION (1976)
- JONES M J "A Longitudinal Study of the Readability of the Chairman's Narratives in the Corporate Reports of a UK Company"  
ACCOUNTING AND BUSINESS RESEARCH Vol 18 No 72 (Autumn 1988):297-305
- JOY O M & TOLLEFSON J O "On the Financial Applications of Discriminant Analysis"  
JOURNAL OF FINANCIAL AND QUANTITATIVE ANALYSIS 10 No 5 (1975):723-39

- JOYCE E J & BIDDLE G C "Anchoring and Adjustment in Probabilistic Inference in Auditing" JOURNAL OF ACCOUNTING RESEARCH Vol 19 No 1 (Spring 1981a):120-45
- JOYCE E J & BIDDLE G C "Are Auditors' Judgements Sufficiently Regressive?" JOURNAL OF ACCOUNTING RESEARCH Vol 19 No 2 (Autumn 1981b):323-49
- KAHNEMANN D & TVERSKY A "Subjective Probability: A Judgement of Representativeness" COGNITIVE PSYCHOLOGY (July 1972):430-54
- KEANE S M "Examining the Problems of Understandability" ACCOUNTANCY 88 (June 1977):82-4
- KEASEY K & WATSON R "The Prediction of Small Company Failure: Some Behavioural Evidence for the UK" ACCOUNTING AND BUSINESS RESEARCH Vol 17 (Winter 1986):49-57
- KELLY-NEWTON L "A Sociological Investigation of the USA Mandate for Replacement Cost Disclosures" ACCOUNTING, ORGANISATIONS AND SOCIETY Vol 5 No 3 (1980):311-321
- KENLEY W J & STAUBUS G J "Objectives and Concepts of Financial Statements" ARS NO 3, AARF MELBOURNE (1972)
- KENNY A "The Computation of Style" (PERGAMON PRESS) LONDON (1982)

- KLARE G R "Assessing Readability"  
 READING RESEARCH QUARTERLY Vol X  
 No 1 (1974-75):255-264
- KLEINER B & HARTIGAN J A "Representing Points in many  
 dimensions by Trees and Castles"  
 JOURNAL OF THE AMERICAN  
 STATISTICAL ASSOCIATION 76  
 (1981):260-276
- KRIPPENDORFF K "Content Analysis: An Introduction to  
 its Methodology"  
 SAGE PUBLICATIONS, LONDON (1980)
- KROSS W & SCHROEDER DA "An Empirical Investigation of the  
 Effect of Quarterly Earnings  
 Announcement Timing on Stock  
 Returns"  
 JOURNAL OF ACCOUNTING RESEARCH  
 (Spring 1984):153-176
- KRUSKAL J B "Multidimensional Scaling in  
 Archaeology: Time is not the only  
 dimension" in FR HODSON (ed)  
 'Mathematics in the Archaeological and  
 Historical Sciences' Proceedings of the  
 Anglo-Romanian Conference (1970)
- KRUSKAL J B & CARROLL J D "Geometric Models and Badness of Fit  
 functions" in PR KRISHNAIAH  
 'International Symposium of  
 Multivariate Analysis' Dayton, Ohio  
 (Academic Press) New York (1969)
- KUNREUTHER H "Extension of Bowman's Theory of  
 Managerial Decision Making"  
 MANAGEMENT SCIENCE (April  
 1969):415-439

- KWOLEK W F  
 "A Readability Survey of Technical Popular Literature"  
 JOURNALISM QUARTERLY (Summer 1973):255-264
- LACHENBRUCH P A  
 "An almost unbiased method of obtaining confidence intervals for the probability of misclassification in discriminant analysis"  
 BIOMETRICS 23 No 4 (1967):639-45
- LACHENBRUCH P A,  
 SNEERINGER C A & REVO L T  
 "Robustness of the Linear and Quadratic discriminant function to certain types of non-normality"  
 COMMUN. STATISTICS 1 (1973):39-56
- LARCKER D F & LESSIG V P  
 "Perceived usefulness of Information: A Psychometric Examination"  
 DECISION SCIENCES Vol 11 No 1 (January 1980):121-134
- LASSWELL H D  
 "The Structure and Function of Communications in Society"  
 in BRYSON L (ed) "The Communication of Ideas" (Harper Row)  
 NEW YORK (1948)
- LAUGHERY K R, ALEXANDER J F & LANE A B  
 "Recognition of Human Faces: effects of target exposure time, target position, pose position and type of photograph"  
 JOURNAL OF APPLIED PSYCHOLOGY 51 (1971):477-83
- LEE T A  
 "Company Financial Reporting: Issues and Analysis"  
 LONDON (1976)



- LEE T A & TWEEDIE D P "Accounting Information: An Investigation of Private Shareholder Usage"  
ACCOUNTING AND BUSINESS RESEARCH  
(Autumn 1975):280-291
- LEE T A & TWEEDIE D P "The Institutional Investor and Financial Information"  
ICAEW LONDON (1981):
- LEFTWICH R, WATTS R & ZIMMERMAN J "*Voluntary Corporate Disclosure: The Case of Interim Reporting* "  
SUPPLEMENT TO VOL 19 JOURNAL OF ACCOUNTING RESEARCH (1981):50-77
- LEWIS N R, PARKER L D, POUND G D & SUTCLIFE P "Accounting Report Readability: The use of Readability Techniques"  
ACCOUNTING AND BUSINESS RESEARCH  
(Summer 1986):199-213
- LI D H "The Semantic Aspect of Communication Theory and Accountancy"  
JOURNAL OF ACCOUNTING RESEARCH  
(Spring 1963) Vol 1:102-107.
- LIBBY R "Bankers and Auditors' Perceptions of the Message Communicated by the Audit Report"  
JOURNAL OF ACCOUNTING RESEARCH  
Vol 17 No 1 (Spring 1979):99-122
- LIBBY R "Accounting Ratios and the Prediction of Failure: Some Behavioural Evidence"  
JOURNAL OF ACCOUNTING RESEARCH  
(Spring 1975):150-161

- LIBBY R "Man versus model of man: Some conflicting evidence"  
ORGANISATIONAL BEHAVIOUR AND HUMAN PERFORMANCE 16 (1969):1-12
- LICHTENSTEIN S & NEWMAN J "Empirical Scaling of Common Verbal phrases associated with Numerical Probabilities"  
PSYCHONOMIC SCIENCE (December 5 1967):563-4
- LICHTENSTEIN S & SLOVIC P "Reversals of preference between bids and choices in gambling decisions"  
JOURNAL OF EXPERIMENTAL PSYCHOLOGY (1971) 89:46-55
- LOTHIAN N "Bad Language in Financial Reports"  
ACCOUNTANCY 89 (November 1978):42-6
- LOTHIAN N "The Nature of Redundancy and its Use in Company Reports and Accounts"  
ACCOUNTING AND BUSINESS RESEARCH (Summer 1976):216-227
- LUHN H P "A Statistical Approach to Mechanised Encoding and Searching of Literary Information"  
IBM JOURNAL OF RESEARCH AND DEVELOPMENT Vol 1 (1957):309-317
- MACDONALD G, BIRD P & CLIMO T "Statements of Objectives and Standard Practice in Financial Reporting"  
(PRENTICE HALL) NEW JERSEY (1975)

- MAYER-SOMMER A P "Understanding and Acceptance of the Efficient Markets Hypotheses and its Accounting Implications"  
ACCOUNTING REVIEW (January 1979):100-106
- MCCROSKEY J C "An Introduction to Rhetorical Communication"  
(PRENTICE HALL) NEW JERSEY (1948)
- MCDONALD G C & AYERS J A "Some applications of the 'Chernoff Faces': A Technique for Graphically representing Multivariate Data"  
in P C C WANG (ed) "Graphical Representation of Multivariate Data" (1978)
- MCKELVIE S J "The Meaningfulness and meaning of Schematic Faces"  
PERCEPTIONS AND PSYCHOPHYSICS 14 No 2 (1973):343-348
- MCNICHOLS M & MANEGOLD J G "*The Effect of the Information Environment on the Relationship between Financial Disclosure and Security Price variability*"  
JOURNAL OF ACCOUNTING AND ECONOMICS (April 1983):49-74
- MESSICK S & DAMARIN F "Cognitive styles and Memory for Faces" JOURNAL OF ABNORMAL SOCIAL PSYCHOLOGY 69 (1964):313-318
- MEZZICH J E & WORTHINGTON D R L "A Comparison of Graphical Representation of Multidimensional Psychiatric Data"  
in P C C WANG (ed) "Graphical Representation of Multivariate Data" (1978)

- MILLER G R & COLEMAN E B "A Set of Thirty-Six Prose Passages Calibrated for Complexity" JOURNAL OF VERBAL LEARNING AND VERBAL BEHAVIOUR 6 (1967):851-4
- MILLER H "Environmental Complexity and Financial Reports" ACCOUNTING REVIEW 47 (January 1972):31-37
- MOIZER P & ARNOLD J "Share Appraisal by Investment Analysts - Portfolio vs. Non-Portfolio Managers" ACCOUNTING AND BUSINESS RESEARCH (Autumn 1984):341-348
- MONTGOMERY H & SVENSON O "On Decision Rules and Information Processing Strategies for Choices among Multiattribute Alternatives" SCANDINAVIAN JOURNAL OF PSYCHOLOGY VOL 17 (1976):283-91
- MORIARITY S "Communicating Financial Information through Multidimensional Graphics" JOURNAL OF ACCOUNTING RESEARCH 17 (April 1979):205-224
- MORRISON D G "On the interpretation of discriminant analysis" JOURNAL OF MARKETING RESEARCH 6 No 2 (1969):156-163
- MORTON A Q "Literary Detection: How to prove authorship and fraud in literature and documents" (CHARLES SCRIBNER) NEW YORK (1978)

- MORTON J R "Qualitative Objectives of Financial Accounting: A Comment on Relevance and Understandability"  
JOURNAL OF ACCOUNTING RESEARCH  
(Autumn 1974):288-98
- MORTON J & JOHNSON M "Four Ways for Faces to be Special" in  
A W YOUNG & H D ELLIS (eds)  
"Handbook of Research on Face Processing" (ELSEVIER) NORTH-  
HOLLAND (1989):49-56
- MOSKOVICH W "Quantitative Linguistics in Natural Language in Information Science" in  
"Natural Language in Information Science: Perspectives and Directions for Research"  
D WALKER, H KARLGREN & M KAY  
(eds) STOCKHOLM (1977):57-74
- MOSTELLER F & WALLACE D L "Inference in an Authorship problem"  
JOURNAL OF AMERICAN STATISTICAL ASSOCIATION 58 (1963):275-309
- NESTVOLD K J "Cloze Procedure Correlation with Perceived Readability"  
JOURNALISM QUARTERLY (Autumn 1972) Vol 49:542-594
- NEWTON C M "Graphica: From Alpha to Omega in Data Analysis"  
in P C C WANG (ed) "Graphical Representation of Multivariate Data"  
(1978)
- NIE N & HULL H "SPSSX: Manual of Operations"  
(McGraw Hill) NEW JERSEY (1984)

- OAKMAN R L "Computer methods for Literary Research" GEORGIA (1984)
- OGILVIE DM "The General Inquirer: A Computer Approach to Content Analysis" CAMBRIDGE M I T (1966)  
in STONE P J, D C DUNPHY,  
M S SMITH & D M OGILVIE
- OLIVER B L "A Study of Confidence Interval Financial Statements" JOURNAL OF ACCOUNTING RESEARCH 10 (Spring 1972):154-166
- OLIVER B L "The Semantic Differential: A Device for Measuring the Interprofessional Communication of Selected Accounting Concepts" JOURNAL OF ACCOUNTING RESEARCH (Autumn 1974):299-316
- O'NEILL T J "The General Distribution of the Error Rate of a Classification procedure with application to logistic regression discrimination" JOURNAL OF THE AMERICAN STATISTICAL ASSOCIATION 75 (1980):154-160
- OSGOOD C E, SUCI G J & TANNENBAUM P H "The Measurement of Meaning" UNIVERSITY OF ILLINOIS, URBANA: UNIVERSITY PRESS (1957)
- OSGOOD C E & WALKER E G "Motivation and Language Behaviour: A Content Analysis of Suicide Notes" JOURNAL OF ABNORMAL AND SOCIAL PSYCHOLOGY 59 (1959):58-67
- PARKER L D "Corporate Annual Reporting: A Mass Communication Perspective" ACCOUNTING AND BUSINESS RESEARCH (Autumn 1982):279-286

- PARKER L D "Corporate Annual Reports: A Failure to Communicate"  
INTERNATIONAL JOURNAL OF ACCOUNTING Vol 16 No 2 (Spring 1981):35-48
- PASHALIAN S & CRISSY W J E "How Readable are Corporate Annual Reports?"  
JOURNAL OF APPLIED PSYCHOLOGY (August 1950):244-248
- PATELL J M & WOLFSON M A "Good News, Bad News and the Intraday Timing of Corporate Disclosures"  
THE ACCOUNTING REVIEW (July 1982):243-256
- PEASNELL K V "The Function of a Conceptual Framework for Corporate Financial Reporting"  
ACCOUNTING AND BUSINESS RESEARCH (Autumn 1982):243-256
- PEEL MJ, PEEL DA & POPE PF "Some Evidence on Corporate Failure and the Behaviour of Non-Financial Ratios"  
THE INVESTMENT ANALYST 75 (January 1985):3-7
- PICKETT R & WHITE B S "Constructing Data Pictures"  
PROCEEDINGS OF THE 7TH NATIONAL SYMPOSIUM OF THE SOCIETY FOR INFORMATION DISPLAY (October 1966):75-81
- PINCHES G E "Factors influencing classification results from multiple discriminant analysis"  
JOURNAL OF BUSINESS RESEARCH 8 (1980):429-56

- PRESS S J & WILSON S "Choosing between logistic regression and discriminant analysis" JOURNAL OF THE AMERICAN STATISTICAL ASSOCIATION 73 (1978):699-705
- REED S K "Pattern recognition and Categorisation" COGNITIVE PSYCHOLOGY 3 (1972):382-407
- REINGANUM M R "Misspecification of Capital Asset Pricing: Empirical anomalies based on earnings yields and market values" JOURNAL OF FINANCIAL ECONOMICS 9 (1981):19-46
- REVSINE L "Data Expansion and Conceptual Structure" ACCOUNTING REVIEW 45 (October 1970):704-711
- ROSE P S, ANDREWS W T & GIROUX G A "Predicting Business Failure: A Macroeconomic Perspective." JOURNAL OF ACCOUNTING, AUDITING AND FINANCE (Fall 1982):20-31
- RULAND W "The Time Series of Earnings for Forecast Reporting and Nonreporting Firms" JOURNAL OF BUSINESS FINANCE AND ACCOUNTING (Summer 1979):187-201
- SALAMON G D & DHALIWAL D S "Company Size and financial Disclosure Requirements with Evidence from the Segmental Reporting Issue" JOURNAL OF BUSINESS FINANCE AND ACCOUNTING (Winter 1980):555-568



- SAINI K & BATES P "Survey of the Quantitative approaches to country risk analysis" JOURNAL OF BANKING AND FINANCE 8 (1984):341-56
- SALAMON G D & SMITH E D "Corporate Control and Management Misrepresentation of Firm Performance" BELL JOURNAL OF ECONOMICS (Spring 1979):319-328
- SAVICH R "Use of Accounting Information in Decision Making" ACCOUNTING REVIEW 52 (July 1977):642-52
- SCHIFFMAN S S, REYNOLDS M L & YOUNG F W "Introduction to Multidimensional Scaling: Theory, Methods and Applications" ACADEMIC PRESS (1981)
- SCHMID C F "Handbook of Graphic Presentation" (RONALD) NEW YORK (1954)
- SCHRODER H M "Conceptual Complexity and Personality Organisation" in H M SCHRODER and P SUEDFELD (ed) "Personality Theory and Information Processing" NEW YORK (1970)
- SCHRODER H M, DRIVER M J & STREUFERT S "Human Information Processing" (HOLT RINEHART & WINSTON) NEW YORK (1967)
- SHANNON C E & WEAVER W "The Mathematical Theory of Communication" (PRENTICE HALL) NEW JERSEY (1968)

- SHEPARD R N "Representation of Structure in Similarity Data: Problems and Prospects" PSYCHOMETRICA (December 1974):373-417
- SIEGEL J H, FARRELL E J, GOLDWYN R M & FRIEDMAN H P "The Surgical Implication of Physiologic Patterns in Myocardial Infarction shock" SURGERY 72 (1972):126-141
- SLOVIC P "From Shakespeare to Simon: speculations and evidence about man's ability to process information" OREGON RESEARCH INSTITUTE MONOGRAPH Vol 12 No 2 (1974)
- SMITH E E & NIELSEN G D "Representations and Retrieval Processes in STM recognition and recall of faces" JOURNAL OF EXPERIMENTAL PSYCHOLOGY Vol 85 No 3 (1970):397-405
- SMITH F "Understanding Reading" HOLT REINHART WINSTON (1971)
- SMITH J E & SMITH N P "Readability: a Measure of the performance of the communication function of financial reporting" ACCOUNTING REVIEW 46 (July 1971):552-61
- SMITH M & TAFFLER R J "Improving the Communication Function of Published Accounting Statements" ACCOUNTING AND BUSINESS RESEARCH No 54 (Spring 1984):139-146

- SOPER F J & DOLPHIN R  
 "Readability and Corporate Annual Reports"  
 ACCOUNTING REVIEW (April 1964):358-362
- SORTER G H, BECKER S W,  
 ARCHIBALD T R & BEAVER W H  
 "Accounting and Financial Measures as indicators of Corporate Personality - Some Empirical Findings" in R J JAEDICKE, Y IJURI & O NIELSEN (eds)  
 "Research in Accounting Measurement"  
 AMERICAN ACCOUNTING ASSOCIATION (1966)
- SPROUSE R T & MOONITZ M  
 "A Tentative Set of Broad Accounting Principles for Business Enterprises"  
 ACCOUNTING RESEARCH STUDY NO 3  
 AICPA: NEW YORK (1962)
- STAMP E  
 "Corporate Reporting: Its Future Evolution"  
 THE CANADIAN INSTITUTE OF CHARTERED ACCOUNTANTS (1980)
- STAMP E  
 "Accounting Standards and the Conceptual Framework: A Plan for their evolution"  
 THE ACCOUNTANT'S MAGAZINE (July 1981):216-222
- STAMP E  
 "First Steps Towards a British Conceptual Framework"  
 ACCOUNTANCY (March 1982):123-130
- STEVENS M  
 "Presentation of Financial Information" ACCOUNTANTS DIGEST No 59 (Winter 1977/78)

- STEVENS W P, STEVENS K C  
& RAABE W JNR
- "Communication in Accounting:  
Readability of FASB Statements"  
REVIEW OF BUSINESS AND ECONOMIC  
RESEARCH Vol 19 No 1 (Fall 1983):110-  
118
- STILL M D
- "The Readability of Chairman's  
Statements"  
ACCOUNTING AND BUSINESS RESEARCH  
(Winter 1972):36-39
- STOBER T L
- "The Incremental Information Content  
of Financial Statement Disclosures: The  
Case of LIFO Inventory Liquidations"  
JOURNAL OF ACCOUNTING RESEARCH  
Vol 24 Supplement 1986:138-160
- STOCK D & WATSON C J
- "Human Judgement Accuracy,  
Multidimensional Graphics and Human  
versus Models"  
JOURNAL OF ACCOUNTING RESEARCH 22  
No 1 (SPRING 1984):192-206
- STONE P J & HUNT E B
- "Computer approach to Content  
Analysis using the general inquirer  
system" in E C JOHNSON (Ed)  
"American Federation of Information  
Processing Societies"  
CONFERENCE PROCEEDINGS, BALTIMORE  
(1963):241-256
- SVENSON O
- "Process Descriptions of Decision  
Making"  
ORGANISATIONAL BEHAVIOUR AND  
HUMAN PERFORMANCE VOL 23  
(1979):86-112
- SWANSON E B
- "Management Information Systems:  
Appreciation and Involvement"  
MANAGEMENT SCIENCE (1974):178-188

- SWIERINGA R, GIBBINS M,  
LARSSON L & SWEENEY J
- "Experiments in the Heuristics of  
Information Processing"  
STUDIES ON HUMAN INFORMATION  
PROCESSING IN ACCOUNTING,  
Supplement to JOURNAL OF  
ACCOUNTING RESEARCH (1976):150-87
- TAFFLER R J
- "Forecasting Company Failure in the  
UK using Discriminant Analysis and  
Financial Ratio Data"  
JOURNAL OF THE ROYAL STATISTICAL  
SOCIETY (Series A) Vol 145 part 3  
(1982):342-358
- TAFFLER R J &  
SUDARSANAM P S
- "Auditing the Board: A New Approach  
to the Measurement of Company  
Performance"  
MANAGERIAL FINANCE (1980):127-147
- TAFFLER R J & TISSHAW H
- "Going, Going, Gone, Four Factors  
which predict"  
ACCOUNTANCY 88 NO 1003 (March  
1977):50-55
- TAYLOR W L
- "Cloze Procedure: A New Tool for  
Measuring Readability"  
JOURNALISM QUARTERLY (Fall  
1953):415-433
- THORNGATE W
- "Efficient Decision Heuristics"  
BEHAVIOURAL SCIENCE (May 1980):219-  
25
- TUKEY J W
- "Exploratory Data Analysis"  
(ADDISON-WESLEY) READING, MASS  
(1977)

- TVERSKY A & KRANTZ D H "Similarity of Schematic Faces: A test of interdimensional activity"  
PERCEPTION AND PSYCHOPHYSICS 5  
(1969):124-128
- WAINER H & THISSEN D "Graphical Data Analysis"  
ANNUAL REVIEW OF PSYCHOLOGY 32  
(1981):191-241
- WANG P C C "Graphical Representation of Multivariate Data"  
(ACADEMIC PRESS) NEW YORK (1978)
- WATKINS P R "Multidimensional Scaling Measurement and Accounting Research"  
JOURNAL OF ACCOUNTING RESEARCH  
Vol 22 No 1 (Spring 1984):406-411
- WATTS R L "Corporate Financial Statements: A Product of the Market and Political Processes"  
AUSTRALIAN JOURNAL OF  
MANAGEMENT (April 1977):53-75
- WAYMIRE G "Additional Evidence on the Information Content of Management Earnings Forecasts"  
JOURNAL OF ACCOUNTING RESEARCH  
(Autumn 1984):703-718
- WHITTRED G P "The Timeliness of the Australian Annual Report:1972-1977"  
JOURNAL OF ACCOUNTING RESEARCH  
Vol 18 No 2 (Autumn 1980):623-628
- WILLIAMSON R W "Evidence on the Selective Reporting of Financial Ratios"  
THE ACCOUNTING REVIEW (April  
1984):296-99

- WILSON D A "A Note on Environmental Complexity and Financial Reports"  
ACCOUNTING REVIEW 48 (July 1973):586-8
- WILTON R L & TABB J B "An Investigation into Private Shareholder Usage of Financial Statements in New Zealand"  
ACCOUNTING EDUCATION (May 1978):93-101
- WINFIELD R R "Shareholder Opinion of Published Financial Statements"  
paper presented at the AAANZ CONFERENCE, UNIVERSITY OF OTAGO (1978)
- WRIGHT P "Using Tabulated Information"  
ERGONOMICS (1968):331-43
- WRIGHT W F "Cognitive Information Processing Biases: Implications for Producers and users of Financial Information"  
DECISION SCIENCES (April 1980):284-298
- YIN R K "Looking at Upside-Down Faces"  
JOURNAL OF EXPERIMENTAL PSYCHOLOGY 8 (1969):141-5
- ZEGHAL D "Firm Size and the Informational Content of Financial Statements"  
JOURNAL OF FINANCIAL AND QUANTITATIVE ANALYSIS (September 1984):299-310

ZMIJEWSKI M E

"Predicting Corporate Bankruptcy: An  
Empirical Comparison of the Extant  
Financial Distress Models"  
WORKING PAPER, STATE UNIVERSITY  
OF NEW YORK, BUFFALO (1983)

ZMUD R W

"An Empirical Investigation of the  
Dimensionality of the Concept of  
Information"  
DECISION SCIENCES Vol 9 No 2  
(1978):187-195