



This is a repository copy of *Effect of different rubber materials on husking dynamics of paddy rice*.

White Rose Research Online URL for this paper:
<http://eprints.whiterose.ac.uk/96842/>

Version: Accepted Version

Article:

Baker, A., Dwyer-Joyce, R.S., Briggs, C. et al. (1 more author) (2012) Effect of different rubber materials on husking dynamics of paddy rice. *Proceedings of the Institution of Mechanical Engineers, Part J: Journal of Engineering Tribology*, 226 (6). pp. 516-528. ISSN 1350-6501

<https://doi.org/10.1177/1350650111435601>

Reuse

Unless indicated otherwise, fulltext items are protected by copyright with all rights reserved. The copyright exception in section 29 of the Copyright, Designs and Patents Act 1988 allows the making of a single copy solely for the purpose of non-commercial research or private study within the limits of fair dealing. The publisher or other rights-holder may allow further reproduction and re-use of this version - refer to the White Rose Research Online record for this item. Where records identify the publisher as the copyright holder, users can verify any specific terms of use on the publisher's website.

Takedown

If you consider content in White Rose Research Online to be in breach of UK law, please notify us by emailing eprints@whiterose.ac.uk including the URL of the record and the reason for the withdrawal request.

Effect of Different Rubber Materials on Husking Dynamics of Paddy Rice

A. Baker¹, R.S. Dwyer-Joyce¹, C. Briggs², M. Brockfeld²

¹ The Leonardo Centre for Tribology, Department of Mechanical Engineering, The University of Sheffield, Sheffield, S1 3JD, UK

² Buhler Sortex Ltd., 20 Atlantis Avenue, London, E16 2BF, UK

Keywords

Rice husking, rice processing, rubber roll husker

Abstract

The conventional way to husk rice is to pass it between two rubber rollers that are rotating with a surface speed differential. The resulting normal pressure and shear stress causes the husk to be peeled away from the kernel. The process is suited to high rice flow rates, but is energy intensive and can result in considerable wear to the surfaces of the rollers. The operating parameters for machines of this design are usually determined and set empirically. In this paper, some experiments and calculations had been carried out in order to explore the mechanisms involved in husking rice grains using this method. A simple sliding friction rig with load cell and high speed camera was used to observe the mechanisms that occur during husking. The husking performance of different rubbers was compared for changes in the applied normal load. It was found that grains rotate between the rubber counter-faces on initial motion before being husked. In addition, harder rubbers were found to husk a higher proportion of entrained grains at lower applied normal load. By measuring the coefficient of friction between rice and rubber samples, the shear force required to husk a given percentage of grains could be calculated and was shown to be constant regardless of rubber type. Based on the mechanism seen in the high speed video it was evident that there was a limiting shear stress that was the governing factor over the husked ratio.

Nomenclature

l	Rice grain length	m
w	Rice grain width	m
t	Rice grain thickness	m
E	Young's modulus	Pa
ν	Poisson's ratio	
a	Radius of circular point contact	m

b	Half width of line contact	m
E^*	Reduced modulus	Pa
R	Radius	m
R'	Reduced radius	m
P	Normal contact force	N
F	Frictional (tangential) force	N
Q	Specific husking energy	kJ/kg
ϕ_n	Peripheral velocity ratio	
l_d	Contact distance	m
R_{ay}	Rice radius of curvature (around width)	m
p_m	Mean contact pressure	Pa
p_0	Maximum contact pressure	Pa

1. Introduction

The processing of rice involves a number of discrete operations from husking to whitening and polishing. The efficiency of each affects the quality and hence market value of the finished product. Further, each of the operations is energy intensive and because the throughput is so great can cause extreme wear to many of the machine parts. There is therefore great interest in maximising the efficiency, increasing machine reliability, and minimising damage to grains during such operations.

Rice as an agricultural material must have its husk removed (husked) in order to be useable as a commercial product. Two types of machine are commonly adopted in husking; impeller type and rubber roll type machines [1]. In impeller type husking machines the rice is scattered radially and husked by the impact of collision with an external surround. The impeller type huskers are not inherently inferior to rubber roll huskers, but continuing advancements of rubber roll type have led to their diminished use. This study focuses solely on the latter process.

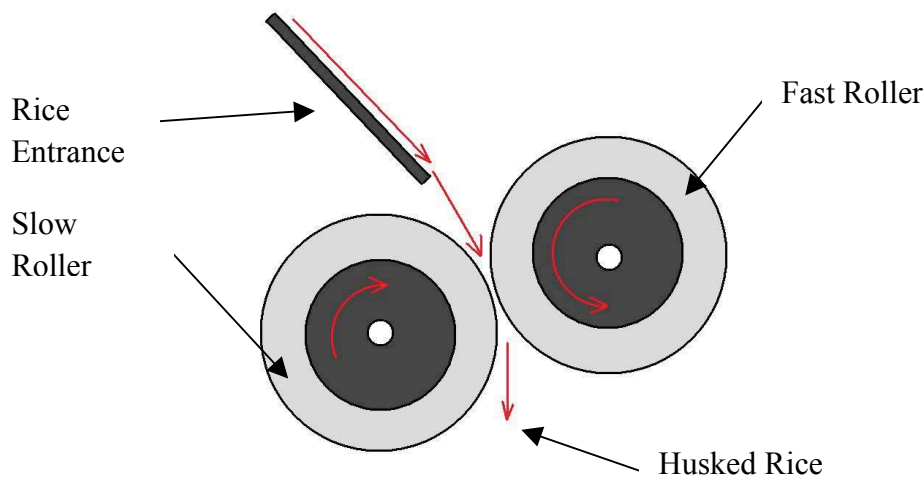

Figure 1 Schematic of Rubber Roll husker

Although some designs vary slightly, for the rubber roll type approach, all use the same fundamental concept (as shown in figure 1). Rice flows down a chute and is entrained between the two rubber coated rollers. One roller rotates faster than the other (typically 950 rpm and 1300 rpm, a ratio of around 1:1.35). The husk is separated into two (or more) parts and the rice falls out freely. Flow rates can be between 3 and 8 tonnes per hour depending on variety of rice. One roller is loaded using a lever arm whilst the other remains stationary. The loading is altered depending on the quality of the product being expelled (increased if husks are being left on, decreased if a large proportion of the rice kernels are breaking during husking). The gap between the two rollers is set so that they do not touch when there is no rice flowing between them. Inevitably this differential slip process leads to frictional heating and the rubber layer on the rollers is subject to high wear rates. The operating parameters (load, gap, roller speeds, and speed differential) of such huskers are largely set experimentally on examining the processed product. The selection of the most appropriate rubber material is frequently chosen on the basis of past experience.

Rubber roll huskers of this type have been in use since the 1920s[1]. Developments since then have been made mostly by trial and improvement, such as wear resistance of the rubber material, optimization of roller speeds and clearances. Modern designs now incorporate automatic adjustment of feed rate and roll clearance, the latter allowing adjustment as the rollers wear. Parallelism has been noted to be of importance to roller efficiency and this in turn limits the width, and hence capacity, of the rollers. Shitanda et al. [2] performed experiments with rubber roll huskers and derived an equation for contact distance based on the radius of curvature of the grain. They used a high speed camera to monitor grain motion and an empirical relationship was found to give a better indication of contact distance than previous equations.

Particulate flow can be difficult to study, since the materials can behave like a solid or a liquid (or like neither) under different conditions. Bulk flow has been investigated extensively and some governing parameters identified which affect not only the flow, but also how the particles fundamentally interact with a surface. These include the relationship of surface wear relative to; particle size and shape[3][4], velocity [5], mass [6] and solid volume fraction [7] amongst other grain and fluid properties. When passing through the rollers, the grains form a single layer, which has different traction characteristics to bulk flow. Some studies have been conducted to identify the behaviour or mono layer particulate flow such as Elliott et al.'s experimental study of monolayer Couette flows [8]. Since each grain interacts with the rollers as an individual, unimpeded by the other grains, it is possible to model the interactions as distinct events which simplifies the analysis greatly.

Little is documented on the fundamental mechanisms of husk removal. The following work has been undertaken to better understand the mechanisms involved in husking rice using rubber rolls so that improvements can be made to the set-up and operation of husking machines. The relationship between the applied load and rubber hardness has been explored in order to find the most appropriate combination for optimum husking.

2. Rice and Rubber Physical Properties

The deformational properties of rubber were generally well understood [8]. Some work had been undertaken to determine basic physical properties of rice [9][10][11]. Since rice is an organic material, and the grain size small, it is usually difficult to determine precise mechanical properties. The mean (sample size 10) dimensions of the long grain paddy rice used in this study have been determined and are shown in table 1. Although no direct measurements were made in this work, values from the literature [9] for the Young's modulus, 0.54 GPa and Poissons ratio, 0.3 were used.

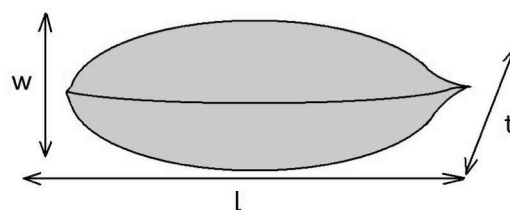

Grain length	l	9.94	mm
Grain width	w	2.47	mm
Grain thickness	t	1.95	mm

Table 1 Mean dimensions of a rice grain (long grain paddy) used in these studies.

The rubbers used in this study came from various sources. Three were selected from those currently in use as commercial roller materials (GRPL T-4, GRPL T-2 and YNOX90), four were Polyurethane (PU) blends which provide a good spread of hardness values (and are labelled by their hardness values), and one was a sample of Food Quality Nitrile (NI65), a material often used in other food applications due to its high wear resistance and thermal stability up to 100°C [8]. The Poissons ratio for all rubber samples has been estimated at 0.45 [12].

Some simple testing was carried out on the rubber samples to determine their elastic modulus. A circular point contact experiment was constructed. A smooth spherical ball was pressed onto the surface of each of the rubber samples under increasing normal load. The rubber surfaces had been inked so that the contact dimensions could be readily measured. Figure 2 shows the measured diameter of the area of contact plotted against the applied normal load.

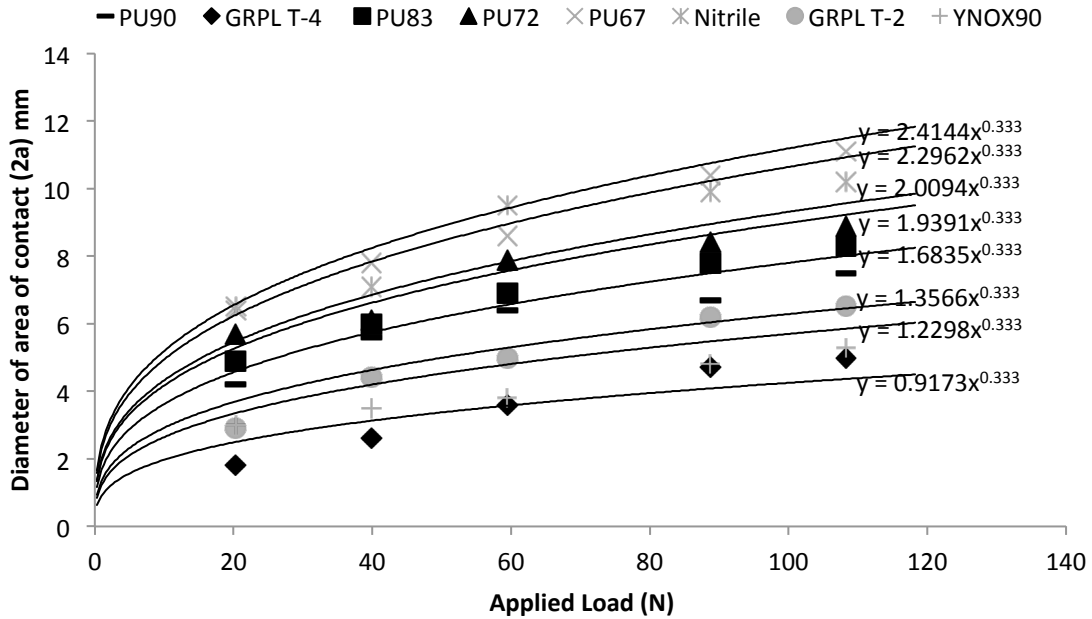

Figure 2 The diameter of the area of contact for a steel sphere pressed against the rubber samples. A power law curve fit is used to estimate the Young's modulus.

The Hertz analysis of elastic contact for a circular point contact [13] gives that the radius of the contact area, a , is proportional to the load P to the power of one third according to:

$$a = \left(\frac{0.75PR^l}{E^*} \right)^{\frac{1}{3}} \quad (1)$$

$$\frac{1}{R'} = \frac{1}{R_1} + \frac{1}{R_2} \quad (2)$$

$$\frac{1}{E^*} = \frac{1-\nu_1^2}{E_1} + \frac{1-\nu_2^2}{E_2} \quad (3)$$

R' and E^* are known as the reduced radius and reduced modulus respectively and subscripts 1 and 2 refer to the rubber material and steel respectively. For the case of a steel sphere pressed against a rubber flat the reduced radius is simply the radius of the sphere.

A cube root power curve ($y=Cx^{1/3}$) has been least squares fitted to the data points of figure 2. The use of the curve fit constant allows the reduced modulus to be found in equation 3. If the modulus and Poissons ratio of the rice material is known then the Young's modulus of the rubber samples can readily be determined.

In addition, the Shore A hardness of each sample was found using a HT-6510A digital hardness tester. For each material, 10 readings were recorded and a mean determined. Table 2 summarises the rubber materials tested.

Sample	Composition	Shore A	Modulus (GPa)
GRPL T-4	Commercial Roller	89	54
GRPL T-2	Commercial Roller	91	17
YNOX90	Commercial Roller	90	22
PU90	Polyurethane	90	8.8
PU83	Polyurethane	83.1	5.7
PU72	Polyurethane	71.5	5.2
PU67	Polyurethane	66.6	3.0
NI65	Food Quality Nitrile	65	3.5

Table 2 Calculated elastic modulus and measured hardness of rubber samples

3. Apparatus

Figure 3 shows the test rig used to husk individual grains of rice in a controlled manner. A motor and worm drive slide the base with the sample of rice pressed between two small blocks of rubber. The loading arm was used to apply the desired load to the contact, and the imbalance of the arm taken into account using a counterweight.

A speed controller was used to set the desired speed for the tests. However, it should be noted that the speed of the sliding base is significantly lower than the rollers in practice (50mm/min velocity difference compared with around 270m/min in reality). This is necessary since the rubber samples are relatively small. The load cell was used to measure the tangential force caused by friction of the samples, while the known applied load allowed the normal force to be calculated. LabView [14] was used to record the results which were then converted to friction coefficient, μ with equation 4, where F is the frictional force and P is the applied normal load.

$$\mu = \frac{F}{P} \quad (4)$$

Increasing loads were applied and the grain observed with a high speed video. The proportion of grains husked (referred to commonly as the husked ratio) at each load were recorded. This was measured by simply inspecting the grains after being loaded in the contact and manually counting each that had been husked. It was frequently difficult to decide whether a grain had been successfully husked, particularly at lower loads since occasionally only a small part of the husk broke away. If more than 25% of the husk was removed (half of one side), then the grain was considered husked. Forty grains were tested at each load for each rubber sample. The larger the number tested then the lower the error and forty grains was decided to be sufficient based on initial testing. Breakage data was also collected. A kernel having equal to or more than 75% intact tissue was considered as whole kernel [15].

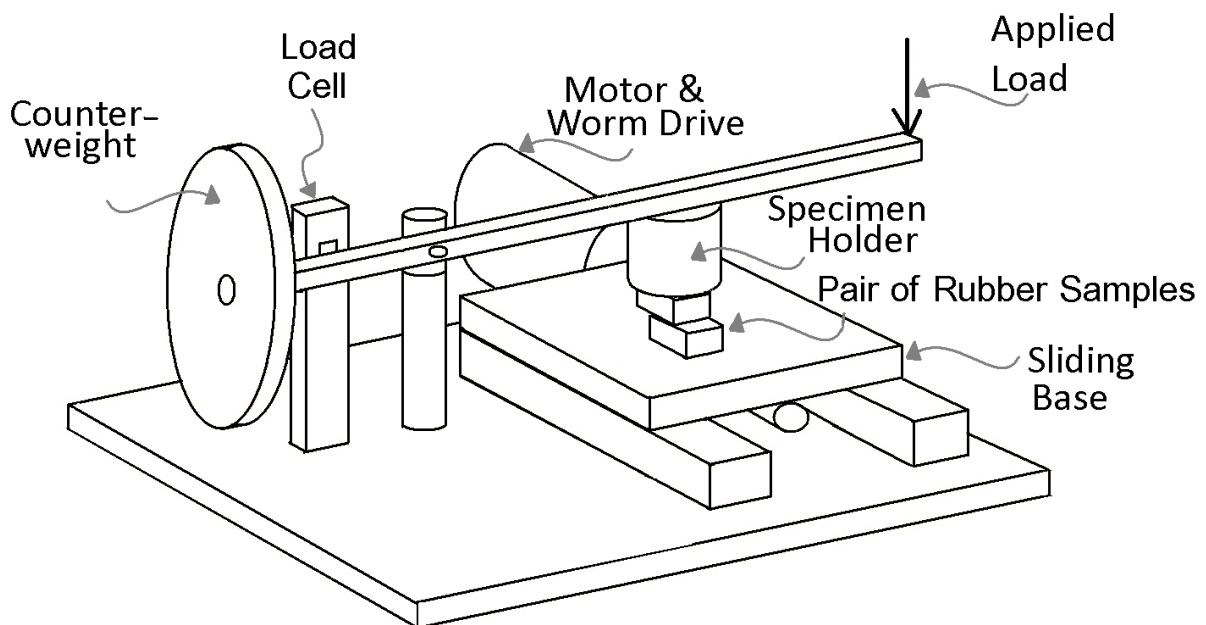

Figure 3 Experimental apparatus for husking and friction testing.

The same test rig was used to determine the coefficient of friction between rice and rubber. Specimens were manufactured by gluing an array of rice grains to a block, as shown in figure 4. The block was then mounted in the upper specimen holder and loaded and slid against the lower rubber samples. The friction force was recorded throughout the sliding motion using a load cell. Five measurements were recorded for each rubber. The friction coefficient was determined by dividing the frictional force by the normal load.

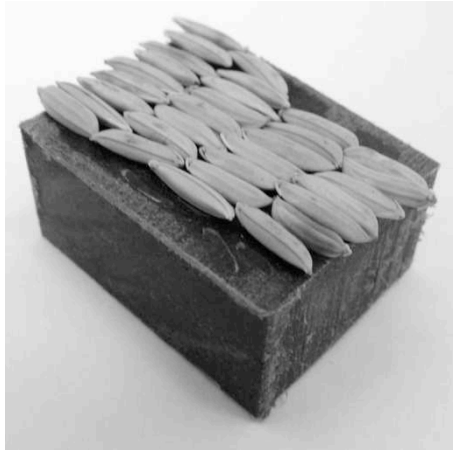

Figure 4 Block for friction test consisting of rice grains glued to a sample holder.

4. Results

4.1 Mechanism of husking

Figure 5 shows images recorded from the high speed video sequence of a rice grain being husked. The mechanisms observed are shown schematically in figure 6.

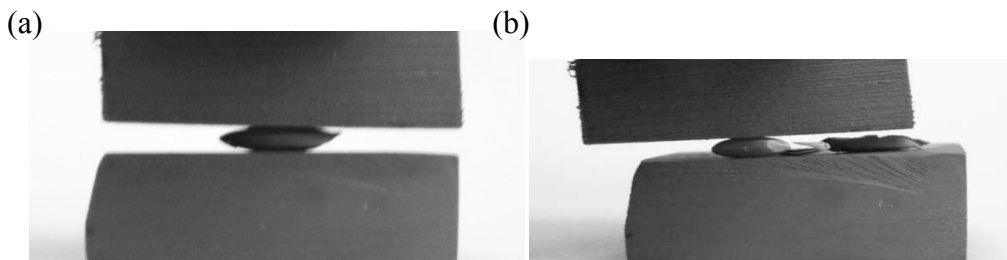

Figure 5 Stills extracted from high speed video footage of rubber samples with grain between, before (a) and after (b) husking

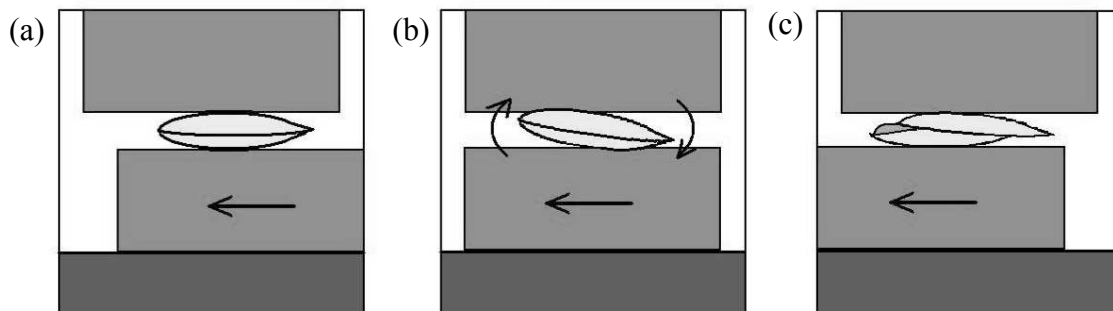

Figure 6 Schematic diagram of the husking mechanism, before (a), during (b) and after husking (c)

The rice was placed between the two rubber samples and the lower sample moved at a constant rate. As the lower rubber moved, the grains initially rotated before husking occurred. It was generally the case that the grains slid over one of the surfaces for a second or so (equivalent to 1-2cm of sliding motion) before husking. The surface to which the rice adhered and the one to which the sliding motion occurred appeared to vary. It is thought that this was due to the organic, non-symmetrical nature of the grains which can be seen in figures 7 and 8.

A scanning electron micrograph was used to image the surface of the husk. Figure 7 is a composite image of the whole husk (20x), whilst figure 8 shows the surface detail at a higher magnification (270x).



Figure 7 Electron Micrograph of Long Grain Rice Husk (composite image)

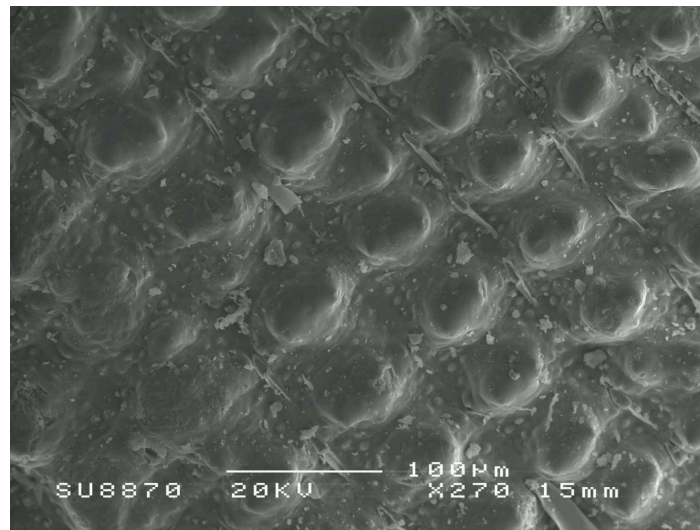

Figure 8 Electron Micrograph of Long Grain Rice Husk (Magnified)

It was often simple to observe when the rice had been husked as the loading arm would vibrate slightly when the husk yielded. Figure 9 shows two typical plots of the frictional force as it changes with time. The sample rate was 20Hz.

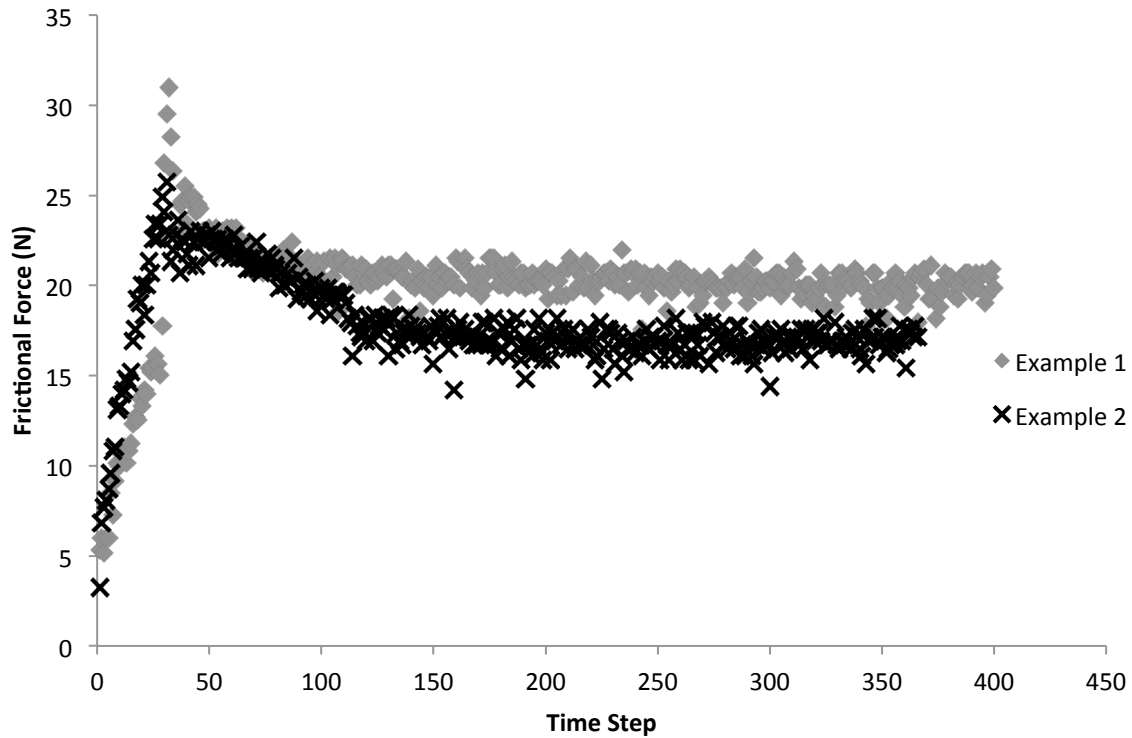

Figure 9 Frictional Force for Grain of Rice Over Test Duration

The frictional force rises as the rubber blocks slide across each other. The elastic strain energy is accumulated as the load builds up. Eventually the force reaches the point at which husking occurs and there is a sudden drop as the husk is removed. This maximum point is an estimate of the coefficient of static friction force between un-husked rice and rubber. Once the husk has been removed, the grain slides against the husk until it runs clear and then slides against the rubber block. This sliding part of the motion gives the dynamic coefficient of friction. From the results shown, coefficient of friction was determined by dividing frictional force by applied load. For the applied load of 19.5N, static and dynamic coefficients of friction for the above two examples could be estimated as 1.6 and 1.0 (example 1) and 1.3 and 0.9 (example 2).

4.2 Load to husk a Grain of Rice

The proportion of husked rice grains for each applied normal load is shown in Figure 10 for each of the rubber materials tested. Each data point was the husked ratio determine from 40 grains of rice being tested. The data correlated reasonably well indicating that 40 runs per data point was sufficient to allow a prediction to be made of the load required to husk a certain percentage of grains. It was clear that the higher the load, the more likely a grain was to be husked. The higher the load the more normal and shear loading on the grain and therefore the more likely the husk is to separate from the grain.

There were clear differences between the different rubber materials. Rather surprisingly the softer rubbers tended to be less effective at husking at the same loads than the harder rubbers. The husking process does not appear to require the surrounding material to conform around

the rice grain. Indeed for the softest rubbers (PU67 and NI65) the husked ratio did not reach 100%. This is because at the higher loads the rubber samples deform sufficiently such that they conform around the rice grain and contact with each other. The increase in load therefore does not increase further the contact between rubber and rice, but rather the load is supported by a growth in the rubber-rubber contact area. An ideal situation is one in which the maximum husking ratio is achieved at the minimum load. This means that frictional forces will be low, thus reducing the loss of energy and likelihood of wear.

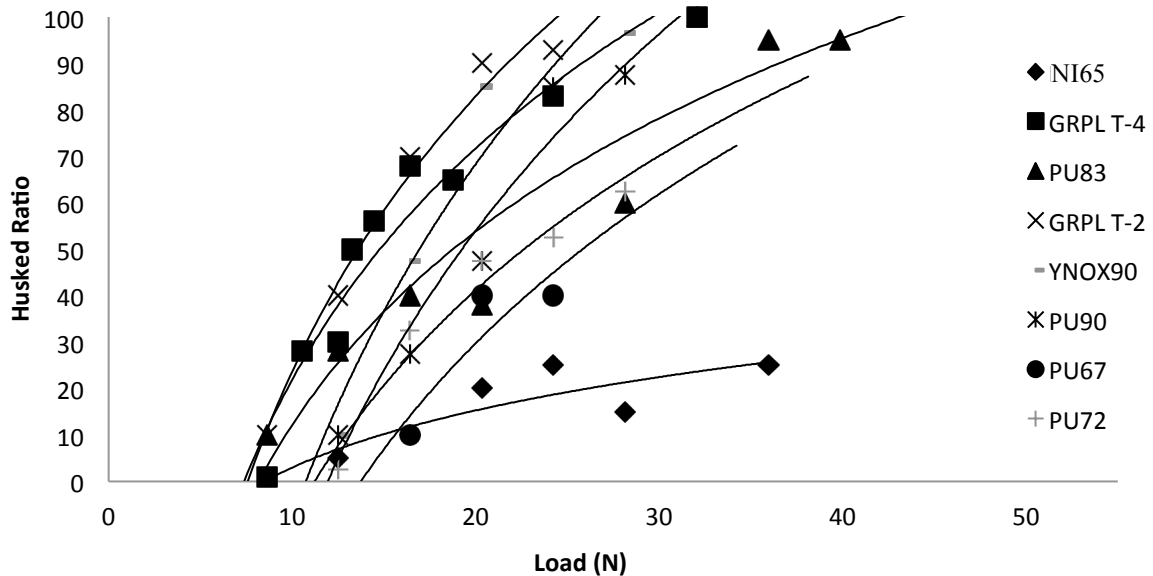

Figure 10 Graph showing husked ratio for various loads and different rubber samples

Figure 11 shows the proportion of rice grains broken or cracked during the husking Process. Breakage rates were low at the loads tested here. The softer polyurethane rubbers did not cause any breakages. There is a broad correlation, as expected between breakage rate and applied load. However, the data is subjected to considerable scatter, largely because the sample size is low and also because of the variability amongst the grains themselves.

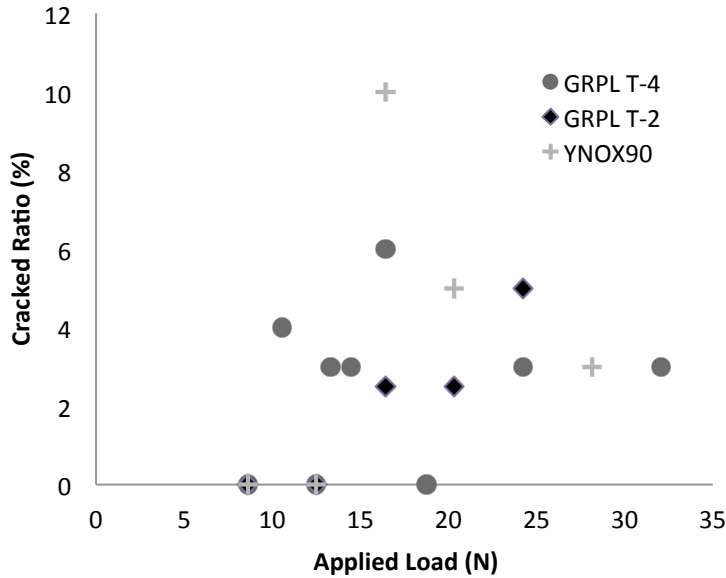

Figure 11 Graph showing proportion of broken grains for various loads and different rubber samples

Shitanda et al. [16] define a specific husking energy as a parameter to define how much energy is being imparted to the rice;

$$Q = 2\mu p\phi_n l_d \tag{5}$$

Where μ is the coefficient of friction between rubber and rice (obtained from the data reported in section 4.3), p is the specific normal force (i.e. the equivalent normal force applied to 1 kg of rice: force per grain multiplied by the number of grains in 1 kg), ϕ_n is the peripheral velocity difference (for the coupon test 50 mm/min) and l_d is the contact distance which was assumed to be the average grain length (9.94 mm).

The husking data for GRPL T-4 from the present tests is presented in figure 12 with experimental data collected by Shitanda et al. [16] on the husked ratio for rubber roll huskers for long grain rice.

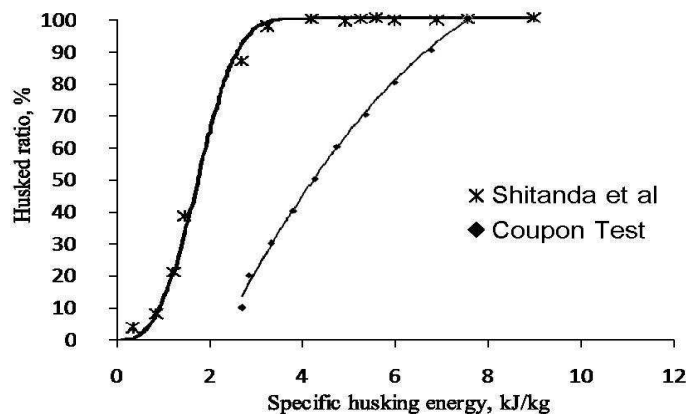

Figure 12 Plot of the rice husked ratio against specific husking energy.

Clearly, for both tests increasing the specific husking energy increases the proportion of grains husked. However, the plot shows some significant difference between the coupon husking and the full size husker. The full size machine would appear to be more efficient than the simple coupon test. This could be due to differences in the rubber samples used but also demonstrates perhaps that optimisation of load and speed in a husking machine can save significant husking energy.

4.3 Friction Between Rice and Rubber

Figure 13 shows some example raw results from the friction tests described above for the rubber samples against un-husked grains, sampled at 20Hz.

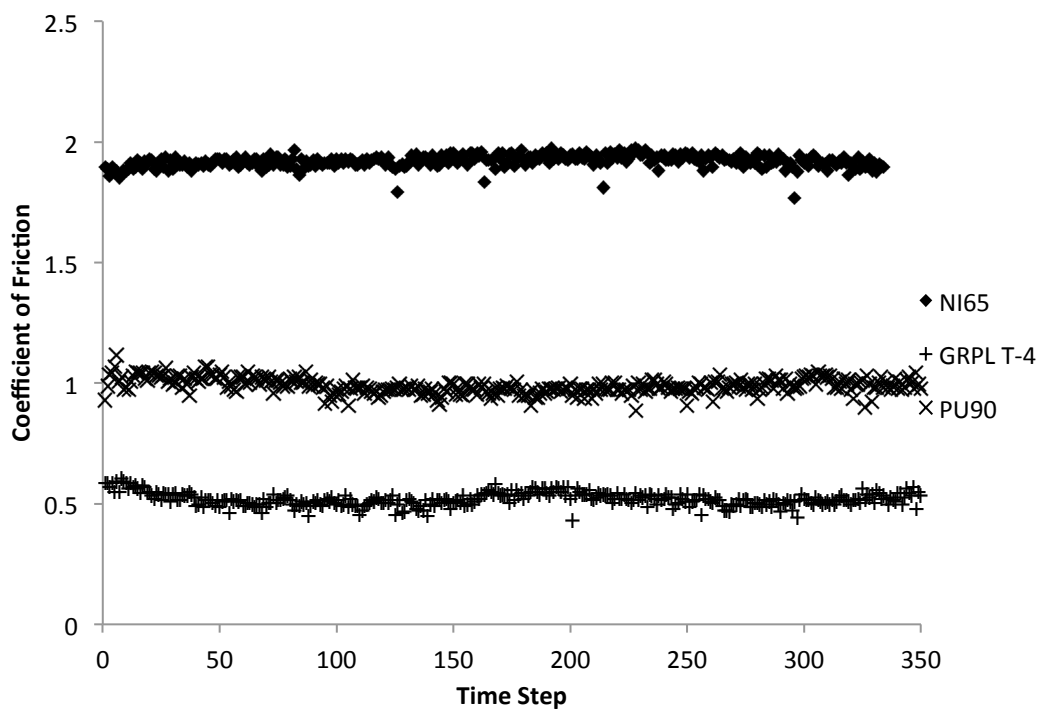

Figure 13 Coefficient of friction recorded as un-husked rice grains slide against for polyurethane samples.

The oscillation in the data is due to the pattern of the rice glued to the block. Table 3 presents this data as an average friction coefficient and a standard deviation. Clearly the selection of rubber has a large effect on the friction between rubber surface and rice grain. The different values indicate varying abilities for the rubber samples to grip the grains and it is thought that a higher coefficient of friction between rubber and grain would provide a more efficient husking process. However, the data shows that the softer rubbers in this study generally have higher friction coefficients. It was observed (figure 10) that this same group of materials was less efficient at husking grains. It has therefore been concluded that efficient husking is dependent on more factors than simply coefficient of friction.

Sample	Dynamic Coefficient of Friction	Standard deviation
GRPL T-4	0.5	0.10
GRPL T-2	0.5	0.11

YNOX90	0.5	0.10
PU90	1.0	0.05
PU83	0.5	0.08
PU72	1.3	0.29
PU67	1.3	0.09
NI65	1.8	0.10

Table 3 Coefficients of friction for un-husked rice against a range of rubber samples

4.4 Contact Pressure and Shear Stress

The load applied to the contact between a rice grain and the rubber surface will cause deformation of the rubber and the formation of a region of contact between the surfaces. The extent of this contact region will control the magnitude of the contact pressure and shear stress along the interface. In order to determine these parameters a simple elastic contact model is assumed.

For simplicity, a grain of rice is modelled as a cylinder of length, l and radius of curvature, R_{ay} (as shown schematically in figure 14). This is then pressed against the rubber material to form a rectangular area of contact which then has a length, l and a half width, b . The Hertz elastic solution for this contact case [13], gives:

$$b = \left(\frac{4 \left(\frac{P}{l} \right) (R_{ay})}{E^* \pi} \right)^{\frac{1}{2}} \quad (6)$$

And the mean contact pressure is given by:

$$p_m = \frac{2bP}{l} \quad (7)$$

It is possible to calculate the contact dimensions by assuming the rice grain is an ellipsoid (rather than a cylinder). If this is performed the length of the area of contact is found to extend beyond the length of the grain. This violates Hertz assumptions of small regions of contact relative to the geometry of the body. The contact is therefore closer to a line contact.

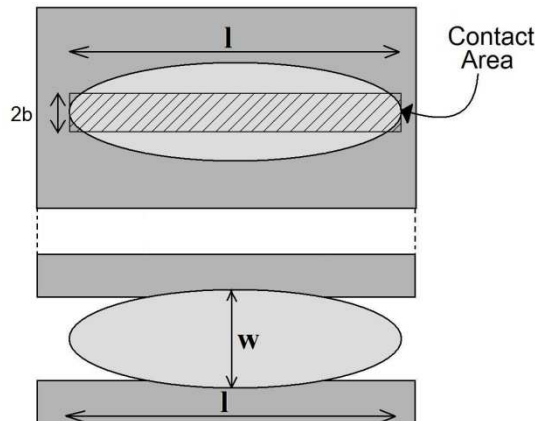

Figure 14 Hertz Line Contact Model

The load to cause both 20% and 80% husking for each rubber material is shown in table 4. This was used along with the rubber moduli determined from section 2 and the dimensions of the rice grain, to calculate the mean contact pressure for 20 and 80% husking.

	load at 20% (N)	load at 80% (N)	p_m at 20% (MPa)	p_m at 80% (MPa)	τ_m at 20% (MPa)	τ_m at 80% (MPa)
GRPL T-4	9	22	2.92	4.57	1.46	2.29
GRPL T-2	9	20	1.68	2.51	0.84	1.26
YNOX90	13	22	2.33	3.03	1.17	1.52
PU90	14.5	26	1.56	2.09	1.61	2.15
PU83	11.5	31	1.13	1.85	0.54	0.89
PU72	15	34	1.22	1.84	1.59	2.39
PU67	17.6	38	1.01	1.48	1.31	1.92
NI65	26	42	1.32	1.68	2.38	3.02

Table 4 Load, mean contact pressure, and mean shear stress, to achieve a 20% and 80% husked ratio.

The mean contact pressure determined for each rubber sample is shown graphically with respect to the rubber modulus in figure 15. The average contact pressure increases with increasing modulus despite the decreasing load required to husk 20% or 80% of grains. This is because the contact area is much smaller for higher modulus rubbers.

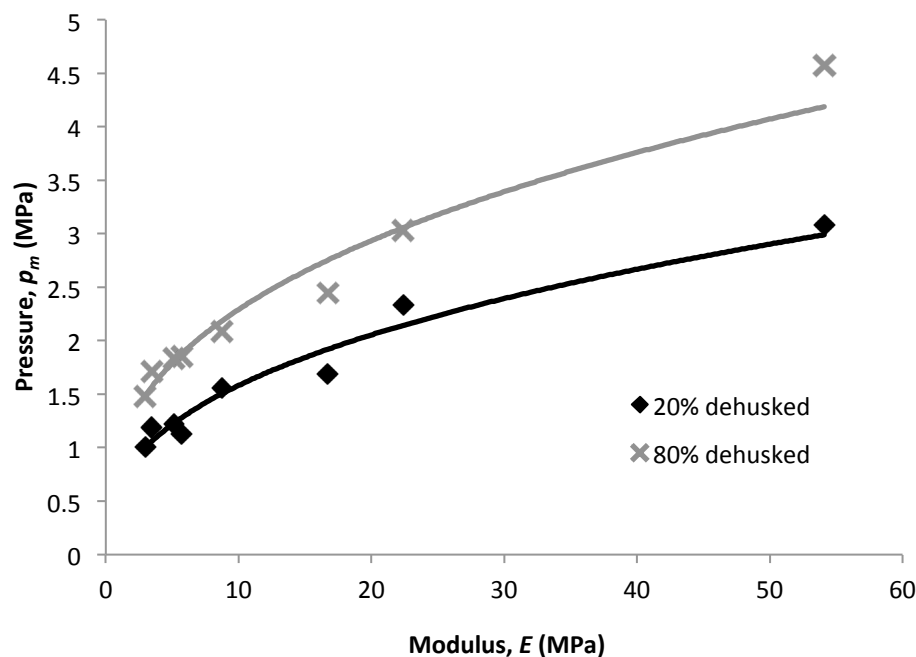

Figure 15 Mean contact pressure to achieve a 20% and 80% husked ratio plotted against the modulus of the rubber sample.

It is more relevant to consider the shear stress at the interface. The husk will separate from the rice kernel when shear yield has been achieved. The shear stress was calculated by multiplying the mean contact pressure by the coefficient of friction obtained from the experiments of section 4.3 (equation 9).

$$\tau_m = \mu p_m \tag{9}$$

The calculated shear stress for each rubber material at husked ratios of 20% and 80% is shown in table 4 and again graphically against rubber modulus in figure 16. Also shown in this figure is a linear least squares fit to the data.

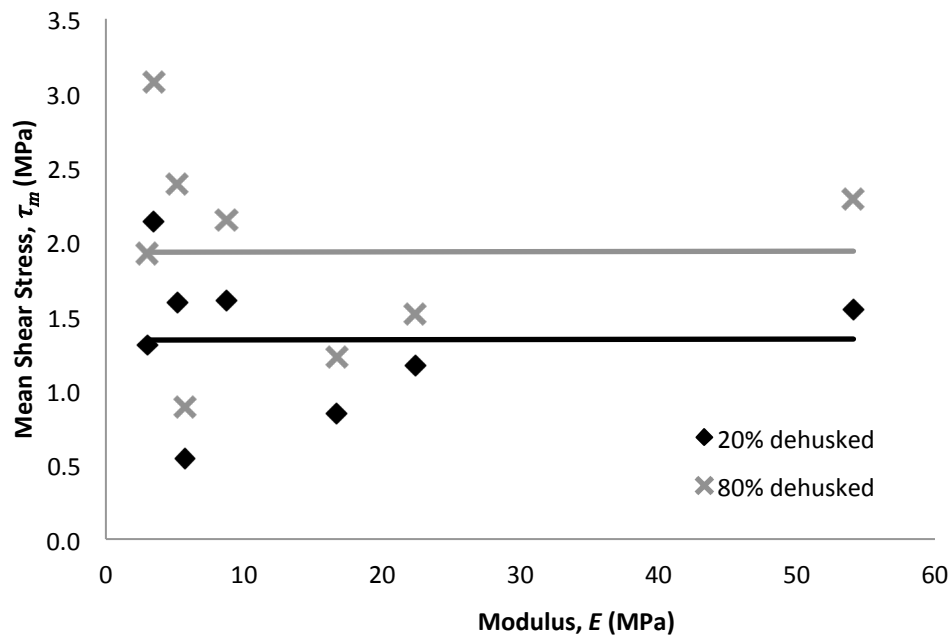

Figure 16 Mean shear stress to achieve a 20% and 80% husked ratio plotted against the modulus of the rubber sample.

Although there was a lot of scatter (standard deviations around 0.5MPa), due to the statistical nature of the grain husking, there is an apparent constant limiting shear stress required to cause the husking of a rice grain regardless of what rubber material is used. It would appear that the applied shear stress was the main controlling factor over the husked ratio.

The limiting shear stress was determined in this way for each of the applied load and husking ratio data pairs. Figure 17 shows the shear stress required to achieve the given husking ratio. It can be seen that to achieve higher husked ratios it was necessary to increase the applied shear stress to the grain.

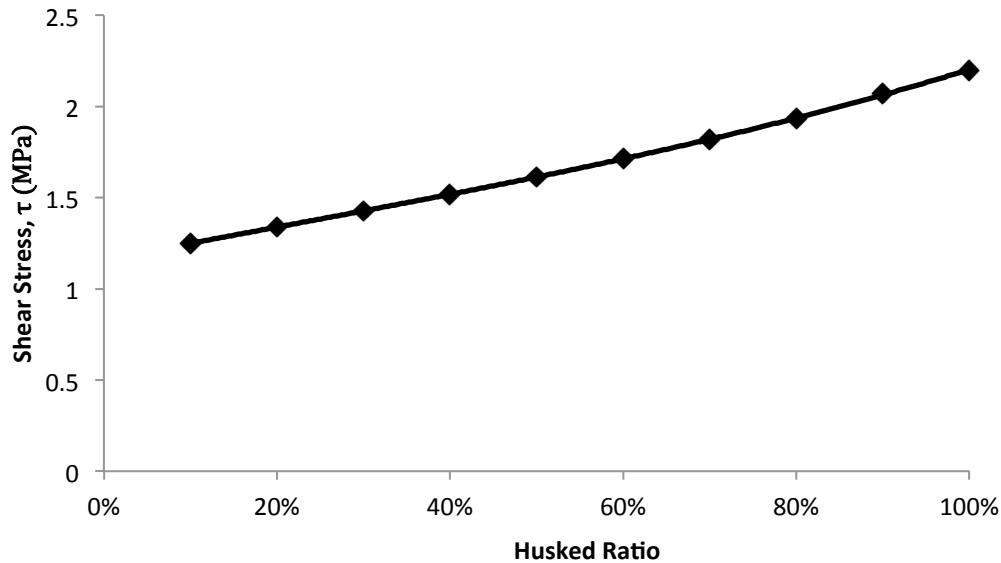

Figure 17 The mean limiting shear stress (assumed to be constant for each rubber sample) required to husk rice plotted against the ratio husked.

5. Discussion

The husking experiments carried out can help understand the mechanism by which the rubber rollers grip and remove the husk. When placed between the two rubber blocks (simulating rollers) the grains have been found to rotate before husking occurs. This action effectively creates two regions of high pressure, one at either end of the grain on opposing rubber blocks. It is thought that this motion allows the rice to be “peeled” along the line of least resistance. By reducing the clearance between rollers, the rotation of each grain is restricted and it is possible that this increases the number of broken grains since the grains cannot rotate as freely. It is also likely that the increased pressure from a reduction in roller clearance has a major role in grain breakage, however, the experiments carried out are unable to give a good indication of the extent of this effect. The number of broken grains recorded had no correlation with applied load. The most likely cause for this is the test speed which is much lower than in practise but this is beyond the scope of the work undertaken. A number of other factors are seen to affect the broken percentage, such as moisture content [17], parboiling[18] and drying conditions[19], amongst other mechanical properties [20], but again these are beyond the scope of this study. In order to demonstrate the link between rubber properties and husked ratio, it is necessary to minimise the number of variables, such as rice variety, moisture content etc.

The structure of the grain husk is as two half shells (palea and lemma) pinned at one end by the rachilla, which also supports the rice kernel (caryopsis), and hooked along the length on either side. The components are shown in figure 18.

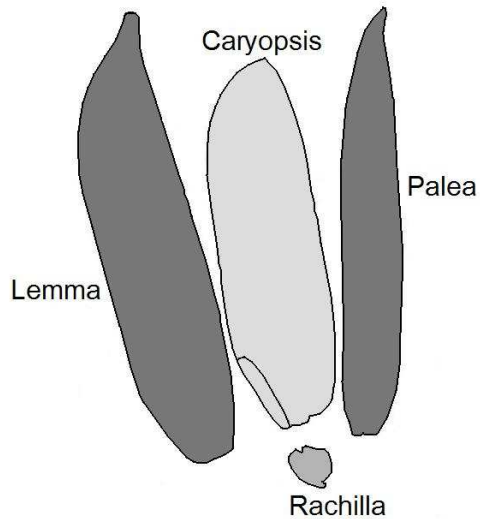

Figure 18 Components of Rice Grain

A microscope image of a grain cross section was taken and is shown in figure 19. The main length of the grain provides little resistance for husking so it is simply the bond of the rachilla which must be broken to remove the husk. Rather than shearing (mode II; in-plane) straight through this bond, it is thought that the rotation of the grain allows the hooked edges to separate and the pinned end split under mode I shear (tensile mode).

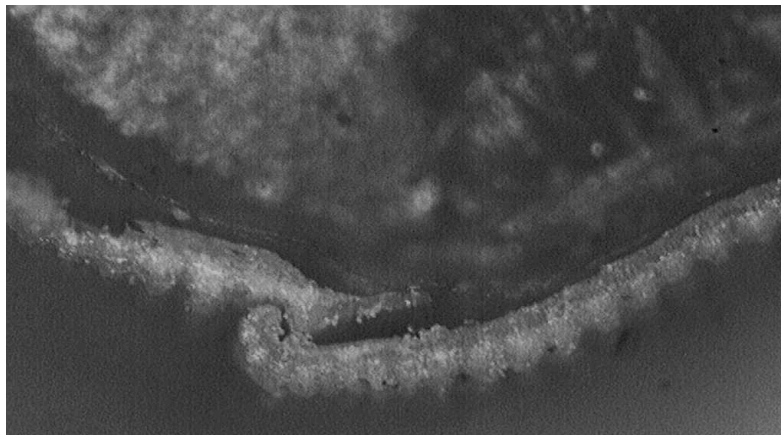

Figure 19 Long Grain Paddy cross section showing shell joint

An interesting result of these experiments is that softer rubbers appear not to assist in husking. Although the contact area is larger than in harder rubbers, the average contact pressure is lower. In very soft rubbers, the grain is entirely conformed between the opposing surfaces before sufficient shear to husk successfully can be applied. It is suggested that a small region of contact between the grain over which a shear stress of 1 – 2 MPa is applied is sufficient to break the rice husk.

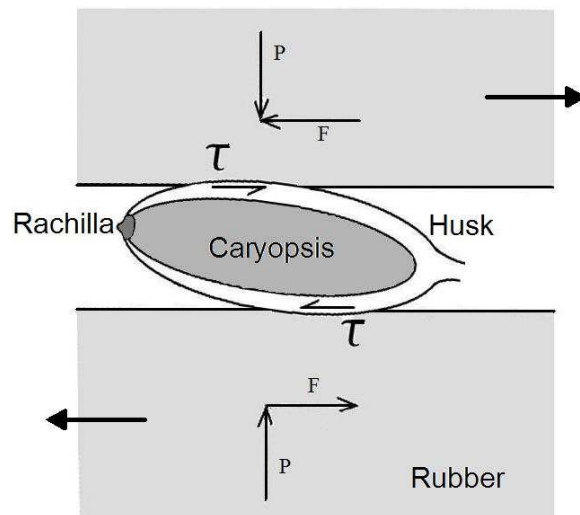

Figure 20 Schematic of the mechanism by which rice is husked between two rubber counterfaces

The coefficient of friction has been determined for each of the rubber samples. The different values indicate varying abilities for the rubber samples to grip the grains. It is thought that a higher coefficient of friction between rubber and grain would provide a more efficient husking, as the rubber would adhere to either side of the grain more effectively. The applied shear stress is then greater for a given normal load.

Despite the softer samples in this study generally having higher coefficient of friction, it has been shown that they are less efficient at husking grains. In combining the coefficient of friction data and mean contact pressure data, the shear stress between grain and rubber has been calculated. When plotted, the data shows that there is an apparent constant shear stress required to cause the husking of a rice grain regardless of what material is used or the contact area. This allows the calculation of the shear stress required to achieve a given husked ratio. Knowing that the shear stress is the governing factor of husking efficiency is a useful result as it allows the comparison of various rubbers in terms of wear rate based on a known loading. Working backwards from the shear stress allows a calculation to be made of the load required to successfully husk any percentage of grains for a given rubber modulus and coefficient of friction. The ideal rubber would be hard to maximise wear resistance but have high coefficient of friction to adhere to the grains and generate a high shear stress. To evaluate a new rubber it would now be enough to measure the modulus and coefficient of friction, from which the load to husk a given percentage of grains could be calculated.

6. Conclusion

The mechanisms involved in husking rice grains using rubber roll type huskers, has been investigated using some simple experiments on individual grains pressed between sliding rubber surfaces. Fast capture camera footage showed that grains rotate between rubber counterfaces before husking effectively creating a high pressure region at either end of the grain (though on opposing sides).

Experiments have shown that the harder rubber samples require a lower normal force to achieve a given husked ratio. For a given load a harder rubber will have a smaller area of contact between rice and rubber rand therefore a higher contact pressure.

The friction coefficient between rice and rubber was measured for the various rubbers tested; values ranged from 0.5 to 1.8. A higher coefficient of friction means that the shear stress along the husk – grain interface will be higher for a given load.

Some simple calculations showed that whilst the load required to husk a rice grain varied with the rubber type, the shear stress required was, within the scatter in the data, constant at 1 to 2 MPa. This implies that to effectively husk rice this value of shear stress needs to be applied. The modulus of the rubber and the degree with which it conforms around the rice grain appears not to be a controlling parameter. The target shear stress can be achieved by either a high normal force with a low friction coefficient, or conversely a low normal force with a high friction coefficient. It is suggested that the latter case is more appropriate because it is likely to lead to reduced wear to the surfaces.

7. Acknowledgements

The authors would like to acknowledge the financial support of Buhler-Sortex Ltd and the Engineering and Physical Sciences Research Council Case

8. References

1. **Satake, T.** *Modern Rice-Milling Technology*. Tokyo : Tokyo Press, 1990. pp. 40-46.
2. *Husking Characteristics of Short and Long grain Rice by Rubber roll Husker. (Part 1). Dynamic Analysis of a Single Grain Motion.* **Shitanda D, Nishiyama Y, Koide S.** 1, Morioka : Science Links Japan, 2001, Journal of the Japanese Society of Agricultural Machinery, Vol. 63, pp. 55-63.
3. *On the Size Effect in Abrasive and Erosive Wear.* **A Misra, I Finnie.** 3, s.l. : Mendeley, 1981, Wear, Vol. 65. ISSN: 00431648.
4. **Hutchings, IM.** *Tribology: Friction and Wear of Engineering Materials*. London : Edward Arnold, 1992.
5. *The Effect of Velocity on the Solid Particle Erosion Rate of Alloys.* **Marder, BA Lindsley AR.** 1, s.l. : Science Direct, 1999, Wear, Vols. 225-229.
6. *The Effect of Erodent Particle Characteristics on the Erosion of Metals.* **Levy, M Liebhard A.** 2, s.l. : Science Direct, 1991, Wear, Vol. 151.
7. *Erosion of Surfaces by Solid Particles.* **Finnie, I.** 2, s.l. : Elsevier, 1960, Wear, Vol. 3.
8. **Materials Engineering Research Laboratory Ltd.** Rubber Selection - A Guide to Outline Properties. *Materials Engineering Research Laboratory Ltd.* [Online] 2009. [Cited: 27 July 2009.] http://www.merl-ltd.co.uk/2003_materials/rubber12.shtml.

9. *Compressive strength properties of rough rice considering variation of contact area.* **Shitanda D, Nishiyama Y, Koide S.** s.l. : Elsevier Journal of Food Engineering, 2002, Vol. 53, pp. 53-58.
10. *Effect of Deformation Rate and Moisture Content on the Mechanical Properties of Rice Grains.* **Kamst GF, Bonazzi C, Vasseur J, Bimbenet JJ.** 1, Michigan : ASABE, 2002, Transaction of the ASAE, Vol. 45, pp. 145-151.
11. **ET, Champagne.** *Rice: Chemistry and Technology (3rd edition).* s.l. : American Association of Cereal Chemists Inc, 2004.
12. **The Engineering Toolbox.** Poisson's Ratio. *The Engineering Toolbox.* [Online] [Cited: 27 July 2009.] http://www.engineeringtoolbox.com/poissons-ratio-d_1224.html.
13. **Johnson, KL.** *Contact Mechanics.* Cambridge : Cambridge University Press, 2008. pp. 427-428.
14. **National Instruments.** Labview. *National Instruments.* [Online] [Cited: 28 July 2009.] <http://www.ni.com/labview/>.
15. *Effects of De-Awning and Moisture Content on Husking Characteristics of Paddy in Rubber-Roll Husker.* **Minaei S, Alizadeh MR, Khoshtaghaza MH and Tavakoli T.** 1, Tehran :IDOSI Publications, 2007, American-Eurasian Journal of Agriculture and Environmental Science, Vol. II, pp. 01-05. ISSN 1818-6769.
16. *Performance Analysis of Impeller and Rubber Roll Husker Using Different Varieties of Rice.* **Shitanda D, Nishiyama Y, Koide S.** s.l. : CIGR Journal of Scientific Research and Development, 2001, Vol. 3, pp. 195-203.
17. *Correlation of Head Rice Yield with Individual Kernel Moisture Content Distribution at Harvest.* **TJ Siebenmorgen, PA Counce, R Lu, MF Kocher.** VI, Michigan : American Society of Agricultural and Biological Engineers, 1992, Transactions of the ASABE, Vol. 35, pp. 1879-1884.
18. *Parboiling of Rice. Part 1: Effect of Hot Soaking Time on Quality of Milled Rice.* **AK Miah, A Haque, P Douglass, B Clarke.** 5, Bedford : s.n., 2002, International Journal of Food Science and Technology, Vol. 37, pp. 527-537.
19. *Effects of Drying Conditions on Head Rice Yield and Browning Index of Parboiled Rice.* **G Elbert, MP Tolaba, C Suarez.** 1, Buenos Aires : Elsevier, 2001, Journal of Food Engineering, Vol. 47, pp. 37-41.
20. *A New Method for the Measurement of the Tensile Strength of Rice Grains by Using the Diametral Compression Test.* **Kamst GF, Vasseur J, Bonazzi C, Bimbenet JJ.** 4, Massy : Elsevier, 1999, Journal of Food Engineering, Vol. 40, pp. 227-232.